

DOCUMENT RESUME

ED 454 735

FL 026 793

AUTHOR Masih, John, Ed.
 TITLE Learning through a Foreign Language: Models, Methods and Outcomes.
 INSTITUTION Centre for Information on Language Teaching and Research, London (England).
 ISBN ISBN-1-902031-68-7
 PUB DATE 1999-00-00
 NOTE 158p.
 AVAILABLE FROM Grantham Book Services Ltd., Isaac Newton Way, Alma Industrial Park Estate, Grantham, Lincs NG31 8SD United Kingdom. Tel: 01476-541-080; Fax: 01476-541-061.
 PUB TYPE Books (010) -- Collected Works - General (020)
 EDRS PRICE MF01/PC07 Plus Postage.
 DESCRIPTORS Bilingual Education; Class Activities; *Curriculum Development; Elementary Secondary Education; Foreign Countries; French; Immersion Programs; Inservice Teacher Education; Language Universals; Multilingualism; *Outcomes of Education; Second Language Instruction; *Second Language Learning; *Teaching Methods
 IDENTIFIERS Chomsky (Noam); *Content Area Teaching; European Union; France; Hungary; United Kingdom

ABSTRACT

This book presents European perspectives on the means of structuring curricula that integrate content and language teaching, drawing on the experience of practitioners at a range of levels. It also provides details of the outcomes of such programs and describes the current and future challenges for wider scale adoption of content and language integrated learning. The book is divided into the following 13 chapters: "Multilingualism across Europe through Plurilingual Education" (Cornelia Grosser); "Language Learning in European Immersion Classes" (Henning Wode); "Teaching History in a Foreign Language: What Language?" (Carol Morgan); "Supporting Students in Content and Language Integrated Contexts: Planning for Effective Classrooms" (Do Coyle); "In-Service Education for Teachers Using English as a Medium of Instruction" (Christa Piber); "Second Language Acquisition through CLIL at Primary School Level" (Heini-Marja Jarvinen); "A Practitioner's Perspective on Bilingual Teaching in Alhaisten Primary School" (Anja Romu, Leena Sjoberg-Heino); "The Language Teacher in a Primary CLIL Curriculum" (Erik Suomela); "History and Geography through French: CLIL Curriculum in a UK Secondary School" (Michael Ullmann); "School Subjects in a Foreign Language: A Decade of Success in Hungary" (Aniko Bogнар); "Task Design in the Bilingual Secondary Classroom" (John Clegg); "Universal Language, Body and Voice" (Jim Wingate); "Developing Bilingual Curricula in Vocational Colleges through the Leonardo Programme" (Walter Christ, Bernd Rosenstiel). Extensive scholarly references appear at the end of each chapter. (KFT)

ED 454 735

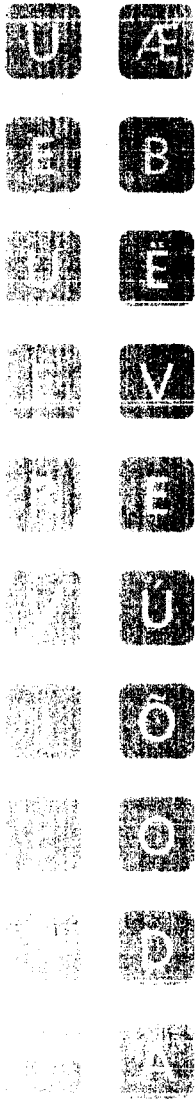

PERMISSION TO REPRODUCE AND DISSEMINATE THIS MATERIAL HAS BEEN GRANTED BY

B. Newson

TO THE EDUCATIONAL RESOURCES INFORMATION CENTER (ERIC)

1

U.S. DEPARTMENT OF EDUCATION
Office of Educational Research and Improvement
EDUCATIONAL RESOURCES INFORMATION CENTER (ERIC)

This document has been reproduced as received from the person or organization originating it.

Minor changes have been made to improve reproduction quality.

• Points of view or opinions stated in this document do not necessarily represent official OERI position or policy.

learning through a foreign language

models, methods and outcomes

edited by John Masih

BEST COPY AVAILABLE



CILT
Centre for Information
on Language Teaching and Research



LANCASTER

2

learning through a foreign language

The Centre for Information on Language Teaching and Research provides a complete range of services for language professionals in every stage and sector of education, and in business, in support of its brief to promote Britain's foreign language capability.

CILT is a registered charity, supported by Central Government grants. CILT is based in Covent Garden, London, and its services are delivered through a national collaborative network of regional Comenius Centres in England, the National Comenius Centre of Wales, Scottish CILT and Northern Ireland CILT.

CILT Publications are available through all good booksellers or directly from:

Grantham Book Services Ltd
Isaac Newton Way
Alma Park Industrial Estate
Grantham, Lincs NG31 8SD
Telephone: 01476 541 080
Fax: 01476 541 061

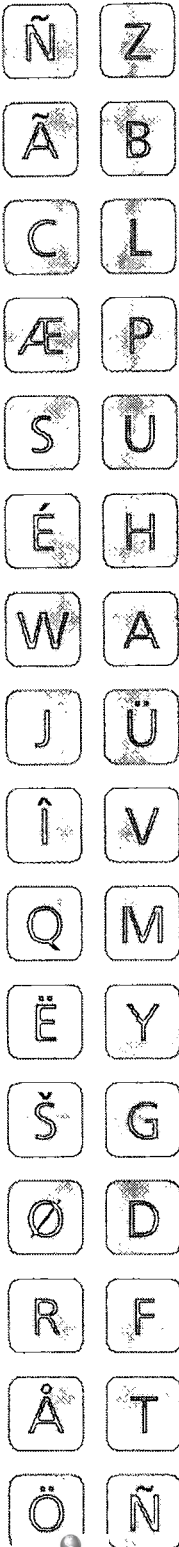

learning through a foreign language

models, methods and outcomes

edited by John Masih

CiLT
Centre for Information
on Language Teaching and Research

ST MARTIN'S COLLEGE

LANCASTER

The views expressed in this publication are the authors' and do not necessarily represent those of CILT.

Acknowledgements

The editor would like to thank Edward Butler for his contribution to this project.

The author and publisher would like to thank the copyright holders for permission to reproduce their material in Chapter 11.

First published in 1999 by the Centre for Information on Language Teaching and Research (CILT), 20 Bedfordbury, London WC2N 4LB

Copyright © of papers by individual authors 1999

Copyright © of this collection St Martin's College 1999

ISBN 1 902031 68 7

2004 2003 2002 2001 2000 1999 / 10 9 8 7 6 5 4 3 2 1

A catalogue record for this book is available from the British Library

All rights reserved. No part of this publication may be reproduced, stored in a retrieval system, or transmitted by any other means, electronic, mechanical, photocopying, recording or otherwise without prior permission in writing from CILT or under licence from the Copyright Licensing Agency Limited, of 90 Tottenham Court Road, London W1P 0LP.

The right of Anikó Bognár, Walter Christ, John Clegg, Do Coyle, Cornelia Grosser, Heini-Marja Järvinen, John Masih, Carol Morgan, Christa Piber, Anja Romu, Bernd Rosenstiel, Leena Sjöberg-Heino, Erik Suomela, Mike Ullmann, Jim Wingate and Henning Wode to be identified as authors of this work has been asserted by them in accordance with the Copyright, Designs and Patents Act, 1988.

Printed in Great Britain by Copyprint UK Ltd

CILT Publications are available from: Grantham Book Services, Isaac Newton Way, Alma Park Industrial Estate, Grantham, Lincs, NG31 8SD. Tel. 01476 541080. Fax: 01476 541061. Book trade representation (UK and Ireland): Broadcast Book Services, 2nd Floor, 248 Lavender Hill, London, SW11 1JL. Tel: 020 7924 5615. Fax: 020 7924 2165.

Contents

Foreword	1
The contributors	6
1 Multilingualism across Europe through plurilingual education Cornelia Grosser	9
2 Language learning in European immersion classes Henning Wode	16
3 Teaching history in a foreign language: what language? Carol Morgan	30
4 Supporting students in content and language integrated contexts: planning for effective classrooms Do Coyle	46
5 In-service education for teachers using English as a medium of instruction Christa Piber	63
6 Second language acquisition through CLIL at primary school level Heini-Marja Järvinen	72
7 A practitioner's perspective on bilingual teaching in Alhaisten Primary School Anja Romu and Leena Sjöberg-Heino	81
8 The language teacher in a primary CLIL curriculum Erik Suomela	89
9 History and geography through French: CLIL in a UK secondary school Mike Ullmann	96
10 School subjects in a foreign language: a decade of success in Hungary Anikó Bognár	106
11 Task design in the bilingual secondary classroom John Clegg	117
12 Universal language, body and voice Jim Wingate	133
13 Developing bilingual curricula in vocational colleges through the Leonardo programme Walter Christ and Bernd Rosenstiel	142

Foreword

John Masih | Woolwich College, London

Learning through a foreign or second language (L2) is a practice of multiple forms. It is ancient (at least from Socrates' Academy), global (found on every continent) and diverse in aims, methods and outcomes.¹

To delimit the scope of this book, it should be made clear what area of non-mother tongue subject learning is under discussion. The recently termed phrase *content and language integrated learning* (CLIL)² describes the situation where an L2 is used as the medium of communication for some or all of the curriculum. The learners in this curriculum will, in general, be native speakers of the majority language (or official language in the case of bilingual or multilingual countries). The general aims of CLIL are twofold:

- to provide learning outcomes in the chosen subjects (history, geography, business, etc) at the same level as the standard mother tongue curriculum;
- to provide learning outcomes in the L2 which exceed the standard curriculum.

Though old in practice, the conceptualisation of learning through a foreign language is much more recent. The first major national studies into the modes of teaching and learning through a foreign language for majority language speakers accompanied the introduction of French immersion programmes in Canada. (See, for example, Swain and Lapkin 1982.) Such studies have opened vistas on the psycho-linguistic elements of CLIL but these results can only provide general guidelines for the **organisation** of such learning, not specific ones. They can only be general because the means and outcomes intended by the school or education authority for using CLIL are highly contextualised.

Baetens Beardsmore (1997) describes a set of variables which affect bilingual teaching and learning. Some of these can be influenced to varying degrees by the school, some not. He lists three macro-variables: **situational**, **operational** and **outcome** under which are context-specific variables. As many of the contributors to

1 Baker (1997) provides an excellent overview of this multiplicity.

2 Bilingual and immersion education are terms which have been in use longer than CLIL. For the purposes of this book, the terms are intended to be generally equivalent.

this book touch on or explore a number of these variables, it is pertinent to reproduce them (albeit in conflated form).

The **situational** variables include:

- target population for bilingual education, and its social and linguistic background;
- public policy with regard to languages in education;
- linguistic homogeneity of the school population;
- geographical location, opportunities for use and distribution of languages in the out-of-school environment;
- status of languages involved;
- attitude and motivational patterns for foreign language learning;
- economic considerations of implementing bilingual education;
- religious and cultural features of the society in which bilingual education is introduced.

The **operational** variables include:

- the nature of the curriculum – at what stage is bilingual education introduced and for how long is it maintained?
- the choice of subjects;
- initial reading and writing – in mother tongue, L2 or both?
- evaluation criteria – and the backwash effect of teaching to the exam;
- materials and learning resource infrastructure;
- teacher competence;
- language strategies;
- support services and parental involvement;
- existence of whole-school policies for bilingual education.

The **outcome** variables are:

- maintenance of a minority, threatened or immigrant language;
- transition programmes to develop competence in the non-majority mother tongue, prior to moving children into mainstream majority language education;
- additive or enrichment designed to add multilingual proficiency;
- biliteracy with native speaker proficiency or not.

In order to take account of these variables, the Council of Europe Workshop 12A (Helfrich and Thürmann 1994) recommended to would-be innovators that models for CLIL should not be bought off the peg.

As the introduction of CLIL programmes in Europe is commonly a school-by-school phenomenon, the impact of context is magnified. The (usually) small group of teachers who have decided to embark on this odyssey can apply little of others' navigational knowledge, whether from home (which is difficult if they are their country's early innovators) or abroad. The bigger picture is frequently unavailable simply because the variables are too numerous to deal with simultaneously (and Baetens Beardsmore, *ibid*, suggests more).

One way to ameliorate the problems encountered in the early days of the CLIL voyage is to have a larger crew, which can watch for obstacles, or bail when these are

hit. An alternative is to sail with others heading in that direction. Though still early days for many parts of Europe, reliable and replicable maps of good practice are evident in CLIL classrooms here, in north America and the rest of the world. Access to this knowledge of these others is essential if some of the variables are to be manipulated favourably from the outset.

Professional networks, formalised or not, can provide this access. In the EU there already exist a number of national/regional networks, for example, the European Platform for Dutch Education in the Netherlands, the Swedish Association of Bilingual and Immersion Teachers (SAINT), the Landesinstitut für Schule und Weiterbildung in Soest, Germany, to name but a few. A European Network for Content and Language Integrated Classrooms (EuroCLIC¹) was created in 1996 following a conference in Haarlem in the Netherlands. The aim of the network is to facilitate communication and collaboration among CLIL teachers, researchers and other stakeholders.

This book is the result of a conference held at St. Martin's College, Lancaster, in spring 1998, organised by the college and EuroCLIC. The book intends to provide an insight into ways in which schools and universities are affecting these variables (or not). The conference provided a forum for teachers and researchers to meet and share maps, and this book also aims to be of similar interest to the school, college and university sectors.

The running of the conference and the production of the book were made possible with the support of the Socrates/LINGUA unit of the European Commission. Socrates/LINGUA has been an important player in facilitating the development of CLIL in Europe. The perspective of the Commission as an active promoter and sponsor are described by Cornelia Grosser.

This and the other chapters are all based on papers and workshops delivered at the conference. The book is organised around the broad division between university researchers and teacher educators and school-based CLIL practitioners, and it ranges from primary² to university teacher education to vocational level through CLIL contexts.

From the university sector, Henning Wode presents research findings which can inform answers to the question of what is the minimum amount of CLIL required to make the difference in L2 competence. Carol Morgan considers the effect of differences in tenor between the subject genre and classroom genre of the mother tongue and target language. Do Coyle outlines an initial teacher education programme, and explains the principles by which her teaching students structure their CLIL classes. Christa Piber describes teacher education for the CLIL classroom from an in-service perspective. Heini-Marja Järvinen presents preliminary findings of a study of grammatical development in a CLIL classroom.

From the school sector, a Finnish primary perspective is given from the points of view of the CLIL teacher (Anja Romu and Leena Sjöberg-Heino) and the foreign language

-
- 1 The EuroCLIC Secretariat is based in the Netherlands at: Bezuidenhoutseweg 253, NL-2594 AM, Den Haag.
 - 2 Taking into account systemic differences across Europe, 'primary' is used here for compulsory schooling up the age of twelve to fourteen.

teacher (Eric Suomela). At secondary level, Mike Ullmann describes the introduction of CLIL in one of the few UK schools breaking new ground, while Anikó Bognár presents the introduction of CLIL in Hungary within the context of change in language teaching nationally. Activities for the secondary CLIL classroom are described by John Clegg and, from an entirely holistic viewpoint, by Jim Wingate. In the final chapter, Walter Christ and Bernd Rosenstiel describe the needs of the vocational education sector based on two Socrates/LEONARDO projects co-ordinated in Germany.

If the conference which generated this book is repeated in the early years of the new millennium, one would expect widely different sets of papers, because European CLIL has a multiplicity of all the above mentioned variables (and the rest!). However, a period of consolidation following a decade of 'pilot and review' should shape the themes of these papers. The prioritisation of the following areas for discussion is left to the contextual demands of the individual school or teacher, but having networked with many CLIL practitioners across Europe during the voyages of innovation, the same issues and questions resurface:

- Where is appropriate teacher education to be found (pre- and in-service), **and** who is to develop this?
- How can materials be developed which truly integrate learning tasks for both language and subject? (And do not involve excessive burning of either midnight oil or two-ended candles.)
- What revisions can be proposed and accepted by foreign language teachers who will teach students with higher levels of competence and expectation?
- How can continuity of CLIL be maintained (or even considered) from primary to secondary and secondary to tertiary?
- What evaluation tasks can be introduced that are sophisticated enough to measure subject and language in combination?
- How can participation in CLIL be widened from the (often) elite streams to other learners?
- How should the dominance of English as a foreign language be addressed, and how can CLIL allow for additional languages to be introduced into curricula?

This list is by no means an exhaustive one. Some of the contributors to this book offer preliminary answers to these questions, while some add more questions to the list.

It is now several years since the first descriptions of European bilingual learning (Baetens Beardsmore 1993; Fruhauf, Coyle and Christ 1997). During this time, the European Commission has been active in facilitating transnational collaboration in teacher education, curriculum and materials development, and dissemination activities. Thus there is now a considerable range of information and experience available on European CLIL. This book is probably the last one of this pre-millennial decade to add to the CLIL map of Europe. Let us anticipate that the millennial decade will see enhanced descriptions of the features which are shared between countries, and robust accounts of the processes which shape these features.

References

- Baetens Beardsmore H (ed) (1993) *European models of bilingual education*, Clevedon: Multilingual Matters
- Baetens Beardsmore H (1997) 'Manipulating the variables in bilingual education' in *Report on the Conference on European Networks in Bilingual Education: 8-15*, Alkmaar: European Platform for Dutch Education
- Baker C (1997) *Foundations of bilingual education and bilingualism (2nd Edition)*, Clevedon: Multilingual Matters
- Fruhauf G, D Coyle and I Christ (1996) *Teaching content in a foreign language: practice and perspectives in European bilingual education*, Alkmaar: European Platform for Dutch Education
- Helfrich H and E Thürmann (1994) *Bilingual education in secondary schools: learning and teaching non-language subjects through foreign language: Report of Workshop 12A*, Strasbourg: Council of Europe
- Swain M and S Lapkin (1982) *Evaluating bilingual education: a Canadian case study*, Clevedon: Multilingual Matters

The contributors

John Masih currently manages International Education Programmes at Woolwich College, London. His CLIL experience is drawn from organising in-service education programmes and conducting research into the implementation of CLIL in the Finnish vocational sector. He has been involved with a number of Socrates/LINGUA projects; creating the frameworks of the *DIESeLL* and *TEL2L* CLIL teacher education projects, and organising several international CLIL conferences. He can be contacted at johnm@woolwich.ac.uk

Cornelia Grosser works in Directorate-General XXII, 'Education, Training and Youth', of the European Commission. She is dealing with LINGUA, the foreign language project section of the Socrates-programme. She has particular responsibility for Action D (promoting the development of language teaching and learning materials). She also has responsibility for following up the plurilingual education recommendations of the Commission's Education White Paper.

Henning Wode is currently Head of the English Department of the University of Kiel. He has conducted extensive research in such fields as first and second language acquisition, language contact and bilingual education. In 1989/90 he was one of the chief consultants to the state government of Schleswig-Holstein to initiate a late partial immersion programme. Wode and his group have since carried out very extensive research on the development of English in this programme. They are currently extending the approach to pre-schools for three-year-olds such that immersion is continued after entry to primary grades. He can be contacted at officeling@anglistik.uni-kiel.de

Carol Morgan is currently Director of Studies for Research Students in the Department of Education at the University of Bath. She is carrying out research into and evaluations of three bilingual schools (two in Austria and one in the UK). She has also developed and taught a Master's level unit on teaching in a bilingual context. Her CLIL-related publications deal with the role of the native speaker, primary-secondary transfer in a bilingual context, and vocabulary choice in CLIL for history. She can be contacted at c.l.morgan@bath.ac.uk

Do Coyle is the teacher educator at the School of Education at the University of Nottingham where she is involved in the initial training of modern languages and CLIL teachers, and has created the first post-graduate teacher education programme for CLIL in the UK. She also runs INSET courses for European CLIL teachers. Her research focus is on bilingual education, learner autonomy and learning strategies, and she is a founder member of the Centre for Research into Second and Foreign Language Pedagogy. She can be contacted at do.coyle@nottingham.ac.uk

Christa Piber works for the Institute for Interdisciplinary Research and Continuing Education at the University of Klagenfurt as a teacher educator. Since 1997, she has been working on a distance learning in-service programme for secondary level CLIL teachers in Austria. She can be contacted at christa.piber@uni.KLU.ac.at

Heini-Marja Järvinen works as a foreign language teacher trainer at the Department of Education in the University of Turku, Finland, where she offers pre-service education for non-language student teachers. She has been involved in a number of in-service CLIL methodology courses for non-language primary and secondary school teachers. She recently completed her doctoral dissertation on the acquisition of English in CLIL at elementary school level. Future research interests include projects on classroom interaction and input processing in CLIL. She can be contacted on hemajar@utu.fi

Leena Sjöberg-Heino is the head teacher at Alhaisten Primary School in Salo, Finland, and was responsible for introducing the school's first CLIL class in 1996. **Anja Romu** was the teacher for that first class, and **Erik Suomela** the foreign language specialist. The school has consolidated and expanded on this experiment and now has CLIL classes in four grades. They can be contacted on leena.sjoberg@salo.fi

Mike Ullmann is the Head of Modern Languages at Hockerill Anglo-European College. The school featured in the *Intertalk* video, which was broadcast by the BBC as *Teaching with foreign languages*. Since taking up post in 1992, he has set up a bilingual section in which history, geography and business studies are taught in French. The school became a language college in 1998 and intends to establish a German bilingual section in 2000. He can be contacted on admin.hockerill@thegrid.org.uk

Anikó Bognár has been vice principal of an English-Hungarian bilingual academic secondary school in Budapest since the beginning of the bilingual/CLIL experiment in Hungary in 1987. Her doctoral thesis was on TEFL, and she has published several articles and co-authored books on TEFL and CLIL. She has lectured in England, the USA and at Council of Europe conferences and workshops. She can be contacted at ba@karinthy.hu

John Clegg is a freelance education consultant specialising in language in education, and in teaching the primary, secondary and tertiary curriculum through the medium of English as Second/Additional Language. He works with teachers in multicultural schools in the UK, bilingual schools in Europe, and English-medium schools in Africa. He runs teacher education courses, evaluates projects and advises on school policy, practice and materials. He can be contacted on jclegg@lineone.net

Jim Wingate is an education consultant. He works four months a year, six lessons a day with classes of 70–90 students (ages three to eighteen) communicating subject matter using body and voice. He has taught science, drama and sport through English in international schools, and has trained teachers in bilingual programmes in seven countries. He has also written fifteen interactive coursebooks, which are used in ten countries. He can be contacted by e-mail at jenniemunro@compuserve.com

Walter Christ is senior deputy headteacher at Ludwig-Erhard College in Fürth, Bavaria. He also lectures in didactics at the University of Erlangen-Nürnberg. His work in CLIL is based upon the development of bilingual teaching and learning in the vocational sector, and he is the co-ordinator of a Leonardo project developing materials in German, English and French for the subject of international trade. He is president of the Bavarian Foreign Language Teachers' Association and organises conferences for teacher training. He can be contacted at walter.christ@t-online.de

Bernd Rosenstiel works for the Ministry of Culture of Thüringen. He is currently co-ordinator of a Leonardo project to develop bilingual teaching modules for the subjects of international trade, mechatronics, computing and domestic science. He can be contacted at tkm@thueringen.de

Multilingualism across Europe through plurilingual education

Cornelia Grosser | European Commission DG XXII,
Brussels

Introduction

When I was preparing my presentation for this conference, I found it difficult to decide how to approach the issue of plurilingual education across Europe, because I knew that I would be addressing an audience experienced in that field; some have been working in it for a shorter period, others already for a long time. So, I will try to establish a common ground by explaining the interest and the objectives of the European Commission regarding plurilingual education.

I guess some of you are rather familiar with the linguistic policy and the concrete actions within the education and training programmes of the European Union (EU). Also, this conference has been preceded by several important meetings at a European level (e.g. the Conference in Haarlem, 1996; the Forum in Helsinki, 1996). The European Commission had a big interest in these events and has supported them. Parts of the audience have certainly participated, the outcomes have been published, and have since been taken further.

The first part of my speech today is devoted to the basic ideas of the EU on language learning and multilingual development, as well as the presentation of concrete possibilities of support for activities promoting plurilingual education within the SOCRATES and the LEONARDO DA VINCI programmes. The second part deals with recent projects funded under SOCRATES, and tries to underline their potential and the challenges which they pose for the future.

I Multilingual development in the context of the EU programmes

The European Union recognises multilingualism as an essential feature of European citizenship. It was the Milan European Council in 1985 which recognised the essential contribution which languages could make to the construction of a Citizen's Europe.

The White Paper on education and training *Teaching and learning. Towards the learning society*,¹ which was adopted by the Commission in November 1995, outlines some courses of action in the perspective of lifelong learning. The purpose of these action lines is to improve access to information and knowledge for everybody. Objective 4 of the White Paper focuses on proficiency in three Community languages. It claims that all citizens should be able to communicate in two languages in addition to their mother tongue.

The ability to communicate in three languages is considered essential for two main reasons: it helps European citizens to understand each other, and it prepares them for the requirements of the European labour market. Put simply, it makes Europeans feel European.

Therefore, the promotion of foreign language learning is crucial, and the White Paper proposes measures to achieve this goal. It encourages the early teaching of languages, and presents teaching content in a foreign language as an innovative curricula and methodological development, and as a further step towards meeting learning needs. From this perspective, it is important to consider all the different approaches which aim at improving language proficiency. If foreign language learning starts at an early stage, in secondary school, subjects can then be taught through that foreign language. This language then becomes self-sustaining, and another foreign language may be introduced into the secondary school curriculum. At this point, I want to underline the importance of ensuring a coherent transition from primary to secondary school regarding the provision of language teaching and learning.

Another innovative approach, the acquisition of partial skills, should be kept in mind as well when we design ways to achieve the objective of plurilingual citizens. When I use the term 'plurilingual', I want to stress the aspect that what is supported is not the learning of one foreign language to the detriment of learning others, but that the aim of the plurilingual approach is to create a learning environment where the use of several foreign languages is strengthened, and where language instruction is offered through a wide range of content input and situations which require the use of foreign languages. Content and language integrated learning (CLIL) is a means of broadening the choice of languages, not restricting it to one language.

The SOCRATES programme

The promotion of multilingualism is at the centre of the Lingua actions within the SOCRATES programme. Initiatives targeted at teacher training, materials development, awareness raising or networking, in order to create strong movements of opinion, are supported through different actions. Each of them offers the possibility of launching an initiative for CLIL.

Action A: European Co-operation Projects (ECPs)

ECPs for language teacher training are based on a partnership which sets up

¹ European Commission (1996) White Paper. *Teaching and learning. Towards the learning society*, Luxembourg.

co-operation between institutions of initial and in-service training. They create products for teacher training, i.e. curricula, materials and modules, and therefore offer the possibility of financing projects in the area of CLIL. In the 1997 selection, four projects have received support, and for the 1998 selection, plurilingual education is a specific priority as well.

Action B: In-service training in the field of foreign language teaching

This action provides grants for two- to four-week courses in order to improve teachers' professional skills. The target groups explicitly include language teachers and teaching staff of other disciplines who teach, or intend to teach, through the medium of a foreign language.

Action C: Assistantships for future language teachers

This enables Lingua assistants, who are future language teachers, to spend time abroad in a host establishment at primary or secondary level, in general, vocational or adult education.

The assistantship has a double objective: which is to improve the assistant's knowledge of a foreign language, the country and its culture; and to offer the learners direct contact with a person from the country the language of which they are learning, thus increasing their motivation. An assistantship is a good opportunity for co-operation with a native speaker on CLIL modules and/or materials.

Action D: Development of instruments for language teaching and the assessment of linguistic competence

This supports transnational partnerships which work on the production of innovative materials, curricula and programmes. One of the priorities of this action is to develop tools for teaching non-linguistic disciplines through a foreign language.

Action E: Joint educational projects for language learning (JEP)

In a JEP, groups of young people from different partner institutions, normally from two participating countries, work together on a specific topic over a period of time. An exchange is part of such a project, which means that direct communication between the young people is the primary focus. During the implementation of a JEP, subject matter and foreign language issues are closely interrelated, and allow CLIL to happen more or less naturally.

Apart from these actions, funding under SOCRATES Complementary Measures is provided in order to promote the dissemination of information on innovative initiatives through conferences, publications and websites, and to raise the awareness of the importance of European co-operation.

A key objective common to all the SOCRATES Lingua measures is to maintain and strengthen linguistic diversity in Europe. Therefore, they promote the use and the teaching of the least widely used and taught languages (LWULT). In the national education systems however, language learning is often limited to the most widely used languages. This is true for CLIL curricula as well where English, French and German

tend to dominate. To meet the goal of linguistic diversification, the integration of the LWULT languages into any plurilingual approach is an absolute necessity.

The LEONARDO DA VINCI programme

In a Europe of professional mobility, proficiency in several languages does more than promote personal development, it also opens up new prospects for employment beyond national borders and contributes to a genuine feeling of European citizenship. Plurilingualism also encourages young people to take fuller advantage of vocational training abroad, by extending the range of countries where such opportunities exist.

Through strand III.1, the LEONARDO DA VINCI programme supports innovative approaches and new developments for vocationally-oriented language learning and linguistic diversification. The culture of vocational training and of the workplace firmly integrates language learning into work processes; the working environment determines how language training is organised. The content of such training is concerned with developing a number of skills of different dimensions:

- communication skills and job related expertise;
- competence in a number of foreign languages;
- awareness and understanding of intercultural issues.

The work environment requires an interaction of these different dimensions to solve demanding and constantly changing tasks. Language learning within this context does not normally proceed according to linguist descriptions of easy to difficult structures, but by communication needs and task-oriented performances. These include easy and difficult language from lesson one, as well as a focus on the content through the means of the foreign language.

Transnational pilot projects for language learning may include:

- analysis of the training needs of organisations, and assessment of existing and required skills;
- language audits, for example at sectoral or regional level;
- the development of training materials and systems for the validation and certification of language performance.

While there is no single ideal model of a Leonardo da Vinci partnership, an eligible language project must meet several specific criteria, in addition to being transnational and involving the end users. At all events, the experience and expertise of the partner organisations should be such that the methodology and/or technology employed takes account of the latest developments and the state of the art in the field.

2 Recent initiatives and developments

Teaching materials

At previous conferences, the difficulty in finding appropriate teaching and learning materials has been identified as one of the challenges for the development of

plurilingual education. It seems that this difficulty still persists. On the one hand it is not profitable for publishers to produce textbooks because print-runs are too small; and, on the other hand, materials for plurilingual courses have to respond to very specific teaching profiles, according to the age and the level of linguistic competencies of the learners, as well as according to the chosen subject matters and the curriculum requirements at a given school.

Surprisingly, among Lingua Action D projects of the 1997 selection, there are rather few partnerships developing instruments for CLIL. In a broader application of the term 'plurilingual education', some projects which aim at raising awareness and language learning at primary and pre-primary level could be mentioned. In the narrow sense of the term, there is only one CLIL project, the *Primary Modern Languages Diversification Project*. It will develop materials to encourage the use of Spanish in classroom management for non language specialist teachers in primary schools. The project in its first stage will be developed for use in the United Kingdom. However, there is no project working on material development at secondary level.

What are the reasons for this situation? It may be that school curricula, teaching and learning situations are so different between countries that it seems too difficult to set up a transnational partnership. Of course, I am quite optimistic regarding, for instance, the British project mentioned above, and I think that it will be possible to transfer its results to other school curricula, and to have teachers in other countries making use of them. However, some effort is necessary to make that happen.

Another explanation for this situation might be that the production of materials for the classroom should go hand in hand with teacher training measures, as well as with modifications in the curriculum and with organisational provisions in the schools. The implementation of the CLIL approach in the different areas at the same time is indeed a complicated process, and it might be difficult to find the best starting point.

The great efforts which project partners undertake, in order to produce materials, must be justified by results which benefit a variety and a larger number of users. Therefore, teaching materials or modules on specific topics which allow a flexible use, also on a small scale, should be developed. These kinds of materials could support a variable, step-by-step introduction of CLIL elements into traditional language courses, and also in schools where plurilingual branches do not exist. In general, multi-disciplinary, cross-curricula work should become a general feature in education.

Teacher training

Another area where a need for further development has been stated is the need for adequately qualified teachers. Currently, four ECPs for teacher training are supported through Lingua Action A. These projects cover initial and/or in-service training, and are targeted at specific foreign languages (English, German, French), one project being non language-specific. They cover primary and/or secondary level. Their target audience consists of language teachers, teachers of subjects other than languages, as well as teacher trainers.

An interesting approach which is being developed by the *TEL2L* project co-ordinated by St. Martin's College consists of having teams of language and non-language subject methodologists working together on the modules. At the same time, they are creating a network with equivalent teams in the country of the target language.

An important issue for these new developments is the creation of structures for a working environment where teachers can support each other in the long term, within their institution, but also through exchange with colleagues outside their school. Therefore, it is necessary to facilitate co-operation between teachers and between their institutions, through multinational contacts and mutual monitoring.

The Commission expects the projects to lead to usable, tangible and practical working tools that can be picked up and used by other trainers in Europe. We are looking forward to the results of these projects, which are now going for a renewal for a second or third year of SOCRATES funding.

Networking within EuroCLIC

As I have stressed the need for networking, I would like to present the project European Network for Content and Language Integrated Classrooms (EuroCLIC) with which many of you are already familiar. The project started with funding under SOCRATES in 1996, and has received further support this year. Its objectives are to disseminate information on CLIL to everybody who is working in this field, and to create a solid basis for an interactive network across Europe, which takes into account existing networks and initiatives. Its tools are a secretariat, a newsletter, and a site on the Internet (<http://www.euroclic.net>). EuroCLIC intends to act as a promoter for plurilingual education at a European level.

As funding provided by the SOCRATES programme is targeted at innovative initiatives in order to help them to take off and become sustainable, the EuroCLIC network should become self-supporting by the end of this year. It could then be financed mainly through the payment of membership fees. We hope that practitioners and researchers, as well as policy makers will be convinced by the infrastructure developed by then, and that they will join the network and contribute actively to further develop the different services, such as the materials bank or the forum on didactic issues, offered on the Internet.

EuroCLIC also takes up the challenge of new languages and countries entering the Community programmes. With the enlargement of the European Union, linguistic diversity will increase even more, and the project has started already to integrate institutions and practitioners from the Central and Eastern European countries.

Conclusion

From the point of view of the European Commission, there are three main challenges:

- 1 To develop plurilingual education for the general public, and to promote it as a majority programme ensuring, at the same time, high quality;

- 2 To explore and implement a wide range of methodological frameworks in the CLIL context;
- 3 To use plurilingual education as a support for linguistic diversification, and to avoid strengthening the position of the already dominant languages.

The overall challenge consists of carrying further, and extending to other languages, what has been developed in the different areas.

Although the Internet offers excellent conditions for networking, I feel it to be very important to provide a forum where direct exchange of experiences takes place, and which facilitates the integration of recent developments in common strategies. Therefore, I welcome the initiative of bringing together practitioners and researchers at this conference, and I thank the organisers for preparing this meeting.

References

European Platform for Dutch Education (1996) *Report on the Conference on European Networks in Bilingual Education*, Alkmar: European Platform for Dutch Education

Primary Modern Languages Diversification Project co-ordinated by Invicta Media Productions Ltd. E-mail: ilsa@invmed.demon.co.uk

15

Language learning in European immersion classes

Henning Wode | Kiel University

Introduction

As far as teaching foreign languages is concerned, most countries in Europe face a serious problem. On the one hand, the various European organisations, the national governments and the general public are in agreement that the cultural and linguistic diversity in Europe should be preserved. This means that multilingualism needs to be promoted on a large scale in such a way that each citizen is given the opportunity to develop an appropriate command of at least three languages through the state education systems. Moreover, students should not all learn the same combination of languages but different mixes of them.

On the other hand, it is commonly agreed that, at the present time, hardly any of the national school systems are up to this task. The level of competence resulting from traditional foreign language teaching tends to be too low; the number of different languages offered by the schools is too small; and the range of languages learnt by students is too narrow. To give just one example, for the overwhelming majority of students in Germany, the first foreign language tends to be English. If there is a second one, it tends to be French. For obvious reasons, therefore, various attempts are currently being made to find ways of improving the situation. The central concern in this paper is whether, and in which way, immersion teaching¹ (IM), i.e. using the language to be learned as the medium of instruction to teach other subjects, can contribute towards achieving these goals in Europe. What needs to be shown is first, that IM does in fact produce better results than other ways of teaching foreign languages, and second that the level of achievement in the other subject areas is at least as high as in the non-IM approaches. The primary focus in this paper is on language learning because this is probably the key issue in the whole enterprise.

The first step is to clarify the notion of IM. Next is a review of how IM programmes can be structured. This is followed by a summary of some of the major results that can be achieved via IM, as highlighted by current research on a particular IM programme in northern Germany for secondary grade levels (roughly age ten to

1 In addition to the term IM, there are others being used for much the same phenomenon, such as content-based language instruction, and content and language integrated learning (CLIL), etc.

sixteen). Finally, some reflections are presented on the feasibility of IM in Europe, and which major areas of difficulty need to be anticipated in setting up IM programmes.

The notion of IM

What crucially defines IM is the way the language to be learnt is handled in the teaching process. In traditional foreign language teaching, the language functions as subject matter (LAS = language as subject). In IM the language is used as the medium of instruction. That is, although the students do not know the language yet (or may not know it well), other subjects are taught in it, for example when maths, history, geography, etc are offered in French to German students, or in German to students in France.

What makes IM such an attractive alternative to LAS becomes obvious when one considers the most likely reasons why LAS, involving as little as three or four periods a week as it normally does, is unsatisfactory. Note that this is not due to poor methodology, poor teachers, poor teaching materials or poor students. Since World War II, so much effort has been invested in improving the methodology of LAS, that we can be sure that it has been taken to extremes. The fact that the results, in general, tend not to be satisfactory is due, in particular, to the small amount of time allowed for a given language. Three or four periods per week are simply not enough. Moreover, if one were to increase the amount of time for LAS, one would have to reduce the periods allocated to, for example, the natural sciences, history, geography or mathematics, which is simply out of the question. Also, to add the required number of teaching periods is not feasible either, for such obvious reasons as having to pay for the additional staff.

17

The only solution appears to be to make use of IM, to use the time that the students spend in school anyway, learning an additional language, while studying subject matter, so that the language is learned as a by-product of that activity. That is, language learning occurs incidentally. Although IM may go counter to much traditional educational theorising, the methodology has proved extremely successful as documented by very extensive research over the past 30 years, notably from North America (see Genesee 1987, Rebuffot 1993, Wode 1995 for reviews).¹

Note that the idea that language learning in IM occurs as a by-product of, teaching other subjects is of particular interest for the linguistic focus of this paper. This notion implies that what needs to be shown is that IM students do, in fact, acquire elements from the target language from the resources available to them without these elements being made the object of instruction.

¹ The way the term IM is used in this paper differs slightly from the way it is currently used in Canada. In Canada, the term IM is applied only to school programmes that teach at least 50% of the curriculum in the foreign language (see Genesee 1987). As will be seen below, the particular European perspective requires us to determine how little IM may be needed to improve results, so that time is gained to promote additional languages, even if the IM component is reduced to less than 50% of the curriculum (details in Wode 1995, in preparation a and b).

Implementing IM programmes: Canada

Although IM is one of the oldest foreign language teaching methods, the term itself, and the revival of the approach in modern times, derives from developments in Canada during the mid-1960s, due to an initiative by a group of anglophone parents in Montreal. They wanted their children to learn French to such a level that they could hold government jobs that require functionally appropriate knowledge of both French and English, in order to render government service in both languages (Lambert and Tucker 1972). The results were so positive that the methodology was quickly adopted throughout Canada. IM has since become a hallmark of Canadian education.

The Canadian experience of teaching French to anglophone children shows that foreign languages can be introduced via IM at different age levels (Harley 1986) and involving different portions of the curriculum. In fact, there are various kinds of IM programmes in Canada.

Early Total IM (Figure 1a) starts when children enter school (in most cases, there is an optional year of pre-school¹ for five-year-olds called kindergarten). Though the children’s first language (L1) is English, the entire day is spent speaking in the foreign language. They learn to read and write in French, they learn mathematics in French, etc. In fact, the entire curriculum is delivered in the foreign language. English may be introduced after two, three or even four years to total IM in French.

18

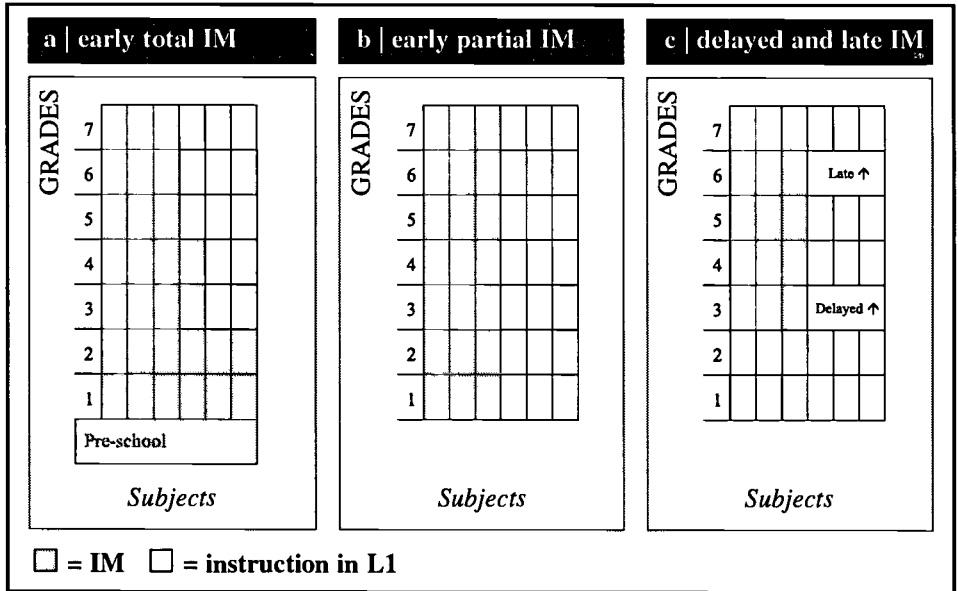

Figure 1 | Canadian Immersion

Figures 1b and c illustrate additional options. In Early Partial IM (Figure 1b), only some part of the curriculum is given to IM teaching. In Delayed or Late IM, the

1 The term pre-school is here used to cover any kind of institutionalised care-taking of children before primary grade 1, i.e. *école maternelle* in France, *Kindergarten* or *Vorschule* in Germany, or nursery school, pre-school or kindergarten in the UK.

children are introduced to school on the basis of their L1; IM in another language is delayed until grade 2, 3 or even up to grade 6 as in Late IM.

There have also been some attempts at early double IM. In some schools in Montreal, French and Hebrew are introduced at age five when the children enter kindergarten. Most of the children come from Jewish families. Their L1 is English and their Hebrew is at best rudimentary, and mostly limited to some devotional rituals (see Genesee 1987).

Research and practical experience show that these Canadian IM programmes are extremely successful. As can be expected, Early Total IM tends to produce the best results. However, the other programme options, including Late IM, all tend to produce results superior to traditional LAS without any negative effects on other domains of learning. The Canadian results across these various IM programmes can be summarised as follows:

- L1 development does not suffer;
- There are no long-term deficits with respect to subject matter;
- There are no negative effects on the students' cognitive development;
- Foreign language proficiency tends to be notably higher than in comparable LAS classes. In fact, comprehension may be native-like; whereas production, in general, is not. The children tend to retain an IM accent;
- The IM methodology seems to be suitable for all students, including those with learning difficulties;
- Literacy can be developed via the foreign language. The children will transfer the principles of literacy on to their L1 once the latter is introduced.

19

Combining IM and LAS: the European Schools

Another way of benefiting from IM is to integrate it with LAS. In fact, one of the most successful school programmes of this sort is the European Schools set up in various European cities, e.g. Brussels, which host major European organisations such as the European Atomic Energy Commission or major European bureaucracies.

Figure 2 | Foreign language instruction at European Schools

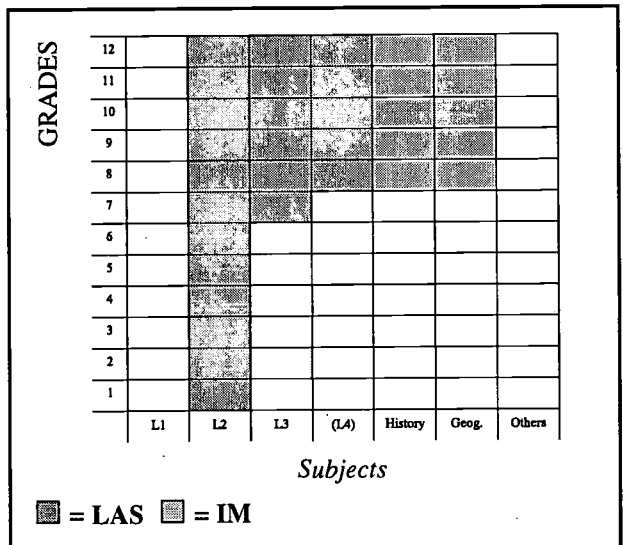

One of the highlights of the European Schools is that the students are encouraged to learn several foreign languages at a high functional level (see Figure 2). The first foreign language (L2) is introduced in grade 1 via LAS. The second one (L3) comes at the beginning of grade 7 and is also taught via LAS. In grade 8, the first foreign language is used as a medium of instruction for two subject areas, namely political sciences, history or geography. These IM courses are attended by students who have different L1s. For example, if such a course is taught in French, it is likely to have students with German, English, or Italian as L1.

Research shows that the results are excellent. As Baetens Beardsmore and his collaborators point out in various publications (Baetens Beardsmore 1990; Baetens Beardsmore and Swain 1985; Baetens Beardsmore and Kohls 1988; Housen and Baetens Beardsmore 1987), the high level of proficiency is due to the structure of the school. In addition, there is plenty of additional language support because there may be 50 or more different languages spoken in the school playground. As for literacy, L1 development, subject matter, etc the students from the European Schools tend to do as well as students who are taught in their L1. Moreover, a comparison between students from Early Total IM in Canada, and students who had taken French as their first foreign language at the Brussels European School, revealed that when given the same test as the Canadian children, the Europeans outperformed them (Baetens Beardsmore and Swain 1985).

Reciprocal IM

In reciprocal IM the class is made up of students, in about equal numbers, from two L1 backgrounds. For example, in the Staatliche Europaschule in Berlin (SESB), the classes are set up in such a way that about half the students have German as their L1, and the other half another language such as English, Russian, Italian, Greek, French, Spanish or Turkish. In this type of programme, one group's L1 functions as the L2 for the other group and vice versa (see Figure 3).



Figure 3 | Reciprocal (two-way) IM

Literacy is developed through the L1 for each group; the rest of the subjects are delivered in both languages. Each language is given about 50% of the total teaching time (see Liepe 1996; Zydatis 1997). Such models are also becoming increasingly popular in North America (see Christian 1994). So far, no research results on SESB are yet available. The first reports from the USA are quite encouraging (Cazabon et al 1993).

Reciprocal IM can also be done in a different way, as in San Diego during the 1970s and 1980s. In this case the two languages were Spanish and English. English was the prestigious language traditionally used for education in the USA. Spanish had less prestige. The programme was organised so that during the first two years, Spanish was mainly used as the language of instruction, with English limited to 15–60 minutes per day. After two years, English became the language of instruction.

This gave the anglophone children an opportunity to learn Spanish and to develop an appropriate attitude towards it. The Spanish-speaking children had the advantage of being allowed to start their school career on the basis of the language they knew best. This meant that their cognitive development continued on the basis of their stronger language. Moreover, they developed the school register for Spanish, discovering that Spanish was just as useful as English for the purpose of education. This, in turn, had a very positive influence on the attitude of the Spanish-speaking children towards their home language.

It turned out that giving the Spanish-speaking children a boost, on the basis of their home language, helped them to develop greater competence in English once it became the medium of instruction. They also performed better in maths and other subject areas when compared to the national standards (Genesee 1987).

Late Partial IM in Schleswig-Holstein

As noted above, much less research on IM has so far been conducted in Europe than in North America (particularly Canada). This section presents recent findings from a Late Partial English language IM programme at secondary level in Schleswig-Holstein, northern Germany. The programme links LAS with IM, and offers several models that can be evaluated with respect to the key issues identified above as being particularly pertinent to the present-day challenges in Europe.

The basic model corresponds to the one that has been successfully operated in Germany since the end of the 1960s for French and German (e.g. Mäsch 1993; Lagemann 1993; Wode 1995). The IM language for this programme is English.

The programme was begun as an experiment in 1991, running for four years. During that time, it proved so successful that it was turned into a regular option. Initially, it was provided for secondary I students (age 10–16). Now, attempts are being made to include younger age ranges. In 1996, the programme was extended into the primary grades to offer English at grade 3 as a language awareness programme of fifteen minutes per day. A more recent move is to have the first foreign language introduced at age three via bilingual pre-schools. The first reports are now available for this pilot programme (Westphal 1998).

The secondary I model shown in Figure 4 has three variants.

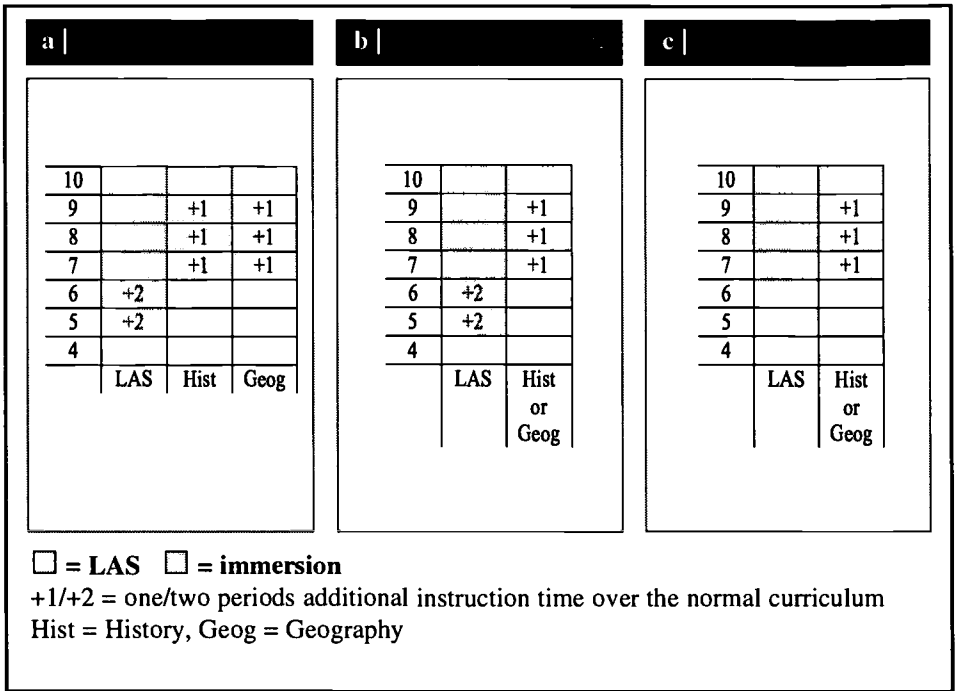

Figure 4 | Late Partial IM at secondary I in Schleswig-Holstein

22

The most time-consuming and expensive version is option (a). English is introduced at age ten in grade 5 via LAS. In order to make sure that the student’s English is good enough, when history and geography are taught in English from grade 7, it was thought necessary to increase the regular number of periods allocated to English by two during grades 5 and 6. Analogously, it was argued that both subjects should be given one additional period each over the regular time, in order to make sure that the subject matter would not suffer. These booster periods for the subject areas continued until grade 9. Obviously, it is the booster periods that make (a) an expensive option, particularly if this option is to be made available to all schools in the country.

The first alternative (b) is structured like version (a), except that there is only one subject area (history or geography) that is taught via IM. The least expensive version is (c) with only one IM subject and no LAS booster periods in grades 5 and 6.

It is easy to see that version (c) is particularly interesting from the point of view of this paper. If it can be shown that such a small dose of IM, in conjunction with LAS, produces superior results over LAS alone, it would be hard for any school board or administration to cease IM once begun. If it can be shown that version (c) is more efficient than LAS, requiring only the regular time for teaching a foreign language plus one single subject area, then this small dose of IM should leave enough time to give at least some students the chance to start an additional language during secondary I/II. This is exactly what the research shows.

Data collection

In the evaluations of the Schleswig-Holstein programme, students of all the above versions were given a test which, among other tasks, asks them to discuss among themselves how to solve a difficult situation, in which they find themselves on an imaginary class trip to the Scottish Highlands. The students were given half a page of written instructions plus three words thought to be unfamiliar to them namely *fisherman's hut*, *forest* and *gas cooker*. The students were to imagine that on such a trip, far away from any town or village, one group member suffers a broken leg and two other students get sick. The rest of the group has to decide to what to do.

The students were grouped into triads, and each were asked to discuss what the best solution might be. The discussion was recorded on audiocassette and analysed for various properties including: phonology, morphology, syntax, discourse, lexis and interactional patterns. The performance of the IM, students was compared to two control groups, one from the same school but which did not have IM, and one from a school in the same city which did not offer IM at all. The reason for these two choices was to determine to what extent the IM classes attract the more gifted or motivated student.

As of May 1998, some 700 students from all three groups had been investigated.⁴ The general finding is that the IM students tend to outperform the control groups by a considerable margin! Note that this is also true for the students from version (c). In fact, there does not appear to be any dramatic difference in the outcomes between the three versions despite the differences in the number of periods taught.

23

Results

Table 1 summarises some of the key findings for a number of lexical features for the first class of seventh graders taught through the (c) version. For administrative reasons, the test had to be administered approximately seven months after the beginning of IM. The table is constructed in such a way as to have a bearing on two issues crucial for understanding IM teaching; namely, why it is that IM works so well, and what kind of competence is likely to result from it. The main contention of IM theory is that the students can learn properties of the input language simply by using it for focusing on matters other than the L2. This ability is not exceptional but available to all learners. The lexical data in Table 1 provide a window onto these issues.

Students	Not in test or vocabulary list	In test only	Passive only	Only in test and passive
A1	jeep	compass fisherman fisherman's hut		camp
A2	compass			
A3				camp
B1	cornfields impossible rescue troop shoot	compass fisherman's hut moor	catch climb grass ill little possibilities stronger	camp hut
B2	(flower power) jeep nature rescue rescue troop signal pistol (walking time)	fisherman's hut moor	around grass ill plan	camp
B3		fisherman's hut	ill	camp
C1	yeah			camp
C2	yeah	fisherman's hut		camp
C3	landrover paddling Suzuki yeah	fisherman's hut moor		camp

24

A = non-IM control group from same school as IM group matched for age
 B = IM group
 C = non-IM control group from non-IM school matched for age
 1, 2, 3 = individual students in each triad

Items in brackets are compounds derived by the students on the basis of items provided in the vocabulary listings of the textbook.
 (adapted from Kickler 1992: Wode 1994 vol 4: 27)

Table 1 | Lexical items used by the students

Table 1 groups the lexical items used by the students in their discussions as to their most likely source, i.e. whether a given item comes from the textbook used during LAS, from the additional material designed by the teacher, or from the wording of the test. It also shows whether the word was for active or passive use. It was also possible to determine these lexical sources, because the textbooks that had been used in LAS classes list all the lexical items that occur in them, and mark them as to whether they are expected to be part of the students' active or passive vocabulary.

The logic behind Table 1 is that if the lexical items used by the students cannot be traced to their English textbooks, then the items were picked up elsewhere. One possible source was the wording of the test (the test instructions and 'new' lexical items), another conversation in the classroom, or elsewhere.

As for the students' overall linguistic performance, the overriding impression created by the data is first, that the IM students clearly outperform the two comparison groups; second, that the latter produce the same kind of evidence, except on a considerably smaller scale; and third, that all three groups appear to operate on the basis of the same language learning abilities, namely those from naturalistic, i.e. untutored L2 acquisition.

The columns of Table 1 indicate that students, no matter whether taught via IM or otherwise, can learn new items on their own, i.e. from situations such as the test instructions, or from conversation with their teacher. Second, the three groups of students can each use the odd item from their supposed passive vocabulary for production. Third, the IM students employed a larger number of items not provided by the active or passive list of the LAS textbook, or via the wording of the test. Note also that some of the compounds may have been derived by the students from the lexical material presented in the textbook (as indicated in brackets).

Contrary to any expectations one might have had, the lexical items of Table 1 that are not based on the textbook or the test do not relate exclusively to the technical vocabulary needed for the specific subject matter pertinent to the situation, such as *compass* or *fisherman's hut*. If there is such a thing as a general vocabulary, then surely most of the non-textbook based items would be part of it. It seems that even such low doses of IM teaching, as in the programme under scrutiny here, induced learners to acquire lexical material and probably other linguistic elements on their own, i.e. solely from oral interactions.

Consider first, the column headed *In test only*. These terms were not part of the vocabulary in the textbook. Whether the student knew these words before taking the test is not known. However, the students did have access to these words because they were contained in the description of the test and the instructions that went with it. The test was administered in such a way that there was no rehearsal of any sort, nor any explanations, as to the meaning of any word apart from *fisherman's hut*, *forest* and *gas cooker*, which were provided with German glosses. As for the other terms, it was assumed that the concepts would be familiar enough, so that the students would go for the words and use them on the spur of the moment as required by the situation.

As Table 1 shows, all three groups managed to pick up the key terms. The students may even have reinforced each other by employing these terms in their verbal exchanges. But note that no group excelled in particular. Contrast this with the evidence in the column labelled *Not in test or vocabulary list*. Although each group of students does have at least one such item, the IM students outperformed the two comparison groups by a considerable margin. The IM students tended to activate a larger number of lexical items, both in terms of tokens as well as types. This affected their entire range of word classes; their lexical fields were more differentiated as measured in terms of the number of synonyms found in each comparison group; and

the IM group produced a greater number of lexical types that were absent in the non-IM control groups (e.g. Wode 1998; Wode et al 1996).

This suggests that the latter may have had many more opportunities for incidental learning in addition to what their English textbook and LAS had to offer. What this in turn suggests is that it is not any superior learning abilities that account for the performance of the IM students, but the fact that IM provides for superior opportunities for incidental learning to take effect.

This insight is further supported by the evidence in the two remaining columns, and relating to words expected to be passively available. All three groups performed at comparable levels with respect to those passive lexical items that also occurred in the wording of the test, but only the IM students activate any of the words in the *Passive use only* column¹. Again, it is probably not differences in their learning abilities that account for these striking differences, but the lack of opportunity to apply these abilities in LAS.

Table 1 also highlights another important point. The compounds in brackets were probably created by the students from the constituent elements available from the textbook. Some of these compounds may be slightly odd in terms of current usage, and may not be listed in standard dictionaries of current English. Evidence of this sort, however, suggests that either IM teaching and/or situations like the test promote the development of word formation without any prior teaching at all. In other words, IM is likely to encourage students to spontaneously activate their endogenous learning abilities, without them being evoked by any LAS based teaching procedure.²

26

Conclusion

Although the above section only deals with a few issues in lexical acquisition, the basic insights carry over to other aspects of lexical competence to those described above, as well as to other structural areas within the Schleswig-Holstein context, such as syntax (e.g. Wellmann 1995; Kiel 1996; Cohrs 1997) or discourse (e.g. Krohn 1996; Claussen 1997; Mukherjee 1997; Ruthenberg 1998). In addition, the first German studies on the development of history and geography indicate that IM students perform as well as, if not better than, the non-IM students (Weber 1993; Walter 1996). Moreover, these findings are fully in line with the research results and practical experience from other parts of the world (see Baetens Beardsmore 1993; Swain and Johnson 1997; Arnau and Artigal 1998 for recent collections of papers to this effect).

- 1 This is a peculiarity of these particular triads. In other cases, students from group C or A may also use the occasional item from the passive list (e.g. Kickler 1995; Daniel 1997).
- 2 Although not reported here, there is further evidence that IM induces students to activate their natural language learning abilities. For example, the analysis of the lexical errors made by the IM students in their negotiations during the test match those that have been for tutored or untutored L2 English/L1 German learners (e.g. Burmeister 1986; Daniel 1997; Eichelberger 1988; Kickler 1995; Nerlich 1998; Reinhardt in preparation; Rohde 1993; Witt 1990; Wode 1987, 1988 and 1993). Similarly, the development of the word classes, the speed of lexical acquisition and other properties characteristic of IM parallel naturalistic and LAS-based acquisition (Wode et al, in preparation).

Obviously, data of the sort discussed above do not support any suggestions that learning a foreign language via IM requires learning abilities specific to this situation, or that IM should only work in Canada. On the contrary, untutored foreign language acquisition, whether via IM or via LAS, is based it seems on much the same acquisitional abilities. This point is important because it supports the assumption that the contingencies of naturalistic foreign language acquisition also apply to IM. Consequently, future developments of IM methodology, including those in Europe, can be based on this assumption.

In this respect, note that the non-IM controls showed traces of the same characteristics as the IM students. Obviously, it is the additional input and, very likely, the way IM is done that allows the IM students to excel in the way they did. Apparently, IM creates better opportunities for students to activate their language learning abilities than any other teaching methodology known today. Moreover, the evidence that is beginning to come in from research on children in bilingual pre-schools is fully consistent with this view (Wode 1996; Westphal 1998).

Of course, the psycholinguistic basis focused on in this paper is only one aspect that needs to be considered when trying to decide whether to adopt IM as a means of improving the results of foreign language teaching. There is a host of other related issues such as the development of IM methodology, teacher training, materials development, administration and securing parental involvement, to name but a few. As for the European scenario, there is no need to start from scratch. There is plenty of experience on all these issues world-wide, which needs to be examined to establish whether it can be made use of, given the local contingencies in which a particular programme is to operate. In any event, it would be highly irresponsible if the opportunity to benefit from the language learning potential, inherent in IM teaching, were withheld from large portions of the younger generation.

This research was supported by a grant from the Cornelsen-Stiftung Lehren und Lernen im Stiftverband für die Deutsche Wissenschaft.

References

- Arnau J and J M Artigal (eds) (1998) *Els programes d'immersio: una perspectiva europea*, Barcelona: Edicions Universitat de Barcelona
- Baetens Beardsmore H (ed) (1993) *European models of bilingual education*, Clevedon: Multilingual Matters
- Baetens Beardsmore H (1990) 'Multilingual education in Europe: theory and practice' in *Korean language education in China*: 107–129, The Korean Society of Bilingualism
- Baetens Beardsmore H and J Kohls (1988) 'Immediate pertinence in the acquisition of multilingual proficiency' in *Canadian Modern Languages Review*, 44: 241–261
- Baetens Beardsmore H and M Swain (1985) 'Designing bilingual education: aspects of immersion and European school models' in *Journal of Multilingual and Multicultural Development*, 6: 1–15
- Burmeister P (1986) *Linguistische Untersuchungen zum L2-Lexikonerwerb*, Kiel: Kiel University

- Cazabon M, W Lambert and G Hall (1993) *Two-way bilingual education: a progress report on the Amigos Program*, Washington DC: National Centre for Research on Cultural Diversity
- Christian D (1994) *Two-way bilingual education: students learning through two languages*, Washington DC: National Centre for Research on Cultural Diversity
- Claussen I (1997) *Ein Vergleich der Diskursfähigkeiten mono- und bilingual unterrichteter Schüler im Rahmen der Unterrichtserprobung in Schleswig-Holstein*, Kiel: Kiel University
- Cohrs I (1997) *Syntaktische Analysen von Schüleräusserungen aus mono- und bilingual unterrichteten 10 Klassen schleswig-holsteinischer Gymnasien (Jahrgang 1995)*, Kiel: Kiel University
- Daniel A (1997) *Querschnitts- und Longitudinaluntersuchungen zum Wortschatz bilingual unterrichteter Schüler in Schleswig-Holstein (Jahrgang 1993/96)*, Kiel: Kiel University
- Eichelberger S (1988) *Der natürliche L2-Erwerb englischer Taxonomien durch deutsche Kinder und seine Relevanz für den Fremdsprachenunterricht an Wirtschaftsschulen*, Kiel: Kiel University
- Genesee F (1987) *Learning through two languages: studies in immersion and bilingual education*, Cambridge, MA: Newbury House
- Harley B (1986) *Age in second language acquisition*, Clevedon: Multilingual Matters
- Housen A and H Baetens Beardsmore (1987) 'Curricular and extra-curricular factors in multilingual education' in *Studies in Second Language Acquisition*, 9: 83–102
- Johnson RK and M Swain (eds) (1997) *Immersion education: international perspectives*, Cambridge: CUP
- Kickler KU (1992) *Lexikalische Aspekte des L2-Wortschatzerwerbs im bilingual Unterricht (Jahrgang 1992)*, Kiel: Kiel University
- Kickler KU (1995) *Wortschatzerwerbs im bilingual Unterricht*, Kiel: 1&f Verlag
- Kiel K (1996) *Linguistische Untersuchungen zur Syntax bilingual unterrichteter Schüler im Rahmen der Unterrichtserprobung in Schleswig-Holstein (Jahrgang 1993/94)*, Kiel: Kiel University
- Knust M (1994) 'Bili ist echt gut ...' *Pilotstudie zur Evaluierung von deutsch-englisch bilinguaem Unterricht in Schleswig-Holstein (Jahrgang 1992/93)*, Kiel: Kiel University
- Krohn G (1996) *Kohäsive Merkmale in mündlichen Texten bilingual deutsch-englisch unterrichteter Schüler im Rahmen der Unterrichtserprobung in Schleswig-Holstein (Jahrgang 1994)*, Kiel: Kiel University
- Lagemann A (1993) 'Erfahrungen mit deutsch-französischen bilingualen Bildungsgängen am Beispiel des Gymnasiums Osterbek in Hamburg' in *Informationshefte zum Lernen in der Fremdsprache*, 5: 5–38
- Lambert WE and GR Tucker (1972) *The bilingual education of children: The St. Lambert experience*, Rowley, MA: Newbury House
- Liepe A (1996) 'Die Staatliche Europa-Schule in Berlin (SESB)' in *Kubanek-German A, Immersion-Fremdsprachenlernen-Primarbereich: 191–199*, München: rother druck
- Mäsch N (1993) 'Grundsätze des bilingual deutsch-französischen Bildungsganges am Gymnasien' in *Deutschland: der fremdsprachliche Unterricht*, 27: 4–8
- Mukherjee V (1997) *Kohäsive Merkmale schriftlichen L2-Daten von bilingual deutsch-englisch unterrichteter Schüler im Rahmen der Unterrichtserprobung in Schleswig-Holstein*, Kiel: Kiel University
- Nerlich B (1998) *Fehleranalyse zum Wortschatz von Schülern aus englisch-deutsch bilinguaem Unterricht der 7. Jahrgangsstufe*, Kiel: Kiel University

- Rebuffot J (1993) *Le point sur l'immersion au Canada*, Anjou, Quebec: Centre Educatif et Culturel inc.
- Reinhardt M (in preparation) *Vergleichende Untersuchung zu Wortschatzfehlern bei bilingual unterrichteten Schülern der 10 Klassenstufe*, Kiel: Kiel University
- Rohde A (1993) 'Die Funktion direkter Antonomie im Erwerb von Adjektive' in Börner W and K Vogel, *Wortschatz und Fremdspracherwerb*: 67–85, Bochum: AKS Verlag
- Ruthenberg T (1998) *Pilotuntersuchung zu geschichtstaktischen Redemitteln bei L1-Sprechern und ihre Anwendungsmöglichkeiten bei L2-Sprechern*, Kiel: Kiel University
- Walter K (1996) *Geschichte im bilingualen Unterricht – Eine Pilotstudie*, Kiel: Kiel University
- Weber R (1993) *Bilingualer Erdkundeunterricht und internationale Erziehung*, Nürnberg: Hochschulverband für Geographie und ihre Didaktik e.V.
- Wellmann S (1995) *Die Evaluierung der Syntax mündlicher Daten von mono und bilingualunterrichteten Schülern im Rahmen der Unterrichtserprobung*, Kiel: Kiel University
- Wesche MB, F Morrison, D Ready and C Pauley (1990) 'French immersion: post-secondary consequences for individuals and universities' in *Canadian Modern Languages Review*, 46: 430–451
- Westphal K (1998) *Pilotuntersuchung zum L2-Erwerb in bilingualen Kindergärten*, Kiel: Kiel University
- Witt K (1990) *Der natürliche L2-Erwerb der englischen Bezeichnungen für 'Natural Category Terms'*, Kiel: Kiel University
- Wode H (1987) *Einige Grundzüge des natürlichen L2-Erwerbs des Wortschatzes* in Melenk H, J Firges, G Nold, R Strauch and D Zeh, 11. Fremdsprachendidaktikerkongress: 483–495, Tübingen: Narr
- Wode H (1988) *Psycholinguistik: eine Einführung in die Lehr- und Lernbarkeit von Sprachen*, Ismaning: Hueber
- Wode H (1994) *Bilingual Unterrichtserprobung in Schleswig-Holstein: Bericht zur Entwicklung eines kommunikativen Tests für die Überprüfung des Englischen bei Schülern der 7. Jahrgangstufe*, 2 vols, Kiel: 1&f Verlag
- Wode H (1995) *Lernen in der Fremdsprache: Grundzüge von Immersion und bilingualen Unterricht*, Ismaning: Hueber
- Wode H (1996) *Bilinguale Kindergärten: Wieso? Weshalb? Warum?* Kiel: Kiel University
- Wode H (1998) 'A European perspective on immersion teaching: the German scenario' in Arnau J and JM Artigal (eds) (1998) *Els programes d'immersio: una perspectiva europea*: 43–65, Barcelona: Edicions Universitat de Barcelona
- Wode H (in preparation) 'Incidental vocabulary acquisition in the foreign language classroom' to appear in Wesche M and TS Paribakht, *Incidental L2 vocabulary acquisition: theoretical, methodological and pedagogical issues*, *Studies in Second Language Acquisition*
- Wode H (in preparation) *How little do we need?* Kiel: Kiel University
- Wode H, P Burmeister, A Daniel KU Kickler and M Knust (1996) 'Die Erprobung von deutsch-englisch bilinguaem Unterricht in Schleswig-Holstein: ein erster Zwischenbericht' in *Zeitschrift für Fremdsprachenforschung* 7 (1): 15–42
- Zydatiss (1997) *Umriss eines Spracherwerbskonzepts für den zweisprachigen Unterricht bilingualer Lerngruppen in der Berliner Grundschule. Gutachten für den Schulversuch der 'Staatliche Europaschule in Berlin'*, Berlin: Senatsverwaltung für Schule, Jugend und Sport

29

Teaching history in a foreign language: what language?

Carol Morgan | University of Bath

Introduction

The use of a foreign language as a medium of instruction, rather than as a separate subject, is becoming more and more common in Europe. Bilingual programmes are well established in Canada, and some sheltered bilingual programmes (where language minority students are taught separately from the language majority students) are also now gaining ground in the USA. European schools, international schools and Anglophone/Francophone schools and colleges in Africa and Asia are delivering lessons in a language other than the learners' mother tongue. There is then a plethora of contexts where the mechanics of the bilingual teaching/learning process may be similar, but where the contextual detail is often very different. In the United Kingdom, there was a flurry of interest in language intensive programmes (Hawkins and Perren 1978; Hawkins 1988), but the current constraints of the National Curriculum and pressure on school performance in league tables has now rather dampened interest and enthusiasm in schools which might seek to introduce content and language integrated learning (CLIL) elements. It is encouraging therefore that a new network of bilingual schools has been set up in the UK (the Bilingual Schools Association, BISA, which has published one newsletter to date) including new language colleges, and that some new initiatives for teacher education are under way (Coyle 1999).

In terms of a subject suitable for bilingual teaching, history is a common choice (Citterio 1994; Sauer 1994; Thürmann 1995; Bierbaumer 1995), and it may also be of particular interest when thinking about the language which occurs in the classroom. History terminology is less technical than in a subject such as science, and may, therefore be perceived as contributing more easily to a learner's general stock of language. (This is discussed in more detail below.) Certainly in the UK, the status of history as a subject in the curriculum is currently under threat, as recent articles and comments by teachers testify (De Marco 1998; Clare 1998), and therefore the enhancement of teaching through a foreign language in a UK context may be particularly welcome. In order to clarify the foreign language instruction context for history teaching, and to understand the particular issues relating to language within this context, there seem to be three important questions:

- Why is history being taught in the foreign language?

- Is there a special language for teaching/learning history?
- What aspects of language in history teaching/learning need special attention?

As I hope to demonstrate, the answers to these questions overlap and influence each other. In other words, the reasons and context for CLIL will influence the kind of language used and chosen; similarly perceptions of genre-related language will affect linguistic priorities.

Why CLIL for history?

Where there is already a commitment to CLIL in a school, it is common for learners to be taught several subjects in the foreign language (in a survey of 21 countries with bilingual schools and streams, only one country (Norway) mentioned using CLIL for a single subject (see Bierbaumer 1995: 36–53). It is thus likely that the reasons for teaching history in a foreign language will be subsumed by the general reasons for CLIL (even though in practice, history may have something special to offer). It is useful to divide the reasons for opting for CLIL into two areas: contexts and purposes, even though these two are themselves already linked. By doing this, it should become evident that on the one hand there can be a plurality of purposes within a narrowly defined context, and also that this context may in itself prevent or discourage certain choices.

CLIL contexts

There are two crucial factors in deciding attitudes towards and constraints of CLIL in different contexts. One is the learners' own language and the mother tongue homogeneity/heterogeneity of the class, and the other is the perception of destinations of the learners: whether these are considered likely to be mother-tongue or foreign-language environments.

In surveying literature from many different sources which deals with CLIL, it seems that there are (at least) three different models to be found:

- the linguistic additive;
- the vocational;
- the comparative/cultural.

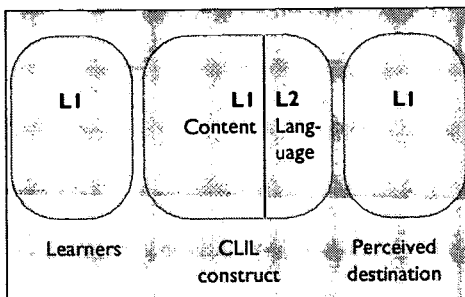

Figure 1

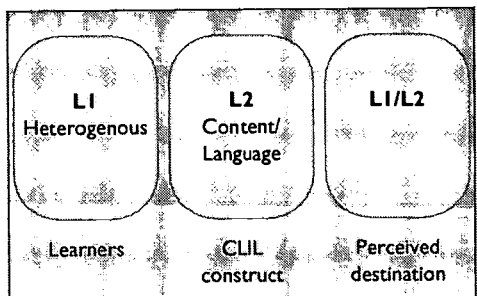

Figure 2

In the first model (see Figure 1), learners are situated in and destined for a mother-tongue (L1) context. The foreign language (L2) is a bonus added onto content which is framed by L1 priorities. This is particularly true for contexts where there has been no possibility or desire for working or studying in an L2 context.

The content-based language here is deemed useful for adding to the general foreign language undertaken by the learner.

The second model seems to be one which applies particularly to the learning of English, and to contexts where English for specific purposes is taught. (See Figure 2.)

Classes (usually adults) may be homogenous or heterogeneous with learners' perceived destination working in their own countries, but in fields of study where the foreign language (English) is particularly useful for professions (medicine, business, engineering, etc). Learning and language then have very specific purposes. Further study may have to be in a foreign country, but the ultimate context will probably be the learner's own country. This model may seem rather remote from a 'non-vocational' subject such as history, but one could envisage say a language for specific purposes (LSP) programme in German for someone wishing to become an art-historian (since much of the literature is in German), and certainly history is included in programmes which have vocational aims (see Christ 1995; Balíková 1995). The foreign language in a 'vocational' context helps to access contexts and data immediately relevant to professions.

32

In the third less common model, there is a mixed constituency of learners, with the mother tongue (L1) of some being the foreign language (L2) for the others (see Figure 3).

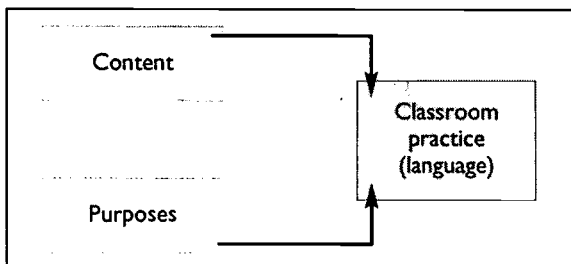

Figure 3

One example is the mixed Spanish and English-speaking bilingual classrooms in the USA (see Freeman 1990), or bilingual schools in Austria with a mixed clientèle. Destinations for these learners may be perceived to be either L1 or L2 contexts, and the content as well as the language of instruction will be a mixture of L1 and L2. There is a much higher latent level of intercultural and interlinguistic comparison in this model, although clearly such comparison is also possible in the other models.

There are two important riders to add to these suggested generalised models:

- one is that perceptions of destinations do not necessarily reflect realities, and up to this point have only been impressionistically gathered;
- and the other, that the central construct of CLIL in each case is suggested as the most likely, but may in fact be espoused in other models.

There are other contextual factors which are also likely to be instrumental. First, any CLIL classroom will be situated in a series of interlinking contexts (see Figure 4

and Baetens Beardsmore 1993b). The attitude to foreign language learning in general will influence the support of and interest in CLIL.

The situation in the UK is, for example, particularly problematic with English perceived as a world language (James 1995; Chambers 1993; Poole and

Roberts 1995) and a corresponding decline in interest in foreign languages (Stables and Wikeley, forthcoming). Linked to cultural attitudes in general is government support for CLIL initiatives. For example, in Austria, any school may apply to the Ministry of Education to use CLIL if they believe this will be beneficial: 'if this ... seems to serve the purpose of improving education in foreign languages' Schulunterrichtsgesetz section 16.3. Federal Law Gazette (1986).

By contrast, bilingual education in Belgium is illegal, apart from experimental projects (see Baetens Beardsmore 1993b).

A further crucial dimension is constituted by arrangements in school which can vary: the whole school may be run bilingually; there may be bilingual streams/strands or CLIL short-term projects (Helfrich 1994); there may be special LSP classes. Learners themselves, as mentioned earlier, may share one language or there may be a heterogeneity of languages (which may or may not be a mix of L1 and L2). The teacher may be an L1 or L2 national. He or she may be both a subject teacher and/or a foreign language teacher; or a system of team teaching may operate with a subject teacher working with a native speaker or with the foreign language teacher. In terms of the specific content of the history lesson, the topic is likely to be world history since most programmes seem to opt to teach their national history in their mother tongue (Sauer 1994). (An interesting situation of course emerges in a bilingual classroom where this allocation of national and international history is not so clear-cut.)

The personalities of those in the classroom are also influential. The teacher is likely to favour particular kinds of activities, and to have his or her own style of language or idiolect. Learner styles also vary and some learners may feel more able to cope with learning subject content in a foreign language. Christ, for example, talks about particular characteristics of CLIL students where parental commitment and learners' ambitions, and their own attitudes to the foreign country, are often crucial (1995a).

It is clear then that contexts for CLIL are extremely varied. Teaching history in a foreign language could thus be anything from a one-off lesson in an isolated project (where simple foreign language terms and language activities focus on a history topic), to lessons integrated into a complete bilingual programme, where different cultural approaches to history are explained, and external qualification recognises the CLIL nature of the course.

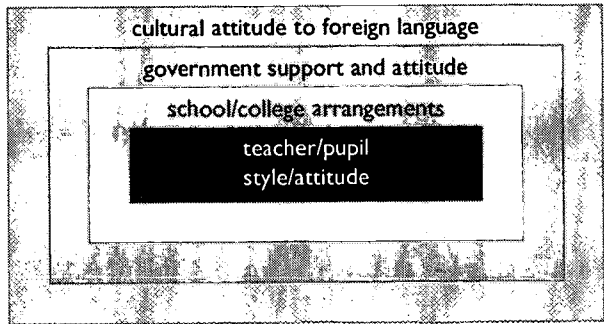

Figure 4

These contextual factors not only directly affect the CLIL lessons (and thus the language that is used), but also contribute to the perceived purposes of the foreign language medium, which then in turn affects the lesson content and classroom activity (see Figure 3, p32).

Purposes of CLIL

The three groups of purposes which are outlined below correspond roughly to the three contexts mentioned above, but the correspondence is not exclusive. Some purposes may be seen as 'transferable'. The three broad categories of purpose which seem to emerge from the CLIL literature and from personal testimonies are:

- linguistic;
- vocational;
- intercultural (see also Abuja and Heindler 1995: 5).

Overarching these is the question of motivation. Particularly in the early stages of a project or programme, participation in any new way of learning brings about a sense of pride and heightened levels of interest and motivation (the so-called 'halo' or 'Hawthorne' effect), and thus increased motivation can be a feature of each of the above three purposes.

Improving linguistic competence

Any CLIL project or programme will – and will want to – improve learners' foreign language competence. In terms of purpose, the crux of the matter lies in whether the content is serving this improvement of the language, or whether the improved language is serving some other purpose (better understanding of the content or of cultural perspectives of the content). A focus on linguistic improvement is adopted for example by Butzkamm who sees CLIL as an excellent way of making language message-oriented rather than medium-oriented, i.e. making language real and a carrier of meaning, (1995: 24–25). He draws particularly on research by Mitchell and others which identified a 'content vacuum' in foreign language classes in the UK (Mitchell et al 1981). The language aspect for Butzkamm is so important that he suggests integrating pure language activities as well in CLIL lessons: 'For the learners, a bilingual geography or history lesson is ... also a language lesson. Teachers are therefore advised to watch out for language problems and occasionally switch to medium-oriented practice [concentrating on form]' (1995: 25). For a teacher then with a primarily linguistic focus, CLIL lessons could also include language activities, where particular kinds of language might be included which serve a foreign-language learning agenda rather than a history-learning agenda.

Other research into bilingual teaching programmes has shown that having a dual vocabulary can lead to mental flexibility (Baker 1993; Wolff 1995). Bilingual learners are much more likely to be divergent thinkers, able for example to think up many different uses for an object rather than just a few. A CLIL lesson could be seen as a kind of micro-bilingual experience, thus providing some training for flexibility.

In similar vein, Hellekjaer talks of improved reading skills among his students in CLIL programmes, particularly in reading academic texts (1995: 139). Hellekjaer suggests that this improvement is not only related to greater knowledge of vocabulary, but also being able to recognise the cohesive divisions and relationships in texts. This could be seen as both an advanced linguistic skill and an advanced cognitive skill.

Hellekjaer also suggests that CLIL is 'the most logical and effective way' of implementing Krashen's theory of comprehensible input (1995: 134), where learners acquire language in a 'natural' way more akin to their mother-tongue learning. Krashen's theories, while still of interest, are now widely criticised (Bourne 1988; Gregg 1984; Hammerley 1991; McLaughlin 1987; Skehan 1989; Swain 1985) so Hellekjaer's recommendation here is less forceful. However, to link this back to Butzkamm's suggestion, learners will obviously be more interested when faced with texts and input that are part of a real communicative event. Hutchinson and Waters make just this point in pointing out the value of specialised subject texts: not because of the special language in these texts, but, because students recognise them as real, these texts 'achieve face validity' (1987: 161).

Vocational purposes

Many of those involved in CLIL claim its usefulness lies in preparing learners for an international world of work or for study abroad. Räsänen for example gives 'internationalisation and professional development' as one of the reasons for offering CLIL in a Finnish context (1995: 31). Questionnaires given to CLIL students in the Czech Republic revealed that 'some of them considered it [CLIL] to be good training for studies abroad or for a potential future career which could require a very active command of a foreign language' (Balíková 1995: 125). Christ in studying her 445 questionnaires (returned from 'graduates' of bilingual streams from 1979–1994 in Germany) reports a fairly low percentage of directly vocational usefulness: '*Eine direkte berufliche Vorprägung ist allerdings nur bei 21% erfolgt*' (1995a: 51), although travel purposes were favoured: '*Diese Sprachkenntnisse werden insbesondere für Reisen genutzt*' (1995a: 51). Helfrich in questionnaires from 28 countries (43 respondents) represented at a 1993 Council of Europe conference on bilingual education noted travel reasons as predominant rather than vocational ones (1994).

Vocational purposes as mentioned earlier are particularly prominent in LSP contexts where CLIL is directly focused on students' future careers. Robinson sums this up: 'LSP is normally goal-directed ... students study English not because they are interested in the English language (or English-language culture) as such, but because they need English for study or work purposes' (1991: 2).

Two important consequences of a vocational perspective or purpose in a CLIL context are the relationship between the foreign language and the content, and the particularities of the language chosen. In a vocational context, it is not the content which is enhancing the foreign language, making it more real as was identified in the more 'linguistic' perspective; the roles are reversed and the foreign language directly serves the content, for purposes beyond the CLIL classroom. For this reason it will be particular kinds of language that are encouraged: those that have been identified useful by needs analysis of students' particular contexts and destinations.

Intercultural aims

One might imagine that if a foreign language is to be truly functional in terms of learners' professional futures, then a purely linguistic understanding would not suffice: understanding discourse behaviours and registers would be equally important (see, for example, Mole 1990). However, this is rarely considered in LSP contexts. In CLIL contexts, however, an intercultural dimension is recognised: Abuja and Heindler give this as one of the reasons for teaching in an Austrian CLIL context: 'to create increased cultural awareness by becoming familiar with different ways of looking at different subjects' (1995: 5). Christ outlines similar guiding principles in her German context: '*Une ouverture pour des contacts interculturels ainsi qu'une curiosité pour d'autres pays et langues seront renforcées et confirmées par l'enseignement bilingue en classe*' (1995b: 8; see also Sauer 1994).

The emphasis on 'otherness' here is important. The foreign language instruction represents not only different, alternative vocabulary for describing events and activities, but it is also likely to be rhetorically organised and ideologically constructed in accordance with cultural as well as personal norms (this is analysed in greater depth in the sections that follow). The relationship between content and the foreign language here assumes yet another role. It is not a question of content bolstering language or language needed for specific content, but rather an awareness of the particular kind of rhetoric being used, both in terms of genre and of the particular cultural context.

36

The choice of language

If we return to the question of what language may be used in a history CLIL context, it has already been suggested that both context and purposes are likely to have a significant effect.

A distinction by Swales in his work on genre analysis (1990) can be helpful here. Swales talks of speech communities, those sharing a common language (in a CLIL context this can be interpreted as L1 or L2), and discourse communities (groups using specific language or jargon, whether this be social groups or professional groups). One could then disaggregate a history-teaching context as a particular discourse community. In doing so, it does not seem unreasonable to imagine that an L1 history-teaching discourse community would have a lot in common with an L2 history-teaching discourse community (see Figure 5).

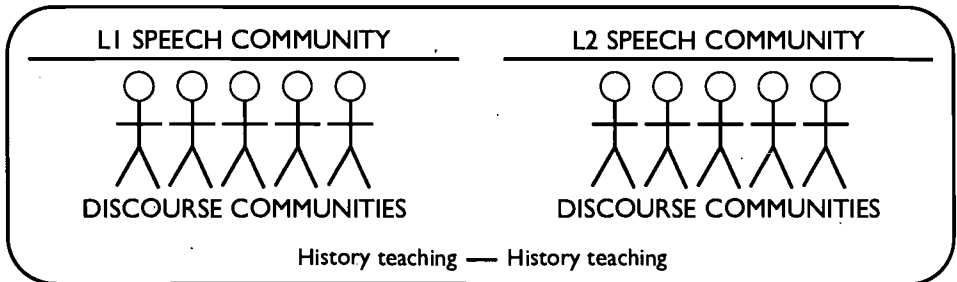

Figure 5

However, Swales argues strongly against this. In talking of different discourse communities (in this case 'science' teaching) he comments as follows: 'it would be difficult to argue that what goes on in those [science] faculties is part of a universal scientific culture. Rather we tend to find ... powerful local influences of many kinds, national, social, cultural, technical and religious' (1990: 65–66).

Valero-Garcés in her comparative analysis of economics articles, written in English by English and Spanish natives, provides a useful taxonomy of:

- genre rhetoric;
- cultural rhetoric;
- personal rhetoric;

where 'some features of scientific discourse are provided by the genre of the text, others by the culture they belong to and also by the writer's own style' (1995: 281).

If one leaves aside for the moment the question of a teacher's own personal style, his or her *ideolect* (which is dealt with more fully later), then it will be useful to examine the particularities of the rhetoric of the history lesson in terms of genre, and also in terms of culture.

Genre rhetoric

Halliday's categories of field, tenor and mode (1979) can inform an approach to genre in general: the field (history teaching); the tenor (the style of the writers of history texts or of the history teacher); and the mode (written language or spoken language).

If we look at the literature on transfer from primary to secondary stages of school with particular reference to the language of history learning (Chapman and Louw 1986; Perera 1986; Wishart 1986), there is a clear recognition of the difficulty of adaptive processes, particularly those relating to the learning of a new rhetoric. Chapman and Louw point to the transfer from the common story narrative of a primary school context to the more academic register in a secondary school: 'Moving pupils from the familiar register of narrative fiction which is read for pleasure towards registers of history and geography which are read for the development of facts and the development of concepts' (1986: 12–13). Wishart similarly points to the difficulties of an abstract register: 'History has long been recognised as a difficult subject for pupils, in that much of what is considered is not only outside the pupils' experience but also abstract in nature' (1986: 40). Attitudes have not changed: since these articles written in the 1980s, Clare (a head of a school history department) commented in a recent article: 'History is too hard ... pupils have to handle ideas and skills at a level way beyond anything they do in other subjects' (1998: 22).

Wishart suggests further that some kinds of learner, in particular those who are field dependent, less able to transfer ideas across contexts, will need particular help with the difficulties of historical genre language: 'those who are field-dependent find it more difficult to use their existing knowledge to illuminate their reading. They also handle complex language structures less well – and ... will need explicit help if they

are to master the use of textbooks effectively' (1986: 142). There is a reminder here then that even without the CLIL dimension, coming to terms with the language of history learning and teaching is difficult in itself for pupils.

In LSP classrooms, specialised subject texts have been analysed in terms of frequency analysis/register analysis (Robinson 1991; Kelliny 1998; Hutchinson and Waters 1987). In other words frequently used lexis and structures are identified to help with a better mastery of the subject. (Such an analysis was carried out for CLIL history contexts by Morgan and Simpson in the context of the Council of Europe 12A workshop on bilingual education, 1995.) Recent thinking in LSP literature though tends to favour a focus on more general English. Robinson comments 'ESP/EAP [English for Academic Purposes] practitioners generally agree that the specialised level is not the one to focus on' (1991: 28; see also Kelliny 1988; Krechel 1989). This then represents a rejection of genre rhetoric, not because cultural rhetoric is more powerful, but because it is suggested that it is the general language items in a text that students need to understand. There is clearly room for debate here.

One final aspect of genre rhetoric which is useful to consider is the notion of specialist vocabulary acting as a key to unlock specialist concepts (see Kress and Knapp 1992). The term 'reliability' for example in terms of history learning needs particular decoding: beyond the usual sense of dependability, students need to understand the particular difficulties in using historical evidence to unearth a 'reliable' picture of an event or situation. Byram points to the existence of 'key words or 'rich' items which express ... beliefs and values' (1997: 52). One may then claim key linguistic elements and approaches which belong to the genre of history teaching/learning. The mistake is to imagine that these are always shared universally across cultures.

38

Cultural rhetoric

Studies of contrastive rhetoric reveal that authors from different cultures writing in the same genre context do not share the same rhetorical habits. Furthermore, they tend to demonstrate similar styles within cultures, even taking personal stylistic differences into account. Wierzbicka comments: 'Although in most societies there is a great deal of variation in people's communicative styles there is a considerable level of intra-societal similarity' (1994: 83).

Alptekin in his analysis of target language culture in EFL materials points to particular features such as 'the rhetorical organisation of a text, audience awareness [and] topical priorities' (1996: 55). Several other writers also identify the particularities of cultural discourse with plenty of detailed research to confirm these opinions (Swales 1990; Clyne 1987; Sauer 1994; Valero-Garcés 1995; Goddard 1997; Hinkel 1997). For example, Valero-Garcés identifies different demands made on the reader by Spanish and English writers, with the former placing the onus on the reader to interpret, and the latter providing a more explicit, 'user-friendly' text. Hinkel in comparing English and Chinese and other Far Eastern writers also identifies greater explicitness in English writing together with a politeness of delivery to avoid 'imposition on the reader' (1997: 362). Wierzbicka, who has written widely on the cultural confines of language (1991a, 1991b, 1992 and 1994) has coined the term 'cultural scripts' to

describe this phenomenon (1994). In a recent article, she points to particular language items in cultural discourse which reveal cultural values and attitudes: the Japanese *ne* signifying a desire to have shared values between interlocutors; English question-tags which acknowledge 'possible differences of opinions or points of view and expressing an acceptance of these differences' (1994: 78) and the Polish '*aléz*' celebrating the desirability of lively confrontation and debate.

One might claim that these are examples of rhetorical habits reinforced over time and not applicable to younger students, who could make their own choices from a range of rhetorical possibilities (see Billig 1987). However, recent research reveals that pupils are likely to reproduce the discourse styles of their classroom textbooks (Morgan and Cain, forthcoming). National textbook writers may also follow the style of other former national subject textbook writers. In a recent survey of Austrian history textbooks for example, it was found that three out of the five books analysed used an identical quotation of a fable by Menenius Agrippa to illustrate the need for an egalitarian social structure in Ancient Rome (Schiepl et al 1979; Schausberger et al 1986; Lemberger 1994).¹

When teaching in an environment where there is concern for intercultural understanding, and where this is seen as one of the purposes, texts from the L2 culture can provide a useful source not only of access to the genre-vocabulary in that language, but also to the specific genre approach of that culture (see also Wertsch 1991 and Sauer 1994).¹

39

Specific language aspects in the CLIL classroom

If we turn to the specific language operating in a CLIL history lesson, this aspect of L2 texts needs to be borne in mind. Texts though, form only one area of language being used. As is shown in Figure 6 there are four linguistic sites which operate in the CLIL classroom:

- the language of the teacher;
- the language of the activities;
- the language of the texts;
- the language of the learner.

There will be interaction between all four: the first three language sources clearly acting as input for the learner and his or her own language, but also text-language to some extent affecting the teacher's language, and the teacher affecting the language of activities.

¹ These texts were analysed by teachers and researchers during INSET at the Vienna Bilingual School (22/4/1997) and at a presentation at the Learning through a Foreign Language Conference (Lancaster 17–19/4/1998).

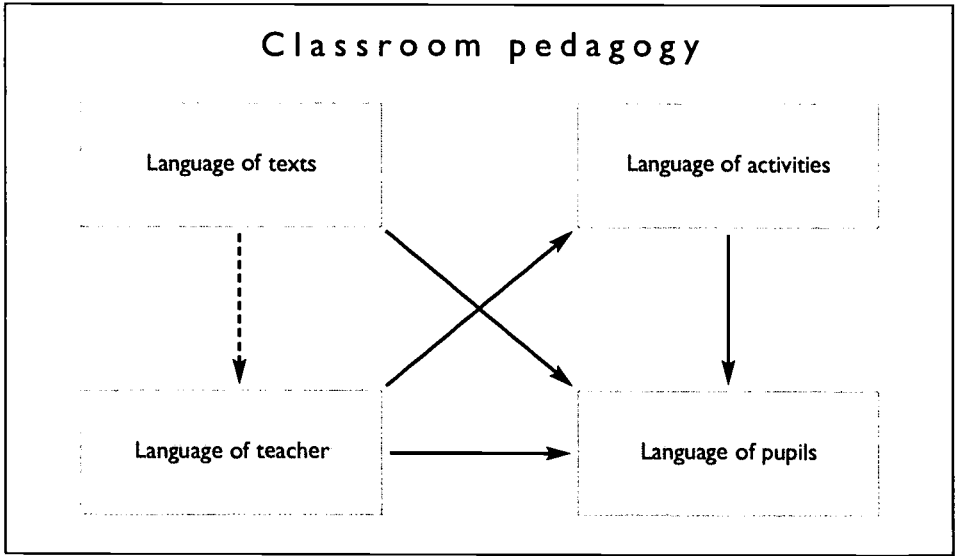
**Figure 6**

To return to Halliday's 'mode' mentioned earlier, the two modes operating in the classroom, written and spoken language, are likely to contribute differently to pupils' learning. The teacher will have a preferred style of speaking. If this is a non-native speaker teacher, then this style may suit a CLIL class (more or less, see Sunderland for the influence of gender styles in teaching, 1994), but this may not reflect a target language style of teaching history. If the teacher is a target language native speaker then the spoken style/approach can constitute a useful L2 input but may not suit CLIL learners. Here then considerable sensitivity needs to be exercised. The spoken rhetoric of the teacher is likely to be far more disruptive to the equanimity of a class (if it is experienced as alien) than the written rhetoric of texts, because it is experienced on a personal level (see comments on cross-cultural encounter in Morgan 1998).

The language and type of activities in a CLIL context are likely to be a mixture of genre and culturally-based language. Historical activities include:

- comparing, contrasting;
- attributing causes;
- focusing on continuity, change and correspondences;
- sequencing;
- predicting;
- making judgements.

These activities are likely to contain a high level of abstraction, and lexis and structures will reflect this (Morgan and Simpson 1995; Wishart 1986).

However, not only the language but also the activities themselves, and the language that they engender, are culture bound. Alptekin points to this crucial factor in an East-West context: 'task-based and problem-solving activities ... are not value-free modes ... they involve Western modes of communication which may not be in harmony with

the traditions of some cultures – including learning conventions’ (1996: 57–58). The same may also be true in an intra-European context: one can think for example of the predominance of the French *explication de texte* which is not immediately shared with other European teaching approaches (see also Kramsch 1991), although for example it may align well with the current interest in the English/Welsh National Curriculum in close analysis of texts in the history curriculum.

A practical point to note in conjunction with activities in the CLIL history lesson, is that the teacher not only has to be sensitive to the language of any activity and its ‘culture-boundedness’, but also to consider which activities are most likely to be fertile in promoting language usage. (This, of course, would be particularly important where the context and purpose were primarily linguistic).

Pupils then will encounter, in a CLIL history lesson, spoken language from the teacher and their peers in classroom interaction and activities (with probably a predominance of L1 rhetorical style), and the written language in historical texts, which may be ‘authentic’ texts from the L2 culture (with accompanying L2 genre rhetoric) or teacher-adapted texts where L1 cultural priorities may predominate.

There are two final points which can usefully add to the consideration of the language in texts. It has already been shown that written language will relate to both genre and cultural rhetoric. A further distinction, often found in LSP literature, is between specialised and non-specialised language. A more general point is that the choice of an authentic text or a teacher-adapted text is likely to have implications for both genre and cultural rhetoric, and to relate to kinds of context and purposes as outlined earlier.

In any written history text there will be a mixture of specialised vocabulary relating to the genre, and more general vocabulary relating to everyday usage. In LSP literature the distinction is drawn between specialised/technical vocabulary, semi- or sub-technical vocabulary (i.e. general and academic) and general vocabulary. It can be useful for the key words in any particular area to be highlighted for learners (perhaps with translations) to aid the content-learning process. This is certainly recommended in accounts by practitioners (Fleischmann 1995; Wildhage 1994; Byram 1997). A variation on this is the terminology offered by Snow et al (1989): ‘content-obligatory language’ and ‘content-compatible language’: the first relating to the needs of the subject-content, and the second to the communicative needs of the pupil. This distinction is likely to be focused on in both vocational and linguistic CLIL models.

The final facet of examining language in the CLIL history lesson hinges on the teacher’s choice of text. If we examine comments from some practitioners, it may be possible to track the underlying CLIL construct that is operating in each case, and to consider this in relation to the three models presented earlier.

It has not been possible to find examples from teachers of history, but hopefully the principle involved will be recognisable as relevant from the following three examples (a geography teacher, a civics teacher and a science teacher). Drexel-Andrieu talks of her experience, teaching in a well-established geography bilingual strand programme in Germany: ‘The German pupils like French Geography books for their beauty as they contain lots of photographs and little text. Being short the texts are, however,

concise and not easy for foreign learners to understand. Sometimes they are even written in the *passé simple* which increases the difficulty. So there is no other solution than to write texts oneself.' (1993: 177). Drexel-Andrieu also goes on to explain the differences between the German 'concrete example' approach and the French 'global' approach (pp180–181).

In quite a different Czech context, Lenochová (1995) describes the 'failure' of a new CLIL project: 'its author failed to grasp the dimension that he was supposed to explore, i.e. not teaching physics but learning (and teaching) physics through English. Therefore he focused only on comparison of the conception of British (and American) textbooks with the Czech ones ... all he did was create a sample of teaching materials and tasks taken over from, or heavily dependent on British textbooks without specifying which universal or language-specific skills these tasks required' (1995: 119). Lastly, Nordmann compares the treatment of gravity in a French and an English physics textbook and concluded that in her French context the English textbook is unsuitable: '*elle ne correspond pas à l'esprit final de l'examen du Baccalauréat*' (1994: 72).

In all these cases, it is clear that the cultural rhetoric in the L2 texts is seen as problematic. Here the linguistic model seems to predominate, with the need for pupils to adhere to an L1 construct of subject approach. If a broader intercultural view were to be adopted, then the rhetorical aspects seen as problematic could be turned round to be a rich source of discovery, not only in broadening perspectives generally, but also in helping to understand the broad spectrum of different cultural viewpoints that learners will encounter in their future social, academic and professional lives. Such a view is offered by Sauer in her description of 'histoire/géographie' bilingual streams in Germany: she accepts the desirability of L2 texts because they provide the pupil with '*l'accès à des informations rédigées en langue étrangère ... lui faire expérimenter des méthodes de travail parfois différentes des siennes*' (1994: 83). Sauer thus identifies an intercultural dimension to the approaches to history which lie beneath the language of the texts.

Language then needs to be considered not only in terms of its subject identity in thinking of which new words are needed for a subject, but also in terms of its cultural indexicality: if a certain range of lexis is used, then what does this tell us about the approach of the author or speaker and is this linked primarily to a personal or national construct? The practical concerns of ensuring maximum acquisition of language items should not blur the opportunities for conceptual and cognitive development which are also available through teaching content in a foreign language.

References

- Abuja G and D Heindler (1995) *Forms of bilingual education in Austria*, Graz: Zentrum für Schulversuch
- Alpetkin C (1996) *Target language in EFL materials* in Hedge and Whitney (eds)
- Baetens Beardsmore H (ed) (1993a) *European models of bilingual education*, Clevedon: Multilingual Matters

- Baetens Beardsmore H (1993b) 'Bilingual learning: Institutional frameworks – whole school policies' in Thürmann and Helfrich (eds)
- Baker C (1993) *Foundations of bilingual education and bilingualism*, Clevedon: Multilingual Matters
- Balíková L (1995) Selected passages from the project 'Teaching civics through English' in Thürmann (ed)
- Bierbaumer P (ed) (1995) *Report on 4th Seminar: Bilingual Schools in Europe*, Graz: European Centre for Modern Languages
- Billig M (1987) *Arguing and thinking: a rhetorical approach to social psychology*, Cambridge: Cambridge University Press
- Bourne J (1988) "'Natural acquisition" and a masked pedagogy' in *Applied Linguistics* 9:1: 83–99
- Butzkamm W (1995) 'Communicative shifts in the regular foreign language classroom and the bilingual content classroom' in Bierbaumer (ed)
- Byram M (1997) "'Cultural awareness" as vocabulary learning' in *Language Learning Journal* 16: 51–57
- Byram M and M Fleming (eds) (1998) *Foreign language learning in intercultural perspective*, Cambridge: Cambridge University Press
- Chambers G (1993) 'Taking the "de" out of demotivation' in *Language Learning Journal* 7: 13–16
- Chapman J and W Louw (1986) 'Register development and secondary school texts' in Gillham (ed)
- Christ I (1995a) '*Befragung von Absolventen bilingualer deutsch-französischer Bildungsgänge*' in Thürmann (ed)
- Christ I (1995b) Progress report in Thürmann (ed)
- Citterio L (1994) '*La pratique d'une langue vivante dans l'enseignement de disciplines non-linguistiques et particulièrement de l'histoire, géographie*' in *Triangle* 13 (ed)
- Clare J (1998) 'Unfair burden' in *Times Educational Supplement* 10, 22 April
- Clyne M (1987) 'Cultural difference in the organisation of academic texts' in *Journal of Pragmatics* 1: 211–247
- Coyle D (1999) 'Supporting students content and language integrated context: planning for effective classrooms' in Masih J (ed) *Learning through a foreign language: models, methods and outcomes*, London: CILT
- De Bot K, R Ginsberg and C Kramsch (eds) (1991) *Foreign language research in cross-cultural perspective*, Philadelphia: John Benjamin
- De Marco N (1998) 'Your subject needs you' in *Times Educational Supplement* 10, 20–21 April
- Drexel-Andrieu I (1993) 'Bilingual geography: a teacher's perspective' in Baetens Beardsmore (ed)
- Fleischmann E (1995) 'Content-based language teaching at GIBS' in Bierbaumer (ed)
- Freeman R (1990) 'Dual language planing at the Oyster Bilingual School: "It's much more than language"' in *TESOL Quarterly* 30:3: 557–576
- Gass S and C Madden (eds) (1985) *Input in second language acquisition*, Rowley, Mass : Newbury House
- Gillham B (ed) (1986) *The language of school subjects*, London: Heinemann
- Goddard C (1997) 'Cultural values and "cultural scripts" of Malay (*Bahasa Melayu*)' in *Journal of Pragmatics* 27: 183–201

- Gregg K (1984) 'Krashen's monitor and Occam's razor' in *Applied Linguistics* 5:2: 79–100
- Halliday M (1979) *Learning as social semiotic: the social interpretation of language and meaning*, London: Arnold
- Hammerley H (1991) *Fluency and accuracy: toward balance in language teaching and learning*, Clevedon: Multilingual Matters
- Hawkins E (1988) *Intensive language teaching and learning: initiatives at school level*, London: CILT
- Hawkins E and G Perren (eds) (1978) *Intensive language teaching in schools*, London: CILT
- Hedge T and N Whitney (1996) *Power, pedagogy and practice*, Oxford: Oxford University Press
- Helfrich H (1994) 'Bilingualer Unterricht in Europa: eine Bestandaufnahme' in *Triangle* 13 (ed)
- Hellekjaer G (1995) 'Developing reading skills in the bilingual classroom: a pilot project' in Thürmann (ed)
- Hinkel E (1997) 'Indirectness in L1 and L2 academic writing' in *Journal of Pragmatics* 27: 361–386
- Hutchinson T and A Waters (1987) *English for specific purposes: a learning centred approach*, Cambridge: Cambridge University Press
- James C (1995) Progress Report in Thürmann (ed)
- Kelliny W (1988) *Language communicative needs: two case studies*, Bern: Peter Lang
- Kramsch C (1991) 'Culture in language learning: a view from the United States' in de Bot, Ginsberg and Kramsch (eds)
- Krechel H-L (1994) 'Inhaltsbezogene Spracharbeit im bilingualen Sachfach Erdkunde' in *Triangle* 13 (ed)
- Kress G and P Knapp (1992) 'Genre in a social theory of language' in *English in Education* 26:2: 4–15
- Lemberger (1994) *Durch die Vergangenheit zur Gegenwart, 2, Geschichte und Sozialkunde*, Vienna: Österreichischer Agrarverlag
- Lenochova A (1995) 'Skills for the bilingual classroom' in Thürmann (ed)
- McLaughlin B (1987) *Theories of second language learning*, London: Arnold
- Mitchell R, B Parkinson and R Johnstone (1981) *The foreign language classroom: an observational study*, Stirling Education Monographs 9, Stirling: University of Stirling Press
- Mole J (1990) *Mind your manners: culture clash in the European single market*, London: Industrial Society
- Morgan C (1998) 'Crosscultural encounter' in Byram and Fleming (eds)
- Morgan C and A Cain (forthcoming) *Foreign language and culture learning from a dialogic perspective*, Clevedon: Multilingual Matters
- Morgan C and S Simpson (1995) 'Analysis of history: identifying bilingual classroom study skills, language processing skills, their mutual relationship and how to promote the required skills in the classroom' in Thürmann (ed)
- Nordmann J (1994) 'Enseigner la physique et la chimie en anglais dans un lycée français' in *Triangle* 13 (ed)
- Perera K (1986) 'Some linguistic difficulties in school textbooks' in Gillham (ed)
- Poole B and T Roberts (1995) 'Primary school and foreign language teaching: some unanswered questions' in *Languages Forum* 1:4: 2–5
- Pütz M (ed) (1994) *Language contact, language conflict*, Amsterdam: John Benjamin

- Robinson P (1991) *ESP today: a practitioner's guide*, New York: Prentice Hall
- Räsänen A (1995) 'Profile of teacher qualifications required for bilingual education programmes' in Thürmann (ed)
- Sauer F (1994) '*L'enseignement de l'histoire et de la géographie en section bilingue franco-allemande dans le Land de Rhénanie-Palatinat*' in *Triangle 13* (ed)
- Schausberger, Oberlander, Possing, Strotska and Walzl (1986) *Wie? Woher? Warum?: Geschichte und Sozialkunde 2. Klasse*, Vienna: Österreichischer Bundesverlag
- Scheipl, J., Scherthauer, E., Tscherne, W. and Wehl, G. (1979) *Geschichte und Sozialkunde 2: Arbeitsbuch für die 2. Klasse der Hauptschulen* Vienna: Hirt and Ueberreuter
- Skehan P (1989) *Individual differences in second-language learning*, London: Arnold
- Snow M, M Met and F Genesee (1989) 'A conceptual framework for the integration of language and content in Second /Foreign Language instruction' in *TESOL Quarterly* 23:2: 201–217
- Stables A and F Wikeley (forthcoming) 'From bad to worse? Pupils' attitudes to modern foreign languages at ages 14 and 15' in *Language Learning Journal*
- Sunderland J (ed) (1994) *Exploring gender: questions and implications for English language education*, London: Prentice Hall
- Swain M (1985) 'Communicative competence: some roles of comprehensible input and comprehensible output in its development' in Gass and Madden (eds)
- Swales J (1990) *Genre analysis: English in academic and research settings*, Cambridge: Cambridge University Press
- Thürmann, E. (ed) (1995) *Second Progress Report: Bilingual Education and Secondary Schools: Learning and Teaching Non- Language Subjects through a Foreign Language, Workshop 12 A* Strasbourg: Council of Europe
- Thürmann E and H Helfrich (eds) (1993) *Report of Workshop 12A: bilingual education in secondary schools: learning and teaching non-language subjects through a foreign language*, Strasbourg: Council of Europe
- Triangle 13* (ed) *Subject learning and teaching in a foreign language*, British Council, ENS Credif and Goethe Institut, Paris: Didier Erudition
- Valero-Garces C (1995) 'Contrastive ESP rhetoric: metatext in Spanish-English economics texts' in *English for Specific Purposes* 15:4: 279–294
- Wertsch J (1991) *Voices of the mind: a sociocultural approach to mediated action*, London: Harvester Wheatsheaf
- Wierzbicka A (1991a) *Cross-cultural pragmatics: the semantics of human interaction*, Berlin: Mouton
- Wierzbicka A (1991b) 'Japanese key words and core cultural values' in *Language in Society* 20: 333–385
- Wierzbicka A (1992) *Semantics, culture and cognition: universal human concepts in culture-specific configurations*, New York: Oxford University Press
- Wierzbicka A (1994) "'Cultural scripts": a new approach to the study of cross-cultural communication' in Pütz (ed)
- Wildhage M (1994) '*Materialienentwicklung für den bilingualen deutsch-englischen Unterricht in Geschichte: Gedanken zur Integration des sachfachlichen und fremdsprachlichen Lernens*' in *Triangle 13* (ed)
- Wishart E (1986) 'Reading and understanding history textbooks' in Gillham (ed)
- Wolff D (1995) 'The learner' in Thürmann (ed)

Supporting students in content and language integrated learning contexts: planning for effective classrooms

Do Coyle | University of Nottingham

A language is a system which relates what is being talked about (content) and the means used to talk about it (expression). Linguistic content is inseparable from linguistic expression. In subject matter learning we overlook the role of language as a medium of learning. In language learning we overlook the fact that content is being communicated. (Mohan, 1986: 1)

The aim of this paper is to explore some of the core principles upon which effective teaching and learning in content classrooms¹ might be based. It is an attempt to try to draw together experiences from a variety of contexts, in the hope that continued professional debate, discussion and curriculum innovation will lead us towards articulating our principles, our practice, and our methodologies, built on a deeper understanding of how to create supportive and motivating learning environments.

The paper identifies three elements for consideration and exploration when planning Content and Language Integrated Learning.² Firstly, the importance of working from clearly defined guiding principles will be discussed. Secondly, an approach to teaching strategies will be explored, followed by a brief overview of the role of learning strategies in the CLIL classroom. Finally, an example planning guide is provided to illustrate some of the issues raised.

Professional dialogue: initial stages in planning

Guiding principles

There has been a recent shift in emphasis from concentrating on teaching first and foremost to considering how learners might learn and under which conditions. This has been in the foreground of learning theory in general, and second language acquisition in particular. Following the old adage that there is nothing so theoretical

-
- 1 Content classrooms refer to those instances where a non-linguistic subject such as geography or history is taught through the medium of a foreign language.
 - 2 CLIL is a current term used to define Content and Language Integrated Learning classrooms.

as good practice and nothing so practical as good theory, then it is clear that an initial stage in organising effective environments must begin by what I would term 'professional dialogue' – pedagogical discussions among practitioners. This serves to highlight a set of guiding principles about learning, which will provide a steer for how that learning might be organised. Moreover, this discussion need not be limited to teachers; learners themselves may have a contribution to make.

In the *Council of Europe Report 12A 1993*, Otten, quoting from Hutchinson and Walker (1987), recommends that:

Content specific methodology would have to focus on the learner, making language and content learning explicit and transparent, defining subject-specific skills and thus enabling the learners to bridge the gap between the learners' conceptual and cognitive capacities and the learners' linguistic level. (Otten 1993)

Working towards 'transparent' definitions involves an articulation of approaches to learning which unites both language learning and content learning. This integration emphasises language as a medium of learning, as well as acknowledging the role of context in communication. Such approaches also imply developing methodologies, teaching styles and strategies which are 'neither in the traditional repertoires of foreign language teachers nor in the repertoires of non-language subject teaching' (Helfrich 1993).

A consideration of some of the work which has already been carried out in related but different contexts, especially in the field of Canadian immersion and second language acquisition, is useful as a starting point to professional discussion. While extensive research has already been published, it may be that we are in danger of dismissing some of the findings as being irrelevant to a European context. It is clear that there is no one definitive theory upon which we can base our methodologies, but examining a range of findings at the macro level might help draw out and clarify, in our collective minds, a set of guiding principles relevant to the micro level of our own classrooms and our own learners.

47

Cognitive processing and content learning

Mohan (1986), for example, working within the Canadian context, suggests a 'knowledge framework' as a means of organising the curriculum. This focuses on improving communication of the subject matter and developing strategies for using both language skills and thinking skills. Central to this model is the notion that 'activity' or 'activities' must be so planned so as to position the learners' background knowledge within classroom tasks, and provide a clear pathway through the development of the three basic, interrelated elements of the curriculum: communication, thinking and language.

He proposes as a logical *point de départ*:

- that subject matter (content) is related to thinking processes;
- then thinking processes are analysed for their linguistic requirements.

Thinking skills are identified as follows:

Structures of knowledge

Thinking processes

Structures of knowledge	Thinking processes
 classification	classifying, defining, using operational definitions, understanding, applying or developing concepts, definitions or classifications
principles	explaining and predicting, interpreting data and drawing conclusions, formulating, testing, establishing hypotheses, understanding, applying or developing generalisations (causes, effects, means, ends, motives, norms, strategies, methods, techniques, impacts, influences, responses, results)
evaluation	evaluating, ranking, appreciating, judging, criticising, expressing, justifying preferences and personal opinions, understanding, analysing and deciding on goals, values, policies and evaluation criteria

(Mohan 1986)

48

Might an analysis such as this of the **content** knowledge, skills and understanding, assist us in analysing the kind of **language** knowledge, skills and understanding our learners will need in order to function effectively?

Fundamental to Mohan's model, however, is a distinction between experiential and expository learning. Based on the principle that effective teaching brings about transitions between the two, he emphasises the importance of the teacher's skill in organising and managing the transition from experiential learning (language in context, language in action, where non-verbal comprehension plays an important role) to expository learning (more abstract language, decontextualised discourse, where much is conveyed through language alone).

In order for the development of content learning to be co-ordinated with the development of language learning, Mohan calls for explicit long-term and short-term planning and sequencing for linguistic progression (from language in use to abstract discourse); content progression (from practical activities to abstract ones, involving a range of thinking skills); and learning progression (from the experiential to the expository).

Matrices and models: the role of language and cognition in task planning

In a recent publication (Smith and Paterson 1998), emphasis is placed on the importance of the learners' 'diet' and the need to incorporate cognitively demanding tasks at all levels. While this publication is based on work in EAL or ESL classrooms in the UK, i.e. English as an Alternative Language or English as a Second Language, nonetheless we share many of the same basic learning principles:

Research has shown that cognitively undemanding work, such as copying or repetition, especially when there is little or no context to support it, does not enhance language learning and can seriously disadvantage bilingual pupils by denying them full access to the curriculum. By actively involving pupils in intellectually demanding work, the teacher is creating a genuine need for pupils to acquire the appropriate language. (Smith and Paterson 1998: 1)

Cummins (1984) in his seminal work on bilingualism, distinguished between two different types of communication: BICS and CALP. BICS constitute basic interpersonal communication skills which a learner needs in order to function in a daily interpersonal context, usually in face-to-face communication with lots of non-verbal cues. CALP is to do with acquiring cognitive academic learning proficiency, where a learner is able to manipulate or reflect on the surface features of language outside the immediate environment, typically in an academic context. Such a setting makes major cognitive demands on the learner, usually in the absence of paralinguistic and situational cues. The division is a useful one, since it allows teachers to consider the appropriateness and the contextual significance of different tasks they are planning for their learners.

However, acknowledging that this distinction was too simplistic, Cummins and Swain (1986) went on to develop a model plotting two intersecting continua – context-embedded and context-reduced tasks against those which are cognitively demanding and undemanding. Using the Cummin’s matrix as a possible model for raising teacher awareness of the relationship between task level and context provides a useful practical basis from which to audit classroom practice. In this model, Cummins argues powerfully against the reduction of meaningful context which results when tasks are broken down into isolated parts. He believes that if tasks are contextualised and language is supported, then learners will have access to cognitively demanding work and thus challenge their thinking as well as their linguistic skills: a case of amplify not simplify!

49

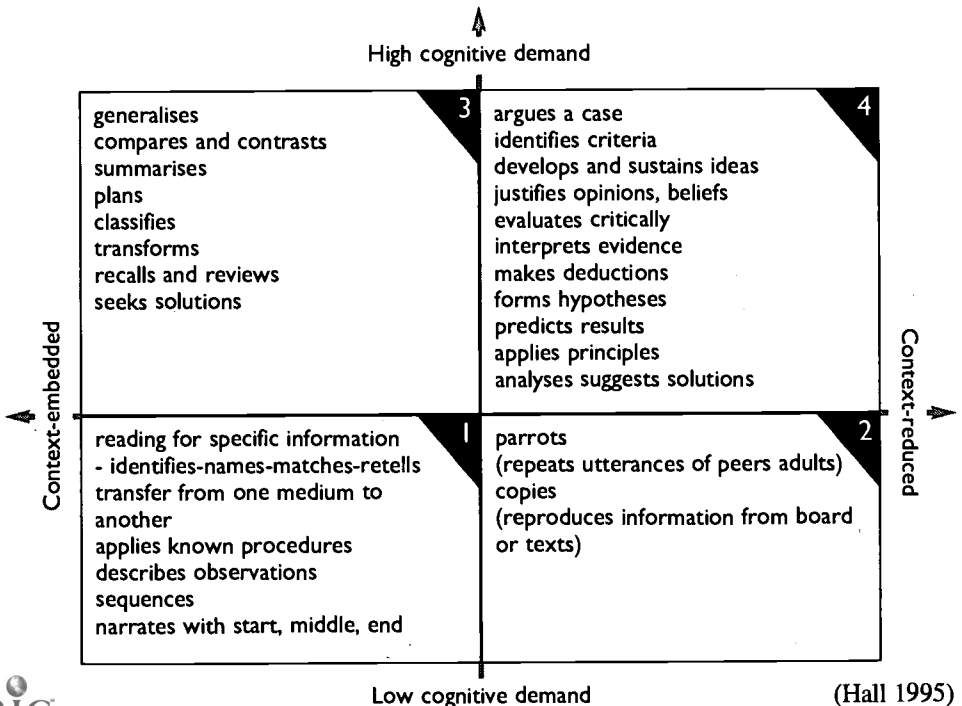

There are now several interpretations of Cummins' original model. O'Malley (1988) developed these ideas further and usefully identified different curricular skills placed in each quadrant, including the context-reduced and cognitively undemanding, such as filling in forms, language drills, predictable telephone conversations, and so on. However, when applying this model to learning in the content classroom rather than the bilingual classroom, it is clearly desirable to move from quadrants 1 to 3 and eventually to 4 so that higher level cognitive functioning is developed alongside language proficiency.

Hall positions BICS in quadrants 1 and 3, and CALP in quadrant 4. However, he warns against activities which could fall into quadrant 2, which he calls 'undesirable territory': 'if tasks are both undemanding and abstract they are undesirable in the classroom. What is their learning potential?' (Hall 1995: 56)

In addition, Smith and Paterson underline the importance of activities which take place in quadrant 3 since for them 'this ensures that pupils have increasing demands made on them which are accessible through concrete and contextualised content and processes' (1998: 3).

The issue for me, however, is that as teachers we are aware of the nature and consequences of the tasks we are requiring our learners to do. Starting with an empty matrix on which to position different tasks may be one way of encouraging teaching teams to work towards common, tangible but articulated goals. Alternatively, analysing activities and tasks carried out by the learners over a given period of time, may well be useful as a measure of interplay between cognition and content in the classroom.

With trainee teachers during the CLIL elements of their initial training programme at the University of Nottingham, we have taken Cummin's idea of a matrix, but adapted it by plotting cognitive demands against linguistic demands during task planning. For trainees, the challenge is to create cognitively demanding tasks, yet using less demanding language – especially in the early stages of bilingual learning.

Thus:

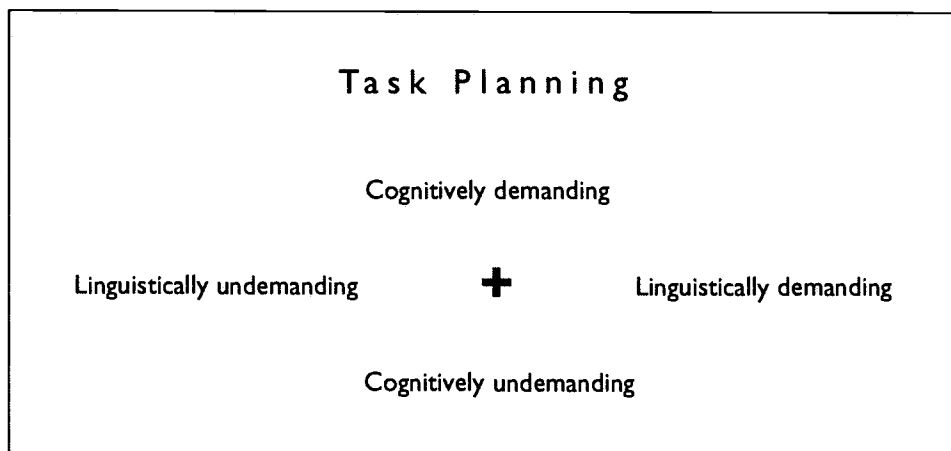

Learning through communicating in the content classroom

Without wishing to enter into the debate regarding interpretations of Krashen's (1981) familiar language learning and acquisition theories, which emphasise the importance of comprehensible input, it is clear that content teaching is about much more than making the subject matter comprehensible. In Krueger and Ryan's (1993) terms, learning about language may be 'incidental' to second-language medium learning but it is certainly not 'coincidental'. No matter how we analyse or divide up the content for teaching and learning purposes, we have to consider the interrelationship between content progression and linguistic demands as fundamental to learning. In this way input must be made **participatory** not just comprehensible.

It is about teachers adapting and modifying their approach in the light of their learners' linguistic ability and subject knowledge; and it is about teachers employing methods and materials with particular linguistic-pedagogic goals in mind. (Klapper 1996: 67)

Thus an integrative approach, inherent in CLIL, demands that content-based teaching and learning is also about language pedagogy.

Interestingly, within the Canadian immersion context, research studies into classroom practice such as those of Swain and Lapkin (1986), Lyster (1987), Lapkin et al (1990) and Snow (1990), reveal that while teacher input is generally abundant, learner output is often minimal, with few instances of learner-centred approaches and opportunities for learner interaction.

Content classrooms present a high proportion of teacher talk, and the opportunities for student response are limited and highly controlled. If teachers can provide more opportunities for exploratory talk and writing, students would have the chance to think through material and make it their own. (Mohan 1986: 13)

Similarly, in Swain and Lapkin's 1986 study, based on nineteen immersion classes, 81% of all pupils utterances were found to be no longer than one word, phrase or clause. Van Lier (1996) also underlines the fact that in content classrooms where little or no thought has been given to the design and sequence of tasks, the teaching is likely to follow a 'transmission model' which concentrates on one-way transfer of knowledge, and what he terms 'IRF communication': Initiation, Response, Feedback, i.e. the teacher asks a question, the learner responds to demonstrate the knowledge already acquired, followed by a teacher evaluation of that response.

Studies such as these are cause for concern, especially in the light of current views which emphasise the crucial role of interaction in the learning process. Yet is this still the case more than ten years on?

Wong-Fillmore's important work in 1985 clearly demonstrated that communication is at the heart of successful classrooms, i.e. where language is used by both learners and teachers to communicate subject matter. Subsequently, there has been an increased focus on the role of learner interaction in both content and second language acquisition fora.

Since communication positions the locus of learning, then it is a useful reminder to revisit some key communicative principles. Johnstone (1989) and Littlewood (1981) underline the crucial nature of the following:

- tasks which involve **real** communication promote learning;
- activities in which language is used for carrying out meaningful tasks promote learning;
- language that is meaningful to the learner supports the learning process.

However, it is the very notion of what constitutes **real communication** which is open to interpretation. In Donato's (1996) harsh words do we 'educate learners towards communicative incompetence rather than competence', due to the paucity of social interaction in classroom?

According to van Lier (1996), social interaction defines a classroom where learning is a joint activity in which teachers and learners work interdependently, where there is an emphasis on negotiating meaning, learning how to learn and where the learning process is as important as learning outcomes. Such a description is in sharp contrast to the classroom where the teacher's role is to provide input, and the learner's role is to provide output as proof that learning has taken place. Van Lier argues that it is the linear cause-effect view, the container input-output metaphor for language processing, which needs rethinking to include a more complex view of the classroom, where input becomes **access**, negotiation becomes **engagement** and the metaphor focuses on mutually developing, 'ecologically designed' relationships.

52

In other words, if quality learning is to take place, then the learner must be engaged with and in the process. There must be also be sufficient means of access to a variety of tasks to activate cognitive processes, thereby creating a link between interaction and cognition, and enabling the socio-cognitive processing cycle to become activated.

Thus it may be that we need to take a much wider view of classroom communication to ensure that the learning process not only provides opportunities for social interaction, but also systematically empowers learners to acquire the language they will need to do so effectively. This will entail a critical analysis of the teaching and learning activities, and their inherent linguistic demands, which we offer our learners.

Prabhu's (1987) work, for example, emphasised the importance of encouraging learner communication through meaning-focused tasks involving reasoning or thinking processes.

He engaged his learners, not only in information-gap, but also in reasoning gap and opinion gap tasks.

Reasoning brings about a more sustained preoccupation with meaning than information transfer does on its own, since it involves deriving one piece of information from another (working things out in the mind) not just encoding or decoding given information ... the interaction resulting from this is a public, dialogic expression of the working out which learners have found difficult to do on their own which, as a result, they are likely to be able to do more independently in a subsequent task. (Prabhu 1987: 48)

In addition, the contribution which cultural awareness can potentially make is fundamental to developing in learners a deeper understanding of different perceptions and interpretations of the world. The CLIL classroom is uniquely placed to offer opportunities to develop this understanding in two ways: by making implicit links between language and culture explicit, and by articulating alternative interpretations of content rooted in different cultures.

The four Cs

During the first part of this paper, I have tried to highlight the importance of professional dialogue, which will result in practitioners articulating their aims and objectives, and the principles upon which the achievement of these will be based. While we know that there are no 'right' answers, we also know that practice based on defined explicit principles will encourage both teachers and learners to have a sense of co-constructing and evaluating a meaningful learning environment.

The guiding principles which have emerged in this paper, based on a selection of research and case studies in the field of bilingual education in its broadest sense, focus on a complex interrelationship between the **four Cs – content, cognition, communication and cultural awareness**. Fundamentally, I would suggest that it is through **progression** in the knowledge, skills and understanding of the content, by **engagement** in associated cognitive processing, **interaction** in the communicative context, and a deepening awareness and positioning of cultural self and otherness, that learning takes place.

CONTENT — PROGRESSION

COGNITION — ENGAGEMENT

COMMUNICATION — INTERACTION

CULTURE — AWARENESS

Planning to teach strategically

Teaching strategies: scaffolding learning

In the second section of the paper, I should like to consider the development of teaching strategies which could contribute to 'scaffolding' or supporting student learning. The term scaffolding was first coined by Bruner (1983) and refers to the provision of a temporary, adjustable support that is provided by a teacher to assist students in developing and extending their skills. As questioning and other learning skills develop and begin to facilitate learning, the scaffolding is gradually removed. Pedagogical scaffolding, therefore, is a 'multi-layered teaching strategy consisting of episodes, sequences of actions and interactions which are partly planned and partly improvised' (van Lier 1996: 199).

At any level, the focus of scaffolding is on the understanding and monitoring of what is difficult and easy for individual students. It also gives the teacher 'a sense of

direction and continuity, a local plan of action, and moment-to-moment interactional decision-making' (Van Lier 1996: 199). Such strategies clearly focus on process rather than product. Scaffolding requires planning in terms of what the teacher might do to facilitate opportunities for learning in four elements of the curriculum. For example:

- | | |
|----------------------|--|
| communication | <ul style="list-style-type: none"> • linguistic forms and functions of the language needed by learners; • development of communication skills, including discourse strategies; • three Ms, i.e. meeting new language, manipulating it and then making it 'my own'; • coping with the unexpected; |
| content | <ul style="list-style-type: none"> • coherence; • progression; |
| cognition | <ul style="list-style-type: none"> • development of tasks related to thinking skills; • construction, sequencing and evaluation of learner tasks; |
| culture | <ul style="list-style-type: none"> • developing a sense of otherness; • contrasting different perceptions of events rooted in different cultures. |

54 At the concrete planning stage, the teacher will be involved in considering the development of those skills which underlie the domain-specific content being taught, for example, in sequencing tasks which range from the controlled to less controlled; in questioning techniques which lead the learners from using simple, supported language to more complex and open-ended discourse; in providing problem-solving opportunities with ever-decreasing in-built support mechanisms; or reasoning tasks embodying ever-increasing complexity. It also involves providing a context for talk which progresses from the structured to the less structured, from the predictable to the exploratory, from teacher-led to student-led, from classroom communication to classroom interaction.

For many researchers (Nunan 1990; Mohan 1986; Snow 1990 and van Lier 1996), this unity of planning is an essential pre-requisite for pedagogical scaffolding. It will also necessitate the teacher in planning which organisational strategies best suit the tasks: groups, individual, pairs and so on.

An illustration of pedagogical scaffolding – supporting writing

The use of language 'frames' provides one example among many of pedagogical scaffolding which supports student writing. Frames are essentially a means of representing written text. The basic structure of a frame consists of a skeleton outline to scaffold student non-fiction writing. These frames constitute a strategy to assist learners in using generic writing structures, for example, of recounting, reporting, explaining, arguing and discussing, until those structures have become assimilated into their writing repertoire.

Frames have been used extensively in pedagogical research in the UK (Lewis and Wray 1995), essentially in either the mother tongue classroom, or the bilingual one where students are using English as an additional language. However, they have the flexibility to be adapted for learners in a CLIL context, since the linguistic level and functional content can easily be adjusted, changed, re-ordered or created. Following a curriculum analysis such as the one outlined in the previous section, writing functions can be related to specific learning objectives based on content, cognitive processing and linguistic requirements. If the content requires learners to be able to discuss their geographical ideas about a new housing development, or report on a scientific experiment, then a teacher-generated frame will provide a means of supporting the language needed to successfully complete the tasks.

In other words, frames provide a structure which enables learners to concentrate as much on the content of what is being written as well as the form (Figures 1–4). At the same time, they provide learners with an opportunity to think about what has been learnt, by encouraging re-ordering of information to demonstrate understanding rather than just copying out written text. However, as with all other support strategies, their effectiveness will depend on how the teacher introduces and monitors their use, through overt discussion with learners and differentiated classroom techniques.

Example 1: Discussion

<p>Discussion</p> <p>The issue we are discussing is whether</p> <p>Make notes in the boxes below listing the arguments for and against (Remember notes are just brief outlines. They don't have to be in sentences)</p>
<p>Arguments for ...</p>
<p>Arguments against ...</p>
<p>My conclusion based on the evidence is ...</p>

Figure 1

<p>Discussion</p> <p><i>Features:</i></p> <ul style="list-style-type: none"> • start with an explanation of what you are going to discuss • present your arguments to support the topic • present your arguments against the topic • finish with your arguments at the end • use emotive words to stress your ideas
<p><i>Useful words and phrases:</i></p> <p>... because ...</p> <p>... therefore ...</p> <p>... consequently ...</p> <p>... however ...</p> <p>... it follows that ...</p> <p>The people who agree with this idea claim that ...</p> <p>They also argue that ...</p> <p>A further point they make is ...</p> <p>However there are strong arguments against this point of view ...</p> <p>I believe that ...</p> <p>Furthermore they claim that ...</p> <p>After considering different points of view, I think that ... because ...</p>

Figure 2

Example 2: Report writing

Report writing

What to do:

- write the names of the objects being compared and contrasted in boxes A and B below. For example A: sandstone, B: chalk
- list the characteristics being studied in the boxes on the left-hand column. For example hardness, crystals.
- use the grid to record information before writing the report

Characteristics	A	B

56

Figure 3

Report writing

Features:

- start the report with a statement which explains what the report is about
- present why you are writing the report: the objective
- it is usually written in the present tense and in the first person
- you might need to explain how you researched your information
- present your findings in order
- you might need to compare and contrast
- end your report with a conclusion or a summary of what you found out
- make recommendations if necessary

Useful words and phrases:

This report investigates ...
 The object of this report is to ...
 I was asked to ...
 I observed that ...
 I discovered that ...
 It is reasonable to conclude that ...
 I recommend that ...

Comparison: For example they both ...
 Another similarity is that ...
 They are also similar ...

Contrast: There is a distinct difference ...
 The main difference is that ...
 They do not share ...

Figure 4

Of course, frames are but one strategy for supporting writing. There are many others with which teachers are familiar: cloze/gap filling, grids/tick charts, sequencing, matching, underlining, vocabulary games, modelling, drafting and collaborative writing, to name but a few. In addition, there is a wealth of literature which discusses different teacher strategies for supporting comprehension, oral communication, reading and writing. It is not within the remit of this paper to make an exhaustive list of teaching strategies, but rather to illustrate the importance of the teacher’s role in carefully selecting, sequencing and experimenting with appropriate and varied strategies to support learner progression, and to prevent an ad hoc approach which allows potential learning episodes to remain untapped.

Teaching strategically – teaching styles re-visited

A teacher’s style or styles are directly related to the teaching strategies contained within. While it is incumbent upon teachers to be flexible and adaptable in their

approach as well as use a variety of teaching styles, it may be that there is a set of teaching strategies which are common to all. Snow (1990) identified a number of characteristics of effective strategies, ‘core instructional strategies’, for immersion programmes in Canada. Similarly, Räsänen (1993) in her Finnish study in the European context reports on ‘adjustments’ in teaching styles, which the teachers had identified. A comparison of the two may be a useful catalyst for discussion:

Instructional strategies (Snow)

- gesture, body language, linking the abstract to the concrete;
- predictability in routines to support student guessing or anticipating;
- exploiting students’ world knowledge – linking known with unknown;
- use of realia, visuals and hands-on concrete examples, increased use of visuals;
- frequent checks on comprehension;
- deliberate use of redundancy – paraphrase, repetition, synonymy – i.e. give learner cues;
- error correction through model responses;
- use of the unpredictable.

Adjustments in teaching styles (Räsänen)

- increasingly adapting a more interactive approach;
- systematic presentation;
- concentration of key ideas – paraphrasing;
- increased use of visual aids, realia;
- exploitation of vocabulary lists;
- clear pronunciation – perhaps a slower pace?
- explicit teaching of language related skills, e.g. reading comprehension, use of dictionaries;
- increase use of study skills;
- a change in assessment procedures to reflect progression and sequencing;
- teacher input, teacher talk.

It would be of benefit for teachers working in CLIL classrooms to observe each other, to try to identify elements of individual teaching styles which can be developed, adapted and shared. Moreover, in Mohan’s (1986) words, if there is to be a transition between experiential learning to expository learning, this will have implications for teaching styles and the management of the sequencing of tasks. If, for example, a teacher is aiming at developing interactional strategies, the way in which input is organised will have an effect on whether or not learners learn to respond by answering or reacting, or whether they learn to interact with the issues inherent in the tasks.

Planning to develop learner strategies

Learning how to learn

One possible definition of learning strategies is as follows: ‘thoughts and behaviours students use to comprehend, store and remember new information and skills’ (Chamot and Kupper 1989).

Learning strategies have been at the forefront of classroom research in recent years, since the notion of learning how to learn, or metacognitive processing, is linked with learner autonomy and independence. In Räsänen's 1993 study, the teachers reported an increased need for the development of study skills by their students. There is an ever-growing and extensive body of literature available on learning strategies, which ranges from taxonomies and lists, to materials for developing strategic competence and recommendations for classroom practice. Yet there is no consensus within the profession as to what exactly is meant by learning strategies or how the development of metacognitive strategies should be approached. Neither is it my intention to enter into a discussion about possible definitions, whether or not learning strategies can or should be taught, the transferability of strategic skills, or the role of mother tongue in metacognition and so on.

The crucial point for me is this: that as teachers we must try to make the learning process as effective as possible. If it seems that our learners will benefit from explicit training, for example, in using dictionaries, tackling a difficult reading text, making sense of authentic source documents, extending vocabulary and taking action when comprehension breaks down, then this needs to be planned for in relation to our specific programmes and their individual content, cognitive and communicative tasks. Moreover, it is through overt and explicit discussion with and by learners and teachers alike as to the nature of individual learning, that together a collaborative working environment can be established; meaning can be negotiated and learning co-constructed.

58

Chesterfield and Chesterfield (1985) make a case for regarding strategies as developmental, distinguishing between a basic and more advanced classification of skills. At one end of the continuum, learning strategies are accessible to learners in organising the surface elements of their learning. A typical example being the self-help books used in the Ashfield Science Project (Coyle 1994). In this instance, thirteen-year-old learners following their science curriculum in French were given learning strategy booklets to encourage them to think about the way they learnt, and how they might develop alternative learning strategies. The booklets included quizzes and hints about how to work out meanings, practising using contextual clues for guessing, using cognate and near cognates to make sense, underlining known words or unknown words, dictionary skills, individualised cassettes tapes, how to remember new words and so on.

Similarly at a basic level, Vee Harris in her *CLT Pathfinder 31: Teaching learners how to learn* (1997) presents a range of practical suggestions for learner training in listening, speaking, reading, writing and study skills.

However, further along the continuum, more advanced metacognitive strategies include higher order skills such as interaction and reflection. In Grenfell and Harris's (1998) research, for example, monitoring, inferencing and elaborating were identified as advanced learning strategies used by their learners. They conclude that a cognitive information processing model of learning was the closest to the practice they observed and, in fact, prefer the term 'learner strategy' to 'express the learner engaging with a second language as problematic process. Such strategies are not repair strategies or study skills but immanent in engaging in and through a second language' (1998: 27).

In other words, if we are to create an environment where interaction and engagement are essential for quality learning to take place, we shall have to include the development of strategic behaviours into our teaching and learning repertoire. This will involve teachers in an in-depth exploration of the skills needed, not only to know how to operate at a surface level, but also to know how to interact, how to initiate and engage in exploratory conversations, how to tackle problem-solving tasks and how to negotiate meaning – otherwise we simply pay lip-service to what becomes yet another pedagogical fashion.

Practical ways forward

In this paper, I have identified four elements or components of the curriculum which if linked during the planning process, have the potential to make a difference to what goes on in our classrooms. These are:

- **communication** – based on interaction rather than reaction;
- **content** – based on progression;
- **cognition** – based on engaging or challenging the learner by developing thinking skills;
- **culture** – based on opportunities for deepening and articulating an explicit awareness.

The developmental process of defining guiding principles has also been underlined, to enable practitioners to take control of the teaching process in such a way that a more transparent and explicit link will be formed to the learning process. Ashman (1997) provides a useful example when he talks of developing learning principles which plot a development:

- from students receiving knowledge to students **constructing** knowledge;
- from teacher or text as the authority to students **creating** meaning;
- from teachers imparting knowledge to teachers **encouraging** thinking;
- from learning should be fun to learning should be **challenging**;
- from thinking develops naturally to teachers can **facilitate** thinking.

(Adapted from Ashman and Conway 1997)

I have also made a case for teachers supporting student learning through exploring a wide range of teaching and learning strategies. Here, the focus is on enabling and empowering learners to interact meaningfully and spontaneously in the classroom, to become engaged with and challenged by their own learning, as well as progressing through the content by developing appropriate knowledge, skills and understanding relevant to the curriculum. To achieve this may require a radical review of how we organise the learning environment, how we plan, monitor and evaluate the learning process (Figure 5), and how we perceive and define our role as CLIL teachers.

There is nothing which is prescriptive in this paper – a ‘must do’ approach is in fact alien to a negotiated environment. Ultimately, what really matters are the key players in the process – how they interrelate, interact and engage collaboratively with the business of co-constructing the learning environment. In the words of Baetens Beardsmore (1998): ‘Bilingual education is about getting education not about becoming bilingual’.

Stage One Guiding principles	<ol style="list-style-type: none"> 1 Define CLIL context 2 Revisit the aims and objectives of teaching programme 3 Define guiding principles for learning 4 Discuss these with other colleagues
Stage Two Analysing the teaching curriculum	<ol style="list-style-type: none"> 1 Carry out curriculum subject audit, i.e. identify the content knowledge, skills and understanding to be taught 2 Carry out a thinking skills or cognitive processing analysis, i.e. relate the content defined in 1 to thinking skills 3 Identify the linguistic elements needed to carry out 1 and 2 4 Create a schema or wall chart to show the interrelationship and interconnectedness of 1, 2, 3
Stage Three Preparing the learning environment	Detailed planning: long, medium and short term <ol style="list-style-type: none"> 1 Use schema to define tasks 2 Identify appropriate related teaching strategies – how to support learners 3 Identify appropriate related learning strategies – how learners can learn to support their own learning 4 Use Cummins matrix or similar to plot different elements such as four Cs (content, cognition, curriculum and culture) or linguistic and cultural awareness, progression and thinking skills. 5 Ensure teaching and learning objectives are clear and achievable, and that tasks are sequenced to build in progression such as: by the end of the year/term/week/series of lessons, I want my learners to ... 6 Prepare appropriate materials – special attention to those incorporating learning strategies and pedagogical scaffolding
Stage Four Monitoring for progression	Monitoring the programme <ol style="list-style-type: none"> 1 Collaboration with other teachers, e.g. observing each others' lesson and analysing according to negotiated criteria, e.g. record and transcribe sections of lessons to compare what is going on with what has been planned 2 Collaboration with learners, e.g. make learning aims explicit, explore use of learner talk, learner diaries 3 Use assessment procedures which relate to process rather than outcomes 4 Check sequencing of tasks
Stage Five Evaluating for effectiveness	Evaluation of teaching and learning process Relate this to schema Involve learners: relate to explicit learning aims Revise or adjust the schema and set new targets

(Extract from materials used by trainee teachers on the BILD¹ PGCE² programme, University of Nottingham.)

Figure 5 | Planning the CLIL curriculum

- 1 BILD – a term similar to CLIL which defines Bilingual Integration of Languages and Disciplines – see note 2. It is also the name given to a Socrates-funded project for training BILD teacher trainers. The project involves the University of Nottingham, UK, the University of Wuppertal, Germany and the IUFM d'Alsace in Strasbourg, France.
- 2 PGCE is the Post Graduate Certificate in Education Programme which is a year-long initial teacher education course leading to qualified teacher status in the UK.

References

- Ashman A and R Conway (1997) *An introduction to cognitive education: theory and applications*, New York: Routledge
- Baetens Beardsmore H (1998) Remarks made at the October CEILINK conference, Strasbourg
- Brinton D, M Snow and M Wesche (1989) *Content-based second language instruction*, New York: Newbury Press
- Bruner J S (1975) 'Language as an instrument of thought' in Davies A (ed) *Problems of language and learning*, London: Heineman
- Bruner J S (1983) *Child's talk: learning to use language*, New York: Norton
- Chamot A U and L Kupper (1989) 'Learning strategies in foreign language instruction'. in *Foreign Language Annals* 22: 13–24
- Chesterfield R and K B Chesterfield (1985) 'Natural order in children's use of second language acquisition strategies' in *Applied Linguistics* 6:1
- Coyle D (1994) 'Science in French in the National Curriculum: a pilot study' in Budd R, P Chaux, C O'Neil, D Arnsdorf and U Gaber (eds) 'Subject learning and teaching in a foreign language' in *Triangle 13*, Paris: Didier Erudition
- Cummins J (1984) *Bilingualism and social education: issues in assessment and pedagogy*, Clevedon: Multilingual Matters
- Cummins J and M Swain (1986) *Bilingualism in education: theory, research and policy*, London: Longman
- Donato R (1996) Paper delivered at the AILA conference, Jyväskylä, Finland
- Grenfell M and V Harris (1998) 'Learner strategies and the A level student' in *Language Learning Journal* 17: 23–28
- Hall D (1995): *Assessing the needs of bilingual pupils: living in two languages*, London: David Fulton Publishers
- Harris V (1996) *Pathfinder 31: Teaching learners how to learn*, London: CILT
- Helfrich H (1993) *Council of Europe: language learning for European citizenship*, Report 12A, Strasbourg: Council of Europe
- Johnstone R (1989) *Communicative interaction: a guide for teachers*, London: CILT
- Klapper J (1996). *Foreign-language learning through immersion : Germany's bilingual- wing schools*, Wales: Edwin Mellen Press
- Krashen S D (1981) *Second language acquisition and second language learning*, New York: Pergamon Press
- Krashen S D (1982) *Principles and practice in second language acquisition*, New York: Pergamon Press
- Kreuger M and F Ryan (eds) (1993) *Language and content: discipline and content-based approaches to language study*, MA: Lexington, DC Heath
- Lapkin S M and M Swain, with S Shapson (1990): French Immersion Research Agenda for the 90s. *Canadian Modern Languages Review* 46: 638–74
- Lewis M and D Wray (1995) *Developing children's non-fiction writing*, Leamington Spa: Scholastic
- Littlewood W (1981) *Communicative language teaching*, Cambridge: Cambridge University Press
- Lyster R (1987) 'Speaking immersion' in *Canadian Modern Languages Review* 43: 701–717
- Mohan B (1986). *Language and content*, Reading, MA: Addison-Wesley

- Nunan D (1990) *Understanding language classrooms: a guide for teacher initiated action*, New York: Prentice Hall
- Otten E (1993) *Council of Europe: language learning for European citizenship*, Report 12A, Strasbourg: Council of Europe
- O'Malley J M (1988) 'The cognitive academic language learning approach' in *Journal of Multilingual and Multicultural Development* 9: 43–60
- Prabhu N (1987): *Second language pedagogy*, Oxford: Oxford University Press
- Räsänen A (1993) 'Adjustments in teaching styles' in *Council of Europe: language learning for European citizenship*, Report 12A, Strasbourg: Council of Europe
- Smith J and F Paterson (1998) *Positively bilingual: classroom strategies to promote the achievement of bilingual learners*, Nottingham: Nottingham Education Authority
- Snow M (1987) *Immersion teacher handbook*, Los Angeles: University of California
- Snow M (1990) 'Instructional methodology in immersion foreign language education' in Padilla A, H Fairchild and C Valdez (eds) *Foreign language education: issues and strategies*, Newbury Park, CA: Sage Publications
- Swain M and S Lapkin (1982) *Evaluating bilingual education: a Canadian case study*, Clevedon: Multilingual Matters
- Swain M and S Lapkin (1986) 'Immersion French in secondary school: the "goods" and the "bads"' in *Contact* 5: 2–9
- Van Lier L (1996) *Interaction in the language curriculum: awareness, autonomy and authenticity*, New York: Longman Group Ltd
- Wong-Fillmore L (1985) 'When does teacher talk work as input?' in Gass S and C Madden (eds) *Input in second language acquisition*, New York: Newbury House

In-service education for teachers using English as a medium of instruction

Christa Piber | University of Klagenfurt

Introduction

English as a Means of Instruction (EMI) refers to the use of a foreign language (L2) as a language of instruction for teaching non-language subjects. In Austria, there are a number of forms of using EMI, varying by the duration of L2 instruction and choice of subject (see Heindler and Abuja 1996). This paper is the description of an in-service training (INSET) course, *Pedagogy and subject methodology for teachers using English as a medium of instruction* at the University of Klagenfurt. The underlying principles were first developed for an INSET course for teachers of English in 1982, and have been constantly revised since then. I will provide examples of a course in progress from one which started in the winter semester 1997/98 with 35 participants.

63

The course at Klagenfurt aims to offer teachers the possibilities to:

- reflect on and improve their methods of instruction by enhancing insight into the processes connected with EMI;
- develop greater flexibility in handling complex situations;
- promote and enhance teamwork with other colleagues who use EMI.

To achieve these, the course emphasises:

- exchange of experience and discussion of aims concerning EMI;
- organisational and administrative fundamentals of EMI;
- continuing education concerning specific aspects of the use of EMI (among others: materials, methodological issues, team teaching);
- quality assurance and curriculum development through action research.

In achieving these aims, the trend in the Austrian school system of improvement in foreign language skills will be supported, and a contribution be made to the enhancement of foreign language proficiency in a united Europe.

Foundations for INSET

Our approach to INSET is that teachers must accept responsibility for their professional development. They are not mere receivers of INSET but must be active

in shaping their INSET. From this approach we have developed a set of basic principles for our course that:

- INSET must start from the teachers' own practical work;
- it should build on their own professional knowledge and practical abilities;
- it must focus on the professional problems the participants consider important;
- the course directors are more often organisers than lecturers, counsellors rather than experts;
- to be able to change something, teachers must know what is going on in their classrooms. So, classroom experiences must be reflected on and lead to new action, and there should be a constant alternation of reflection and action;
- continuity and involvement over a longer period are necessary to help participants extend their responsibility and initiative gradually and step by step;
- co-operation and communication must exist among course directors, between the course directors and the participants and among the participants.

It is our aim to help teachers to reflect upon their everyday experiences, to pass on their experiences and to further develop their professionalism. Professionalism in teaching is characterised by three dimensions, which we try to take into account in our course:

- **reflection:** orientation towards and competence in (self-)critical work which systematically reflects one's own actions;
- **autonomy:** orientation towards and competence in self-initiating, self-determined, and self-organised work;
- **networking:** orientation towards and competence in communicative, co-operative work with increasingly public reference.

64

INSET for EMI

The course is organised by the Centre of Interdisciplinary Research and Development (IFF) of Austrian Universities in Klagenfurt. The course directors are an interdisciplinary team of six people:

- one pedagogue;
- two members of the English department of the University of Klagenfurt;
- three subject teachers (one is a full-time teacher in school, one works part-time at the Centre and one works at the Centre for School Development in Graz).

The course is open for teachers who are working with pupils aged between ten and nineteen and who already have some experience with EMI, or who have started with EMI in the school year of the course. The INSET participants need not have English as their second subject but must have a good command of English¹. Our participants come from different fields, and this interdisciplinarity helps to see the questions and topics in a wider context.

¹ In Austria, teachers have to be qualified in two subjects, i.e. a foreign language plus another subject.

In order to maximise the potential for professional development in the long term, the course runs over two years (four semesters) through a combination of contact and distance learning. The programme consists of three central seminars held in Klagenfurt and five regional group meetings. The content of the seminars depends to a great extent on the interests of the participants. The agenda for the regional group meetings, consisting of six to eight participants, is entirely set up by the participants. In these sessions they determine, with the support of the teaching team, contents and topics they want to deal with at the seminars, which they would then organise themselves. The regional meetings have, among other functions which will be discussed later, the tasks of creating an atmosphere of trust, giving support, and practising communication. The distance-learning element of the course is based upon work which is done at their schools, and consists of cycles of observation, reflection and action.

On completion of the course the participants receive a certificate if they:

- attend the seminars;
- attend the regional groups;
- write a case study;
- write a second case study, develop material for EMI or do peer-teaching in the seminars.

Their individual activities (organising initiative groups, giving inputs in workshops) are listed on the certificate. Participants who do not meet the requirements are given a certificate of attendance. The fee per participant is AS 1000 per semester.

The course

The programme begins with a five-day seminar, during which the sharing of practical knowledge and experiences is a key element. The participants have to bring examples of their teaching to the first seminar. They are asked to describe one lesson on a poster and, if possible, also bring examples of the students' work resulting from that lesson.

From the outset, the participants are divided into groups according to the regions they come from. The reason for using geographical proximity as a criterion is that the further apart the participants are located, the more difficult it is to meet. Each group is guided by one team member. My own group consists of seven teachers. One is a mathematics and history teacher. Of the others, they are all English teachers, two have mathematics as their second subject, two geography, one has history and one biology.

On the first morning, the participants start in their regional groups, by putting up their posters in their regional-group rooms. There is time for looking at the 'exhibition' and then they are asked, in turns, to present their posters. An example of this session comes from a teacher in my group who had used EMI in her secondary school, second form mathematics lessons (pupils aged twelve to thirteen).

Her aims were to teach mathematical terms in English and German, and to give the pupils enough time for practising. She used two lessons for the repetition of basic

calculations and proceeded as follows: Pupil B dictates the calculation and pupil A writes this on the blackboard. Then pupil C dictates and B writes on the blackboard. Then pupil D dictates and C writes and so on. The next three lessons she taught fractions. She started in German with measures and weights (a quarter of a pound ...), and continued with telling the time (half an hour ...). She had asked the English language assistant at her school to record the terms on tape and prepared two sets of cards with the terms, one in English and one in German. She played the tape in class and the pupils had to find the correct card while listening to the recording. Then they had to match it with the corresponding German card. She also used another game with questions and answers about vocabulary and calculations. She introduced a fraction disc ($1/2$, $1/4$...), and prepared cards, the size of which corresponded to the figures. With these cards the pupils did additions and subtractions and had to say the results. The last game she prepared was a trimino with English and German terms which had to be matched. For homework the pupils did problem-solving calculations. She also asked the assistant to record problem solving calculations. While listening to them, the pupils had to write what they understood on prepared sheets and then do the calculations. The solution was given on the back of these sheets.

After the presentations there is time for questions. This discussion follows the rules of the analytic discourse that there are only questions, no suggestions and no criticism.

The participants asked questions like:

- Why have you started with EMI and how often do you use it?
- Which topics do you teach in English and how do you decide which to choose?
- What were your expectations about the outcome of this project?
- Where do you get your ideas for the exercises from?
- Do the pupils write in English in your history lessons?
- Did the children have any information about the lesson content in German before you started with it in English?
- How do you deal with new words in the text?
- What are the tests like?
- Did the pupils like it?
- What did they find difficult?
- What are the effects of such a project on the pupils' knowledge of English?
- Does the English teacher know about this?

After each presentation and question time, there is a feedback session in which the group discusses how each of them has experienced the procedure. From my group in this particular course, the conclusions of this session were that it was very interesting to hear something about the methodology of other subjects, and that it is reassuring that other teachers have similar problems. Also, from having shared experiences, the motivation to continue with EMI had increased.

The course team had anticipated some of the most burning questions that teachers using EMI will have. These were addressed in three workshops.

1 What are the criteria for the use of EMI?

For the first workshop we have devised a role play. The roles given to the participants pertained to a school which already had some experience with EMI, and which was asked for advice by another school intending to set up some kind of bilingual programme. The advice should contain information on the aims of the EMI programme, the age of pupils and the subjects used. The participants' roles included teachers, parents and pupils. Some of the roles allocated were supportive to EMI, but there were also some critical ones included.

The discussion for this year's group clearly showed that no clear agreement is possible. There was, however, agreement that it is most important to consider first your aims and your possibilities before starting any bilingual programme. Foremost among the aims was the wish to equip pupils with greater language competence and thus improve their employment potential. As to age group and subjects, this depends mainly on the resources available at the school and the type of school.

2 What are the criteria for the selection of topics for EMI?

For the second 'criteria workshop' we prepared 22 cards with criteria for the selection of topics, such as:

- the topic provides knowledge necessary for further topics;
- the topic represents basic knowledge in the subject;
- the topic introduces (practises) generally useful vocabulary;
- the topic is of interest for the learner;
- the topic area contains many different activities;
- the topic is listed in the curriculum.

The participants had to individually select those which were relevant for them, and add others which we had not mentioned. They then had to divide the remaining cards into two piles:

- (a) criteria generally important for EMI;
- (b) criteria important for them and their subject.

In groups they then had to decide upon the three most important criteria from pile (a) and pile (b), and prepare a presentation of their results on posters. The posters were presented and discussed. From pile (a) 'many different activities are possible', 'topic is of interest for the learner' and 'topic is listed in the curriculum' were chosen in most groups. From pile (b) 'suitable material is available', 'topic invites co-operation with other subjects' and 'topic represents basic knowledge in the subject' were selected in all groups.

3 What are the criteria for the selection of material for EMI?

In the last unit dealing with criteria, the participants looked at teaching materials they had brought along and discussed reasons for selecting them. After sharing their opinions they had to write a text 'Recommendations for the selection of teaching material'. 'Various activities should be possible', 'the material should be authentic'

and ‘the language level should be appropriate for the pupils’, were the three criteria which were considered as most important when selecting material.

Action research

A whole day was spent on introducing action research as the link between action and reflection. We want to help the participants to work on and improve their own situation at school and their way of teaching, respectively. Analysing situations, routines and issues in groups, and engaging seriously in the situations of other teachers, not only enhances the ability to judge and deal with certain situations at school in general and when teaching, but also enhances the quality of discussion about teaching and school. ‘Don’t cheat yourself or others’ is one of the most important principles when investigating one’s own work at school. Participants as well as INSET team members reflect on their own work during the course. The fact that both groups belong to different systems – school and research centres, or, if you like, theory and practice – offers manifold possibilities to learn from one another.

On the third day, the teachers observed an in-service lesson held by a team member. Some of the group acted as pupils, while the rest practised data-gathering methods such as interviewing, analysing questionnaires and working with the recording of the lecture. Each data collection method and its results was compared and discussed. The following morning, there was a lecture on action research, with theory and examples from a case study on EMI written by a team member. To consolidate the action research work, there followed group discussion options for subject specific groups.

In the afternoon the regional groups met again. The sessions were devoted to finding a topic for the case studies. It started with an exercise which should help the participants decide which aspect of their teaching they wanted to investigate. Such study areas included:

- Is EMI possible with weaker learners?
- How do pupils’ attitudes towards EMI compare before and after they have experienced it?
- What effect does EMI have on the pupils’ motivation in history lessons?
- Does the use of EMI influence the willingness to speak about certain topics?
- Can I motivate other colleagues to use EMI?

With formative areas for study explored, the teachers had then to decide both on their aims and strategies for collecting data, and formats for reporting the findings of their case studies. This was to be the practical work carried out at school. The final session of the seminar was for the regional groups to set the time and place for their meetings, and divide responsibilities for the organisation of the meetings.

From central seminar to regional meetings

The first regional group meeting allows for discussion of the work on their studies. It happens quite often that the topic of the case study changes in the course of the research.

In my group, one teacher planned to convince her colleagues that using EMI is worthwhile and developed strategies accordingly. As a first step she used a questionnaire to ask about her colleagues' interests and concerns about EMI. She found out that all were interested and none of them had any worries. So there was no need for her to convince her colleagues, and she is now proceeding with exploring the use of EMI with weaker pupils. This meeting also focuses on the progress of the reflective processes that the course promotes with discussion and review of reflective documents.

At the second and third regional group meeting, there is usually more time for practical work. This is one point where the principle of autonomy comes in. One of the basic ideas of the course is that the participants should be increasingly responsible for their own further education. My group decided to work on the use of visual aids and on the preparation of task sheets. For the third meeting, we planned to practise the use of CD-ROM and the Internet. There will also be some exercises to help them with the writing of their case studies.

They also make suggestions for various activities in the second seminar. Only for Monday and Friday are the contents set by the team. Sessions on presentation and discussion of the case studies and giving feedback to them as well as a lecture on 'language acquisition' are planned by us for Monday. On Friday the regional groups meet again in which they plan their next meetings and there is an evaluation. In groups of three, the participants interview one another alternatively (this is practising making interviewing at the same time), in order to give a short report on their results in the final plenary session.

According to the participants' suggestions, the rest of the second seminar will look like this:

On Tuesday there are parallel workshops held by us, the team. They will deal with 'task-based learning', 'vocabulary and texts', and 'self-directed learning'. On Wednesday there will be a visit to LISA, a school with a bilingual stream in the nearby city of Linz. On Wednesday afternoon there is a unit 'initiative groups'. These are small working groups which are organised by the participants, who decide upon the topics and are responsible for the structure and procedure. Among the offers we have are:

- information about international business examinations;
- report on 'English Weekends';
- sharing experiences on language learning with classes in England;
- topics and aims for EMI in mathematics instruction;
- EMI and weaker pupils;
- scientific observation methods as didactic strategy;
- young adult literature;
- assessment with EMI.

The participants get the complete list of offers, and have to choose from it their favoured topic and one alternative. It is my task then to select the groups which will actually take place according to the number of entries.

On Thursday there is a materials development workshop. The following topics were suggested:

- children and women (as part of the workforce);
- the body and food;
- agriculture;
- developing countries and India;
- European Community;
- immigration;
- violence;
- human habitats: where and how we live(d);
- cities and urbanisation.

The procedure is the same as with the initiative groups. There will be the possibility of working either with teachers who teach the same subject or a different subject.

Our aims for this workshop are that the teachers should:

- prepare something that they can really use at school;
- practise teamwork when preparing lessons;
- share know-how;
- define teaching aims and put them into practice;
- use and adapt ideas from the didactic units (i.e. task-based learning ...) from Tuesday.

The contents of last seminar will have to be negotiated again with the participants. We, the team, plan to encourage and increase support for exchange of professional knowledge. We want to enable the participants to work in in-service education to pass on their know-how to other colleagues. They can gain some experience in this respect by organising initiative groups, and by giving inputs in the workshops on the seminar.

70

Teachers as networkers

The third dimension of professionalism in the teaching profession mentioned above, networking, is a crucial skill to develop. Teachers usually still work individually, teaching in isolation. This makes exchange of experiences and mutual counselling difficult. It also hinders working on common issues across the various subjects. Co-operation and communication with other colleagues very often happens by chance in breaks, during spare time, and informally. The regional groups are a first step to establishing small, professional communities. In these groups, there is not only an exchange of experiences but also emotional support and mutual motivation. We support their existence beyond the course. In two regional groups, participants brought along colleagues from their schools who joined the meetings and participated in the work there. And we hope that, once the course has finished, some participants will continue their teamwork. But the exchange of practical knowledge should not be restricted to these small groups. The case studies written during the course are another contribution to networking. They are primarily for the authors' benefit in that the process of identifying problems, constructing research questions, and the writing up of findings and proposal of recommendations enhances professional knowledge. However, the case studies have also another purpose: written papers can be published and so a wider audience is reached. The writing of the case studies is supported by:

- the presentation and discussion in the regional groups;
- the first draft is discussed in the seminar, within a different group;
- a team member helps with editing if the participants want to publish it;
- the IFF and the Centre for School Development publish the studies.

Conclusion

The EMI teachers' work is a very interesting, but at the same time, an extremely complex activity. It needs much more than competence within one's own subject and a pedagogic and methodological repertoire to help pupils acquire knowledge and skills. In the course described, we try to do justice to this complexity. We are successful when we use concrete practical situations as a starting point. From this foundation, there are two basic ideas: firstly, that it is not only a matter of carrying out adequate actions concerning teaching and learning but there must be a critical and systematic reflection on these actions. Secondly, further professional development requires that as every teacher autonomously acquires competence, experience and know-how, and that thirdly, this process is facilitated by the introduction of a professional exchange of experience among colleagues.

References

- Altrichter H (1986) 'The Austrian INSET-Project "PFL". Establishing a framework for self-directed learning' in *British Journal of In-Service Education* 12: 170-177
- Altrichter H, P Posch and B Somekh (1993) *Teachers investigate their work. An introduction to the methods of action research*, Routledge
- Heindler D and G Abuja (1996) 'Forms of bilingual education in Austria' in Fruhauf G, D Coyle and I Christ *Teaching content in a foreign language: practice and perspectives in European bilingual education*, Alkmaar: European Platform for Dutch Education
- Krainer K (1994) 'PFL-Mathematics: a teacher in-service education course as a contribution to the improvement of professional practice in mathematic instruction' in *Proceedings of the 18th International Conference on the Psychology of Mathematics Education*, University of Lisboa
- Krainer K, M Krainz-Dürr, C Piber, and T Stern (1997) *University Courses 1997-1999*, Klagenfurt: IFF
- Krainer K and W Peschek (1993) *Pedagogy and subject-specific methodology for mathematics teachers. Reflections on an in-service education university programme in Austria*, Paper for OECD Klagenfurt: IFF/University of Klagenfurt

Second language acquisition through CLIL at primary school level

Heini-Marja Järvinen | University of Turku

Introduction

Content and language integrated learning programmes (CLIL) are a relative newcomer in the European educational context. Therefore, there is little research done into this field. Predecessors of CLIL, most prominently the Canadian immersion programmes, have been widely and consistently investigated from the 1960s onwards. However, there is little research into implicit language acquisition, although large-scale research into second language proficiency in immersion programmes has been carried out (e.g. Harley et al 1990).

This paper describes preliminary research into implicit acquisition of English by Finnish primary level students from grade 1 up to grade six in English-medium teaching. Implicit acquisition of language is viewed as a process of complexification of utterances, i.e. language develops from discontinuous entities (words) to larger continuous wholes (sentences consisting of main clauses and subordinate clauses). Language development may also be seen as a gradual introduction of functional categories to facilitate syntactic development. In the present study, implicit syntactic development in second language acquisition (SLA) is approached from the viewpoint of relativisation.

First, a brief account of relevant characteristics of implicit learning is provided. Then the theory of Universal Grammar is briefly described, and its relevance to implicit acquisition of language is discussed. After that, the present study is addressed, and finally some preliminary pedagogical implications are discussed and suggestions for further research are given.

Implicit learning

Implicit learning (see, for example, Winter and Reber 1994) describes an inductive process that derives information about structural regularities in the complex stimulus environment. These relationships are then represented in an abstract and tacit form. The stored representations form a generalised and domain-free knowledge base which can be utilised in guiding subsequent judgements and decisions. Implicit

learning is an automatic process which operates largely independently of awareness, in order to detect covert underlying regularities in a rich and unstructured stimulus environment, whereas explicit learning is an intentional process which is employed to process a restricted number of overt, salient features in a given structured stimulus domain, typically involving deliberate processes such as hypothesis testing and problem solving. Optimally, implicit and explicit learning are complementary processes which operate simultaneously upon environmental data, and produce a cohesive synthesis of the two analyses.

Implicit learning of language

It is not clear whether implicit learning as described above is able to adequately describe such a complex and unique process as language learning, as the most compelling evidence comes from the domain of non-language learning. However, Winter and Reber (1994: 118 –119) argue that implicit learning has the capacity to capture the acquisition of natural language for two reasons: 'one essential feature is that it operates independently of consciousness and of the modulating and controlling functions of consciousness. A second feature is that the processes of implicit learning have, again in principle, the capacity to establish representations of considerable complexity, a property that any coherent theory of language acquisition must have'. The research that is relevant to language learning consists mainly of research into learning of artificial grammars. The results indicate that subjects exposed to a stimulus environment become sensitive to underlying regularities in the input, and are consequently able to transfer this implicitly learned information and apply it in new situations. They are capable of categorising novel strings into grammatical and ungrammatical ones without being able to consciously attend to the process or verbalise the process (Ellis 1995).

73

SLA researchers seem to agree on the dual nature of linguistic knowledge, i.e. language is comprised of two distinct fundamentally different parts. One part is characterised as a universal implicit representation incorporating all the languages known by the user. The other part consists of an explicit representation of language-specific data that are separately stored for each language the user commands. However, the consensus ends and the controversy begins with the question of the mutual relationship of the two modes of linguistic representation. An increasing number of SLA researchers seem to agree that there is an innate component and a more explicit cognitive skill component, which interact in order to produce language learning. Other researchers may acknowledge the influence of an endowed linguistic faculty in first language acquisition, but consider the learning of subsequent languages as an entirely cognitive enterprise, no different from hypothesis formation and testing or problem solving; while others view the origin of the acquisition of first and second language fundamentally resulting from a common biological language faculty. Another related question concerns the nature of linguistic knowledge, more particularly the possibility of one type of knowledge being converted into the other. Supporters of the non-interface position (notably Krashen 1981) do not allow for transition of linguistic knowledge; supporters of the interface position view such conversion as an integral part of the language learning process. The transition may involve language use becoming more implicit and increasing in fluency, or becoming

more explicit, increasing in clarity and structure. The latter one-way direction of development is exemplified in the model presented below.

Bialystok's model

The model described here (Bialystok 1994) has been chosen to represent the posited contribution and mutual relationship of implicit and explicit learning processes operating within and between the three representations that interact to produce language. The model is suitable to present purposes as it provides a concise and parsimonious account of SLA. It integrates and explains a number of controversial issues in SLA, such as the effect of age on language learning, the representation of two languages in one brain/mind, and the relationship of universal and language-specific grammars.

The model incorporates three main components: the conceptual component (Conceptual), the universal language component (Language) and the language-specific component (Language-Specific Details or LSD). The central component, the representation of Language, is the part of language that is universal and biologically specified, and contains the universal principles that define all natural languages. The Conceptual representation contains the learner's knowledge of the world: the semantic knowledge, which is comprised of meaning components and meanings which develop into conceptual categories. The Language-Specific Details component contains all the unique characteristics of any number of languages that are not part of the Language representation, i.e. the lexicon, the pragmatics and the parameter-settings specific for each language. All these three components interact with each other. The Conceptual and Language representations interact to form the connection between expression and intention. The relationship between the LSD and the Language representation is symbiotic in that the Language representation provides the LSD with the universal categories, principles and parameters, whereas the LSD processing leads to a restructuring of the Language representation if the learning of a new word or structure presupposes more explicit representation in the Language component. The LSD is in immediate interaction with the Conceptual space of representation as the meanings and their linguistic forms need to be combined.

In Bialystok's model, learning can be described as the process of implicit knowledge becoming more explicit. Implicit and explicit knowledge are fundamentally different and remain so: the change is functional in character. Part of implicit knowledge increases in explicitness, i.e. becomes more structured and clear; part of implicit knowledge remains implicit. Explicit knowledge may increase in explicitness, but explicit knowledge cannot become implicit. Implicit knowledge is unconscious, and explicit knowledge may also be unconscious but becomes more conscious as it becomes more explicit. The process in which linguistic and conceptual representations become more explicit, more structured, and more accessible to inspection is called the analysis of knowledge (Bialystok 1991). Analysis converts implicit unstructured representations to an increasingly explicit form. At the same time, that the Language store is being analysed, and the LSD store is being built up. Entries in the LSD store come either through the process of analysis or enter the store directly in explicit form. These entries differ from the representations in the Language

and Conceptual stores. They are not constrained by universal principles, but are learnt in conventional ways. The analysis of knowledge of representations in the Language and Conceptual representations paves the way for conventional forms of learning.

In this view, explicit knowledge of language differs from implicit knowledge of language in a number of respects. Explicit knowledge is either derived from implicit knowledge through analysis, or learned directly as discrete propositions. It is categorised and conceptually related to other concepts and it can be accessed. None of these properties applies to implicit knowledge. The LSD store is more or less explicit and the Language and Conceptual stores increase in explicitness. The portion of the Language component that remains implicit contains the universal linguistic principles and initiates implicit learning.

The best-known account for the features and function of universal principles of language is the theory of Universal Grammar (UG). The following account provides a narrow and biased perspective to the theory of Universal Grammar, focusing on universal mechanisms underlying what traditional grammars call relativisation.

Universal Grammar

Universal Grammar (UG) emanates from Noam Chomsky's revolutionary work on human linguistic capacity, which broke the behaviouristic era in the late 1950s. The theory has changed a great deal and taken several different forms, but a number of basic assumptions remain intact. The fundamental one is the assumption of an organic, endowed component dedicated to language in the human mind or brain (Chomsky 1996).

The common argument for the existence of such an innate language faculty is presented in the form of the so called poverty-of-stimulus argument which is based on the observation that human beings have knowledge that cannot be derived from the deficient and 'dirty' linguistic input they are exposed to, but must be an innate capacity (see, for example, Cook 1985; Roberts 1994).

The language properties inherent in the human mind make up Universal Grammar which consists of a restricted set of general principles that apply to all grammars and parameters, with values to be set by the language(s) the speaker is exposed to. The grammar of a specific language can be regarded as a particular set of values for these parameters.

Universal Grammar and second language acquisition

The influence of Universal Grammar in first language acquisition is widely acknowledged, and it has been extended to apply to second language acquisition. However, in SLA the role of UG is not as straightforward as it is in first language acquisition. The obvious difference between first and second language acquisition is that second language learners have already accessed UG, and consequently set its parameters on the basis of their first language. SLA researchers are divided according

to their view on access to UG in SLA. The access may be direct (*full access*, see e.g. Flynn 1996), or indirect through the first language, or there may be no access at all (Bley-Vroman 1989; Clahsen 1990). While a number of SLA researchers acknowledge a partial access to UG in SLA, and a great majority agree that UG plays a role in SLA, unanimity has not been achieved.

Relativisation

Language acquisition can be investigated by tracing the development of complex utterances. Children start with one-word utterances and proceed to long, elaborate and coherent sentence strings in which meaningful semantic units are combined by means of functional syntactic operators. These strings are characterised by the emergence of subordination. One type of subordination is relativisation – a process in which two clauses are combined into one main clause and one subordinate clause (a relative clause), so that both clauses share one common element, a noun phrase (NP). In the main clause, the NP preserves its original form, but in the relative clause the corresponding NP is replaced by a relative pronoun (e.g. in English *who*, *which* or *that*). The main clause element functions as the antecedent or head or the relative pronoun.

The acquisition of relative clauses has been widely studied (Hyltenstam 1984, 1987; Pavese 1986; Doughty 1991; Klein 1993, 1995). The results confirm that the process is in many ways systematic.

76

Government and Binding Theory

Within Government and Binding Theory of UG¹, the processes relevant for relativisation are X-bar theory and Binding Theory and their interaction. X-bar theory implies that the speaker knows that languages have phrasal categories that consist of heads and complements (e.g. relative clauses). Binding Theory implies that NP categories may be bound by other antecedent NPs under certain conditions. The interaction of X-bar theory and Binding Theory determines that language learners know, prior to any exposure to language in the environment that a given phrasal category is possible in natural languages. This is of the form [NP(S)] (in which the head (NP) is co-referential with (i.e. binds) an NP in the subordinate clause (S), i.e. learners know in advance the form that relative clauses will take in a given language (Hawkins 1989).

Relative Clause Parameter (RCP)

RCP is a parameter suggested by Berent (1994) on the basis of the varying degree of difficulty experienced by learners with different first languages in learning relative

1 Government and Binding Theory (for UG in SLA, see e.g. Cook 1985; White 1989; Cook et al 1996) has until recently been the general framework for universal SLA research. For more recent advancements, especially the Minimalist Theory, see e.g. Weibelhuth 1995, Chomsky 1996, Cook et al 1996, Flynn et al 1998.

clauses in a second language. The UG principle that RCP is associated with is operator-variable binding. This principle states that an operator is licensed by binding a variable. The following examples (Berent 1994: 34) illustrate the case in point.

- (1) We saw the girl_i [_{CP} who_i [_{IP} t_i [_{VP} bought the book]]]
- (2) We saw the girl_i [_{CP} who_i [_{IP} the boy [_{VP} knows t_i]]]
- (3) We saw the girl_i [_{CP} who_i [_{IP} the boy [_{VP} took the book [from t_i]]]]]

The **wh**-operator **who** moves to the specifier position of the complementiser phrase (CP) and leaves behind a trace (**t**). The trace is a variable whose position in the CP reflects the perceived difficulty that the learner faces in processing relative clauses. The longer the distance between the co-indexed elements (**who_i** and **t_i**), the more difficult the relative clause is to process. In (1) the operator crosses one maximal projection (IP), in (2) the operator crosses two maximal projections (VP and IP), and finally in (3) three maximal projections (PP, VP and IP). In addition to operator-variable binding, also relevant to the binding requirements of relative clause formation is R-binding. In the above examples, **the girl** binds the operator **who** (and the variable **t**) (Berent 1994: 35).

According to Hawkins (1989: 174–176), what is described above as the perceived difficulty in processing relative clauses, reflected by the number of maximal projections the operator crosses, may be interpreted as part of the learner's processing capacity. The ranking order of difficulty is probably not part of the learner's internal UG. Instead, the grammatical component of UG contains the sites (NPs) that languages can relativise on, but the learner needs primary data to find out what they are. Their task is to determine how three subcomponents of relative clauses interact: the head, the relativiser and the extraction site.

The study

Experimental design

The objective of the present study was to explore implicit learning of second language. The study tracked acquisition of subordination as an indication of implicit learning. Acquisition of subordination was assumed to be reflected by the process of parameter-setting, as defined in Universal Grammar. Elicited imitation was used to test implicit knowledge of relativisation. With this task the learner is supposed to reproduce the linguistic structure of the sentence heard; thus the utterance elicited is argued to reflect the degree to which a learner is able to assimilate the stimulus into his or her grammar (Flynn 1996: 130–131). The length of the imitated sentences has to override the limitations of the short-memory store (approximately 25 syllables, which generally make up 10–15 words per sentence). The values of the operator trace covered the following functions: Subject (see (4) below), Object, Indirect Object and Genitive (see (5) below). The position of the relative clause within the sentence was varied between initial, medial and final positions in order to control for memory effects. For analysis, imitations were recorded and transcribed.

- (4) The little boy that likes to play football lives in the yellow house.
- (5) The little boy whose mum is a teacher plays football in a team.

Subjects

Subjects consisted of all the students (n=93) in the bilingual¹ classes in grades 1–5 (7–12 years of age). Students from parallel classes (grades 3–5, n=45) were used as controls. Finnish was the first language of both the subject and control groups.

The main instructional difference was the quantity and quality of the English the students were exposed to. The bilingual class subjects received part of their content teaching through the medium of English throughout the primary level. The amount and content taught in English varied. In grades 1 and 2, teachers preferred a theme-based approach with teacher-initiated and maintained English language input and very little student output. In grades 3–5, teaching in English was more subject-centred with greater student target language output. In addition to subject teaching in English, the bilingual class also attended formal English instruction in grades 3–5. The control group's entire exposure to English at school consisted of two English classes a week (2 x 45 minutes) starting at grade 3 (as formal foreign language teaching is normally introduced in grade 3 for all students).

Every spring, the students in the bilingual stream in the test school are selected from among approximately double the number of applicants that are eventually taken in. The selection is based on a commonly used, conventional 'maturity' test. Most students in parallel grades live in the area and attend the school assigned to them by the school district authorities. The only selection criteria applied to the control group was that they were students from parallel grades whose first foreign language was English and that they were available at the time of testing.

It is possible that the bilingual class students differ from the controls in some respect that has an effect on the results of the present paper. However, as far as the grade 5 test and control students are concerned, they do not differ statistically significantly in non-verbal problem solving (Raven's progressive matrices) and first language lexicon and concepts (WISC-R). Also, one of the basic assumptions in Universal Grammar is that, as an endowed faculty, its contribution to language acquisition is independent of individual differences of ability.

Results

The tentative results indicate that the bilingual subjects' acquisition of relativisation was faster and more homogeneous than that of the control students. Judging by the results of elicited imitation, the bilingual subjects' acquisition of relativisation was completed by the end of the fourth year. The imitations they produced showed very little individual variation. The monolingual control group's development was slower and there was considerable variation in the produced imitations. There was no sign of

¹ CLIL classes with 25–30% of teaching in English.

completed relativisation by the end of the fifth year (after three years of formal English), and the individual differences were great.

Discussion

The results of the present study indicated that content and language integrated instruction was able to facilitate the acquisition of the second language. This is partly due to the time and amount of the second language that the students in bilingual programmes are exposed to. The influence of the quality of input is more difficult to determine, but it is possible that the functions of the conceptual component and the language component (Bialystok's model above) are stimulated and the interaction of these components is enhanced, and implicit learning is consequently emphasised. As far as the role of Universal Grammar is concerned, very little can be said on the basis of these preliminary results. It remains to be seen whether the bilingual subjects' unvaried performance is an indication of access to and use of the implicit unconscious endowed capacity, and whether the control students' heterogeneous performance is a sign of more controlled, explicit performance that is due to explicit conscious processing constraints and individual differences.

Further analysis of the results will give a more detailed account of the development of relativisation. Answers are sought to at least the following questions: how does complexification of utterances take place? What are the roles of semantic and functional categories and how do they develop? How does the setting of the values of the Relative Clause Parameter take place? What is the role of the first language in the setting of the Relative Clause Parameter values? The key issue is an obvious one: optimal acquisition of language.

79

References

- Berent G P (1994) 'The subset principle in second-language acquisition' in Tarone E E, S M Gass and A D Cohen (eds) *Research methodology in second-language acquisition*, Hillsdale, NJ: Lawrence Erlbaum: 17–39
- Bialystok E (1994) 'Representation and ways of knowing: three issues in second language acquisition' in Ellis N (ed) *Implicit and explicit learning of languages*, London: Academic Press: 549–569
- Bialystok E (1991) 'Metalinguistic dimensions of bilingual language proficiency' in Bialystok E (ed) *Language processing in bilingual children*, London: Cambridge University Press: 113–140
- Bley-Vroman R (1989) 'What is the logical problem of foreign language learning?' in Gass S M and J Schachter (eds) *Linguistic perspectives on second language acquisition*, Cambridge: Cambridge University Press: 41–68
- Chomsky N (1996) *The minimalist program*, Cambridge, MA: MIT Press
- Clahsen H (1990) 'The comparative study of first and second language development' in *Studies in Second Language Acquisition* 12(2): 135–153
- Cook V J (1985) 'Chomsky's Universal Grammar and second language learning' in *Applied Linguistics* 6(1): 2–18

- Cook V J and M Newson (1996) *Chomsky's Universal Grammar. An introduction*, Oxford: Blackwell
- Doughty C (1991) 'Second language instruction does make a difference. Evidence from an empirical study of SL relativization' in *Studies in Second Language Acquisition* 13 (3): 431-469
- Ellis N (1995) 'Consciousness in second language acquisition: a review of field studies and laboratory experiments' in *Language Awareness* 4(3): 123-146
- Flynn S (1996) 'A parameter-setting approach to second language acquisition' in Ritchie W C and T K Bhatia (eds) *Handbook of second language acquisition*, San Diego, CA: Academic Press: 121-158
- Harley B, P Allen, J Cummins and M Swain (eds) (1990) *The development of second language proficiency*, Cambridge: Cambridge University Press
- Hawkins R (1989) 'Do second language learners acquire restrictive relative clauses on the basis of relational or configurational information? The acquisition of French subject, direct object and genitive restrictive relative clauses by second language learners' in *Second Language Research* 5(2): 156-188
- Hyltenstam K (1984) 'The use of typological markedness conditions as predictors in second language acquisition. The case of pronominal copies in relative clauses' in Andersen R W (ed) *Second languages. A cross-linguistic perspective*, Rowley, MA: Newbury House Publishers: 39-58
- Hyltenstam K (1987) 'Markedness, language universals, language typology, and second language acquisition' in Wollman Pfaff C (ed) *First and second language acquisition processes*. Cambridge, MA: Newbury House Publishers, 55-78
- Klein E C (1993) *Toward second language acquisition: a study of null-prep*, Dordrecht: Kluwer Academic Publishers
- Klein E C (1995) 'Evidence for a "wild" L2 grammar: when PPs rear their empty heads' in *Applied Linguistics* 16(1): 87-117
- Krashen S D (1981) *Second language acquisition and second language learning*, Oxford: Pergamon
- Pavesi M (1986) 'Markedness, discursual modes, and relative clause formation in a formal and informal context' in *Studies in Second Language Acquisition* 8(1): 38-55
- Roberts I (1994) 'Universal Grammar and L1 acquisition' in Ellis N (ed) *Implicit and explicit learning of languages*, London: Academic Press: 455-475
- Webelhuth G (ed) (1995) *Government and binding theory and the minimalist program*, Cambridge, MA: Blackwell
- White L (1989) *Universal Grammar and second language acquisition*, Amsterdam/Philadelphia: John Benjamins

A practitioner's perspective on bilingual teaching in Alhaisten Primary School

Anja Romu | Alhaisten koulu, Salo

Leena Sjöberg-Heino | Alhaisten koulu, Salo

Terminology of bilingual education

Much has been published concerning the varieties and terminologies of bilingual education (for comprehensive review, see Baker 1997). In Finland, a number of these varieties and terms can be found. Nikula and Marsh (1997) describe the differences of many terms used in this field. They say that the term *bilingual teaching* is often used when the aims are to provide language minorities with teaching, both in their own, as well as in the majority language. In this way the cultural identity of the language minority is preserved. This, however, is not the case in Alhaisten koulu, where the majority language (98.5%) is Finnish, and all the pupils in the language-integrated classes are Finnish-speaking.

What happens in our school is bilingual education with the emphasis on language teaching, but having surveyed the terminology, we feel that the term *content and language integrated learning* (CLIL) describes more precisely the methodology that is being used. For us, this term clearly says that the learning of a foreign language and that of the content of another school subject take place at the same time.

Aims of the CLIL classes

In reacting to the need perceived by the city council, the school has set aims for the CLIL classes which are both (a) linguistic and (b) broadly educational:

- (a) • to develop pupils' reading, writing and listening skills;
• to encourage pupils to use the English language in communicative situations.

Pupils are keen to use their English language, although their oral skills are not very well developed. One of the reasons might be that the class teacher does not make any comments while the pupil is speaking. Mistakes are pointed out afterwards and to all of the pupils at the same time, if necessary: minor language mistakes are not ignored. If the atmosphere in the classroom is good, pupils are not afraid of making mistakes. Also, class teachers make mistakes and we should not be afraid to reveal this to our pupils. I believe the greatest pleasure for the pupils is when they notice that the teacher also makes

mistakes. It gives them self-confidence, and it shows the teacher that the pupils are interested in the English language and that they are concentrating on the topic at hand.

- (b) • to awaken positive attitudes towards learning;
 • to awaken interest in different cultures and an appreciation of Finnish culture.

Learning a new language is also learning new things about different countries. When we find new ways of doing things, we reflect them on our own background and culture, and thus appreciate it more.

Starting the CLIL class

Alhaisten koulu is a medium-sized primary school of 270 pupils in Salo in southern Finland. There are twelve class teachers, a language teacher, a special needs teacher, a craft teacher and the head. The school is 115 years old, but has recently been renovated and also partly rebuilt. All the equipment is also new, including computers, with the possibility of networking, and there is audiovisual equipment in each classroom. Within the curriculum, environment and internationalisation are mentioned as leading topics. These topics are taught during the year through various projects and theme weeks.

Being an international business city (Nokia produces the majority of its mobile phones in Salo), the city council started debating having a bilingual class in Salo in order to help the internationally mobile families that move back from abroad. The children of these families might have started school in the USA or the UK, or in an English-medium International School. If the city wanted to acknowledge and maintain these children's English language skills, then it should do something. The suggestion was offered to Alhaisten koulu to develop a provision which could satisfy this wish. There was, however, no social call for such a class, but the teachers responded quickly and after discussing various issues such as materials and salary, they decided to take up the challenge of CLIL-teaching.

Parents have been very keen to enrol their children in CLIL classes, and during the past two years almost 60 families have applied each year. The entrance is strictly limited to 26 pupils in these classes due to the limited resources in the secondary level where all these pupils go as a whole group.

Our CLIL classes start from the third grade (age nine to ten) and go up to the sixth grade (age twelve to thirteen). The first CLIL class started in autumn 1996. This class is now finishing its fourth grade. These pupils had not studied any English before, so their English language level at the beginning was zero.

In the third grade, the proportion of teaching content through English is 25–30%. In the fourth grade this is increased to 40%. In the fifth and sixth grade the aim is to increase the level up to 50–60%. By this time, more than half of the teaching of the school will be done in English. By the sixth grade, it is intended that the pupils' knowledge of English should be at the level of the secondary school seventh grade.

All the CLIL classes follow the school curriculum. Pupils have 25 lesson hours per week and six of them are half-group lessons (half the group has formal English while the other half has a lesson with a class teacher).

Selection for the class

All the second year pupils that have sent their applications are tested, using the same test every year. The test itself was originally developed in co-operation with the Turku University Learning Research Centre. The test has five separate sections, three of which are done in groups and two of which are individual tests.

The first part is a reading comprehension test. The test is in Finnish and after a time-limited period of reading, the pupils have to answer questions orally. The second part has a similar structure, but is a listening comprehension test. One teacher reads aloud a short text, and then questions asked by a second teacher have to be answered. The third part is a dictation, which includes difficult combinations. The fourth part measures the ability of the mechanics of reading through speed and the number of mistakes. The fifth part is auditive discrimination. The language used is Italian. One reason for this is that it is unlikely that Italian is known by any of the candidates; the other is that Italian and Finnish have a lot in common regarding pronunciation. First a word and then a short sentence is read to the pupils who repeat what they have heard as accurately as possible.

As Marsh et al (1997) mention, there is still not enough information about suitable criteria for selecting the pupils. The issue should have nothing to do with intelligence as such, because it seems that even those pupils with a lower level of intelligence still get some benefit when learning the target language in a CLIL class (see Cummins and Swain 1986).

All the parts of the test, except for the fifth, measure the candidate's abilities in the Finnish language. There is a certain schema behind this thinking. Testing the knowledge of the native language ascertains that the basis of the native language is well developed. In our CLIL curriculum, we stress the importance of the maintenance and development of the mother tongue. Linguistic skills cannot be the only criterion: motivation and attitude are as important. In Alhaisten koulu, all the class teachers whose pupils have applied are also given a questionnaire about the pupil, including questions such as their ability to work in groups, difficulties in learning the mother tongue and motivation.

Teacher education for CLIL

All the teachers involved in teaching the CLIL classes in Alhaisten koulu have a master's degree in education, and two of them are also qualified as English subject teachers at primary level. Three of the teachers have also spent shorter or longer periods in an English-speaking country, so there are varieties of pronunciation and spelling from England, the USA and Australia.

The city council provides a free, weekly English language course for both primary and secondary teachers in Salo. To support the CLIL initiative, the particular needs of the teachers from Alhaisten koulu as well as from Hermannin koulu, the pupils' future secondary school, are taken care of. The course is run by a native speaker American tutor who corrects the teachers' pronunciation, and helps with the sample lessons which they give each other. All the Alhaisten koulu teachers who have CLIL classes attend this course.

Turku University organises a course of fifteen credits (600 learning hours). This kind of course was previously only available for secondary school teachers, but is now also available to primary teachers. We have positive experiences of these longer courses of five to fifteen credits. Courses of this kind were also held in Vantaa, which has a link to the Helsinki University. Classroom pedagogy, and the development and application of bilingual materials, have been of particular importance in these courses.

Teaching methods

Content and language integrated learning includes aims for both subject content and the English language. This has an impact on the classroom working methods. The teaching methods need to become more concrete, concise and focused. Our CLIL classes' teaching methods are:

- **Active** (learning by doing) – Total physical response (TPR) is used from the beginning, for example 'Clap your hands, jump, sit down'. Non-verbal communication is essential so that as much language input comes through visually and kinaesthetically, as well as orally.
- **Concrete** – If we want to be concrete, we have to use all of our senses. We use a lot of illustrative material, for example pictures and different objects. In the third grade we name all the things in the classroom. We write name tags and fasten them on the object in question. We make much use of overhead projector and blackboard, especially when teaching new vocabulary or terms.
- **Miming** (use of drama and games) – These are very useful and a lot of fun when working with children. Whenever we use miming and drama, the pupils learn the language almost unconsciously.
- **Repetition and redundancy** – Repetition is probably one of the most important things in learning languages. With a lot of repetition and redundancy, pupils get more opportunities to process the information. Studying in the CLIL class demands more concentration, so repetition can be very helpful for pupils.

Teacher- and pupil-centred methods

This is the second year of teaching CLIL classes, and with hindsight the learning methods used at the beginning have been more or less teacher-centred. The choice of teaching method depends on the aims of the lesson. The pupils' foreign language skills are very weak at the beginning, and the lexis they would have to have to be able to work in a more pupil-centred way is only just being acquired. As the pupils' language skills improve, we can use pupil-centred methods more often than has been done in the first year of CLIL.

Last autumn we had a 'weekend book' system with the fourth graders. Every weekend they read a book at home and the following Monday had a group discussion about their books. Pupils sat in a groups of four and asked and answered questions such as, 'What's the name of your book?', 'What kind of book is it?', 'Did you like it and why?', etc. I provided the questions and some vocabulary beforehand. All pupil-centred work must be well planned, so that it moves on without major difficulties. After pupils got used to the weekend book group discussions, we still had the problem of how to make them speak only English. We discussed this with the children and decided to have one 'language encourager' in each group. Their job was to remind the group members to speak only English. It worked well. In pairwork the pupils get a lot of language practice, so it is even more effective than groupwork. We have used pairwork for checking homework or practising and reinforcing new concepts, such as multiplication in mathematics and for finding information from longer or more difficult texts.

Whenever possible, we try to use the half-group lessons for teaching in English as it is much easier to work with pupils in a smaller group, because there is more time for each pupil. If some pupils take a very passive role in the classroom, a smaller group can encourage them to use their English language skills.

Class teachers have the freedom to plan their class's timetable except English, crafts and gymnastics. These lessons can be environmental studies, mathematics, religion, art, music or Finnish language. Children do not generally know which subjects are planned, and this gives freedom to arrange the week's schedule as needed. Children do not get worried about changes in the timetable, and we can concentrate on certain themes for a longer time if necessary. This flexibility allows for planning suitable places in the timetable to teach in English. If the English-medium lessons are consecutive in the timetable, it can be tiring for the pupils and affect their concentration.

85

Teaching materials

We have been able to buy material from the USA and the UK, and since the renovation of our school we have an Internet connection, which is very useful in gathering English material. However, authentic material is not always trouble-free. There are often cultural differences and a difference in the curriculum where the emphasis on the subjects varies. As these materials are also designed for native speakers, they often do not meet our special needs. There is also the problem of finding the right material for our age levels to match the right language level. So although there is a lot of material available, not all of it is suitable for us.

We use Finnish textbooks, so a lot of material is translated by the teacher for the children. Creating suitable material for teaching is probably one of the most time-consuming, hardest and onerous aspects of a class teacher's work. There have been some initiatives to start networking among teachers, but these have not been very productive. Teachers probably do a lot of overlapping work in CLIL.

Subjects in the curriculum

The third grade class's school year starts with becoming acquainted with a new teacher and friends. English is used for everyday routines like greetings, the date and saying grace, but Finnish is used in the beginning to settle the children and make them feel secure and comfortable in the group. Our experience is that if children have to adapt to too many new and – possibly – scary situations before the atmosphere in the class is safe, it can be an obstacle to learning a foreign language. By the end of October, whole lessons are taught in English, and the children are very relaxed. They follow the teaching and work well together. They realise that you do not even have to understand everything the teacher says. When we teach we try not to mix Finnish and English. Even when teaching new words we try to explain them in English. If we realise that many of the pupils have not absorbed our teaching, we can always switch to Finnish. Pupils are allowed to use Finnish, but of course we try to encourage them to use English, i.e. 'How do you say it in English?'

Environmental studies is a good core subject for CLIL. It favours pupil-centred methods and often the topics chosen interest pupils. Pupils become familiar with concepts first in Finnish; some areas are then taken up in English. We usually do some experiments, which pupils can do individually in English. Art is very concrete as a subject and also very suitable for CLIL.

In mathematics the concepts are sometimes very specific and difficult even in Finnish. Mathematical knowledge builds up on a spiral structure, where pupils have to master the subject learnt earlier before they can move forward. In the third grade, we used more English in the lessons than in the fourth grade. In these types of subjects, we need to focus more on the concept than on the target language.

Finland's state religion is Evangelical-Lutheran and 96% of Finnish schoolchildren attend the religion lessons. All of the students in the CLIL class so far have attended religion lessons and worked on religious themes and festivals. We find this subject very suitable as the topics and stories from third grade onwards are familiar to most of the pupils and still – even at the age of nine – popular. It is quite easy to introduce new vocabulary, and the subject permits an easy choice of a range of teaching strategies. Lessons are frequently narrative based. The topic is introduced in Finnish and then the story is read and explained in English. The morals underlying the stories are discussed in both mother tongue and target language, as it is important that moral and ethical values are grounded in the child's first language.

In the fourth grade we still strongly concentrate on oral competence, but we also start to focus more on reading and writing skills. During the spring term the children are given more English homework, which they have to do independently. This spring, children wanted to give talks on animals, and they searched for information on the Internet and picked out some interesting facts about animals. Some children worked independently without any help from the teacher.

The mother tongue

Despite the emphasis on English, the Finnish language plays the most important role of all the school subjects. Finnish is taught five lessons per week. The subject consists of a variety of integrated topics: literature, grammar, reading and writing, speaking and listening, and drama.

The pupils in CLIL classes are tested on all aspects of the mother tongue syllabus. The tests are the same as for the standard monolingual classes. The results for our CLIL pupils have been similar to the standard groups, but some differences have been noted. At the end of the third year, the quality of expression and the use of idiom were often better for the CLIL pupils. In the fourth year, there was a slight increase in the number of grammatical errors for the CLIL class in, e.g. compound words (the structure of compound words is completely different in English and Finnish).

Evaluation

Evaluation in the third grade is based on the teacher's observation and a few simple tests. All of the tests in the CLIL classes are in Finnish, except for the English tests. We wanted to focus on the content, not the language when testing. Children get two reports in a school year. From the first to third grade, pupils receive a verbal report which provides an overview of their performance in the Finnish language, maths and the foreign language. In the CLIL class we add a sentence to the report stating that the pupil has been studying in a CLIL class. In the fourth grade, the evaluation is based on a numerical scale of 4 to 10 (where 10 is excellent and 4 a fail). All the tests are also marked using this scale. Evaluation across subjects consists of the average of the test scores with the addition of the teacher's notes of observation of motivation and participation in lessons. In CLIL classes the quantity or accuracy of the target language is not measured: evaluation is based strictly on the accuracy of the content.

87

Attitudes towards CLIL

Pupils' and parents' attitudes towards the CLIL classes have been very positive and encouraging. Every year we have conducted a survey on what pupils think about studying in a CLIL class. The feedback has been positive so far. Pupils of this class are hard-working. They have never said – to me at least – that studying through English is boring, or asked whether the teacher could speak more Finnish in class. In the survey done before the Christmas break, four pupils would have liked me to use more English in my teaching, and the rest of them thought that the amount used is suitable for them. A teacher trainee from the University of Turku is currently doing research about the attitudes and motivation of the CLIL fourth grade class pupils in Alhaisten Primary School. She has conducted a survey and interviewed the pupils and some parents. We look forward to seeing her results.

The parents of these CLIL classes are interested in their children's education. Interaction between the school and home is active. The parents' association has also had an active part in this class's work. We have arranged Christmas parties, spring trips and

last year we printed a recipe book, which was sold out in no time. With the money collected from different projects, we are hoping to travel to England in the sixth grade.

This work is very challenging but the positive attitude of the pupils, parents and, of course, my colleagues gives me the strength to go on, and makes me to want to do this work better and better each day.

Discussion from the conference

After presenting this paper at the Lancaster conference, we had an interesting discussion about starting age and testing. Some experiments in Europe strongly support an early start, and our worries about the development of mother tongue skills seemed rather unnecessary in a European perspective. In the final discussion, we also recognised the fact that Finnish has very little in common with any other European languages, so studying language other than one from the Finno-Ugric language group does not support the development of knowledge of the mother tongue. This is one of the reasons we feel that the basis of the Finnish language should be learnt first. Studying an analytic and synthetic language at the same time might cause problems for very young children, and we want to avoid difficulties and increase the eagerness to learn more.

Testing the candidates was also an issue that divided opinions. Testing as we do can never be as valid as we would like, but at the same time it is the only possible way of selecting the 26 pupils out of almost 60. In some countries, as we found out, pupils are also tested in mathematics. This kind of test has much to do with measuring intelligence, and as we feel that entering the CLIL class should not be a matter of intelligence, but of basic language acquisition abilities, we will continue to select as we have to, and strive for our intended aims.

88

References

- Baker C (1997) *Foundations of bilingual education and bilingualism (second edition)*, Clevedon: Multilingual Matters
- Cummins J and M Swain (1986) *Bilingualism in education*, New York: Longman
- Marsh D, B Marsland and T Nikula (1997) *Aspects of implementing plurilingual education: seminar and field notes*, Jyväskylä: University of Jyväskylä

The language teacher in a primary CLIL curriculum

Erik Suomela | Alhaisten koulu, Salo

The practice of content and language integrated learning (CLIL) is now spreading through Europe. The schools and institutions experimenting in this new approach to language learning are gaining experience, gathering data and gradually developing an insight into what CLIL means in their particular language-learning environment.

Today, at this experimental stage, there seem to be almost as many versions of CLIL as there are institutions that practise it. The main reason for this is that there are a number of situation-specific variables which make these versions more or less different from each other. Such variables are:

- the **age** range of the students varies from primary school children to young adults;
- the **proportion** of CLIL lessons within curricula differs;
- the **pre-testing** or selection of students is carried out in some but not all cases;
- the availability of **native speaker teachers** is not equal in all countries.

All this makes it necessary when talking about any experiences of CLIL to define the setting in which the learning activities take place. Thus, when discussing the role of the language teacher in a CLIL curriculum, it is necessary to understand that it is always a certain kind of curriculum in a certain kind of setting, and the role of the language teacher will vary accordingly.

The foreign language curriculum in Finland

Children in Finland start school in the year when they become seven years old. The most usual time for all Finnish pupils to start learning their first foreign language is in the third form, i.e. when they are nine years old. Although there are possibilities for schools to start with formal language teaching earlier, they are not widely made use of.

Primary school lasts for six years, and during that time the class is usually taught by a form teacher for all subjects except foreign languages. In smaller communes and in some individual schools, the form teacher may also teach language lessons, having first qualified to give lessons in that particular language.

The language that the children take up (usually) in the third form is called the A1 language. In Finland, more than 90% of the pupils start English as their first foreign language. The remaining portion consists of German, Swedish, French and Russian. In forms 3–6 the A1 language is usually taught for two lessons a week.

Quite a few pupils today also like to start another language, A2, when in primary school. Most often this happens in their fifth form, in which case the lessons are twice a week. These ‘voluntary’ language lessons appeal especially to those who have something other than English as their A1 choice, in which case English is usually their A2 language.

As Finland has two official languages it is also obligatory to study Swedish as a part of basic education. If a pupil did not start Swedish as their A1 language in primary school, they start it in the seventh form, typically with two lessons a week. This language starting at the seventh form is labelled B1. In addition to this, a pupil has the option of starting yet another foreign language in the eighth form. Here the selection of languages varies greatly according to the school’s resources. About 30% of pupils in Salo take this option.

Entering the seventh form marks the change of leaving the form teachers behind and starting the last three years of a comprehensive school system under the instruction of subject teachers. The A1 language is taught eight lessons a week during the whole of upper comprehensive, i.e. forms 7–9. The actual allocation of these lessons to any of the three forms in upper comprehensive is much the choice of that particular school, in that the aggregate total for the three years must equal eight per week, i.e. in the seventh and the eighth form, the pupil may study three lessons a week, in the ninth form only two lessons a week.

To summarise this situation: in Finland every pupil at school studies a **minimum of two** foreign languages and a **maximum of four**. After completing the nine-year general education in a comprehensive school, a student may find it possible to start yet another language, for example in an upper secondary school. Thus, from all that has been described above, it can be maintained that Finland is quite well equipped to meet the European Commission’s challenge of providing a citizen with the knowledge of three official EU languages.

Foreign language learning principles and methodologies

In comprehensive schools, the primary concern is often how to develop the pupils’ communicative skills in general, and oral skills in particular. The current emphasis on communicative skills can be seen against the background of language teaching practices in the 1960s and the 1970s, where the main emphasis was on grammatical correctness and classroom work consisted mainly of written translation. Oral pairwork was virtually unheard of. Also, developments in the study of foreign language learning suggest the importance of communication-oriented learning experiences. So now the catchword is: get the children talking.

Since the 1980s, the concept of communicative competence (see, for example, Canale 1983) has been available as the overall framework within which an individual teacher

may carry out their everyday work. We no longer think that the hard work and study directed towards a superb mastery of grammar is a pivotal factor in developing a young person's mind. Instead, the modern world calls for the skills needed when we come into contact with various people in various settings. Indeed, in place of the modern phrase 'information society' the term 'communication society' might well be adopted.

When striving for the development of a pupil's communicative competence, we must take special care to create classroom situations where a real information gap arises between the participants. Here I use this term to describe a situation where some of the speakers have information that the other speakers do not have, and it is in the interest of each of the participants, within the given limited situation, to try and share the information. As it happens, the kinds of dialogues usually suggested for pupils to practise 'a typical situation' in the target language rarely provoke any personal interest in the pupils. A most common lament among researchers in classroom pedagogy is that the discourse in the foreign language is not 'real', that is, the pupils do not say things to each other that have a personal meaning to one or another participant.

One other idea about foreign language learning that has some bearing on the subject of CLIL classes is that of the so-called monitor model. This hypothesis promoted by Krashen (1982), with the opposition of language **acquisition** versus language **learning** suggests that when pupils are exposed to a great amount of language use, i.e. **input**, they will benefit from it and eventually start producing their own language **output**.

Although this assumption has been under some critical discussion (e.g. Swain 1993), it nevertheless seems to serve and function as a working hypothesis underlying the CLIL endeavours. Krashen's work has left its mark on many language teachers in that they feel more confident now in speaking more complex, everyday language in the classroom, without having to worry much about everybody understanding every word they say. Krashen's idea has further developed into the assumption that much active language use by the student will result in good language skills – the output hypothesis – but even this has faced some critical scrutiny (Swain *ibid*).

Suggestopaedia (Losanov 1978) gained quite a firm foothold in Finland in the 1980s, and has since then maintained its role as a thought-provoking approach to language teaching. Though there are few orthodox suggestopaedics among teachers at comprehensive schools, the method has endowed us with insights into any practice of teaching such as:

- the use of all senses;
- using deliberately positive suggestions in going about the business of learning;
- understanding that we do have a subconscious mind which works for us;
- the importance of a relaxed and safe atmosphere.

Quite liberating is also the idea found in suggestopedia that it is indeed allowed to have fun with the language!

In Finland, as in many other countries, the most recent ideas about learning in general are those arising from cognitive psychology. For some years now there has been much

91

discussion of a trend called constructivism (von Wright 1996), but its large-scale contribution to language teaching practices has not yet been seen. We only know that we as teachers should guide the students, so that they develop their metacognitive skills and become aware of their own learning strategies. We should also allow for the students to construct their own knowledge to fit into the framework of their already existing information structures or schemas. It will be interesting in the future to work with language teaching material that takes this kind of approach into account, but as yet its ideas appear to be a bit distant to a primary school, beginner-level language course. In so saying, I fully appreciate the future potential of these ideas, and hope to see them put into practice in our teaching materials sometime in the future.

The practical and methodological shift for CLIL

In what way, then, has the adoption of CLIL affected formal English teaching in Alhaisten Primary School? How well do the familiar methods and practices suit the new kind of framework? When trying to get a grasp of the changes, we are still somewhat handicapped by the fact that our experience of CLIL in our school is fairly limited. We set out with this new method two years ago, so observations from only two forms are available. Accordingly, any conclusions drawn from these experiences can be nothing but preliminary opinions, an opening for discussion at best.

All pupils at Alhaisten Primary start their first foreign language in the third form when they are nine years old. This also applies to pupils starting in the English CLIL class. The amount of formal English with the language teacher is also the same for all the pupils: two lessons a week, with the exception of the third formers beginning the CLIL class who have an extra lesson every other week. In the autumn term, we use this extra time mainly to learn how to use dictionaries, and how to interpret and make use of phonetic transcription. The CLIL lessons with the form teacher start with very little English; most of the classroom work is conducted in Finnish. By the fourth form, entire lessons may be in English.

The group of pupils in my CLIL class is not like any other group of pupils. There are two main differences. The first is quite obvious and common to all CLIL pupils, no matter where they are: that the children get a lot of practice in their English outside the language classroom. The second difference does not necessarily exist in all CLIL classes. The pupils in our version of CLIL all come to the class through a selection process (see Romu and Sjöberg-Heino 1999). This is mainly because we want to make sure that the would-be CLIL pupil does not have such diagnosable disorders in their linguistic development that would probably make the pupil's learning efforts a source of frustration.

With these differences, the pupils show certain characteristics in the language lessons after studying in the CLIL class for two years. Firstly, the pupils' pronunciation skills are more advanced when compared to an ordinary group. Secondly, many of the pupils show more fluency of speech. Thirdly, pupils have a more advanced ability to use clusters or chunks of language instead of word-by-word constructions. They have obviously benefited from the enriched input and have picked up phrases and collocations typical of the English language, e.g. *get married, was born, by the way,*

never mind, I've never been to. Fourthly, the pupils clearly show more linguistic awareness and make clever observations about language use. For example, I once told them that in English the titles of stories and headlines are usually written in initial capital letters. A few days later the story title *Look at That!* caught one pupil's eye: 'Teacher, you said that in titles we use capital initials. Look, here the second word is with a small initial!' Fifthly, many feel confident enough to play with the language, making funny compound words or exaggerating the sounds in speech. Of course they also know more words to play with. Finally, the pupils' reading skills are better. This, however, is as expected because a reading test is included in the initial selection procedure.

Some of these features mentioned above are clearly a result of the pupils' daily exposure to CLIL, some stem from an interaction between CLIL and the initial selection. One other obvious outcome from the selection process is that this group of pupils is linguistically much more homogeneous than their peer group. It may also be that their linguistic aspirations will make it easier for them as a group to build up a kind of team spirit. The fact that they have fairly similar linguistic and motivational starting points makes for a good, supportive class atmosphere. This is no small matter in the language classroom, where pupils are supposed to engage in communication 'in public' to express their ideas by means of a most incomplete medium.

The final point made above, about the pupils' reading skills, also deserves a closer look. Good reading skills can be said to provide an extra boost into foreign language learning in many ways. According to Vaurio (1990), the following are among the features that distinguish a fluent reader from a slow one:

- 1 The recognition of words is better;
- 2 The processing of word chunks is better;
- 3 More mental energy can be spared to understand larger entities of discourse;
- 4 It is easier to tell the important words from the less important.

These points may not bear so much relevance in the beginners third form, but in the fourth the use of text material is already quite abundant. From the language teacher's point of view, the more easily a pupil understands the basic information and structure of a text, the more room is left for discussing the language points in the text.

As the group of pupils is different, how has this affected the work of the language teacher? Usually, with a non-CLIL group of pupils, much of any language teacher's effort with beginner students is directed towards the learning of vocabulary. Also, the early development of basic listening and reading skills needs much attention. In addition when talking about 'We Finns', the courage to say something – anything – in a foreign language needs some conscious support (we seem to have an international reputation of being a reserved and non-talkative nation!) In a CLIL class, all these seem to pose no problem. The pupils obviously get enough practice in these areas outside the formal English lessons. So many of these physical and mental efforts, that in a normal class are put into the learning of these basic skills, can be directed in a CLIL class to other activities. Clearly some new thinking is called for here.

The language teacher's work has indeed changed with the introduction of CLIL, the major motivation for the changes being the following up and supporting of the pupils' activities with the form teacher. The actual work I have done differently with the CLIL class includes things like:

- 1 reinforcing the vocabulary to suit the current topics in CLIL;
- 2 introducing points of grammar much in advance when compared to the regular class, e.g. the comparison of adjectives, the past tense, the *s*-genitive plural;
- 3 more practice on the use of available study material, like dictionaries and phonetic transcription;
- 4 more acting, tape recording and videotaping;
- 5 writing short stories at quite an early stage;
- 6 introducing more vocabulary in almost everything we do;
- 7 using English with complex structures quite freely.

In addition to the differences in the classroom work, there has been a marked increase of co-operation with the form teacher in planning the lessons and even teacher exchange.

These 'innovations', then, seem to fall into two main categories. Firstly, I have done basically the same kinds of things as with the peer group, but only **more and more elaborately**. Secondly, I have **speeded up** the handling of the topics in the curriculum so that, for example, the past tense, which is normally a part of our sixth form curriculum, is now introduced and practised significantly earlier, in the fourth form. Since there has been no pre-ordained language curriculum available for this kind of CLIL group, I have been quite free to follow the pupils' day-to-day needs, keeping however the normal third and fourth form syllabuses as the core of studies. Indeed, in purely logical terms, these two ways of doing things differently, viz. **more** and **faster**, are the most obvious ones, while still waiting for a possible new language pedagogy altogether for these kinds of CLIL students.

Quite another situation may lie ahead in the future. Both our own experience and comments in personal contacts and in literature (Nikula and Marsh 1997) suggest that as the overall fluency and courage of expression get better, the grammar remains almost as poor as with the peers in the regular class. This again is as might be expected from a method that lays such an emphasis on language as primarily a means of communication; it is true that more often than not the basic message does come through, with a good knowledge of vocabulary in spite of a poor knowledge of grammar. The latter does not seem to improve automatically as a by-product of being exposed to language use. So, is there now a case for more grammar practice in the language lessons, just as we have got used to organising such communicative activities in the class where the sharing of information, not the grammar, is the foremost concern?

However, our own experience so far at this early stage of CLIL suggests the opposite, a need for a language teacher to encourage each and every pupil, in the class to take an active part in communication, no matter how small. Whereas some pupils are swift in using their language potential, others still need to be put into the situation where they express themselves.

There are, of course, the same kinds of problems facing the language teacher as there are for the CLIL form teacher, the availability of suitable teaching material being one and the question of evaluation being another. Finally, from the language teacher's viewpoint, it is clear that the development of the pupils' language skills is highly dependent on the form teacher's language abilities. The richer the teacher's expression, the more the pupils will benefit from being in a CLIL class. We have been very fortunate in Salo in that both our form teachers, though not native speakers of English, are well at ease with the language, and also know the Anglo-American culture well.

References

- Canale M (1983) 'From communicative competence to communicative language pedagogy' in Richards J C and R W Schmidt (eds) *Language and communication*, London: Longman
- Krashen S (1982) *Principles and practice in second language acquisition*, New York: Pergamon Press
- Losanov G (1978) *Suggestology and outlines of suggestopedy*, New York: Gordon and Breach
- Nikula T and D Marsh (1997) *Vieraskielisen opetuksen tavoitteet ja iötuttaminen*, Helsinki: Opetushallitus
- Romu A and S Sjöberg-Heino (1999) 'A practitioner's perspective on bilingual teaching in Alhaisten Primary School' in Masih J (ed) *Learning through a foreign language: models, methods and outcomes*, London: CILT
- Swain M (1993) 'The output hypothesis: just speaking and writing aren't enough' in *The Canadian Modern Languages Review* 1: 158-164
- Vaurio L (1990) 'Sanapäätelyn opettamisesta ja harjoittamisesta englannin kielessä lukiosteella' in Tommola J (ed) *Foreign language comprehension and production*, Turku: AFinLA Yearbook: 189-198
- von Wright (1996) 'Oppimisen tutkimuksen opetukselle asettamia haasteita' in *Kasvatus* 1: 9-21

History and geography through French: CLIL in a UK secondary school

Michael Ullmann | Hockerill Anglo-European School,
Bishop's Stortford

Introduction

Though interest in bilingual education is increasing across Europe, bilingual sections are rare to find at the best of times and are almost unheard of in the United Kingdom. Even those schools which claim to have a bilingual section often embrace the term more than the concept through running short, modular courses taught partially in the foreign language. The recent coinage of the acronym CLIL (content and language integrated learning) is in many ways an appropriate way of dealing with the many interpretations given to bilingual teaching, and I shall occasionally refer to this all-embracing term during the following explanation of how a *section bilingue* was born, and how it operates with some success at our state comprehensive school. I shall also speak in more general terms on the many issues involved when trying to introduce CLIL into the curriculum, although this too will be based on my own experiences at Hockerill, where other subjects are taught through the medium of the French language.

96

Hockerill's rationale

Bilingual sections do not just happen; they need considerable planning. But, above and beyond this, the teachers involved must wish for the concept to become reality. They must feel committed to setting up a curricular innovation which could revolutionise the school. There must be a fundamental reason, a rationale, for wanting this key step to be taken. Colleagues can easily be led to believe that such a step is simply an 'empire building' device of modern linguists. After all, which other area of the curriculum could be accused of planning a total takeover of another discipline's curricular provision? Whether it be the linguists, who are considering teaching history and geography through French, or humanities teachers teaching their subject through French, colleagues may well feel concerned and upset, so the rationale must belong to the whole school. There should be a gut feeling and burning desire to improve learning through innovation, even if in the process some sacrifices must be made.

The Hockerill model was thought out some six years ago when I took over the Modern Languages Faculty. As so little seemed to be happening in this vital area, with staff morale rock-bottom and pupil interest nil, there seemed to be nothing to

lose in suggesting a totally new and challenging initiative. Hockerill was at that time a microcosm of what was happening in many parts of the United Kingdom regarding the malaise and aversion that many people had to learning another language.

The rationale therefore was easy to put forward, and won immediate support from a staff full of francophiles and francophones, who felt quite excited at paying at least lip service to the concept of a European dimension. At this early stage, everybody wanted to embrace the idea of CLIL, even if key issues had still to be addressed.

Main factors to consider

There are many major issues involved which need careful consideration, and I am outlining here those from the experience of Hockerill that I consider to be of paramount importance, and without which a successful bilingual section could not have been set up.

A supportive senior management team

Whatever your enthusiasm, little can be achieved without the total support and commitment of the senior management team (SMT). There are questions of curriculum, staffing and resourcing which are of crucial importance, and which require much more than the lukewarm approval of the SMT. At a previous school, I had suggested the creation of a bilingual section and received a very positive reaction from the headteacher, who rather liked the sound of the term, rather than what it involved. When I suggested that more than the average allocation of French lessons would be necessary to raise the general standard of language competence before embarking on a CLIL approach, his face dropped and he had to admit that the broad curriculum of which he was so proud would have to be slightly trimmed and that, he felt, was impossible to do. Instantly the idea had to be shelved.

97

A new *esprit* needs to exist within the whole establishment for bilingual education to be established, and this needs to permeate down from the top.

The support and enthusiasm of the teaching staff

Strong leadership and clear support within the modern languages faculty are essential once the green light has been given from above. Whether the more customary British model of modern foreign languages (MFL) teachers doubling up as humanities specialists, or the more desirable alternative of bilingual humanities teachers is chosen, committed linguists need to be at the forefront of the experiment. Success will not be maintained if the idea belongs to one or two interested parties. If there is solidarity and dedication among the linguists, this will make it simpler to convince more doubtful colleagues of other subjects.

Teaching other disciplines in French (or any foreign language) requires a commitment from the whole staff, and an understanding that existing teachers of those disciplines may have to accept that French speakers teach their subject to members of the bilingual section through the medium of the foreign language. Ultimately, assuming

that humanities is the chosen area, new humanities appointments may well be bilingual, so that the delivery in French is given by specialists.

Criteria for any future appointments should include linguistic competence, so that the *section bilingue* may gradually be extended to other areas of the curriculum. What may start as an MFL/humanities initiative could quickly develop and involve interested colleagues from other disciplines. Existing staff must not feel threatened, but need to be made aware of the overall benefits to the school and the pupils. Visits to establishments with bilingual sections will need programming and, initially, visiting speakers from successful sections or researchers could be brought in. If handled sensitively, this could lead to a transformation of the international climate within the school and this must naturally begin with the teaching body.

Convincing parents and pupils

Once again, if this is managed with care, most parents and pupils will be very excited at the prospect of being part of a relatively unusual teaching experience, which already has an excellent track record throughout Europe (see Baetens Bearsdmore 1993 and Fruhauf, Coyle and Christ 1996). It would be worthwhile, as with the staff, bringing in youngsters and staff from existing sections to promote the idea. There may be problems explaining the idea to the present cohort of pupils, but as the change is phased in, one would hope to see an increasing awareness of how a bilingual section can benefit the whole school, and the old mentality should gradually disappear. Parents will need explaining that examination boards will almost certainly dig their heels in and ultimately prevent the chosen subjects from being examined in French, but that even if one reverts to English, results will only be affected in a positive sense and the language skills will have been acquired anyway (see Coyle 1996).

In time, when the plan becomes reality, the nature of Year 7 (and other years') applications will change considerably, as the school will appeal to those interested in the international dimension and to those parents wishing their children to receive tuition of other subjects through a foreign language. At Hockerill, the nature of our intake has changed dramatically since the bilingual section opened, and we are now taking in pupils from across the road, across the Channel and across the world, who are here primarily because of the international dimension and the bilingual section. This in itself provides us with new challenges, as many more parents wish their children to be in the bilingual section than there are places. Quick decisions will have to be made which include the possibility of extending the section more across the ability range.

Curriculum implications

This is a huge area and involves the support of senior management and the goodwill of all the staff. At Hockerill, geography and history are taught in French to the top 35–40% (one group) of each year in Years 9 and 10 (ages fourteen to sixteen). Each school must make its own decisions on how to structure bilingual teaching and consider:

(a) to whom it should be delivered (a top, express group/mixed ability/whole year?)

This is of course a thorny issue as it is normally felt that only good linguists can benefit from a bilingual education. However if target language teaching becomes the norm in all classes – and we are aiming to achieve this at Hockerill – then pupils below the top group may well be able to cope with a limited amount of bilingual work.

(b) which subjects will be taught (humanities, science?) and to what level (Key Stage 3, GCSE?¹)

It is assumed that the humanities area lends itself to the CLIL approach more readily than other parts of the curriculum. However, schools wishing to embark on small modules of bilingual work may find it easier to take the more instructional and creative subjects of PE, art and music, or use the existing personal and social education (PSE) multilingual package, rather than aim at the more ambitious academic subjects.

History and geography are also chosen because resources are relatively easy to find in other European languages. The GCSE history syllabuses, for example, on the twentieth century match the French programme perfectly, and the source-based learning which is the modern way of interpreting history is as commonplace across the Channel as in the United Kingdom.

Science is a distinct possibility as another subject to teach through the medium of a foreign language, as there already exist a number of excellent packages such as Science Across Europe.² Originally, teachers thought that science was a non-starter, but there seems to be a growing feeling that there is mileage in experimenting with the subject, providing that quality teachers can be found.

There are now courses available in Britain to teach bilingual teachers of other disciplines, notably under Do Coyle's guidance and supervision at Nottingham. The sooner more interest is shown in encouraging the development of such programmes, the quicker CLIL can succeed in more than isolated pockets of the country.

(c) from which year (starting in Years 8, 9³?)

Some schools feel that the sooner pupils become exposed to French-medium learning, the better, and feel they can begin in the second year at secondary school. Of course, there are many examples from Europe and North America of successful examples of total immersion from a very early age (Lebrun and Baetens Beardsmore 1993; Cummings and Swain 1986). However, a British school considering setting things up should ensure that the pupils have a sufficiently high standard of French first. I believe Hockerill's model of two intensive years of exposure to the target

1 The English National Curriculum for compulsory education is divided into four Key Stages from ages 5–16. The General Certificate of Secondary Education (GCSE) is the examination taken at the end of Key Stage 4. The GCSE is graded from A* to F.

2 There are currently nine units in ten languages available for collaborative international school projects. Science Across Europe, The Association for Science Education, College Lane, Hertfordshire AL6 9AA. saw@bp.com

3 Approximate ages 13–15.

language, culminating in a three-week class-to-class exchange at the end of Year 8 as a final preparation for the bilingual work at the start of Year 9, is appropriate.

(d) in what form (modular, alternate lessons, whole curriculum?)

The well-used analogy of starting with a small mountain and perhaps moving higher, perhaps staying still, justifies even a very modest amount of CLIL in a school. If a school cannot offer more than a single module of science taught over half a term with one class, that school is still achieving so much more than the vast majority of schools in Britain. Exceeding this would put you in the tiny and *avant garde* group of educational establishments doing the most progressive type of developmental work.

(e) by whom (language specialists, humanities/science specialists with French?)

This has already been dealt with. What is the ideal and what is the most realistically possible are two separate things. Having staff keen to 'have a go' and confident at enthusing pupils is, basically, priority number one. However, it is likely that a French-speaking specialist would feel more comfortable in the classroom, although here too, such a specialist may have to take a page out of the linguist's copybook and use MFL methodology so that the language delivery is appropriate to the learners' understanding (see Coyle *ibid*: 168–170). Clearly, humanities specialists who are struggling to cope with the demands of the foreign language can be as ineffective as linguists attempting to teach sophisticated historical and geographical concepts, while barely skimming the surface.

It is clear that we are talking about interdisciplinary skills – those peculiar to the humanities specialists and those peculiar to the language teachers, and the happy marriage of the two, would produce a bilingual teacher par excellence. Once again, adequate training to prepare these teachers is required in Great Britain before we can claim to be among the leading practitioners in bilingual education. More training establishments should follow Nottingham's example!

(f) whether extra time needs allocating for French teaching, particularly in the preparatory years prior to the bilingual input.

A pre-requisite for setting up a *section européenne* in France is a minimum of three hours' teaching of English per week. This would be recognised in most countries as a minimum, although in Britain it is regarded as a fairly generous allocation of time for the delivery of a foreign language. The anecdotal example of the headteacher who wanted a *section bilingue*, without allocating a reasonable number of lessons to the teaching of the target language, serves to underline the lack of a reasonable entitlement of language provision here. A head may argue that English, maths and science are the key core subjects here with languages relegated to the lower level. In France, the native French language, maths and the first foreign language dominate, so the difference in mentality largely explains the curriculum bias against languages here.

Resourcing

Resourcing also, of course, includes staffing, which has been dealt with above, but for learning materials, textbooks need to be purchased directly from France. In Year 9, our

National Curriculum does not really match the French programme, and in Hockerill, as it is the first year of true bilingual teaching, we provide relatively easy books to supplement the comprehensive notes, worksheets and vocabulary lists which are prepared. In Year 10 history, the programme matches and the textbooks used are those used in France. What is more, there is an impressive array of videos from which to choose in French shops, such as FNAC, and in war museums such as the Mémorial at Caen, there is a really huge choice of videos, books and memorabilia. Naturally, care must be exercised in choosing resources which are appropriate to the class in question. This material should be used to supplement the notes, and not as textbooks in their own right, as firstly, the French do not go into the necessary detail on the covered topics, and secondly, the use of language can sometimes prove to be very difficult if the textbook is to be the only source book used.

In geography, with an entirely different methodology, the buying of resources remains a constant problem. The National Curriculum allows for more conventional geography to be taught in Great Britain, and for this purpose material is available from French bookshops at a basic, intermediate or higher level. However, once in Year 10, the emphasis on geographical concepts rather than geographical detail makes matching up very difficult. French textbooks contain studies of nations and their economies, and do not cover such subjects as the environment. Consequently, apart from a few specialist books on themes such as water, volcanos and pollution, one is left with little option but to make up one's own notes, worksheets and transparencies and even translate British texts. Naturally, videos and television programmes can be used to cover geography, but one can sympathise with the frustrated bilingual geographers who look in envy at the wealth of material available to their history counterparts.

Resourcing is expensive, but there are ways savings can be made. As our French partner school was having a general clear-out we managed to obtain 65 invaluable textbooks, all in good second-hand condition, at no cost. As well as the resourcing of textbooks, maps, posters, realia and, of course, video material need to be brought in, as the setting up of a resource bank is crucial.

Examination and certification

There is a constant battle being fought between the determined, progressive and innovative bilingual sections and the rather conservative, traditional examination boards who refuse to move on the issue of whether their examinations can be conducted in French. Hockerill, like the other sections, have written to all the main boards and even suggested translating the paper and finding appropriate examiners at the school's expense, as the boards have always claimed that the experiment would not be cost-effective. However, no progress has been made on this front. After a while, the pupils do need to be convinced that what they are doing is still of considerable value, even if the final revision period and examination itself must be conducted in English. It would be sad indeed and quite an indictment on our parochialism and lack of imagination if the few schools who have taken the bold step of introducing a CLIL approach into their curriculum had to stop their experiment for such fundamentally illogical and short-sighted reasons.

The practice

The Hockerill bilingual section came into being in September 1993, when the first cohort of Year 7 pupils entered the school. They have been through the entire process of learning French at a rapid pace for two years. Their progression is: on to a class-to-class exchange in Year 8; starting history and geography in French in Year 9 and continuing into Year 10; doing other exchanges and trips to France in Year 9; doing some work experience in France, just prior to sitting their French GCSE in Year 10 (results: 21 A or A*, 4 B grades and 1 C grade); and following an AS¹ course in Year 11 before sitting their GCSE history and geography in English. We opened our sixth form in September 1998, and many of the group have continued their language study with the introduction of the International Baccalauréat.

The present Year 9 and Year 10 pupils from the *section bilingue* are all doing their humanities work in French, and most pupils are gaining benefit from the experience. We are fortunate in having an increasing number of international students who are coming to our school for the sole purpose of jumping on the bilingual band-wagon.

The outcomes

Our own staff, parents, pupils and visitors, including several researchers, are quite convinced that the experiment (which is now the norm in the school) has succeeded. As with all ventures, fine-tuning is required and some basic curriculum modifications still have to take place. The fact that language specialists are still being used to deliver the humanities programme means that they too must don a humanities hat when assessing the work of the pupils. It was very tempting in the early days to base marks on the correctness of the French at the cost of the content. Now, although key grammar errors such as tenses, which are of vital significance in history, are corrected, the emphasis is on marking the history and geography and teaching these skills. Consequently, it is soon clear that the students who are natural linguists have to learn a new ball-game, and are not automatically the best in the humanities subjects.

On the contrary, some actually struggle while other students, who find the basic French language demanding, cope much more easily in geography or history. These phenomena are particularly marked in our school where there are a number of francophone students, some of whom find history and geography really hard in whichever language they study them.

The success of the scheme has meant that we will now be offering, initially, history to middle-ability pupils for the first time, and therefore dispelling the myth that bilingual work is the prerogative of the academic elite.

1 Post-compulsory education in England leads to a number of qualifications including A level (usually three subjects studied over two years at ages 16–19) and AS (equivalent to half an A level studied over one year).

What the pupils think

People who know little about bilingual education assume that learning history or geography through French could:

- (a) provide the learners with unnecessary burdens of comprehension because of the added difficulty of learning through a foreign language;
- (b) be detrimental to their study of the humanities;
- (c) be a pointless exercise, as the examination will probably be conducted in English anyway.

I interviewed pupils from Years 9, 10 and 11 to ask them generally about their bilingual education, and specifically about these points so often cited by sceptics. Their obvious enthusiasm for what they have been doing and their positive responses should provide a real rebuff to critics, and give encouragement to schools about to embark on bilingual education. The key points made by the pupils were:

1 Concentration

Because of the concentration – you have to listen – you can't let your mind wander because of the language. After a while you don't notice you're doing it in a different language. (Redzi Mangwana – Year 11)

You have to pay more attention or you don't know what's going on. If I don't understand it's because I don't concentrate all the time not because of the language. (Ollie Biobaku – Year 9)

103

2 Learning of humanities skills: do they suffer?

They have definitely been enhanced. They don't change because you're doing them in a different language. (Redzi Mangwana – Year 11)

My history wasn't going anywhere but now I'm A/B borderline so it's definitely improved a lot. (Jonathan Holden – Year 11)

At the beginning I was quite sceptical because I thought my geography and history would suffer but no, it hasn't, and I think it's got better. (Lianne Moule – Year 10)

You don't take it as the language. The lesson is more history or geography. (Glenn Weber – Year 9)

3 Having to sit the exam in English

The French phrases come quite naturally to us and now it's going to be hard going into English. (Jonathan Holden – Year 11)

I'd much rather the test was in French. (Glenn Weber – Year 9)

4 It's been a bonus and a challenge

You learn the history and geography but you learn it in French so you get the bonus of learning French as well. (Alex Warsop – Year 10)

I'm continuously learning the history and geography and the French is just a bonus on top. (Glenn Weber – Year 9)

I've really enjoyed the history and the geography. It is like a challenge. (Lianne Moule – Year 10)

People can say they've learnt history and geography. They can't really say they've learnt it in French and that is an achievement. (Ollie Biobaku – Year 9)

The future

I remember seeing a BBC *Horizon* (1983) programme some years ago showing how naturally children throughout the world communicated in a variety of languages, and had little problem learning different subjects in different languages. The *Intertalk* video (1997) (and the subsequent *Teaching with foreign languages* video (1998)) is in some ways an updated version of this programme. However, there was a short part of the original programme which featured what the British were, or rather were not, doing. The programme, made in the early 1980s, featured no bilingual sections as they were virtually non-existent at the time. Instead businessmen from the City of London, some of the country's financial elite, were asked in basic Year 7 French whether they could speak the language. The answers were abysmal and the commentator went on to cite examples of British companies losing valuable business because of their failing to understand foreign orders. One company had gone into liquidation, and as the receivers were looking through paperwork, they found that what would have been the company's largest ever order had been ignored because it had been in a foreign language.

This video greatly influenced my thinking and made me realise that future generations need to become more than competent in foreign languages. Bilingual education would have to become the norm and not the exception. CLIL must become more than just a trendy acronym.

There is nothing special about being bilingual. Three quarters of the people on this planet speak more than one language and few of them boast about their talent. It is quite natural for inhabitants of Europe's smallest countries to speak two, three or more foreign languages. However, Britain has been slow off the mark and too few schools are prepared to take the risk of trying out something which even the pupils will soon find is quite natural.

Conclusion

To become and remain globally competitive, the British must start taking language learning seriously, go beyond communicative methodology and plan to take on the

mantle of content and language integrated learning. We at Hockerill took that brave step a few years ago and there are no regrets. Now, pupils and staff are applying in increasingly large numbers to sign up for bilingual education, and become part of a type of teaching which should soon be gaining momentum throughout the world. We could be on the verge of the most exciting developmental work to have hit European education since the war.

At a time when the European Community is gaining in credibility, it is an opportune moment to narrow the linguistic and cultural gaps which remain, raise the expectations of our pupils, and aim at something which has been tried and tested with considerable success across the globe. CLIL may still be just a concept at the moment, but could revolutionise education as we know it, if only politicians and educationalists throughout Britain and the rest of Europe have the vision and courage to implement it throughout our schools.

References

- Baetens Beardsmore H (ed) (1993) *European models of bilingual education*, Clevedon: Multilingual Matters
- Coyle D (1996) 'Language medium teaching in Britain' in Fruhauf G, D Coyle and I Christ (ibid): 155–176
- Cummings J and M Swain (1986) *Bilingualism in education* London: Longman
- Fruhauf G, D Coyle and I Christ (1996) *Teaching content in a foreign language: practice and perspectives in European bilingual education*, Alkmaar: European Platform for Dutch Education
- Horizon* (broadcast 31/10/1983) *A child's guide to language*, British Broadcasting Corporation
- Intertalk—Plurilingual Education across Europe* (1997) Promotional video available from the Continuing Education Centre of the University of Jyväskylä, PL 35, 40351 Jyväskylä, Finland
- Lebrun N and H Baetens Beardsmore (1993) in Baetens Beardsmore H (ibid)
- Teaching with foreign languages* (1998) produced for the BBC Learning Zone, London: CBEVE

School subjects in a foreign language: a decade of success in Hungary

Dr Anikó Bognár | Karinthy Gimnázium, Budapest

Introduction

The Hungarian education system has been subject to restructuring for many years, during which there has been much change in the means and methods of foreign language learning.

The Education Act (1993) saw local initiatives integrated into new legislation, which led to the redefinition of primary and secondary education. The borders between the two educational levels have changed. Now, some pupils may enter secondary education at the age of ten or twelve, others at fourteen. In this paper I will describe the successful restructuring of foreign language learning for secondary students aged fourteen to nineteen (with some reference to younger cohorts).

A background to foreign language learning and teaching in state education and the current situation

The political situation has always had a determining effect on foreign language teaching and learning in Eastern Central Europe. This fact has to be considered when looking at the present situation of foreign language education, especially as the structure of it has not changed as radically as has, for example, the choice of languages and materials on offer.

Between the end of World War II and 1989, Russian was the compulsory foreign language in schools in Hungary and in Eastern Europe. Almost all students started learning it at the age of ten in the fourth or fifth grade of primary education, and had at least four years of study of it there, and another four years in secondary schools. Thus, Russian was the number one foreign language. However, after eight years of compulsory learning of the language, the knowledge of the vast majority of the Hungarian population was hardly above survival level in Russian. For obvious reasons (educational and non-educational ones), the synonym of total failure in language education in Hungary has been since then: teaching Russian to Hungarians: a fine example of counter-motivation in education. In the first year of secondary education (ninth grade of schooling), students started the second foreign language,

generally a western European one such as English, German, French, Italian or perhaps Spanish. This was studied for four years.

In 1989 Russian ceased being the compulsory foreign language. Naturally, everybody wanted to start learning other languages, creating the problem of finding teachers for western European languages. One solution seemed to be to turn Russian teachers into English ones for example, preferably overnight. Teacher training for modern foreign languages became a national priority and is still a burning problem in Hungary.

At present, most pupils in primary education start their first foreign language in the fifth grade, while some begin in the third grade with a second foreign language introduced in the fifth grade. Students in academic secondary schools are obliged to study two foreign languages. Only a small number of secondary vocational schools offer foreign language education, but where this is available, one foreign language is compulsory. While German is the first choice in primary, English is that in secondary education. (See Table 1.)

Language		English	German	Russian	French	Spanish	Italian	Other	Total
School type	Primary, first foreign language	277,404	346,460	12,661	8,874	312	1,804	2,708	650,223
	Primary, second foreign language	18,950	13,135	1,180	1,526	86	826	5,058	40,761
	Secondary vocational (one language compulsory)	98,045	92,612	5,244	8,189	0	0	0	204,090
	Secondary academic (two languages compulsory)	112,097	88,525	12,756	19,806	0	0	0	233,184
	Vocational	7,556	26,790	0	1,548	0	0	0	35,894

107

Table 1 | Students learning foreign languages 1995/96

Changing foreign language teaching and learning at secondary level

Both first and second foreign languages have usually been taught in three lessons per week as a basis. From 1970, two more lessons per week could be given in specialised classes. There were schools/classes where specially authorised programmes had six, nine or even sixteen lessons a week (the latter ones were very special cases in Russian, later in English and French). Since 1982 these programmes have spread more widely. Now, most schools not only give three lessons a week in a foreign language, but the students can add two more as an optional course, or three and even six more if they specialise in the language.

The present National Core Curriculum conveys the most commonly accepted values and aspects of human knowledge and skills in general. The foreign-language curriculum specifies the general aims of foreign language education, providing a set of requirements with respect to the four language skills, and functions in accordance with the norms set by the educational authorities of the European Community. This Core Curriculum is expected to serve as a framework for the elaboration of syllabuses for each foreign language. For the time being, it only requires one foreign language to be learnt before the age of sixteen. If students pass the State Language Examination of the Hungarian Foreign Language Examination Board, they can be exempted from the foreign language component of the final matriculation exam, with the best mark, after the twelfth grade.

Teaching languages for special purposes (LSP) has also gained far more weight in state education. A great variety of courses and materials appeared on the market. Schools have offered, for example, business English or English for tourist guides to help students in their future jobs. Relevant materials have been developed inside and outside Hungary, often through the collaboration of native and non-native speakers of the target languages.

Outside the foreign language classroom, the expansion of satellite television channels and the increase in tourism have helped greatly to improve students' language competencies. In 1987, the Ministry of Education established fifteen bilingual secondary schools, where five subjects were to be taught in the target language (history, geography, mathematics, biology and physics) after an initial year of language improvement of twenty foreign language lessons per week. Bilingual instruction has been extremely popular, expressing a public demand for intensive language learning and the method is spreading like wildfire, creating a real problem of finding good teachers for it.

108

Teacher education for modern language teaching in Hungary¹

Pre-service and CETTS

Due to the already described primacy of the Russian language, even as late as 1988/89, only 3% of primary school pupils and less than 20% of secondary school pupils had the opportunity to learn English, by then the most popular foreign language. This low percentage, interestingly, was not fully reflected in the pre-service training of foreign language teachers.

With the disappearance of Russian as the compulsory foreign language, the road opened for the other major foreign languages. State education, on the other hand, was not ready to meet parental and pupil demands, which far exceeded the supply of qualified foreign language teachers. Just for the provision of proper English and German teaching, 10,000 teachers would have had to be trained as fast as possible.

All universities with faculties of humanities, as well as teacher training colleges, provided diploma and degree programmes for teachers of foreign languages, particularly in English, German and Russian, less so in French, Spanish, Italian and in lesser known languages.

¹ With thanks to Péter Rádai, Assistant Director, Centre for English Teacher Training, Eötvös Loránd University.

The training followed a rather old-fashioned model, in which – mostly double-major – students were obliged to focus their studies on literature and linguistics, and on the acquisition of the highest level of proficiency in the foreign language. Methodology components were treated as being of minor importance, and graduates often entered the profession with an unacceptably brief spell of teaching practice.

The traditional university-level (five years) and college level (three to four years) initial teacher training programmes could not meet these demands. The action the Hungarian government took intended to handle the problem on two fronts:

- (1) A large number of teachers had to be trained in a preferably short time at pre-service level. From 1990 onwards, several universities and teacher training colleges set up the so-called Centres for English Teacher Training (CETTS) and their German counterparts, later followed by one such centre to supply teachers of French.
- (2) Thousands of teachers of Russian, who suddenly found themselves superfluous, had to be retrained to become fully qualified teachers of another foreign language, in most cases English and German.

Even more universities and colleges with language departments took part in the so-called re-training programme for Russian teachers (a three-year initial teacher education programme of the in-service type, common to most or all ex-Soviet-block countries). This programme, which ceased to exist in 1998, has arguably relieved the dire shortage of foreign language teachers. Its motivational implications cannot be underestimated either, since graduates of the programme now proudly claim that they have managed to keep their jobs, obtained another degree in foreign language teaching and thus gained more confidence and self-esteem.

Table 2 provides an outline of the various pre-service programme types (including some of their special features) in operation in Hungary in 1996/7.

Level of teacher training	Length of studies	Length of teaching practice	Degree (expressed in internationally accepted terms)	Level qualified to teach
University	4–5 years	15 hours + observation (observation may start in year 3)	M.A. in English, French, German, Russian, etc.	Primary Secondary Tertiary
3-year programmes (CETTs and German Centres)	3 years	3 months > 1 year (includes observation)	B.Ed. TEFL or equivalent in teaching German and French	Primary Secondary
Upper primary teacher training college	4 years (double majors)	2 months + observation (observation and limited teaching in year 3)	B.Ed. in upper-primary foreign language teaching	Upper primary (10–14)
Lower primary teacher training college	4 years (double majors)	4–6 weeks in final year + observation and teaching in year 3	B.Ed. in lower primary foreign language teaching	Lower primary (6–10)

Table 2 | Pre-service teacher training programmes in Hungary

INSET

Pre-service teacher training and In-service Training (INSET) have always been fairly strictly separated in Hungary. Higher education institutions have not been officially associated with INSET, which has been provided mainly through a network of local pedagogical institutions. Although foreign language teachers were encouraged to take part in INSET, no moral and financial incentives have been offered apart from meaningless certificates. Courses and sessions were and are still provided by local experts, foreign agencies (e.g. The British Council, Goethe Institut) and publishers, but mainly to a small section of the most highly motivated core of the teaching population.

The major criticism about most of these attempts is that they lack full professional co-ordination, since the basis for this INSET provision is mostly what expertise is available locally, instead of what expertise teachers would need to improve their teaching. This remains true, even though teachers of the most popular foreign languages have already formed their own associations (or pressure groups). However, such initiatives have achieved very little in trying to represent professional demands of, and career opportunities for, foreign language teachers.

At last in 1997, the Hungarian government initiated several programmes which intended to ultimately change this (so far) unsatisfactory system. Teachers who strive for even higher degrees and professional competencies are eligible for a number of Ph.D. programmes in applied linguistics, which shows the acknowledgement of the profession of foreign language teaching at the highest academic level. In addition to this, a number of Hungarian language teaching professionals involved in all levels of teacher education have registered for and completed M.Ed. or M.A. courses at foreign universities, thus ensuring an international perspective on both foreign language teaching and teacher education.

Plans to offer teachers a menu for nationally accredited and certified, but not necessarily university- or college-provided INSET, courses and programmes which took effect from September 1997. The main aim of this new scheme is to involve the largest possible number of teachers in long-term professional development, thus ensuring that the ultimate beneficiaries of teacher education, learners, are provided a higher quality of foreign language teaching. However, none of the above programmes cater for the special professional needs and level of teachers of the language of instruction in bilingual schools.

Teacher training for bilingual education and CLIL

A lot of aspects of bilingual and minority language education teacher training are very similar. However, teacher training is provided only for minority schools, mainly for political reasons. Foreign language teacher training for minority schools in Hungary happens at:

- teacher training college (for kindergarten and elementary students) for Croat, German, Romanian, Slovak;
- university/college courses (for degree students) for Croat, German, Romanian, Slovak, Slovene;

- university/college courses (in-service) for German, Romanian, Slovak, Slovene.

Unfortunately, hardly anything has ever been done in any language for CLIL, except for participants in Council of Europe workshops.

As mentioned, there is no provision for language specialisation for CLIL teachers. However, subject-teacher training for bilingual schools has been developed for almost ten years in Hungary. First, however, we had to learn the hard way that the best method to find good teachers for the subjects taught in a FL is to train them in the country, rather than import native speaker teachers. Also, subject teachers' language awareness should be raised rather than language teachers' competence of school subjects. In other words, it is more effective to teach biologists good English than to train EFL teachers in biology so that they could teach the language of biology well enough.

There are different types of teacher training projects:

- 1 university-based programmes such as at Budapest University Faculty of Science which provides a five-year course for science students and in-service courses for subject teachers;
- 2 foreign language departments of different universities – re/further training of subject teachers;
- 3 summer courses and conferences organised by: USIS, British Council, French Institute, Goethe Institut;
- 4 school-based support for raising language awareness of subject teachers with:
 - lesson observation (by native speakers, TL teachers);
 - acquisition of foreign teaching materials;
 - acquisition of foreign reference materials (e.g. lexicons, periodicals, magazines, audio- and videotapes);
 - availability of the Internet;
 - job-related extracurricular work (e.g. translation, supervision);
 - attending conferences;
 - study trips with/without students;
 - staff exchange programmes.

Content and language integrated learning in Hungary: programmes and materials

Teaching began in bilingual academic secondary schools in 1987, when fifteen such schools started on the first year of their content and language integrated learning (CLIL) programmes with English, French, German, Spanish, Italian and Russian being the languages of instruction or target languages (TL).

The aim of bilingual instruction is dual. Not only are the students expected to study all these subjects through the medium of the foreign language, but also are equally encouraged to excel within the sphere of each separate academic discipline. Thus the

process of learning foreign languages is not for its own sake; the knowledge of the foreign language is not the aim but it is the means of acquiring further knowledge. In this way, higher standards can be achieved, both in the target languages and the subjects (with the right kind of students). As the biblical proverb says, 'Palms grow better under pressure'.

Since 1987 the number of schools offering CLIL has increased. See Table 3.

Year	School	Student	Students' number/studied language					
			English	German	French	Russian	Spanish	Italian
1994/95	46	6,434	2,054	2,517	815	287	327	434
1995/96	38	6,538	2,005	2,703	864	230	338	398
1996/97	44	6,959	2,086	3,103	880	166	334	390

Table 3 | Schools, student numbers and target languages

There are two types of programme over four and five years of secondary education.

A wide range of subjects is taught in the target language(s) in schools with the bilingual streams. Three subjects are compulsory for a school to be bilingual. Academic subjects taught in foreign language (FL) in different vocational schools in Hungary are mathematics, chemistry, physics. Vocational subjects taught in target language in different vocational schools in Hungary include computing, engineering, hotel and catering, guiding and tourism, trade and commerce. Other subjects taught in the target language in different types of schools in Hungary include art, music, and history of art.

In the Karinty Frigyes Gimnázium, where English is the TL, the following subjects are in English: (following the national programme) history, geography, mathematics, biology, physics, computing and physical education. In the International Baccalauréat programme the following subjects are taught in the TL: history, geography, mathematics, biology, physics, computing, chemistry, psychology, philosophy, environmental studies and theory of knowledge.

Five years

Then as now, students were selected from among several hundred applicants on the basis of their success in an objective entrance examination, designed to measure their academic potential. Inevitably, this examination has ensured that the schools receive students of high ability and potential for academic growth.

A knowledge of the TL, however, is by no means a prerequisite for successful entrance to the bilingual programme. In fact, only a small proportion of the students arrive at the schools with reliable experience of some foreign language instruction in the TL from their primary years. Hence, during their first year, known as the zero year, all students are required to take part in a highly intensive language course consisting of twenty foreign language lessons a week. At the end of this first essential stage of their education, a very sound knowledge of the foreign language should be acquired.

In their remaining four years at these schools, students must study the core subjects on the Hungarian curriculum: mathematics, history, geography, physics and biology.

Four years

The subjects for CLIL are the same, but in the schools offering these programmes, previous studies in the primary years and intensive preparation/additional periods provide the foundation knowledge of the TL. The additional TL study can take the form of:

- four weeks in the summer before the first year are spent with 30–35 language lessons per week;
- initiation language programmes organised for three to four weeks of the first year;
- weekend studies all year (eight hours of language instruction every Saturday);
- every summer, two to four weeks of intensive language course.

The curriculum is arranged according to Table 4 (p114). A comparison is made here between the mono- and bilingual programmes.

Potential and actual problems with implementing CLIL

Both parents and teachers had reservations with this new programme in education. Some of those, and the subsequent experience, were the following:

- knowledge of the subjects taught in a TL would suffer. This has proved unfounded given the current level of acceptance into university (see Results section);
- university acceptance would be endangered (unfounded as above);
- students would leave bilingual schools for monolingual schools, having learnt the target language well enough and free of charge, thus creating problems for school management at the higher grades. This has also proved unfounded.

Some anticipated problems which have been found:

- students would be assessed in subject classes by their knowledge of the TL, rather than their knowledge of the subject. This is indirectly founded – if/when the message in the subject suffered due to lack of TL competence;
- either mother tongue or first language would suffer;
- native speaker teachers, brought in to teach on the bilingual lines, would not know the local requirements in the subject matter, even in the TL.

In addition to these, there are two resource deficiencies which affect the development of CLIL:

- a lack of foreign language teacher training for the target language. This shortage is particularly acute for proficiency level foreign language teaching in general. There is no training for teachers of language improvement at university language departments either;

	Number of lessons per week by year						
	0	1st	2nd	3rd	4th	All years	Normal section
Subject							
Target language	20*	5**	4	4	5	40	20
Hungarian language	3	1	2	1	1		
Hungarian and world literature	0	2	2	3	3	18	17
CLIL Subject							
Mathematics	1	4	3	3	3	14	13
History	0	2	2	3	3	10	10
Geography	0	2	3	0	0	5	5
Physics	0	2	2	3	2	9	9
Biology	0	2	2	2	0	6	6
Chemistry	0	2	2	2	0	6	6
Technical workshop and computing	2	0	0	0	2	4	4
PE	3	3	3	3	3	15	12
Second foreign language - German, French, Spanish or Russian	0	4	4	4	0	12	12
Philosophy	0	0	0	0	2	2	2
Music	1	1	1	0	0	3	3
Art	1	1	1	0	0	3	3
Form-teacher's lesson	1	1	1	1	1	5	5
Compulsory lessons	32	32	32	31	25	153	
Optional extra lessons	0	0	0	4	4	8	
Total	32	32	32	35	29	160	129
# of lessons in normal section	0	32	32	33	30	129	

* = 16 EFL plus 1 language of maths, 1 language of physics, 1 language of history, 1 language of geography

** = 4 EFL plus 1 language of biology

Table 4 | Distribution of lessons in bilingual academic secondary schools (students' age: 14–18/19)

- insufficient financial support: bilingual education is expensive because there are smaller groups of students in the subject classes taught in the target language, thus more teachers and rooms are needed. Very well-trained teachers are needed, but these are difficult to keep in the very underpaid profession.

An 'evergreen' problem debated in language education on the whole is the native versus non-native speaker as teacher. It is even more relevant in bilingual programmes. Experiences in Hungarian CLIL of the plusses and minuses of native versus non-native speaker teachers include:

 Native speaker plus points

- Has knowledge of current usage
- Has 'novelty' value for motivation
- Is an authentic model
- Has positive cultural baggage (from gestures to latest hits)
- Is a resource for non-native speaker colleagues
- 'Confidence inspires confidence'
- Provides 'perfect communication' in the FL without access to students' mother tongue
- Has more modern approaches (?)
- Emphasises teaching of writing skills (more important in English-speaking world than in Eastern Europe)

 Native speaker minus points

- Is ignorant of the local culture
- Has potential to clash with institutional requirements
- Has lack of commitment – 'back-pack' teachers who come for a short stay (?)

 Non-native speaker plus points

- Knowledge of students' L1 thus:
 - empathy
 - intimacy with students' problems: cultural, personal, linguistic
 - language learning strategies
 - experience as language learners
 - contrastive-comparative methods with L1
 - awareness of difficulties of interference
 - anticipation thus prevention of difficulties
- Can teach in translation
- Better teaching of grammar
- Better teaching of pronunciation
- Greater percentage of trained teachers
- Preference by some levels/age-groups of students
- Knowledge of institutional culture from schools to national exams

 Non-native speaker minus points

- Lack of confidence
- Over-concerned with accuracy
- Obligation to follow institutional style

122

Results through CLIL

The aims of bilingual projects are obviously ambitious, and have demanded a high degree of commitment from both the students and the teaching staff involved. However, on completion of the programme (that is: since the graduation of the first intake after five years of study in the bilingual line), we have been more than satisfied with the results of the combined efforts. On average, between 65–100% of final year students of bilingual schools are accepted by institutions of higher education, a figure which compares very favourably with the success-rate obtained by the best schools in the country. Indeed, many of the most prestigious universities have given their recognition to the value of the bilingual project by awarding extra examination points to students completing the programme.

Conclusion

Has the ten years of CLIL education been worth it in spite of all the difficulties and costs? Emphatically the answer is yes because in bilingual education:

- cognitive improvement is at its best;
- development of tolerance and receptivity for multicultural values is at its best;
- it is easier to learn any other/more languages;
- awareness of the mother tongue is greater;
- involvement in the international languages of science starts at an early age; it is thus easier to integrate into the international scene of that professional field and the international job market.

References

- Bognár A (1995) *Report*, Workshop No. 4/95 European Centre for Modern Languages, Graz
- Bognár A, (1997) *Report*, Workshop No. 20/97 European Centre for Modern Languages, Graz
- Medgyes P (1996) 'Chapter 1: foundations' in Malderez A and P Medgyes (eds) *Changing perspectives in teacher education*, Oxford: Heinemann

Task design in the bilingual secondary classroom

John Clegg | Education Consultant, London

Balancing the language and cognitive demands of the lesson

Students in the bilingual classroom are doing two jobs: they are acquiring subject-matter knowledge and at the same time mastering the language which is the vehicle for that knowledge. This means that considerable learning demands are being made on them. If both cognitive and linguistic demands are heavy, it is unlikely that they will learn much: they will simply not have the mental processing capacity available.

Cummins (1984) uses what has now become a familiar diagram to show how these language and cognitive demands need to be balanced in order for bilingual students to be able to develop on both fronts.

By 'context-embedded/ reduced' Cummins means, broadly speaking, that the task which the student is doing is linguistically easy/difficult depending on the degree to which information is communicated by means other than language, for example by means of visuals of all kinds, objects, body language, facial gestures, etc. A student working in a science class, doing a practical experiment, using a textbook which

contains few long texts and many diagrams, and with a teacher who speaks clearly with lots of examples and puts diagrams and charts on the board, is using language which is well-embedded in context. Using Cummins' diagram to measure the difficulty of bilingual classroom tasks, we could say that a task in quadrant B would be very difficult, whereas one in quadrant C would be linguistically easy but possibly not challenging enough. A task which is difficult linguistically ought to be adjusted by the teacher to make it cognitively

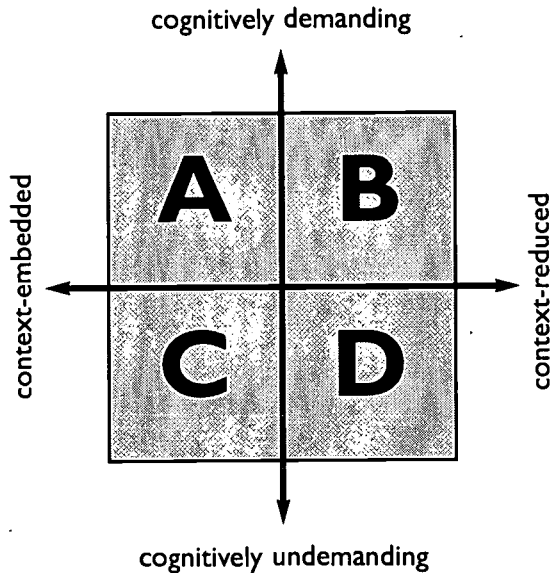

easier (quadrant D), and one which contains a lot of new concepts ought to be handled in familiar language (quadrant A). There are many ways of regulating this balance. Teacher-talk – and how understandable it is – is one; the use of visuals and especially the board, is another. Here, I will concentrate on supportive task design.

By referring to a task as ‘supportive’, I mean an activity found in a textbook or produced by the teacher, to reduce the language or conceptual demands of the work in hand. Such tasks are not language tasks *per se* but subject-related tasks which take language into account. In language terms, they may be orientated to reading, writing, listening or speaking. Here, I will take the example of reading.

To make a reading task accessible to bilingual students, subject teachers can – on the model shown above – either make the task easier cognitively or easier linguistically (in practice, these dimensions overlap somewhat, but it is useful for this discussion to treat them as separate). To do the former, they might, for instance, reduce the number or complexity of the things which the student must do to complete the task, a gap-filling exercise might have some of the gaps already completed or part-completed, or a reading exercise might require the student to find three items of information only, rather than read the whole text. Here, however, I will focus on reducing the language demands of the activity, partly because this is what subject teachers in bilingual classrooms are less often able to do, and partly because this approach allows us to tap a rich source of task-types.

Reducing the language demands of tasks

One can make activities linguistically easier by pre-teaching difficult language – making sure, for example, that before an activity, bilingual students have learned the key vocabulary. Subject teachers, however, may not have the time or the language knowledge to do this. They may find it easier to adopt the other main way of reducing language demands – that of using visual, rather than linguistic means of communication. The most common way of making demanding language visual is to ‘visualise’ concepts. A scientific concept, for instance, might be shown on the board by diagram; science textbooks, in common with those of many other subjects, tend to do this as a matter of course without bilingual learners in mind. Another approach, which has for a long time had a following among teachers of ESOL/EAL (English for Speakers of Other Languages/English as an Additional Language) and subjects alike, is to ‘visualise’ the structure of discourse (Clegg 1996; Mohan 1986; Hooper 1996). It is to this latter approach that this paper is largely devoted.

Text structure and knowledge structure

Texts have a structure. The structure depends on the function which the text serves. Texts in school tend to perform a limited but commonly recurring set of functions. For example, they classify, define, hypothesise, compare, contrast, draw conclusions, give and support opinions, describe sequences of events or systems or objects, etc. It may be that some of these functions of school language are cross-curricular, whereas others may be more characteristic of certain subjects. The most useful way to recognise the function of a text is to perceive certain linguistic signals. A children’s story, for instance, will be

marked by signals of time sequence (*once upon a time, then next, after that, at last, etc.*). A sequence of events in history is also marked by such time connectors (*before ..., following ..., after 1918, eventually, etc.*) as well as by the use of certain past tenses. The description of an experiment in science is also likely to contain such words and phrases indicating the sequence of events in the experiment, but will also perform other functions such as describing apparatus (*we used a ... and a ...*), recording results (numbers), drawing conclusions (*so, we can see from this ..., what this means is ...*). All these functions are recognisable by the reader in one way or another. Sometimes the signals are clear, as in the example of time connectors above. Sometimes they are more hidden.

It is important that students perceive what a text is doing, i.e. what function it fulfils, as well as what it is about, i.e. the topic. There are various linked reasons for this: one is that these functions of school language are the representations of basic forms of thinking which we expect students to learn to do in school. Discourse structure – which is something we can see – is, in other words, closely related to knowledge structure – which is something we cannot see, but which is what school is all about. Thinking about the world in scientific ways is one of the main things which students in school are supposed to do. When we describe the contents of syllabuses, for example, we use these terms (*define, classify, analyse, describe, give an example, say why ... etc.*); we do the same when we write examination questions.

Another reason why students should be aware of discourse functions is that, since these forms of thinking are so fundamental to schoolwork, teachers use them over and over again in their lessons. Most of what teachers talk about (when they are 'on task'), what textbooks write about and what students are required to say, read and write, falls into this limited class of cognitive acts. So getting students to become familiar with these ways of thinking means ensuring that they have a knowledge of the patterns of the discourse structures, when they see them in textbooks or hear teachers using them. Often (and perhaps with negative consequences for learning), we do not teach them, but we do assume students know them.

Perceiving the function of a text may sound over-abstract. It is perhaps more palatable to talk of perceiving its structure – the way it is organised. This is the surface representation of the textual function. There are two ways in which we can help students perceive the structure of a text. One is by drawing their attention to the signals which mark it, and the other is by making it visual, that is, representing it graphically. Making text structure visual is hugely helpful to students learning in a second language. A text is a mass of words: you cannot, by simply looking at it, 'see' the structure of knowledge which is contained within it. You have to read it, which may be very demanding – for any pupil, but especially for learners working in a second language. If you make the text structure visual, however, it allows the contents of the text to appear far more directly. It cuts through the language and goes straight to the heart of the knowledge structure. Again, this useful for all students, but especially for those in bilingual classrooms.

To summarise, if we want to help students to read a text, we should be drawing their attention to two aspects of it: firstly the linguistic signals which mark its organisation, and secondly the graphic form which can represent it. Table 1 shows some linguistic signals and graphic representations of common school ways of thinking/language functions.

Discourse functions	Typical language	Graphic representation
Classifying	There are three kinds of ... For example ... First, there is Then ... A (frog) is an (amphibian) (Crocodiles) are different from (alligators)	
Giving examples	For example For instance Let's take an example	
Defining	A (plumber) is a (man who ...) A (rake) is a (tool which ...)	
Describing place	prepositions of place, location, relation, etc	map, route, diagram
Contrasting	... is different from is more .../bigger than ... whereas, but nevertheless, however, in contrast on the one hand ... on the other hand	
Comparing	... is like/similar to has/doesn't have is as big as ... likewise, similarly, in the same way	
Describing number, proportion, etc	lexis of number	types of graph
Describing a sequence of events	first, then, next, finally when, as soon as, after + specific tenses	
Cause and effect	because, that is why consequently, so, thus, therefore	
Hypothesising	If ... (then) ... + grammar of if-clauses	
Describing objects	lexis of descriptors, characteristics, etc	diagram, picture 

Table 1 | Discourse functions: typical language and graphic representations

Making text structure visual

Let us look at an example of representing text structure visually in Figure 1 from *Reading and thinking in English: discovering discourse* (British Council 1979). The text has a clear structure: the first paragraph describes three operations performed on milk; the second describes five stages in the processing of milk and names the purpose of each of the first three stages. This structure is shown visually in the task by means of a chart: the students read and fill in the chart. How do they perceive what to write in each box? By looking for the textual signals which mark the discourse structure, e.g. *three different operations*; *grading, weighing and sampling* and repetition of these items; the repetition of *then* for sequence and *to* for purpose.

Looking now at the text in Figure 2 (Pople 1994), you may recognise that the structure of each paragraph is similar. Each describes a human activity related to the environment, why we carry out the activity and a damaging consequence of the activity. Some paragraphs contain further information, such as examples and further consequences. This information structure is marked in each paragraph by headings in bold and linking words, mainly *but*, *and* and *so*. These are clearly constructed paragraphs – not all textbooks are written like this! An appropriate graphic form for the key information in this text might be a matrix, as in Table 2, though there are obviously other forms this graphic could take.

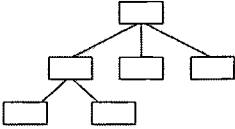
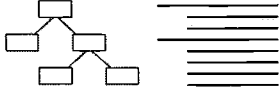
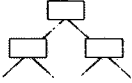
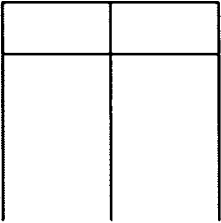
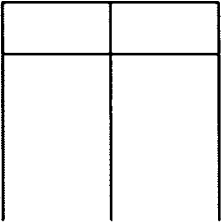
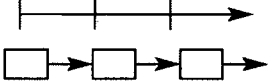
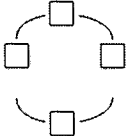
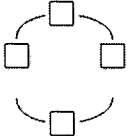
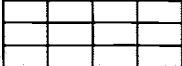
Milk processing

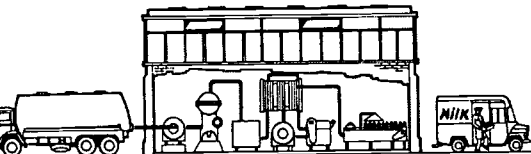







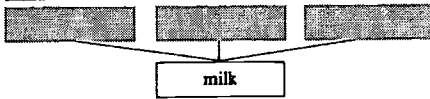

Milk is first received at the milk plant where three different operations are performed on it: grading, weighing and sampling. It is graded by examining it for abnormal odours and flavours. The milk is weighed by emptying it into a tank on scales. A sample of the milk is then taken and tested for butterfat.

The milk then flows to a clarifier whose purpose is to remove foreign material and sediment. The clarified milk may then be homogenized to prevent cream formation. The homogenized milk is then pasteurized to destroy all pathogenic bacteria. The pasteurized milk is cooled to 50°F or below. The cooled milk is then ready for distribution.

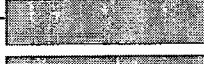
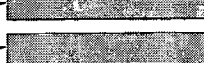
1 Using information in paragraph 1, complete this diagram to show the operations performed on milk.

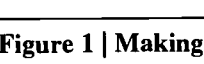

2 Using information in paragraph 2, complete this diagram to show each stage and its purpose.

THEME	STAGE	PURPOSE
milk		
clarified milk		
homogenized milk		
pasteurized milk		
cooled milk		

© British Council (1979) *Reading and thinking in English: Discovering discourse*, Oxford University Press: 43

Figure 1 | Making text structure visual

Populations and pollution

The world's human population is growing. As it does so, it needs more crops, meat, wood, fuels, and minerals. This is causing problems for other populations, and for humans as well:

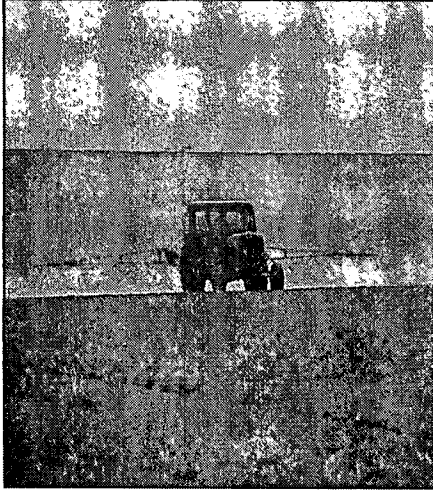

Using fertilizers To help crops grow, chemical fertilizers are often sprayed onto soil. But they can be washed into lakes and rivers, where they encourage the growth of green, plant-like algae. Microbes feeding on dead algae use up all the oxygen in the water, so fish and other organisms die.

Pesticides These are chemicals sprayed onto crops to kill off insects and other pests. But they can build up in the bodies of birds which feed on the pests. And they can also be washed into lakes and rivers.

Cutting down forests Huge areas of forest are being cut down for timber, or to make space for agriculture or industry. But trees supply the world with some of its oxygen. And they provide shelter for many forms of wildlife. When trees are removed, the soil is easily eroded (worn away), and large areas of ground can be turned into desert, or bog if it is wet.

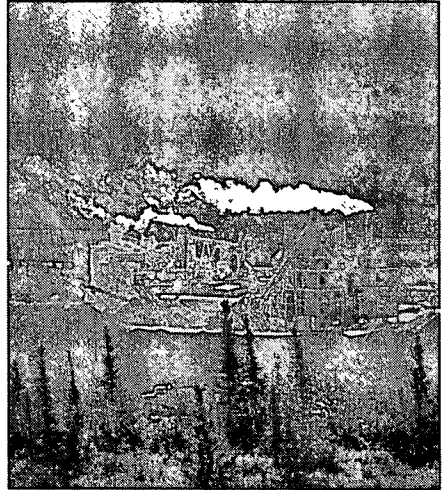

Digging up land Industry needs fuels and other materials from the ground. For example, huge amounts of limestone (above) are needed for making concrete. And limestone is also used in the manufacture of steel and glass. But mining and quarrying damage the landscape. They can also produce huge heaps of waste materials. Some of these contain poisonous metals which can harm plants.

Fishing Fish is an important food for millions of people. But if too many fish are taken from the sea, there are not enough left to breed. Soon, the fish die out altogether.

Crops Farmers find it more efficient to grow single crops in huge fields. But cutting down hedges destroys the habitats for many forms of wildlife. And pests which feed on the one crop can flourish.

Pople S (1994) *Science to 14: summary book*,
Oxford University Press: 38.

By permission of Oxford University Press.

Figure 2 | A school science text

Activity	Purpose	Consequence	Further consequence
Using fertilisers	to help crops grow	encourage algae in lakes	use up oxygen fish die
Pesticides	kill insects	1 build up in the bodies of birds 2 washed into rivers	
Cutting down forests	for timber/to make space for agriculture	1 reduce oxygen 2 reduce shelter for wildlife 3 soil is eroded, turned into desert/bog	
Digging up land	for fuel and manufacturing	1 damage the landscape 2 produce waste materials	poisons harm plants
Fishing	for food	not enough fish to breed	fish die out
Crops	farmers grow single crops	1 cutting down hedgerows destroys habitats 2 pests can flourish	

123

Table 2 | A graphic representation of the key information in the text in Table 3

Reading support tasks

What is the connection between textual structure and reading support for students in bilingual classrooms? If making reading easier means reducing the language demands of the reading activity, then one key way of doing that is by making the information structure visible. Graphic representations of information structure strip away the language from the task – not wholly, but to a considerable extent. The student can understand the information without having to fight a battle with the text – and possibly losing it.

Clearly, graphic representations of knowledge can actually short-cut language and text. Teachers can use them to avoid facing students with the problem of reading. That may sometimes be useful, but not in the long term. What I am proposing here is that they be used as reading support tasks; in other words, students read the text and perform an activity. The graphic acts both as a way of helping students to get information out of complex texts, and to acquire gradually the skill of reading them.

Tasks such as these can be found in some schoolbooks, and especially in materials published for the bilingual classroom; but by and large, teachers will need to create them themselves. Here, problems will have to be faced: for instance, the texts they use may not be as clearly written as the two examples above, and may thus not lend themselves so easily to this form of 'visualisation'. Alternatively, they may be well-written but not clearly marked by linguistic signals; and students will have to work a little harder to see their structure. In addition, busy teachers may not have the time to make tasks like these; in which case, it will be useful to bear in mind that some are easier to make or put on the board than others.

'Read and do' tasks of this kind can take various forms; in what follows, four of the commonest are outlined, together with notes on their use. The tasks are shown in the Appendix.

Read and fill in a diagram

The teacher needs to make a text structure diagram to fit the text. Students read the text and fill in the diagram. It can be partially completed to make it easier. The first example (Appendix, Task 1) shows a text with a time-sequence function and comes from Bates and Dudley-Evans (1976). The second (Appendix, Task 2) shows a text with a classifying function and comes from *Reading and thinking in English: discovering discourse* (British Council 1979).

124

Read and sequence

This requires a text with a time-sequence or cause/effect function. The teacher cuts up the text; the students sequence the parts. Alternatively, students number the sentences in their correct order. The organisation of the text should be well-enough signalled so that the students can work out the sequence. The example in Task 3 (Appendix) comes from Diana Wells of the Hounslow Language Service, London and shows a time sequence in history. The example in Task 4 (Appendix) comes from David Smith of the Islington Language Service London SPEAL project.

Read and make notes

This can be used for texts with a variety of functions. The teacher prepares a note-taking outline; the students read and fill in. An example is Task 5 (Appendix) which is intended to accompany the text from Waugh and Bushell (1993).

Read and match

In the example from geography in Task 6 (a sequence of events), students match sentence beginnings and endings (Biederstaedt 1994). The category could also include matching sentences with visuals, headings with paragraphs, etc. The issue of where to split the sentences requires care on the part of the teacher. The science example in Task 7 comes from Roach et al (1990): students read, match and sequence.

Conclusion

I have focused here on graphic representations of text structure as one type of reading support task. There are many more types which teachers will be familiar with (e.g. gap-filling, underlining, answering questions, etc). I have also focused on using text structure to support reading; it can also be used to support listening, speaking and writing skills. I have suggested that support tasks of this kind are normally reproduced in worksheets; but they can easily be written on the board, as long as they are not complex and do not take too much time.

The important thing is that they should be used by subject teachers, and seen by them to be part of the repertoire of a subject teacher, and not exclusively as language tasks. One implication of this is that they should not demand too much language knowledge on the part of the teacher; some demand more than others and may less easily become part of the subject teacher's repertoire. Another implication is that they should be quick to make. Again, some can be made more quickly than others. These kinds of task are widely used by teachers of ESOL/EAL and are common in published materials for bilingual schools. It remains to be seen to what extent subject teachers in these schools will make them their own.

References

- Bates M and T Dudley-Evans (1976) *Nucleus: general science*, Harlow: Longman
- Biederstaedt W (1994) *Around the world*, Berlin: Cornelsen
- British Council (1979) *Reading and thinking in English: discovering discourse*, Oxford University Press
- Clegg J (ed) (1996) *Mainstreaming ESL*, Clevedon: Multilingual Matters
- Cummins J (1984) *Bilingualism and special education: issues in assessment and pedagogy*, Clevedon: Multilingual Matters
- Hooper H (1996) 'Mainstream science with a majority of ESL learners: integrating language and content' in Clegg J (ed)
- Mohan B (1986) *Language and content*, Reading, MA: Addison-Wesley
- Pople S (1994) *Science to 14*, Oxford University Press
- Roach T, D Smith and M Vazquez (1990) *Bilingual pupils and secondary science*, Hounslow: Hounslow Language Service
- Smith D, *SPEAL project: materials and their properties*, London: Islington Language Service
- Wagh D and T Bushell (1993) *Key geography: interactions*, Stanley Thornes

Addresses

Hounslow Language Service, Hounslow Education Centre, Martindale Rd, Hounslow, Middlesex TW4 7HE, UK

SPEAL Project, Islington Language Service, Barnsbury Complex, Offord Rd, London, N1 1QF, UK

Appendix

Task 1: Read and fill in a diagram: time sequence in science.

The heart-lung machine

The heart-lung machine is used for maintaining the circulation and oxygenation of the patient's blood. It consists of an artificial lung, pumps, tubes and devices for controlling the heat and filtering the blood. The artificial lung serves to oxygenate the blood, which is diverted from the vena cava before reaching the heart.

On leaving the vena cava, the blood enters a plastic tube and flows down this until it enters the artificial lung. This is a horizontal glass cylinder which is partly filled with blood. It contains rotating steel discs. After the blood enters the cylinder it forms a thin film on the surface of the discs. This enables the blood to absorb oxygen, which is pumped through the cylinder. The oxygenated blood subsequently passes through a heat regulator and a filter before returning to the patient's body circulation.

Now answer these questions:

- a) What does the artificial lung do to the blood?
- b) What is the function of the heat regulator?
- c) What does the artificial lung consist of?
- d) Why is the blood able to absorb oxygen?
- e) Look again at paragraph 2, and complete this chart showing stages in the movement of blood through the heart-lung machine.

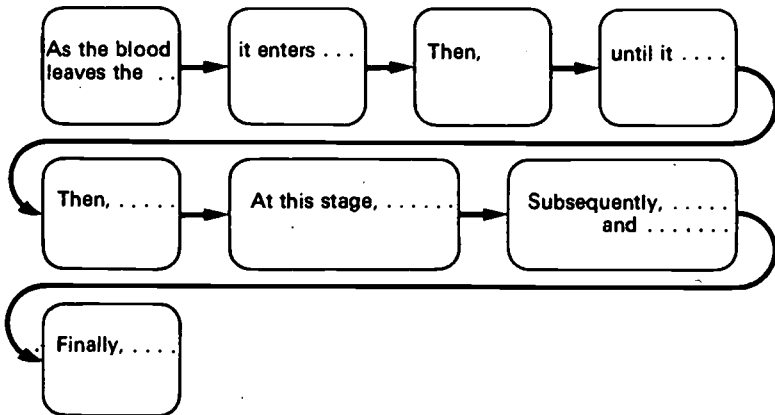

Bates M and T Dudley-Evans (1976) *Nucleus: General science*, Longman: 55.
 Reprinted by permission of Addison Wesley Longman Ltd.

Task 2: Read and fill in a diagram: classification in science

1 Read the whole passage rapidly in order to answer these questions concerning specific details:

- a What is the proportion of carbon in the earth's crust?
- b Where are diamonds found?

2 Read the passage again paragraph by paragraph in order to answer the comprehension questions. Use the language study questions in the margins to help you understand the paragraphs.

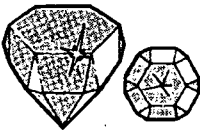

CARBON

Carbon is a solid non-metallic chemical element (symbol C) occurring in the pure crystalline form as¹ diamond and graphite. It is also found in the combined form as a constituent of all organic materials, including coal and petroleum,² and of inorganic compounds such as limestone and baking powder. Despite its wide distribution, carbon constitutes only 0.19 per cent of the earth's crust.

1 Summarize the paragraph by completing the following diagram.

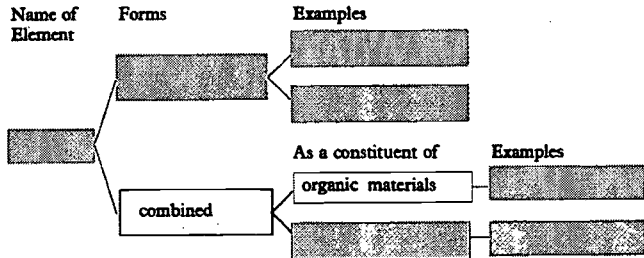

- ¹ as here means:
- a in the form of
 - b since
 - c similar to.

- ² This means:
- a carbon includes coal and petroleum.
 - b organic materials contain coal and petroleum.
 - c coal and petroleum are examples of organic materials.

The two elementary forms of carbon³ have very different properties. In diamond the atoms are so tightly bound one to another that it provides man with his hardest⁴ known substance. On the other hand, the second crystalline form of carbon, graphite, is a soft black substance with atoms hexagonally arranged in parallel sheets.⁵ Each

³ Which are the two elementary forms?

⁴ Hard is the opposite of
⁵ is the opposite of right.

Task 3: Read and sequence: time sequence in history

Henry II and Thomas Becket

Question 4: Chronological order: what happened first?

Becket is made Archbishop of Canterbury by Henry.

Henry decides to make up the quarrel.

Henry loses his temper when he hears news of this.
Four knights travel to England.

King Henry wants priests to be tried for crimes
in the king's law-courts, not tried by the church courts.

Becket's character changes: he becomes more serious
and holy and refuses to do what Henry wants.

Becket returns to his position in Canterbury.

Becket expels from the church all the clergy (priests)
and the barons who support Henry in the quarrel.

The quarrel between Henry and Becket is so bitter
that Becket goes to stay in France.

- a** Decide which events happened first, second, third and so on.
- b** Number the events 1-8.
- c** Underline the verbs e.g. wants.
- d** Write out the eight sentences in the past tense.

With permission from Diana Wells, Hounslow Language Service

Task 4: Read and sequence: process in science

Fractional distillation in the laboratory

a) Label the picture with the names and functions of the parts

Names:

crude oil	thermometer	water	delivery tube
boiling tube	Bunsen burner	petrol	collecting tube

Functions: (there are only six)

shows temperature of vapour	heats the crude oil
carries vapour to collecting tube	cools and condenses the vapour
A mixture of useful substances	a pure, useful substance

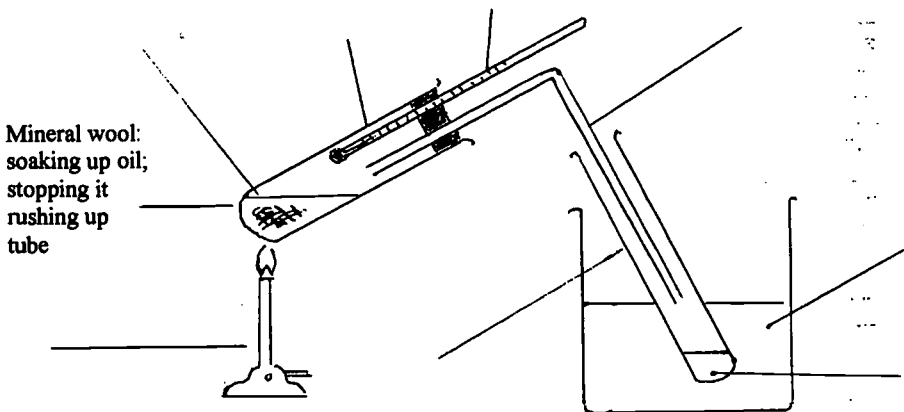

b) Sequence these sentences:

- Petrol evaporates from the crude oil.
- The crude oil is heated until it reaches 80 degrees C.
- The vapour condenses to give petrol in the collecting tube.
- The petrol vapour passes along the delivery tube.
- A sticky black substance is left in the tube.
- These other substances are collected one after the other.
- At higher temperatures, other substances evaporate.

129

Task 5: Read and make notes: description in geography

Giving aid

Aid is a way for _____
to help _____

Aid is given in two ways:

1 _____
This helps solve immediate problems like
disasters and emergencies

E.g. _____

2 _____
This helps people increase _____
and use _____
better

Problems caused by aid:

1 Some aid projects are too big: they damage
the environment and are difficult to manage

E.g. _____
2 Others spoil local traditions

3 Some do not reach the people they were
intended for

E.g. _____

because _____

One way to help countries develop and improve their living standards is to give them aid. Aid is a form of help. It is a practical way for wealthy countries to help poorer countries. It can be given in two main ways.

- The first is as **short-term aid**. Short-term aid helps solve immediate problems. It brings help quickly to people affected by disasters and emergencies. Floods, earthquakes, volcanic eruptions, famine and even wars are some of the events that bring about a need for short-term aid.
- The second is **long-term aid**. The aim of this type of aid is to improve basic living standards and enable people to make better use of their own resources. Long-term aid should help a country progress and improve its overall level of development.

Aid can be given in many different ways. Some of these are shown in diagram A.

Giving help to others can bring many benefits but it can also cause problems. Some aid projects, for example, are so large that they damage the environment and are too big and complicated for local people to manage. The Aswan Dam in Egypt is one such example. Others cause people to change their lives too much and spoil the traditions of the area. Some forms of aid even fail to reach the people for whom they were intended. In Somalia, for example, some of the food aid sent there never reached the millions of people who were dying of starvation. This was partly due to a lack of transport but also because of civil war in the country.

Great care has to be taken in providing countries with the right kind of aid. A well thought out and carefully planned programme can help to provide the building blocks for a country's future. Cartoon B shows the kind of aid which is most likely to bring benefits to a country and help its poorest people.

Waugh D and T Bushell (1993)
Key geography: Interactions,
Stanley Thornes: 90

130

Task 6: Read and match: sequence of events in geography

Match the heads and tails below to explain the following diagram.

WHY DESERTS ARE FORMED

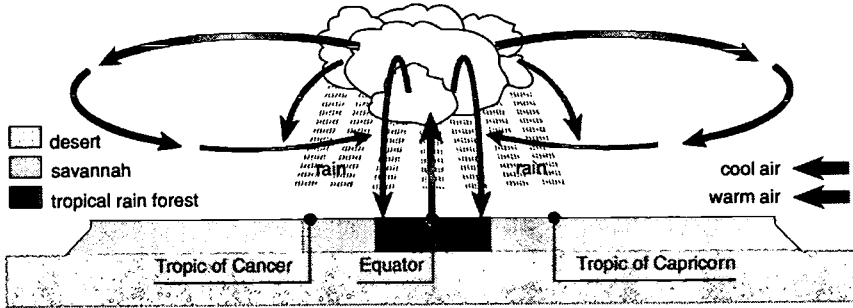

HEADS → **TAILS**

The large deserts are all ...
 When the moist air over the equator
 is heated, ...
 The warm, moist air moves ...
 As the air cools down, the water
 vapour condenses and ...
 Large masses of air sink ...
 But now these air masses ...
 Dry winds blow across ...
 Because the wind that passes over
 the Sahara is dry, ...
 The heat of the sun ...

... falls as heavy rain over the
 tropical rain forests of Central
 Africa.
 ... are dry.
 ... there are no clouds or rain.
 ... the deserts towards the equator.
 ... it rises.
 ... beats down on the ground with
 nothing to block its rays.
 ... where deserts are located.
 ... about the same distance north
 and south of the equator.
 ... north towards the Sahara and
 south towards the Kalahari.

131

Biederstädt W (Berlin, 1993) *Around the world*, Cornelsen Verlag: 41. Reprinted by permission.

Universal language, body and voice

Jim Wingate | Language Education Consultant

This paper describes a workshop which will explore ways of communicating any concepts, any new words and any subject matter at any level. It will train your body and voice to be more expressive in order that you can then communicate subject matter, information, technical terms and concepts much more effectively as a teacher. We look at left-brain and right-brain learning, and teaching with reference to body and voice. We explore techniques your learners can use to make them more effective using their body and voice and making 'Whole-brain notes'.

These techniques come from *Learning another language through actions* (Asher 1996), *Suggestology and outlines of suggestopedya* (Lozanov 1978), and *Righting the educational conveyor belt* (Grinder and Grinder, 1989) and through experience of teaching science, drama and sport through English in international schools (ages three to eighteen) and teacher training in bilingual programmes in seven countries.

133

True story one: become it

The chemistry teacher complained: 'They can't understand even the basic differences between solids, liquids and gases! When I ask questions on what I've explained again and again, they just look blank!'

The visiting teacher said: 'Give me a minute. OK girls and boys, stand up. Come here to this space. Be a solid ... Be a liquid ... Be a gas ... Be a liquid ... Be a gas ... Be a solid ... Be a gas ... Be a liquid ...' The pupils had no problems acting out together the structural strength of solids, the fluidity of liquid, the free movement of gas molecules. Then the visiting teacher whispered to the chemistry teacher: 'Now, ask your questions', and the pupils answered correctly and with motivation.

Insight 1

V.A.K.

It is not enough just to explain. The best teachers enable their learners to **experience** the subject matter, to be it, to become it. Such experiences are automatically *V* = visual (something to see), *A* = audial (something to hear) and *K* = kinesthetic (something to do or sense or feel or have feelings and emotions about).

Insight 2**What is communication?**

Of communication, only 7% is just the words. This means that 93% is **not** just the words. The 93% is the voice (38%), plus body language (55%). Your learners **are already experts** at 93% of communication. The best teachers **use** the 93% (of voice and body, which the learners are already experts in) to communicate the 7%, the new words, concepts or subject matter (Mehrabian 1996).

True story two: algebra

'I can't do maths' said the low ability-teenage pupil from the low ability-class. The visiting teacher questioned the pupil to find an area of maths the pupil hadn't studied yet. Algebra. The pupil said: 'I've never done algebra. People say it's very difficult.'

The visiting teacher took the year's coursebook for algebra. He turned to the final algebra problem on the final page and showed the pupil how to solve the problem. The teacher paused and showed the pupil again. Then the teacher said: 'Turn to the first problem at the beginning of the book. Solve that one, then the next, then the next and so on. I'll be sitting here if you want to ask any questions.'

The pupil asked no questions. He just solved problem after problem until, in 40 minutes he'd finished the whole year's book of problems correctly solved. 'I've finished', he said. The visiting teacher said: 'Have you got any questions?' 'Yes', said the pupil, 'I've got one question. Why do people say algebra is very difficult?'

Insight 3**The subject as a whole**

The human brain is designed to encounter the world, a language, a subject **as a whole**. By analysing a subject into tiny parts, then feeding each tiny part to pupils step-by-step, we disable the pupils, preventing them using the marvellous ability of their brains.

Teacher activity A

Here are the specialised functions located in each half of the brain. Look through and tick (✓) those you like.

Add up your ticks. Are you more left-brain than right-brain, or are you more right-brain than left-brain? (Don't worry, there's no correct answer.)

Insight 4**Words and concepts**

The **words** are located in the left-brain, the **concepts** are made up of connections between both sides of the brain.

Using your whole brain

Skills associated with hemispheric specialisation:

LEFT HEMISPHERE

✓ if strong

- Handwriting
- Symbols
- Language
- Reading
- Phonics*
- Locating details and facts
- Talking and reciting
- Following directions
- Listening
- Auditory association

TOTAL

* meaningful sounds

** awareness of the position and movement of your body

RIGHT HEMISPHERE

✓ if strong

- Haptic** awareness
- Spatial relationships
- Shapes and patterns
- Mathematical computation
- Colour sensitivity
- Singing and music
- Art expression
- Creativity
- Visualisation
- Feelings and emotions

TOTAL

Source: *Unicorns are real* by Meister-Vitale (1982)

Table A

Teacher activity B

Now look at Table A again. Write *V* (= visual) next to the visual items. Write *A* (= audial) next to the audial items. Write *K* (= kinesthetic) next to the kinesthetic items (see Insight 1 above).

Visual items	spatial (R), shapes (R), colours (R), art (R), creativity (R), visualisation (R), reading (L).
Voice-audial items	language (L), reading (L), phonics (L), talking (L), listening (L), auditory association (L), singing and music (R).
Body kinesthetic items	haptic (R), spatial (R), shapes (R), feelings and emotions (R), handwriting (L).

Insight 5

Whole-brain
learning

So, if you use *V.A.K.* in all stages of all your lessons, you are automatically using **both** sides of your learners' brains and linking new words with the experiences and the concepts.

Teacher activity C

Take a blank sheet of paper and summarise what you have learned so far in this paper, but please do your summary **using** V.A.K. and your left and right brains. How? Do a mind-map/spider diagram. Why? Because a vertical list of notes is audial only and left-brain only, but a mind-map uses the right-brain because it is visual and, using movement and spatial relationships, is kinesthetic.

Warm-up 1: making every lesson work well 1

What's the topic of your lesson? At the very beginning of the lesson, write the topic on the board, and invite your learners to say words they know about the topic and you write their words (scattered, not in a list, see Activity C). Then you say: 'Which words can you connect?' and they tell you, and you draw lines between the words they connect. Then you say: 'With a partner, make sentences. You can use these words and any other words.' As the noise level rises, before it falls say: 'Stand up, go round shaking hands, saying your sentences and you do the same.' Notice how this is 3-4 minutes at the most and is visual, audial and kinesthetic. You then say: 'Open your books at page ...' and your learners have been prepared for that topic and they **want** that topic, that lesson.

Warm-up 2: making every lesson work well 2

What's the topic of your lesson? Tell a short, personal anecdote on that topic using your voice and body to communicate the meanings. Let it be an emotional anecdote, e.g. 'I like ..., I don't like ...' Then it is V.A. and K. Say: 'Talk to your partner'. Your learners talk on the topic. Say: 'Change partners'. They move and talk again. Notice how this is 3-4 minutes at the most and is visual, audial and kinesthetic. You then say: 'Open your books at page ...' and your learners have been prepared for that topic and they **want** that topic, that lesson.

But how can you make the coursebook **text** V.A.K. too?

Listening activity one – words you like: any text, any level

Lead your learners in a 30-second relaxation, doing it as you say it. (Do **no** pre-teaching of new words or concepts.)

T
o
t
a
l
r
e
l
a
x
a
t
i
o
n

Make yourself as comfortable as you can in your chair.
Put your feet square on the floor if that helps.
Stretch your arms straight out in front of you.
Clench your fists, then relax your fists and drop your arms.
Bring your shoulders up to your ears and drop them.
Let your head go forward, very slowly and gently.
Put it up again slowly and gently.
Then feel your neck relaxing.
Then feel your shoulders relaxing.
Then feel your back relaxing.
Then feel your chest relaxing.

Then feel your stomach relaxing.
Then feel that relaxation going all through your legs to your toes.
Then feel the muscles of your face relaxing.
Then feel your eyebrows relaxing.
Then feel your eyes relaxing.
Then feel your lips relaxing.
Then feel your tongue relaxing.
Then feel your jaws relaxing.

> > > And now: hold your head still and listen.

Then say: 'I'm going to read you a text. If you like, listen with your eyes closed. If you like, listen with your eyes open and watch me. If you watch me, if you like, you can move one hand as I move my hand.'

Notice you have given your learners permission to listen **internally V.A.K.** (eyes closed, seeing, hearing and feeling inside) or **externally V.A.K.** (eyes open, hearing, watching you and doing your actions). You read the text, e.g. ten to twenty sentences, and you gesture the meanings of the key words and new words while you read. Then you say: 'I'm going to read the text again. This time listen for the words you like.' You read the text again, gesturing as before.

Then you say: 'I'm going to read the text again. This time, when you hear a word you like say it aloud.' You read the text again, gesturing as before. Your learners say aloud the words they like as you read. Then you say: '#Tell your partner which words you liked.' Then you say: 'Open your books at page ... and read the text.'

Notice that your learners **want** to read the text. They have listened to the text three times and, with your gestures, they have guessed the meanings of the new words and concepts, or are interested and curious, very familiar with the context and very ready **wanting** to learn the new words.

Teacher activity D

Take a text from your coursebook. Hold the text in one hand. Read the text aloud (as in Listening activity one), gesturing with your other hand the key words and new words.

Notice your **voice** becomes more expressive **because** you are gesturing.

Teacher activity E

When you change your behaviour as a teacher, your learners can think you have gone mad! They **will** think you've gone mad if you suddenly start gesturing as you **read!**

They won't think you've gone mad if you give them a reason, e.g. 'I'm going to gesture as I read to help me to be more expressive' and/or 'I'm going to gesture as I read, to help you to understand.' Practise saying those. Will you say one, or the other or both?

Listening activity two: oral cloze – any text, any level

Mark the text, e.g. a dot under each word which you are going to cloze, e.g. each seventh word, (cloze = miss out). Say: *I'm going to read this text (ten to twenty sentences) twice. The second time, tell me the words I've missed out.*

You read the text replacing the marked words with *uh* or *uh-uh* or *uh-uh-uh-uh*. For example: 'relaxed is *uh-uh*, comfortable is *uh-uh-uh*, began is *uh-uh*', etc. (This is

funny, humorous, so smile and laugh.) You say: ‘Now tell me the words I’ve missed out.’ You read the text again as before but pause for your learners to say the words.

Then you say: ‘Open your books at page ... and read the text.’

Notice that your learners **want** to read the text. They have listened to the text twice, and with the contexts and syllables and stress they have guessed the meanings of the new words and concepts, or are interested and curious, very familiar with the context and ready, **wanting** to learn the new words.

Teacher activity F

Take a text and practise doing Listening activity two.

Insight 6

Focus on the positive

Warm-ups one and two, and Listening activity one and two are all V.A.K. and they focus on the positive, i.e. your learners pay attention to what they **do** know already, their brains work confidently with what they do know already. They therefore feel positive and capable, and they **use what they know to guess what they don’t know**.

Insight 7

Focus on the negative

If, instead, you pre-teach the new words, your learners pay attention to what they **don’t** know. They lose confidence and sit back and let you, the teacher, do all the work.

Insight 8

Three contexts

The human brain understands a new word by experiencing the word in **three** contexts.

Coursebooks give a new word in **one** context.

Your learners therefore say: ‘Explain! Translate!’, i.e. they use **your** brain.

Instead, give your learners **two more** contexts and they will use **their** brains instead.

If you give the three contexts using appropriate actions or gestures, you are communicating the concept V. and A.

If you say: ‘Do this’, your kinesthetic learners will do your gesture K. and therefore experience the concept in the way they need to experience it. (Your visual learners do not need to do a gesture, just to see it).

138

Insight 9

Autobiography

If at all possible, make at least one of the contexts be about yourself = autobiographical for you.

Then, when your learners have heard and understood the new word in several contexts, encourage them to say and write the new word about themselves = autobiographical for them.

Listening activity three: parallel anecdote – any text, any level

In this activity you use three contexts instead of pre-teaching. Don't pre-teach the new words which are in the text. Say: 'I'm going to read you a text, but first I'm going to tell you a story.'

Make up and tell a very brief personal anecdote which **uses** the new words in the text in three contexts each. As you say each new word, do a gesture to communicate the meaning. Then read the text using the same gestures again for the new words. Then say: 'Open your books at page ... and read the text.'

Notice that your learners **want** to read the text. They have heard each new word in three different contexts in your anecdote. They have heard each new word in a fourth context when you read the text. They have seen your gestures. They have understood the new words and the text and read it with confidence.

This is one of the quickest and most effective ways to enable your learners to understand new words.

Insight 10

Variety

If a text is long, use Listening activity one, then two, then three so the text is in smaller pieces, and the experience of the text is varied. This uses more of your learners' brains.

Listening activity four: secret words – any text, any level

Select, e.g. three words in the text which occur more than once.

Alternative one: give each learner a word on a piece of paper.

Alternative two: go round quickly and whisper a word in each learner's ear.

Alternative three: Have the words, e.g. 3 words, each big on one big card. Say: 'You decide: are you A, B, or C?'

Hands up As. Hands up Bs. Hands up Cs.

Bs and Cs close your eyes. As open your eyes. As, this is your secret word.

As and Cs close your eyes. Bs open your eyes. Bs this is your secret word.

As and Bs close your eyes. Cs open your eyes. Cs this is your secret word.

All open your eyes.

Listen to the text, whenever you hear your secret word, stand up and sit down again.

You then read the text aloud. They jump up and down. Then you say: 'Open your books at page ... and read the text.'

Again, this activity is *V.A.* and *K.* It focuses on the positive and it gives your learners confidence to read the text. The text is familiar, demystified, experienced **before** they guess the new words.

Project one

Remember Insight 9? Here's a way to motivate your learners to make your subject autobiographical.

Lead your learners in a relaxation. (See Listening activity one.) You say: 'I am (new first name), (new second name) a (professional in your subject, e.g. biologist, historian) working in (a field in your profession, e.g. research, industry, computers) I like (your subject) because I can use it to (application).'

Then you say to your learners: 'You are each a person from (country where the target language is spoken). What is your new family name? You can say, silently in your head your new first name and your new family name. You are a (professional in the subject. Say silently in your head 'I am first name, family name, a (professional in the subject). How old are you? Where do you live (country)? What field of (subject) do you work in (name fields)? What do you like about (subject)? How do you use (subject) in your field?'

Then you say: 'turn to your partner. Introduce yourself as your new personality.' As the noise level increases go round saying Go and meet somebody **else**. So they get up and go and talk as their new personality to others.

In each lesson after this you can ask your learners to add more detail to their new personality, e.g. house, car, family, leisure activities, holidays. Add in items from the subject, e.g. 'You are preparing to go to an international conference on (topic). What do you want to say at the conference? What do you want to discover?'

In each lesson, you can ask your learners to be their new personality for a part of the lesson, e.g. discussion, conversation, so that they talk **using the new items** learned in that lesson, imagining how they would use those items as a professional in that subject.

Teacher activity G

Practise saying the relaxation (see Listening activity one), and saying your version of Project one.

Notice how Project one is *V.A.* and *K.* and how it makes Insight 9 possible.

Project two

For pairwork in any lesson in each pair there is A and B. You say:

A and B you are both your new (professional See Project One) personality. Talk about (that lesson's topic).

Now As change partners. Now As you are yourselves. Bs you are your new personality. Talk about (topic).

Now As change partners again. Now As you are your new personalities. Bs you are yourselves. Talk about (topic).

Now As change partners again. As and Bs you are yourselves. Talk about (topic).

Project three

In any lesson, and for any homework, your learners can be their new personalities and write penfriend letters as professionals in the subject to one another, e.g. they each write an introductory letter which you put in a box. Each then reaches in and picks out a letter and replies to it.

Encourage them to look ahead in the course book to ask questions in their letters about topics you haven't covered yet. Encourage them to do the same in newspapers and magazines in the target language or their own (see Insight 3).

Insight 11

**K = Action
or Emotion**

Your kinesthetic learners are hooked by action or emotion. Projects one, two and three capture all your learners' imaginations = right-brain = emotions. They really **become** a person, really motivated and really involved in the subject. Imagination is another reality.

141

References

These techniques come from:

Asher J J (1996) *Learning another language through actions*, Sky Oaks Productions

Grinder M and J Grinder (1989), *Righting the educational conveyor belt*, Portland: Metamorphous Press

Losanov G (1978) *Suggestology and outlines of suggestopedy*, New York: Gordon and Breach

Mehrabian A and W Molton (1996) *Language within languages*, New York: Irvington Publications

Meister-Vitale B (1982) *Unicorns are real: a right-brained approach to learning*, Torrance: Jalmar Press

Developing bilingual curricula in vocational colleges through the Leonardo programme

Walter Christ | Ludwig-Erhard-Schule, Fürth

Bernd Rosenstiel | Thüringer Kultusministerium, Erfurt

Introduction

Content and language integrated learning (CLIL) is not new in Europe. Some countries can look back on twenty years of bilingual teaching (see Baetens Beardsmore 1993). However, throughout Europe, this approach seems to be concentrated in general education rather than in vocational training. In Germany, for example, history, geography and social studies are the most favoured subjects for the content and language integrated classroom. English is by far the most favoured language in the whole of Europe (through this hegemony a problem in itself).

Due to the increasing mobility of the labour market across the European Union, there is a growing demand for the development of foreign language (L2) competence in vocational training. Within a framework of vocational training based upon the German model, Ludwig-Erhard School in Fürth and the Thüringer Kultusministerium in Erfurt are seeking to create a basic concept for bilingual teaching in English. The two organisations are lead partners of two pilot projects funded by the European educational programme, Leonardo da Vinci. This paper describes the contexts for the projects, and discusses the main factors which will influence the developments.

Foreign language learning needs for vocational students

Languages and culture play an important role in all trades that focus on export and import and/or mobility of people and labour. Examples from the production sector of the economy in Germany show that more than 50% of goods are exported. In the service sector, tourism renders services to people travelling into, and from, almost all parts of the world. From both sectors, experts are sent abroad to work often for years on national and international projects.

In this global economy, English has become the language of communication, playing the role of an international *lingua franca* having no specific country and culture as a background. The situation is different for most other languages e.g. French, German, Spanish, Russian, Arabic, etc which, although they are international languages like English, the culture of the specific home countries of these languages is more important for understanding and working with them than is the case with English.

The L2 needs of business and technical students differ a lot from each other depending on their future position in a company and the complexity of the tasks they will have to fulfill. Most technical and business students need just some English for communication with visitors and/or coping with some standard correspondence. What they need are basic interpersonal communicative skills (BICS from Cummins 1986). Some of them have already acquired these skills in general education. Lessons in vocational education are based on this previous knowledge, and try to help students to maintain their standard and to use their skills and knowledge in specific vocational settings, e.g. English for banking or computing. According to the number of lessons available, these courses can be expanded to English for Specific Purposes (ESP), offering students/trainees a specific approach to the communication needs of their trade and branch.

Bilingual teaching is not identical with ESP. It is more demanding. Bilingual teaching means that a specific vocational content is taught in a second (or international) language. So the fundamental concepts of the subject and relevant technical vocabulary belong to the core curriculum of the content and language integrated classroom. Students acquire the knowledge of the subject using the terminology of the target language. Their language needs are different from those of the communicative L2 teaching classroom. Therefore students in bilingual classes need a cognitive academic language proficiency (CALP) (see Cummins *ibid*) in order to understand and build up knowledge of their vocational subject.

For most vocational students who do not have a good basic knowledge in a foreign language, it will be almost impossible to profit from CLIL. Therefore, bilingual students can only be successful if foreign languages are taught at a high level in the system of general education. Most students of European countries (with the exception of Britain and Ireland of course!) have a sufficient command of English before they enter vocational education. They come with language skills in English at the waystage or threshold level, as defined by the European Council.

The situation for other languages is much worse. This unpleasant situation cannot be changed within vocational education. It can only be improved if more modern languages can be learnt in general education. So, from our perspective, CLIL classes will concentrate on combinations of subjects with English.

Fundamental issues in CLIL

The positive results of CLIL in enhancing L2 proficiency have been widely reported (see Baetens Beardsmore *ibid*), but as mentioned, these are in the main for general education students. To achieve similar results in the vocational sector, consideration needs to be given to those same aspects as relevant for CLIL in general education. With reference to these aspects, the following questions have to be answered:

- students: what is their educational and vocational background?
- teachers: what kind of language and content-based training have they got?
- subjects: what are suitable vocational areas for bilingual education?
- language: what is the relationship between communicative language skills and academic/ professional language proficiency?

- organisational structures: where and when should bilingual teaching take place, in companies and/or colleges: during initial training or afterwards?
- methodology: how can professional teacher skills be combined with student activity?
- exchanges: how should they be organised so that the quality of CLIL can be improved?
- assessment: how can traditional testing be supplemented by an evaluation of comprehensive and creative tasks?

In addition to these general aspects, there are a number of differences between bilingual teaching in general education and in vocational training. The most obvious differences are:

- In vocational training, students are often older and therefore more mature. This seems to be an advantage;
- The level of language competence varies greatly from student to student because they come from very different educational backgrounds. This makes teaching more difficult;
- It is not only the college that is involved in the training of the young person, but also the company to which he or she is apprenticed. And as the trainees enter into a contract with the companies, these companies also have to be convinced of the advantages of bilingual teaching;
- The colleges are not the only ones to administer the final examinations. Chambers of Industry and Commerce as well as Chambers of Crafts administer the examinations. That is why they have to be involved in the matter as well.

144

CLIL into vocational colleges: aims of the projects

With such an apparent lack of vocational focus in European CLIL, the two projects were proposed to address this shortfall. The Thuringia pilot project, *Bilingual classes in the dual system of vocational training*, is assisted by partners from Ireland, Finland and the UK. Following a needs analysis, the project will produce teaching modules (curricula and materials) for the areas of international trade, mechatronics, computing, domestic science and catering. Accreditation systems for these modules will also be developed.

It is intended that the concept can later be applied to other vocational areas and other countries, thus a secondary intended outcome is the introduction of CLIL in vocational colleges throughout Europe. In co-operation with departments of education (or equivalent bodies) in the project countries, proposals will be made to suggest CLIL-oriented changes in curricula and examinations.

The Ludwig-Erhard-Schule is developing a *Module in international trade in commercial vocational education* in co-operation with partners from Finland, France and the UK. The project will develop materials that can be used in commercial schools and college. The materials will consist of readers relating to:

- marketing and advertising;
- negotiations and agreements;

- procedures and documents;
- international economics and financing;
- ethical problems of international business.

These readers will be supplemented (in CD-ROM format) by a framework of a European curriculum for international trade, and a glossary of economic terms and concepts.

In order to understand the challenges to be faced in these pilot projects, it is necessary to review the current situation of vocational training.

Subjects and systems in vocational colleges

Vocational training specialises in hundreds of different trades. In Germany, for example, there are more than 350 state-recognised trades. Table 1 provides an overview of popular trades in vocational education.

Business	Technical	Service
banking wholesale retail transport computing	mechanical engineering electrical engineering building various crafts computing	tourism catering domestic computing

145

Table 1 | Popular trades in vocational education

Not all of these have close links with the international technical and business community. But there is a tendency towards internationalisation, even at the lower levels of company hierarchies.

In general, there are two different systems of vocational education:

System A (education in colleges) is similar to general education. The instruction and training of students takes place in vocational colleges. They receive full-time training in the college and spend most of their time in classrooms. They have to pay for some courses. They do practical work in workshops in the college and/or they get time for working outside the college. So they get some work experience but not necessarily in the same vocational sector as they have chosen for their future career.

System B (the dual system of vocational training) is different from general education. Students apply for a training contract with a company and get most of their practical training in that company. They are called trainees or apprentices and get a monthly salary from their company. They go to a vocational school for one or two days a week or as a block. The curricula for practical training and lessons in vocational schools are related to each other.

System A can be found in many countries throughout the world whereas System B was mainly developed in Germany and Austria. It is easier to introduce bilingual teaching in System A for the evident reason that there are more lessons available. On

average, there are only about twelve lessons a week in System B. This means that, for example, in Germany, not more than two lessons a week can be used for bilingual teaching. It is normally not possible to do bilingual teaching in the apprentices' companies because most of these lack teachers or instructors with suitable language proficiency. However, in companies there are chances for other forms of content and language integrated learning, e.g. learning in tandem with employees from different countries. Especially in many larger companies, there are employees with different mother tongues working together in the same departments. But in general, it is not possible to organise something like tandem learning during working hours. Taking into account the general tendency to reduce working hours in industrialised countries, the expertise of native speakers from other countries could probably only be used outside the official training system and office hours.

Issues to be addressed by the projects

Ways of learning and teaching in bilingual vocational classes

How do we get the best results in the content and language integrated classroom? CLIL should help to improve language proficiency as well as progress in vocational subjects. Two different concepts of classroom management are competing with each other: the more traditional teacher-centred approach and the more modern student-centred approach.

There are some good arguments for a teacher-centred approach in bilingual teaching:

- the contents of the subject is mostly new for the students;
- the students do not know the technical and conceptual language of their subject (CALP);
- many students do not have sufficient BICS in order to communicate about their subject with fellow students.

Thus, teacher-centred lessons could guarantee for the correctness of information, quality of language and a motivating and understandable presentation.

There is, however, one major disadvantage to the teacher-centred approach: the students will not learn to use the target language actively and work with it in vocational settings. Could a student-centred approach help to avoid this drawback of teacher-centred lessons? If a student-centred approach is understood as a method, where students try to study their subject by collecting, structuring and discussing information in small groups consisting of members of the same culture with an identical mother tongue, it will probably not work. They will not manage to do their investigative work and discussions in the target language. They would feel from the very beginning that their command of the target language is not good enough for complex discussions about economic and/or technical problems.

Neither the teacher-centred nor the student-centred approach will lead to the best possible outcome of CLIL. But the antagonism of both concepts can be changed to a synergy by developing a mixed approach. This approach gives a leading role to the

teacher, but not as a lecturer and presenter of material. The teacher’s job would be to take care of:

- general introduction to and motivation for CLIL;
- basic text material including video and computer software;
- glossaries, bilingual vocabulary lists and collections of phrases;
- dividing the subject into small packages of content, so that individual students deal with those small packages on their own;
- individual feedback from students about their chosen topic;
- guidelines for students on how to make presentations about specific topics;
- assignments and tasks which give students clear access to the problems;
- correction and improvement of students’ assignments;
- question and answer sessions after presentations;
- testing subject knowledge and correct use of the target language.

Through this approach teachers can use their professional knowledge of subject, language and methodology to guarantee a high educational level in the classroom, whereas the students take an active part in working with small packages of the subject, the relevant technical language and the methodology of presentation. They get a lot of feedback by direct contacts with the teacher. Additional assignments and tasks guarantee that they have to deal with all aspects of their subject and the relevant language. Question and answer sessions, as well as discussions after presentations, make it more probable that an adequate standard of subject knowledge and language will be achieved.

Skills for CLIL teachers in vocational colleges

Teachers in vocational education are mostly subject teachers exclusively using their mother tongue in the classroom. Even if they can speak and understand a foreign language they do not use it for teaching. There are also foreign language teachers employed in vocational colleges. They work in foreign language classes concentrating on the problems of language acquisition. In general (with the exception of a special training system for vocational business plus English teachers in Germany), there are no teachers who have had a special training for CLIL teaching.

Bilingual teachers can be recruited from language teachers and/or from content teachers. There are advantages and disadvantages to both approaches. Table 2 gives an overview.

Language Teacher	Bilingual Qualification (Teaching of English)	Content Teacher
Always available	BICS	Often available
Generally not available	CALP	Often available
Not available	Methodology of subject	Always available
Available for BICS	Methodology of language	Not available

Table 2 | Skills of vocational language and content teachers for the CLIL context

The above overview shows that it seems to be easier for the content teacher to acquire the necessary language proficiency for bilingual teaching than vice versa. However, this is true only for English, because a lot of vocational teachers have quite a good command of that international language – but only of that one. If bilingual teaching should be realised in other languages than English, it will be almost impossible for most content teachers to acquire the language proficiency needed. Whether it is easier for the language teacher to acquire the knowledge of the subject depends on the nature of the subject itself. In many cases, it seems to be easier to acquire subject knowledge for business, tourism and computing than for mechanical and electrical engineering.

A solution to that problem would be if teacher training at the universities could be shaped according to produce a teacher who has:

- foreign language studies (full access to both BICS and CALP, and L2 methodology);
- subject studies, e.g. international trade, computer science, tourism.

Methods of assessment in vocational colleges

Examinations and tests have a backwash effect on learning and teaching. Therefore it is very important to develop testing methods which give students information about the aims of the syllabus of their classroom subject, not just the skills/knowledge under examination. Tests for bilingual education have to consider both language and knowledge of a subject.

Testing knowledge of the subject can be done by traditional methods such as various forms of multiple choice, matching and ranking exercises, and fill-in exercises. When using the target language for this kind of testing, there is the problem as in all language teaching that students may not be able to find the correct answer, more because of not understanding the language than not having acquired the knowledge of their subject. So writers of knowledge tests must be very careful in choosing vocabulary and phrases used in test questions. They should use similar language to that used in the bilingual classroom.

Testing only language should not only consist of multiple choice and fill-in exercises, but also include translation of technical terms and phrases into the students' mother tongue. Even if vocational students in bilingual classes attend those classes primarily because they should learn to talk about their subject in a second language, there is a factual need for communication with experts in their company in their mother tongue. Therefore bilingual students/trainees need an exact knowledge of technical terms in both languages.

Testing language and knowledge in combination can allow for a more flexible performance by the learners. It is possible to ask open questions, or for students to write subject-oriented reports. In addition to testing in writing, it is necessary to also have task-oriented oral examinations, e.g. a short talk in the target language about a basic technical term or concept of the subject in question. With reference to the ways of learning used in the classroom, it is very useful to make evaluations of presentations and/or projects.

International exchanges

International exchanges can be used in different ways for enhancing content and language integrated learning. The main features of those exchanges are:

- mixed groups of students with native speakers from different cultures;
- project work with tasks to be fulfilled in the target language;
- presentations before an audience of native speakers;
- formation of cultural awareness through contacts with families and employees;
- exchange of textbook material and opinions;
- motivation for getting into contact, and building up communication links;
- establishing an international network of business friends.

International exchanges in vocational education are of a new quality compared to traditional school partnerships. Preconditions for a successful exchange are not only a similar age and educational background of students, but also that the students/trainees are being trained in a similar business or technical sector of the economy. The areas and special subjects of their training in different countries should correspond with each other as closely as possible.

Challenges facing CLIL in vocational colleges

Bilingual learning in vocational classes is a new development. It offers a lot of new opportunities. However, there are also limitations. Table 3 compares opportunities and limitations by looking at the criteria of a general framework of CLIL as listed above.

149

Opportunities	Criteria	Limitations
Focus on international aspects	Subject	Very good knowledge of target language necessary
Sufficient study time Work practice abroad	Organisational structure	Often no work practice
International contacts of many companies		B. Dual System
Application of target language in a vocational context	Language needs of students	Not much input of languages other than English from general education
Training of a content/language teacher possible	Content/Language Skills of teachers	Many language teachers without subject knowledge
Professional classroom management supporting student activity	Ways of learning and teaching	Communication of native students in target language difficult
Comprehensive and flexible forms of testing	Assessment and Testing	Testing in target language may lead to lower level of subject knowledge
Learning in mixed-culture groups possible	International exchanges	High travel and subsistence costs

The above summary shows that the many opportunities of the content and language integrated classroom can only be used if some fundamental basic conditions can be fulfilled. In closing, we list the conditions in whose direction our projects seek to move:

- students with a good knowledge of the target language;
- a training system with the possibility of work practice abroad;
- teacher training which consists of a combination of studying the subject and a target language tailored to the linguistic needs arising from that subject;
- well-resourced classrooms with presentation facilities, recourse to encyclopaedias and relevant books on paper and CD-ROM, as well as access to the Internet;
- examination boards supplementing their traditional assessment by developing new comprehensive and active forms of performance testing;
- exchanges for students/trainees in bilingual classes have to be funded by national or European programmes.

References

- Baetens Beardsmore H (ed) (1993) *European models of bilingual education*, Clevedon: Multilingual Matters
- Cummins J and M Swain (1986) *Bilingualism in education: theory, research and policy*, London: Longman

150

Contact addresses

Bilingual classes in the dual system of vocational training

Bernd Rosenstiel
 Thüringer Kultusministerium
 Abteilung 4 Berufsbildende Schulen
 Herr Jürgen Pein
 Werner-Seelenbinder-Straße 1
 D-99096 Erfurt
 Email: tkm@thueringen.de

A Module international trade in commercial vocational education

Walter Christ
 Ludwig-Erhard-Schule, Fürth, Germany (leading partner)
 Theresienstraße 15, D-90762 Fürth, Germany,
 Walter.Christ@t-online.de

Learning through a foreign language is recognised as an effective means of enhancing language competence. The successes of the French Immersion programme in Canada, the trilingual education system in Luxembourg and the European Schools attest to this claim. In the past decade, the practice of teaching, for example, geography through French or history through English has seen significant growth in schools throughout Europe from primary to tertiary levels.

Learning through a foreign language presents European perspectives on the means of structuring curricula which integrate content and language learning, drawing on the experience of practitioners at a range of levels. It also provides details of the outcomes from such programmes and describes the current and future challenges for wider scale adoption of Content and Language Integrated Learning (CLIL).

This collection of papers is the result of an international conference organised by St Martin's College, Lancaster, with the support of the Socrates/LEONARDO A unit of the European Commission, the European Network for Content and Language Integrated Classrooms (EuroCLIC) and CLIL. It is relevant to current practitioners and those interested in introducing CLIL into their own institution.

John Masih currently manages International Education Programmes at Woolwich College, London. His CLIL experience includes organising in-service education programmes and conducting research into the implementation of CLIL in the Finnish vocational sector.

ISBN 1-902031-68-7



781902 031682

158

BEST COPY AVAILABLE



U.S. Department of Education
Office of Educational Research and Improvement (OERI)
National Library of Education (NLE)
Educational Resources Information Center (ERIC)



NOTICE

REPRODUCTION BASIS



This document is covered by a signed "Reproduction Release (Blanket) form (on file within the ERIC system), encompassing all or classes of documents from its source organization and, therefore, does not require a "Specific Document" Release form.



This document is Federally-funded, or carries its own permission to reproduce, or is otherwise in the public domain and, therefore, may be reproduced by ERIC without a signed Reproduction Release form (either "Specific Document" or "Blanket").