

DOCUMENT RESUME

ED 451 986

RC 022 921

AUTHOR Stephens, Sidney
TITLE Handbook for Culturally Responsive Science Curriculum.
INSTITUTION Alaska Univ., Fairbanks. Alaska Native Knowledge Network.
SPONS AGENCY National Science Foundation, Arlington, VA.
PUB DATE 2001-00-00
NOTE 67p.; Some graphics may not reproduce adequately.
AVAILABLE FROM For full text: <http://www.ankn.uaf.edu/UNITS/index.html>.
PUB TYPE Guides - Classroom - Teacher (052)
EDRS PRICE MF01/PC03 Plus Postage.
DESCRIPTORS Academic Standards; *Alaska Natives; *American Indian Education; *Culturally Relevant Education; *Curriculum Development; Elementary Secondary Education; Integrated Curriculum; *Science Curriculum; Science Education; *State Standards; Teaching Guides; Yupik
IDENTIFIERS Alaska; Eskimo Culture; *Indigenous Knowledge Systems; Intergenerational Transmission

ABSTRACT

The Alaska Science Consortium, the Alaska Rural Systemic Initiative (AKRSI), and the Alaska Department of Education have collaborated on developing standards-based, culturally relevant science curricula that effectively integrate indigenous and Western knowledge. This handbook is designed to assist teachers in developing and teaching culturally responsive science curricula. After an initial explanation of the characteristics, strengths, and difficulties associated with culturally responsive science curricula, the guide suggests that much common ground is shared by traditional Native knowledge and Western science and discusses the implications of integrating the two. A chapter is devoted to each of four factors to be considered by developers of culturally relevant science curricula: cultural relevance, best practices, state standards, and assessment. Areas covered include how to involve Elders in the classroom, topics of cultural significance, cultural standards, guidelines for standards-based units, correlating local knowledge with science standards, how to adapt topics to standards, traditional Yup'ik learning, sharing knowledge, integrated study, and promising assessment strategies. Appendices present the AKRSI unit-building assessment rubric and sample units on lure construction and ice fishing with elder involvement, winds, and weather. Each unit identifies grade level, context, AKRSI region, cultural and academic standards, and skills and knowledge addressed, and presents lessons and activities. (TD)

This document has been reproduced as received from the person or organization originating it.

Minor changes have been made to improve reproduction quality.

• Points of view or opinions stated in this document do not necessarily represent official OERI position or policy.

HANDBOOK FOR

Culturally Responsive Science Curriculum

BY SIDNEY STEPHENS

"PERMISSION TO REPRODUCE THIS MATERIAL HAS BEEN GRANTED BY

Ray
Barnhardt

TO THE EDUCATIONAL RESOURCES INFORMATION CENTER (ERIC)."

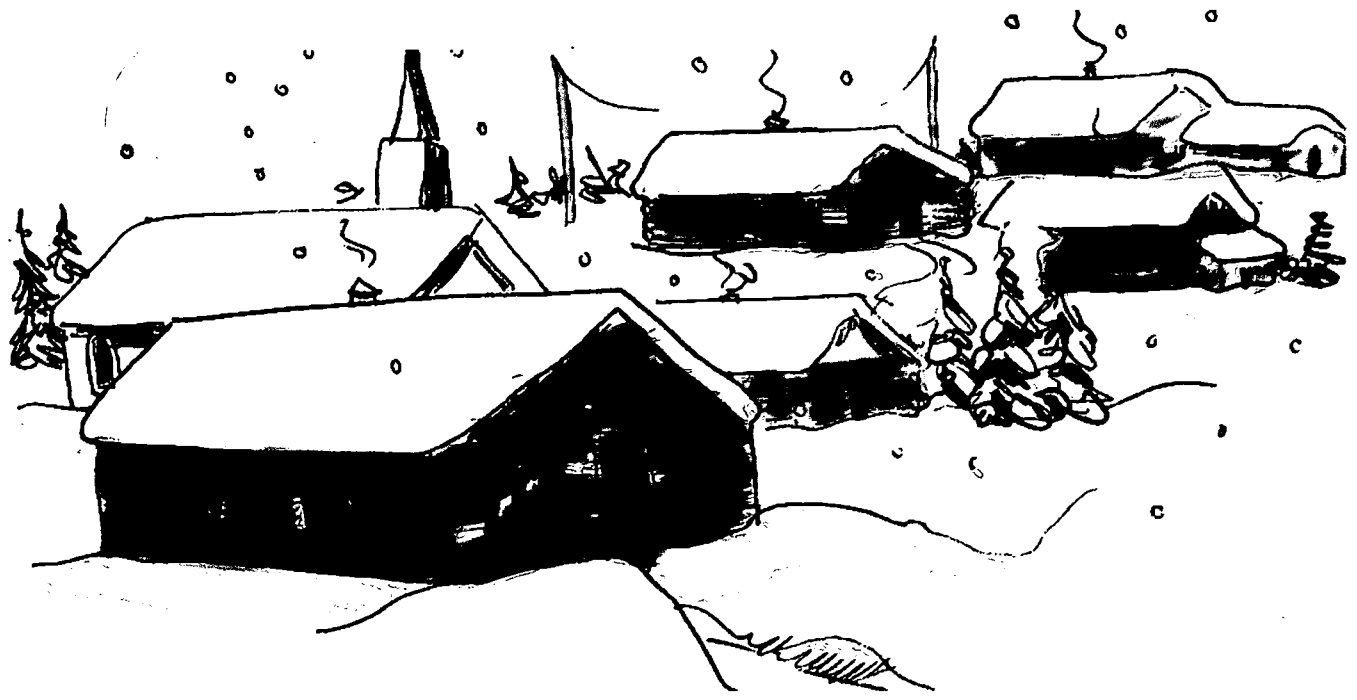

ED 451 986

“ In the winter in Selawik, if it’s clear and cold, -20° or -30°F, maybe there are a few clouds but it’s nice and calm. The wind isn’t supposed to blow now. If the wind starts to blow when its not supposed to, people gathered maybe in the store will say “ooo, cold”. In Iñupiat they say *qiunaurauqtuq* which means *he’s beckoning the storm*. You know it will be stormy—blowing, drifting snow. It makes you decide to stay home. Animals will stay home too. This is very reliable. ”

Jonas Ramoth, Iñupiat Elder

PUBLISHED BY THE ALASKA SCIENCE CONSORTIUM AND THE ALASKA RURAL SYSTEMIC INITIATIVE

RC022921

HANDBOOK FOR

CULTURALLY RESPONSIVE SCIENCE CURRICULUM

BY SIDNEY STEPHENS



“ In the winter in Selawik, if it’s clear and cold, -20° or -30°F, maybe there are a few clouds but it’s nice and calm. The wind isn’t supposed to blow now. If the wind starts to blow when its not supposed to, people gathered maybe in the store will say “ooo, cold”. In Iñupiat they say *qiunaurauqtuq* which means *he’s beckoning the storm*. You know it will be stormy—blowing, drifting snow. It makes you decide to stay home. Animals will stay home too. This is very reliable. ”

Jonas Ramoth, Iñupiat Elder

PUBLISHED BY THE ALASKA SCIENCE CONSORTIUM AND THE ALASKA RURAL SYSTEMIC INITIATIVE

Since 1996, the Alaska Science Consortium has been working with the Alaska Rural Systemic Initiative (AKRSI) and the Alaska Department of Education to help develop standards-based, culturally relevant curriculum that effectively integrates indigenous and Western knowledge around science topics. This work has been generously funded by the AKRSI project through a National Science Foundation grant. It has involved teachers, Elders, Native community leaders, agency personnel, and educational consultants and has taken many forms. This handbook represents some of the thinking and products that have resulted from this slowly evolving and highly collaborative process. It is hoped that some of these ideas prove helpful to you as you begin or continue similar work. We are most grateful to the AKRSI program for support of these efforts and to AKRSI staff for their ongoing dedication, helpfulness, and vision. For a more complete look at the purpose, accomplishments and resources funded and gathered by AKRSI, check out their website at <http://www.ankn.uaf.edu>.

FOREWORD

The information and insights contained in this document will be of interest to anyone involved in bringing local knowledge to bear in school curriculum. Drawing upon the efforts of many people over a period of several years, Sidney Stephens has managed to distill and synthesize the critical ingredients for making the teaching of science relevant and meaningful in culturally adaptable ways. Coupled with the "Native Ways of Knowing" section in the Alaska Math/Science Curriculum Frameworks document and the Alaska Science Performance Standards, this handbook will provide teachers invaluable assistance with the task of developing and teaching "culturally responsive science curriculum."

There is mounting evidence that curricular and teaching practices that link schooling to the surrounding cultural and physical environment produce positive results on all indicators of student and school performance. This handbook reflects the most current pedagogical principles that move educational practice from teaching about (*italics*) culture as another discrete subject to teaching through (*italics*) the local culture as a way to bring depth, breadth and significance to all aspects of the curriculum.

We wish to express our appreciation to Sidney and the Alaska Science Consortium for venturing with us into this previously uncharted terrain and bringing new insights to bear on long-standing issues in Alaskan education. The results of this collaboration have exceeded our expectations and will be of benefit to educators throughout Alaska and beyond. Thank you to all who have contributed to this undertaking.

Ray Barnhardt, Angayuqaq Oscar Kawagley and Frank Hill
Co-Directors, Alaska Rural Systemic Initiative

CONTENTS

What is Culturally Responsive Science Curriculum?	7
Where to begin?	9
Integrating Traditional Native Knowledge and Science	10
Cultural Relevance	12
Involving Cultural Experts	12
Traditional Knowledge, Environmental Assessment, and the Clash of Two Cultures	13
Elders in the Classroom	15
Topics of Cultural Significance	17
Cultural Standards	17
Snowshoes	20
Standards Based	21
Summary Guidelines for Standards-Based Units	21
Correlate Local Knowledge with Science Standards	22
Alaska Science Performance Standards	24
Topics to Standards: A Discrepant Event	26
Best Practices	28
Traditional Yup'ik Learning	29
Cultural Relevance and the Learning Cycle Model	30
Share Knowledge	31
Integrated Study, Traditional Camps and Science Fairs	32
Assessment	34
Promising Assessment Strategies	35
Alaska Science Performance Standards: Assessment Ideas	36
References	39
Curriculum Resources	39

APPENDICES

AKRSI Unit Building Assessment Rubric	A-1
Lure Construction and Ice Fishing with Elder Involvement	A-3
Winds and Weather Sampler	A-9

WHAT IS CULTURALLY RESPONSIVE SCIENCE CURRICULUM?

Culturally responsive science curriculum attempts to integrate Native and Western knowledge systems around science topics with goals of enhancing the cultural well being and the science skills and knowledge of students. It assumes that students come to school with a whole set of beliefs, skills and understandings formed from their experiences in the world, and that the role of school is not to ignore or replace prior understanding, but to recognize and make connections to that understanding. It assumes that there are multiple ways of viewing, structuring, and transmitting knowledge about the world—each with its own insights and limitations. It thus values both the rich knowledge of Native Alaskan cultures and of Western science and regards them as complementary to one another in mutually beneficial ways.

What are the characteristics of culturally responsive science curricula?

- It begins with topics of cultural significance and involves local experts.
- It links science instruction to locally identified topics and to science standards.
- It devotes substantial blocks of time and provides ample opportunity for students to develop a deeper understanding of culturally significant knowledge linked to science.
- It incorporates teaching practices that are both compatible with the cultural context, and focus on student understanding and use of knowledge and skills.
- It engages in ongoing authentic assessment which subtly guides instruction and taps deeper cultural and scientific understanding, reasoning and skill development tied to standards.

What are some strengths of culturally responsive curriculum?

- It recognizes and validates what children currently know and builds upon that knowledge toward more disciplined and sophisticated understanding from both indigenous and Western perspectives.
- It taps the often unrecognized expertise of local people and links their contemporary observations to a vast historical database gained from living on the land.
- It provides for rich inquiry into different knowledge systems and fosters collaboration, mutual understanding and respect.
- It creates a strong connection between what student's experience in school and their lives out of school.
- It can address content standards from multiple disciplines.

What are some difficulties associated with culturally responsive curriculum?

- Cultural knowledge may not be readily available to or understood by teachers.
- Cultural experts may be unfamiliar, uncomfortable or hesitant to work within the school setting.
- Standard science texts may be of little assistance in generating locally relevant activities.
- Administrative or community support for design and implementation may be lacking.
- It takes time and commitment.

WHERE TO BEGIN?

Creating and implementing culturally responsive curriculum is a time-consuming process that is generally collaborative in nature and decidedly marked by what authors know and believe worth knowing. It generally involves reaching out past our own knowledge or comfort range and synthesizing what we find. The process is slightly different for everyone, but general factors for everyone to consider are summarized in the chart below and are used to organize the material in this handbook. An elaborated rubric for assessment of culturally responsive units is included in Appendix A.

CULTURALLY RESPONSIVE SCIENCE CURRICULUM

<p><i>Cultural Relevance</i></p> <p>Examines topics of cultural significance, involves cultural experts, addresses cultural standards and provides adequate opportunity for reaching deeper cultural understanding.</p>	<p><i>Standards Based</i></p> <p>Identifies an appropriate number of state science standards; describes specifically what is to be learned about those standards; and provides an adequate number of properly sequenced opportunities that lead students to a deeper understanding of the standards.</p>
<p><i>Best Practices</i></p> <p>Incorporates strategies which are culturally appropriate; focuses on student understanding and use of knowledge, ideas and inquiry process; guides students in active and extended inquiry; and supports a classroom community with cooperation, shared responsibility and respect.</p>	<p><i>Assessment</i></p> <p>Engages in ongoing assessment of student: understanding of highly valued, well-structured knowledge; skill development and reasoning; and ability to apply knowledge to the real world. Allows for diverse demonstrations of understanding.</p>

INTEGRATING TRADITIONAL NATIVE KNOWLEDGE AND SCIENCE

PERSPECTIVES

Over the course of the last several years there has been lots of discussion about the fit between traditional Native knowledge and Western science. Opinions expressed have run all the way from “they are mutually exclusive systems” to “they are equivalent systems” and everywhere in between. We believe such disagreement and even polarity results from the human tendency to view things from your own spot in the world, and that thoughtful consideration of these two knowledge systems reveals much common ground (see diagram on facing page). We also believe that the work of creating culturally responsive science curriculum is context specific, dynamic and ultimately reflective of what one believes, values and thinks worth knowing.

For many Native educators, culturally responsive science curriculum has to do with their passion for making cultural knowledge, language and values a prominent part of the schooling system. It has to do with presenting science within the whole of cultural knowledge in a way that embodies that culture (see Traditional Native Knowledge circle on facing page), and with demonstrating that science standards can be met in the process. It also has to do with finding the knowledge, strategies and support needed to carry out this work.

For those educators not so linked to the local culture, culturally responsive science curriculum has more to do with connecting what is known about Western science education to what local people know and value (see Western Science circle). It has to do with accessing cultural information, correlating that information with science skills and concepts, adjusting teaching strategies to make a place for such knowledge, and coming to value a new perspective. It too has to do with addressing science standards and finding the knowledge, strategies, and support needed to carry out this work.

IMPLICATIONS

Although educators obviously differ in their perspective, there is no doubt that the creation of culturally responsive science curriculum has powerful implications for students for at least three reasons. The first is that a student might conceivably develop all of the common ground skills and understandings while working from and enhancing a traditional knowledge base. The second is that acquisition of the common ground, regardless of route, is a significant accomplishment. And the third is that exploration of a topic through multiple knowledge systems can only enrich perspective and create thoughtful dialog. One way of envisioning this merger would be for young children to consistently focus on traditional knowledge as a way of enhancing a cultural foundation and developing skills and knowledge common to both systems. As children get older, this traditional focus might continue with increased use and discussion of some of the tools and procedures of Western science and how they differ from traditional ways of knowing. By middle/high school, students

could tackle more sophisticated science concepts/skills and develop more sophisticated cultural understanding while also becoming more able to apply them in the real world, and more able to analyze and compare the insights and limitations of each system. In this way, students could have a truly rich and relevant education without demeaning or subjugating either knowledge system.

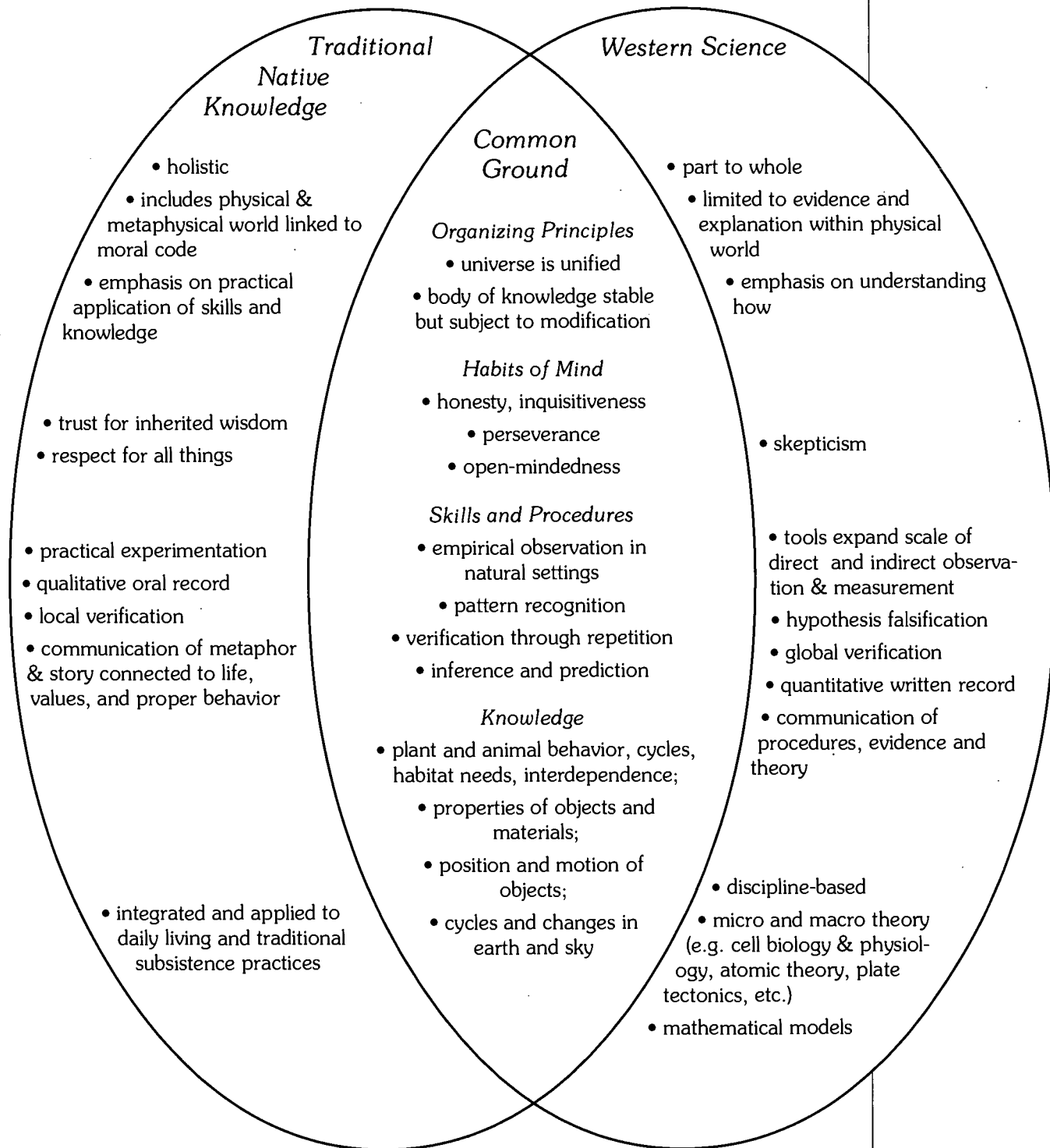

CULTURAL RELEVANCE

INVOLVING CULTURAL EXPERTS

Creating and implementing culturally responsive curriculum is a collaborative process involving local cultural experts as much as possible throughout the process. It involves an exchange of information and perspective in which the classroom teacher comes to understand what local knowledge is valued and held locally and by whom. It then involves the connection of these cultural experts and their knowledge to classroom practice.

But as many of you may know, creating such rich partnerships and exchanges is often easier said than done. On the one hand, teachers may not know where to start, who to ask or what to ask for. They may feel rebuffed in their first attempts or may feel that the answers they receive are unrelated to their question or that this information is not as significant as the curriculum they are mandated to teach. On the other hand, cultural experts may feel unaccustomed to such inquiries; may have had bad experiences in the past; may feel that the teachers aren't truly listening; or may feel uncomfortable with the school or what is expected of them.

While it's beyond the scope of this handbook to deal in depth with these complex issues, we have chosen two particularly relevant articles to help shed some light on the subject. The first, by Richard Glenn, thoughtfully portrays an Iñupiat perspective on the sharing of knowledge about the local environment. The second, by Roby Littlefield, provides some pointers on working with Elders in the classroom. Beyond this, we refer you to the extensive work of Ray Barnhardt on teaching and learning across cultures, and to the work of Oscar Kawagley on Native ways of knowing (see references section of this handbook).

Beyond reaching out to the community yourself, students can also become involved in gathering and documenting local knowledge. This can be as basic as having students work with tapes or documents that are already in existence or it can involve them in gathering relevant information from such sources as their families, resource people, Elders groups and so on. It can take the form of informal interviews, note taking, audio or video recording can be as complex as hosting an Elder's Conference on the topic of choice or creating a CD program documenting knowledge. Any way you do it, the point is for students to seek out and document local knowledge as a basis for further class investigations.

TRADITIONAL KNOWLEDGE, ENVIRONMENTAL ASSESSMENT, AND THE CLASH OF TWO CULTURES

by Richard Glenn, Barrow, Alaska

Native American people have, since the time of the first European contact, struggled with the idea of sharing a storehouse of raw information, truisms, philosophies and ways of life with the outside world. This storehouse, wrapped in a big blanket and named by the outside world as "traditional knowledge", has been obtained (as in any culture) over time by observations of nature, trial and error, dogged persistence and flashes of inspiration. In cultures without a written history, such as North Slope Iñupiat culture in Alaska, knowledge is passed person to person through social organizations and individual training, as well as through stories and legends.

The Iñupiat culture is based on knowledge of the natural environment and its resources. Our foundation is knowledge of the arctic tundra, rivers, lakes, lagoons, oceans and food resources. Knowledge of snow and ice conditions, ocean currents and weather patterns and their effects on natural systems are necessary for navigation, finding game and locating shelter and each other. This knowledge has value. First, to share with each other and pass on to our children and second, (if desired) to pass on to those outside of the Iñupiat culture.

To someone unfamiliar with the Iñupiat culture or the Arctic environment (such as a youngster or an outsider), the storehouse of information must seem infinite and inaccessible. In addition, stereotypes abound among ourselves and in the eyes of outsiders. Legends of the "hundred different terms for snow or ice" perpetuate the mystery. Most importantly, those wishing to learn the Iñupiat culture or environment, there is a stigma: bad experiences too numerous to count begin by good-faith sharing of traditional knowledge with outsiders. These range from simple plagiarism to exploitation and thievery. Legends and stereotypes abound. Such experiences have led many Iñupiat people to first ask "Why share?" And, even if this challenge has been answered sufficiently, an equally difficult challenge remains for both sides: "How to share?"

WHY SHARE?

Why do Iñupiat share traditional knowledge? Despite the stigma, our community is proud of a long history of productive, cooperative efforts with visiting researchers, hunters, travelers, scientists, map makers and others. We share when we consider others close enough to be part of Iñupiat culture and share when it is in the best interest of a greater cultural struggle.

Experts Sharing With Each Other

The question of "why" is always easy to answer when two individuals are sharing equally and the joy of discovery takes place on both sides. Examples of the Iñupiat hundred-year history of cooperation serve as good models: the wildlife biologist and the whaler, the nomadic traveler and geologist, the archeologist and the village Elders. This two-way exchange has often worked when a given researcher has been around long enough to be considered "one of us" or at least has displayed to the community that he possesses some common values.

Sharing for the Greater Good

For a more locally important reason, we share traditional knowledge when we believe it will lead to preserving the land, its resources or the Iñupiat way of life. This reason has prodded us to work hard with regulatory agencies and other organizations to develop policies, to draft environmental impact statements or to offer even the most specific knowledge of the environment, wildlife or cultural practice.

Sharing as a part of Iñupiat Education

A third reason exists: pure instruction. Like a teacher to a student, our Elders and experts teach the rest of our community in all facets of traditional knowledge. We share to perpetuate our culture. How does one become involved in this kind of sharing? The answer is simple: become a student. However, this can take a lifetime—pairing with a given expert through years of learning. Chances are that the teacher is learning, too. This is the method most commonly used by Iñupiat people to transfer knowledge with each other. Iñupiat culture has many vehicles to allow this kind of instruction to take place. However, this method faces challenges due to changing culture, loss of language and other factors.

HOW TO SHARE?

How can an outsider partake in vehicles of sharing traditional knowledge? Choose one or all of the criteria: an exchange among experts, become part of an effort that is of value to the Iñupiat or remain in the community and become a real student. Any other method risks lack of context, data gaps from abbreviated efforts and other problems such as trying to gather traditional knowledge in non-traditional ways or trying to force what should take years of heart-to-heart collaboration between experts into a period of weeks to months.

Knowing that change happens slowly and that one can only do so much, there are a few more cautions to those interested in documenting traditional knowledge, learning about the environment without reinventing the wheel and working with Native communities on regionally important issues.

Choose the Forum with Care

A meeting's attendees must be matched to the issue. When expertise is really needed, it should be stated. Stereotypes will allow any agency to assume the expertise is there. There is a scene from the movie *On Deadly Ground* where the leading actress (an Asian woman playing a Yup'ik) jumps on a horse to the surprise of Steven Seagal's character. He asks, "You can ride a horse?" to which she answers, "Of course, I'm Native American!" A comical analogy, but not far from the mark.

Don't put your Eggs in One Basket

Check sources. Stated another way, the most talkative person may not be the most knowledgeable. Ours is a culture of consensus. Agreement is mandatory on nearly every item passed as traditional knowledge. If one person stands alone, he may be an expert or he may be wrong.

Given the size of the task, it is easy to run away from documenting traditional knowledge for use by others, even for our own reasons. For many like me, it can be an intensely personal endeavor. Still, such documentation will continue—by Iñupiat as well as by outside groups. Our culture is changing and some day we may be learning traditional knowledge using the same techniques employed by those who are outside looking in. We may be learning of Iñupiat traditional knowledge as if it belonged to others. Just as today, in many places, we are learning Iñupiat language as if it were a foreign language. As long as we are pledged to the task, we should look past the requirements of this contract or that mandate and remember the quality of information—time-tested and true. With everything changing, it is a valuable reference plane. If it is not where we are going, at least it is where we are coming from.

ELDERS IN THE CLASSROOM

by Roby Littlefield

All students can benefit from inter-generational contracts. In Alaska Native cultures, grandparents were held in high regard as they contributed to the community by passing on knowledge and skills. Children learned by listening to and watching Elders and often didn't realize they were in training. Bringing grandparents in to share personal knowledge when studying subjects like nutrition, customs, plants, biology, and history can benefit the entire class.

To get started, first look to your class members. Send home a note or survey expressing your desire to include parents, grandparents, and Elders in your lessons. Get referrals for possible speakers from organizations that work with Natives and/or the Elderly.

The way to ask Native American Elders for help is different from Western customs. Initial and subsequent contact should be subtle. Visit with them, allowing time for the conversation to wander. Allow for extended pauses, giving them time to think and decide. If their hearing is poor, sit on the side of their better ear and make sure your lips can be seen. Direct eye contact should be limited. Standing or sitting at an angle can increase an Elder's comfort level. Keep your questions basic and specific.

Begin the request by telling a little story about your class and how the Elder could help. If you are not sure if the Elder is interested, hint strongly that you would like to have their help and ask if she or he knows of someone who might be willing to participate. Custom teaches that it is rude to give someone a frank "no" to a request for help, so you need to recognize that a noncommittal response might mean "no," or it might mean that the request is being considered. If at some point the Elder changes the subject more than once while you are explaining your request, you should be aware that she or he might be trying to say "no." Don't force a response; if it is clearly not a "yes," let it go, or suggest they can contact you after they've thought about it.

It is important to ask before a meeting for permission to make audio or video recordings. Don't show up with the equipment; you may force consent and cause bad feelings. Permission to listen to or tape a story or lecture does not give you any right to rebroadcast or write the story with you as author.

If an Elder has agreed to participate in a classroom, suggest an activity or topic outline so they know what you are expecting. Provide them with optional dates and the logistics. It is helpful to explain the routine, consequences for students' misbehavior, and possible options if problems come up during the lesson. It is your responsibility to ensure discipline is maintained. Be aware, however, that Elders generally do not support strict discipline in a public setting. Discuss how to make a smooth transition to help the Elder leave the class. Agree on some visual signs and ground rules.

When the Elder arrives, properly introduce her or him so the Elder understands your respect for them. The teacher should be alert for visual cues from the Elder during the visit and be prepared to give unspoken signals back. The teacher should stay in the room.

Give the Elder a chance to use traditional discipline. Be prepared to move a child to sit by an adult who can role model how to listen respectfully. If you have problems with students degrading or ignoring an Elder, have a teacher's aide or adult Native quietly intervene.

Most traditional stories are like a round, crocheted pot holder. The story teller goes round and round the subject until it all comes together and finally comes to the lesson or point. Be patient; allow the Elders to share their culture in their own way. Your students are learning how to listen. Students should refrain from interrupting to ask questions. There will be a proper time to ask questions.

As a thank-you, Elders usually appreciate students and teacher letters, pictures, and story booklets, which are treasured and shown to friends and relatives. This may also encourage other Elders to participate in classroom projects.

Sometimes you will find a resource person who is available for a wide variety of subjects and projects. If you use an Elder more than once, the school should provide some type of stipend in appreciation of the energy and knowledge the Elder is contributing. Be careful not to burn out your Elders. Whenever you make a request, be sure the Elder understands she is not obligated.

Keep your lessons flexible in case the Elder can't come at the last minute. Once an Elder has agreed on a time to come into your classroom, avoid changing or postponing the visit.

TOPICS OF CULTURAL SIGNIFICANCE

The possibilities for integrating cultural knowledge and science are almost endless. The topics listed in the sidebar to the right are just a few of those most commonly mentioned.

The topic you choose to work on will depend a lot on your local environment, the seasonal appropriateness of such study, the science curriculum goals established for your grade level and what your Native partners want to teach about. With regard to the latter, it is likely that their choice of subject matter will be highly dependent upon two things: first, knowledge that is practical and can be applied to the real world; and second, the need to know.

The **application of knowledge** is of paramount importance in Native cultures and has traditionally been equated with the ability to survive. This emphasis on the practical application of knowledge has been reinforced over and over again in numerous conversations. As Richard Glenn, an Iñupiat geologist in Barrow said, an Elder has little use for all of the physics formulas that describe sea ice movement, but knows intimately which ice is safe to walk on or travel through, and what ice conditions to watch for in order to stay safe when out hunting. The same could be said for weather prediction, hunting and fishing practices, navigation and so forth. As suggested later in this handbook, the implication of this is that students begin their science study with the application of knowledge and then work around to understanding why and how.

Related to the application of knowledge is the **need to know**. Plainly said, this means that you teach children what they need to know when they need to know it. For example, in Selawik, weather is never the first thing taught to children because until they start hunting, at age 12, they don't really *need to know*. They are just traveling from home to school and only need to know the danger of the weather that is already there. Their parents help them dress appropriately for existing weather. Young children are taught to be careful observers of the world around them, but direct instruction about weather signs and prediction does not occur until there is the need to know associated with independent travel on the land in connection with such things as spring hunting for muskrat at about age 12.

CULTURAL STANDARDS

The *Alaska Standards for Culturally Responsive Schools* (<http://www.ankn.uaf.edu>) were developed in 1998 by "Alaska Native educators to provide a way for schools and communities to examine the extent to which they are attending to the educational and cultural well being of the students in their care. Standards have been drawn up in five areas, including those for students, educators, curriculum, schools and communities. These standards serve as a complement to, not as a replacement for, the content standards adopted by the State of Alaska. While the state standards stipulate what students should know and be able to do, the cultural standards are oriented more toward providing guidance on how to get them there in such a way that they become responsible, capable and whole human beings in the process."¹

As you develop culturally relevant science units, we encourage you to review these standards, thinking particularly about how your unit supports and enhances the cultural well being of the students. We also encourage you to try to be as specific as possible with regard to the cultural skills and knowledge gained AND to hold students accountable in some way for those gains. The following cover page for the Snowshoe Unit is one example of how to become more specific with regard to cultural standards. The science units posted on the ANKN web site and the units in the back of this handbook provide other examples.

Topics for Integrating Cultural Knowledge and Science

- medicinal and edible plants
- weather
- river dynamics
- seasons
- food gathering and preservation
- navigation
- animal behavior/habitat
- tides
- erosion and relocation
- tools and technology
- snow and ice
- land forms
- shelter and survival
- anatomy
- use of local materials

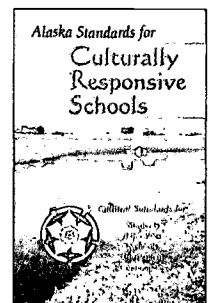

¹ *Alaska Standards for Culturally-Responsive Schools*, Alaska Native Knowledge Network, 1998, pp 2-3

CULTURAL STANDARDS FOR STUDENTS

Cultural Standards for



Students

A. Culturally-knowledgeable students are well grounded in the cultural heritage and traditions of their community.

Students who meet this cultural standard are able to:

1. assume responsibility for their role in relation to the well-being of the cultural community and their life-long obligations as a community member;
2. recount their own genealogy and family history;
3. acquire and pass on the traditions of their community through oral and written history;
4. practice their traditional responsibilities to the surrounding environment;
5. reflect through their own actions the critical role that the local heritage language plays in fostering a sense of who they are and how they understand the world around them;
6. live a life in accordance with the cultural values and traditions of the local community and integrate them into their everyday behavior.
7. determine the place of their cultural community in the regional, state, national and international political and economic systems;

5

CULTURAL STANDARDS FOR STUDENTS

B. Culturally-knowledgeable students are able to build on the knowledge and skills of the local cultural community as a foundation from which to achieve personal and academic success throughout life.

Students who meet this cultural standard are able to:

1. acquire insights from other cultures without diminishing the integrity of their own;
2. make effective use of the knowledge, skills and ways of knowing from their own cultural traditions to learn about the larger world in which they live;
3. make appropriate choices regarding the long-term consequences of their actions;
4. identify appropriate forms of technology and anticipate the consequences of their use for improving the quality of life in the community.

C. Culturally-knowledgeable students are able to actively participate in various cultural environments.

Students who meet this cultural standard are able to:

1. perform subsistence activities in ways that are appropriate to local cultural traditions;
2. make constructive contributions to the governance of their community and the well-being of their family;
3. attain a healthy lifestyle through which they are able to maintain their own social, emotional, physical, intellectual and spiritual well-being;
4. enter into and function effectively in a variety of cultural settings.

6

D. Culturally-knowledgeable students are able to engage effectively in learning activities that are based on traditional ways of knowing and learning.

Students who meet this cultural standard are able to:

1. acquire in-depth cultural knowledge through active participation and meaningful interaction with Elders;
2. participate in and make constructive contributions to the learning activities associated with a traditional camp environment;
3. interact with Elders in a loving and respectful way that demonstrates an appreciation of their role as culture-bearers and educators in the community;
4. gather oral and written history information from the local community and provide an appropriate interpretation of its cultural meaning and significance;
5. identify and utilize appropriate sources of cultural knowledge to find solutions to everyday problems;
6. engage in a realistic self-assessment to identify strengths and needs and make appropriate decisions to enhance life skills.



7

E. Culturally-knowledgeable students demonstrate an awareness and appreciation of the relationships and processes of interaction of all elements in the world around them.

Students who meet this cultural standard are able to:

1. recognize and build upon the inter-relationships that exist among the spiritual, natural and human realms in the world around them, as reflected in their own cultural traditions and beliefs as well as those of others;
2. understand the ecology and geography of the bioregion they inhabit;
3. demonstrate an understanding of the relationship between world view and the way knowledge is formed and used;
4. determine how ideas and concepts from one knowledge system relate to those derived from other knowledge systems;
5. recognize how and why cultures change over time;
6. anticipate the changes that occur when different cultural systems come in contact with one another;
7. determine how cultural values and beliefs influence the interaction of people from different cultural backgrounds;
8. identify and appreciate who they are and their place in the world.



8

SNOWSHOES

Authors: Elder – Catherine Atlla
Amy VanHatten, Susan Rogers, Zelma Joseph Axford, Sarah McDaniel, Sarah McClellan, and Alan Dick

Grade Level: 5–6

Region: Athabaskan

Context: winter for 2 weeks or potentially more

Cultural Standards

A4—Practice their traditional responsibilities to the surrounding environment

D1—Acquire in-depth cultural knowledge through active participation and meaningful interaction with Elders

Skills and Knowledge

- know which types of snowshoes are appropriate for which conditions
- demonstrate traditional weaving techniques and integrate with tessellation
- show how to properly take care of snowshoes
- develop respect for Elders and others who have traditional knowledge and skills

Science Standards

D1—apply scientific knowledge and skills to understand issues and everyday events

Skills and Knowledge

- apply understanding of the concept of weight distribution over a specific area to the construction of snowshoes and
- identify different types of snowshoes and describe the importance of the various shapes in forested or open areas

Math Standards

A2—select and use appropriate systems, units, and tools of measurement, including estimation

A4—Represent, analyze, and use mathematical patterns, relations and functions using methods such as tables, equations, and graph

Skills and Knowledge

- compare and contrast western means of measuring (rulers) with native use of anatomical measures
- conduct a survey of how many snowshoe types, sizes, who owns them, etc. in their community and graphically display their results

STANDARDS BASED

The challenge of preparing students to meet science standards is one currently faced by all educators, not just those trying to create culturally relevant units and certainly not those just in Alaska. It can be a daunting task for anyone involved because the standards represent and codify changes from business as usual in terms of curriculum, instruction and assessment. It is not our purpose here to describe the world of standards-based education, but rather to share some insights from our work in this area through the following guidelines and article.

SUMMARY GUIDELINES FOR STANDARDS-BASED UNITS

△ *Correlate local knowledge with science standards*

Indigenous knowledge is generally holistic in nature and thus integrates aspects of many different school disciplines. Rarely does the speaker break out his or her knowledge in discrete bundles, let alone in terms of the science principles that we recognize. Consequently, the challenge for teachers creating culturally responsive, standards based units, is to correlate local knowledge with pertinent science standards and then decide which ones to target specifically. (See Selawik Weather, on the next page)

▷ *Identify an Appropriate Number of Standards*

Pursue fewer standards in greater depth. Learning is better served by selecting and focusing on a few key complementary standards than it is to list multiple standards and treat them lightly. It is also preferable to integrate complementary standards into lessons where possible than to concentrate solely on one area. By so doing, you can simultaneously address content and inquiry or application standards in a rich and meaningful way.

▽ *Describe specifically what is to be learned about those standards:*

Narrow your focus of study from broad science content standards to the core concepts and skills that are developmentally appropriate for the grade level you are teaching. Use these core concepts/skills to focus planning, instruction, and assessment. Consult the new draft Alaska Science Performance Standards (see sample elsewhere in this handbook), the National Science Standards or Benchmarks documents for help.

◁ *Provide Adequate Learning Opportunities*

Students require time and active engagement to reconcile prior knowledge with new knowledge and these requirements vary from student to student. That being said, a common rule of thumb for planning is that the learning of new science concepts requires a minimum of 3 to 5 experiences with that concept before an adequate experiential base has been established, with additional experiences provided as needed. Teacher judgement is key as are focused, purposeful activities, active questioning and ongoing authentic assessment and lesson adjustment.

CORRELATE LOCAL KNOWLEDGE WITH SCIENCE STANDARDS

One of the challenges and one of the rewards of creating culturally responsive curriculum is learning enough about both local knowledge and science standards to realize how readily they relate to one another. Correlating one with the other is a critical step because it validates local knowledge as a pathway to science learning and demonstrates that standards can be met by following this path. The following information on Selawik weather was generously shared by Jonas Ramoth, an Iñupiat Elder and is elaborated upon later in the *Winds and Weather Sampler*. The accompanying chart demonstrates one way to correlate such knowledge with possible observations, questions, concepts and standards that might form the basis of future study.

Selawik Weather: Winter Winds

If it's clear and cold, -20° or -30°F, maybe there are a few clouds but it's nice and calm. The wind isn't supposed to blow now. If the wind starts to blow when it's not supposed to, people gathered maybe in the store will say "ooo, cold". In Iñupiat they say *qiunaurauqtuaq* which means *he's beckoning the storm*. You know it will be stormy—blowing/drifted snow. It makes you decide to stay home. Animals will stay home too. This is very reliable. (In Kotzebue, though, it's different. You can have the same conditions—cold and clear with a wind coming but a storm doesn't necessarily come.)

The west winds are always cold this time of year. If there's a storm from the west, it's cold. People say the west wind is a "poor artist". It piles up snowdrifts here and there, messy, rough and uneven.

Selawik is in a valley. East winds blow regularly. They prevail in Selawik. In flat country, the east winds leave long, straight 10"–12" drifts that are very consistent. Unlike the west wind, the east wind does beautiful work. When it's white all over and you're not sure where you are, these drifts are very helpful.

We talk about wind in terms of how it's handling visible stuff like grass in summer and snow drifts in winter. If you're home and look out the window, if smoke from a neighbor's stack is leaning over, you know there's a little bit of a breeze or maybe the smoke is moving vigorously. If snow is drifting on the ground, the wind is strong, a surface wind. In storm conditions, visibility is affected and you can't see across the street—on a snow machine, you can't see your skis. 20–25 mph winds are a storm. 30mph winds are a blizzard and even if it's warm, a fine powder of snow finds its way in through your clothes. If you go out, you need a facemask and goggles. It's better to stay put, stay home.

We don't dread the cold; it's just an everyday thing. We just dress for it. We have no concerns about it. Before we learned to say "good morning" in English, our greetings might have to do with observations of the day. You might say, "you can see tracks," meaning that you are going hunting or trapping. If you say "it's cold" as a greeting, if the cold is worth a comment, then it's cold. The person you greet will likely ask more—wanting to know if it's colder than yesterday. You might also greet saying "even though it's cold, you were able to wake up." We don't really have terms for different amounts of cold.

<i>Local Observations</i>	<i>Possible Investigations</i>	<i>Possible Science Concepts</i>	<i>Alaska Science Standards</i>
<ul style="list-style-type: none"> wind direction, speed, temperature 	<ul style="list-style-type: none"> What causes the wind? Why are west winter winds cold? Why are east winds warmer than west winds? What is surface wind? How is surface wind different than atmospheric wind? 	<ul style="list-style-type: none"> density convection radiation 	<p>A-1 (structure and behavior of matter)</p> <p>A-4 (earth/weather)</p> <p>A-8 (heat transfer)</p> <p>B-1 (process skills)</p>
<ul style="list-style-type: none"> snow movement/drift pattern 	<ul style="list-style-type: none"> Why are west winds erratic and gusty? Why do east winds create consistent drifts? How can drift patterns aid in navigation? 		
<ul style="list-style-type: none"> cloud cover temperature cold as a relative factor 	<ul style="list-style-type: none"> Why are clear winter days colder than cloudy winter days? Is this also true for summer? 	<ul style="list-style-type: none"> insulation 	
<ul style="list-style-type: none"> influence of wind and cold on human and animal behavior 	<ul style="list-style-type: none"> How does weather affect animals? Do all animals respond similarly to the same temperature? What kind of weather is best for hunting and trapping? 	<ul style="list-style-type: none"> adaptation 	<p>A-12 (diversity)</p>

ALASKA SCIENCE PERFORMANCE STANDARDS

Because the Alaska Content Standards for Science are broad and not correlated with grade level groups, they have been admittedly hard for teachers and school districts to work with in any targeted way. The newly created *Alaska Science Performance Standards*, however, attempt to remedy this problem by using numerous examples and sample assessments to the kinds of understandings and skills that students should have at K-2, 3-5, 6-8 and 9-12 grade level groups. They are designed for use by teachers and curriculum committees and are referenced to both National Science Standards and Benchmarks. Their creation was fully funded by the Alaska Rural Systemic Initiative with Alaska's diverse population in mind. The Alaska Science Performance Standards are available from The Alaska Native Knowledge Network, Fairbanks, Alaska. The ulus below represent sample performance standards for each grade level. Sample assessments tied to these performance standards are included in the assessment section of this handbook.

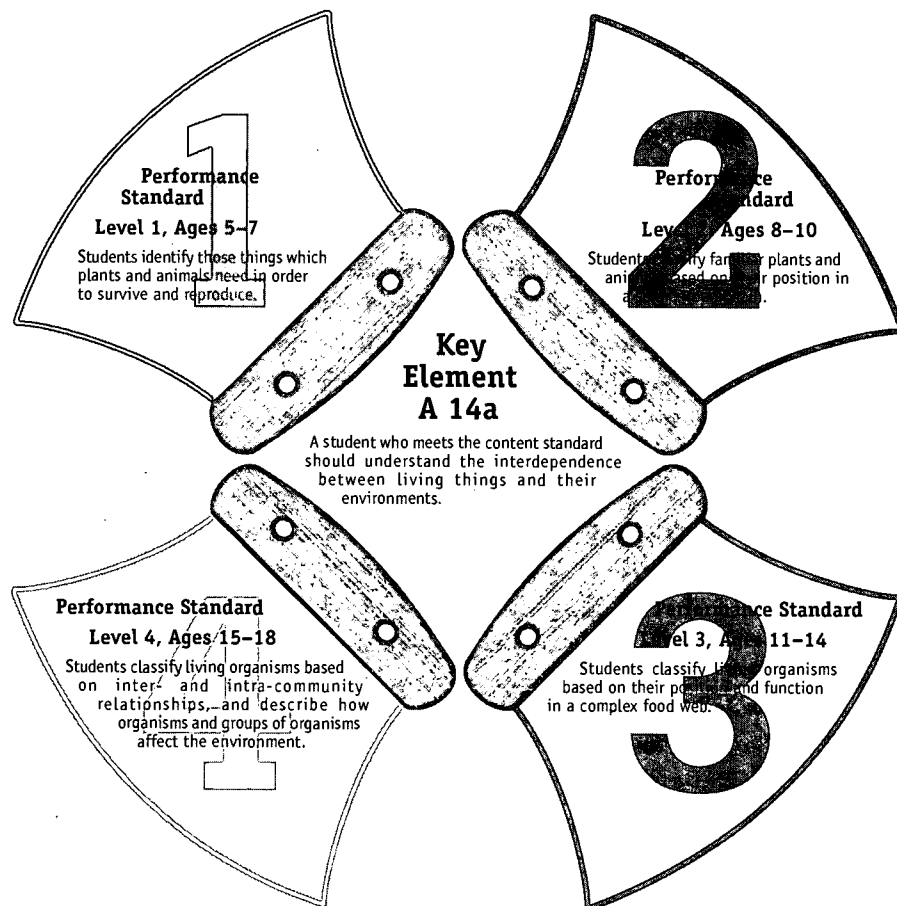

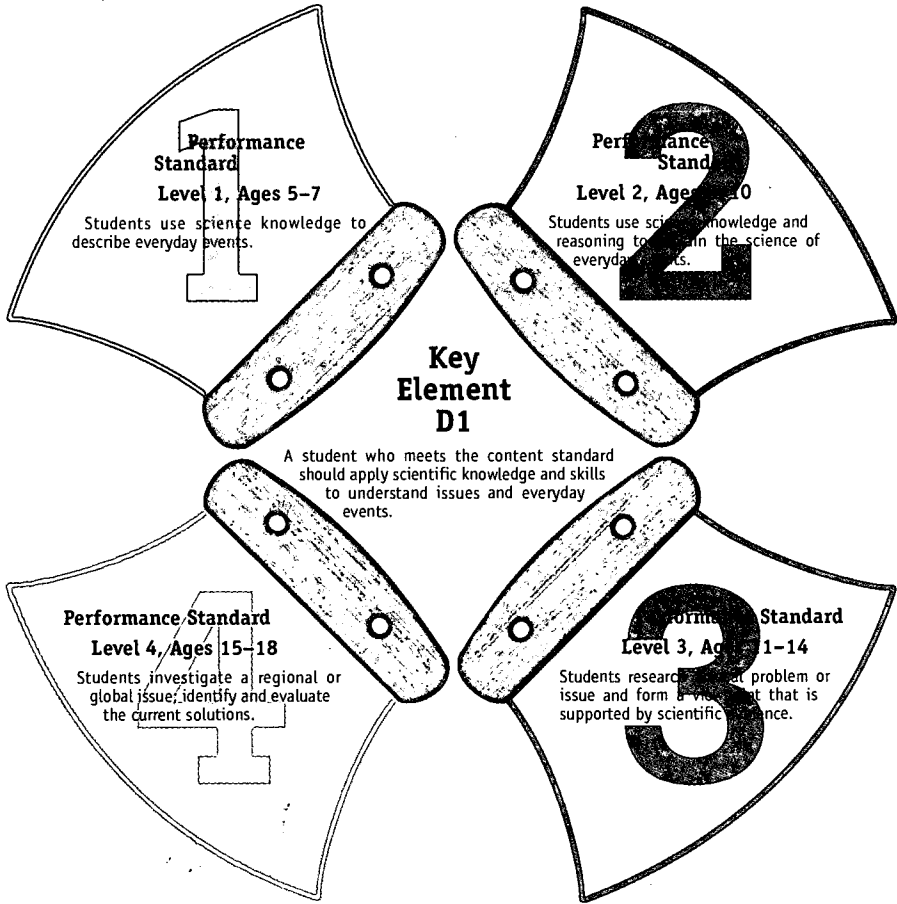
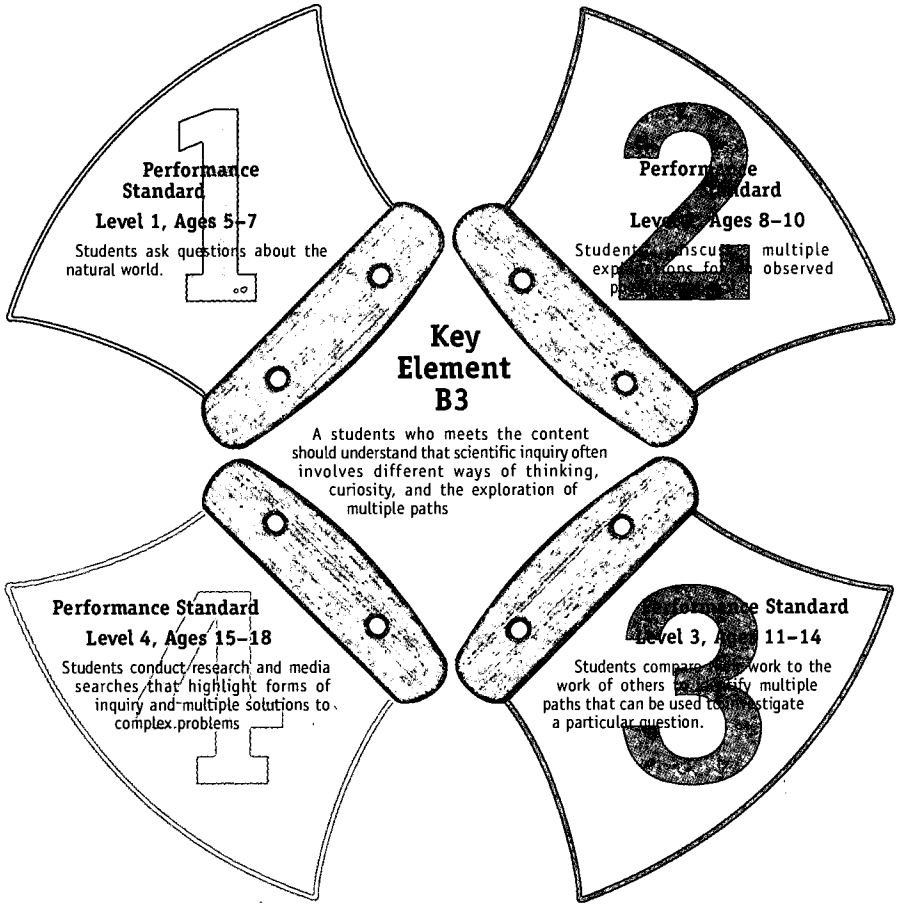

TOPICS TO STANDARDS: A DISCREPANT EVENT

As Science Consortium teachers, we have long-advocated for the power of disequilibrium in the learning process. Remember those discrepant events? The water glass with a 3" x 5" card on top, turned quickly upside down? And remember how we cheered when students became consumed with the puzzle presented therein and went on to explore and explore until they made their own sense of air pressure? Well, as teachers contemplating standards, I think many of us are in a similar state of disequilibrium, and we will require similar extended explorations to work it out. Our reactions range from "What are the standards anyhow, and what in the world am I supposed to do in class to make sure students can meet them" to "what does this mean for the pond unit I've always taught and my students have always loved?" Since much is written elsewhere on what science standards are and why we need them, I'd like to concentrate now on curricular implications and how to hone existing units to standards-based instruction.

For quite a while, the essence of the elementary classroom has been the integrated unit using familiar topics as organizers—dinosaurs, spiders, ponds and so forth. Central to this unit is the idea that students eat, sleep and drink the topic—it's the focus of art and science, of math and language arts. Students are busy and usually enjoy themselves and there is something that will appeal to everyone. Successful teachers have developed lots of these units and recognize the power and efficacy of integrated instruction.

Then along come standards where there is NO MENTION of topics at all—students are not accountable for knowledge of dinosaurs, spiders, ponds or any of the familiar organizers that still dominate most school district curricula. Instead, elementary students are to show developmentally appropriate mastery of enduring ideas, core concepts, attitudes and skills central to the discipline of science. But just how do you do that without throwing out those favorite units?

For many harried teachers, the first step is to do a quick read of the standards, which are admittedly broad and vague, and then to correlate, equally vaguely, the activities that they already do (one good turn deserves another). Something like—"let's see, we looked at pond critters so we've done A-12—diversity (check ✓), A-14 a, b and c, interdependence (check ✓), A-15—local environment (check ✓) and B-1—process skills (check ✓)." But have they really "done it"? If fourth graders, for example, have looked at pond critters, have they really mastered the diversity, interdependence, local environment and process skill standards? Can they, for example, "categorize groups of plants and animals according to external features and explain how these features help organisms survive in different environments"² and can they "observe, measure and collect data from experiments and use this information in order to classify, predict and communicate about their everyday world"³? I doubt it and so do most teachers who take a second look at standards.

So, what to do with that pond unit? Seems to me, a couple of things are necessary. The first is to reorient our noggins, thinking not of all the fun activities we want to do at the pond, but asking ourselves, what essential skills and understandings can students develop using ponds as the vehicle? Where do we want pond study to take us? The possibilities are almost endless, but the following is a sample of what you might do with life science at a K-4 level. (Addressing inquiry skills would generate an equally substantial list of possibilities.)

Unless you want to do a very long and extensive pond study, the next step is to limit the number of concepts/skills that you choose to address. One way to go about this is to figure out what your students already have a handle on and where they need more work. For example, by the fourth grade, students will hopefully understand the concept of habitat and be adept at classifying organisms according to external features. If this is so, then you might want to choose adaptation or life cycle as your focus.

² Alaska Science Performance Standard A-12, Level 2

³ IBID, B-1, Level 2

<i>Topic</i>	<i>Concept</i>	<i>Concept Description</i> (often embedded in Performance Standards or Benchmarks)	<i>Content Standard</i>
Ponds	Classification	Animals and plants are alike and different in a variety of ways. Groups of plants and animals have similarities that distinguish them from other groups.	A-12, Diversity
	Adaptation	Plants and animals have a great variety of body plans to help them survive and reproduce.	A-12, Diversity
	Life cycle	Plants and animals have life cycles that include being born, developing into adults, reproducing and eventually dying. The details of this life cycle are different for different organisms.	A-12, Diversity
	Food chain	All animals depend on plants. Some animals eat plants for food. Other animals eat animals that eat the plants.	A-14, Interdependence
	Habitat	Animals and plants have specific requirements for life. Organisms can survive only in environments in which their needs can be met.	A-14, Interdependence

Having chosen your concept, review the activities you already do at the pond and select those that address the chosen concept. Chances are you will be able to use several of your favorite activities so long as you keep foremost in your mind and in your students' minds, the reasons for doing them. Remembering that students need 3–5 different experiences in order to grasp new concepts, you may well have to create several new “adaptation” or “life cycle” activities in order for students to learn enough to be able to demonstrate their mastery. Such culling and rewriting of lessons to address selected concepts characterizes the switch from breadth to depth and is to be expected as you switch to standards-based instruction. The idea is not to chuck your favorite unit or sterilize it beyond recognition; it's simply to selectively focus on key ideas, teaching them thoroughly and well.

And yes, some of your favorite activities might not fit, but lots will and the new activities that you create might be even more exciting than the old. It still will be important to provide different avenues for different learners, so literature, math, art, music and technology connections remain important. In fact, if you are accustomed to doing hands-on explorations within an integrated unit, then a switch to standards-based science instruction could be relatively painless or even liberating. I mean, instead of feeling compelled to “cover” jillions of science facts, you can focus on just a few key concepts or skills, keep them as targets through use of focusing questions, KWL charts etc., and then explore the daylight out of them. And if, as a result of pond study, your students truly understand that “plants and animals have a great variety of body plans to help them survive and reproduce” and if they can apply that understanding across the board to spiders and dinosaurs and trees, then hoopla—how liberating! They have an idea and experience upon which to hang a whole set of understandings—a core concept that works in all life systems.

BEST PRACTICES

In the excerpt on the facing page Esther Ilutsik sensitively sketches a view of traditional Yup'ik learning. It takes little effort to realize that such learning looks and feels quite different than what goes on in many rural communities today, let alone in many classrooms. For one thing, in traditional learning the curriculum is not broken down into academic disciplines, but represents a holistic view of the world intimately connected to Yup'ik life, values and culture. For another, there is no set place or time to learn: learning takes place as part of the flow of life and community with extended exploration over time. For another, there is no one set teacher: the girl learns from her mother, older girls and community interactions. And for another, the teachers are Yup'ik and speak Yup'ik.

For those most concerned about culture and able to share cultural knowledge, language immersion schools, culture camps, Elder/youth conferences, Native teacher associations, an increased emphasis on supporting Native teacher education, and the development of Native curricula are powerful responses to the differences noted above and to the concerns raised by educators like Ilutsik. However, for those not engaged in such efforts, the issues are different. Among other things, we want to know which teaching practices might best support science learning while enhancing the cultural well being of students. For possible answers, we consider the similarities or potential similarities between traditional teaching and learning and strategies for teaching inquiry-based science. The following chart is one way to start thinking about this.

<i>Traditional Teaching</i>	<i>Inquiry Teaching</i>	<i>Compatible Strategies</i>
<ul style="list-style-type: none"> • Elders, family, community and peers teach • learning connected to life, seasons, and environment • learn by watching, listening and doing; Elder is expert • emphasize skills and practical application of knowledge • knowledge shared through modeling, story telling and innovation 	<ul style="list-style-type: none"> • teacher as facilitator of learning; science as a social endeavor • investigate fundamental science questions of interest to students • active and extended inquiry over time; use of print and electronic sources to help interpret or revise explanation • focus on student understanding and use of scientific knowledge, ideas and inquiry skills • classroom communication and debate of understandings 	<ul style="list-style-type: none"> • community involvement, cooperative groups, peer tutoring; multiple teachers as facilitators of learning; • investigate fundamental science questions related to life, seasons and environment; investigate questions from multiple perspectives and disciplines • learn by active and extended inquiry; use multiple sources of expert knowledge including cultural experts • integrate skill development, understanding and application of knowledge • diverse representations and communication of student ideas and work to classmates and community

TRADITIONAL YUP'IK LEARNING

By Esther Ilutsik

The following is an excerpt from *Sharing Our Pathways, Volume 4, Issue 4* newsletter published by the Alaska Native Knowledge Network

Let's take a look at a traditional Yup'ik learning situation. In the past, the Yup'ik people learned a lot by participating and observing. This does not imply passive observing as defined in the Webster Dictionary (to watch attentively), but rather immersing yourself in the activity. This could be with immediate family or extended family members or at the community level. Consider the following scenarios:

Scene 1

A young girl plays near her mother as her mother is making a squirrel parka. She is playing with her dolls. Her mother gives her some scraps of fur to make a simple piece of clothing for her doll. She tries her hand at sewing with her mother showing her how to thread, to make a knot and doing the first few stitches for her as she observes (this time the Webster definition is valid.) Then she finishes what her mother started and has her help with tying the knot.

Scene 2

The young girl is outside playing with a few older girls as well as girls her own age. They are all seated in a circle each with a *yaruin* (a story knife) and are taking turns telling a story. She watches as the other girls draw a squirrel parka detailing all the parts of the parka, sharing the stories and meaning behind each design and pattern. She also draws as she watches and listens. When it is her turn, she is helped by the other girls.

Scene 3

The young girl is with her mother and father at a gathering and observes and listens. She notices that her mother and father greet certain people as relatives. She notices that the parkas that they wear are all similar. One part of the parka stands out as the important symbol that signifies relationships. She also notices that those with the most similar designs are invited to the home as overnight guests.

Scene 4

The young girl is a little older and again sits with her mother as she sews a parka. The girl indicates to her mother that she would like to make a small parka for her doll detailing some of the family patterns. The mother shares with her the most significant part of the parka design, then shows her how to make it and has her make one for her doll.

These scenes are played out over-and-over again until the young girl has reached marriageable age. She has all this knowledge, experience and practice which she brings to her early years of marriage and now, with her own family, continues the cycle.

CULTURAL RELEVANCE AND THE LEARNING CYCLE MODEL

Since the inception of the Alaska Science Consortium, we have pondered the fit between learning cycle model instruction (LCM) and Native ways of teaching and learning. As Native teachers began to participate in our institutes, we made a point of asking them whether the approach we advocated was appropriate for Native students, but it wasn't until 1996 that we held a meeting with Native fellows to discuss just this topic. In general, Native ASC fellows were supportive of the LCM approach because it is constructivist in nature and emphasizes science as a process of understanding; students as explorers of science; and teachers as facilitators of learning. Nita Reardon in fact said, that the ASC gave her permission to teach the way she wanted to and the way she was used to. That being said, two caveats apply.

First, the application of knowledge is of paramount importance in Native cultures and has traditionally been equated with the ability to survive. Consequently, teachers viewed the "apply" phase of the cycle as most important—as true-to-life performance assessment (If given 3 bullets, do you return with 3 birds?). This emphasis on practical knowledge is so critical to Native teachers that they advocate beginning instruction with the "apply" phase (rather than with "gear-up") and then working clockwise through the other steps as illustrated below.

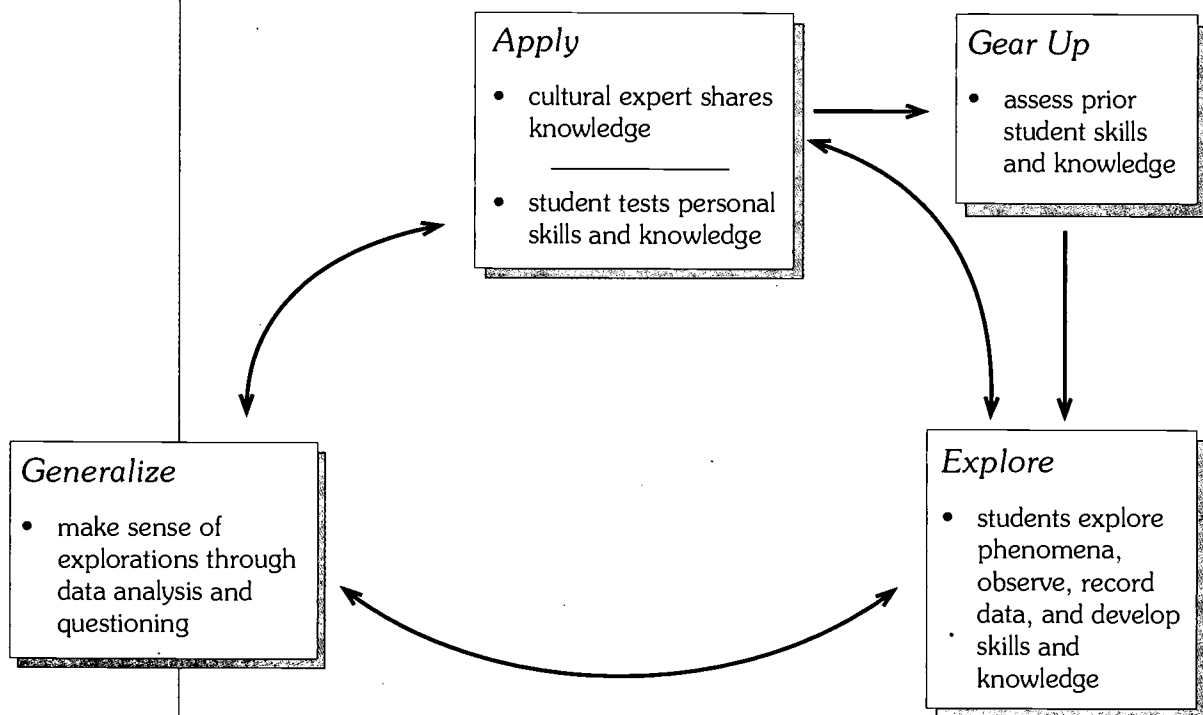

Second, Native teachers were uncomfortable with the "generalize" phase of the LCM believing that sense-making is an ongoing and often internal process, and that identifying it as a formal step often feels uncomfortable and artificial. They also thought that while students would indeed be puzzling through things during their explorations, that the biggest ah-ha's would occur when students actually tried to apply their knowledge in the real world (Why aren't there ptarmigan where I expected them? Why didn't it rain when the weather signs indicated it would?). Consequently, they favored a more subtle, student-driven, sense-making approach embedded throughout the LCM.

These 2 shifts in instruction are significant because they ground the experience for students in locally significant ways and because they alter the essence of the LCM not one whit. Beginning and ending lessons with “apply” readily incorporates traditional application and Elder knowledge at the beginning of the lesson where it belongs (almost as a gear-up) and at the end of the lesson when students test their learning. It also accomplishes the ultimate goal of applying knowledge to the real world. Similarly, treating “generalize” with a lighter (but still purposeful) hand allows for differences in the sense-making process and reflects the role of students as inquirers and of teachers as facilitators of learning. Again, it is a win-win situation so long as students truly explore first and so long as attention is truly paid to making sense of, rather than just running through explorations.

This latter point, however, cannot be emphasized too strongly. In other words, while it is critical that an Elder or other expert describes and repeatedly points out medicinal and edible plants or that they model (set the standard) for the skillful setting of snares, it is not enough. Students must have the opportunity to observe, collect and classify plants themselves or set snares themselves in order to develop their own skills and understanding. It is one thing to be told or even shown information, and it is quite another thing to learn and test personal knowledge and skills sufficiently enough to be able to use them in daily life. It is also important to remember that while “bringing in grampa” to talk to the class or accompany them on a field trip is a step in the right direction, it does not have the same impact as actually following up on that visit by creating relevant studies using grampa’s knowledge as a base, and involving students in meaningful exploration and application. The chart on the next page depicts some of the studies that meet these criteria.

You’ll notice that in all of these examples students are guided in active and extended inquiry through student investigations and use of questioning strategies which directly target student understanding and use of knowledge and skills. All of the activities involve cultural experts and the out of doors. And finally, all begin with a modeling of applied knowledge and end with student testing of their own expertise.

SHARE KNOWLEDGE

The sharing of knowledge is an important aspect of both scientific and Native communities. Scientists share and often harshly debate the procedures, merits and conclusions of scientific study, with the ability to replicate studies and reach similar conclusions being a critical aspect of the scientific process. Perhaps more softly and subtly, debate or at least sharing, is also a part of traditional systems. As pointed out earlier by Richard Glenn, “Ours is a culture of consensus. Agreement is mandatory on nearly every item passed on as traditional knowledge. If one person stands alone, he may be an expert or he may be wrong.”⁴ Such sharing of traditional knowledge is often done through storytelling, modeling and innovation connected to life, values and proper behavior. So in a classroom context, diverse representation and discussion of student observations, interpretations and explanations is a critical aspect of culturally responsive science instruction from dual perspectives. It is a process by which students clarify and extend their learning through discussion and questioning by others.

But the sharing of knowledge has another purpose more related to plain old manners and giving back to those who have given. Elders, community members and scientists who have helped with classroom studies will be eager to see the products of student work as will parents and community members who may have been only peripherally involved. Hosting a community night where people are thanked publicly and where studies and learning are showcased is a great way to share. By its very nature, it invites comment and discussion which can only promote learning. Things like booklets, posters or collections of work that can be made simply and distributed are also beneficial, as are political statements such as letters, resolutions or public testimony. This “giving back” completes a cycle that will build knowledge and encourage all to participate again.

⁴ Glenn, Richard 1999 *Traditional Knowledge, Environmental Assessment and the clash of Two Cultures in SOP*

Topic	<i>Elder Discussion or Demonstration (Apply)</i>	<i>Student Exploration</i>	<i>Student Generalize/Apply</i>
Rabbit Snaring (see ANKN website for whole unit)	How to recognize hare tracks and where to find them. Demonstrate snare making/setting.	Field trip to find tracks noting type, direction, size, location/habitat etc. Students practice making snares in class. Brainstorm results of different variables in snare design/set. Chose a design/set and test it.	<p>What kinds of tracks did you find? Where were hare tracks most common? What does this tell you about hare habitat needs? Were the tracks fresh? Can you tell the speed of movement from tracks etc.? Where would you go if you wanted to trap hare?</p> <p>Chart results of hare snaring activity. What sets were successful? Which weren't? What is the difference between successful and unsuccessful sets? If you were to set snares again, what would you try? Etc.</p>
Plants of the Tundra (see ANKN website)	Field trip with Elder identifying plants and discussing their significance/use.	Classroom observation and classification of plant samples. Collect, press and label samples with Yup'ik name. Make plant booklets with pressed plant including Elder information. Predict, pick and measure the amount of berries that can be picked in a 1-meter diameter circle.	How are plant leaves, stems, roots, flowers and berries alike and different? What plants grow in similar habitats? What is the best place and time to find certain plants? Plan and conduct a gathering festival. Prepare plants for food/medicine.
Weather	In repeated field settings, Elder shares knowledge of local weather signs and predictions	Students create, conduct and record local weather observations based on Elder information	What do you notice about wind speed and direction? Is there a relationship between temperature and cloud cover? What factors in combination seem to be predictors of weather change?

INTEGRATED STUDY, TRADITIONAL CAMPS AND SCIENCE FAIRS

While the above discussion has attempted to detail some key aspects of culturally relevant teaching with regard to the learning cycle model, there are many other strategies that could be included under "best practices." Some of these are: (1) integrated (multidisciplinary or interdisciplinary) instruction; (2) use of traditional camps as educational settings; and (3) science fair camps and projects which explore traditional knowledge and merge with Western science concepts.. Brief discussion of these best practices follow.

Integrated Study

As has been stated throughout this handbook (and multiple other sources), Native knowledge is holistic in nature and inherently integrates aspects of many different school disciplines. Consequently, approaching culturally responsive science curriculum as integrated study makes consummate sense both in terms of Native knowledge and in terms of the need to address multiple subjects/standards in a single school day. Teachers are really good already at creating such integrated units and they value integration for the diverse learning opportunities and connections it creates. Extending such integration to feature/incorporate traditional knowledge can only strengthen such opportunities and connections while enhancing the cultural well-being of students. The following snow studies diagram is a sample of such integration.

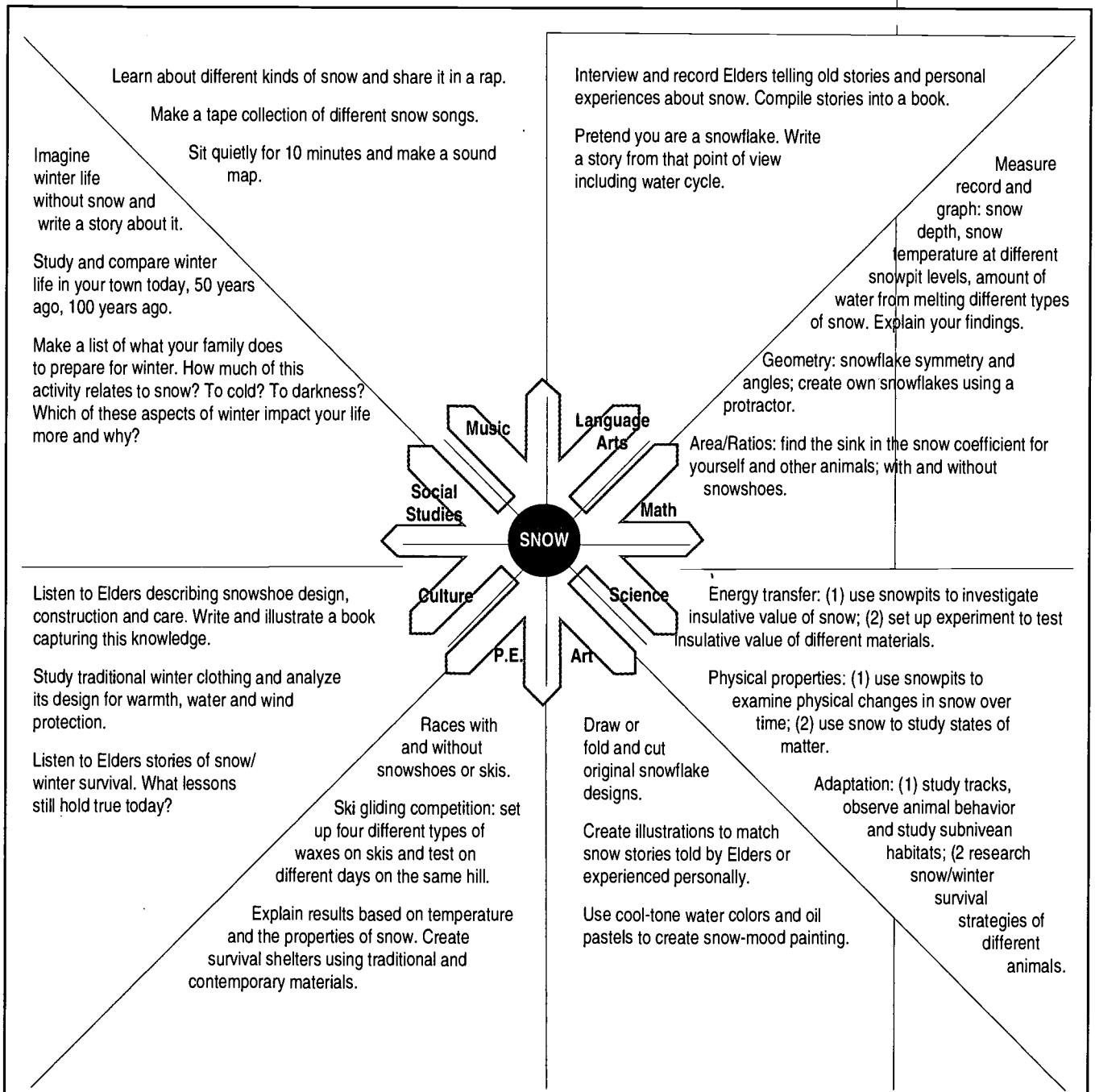

Traditional Camps

As educators seek more effective ways to teach students, camps are emerging as a most successful means of connecting the school curriculum to students lives in culturally and educationally meaningful ways. Such camps are proliferating all over the state and occurring mostly during the summer with some notable exceptions⁵. As Kawagley (2000) points out, such camps can take a variety of forms from cultural immersion to language development to bridging science camps and thus serve a variety of needs. The most obvious advantages to such camps are that they allow young people the opportunity to interact with Elders and instructors in an environment that naturally promotes hands-on, culturally relevant learning according to the flow of life and seasons. For more information on such camps see the ANKN website and look for an ANKN “how to” booklet to be published in the near future.

Science Fairs

Along with the recognition that traditional Native knowledge has much to contribute to the understanding of the natural world has come the recognition that science fairs should be redesigned to accentuate this understanding. The American Indian Science and Engineering Society (AISES) and AKRSI have taken a lead in developing such science fairs, in which projects are based on questions that are important to the community and culture and Elders are recognized as experts along with Western scientists. Projects are judged both on cultural and scientific merit and must demonstrate thoughtful insight and understanding on all counts. The mechanisms for creating and participating in such fairs are well described on the ANKN website, and again, a “how to” booklet will be published in the near future.

ASSESSMENT

With the merger of cultural knowledge and science, and with the shift in science education from science as only content to science as a complex combination of attitudes, inquiry skills, and conceptual understanding come necessary shifts in assessment. In other words, if we truly value student growth and understanding of cultural knowledge, then we must find ways to assess such knowledge and we must resist the temptation to merely treat cultural knowledge as a vehicle for science learning. If we truly value student abilities to: reason scientifically; apply science learning in real life situations; and understand the contexts and constraints under which science functions, then we must assess in all those areas as well. And finally, if we recognize that learning includes the process of exploration and the student’s autonomous construction of meaning, then we must allow for diverse pathways to and demonstrations of understanding.

This is a tall order. We are making progress with authentic assessment of all aspects of science, but have less experience with the issues of assessing cultural behavior, knowledge and values—things that are all critically important to Native communities. The following chart offers a look at some promising practices with regard to culturally relevant assessment, as does the sample assessment from the Alaska Science Performance Standards. This look however, is admittedly tentative, both because our knowledge of traditional assessment practices is naive and inadequate, and because our experience with authentic, standards-based assessment in classrooms is evolving but not secure. With these significant limitations in mind, we offer the following information and we also encourage you to consult both local experts and suggested readings for more insight.

⁵ In Alakanuk, for example, a one-week fall culture camp for the whole school has begun the school year for the last four years, and they are looking to expand the camp experience in to other seasons and extended curriculum (See *Sharing Our Pathways* 5(2) 10-11

PROMISING ASSESSMENT STRATEGIES

	<i>Traditional Assessment</i>	<i>Inquiry Assessment</i>	<i>Compatible Assessment Strategies</i>
<i>1. Diagnostic</i>	<ul style="list-style-type: none"> • Elder sets standards using cultural knowledge continuum and “need to know” as a guide • Elder watches and interacts with children in daily life and gauges individual readiness for specific tasks 	<ul style="list-style-type: none"> • Teacher uses standards and district curriculum as a guide to instructional priorities • Prior to instruction, teacher gauges student’s background experiences, skills, attitudes and misconceptions 	<ul style="list-style-type: none"> • Informal discussions of topic to be studied • Observational evidence from prior activities • Concept mapping
<i>2. Formative</i>	<ul style="list-style-type: none"> • Elder observes children at work on task during daily life, offering continued modeling, encouragement and positive acknowledgments of individual progress • Elder provides additional tasks as student skills and knowledge develop and they appear ready for the next challenge • Skills and knowledge are not assessed in isolation from their purpose and application 	<ul style="list-style-type: none"> • Teacher monitors student progress and adjusts learning activities to reach goals • Teacher provides helpful feedback to improve student’s understanding • Assessments tap developing skills, attitudes and conceptual understanding 	<ul style="list-style-type: none"> • Observations • Informal Interviews • Journals and Learning Logs • Self-evaluations • Performance Tasks
<i>3. Summative</i>	<ul style="list-style-type: none"> • Ultimate evaluation is whether or not child can apply their learning effectively in daily life (e.g. do they have adequate skills and understanding to successfully trap hares, collect and preserve berries etc.?) 	<ul style="list-style-type: none"> • Teacher assesses student’s ability to transfer skills and understandings to other tasks in other contexts 	<ul style="list-style-type: none"> • Performance Tasks • Performance Events • Self-evaluations • Portfolios • Creative Performances and Exhibitions

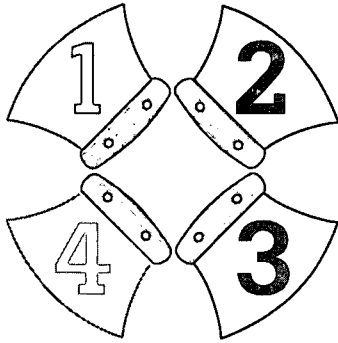

ALASKA SCIENCE PERFORMANCE STANDARDS: ASSESSMENT IDEAS

In an effort to aid teachers in their transition to standards-based, authentic assessment, the Alaska Science Performance Standards document includes both Sample Assessment Ideas and Expanded Sample Assessment Ideas. The following examples illustrate the nature of these ideas and are included to prompt further thinking about culturally-responsive curriculum assessment.



Alaska Science Key Element A14a

A student who meets the content standard should understand the interdependence between living things and their environments.

Performance Standard Level 3, Ages 11–14

Students classify living organisms based on their position and function in a complex food web.



Sample Assessment Ideas

- Students discuss the short-term and long-term consequences of removing a specific organism from a food web.
- Students describe the relationship of bacteria and plants in the nitrogen cycle.



Expanded Sample Assessment Idea

- Students report on a predatory animal in their local area; determine which other predators are in direct competition for food.

Procedure

Students will:

1. Choose an animal to study.
2. Make observations, do library and internet research, contact state park agencies for information, and discuss their assignments with knowledgeable Elders; determine what prey animals these predators eat, and how much territory is required to support each predator.
3. Identify inter-species and intra-species predators in direct competition with one another for food.
4. Illustrate and describe the food chain of the animal.
5. Produce a class poster, written, or oral class report. (The list of predators in an area could become unmanageable if insects are included. Teachers will have to set some limits on types of animals under consideration.)
6. Compare and classify the animals in the food web according to the level they occupy in the food chain.

Reflection and Revision

Describe the changes that would occur if one predator or one prey were removed from this area? How would other organisms in the food chain be affected? What happens to

human consumption when one food animal is no longer available? Why are some predators no longer found in their original area or in our community?

Level of Performance

- Stage 4** Student work is complete, and shows evidence of clear and logical reasoning. Student conducts a thorough investigation of an animal and produces a detailed food web that includes organisms from all trophic levels of the food chain. Student correctly identifies predators in direct competition with one another and explains how these animals avoid direct competition. Student work shows extensive evidence of transfer and extension of knowledge in a detailed discussion of how an organism's change affects the food web.
- Stage 3** Student work shows evidence of logical reasoning, but may contain minor errors or omissions. Student conducts an investigation of an animal and produces a food web that includes organisms from all trophic levels of the food chain. Student correctly identifies predators in direct competition with one another and explains how two of these animals avoid direct

competition. Student work shows evidence of transfer and extension of knowledge in a discussion of how an organism's change affects the food web.

- Stage 2** Student work may be incomplete, or contain errors of science fact and reasoning. Student conducts an investigation of an animal and

produces a simple food chain. Student may identify another animal that competes for food or other resources. Student work shows limited evidence of transfer and extension of knowledge.

- Stage 1** Student work is largely incomplete, and may contain major misconceptions regarding an animal and its needs or complex food chain.

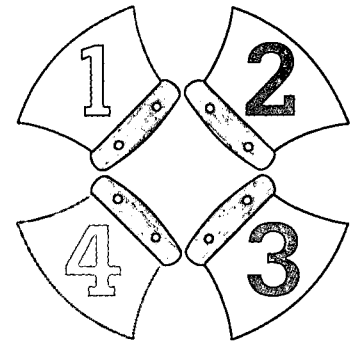

Alaska Science Key Element B3

A student who meets the content standard should understand that scientific inquiry often involves different ways of thinking, curiosity, and the exploration of multiple paths.

Performance Standard Level 4, Ages 15–18

Students conduct research and media searches that highlight forms of inquiry and multiple solutions to complex problems.



Sample Assessment Ideas

- Students read recent scientific research and reviews of that research to examine suggestions for improvement.
- Local students conduct independent parallel investigations with a student team in a different location on the same research question, compare results, and discuss the processes used to arrive at their respective conclusions.



Expanded Sample Assessment

- Students use primary and secondary research to determine an ideal method for tanning salmon skins in their locality and describe how they arrived at that result.

Procedure

Students will:

1. Investigate salmon skin tanning, including reasons for tanning, why skins and hides are tanned, and traditional and modern methods of tanning.
2. Brainstorm about types of information that might be useful in solving the problem.
3. Divide into small groups to investigate the problem from different perspectives (conduct experiments with skins and hides, interview elders and professional tanners, research Internet).
4. Share the research results with each other, critique each method of tanning, and develop alternative methods of tanning.

Reflection and Revision

Reflect on ways in which collaboration, creativity, multiple paths of exploration, and personal integrity helped to solve the problem.

Level of Performance

- Stage 4 Student work is complete, correct and shows evidence of elaboration and extension. Student uses multiple sources to identify reasonable solutions to the tanning task including Internet research, and local interviews; designed controlled, quantitative experiments.
- Stage 3 Student work is generally complete, correct and shows some evidence of elaboration and extension. Student uses multiple sources to identify solutions to the tanning task including Internet research and local interviews. Although experimentation is included, it may be poorly controlled, lack quantitative measurements or result in a questionable solution to the tanning task.
- Stage 2 Student work is generally on task but shows little evidence of elaboration. Student may use one or two sources to identify solutions to the tanning task. Although experimentation is included, controls and measurements are lacking.
- Stage 1 Student work may be related to tanning but is not targeted to identify multiple solutions to

Solutions, if included, may not be related to the experimental procedure presented.

- Stage 1 Student work may be related to tanning but is not targeted to identify multiple solutions to

the tanning task. Experiments and use of outside information sources, if included, may not be appropriate or useful.

BEST COPY AVAILABLE

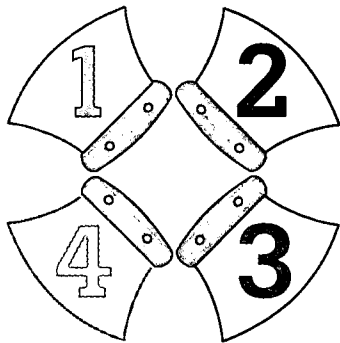

Alaska Science Key Element D1

A student who meets the content standard should apply scientific knowledge and skills to understand issues and everyday events.

Performance Standard Level 1, Ages 5-7

Students use science knowledge to describe everyday events.



Sample Assessment Ideas

- Students tell why it is easier to make snowballs in the spring than in the winter.
- Each student observes where the snow remains on the playground in the spring; give possible scientific explanations as to why the snow is still there.



Expanded Sample Assessment Idea

- Students test three sleds to determine which travels the greatest distance.

Procedure





Students will:

1. Hold the sled at the top of an incline. another student rides the sled, and a third student at the bottom of the hill measures the distance. The same student should ride the sled for each trip down the incline.
2. Measure, record and graph the distance traveled by the sled. Repeat experiment with each sled.
3. Use simplified language to discuss friction, motion and force.
4. Relate this activity to another similar activity, such as sliding down the playground slide, and so on.

Reflection and Revision

Discuss factors other than the sled design that would increase the distance traveled by the sled. Repeat experiment using these factors.

Level of Performance

- Stage 4  Student work is complete, correct, and contains evidence of elaboration, extension, higher order thinking skills, and relevant knowledge. Student actively participates with group to perform an accurate test that considers several factors that may affect the distance traveled by the sled.
- Stage 3  Student work is generally complete and correct but may contain evidence of some inaccuracies or omissions. Student participates with group to perform an accurate test to determine the distance traveled by the sled. Multiple factors are not considered.
- Stage 2  Student work may be incomplete or inaccurate. Student may be a reluctant group participant. The test may include three types of sleds but does not control the variables or make accurate measurements.
- Stage 1  Student work is incomplete and inaccurate. Student does not participate in group task or participates in group sledding adventure rather than testing the sleds.

BEST COPY AVAILABLE

REFERENCES

- Barnhardt, R. (1997). Teaching/learning across cultures: strategies for success. *Sharing our Pathways*. 2 (1,2,3)
- Glenn, R. (1999). Traditional knowledge, environmental assessment, and the clash of two cultures. *Sharing Our Pathways*. 4(5) 12-13
- Ilutsik, E. (1999) Traditional Yup'ik knowledge—lessons for all of us. *Sharing Our Pathways*. 4 (4)
- Kawagley, A.O. (2000). Identity creating camps. *Sharing Our Pathways*. 5(2) 4-5
- Kawagley, A.O. (1995) *A Yupiaq Worldview: a Pathway to Ecology and Spirit* . Illinois. Waveland Press
- Kawagley, A.O., & Barnhardt, R (1997). Education indigenous to place: western science meets native reality. *Ecological Education in Action*, G. Smith & D. Williams, Editors SUNY Press.
- Lipka, J. (1998). Expanding curricular and pedagogical possibilities: Yup'ik-based mathematics, science and literacy. *Transforming the Culture of Schools—Yup'ik Eskimo Examples*. Lipka, J, Mohatt, G.V. & the Ciulistet Group. New Jersey: Lawrence Erlbaum Associates
- Murphy, N. & Rutherford, M. (1996). Native ways of knowing. *Math/Science Alaska Framework*, Alaska Department of Education 2-22-35

CURRICULUM RESOURCES

<http://www.ankn.uaf.edu>

The Alaska Native Knowledge Network is a resource for information related to Alaska Native knowledge systems and ways of knowing. It has a searchable curriculum database, sample science units, copies of Alan Dick's science books, AISES Handbooks, links to multiple related sources and much, much more.

<http://www.anroe.org>

The Alaska Natural Resources and Outdoor Education Association has published an invaluable and complete guide to Alaska relevant science kits, curricula, and field guides.

Dick, A. (1999) *Village Science, Teacher and Student Editions*. Fairbanks, Alaska: Alaska Native Knowledge Network

Dick, A. *Alaska Alive: Inspiring and Instructing for the Development of Alaskan Science Fair Projects*. Fairbanks, Alaska: Alaska Native Knowledge Network

Dick, A.(1998) *Northern Science or Alaskans are Never Stuck, Teacher and Student Editions*. Fairbanks, Alaska: Alaska Native Knowledge Network

APPENDICES

AKRSI Unit Building Assessment Rubric	A-1
Lure Construction and Ice Fishing with Elder Involvement	A-3
Winds and Weather Sampler	A-9

AKRSI UNIT BUILDING ASSESSMENT RUBRIC

Parameter	Level 1	Level 2	Level 3	Level 4
Cultural Relevance How well does the unit examine topics of cultural significance, involve cultural experts and address cultural standards?	Cultural significance unclear or absent.	Cultural knowledge is suggested or implied.	Cultural knowledge is apparent.	Cultural knowledge is prominent and insightfully explored.
	Involvement of cultural experts not mentioned.	Role of cultural experts unclear.	Cultural experts involved.	Cultural experts are a significant and critical part of unit implementation.
	Cultural values, skills and standards not identified.	Cultural values, skills and standards suggested or implied.	Cultural values, skills and standards identified.	Cultural values, skills and standards clearly identified and tied closely to and readily accomplished by lessons.
Standards Based How well does the unit identify an appropriate number of state math or science standards; describe specifically what is to be learned about those standards; and provide an adequate number of properly sequenced opportunities that lead students to a deeper understanding of the standards?	Standards not identified.	Standards identified but inappropriate.	Appropriate standards identified.	Appropriate number of standards identified and specifically tied to unit.
	Skills and/or knowledge to be gained not identified	Skills and/or knowledge to be gained are identified but not relevant to standards chosen.	Skills and knowledge to be gained are identified.	The specific content and skills to be learned are clearly identified, age-appropriate and clearly tied to standards.
	Lesson activities not described.	Activities don't address standards or are described inadequately to ascertain targeted skills and knowledge.	Includes an adequate number of appropriate activities.	Activities thoroughly explained and properly sequenced to allow for development of skills and knowledge (standards).

continued

Parameter	Level 1	Level 2	Level 3	Level 4
Best Practices: How well does the unit incorporate strategies which: focus on student understanding and use of scientific knowledge, ideas and inquiry process; guide students in active and extended scientific inquiry; and support a classroom community with cooperation, shared responsibility, and respect?	Teaching strategies unclear or not described.	Teaching strategies do not attend to student understanding and use of knowledge and skills.	Strategies include some attention to student understanding and use of knowledge, ideas and inquiry processes.	Strategies directly target student understanding and use of knowledge, ideas and inquiry processes. (conceptual understanding and skill development.)
	Teaching strategies unclear or not described.	Strategies do not engage students in active investigations.	Activities include some active student investigation.	Teachers guides student in active and extended inquiry by provision of appropriately sequenced student investigations and use of questioning strategies to elicit concept.
	Teaching strategies unclear or not described.	Teacher maintains responsibility and authority for learning.	Some evidence of shared responsibility for learning.	Responsibility for learning is shared with students by teacher acting as a facilitator and creating a classroom community of cooperation and respect
Assessment: How well does the unit engage in ongoing assessment of : student understanding of highly valued, well-structured knowledge; student skill development and reasoning ability; diverse representations of understanding	Assessment not described.	Students tested at end of unit on factual understanding that can be easily measured. Assessment of deep scientific, mathematical, or cultural understandings or skill development is absent.	Some evidence of ongoing assessment to determine what students know and are able to do.	Students assessed throughout unit as a guide to instructional choices. Assessments tap deeper cultural, scientific and mathematical, understanding, reasoning and skill development tied to standards. Diverse representations of understanding encouraged.

SAMPLE PRIMARY UNIT

LURE CONSTRUCTION AND ICE FISHING WITH ELDER INVOLVEMENT

Authors: Elder Luci Savetilik, Shaktoolik ; Ben Howard, Elim; Cheryl Pratt, White Mountain

Grade Level: Primary

Context: After rivers freeze for 1 week*

AKRSI Region: Seward Peninsula, Bering Straits Region

Cultural Standards	C1: Perform subsistence activities in ways that are appropriate to local cultural traditions
	D1: Acquire in-depth cultural knowledge through active participation and meaningful interaction with Elders
Science Standards:	B1: Use the processes of science
	B2: Design and conduct scientific investigations using appropriate instruments
Skills and Knowledge	B1-Level 1: Students observe and describe their world
	B1-Level 2: Measure and collect data from experiments and use this information in order to classify, predict and communicate about their everyday world.
	B2-Level 1: Raise questions and share observations
Math Standards	A6: Collect, organize, analyze, interpret and represent data
	E1 Explore problems and describe results using graphical, numerical and physical models or representations
Skills and Knowledge	M.A6 <ul style="list-style-type: none">• Collect, record, organize, display and explain the classification of data;• Describe data from a variety of visual displays including tallies, tables, pictographs, bar graphs and Venn diagrams;• Use the terms "maximum" and "minimum" when working with a data set.

* This unit is meant to be an integral part of a larger unit involving cultural activities that may take place over a one-year period. Luci Savetilik, an Elder from the village of Shaktoolik described the cycle for her area. She began with the collecting of greens in the month of June, the cutting and drying of salmon and picking salmonberries in July, picking blueberries, cranberries and blackberries in the months of August and September, and ice fishing for trout and grayling in late October and November. As the days get colder and daylight shorter, the chores turn to sewing, beading and baking. January and February are good months for camping and hunting for moose and caribou. In March and April wood collecting is a good activity to help get prepared for next winter. These months are also ideal times for ice fishing for trout, grayling, pike and tomcod.

M.E1 • Apply mathematical skills and processes to situations with self and family.

Lesson Outline

Day 1. Fishing Pole Construction with Elder Involvement
Day 2. Lure Construction with Elder Involvement
Day 3. Class Activity: Ice Fishing and Graphing Data
Day 4 Class Activity: Ice Fishing and Graphing Data
Day 5 Ice Fishing: Bar Graph, Potlatch with Elders and Families

Vocabulary⁶

bait: na-gi-uk	big: a-ka-ga
collect: ga-da-see	experiment: uuk-do-ak
fish: il-ga-luk (more than one)	il-ga-lu-it)
grayling: soo-luk-bow-gruk	
ice: see-goo	ice pick: duk
ice fishing: ma-nuk-do-dung-ga	
lure: nik-see-ruk	maximum: il-ga-lu-i-at
minimum: cup-see-rut	salmon eggs: song-nik
small: u-too-goo	trout: i-gaa-loo-bik

Assessment

Graphic Organizers, Observations, Journals, and Reporting

Lesson 1: Fishing Pole Construction with Elder Involvement

Materials

One 12–18 inch piece of wood /student
Sandpaper/student
Fishing line

Procedure

Gear Up

Begin the Ice Fishing unit with a group activity and discussion to discover what students already know about ice fishing in their region. You can label a piece of chart paper, "What We Know About Ice Fishing." Have the children sit in a circle and share at least one thing they know about ice fishing. Write all responses down. Encourage children to further share their knowledge by asking questions about the local area: What kind of fish can we catch here? What do people use to fish with? Who taught you to fish? What's the biggest/smallest fish you've caught? What are some different ways to prepare/eat fish? What kind of things do fish eat? What kind of bait/tackle do you use for certain fish? Etc. The teacher should then prepare another chart to post in the room that lists questions or "What More We Want to Know About Ice Fishing." This chart will be returned to as questions are answered or other questions arise during the unit. (Embedded assessment: prior knowledge)

Apply

Invite an Elder to share/explain how the local community ice fishes. The Elder may show the class their favorite fishing pole and lure; demonstrate how they use their pole; talk about what kind of fish they use it for; and show how they made their pole.

Explore

The Elder or teacher may invite the students to make their own fishing poles. Each student will receive a 12–18 inch piece of wood and a piece of sandpaper. The Elder or teacher may model the procedure for cutting and sanding a depression at both ends of the piece of wood. See illustration. The teacher may want to have an adult do the cutting.

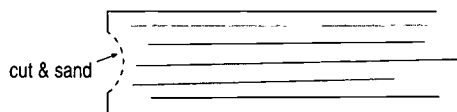

⁶ As told by Lucy Savetelik for Shaktoolik

When students have finished sanding their fishing poles, they may begin wrapping fishing line around the entire length of the pole, using the depressions at each end to hold the line in place. It is important to tie a strong knot around the first loop. Students may label their poles.

After students have completed their fishing poles, it is important to have an Elder demonstrate the proper way to retrieve fish from an ice hole. Allow time for students to practice the technique. For younger students, it may be appropriate to role-play the technique.

Generalize

Teachers are encouraged to provide the class with at least ten minutes undisturbed, free writing time. It is a chance for students to retell or share some of their experiences during the ice fishing unit. Teachers are encouraged to provide art materials to supplement longer free writing activities. It is important to remember that this is a free writing time. More formal writing activities may be integrated into the unit as the teacher deems appropriate.

To close each day's fishing activities, the teacher should assist students in adding information to a chart labeled "What We've Learned" posted somewhere in the classroom. Children are encouraged to share at least one new thing they learned from the day's activities as the teacher or students write them on the chart. The teacher can review the list of student questions from *What More We Want to Know About Ice Fishing* to see if any of them had been answered in the day's activities. This is a daily activity.

Lesson 2: Lure Construction with Elder Involvement

Materials: The lure materials center should have stations like the following:

- #1 beads of multiple colors
- #2 yarn of several colors
- #3 metals such as tin foil, copper sheets etc.
- #4 colorful feathers
- #5 J-hooks with fish-line leader: two sizes (large and small) and barbless

Procedure

Apply

An Elder from the community will discuss with the children the construction of the most basic fishing lure while sharing traditional methods/materials. The discussion may include what types of fish are found in the local area, what seasons are the best for certain species, what bait or techniques are used to catch certain species. The Elder may include a story or share a fishing experience related to the topic. The Elder will then display and explain the fishing lures that he or she uses. We will concentrate on the types of lures that attract trout and grayling (fish species may vary from region to region and season to season).

Explore

The Elder or teacher will explain to the children that they will be making lures of their own. Remind students to recall what the Elders shared and what their lures looked like, to be creative, and think about things/colors that might attract fish. Students will be given a small paper bag and visit the lure materials centers individually to collect the materials they would like to use to make their lure. Visiting the centers individually will avoid the "copy cat" syndrome often occurring when young children choose materials.

The center may include other materials students can use to construct a lure. Allow students to brainstorm other materials that may be useful. Constantly remind the students to think like a fish! What color do you think might attract a fish to your hook?

Remember what the Elders said! Be creative!

When all of the students have finished collecting their materials, have them sit in small cooperative groups. Instruct and model adding beads, yarn, feathers and metal to J-hooks. Students may need assistance threading beads through J-hook leaders. Students may also need assistance attaching metal materials to J-hook leaders.

- Generalize** While students are making their lures, check for understanding and assess by asking students to explain why they chose particular colors and designs, and retell how they made their lures. They may wish to show-and-tell the class about their lures.
- Explore** If time permits, students may further compare their lures by sorting them using Venn diagrams. They may also create and sort their lures using dichotomous keys. See examples.
- Generalize** Teacher should help students analyze their classification schemes by asking questions to aid comparison and communication.

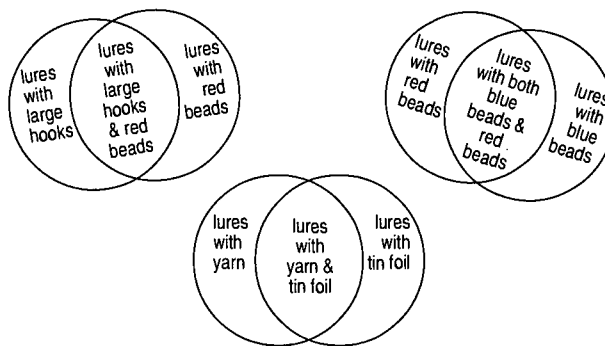

Lessons 3 & 4: Class Activity—Ice Fishing with Elder Involvement & Graphing Data

Materials Fishing poles and lures constructed by children
Supplies for creating graphs

Procedure

Apply/Explore Students, Elders and community members will travel to a local fishing area and fish for a local species of fish. For this lesson and region, trout and grayling will be the sought-after fish. This is a great opportunity for informal lessons, stories, and instruction to take place between Elders, community members and students. These fishing activities are perhaps the most powerful components of the entire unit. Students and Elders will be in an appropriate context to begin sharing and educating in a culturally responsive context. Proper cleaning and handling of fish to avoid spoilage should be part of this experience.

Before students leave for fishing, have them predict and record (either written, pictorial, or oral) how many fish they will catch and which lure in the class will catch the most fish. Before leaving, you may also want to have students prepare their graphs for data entry.

Generalize There are several types of graphs that can be prepared to represent fishing data.

1. Line graphs: each student can keep track of their own fishing success by constructing a line graph with the vertical (y-axis) representing the number of fish caught and the x-axis (horizontal) representing the days fished. There can also be a whole-class line graph which tallies the number of fish caught by everyone per

day. Questions such as the following would prompt students to analyze their data: which day were the most fish caught? The least? How many more fish were caught on one day vs. another? How might you explain the differences in number of fish caught? Etc.

- Bar graphs: students can create a class bar graph where the x-axis has a colored drawing of each child's lure plus their name and the y-axis represents number of fish caught. Fishing data for each day can be entered by each child for their lure, using a different color pen for each day of fishing (e.g. Wednesday blue, Thursday red, and Friday green). Or, depending upon time and their ability, they might also classify their lures into appropriate groups and construct a bar graph indicating total fish caught per day/lure type or total fish caught for all fishing days/lure type. Possible lure groupings might be made according to bead color, with or without feathers/metal, barb size and so on. Classification using a Venn diagram might be most helpful here prior to graph construction.

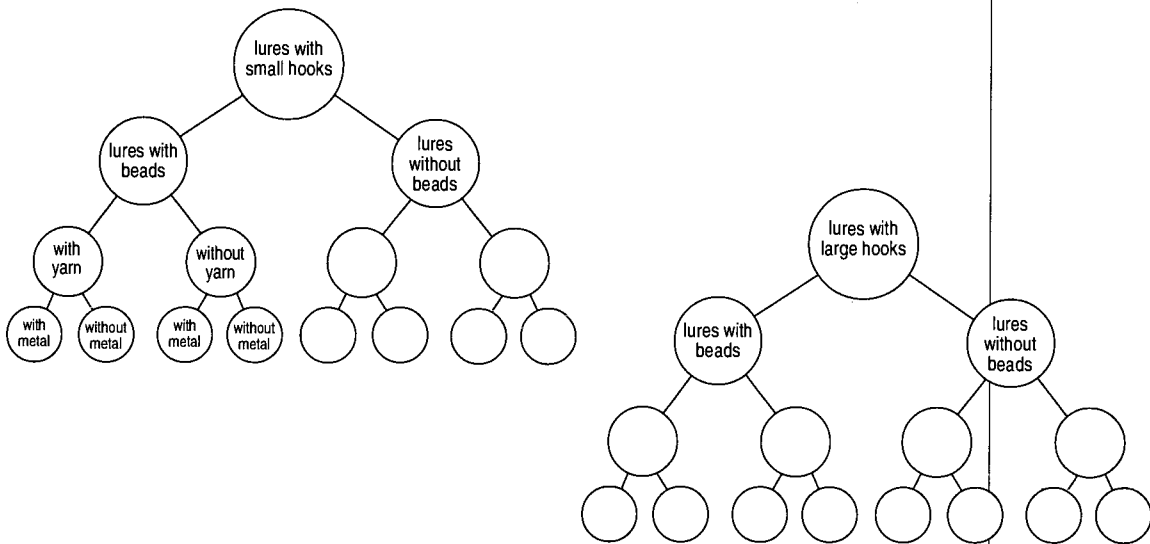

Students might also want to construct bar graphs of the size of fish caught using categories such as small = under 5", medium = 6"-10", large = 10"-12" etc.

In addition to entering and analyzing the data above, students should also be encouraged to share stories and at least one new thing they learned from fishing that day and also do the daily journal writing as explained previously.

Lesson 5: Ice Fishing and Graphing Ending with Potlatch with Elders and Families

Materials Fishing poles and lures
Gathered Food for Potlatch

Procedure

Apply/Explore The students will spend the morning with another fishing trip. The procedure is the same as in Lesson 3 and 4. This will give the students three sets of data to observe and sort.

Generalize Students will add their fish tallies for the final day to the class bar graph and to their individual line graphs. The class can then discuss the results and begin ordering the

data from least to greatest or greatest to least. Once the list has been discussed, the class may decide how they want their data to appear on a final class bar graph. Begin using the vocabulary words maximum (il-ga-lu-i-at) and minimum (cu-see-rut) when discussing the graph. Have the students predict what the graph will look like if they choose to go from least to greatest or greatest to least. Once the class has agreed on an ordering format, begin inviting students to add and color their data on the class bar graph.

When data has been entered, explore the results with the students: What is the maximum amount of fish our graph shows? What is the minimum? Is there anyone who caught the same amount of fish? Which lure caught the most fish? Does this lure resemble the lures used by the Elders? What colors did that person use? Which lure caught the least amount of fish? What colors did that person use? What is the difference between the maximum and minimum numbers on our graph? If you were going to make another lure, what colors/materials would you use? Why?

Apply

If time allows, have the children make and test another lure with the idea in mind that they should try to make a lure using the same colors/materials as the lure that caught the most fish.

As a final component or activity of the ice fishing unit, the students will sponsor a fish fry or potlatch for Elders and parents using the fish they caught during the week. During the potlatch, students can share their journals, graphs and experiences with their parents and Elders. The teacher may have a small awards ceremony and present students with "Most Fish", "Biggest Fish", "Smallest Fish", and other participation awards. The teacher should also present an appreciation award such as a replica of the lure that caught the most fish, to the Elders who helped with the unit. In the event that the class does not catch enough fish to sponsor a potlatch, you might stretch the catch by making a fish chowder

Extended Activities

To extend upon the activities within this particular unit a class might:

1. Continue to experiment with this investigation to help create a firmer data set.
2. Expand the exploration to include other variables as developmentally appropriate e.g. temperature, various fishing sites, fishing technique, time of day, etc.
3. Study the different species of fish.
4. Engage in writing activities that may include sharing knowledge with other students; creating a book about ice fishing in the area; or keeping a detailed journal of findings.
5. Participate in activities that help bring about awareness of safety issues when ice fishing.
6. Discuss subsistence.
7. Replicate this activity during the spring ice-fishing time to note similarities and differences.
8. Write a song or dance to help describe or recreate the findings of this unit.
9. Continue to involve the Elders of the community in the education of the students.
10. Explore the many ways in which other villages engage in ice fishing.
11. Read children's literature that relates to subsistence issues, ice fishing or arctic survival.
12. Learn ways in which fish are best preserved and prepared.

WINDS AND WEATHER SAMPLER⁷

Authors Elder Jonas Ramoth, Selawik; Sidney Stephens, Fairbanks

Grade Level 6–8

Context: Winter-Long Investigation

Cultural Standards

B2: Make effective use of the knowledge, skills and ways of knowing from their own cultural traditions to learn about the larger world in which they live

D1: Acquire in-depth cultural knowledge through active participation and meaningful interaction with Elders

Skills and Knowledge

- A. Develop respect for Elders and others who have learned to read the weather.
- B. Recognize that weather cannot be controlled and must be respected.
- C. Develop the habit of frequently observing the weather and noting specific signs, changes and patterns that are important for their area.
- D. Use local weather knowledge and skills to make decisions about how to prepare and dress for weather conditions and how to travel and conduct activities safely.

Science Standards

A4: Understand observable natural events such as tides, weather, seasons and moon phases in terms of the structure and motion of the earth.⁸

B1: Use the processes of science; these processes include observing, classifying, measuring, interpreting data, inferring, communicating, controlling variables, developing models and theories, hypothesizing, predicting and experimenting

B2: Design and conduct scientific investigations using appropriate instruments.

C3: Understand that society, culture, history and the environment affect the development of scientific knowledge.

Skills and Knowledge

- A. Understand that differential heating of air masses produces both local breezes and global winds. (SA4)
- B. Understand that global patterns of atmospheric movement influence local weather. (SA4)

⁷ Unit available in full at <http://www.ankn.uaf.edu>

⁸ Science Content Standard A-8 related to heat-transfer could also be used

- C. Understand that the sun is the major source of energy for phenomena on the earth's surface and that seasons result from variations in the amount of the sun's energy hitting the surface, due to the tilt of the earth's rotation on its axis and the length of the day. (SA4)
- D. Make qualitative and quantitative observations, interpret data and use this information to explain everyday phenomena and make predictions. (SB1)
- E. Design and conduct an investigation of local weather using appropriate tools and techniques. (SB2)
- F. Describe how local history, culture and environment have affected the development of scientific knowledge. (SC3)

Math Standards

A2: Collect, organize, analyze, interpret, represent, and formulate questions about data and make reasonable and useful predictions about the certainty, uncertainty or impossibility of an event.

Skills and Knowledge

- A. Collect, analyze, and display data in a variety of visual displays. (MA2)
- B. Interpret and analyze information found in newspapers, magazines and graphical displays. (MA2)

Unit Overview

The simplest way to define weather is as the condition of the atmosphere at a given time and place. And while this definition readily conjures up a range of factors like rain, snowfall, wind speed and direction, temperature and so forth, such a definition also reduces one of nature's most powerful forces to a series of measures which most consumers of weather would recognize but fault as inadequate. Ask a poet, a flood survivor, a meteorologist, a farmer, or a trapper about the weather, and you'd get a lot more than individual measures. Ask an Elder and you'd get a lifetime – a lifetime of observations, of stories, of values, of connections between man, the natural world and weather.

Traditionally, weather watching and forecasting relied on keen observation of the natural world and an ability to remember and correlate observations with weather patterns from the past. Today, such traditional forecasting is still quite prominent all over Alaska and is a time-proven method for gauging local weather conditions and judging safety of travel. In many cases such traditional methods are augmented by access to modern technologies and to broadcasts like *Alaska Weather*. But in both traditional and contemporary weather realms, one basic process is the same: forecasters gather as much information as possible about present conditions, relate it to what they know about weather patterns from the past and predict what is likely to happen.

Understanding and predicting weather from either traditional or contemporary perspectives is a very complicated process, involving multiple variables, patterns and relationships, and taking years of experience and study to master. This unit attempts to set students on the road to weather competency by: (1) grounding them in the practice of locally significant weather observation; (2) exploring the physical phenomena that drive winds⁹ and; (3) connecting local investigations to global weather studies.

⁹ This unit deals exclusively with winds and not with other critical aspects of weather (such as the water cycle) because winds are the most significant weather sign discussed by Jonas Ramoth for Selawik.

Section 1: Observing Locally

1. Traditional Forecaster
2. Weather Journal
3. Agreeing on Terms
4. **Designing Local Investigations**
5. Conducting and Analyzing Local Investigations
6. Community Memories

Section 2: Understanding Wind

1. **Activity Series 1: Convection**
2. Activity Series 2: Heat Absorption and Radiation
3. Activity Series 3: Topography
4. Activity Series 4: Heating the Earth
5. Activity Series 5: Global Winds

Section 3: Connecting Globally

1. **GLOBE Overview**
2. Community Memories II

Appendix A: Selawik Weather Information from Jonas Ramoth
Appendix B: Assessment
Appendix C: Weather Resource List
Appendix D: Interdisciplinary Integration

Bold print indicates that this item has been included in this document as a sample. All other activities summarized in this document are also available in full at <http://www.ankn.uaf.edu>.

SECTION 1: OBSERVING LOCALLY

Each community in Alaska has its own weather pattern related partly to the general circulation in the atmosphere, and partly to local disturbances and variations. Long-term observers often know the nuances of local weather with great intimacy and have a sense of which factors in combination are predictive of which weather outcomes for their particular area. They depend upon this knowledge to make decisions about such things as how to dress, the safety of travel, and the best times for subsistence activities. Such knowledge bearers believe that it is critical for adolescents to learn weather observation and forecasting skills so that they too will know how to be safe when travelling independently on the land.

Consequently, in this section students work with local experts and their teacher to design and conduct a weather study built initially upon traditional weather knowledge. Such a study is aimed at developing the habit of weather watching and the skills of: observing and describing weather; noticing sequences of events; identifying locally significant patterns and relationships; and applying this knowledge to their daily lives. It is also aimed at developing appreciation and understanding of the ways in which the local culture and environment have affected the development of scientific knowledge about weather. This unit is built upon the information generously shared by Jonas Ramoth, an Iñupiat Elder from Selawik.

Activity 1: Traditional Forecaster

Summary This unit hinges on students spending field time repeatedly with a traditional forecaster (TF) for the purposes of: exploring weather from the perspective of that Elder/expert; learning to recognize specific weather signs, changes and patterns that are important

for the area; and coming to understand how the local culture and environment have affected the development of scientific weather knowledge. Such a TF might be an Elder or a younger hunter, trapper or other cultural expert with traditional knowledge to share. Observations about weather or climate change over the years, advice about safety and travel, or more subtle understandings, aesthetics, or values might also be shared by the expert.

Such field time is intended to be at least monthly for every student and the knowledge gained therein is: recorded by students in journals; discussed regularly in class; and used as a basis for developing local weather studies.

Activity 2: Weather Journals

Summary Since weather results from the ever-changing, dynamic, interplay of multiple forces, attentive observation of weather signs throughout the day is critical to accurate forecasts. The TF will undoubtedly encourage students to develop the habit of checking weather first thing in the morning and at night. To further promote such attentive observation, students use personal weather journals throughout this unit to record their daily weather observations. Journals are also used to record thoughts and understandings about weather gleaned from the TF, class, or community studies.

Activity 3: Agreeing on Terms

Summary In order for students to design and carry out local studies of the weather, their descriptions of weather elements need to be uniform, consistent and agreed upon by all. In rural Alaska, consensus on the meaning of words has been built through shared experience and communication over time. The words or expressions used to describe weather are specific to the area/culture and fit the range of local weather conditions perfectly. In science, understanding and agreement on terms is also critical and is often called “defining operationally.”

In this activity students observe and describe the wind, analyze their descriptions for clarity, and compare them both with Jonas’ descriptions and with the Beaufort Wind Scale. Students then decide which terms are most appropriate for their study (define operationally) and create a Selawik Wind Scale for use in future observations.

Activity 4: Designing Local Studies

Summary In this lesson students think about and identify significant aspects of local weather patterns by reflecting on their own observations and their time with the Traditional Forecaster (TF) and deciding which information is most important to collect. They then decide how to collect and record information consistently, and design local weather studies accordingly. Depending upon their information and priorities, these studies may be replicas of the qualitative descriptions which characterize traditional forecasting, or they may include some contemporary measures such as wind speed or temperature as well. Such an approach is consistent with weather forecasting in villages today in which old-timers may both scan the morning horizon from their rooftops and listen to/incorporate forecasts from programs like *Alaska Weather*.¹⁰

¹⁰ It is important to note that Jonas Ramoth sometimes incorporates wind speed or temperature measurements in his otherwise qualitative descriptions and that students should be encouraged to develop/use qualitative descriptions with a similarly minimal use of measurement for now.

Materials

- chart paper or blackboard
- student journals
- class log

Procedure

Apply

1. Students will have already spent time with the TF, and will have recorded and discussed their own, unstructured, daily weather observations in journals.

Gear-up

2. Ask students to review their journals and then brainstorm as a class, a list of weather signs that are most significant for their community as gleaned both from the TF and their own observations. Record lists on chart paper and post. (Embedded Assessment: Current Knowledge).
3. Discuss the list as a class, selecting the most significant weather signs to watch for on a daily basis. For Selawik in the winter, the list might look something like this: (See Handbook pages 20–21 for more detail.)
 - evidence of wind speed and direction and changes in wind from last observation
 - relative temperature and changes in temperature
 - cloud cover and change in cloud cover
 - animal behavior and signs; human behavior
 - atmospheric phenomena like sun or moon dogs

Explore

4. Tell students that they are about to work in teams to design a local weather study. They will first create and try out their team study, and then the team studies will be pooled into a cohesive class study. Provide students with a copy of the *Designing Local Studies* rubric (page A-16) and discuss/clarify expectations. Let them know that their work will be self-assessed and teacher-assessed using this guide and that the TF will also review their work.

Designing Local Studies, Student Scoring Guide on following page . . .

Designing Local Studies
Student Scoring Guide¹¹

	Developing	Proficient	Exemplary
<p>Connecting</p> <p>Links local cultural knowledge, experiences, and observations to creation of a weather investigation.</p>	<ul style="list-style-type: none"> • I did not make clear connections between cultural knowledge and my investigation • I did not analyze the adequacy of my present cultural knowledge 	<ul style="list-style-type: none"> • I identified, explained or illustrated related knowledge, experiences and observations and used them as a basis for my study. • I analyzed the adequacy of my present cultural knowledge 	<ul style="list-style-type: none"> • I clearly explained and made explicit connections to cultural knowledge, experiences and observations and used them as a basis for my study. • I analyzed the adequacy of my present knowledge and made a plan for gaining necessary information.
<p>Designing</p> <p>Develops a plan to guide the investigation</p>	<ul style="list-style-type: none"> • The plan I wrote was confusing or didn't address the topic identified. • My plan inconsistently reflected the importance of clear language, careful observation and measurement. • I made inappropriate or no decisions concerning quantitative and qualitative methods, use of estimation or units. • I did not make or respond to suggestions for improvement in my design. 	<ul style="list-style-type: none"> • The plan I designed made sense and could be followed by others without further explanation. • My plan showed the importance of clear language, careful observation and measurement. • My decisions about qualitative and quantitative methods, estimation and use of units were mostly appropriate. • I reconsidered my design by describing problems and making improvements 	<ul style="list-style-type: none"> • I wrote a very comprehensive plan that directly outlined all aspects of my investigation. • My plan showed the importance of clear language and integrated the most appropriate techniques for observation and measurement. • I made appropriate decisions about qualitative and quantitative methods and use of units. • I repeatedly reconsidered your investigation design by describing problems and making improvements.

¹¹ Adapted from Northwest Regional Educational Laboratory (1999), Science Inquiry Scoring Guide

5. Ask students to self-select the team they want to work with (e.g. wind, temperature, clouds/atmosphere, animal/human behavior). Let them know that each of them will continue to spend time with the Traditional Forecaster in order to gain the skills and knowledge needed to make good observations, and that the procedures they design now can be modified later as more knowledge is gained.
- Explore 6. Ask teams to discuss weather observations, knowledge and experiences that might be pertinent to their study. Encourage review of past journal entries and the class log. Students should record this information individually in the "connecting" section of their journal. They should also decide if both individually and collectively (as a team) they have enough knowledge/information to design a weather study. If not, they should make a plan for filling in needed skills/knowledge or revising plan.
- Generalize 7. As teams work, rotate around to each group facilitating discussion, helping students to sort out their current understandings and to organize their thinking. Emphasize the importance of individual expression of ideas, and point out that listening to the ideas of others might help better explain their own ideas. If the TF is available for this discussion time, he or she could be most helpful in this role as well. (Embedded assessment: prior knowledge and group skills.)
- Explore 8. Next, ask student teams to put their heads together to design a plan to collect relevant weather information. (In science such a plan is called a protocol and involves designation of very specific procedures.) This design process should be recorded in their journal under "designing".
- Encourage students to perform a trial run of the procedure so that steps can be organized in a workable manner.
 - Emphasize the use of detail to communicate clear directions.
 - Ask students to include precise definitions of terms (e.g. the term "calm" means that smoke rises vertically); and steps or rules that will be followed throughout the procedure (e.g. wind direction is to be gauged daily at noon).
 - Prompt student analysis with questions such as:
 - Will your design yield enough information for analysis?
 - Does your design include information needed for connections to other weather signs? (E.g. Both wind speed and direction are critical measures. Collecting only one or the other would be inadequate for prediction of upcoming weather change.)
 - How accurate and workable are your measurements/estimates and use of tools?
- Generalize 9. Ask the team reporter to share the team's procedure/protocol with the class as a whole. Prompt student audience critique using by asking questions such as the following (posted on a chart for clear reference):
- Are the terms clearly defined?
 - Are the steps/procedures of the task clear?
 - Does it tell specifically what data is to be collected? When? Where? By whom? Etc?
 - Does the plan reflect what has been learned from the TF?
 - Does the plan include attention to information needed by other studies in order to make clear connections?
- Explore 10. After all teams have shared and been critiqued, have them work in their teams to revise.
11. Have teams conduct observations as designed for 1 week.

- | | |
|------------|--|
| Generalize | <p>12. After 1 week of observation, have teams meet to assess how well their observations/recordings are going. Provide structured discussion questions as above. Teams revise for clarity.</p> <p>13. After the revision work, use a cooperative learning structure such as jig-sawing during which students become fully acquainted with the details of each of the other weather watching protocols.</p> <p>14. Have a class discussion in which you help negotiate an overall weather observation schedule and data recording procedure for the all observations considering such issues as:</p> <ul style="list-style-type: none"> • Can/should observation times for all protocols be the same? • Are there any duplications in data collected? • Can individual data sheets be consolidated into one for purposes of entry into the log? (see sample) • How should incidental information be handled? (Incidental information is any other data that could contribute to understanding such as faulty equipment, extreme weather conditions not anticipated, described or quantified in protocol, etc.) |
| Apply | 15. Conduct weather observations |
| Assessment | <ul style="list-style-type: none"> • Embedded Assessment as indicated in lesson text • Traditional Forecaster reviews designs and provides feedback. • Teacher and student completion of Scoring Guides and conference |

Activity 5: Conducting and Analyzing Local Studies

Summary Students carry out the collective weather study: recording , organizing and discussing data daily. Once sufficient data have been collected, students look for patterns and relationships in data, link these with what they knew and with traditional knowledge, and ask questions related to the investigations. By so doing, student knowledge of local weather patterns as well as their analysis, inference and prediction skills are improved over time.

Activity 6: Community Memories I

Summary This lesson is a combination of a community weather night and mini science fair, hosted by the students for the purposes of: sharing what they have learned to date about local weather; and learning more from the community as a whole by listening to weather stories. In this way, it's both a celebration of what students have learned so far and an invitation for the community to join in the fun. It should take place once the students feel well-grounded with their local studies and have sufficient information to share. Diverse representations of understanding are encouraged.



SELAWIK WINTER WINDS

Daily Observation Sheet

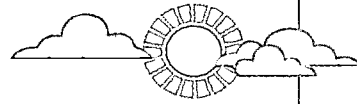

Date _____ Time _____ Observers _____



	Direction		Notes
Effect on visible things	<input type="checkbox"/> calm, still air; smoke rises vertically or drifts a little (calm)	<input type="checkbox"/> wind felt on face; smoke from stack leans over (light breeze)	<input type="checkbox"/> snow drifting on ground (surface wind)
	<input type="checkbox"/> snow blowing; can't see across the street (storm)	<input type="checkbox"/> can't see; fine snow powder finds its way in through your clothes; need a face mask and goggles (blizzard)	

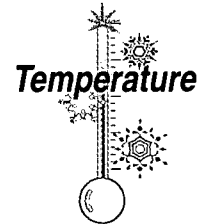

Cloud cover	<input type="checkbox"/> Clear (maybe a few clouds)	<input type="checkbox"/> Cloudy (at least 1/2)	<input type="checkbox"/> Overcast
Cloud movement	<input type="checkbox"/> None	<input type="checkbox"/> Drifting	<input type="checkbox"/> Rapid
Snow and rain	<input type="checkbox"/> None	<input type="checkbox"/> Lightly Snowing <input type="checkbox"/> Lightly Raining	<input type="checkbox"/> Snowing <input type="checkbox"/> Raining
Notes			

Temperature	<input type="checkbox"/> very cold (feel it in your nose; breath sounds and looks like a jet.)	<input type="checkbox"/> cold (cold enough to mention)	<input type="checkbox"/> no comment
Compared to Yesterday	Degrees F. _____		Notes
<input type="checkbox"/> about the same <input type="checkbox"/> colder <input type="checkbox"/> much colder <input type="checkbox"/> warmer <input type="checkbox"/> much warmer	Activities of People in Town		
	Animal Activity and Signs		

SECTION 2: UNDERSTANDING WIND

It is assumed that as students spend time observing the weather, they will come up with questions about the weather which interest them greatly (see Handbook page 20–21.) While some of these questions will undoubtedly relate to developing proficiency with forecasting and to dealing with weather-related issues of travel and safety, other questions will probably relate to developing a more sophisticated understanding of what causes the wind. These questions can be investigated in at least two constructive ways: inquiry and/or guided discovery.

If an inquiry approach were taken, students would identify their own question with regard to wind/weather and pursue it intensely through a combination of research and experimentation of their own design. If a guided discovery approach were taken, the teacher would set up a series of activities designed to enable students to develop an understanding of the driving forces behind wind.

To help enable either approach, the following series of lessons (in a guided discovery format) is provided on the core concepts of convection, absorption, and radiation, as related to the creation of both local and global winds. These lessons assume some understanding of the nature and behavior of matter and molecules in the solid, liquid and gaseous states. They also assume some familiarity with the concept of density.

Activity 1: Convection

"If you open the door of a warm house on a cold day, there's the wind."

—Jonas Ramoth

Background

Convection currents stirring the atmosphere produce winds. Convection is a cyclic process in which heat energy is transferred in fluids (liquids or gases). If a fluid is heated (a), it expands, becomes less dense and rises (b). When this warm liquid reaches the surface, it spreads out and begins to cool (c). As the fluid gets farther from the heat source, it cools down, and the cooler fluid sinks (d). Thus a convection current or cell is completed when the cooler, sinking fluid flows inward (e) towards the heat source to replace the upward-moving, hotter fluid (a). This cycle is what drives both local and global winds as well as volcanic eruptions, the swirling patterns in miso soup, ocean currents, home heat circulation patterns and mountain building.¹²

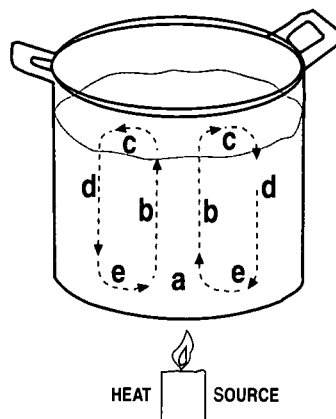

¹² Gould, A., (1988) p. 30

Activity 1a

Materials Pencils, tape, tissue paper, scissors, string, hole punch

Procedure

Gear-up

1. Read the opening quote from Jonas Ramoth: *If you open the door of a warm house on a cold day, there's the wind.* Ask them what they think Jonas means by this. Ask them to imagine this situation and to diagram and describe in their journals the movement of air when the door is opened. Students will have had lots of experience with this phenomena and will probably say things like "hot air rises" and "cold rushes in", but use questions like the following to probe their understanding of air movement particularly with regard to the convection cycle.

- Can you feel air movement or just a temperature change?
- Does air move into or out of the house or both?
- If cold air is moving into the house, what is happening to the warm air ?
- If the air is moving, are hot and cold air moving in the same way at the same place?

Discuss these ideas as a class, recording predictions and explanations. (EA: prior knowledge of convection)

2. Provide students with a copy of the Learning Cycle Model Scoring Guide¹³ and let them know that their learning will be assessed using this checklist. Students will use the form as a self-evaluation and you will use it as a checklist as students work through the explorations and as you review their journal entries.

Explore/Generalize

3. Have students construct wind detectors by using string to attach a 1 x 3 inch strip of tissue paper to a pencil as shown. (You'll want to test design ahead of time to make sure it is weighted sufficiently to swing with wind.)

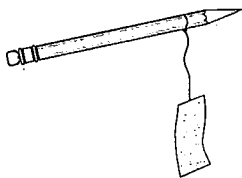

4. Ask them to go to an outside door on a cold winter day¹⁴, open the door just a few inches (from inside) and hold the detector near the floor. Observe and record which way the tissue/wind moves.
5. Now hold the detector in the middle of the door and then near the top. Observe and record movement of wind detector.
6. Ask which way the air is moving at each of these locations. Does the air movement seem to be as strong at each level? What are your ideas about this? How do these observations compare with your original ideas?
7. How do you think air would move if you opened the door of a hot oven in a warm room? Test and find out.
8. Discuss how these observations compare with their original ideas. Have them revise journal diagrams if they want.

¹³ Note: originally called "Learning Cycle Model: Analytical Trait Assessment" in Murphy, N. 1992 pp 27-28

¹⁴ Opening a freezer door also works

LEARNING CYCLE MODEL SCORING GUIDE

Exploration		
1	2	3
<ul style="list-style-type: none"> Initiates activities with no forethought or avoids activity completely ignores needs and contributions of peers 	<ul style="list-style-type: none"> interacts with phenomena as instructed works politely with peers, but sticks to personal agenda 	<ul style="list-style-type: none"> asks clarifying questions uses a variety of methods to interact with the subject works cooperatively with peers and gains insights from their activities
<ul style="list-style-type: none"> no organized attention or skills applied to task at hand 	<ul style="list-style-type: none"> measurements, observations, and classifications are recorded, but with little attention to detail 	<ul style="list-style-type: none"> makes careful observations, measurements, and classifications records measurements, observations, and inferences
<ul style="list-style-type: none"> shows minimal intellectual interaction with materials being manipulated 	<ul style="list-style-type: none"> fluid interactions with phenomena, but they sometimes are off target with intended activities 	<ul style="list-style-type: none"> identifies and seeks to expand personal understanding of the concept or phenomena

Generalize		
1	2	3
<ul style="list-style-type: none"> shows little participation in discussions demonstrates non-supportive behavior for others' input 	<ul style="list-style-type: none"> engaged in discussion as a participant does not initiate many questions 	<ul style="list-style-type: none"> asks thoughtful questions shows respect for other ideas
<ul style="list-style-type: none"> does not distinguish between observations and inferences looks upon guesses as fact 	<ul style="list-style-type: none"> has basic understanding of the differences between observation and inference. understands that a hypothesis is a kind of scientific guess 	<ul style="list-style-type: none"> distinguishes between observations and inferences identifies relevant observations and interpretations looks upon guesses as hypotheses to be tested
<ul style="list-style-type: none"> jumps to conclusions that are not based upon recent manipulations of the phenomena 	<ul style="list-style-type: none"> considers data before making conclusions 	<ul style="list-style-type: none"> avoids jumping to conclusions identifies alternative explanations for phenomena

Apply		
1	2	3
<ul style="list-style-type: none"> does not recognize applicability of knowledge gained from both successes and failures of experimental process 	<ul style="list-style-type: none"> creative application ideas, but they do not address personal or societal needs 	<ul style="list-style-type: none"> offers to apply new knowledge to positive benefit of society
<ul style="list-style-type: none"> does not refer to principles and concepts discovered in earlier generalizations 	<ul style="list-style-type: none"> applications loosely associated with principles of concept 	<ul style="list-style-type: none"> refers to principles which were discovered in the generalize stage in spite of new context
<ul style="list-style-type: none"> does not offer applications of new knowledge regardless of context 	<ul style="list-style-type: none"> applications offered, but does not transcend original context 	<ul style="list-style-type: none"> transfers application of concept to new context

Activity 1b

Materials

Per group: large, wide-mouthed jar, water, baby food jar, aluminum foil, food coloring, rubber bands, string, sharp pencil

- Explore/Generalize 9. Have students fill a large (gallon), wide-mouthed jar two-thirds full with cold water. Next, put three drops of food coloring in a baby-food jar. Fill the baby-food jar to the top with hot water. Cover it with aluminum foil and secure the foil tightly with rubber bands. Tie a string around the baby-food jar and lower it into the bottom of the large jar. Predict what you think will happen when you punch a hole in the foil and record prediction in journal.
10. Wait until the water is still and then punch one hole in the foil with a long pencil. Watch and record what happens. (Nothing happens because the cold water is heavier than the warm water and pressing down upon the hot water, but there is no "escape hole" allowing the warm water to be pushed out by cold.)

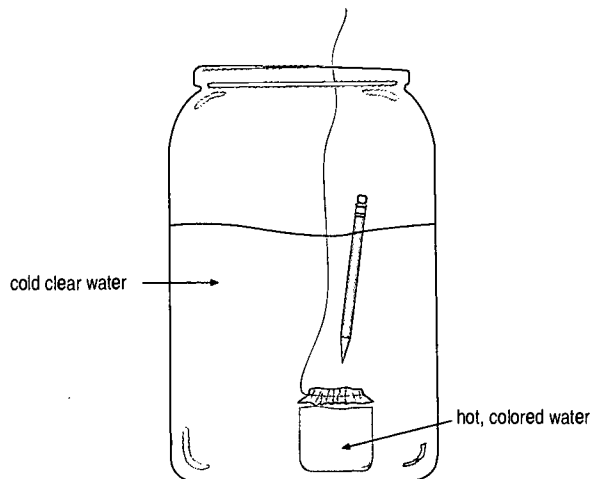

11. Ask students why nothing happens with just one hole. Ask for solutions and then have them punch a second hole, observe and record.
12. Ask what they observed when the second hole was punched? Did the colored fluid rise from only one, or both of the holes? What are your ideas about this? How long will it keep rising? After a long time, what will the fluid in the large jar be like? What are your ideas about why this is so? (The colored hot water will rise from one hole in a fairly straight line. As it rises, it will cool and begin to both sink and diffuse into the cold water as water temperatures equilibrate. Depending upon water temperatures, a complete convection cell may or may not be visible with the red/hot water.)
13. Ask students to compare this activity to the door activities. What do they now think the air movement in a warm room on a cold day might look like?

Activity 1c¹⁵

Getting Ready

The last two activities demonstrated what happens when fluids of unequal temperature meet. This activity demonstrates how warm and cold surfaces affect air. To do this, an observation box and smoke-filled air piston must be created as follows:

Materials

Observation Box: 1 per Student Team

1 cardboard box (about 30 cm x 30 cm x 50cm) per team
clear plastic food wrap
plastic tape
straws
Smoke Piston
1 large air piston
1 plastic straw
heavy cotton string, 12 cm long
matches
scissors
baby food jar of tap water

Procedure

1. Remove one side of the box; then cut a window in two sides as shown. but leave about 1/3 of the top intact. Tape plastic food wrap over the windows so that they are airtight. In one end of the box, cut a small hole just large enough to insert a plastic straw.

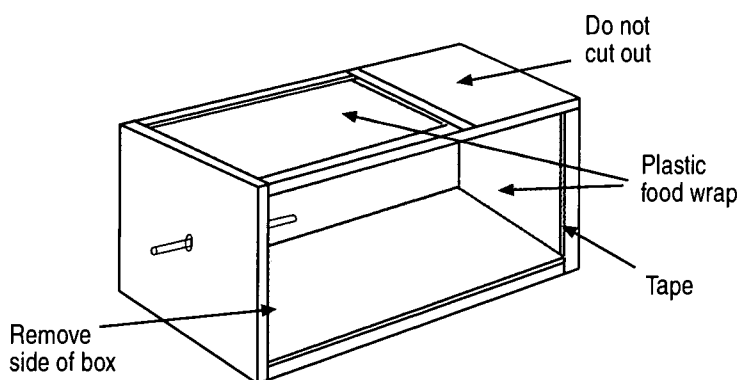

2. Cut the straw into 4–5cm lengths. Cut the string into lengths of about 4cm. Double one of the pieces of string twice or more until it will fit snugly in the end of a piece of the plastic straw. Leave about 1/2 cm of the doubled string sticking out of the straw. Repeat the procedure for the other pieces.

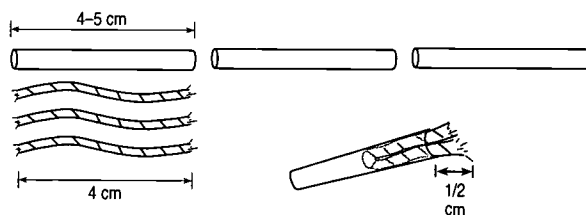

¹⁵ Adapted from Intermediate Science Curriculum Study (1972) p. 2-4

- Slip a section of the prepared straw onto the air piston. Light the string, being careful not to melt the straw. Collect smoke in the cylinder by slowly drawing out the plunger. Remove the straw and lay it aside where it won't burn anything. You may need more smoke later. Insert figure six with step 3 narrative.

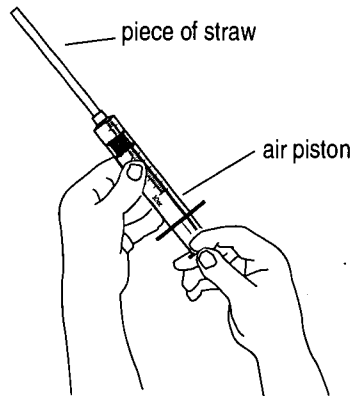

Explore

- Working in student teams, place a pan of cold water, ice water, ice cubes or snow inside the observation box. Be sure the straw is in place through the end of the box. The end of the straw should not be over the pan of water.
- Insert a smoke-filled air piston into the straw of the observation box. Gently force smoke through the straw into the box so that it moves very slowly over the cold water. Observe and record what happens to the smoke.

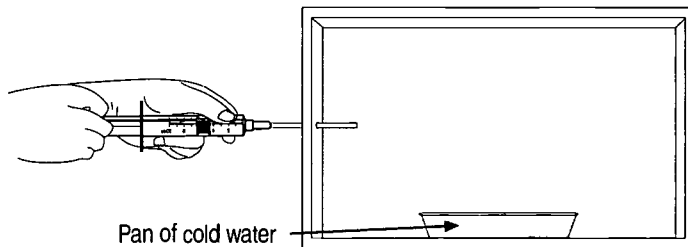

- Repeat using a pan of hot water. Observe and record what happens.

Generalize:

- Ask student to report what they observed with the smoke and cold water. (See diagrams below.) Ask them to use arrows to diagram the movement of air in the box. What are their ideas about this? How about for hot water?

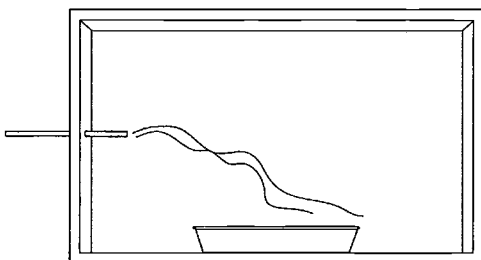

Pan of cold water

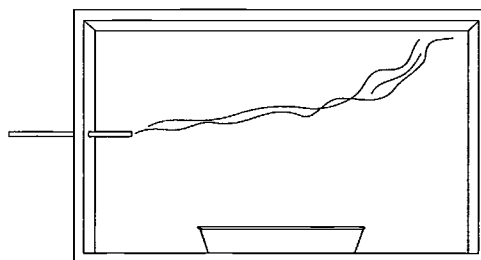

Pan of hot water

Apply

8. Ask how these observations and ideas compare with their earlier ideas about the open door.
9. Ask students what their ideas now are about air movement when a door is opened on a cold day? Ask them to review their original journal predictions and revise the diagram/explanation using evidence from explorations as support for their ideas.
10. Take students outside on a calm day when smoke is visible from smoke stacks. Ask them to diagram and explain smoke movement and air temperatures at different levels using evidence from these explorations in support of their ideas. (See sample diagram)



11. Ask students to imagine a hot summer day in Selawik where the air temperature is much warmer than the water temperature of Selawik Lake. Ask them to diagram air movement and explain it using evidence from these explorations.
12. Ask what might wind patterns be like in the late fall just before freeze-up of Selawik Lake when the water temperatures are warmer than air temperatures, particularly at night? Do your predictions match your experience? Check with the TF to see if your predictions match his or her experience.

Assessment

Embedded assessment using LCM Scoring Guide
Student self-assessment using LCM Scoring Guide
Review and response to student journal entries

Activity 2: Heat Radiation and Absorption¹⁶

"When you see what looks like fog rising from the lakes and ponds, their heat temperature is balancing with the air's."¹⁷

Summary

Some parts of the earth's surface absorb, store and re-radiate (or emit) heat more readily than others and this uneven heating of the air near the earth's surface sets convection currents and winds in motion. In this activity students measure and analyze the ability of different materials to absorb and emit heat, and then connect this understanding to their ideas about convection and the creation of local and global winds.

¹⁶ Adapted from Intermediate Science Curriculum Study (1972) p.7-10

¹⁷ Martz, C. (1999) p. 5

Activity 3: Topography

"The west wind is a poor artist but the east wind does beautiful work."

—Jonas Ramoth

Summary

Selawik is located in a valley, at the base of the Kobuk River to the east and facing Selawik Lake and Kotzebue Sound to the west. The Kobuk valley acts as a funnel for prevailing east winds which create long, straight, consistent drifts of snow about 10–12 inches wide in flat country. West winds, however, do not prevail and are not funneled by mountains, but rather, cover largely open tundra interrupted by minor hillocks or trees. This situation results in erratic wind patterns and characteristic rough, uneven snowdrifts. In this series of activities, students measure and graph snowdrifts around a building and explore the creation of eddies in water as a way of understanding the effect of topography on local wind patterns.

Activity 4: Heating the Earth

Summary

In this series of activities, students explore how the angle of sunlight affects the Earth's temperature and seasons and then apply this understanding to their local situation.

Activity Series 5, Global Winds

Summary

In this activity, students extend their understanding of convection to consider global winds and the effect of the earth's rotation on the creation of patterns of prevailing wind direction.

SECTION 3: CONNECTING GLOBALLY

Once students have become grounded in observing and understanding local weather patterns in terms of cultural and scientific knowledge, and once they begin to realize through these studies that what happens locally is connected to what happens globally, the stage is well set for expanding learning activities to focus on those global connections and their implications for life and behavior at home. Such connections are especially important in Alaska and other high latitude areas where global warming is expected to be of a greater magnitude.

GLOBE Investigations

The GLOBE Program (Global Learning and Observations to Benefit the Environment) is a hands-on science and education program that unites students, teachers and scientists from around the world in study and research about the dynamics of the Earth's environment particularly as related to global climate change. In this program, students take careful measurements of the environment at their school and share the data with scientists and with GLOBE students in other countries through the Internet.¹⁸ Because one of the goals of GLOBE is to provide educational activities for students and uniform data for scientists, the GLOBE Learning Activities and Protocols clearly lay out the precise student measurement procedures and data quality techniques. Calibration of equipment, control of variables, and standardization of measurement are critical aspects of the activities. As such, they provide many opportunities for students to observe, measure, collect, record and analyze data and thus address key science standards. They also present a clear example of how Western science is done and, by comparison, illuminate the similarities and differences between Traditional Ecological Knowledge and Western science. It is for these reasons that extending local weather observations to include the Atmosphere and Seasons Investigations of GLOBE is suggested.

A listing of relevant GLOBE protocols and learning activities for these two investigations follows. All of these can be fully accessed at the GLOBE website: <http://www.globe.gov>.

Atmosphere Investigation Protocols: <ul style="list-style-type: none">• Cloud Type• Cloud Cover• Rainfall• Solid Precipitation• Precipitation pH• Maximum, Minimum and Current Temperatures	Learning Activities <ul style="list-style-type: none">• Observing, Describing & Identifying Clouds• Estimating Cloud Cover: A Simulation• Studying the Instrument Shelter• Building a Thermometer• Land, Water and Air• Cloud Watch
Seasons Investigation Integrates protocols from other investigations	Learning Activities <ul style="list-style-type: none">• What Can We Learn About Our Seasons?• What are Some Factors That Affect Seasonal Patterns?• How Do Regional Temperature Patterns Vary Among Different Regions of the World?• What Can We Learn by Sharing Local Seasonal Markers with Other Schools Around the World?

¹⁸ It should be noted, however, that since readers of this unit are not trained GLOBE teachers, access to the data entry and retrieval portion of the GLOBE Internet site is not possible. It is possible, however, to use and adapt the GLOBE lessons for local purposes and thus involve students in a learning experience that will broaden and deepen their understanding of global weather phenomena.

Community Memories II

Summary

This lesson is a sequel to Community Memories I evening, differing from it only by the addition of the GLOBE studies as well as any new work on local studies. Again, the purposes would be to display and discuss student work, get input from community members and gather new information from the stories and experiences shared by others. It should take place once the students feel well-grounded with their GLOBE studies and have sufficient information to share.

References

Gould, A. (1988) *Convection—A Current Event*. Berkeley: Lawrence Hall of Science, University of California, Berkeley

Hewitt, P. (1997) *Conceptual Physics—Teacher's Edition*. California: Addison-Wesley Publishing Company

Intermediate Science Curriculum Study (1972) *Winds and Weather—Probing the Natural World/3*. Florida: Florida State University

Martz, C. (1999) KuC 1999 graduation address in *Sharing Our Pathways*. 4(4) 4–5

Murphy, N. (1992) Learning cycle model and science analytical trait assessment tool in *The Great Northern Science Book*. Alaska Science Consortium. Spring 1992



U.S. Department of Education
Office of Educational Research and Improvement (OERI)
National Library of Education (NLE)
Educational Resources Information Center (ERIC)



REPRODUCTION RELEASE

(Specific Document)

I. DOCUMENT IDENTIFICATION:

Title: Handbook for Culturally Responsive Science Curriculum	
Author(s): Sidney Stephens	
Corporate Source: Alaska Native Knowledge Network	Publication Date: 2000

II. REPRODUCTION RELEASE:

In order to disseminate as widely as possible timely and significant materials of interest to the educational community, documents announced in the monthly abstract journal of the ERIC system, *Resources in Education* (RIE), are usually made available to users in microfiche, reproduced paper copy, and electronic media, and sold through the ERIC Document Reproduction Service (EDRS). Credit is given to the source of each document, and, if reproduction release is granted, one of the following notices is affixed to the document.

If permission is granted to reproduce and disseminate the identified document, please CHECK ONE of the following three options and sign at the bottom of the page.

The sample sticker shown below will be affixed to all Level 1 documents

PERMISSION TO REPRODUCE AND DISSEMINATE THIS MATERIAL HAS BEEN GRANTED BY

Sample

TO THE EDUCATIONAL RESOURCES INFORMATION CENTER (ERIC)

1

Level 1

↑

Check here for Level 1 release, permitting reproduction and dissemination in microfiche or other ERIC archival media (e.g., electronic) and paper copy.

The sample sticker shown below will be affixed to all Level 2A documents

PERMISSION TO REPRODUCE AND DISSEMINATE THIS MATERIAL IN MICROFICHE, AND IN ELECTRONIC MEDIA FOR ERIC COLLECTION SUBSCRIBERS ONLY, HAS BEEN GRANTED BY

Sample

TO THE EDUCATIONAL RESOURCES INFORMATION CENTER (ERIC)

2A

Level 2A

↑

Check here for Level 2A release, permitting reproduction and dissemination in microfiche and in electronic media for ERIC archival collection subscribers only

The sample sticker shown below will be affixed to all Level 2B documents

PERMISSION TO REPRODUCE AND DISSEMINATE THIS MATERIAL IN MICROFICHE ONLY HAS BEEN GRANTED BY

Sample

TO THE EDUCATIONAL RESOURCES INFORMATION CENTER (ERIC)

2B

Level 2B

↑

Check here for Level 2B release, permitting reproduction and dissemination in microfiche only

Documents will be processed as indicated provided reproduction quality permits.
If permission to reproduce is granted, but no box is checked, documents will be processed at Level 1.

I hereby grant to the Educational Resources Information Center (ERIC) nonexclusive permission to reproduce and disseminate this document as indicated above. Reproduction from the ERIC microfiche or electronic media by persons other than ERIC employees and its system contractors requires permission from the copyright holder. Exception is made for non-profit reproduction by libraries and other service agencies to satisfy information needs of educators in response to discrete inquiries.

Sign here, please →

Signature: <i>Ray Bernhardt</i>	Printed Name/Position/Title: Ray Bernhardt, Director
Organization/Address: AK Native Know. Net., UAF	Telephone: 907-474-6431
	FAX: 907-474-1957
	E-Mail Address: frjb@uaf.edu
	Date: 5/8/01

RC022921

III. DOCUMENT AVAILABILITY INFORMATION (FROM NON-ERIC SOURCE):

If permission to reproduce is not granted to ERIC, or, if you wish ERIC to cite the availability of the document from another source, please provide the following information regarding the availability of the document. (ERIC will not announce a document unless it is publicly available, and a dependable source can be specified. Contributors should also be aware that ERIC selection criteria are significantly more stringent for documents that cannot be made available through EDRS.)

Publisher/Distributor:
Address:
Price:

IV. REFERRAL OF ERIC TO COPYRIGHT/REPRODUCTION RIGHTS HOLDER:

If the right to grant this reproduction release is held by someone other than the addressee, please provide the appropriate name and address:

Name:
Address:

V. WHERE TO SEND THIS FORM:

Send this form to the following ERIC Clearinghouse: ERIC/CRESS AT AEL 1031 QUARRIER STREET - 8TH FLOOR P O BOX 1348 CHARLESTON WV 25325 phone: 800/624-9120

However, if solicited by the ERIC Facility, or if making an unsolicited contribution to ERIC, return this form (and the document being contributed) to:

ERIC Processing and Reference Facility
1100 West Street, 2nd Floor
Laurel, Maryland 20707-3598

Telephone: 301-497-4080

Toll Free: 800-799-3742

FAX: 301-953-0263

e-mail: ericfac@inet.ed.gov

WWW: <http://ericfac.piccard.csc.com>