

DOCUMENT RESUME

ED 449 591

EC 308 195

AUTHOR Springle, Stephen, Ed.
TITLE Proceedings of the RESNA '98 Annual Conference: The State of the Arts and Science (Minneapolis, Minnesota, June 26-30, 1998). Volume 18.
INSTITUTION RESNA: Association for the Advancement of Rehabilitation Technology, Arlington, VA.
ISBN ISBN-0-932101-40-2
ISSN ISSN-0883-4741
PUB DATE 1998-06-00
NOTE 416p.
AVAILABLE FROM Association for the Advancement of Rehabilitation Technology (RESNA), 1700 North Moore St., Suite 1540, Arlington, VA 22201-1903; Tel: 703-524-6686 (Voice); Fax: 703-524-6630.
PUB TYPE Books (010) -- Collected Works - Proceedings (021)
EDRS PRICE MF01/PC17 Plus Postage.
DESCRIPTORS *Accessibility (for Disabled); Adults; *Assistive Devices (for Disabled); *Augmentative and Alternative Communication; Children; *Computers; Delivery Systems; *Disabilities; Distance Education; Educational Environment; Federal Legislation; Mobility Aids; Rural Areas; Special Education; Transportation; *Wheelchairs; Work Environment; Young Children
IDENTIFIERS Functional Assessment

ABSTRACT

This text contains papers presented at the 1998 conference of the Rehabilitation Engineering and Assistive Technology Society of North America held on June 26-30, 1998, in Minneapolis, Minnesota. Papers are divided into the following sections: (1) service delivery and public policy, including papers addressing independent literacy, integrating technology into a new occupational therapy assistant curriculum, and optimizing the use of assistive technology by people with multiple sclerosis; (2) personal transportation; (3) augmentative and alternative communication; (4) quantitative functional assessment, including a paper on strategies for promoting vocal development in young children relying on augmentative and alternative communication; (5) special education, including papers evaluating software, evaluating a math processor, and presenting a computer-based solution for making science experiments accessible; (6) technology transfer; (7) sensory loss and technologies; (8) wheeled mobility and seating; (9) electrical stimulation; (10) computer applications, including a paper on the Learn-Ed Distance Teaching System; (11) rural rehabilitation; (12) assistive robotics and mechatronics; (13) job accommodations; (14) information networking; (15) the Tech Act; (16) universal access; and (17) cognitive disabilities and technology. The last two sections present papers from the Student Scientific Paper Competition and the Paralyzed Veterans of America Student Design Competition. (Papers include references.) (CR)

Proceedings

ED 449 591

PERMISSION TO REPRODUCE AND DISSEMINATE THIS MATERIAL HAS BEEN GRANTED BY

Galetka

TO THE EDUCATIONAL RESOURCES INFORMATION CENTER (ERIC)

U.S. DEPARTMENT OF EDUCATION
Office of Educational Research and Improvement
EDUCATIONAL RESOURCES INFORMATION CENTER (ERIC)

- This document has been reproduced as received from the person or organization originating it.
- Minor changes have been made to improve reproduction quality.

- Points of view or opinions stated in this document do not necessarily represent official OERI position or policy.

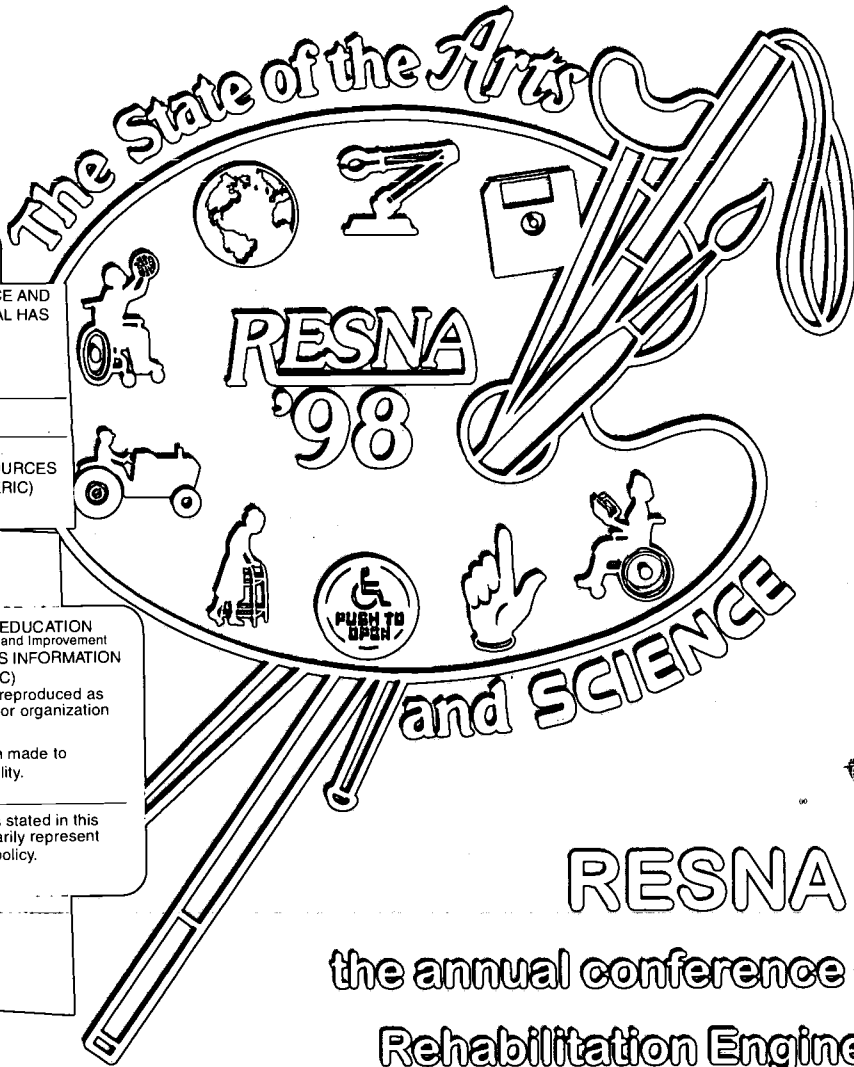

RESNA '98

the annual conference of the
Rehabilitation Engineering
and Assistive Technology Society

of North America

June 26 - 30, 1998

Hyatt Regency Hotel

Minneapolis, MN

EC 308195

ERIC
Full Text Provided by ERIC

PROCEEDINGS
of the
RESNA '98
Annual Conference

The State of the *Arts* and **Science**

June 26-30, 1998

Hyatt Regency Hotel

Minneapolis, Minnesota

Stephen Springle, PhD
Editor

Simon Margolis, CO ATP ATS
Rachel Wobschall, MIM ATP
Conference Co-Chairs

RESNAPRESS

**Proceedings of the RESNA '98 Annual Conference
Minneapolis, Minnesota
June 26-30, 1998**

**Volume 18
ISSN 0883-4741
ISBN 0-932101-40-2**

**Copyright © 1998
RESNA**

**All rights reserved. This book or any part thereof may not be
reproduced in any form without the permission of the publisher.**

RESNA PRESS

**1700 North Moore Street, Suite 1540
Arlington, Virginia 22209
(703) 524-6686**

**Printed in the United States of America
Dependable Printing Company, Inc.**

Foreword

Though each RESNA Annual Conference has its own character, that special pizzazz that makes each host city unique - there is a common thread that is eminently predictable. The authors of scientific papers and presentations come to RESNA to "share". They know that their work is meaningless if their colleagues and consumers of assistive technology don't know about it.

The Proceedings of the RESNA '98 Annual Conference becomes a part of the body of knowledge in assistive and rehabilitation that was started almost two decades ago. The work done by the contributors to this body of work have changes the face of technology for people with disabilities. They have helped to mold the general publics improving attitude toward disability. This body of knowledge has already made a difference - and each addition will make even more of a difference in the future.

If your work is in this volume, or in previous Proceedings, the RESNA '98 Local Organizing Committee, the RESNA Meetings Committee and the RESNA Board of Directors thank you and salute you. If you have work to share, and haven't, we urge you to submit a paper, an instructional course or concurrent session proposal. You have little to lose and your colleagues and people with disabilities potentially have everything to gain.

Rachel Wobschall
Simon Margolis
On behalf of the RESNA '98 Local Organizing Committee

Al Cook
RESNA President

Preface

Welcome to RESNA '98: The State of the Arts and Sciences.

This will be my 15th year of attending the RESNA Conference and as I look over the program and proceedings, I see a nice mixture of established features and new events that offer the best in assistive technology education and information sharing. The conference continues to change every year, not only in content but in structure and organization. These changes occur in response to the feedback received by the Meetings Committee, so please feel free to discuss any aspect of the conference with us.

The scientific program includes a diverse array of platform and interactive poster presentations, computer demonstrations and concurrent sessions. Much of the content is captured by the Proceedings of RESNA '98 that will, hopefully, become a valuable addition to your reference library. Each paper includes contact information of an author in case you desire additional information.

In addition, many meetings are scheduled that offer attendees an opportunity to discuss many important assistive technology issues. Anyone interested in assistive technology will be able to find others with similar interests.

RESNA '98 is the result of efforts by many people. The conference Chairs, Simon Margolis and Rachel Wobschall, led a Local Arrangements Committee that employed creativity and hard work to organize this event. The Meetings Committee, headed by RESNA's President-Elect, Mary Binion, worked throughout the year planning the many aspects that comprise a conference.

Jim Geletka and the RESNA staff comprise the quality assurance backbone of the conference by making sure everything is coordinated and organized and by doing the majority of the work. Without the efforts of Susan Leone and Terry Reamer, RESNA '98 would not have happened.

Enjoy.

Stephen Sprigle, PhD
Chair, Scientific Program

RESNA Board of Directors

Executive Committee

President

Albert M Cook, PhD PE

University of Alberta Faculty of Rehabilitation Medicine

President Elect

Alexandra Enders, OTR

University of Montana Rural Institute on Disabilities

Secretary

Gerald Weisman, MS

Vermont Technical College

Treasurer

Michael Silverman, CO MBA

Evanston, Illinois

At Large Members

Carol Sargent, BSEE OTR/L

Falmouth, Ohio

Immediate Past President

Clifford E Brubaker, PhD

University of Pittsburgh School of Health/Rehab Sciences

Board of Directors

Leonard Anderson, Cerebral Palsy Research Foundation of Kansas

Peggy Barker MS ATP, Applied Assistive Technology

Kathleen Barnes BSPT, Endicott College

Kevin Caves MS ATP, Rancho CART

Rory Cooper PhD, University of Pittsburgh School of Health/Rehab Sciences

Glenn Hedman ME ATP, University of Illinois-Chicago

Simon Levine PhD, University of Michigan Hospital

Simon Margolis CO ATP-ATS, The MED Group

Stephanie Reed OTR, Gloucestershire, United Kingdom

Carol Sargent BSEE OTR/L, Lake Forest, Illinois

Lawrence Scadden PhD, National Science Foundation

Marcia Scherer PhD CRC, Webster, New York

Michael Rosen PhD, National Rehabilitation Hospital

Therese Willkomm ATP PhD, New Hampshire Alliance for Assistive Technology

Past Presidents

Gregg C Vanderheiden PhD, Trace R&D Center, University of Wisconsin

Douglas A Hobson PhD, University of Pittsburgh School of Health/Rehab Sciences

Richard A Foulds PhD, AI duPont Institute ASEL

C Gerald Warren MPA, C Gerald Warren & Associates

Sheldon R Simon MD, Ohio State University

Dudley S Childress PhD, Northwestern University

Morris Milner PhD PEng CCE, Hugh MacMillan Rehabilitation Centre

Donald R McNeal PhD, Rancho Los Amigos REC

Colin A McLaurin ScD, University of Virginia REC

James B Reswick ScD, National Institute on Disability & Rehabilitation Research

Conference Organizing Committee

Conference Chairs

Simon Margolis, CO ATP ATS, The MED Group
Rachel Wobschal, MIM ATP, Minnesota STAR Program

Meetings Committee Chair

Mary Binion, ORCLISH

Computer Tech Lab

Denis Anson OTR, University of Washington

Concurrent Sessions

Cynthia Cress PhD, University of Nebraska-Lincoln

Instructional Program

Kevin Caves MS ATP, Rancho REC/CART

Research Symposium

Roger O Smith, PhD OTR, University of Wisconsin-Milwaukee

Scientific Program

Stephen Sprigle PhD, Helen Hayes Hospital CRT

PVA Student Design Competition

Glenn Hedman ME ATP, University of Illinois-Chicago

Student Scientific Paper Competition

Richard A Foulds PhD, AI duPont Applied Engineering & Science Lab

Volunteers

Linda Szczepanski, University of Pittsburgh Medical Center

Conference Management

James R Geletka, Executive Director
Susan P Leone, Meetings Director
Terry Reamer, Conference Coordinator
Nashiydah Anderson, Registrar
Elizabeth Smith, Registrar

Minneapolis Local Arrangements Committee

Margaret Christianson
Lifease

Helen Fleck
MN Governor's Advisory Council on Technology
for People with Disabilities

Bobbie Hansvick
Otto Bock

Mary Jo Hapy
Courage Center

Ronna Linroth
Minnesota STAR Program

Jean Little
Minnesota STAR Program

Layne Nelson
Minnesota Department of Administration

Nancy Perlich
Midwest Medical Services

Janet Peters
Pacer Center Inc

Sharon Rushman
MS Achievement Center

Tom Shaffer
Minnesota STAR Program

Dwayne Szot
Arts for All

Cheryl Volkmann
Ablenet

Carol Wobschall
Waseca, MN

RESNA Gratefully

**...acknowledges conference support
from the following PATRONS**

3M

Ablenet, Inc

Courage Center

Everest & Jennings, Inc

Gillette Children's Specialty Healthcare

Handi Medical Supply

HealthEast

Invacare/Pin Dot Products

The Life Place

The MED Group

Medtronic

Microsoft

Minnesota Governor's Council on Developmental Disabilities

Minnesota S.T.A.R. Program

Otto Bock Rehab

Paralyzed Veterans of America

Sister Kenny Institute

Sunrise Medical

Tamarack Rehabilitation Technologies

Theradyne, a division of KURT

US West

Whitaker Foundation

**...AND recognizes the assistance of
the following organizations**

Al duPont Institute ASEL

Helen Hayes Hospital CRT

The MED Group

Minnesota STAR Program

College Misericordia

ORCHLISH

Rancho RECICART

University of Illinois-Chicago

University of Nebraska-Lincoln

University of Pittsburgh Medical Center

University of Wisconsin-Stout

University of Wisconsin-Milwaukee

TABLE OF CONTENTS

SIG-01 Service Delivery & Public Policy

Operative Acquired Pressure Ulcer Prevention: A Cost Benefit Method for Operating Table Overlays	2
Independent Literacy in the Information Age: Changing the Way Disability Services are Provided at UIUC	5
Integrating Technology into a New OTA Curriculum	8
Traid Interactive Model of Ergonomics and Disability: Theory to Valid Practice	11
Outcomes of Assistive Technology Services and Use by Adults with Developmental Disabilities	14
Project IMPACT: Integrated Multi-Perspective Access to Campus Technology	17
Optimizing the Use of Assistive Technology by People with Multiple Sclerosis	20
An Exploration of People with Disabilities in the United States: Marketing Implications for Engineering and Design Professionals	23
The Delivery of Assistive Technology Viewed from the Consumer Perspective: Independent Living Considerations	26
Center for Assistive and Rehabilitative Technology (CART) Network	29

SIG-02 Personal Transportation

Testing and Evaluation of Wheelchair Caster Assemblies Subjected to Dynamic Crash Loading	34
Status of Universal Design Standard for Mobility Device Docking on Vehicles	37
Belt Fit Evaluation of Fixed Vehicle Mounted Shoulder Restraint Anchor Across Mixed Occupant Populations	40

SIG-03 Augmentative & Alternative Communication

Strategies for Promoting Vocal Development in Young Children Relying on AAC: Three Case Illustrations	44
Digitized Speech AAC Device Feature Ratings	47
A Probabilistic Word Prediction Program	50

SIG-05 Quantitative Functional Assessment

Impacts of Assistive Technology on Clients with ALS	54
Using a Flowchart as an Effective Time-Management Approach to the Evaluation and Treatment of Patients with High-Level Spinal Cord Injuries using Assistive Technology Devices	57
Analysis of Sit-to-Stand Performed by Young Normals, Using Force Plate and Accelerometric Data	60
Measurement of Soft-tissue Neck Injury by Video Motion Analysis	63
A Method to Determine the Workspace of Persons with Cerebral Palsy - A Preliminary Study	66
Testing of an Activity Monitor with Below-Knee Prosthesis Users	69
A Simple Decomposition Method for Analyzing Ground Reaction Force in Gait Analysis	72
Biomechanical Analysis of Scott Craig Long Leg Type Braces During Ambulatory Tasks	75
Interactive Video Exercise System for Pediatric Brain Injury Rehabilitation	78

SIG-06 Special Education	
Exploring Patterns: Software Evaluation	82
Evaluation of MathPad - A Math Processor	85
A Computer-Based Solution for Making Science Experiments Accessible	88
SIG-07 Technology Transfer	
A Survey on the Presentation of New Assistive Technology to Manufacturers	92
Customer Orientation: The Emerging Role of Independent Living Centers in Participatory Research in Assistive Technology	95
SIG-08 Sensory Loss and Technologies	
Evaluation of Dark-Adapting Eyewear for People with Low Vision	100
Joint Haptic and Rural Methods for Data Visualization	103
A Portable Reading Device with Guided Feedback for Locating and Tracking Text	106
SIG-09 Wheeled Mobility and Seating	
Repositioning the Able-Bodied: Effect of the Shape Cushion on Pressure Distribution	110
Design of a Test Fixture for Wheelchair Cushion Testing	113
Skin Temperature Measurement to Predict Incipient Pressure Ulcers	116
Effects of Tissue Type on Seating Pressure	119
Efficacy of Seat Cushions in Preventing Pressure Ulcers for At-Risk Elderly Nursing Home Residents: Research Issues	122
A Method for Contoured Cushion Design using Pressure Measurements	125
Relationship between Wrist Biomechanics during Wheelchair Propulsion and Median Nerve Dysfunction	128
Effect of Vinyl Coated Pushrims on Wheelchair Propulsion Kinetics	131
Quantitative Assessment of the Vibration Experienced by Wheelchair User During Activities of Daily Living	134
Effect of a Cushion on Whole Body Acceleration during Wheelchair Propulsion	137
Effects of Caster Type on Wheelchair Propulsion Work Requirements	140
Finite Element Modeling of Wheelchair Seat Cushions	143
A Mathematical Method for Comparison of Contoured Seating Shapes	146
Repeatability of a 3D Postural Evaluation Method in Seated Position	149
Consumer Criteria for Evaluating Satisfaction with Wheelchair Seating Aids: QUEST Results	152
Postural Changes with Aging in Tetraplea	155
Identifying Elderly Wheelchair Users' Needs: Results of a Focus Group	158
Preliminary Test Methods for Wheelchair Seating Components	161
Modeling the Dynamic Stability of an Occupied Wheelchair	164
A Kinematic Method for the Evaluation of Lateral Stability of the Users Provided by Wheelchair Backrests	167
Biomechanical Comparison of Wheelchair Basketball Players and Non-Basketball Players	170
Validation of Dynamic Models for Power Wheelchairs	173
Computerized Tracking using Force- and Position-Sensory Joysticks	176
Seating and Mobility for a Spinal Muscular Atrophy Teenager: A Hong Kong Experience	179
Development of a Simulator of Powered Wheelchair	182
A Low Cost Contour Copier for Custom Contour Cushion Fabrication	185
Rehabilitation Technology as Art: The Effect of Aesthetics on Consumer Acceptance	188
Selecting a Rural Outdoor Mobility Device	191
The Development of "Office Wheelchair"	194

Fishing Aid for Wheelchair Recreation	197
Modifications of a Side-by-Side Tandem Bicycle to Accommodate a Physically Challenged Child	200
The Art and Science of Compassion in Product Design: A Prone Stander Which Satisfies the Qualitative Needs of Children and Parents and the Quantitative Needs of Therapists	203
Temperature Control Shower Unit	206
Development of a Dynamic Pelvic Stabilization System	209
 SIG-10 Electrical Stimulation	
Evaluation of Implantable Electrode Leads in a Growing Limb	214
Shoulder Subluxation and Pain in Chronic Hemiplegia Treated by Intramuscular Electrical Stimulation	217
Evaluation of Adaptive Neural Network Controller in Cyclic Movement using Functional Neuromuscular Stimulation	220
Performance of Implanted Epimysial Electrodes in the Lower Extremities of Individuals with Spinal Cord Injury	223
Functional Electrical Stimulation Application for Augmentation of Gait in Adolescents with Incomplete Tetraplegia	226
Evaluation of the Freehand System in Adolescents with Tetraplegia	229
Outcome of Functional Electrical Stimulation in the Rehabilitation of a Child with C5 Tetraplegia	232
Selectivity of Intramuscular Stimulating Electrodes in the Lower Extremities	235
A Comparison of Three Mechanical Interventions in Reducing Lower Limb Edema in Stroke Patients	238
Therapeutic Applications of Neuromuscular Electrical Stimulation to Improve Tissue Viability in Persons with Spinal Cord Injury	241
 SIG-11 Computer Applications	
Towards Task Transparency: Scanning Text Selection	246
Evaluation of the Half-QWERTY One-Handed Keyboard Software	249
The Keyboard Channel as an Invisible Command Path: Design of a Configuration Utility	252
The Learn-Ed Distance Teaching System - Results of Use by Disabled Students	255
Further Exploration of Adaptive One-Switch Row-Column Scanning for Text Entry	257
An Electronic Manual on Special Seating	260
Development of Infrared Light Head Pointing Device for People with Severe Physical Disability on Manipulating Personal Computer	263
Usability Testing of Software for Assessing Computer Usage Skills	266
Making the Internet Accessible to the Visually Handicapped	269
Automated Alignment of Contour Pairs: A Hybrid Approach with Applications to Prosthetics	272
Medication Database System with Integrated Bar Code Reader	275
Scientific Instrument Access for Students with Disabilities	278
 SIG-12 Rural Rehabilitation	
Ergonomic Risk Factors and Tractor Modifications for Farmers with Spinal Cord Injuries	282
 SIG-13 Assistive Robotics and Mechatronics	
Dual-Agent User Interface for an Assistive Robot	286
Quantitative Evaluation of Human-Machine Interaction when Using an Arm Robot	289

Control Problems in Robotic Therapy for Upper Limb Rehabilitation:	
An Initial Investigation	292
An Assistive Control System to the Manipulation of the Manus Arm Robot	296
Driver Performance using Single Switch Scanning with a Powered Wheelchair:	
Robotic Assisted Control versus Traditional Control	298
SIG-14 Job Accommodations	
Design of a Horizontal Arm Support System	302
Utilizing Ergonomic Principles: A Case Study Accommodating an Individual	
with Cerebral Palsy	305
A Quantitative Economics Model for Assessing Reasonableness	
of an Accommodation	308
Learning from a Distance: Assistive Technology Training for	
Rehabilitation Counselors	311
Rehabilitation Technology in Supported Employment: Two Case Studies	314
SIG-15 Information Networking	
Distance Education for Postsecondary Students with Diverse Needs:	
The State of the Art and Science	318
International Training in Assistive Technology	321
SIG-18 Tech Act	
The Power of Partnerships or Collaboration as a Key to Cost Control	326
The Ability Program: A Privately Funded Statewide Assistive	
Technology Initiative	329
The Ability Projects: Increasing Assistive Technology Services	
to Adults in North Carolina	332
The Accommodation Station: An interactive Exhibit to Teach Children	
about Assistive Technology	335
SIG-19 Universal Access	
Effects of Wet Surface Conditions on Wheelchair Propulsion Work	
Requirements	340
W3C Web Accessibility Initiative: Development of WWW Browser	
User Interface Guidelines	343
Cross-Product, Cross-Disability Interface Extensions: EZ Access	346
Why Companies Might Adopt Universal Design: An initial Report	
from the Universal Design Research Project	349
Stove Modification for Client with Traumatic Brain Injury: How to Keep	
from Burnin' Your Beans	352
A Loss Function Approach to Universal Design	355
Trails Web Site with Universal Access Information	358
Proposal for a Universal Remote Console Communication (URCC) Protocol	361
SIG-20 Cognitive Disabilities & Technology	
Effective Cueing Techniques for Prompting Patients with Dementia	
During a Washroom Task	366
Passive Wandering-Deterrence Device for Use with Cognitively Disabled	
Nursing Home Residents	369
Student Scientific Paper Competition	
Estimating Postural Disturbances Caused by Voluntary Arm Movements	375
A Relationship between Pushrim Kinetics and Median Nerve Dysfunction	378
Signal to Noise Ratio Based Sorting of Voluntary Event Related Potential	
Averages for Assistive Technology Applications	381

The Effect of Stimulated Hip Extensor Moment on the Loads Imposed on the Arms during Standing with FES	384
Delaying the Onset of FNS Induced Muscle Fatigue: A Study of Muscle Fiber Recruitment during Intramuscular Stimulation	387
Paralyzed Veterans of America (PVA) Student Design Competition	
Design of a Rain Protection Device for Persons using Manual Wheelchairs	393
Outdoor Exploration for Individuals with Disabilities using the Adapted Hiking Chair	396
Voice Activated Environmental Control Unit	399
Design of a Wheelchair-Accessible Shelving System	402
Design of an Exercise Arcade for Children with Disabilities	405
Author Index	409

SIG-01
Service Delivery and Public Policy

OPERATIVE ACQUIRED PRESSURE ULCER PREVENTION: A COST-BENEFIT METHOD FOR OPERATING TABLE OVERLAYS

Edward A. Rivers, Graduate Rehabilitation Engineering Program
Biomedical and Human Factors Engineering, Wright State University, Dayton, Ohio

ABSTRACT Information from medical center logistics and from records on patients who developed hospital acquired pressure ulcers was evaluated for risk of operative acquired pressure ulcers. This effort quantifies the incidence and risk; describes a cost-benefit method; and establishes criteria for use of operating table overlays. The cost-benefit method is based on research results by Kosiak (1959) and by Reswick & Rogers (1976).

INTRODUCTION During 1996, 42 surgical patients at a south central medical center who were identified as having developed stage II+ hospital acquired pressure ulcers were at risk for having developed operative acquired pressure ulcers. An estimated 45 surgical patients developed stage I pressure ulcers.

Maklebust¹ (1986) reported that between 1.1 and 1.8 million hospital patients in the US develop pressure ulcers annually at a cost between \$3.5B and \$7.0B. The average treatment cost at this institution was estimated at \$4,714 per disposition.

APPROACH Three primary assumptions are made: First, the 42 stage II+ pressure ulcer patients represent the complete incidence of stage II+ operative acquired pressure ulcer patients for this institution. Second, the stage I+ pressure ulcer patient treatment cost averages \$4,714. Third, the pressure-time risk is based on research results by Reswick & Rogers² to represent the 1st-percentile risk (stage I threshold), and by Kosiak³ to represent the 99th-percentile risk (stage II threshold). The Kosiak curve was extrapolated from 12 to 16 hours. The risk between (and beyond) these thresholds corresponds to some probability distribution representative of the 42 stage II+ pressure ulcer patients (figure 1). The linear distance between any

two vertically aligned points on each curve is defined as a scale of probability ratios (modified Z-scale).

COST-BENEFIT METHOD Probability ratios are calculated at each surgical duration interval for each overlay. However, because their respective probability values are unknown, it is necessary to establish a probability profile for the baseline overlay, and to translate this profile to the candidate overlays. The distribution of the 42 stage II+ pressure ulcer patients is used as the basis for calculating the baseline probability values. First, smooth curves are generated for the surgical and pressure ulcer patient distributions. The baseline probability distribution (profile) is calculated by dividing the ulcer patient distribution into the surgical patient distribution. Then, by interpolation, probabilities are calculated and assigned to the probability ratios of the candidate overlays (figure 2).

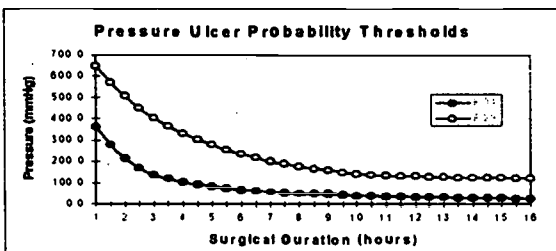

Figure 1. Adaptation of Kosiak and Reswick & Rogers Pressure-Time Curves

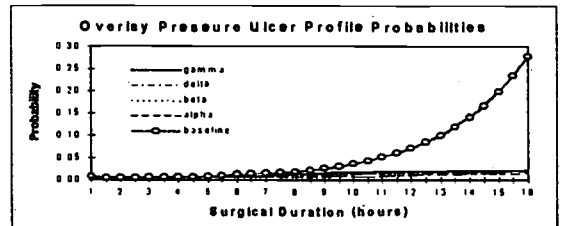

Figure 2. Baseline Probability Profile Applied to Candidate Overlays

Multiplying each nominal surgical caseload by its respective baseline probability of ulceration results in each predicted pressure ulcer caseload (figure 3) and compared against the actual incidence of patient ulceration.

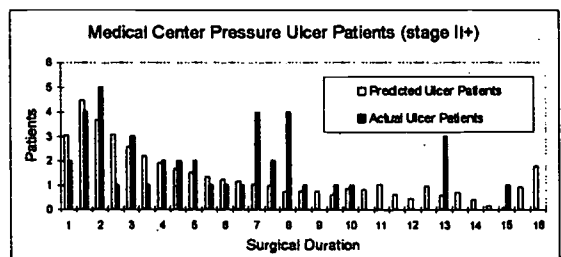

Figure 3. Nominal Operative Acquired Pressure Ulcer Patient Population Profile Distribution by Discrete Surgical Duration

Table 1. Nominal Procedure Costs (Logistics and Treatment) by Discrete Surgical Duration for Baseline Overlay

Surgical Duration	1.00	1.50	2.00	15.00	15.50	16.00	Total
P01	364	279	215	26	26	25	
P-baseline	87.8	87.8	87.8	87.8	87.8	87.8	
P99	649	570	505	122	121	120	
P-ratio	-0.971	-0.656	-0.438	0.643	0.652	0.661	
probability	0.0042	0.0042	0.0042	0.1982	0.2347	0.2780	
number of OR procedures	1482	2168	1783	1	8	13	11621
number of OR ulcer patient	6.24	9.14	7.51	0.20	1.88	3.61	86.05
OR overlay logistics cost	13939	20391	16770	9	75	122	109301
OR ulcer treatment cost	29438	43064	35417	934	8853	17036	405647
total intervention cost	43377	63455	52187	944	8928	17158	514948

Table 2. Comparison of Nominal Procedure Costs (Logistics plus Treatment) per Surgical Procedure for Each Candidate Overlay

Surgical Duration	3.50	4.00	4.50	5.00	8.00	8.50	9.00	9.50	10.00	10.50
gamma	28.76	29.05	29.97	32.23	60.84	66.87	73.37	79.55	81.97	84.20
delta	30.23	31.60	31.68	37.83	44.70	50.89	59.73	64.76	69.65	74.54
beta	33.37	34.71	35.16	35.17	44.99	48.71	55.07	63.34	67.92	72.23
alpha	46.02	47.12	48.13	48.95	53.12	54.19	55.48	57.07	58.95	61.75
crossovers at		4.9	&	8.1	&	9.0	hours			

The probability distribution of each overlay is used to predict incidence of pressure ulceration and respective treatment costs (table 1). Logistics costs depend on surgical caseload while treatment costs depend on pressure ulcer incidence. Summing across the entire spectrum of surgical durations, from 1 to 16 hours, results in the predicted total number of ulcer cases and intervention cost associated with that particular overlay.

Table 3. Cost Comparison of Baseline and Candidate Overlays Evaluated Using Profile Probabilities

Cushion Material	Alpha	Beta	Delta	Gamma	Base	Tiered
interface pressure (mmHg)	44	55	58	68	87.8	
cushion material life cycles	1500	1100	400	1100	1100	
number of pressure ulcer patients (stage I+)	54	57	58	62	86	57
estimated overlay logistics costs (\$K)	276	115	75	44	109	92
predicted pressure ulcer treatment costs (\$K)	255	270	275	292	406	270
Total predicted intervention costs (\$K)	531	385	350	336	515	361

Dividing each nominal total intervention cost by its respective surgical caseload equals the intervention cost (ulcer treatment plus logistics) per procedure for each OR table overlay. Table 2 shows that, for a tiered approach, overlay gamma is most cost effective for surgical durations up to 4.9 hours, overlay delta for durations between 4.9 and 8.1 hours, beta for durations between 8.1 and 9.0 hours, and alpha for durations over 9.0 hours (anesthesia start/stop).

Table 3 shows the total cost for the baseline overlay is \$515K. The tiered overlays (gamma \Rightarrow delta \Rightarrow beta \Rightarrow alpha) reduce total cost to \$361K (\$154K savings) and reduce the pressure ulcer incidence to 57 patients. Alpha minimizes the incidence (to 54 patients) but increases overall costs to \$531K (\$16K loss from baseline). This comparison only uses surgical duration as the criterion for pressure ulcer prevention. Additional savings can be realized by limiting the use of alpha to the high-risk population and continuing the baseline on the low-risk population.

From the data available, all 42 patients could be categorized into at least one of four criteria (table 4): being age 57 or more; having a surgical duration greater than 4:45; receiving procedural services from AAQA (bone marrow transplant) or ABBA (cardiothoracic) or ABDA (neurosurgery); or being age two or less. An ASA score of 4 is significant, but the patients can be accounted for by the other criteria. The surgical duration criterion represents only 1902 surgical procedures. All criteria combined represent 6385 procedures and overall reduction in costs of \$61K.

Three alternatives of the profile method are:

	savings	incidence (stage I+)
alpha	-\$16K (loss)	54
baseline \Rightarrow alpha tier with criteria	\$61K	54
gamma \Rightarrow delta \Rightarrow beta \Rightarrow alpha tier	\$154K	57

Now the distribution of stage II+ pressure ulcer patients is re-examined using a normal distribution between the Reswick and Kosiak thresholds instead of the profile distribution (figure 4) and compared against the actual incidence of patient ulceration.

Table 4. Cost-Benefit Evaluation Using Inclusion Criteria for Overlay Alpha (Profile)

Criteria for Overlay Alpha	Procedures on Patients Age 57 or More	Procedures > 4:45 Duration	Procedures in AAQA & ABBA & ABDA	Procedures on Patients with ASA=4	Procedures on Patients Age 2 or Less
Singular Ulcer Case Load	29	22	13	8	2
Additive Ulcer Case Load	29	8	3	0	2
Cumulative Ulcer Case Load	29	37	40	40	42
Singular Impact (%)	25.84	19.45	11.49	7.07	1.77
Additive Impact (%)	25.84	7.07	2.85	0.00	1.77
Cumulative Impact (%)	25.84	32.71	35.36	35.36	37.13
Singular Surgical Procedure Load	4218	1902	1179	324	369
Additive Surgical Procedure Load	4218	1212	628	155	172
Cumulative Surgical Procedure Load	4218	5430	8058	8213	8385
Change in Logistics Costs (\$K)	60	78	87	89	91
Change in Treatment Costs (\$K)	-73	-118	-138	-138	-152
Change in Total Costs (\$K)	-12	-41	-51	-49	-61

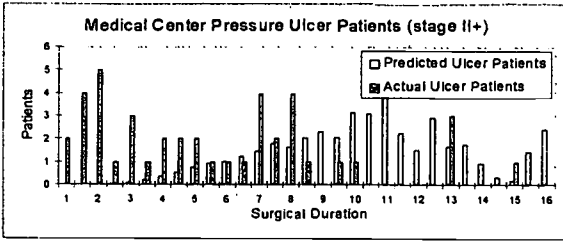

Figure 4. Nominal Operative Acquired Pressure Ulcer Patient Population Normal Distribution by Discrete Surgical Duration

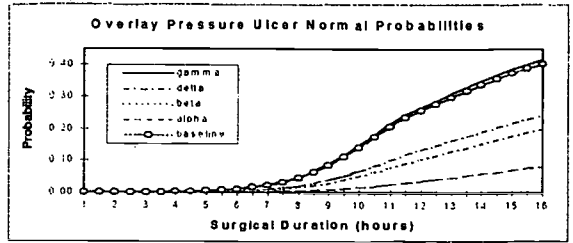

Figure 5. Normal Probability Applied to Candidate Overlays

The normal pressure-time probabilities of ulceration (figure 5) correspond more proportionately with their assigned interface pressures compared to the profile probabilities of figure 2.

Table 5 shows the total cost for the baseline overlay is \$520K. The tiered overlays (gamma ⇒ delta ⇒ beta ⇒ alpha) minimize total cost at \$167K (\$353K savings) and reduce the incidence of pressure ulcers to 16 patients, but is less effective than alpha. Alpha minimizes the incidence to 13 patients, and reduces overall costs to \$337K (\$183K savings from baseline). With inclusion criteria (table 6), the overall savings is now \$257K (logistics cost increases \$91K while treatment cost decreases \$348K) using the baseline ⇒ alpha tiered overlay.

Three alternatives of the normal method are:

	savings	incidence (stage I+)
alpha	\$183K	13
baseline ⇒ alpha tier with criteria	\$257K	13
gamma ⇒ delta ⇒ beta ⇒ alpha tier	\$353K	16

CONCLUSION This evaluation shows that overall costs can be reduced, even if logistics costs increase, if pressure reduction materials are used. At the national level, every 1% reduction in the number of pressure ulcer patients would reduce annual treatment costs approximately \$35M. Universally applied, the added investment would be \$9M to \$21M (using results from this study). The benefit exceeds the cost.

SUMMARY Pressure ulcers are a \$3.5B industry lacking in cost-benefit control. This report showed the quantified incidence of pressure ulcers; described a cost-benefit method; established tentative criteria for

Table 5. Cost Comparison of Baseline and Candidate Overlays Evaluated Using Normal Probabilities

Cushion Material	Alpha	Beta	Delta	Gamma	Base	Tiered
Interface pressure (mmHg)	44	55	58	68	67.4	
cushion material life cycles	1500	1100	400	1100	1100	
number of pressure ulcer patients (stage I+)	13	36	47	96	87	16
estimated overlay logistics costs (\$K)	276	115	75	44	109	92
predicted pressure ulcer treatment costs (\$K)	62	172	220	453	411	76
Total predicted intervention costs (\$K)	337	287	294	497	520	167

intervention; and compared cost saving approaches for preventive intervention.

REFERENCES

1. Maklebust, J.; Mondoux, L.; Sieggreen, M.; Pressure Relief Characteristics of Various Support Surfaces Used in Prevention and Treatment of Pressure Ulcers, Journal of Enterostomal Therapy, 13:85-89, 1986
2. Reswick, J. B.; Rogers, J. E.; Experience at Rancho Los Amigos Hospital with Devices and Techniques to Prevent Pressure Sores, Bedsore Biomechanics, University Park Press, 301-310, 1976
3. Kosiak, M.; Etiology and Pathology of Ischemic Ulcers, Archives of Physical Medicine and Rehabilitation, 62-69, February 1959

Table 6. Cost-Benefit Evaluation Using Inclusion Criteria for Overlay Alpha (Normal)

Criteria for Overlay Alpha	Procedures on Patients Age 57 or More	Procedures > 4:45 Duration	Procedures in AAQA & ABBA & ABDA	Procedures on Patients with ASA=4	Procedures on Patients Age 2 or Less
Singular Ulcer Case Load	29	22	13	8	2
Additive Ulcer Case Load	29	8	3	0	2
Cumulative Ulcer Case Load	29	37	40	40	42
Singular Impact (%)	58.65	44.50	28.29	16.18	4.05
Additive Impact (%)	58.65	16.18	6.07	0.00	4.05
Cumulative Impact (%)	58.65	74.83	80.90	80.90	84.95
Singular Surgical Procedure Load	4218	1902	1179	324	369
Additive Surgical Procedure Load	4218	1212	828	155	172
Cumulative Surgical Procedure Load	4218	5430	6056	6213	6385
Change in Logistics Costs (\$K)	60	78	87	89	91
Change in Treatment Costs (\$K)	-166	-270	-316	-316	-348
Change in Total Costs (\$K)	-106	-193	-229	-227	-257



Independent Literacy in the Information Age: Changing the Way Disability Services are Provided at UIUC

Jon Gunderson, Ph.D., APT
Division of Rehabilitation – Education Services
University of Illinois at Urbana/Champaign, USA

ABSTRACT

In the information age literacy is fundamental to a persons educational and employment opportunities. Today, too many students with print or writing impairments are provided with dependent literacy accommodations for their reading and writing needs. Dependent literacy creates both timing problems for the delivery of accessible materials and more importantly does not provide the independent literacy skills needed by students for continued education or employment upon graduation. This paper outlines the steps being used at UIUC to improve the independent literacy skills of students with disabilities.

BACKGROUND

During the fall 1997 semester, UIUC students made requests to the Division of Rehabilitation – Education Services (DRES) for the translation of over 41,000 pages of print materials to large print, Braille and audio tape. The average reader can only convert about 6 to 7 printed pages per hour to audio tape, so it would take about 6,500 hours to translate half of the requests to audio tape. A 1996 survey of UIUC students with disabilities found that students with visual impairments used computer technologies like e-mail and the WWW at half the rate of their able-bodied peers. These numbers indicate that a large number of students with disabilities are dependent on DRES or other readers for access to print materials and are not using information technologies at the same level as their able-bodied peers.

It is clear that persons with independent literacy skills have many more opportunities than

people with out independent literacy skills. One of the most telling statistics is related to the blind. Persons of working age that are blind who can read Braille are employed at the rate of 70%, while persons who are blind that do **not** read Braille are employed only at the rate of 30%.

The print translation services required for students under section 504 of the Rehab Act are not required to be provided by employers under the reasonable accommodation provisions of ADA. Most employers will probably not view extensive surrogate translation services as a reasonable accommodation. Students who don't develop independent literacy skills will therefore be severely limited in their career opportunities. It is the educational system that needs to provide leadership in creating opportunities and supporting the needs of persons with print and writing impairments to develop independent literacy skills.

OBJECTIVE

The objective is to improve the independent reading and writing literacy skills of UIUC students with sensory, motor and cognitive disabilities.

METHOD

Developing independent literacy skills requires a combination of providing assistive technologies for reading/writing, making students aware of the capabilities/limitations of assistive technologies, training students to be proficient in the use of assistive technologies, and working with the university to create information that is easier to transform into alternative modalities.

Independent Literacy at UIUC

Decentralizing Assistive Technology

One of the main factors related to the use of the assistive technologies at UIUC is location. UIUC has one specialized computer lab for most of the assistive technology available on campus. The location though was in a remote part of campus and is only open during business hours due to limited staff. The lab also does not have all of the software that is available in other campus computer labs or staff that is proficient in the operation of the software even if it was available. Therefore the assistive technology was not in a location that was convenient for many students with disabilities to access.

A new decentralized model was developed for the provision of assistive technologies. Site licenses were purchased for major software, including: screen magnification, enhancement and speech output software like Zoomtext, screen reader software like Henter-Joyce JAWS, Arkenstone Optical Character Recognition (OCR) reading systems, and NewType. NewType is a typing enhancement program with speech output capabilities designed for use by persons with learning disabilities to improve writing. The purchase of site licenses allows assistive technology to be available on any computer or server on campus. In addition to software, hardware like 21" monitors for persons with low vision, adjustable workstations for wheelchair users, keyguards and other alternative keyboards for the motor impaired have been purchased and moved into both general university and specialized departmental computer labs across campus. In general the goal is to transform the current specialized assistive technology computer lab from a general user lab to a lab used primarily for demonstrations, training and testing accommodations.

One of the most important locations on campus for decentralization was the UIUC library, where there was virtually no assistive

technology available to students with disabilities to access print materials or to use the electronic card catalog. Students were dependent on librarians to assist in searching for books and other documents, and then either use their own personal surrogate reader to read the materials or take them to DRES to have them translated. The goal for the library is to make available assistive technologies in the library for students to develop independent access to the electronic card catalog, journals and databases, and to allow students to read print materials with OCR and CCTV technology.

Raising Student Awareness

Previous attempts to move assistive technology into campus computer labs had met in failure. The primary problems were both the lack of awareness on the availability of the technologies by students who could benefit from them, and the placement of the technology in locations that the students would rarely go to.

Another issue is student motivation. Many students with print and writing impairments go through primary and secondary school using dependent literacy accommodations and are comfortable with them even with their long term disadvantages. In the pressures of higher education many students feel they have little time to learn new technology that is often not as flexible as their human surrogates. Rarely will a student totally give up their familiar accommodations. Therefore the introduction of independent literacy technology needs to be introduced in a way that improves the students educational efficiency and targets areas where the current dependent literacy accommodations break down. A common situation is when an instructor hands out a reading assignment to be discussed in the next class meeting in 2 days. From a logistical standpoint it is very difficult for the student to get the materials to DRES for translation and have them read before the next

Independent Literacy at UIUC

class meeting. In this case having OCR software with speech output or CCTV equipment available in a campus library near the student's classes or residence provides them with a convenient opportunity to read the materials independently before the next class.

Training

Training is critical for the successful implementation of assistive technology. Some types of assistive technology require very little training, like setting the resolution on a 21" monitor to low resolution and high contrast for a person with a visual impairment. But other technologies, especially technologies using speech input and output, require more skill and knowledge for effective usage. This is one of the problems of a decentralized assistive technology model. When the assistive technology is all in one centralized lab, trained staff in the lab can assist students with disabilities to learn the assistive technology as needed. In the decentralized model being implemented at UIUC it's not very likely that any of the lab staff (usually low skill student workers with a high turn over rate) will know anything about assistive technologies.

To cope with this training and support problem two strategies are being implemented. The first is providing students with initial one-on-one training in the computer labs where they will commonly use the assistive technology. Lab supervisors will be invited to participate in the training so they are somewhat familiar with the student and the technology they are using when questions arise. The second is the development of just-in-time training materials that are available on the WWW, large print, audio tape and Braille. The just-in-time training materials are designed to answer specific questions about how to complete a functional task. They are intended to supplement the one-on-one training and serve as a reference to lab staff and supervisors for assisting the student.

Long term DRES hopes to prepare prospective

UIUC students before they even arrive on campus through summer technology literacy camps. The camps are a week long and provide students with hands on experience using assistive technology to solve specific academic literacy needs. The camps also help students understand their educational rights and how they can receive these accommodations in their home schools.

Creating Accessible Materials

In the information age print materials are giving way to a wide variety of electronic materials available through Internet and CD-ROM technologies. UIUC is using and developing these technologies on campus for educational and administrative purposes. It is important that the university develop electronic materials that are accessible to students with disabilities. There are many problems with making electronic information technologies more accessible. To address the problems DRES is raising the awareness on campus of the need for accessibility and providing information on how to make campus materials more accessible. DRES has developed campus wide seminars to give WWW authors the knowledge they need to create accessible WWW documents and has started two projects with educational technology developers on campus to demonstrate how to create accessible course materials.

ACKNOWLEDGMENTS

I would like to acknowledge the UIUC Educational Technologies Board for their support of the literacy initiatives and contributors to DRES UI Foundation accounts for sensory accommodations.

Jon Gunderson, Ph.D., APT
Div. of Rehabilitation - Education Services
1207 S. Oak Street, Champaign, IL 61820
Voice: (217) 244-5870
E-mail: jongund@uiuc.edu
WWW: www.als.uiuc.edu/InfoTechAccess

INTEGRATING TECHNOLOGY INTO A NEW OTA CURRICULUM

Aimee J. Luebben, EdD, OTR/L, FAOTA; Hahn C. Edwards, MA, MS, OTR/L;
and Mary Metzger Edwards, RN, OTR
Occupational Therapy Assistant Department, Occupational Therapy Program
University of Southern Indiana, Evansville, IN

ABSTRACT

While many occupational therapy (OT) and occupational therapy assistant (OTA) schools have retrofitted their curricula with additional coursework in technology, others have redesigned their curricula around a technology related content core. This paper describes a developing entry-level OTA program in which technology was designed as an integral part of the curriculum. In addition, this paper examines the extent to which the OTA program addresses *Technology Competencies for Occupational Therapy Practitioners (OT Tech Competencies)* (1), a document that lists minimum technology competency recommendations for OT practitioners.

BACKGROUND

OT practitioners have provided technology services since the inception of the profession more than 80 years ago. In a survey, 69% of responding occupational therapists had recommended technology during their previous two years of practice (2). Some entry-level OT and OTA curricula, however, have been slow to implement instructional units or additional courses in assistive technology (AT) even though both types of entry-level educational programs have been mandated by the Accreditation Council for Occupational Therapy Education to include AT content. OT and OTA programs have addressed technology education in various ways. Some OT and OTA schools have retrofitted their curricula with additional required or elective AT courses, while others have redesigned their curricula around a core of technology related

content. The new educational program has the unique opportunity of designing technology as an integral part of the curriculum (3,4).

The OT profession began formulating technology competencies in 1993. The resulting document, *Technology Competencies for Occupational Therapy Practitioners* (1), lists specific competencies in three areas (evaluation, intervention, and resource coordination) for three levels (entry, intermediate, and advanced) of occupational therapists and of COTAs. Although the occupational therapist practicing at the advanced AT level is expected to achieve a total of 42 technology competencies, the entry-level COTA should be able to (a) demonstrate full performance of 18 technology competencies (43%) and (b) assist occupational therapists at higher levels of AT competency with 22 (52%) additional competencies. The entry-level COTA is expected to demonstrate 1 of 15 (7%) evaluation competencies (referral to appropriate OT and AT resources). The entry-level COTA is also expected to show 5 of 8 (63%) intervention competencies which include providing AT interventions as part of a comprehensive OT plan (3 competencies) and providing basic AT interventions (2 competencies). Additionally, of the 19 competencies delineated as resource coordination, the entry-level COTA is expected to demonstrate 12 of 13 (92%) competencies listed under providing and coordinating OT and basic AT resources to consumers and significant others.

OBJECTIVE

According to *OT Tech Competencies* (1), all OTA students should possess the competencies

at the COTA entry level upon completion of accredited OTA education programs. In a new OTA program, designed with technology as an integral part of the curriculum, the objective is: To determine to what extent does the developing program address the technology competencies for entry-level COTAs.

METHOD

A course-by-course curriculum audit was performed on this 2.5 year 75 credit OTA program in which accepted OTA students (in cohorts) begin the OTA technical component comprised of 49 credits (including 520 clinical hours) after successful completion of 26 credits of prerequisite courses. The curriculum audit determined to what extent the new OTA program addresses the *OT Tech Competencies* delineated for entry-level COTAs. Descriptive statistics were utilized to provide frequencies and percentages.

RESULTS

Table 1 displays the systematic integration of the technology curriculum strand into all 13 didactic courses and shows the numbers of hours available to practice skills for the three *OT Tech Competencies* areas in each course. Of the 705 total contact hours, the didactic coursework offers 136 hours (19%) of AT content related to the 18 entry-level *OT Tech Competencies*. This OTA curriculum offers 13 hours (2%) related to the evaluation competency, 75 hours (11%) that address the five intervention competencies; and 48 hours (7%) focused on the 12 resource coordination competencies. In addition to the didactic portion of the curriculum listed, students spend a minimum of 440 internship hours in two clinical courses not listed, and are expected to integrate technology related information into their clinical experiences.

Table 1. AT Related Curriculum Hours

Course	C	OT Tech Competencies Areas			T
		E	I	R	
OT Orientation	15	1	2	5	8
Pathophysiology & Conditions I	45	1	5	1	7
OPC I	90	1	10	3	14
Technical Communication	45	1	1	5	7
Therapeutic Media	45	1	5	3	9
Path & Cond II	45	1	5	1	7
OPC II	75	1	10	3	14
OPA I	75	1	15	5	21
Practicum Seminar A	60	1	5	1	7
OTA Management	45	1	1	8	10
OPA II	60	1	10	5	16
Pract Sem B	60	1	5	3	9
OTA Issues	45	1	1	5	7
Total hours	705	13	75	48	136
AT Percentage		2	11	7	19

KEY: C=Contact hours, E=Evaluation hours, I=Intervention hours, R=Resource Coordination hours, T=Total AT hours

DISCUSSION

The numerous hours of AT content in the OTA coursework can be explained by two factors in the design of this curriculum. First, when the program was originally developed, the curriculum designer utilized a systems approach to integrate technology across courses rather than adding an AT. Technology became one of six curriculum strands (wellness, ethics, communication, diversity, technology, collaboration with occupational therapists)

threaded throughout the OTA technical coursework. The curriculum core is the second design factor that explains the number of AT hours in this curriculum. Comprised of four courses (20 credit hours), the technical core is based *Uniform Terminology for Occupational Therapy* (6) which organizes human function into three occupational performance (OP) parameters: components, areas, and contexts. OP areas (OPA) include activities of daily living, work and productive activities, and play/leisure activities; OP components (OPC) consist of sensorimotor, cognitive, and psychosocial skills; and OP contexts are comprised of temporal and environmental aspects. Two of five core courses are named for the OPAs and three for the OPCs. Since the performance of persons needing OT services varies with age and environment, lifespan and OP contexts are dimensions across the five core courses. Because AT devices and services have such broad definitions (7), AT is considered in all aspects of occupational service delivery.

Graduates of this OTA program will possess the means to operate at the COTA, entry level, in AT service provision. In addition these graduates will have the methods to seek additional information to move to the COTA, intermediate level.

The adoption and implementation of technology competencies into preservice educational programs is the first step in the process of establishing OT within the AT service provision arena (5). For existing OT and OTA programs, curriculum redesign and coursework retrofit to include technology content have been used successfully. New entry-level OT and OTA programs, on the other hand, have the luxury of creating all course content from the beginning, and can readily design curricula around technology. With the comprehensive inclusion of a technology curriculum strand threaded throughout the coursework, an OT or OTA

program can easily modify AT content to address current and future technology competencies of the profession.

REFERENCES

1. Hammel, J., & Angelo, J. (1996). Technology competencies for occupational therapy practitioners. *Assistive Technology*, 8(1), 34-42.
2. Somerville, NJ, Wilson, DJ, Shanfield, KJ, & Mack, W. (1990). Assistive technology training needs survey. *Assistive. Technology*, 2, 41-49.
3. Luebben, A.J. (1994). Integration of technology into a new occupational therapy curriculum. In M. Binion (Ed.), *Tuning in to the 21st century through assistive technology* (pp. 31-33). Arlington, VA: RESNA Press.
4. Luebben, A.J. (1996). A technology curriculum strand. In A. Langton (Ed.), *Exploring new horizons...Pioneering the 21st century* (pp. 2-4). Arlington, VA: RESNA Press.
5. Hammel, JM, & Smith, RO. (1993). The development of technology competencies and training guidelines for occupational therapists. *American Journal of Occupational Therapy*, 47(11), 970-979.
6. American Occupational Therapy Association (1994). Uniform terminology for occupational therapy --- Third Edition. *American Journal of Occupational Therapy*, 48, 1047-1054.
7. 20 U.S.C. 1401 (a) (25) Public Law 100-407: *The Technology Related Assistance for Individuals with Disabilities Act of 1988*.

Aimee Luebben, EdD, OTR/L, FAOTA
Occupational Therapy Program
University of Southern Indiana
8600 University Blvd.
Evansville, IN 47712-3534
812-465-1179 (vox), 812-465-7092 (fax)
aluebben.ucs@smtp.usi.edu

TRIAD INTERACTIVE MODEL OF ERGONOMICS AND DISABILITY: THEORY TO VALID PRACTICE

Roger O. Smith, Ph.D., OT, FAOTA, Paul Grow, BS,
Arun Garg, Ph.D., and Phyllis King, Ph.D., OT, FAOTA
University of Wisconsin-Milwaukee, Milwaukee, WI

ABSTRACT

The fields of engineering, rehabilitation/medicine, and assistive technology have historically focused on optimizing successful work situations to prevent work injuries and assist people with disabilities in successful employment. These fields, however, are very different. They are distinct in their fundamental training, philosophy, bodies of literature, professional conferences, views of disability, and funding sources. On the other hand, each of these fields contributes a unique component to the successful employment of people with disabilities and the prevention of disabilities. The Triad Interactive Model of Ergonomics and Disability highlights the differences and commonalities between these fields and suggests a mechanism for these three distinct professional areas to work together in concert.

This triad model integrates prevention, remediation, and accommodation perspectives to assure continuity of services across individuals who are at risk of injury or disability, those who have been recently injured, to those who have long term disability. All of these groups have a common interest on optimizing their ability to work.

Implications of this model include the need to continue to develop this model, develop an outcome data collection methodology, and compare the efficacy of the model with more traditional current approaches.

BACKGROUND

More than 43 million Americans have physical or mental disabilities. According to the Committee on a National Agenda for the Prevention of Disabilities, one in seven Americans has a disabling condition (2). Of these, it is estimated that between 25 and 45 million Americans with disabilities could benefit from the use of some type of assistive technology (5). As an intervention, ergonomics, provides an important avenue to implement reasonable accommodations and promote implementation of the ADA (3). Smith, Vanderheiden, and Fox (4), spoke of the specialization in technology service delivery and the importance of the interdisciplinary team approach when providing assistive technology solutions. Ergonomic services, however, have not adopted this approach.

Today, three independent fields focus on optimizing the workplace for people with disabilities for the purpose of improving successful employment. Engineering, rehabilitation/medicine, and assistive technology, however, are substantially different. Each field brings expertise which is unique and extensive. On the other hand, each field is proudly independent and interacts very little with the others. The result is a service delivery model which has several players, but lack continuity or collaboration. See Figure 1. This model challenges the worker. The worker becomes ultimately responsible for managing each of the professional services, understanding which is most applicable when integrating information, and surviving within the unique funding sources of each field.

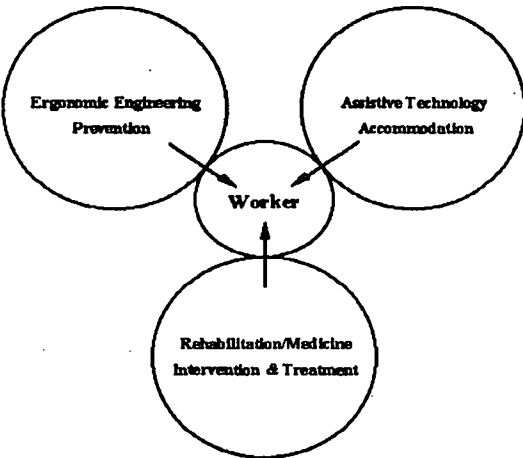

Figure 1.

Current model for ergonomic service delivery in the workplace. This model depicts three distinct fields of experts providing services independent of each other. This leaves the worker isolated and responsible for identifying and coordinating their own service delivery. Additional details are provided in the text.

STATEMENT OF THE PROBLEM

This problem emerges from the autonomy and substantial differences between engineers, rehabilitation/medicine, and assistive technology professionals. Each has unique professional training, bodies of literature and research, emphasizes different basic sciences, is supported for their services and research by different funding agencies, and has a different view of disability.

Perhaps the most striking and unique features of each field is the varied perspective and composition of professions. Engineering is oriented towards addressing individuals who are at risk for injury or disability through design and prevention. Ergonomists routinely assess job designs to reduce or eliminate ergonomic related problems at work (3). The rehabilitation/medicine field is oriented primarily towards intervention and remediation of problems through corrective and curative methods oriented towards improving individual worker function. The assistive technology field is oriented towards design and accommodation. Uniquely, the assistive technology field does

not limit its focus to the environment (as engineering), or the worker (as the rehabilitation/medicine), but looks more holistically at the worker and the work environment while seeking improvements to both.

These substantial differences between fields make it difficult for professionals viewing from one perspective to understand the perspectives of others. Unfortunately, only a few individuals have crossed fields in training, research, and practice to see more than one side. Fortunately, some of those who have expanded their view, can see the value of an interactive service delivery model. The authors of this paper have each personally had the opportunity of cross training from student and teaching perspectives. This cross-field experience is what has generated this potential new service approach: The Triad Interactive Model of Ergonomics and Disability.

APPROACH

Triad Interactive Model of Ergonomics and Disability is portrayed in Figure 2. This shows the relationships between the fields and the worker. When juxtaposed to the typical current ergonomics service delivery model differences are clear. In this new model each of the fields overlap with the worker as an integrated part of services as opposed to a more isolating and demanding management role of the worker. The worker remains central, and serves as a team member. Several specific mechanisms bring the triad together in this approach. These mechanisms include interdisciplinary training, dissemination of information, referrals; all supplementing practice. While interdisciplinary teams have been promoted in the rehabilitation field for many years. According to Bain, Cohen and Dooley (1), it is "imperative that all professions, each with its unique skills and expertise, collaborate to enhance the effectiveness and efficiency of the rehabilitation process." This has not been the

case in ergonomics. Additionally, this concept does not suggest a transdisciplinary format where there is a blurring of roles. There is an acknowledgment that each field has its own depth of information which cannot be "watered down".

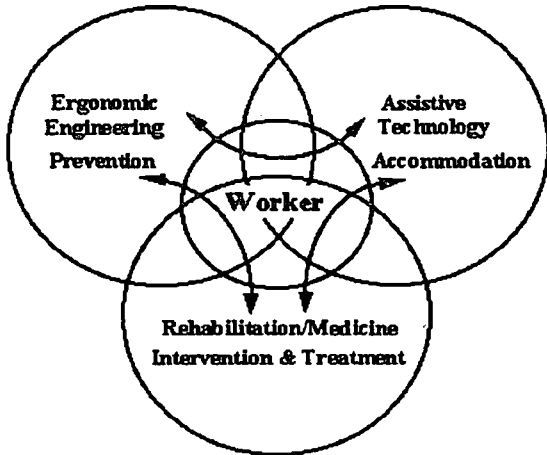

Figure 2.

Triad interactive model for ergonomics service delivery in the workplace. This model depicts three distinct fields of experts in an interactive collaborative approach to providing services to the worker. This involves the worker from all sides, and as a team member. Additional details are provided in the text.

To operationalize this model, specific changes in service are needed. These include 1) a fluent referral system, 2) consultation mechanisms using newer communication media including a World Wide Web based central referral system, audio and video conferencing providing virtual teaming, and 3) fundamental training for each field by the other fields for the expressed purpose of each field understanding the value of including the expertise from the others.

IMPLICATIONS AND DISCUSSION

When information and expertise become integrated from three separate fields the effectiveness of an ergonomics program can synergize. The potential is awesome. The substantial differences between these fields, however, threatens this ever happening. It will

take deliberate thinking and action of those who can see from multiple perspectives to lead the development and test this triad service format. Assistive technology practitioners are already the most interdisciplinary in mindset. Some of the leadership which links ergonomics to disability should emerge from the assistive technology field. The model which assistive technology professionals can help promote would be viewed as an entire new paradigm of service applying ergonomics to employment for people with disabilities.

REFERENCES

1. Bain, B. K., Cohen, W., & Dooley, K. F. (1993). Collaboration of occupational therapists and vocational rehabilitation counselors in the application of assistive technology. Proceedings of the RESNA '93 Annual Conference, USA, 13, 12-13.
2. Jacobs, K., & Bettencourt, C. M. (Eds.). (1995). Ergonomics for Therapists. Boston: Butterworth-Heinemann.
3. Lanciault, M. CS., & Walker, S. A. (1993). Title I of the Americans with Disabilities Act: Ergonomics, return-to-work and reasonable accommodation. Proceedings of the RESNA '93 Annual Conference, USA, 13, 514-515.
4. Smith, R.O., Vanderheiden, G.C., & Fox, L. (1990). Specialization in technology service delivery: What is an interface specialist? Proceedings of the RESNA 13th Annual Conference, USA, 10, 240-241.
5. Thorkildsen, R., & Lowry, W. H. (1993). Assistive technology career development project. Proceedings of the RESNA '93 Annual Conference, USA, 13, 4-6.

Roger O. Smith smithro@csd.uwm.edu
Occupational Therapy Program
University of Wisconsin-Milwaukee
P.O. Box 413
Milwaukee, Wisconsin 53201
(414) 229-5625 PHONE/(414) 229-5100 FAX

OUTCOMES OF ASSISTIVE TECHNOLOGY SERVICES AND USE BY ADULTS WITH DEVELOPMENTAL DISABILITIES

Joy Hammel, Ph.D., OTR/L; Tamar Heller, Ph.D.; Gui-Shuang Ying, M.S.
Institute on Disability and Human Development
University of Illinois at Chicago, Chicago, IL

ABSTRACT

An outcome study of AT service delivery, use, and relationship to functional status changes over time was conducted with a group of 35 adults with developmental disabilities, specifically cerebral palsy and mental retardation, living in the community. Data were collected in community sites at intake and at follow-up an average 19 months after intake referral for AT services. Results point to long term use and benefits of follow-up AT services and devices during adult and older adult years.

BACKGROUND

Although there is a growing body of literature on AT outcomes, a significant need remains to study outcomes over time with identified groups of AT users at specific periods during the lifespan. Relatively few studies have focused on tracking AT services, use and relationship to functional changes over time among adults with developmental disabilities as they age within the community [1] (see 4 (1995) issue of *Technology and Disability* for sample studies).

As part of a grant-sponsored program, 45 people with cerebral palsy were seen by an interdisciplinary team to assess their medical, health and functional status; to collaboratively determine their current needs; and to provide recommendations for follow-up community services. An AT screening was included in the initial intake. The overall purpose of the study was to track the implementation and effectiveness of these screenings and service recommendations over time in the community.

Of the 45 program participants, 35 were referred to and received AT follow-up services from local providers. Referrals ranged from basic adaptive devices, such as eating utensils, to more complex integrated technology solutions, such as augmentative communication, environmental control, custom seating, mobility, and computer access. This study reflects intake to follow-up data from this pool of 35.

RESEARCH QUESTIONS

The following research questions were studied:

-What are the results of AT intake referrals in regard to follow-up services received?

-What are the demographics of AT use at follow-up in regard to types of technology received, use or nonuse of previous and new AT, reasons for not using, and funding sources of services and AT?

-What is the relationship of AT use to functional status changes as measured by the FIM motor items at intake and follow-up?

METHODS

Subjects: All subjects had a primary diagnosis of cerebral palsy since birth or early childhood. All were physically involved, although level of involvement ranged from significant upper and lower extremity impairment to involvement primarily affecting fine motor coordination. The majority of subjects (86%) had a coexisting diagnosis of mental retardation (40% mild, 17% moderate, 23% severe or profound, 6% missing data on level). Average age at time of intake was 41.8 years (range: 29-57). All were living and operating in the community at follow-up.

Of the 35 people tracked, all were using some AT at the time of intake given their disability since childhood. This study, then, explored the long term use of previous AT, with the cumulative effect of new AT and services received since intake through follow-up.

Instruments: The motor subset (includes self care, sphincter control, transfers and locomotion) of the Functional Independence Measure (FIM) [2] was used to measure functional status in basic ADLs at intake and follow-up. A standard FIM score was given that included AT and human assistance together in the score (coded as With AT). Additionally, a clinical judgment score was given to approximate the level of function if the AT were not used as part of the task (coded as Without

AT). Although an approximation and not part of the standard FIM scoring, this variation of item scoring was done as a pilot to explore the "added bonus" or effect of AT. Additionally, functional scales from the ICAP (Inventory for Client and Agency Planning) [3] and open-ended interviews with AT users and their case managers and/or caregivers were done to add to functional status data. To track AT demographics, data on AT service delivery and use or nonuse over time was collected.

To track outcomes over time, follow-up was scheduled for a minimum of 8 months post from the intake AT referral; average time from intake to follow-up was 19 months. Data were collected onsite in community settings in which subjects frequently operated on a daily basis (e.g., home, work, sheltered workshop). Family and primary case managers provided assistance for subjects with moderate or severe cognitive impairments. Data were analyzed using SPSS software.

RESULTS

Over 230 AT products were reported as recommended or obtained from intake to follow-up for the 35 participants, with an average of 8 AT devices per subject. The AT was obtained through a variety of sources; most frequently identified included AT specialty evaluation centers, disability centers such as UCP, general hospital clinics, and direct from vendors. Most frequently identified AT fell into the categories of communication (33%), mobility and transportation (29%), and personal care (22%). Frequent sources of funding included state public aid (52%), disability centers (12%), and family/self (8%); 12% of the subjects did not know how the AT was funded.

For use over time, 77% were using the AT, 17% were not, and 6% had not received the recommended AT since the evaluation and initial order. The most frequent reasons for not using were that the AT was not working (20%), was not needed (13%) or not useful (11%), was unsafe (7%) or was lost (6%).

In regard to functional status changes, post hoc t-tests showed a significant difference in total FIM motor score from intake to follow-up in the With AT condition ($p < .000$), but not in the Without AT condition ($p < .204$). At follow-up, a significant difference was also shown in

functional performance with AT (mean: 43.97 (SD: 23.33)) versus without AT (mean: 32.40 (SD: 18.95) ($p < .000$). For specific activity areas, significant differences (improved scores) were found from intake to follow-up for self-care, sphincter control and transferring, but not for locomotion.

DISCUSSION

The results of this study support the long term use by and functional benefits of AT for adults with cerebral palsy, with and without coexisting mental retardation, on a pilot basis. This is particularly intriguing since this group of people, who experienced their disability and used AT since childhood, still showed a functional status gain given follow-up AT services and products, or adjustments to existing AT, during the adult and older adult years. Qualitative interview results also point to interactions of AT use and outcomes with handicap level factors, including level of social support, caregiver/staff AT training, and environmental opportunities to explore, practice and troubleshoot AT within the contexts of daily living.

Although interpretation of individual FIM items should be done with caution, the lack of significant change or improvement in locomotion scores from intake to follow-up may be explained in that the majority of subjects were already using mobility devices for many years prior to the study. The FIM's definition of locomotion is limited and may not have reflected an adequate measure of functional mobility in the community. Also, seating and mobility technology additions or adjustments may have led to gains in other functional activities, such as eating or transferring, but this specific contribution could not be determined given the methods used. The interactional impact of various types of AT across multiple areas of function will be explored in more detail in future studies.

Results and interpretations of this preliminary data are limited in that a relatively small, nonrandom group of people was studied ($N=35$), one rater was used with the potential for rater bias, and a variation in FIM scoring to approximate "with versus without AT" effects was pilot tested and needs to be validated further.

AT Outcomes

Results point to the need for future studies to further research the effectiveness and efficiency of follow-up services to screen, evaluate and address changing technology and functional needs to maintain or potentially even improve function and community integration as people age.

REFERENCES

1. Heller, T. (1995). Assistive technology and persons with developmental disabilities. *Technology and Disability*, 4, 191-193.
2. Uniform Data Set for Medical Rehabilitation (1993). *A Guide for the Uniform Data Set for Medical Rehabilitation (Adult FIM), version 4.0*. Buffalo, NY: SUNY-Buffalo.
3. Bruininks, R., Hill, B., Weatherman, R., & Woodcock, R. (1986). *Inventory for Client and Agency Planning*. Allen, TX: DLM Teaching Resources.

ACKNOWLEDGEMENTS

This project was supported in part by the Rehabilitation Research and Training Center on Aging with Mental Retardation, University of Illinois at Chicago, through Grant No. 133B30069 from the U.S. Dept. of Education, National Institute on Disability and Rehabilitation Research. Special thanks are given to the participants, caregivers, staff and service providers involved in this study.

Joy Hammel, hammel@uic.edu
Institute on Disability and Human Development
/OT Dept.
1919 W. Taylor Street, 3rd Floor, M/C 811
Chicago, IL 60612
(312) 996-3513 Fax: (312) 413-0256

PROJECT IMPACT: INTEGRATED MULTI-PERSPECTIVE ACCESS TO CAMPUS TECHNOLOGY

Roger O. Smith, Ph.D., Marlene K. Stanley, BS, and Dave Edyburn, Ph.D
University of Wisconsin-Milwaukee, Milwaukee, WI

ABSTRACT

Technology is advancing so rapidly on university campuses that students with disabilities will either encounter opportunities like never before, or they will be moved aside and left behind as new educational environments march ahead. This project innovates several strategies to successfully recruit, retain, graduate, and place university students with disabilities through the effective integration of assistive technology into the post-secondary education setting. The overall approach involves the integration of a number of campus departments and administrative structures to coordinate a comprehensive technological approach for students with disabilities. In addition, students trained with assistive technology, including those from exceptional education and occupational therapy will provide direct one to one support to students with disabilities. Specific strategies include creating an interdisciplinary assistive technology evaluation and training laboratory, developing and using existing assistive technology loan programs, implementing an assistive technology "IMPACT Buddy" system.

BACKGROUND

Advances in educational technology include: multimedia lecture halls, computer-based laboratories with animations, videos, audio narratives, interactive communication, World Wide Web-based instruction, textbooks on compact disks, and computer based library holdings. Opportunities for students with disabilities to advance equally with their peers depend on their ability to access this new educational technology (1, 2). Nationally, approaches to accommodate the technology

needs for students with disabilities have had some success, but little future. Brief descriptions of four campus strategies are reviewed. The first strategy, called "The Squeaky Wheel" highlighted the need for students to advocate for themselves and persist in receiving the appropriate assistive technology support. This strategy was only successful for students who were aggressive and continually persistent in their requests. The second strategy, called "Let's Make All Laboratories Accessible" advocated making all the laboratories on campus accessible by infusing sufficient technology and expertise. This resulted in underutilization of newly installed equipment because of lack of trained staff to run it and inaccurate equipment predictions. The third strategy, called "The State-of-the-Art Accessible Campus Center" had some campuses focusing all of their assistive technology needs in one local center. This segregated and isolated the students with disabilities. The fourth and final strategy reviewed, called, "The Accommodation Plan" involved the accommodation of a system as the accessibility problem arose. This resulted in a reactive patching of the problem rather than a proactive solution for a systemic fix. Although each of these strategies have some merit, the shortfalls of solving a complex need for a campus system are evident.

The overall goal of this project is to evaluate the effectiveness of specific strategies outlined in its plan on a mid-size campus. This campus is poised for system change and proposes to implement a comprehensive campus-accessibility plan, initiate strategies specifically designed to demonstrate a combination of successful methods of the past with promising

innovations, collect and process outcome data, and widely distribute its findings.

OBJECTIVE

The implementation of a campus accessibility program is imperative to a student with disabilities in that it will be able to:

- Provide educational opportunities for students with disabilities that are commensurate with their peers;
- Provide a proactive approach to solving assistive technology issues
- Provide more specific information in how to better deal with ADA implementation policies;
- Decrease the cost to accommodate the educational technology
- Increase and/or maintain retention of students with disabilities in post-secondary educational settings.
- Provide learning opportunities to professional staff and professional students in training as well as the students with the disabilities.

With the ongoing dependence on technology in education, the need to reduce the barriers of campus accessibility for students with disabilities becomes more pressing. The model presented in this paper illustrates a comprehensive campus accessibility service delivery model to increase the availability of educational technology and assistive technology appropriate for the needs of individuals with disabilities.

METHOD

This model includes a systematic approach for evaluating, training, and identifying appropriate assistive technology needs of students with disabilities. The approach takes into account the individual's strengths and abilities in matching each individual with the necessary and correct assistive technology. There are four particularly unique contributions this project will make in

specific distributable products. They are: 1) Accessibility Audits: these address accessibility issues on campus; 2) Mini-Guidebooks: these will provide educational materials accessible as they are being created to support the faculty in campus accessibility decisions; 3) IMPACT Buddy System: this approach will provide a strategy for matching a student with a disability entering the campus with a student who has been on campus and is learning to work with disabilities to provide helpful information and work together to optimize educational outcome; and 4) Individual Technology Integration Plan: this plan will augment the Individualized Accommodation Plan with a formalized assistive component added to ensure all assistive technology needs are met.

The model also provides eleven additional strategies such as an Integrated Loan Bank, Full Vertical Program, and Expert Consultation strategies for identifying optimal campus accessibility for students with disabilities. Figure 1 shows the complete listing of the fifteen strategies identified in this model.

Strategy #1	Campus Assistive Technology Locator Data Base
Strategy #2	Integrated Loan Bank
Strategy #3	Accessibility Audits
Strategy #4	Accessibility Mini-Guidebooks
Strategy #5	High Campus Visibility
Strategy #6	Interdisciplinary Assistive Technology Evaluations and Training
Strategy #7	Full Vertical Program
Strategy #8	Multiple Funding Targets for Assistive Technology Devices
Strategy #9	Distributed Campus Assistive Technology Applications
Strategy #10	Expert Consultation
Strategy #11	IMPACT Buddy System
Strategy #12	Tapping into National Resources
Strategy #13	Courses to Support Assistive Technology Peer Expertise
Strategy #14	Emphasis on Feedback and Participation
Strategy #15	Individual Technology Integration Plan

Figure 1
Strategies of Implementation for Project IMPACT

RESULTS

Thirty-five accessibility audits of information pertaining to the access needs of students with disabilities were identified. Sample audit topics included: Information posting on doors, information posted on bulletin boards, automatic doors, elevators, parking spaces, overheads used in classes, slides used in classes, University of Wisconsin-Milwaukee (UWM) Home WWW page, and the School of Allied Health Home WWW page. These audits are performed on an on-going basis in a measurement and theory course. Results of the audits show a wide variance of accessibility. For example, web pages at the UWM site are used in a graphical text inaccessible to blind students, which were already identified. Access audits provide a baseline for attacking accessibility problems. The audits provide suggestions for improvement and are given to originators of the information. Follow-up audits are to be performed on a regular basis. Progress will be monitored and reported to information originators, interested parties on campus and nationally, and interested funding agencies.

DISCUSSION

This national demonstration project is significant to students with disabilities at a local and national level. Colleges and universities throughout the country are being increasingly challenged to provide equal educational opportunities for students with disabilities so that they may compete effectively alongside their peers. This model will provide valuable experiences from which other campuses can assess for their own use. There are many applications of assistive technology for people with disabilities which can be of immense benefit (3). We need to unleash the power of assistive technology and related interventions to optimize the education of students with disabilities.

REFERENCES

1. Day, S.L., & Edwards, B.J. (1996). Assistive technology for postsecondary with learning disabilities. *Journal of Learning Disabilities*, 29,5. 486-492, 503.
2. Male, M. (1994). *Technology for inclusion. Meeting the special needs of all students*. Boston: Allyn and Bacon.
3. Cook M. & Hussey, S.M. (1995). *Assistive technologies: principles and practice*. St. Louis, MO: Mosby-Year Book, Inc.

ACKNOWLEDGEMENTS

This work is supported in part by Grant # H078C70021 provided by the U.S. Department of Education.

Roger O. Smith, Ph.D., OT, FAOTA
Occupational Therapy Program
University of Wisconsin-Milwaukee
P.O. Box 413
Milwaukee, WI 53201
(414) 229-5625 PHONE
(414) 229-5100 FAX
smithro@csd.uwm.edu

OPTIMIZING THE USE OF ASSISTIVE TECHNOLOGY BY PEOPLE WITH MULTIPLE SCLEROSIS

Susan E. Fridie, M.S., O.T.R./L.

Martin Ferguson-Pell, Ph.D.

Kimberly Davis, M.S., P.T.

ABSTRACT

A nationwide mail survey of people with multiple sclerosis was conducted to explore patterns of assistive technology (AT) use. This paper reports results from 256 respondents. Use of mobility devices far exceeded that of other technologies. Respondents who used AT were generally satisfied with AT used, and AT services received. Results point to the need for education about AT to people with MS.

BACKGROUND

People who have stable, lifelong disabilities appear to embrace assistive technology (AT) as a vehicle for increased independence. On the other hand, people who experience progressive changes in their condition often see technology as a symbol of their gradual loss of function and tend to feel that an assistive device calls attention to their disabilities. Multiple sclerosis, which manifests itself in adulthood, is a prime example of this phenomenon.

Multiple sclerosis is a chronic disabling disease of the central nervous system. It is thought to result when the body's immune system begins to destroy the myelin nerve sheaths in the brain and spinal cord. The cause is unknown. Loss of myelin compromises the nerves' ability to transmit signals to sensory and motor organs. With the average age of onset in the mid-thirties, little effect on life expectancy, and a generally progressive course of increasing disability, MS can have a devastating effect on individuals and families. The nationwide population of people with MS has been estimated at more than 300,000.¹ Because of its long-

term, unpredictable, and disabling nature, the cumulative financial costs of MS are far greater than this number suggests, and greater than for some other disorders with onset later in life.

The clinical manifestations of MS vary widely and the course is unpredictable. Depending on which parts of the central nervous system are affected, symptoms can include fatigue, heat sensitivity, difficulty walking, visual loss, sensory changes, pain, bladder dysfunction, spasticity, incoordination, sexual dysfunction, and cognitive deficits. There is a very high probability of experiencing some sort of activity limitation, and total disability sometimes results. Hence, MS can severely compromise family, social, and vocational roles. Moreover, MS carries with it a burden of changeability and uncertainty. The course is often characterized by exacerbations and remissions, making long-term planning an elusive and often frustrating exercise.

OBJECTIVE

This study investigates the problem of technology acceptance in people with MS, and examines the nature and extent of barriers faced by people with MS in using assistive technology for increased independence and improved quality of life. The data has been gathered from people with MS at different stages in their illness. A companion project, surveying family members of people with MS, and another surveying professionals who assist people in selecting AT have also been done and will be reported elsewhere.

¹Anderson et al (1992). Revised estimate of the prevalence of multiple sclerosis

in the United States. *Annals of Neurology*, 31, 333-336.

METHODS

Surveys were done via questionnaires mailed to the three target populations. In order to ensure that a representative set of issues were addressed in designing the survey questionnaires, focus groups were conducted with 1) people with MS, 2) "family members", defined as someone in the personal life of the one with MS, who knows a lot about the impact of MS on that individual, and 3) assistive technology professionals, including clinical practitioners and rehabilitation technology suppliers (RTSSs).

The focus groups raised a large number of issues that participants discussed in connection with resistance to AT use. The survey instruments were designed to include items touching on each of these issues. A variety of question formats were used, as appropriate to the information sought.

A total of 4725 surveys were distributed to people with MS (consumers). The lengthy (10-page) survey instrument covers

- Knowledge about AT
- Experience with AT
- Help received in choosing AT
- Experience with AT practitioners
- Experience with AT suppliers
- Personal information (demographic data, degree of disability, care received, etc.)
- Attitudes toward MS, toward technology in general, and toward AT.

The first 4,000 questionnaires were distributed via mail to a random sampling of the nationwide membership mailing list of the National Multiple Sclerosis Society (NMSS). The remaining surveys went to people who had heard about the study in a variety of ways (mostly via our World Wide Web page), and volunteered to participate.

Each recipient received a cover letter from the NMSS, a Consumer Survey, a Family Member Survey for distribution to an appropriate person in his or her life, a list of terminology definitions, and instructions. Recipients were asked to complete the survey whether or not they had had experience with AT.

At the same time, a different survey was mailed to AT practitioners and suppliers. Recipients were asked to complete the questionnaire if their AT clientele included people with MS.

RESULTS

The results reported in this paper represent the responses of 256 people with MS. Their mean age was 48.7 (s.d. 13.7) years. Twenty seven percent were male and 71% female, with 2% not completing this question. The mean (s.d.) number of years of education received by the respondents was 14.4 (3.1) years. The mean time since diagnosis of MS was 11 (8.7) years and 16.6 (10.7) years since the first appearance of symptoms.

A substantial proportion (48%) had first heard of assistive technology through this survey while 25% had been informed about AT around the time of their diagnosis. Only 5% felt that they had heard of AT well after their first need for it.

In reporting their difficulties in obtaining information about AT, respondents rated the helpfulness of information from printed materials highest: 3.8 on a scale of 1 (low) to 5 (high). Next was therapists who were not AT specialists (mean 3.5). AT consultants, AT suppliers, doctors, and people with MS rated equally (mean 3.2), whereas shows/expos and non-medical facilities ranked lowest (2.2).

Of the 61% who responded to the question, 25% had received services from AT practitioners or suppliers, and 36% had not. Those that had consulted with AT specialists found it easy to find a suitable specialist. Those who responded were very satisfied with the services provided by AT specialists.

When asked about the AT devices used, 54% used wheeled mobility devices and 35% low tech AT. Twenty per cent made building modifications, and 18% vehicle modifications. Augmentative communication and environmental controls were each used by 5% of respondents,

while 4% used computer access devices. Five per cent used no assistive devices.

Of the devices named most satisfactory, powered mobility systems predominated (scooters and power wheelchairs). The least helpful were aids for ambulation and feeding.

DISCUSSION

While most participants in all the focus groups agreed with the premise that the MS population uses AT less than other groups with similar degrees of disability, no research into this issue could be found in the literature. This study, then, is seen as exploratory rather than definitive.

Lack of information is a primary cause of under-use of AT, with nearly half the respondents having no information about AT prior to this survey. Since neurologists are the usual route through which people are diagnosed with MS, efforts to improve awareness of AT's potential benefits may best start there. Wider distribution of print materials for neurologists to pass on to their patients would appear to be effective and relatively easy to implement.

The strong predominance of the use of mobility devices among respondents, may be due to their visibility--the existence of wheelchairs and scooters is well known to the general public; so well known that they appear not to be considered assistive technology by many (since it is difficult to believe that the 48% who said they had no previous knowledge of AT have never seen a wheelchair.)

In contrast, the low use of some AT may be due more to people being unaware of its existence than to lack of interest, poor reimbursement, or effectiveness of these devices. With the current spread of microcomputer technology into nearly every aspect of modern life, computer access adaptations, for example, may be expected to be highly desirable, yet they are little used by this population.

Limitations of the study include the sample coming from a mailing list and volunteers. There is no way to know how representative of the MS-

population-at-large the overall sample is. A response rate about 15% seems quite respectable, considering the length of the surveys, and that they were sent "cold," without previous contact between researchers and respondents. Nevertheless, such a low rate signifies strong self-selection, which may introduce bias. For example, as many as 25% of respondents reported consulting AT practitioners and/or suppliers, and that they found it easy to locate such assistance. It may be supposed that those who found, used and were satisfied with AT services were more likely to obtain appropriate AT, and were perhaps more likely to respond to the survey than those who could not locate suitable help and gave up.

We can postulate that the least-disabled people are under-represented, as they can function well without AT, and may resist associating themselves with a disability-related project. The most-disabled may be also under-represented, because it may be difficult for them to complete the questionnaire. Certainly, the people who volunteered to participate responded at a higher rate than those who received their surveys unsolicited.

Because we were committed to exploring all the major issues raised in the focus groups, our survey instruments became large and complex. Future studies can be more focused, use less intimidating instruments, and therefore receive a larger and less-biased response.

ACKNOWLEDGMENTS

Funded by the National Institute on Disability and Rehabilitation Research, US Dept. of Education, Project H133B30015-95.

Susan E. Fridie
Helen Hayes Hospital
Center for Rehabilitation Technology
Route 9W, West Haverstraw, NY 10993
914/786-4587 (v), -4951 (fax)
susan.fridie@oapwd.state.ny.us

AN EXPLORATION OF PEOPLE WITH DISABILITIES IN THE UNITED STATES: MARKETING IMPLICATIONS FOR ENGINEERING AND DESIGN PROFESSIONALS

Robert L. Todd, M.S.
Georgia Tech's Center for Rehabilitation Technology
Atlanta, Georgia

ABSTRACT

Approximately 49 million Americans have a disability; this is about 1 out of every 5 people. This number and its percentage of the total population is rapidly growing as people continue to live longer and survive serious medical conditions. People with disabilities have heterogenous but exceptional needs for assistive devices and adapted design of products and environments. As a group, they present a large market for these products and designs. Unfortunately, there is little understanding among most design professionals about this population. This paper explores the characteristics of Americans with disabilities as a means to identify marketing potentials. The variables of moderate versus severe disability, aging, income, assistive technology use and others will be examined separately and together to identify promising marketing areas for design professionals.

BACKGROUND

Approximately 49 million Americans have a disability; this is about 1 of every 5 people (2). This is a large number of people who have special needs in accomplishing life activities and who are potential consumers of assistive devices and designs to fulfill their needs.

OBJECTIVE

It is imperative for engineers and designers of assistive technology to understand their potential consumers in order to design successful and useful products. Engineers often design on a case-by-case basis for individuals; a successful strategy for the individual user but

not conducive to satisfying a wider market. This paper seeks to identify possible consumer markets for these adapted products.

METHOD

This study accessed published Census Bureau information and studies investigating the status of people with disabilities in the United States. The author reviewed numerous reports on disability severity, aging, income, and assistive technology use and condensed the findings into a brief narrative. The working hypotheses for this study was that the growing population of the "elderly" would emerge as the largest identifiable disability "grouping" and therefore indicate the most important marketing sector.

RESULTS

Of the total 49 million Americans with disabilities, moderate disabilities occur in a ratio of 2:1 versus severe disabilities (4). The risk of a chronic disabling condition causing activity limitation, or functional limitation, is inversely related to the prevalence of the condition; the disabilities that cause the greatest functional limitation are the least prevalent, while those that cause relatively moderate to light disability are more prevalent. The five most common disabling chronic conditions (hearing impairment, hay fever, hypertension, osteoarthritis, and sinusitis) have relatively low values of associated activity limitations. By contrast, individuals with one of the five least prevalent conditions (general paralysis, digestive system cancer, lung cancer, multiple sclerosis, and loss of arms/hands) reported much greater chance of associated activity

limitations (4).

The prevalence and nature of disabilities differ considerably by age. Only 5.8% of children up to 18 years of age have disabilities, while the rate increases to 13.6% for those 18-44 and continues to rise steadily with age to 84.2% for those 85 and over (6). Similarly, the percentage of those with a severe disability increases steadily with age (6). See Figure 1.

Disability Rates, by Age: 1991-1992

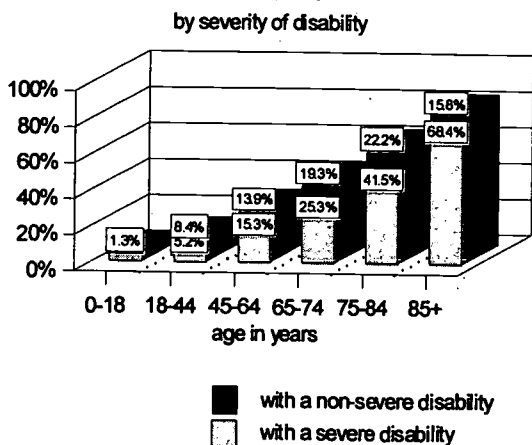

Figure 1

As might be expected with increasing levels of disability, limitations in activities of daily living (ADL's) also increase steadily with age (7). These activities differ with each age group. Similarly, the need for personal assistance with activities of daily living also increases with all age groups, and along with the need for personal assistance, individuals use assistive technology devices more frequently with age. Fully 52% of all assistive technology devices are used by persons 65 and older (3). See Figure 2.

Individuals differ according to age in the nature or type of disabilities most commonly reported, as well. The population of those over 65 share susceptibility to a large number of conditions with the adult population in general, but some

Assistive Technology Usage

Percent distribution of persons using assistive technology devices

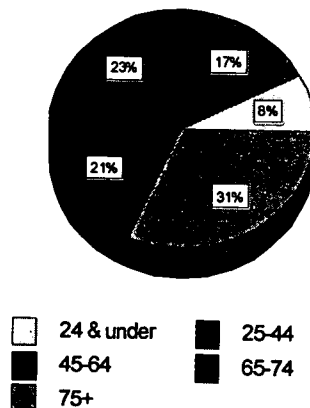

Figure 2

disabilities are more frequently encountered by them than those under 65, such as loss of lower extremities due to amputation, rheumatoid arthritis, and blindness. Thus the nature of the disabilities also changes over the lifespan (4). In short, the prevalence of disabilities, activity limitations, need for assistive technology and personal assistance all increase with age.

Individuals with disabilities have lower incomes and are more likely to be in poverty (5). This disparity of income also reveals itself in the need for assistive devices to compensate for functional limitations. There are a number of persons with unmet needs for assistive technology devices and the single greatest reason that most cannot meet these needs is that they cannot afford it (3). In fact, "cannot afford" was cited as the reason 61.1% of the time, as opposed to 38.9% for all other reasons combined, in a sample of over 2.5 million consumers. However, as poverty does tend to increase with the severity of disability, there are significant differences due to age (see Figure 3).

Those 65 and over are less likely to suffer from low income at all levels of disability. In fact, the highest level of discretionary income in the population of the United States is held by older

Percent with Low Income

by age and disability severity

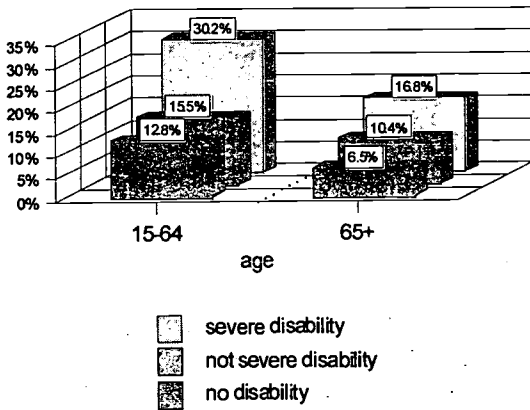

Figure 3

Americans, specifically the highest level of such income is held by those older Americans between the ages of 64 and 69 at \$6,920.00 per year (1). While older Americans are more likely to suffer from disabilities, even multiple ones (5), they also have the greatest amount of discretionary income for the purchase of assistive technology.

DISCUSSION

This study shows that there is an overwhelmingly high correlation between aging and disability, and consequently between aging and functional limitations. The need for assistance in everyday activities rises proportionately with age, as does the demand for assistive technology. Clearly, one important focus in the generation of products and services for people with disabilities is that the "elderly"- often with two or more disabling conditions per person over the age of 65 (8) - cannot be ignored. This need, coupled with the increased discretionary income of those 65 and over, identifies this age group as an important market for assistive technology. A strategy that seeks to place assistive technology in the consumer retail market should have appeal to this market segment for the greatest chance of success.

An important next step is the identification of

particular consumer needs for Americans 65 and over. As mentioned in this study, consumers in this age group experience a large number of disabilities in common with the general adult population, but some are more common or characteristic of their age group. An understanding of these disabilities and their functional limitations could be vital to engineers and designers.

REFERENCES

1. Koncelik, J. "Aging: Marketing Implications" in Disabilities Categories and Marketing Matrix (1997) Atlanta, GA: Center for Rehabilitation Technology
2. Kraus, L., Stoddard, S., & Gilmartin, D. (1996). Chartbook on disability in the United States, 1996 Washington, D.C.: U. S. National Institute on Disability and Rehabilitation Research
3. LaPlante, M., Hendershot, G., & Moss, A. (1992). Advance Data no 217. Assistive technology devices and home accessibility features: Prevalence, payment, need, and trends U. S. Department of Health and Human Services.
4. LaPlante, M., Rice, D., & Kraus, L (1991). Disability Statistics Abstracts, no. 1 San Francisco: U. S. Department of Education
5. McNeil, J. (1993). Americans with Disabilities: 1991-1992 Washington D. C.: U. S. Census Bureau
6. McNeil, J. (1996). Disability Washington, D. C.: U. S. Census Bureau
7. National Health Interview Survey, 1983-1986 (1987). Washington, D. C.: National Center for Health Statistics
8. Trupin, L. & Rice, D. (1995). Disability Statistics Abstract no. 9 San Francisco: U.S. Department of Education

Robert L. Todd
 Center for Rehabilitation Technology
 490 10th Street, NW
 Atlanta, GA 30318
 (800) 726 - 9119/ robert.todd@arch.gatech.edu

The Delivery of Assistive Technology Viewed From the Consumer Perspective: Independent Living Considerations

Laurie Ringaert

Canadian Institute for Barrier Free Design
Faculty of Architecture
University of Manitoba

ABSTRACT

Objective The goal of this study is to describe the experiences of adult consumers with disabilities who receive assistive technology service delivery in Manitoba. The study examines the impact of the delivery of assistive technology on the consumer's ability to live independently in the community. Experiences of persons with disabilities, both with and with little involvement in the Independent Living movement, are explored. Their perceptions of the delivery of the assistive technology including professional, political, and vendor relationships are described.

Method Seventeen adults with a range of disabilities, who were either highly or minimally involved with the Independent Living Movement, participated in tape-recorded semi-structured interviews from November 1994 to February 1995. The respondents were asked what it was like to acquire equipment and about their relationships with professionals and vendors. Data were coded to facilitate analysis using thematic categories including barriers and facilitators influencing access to assistive technology and strategies for overcoming obstacles. A modified critical ethnographic methodology was used.

Results Barriers to getting equipment included its cost, the eligibility requirements, lack of information, lack of choice, complicated bureaucracies, attitudes of professionals and vendors, and the lack of an accessible

environment. To overcome these barriers individuals developed various strategies including: "playing the game", the invention of new assistive technology, peer support, the development of resource networks, and speaking up for what they needed. Participants offered recommendations for improvement in the delivery of assistive technology which include providing consumers with funds to purchase their own assistive technology and maintaining a product display centre. Participants recommended that a government-funded program be maintained, but that a new program incorporate Independent Living principles.

Conclusion The delivery of assistive technology in Manitoba was perceived by participants to offer minimal opportunities for application of basic elements of Independent Living Principles. Both consumers and the researcher recommended changes to improve service delivery and make it more compatible with the Independent Living model of service delivery.

BACKGROUND

The Independent Living Movement is a major social movement, initiated by consumers with disabilities, which seeks opportunities and rights equal to those enjoyed by non-disabled persons. It is seen as a major force in the emancipation of persons with disabilities (Enns, 1986). An important component of living independently with

The Delivery of Assistive Technology Viewed From the Consumer Perspective: Independent Living Considerations

a disability is assistive technology - equipment made for persons with disabilities which enables increased independence in everyday living.

Assistive technology has traditionally been provided at the recommendation of a professional, not at the request of the consumer. Recent societal changes which challenge the current assumptions in the delivery of this equipment include:

- the increased influence of the Independent Living Movement reflected in the demand of consumers for rights and control
- policies and laws that mandate rights for consumers with disabilities.

These changes have occurred during a period of other societal changes such as decreasing health-care resources and a proliferation of assistive-technology vendors. Current changes in societal attitudes brought about by these and other factors force a re-examination of the delivery of these services within the paradigm of the Independent Living Movement. Very little information exists that measures the impact of assistive technology on persons with disabilities. The impact of the current delivery of assistive technology has not been thoroughly examined in the light of these societal changes.

Significance of the Research

Little systematic documentation of the consumer's perspective on the delivery of assistive technology has been found. While some research has been done in the United States, the Canadian system has virtually remained unexamined. It is essential that we begin to study our own system within the context of Canadian culture including our political, legal and health care systems.

This research is of potential interest to a number of groups. Disability consumer groups need to know if services are delivered according to their expectations. Governments, rehabilitation professionals, and vendors are interested in ways of delivering the most cost effective and efficient services. It is hoped that this research will become a step toward enhancing our present delivery of assistive technology.

RESEARCH QUESTION

1. To describe the experiences of urban dwelling adults with disabilities with the delivery of assistive technology service in Manitoba.
2. To identify the barriers and facilitators in the present delivery of assistive technology that inhibit/promote independent living.
3. To describe the extent to which the delivery of assistive technology in Manitoba facilitates achievement of Independent Living principles.
4. To describe the social and political contexts within which the delivery of assistive technology to adults in Manitoba occurs, including organizational and historical perspectives.

METHOD

Seventeen adults with a range of disabilities, who were either highly or minimally involved with the Independent Living Movement, participated in tape-recorded semi-structured interviews from November 1994 to February 1995. The respondents were asked what it was like to acquire equipment and about their relationships with professionals and vendors. Data were coded to facilitate analysis using thematic categories including barriers and facilitators influencing access to assistive technology and strategies for overcoming obstacles. A modified critical ethnographic methodology was used.

RESULTS

Barriers to getting equipment included its cost,

The Delivery of Assistive Technology Viewed From the Consumer Perspective: Independent Living Considerations

the eligibility requirements, lack of information, lack of choice, complicated bureaucracies, attitudes of professionals and vendors, and the lack of an accessible environment. To overcome these barriers individuals developed various strategies including: "playing the game", the invention of new assistive technology, peer support, the development of resource networks, and speaking up for what they needed. Participants offered recommendations for improvement in the delivery of assistive technology which include providing consumers with funds to purchase their own assistive technology and maintaining a product display centre. Participants recommended that a government-funded program be maintained, but that a new program incorporate Independent Living principles.

DISCUSSION

The delivery of assistive technology in Manitoba was perceived by participants to offer minimal opportunities for application of basic elements of Independent Living Principles. Both consumers and the researcher recommended changes to improve service delivery and make it more compatible with the Independent Living model of service delivery.

REFERENCES

Albrecht, G. (1992). The disability business: Rehabilitation in America. Sage Library of Social Research 190. Newbury Park, California: Sage Publications.

Americans with Disabilities Act of 1990 (ADA), PL 101-336. (July 26, 1990). Title 42, U.S.C. 12101 et seq: U.S. Statutes at Large, 104, 327-378.

Brooks, N. (1991). Users' responses to assistive devices for physical disability. Soc. Sci. Med. 32. (12), 1417-1424.

Cook, A. & Hussey, S. (1995). Assistive technologies: Principles and practice.

St. Louis: Mosby.

Cooper, B. A. & Hasselkus, B.R. (1992). Independent living and the physical environment: aspects that matter to residents. Canadian Journal of Occupational Therapy, 59,(1).

Crewe, N. & Zola, I. (1984). Independent living for physically disabled people. San Francisco: Jossey-Bass Inc.

DeJong, G. (1979). Independent living: from social movement to analytic paradigm. Arch Phys Med Rehabil. 60, 435-446.

Enns, H. (1986). An excerpt from the historical development of attitudes towards the handicapped: a framework for change. In

D'Aubin, A. (Ed.) Defining the Parameters of Independent Living. Winnipeg, Man. COPOH.

Gradel, K. (1991). Customer service: What is its place in assistive technology and employment services? The Journal of Vocational Rehabilitation. Spring.

Hahn, H.(1984). Reconceptualizing disability: A political science perspective. Rehabilitation Literature, 45, 362-365.

Law, M. (1991). The environment: a focus for occupational therapy. Canadian Journal of Occupational Therapy, 58.(4), 171-179.

Law, M., Baptiste, S., & Mills J. (1995). Client-centred practise: What does it mean and does it make a difference? Canadian Journal of Occupational Therapy 62,(5): 250-257.

ACKNOWLEDGEMENTS

This research was supported in part by the National Health Research and Development Program through

A National Health Fellowship (6607-1633-47) and the

Canadian Occupational Therapy Foundation

through the Thelma Cardwell Scholarship

CENTER FOR ASSISTIVE AND REHABILITATIVE TECHNOLOGY (CART) NETWORK

Jorge E. Letechipia, MSc.
University of Pittsburgh, SHRS

ABSTRACT

The Pennsylvania Office of Vocational Rehabilitation (OVR) has established the Center for Assistive and Rehabilitative Technology (CART) as the hub of a network of assistive technology providers. This paper describes three distinct AT service delivery models and the elements that were taken into consideration for the design and implementation of the CART Network.

Introduction

The OVR Hiram G. Andrews Center (HGA), an educational and comprehensive rehabilitation facility for persons with disabilities, has established the Center for Assistive and Rehabilitative Technology. CART provides screening, evaluation, equipment procurement, training and follow up in all of the following AT services: positioning and mobility, computer access, environmental control, augmentative communication equipment; home, school and work site modifications; vehicle modifications and driver training, devices for low vision, devices for hearing impaired, orthotic devices, wheelchair repair shop, and the design and fabrication of custom devices.

CART was designed and implemented as the service delivery hub of a network of assistive technology providers (1). The CART Network is presently being implemented. Three distinct service delivery models are being explored as components of the network. This paper describes the criteria that were considered in the design of the network and explains the three service delivery models used to deliver the AT services.

CART Network

Presently, OVR counselors at each District Office interact personally with local service providers (LSP) to arrange for the provision of AT services for their clients. The district counselor is, therefore, responsible for quality

management as well as integration of the AT services, especially when multiple AT services are required. The multiple responsibilities that district counselors presently have, in addition to the non integrated and scarce availability of AT services in some districts, results in a less than ideal situation for the counselors and their clients.

To improve this situation, the CART Network will coordinate the provision of AT services between the LSP and the OVR counselors. In addition, the CART Network will establish a link between each OVR district and the CART program (figure 1). CART will then provide the AT services not available locally or when the available services are not provided in a timely manner and with the required quality.

Implementation of the CART Network

In order to implement the CART Network, three key parameters were identified: (1) The number of AT services that the person requires, (2) the location for the provision of the required services, and (3) the availability of the required AT providers.

1. Required AT Services

For the purpose of the model there are only three distinct client categories.

Single Service - Single Provider (SS-SP)

This classification of clients refers to those needing services in one category of assistive devices, for example a client needing a device to assist him/her with activities of daily living. The recommendation will take place at one location (single provider).

Multiple Service - Single Provider (MS - SP)

This classification applies to clients needing a variety of assistive devices, however, all of the client requirements can be resolved by a single provider.

Multiple Service - Multiple Provider (MS - MP)

This classification applies to clients that require a

CART NETWORK

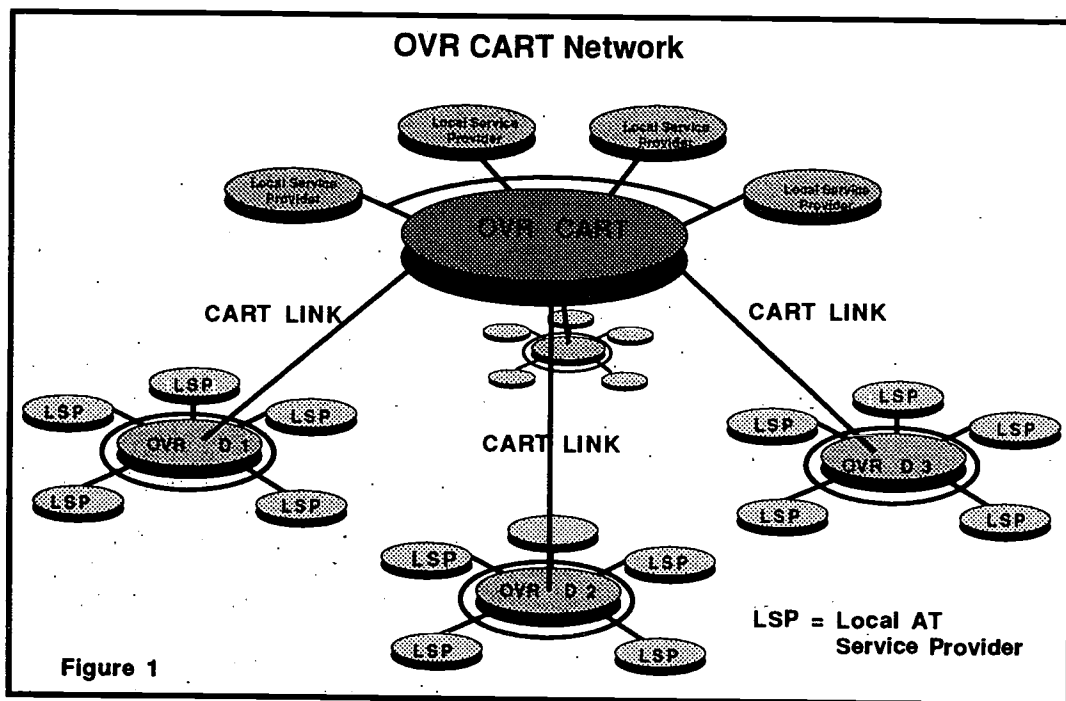

Figure 1

variety of assistive technology services that can only be provided by two or more AT providers.

2. Location for the Provision of the AT Services
For the purpose of this model, two locations were clearly identified, the service delivery provider clinic / demonstration lab and the home, work or school location.

The location where services are provided is important because it requires transportation whether the client travels to a clinical facility or demonstration lab or the AT team travels to the home, school or work-site location.

3. Local Availability of Service Providers

The availability of local service providers affects the timeliness of the provision of services.

These three parameters were considered to determine different service delivery methods of linking each OVR district and its network of LSP with the CART.

Population concentration and its related number of LSP were deemed the most influential factor in the design of the network. The combination of these parameters rendered the need to explore three distinct models of linking OVR districts with the CART.

OVR Districts - CART Links

The three models to be explored were labeled: (a) the Large City Model, (b) Small City Model and (c) Rural Area Model.

(a) Large City Model

This model consists of identifying, within a large city, a LSP that has the required infrastructure to provide, with quality and in a timely manner, the largest number of AT services of a comprehensive service delivery program, as defined by the CART organization (1). This service provider will act as a secondary hub of the CART Network. Services not provided by this secondary hub will be subcontracted with other LSP or with the CART.

(b) Small City Model

This model consists of establishing a representative of the CART at selected small cities. The responsibilities of the CART representative include the coordination and integration of the provision of AT services by LSP's and CART or the secondary hubs and the direct provision of AT services specifically the home, school and work-site assessments. Coordination of LSP will be implemented using

CART NETWORK

the Inter-Agencies Service Delivery Model as proposed by Letechipia, Kolar and Frye (2).

(c) Rural Area Model

Providing comprehensive and cost effective AT services to residents of rural areas is certainly a challenge. Several models of AT delivery are being considered including telerehabilitation, transporting the client to the CART or secondary hub, and transporting the CART team to the client location. Telerehabilitation consists of sending a technical staff member to the client location, while communicating through real time video with the expert teams at the CART or secondary hubs.

Preliminary Results

Several components of the CART Network are fully implemented. CART has provided services to more than 800 clients since it started operations in June of 1996. A large collection of assistive devices for evaluation and demonstration is available for clients.

To test the Large City Model, a program called CART - CAT was established. This program is a joint venture between the CART and the Center for Assistive Technology (CAT) at the University of Pittsburgh Medical Center. CAT acts as a secondary hub. The program has been in operation for 9 months. Preliminary results indicate that the program is mostly used when counselors have clients requiring multiple services-multiple providers.

To assess the Small City Model, a pilot program providing services to two small cities in PA is presently being implemented. Results of this model will be available in 1999.

To implement the Rural Area Model, two pilot programs are being implemented. One, is the use of commercially available videoconferencing equipment to conduct telerehabilitation service delivery. Several commercially available technologies and video links are being evaluated.

The second pilot program consists of assessing the cost of transporting clients to the CART or secondary hubs for AT evaluations vs. transporting the AT team to the client location. Both pilot programs will try to identify

qualifying parameters to assess, prior to conducting the AT evaluation, which method will be the most cost and quality effective.

Discussion

The planning and implementation of the CART Network presents many challenges. AT providers utilize different procedures, evaluation tools, and quality assurance methods. The levels of expertise among providers and OVR counselors varies greatly. However, the goal to provide personalized and comprehensive services to all residents of Pennsylvania remains a priority of the CART program.

The three models being assessed will provide a tiered approach to the delivery of AT services. This approach has the potential to deliver individualized, comprehensive AT services in the most cost and quality efficient manner.

Preliminary information on the Small City and Rural Area Models will be available within one to two years. It is expected that the proposed CART Network will be completed in five to six years. The proposed model is still in its early stages of implementation and therefore, many modifications are expected to occur. Besides selecting the best methods to deliver AT services, the CART Network will improve significantly the availability of comprehensive AT services throughout Pennsylvania.

Acknowledgments

This work was sponsored by a service contract with the Hiram G. Andrews Center, and the Pennsylvania Office of Vocational Rehabilitation.

REFERENCES

1. J.E. Letechipia, T. Pelleschi, Implementation of a Comprehensive Assistive Technology Service Delivery Program as a Hub of a Regional Network of AT Services, RESNA 96 Proceedings, June 1996
2. J.E. Letechipia, K.A. Kolar, Inter-Agencies Service Delivery Model, RESNA 95 Proceedings, June 1995

SIG-02
Personal Transportation

TESTING AND EVALUATION OF WHEELCHAIR CASTER ASSEMBLIES SUBJECTED TO DYNAMIC CRASH LOADING

Gina Bertocci¹, Joseph Esteireiro², Cherian Thomas², Therese Young¹

¹University of Pittsburgh; Department of Rehabilitation Science and Technology

²Q'Straint

ABSTRACT

Safe transportation is critical to the integration of wheelchair users into society. Many wheelchair users are required to travel while seated in their wheelchairs. Transportation conditions call for more stringent wheelchair design criteria since crash loads are dynamically applied and exceed loads encountered during normal mobility. This study utilized dynamic drop testing to evaluate the crash integrity of common wheelchair caster assemblies. Results suggest that current caster assembly designs may not be able to withstand forces associated with a crash. Five of seven evaluated caster assemblies failed when loaded to 1800 lb, or less. Wheelchair manufacturers intending to market wheelchairs as suitable for transportation should closely evaluate caster assembly strength to assure crashworthiness.

BACKGROUND

Motor vehicle seat designs incorporate many features which serve to protect their occupant in a crash. However, many wheelchair users are unable to transfer to a vehicle seat, and are thus unable to take advantage of vehicle seat safety features which provide adequate crash protection. Instead, wheelchair users are often forced to rely upon their wheelchair, which was most likely not intended to function as a vehicle seat.

Key to occupant crash protection is structural integrity of the seat. That is, the seating system must provide adequate support to the occupant and not undergo catastrophic failure in a crash. When using a wheelchair as a vehicle seat, the wheelchair seat, seat back, wheels, and other structural components must be capable of withstanding dynamically applied crash level forces. With rear securement points located below the wheelchair center of gravity, wheelchairs have been shown to rotate forward applying large loads to caster wheels and forks in frontal crashes[2]. Common caster assemblies may not have strength capabilities to withstand

these crash conditions. Caster system failure, through fracture or severe bending, can result in excessive occupant excursion, increasing the risk of occupant injury. Therefore, proper caster design is critical when using wheelchairs as motor vehicles seats.

RESEARCH QUESTION

The purpose of this study was to develop and use an appropriate component test to evaluate the crash integrity of common wheelchair caster assemblies.

METHOD

Using a dynamic drop tester, six commonly used caster assemblies were evaluated under dynamic loading. Table 1 describes the caster assemblies tested. As shown in Figure 1, a test fixture was designed to apply loading vertically upward on the caster, simulating the caster wheel being driven downward into the vehicle floor in a crash. As weights were dropped from a predetermined height, a connecting cable pulled upward driving the false floor of the test fixture into the bottom of the caster wheel. A load cell mounted in-line with the cable measured the applied force. A data acquisition system was used to record load history during the event.

Table 1 Tested Caster Assembly Details

Test #	Wheel	Caster Fork
A5a & b	5" Hrd Rubber, Plastic Hub	Cast Aluminum
B2	6" Pneumatic, Plastic Hub	Cast Aluminum
C4	5" Hrd Rubber, Plastic Hub	Stamped Steel
D8	8" Pneumatic, Plastic Hub	Cast Aluminum
D7 & D7a	8" Pneumatic, Plastic Hub	Cast Aluminum

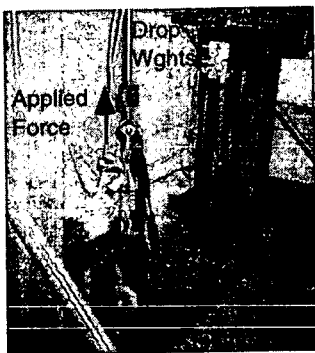

Figure 1 Dynamic Drop Tester and Caster Test Fixture

To simulate crash loading conditions, both the magnitude of force and the loading rate should be approximated. Previously conducted sled tests and computer simulation were consulted to obtain this information [1,2]. Computer simulations show that caster loading is dependent upon location of rear tiedown attachment to the wheelchair. As the rear securement point is moved below the wheelchair center of gravity, the wheelchair will tend to rotate forward in a frontal crash leading to increased front wheel loading. Table 2 shows the range of caster loads and the rate of loading for both computer simulations and sled tests which subject the occupied wheelchair to a 20g/30mph frontal crash. In all cases wheelchair weight was 187 lb and the anthropomorphic test device weight was 168 lb. Based upon these findings, dynamic drop testing goals were to apply a 1500 lb vertical load at a rate equal to or less than that seen in sled testing or simulations.

Table 2 Target Loading Conditions

Source	Front Wheel Load Range	Front Wheel Rate of Loading Range
Sled Tests[1]	864-1772 lb	15-59 lb/msec
Computer Simulations[2]	120-1818 lb	25-30 lb/msec

RESULTS

Table 3 provides the results of caster testing using the dynamic drop tester and the maximum applied load. Four of the seven caster assemblies tested failed at less than 1500 lb loading. An additional failure (Test D7a) occurred at 1715 lb.

Table 3 Caster Assembly Test Results

Test #	Test Results	Maximum Applied Force
A5a	No Failure	1089 lb
A5b	No Failure; Mounting Bolt Bending	1110 lb
B2	Failed; Fractured Wheel Hub	1473 lb
C4	Failed; Severe Caster Fork Bending	1070 lb
D8	Failed; Fractured Fork Mounting Post	1436 lb
D7	Failed; Fractured Caster Fork	1098 lb
D7a	Failed; Sheared Fork Mountg Screws	1715 lb

As indicated, failure modes include fracture of wheel hubs and caster forks, extreme bending of caster forks, and shearing of mounting hardware. Figure 2 shows the results of a 1473 lb load applied in Test B2 before removing the caster assembly from the test fixture. In this test, the plastic wheel hub fractured. Figure 3 shows a selection of failed caster wheels and forks.

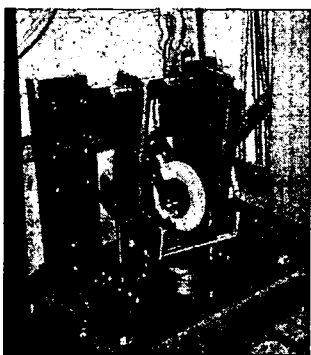

Figure 2 Test B2 Fractured Wheel Hub

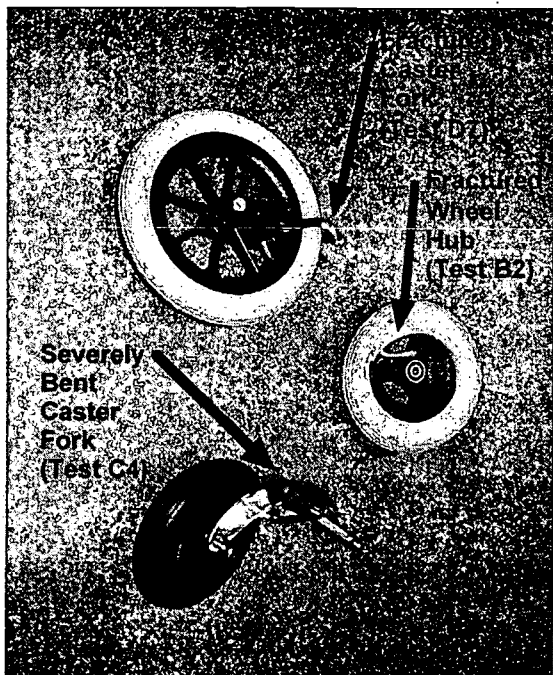

Figure 3 Select Caster Assembly Failures

DISCUSSION

Study test results suggest that current wheelchair caster assemblies may not be capable of withstanding forces associated with a 20g/30mph frontal crash without failure. Computer simulations and sled tests indicate caster crash loads can be as high as 1800 lb, while drop testing produced failures at, or less than this level of loading. Such failures can produce occupant submarining, or excessive occupant excursions leading to secondary impact

with the vehicle interior. Both conditions increase the risk of occupant injury.

Factors such as wheelchair and occupant weight, rear securement location and crash severity can influence loads applied to casters. Rear securement point location can be used as a strategy to reduce forward wheelchair rotation in a frontal crash, thereby reducing caster loads[2].

Wheelchair manufacturers must be aware of the increased loading placed on wheelchair components in a crash and must modify design criteria accordingly. Dynamic drop testing can serve as a valuable and cost effective tool in the preliminary evaluation of wheelchair component crash integrity. Drop testing is flexible in that loading levels and rates can be adjusted to match those found in sled impact testing. However, complete assembled wheelchairs intended for transport should be sled tested following the ANSI/RESNA WC-19 frontal crash test protocol[3].

REFERENCES

1. ANSI/RESNA Subcommittee of Wheelchairs and Transportation, (1996). Seating Insert Eval Sled Tests, University of Va. Auto Safety Lab.
2. Bertocci GE, Hobson DA, Digges, KH, (1996). Development of Transportable Wheelchair Design Criteria Using Computer Crash Simulation. *IEEE Trans on Rehab Engr*, 4, 171-181.
3. ANSI/RESNA Subcommittee of Wheelchairs and Transportation, (Dec, 1997). WC-19 Wheelchairs Used as Seats in Motor Vehicles.

ACKNOWLEDGMENTS

The authors wish to thank Q'Straint for the use of their testing facility and equipment, and the VA Pittsburgh Healthcare System - HERL for caster donations. This work was supported by NIDRR Grant H133E30005, RERC on Wheeled Mobility. The opinions expressed herein are those of the authors and do not necessarily reflect the views of NIDRR.

Gina E. Bertocci, PhD
 University of Pittsburgh
 5039 Forbes Tower
 Pittsburgh, PA. 15260

STATUS OF UNIVERSAL INTERFACE DESIGN STANDARD FOR MOBILITY DEVICE DOCKING ON VEHICLES

Patricia Karg, Gina Bertocci, Douglas Hobson
Department of Rehabilitation Science and Technology
University of Pittsburgh
Pittsburgh, Pennsylvania, U.S.A.

ABSTRACT

There has been work ongoing to develop a universal interface design standard to foster compatibility between wheeled mobility devices and the securement systems available on transport vehicles. Some of the results of this work have been reported in previous proceedings, as discussed below. This paper is an update on the state of this effort and primarily reports the work done to evaluate the potential designs for compatibility and dynamic strength, and the status of the development of the design standard.

BACKGROUND

Work has been ongoing in an effort to facilitate the development and adoption of a universal interface design standard among involved industries. The intent is to standardize the geometry and location of the hardware available on the wheeled mobility device (WMD) to connect to docking-type securement devices. This will allow industry to design and produce docking devices that are universally compatible.

The concept of the universal interface was presented in the 1995 RESNA Proceedings [1]. Previous activities were then reported in last year's proceedings [2]. These included surveying and categorizing WMD frames for commonalities [3]. This was used to identify the optimal location for placement of the hardware, as well as the necessary clear zones. Information was gathered on the state of securement technology. Industry meetings and consumer focus groups were organized and hosted to confirm the need for such a solution and identify and rank design specifications for it. The resulting design criteria were reported [2]. The design criteria were used to implement the Quality Function Deployment (QFD) design process. Finally, several hardware designs were developed and some fabricated for consideration and evaluation. Industry and consumer

representatives indicated they would like the feasibility of the designs evaluated before the standard was created and subsequent work has been performed to this end.

STATEMENT OF THE PROBLEM

Current securement of riders seated in their WMDs is often inadequately applied, time consuming, and requires an attendant. A universal solution is needed that provides independent, quick, and safe securement.

RATIONALE

WMDs, their securement devices, occupant restraints and transport vehicles all need to function as a system if individuals are to safely and independently use both public and personal vehicles while remaining seated in their WMDs. Improving accessibility and safety relies upon standardized methods being developed and adopted for interconnecting the respective technologies. The successful development of new docking-type securement devices, that eliminate several of the disadvantages of commonly used belt-type devices, depends upon standardized ways of interconnecting the WMD with vehicle-mounted securement hardware. The adoption and promulgation of a universal interface hardware design standard for docking devices can ultimately mean that a person can access and have their WMD secured in any transport vehicle, in a manner offering equivalent safety to that of any other rider seated on the vehicle.

DESIGN AND DEVELOPMENT

The design standard will provide the basis by which all involved industries can design and produce compatible WMD securement products. Design of the docking devices will be limited only in that the WMD hardware (i.e., the universal interface) geometry, location in space, and surrounding clearance will be defined. The industry meetings have centered around the debate of two configurations of an interface located on the

DOCKING UNIVERSAL INTERFACE

lower rear portion of the WMD. One configuration, that was favored after the second industry meeting, is two vertically oriented structures, aligned side by side (e.g., two D-rings). However, the discussions in the third meeting (June 1997) tended to return to the appealing approach of having a horizontal bar across the rear, similar to the grab bars offered on several scooters. Evaluations of these two configurations revealed several pros and cons of each (details below). The horizontal bar proved better for ease of retrofit of existing WMDs, however does not provide a reaction point to prevent WMD rotation during a crash. Thus, two horizontal bars may be necessary. The action plan from the third meeting included further investigation of the horizontal bar with respect to reaction points. The vertical configuration would allow for the needed stability, however looks to be more difficult to retrofit and integrate into existing WMD designs. As a result of additional investigation, a hybrid interface has been proposed (Figure 1), which combines the vertical and horizontal concepts. Clear zone requirements with respect to the WMD to allow access to interface hardware have been established.

EVALUATION

Compatibility testing: Field tests were performed by our team to evaluate the compatibility of the vertical and horizontal design configurations with existing production WMDs to assess the ease of retrofit, as well as the ease of incorporation in future designs. Approximately a dozen WMDs representing the different classes, including pediatric wheelchairs, were evaluated. In general, the horizontal interface was more readily accommodated by the WMDs surveyed. However, in some cases, overall WMD length was increased, which is undesirable. The problems generally found with the vertical configuration were battery box interference in placement, inadequate distance between the battery box and wheel for access of the interface. In addition, due to the various WMD widths, thus dictating various spacing of the vertical interface components, more demands are placed on the docking system.

Dynamic testing: The vertical interface design was dynamically tested for strength using a drop test jig to simulate dynamic conditions for a 20 g crash with a 200-220 lb WMD and a 50% male occupant. The load was applied perpendicular to the 3/4" solid aluminum tubing making up the vertical interface component. With successive testing at these loads slight deformation occurred.

Reaction point analysis: Since the primary concern with using a rear-only securement was WMD rotation, crash simulations were performed to analyze various interface configurations. The simulations represented a surrogate wheelchair used in sled testing of securement systems. The surrogate was designed to represent a standard power wheelchair and contained a 50% male occupant wearing an integrated restraint. The simulations were not validated with sled testing, but can be used for comparative purposes. Front wheel excursions at time of 250 msec during the rebound phase of a frontal crash were used to characterize the crash response of the wheelchair. Initially a 1" diameter horizontal bar was placed 11" above the floor (at the center of gravity of the wheelchair) and had an excursion of 6.9". Then two horizontal circular bars were tested separated by 5" and 2" and had excursions of 3.5" and 3.9", respectively. The results show that a double horizontal bar would be justified in this case. The analysis emphasizes the need for a reaction point to prevent excessive WMD rotation when securing the WMD at the rear only.

DISCUSSION

Based on the information and research to date, the group at the June 1997 industry meeting discussed the relative merits of the vertical versus the horizontal interface configurations. The vertical configuration had been chosen as the most promising in previous meetings. In light of the new data, the group decided the horizontal configuration looked promising as well and that it should be further researched by our team, especially with respect to stability and WMD rotation. Our followup analysis emphasizes the need for a reaction point to prevent WMD rotation when securing

DOCKING UNIVERSAL INTERFACE

the WMD only at the rear. Although the two horizontal bars satisfy this need, we are proposing a "hybrid" interface which is a combination of the vertical and horizontal concepts. This hybrid interface provides the advantages of both concepts, along with providing critical anti-rotational reaction points. This approach has an advantage over the double horizontal bar approach by reducing the level of complexity of docking system-to-interface engagement. Additionally, the hybrid interface promotes docking system centering on the WMD.

We have conducted preliminary simulations and are planning a series of tests to evaluate the hybrid interface concept, including its ability to control WMD rotation. Testing will consist of both static evaluation and mounting the interface on a surrogate wheelchair for sled testing. Further information will be made available as it is completed. Proposed dimensions are intended to be WMD compatibility, and are based upon previous surveys and data analysis across varying WMD types. In addition, development and fabrication of a docking concept that will successfully mate with the hardware and provide adequate response in driving and crash situations is ongoing.

Another result of the 1997 industry meeting was the action plan for the industry standard. It was decided to proceed with the preparation and submission of a formal request to the RESNA/ANSI Technical Guidelines Committee to initiate a new standards work item on the Universal Interface for Wheelchair Docking Securement (UIWDS). This process has been initiated and a draft standard has been compiled. The participants felt that this would bring more groups with a vested interest to the discussion table.

REFERENCES

- [1] Karg PE, Bertocci GE, Hobson DA. Universal interface hardware design standard for mobility device transport docking systems. Proceedings of the RESNA '97 Annual Conference, RESNA Press, Washington DC, 1997: 29-31.
- [2] Hobson DA, Securement of Wheelchairs

in Motor Vehicles. Proceedings of the RESNA '95 Annual Conference, RESNA Press, Washington DC, May 1995.

[3] Bertocci GE, Karg PE, Hobson DA, Wheeled Mobility Device Classification System and Database, Technical Report #6, University of Pittsburgh RERC on Wheelchair Mobility, Pittsburgh, PA 1996.

ACKNOWLEDGEMENTS

This work was supported by Grant No. H133E30005 by the National Institute of Disability and Rehabilitation Research (NIDRR). Opinions expressed are those of the authors and should not be construed to represent opinions or policies of NIDRR.

Patricia E. Karg, MS (tkarg+@pitt.edu)
University of Pittsburgh
Forbes Tower, Suite 5044
Pittsburgh, PA 15260
412-647-1286; 412-647-1277 (fax)

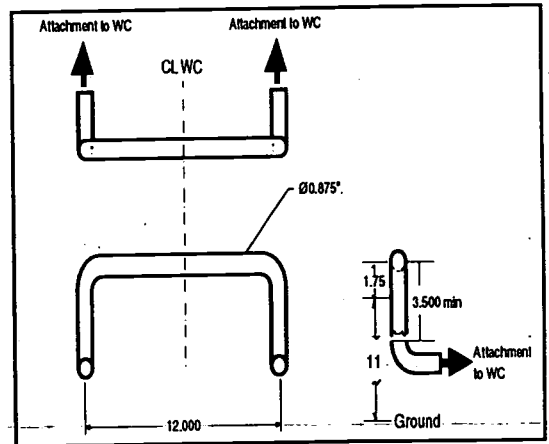

Fig. 1 Proposed hybrid interface

BELT FIT EVALUATION OF FIXED VEHICLE-MOUNTED SHOULDER RESTRAINT ANCHOR ACROSS MIXED OCCUPANT POPULATIONS

Linda van Roosmalen, M.S., Gina E. Bertocci, Ph.D.,
Patricia Karg, M.S., Therese Young, M.S.
Department of Rehabilitation Science and Technology
University of Pittsburgh, Pittsburgh, PA

ABSTRACT

Occupant restraints, including shoulder and lap belts, are necessary to protect wheelchair occupants during motor vehicle transportation. It has been shown that proper belt fit is needed for effective occupant protection. In many cases, shoulder belt restraint systems incorporate a fixed vehicle-mounted anchor. The anchor is installed based upon a 50th percentile (P50) male occupant. This study evaluates the influence of fixed shoulder belt anchor location on the belt fit of a 5th percentile (P5) female and a 6 year old occupant. Belt fit is assessed using anchor guidance from SAE J2249 and WTORS manufacturers instructions, as well as accounting for physical vehicle constraints. This study found that anchor configuration can lead to poor belt fit and compromised crash protection in smaller occupants.

BACKGROUND

Wheelchair tiedowns and occupant restraint systems (WTORS) used in public transit are typically equipped with both lap and shoulder belts. Lap belts are available in both vehicle anchored and tiedown anchored systems. Currently, shoulder belt systems are available only with vehicle mounted upper anchor points. This can present a problem in those commonly used systems which employ a fixed anchor point since vehicles typically transport a mixed occupant population. Despite the availability of SAE J2249 WTORS guidance for varying occupant populations, installation of a fixed shoulder belt anchor requires installers to select a single location which is likely suitable for a select occupant population [1]. Often anchorage recommendation and placement are based upon a P50 male occupant. Smaller occupants, such as a P5 female and a 6 year old, attempting to utilize a shoulder belt installed based upon a P50 male occupant, can lead to poor belt fit. Wheelchair users have the added disadvantage that seat height relative to anchor height also varies across occupant populations, whereas non-disabled

travelers using OEM vehicle seats typically have a fixed seat height.

It has been shown in both non-disabled and wheelchair transportation that shoulder belt fit influences the effectiveness of occupant crash protection [3,4]. Shoulder belts which pass the torso close to the neck will reduce occupant forward excursions in a frontal crash, but will also increase risk of neck injury. Conversely, shoulder belts crossing the torso outboard of the occupant shoulder will allow the shoulder/torso to rotate free of the belt, leading to increased forward excursions in a frontal crash and risk of internal injury caused by belt loading of soft tissues.

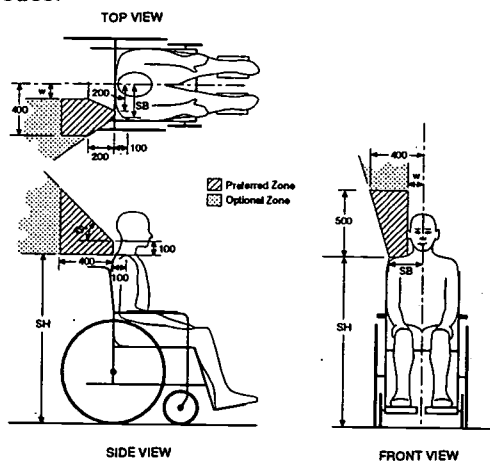

Figure 1: SAE J2249 Preferred and optional zones for upper vehicle anchor point of shoulder restraint [1].

RESEARCH QUESTION

Is it possible to obtain an acceptable shoulder belt fit in P5 women and 6 year old occupant populations when using a fixed upper anchor point installed following SAE installation guidelines and WTORS manufacturer installation instructions? Also, how do physical vehicle constraints, i.e. windows, influence shoulder belt anchor location and belt fit in the same occupant populations?

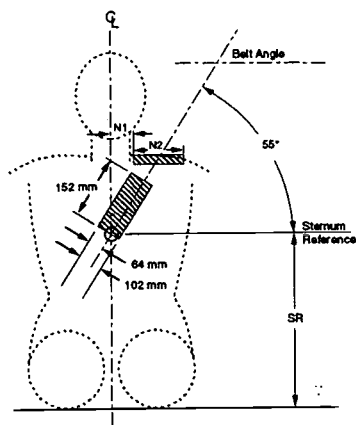

Figure 2: Preferred zones for location of shoulder belt on occupant's torso [1,2].

Occupant Size	N1(mm)	N2(mm)	SR(mm)
6-year old	52	91	273
small female P5	66	109	353
midsize male P50	76	127	406

Table 1: Recommended Belt-Fit Values for Fig. 2 [1,2]

METHOD

To analyze shoulder belt fit, a mock-up of a wheelchair securement station was employed (Figure 3). The station was installed according to WTORS manufacturers instructions [4], using four point wheelchair tiedowns and a vehicle mounted occupant restraint system. The laboratory mock-up allowed for adjustment of upper shoulder belt anchor point to evaluate the effects of various anchor positions on belt fit.

Two test subjects having upper torso measurements consistent with the P5 and 6 year old populations, were seated in appropriately sized wheelchairs. (P5 female wheelchair seat height of 508 mm., 6 year old wheelchair seat height of 419 mm.) The occupied wheelchair was centered in the transverse plane with the centerline 305 mm from the shoulder belt anchor point. It was also positioned in the longitudinal plane: centered in the station, forward so as to minimize front tiedown strap length, and rearward so as to minimize rear tiedown strap length. In each of the three wheelchair positions, shoulder belt fit was assessed using shoulder belt anchor locations described in Table 2, aligned longitudinally with the rear floor tiedown anchors. Shoulder belt anchor locations no. 1 and 4 were selected for evaluation based upon avoiding vehicle constraints. Shoulder belt anchor location no. 2 represents both, Q'Straint manufacturers instructions and the upper

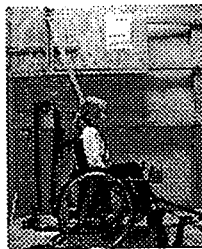

Figure 3: Laboratory Test Setup with Wheelchair Tiedown and Occupant Restraint System

Shoulder Belt Location	Anchor Location Basis
1	Below transit bus window 914mm above floor
2	Q'Straint instructions & SAE J2249 Lowest Anchor Point for P50 Male 1194mm above floor [4,1]
3	SAE J2249 Highest Anchor Point for P50 Male 1600mm above floor [1]
4	Above transit bus window 1702mm above floor

Table 2: Evaluated Shoulder Belt Anchor Locations [3]

limit of the SAE recommended zone [4,1]. Anchor location no. 3 represents the lower limit of the same SAE recommended zone [1]. Fit analysis consisted of measuring upper torso frontal plane belt angle at the sternum reference plane as shown in Figure 2 and the distance from the belt to the medial plane of the neck. Belt angles were measured using an inclinometer.

RESULTS

Figure 3 provides an example of the belt fit analysis using shoulder belt anchor location no. 3 for both the P5 female and 6 year old occupants. Shoulder belt fit measures are presented in Figures 4 and 5 for each of the evaluated anchor locations with the various wheelchair positions (rear, center, forward). Both figures compare measured values to optimum FMVSS/SAE values. As shown in Figures 4 and 5, the P5 female occupant using the lowest (914mm height; below bus window) anchor scenario results in the greatest deviation from FMVSS/SAE recommended zones. The shoulder belt crosses the torso at a shallow angle (25-32 deg) allowing the shoulder to rotate free of the belt.

The FMVSS/SAE optimum angle ranges between fifty and sixty degrees. Steep belt torso angles result when shoulder belt anchors are placed in locations no. 3 (upper SAE limit) and 4 (above bus window). As shown in Figure 3 the belt passes over the neck, instead of the shoulder, of both the P5 female and 6 year old occupants.

DISCUSSION

This study shows that less than optimal shoulder belt fit results when P5 female and 6 year old occupants are required to use fixed anchored systems based upon the P50 male population. Vehicle constraints, such as inadequate structure,

can also lead to anchor locations which produce poor belt fit.



Figure 3: Belt fit using shoulder belt anchor location no. 3 for P5 female and 6 year old child

To provide effective occupant protection across a mixed wheelchair occupant population, solutions other than fixed anchor systems must be developed. Alternative designs should consider adjustable vehicle mounted anchors and/or ideally, a wheelchair integrated shoulder belt system. Such integrated systems have been shown in automobile seats to be superior in their crash protection [5]. Another advantage of wheelchair integrated belt systems is the reduced time to restrain a wheelchair occupant in a vehicle.

REFERENCES

- [1]SAE. SAE J2249, WTORS for Use in Motor Vehicles, September 1997
- [2] NHTSA, (1992). Occupant crash Protection, Federal Reg, Vol 57, No 104, 22689-22695.
- [3] Bertocci, G, Digges, K, Hobson, D, (1996). Shoulder Belt Anchor Location Influences on Wheelchair Occupant Crash Protection, *Jof Rehab R&D*, Vol 33 No.3, July 1996
- [3] Ziegler, P, (1982). Relationship Between Shoulder Belt Fit and Occupant Protection, *AAAM Proceedings*.
- [4] Q'Straint Installation Manual
- [5] Ruter, G, Hontschik, H (1979). Protection of Occupants by Integrated Seat/Belt Systems, SAE Paper No. 791002.

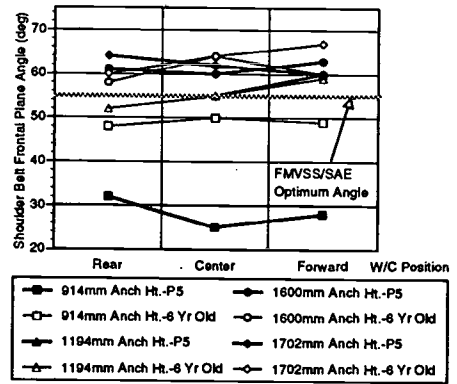
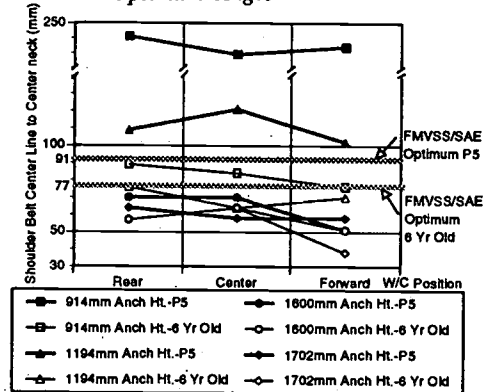

Figure 4: Shoulder Belt Frontal Plane Torso Angle for P5 Female and 6 Year Old Occupants compared to FMVSS/SAE Optimum Angle



Note: Optimum values are 'N1' (Fig 2) + 1/2 belt width for consistency with measured values.

Figure 5: Shoulder Belt Position Relative to Neck for P5 Female and 6 year Old Occupants compared to FMVSS/SAE Optimum Positions

ACKNOWLEDGMENTS

The authors wish to thank Rehab Dimensions for the use of wheelchairs and the Pittsburgh Port Authority Transit for the use of their vehicles. This work was supported by NIDRR Grant H133E30005, RERC on Wheeled Mobility, and NIH STTR Grant HD34976. The opinions expressed herein are those of the authors and do not necessarily reflect the views of the funding agencies.

Linda van Roosmalen M.S
 University of Pittsburgh
 5039 Forbes Tower
 Pittsburgh, PA 15260

SIG-03
Augmentative & Alternative Communication

STRATEGIES FOR PROMOTING VOCAL DEVELOPMENT IN YOUNG CHILDREN RELYING ON AAC: THREE CASE ILLUSTRATIONS

Cynthia J. Cress, Ph.D., CCC-SLP, Laura Ball, M.S., CCC-SLP
University of Nebraska-Lincoln, Lincoln, NE USA

ABSTRACT

This paper describes some strategies for promoting vocalizations in young nonspeaking children, with three case examples illustrating different vocal objectives. Target skills included frequency of vocal initiation, diversity of vocal output, and association of specific vocalizations with related activities and messages. Each of the children were participating in a longitudinal study of language development of children with physical impairments, which began when these children were under two years of age. While these illustrations cannot demonstrate the long-term efficacy of these vocal strategies, due to limited sample sizes, this paper documents the clinical application of vocal strategies in AAC for children with physical impairments who are too young for traditional didactic intervention.

BACKGROUND

Early communication involves behaviors such as facial expression, gestures, and vocalizations, which are usually interpreted as meaningful by adult interactants (Wilcox, Bacon, & Shannon, 1985). Labelling children as "nonspeaking" does not indicate that they cannot use speech for any type of communication during this early stage of development. However, children who are having difficulty controlling the muscles involved in the speech/respiratory process, or who have other neurological or cognitive limitations that affect speech and language, are at risk for developing independently intelligible speech. Indicators of concern for vocal speech development include: neuromotor difficulties, delayed onset of vocalization, feeding difficulties or persistent oral/motor control problems, and birth or developmental conditions associated with ongoing difficulties in vocal development (MacDonald, 1980).

Multimodal AAC intervention should incorporate strategies for promoting children's deliberate control and variation of vocalization. Even children with limited sound repertoires tend to use those sounds for specific purposes such as attention or emotional signals, and parents of nonspeaking children can discriminate between different types of vocalizations produced by their child. Typical strategies for improving intelligibility in school-aged children and adults using AAC presume a level of compliance with didactic instruction that is inappropriate for preschool children and infants (e.g. Dowden, 1997). Other published strategies addressing vocalization in infants (e.g. Casey-Harvey, 1995) do not tend to account for differences in motor and interaction characteristics typical of children with physical impairments. For instance, Cress (1998) reported that young children with physical impairments are less likely to imitate parental gestures and behaviors than expected, even for behaviors the children initiate spontaneously in other circumstances. With less imitation, parents of nonspeaking children have fewer opportunities for prompting vocal imitation that is a common strategy for vocal intervention with typically developing children. This paper illustrates clinical application of vocal intervention for three young children with physical impairments.

CASE DESCRIPTIONS

The children described in these case examples were identified to be at risk for vocal speech development due to physical disabilities. All of the children participated in a longitudinal study of language and symbolic development in children under 2 years of age conducted by the first author. Vocal strategies were included in trial therapy as part of this ongoing study.

Case Description: ZC

ZC is a 22-month-old boy with cerebral palsy. He sits without support, can pull himself to stand with support, and uses his hands to grab and hold objects. His fine motor and balance skills are poor, and age equivalence (a.e.) scores on the Battelle Developmental Inventory (BDI) are 7 mo. for fine and gross motor skills. Relative strengths are in cognition and receptive language development, both of which are at 15 mo. a.e. Expressive language is at 12 mo. a.e., with particular difficulty in vocal output. ZC produces 2-3 distinct vowel sounds and 4-5 consonant sounds, but does not combine consonants and vowels and babbles only infrequently. Parents report that he seems to have difficulty vocalizing when he wants to, and that they rarely elicit vocalizations from ZC when playing sound games. Goals for ZC included increasing frequency of vocalization during activities.

Case Description: OA

OA is a 21-month-old boy (corrected age) with a history of prematurity and cerebral palsy. He does not sit without support, has a weak palmar grasp with both hands, and his fine and gross motor skills are at 5 mo. a.e. on the BDI. Cognitive and communication skills are both at 10 mo. a.e. overall; expressive communication is slightly ahead of receptive skills at 12 mo. a.e. This is attributed to emphasis on frequent vocal play by parents. OA has 3-4 distinct vowel sounds and 7-8 consonant sounds that he combines with open vowels. OA uses an open vowel for attention and functional play, but will actively attend to vocal imitation play with parents. Goals include taking advantage of imitation play to increase the frequency and diversity of his vocalizations within activities.

Case Description: MB

MB is a 20-month-old girl with a history of hydrocephalus and spina bifida with Arnold Chiari malformation. Her social, fine motor, and receptive communication scores on the BDI are at age expectations, and cognitive and

expressive scores are at 14 mo. a.e. She sits alone, does not stand without support, and has a slow pincer grasp. She frequently babbles during play using vowels with intonation contours, but rarely incorporates her 4-5 consonants into vocal play. Her functional vocalizations for attention or requests are almost exclusively vowels. Goals for MB include using vocalizations to represent meanings within a variety of activities.

OBJECTIVE

The objective of these case illustrations was to demonstrate clinical application of strategies for promoting vocal development in young children with physical impairments.

METHOD/APPROACH

All of the children received consultation in language and AAC from the first author every three months for 2-4 hours per visit. Parents and school staff were provided modelling, trial therapy, recommendations, and materials reinforcing communication goals. Part of the ongoing consultation in the study included modelling for each child's vocal goals and general guidelines for supporting vocalization. All families received coaching in general vocal support listed below. In addition, each family received specific guidance in one of the following three areas for their child's goals:

General Vocal Support:

- positioning for trunk and head control
- breath support (e.g. blowing, towel rolls)
- reducing other distractions or discomforts
- desensitization and stimulation of oral structures e.g. "toothettes" to brush mouth

1. Produce sounds more often within activities

- pair vocalizing with child in motion, esp. sensory integration activities (rolling, etc)
- provide lots of modelling at or just above child's sound ability
- give tactile responses when children vocalize
- give children a variety of ways to participate in activities if they can't vocalize right away

2. Increase variability of children's sounds

- imitate child's sounds after they make them
- look for continuation of sound and turntaking by child, often in the context of activities
- gradually introduce variation of sound, often paired with different motion or activity
- give lots of feedback to child when they use different sounds, try to repeat circumstances

3. Associate vocalizations with meanings

- pair achievable sounds with activity, but place low stress on child production at first
- provide tactile, social cues for sound (e.g. phone, microphone/tape, social routines)
- include activities where sounds are natural (songs, books with repeated lines, rhymes)
- provide functional feedback within activity related to children's vocalizations

RESULTS/DISCUSSION

For more frequent vocalizations, ZC's family developed several new vocal routines with movement. For instance, adults would roll ZC, making one of his achievable sounds with each roll. After several repetitions, adults would pause or slowly initiate the roll without sound to encourage ZC to vocalize. Also, adults modelled one of ZC's sounds with a typical play movement with a toy. For instance, as ZC bounced a toy animal, adults would imitate that action and add a sound. Adults paused to encourage turntaking and changed the modelled sound if ZC changed movement. ZC tended to vocalize frequently within these activities and more promptly initiated vocalization during pauses. After six months of consultation, ZC added one new sound, and often began spontaneously babbling and coordinating his vocalizations with functional interaction.

Since OA's parents already provided frequent vocal modelling in a wide variety of activities, consultation addressed OA's productive sound repertoire in imitation. His parents began to help OA focus his attention on vocal play by full-face contact and reducing distractions. They were encouraged to begin this play when OA spontaneously vocalized, and start

turntaking with his sounds before introducing new ones. New strategies for giving feedback included socially and tactily reinforcing new sounds and responding to his imitation of modelled sounds before shifting to new ones. After three months, OA attended closely to parent models, and he began to orally posture sounds and attempt to change vocalization with parent models by six months.

Easily implemented vocal routines for MB included adding sounds to her gestural routines like bye-bye and telephone play. For other activities like requests or comments, parents were encouraged to reduce modelled sounds to single CV's, like /mu/ for more or /ba/ for ball. Other songs and routines were adapted to give MB an achievable sound role within the game. After 6 months, MB's expressive vocabulary was 15 CV words, which she had already begun to combine into two-word utterances.

REFERENCES

- Casey-Harvey, DG (1995). *Early Communication Games: Routine-Based Play for the First Two Years*. San Antonio, TX: Communication Skill Builders.
- Cress, CJ, Andrews, TA, & Reynolds, CD (1998). Gestural imitation and contingent parent responses in nonspeaking children with physical impairments. XIth International Conference on Infant Studies, Atlanta, GA.
- Dowden, PA (1997). Augmentative and alternative communication decision making for children with severely unintelligible speech. *Augmentative and Alternative Communication*, 13 (1), 48-58.
- MacDonald, ET (1980). Early identification and treatment of children at risk for speech development. In RL Schiefelbusch, *Nonspeech language and communication: Analysis and intervention*. Baltimore: University Park Press.
- Wilcox, MJ, Bacon, CK, & Shannon, MS (1995). Prelinguistic intervention: Procedures with young children with disabilities. Presented at ASHA Conference, Orlando, FL.

ACKNOWLEDGEMENTS

Supported in part by research grant 1 K08 DC 00102-01A1 from the National Institute on Deafness and Other Communication Disorders, National Institutes of Health.

Cynthia J. Cress, Ph.D., CCC-SLP
University of Nebraska-Lincoln
202G Barkley Center
Lincoln, NE 68583-0732
ccress@unlinfo.unl.edu

Digitized Speech AAC Device Feature Ratings

Andrew F. Jinks, M.A. CCC-SLP, ATP
The Rehabilitation Institute of Pittsburgh
6301 Northumberland Street
Pittsburgh, PA. 15217

ABSTRACT

Eight digitized speech augmentative communication devices were rated by 30 professionals who interact with AAC users and assistive technology. Twenty device features, including: durability, design, ability to learn, speech output quality, and price were rated on a five point scale. Results revealed important differences between devices. Mean rating scores and rankings of device features according to the five quality levels will be provided.

BACKGROUND

A significant number of AAC devices that provide digitized speech output have come on the market in the past few years. While manufacturers typically provide specifications of device features and a number of resources offer descriptions of the devices, no professional ratings of device features appear to be available.

Many consumer products are reviewed and rated in popular periodicals, however disabled consumers and AAC professionals do not have the opportunity to receive unbiased feedback of AAC devices. This research begins to provide information regarding perceived views of features of selected digitized speech augmentative communication devices.

METHOD

Thirty professionals including speech-language pathologists, teachers, assistive technology practitioners, rehabilitation therapists, and rehabilitation engineering students rated 20

features of eight digitized speech AAC devices. The devices and manufacturers selected were - the 15 Talker (Attainment), Alpha Talker (Prentke-Romich), Black Hawk (Adamlab), Chat Box (Sautillo), DigiVox (Sentient Systems Technology), Macaw II (Zygo), Message Mate 20 (Words+) and SuperHawk (Adamlab). These devices were owned by The Rehabilitation Institute of Pittsburgh and used on a routine basis in augmentative communication evaluations and training. The digitized speech devices selected were chosen to represent a range of sophistication and application to a variety of patients. All devices were operable in a direct selection access technique. Evaluation of other access techniques was not in the scope of this research.

All subjects were provided with a 20 item, 5-point scale rating sheet. Features were rated as excellent, very good, good, below average, or poor. Subjects were encouraged to compare devices in order to make judgments of feature quality. Main features rated included: design, durability, learnability, portability, price, operability, overlay access, and speech output. Additional features rated included: key size, keyguard, touch sensitivity, record/play keys, speaker location, volume control, speaker feedback, level indicator, charge indicator, cheat sheet onboard, overlay design, and manual. Definitions of all 20 device features were provided. Examples of device definitions are as follows: Design - is the design attractive?, Would you feel comfortable if others viewed you using the device?, Is the design functional? Is it ergonomically appropriate?. Overlay access - Is it easy to change the overlay?, Do

overlays seem like they would hold up over time ?. Touch sensitivity - Is it easy to activate the keys ?, Does the amount of pressure required seem reasonable ?. Information regarding amount of recording time and price of the device were also provided to subjects.

All subjects were given the opportunity to use each of the devices. They were encouraged to select message keys, examine operating and programming features, record messages, and review the manual. Subjects were typically able to rate 4 devices in a one hour evaluation session. Subjects rated between 1 and 7 of the 8 devices based on their availability to participate in the study. At least 15 rating forms were completed on each of the devices. Most of the devices received 20 ratings or more.

RESULTS

Rating score were tabulated for each of the features. The device with the top mean rating score for each feature is listed in Table 1.

TABLE 1. Devices with top mean score/feature

Design	Chat Box	3.90
Durability	MessageMate	4.30
Portability	Black Hawk	4.06
Operability	Black Hawk	4.13
Learnability	15 Talker	4.33
Speech Output	Black Hawk	4.33
Overlay Access	Chat Box	4.42
Price	Super Hawk	3.92
Key Size	Alpha Talker	4.18
Key Guard	Alpha Talker	4.24
Touch Sensitivity	Super Hawk	3.76
Record/Play Keys	15 Talker	3.77
Speaker Location	Black Hawk	4.05
Volume Control	15 Talker	3.59
Speaker Feedback	Black Hawk	3.60
Level Indicator	Macaw	3.57
Charger Indicator	Macaw	3.28
Cheat Sheet Onboard	Alpha Talker	3.11
Overlay Design	Alpha Talker	3.56
Manual	Alpha Talker	3.73

Rankings of specific main device features are contained in Table 2.

TABLE 2. Device rankings per selected features

<u>Design</u>	<u>Durability</u>	<u>Portability</u>
1. ChatBox	Message Mate	Black Hawk
2. Macaw	Chat Box	Chat Box
3. DigiVox	Macaw	Alpha Talker
4. Alpha Talker	Super Hawk	MessageMate
5. Black Hawk	DigiVox	15 Talker
6. Super Hawk	Black Hawk *	Digivox
	Alpha Talker	
7. 15 Talker		Macaw
8. MessageMate	15 Talker	Super Hawk
<u>Speech Output</u>	<u>Overlay Access</u>	<u>Price</u>
1. Black Hawk	Chat Box	Super Hawk
2. Alpha Talker	DigiVox	Chat Box
3. Macaw	Macaw	Black Hawk
4. Chat Box	Super Hawk	Alpha Talker
5. Super Hawk	15 Talker	15 Talker
6. 15 Talker	Alpha Talker	Macaw
7. DigiVox *	Black Hawk	MessageMate
	Message Mate	
8.	Message Mate	DigiVox
* Tie score		

Features were then categorized according to function (i.e., hardware, learning, speech). The devices with the highest overall ranking per function are listed in Table 3.

TABLE 3. Highest ranking device by function

Hardware - Chat Box
(Design, Durability, and Portability)

Learning - Black Hawk
(Operability, Learnability, Cheat Sheet Onboard)

Speech Features - Black Hawk
(Speech Output, Speaker Location, Volume, Feedback)

Key and Overlay Features - Alpha Talker
(Overlay Access & Design, Key size, Key guard)

Indicators - Macaw
(Charge and Level indicators)

AAC Device Ratings

DISCUSSION

Several factors appeared to influence the raters judgements of device features. Devices designed with angled keyboards and stylish molding received better ratings. Devices with a 4x4 key matrix were viewed as more portable. When record and playback keys were located on the top panel of the device, they were considered to enhance operability and learnability. Speaker location on the top panel also influenced raters' view of speech output quality. Volume control dials were preferred over knobs. Overlays which slid easily under keyguards were viewed as best. Long rectangular overlays were considered undesirable for easy access. Devices that sold in the \$500 - \$1250 range received highest ratings for price appropriateness. Devices with large selection areas and sensitive membrane keys received higher ratings for key design. Manuals that were comprehensive and well organized were rated best.

REFERENCES

Friel, D. and Bailey, A. Augmentative Communication Device Descriptions, (1995).

The Guide to Augmentative and Alternative Communication Devices, Applied Science and Engineering Laboratories, Wilmington, DE (1996).

Andrew F. Jinks
The Rehabilitation Institute of Pittsburgh
6301 Northumberland St.
Pittsburgh, PA 15217
(412) 420-2422

A PROBABILISTIC WORD PREDICTION PROGRAM

Johan Carlberger, M.S. and Sheri Hunnicutt, Ph.D.

Dept. of Speech, Music and Hearing
KTH, Stockholm, Sweden

ABSTRACT

The results of a Master's thesis are presented in which a probabilistic word prediction algorithm was developed. The information sources for the algorithm are word and word pair frequency, grammatical tags, tag bigrams and trigrams and word recency. All information except recency forms the basis for the calculation of word probability using two Markov models, one each for words and tags. An additional term is added for recency promotion. Other heuristic modifications are facilities for repetition delay, case sensitivity and auto-inflection. Results show an improvement in keystroke savings from about 35% for the previous frequency-based model to 46% for the probabilistic model with 5 predictions.

BACKGROUND

For some years, research has been carried out in the area of word prediction. The programs previously developed have often used word frequency, word pair frequency and sometimes word recency in predicting words while constructing a text. For a program developed for Swedish, the keystroke savings were about 26% for one prediction (2) and about 35% for five predictions for a lexicon containing approximately 7,000 words and about the same number of word pairs.

RESEARCH QUESTION

Some years ago, a simulation was carried out to determine to what extent these keystroke savings could be increased by a probabilistic

model. The results indicated that around a 10% increase could be expected. When it became possible to program Markov models on a PC, work on a probabilistic word predictor was begun. This last year, a Master's thesis has presented an algorithm which delivers at least this increase in keystroke savings. It is based on the language model developed at IBM (4).

METHOD

Training text

A large training text of about 100 million words (1) was used to extract information about the language to be modelled. In order to include grammatical information, a training sub-text containing about one million words with grammatical tags for each word was also employed. The tag set consists of roughly 150 grammatical tags. This information is used by the language model in order to predict successive words given a sequence of words. The quality of the model has been evaluated by using it to predict words of a smaller test text.

The Markov models

The language model is based on two Markov models, one for words and the other for grammatical tags. The two models interact, but the separation enables the predictor to work with lexicons of either tagged or untagged words. A probability estimation for the tag of the next word is first obtained, using the tag Markov model, and then the word Markov model is used to obtain the probability estimation for the next word. In the second step, the tag probability estimation is taken into

account, in order to promote words with a likely tag according to the tag Markov model.

Heuristic improvements

Additional features are the following: (1) The promotion of words that have been used in the recent text history is accomplished by the addition of an additional term which has been experimentally derived. (2) The user's employment of capital letters is also monitored in order to improve the quality of predictions. (3) Predictions which have not been chosen by the user may be repeated as long as they are valid, or repeated only after all other predictions have been supplied. (4) A variety of sorting methods have been made available for the displayed prediction list including increasing length, alphabetic sorting or probability-based sorting. (5) A complete list of inflected forms of content words may be requested.

RESULTS

Impact of different features

The tag Markov model, adaptivity by using topic lexicons, and the heuristic modifications of the language model all contribute to improve the predictions. By comparing the keystroke

Feature	% saved	% increase
-	46.0	
learning new words	40.9	12.6
tagging	43.2	6.4
recency promotion	43.9	4.8
repetition delay	45.4	1.3
case sensitivity	45.8	0.5
auto-inflection	45.7	0.7

Table 1. Impact on keystroke savings by different features.

savings of an optimized configuration with the keystroke savings of the same configuration, but with one feature removed, the impact of that feature is revealed. Table 1 lists the features and the increase in keystroke savings obtained when each feature was added to an otherwise optimal configuration in a test on a sample text.

Number of suggestions

The number of words in the suggestion list has a large impact on keystroke savings, the keystroke savings increasing monotonically with the number of alternatives. But the more suggestions displayed, the longer time it takes for the user to inspect them and the greater the chance of missing correct suggestions. Also, as the number of suggestions grows, the increase in keystroke savings diminishes. Most users are able to quickly scan five alternatives, which is the default setting. In the test on a sample text, the percent keystroke savings for one suggestion was 33%, for five suggestions, 46% and for nine suggestions, 49% as seen below in Figure 1.

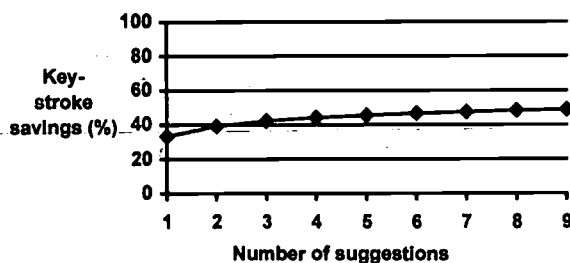

Figure 1. Keystroke savings as a function of the number of suggestions.

DISCUSSION

Performance

In the project for which this word predictor was developed, the aim was to develop a writing support aid for persons with dyslexia,

or other reading and writing problems. The entire program also contains a spell checking component which co-operates with the word predictor. Spell checking is an important component since the predictor itself cannot determine whether a new word typed by the user is purposeful or simply a mistake. In the past, this has led to incorrectly spelled words being stored in the predictor's lexicon, later to be predicted and reused.

This new program is a sound implementation of well-established probabilistic methods and a number of heuristic complements. The work has not made any theoretical breakthroughs in the field of natural language processing and the program uses language modeling theories which have been in existence for some years. Nonetheless, the resulting application will outperform the word predictors with which the authors are familiar, given the features and keystroke savings reported for these programs.

Increasing the size of the lexicon also increases keystroke savings. The word and word pair lexicons were held at around 7000 words in this study in order to be able to compare the results with previous work.

Reports from test users indicate that the new version gives the impression of being more intelligent, and that it suggests words which fit much better into the context than did the old version.

Limitations

The major limitation of the language model is the small scope. Presently, the predictor considers the previous word and the two previous tags in order to make predictions. Hence, words outside the scope, which often have an impact on the next word are not considered at all, and consequently the prediction quality suffers.

The scopes can be extended by one word and one tag, respectively, but it seems impractical

to extend them further. Thus, to make improvements beyond the capability of Markov models as used in this project, other methods must be investigated. Interesting approaches are clustering, proposed by Hutchens (3) and other methods described in Jelinek (4).

REFERENCES

1. Ejerhed E., Källgren G., Wennstedt O. & Åström, M. (1992) The Linguistic Annotation System of the Stockholm-Umeå Corpus Project, DGL-UUM-R-33, Department of General Linguistics, University of Umeå, Report no. 33.
2. Hunnicutt, S. (1986) Lexical Prediction for a Text-to-Speech System, Communication and Handicap: Aspects of Psychological Compensation and Technical Aids, Hjelmquist & Nilsson, eds., Elsevier Science Publishers.
3. Hutchens, J. (1995) Natural Language Grammatical Inference, University of Western Australia.
4. Jelinek, F. (1989) Self-Organized Language Modeling for Speech Recognition, Readings in Speech Recognition, Waibel & Lee, eds., Morgan Kaufmann.

ACKNOWLEDGEMENTS

We would like to thank the National Labour Market Board (AMS), the National Social Insurance Board (RFV) and The Swedish Handicap Institute (HI) for the resources to carry out this work.

Johan Carlberger johanc@speech.kth.se
Dept. of Speech, Music and Hearing, KTH
SE-100 44 Stockholm, Sweden
+46 8 790 9268 fax +46 8 790 7852

SIG-05
Quantitative Functional Assessment

IMPACTS OF ASSISTIVE TECHNOLOGY ON CLIENTS WITH ALS

Jeffrey Jutai, Ph.D., C. Psych.¹ and Pearl Gryfe, OT(C)²

Research Department, Bloorview MacMillan Centre, Toronto, Ontario, CANADA¹

and

Assistive Technology Clinic, Sunnybrook Health Science Centre, Toronto, Ontario, CANADA²

ABSTRACT

The Psychosocial Impact of Assistive Devices Scale (PIADS) is a 26-item self-rating scale designed to measure the impact of assistive technologies (AT's) on the quality of life of the users of these devices. This paper will report on the results available to date which suggest how outcome measurement research using the PIADS can improve the prescription and delivery of AT's to clients with ALS.

BACKGROUND

The Assistive Technology Clinic at Sunnybrook Health Sciences Centre in Toronto provides clients with Amyotrophic Lateral Sclerosis (ALS) with assistive technologies (i.e., power mobility devices, computers for environmental controls and communication) to help them function independently and productively with dignity. Anecdotal reports from clients, their families and caregivers, and clinicians have suggested that assistive technologies have a significant positive impact on the quality of the lives of individuals with ALS. It is increasingly important though to attempt to well document these impacts through systems of consistent, complete, and continuous measurement (1). The literature describes a number of generic and disease-specific "quality of life" instruments for potential use in the evaluation of assistive technologies. The medically oriented instruments that are available do not totally fulfill the needs for measurement with ALS clients, including clinical economy and

relevance of test scores for improving clinical practice.

RESEARCH QUESTION

The Assistive Technology Clinic desired a measurement system that included a more client-centered evaluation of the impact of technology prescriptions on the ALS population.

The project described in this report had four objectives:

1. To evaluate how assistive devices such as wheelchairs, writing aids, communication aids (VOCA's), and environmental control units (ECU's) influence the quality of life of a person with ALS.
2. To see whether the PIADS questionnaire can be used routinely in the clinic to collect client-centered perspectives on quality of life impacts of assistive technology.
3. To determine if the PIADS correlates meaningfully with information collected as part of clinic routine that might give insight into device prescription and follow-up.
4. To determine if PIADS scores can predict long term outcomes associated with device use such as patterns of use, abandonment, and occupational performance.

METHOD

The Psychosocial Impact of Assistive Devices Scale (PIADS) is a 26-item self-rating scale designed to measure the impact of assistive technologies (AT's) on the quality of life of the

users of these devices (2). It can be completed within 5 to 10 minutes. The PIADS asks users to rate the impact of their devices on items that reflect important psychosocial constructs in evaluating assistive devices, such as acceptance (or adaptability), feelings of competence, self-efficacy, self-confidence and self-esteem. Scores are summarized in 3 domains: Adaptability (reflecting attitude toward participation and risk-taking), Competence (reflecting perceived functional capability, independence and performance), Self-esteem (reflecting self-confidence, self-esteem, and emotional well being). The PIADS has been shown to be a reliable and responsive measure that, because of its brevity, can be easily included with routine clinical assessments.

The PIADS has been included in a project to evaluate an approach to outcome measurement of AT's for ALS clients that integrates measures of clinical, functional, and quality of life variables. Other measures include a questionnaire designed to record relevant information for each type of device (wheelchair, VOCA, writing aid, ECU). It records the exact kind of device prescribed, how the device is accessed or controlled, reasons for device prescription, where the device is used, ratings of satisfaction with the device, ratings of how difficult it was to adjust to the device, and questions about general health status and medication. Device ratings were obtained using 5-point Likert scales.

Measures are taken at the time of first follow-up visit to the clinic following device prescription, and at subsequent visits. First-visit questionnaires have been completed for 55 clients with ALS to date (33 males, 22 females). 24 clients (44%) completed forms by themselves. 15 (27%) were completed collaboratively by clients and their caregivers, in instances where the caregiver acted as a facilitator of communication with the client. 16

(29%) were completed by caregivers on behalf of clients who were unable to give answers themselves.

Statistical analyses were performed using analysis of variance (ANOVA), multivariate ANOVA's, and Pearson correlations. Only those results which were statistically significant are reported in this paper.

RESULTS

There was good agreement among PIADS scores produced by clients, clients assisted by caregivers, and caregivers on behalf of clients. On average, positive impacts were reported for all four types of device. Patterns of psychosocial impact appear to differ across device types. For wheelchairs, the highest scores were in the Adaptability domain, and the lowest in the Self-esteem domain, with scores on Competence being midway between the two. For VOCA's, scores were slightly higher on average than scores for wheelchairs, with no difference across PIADS domains. Writing aids produced higher scores in the Adaptability and Competence domains than wheelchairs and VOCA's; Self-esteem scores were significantly lower than scores on the other two domains. Overall, these findings suggest that reported impacts were greater in domains associated with perceived productivity rather than self-esteem. Too few questionnaires have been completed for ECU users to permit meaningful statistical analysis at this time.

The most often prescribed device for clients with ALS was a wheelchair (49%). Among wheelchair users, higher PIADS scores were reported by females than males. Caregivers tended to rate impacts more highly than clients. PIADS scores were positively correlated with user ratings of satisfaction with the wheelchair and negatively correlated with ratings of how difficult it was to adjust to the wheelchair.

PIADS scores were not correlated with changes in general health status since the client's last clinic appointment.

To date there are insufficient data with which to evaluate the PIADS's ability to predict long term outcomes associated with device use for the ALS population.

DISCUSSION

The first results from this project are very encouraging. It seems that the PIADS can be used routinely in the clinic to measure clients' perceived impacts of assistive technology in a reliable and standardized fashion. In situations where clients cannot respond directly himself/herself, caregivers can use the PIADS and appear to report impacts which are typical of those reported by a particular group of device users themselves.

The PIADS correlates with user ratings of device satisfaction and adjustment. This suggests that the PIADS can substitute for other, lengthier assessment instruments in situations where it is important only to get a preliminary, global indication of user satisfaction or user's personal adjustment to the device, to help decide if further assessment in these areas is warranted.

The ease with which PIADS scores can be collected routinely and added to the clinical database affords good opportunities for device prescribers to use the scores to influence their daily clinical practice and review long term trends in user-reported impacts.

Overall, clients and caregivers reported positive psychosocial impacts for all four classes of device included in the project. This validates the assumption that assistive technology helps people with ALS function and helps them adapt or better cope with their disease. Follow-up

studies using the PIADS will help shed light onto the reasons for patterns of use and abandonment of devices in the longer term. They will be useful for suggesting changes to the design and prescription of devices so as to improve their ability to enhance the occupational productivity and perceived quality of life for clients with ALS.

REFERENCES

1. Jutai, J., et al. (1996). Outcomes measurement of assistive technologies: an institutional case study. *Assistive Technology*, 8, 110-120.
2. Day, H. and Jutai, J. (1996). Measuring the psychosocial impact of assistive devices: the PIADS. *Canadian Journal of Rehabilitation*, 9, 159-168.

ACKNOWLEDGEMENTS

Funding for this research has been provided by the Ontario Ministry of Health through the Ontario Rehabilitation Technology Consortium.

Jeffrey Jutai, Ph.D., C.Psych.
Research Department
Bloorview MacMillan Centre
350 Rumsey Road
Toronto, Ontario, CANADA
M4G 1R8
Ph: 416-425-6220 ext. 3509
Fax: 416-425-1634
E-mail: ortcjj@oise.utoronto.ca

USING A FLOWCHART AS AN EFFECTIVE TIME-MANAGEMENT APPROACH TO THE EVALUATION AND TREATMENT OF PATIENTS WITH HIGH-LEVEL SPINAL CORD INJURIES USING ASSISTIVE TECHNOLOGY DEVICES

Cindy Nead, COTA, Susan D. Drastal, M.S., Heather Logie, MOT, OTR, and Beverly K. Bain, Ed.D.
Kessler Institute for Rehabilitation

ABSTRACT

The purpose of this paper is to present guidelines for an effective time-management approach to the assessing and treating of persons with spinal cord injuries (SCI) for appropriate assistive technology (AT) devices. The approach was developed within the Kessler Institute for Rehabilitation facility, but can be modified to meet the needs for other facilities. The flowchart provides a step-by-step guide to assessing persons with C1-C6 tetraplegia for appropriateness of various AT devices. Our goal is to encourage primary therapists, who best know the patient's function and ability, the opportunity to participate with the AT team in the evaluation and treatment process in order to enhance the patient's independence.

BACKGROUND

Survivors of SCI level C1-C6 are experiencing shortened hospital stays as a result of the current changes in the health care system affecting the delivery of medical services. The patients are surviving higher level injuries and are living longer. Subsequently, as patients are discharged home or to alternative care facilities, the burden of care is being put on the patient's family.

Through the use of ATDs (AT devices), the patient is offered the potential to regain control of some elements of his life, whether it be to control electronic devices in his environment, independently propel a wheelchair, or learn to drive a car with alternative controls and steering options.

Kessler Institute for Rehabilitation is an 84-bed acute rehabilitation facility that treats

approximately 225 new patients with SCI per year. Kessler is a model SCI center, participating in a grant from NIDRR. Kessler is the site of the Northern NJ Spinal Cord Injury System, serving as a research and demonstration model of a comprehensive service delivery system of patients with SCI. Patients with C1-C6 spinal cord injuries are greatly limited in their ability to access their environment and are highly dependent on AT in order to function independently. Generally, the higher the injury in the spinal cord, the more dependent a person is on technology. For instance, persons with C1-C2 injuries have limited movement, are usually ventilator dependent and have few access options for switch(es) to control their environment. Their switch operation is usually pneumatic (breath control), voice and/or eye movement.

Many therapists and AT practitioners (ATPs) are faced with the task of assessing a patient with high-level SCI, without knowing where to begin. For AT to be effective, an interdisciplinary team effort is required. The interdisciplinary team member must consider: (1) the patient's goals, functional abilities; cognitive, sensory, neuromotor and psychosocial status; (2) the task(s) the person wants to accomplish; (3) all the environments (bed, wheelchair, home, school and community) where the tasks are to be performed; and (4) the characteristics of the devices such as, the access means (switch or voice), transmission method (electric or battery), and the feedback (auditory, visual or proprioceptive). The AT evaluation is a continuous process that requires periodic re-evaluation. When evaluating an individual for

possible use of AT, other items need to be considered: the user's interest(s), the user's daily routine, what the user feels is important, and the caregiver/user relationship. During this process, the evaluators should be weighing the user's beliefs, goals, needs and rewards vs. the cost of the device.

In order to access most ATDs, the user needs to activate a switch. The first step is to determine the user's most reliable, dependable site to access a switch. A person can essentially use any body part to activate a switch.

OBJECTIVE

The purpose of this paper is to formulate the basis for a step-by-step guide to assist with effective treatment for survivors of C1-C6 SCI. Our main objective is to highlight important issues regarding treatment including assessment for appropriate assistive devices used both in-house and upon the patient's discharge from inpatient rehabilitation. The areas assessed include access to nurse call bell, telephone, environmental control units (ECUs), powered mobility, driving and driver education, home evaluation and modification, computer access and page turners.

METHOD

We have developed this checklist flowsheet to assist the occupational therapist and rehabilitation team members in the process of effective service delivery to patients with SCI. It is our objective to offer an efficient means to plan treatment time and resources in order to enhance the patient's ability to lead a productive life (see figure 1: the first page of the checklist flowchart).

The flowchart starts with the question: Is there a SCI? If yes, then the OT assesses the patient's range of motion (ROM), muscle strength, cognitive and respiratory status, also positional devices such as a halo or collar. It is explained to the patient at this time that this

assessment is ongoing throughout their stay. In the next step, the therapist evaluates the patient for minimal head/neck flexion/extension and rotation. Should the patient have 0-poor head/neck ROM, then the AT team sets up a pneumatic switch nurse call and trains the patient. If the patient has appropriate head/neck ROM and muscle strength, then the AT team sets up a pancake or teepee switch and gives appropriate training. The patient must be independent in giving verbal instructions to others for set up of the switch, even though diagrams are left at bedside. These steps are completed within 24-48 hours of admission by the primary OT and the AT team. The flowchart shows the therapist that an ongoing evaluation of ROM, muscle strength, etc., is done following set up of the pneumatic switch, pancake or teepee switch to determine if there has been increased strength.

Typically, the patient's first need is to signal to the nurse for assistance. Once the patient has adjusted to his injury, the patient generally is interested in entertainment. From the third step, the question arises: Is the patient interested in use of high end ATDs? Should the patient not be interested or need an ECU, the primary OT will set the patient up with low technology assistive devices to control the television and perhaps their phone and radio. The C6 and sometimes C5 patients are generally candidates for low end assistive devices. However, the C1-C5 patients will require the need for an ECU. Should they be interested in its use, the AT team will evaluate the patient for the appropriate switch and ECU set up in his room. The ECU can control the nurse call, TV, phone, radio, fan and the bed. From this step, the primary OT needs to contact the case manager and insurance company for authorization to pursue evaluation and trial of high end technology devices prior to prescription of them. These areas include: ECU, computer, software for

hands-free dictation, power wheelchair, passenger van, driving, home modification evaluation and page turners. The icons at the bottom of figure 1 allow the therapist to go directly to that section of the guide and assess the patient for each of its uses.

RESULTS

The authors' intent was to enhance the critical pathway documentation currently utilized at Kessler Institute. This paper was presented as an in-service to the occupational therapy staff. Therapists were asked to complete forms with their impression after utilizing the flowchart for patient assessment. Presently, the forms are being collected and the data compiled.

DISCUSSION

There is clearly a need for a guide for therapists to follow when beginning to assess patients with high level SCIs. More survivors, less therapy being paid for by insurance, and time-management for therapists, all contribute to needing a description of how to assess for AT devices. This is our attempt to encourage therapists to more effectively manage their time, by following a flowchart when evaluating patients carefully and correctly. It is anticipated there will be exceptions to these "rules"/guidelines that the authors will continue to refine the document as feedback is received from therapists utilizing the flowchart.

REFERENCES

Bain B, Leger D (1997). Assistive Technology: An Interdisciplinary Approach New York, NY: Churchill Livingstone, Inc.

Cindy Nead, COTA
 Kessler Institute for Rehabilitation
 In-Patient Occupational Therapy Department
 1199 Pleasant Valley Way
 West Orange, NJ 07052

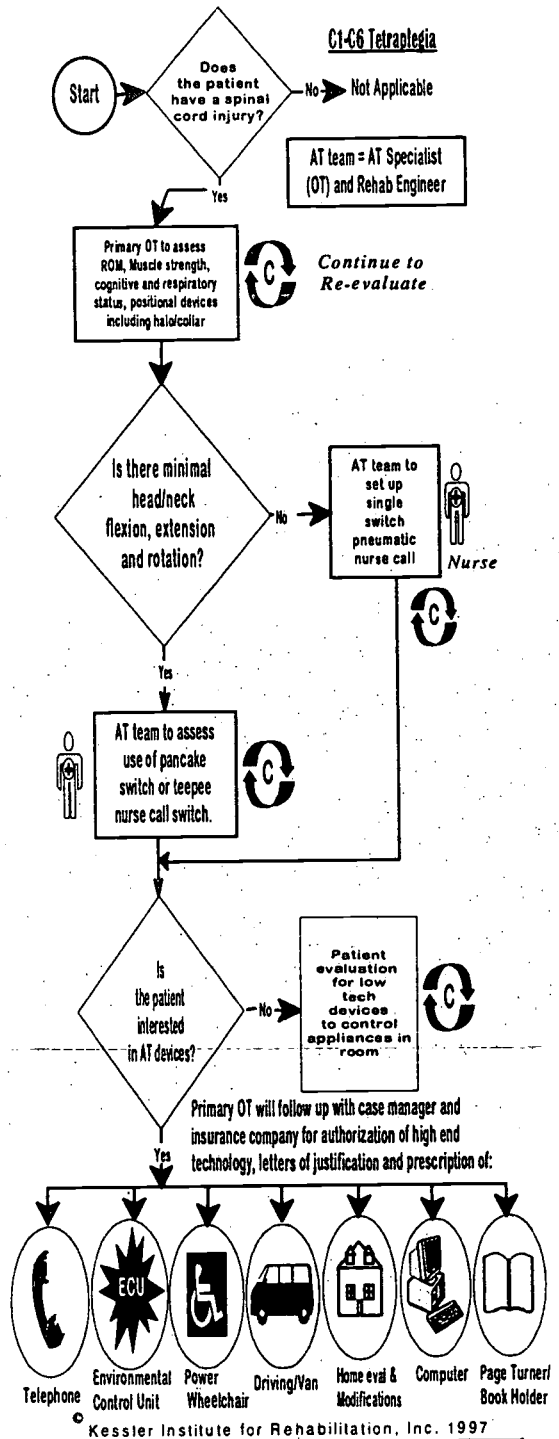

Figure 1: First page of the flowchart the evaluator follows for patient assessment

ANALYSIS OF SIT-TO-STAND PERFORMED BY YOUNG NORMALS, USING FORCE PLATE AND ACCELEROMETRIC DATA

Betty S. Troy, Eric E. Sabelman, Deborah E. Kenney, Sandy Dunn-Gabrielli, Ruth Yap, Margaret Willits
Rehabilitation R&D Center, VA Health Care System, Palo Alto, CA 94304

ABSTRACT

Performance of normal-speed sit-to-stand with arms crossed by five young healthy subjects (24-33 years) was measured by simultaneously collecting data from two 3-axis accelerometers at the waist and from two force plates. Both force and accelerometry wave forms in the vertical direction were similar in shape. Force plate data predominantly showed effects of vertical forces while accelerometry emphasized front-to-back motion. We concluded that there is potential for accelerometry to be used as a supplement or as an alternative to ground reaction force for assessment of balance using the sit-to-stand test.

BACKGROUND

Rising from a chair is an important element in the task of ambulation (i.e., one must first rise from a chair *before* walking). The motion itself, consisting of transition from a stable seated position to the less stable position of standing on two limbs, is sufficiently complex that it is difficult to quantify.

There is little consensus on the definition of its stages. Millington, et al. (1) studied sit-to-stand in elderly using force plates, video motion analysis, and electromyography. Three phases were defined as follows: [A] *Weight shift* occurs from the first noticeable trunk flexion until knee extension is initiated. [B] *Transition* begins with the initiation of knee extension and ends with the reversal of trunk flexion to trunk extension. [C] *Lift* ends with full extension and standing without noticeable motion.

Riley, et al. (2) studied sit-to-stand in healthy young women using LED's placed at joints, recorded and analyzed by kinematic software. Force plate data were also collected. Their definition contained four phases: [A] *Flexion momentum* begins when the upper body rotates forward and ends with lift off from the seat. [B] *Momentum transfer* is the phase where a transition from primarily forward to primarily vertical movement is made. [C] *Extension* occurs as the center of mass rises to standing position. [D] *Stabilization* occurs as the center of mass settles to amplitudes of normal postural sway during quiet stance.

Kralj, et al. (3) examined sit-to-stand in normal subjects using goniometry and force plates. Sit-to-stand was divided into five intervals of time. [A] *tu0-tu1* consists of initiation of motion where forward momentum is generated. [B] *tu1-tu2* is defined by acceleration to prepare to lift off the seat. [C] *tu2-tu3* consists of the vertical acceleration phase of ascent. [D] *tu3-tu4*

consists of the deceleration phase of ascent, ending with legs straight. [E] *tu4-tu5* is the stabilization stage where balance is tuned.

The majority of studies on sit-to-stand have used force plates (1,2,3,5,6,7,8,9,10), along with video imaging or goniometry. However, the design of force plates may introduce some bias due to limitations in a natural performance of sit-to-stand. For example, their boundaries may not permit natural foot and/or chair placement. They are also not typically portable.

Newton's second law states that the force acting on a body is equal to the product of its mass and its acceleration ($F=ma$), expressing the relationship between force and acceleration. We explored this relationship by examining events observed by data simultaneously collected from each method. An accelerometry system developed at the Palo Alto VA Rehab. R&D Center [4] was modified to synchronously collect force plate and accelerometric data. The accelerometry system we have developed is worn by the subject and is completely portable, without requiring the subject to be tethered to any other device [4].

RESEARCH QUESTION

What events can be distinguished using accelerometry compared to those identified in ground reaction forces within corresponding time intervals?

METHOD

Five healthy young (24-33 years old; 2 females, 3 males) subjects were asked to perform sit-to-stand at a comfortable speed with their arms folded across their chests and with one foot on each of two force plates. A standard shower chair was placed behind two force plates and its seat was adjusted to be at popliteal (knee) height for each subject. Subjects wore the accelerometry belt, having one set of 3-axis accelerometers placed on each side of the waist above their hips. Each trial was repeated three times.

Data from the two 3-axis accelerometers and two 3-axis force plates were collected and stored in the computer worn on the belt. Following collection, data were downloaded to a fixed computer for analysis.

Because Kralj, et al. (3) calculated time intervals directly from force plate data rather than by visual observation, we chose to implement similar methods to define time intervals. The initiation of the sit-to-stand motion (t_0) was defined as the first time the time derivative of force in the Z direction (vertical) fell below 2.5% of its peak-to-peak range. Point t_1 was marked when the time derivative of force in the Z direction

Accelerometry & Sit-to-Stand

increased to 10% of its peak-to-peak range. At this point, forward momentum shifts to become vertical momentum. The maximum of the forward force (F-X) was marked when the subject came off the seat (t2). Extension of the lower limbs continued until the minimum of the slope of the vertical force (F-Z) was reached (t3). The beginning of stabilization was not calculable, since Kralj, et al., used knee angle to mark this point; we did not collect knee angle data. The end of settling (t4) was found when F-Z ceased to fluctuate less than $\pm 0.5\%$ of body weight. The time intervals so obtained from force data were used to partition the synchronous accelerometric data for comparison between the two methods.

RESULTS

Traces for force and acceleration vs. time are shown for one trial in Fig. 1, and events noted from all trials are listed in Table 1. Motion in the vertical (Z) axis, for both force and acceleration possess similar shapes if seated force is also measured by the force plate. The amplitude of the baseline trace before t0 for B-Z matches the

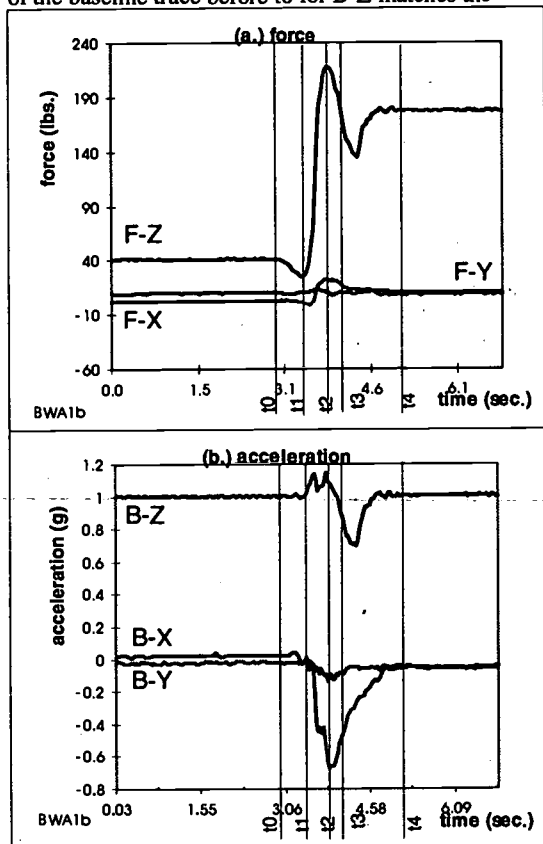

Figure 1. Sample plot of (a.) sum of left & right side forces, and (b.) mean left & right side accelerations from body sensors vs. time of sit-to-stand. F-Z= vert. force, F-Y= lat. force, F-X= ant.-post. force; B-Z= accel. on vert. accelerometer axis; B-Y= accel. lat. axis; B-X= accel. on ant.-post. axis.

amplitude of the ending baseline trace, after t4, whereas for F-Z, the beginning baseline amplitude is much less than that at the end. In addition, data from the vertical (Z) axis predominates in the force traces, whereas motion in the anterior-posterior (X) axis is more evident in the accelerometry data.

Table 1.	Event	Force Plate	Accelerometers
t0 - t1	Upper body flexed forward.	F-Z decreases as upper body flexed forward and legs briefly unweight.	As upper body flexed forward, B-Z increases and B-X decreases.
t1 - t2	Forward momentum shifts to vertical momentum, while subject is still on seat.	F-X decreases first, indicating a push backward at the feet. Feet press into the ground, resulting in a steep increase in F-Z & F-X	B-X continues to decrease & B-Z increases as upper body is still flexed. A brief dip occurs in B-Z & is suspected to correspond to push from chair.
t2	Weight comes off seat.	F-X is at maximum.	B-X is at minimum.
t2 - t3	Immediately after seat off, momentum is upward & forward. Knees and hips extend.	Decrease in F-Z and F-X.	B-X increases, and B-Z decreases as the upper body straightens.
t3 - t4	Extension is continued. Stabilization occurs near the end.	F-Z & F-X decline further. F-Z begins to rise again as the subject's weight settles on the force plates. Weight shifts in all directions until stabilized.	B-X continues to increase. B-Z decreases and then increases as the body and lower limbs straighten. Both exhibit settling at the end.

Table 2.	5 Subject Mean (SD)	Kralj, et al. Mean (SD)
t0 - t1	0.60 sec. (+0.26)	0.91 sec. (+0.39)
t1 - t2	0.42 (+0.08)	0.22 (+0.04)
t2 - t3	0.44 (+0.33)	0.39 (+0.11)
t3 - t4	2.05 (+1.00)	0.81 (+0.27)
Total	3.51 (+1.23)	3.33 (+0.58)

Mean and standard deviation of times calculated for time intervals of sit-to-stand for five subjects and those reported by Kralj, et al. (3) are shown in Table 2. Note that t3-t4 in this study consists of tu3-tu5 in the Kralj, et al. study, since knee angle was not measured to determine end of extension in our study. Subjects took

longest between t3-t4, while extension is completed and settling takes place.

DISCUSSION

Each method of measurement of sit-to-stand provides useful information. Force plates have been more commonly used in studies of sit-to-stand. The force plate measures ground reaction forces at the feet, from which motions of the body are deduced. Accelerometry data is in the form of motion patterns that depend on the location of accelerometers on the subject. Our sensors were placed on each side of the waist, near the body's center of gravity.

The force and accelerometry traces in the vertical (Z) direction possess similarities in shape, containing a small negative peak, then a positive peak, and then one more negative peak. They would be even more similar if the subject's chair was also on the force plate, starting and ending with all weight on the force plates. In the X direction (anterior-posterior), the force and accelerometry traces do not appear to be similar. Their peaks are in the opposite direction from one another, and of different proportion to their respective Z traces. This is associated with the fact that the body accelerometric sensors are tilted as the subject flexes the upper body forward. Therefore, the accelerometric traces do not represent accelerations relative to a fixed set of axes relative to the ground, as is the case with force plates. Instead, the axes move with the sensors. Because of this, the time intervals containing extension are very apparent on the B-X trace as a steep increase in acceleration.

In both cases, the Z and X sets of data provide more information than Y, as expected, since most motions occur in these planes. There was little side-to-side motion in any of our healthy young subjects during the performance of sit-to-stand in both accelerometric and force plate data.

The start of sit-to-stand motion was more apparent in F-Z data from force plates, while it was more apparent in the B-X accelerometry data.

The difference in times as compared to that reported by Kralj, et al. may have been due to a number of factors. For example, Kralj, et al. used only one force plate, having the chair and subject on the force plate. In our study, the chair was off of the force plates, while the subject was asked to perform sit-to-stand with one foot on each of two force plates. The forces from both plates were summed. This could have contributed to differences in peak-to-peak values used to mark time intervals. In addition, all subjects in our study were young (24-33 yrs.), while the age group ranged between 24 and 51 years of age in the study by Kralj, et al.

CONCLUSION

Since Newton's second law relates force and acceleration, it should be possible to estimate force using

the acceleration data collected if the masses of segments in motion are known. Ground reaction forces obtained by force plates can be compared to calculated forces using accelerometry data, after compensation for effects from tilt. Data from a larger number of subjects now under study should clarify the relationship between force plate and accelerometric data in the study of sit-to-stand. There is potential for acceleration to be used as a supplement or alternative to force plate data.

REFERENCES

- (1) Millington, P.J., B.M. Myklebust, G.M. Shambes. "Biomechanical analysis of the Sit-to-Stand Motion in Elderly Persons." *Archives of Physical Medicine and Rehabilitation* 73(July 1992): 609-617.
- (2) Riley, P.O. M.L. Schenkman, R.W. Mann, W.A. Hodge. "Mechanics of a Constrained Chair-Rise." *Journal of Biomechanics*. 24, no. 1 (1991): 77-85.
- (3) Kralj, A, R.J. Jaeger, J. MuniH. "Analysis of Standing Up and Sitting Down in Humans: Definitions and Normative Data Presentation." *Journal of Biomechanics*. 23, no. 11 (1990): 1123-1138.
- (4) Sabelman, E.E., J.J. Gadd, D.E. Kenney, P.M. Merritt, C.H. Winograd. "Balance Diagnosis Using a Wearable Upper Body Motion Analysis Computer." *Proc. To RESNA International 1992*: 81-83.
- (5) Engardt, M., E. Olsson. "Body Weight-Bearing While Rising and Sitting Down in Patients with Stroke." *Scand J Rehab Med*. 24 (1992): 67-74.
- (6) Engardt, M., T. Ribbe, E. Olsson. "Vertical Ground Reaction Force Feedback to Enhance Stroke Patients' Symmetrical Body-Weight Distribution While Rising/Sitting Down." *Scand J Rehab Med*. 25(1993): 41-48.
- (7) Hanke, T.A., Y.C. Pai, M.W. Rogers. "Reliability of Measurements of Body Center-of-Mass Momentum During Sit-to-Stand in Healthy Adults." *Phys Ther* 75(1995): 105-118.
- (8) Hesse, S., M. Schauer, M. Malezic, M. Jahnke, K.H. Mauritz. "Quantitative Analysis of Rising From a Chair in Healthy and Hemiparetic Subjects." *Scand J Rehab Med*. 26(1994): 161-166.
- (9) Stevens, C. F. Bojsen-Moller, R.W. Soames. "The Influence of Initial Posture on the Sit-to-Stand Movement." *Eur J Appl Physiol* 58(1989): 687-692.
- (10) Yoshida, K, H. Iwakura, F. Inoue. "Motion Analysis In the Movements of Standing Up From and Sitting Down on a Chair. A Comparison of Normal and Hemiparetic Subjects and the Differences of Sex and Age Among the Normals." *Scand J Rehab Med*. 15(1983): 133-140.

ACKNOWLEDGMENTS

Supported by VA Rehabilitation R&D Merit Review project E601-2RA.

VA Rehabilitation R&D Center, 3801 Miranda Ave., #153, Palo Alto, CA 94304

MEASUREMENT OF SOFT-TISSUE NECK INJURY BY VIDEO MOTION ANALYSIS

S.C. Morgan, I.A. Dhalla, K. Habdank, D.P. Romilly, Ph.D., P.Eng., and C. Hershler, M.D., Ph.D.

Rehabilitation Engineering and Clinical Technology Laboratory
Department of Mechanical Engineering, University of British Columbia
Vancouver, Canada

ABSTRACT

At present, no objective method of diagnosing soft-tissue neck injury exists. This study was undertaken to analyze, using a marker-detection video motion analysis system, the two-dimensional neck motion trajectories of three subject groups: patients with soft-tissue neck injuries, healthy subjects (normals), and malingerers. The aim was to determine whether significant and repeatable differences in motion exist between these groups. The motion of subjects in each group in extension-flexion, axial rotation, and lateral bending was recorded and analyzed. Several parameters that characterize the motion were identified as possibly distinguishing patients from normals and malingerers. These include range of motion, smoothness of motion, and the repeatability of these parameters between trials. Patients were consistently differentiated from normals on the basis of range of motion.

BACKGROUND

Soft-tissue neck injuries are common sequelae of rear-end motor vehicle collisions. Such injuries are often referred to as whiplash; this term, however, implies a specific mechanism of injury rather than a precise set of symptoms and its use has been avoided here. Despite their frequent incidence, soft-tissue neck injuries are not well understood. This is due mainly to the nature of the injuries: they are often characterized by complaints of pain and impaired function in the absence of detectable neurological, muscular, or skeletal damage [1]. Diagnosis of injury has to date been largely based on subjective clinical examination. Litigation and insurance factors have complicated the confusion surrounding diagnosis. In order to prevent fraudulent claims for compensation and to confirm bona fide injury, an objective means of diagnosis is needed. A reliable method would hold great value to the medical profession and insurance industry, and perhaps most importantly, to patients themselves.

Motion analysis as a means of diagnosing neck trauma remains a little-explored subject in biomechanics and rehabilitation engineering. A review of the published research in the field turned up only a handful of studies. Mimura et al [2] and Winters et al [3] have recorded the three-dimensional head-neck motion of human subjects. The latter group reports abnormalities in the motion of injured subjects. However, the authors are not aware of any published study in which an attempt has been made to differentiate between the motion of malingerers and patients with genuine injuries.

A foreseeable outcome of research in this area is the development of a clinical device capable of quantitatively assessing the extent of soft-tissue neck injury. Such a device would be useful not only to physicians in the initial diagnosis of injury but also to rehabilitation therapists as an aid in tracking recovery. Ålund and Larsson [4] have developed a clinical apparatus employing electrogoniometers to record neck motion but do not report having used it successfully in injury diagnosis.

RESEARCH QUESTIONS

1. Does the neck motion of injured subjects differ significantly and repeatably from normals?
2. If a difference is found between patients and normals, can the motion of patients also be distinguished from that of malingerers?

METHODS

Physical Set-up of Experiment

A video motion analysis software package [5] was used to collect data. The software tracks the motion of bright spots called markers through successive frames of video and generates a two-dimensional trajectory for each marker.

During testing, the subjects wore a lightweight, plastic headgear (Figure 1). Spherical reflective markers were attached to the ends of four rigid extensions from this headgear. The effect of mounting the markers on extensions was to exaggerate the subjects' motion and hence produce more easily analyzable data.

Two Pulnix TM 545-A CCD cameras recorded the subjects' motion. One was positioned approximately 1.5m above the subject's head and the other about 1.5m to the side of the head. The subjects stood while their motion was being recorded. The system accuracy in this configuration was determined to be less than 5mm in translation.

To guide the subject's motion along paths that were consistent between subjects, a stimulus was used. It consisted of a laser pointer mounted on the output shaft of a gearmotor. The subject followed the path of the beam as it passed either horizontally across a wall (to stimulate axial rotation) or vertically up the wall (to stimulate extension-flexion). Lateral bending was not stimulated. To furnish the subject with information about the position of his head, a laser pointer was mounted to the top of the headgear. The subject used this pointer to follow the motion of the other laser beam. This

technique was derived from a similar one used by Winters et al [3].

Protocol

Five patients, four normals, and six malingerers participated in the study. The patients were recruited by a specialist in rehabilitation medicine and varied in age, gender, and the length of time for which their symptoms had persisted. The normals and malingerers that were recruited had no history of head or neck trauma.

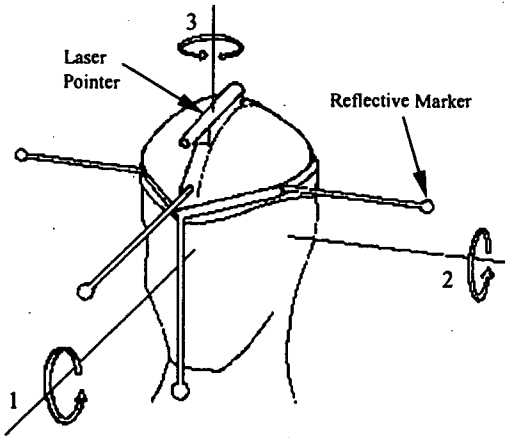

Figure 1. Headgear worn by subjects and the axes of rotation for lateral bending (1), extension-flexion (2), and axial rotation (3).

For each subject, five trials of axial rotation, extension-flexion, and lateral bending (Figure 1) were recorded. A single trial consisted of the subject moving from the left limit (in the case of axial rotation and lateral bending) or bottom limit (in extension-flexion) of his range all the way to the right or top limit, and then returning back to the starting point.

For each type of motion, it was emphasized to the subjects that, within their range of motion, they should move as far as they could without causing themselves significant extra discomfort. It was also stressed that subjects should move their heads only (i.e., shoulders and torsos kept stationary) so that the rotations would be as distinct as possible.

Malingerers were asked to simulate a soft-tissue neck injury. They were not told how such an injury might affect their neck motion. In effect, they were asked to fool the measurement system.

Analysis Techniques

The output of the motion analysis software was the x and y coordinates of each marker in each video frame for both the overhead and side cameras. The data from each camera were post-processed separately using MATLAB. Plots were generated of the two-dimensional trajectories of the markers in each trial. In addition, graphs of the distance through which each marker traveled as a function of time (where the distance calculated is the projected distance that the marker moved through in the image plane of the camera) and graphs of speed versus time were produced.

It may be argued that since two-dimensional tracking gives only a planar approximation of neck kinematics, subtleties of the motion are lost without the third dimension. The authors contend that while two-

dimensional coordinates may be a limiting factor when studying very complex motions, they are sufficient for the analysis of isolated rotations as in the present case. In fact, since two-dimensional trajectories have a more natural representation on paper than three-dimensional ones, they are more easily interpreted.

RESULTS

The results obtained suggest that primarily two characteristics of motion can be used in discriminating between normals, malingerers, and patients. These are the range of motion and smoothness of motion and the variation of each of these characteristics over a number of trials.

Range of Motion

The analysis software computes the range for each marker for each motion sequence. To analyze range data for each type of motion, the range values obtained from each of the five trials of a single subject were averaged. This produced an average range for each subject, for each type of motion. Then, the mean of the average range was computed for each of the subject groups. Figure 2a displays the range measurements of one marker for each subject group for extension-flexion as viewed from the side camera. Similar results are observed for the other markers and for the other motion types. It can be seen that the average range of motion of the normals exceeded that of both the malingerers and patients. In fact, the normal subject with the smallest range still had greater range than the most mobile patient. Figure 2a also reveals that variation in range between different malingerers is greater than that observed among patients.

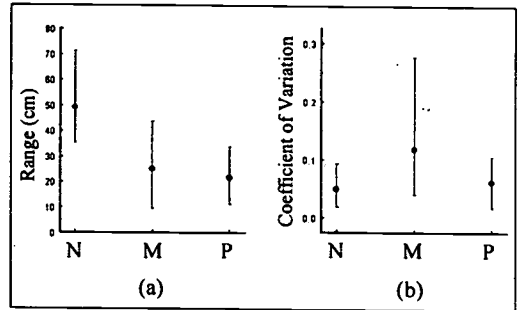

Figure 2. (a) Ranges in extension-flexion. (b) Coefficients of variation. "N," "M," and "P" denote normals, malingerers, and patients respectively. For both plots, the vertical bars encompass all values calculated for a particular subject group while the dot indicates the average value.

Since, for each subject, five trials were recorded for each type of motion and the range was calculated independently for each trial, it was possible to determine how consistent a subject was between trials. In order to examine the repeatability of the range of motion, the coefficient of variation (standard deviation over mean) of the range for each subject was calculated. Within a single subject group, these coefficients of variation (COVs) were then averaged. Figure 2b displays the COVs for each of the three subject groups for extension-flexion. Again, similar results hold for axial rotation and lateral bending. The COVs for the malingerers are

clearly larger than those for normals and patients. Moreover, the malingerers show substantially larger variations between subjects than either normals or patients. It is instructive to note, however, that high upper end variations for the malingerers can be attributed to two unusually inconsistent subjects.

Smoothness of Motion

The smoothness of the motion was examined qualitatively. Attention was paid to the position of the data points that compose the trajectory of a marker in each plot. In particular, the spacing between points was examined for changing gap size, which would indicate erratic velocity and irregular movement. Also, the deviation of points from a smooth line was investigated as an indicator of jerkiness.

In general, the normals' trajectories were the smoothest (Figure 3a). Patients and some of the malingerers also exhibited trajectories that were quite smooth. However, some malingerers exhibited trajectories that were quite jerky, the result of a simulation strategy involving irregular movements (Figure 3b).

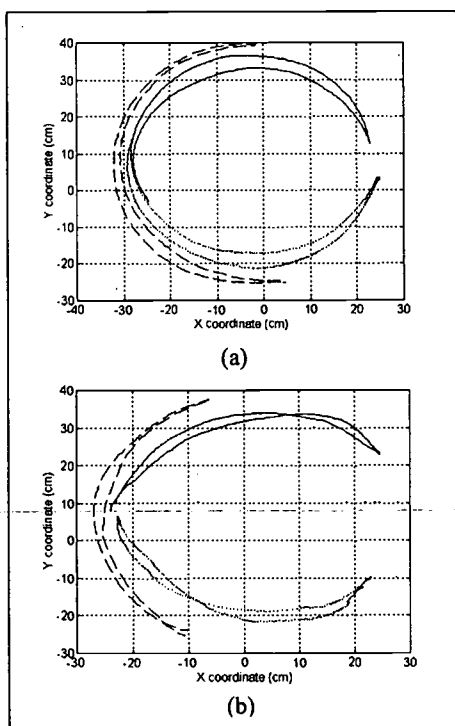

Figure 3. (a) The marker trajectories typical of a normal (viewed from the overhead camera) for a single trial of axial rotation. (b) The irregular trajectories of a malingerer. For both plots, the three line types correspond to the trajectories of three different markers. The motion of the fourth marker, the one nearest the subject's chin (see Figure 1), was not tracked for axial rotation recordings by the overhead camera.

In order to evaluate the consistency of trajectory smoothness, several trajectories of the same subject were compared. It was found that all of the normals' and patients' trajectories were substantially more consistent than some of the malingerers' trajectories. This could be

used as an indicator that trajectories that are inconsistent are likely to belong to a malingerer.

DISCUSSION

Due to the small number of subjects that participated in the study, the results presented here are of limited statistical validity. Nevertheless, the authors believe that the potential for soft-tissue neck injury diagnostic techniques employing motion analysis has been demonstrated.

It has been shown that normals and injured patients can be clearly distinguished from one another, simply on the basis of range of motion. Furthermore, two motion characteristics - smoothness and the repeatability of range - have been identified that could potentially be used to detect malingerers.

The authors also believe that qualitative analysis can be used as a valuable tool in the diagnosis of injury. While it would be preferable to have an entirely quantitative means of assessing injury, this may not be possible. With practice, a rehabilitation specialist may be able to qualitatively interpret plots such as those of Figure 3, identifying characteristic motion profiles and diagnosing the severity of injury.

In summary, motion analysis techniques hold the promise of supplementing more subjective conventional means of diagnosing soft-tissue neck injury.

REFERENCES

1. Riley LH III, Long D, and Riley LH Jr. The science of whiplash. *Medicine* 74: 298-299, 1995.
2. Mimura M, Moriya H, Watanabe T, Takahashi K, Yamagata M, and Tamaki T. Three-dimensional motion analysis of the cervical spine with special reference to the axial rotation. *Spine* 14: 1135-1139, 1989.
3. Winters JM, Peles JD, Osterbauer PJ, Derickson K, Deboer KF, and Fuhr AW. Three-dimensional head axis of rotation during tracking movements. *Spine* 18: 1178-1185, 1993.
4. Ålund-M and Larsson S. Three-dimensional analysis of neck motion: a clinical method. *Spine* 15: 87-91, 1990.
5. Rohling G and Anglin C. *SHADOW 1.0/1.3 Marker Location Software Manual*. Vancouver: Department of Mechanical Engineering, University of British Columbia, 1993.

ACKNOWLEDGEMENTS

The authors wish to acknowledge the support given for this research by the Engineering Physics Project Laboratory at the University of British Columbia.

Scott C. Morgan
B.A.Sc. Student, University of British Columbia
5959 Student Union Boulevard Box 943
Vancouver, BC V6T 1Z2
Canada
smorgan@physics.ubc.ca

A METHOD TO DETERMINE THE WORKSPACE OF PERSONS WITH CEREBRAL PALSY - A PRELIMINARY STUDY

Mark L. McMulkin, Kamariah H.K. Bahrain, and Don Malzahn
Department of Industrial and Manufacturing Engineering
Wichita State University, Wichita, KS

ABSTRACT

The maximum reach envelope was measured for five male subjects with cerebral palsy. Subjects were asked to extend their arms as much as they could, within normal daily movement capabilities. Reflective balls placed at the center of both hands were videotaped and digitized. Data obtained were in terms of distances from midpoint of the intersecting line between the seat surface and seat back. In general, subjects did not reach below the seat level or behind the seat back. Based upon these preliminary results, a recommendation requiring further testing has been generated: essential controls and switches should be located in front of the body and in the area between 30 cm to 70 cm above the seat surface.

BACKGROUND

A principle of ergonomics is to locate primary controls and displays within the normal reach area and secondary controls and displays within the maximal reach area. Therefore, the design of environments requires the knowledge of acceptable reach envelopes. Established data on these measurements exist for the population without disabilities (such as Das and Grady, 1983; Pheasant, 1980). Kozey and Das (1992) reviewed the anthropometric data for wheelchair mobile individuals. However, in general, anthropometric studies with respect to specific populations with disabilities have not been extensively undertaken (Hobson and Molenboek, 1990).

Maximal reach areas for persons with disabilities have been projected based on anthropometric measurements (e.g., Nowak, 1989). Kozey and Das (1993) pointed out the limitations of modeling the maximum reach area as a partial circle. Workspace envelopes for persons with disabilities, specifically people using wheelchairs, have been determined by direct measurement of maximum reaches (Floyd et al., 1966; Kozey and Das, 1997; Smith and Goebel, 1979).

The issue of workspace areas for the population of persons with disabilities still has not been adequately addressed. In general, studies related to workspace area for people with disabilities were performed mostly on individuals with motor dysfunction of the lower extremities. Reach envelopes for other types of disabilities have not been addressed.

RESEARCH QUESTION

The primary objective of this study was to establish a method to measure the maximal reach area for persons with cerebral palsy. A second objective was to implement the method and generate preliminary recommendations on designing work spaces for persons with cerebral palsy.

METHOD

Five male subjects with cerebral palsy that required the use of a wheelchair for mobility were recruited from the Cerebral Palsy Research Foundation of Kansas. The age of the subjects ranged from 29 to 41 years.

Hand movements were videotaped using three cameras and were digitized using the PEAK5 system (PEAK Performance Technologies, Inc.). Reflective markers were placed on the midpoint of the third metacarpal bone on the left and right hands. The subjects' individual wheelchairs were used in this experiment. A reflective marker was positioned and recorded at the location of the reference point (the midpoint of the intersecting line between the seat surface and seat back).

After reading and signing an informed consent form, subjects were given the following instructions to determine maximum reach envelope. "Try to reach out as far as you can, but not more than what you are used to doing everyday. You can move your arms with a speed that you are normally used to. You can also use your trunk to support your movements." Subjects were asked to complete horizontal and vertical movements one arm at a time. They moved their arms toward the floor and ceiling and laterally toward and away from the body. A total of six trials were performed with each arm.

RESULTS

Video tapes containing the recorded movements were digitized into the Cartesian coordinate system. The data compiled for the left and right hand of each subject were sorted into 10 cm slices (Kozey and Das, 1997) with respect to the Z axis (floor to ceiling). The slice of 0 cm to 10 cm was defined as the region between the seat surface and 10 cm above it. The hand movements were divided into 14 different 10 cm slices (Table 1). For the right hand, all subjects had movements in the area between 10 cm below the seat surface to 80 cm above the seat surface. For the left hand, all subjects had movements in the area between 30 cm to 70 cm above the seat surface.

Table 1. The number of subjects which exhibit movements in 10 cm slices above and below the seat level.

Slice (m)	Right (# Sub)	Left (# Sub)
-0.3 to -0.2	1	0
-0.2 to -0.1	1	0
-0.1 to 0.0	5	0
0.0 to 0.1	5	2
0.1 to 0.2	5	3
0.2 to 0.3	5	4
0.3 to 0.4	5	5
0.4 to 0.5	5	5
0.5 to 0.6	5	5
0.6 to 0.7	5	5
0.7 to 0.8	5	3
0.8 to 0.9	4	3
0.9 to 1.0	2	1
1.0 to 1.1	0	1

The maximum reach areas for the right hand are shown for each subject in Figure 1 (for the section 30 to 40 cm above the seat surface).

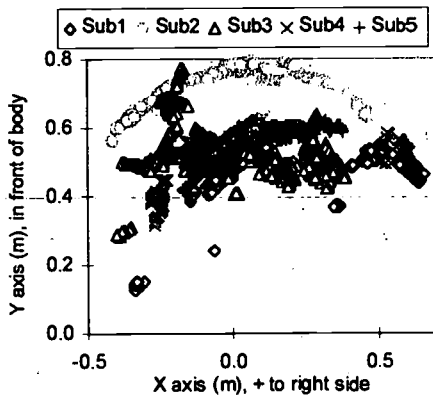

Figure 1. Right hand movements, 0.30m to 0.40m above seat

DISCUSSION

The maximum reach areas found for each vertical section have some limitations. They

indicate the outer reach limit, but they do not indicate the inner reach. Even though this is the preferred area in terms of reach, it is not certain whether this area is functionally applicable in terms of vision or upper body posture while holding a load.

Movements obtained from the subjects in this study exhibit a smaller range than those reported by Kozey and Das (1997). However, an exact comparison cannot be made because the population under study was different and the reference point was different.

Design recommendations were generated from this study which require further data collection for verification. 1) Essential controls and switches should be located at the areas between 30 cm to 70 cm above the seat surface, 2) Do not locate anything behind the subjects' seat back, 3) Do not locate anything below the seat surface, 4) Do not locate anything by the sides (in the frontal plane), and 5) movements at the lower areas were limited by arm rests and controls.

REFERENCES

1. Das, B., and Grady, R. M. (1983). Industrial workplace layout design : An application of engineering anthropometry. *Ergonomics*, 26(5), 433 - 447.
2. Floyd, W. F., Guttman, L., Noble, C. W., Parkes, K. R., and Ward, J. (1966). A study of the space requirements of wheelchair users. *Paraplegia*, May(1966), 24 - 37.
3. Hobson, D. A., and Molenbroek, J. F. M. (1990). Anthropometry and design for the disabled : Experiences with seating design for the cerebral palsy population. *Applied Ergonomics*, 21(1), 43 - 54.
4. Kozey, J. W., and Das, B. (1992). An evaluation of the existing anthropometric measurements of wheelchair mobile individuals. In *proceedings of the 25th Annual Conference of the Human Factors Association of Canada* (pp. 307 - 312). Mississauga, Ontario, Canada : The Association.
5. Kozey, J. W., and Das, B. (1993). A model of the maximal reach area for wheelchair mobile paraplegics based on direct anthropometric measurement. In *proceedings of the 26th Annual Conference of the Human Factors Association of Canada* (pp. 103 - 108). Mississauga, Ontario, Canada : The Association.
6. Kozey, J. W., and Das, B. (1997). The determination of the maximum reach envelope for wheelchair mobile adults. *Advances in Occupational Ergonomics and Safety II* (pp. 315 - 318).
7. Nowak, E. (1978). Determination of the spatial reach area of the arms for workplace design purposes. *Ergonomics*, 21(7), 493 - 507.
8. Pheasant, S. (1980). *Bodyspace. Anthropometry, ergonomics and design*. London : Taylor and Francis.
9. Smith, D. R., and Goebel, L. A. (1979). Estimation of the maximum grasping reach of workers possessing functional impairments of the upper extremities. In *proceedings of the 1979 Spring Annual Conference of the Institute of Industrial Engineers* (pp. 52 - 62).

ACKNOWLEDGEMENTS

The authors wish to thank Dr. Alex Brzezny and the subjects who helped considerably in conducting the experiment.

Mark L. McMulkin
Industrial and Manufacturing Engineering
Wichita State University
Wichita, KS 67260-0035

TESTING OF AN ACTIVITY MONITOR WITH BELOW KNEE PROSTHESIS USERS

Brian Riordan, M.E. , Stephen Sprigle, Ph.D., Maureen Linden, M.S.
Center for Rehabilitation Technology
Helen Hayes Hospital
West Haverstraw, NY 10993

ABSTRACT

Amplitude and repetition of loading are factors in skin breakdown. This paper describes the development of an activity monitor that records gait patterns of below-knee prosthesis users outside of the laboratory. The activity monitor will ultimately incorporate a socket pressure sensor. The monitor was tested with twelve prosthesis users. These subjects averaged 1328 steps/day. The median bout of walking consisted of 6 steps. Implications for the design of an integrated activity monitor/socket pressure sensor are discussed.

BACKGROUND

Use of a prosthesis subjects the skin to unusual amounts of loading, producing the potential for skin breakdown. Magnitude, duration and repetition of loading are important factors in tissue tolerance. Load vs. time profiles for prosthesis users, similar to those available for wheelchair users¹, would be valuable in the design, fitting and evaluation of prostheses. The ultimate goal of this project is to combine activity, socket pressure and skin response data to develop these profiles for below knee prosthesis users during normal daily activities.

RESEARCH QUESTIONS

This paper describes a part of the study undertaken to establish several performance criteria for the finished system:

1. An estimate of the total amount of activity for our subject group was necessary to determine needed battery life and memory capacity.
2. The activity monitor will be used to trigger sampling by a prosthetic socket pressure sensor. Typical patterns of walking for our subject group are important for the design of pressure sensor triggering and data management algorithms.
3. The monitor will be used in the subjects' home and community. Durability and stability of the activity monitor over the measurement period needed to be established.
4. The impact of the device on our subjects' daily routine was assessed. Mounting options were explored to establish the least interference with donning and doffing of the prosthesis or clothing.

METHOD

The activity monitor consists of a footswitch, interface electronics and a data logger. It is powered by a 9 V transistor battery.

The footswitch (Vicon) was shaped for insertion into the subject's shoe. The sensor contains four switching areas corresponding to the great toe, first and fifth metatarsal and the heel.

The foot switch is logically divided into two areas: forefoot and hindfoot. The data logger (Onset TT8) stores the area loaded and the duration of each event. The logger was programmed to enter a low power sleep mode if there was no activity on the foot

switch for more than 5 sec. The date and time are recorded for each sleep cycle.

The monitor was tested with 12 below knee prosthetic users. Three of the subjects were bilateral amputees. Age ranged from 39 to 82. All of the subjects had been using prostheses for more than a year.

The sequence "hindfoot, forefoot, open", along with time constraints, was used by our step detection algorithm. Steps with durations between 0.8 sec and 2.0 sec were defined as "standard" steps. Steps with durations less than 0.8 sec or between 2.0 sec and 5.0 sec were defined as non-standard. Events not fitting this profile were defined as non-walking activity and were not included in subject walking analysis. Non-walking events were included in analysis of power and memory requirement.

The activity monitor was adjusted for each subject such that the sensor was inactive when the subject was sitting and was just at the activity threshold in passive standing. The investigator confirmed that steps during the subject's natural gait were detectable by the algorithm.

Each subject wore the monitor for 3 days. Upon their return, the investigator checked the performance of the monitor to note any changes since the initial configuration of the system. Durability was assessed by visual inspection of the footswitch. Impact of the system on the subject's daily routine was assessed by questioning of the subject by the investigator.

RESULTS

Four of the subjects' walking data was not analyzed due to hardware problems. The remaining eight subjects' data was analyzed by bout of walking. A bout of walking was defined by the time between "sleep" periods, i.e. continuous activity without any pauses greater than 5 sec in duration.

The number of steps in each bout was displayed in histogram form to give an impression of patterns of activity. Below is a sample histogram.

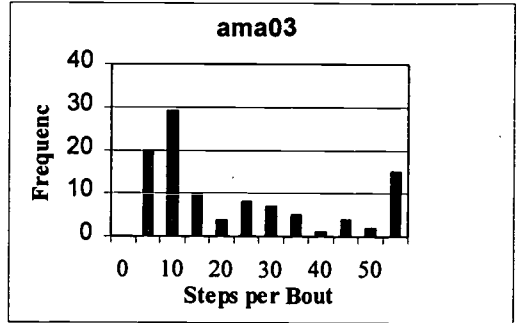

The median number of steps per bout ranged between 3 and 109. The median of all subjects' data was 6. The maximum steps per bout for each subject ranged between 183 and 1813. The median was 336.5. The median duration of a bout of walking was 13.6 sec.

The total steps per day for our subjects was 1328 ± 660 (Mean ± SD). The range was 527-2564. This is in general agreement with past studies. Holden and Fernie reported an average of 760 steps/day for inpatient below-knee prosthesis users. The average increased to 2000 steps/day in their first year as outpatients².

Total walking time ranged from 0.5 to 1.5 hours per day. This is considerably less than the 8 hours per day reported by Coleman *et al* in their study of able bodied subjects.³ It is to be expected that our subject group would show lower activity levels than non-disabled individuals. The discrepancy also may be due in part to our exclusion of "non-walking" activity data.

To determine battery life expectation, the capacity of six of the batteries was analyzed after use. The average remaining capacity was 904 ± 290 mA-hours. This corresponds to approximately 18 hours of active monitoring time still available. The average length of the data files was 109 kb; the

maximum length was 206 kb. This indicates approximately 2.5 Mb remaining for socket pressure data.

DISCUSSION

Two subjects reported that the activity monitor made their limbs feel heavy. Neither of these subjects thought it had affected their activity level. None of the subjects said the activity monitor interfered with donning or doffing their prosthesis or clothing. The subjects expressed no other concerns about wearing the system.

The footswitches did not show any signs of damage after being worn for three days. Hardware failures that occurred did not appear to be due to damage during the test. There did not appear to be any change in the sensitivity of the switches over the testing period.

Of the four subjects whose data was dropped from the analysis, three had failures for known causes. The fourth subject's gait pattern as recorded by the activity monitor could not be processed by our current software. This individual was a bilateral amputee and used a walker. It is possible that data from certain individuals (bilateral amputees, users of ambulatory aids) will require preprocessing by hand.

The major problem found with the activity monitor was "sticking" of the switch for long periods of time. We believe this is due to mechanical sticking of the foot in the shoe. This problem had not been observed in earlier long term testing of the system with non-disabled individuals, probably due to the complete unweighting of the switch at night and the greater flexibility of the anatomical foot. The implication for this study is a probable underestimate of walking activity. We are currently considering other configurations of the footswitch to address this problem.

There is a great deal of non-walking activity for all subjects which was not analyzed in determining walking patterns. The data consists of extremely variable patterns of loading and event durations. Automated processing of this data will be difficult in any case.

In conclusion, his activity monitor is capable of recording ambulatory data over a three day period. The battery and memory of the system appear to be sufficient. The step detection algorithm is effective with this population. We gathered sufficient information on the activity patterns of our subjects for use in development of the sampling algorithm for socket pressure. The system was acceptable to the subjects for three days of home and community use.

REFERENCES

1. Reswick JB, Rogers JE: Experience at Rancho Los Amigos Hospital with devices and techniques to prevent pressure sores. In *Bedsores Biomechanics*, Kendi RM, Cowden JM, Scales JT (Eds.), 301-310
2. Fernie GR, Holden JM: A data-logger for recording patterns of daily activity. *J Med Eng Tech*, 7: 93-95; Mar/Apr 1983
3. Coleman KL, Smith DG, Joseph AW, Boone DA: *Gait activity monitor for long term measurement of ambulatory function*. RESNA Proceedings 1995, 168-169.

ACKNOWLEDGMENTS

Funding provided by NIH, National Center for Medical Rehabilitation Research

Brian Riordan, M.E.
 CRT- Helen Hayes Hospital
 Rt. 9W, West Haverstaw, NY 10993
 email: crthhh@mindspring.com

A SIMPLE DECOMPOSITION METHOD FOR ANALYZING GROUND REACTION FORCE IN GAIT ANALYSIS

Daniel H.K. Chow¹, Eric W.C. Tam¹, Terry K.K. Koo¹, Kelvin K.T. Ng¹ and Stephen Naumann²

¹Jockey Club Rehabilitation Engineering Centre, The Hong Kong Polytechnic University

²Rehabilitation Engineering Department, Bloorview MacMillan Centre

ABSTRACT

In order to facilitate clinicians in interpreting comprehensive gait parameters, a simple decomposition method was proposed. Gait parameters of *continuous* pattern were transformed into *discrete* coding pattern. As a preliminary study, vertical and anterior-posterior components of the ground reaction force during stance phase of 15 normal subjects walking at normal and slow speed were analyzed using the new method. For both walking speeds, two consistent coding patterns were obtained. The potential applications of the new approach for studying gait disorders and coordination strategy were highlighted.

INTRODUCTION

Human walking is a complex process involving coordination of the body's musculoskeletal elements and their neural controls. Human locomotion researches conducted in the past decades have provided the basic knowledge for identifying possible underlying causes of gait disorders. This knowledge is useful in assisting surgeons in planning proper corrective surgery, and clinicians in prescribing effective treatment and/or rehabilitation program. However, conventional clinical gait assessments are subjective and highly dependent on visual observation by the 'trained-eyes' and the experience of individual clinicians. With the advancement of modern electronic technology, sophisticated gait analysis systems are now commercially available for performing gait analysis in an objective manner. However, due to the comprehensive nature of such an analysis, voluminous data are generated. This makes comparative analysis and clinical application difficult as most gait analysis parameters obtained are not presented in such ways that clinicians could make direct interpretations. This significantly comprises the usefulness of

objective instrumented gait analysis in clinical application.

The development of an intelligent system that automates the whole process of gait analysis, from data collection, organization, analysis, diagnosis and even provides expert recommendations to treatment plans, has been one of the research foci since the late 70's. A number of expert systems have been developed including the Stanford Gait program [1], GAITSPERT [2], Dr. Gait-1, Dr. Gait-2 and QUAWDS [3], and GAIT-ER-AID [4]. However, due to the complexity of these systems, their applications in clinical situations are still very much limited to the associated clinical settings where these expert systems were developed. In view of that, our attempt is to devise a simple method to assist clinicians in sorting and interpreting the gait parameters. As a preliminary study, the feasibility of the new method in analyzing ground reaction force during stance phase was investigated.

METHODOLOGY

Fifteen subjects with age within 23 to 37 years old, with no history of lower limb disorder or trauma were recruited. Their physical measurements including height and weight were recorded. Each subject was asked to walk with bare foot over a force platform (AMTI, Advanced Mechanical Technology Inc., USA). Twenty walking trials were recorded for each subject, i.e. 10 trials (5 trials for each limb) at the subject's normal walking speed and 10 trials at slow walking speed. The speed of each walking trial was also recorded.

Two components of the three-dimensional ground reaction force including the vertical reaction force (VRF) and the anterior-posterior shear force (APF) were extracted and decomposed by the new method as follows. Firstly, the force-time curves of the two

reaction forces were normalized with respect to the duration of the stance phase. Critical points (i.e. local maxima and local minima) of the two normalized curves were then identified and their corresponding event times were recorded. In order to avoid possible false detection of critical points due to background noise embedded in the signal, any changes within 5% of the amplitude of each curve were disregarded. Subsequently, the identified event times for the two curves were used to divide the stance phase into sub-phases. A code of either '+', '-' or '0' was then assigned to each sub-phase of each curve if the slope between two consecutive event times was positive, negative or unchanged, respectively. Accordingly, a coding pattern could be obtained for each pair of curves (figure 1). The whole decomposition process was performed using a simple computer program.

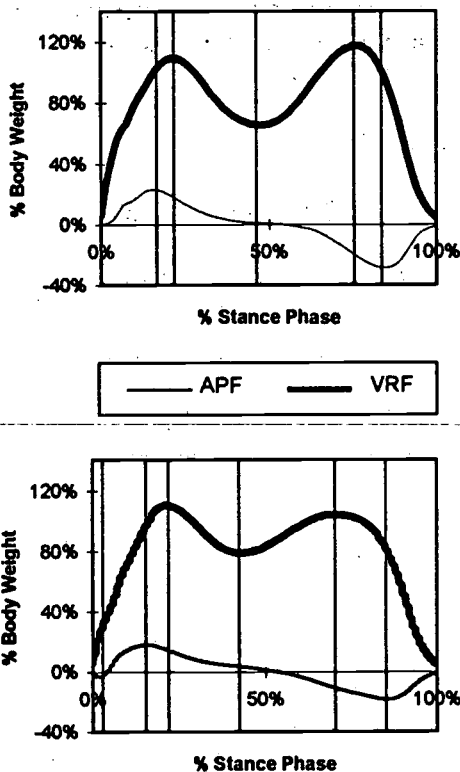

Figure 1. Curves for the vertical reaction force and the A-P shear force were decomposed by the new method - Pattern 1 (above), Pattern 2 (below)

RESULTS

A total of 15 subjects, 11 males and 4 females, with an average age of 31 years old participated in this study. Force platform data were obtained from both limbs during bare foot walking condition. For the subjects walking with normal or slow speed (average 1.4 m/s), the following two coding patterns were obtained.

Pattern 1	VRF	+	-	-	-	-	+
	APF	+	+	-	+	-	-
Pattern 2	VRF	-	+	-	-	-	+
	APF	+	+	+	-	+	-

The number of subjects in each coding pattern for each limb of the subjects walking with normal and slow speed is given in the following table.

Table 1. No. of subjects in each coding pattern for each limb during normal and slow walking

		Pattern 1	Pattern 2
Normal	Left	14	1
	Right	12	3
Slow	Left	13	2
	Right	14	1

DISCUSSIONS

A simple method was proposed for sorting gait parameters. As a preliminary study, the new method was applied to analyze ground-reaction force during stance phase. Two consistent coding patterns were obtained for all the 15 normal subjects walking at either normal or slow speed. The difference between the two patterns was the additional initial sub-phase shown in pattern 2 (figure 1), which was due to the 'claw back' action detected from the APF curve during initial loading. This action has been regarded as normal and was found to occur in about 12% of the subjects' walking trials.

Conventionally, the stance phase was subdivided into 4 events or sub-phases, i.e. loading response, mid-stance, terminal stance and pre-swing. Not all the onset times of these

4 events could easily be determined using only force platform data. It was demonstrated that by means of the proposed method, the stance phase could easily be subdivided into 6 or 7 (including the claw back action) sub-phases with good repeatability. Moreover, gait parameters of *continuous* pattern could be transformed into *discrete* coding pattern. Any missing or extra sub-phase(s) could be identified immediately. This could prompt the clinicians to focus on the sub-phase(s) with potential disorders.

It was also noted that the codes of each sub-phase are always different from the sub-phases before and after that sub-phase. It might allude that a specific control or coordination strategy is being used in each sub-phase. Further investigation is being conducted to study the coordination of various lower limb muscles within each sub-phase.

In order to eliminate the background noise embedded in the force platform data, a simple approach was adopted in the preliminary study. Any peak-to-peak variation of less than 5% of the amplitude of each force-time curve was disregarded. It was suggested that the size of this window could be adjusted according to the level of the noise of the acquired signal or the signal could be low-pass filtered.

The new decomposition method had also been applied to analyze the medial-lateral component of the ground reaction force. However, inconsistent coding patterns were obtained. This might be due to the large variation of this component in the normal population.

REFERENCES

1. Tracy K, Montague E, Gabriel R, Kent B (1979) Computer-assisted diagnosis of orthopaedic gait disorders. *Physical Therapy* 59(3): 268-277.
2. Dzierzanowski JM, Bourne JR, Shiavi R, Sandell HSH, Guy D (1985) GAITSPERT: an expert system for the evaluation of abnormal human locomotion arising from stroke. *IEEE Transaction Biomedical Engineering*, BME-32 (11): 935-942.

3. Hirsch DE, Simon SR, Bylander T, Weintraub MA, Szolovits P (1989) Using Causal Reasoning in Gait Analysis. *Applied Artificial Intelligence* 3:253-272.
4. Bekey GA, Kim JJ, Gronley JK, Bontrager EL, Perry J (1992) GAIT-ER-AID: An Expert System for Diagnosis of Human Gait. *Artificial Intelligence in Medicine* 4:293-308.

ACKNOWLEDGEMENTS

This work is supported by the Departmental Research Grant of the Hong Kong Polytechnic University.

Daniel HK CHOW, Ph.D.

Assistant Professor

Jockey Club Rehabilitation Engineering Centre

The Hong Kong Polytechnic University

Hunghom, Kowloon

Hong Kong

Tel: (852) 2766-7674

Fax: (852) 2362-4365

Email: RCDANIEL@PolyU.edu.hk

BIOMECHANICAL ANALYSIS OF SCOTT-CRAIG LONG LEG TYPE BRACES DURING AMBULATORY TASKS

Tom Dang, M.S.E., John Noiseux, M.S., Joyce Luncher, B.B.E., Bradford Blaise, B.B.E.
Assistive Technology Research Center, Rehabilitation Engineering Service
National Rehabilitation Hospital
Washington, D.C.

ABSTRACT

The primary aim of this study was to obtain a quantitative understanding of the overall mechanical stress patterns, during various ambulatory and functional tasks, of the Scott-Craig long leg brace used by paraplegics. Conventional, foil-type strain gages were used to measure the stresses at specific sites along axes of the brace uprights. Data acquired from these gages were used to determine the mechanical stresses of the braces during the following ambulatory tasks: (I) swing through gait, and (II) ambulating up and down steps.

One goal of this study was to provide information to the orthotics industry to address the issue of over-design which results in excessive safety margins, and increased weight and bulk. Results from this study will also be of use in future development of non-metallic composite bracing components.

BACKGROUND

Several brace designs have been evaluated objectively. These studies, however, only examined a few load components, and provide a very limited view of overall loading patterns.

Lehmann *et al.* (1976) conducted several biomechanical and functional evaluations of different designs of bilateral long leg braces for paraplegics. Using force platform and transducer (strain gage) data to measure mechanical work, and heart rate and oxygen consumption data to measure energy expenditure, Lehmann focused primarily on comparing existing designs, rather than obtaining information on loading patterns.

In 1971, Lippert attempted to measure forces exerted on selected ischial weight-bearing braces during ambulation. That study was

designed to measure the magnitude of forces and moments only at specific brace structures and to assess the function of various brace components.

In 1981, Trappitt *et al.* designed six-channel force transducers to measure the loads in a conventional knee-ankle-foot orthosis.

RESEARCH QUESTION

The focus of the current study was to answer the question: "How are stresses distributed throughout the Scott-Craig long leg brace components during ambulatory activities?"

METHOD

Data were collected for a total of three subjects. All subjects were paraplegics that ambulated with Scott-Craig braces for more than one year. Stresses were studied by measuring the resultant surface strains along the brace uprights using general-purpose, miniature single-grid gages.

The gages were mounted on the medial, lateral, anterior and posterior surfaces of the upright. The types of stresses measured at specific sites along the brace were consistent to all braces.

For this study, the major loading axis was assumed to be along the longitudinal axis of the upright. Gages were placed at four sites on each upright: above ankle, below knee, above knee, and below ischial band. Designation of each gage was specified as follows: left or right brace (L, R), medial or lateral upright (M, L), site on upright (AA = above-ankle, BK = below-knee, etc.), and face of upright (AP = anterior-posterior, L = left, R = right). For example, LM AA R denotes the Left brace, Medial upright, Above-Ankle gage on the Right face of the

upright.

Medial-Lateral bending was measured by single-grid gages mounted opposite each other on the medial and lateral sides of the upright. Each Medial- and Lateral-gage was a component of a quarter-bridge circuit. Anterior-Posterior bending was measured by single-grid gages mounted precisely opposite each other on the anterior and posterior surfaces of the upright. Each Anterior- and Posterior-gage was a component of a half-bridge circuit.

The custom-built, strain gage data collection circuit consisted of Wheatstone quarter- and half-bridges, multiplexers to sample the strain gage data, and instrumentation amplifiers with 1000x gain. A 25-foot, shielded tethered cable was used to interface the data collection boxes to a PC via a data acquisition card (National Instruments). All data collection circuits were powered by +5V DC supplied from a power supply, while the strain gages were powered by an independent +3V power supply (with constant voltage).

Each Wheatstone bridge was balanced prior to data collection through the adjustment of trimming potentiometers built into the circuitry. The LabVIEW (National Instruments) software package was used to acquire and reduce the data.

During testing, patients were asked to don their instrumented braces and perform the following tasks (under the supervision of a physical therapist and the research team): (I) swing-through gait, (II) ambulating up a step, and (III) ambulating down a step. Applied loads caused stress and strain fields to develop within the braces. Strains were transformed to voltage signals by the gage bridge circuits and used to calculate stresses using the gage factor and bridge output equation (both supplied by Micro-Measurements). The data were reduced to obtain the peak stresses observed at each site during each task.

RESULTS

Only representative samples of the data

collected are included in this section, due to the volume of data generated.

A sample of the stresses calculated for a typical gait trial for the above-ankle site of a single brace upright are included as Figure 1.

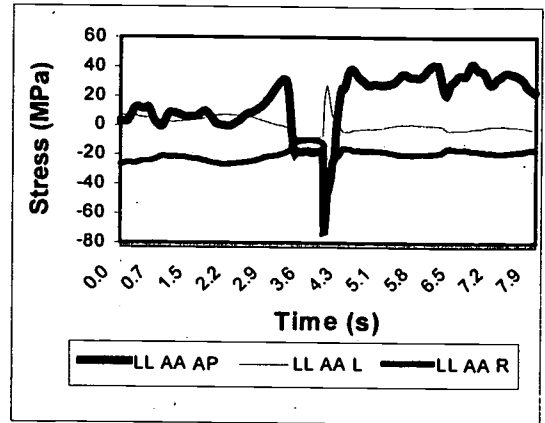

Figure 1. Plot of stress at above-ankle gages vs. time during ambulation task.

Peak stresses calculated at RM AA AP during each gait trial, for each subject, are tabulated in Table 1.

Gait Trial #	Subj. 1 (MPa)	Subj. 2 (MPa)	Subj. 3 (MPa)
1	-47	-88	-29
2	-43	-61	-26
3	-43	-59	-20
4	-41	-88	-48
5	-37	-83	-44
6	-40	-67	-39
7	----	-71	-42
8	----	-93	-49

Table 1. Maximum stress recorded by the Right brace Medial upright Above Ankle Anterior-Posterior (RM AA AP) gage by gait trial and subject. NOTE: "-" denotes compression.

Highest magnitudes of stress (both tensile and compressive), for each subject and task, have been tabulated in Table 2. The data included in the table are the peak stresses averaged over all trials. Only the subjects' overall maximum stress (in MPa), and the gage site where it was

recorded, for each task, are included.

	Subject 1		Subject 2		Subject 3	
	Gage	MPa	gage	MPa	Gage	MPa
Gait	LL AA AP	-68	RM IS R	-102	LM AA R	-34
	RL BK R	52	RM AA L	66	RM AA AP	92
D. Step	LL AA AP	-112	RM IS R	-105	RL AA R	-51
	LM BK R	138	LM AA R	51	RM AA AP	69
U. Step	LL IS L	-84	RM IS R	-122	RL AA R	-67
	LL IS AP	107	LM AA L	62	LM BK L	101

Table 2. Maximum stress, and site at which they were recorded, for each subject. NOTE: “-“ denotes compression & “+” denotes tensile.

DISCUSSION

The highest stresses measured were not consistently located at any one site (even within any single subject's data) (see Table 2). It was, however, noted that the above-ankle site was the most frequent site of high stress. This was consistent with physical reasoning and comments by orthotists indicating that a frequent site of brace failure is at the ankle joint. Large variations in maximum stresses were noted both between subjects, and between repetitions of identical tasks by the same subject (see Table 1). The highest stresses were recorded during the up and down a step tasks, but stresses over 100MPa were recorded even during gait trials. The highest stress recorded during the study was approximately 138 MPa, due to Medial-Lateral loading. This occurred during the down a step task, at the below knee site.

Variations in stress are due to many factors, among these, patient height and weight, the customized shape of each user's brace uprights, proficiency and functional ability of the walker, and walker's fatigue.

CONCLUSION

The highest maximum stress measured from the Scott-Craig braces was about 45% of the tensile yield strength of stock Aluminum 2024-T4, which is well within loading limits. However, this data is inconclusive because factors such as work-hardening, and cyclic loading were not investigated.

REFERENCES

1. Lehmann, J.F. *et al.* (1976) Trends in Lower Extremity Bracing. *Arch Phys Med Rehabil*, 57: 438-442.
2. Lippert, F.G. (1971) A Long Leg Brace for Comprehensive Force Measurement. *Acta Orthop. Scand. Supp.*, 138.
3. Trappitt, A.E. *et al.* (1981) A Transducer for the Measurement of Lower Limb Orthotic Loads. *Engineering in Medicine*, 10:149-153.

ACKNOWLEDGEMENTS

This project was supported by the National Rehabilitation Hospital's Assistive Technology Research Center funded by the U.S. Army Medical Research and Materiel Command of the Department of the Army under Cooperative Agreement Number DAMD17-94-V-4036.

Tom Dang tdd1@mhg.edu
 Rehabilitation Engineering Service
 National Rehabilitation Hosp.
 102 Irving Street, NW
 Washington, D.C. 20010-2949
 (202) 877-1932 Fax: (202) 723-0628

INTERACTIVE VIDEO EXERCISE SYSTEM FOR PEDIATRIC BRAIN INJURY REHABILITATION

Tom Dang, M.S.E., David Brennan, B.B.E., and Melanie Brown, M.D.
Assistive Technology Research Center, Rehabilitation Engineering Service
National Rehabilitation Hospital
Washington, D.C.

ABSTRACT

The Interactive Video Exercise System (IVES) has been developed as an instrumented video-game-enhanced exercise program for pediatric brain injury patients. This paper presents the design specifics of the system, which is both an alternative therapy method for providing an interactive and entertaining form of therapy for lower extremity pediatric rehabilitation, and an economical, quantitative measure of lower extremity strength for the pediatric population.

BACKGROUND

Lower extremity rehabilitation for children with brain injury poses a challenge to therapists. Brain injury commonly results in weakness, spasticity, and difficulty coordinating muscle actions in the lower extremities leading to functional limitations such as walking difficulty. Over the years, various therapeutic interventions have been developed and used in the treatment of children with brain injuries. Although occupational and physical therapies are components of the treatment program, their effectiveness as conventionally practiced has not been proven (Tirosh 1989).

BIOFEEDBACK

During the past twenty years, biofeedback instrumentation has been a growing part of pediatric rehabilitation. Biofeedback is defined as the processing of covert physiologic responses so that patients can react to and interact with overt visual and auditory representations of the responses to achieve purposeful behaviors (Wolf 1978). In other

words, an individual sees or hears cues, which represent any one of several physiologic variables (e.g., heart rate, muscle activity, skin temperature, etc.). The individual can control (self-regulate) the physiologic variables by responding to the cues. When high quality EMG biofeedback systems are used, there has been evidence that they are effective. Seeger *et al.* (1981 & 1982) conducted two studies to investigate the use of biofeedback to achieve symmetrical gait in children with hemiplegia due to cerebral palsy.

DYNAMOMETRY

Therapists assess muscle performance to evaluate treatment effectiveness and status. There is a need for quantitative, objective measures of muscle performance to provide documentation of progress and intervention efficacy. Three commonly used methods are hand-held, isometric, and isokinetic dynamometry. Studies have shown that all three measures of muscle performance are reliable but have several limitations (Deones *et al.* 1994, Kues *et al.* 1994). With the exception of hand-held devices, dynamometers are expensive, require large space and extensive training, and are made to be used by average adults, not children (Reinking, 1996).

STATEMENT of the PROBLEM

Lower extremity rehabilitation for pediatric, brain injury patients poses a challenge to therapists. The two goals of this project were: (1) to develop motivational instrumented video game exercise programs for pediatric rehabilitation, and (2) to develop a low cost,

Interactive Video Exercise System
reliable, objective device to measure muscle
performance for a pediatric population.

RATIONALE

The feasibility of an **IVES** program has been demonstrated in the Assistive Technology Research Center at the National Rehabilitation Hospital. The original design of the instrumented video game consisted of a video game control module in which one of the switches was replaced by a surface EMG electrode. When this surface EMG electrode was placed over the tibialis anterior or rectus femoris, several volunteers were able to manipulate the main character in the video game through repeated ankle dorsiflexion or knee extension, respectively. The game could not be successfully played without repeatedly performing the lower extremity strengthening exercises. Observation and comments by parents suggest that the concept of motivating children to perform exercise therapy by using instrumented video games has considerable potential.

DESIGN

The system consists of three main components: an isometric test apparatus, a data processing circuit box, and a Super NES™ system with an adapted game controller. The isometric test apparatus (Fig. 1) consists of two super-mini, single-axis load cells (Interface, Inc.). Load cell 1 (LC1) is rigidly mounted onto a metal cross-bar, which clamps to the two rear legs of a chair. A high tensile cable and an ankle band couple the subject's shank to this load cell. Load cell 2 (LC2) is mounted in the FootBox, which rests on the floor. The FootBox is essentially a modified load platform consisting of LC2 rigidly mounted between two aluminum plates. The subject's foot rests on the top plate against a heel stop, and is secured with two Velcro straps.

Isometric knee extension moment is measured by LC1 with the knee resting at 90 degrees. Isometric ankle dorsiflexion moment

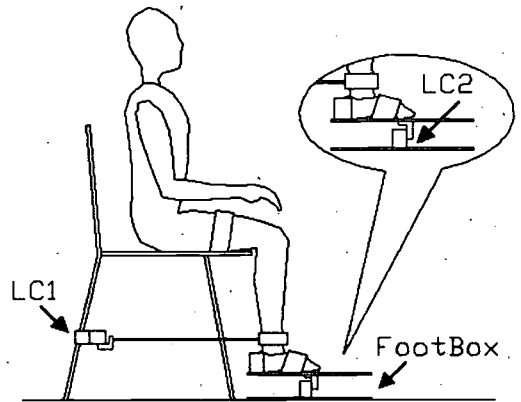

Fig. 1 IVES Setup

is measured by LC2 with the ankle resting in neutral position. The signal from either LC1 or LC2, dependent on the muscle group being isolated, is transmitted to the data processing box, where it is processed and compared with a variable threshold value set by a potentiometer. When the transducer's signal exceeds the threshold value, voltage is passed to the adapted game controller whereby the selected operation is executed (e.g., move right, move left, move up, move down, A, B, etc.). As a result, the subject can only play the game by performing certain isometric exercises.

Additionally, the load cell signals are collected on a PC through LabVIEW (National Instruments) and are used to calculate net joint moment at the knee and ankle. The data collected provides therapists with objective measures of muscle performance.

DEVELOPMENT

The current **IVES** prototype is still being refined. After preliminary testing with subjects, some necessary modifications were evident. The circuitry was originally built onto a soldering board, which caused some loose connections. As a result, most of the circuitry was rebuilt onto PCB boards. Once the method for measuring net isometric joint moments is verified, the next stage of development will be better packaging. For example, the data collection box for the load cells could be

Interactive Video Exercise System redesigned to be a stand-alone system rather than requiring a PC.

EVALUATION

A pilot study is planned to evaluate the effectiveness of IVES as compared to traditional therapy methods for a pediatric brain injury population. Two groups (A & B) of 5-10 subjects each will be recruited for the pilot study. Group A will first have six weeks of traditional strengthening therapy and then switch to another six weeks of therapy with IVES. Group B will have their therapy in the opposite order. The number of hours per week that are spent in traditional strengthening exercise will be the same time that the subjects will spend using IVES.

The objectives for this pilot study are: 1) to evaluate the use of an instrumented video exercise system to increase lower extremity muscle strength in children with brain injury, and 2) to compare the strength gains obtained using an instrumented video exercise system to gains made with conventional strengthening rehabilitation programs alone.

DISCUSSION

The prototype IVES is nearing completion and the pilot study will soon begin (pending Institutional Review Board approval). Following the completion of the pilot study, a larger scale (larger sample population) experiment will be conducted to add power to the experimental results.

With a system that can motivate patients to perform video game exercises to strengthen muscles and can objectively measure net isometric joint moments, the authors hypothesize that therapists will have an enhanced method of pediatric brain injury rehabilitation.

REFERENCES

1. Deones VL, Wiley SC, & Worrell T, (1994). Assessment of quadriceps muscle

performance by a hand-held dynamometer. *J Orthop Sports Phys Ther.* 20(6), 296-301

2. Kues J, Rothstein JM, Lamb RL, (1994). The relationship among knee extensor torques produced during maximal voluntary contractions under various test conditions. *Phys Ther.* 74(7), 674-682.

3. Reinking MF, Bockrath-Pugliese K, Worrell T, Kegerreis RL, Miller-Sayers K, Farr J, (1996). Assessment of quadriceps muscle performance by hand-held, isometric, and isokinetic dynamometry in patients with knee dysfunction. *J Orthop Sports Phys Ther.* 24(3), 154-159.

4. Seeger BR, Caudrey DJ, Scholes JR, (1981). Biofeedback therapy to achieve symmetrical gait in hemiplegic cerebral palsy. *Arch Phys Med Rehabil.* 62, 364-8.

5. Seeger BR, Caudrey DJ. (1982). Biofeedback therapy to achieve symmetrical gait in children with hemiplegic cerebral palsy: Long term efficacy. *Arch Phys Med Rehabil.* 64:160-2.

6. Tirosh E, Rabino S. Physiotherapy for children with cerebral palsy: evidence for its efficacy. *Am J Dis Child.* 143:522-525, 1989.

7. Wolf S.L. Essential considerations in the use of EMG biofeedback. *Physical Therapy.* 58:25-31, 1978.

ACKNOWLEDGEMENTS

This project was supported by the National Rehabilitation Hospital's Assistive Technology Research Center funded by the U.S. Army Medical Research & Materiel Command of the Department of the Army under Cooperative Agreement Number DAMD17-94-V-4036.

Tom Dang tdd1@mhg.edu
Assistive Tech. Research Center
Rehabilitation Engineering Service
National Rehabilitation Hosp.
102 Irving Street, NW
Washington, D.C. 20010-2949

SIG-06
Special Education

EXPLORING PATTERNS™: SOFTWARE EVALUATION

Carol Stanger and Arjan Khalsa
IntelliTools, Inc.
Novato, CA

ABSTRACT

Two programs were developed in order to make it easier for children with special needs to learn about patterns – *Exploring Patterns* and the *Exploring Patterns Activity Book*. To evaluate the efficacy of these programs, students across the country were observed while using the programs in a classroom environment. It was found that the programs were effective in teaching patterns content and that they contributed to the inclusion of children with special needs in regular education classrooms.

BACKGROUND

Patterns are a fundamental building block of understanding mathematical principles in early elementary education. Young children learn basic patterns by participating in a number of pattern activities that take place in the classroom. Examples of common activities include: copying finger snap and hand clap patterns modeled by the teacher; or building an AB pattern by connecting Unifix cubes of two different colors. Children with special needs often have difficulty taking part in such activities because of motoric, cognitive or other barriers to participation. To address the needs of such children we developed two complementary programs: *Exploring Patterns* and the *Exploring Patterns Activity Book*. These programs were designed to teach patterns curriculum content, as identified by the National Council of Teachers of Mathematics (NCTM) (*Professional Standards*, 1991, *Mathematics Framework*, 1992), while offering full accessibility to children with special needs. Both software programs can be operated

through a computer mouse, the IntelliKeys Keyboard or through on-screen scanning techniques. Evaluation of the programs took place at 13 schools across the country where 31 children in the Kindergarten to Fifth Grade range used one or both of the programs.

RESEARCH QUESTION

The fundamental question addressed by this research was whether the Exploring Patterns software allowed children with disabilities to participate in learning standard patterns curriculum content. In answering this question, more specific research questions were: a) Does the software allow children with special needs to be fully included in regular education classrooms? b) Does the software match standard curricula used across the country?

METHOD

The NCTM standards specify that the mathematics curriculum should include copying, extending and creating patterns. To teach this, we created products which allow for both an exploration of patterns in the environment and in a structured activity format. The *Exploring Patterns Activity Book* contains 30 screens (or pages) of black-line outlined graphics of animals, geometric patterns, international textile designs, and tessellations which are colored in by the child to produce multi-color patterns. To address the need for a structured experience with copying, extending, and creating patterns, we developed a program called *Exploring Patterns*. *Exploring Patterns* is designed to start the child with two color AB, AAB, and ABB pattern types and then to move on to three and four color patterns as well as

EXPLORING PATTERNS

growth patterns. It is made up of five separate modules: Two Color (AB), Sound (AB), Translating (AB with Labeling and Translations), Four Color (ABCD), and Growth Patterns.

Most of the modules have thirty separate pages of activities. The programs both provide children with an opportunity to listen to and learn about the pattern while requiring a demonstration of their mastery with patterns.

Children with disabilities across the country, most of whom were in mainstreamed regular classrooms, used this software over the course of the school year. Children involved in this study had great difficulty learning about patterns in the traditional means as a result of cerebral palsy, Down's Syndrome, autism, multiple disabilities including deafness, and learning disabilities. In each geographic location a leader in the field of technology access for children with disabilities served as a National Trial Site Leader. The Site Leaders identified students within schools in the area who might benefit from the use of this software. A total of 31 students across 13 schools participated, as noted in Table I.

TABLE I

Grade	TN	MA	CA	WI	Total
Kindergarten	2	3		1	6
First		2		3	5
Second	3				3
Third	1	1			2
Fifth		1			1
Ungraded				1	1
Resource			8		8
Special		3	2		5
Total	6	10	10	5	31

The National Trial Site Leaders were trained in the curriculum and use of the software. These leaders then trained the teachers and aides in the schools. Observers visited each classroom and recorded the child's interaction with the software. At the conclusion of the school year, two types of information

were collected: a) Observer's perceptions of the child's interaction with the software; b) Teacher's perceptions about the software.

RESULTS

Observer data

The observer was asked to rate the student's use of the software by looking at the student's participation in the activity and inclusion in the classroom. Questions were rated from 1 (no, never) to 5 (yes, very much so). Table II lists the question content and results for each piece of software.

TABLE II: OBSERVER DATA ON STUDENT

Questions	Exploring Patterns		Patterns Activity Book	
	#	Avg.	#	Avg.
1) Student engaged?	31	4.3	22	4.3
2) Student satisfaction?	31	4.6	22	4.7
3) Student frustration?	31	2.8	22	2.7
4) Appropriate?	31	4.1	22	4.0
5) Student enjoyment	31	4.3	22	4.4
6) Foster inclusion by teacher?	17	3.5	11	4.0
7) Student more included?	17	3.8	11	4.4

Note: Some student used both pieces of software, some only one. Answers to questions 6 and 7 were collected only for the students in full inclusion classrooms.

In general, students were engaged in the work, showed satisfaction, and experienced an average level of frustration. All of these factors are notable as the population of users who participated in this study generally has difficulty engaging in learning this material otherwise.

The work was generally appropriate for the students and they appeared to enjoy the activity. Of the 23 classrooms, 17 were full inclusion environments. In these classrooms it was generally found that the software assisted in the

process of inclusion.

Teacher Questionnaire

Teachers were asked to rate the software in terms of ease of use, meeting classroom and curricular and student needs (see Table III). Overall, data was collected from 19 teachers regarding *Exploring Patterns™* and from 11 teachers regarding the *Patterns Activity Book*. Statements were rated from 1 (lowest/hardest/worst) to 5 (highest/easiest/best).

TABLE III: TEACHER QUESTIONNAIRE

Questions	<i>Exploring Patterns</i>		<i>Patterns Activity Book</i>	
	#	Avg.	#	Avg.
1) Program operation	19	3.9	11	4.3
2) Correlation with math curriculum	18	3.9	11	3.9
3) Meeting needs of students	19	4	11	3.9
4) Appropriate for class?	18	3.9	11	4.4
5) Fostering independence	19	4.2	11	4
6) Helping Students feel included	19	4.4	11	4
7) Popularity	19	4.4	11	4.2
8) Overall	18	4.2	11	4

Note: Not all teachers answered all questions.

Teachers generally concluded that the software did correlate to their math curriculum. They also felt that it met the needs of individual students, was appropriate for the class, and fostered independence for students with disabilities. As shown in Table I, teachers gave *Exploring Patterns* high ratings for its popularity with students as well as its effectiveness in helping students with disabilities feel included.

DISCUSSION

This study evaluated the use of two new, fully accessible programs which teach patterns curriculum based on the NCTM Standards. Thirty-one students in 13 different schools in four parts of the country evaluated the programs, *Exploring Patterns* and *Exploring Patterns Activity Book*. This software was found to be very beneficial for most of the children targeted for use within this study. Teachers who were using technology to include children with disabilities into the regular classroom community found the software very beneficial for teaching patterns curriculum. Children who used the software were successful in gaining skill and demonstrating their gain in skill. It was found that the software did correlate to the curriculum otherwise being taught in the classroom.

In anecdotal information collected from the teachers participating in this study, one teacher explained that the student could not have been included in the regular education classroom if it were not for the programs. And finally, teachers generally noted that they grew to expect more from the children as a result of their success with the programs.

REFERENCES

- Professional Standards for Teaching Mathematics*. Reston, VA: National Council of Teachers of Mathematics, 1991.
- Mathematics Framework for California Public Schools, Kindergarten Through Grade Twelve*. Sacramento: California Department of Education, 1992.

ACKNOWLEDGMENTS

This work was funded by the National Science Foundation, under Instructional Materials Development Grant #ESI-9550532.

Carol Stanger, Curriculum Adaptations
IntelliTools, Inc., 55 Leveroni Court, Suite 9,
Novato, CA 94949; cstanger@intellitools.com

EVALUATION OF MATHPAD® - A MATH PROCESSOR

Carol Stanger and Arjan Khalsa
IntelliTools, Inc.
Novato, CA

ABSTRACT

The *MathPad* program was developed in order to make it possible for children who are unable to use pencil and paper to be able to practice solving addition, subtraction, multiplication and division problems. During this study, students using *MathPad* were observed in order to evaluate its effectiveness. It was found that *MathPad* provided an excellent alternative, allowing children with motoric difficulties to do more problems in a shorter time, or, in some cases, to participate where they were unable to without the software.

BACKGROUND

If a child is unable to hold a pencil and work out addition, subtraction, multiplication and division problems on a sheet of paper, it is extremely difficult to become competent in the operations. Writing out problems with a word processor does not provide a solution to this difficulty. Word processors automatically move the cursor from left to right. However, when solving math problems, one needs the cursor to move right to left. When conducting long division or multiple digit multiplication problems, the position of the cursor follows the rules of the mathematics problem, not the rules of a word processor. The actions of regrouping, crossing out numbers, and adding super-scripts is also problematic for word processors. For these reasons, a 'math processor' was created to allow children with motoric difficulties the ability to practice solving problems on their own.

MathPad was initially developed by Info Use with the assistance of the Center for Accessible Technology, both of Berkeley, CA.

Additional design criteria including user interface, on-screen keyboard modifications, printing format, user feedback, single switch and IntelliKeys accessibility, were contributed by the IntelliTools staff. The program can be simultaneously operated by a mouse, keyboard, IntelliKeys keyboard, or single switch. Testing of the product was conducted at two sites across the country. Eleven students used the program.

RESEARCH QUESTION

The fundamental question addressed by this research was: Did *MathPad* allow children with disabilities to participate in learning mathematical operations? More specifically: a) Does the software allow children with special needs to be fully included in regular education classrooms? b) Are children able to take part in doing the operations by way of the computer program?

METHOD

Children with disabilities in Eastern Tennessee and the Boston area of Massachusetts, most of whom were in mainstreamed regular education classrooms, used this software over the course of the school year. Children involved in this study faced great challenges using a pencil and paper to conduct math problems as a result of motoric difficulty.

In the two geographic locations leaders in the field of technology access for children with disabilities served as the National Trial Site Leaders. The Site Leaders identified students within schools in the area who might benefit from the use of this software. A total of 8 schools participated, as noted in Table I.

TABLE I

Location	School	Classroom	Students
Eastern Tennessee	#1	Second	1
	#2	Second	1
	#3	Second	1
	#4	Third	1
Boston, MA	#1	Third	1
	#2	First	1
Boston Suburb	#1	Fifth	1
		First	1
	#2	Special	1
		Special	1
		Special	1
TOTAL	8	11	11

The National Trial Site Leaders trained the teachers and aides in the schools on how to use the software. Observers visited each classroom and recorded the child's interaction with the software. At the conclusion of the school year, two sources of information were collected: a) Observer's perceptions of the child's interaction with the software; b) Teacher's perceptions about the software

RESULTS

Observer data

The observer was asked to rate the student's use of the software by looking at the student's participation in the activity and inclusion in the classroom. Questions were rated from 1 (no, never) to 5 (yes, very much so). Table II lists the questions and results. The results indicate that the students were engaged when using the software, all showed great satisfaction upon completing the activities, and they experienced a moderate level of frustration. The work was appropriate and students generally enjoyed the activity. Most notably, the students were more included as a result of using the software.

TABLE II: OBSERVER DATA ON STUDENT

Questions	No. of Students	Average
1. Was the student engaged in the task?	11	4.4
2. Did the student show satisfaction upon completing the activities?	11	5
3. Is the student experiencing any frustration while doing the activities?	11	2.5
4. Is the work appropriate for the student?	11	4.9
5. Does the student appear to enjoy the activity?	11	4.4
6. Did the teacher use the software to foster inclusion for this student?	10	4.8
7. Was this student more included in the classroom environment as a result of the use of this software?	9	4.8

Teacher Questionnaire

Teachers were asked to rate the software in terms of ease of use, meeting classroom and curricular needs, and inclusion (see Table III). Statements were rated from 1 (lowest/hardest/worst) to 5 (highest/easiest/best). The teachers found the software fairly easy to use and it correlated exceptionally with their math curriculum. In general, it met the needs of individual students and was appropriate. It both fostered independence and helped students with disabilities to feel included. It was popular and received a high overall rating.

TABLE III: TEACHER QUESTIONNAIRE

Questions	No. of Responses	Average
1. Operating the program	11	3.8
2. Correlation with your current math curriculum	11	4.9
3. Meeting the needs of individual students	11	4.5
4. Appropriateness for the entire class	11	4.6
5. Fostering independence for students with disabilities	11	4.6
6. Helping students with disabilities feel included	11	4.8
7. Popularity with students	11	4.4
8. Overall rating	11	4.5

DISCUSSION

This study evaluated a fully accessible math processor called *MathPad*®. Eleven students in two parts of the country from the first through fifth grade took part. The study found that, by using the software, children were included in conducting the operations where they otherwise could not stay on par with their classmates. Teachers noted that the students would not have been able to do as many math problems or simply would not have been included without the software. Students were able to keep up with the class work where they could not have without the *MathPad* program. Other teachers noted that *MathPad* helped children to focus on the problem and to keep on task with re-grouping. Students were noted to have an increase in confidence in their math ability and a consequent increase in self esteem. Children who used *MathPad* demonstrated independent competence. Overall, this study indicated that *MathPad* allowed for the inclusion of students in math class and allowed children to practice computational skills.

ACKNOWLEDGMENTS

Many people have contributed to the work represented in this paper. Special thanks go to the National Trial Site Leaders, the Center for Accessible Technology, the dedicated teachers who took part, and, most of all, the students. This work was funded by the National Institute of Child Health and Human Development Services, Grant #1 R43 HD33310-01 and in part by the National Science Foundation, under Instructional Materials Development Grant #ESI-9550532.

Carol Stanger, Curriculum Adaptations
IntelliTools, Inc., 55 Leveroni Court, Suite 9,
Novato, CA 94949; cstanger@intellitools.com

A COMPUTER-BASED SOLUTION FOR MAKING SCIENCE EXPERIMENTS ACCESSIBLE

Karen Milchus, John Goldthwaite
Center for Rehabilitation Technology
Georgia Institute of Technology, Atlanta, GA

ABSTRACT

Science laboratory activities pose many barriers to students with disabilities. This paper and computer demonstration will show several ways that high school or college level chemistry and physics laboratory activities can be made accessible to students with physical or visual disabilities. Computer-controlled lab equipment, combined with assistive technology and alternative techniques, was used to design a set of accessible sample experiments.

BACKGROUND

Skills in science and mathematics are becoming a more important factor in maintaining employment in a competitive environment. Unfortunately, students with disabilities face a variety of barriers in accessing science lab activities. While schools have begun to eliminate architectural barriers, laboratory activities have not been addressed, and equipment is usually inaccessible. Students with mobility impairments have obvious difficulties manipulating equipment such as pipettes and gages. Likewise, visually impaired students have difficulty reading measurement devices such as graduated cylinders, and multimeters. By not being able to participate in science labs, these students are discouraged from taking science courses and pursuing technical careers.

STATEMENT OF THE PROBLEM

Under a current NSF project, *Developing Accessible Laboratory Experiments*, the presenters are developing and compiling

information about how to make high school and college level chemistry and physics courses more accessible. This is being done by:

- Testing and developing guidelines for the combination of computer access and computer simulations of experiments.
- Testing and developing guidelines for the combination of computer access and computer controlled laboratory technology.
- Identifying low tech. tools and techniques for making laboratory activities accessible.
- Creating a series of experiments that are accessible to people with disabilities through the use of computers, assistive technology, and modified lab techniques.

It may not be possible to make an experiment fully accessible for a particular student, but our goals are to let the students conduct as much of the experiment themselves as possible, and to enable them to make the required scientific decisions during the course of the experiment.

APPROACH

Many high school and college chemistry and physics instructors are developing computer-controlled labs using the relatively inexpensive interfaces and software from firms such as Vernier Software and SCI Technologies. Computer-based data acquisition devices offer a variety of sensor options to measure light, pH, temperature, force, and voltages. Dr. David Lunney of East Carolina University has demonstrated that laboratory computers can be adapted with assistive technology and that these computers can make the labs accessible to

students with disabilities.[3] However, his work has focussed on specialized computer systems. Our approach is to combine the computer-controlled lab systems more commonly found in introductory labs with common alternative computer access methods so that students with disabilities can conduct experiments themselves. For example, a computer can record measurements from a temperature probe, and the readings can be magnified or spoken by a synthesizer for students with visual impairments. A student who has difficulty using his or her hands can control the timing and recording of measurements through voice commands.

DISCUSSION

We are developing detailed instructions for science teachers on how to add assistive software to computer-controlled lab software to make it fully accessible. Two lab control systems, Vernier Software's Universal Lab Interface and SCI Technology's LabWorks II, are presently being tested on IBM and Macintosh computers with access software. The access software includes keyboard access utilities (e.g., StickyKeys), on-screen keyboards with mouse emulators, voice input programs, magnification programs, and voice output programs. We have discovered, for example, that the more standard DOS software for the Vernier lab interface will not run simultaneously with other software (such as MouseKeys). Students who need software-based assistive technology would need to use the new Windows 95 interface software (which has shown to be compatible). As the combinations of technology are being tested, project personnel are developing configuration files and customizing the software as needed to permit access to the information displayed by the computer. We will complete the testing and customization this winter, and a panel of students with disabilities will test the software combination for usability.

Many laboratory tasks are not computer-based and require additional assistive technology or techniques.[1,2,5] Existing assistive technology is being identified and other approaches are being developed. For example, measuring liquids poses a problem for students with visual impairments. Accommodation suggestions for this task (depending on the liquid used, accuracy needed, and degree of visual impairment) include:

- making liquid levels easier to read with food coloring or an opaque background
- using liquid measuring spoons (1 teaspoon equals 5 mL),
- using a syringe with tactile markings on the plunger,
- using a liquid level detector (with a jig developed for the project to indicate it's position within a beaker),
- weighing the liquid on a digital balance connected to a voice output computer, or
- using an electronic burette.

Finally, the information on using computer-controlled lab software, computer access technology, and other assistive technology is being combined to create a series of twelve sample accessible chemistry and physics experiments. The chemistry experiments are Changes of State, Separation of a Mixture by Fractional Crystallization, Conductivity of Electrolytes and Non-Electrolytes, Gas Laws, Chemical Equilibrium (using a colorimeter), and Acid/Base Titration. The physics experiments are Force & Motion, Periodic Motion, Electrical Measurements, Oscilloscopes, Magnetic Fields, and Properties of Light. In many cases, computerized and non-computerized versions of the experiment are being developed. For example, the conductivity experiment can use a conductivity meter attached to the computer. An articulating arm, a magnetic stirrer, and a means to type sample labels into the computer can make the procedure physically accessible. Screen reading or magnification can make the readings

accessible to students with visual impairments. However, the experiment can also be conducted by using measurements from a talking multimeter rather than from the computer. We will complete the development of the experiments in March, and a group of science and special education teachers will field test them with their students.

The experiments and accommodations developed for this project are being compiled into a resource guide.[4] The guide is also available to the public via the Internet site *Barrier Free Education: Resources for the Inclusion of Students with Disabilities into Math and Science Education* -- <http://barrier-free.arch.gatech.edu/BFE/>

REFERENCES

1. Cetera, M.M. (1983). Laboratory Adaptations for Visually Impaired Students: Thirty Years in Review." *Journal of College Science Teaching*, 12, 394-93.
2. Blumenkopf, T.A. et al., (1981). Mobility-Handicapped Individuals in the College Chemistry Curriculum: Students, Teachers and Researchers." *Journal of Chemical Education*, 58, 213-221.
3. Lunney, D. and Morrison, R. C. (1994). Development of a Data Acquisition and Data Analysis System for Visually Impaired Chemistry Students. *Journal of Chemical Education*, 71(4), 308.
4. Milchus, Karen and Goldthwaite, John (1998). *Developing Accessible Laboratory Experiments*. Center for Rehabilitation Technology, Atlanta, GA. Draft.
5. Willoughby, Doris (1989). *Handbook for Itinerant and Resource Teachers of Blind and Visually-Impaired Students*. National Federation of the Blind, Baltimore, MD.

ACKNOWLEDGEMENTS

This project was supported by the National Science Foundation, grant #: HRD-9700150. Additional support for the website has come from the Toyota and NEC Foundations.

Karen Milchus
Center for Rehabilitation Technology,
Georgia Tech., Atlanta, GA 30332-0156
karen.milchus@arch.gatech.edu
(404) 894-4960 Fax: (404) 894-9320

SIG-07
Technology Transfer

A SURVEY ON THE PRESENTATION OF NEW ASSISTIVE TECHNOLOGIES TO MANUFACTURERS

Jeffrey A. Kohler and Brian D. Kon
AZtech Inc.

Rehabilitation Engineering and Research Center (RERC) on Technology Evaluation and Transfer
1576 Sweet Home Road
Amherst, NY USA

1. OBJECTIVE

This paper will demonstrate how AZtech has fine tuned its presentation of assistive technology presentations to manufacturers for potential sale or license using our feedback from a marketing survey. It will show what information is most valuable to a manufacturer in making new product decisions. AZtech, in collaboration with The RERC on Technology Evaluation and Transfer, solicits assistive devices from inventors for commercial evaluation. For devices that meet a significant unmet need in the marketplace, we seek to license the device to a manufacturer who will bring it to market. The information is packaged in a way to satisfy the needs of the manufacturers and expedite the new product evaluation process.

2. BACKGROUND

Few industries are more greatly affected by technology than healthcare. Technology refers to the innovations or inventions from applied science and research. (1) AZtech has reviewed hundreds of assistive technologies and inventions submitted to the RERC on Technology Evaluation and Transfer. AZtech has solicited a large number of companies to review the promising assistive technologies for the possibility of manufacturing and selling under a *licensing agreement*. (2) A licensing agreement gives a manufacturer the right to make and sell a technology. In exchange for this right, the manufacturer pays a royalty or commission to AZtech and the inventor on each product sold. Technologies or devices submitted to AZtech have ranged from wheelchair accessories and ADL products to electronic timers and therapeutic devices. Inventors of the devices come from all backgrounds.

AZtech assists the inventors by presenting potential manufacturers with information on their devices in the form of a *commercialization package*. AZtech's commercialization package introduces

the technology to the potential licensee and highlights the benefits of licensing the device. Included in the package is the prototype or a video tape of the device in use, any intellectual property or patent information, a competitive product analysis, potential sales forecast and target markets definition, technical evaluations including performance test results, results of a consumer focus group and the licensing arrangement we are seeking. If a company shows a strong interest, AZtech's Commercialization Director initiates discussion on licensing the rights to manufacturer and sell the technology.

AZtech surveys all manufacturers and inventors to continuously improve the quality of this technology transfer process. This paper reviews the results of a survey which has been sent to the companies to determine which materials are most critical in the commercialization package to expedite this decision process. Results of the survey conclude that the combination of the above information provides an informative complete report necessary for the manufacturer to make a new product decision.

3. METHOD/APPROACH

A questionnaire is sent to all companies that have reviewed AZtech's commercialization packages. The intent was to determine what information on new assistive technologies and devices was most important in their new product decision making. Based on the results, AZtech has refined the commercialization package accordingly. AZtech has licensed over twenty percent of the devices accepted into the commercialization program to manufacturers. Statistics indicate that if 100 companies are contacted by an inventor with an offer to license, the chance of making a deal is as low as 1%. (3) In AZtech's case, the decision to license has been greatly influenced by our commercialization package presentation.

4. RESULTS

Sixty six manufacturers have reviewed commercialization packages from AZtech and all were mailed a questionnaire. While response rates to mail surveys are usually low (industry average is less than 10%), the response to AZtech's survey was high with 25 companies (38%) responding. Strategies that improved the response rate of the questionnaire were the inclusion of a cover letter and return envelope, and the short length of the form. (4) The questionnaire consisted of two rank order questions and two open questions. They were asked to rank the contents of the commercialization package (two sets), and asked what percentage of external devices do they review as compared to internal and what materials they would like to review in their decision making process.

4.1 Company Profiles

Companies ranged in size from 12 employees to 300+ employees. Annual sales range from hundreds of thousands of dollars a year to hundreds of millions. All of the companies sell products in the assistive technology industry and the products range from aids for daily living products to sports related equipment. The larger companies sell products crossing into other industries while the smaller ones concentrate on assistive or rehabilitative devices. (See Table 1 below.) All of companies that responded are located in the United States and Canada.

Table 1. Company Profiles
Product Lines

Product Lines	Number
ADL	4
Augmentative Communication	1
Bathroom Accessories	3
Beds	1
Educational	1
Hardware, tools	2
Hardware, wheelchairs	2
Heating units	1
Home Health Care	2
Medical	2
Orthotics	1
Recreational Seating	1
Rehabilitation	1
Toys	1
Walkers	1
Wheelchair Tires	1

4.2 Percentage of Products from External Sources

The companies were asked what percentage of the new products they introduce each year come from other sources or outside submissions, other than their internal research and development teams. Most of the companies (68%) review and accept less than a quarter outside submissions of new devices each year. Sixteen percent (16%) accept up to half of their products from outside resources. Only four companies reviewed and accepted more than half. It is interesting to note that these four companies vary in both size and type of products sold, therefore showing no correlation between size and new product review processes. Four other dissimilar companies marked zero as the number of products they introduce from outside developers with one commenting, "none, presently." All of the companies are open to review outside submissions from AZtech.

4.3 Rank Order of Commercialization Information

What is most and least important information to include in a commercialization package on a new device from AZtech? Two sets of four items were ranked by the companies. The first set consisted of the device description and background. The second set consisted of marketing and technical related information. (See Table 2.)

Table 2. Rank Order Questions.

1. Please number the following four items we typically include in a commercialization package from the most important to the least important. (1 being most important).			
Patent Status	Prototype	Licensing	Inventor
12*	25	8	4
2. Please number the next four items following the directions in previous question.			
Focus Group	Mktg	Comp Prod	Mfg Costs
10	12	13	14
*Numbers indicate # times ranked 1 and 2.			

In the first set, the prototype or a video tape of the prototype in use was ranked most important most frequently. Following this were the intellectual property status, and then the terms of the licensing arrangement that AZtech and the inventor are seeking. The least important item was the background information on the inventor or designer. One manufacturer summed this up in their comments, "If you cannot see it [the prototype] you cannot appraise it properly...Send

more photos and less copy, especially on initial presentation." AZtech has not included any information on the inventor unless specifically requested by the manufacturer. Always included is the patent status, licensing terms and a visual of or actual prototype.

In the second set, estimations of the manufacturing costs and information on competition ranked number one and two. Ranked third was market size estimates and last was consumer or user focus group results. Note that the four items in the second set all ranked closely together and appear to be of similar importance. Because of this, AZtech includes all of this marketing and technical information in the commercialization package.

4.4 Suggestions

What suggestions did the companies have about the information they received from AZtech on the assistive technologies? While several companies suggested that the materials were sufficient in enabling them to make a decision on whether to license a product, many had comments usually regarding their marketing strategies and abilities. One company said that their "products are very specific and targeted to a very limited population/use. If something does not match with this, we are really not inclined to pursue." Another company said, "Data on performance is key. We know our markets and on that basis can judge the value." Several companies suggested we include sales projections, pricing analysis and strategies, and production costs. Many comments from manufacturers suggested that the package was quite complete and met their needs. AZtech has included realistic target market estimates, consumer feedback including purchase intent and design modification suggestions, production parts lists, manufacturing capability needs and cost projections, and customized research based on the reviewing manufacturer's request.

5. CONCLUSIONS

AZtech's commercialization package presentations to companies regarding new assistive technologies available for license or sale have proven to facilitate the technology transfer process. Most companies are open to outside invention submissions. Individual inventors may not include sufficient information for a company to make a

sound decision and an opportunity may be lost. AZtech's combination of device, marketing research, consumer research and technical input in the commercialization package provides a complete concise tool desired by companies which saves them time and resources in their new product research and development. In successful projects, market analysis and technical development are symbiotic and most effectively proceed in tandem. Diversion of capital to pursue technically driven product development at the expense of gathering sound market information constitutes the fatal flaw most common to innovation projects. (5) AZtech's commercialization package can help prevent a company from making this error in product development.

References

1. E. Berkowitz, *Essentials of Healthcare Marketing*, (1996), p.76.
2. J. A. Leahy, Technology Transfer Via Invention Review, *Proceedings of the RESNA '97 Annual Conference*, (1997), p. 145.
3. Licensing Executives Society, *The Basics of Licensing*, (1995), p. 12.
4. F. J. Yammarino, S. J. Skinner, T. L. Childers, Understanding Mail Survey Response Behavior, *Public Opinion Quarterly*, Vol. 55 (1991), pp. 613-619.
5. M. Rorke, E. Astolfi, B. Friedlander, Licensing Federally Funded Research Results, U.S. Department of Commerce, *Report to Association of University Technology Managers*, (1992).

Acknowledgment

This work is supported by a grant from the National Institute on Rehabilitation Research of the Department of Education under grant number H133E30023-97. The opinions contained in this publication are those of the grantee and do not necessarily reflect those of the Department of Education.

Jeffrey Kohler
Director of Commercialization
AZtech Inc.
1576 Sweet Home Road
Amherst, NY 14228
(716) 568-1175
kohler@acsu.buffalo.edu

CUSTOMER ORIENTATION: THE EMERGING ROLE OF INDEPENDENT LIVING CENTERS IN PARTICIPATORY RESEARCH IN ASSISTIVE TECHNOLOGY

Roderick L. Grubbs and Douglas J. Usiak
The Independent Living Center of Western New York,
RERC on Technology Evaluation and Transfer

ABSTRACT

We report on the last four years of successful implementation of a model of participatory research and evaluation we have applied. We present the model applied to move participatory research from an idea to a successful reality using a network of Independent Living Centers (ILC). Our methodology includes the establishment of the network, demographics of Independent Living Center's populations, recruiting, sampling, design of research and evaluation, capture, analysis and reporting of results. Finally, we list the outcomes of this participatory research.

BACKGROUND

To improve current assistive technology devices and develop new assistive technology devices (ATD's), the need for participatory research and evaluation with people with disabilities (PWD's) has been documented and discussed [1, 2]. At issue here is how participatory research can be accomplished with a relatively small segment of the overall population in the United States. In cooperation with the RERC on Technology Evaluation and Transfer, we have applied a mix of grant and contract funding to successfully implement this model. The results include valid and useful outcomes for major national telecommunications companies, Fortune 500 companies, assistive technology manufactures, human resource providers, non-profit corporations and device inventors. Through 162 focus groups and 13 national surveys, well over 4000 primary users; secondary users (e.g. family members, care providers), and professionals involved with assistive

technology have participated nationwide. These individuals and corresponding ILC's now comprise the national testing network which is available for future evaluation and research.

STATEMENT OF THE PROBLEM

Both clinical researchers and manufacturers who survey small samples within the population of people with disabilities, often find that their results do not accurately reflect the larger population's demographics. Further, the results often cannot be generalized to the larger population of persons with disabilities. These researchers encounter internal validity and reliability problems and manufacturers suffer from lost sales and dissatisfied customers [3, 4]. How can participatory research that is both reliable and valid and leads to useful outcomes for customers and device manufactures be accomplished?

APPROACH

Recruiting

To reduce sampling errors, improve validity and reliability and increase outcomes for end-users, inventors and manufactures of ATD's, we have developed a network of national testing sites across the US. We selected ILC's for this network because they are community-based organizations capable of accessing PWD's across disability and age groups. They also demonstrated their capacity to recruit participants in sufficient numbers and in a timely manner. These factors were important in allowing us to generalize our results to the larger population of PWD's. ILC's have a positive community profile, a cross-disability

CUSTOMER ORIENTATION

orientation and engage in both advocacy and service activities. We trained these ILC sites to recruit and host focus groups and participate in national surveys. All participants and testing sites are compensated for participation in and administration of research and evaluation.

To help our national network of sites recruit, we direct the ILC staff to ask all ILC participants if they would like to participate in the *Adapt Your Future* program. Potential participants next complete screening forms we developed called the *ILC Consumer Questionnaire*, *The Care Provider Questionnaire* and *The Prescriber Questionnaire*. These screening forms focus on functionality and activity, not on disability type or medical diagnosis so we avoid possible mismatches or grouping bias. The screening form covers assistive technology experience, community services used, marital status, household size, age, gender, ethnicity, education and vocational status and income information. Focus group participants are presented with a secondary screening process to identify needed human factors for appropriate sampling.

Sampling

Surveys and focus groups are conducted with experienced users but not with professional focus group participants. Recruited participants are sampled according to industry standards and market segments needed to produce valid and reliable results and avoid sampling errors. Focus groups typically involve three groups of 8 to 12 potential users each, for a total sample of thirty people. National surveys involve 100 participants to help generalize to larger populations of PWD's.

Design Issues And Outcomes

In collaboration with RERC-TET researchers, we designed qualitative research protocols; one protocol for technology supply push projects

and one for market demand pull projects. Technology supply push means that technology evaluation and transfer efforts start with the technology and seek an appropriate application – the technology supplied is pushing toward a demand. Market demand pull means that technology evaluation and transfer efforts start with defining an unmet need and seek an appropriate technology – the demand identified is pulling a technology toward it [5]. Both qualitative research protocols use focus groups and survey instruments, but the structure, sequence and participants vary.

In the technology supply push protocol, the focus group participants describe the ideal product that will meet their needs for an identified task set, identify key product features using specific criteria and describe how current technology fails to meet their expectations. Next, participants receive a demonstration of a submitted prototype device from an inventor. They evaluate the prototype on the same criterion they used to identify the ideal product and make suggestions for modifications to the prototype device. This data is captured, analyzed and reported to the inventor and/or manufacture who can use the information to make changes to the prototype that will address the unmet requirements of potential users [2].

In the market demand pull protocol, survey participants are asked to rate product features generated from focus groups, organized around general evaluation criteria. They rank product features from highest to lowest or from most important to least important when defining an ideal device. These data can be captured, analyzed, reported and generalized to the larger population of PWD's and used to create lists of product features, competitive product reviews, and a 'buyers guide' that includes a check list of ideal product features. This outcome called, *The Voice of the Customer*, is being developed and published based on survey research

CUSTOMER ORIENTATION

conducted by the national network of ILC's. The results should help manufactures improve their products and help primary and secondary users make informed choices [6].

IMPLICATIONS

Participatory action research, as applied to technology evaluation, transfer and commercialization, has three implications:

1. Introducing the model of consumerism, along with standard industry practices to the field of assistive technology will improve product design, focus manufacturer's efforts on priority needs, reduce the overall cost of ATD's, and improve consumer satisfaction.
2. Involving consumers and ILC's in the product evaluation and development process, particularly through contracts with industry, reveals a business opportunity in serving these niche markets. Consumer input can help corporations develop product advantages for competing in both domestic and international markets.
3. A national network of ILC testing sites produces a well informed national resource of PWD's, who become more aware of ATD's, more discerning about product features and functions, and more empowered to participate in device selection, acquisition and use.

DISCUSSION

This approach produces positive outcomes for manufacturers, primary and secondary users and inventors. Expanding this work to include more of the over 400 ILC's in the U.S. and to link with similar programs in other nations, will further involve the end users and increase the reliability and validity of the information produced. We have found that the information reported from participatory research and evaluation has increased the understanding that clinical researchers, inventors, users, vendors, practitioners, manufacturers and rehabilitation engineers have of assistive technology and technology transfer. In short, our experience

demonstrates that ILC's -- and the consumers they represent -- can and should play a key role in participatory research and evaluation.

ACKNOWLEDGEMENT

This work is supported by a grant from the National Institute on Disability and Rehabilitation Research, U.S. Department of Education under grant number H133E30023-97. The opinions contained in this paper are those of the grantee and do not necessarily reflect those of the Department of Education.

REFERENCES

1. Jain, AK and Usiak, DJ (1997). Customer orientation: A blueprint for action. In J.J. Presperin (Ed.), *Proceedings of the RESNA '97 Annual Conference*. Washington, DC: RESNA Press. 136-138.
2. Jain, AK, Usiak, DJ & Lane, JP. (1996). Customer orientation: Key to useful assistive devices. In J.J. Presperin (Ed.), *Proceedings of the RESNA '96 Annual Conference*. Washington, DC: RESNA Press. 143-145.
3. Philips-Tewey, B., Barnicle, K. & Perr, A. (1994). The wrong stuff. *Mainstream*. 10, 19-23.
4. Rushmore, H. and Trefler, E. (1997). In focus. *TeamRehab Report*. June 1997, 41-43.
5. Lane, JP. (1997). Technology evaluation and transfer in the assistive technology marketplace: Terms, process and roles. *Technology and Disability*, 7, 5-24.
6. Lane, JP, Usiak, DJ, Stone, VI and Scherer, MJ. (1997). Voice of the customer: Consumers define the ideal battery charger. *Assistive Technology*, 9, 2, (in press).

ADDRESS

Roderick L. Grubbs, MA, MEd.
Independent Living Center of WNY
3108 Main Street, Buffalo, NY 14214
(716) 836-0822 x130
visrg@cosmos.ot.buffalo.edu

SIG-08
Sensory Loss and Technologies

EVALUATION OF DARK-ADAPTING EYEWEAR FOR PEOPLE WITH LOW VISION

David A. Ross, M.S.E.E., M.Ed.; and Gary L. Mancil, O.D., F.A.A.O.
Atlanta VA Rehabilitation Research and Development Center
Decatur, Georgia 30033

ABSTRACT

In this study the visual performance of people with low vision was evaluated under varied ambient lighting conditions while wearing 1) no sunwear, 2) their preferred sunwear, and 3) newly developed Liquid Crystal (LC) sunglasses. Subjects included people with age-related macular degeneration (ARMD), cloudy ocular media, pseudo-aphakia, retinitis pigmentosa (RP), and people without a visual disability. When wearing the LC sunglasses, the subject population as a whole exhibited statistically significant improvements in visual function, and ARMD subjects exhibited the most statistically significant improvements.

BACKGROUND

Persons with ocular diseases such as RP, albinism, aniridia and achromatopsia have extreme problems with varying light conditions and can usually function effectively only under controlled lighting conditions. Other ocular diseases such as ARMD and conditions affecting the ocular media (e.g., cataracts, corneal dystrophy) have varying effects on retinal adaptation. Dark adaptation times as long as 30 minutes are not unusual [1].

Of these diseases, ARMD is the most common cause of legal blindness in the United States in persons over the age of 60; and its prevalence increases significantly after age 65 [2]. For people with ARMD the problem of light adaptation is related to the atrophy of their cone cells. As the normally sighted person moves from a bright to dimly-lit area, the cone function fades as the rod function adapts to photopic vision. When returning to the bright environment, the adaptation time is shorter as cones begin to function fully in just a few minutes. However, when the cones have atrophied, full adaptation to bright light may be quite slow. For all persons (fully sighted as well as persons with low vision), a fairly narrow range of overall illumination is optimal. Too much or too little light results in dramatic reductions of visual acuity and a corresponding reduction of visual function [3]. However, the unimpaired person has a type of visual reserve

(i.e., more acuity, more field of view, more contrast sensitivity, more light/dark adaptation, etc. than the minimum required by the visual task) [4] that gives this person the ability to maintain functional performance in less than optimal conditions.

The low vision traveler experiences two primary functional vision problems: detection of changes in terrain (such as curbs), and adapting to changing lighting conditions [5]. In a recent national survey of low vision consumers and their mobility instructors, "Changing environmental lighting conditions" was considered their most difficult mobility problem [5]. "Drop offs," down curbs and steps, were reported as second most difficult. In terms of functional mobility, these problems result in reduced travel speed and gait changes [6].

Limiting the amount of light reaching the low vision person's eyes to a set amount might, in and of itself, provide sufficient increases in acuity and contrast sensitivity to mitigate this problem for many [5]. Light-absorbing lenses are prescribed in a variety of styles, colors and levels of light transmission. However, in order to adapt to a variety of conditions (bright sun, shade, cloudy, and a range of indoor lighting levels from fluorescent or incandescent lights) it is necessary to employ a range of absorptive tints and to change back and forth among them—a rather cumbersome process [7]. Photo-darkening lens coatings are not used because they are slow to change, especially when going from bright sunlight into shadow—a particularly hazardous situation. Further, because these coatings are sensitive only to ultra-violet light, they do not adapt to changing light intensities indoors, nor the changing light levels experienced while driving a car.

RESEARCH QUESTION

Does the visual function of people with low vision improve when sunwear is worn that darkens and lightens quickly with changes in ambient lighting? Specifically, do acuity, contrast sensitivity, and functional mobility improve when LC sunglasses are worn versus the sunwear subjects currently prefer and use?



Figure 1. LC sunglasses employed in subject testing.

METHOD

LC sunglasses were developed with hooks enabling the user to attach them to most types of existing corrective lens frames. The LC sunglasses employed in subject testing have an overall light transmission range of 68% to 2% achievable in two ranges through the use of a flip-down polarizer (Figure 1). With the polarizer flipped up (indoor use) the glasses darken from 68% to 37% transmission. With the polarizer flipped down (outdoor use), the glasses darken from 23% to 2% transmission. A photosensor on the inside of each lens provides feedback to a driver circuit that controls the darkening of the lens. The response time of the LC lens to changes in light intensity is 30 milliseconds. The constructed LC lenses begin darkening when the light passing through them reaches about 500 lumens. The lens reaches maximum darkness when the light passing through it reaches about 2000 lumens. This is the range of light intensity that reaches the user's eyes as the actual ambient light intensity ranges from 735 lumens (well lighted office building—polarizer flipped up) to 100,000 lumens (light reflected from white concrete on a bright, sunny summer day in Atlanta—polarizer flipped down).

Subject selection criteria were as follows:

Age: 55 to 75

ARMD—acuity from 20/100 to 20/300

Cloudy Media—acuity from 20/40 to 20/300

Pseudo-aphakia—acuity from 20/40 to 20/30

RP—acuity from 20/20 to 20/200

Normals—acuity 20/40 or better

In phone interviews the subjects were screened for any physical or orthopedic problems which would prevent them from walking a test route, and they were given a cognitive (mini-mental) test to insure that they could easily follow directions.

When each subject arrived on site, a sunwear evaluation was conducted to determine their preferred sunwear. Under outdoor sunny conditions subjects were given a wide selection of available sunwear to test and determine which sunwear they preferred. This selection included their own sunwear which they brought with them. The sunwear selected by them was then used by them whenever “preferred” sunwear was to be tested in the protocol.

Clinical testing of acuity and contrast sensitivity was conducted first. This was done under varied lighting conditions employing a BVAT testing system and the Berkeley Glare test. Visual Acuity and Contrast Sensitivity were first measured under normal room lighting conditions. Then, employing the Berkeley glare test, the brightness was increased in a sequence of three brightness options. These tests were all administered in standard sequence. The subjects took this battery of tests under three test conditions, wearing: 1) their habitual lens correction only, 2) their preferred sunwear over their corrective lenses, or 3) the LC sunglasses over their lenses. The sequence in which these were worn was randomized.

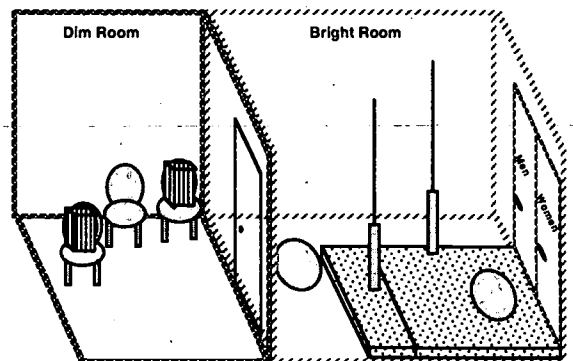

Figure 2. Functional mobility testing rooms.

A mobility test followed the clinical tests. Here the subjects walked from a room with black walls lit by a 40 watt light bulb into a room with simulated sunlight pouring in from above, and white walls (Figure 2). The object was to walk the length of the brightly lit room, past obstacles, up a step, and to a rest room

door that matched their gender. They were then to walk from the bright room into the dimly lit room, locate an unoccupied chair, and sit down. Again, subjects performed these tasks 3 times wearing 1) no sunwear, 2) preferred sunwear, or 3) LC sunglasses; and again, the sequence in which these were worn was randomized. In addition, the position of the obstacles, the step, the rest room doors, and chairs were repositioned each time. Performance times were measured and errors (stumbles, bumps) noted.

After completing all the tests, subjects were asked a number of forced choice questions about their ability to function when using each of the three eyewear options.

RESULTS

A total of 107 subjects were tested, including 23 with ARMD, 32 with cloudy ocular media, 14 with pseudo-aphakia, 8 with retinitis pigmentosa, and 30 normals. Each subject's performance scores with the preferred and LC sunwear was referenced to their base-line score using no sunwear. These base-line referenced scores for preferred and LC were then compared to each other in data analyses. Table 1 below lists instances where differences in performance between preferred and LC was statistically significant. Numbers preceded by a "+" sign indicate improved performance when wearing the LC sunglasses. Numbers preceded by a "-" sign indicate improved performance when using the preferred sunwear.

Test	Population	N	LC Improvement
Acuity (Logmar) (Normal Lighting)	All Subjects	107	+0.023
	ARMD	23	+0.041
	Cloudy Media	32	+0.034
Contrast Sensitivity (Normal Lighting)	All Subjects	107	+15.5%
	ARMD	23	+27.5%
	Normals	30	+36.1%
Contrast Sensitivity (Low Glare)	All Subjects	107	+10.2%
	Pseudo-aphakia	14	+27.1%
	Normals	30	+20.6%
Mobility (Bright)	Cloudy Media	32	-19.9%
Mobility (Dim)	All Subjects	107	+35.5%
	ARMD	23	+33.9%
	Cloudy Media	32	+19.9%
	pseudo-aphakia	14	+54.0%
	Normals	30	+38.0%

Table 1. Results showing cases where LC sunglasses were a significant improvement over preferred sunwear.

DISCUSSION

As can be seen from Table 1, subjects with ARMD showed significant improvements in

acuity, contrast sensitivity, and in the mobility task where they moved from a bright space to a dimly lit space. Surprisingly, no improvement was seen when subjects moved into the brightly lit room. Comments from the subjects indicated that the LC glasses darkened too much in the bright room, making the task more difficult. This problem can be easily remedied, however, with a circuit modification that would give the user control of the rate at which the lens darkens with increasing ambient light.

Also of note is the fact that normals exhibited considerable improvement. This indicates a potential for mass market of such LC sunwear.

REFERENCES

- Fraser, K.E. (1992) Training the low vision patient. *Problems in Optometry*. Philadelphia: Lippincott Co. Vol.4, No.1, pp. 72-87.
- Gittinger, J. & Asdourian, G. (1988) *Manual of clinical problems in ophthalmology*. Boston: Little, Brown.
- Luria, S.M. Vision with Chromatic Filters. *American Journal of Optometry and Archives of American Academy of Optometry*, 49(10), 1972m 818-829.
- Whittaker, S., Lovie-Kitchin, J. (1993). The Visual Requirements for Reading. *Journal of Optometry and Visual Science*, 70, pp.54-65.
- Smith, A.J.; De l'Aune, W.; Geruschat, D.R. (1992). Low Vision Mobility Problems: Perceptions of O&M Specialists and Persons with Low Vision. *Journal of Visual Impairment & Blindness*, 86 (1) 58-62.
- Barber, A. (1985). The Effects of Low Vision Aids and Traditional versus Non-Traditional methods in the Mobility Performance and Stress Levels of Low Vision Individuals. *Final Report: The Orientation and Mobility of Low Vision Pedestrians*. Philadelphia: Pennsylvania College of Optometry.
- Weiss, N. J. Low Vision Management of Retinitis Pigmentosa. *Journal of the American Optometric Association*. 1991; 62: 42-52.

ACKNOWLEDGMENT

Funding for this project was provided by the Department of Veterans Affairs, Rehabilitation Research and Development Service.

David A. Ross (davidross1@mindspring.com)
 Atlanta VA Rehabilitation R&D Center
 1670 Clairmont Road (MS 151-R)
 Decatur, GA 30033
 (404) 321-6111x6817 FAX: (404) 728-4837

JOINT HAPTIC AND AURAL METHODS FOR DATA VISUALIZATION

Nikolai A. Grabowski, M. Waqas Asghar, and Kenneth E. Barner
Department of Electrical and Computer Engineering, University of Delaware

ABSTRACT

A scientific visualization interface for blind and visually impaired individuals is being developed which employs a combination of the sense of touch, using the PHANToM™ haptic interface, and the sense of hearing using the techniques of data sonification. This paper presents our current implementation and related research.

BACKGROUND

Within the past ten years, work in the field of haptics has made it possible to touch three-dimensional computer-generated objects (3,10). Most of the devices designed for this task use kinesthetic force feedback to render objects. Kinesthetic information includes shape, weight, and stiffness. It is different from tactile information which is associated with surface properties such as texture. The PHANToM haptic interface, shown in Figure 1, is a force feedback device with which a person can use his or her fingertip to explore virtual objects.

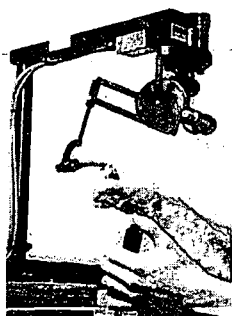

Figure 1: The PHANToM Haptic Interface

The PHANToM provides kinesthetic information and can also create sensations of friction and texture. However, it does not

provide information requiring multiple skin contact points such as Braille. Rather, it calculates a single force vector at the “thimble-like” interface point (IP).

The PHANToM has been used for scientific visualization by rendering data plots as virtual surfaces (4,11). In our current work we seek to implement such a haptic plotting system which is expanded to include an audio component.

One possible aural enhancement to the haptic display is the addition of speech output when the user desires specific numeric values. However, human hearing is useful for more than gathering verbal information. Researchers in the field of sonification have been exploring ways of mapping data to abstract sound parameters for aiding visualization (1,5,7,8,9,13). There is much to be learned in this field, and many experiments have yielded promising results. For example, Mansur sonified x-y plots by representing the y-value as a changing pitch and found that, with limited training (often two or fewer trials), subjects were able to recognize qualities of the data such as linearity, monotonicity, and symmetry on 79 to 95 percent of the trials (9). Lunney and Morrison found that, when they mapped chemical spectral information to pitch, students were able to identify compounds after listening to the associated tone patterns and chords (8).

Haptics and sonification are young fields of study. In order to formalize theories and methods in these fields, further research needs to be conducted (7,10).

STATEMENT of the PROBLEM

Scientific visualization is usually accomplished through graphical means and often involves looking at data on a computer

HAPTIC & AURAL DATA VISUALIZATION

screen. However, conveying this data to a blind person requires an alternate method.

The goal of this project is to create haptic renderings of data as surface plots and to enhance these plots with sound. The goal is set in order to provide greater access to data through multisensory exploration.

RATIONALE

"Visualization" refers to forming a mental image, and the sense of sight is not required. Blind people rely on other senses to visualize things. Of particular importance is the kinesthetic sense because it allows two-way information flow, and thus, interaction with an environment. The haptic interface makes use of this unique attribute to provide a means of data exploration and analysis without vision. At the same time, perceptual studies indicate that the sense of touch is capable of handling much less information than vision (2,6). Thus, the haptic interface requires enhancements.

Sound can be readily generated with a computer and has the potential to enrich the haptic interface. Humans have the ability to distinguish contours and textures in sound, and experiments with sonification have shown that sound can be used to display trends in data. Haptic contours and textures may have sonic analogues that have not yet been discovered or formalized.

DESIGN & DEVELOPMENT

Our current system consists of the PHANToM haptic interface from SensAble Technologies connected to a Dell 300MHz Pentium workstation running Windows NT. The PHANToM is programmed using its accompanying GHOST API, and the sound is programmed with Microsoft's DirectSound API. All programming is done in Microsoft's Visual C++5. In addition, we implement graphic renderings for testing and development purposes as well as for the benefit of potential

sighted users. The graphics are programmed using OpenGL and accelerated with an Elsa Gloria card.

As a design choice, the PHANToM has many benefits. It is a convenient desktop module that is commercially available. Programming the PHANToM is relatively simple because it renders virtual objects using a single force vector at the user's fingertip. Programming is further simplified because the PHANToM is shipped with its own set of C++ classes, called GHOST, which performs fundamental haptic routines. Using GHOST, we developed an interface with which the user can enter arbitrary surface equations of the form, $z=f(x,y)$, as well as the bounds of the variables. The surface is haptically rendered using a polygon mesh analogous to that of computer graphics. The user is then free to haptically explore the surface within a workspace of 5x7x10 inches.

For sonification, we mapped the vertical position, z , of the PHANToM's interface point to the pitch of a sine wave tone. The range and scaling (e.g. logarithmic or linear) of the pitch can easily be varied for experimentation. We chose to use pitch because sonification researchers have successfully used it as means of conveying data, and experiments have been conducted which suggest some design guidelines (1,12). In addition, when considering visual/aural metaphors, Ballas notes that sound frequency has been found to be commonly associated with vertical placement (1).

EVALUATION

The haptic renderings create a compelling feeling that one is touching three-dimensional data plots. When the data contains abrupt changes, the edges of the polygons become noticeable. Depending on the desired resolution, we can increase the number of polygons used to construct the surface. In

HAPTIC & AURAL DATA VISUALIZATION

addition, GHOST provides routines for smoothing the edges.

When adding the sonification, the range of frequencies for the tone was chosen heuristically to be 100Hz to 1KHz. This range can be easily changed according to user preferences or hearing capabilities. Although the tone is continuous, updates to the sound lag the PHANToM by approximately 100ms due to the latency of DirectSound. This is generally not noticeable because most movement of the PHANToM, when exploring a surface, is relatively slow (at most 3Hz).

Informal testing reveals that adding pitch-change information to the haptic surface plot improves visualization. Detecting relative maxima and minima is quick and precise. Touch is used to find the general area of an extremum, and the sense of pitch is used to "hone in" more precisely on the extremum point.

DISCUSSION

The fields of haptics and sonification have made important advances in the nonvisual display of data. We have brought these two worlds together in a functioning data visualization system. We intend to conduct formal evaluations with human subjects once further refinements have been made. These will include haptic grid planes, textures and further sonifications. It is hoped that continued research and future reductions in the cost of haptic and computing systems will make fully functional, richly illustrative visualization systems more widely available.

REFERENCES

1. Ballas, J. A. Delivery of Information Through Sound. In (4), pp. 79-94.
2. Brooks, F. P., (1990). Telerobotic Response Requirements. *Proc. IEEE Int. Conf. Systems, Man, and Cybernetics*, pp 113-120. Los Angeles.

3. Burdea, G., (1996). *Force and Touch Feedback for Virtual Reality*. Wiley, New York.
4. Fritz, J., (1996). Haptic Techniques for Scientific Visualization. Master's Thesis, University of Delaware.
5. Gardner, J. A., Lundquist, R., and S. Sahyun, (1996). TRIANGLE: A Practical Application of Non-Speech Audio for Imparting Information. *Proc. ICAD'96*.
6. Kokjer, K. J., (1987). The Information Capacity of the Human Fingertip. *IEEE Trans. On Systems, Man and Cybernetics*; SMC-17(1).
7. Kramer, G. (ed.), (1994). Auditory Display: Sonification, Audification and Auditory Interfaces - *Proc. ICAD'92, the First International Conference on Auditory Display*, Addison-Wesley.
8. Lunney, D., and R. C. Morrison, (1981). High Technology Aids for visually Handicapped Chemistry Students. *J. Chem. Ed.*, 58(3): 228-231.
9. Mansur, D. L., (1984). Graphs in Sound: A Numerical Data analysis Method for the Blind. Unpublished Thesis, University of California, Davis.
10. Massie, T. H., (1996). Initial Haptic Explorations with the Phantom. Master's Thesis, Massachusetts Institute of Technology.
11. Sjöström, C., (1997). The Phantasticon - The Phantom for Blind People. *Proceedings of the Second PHANToM User's Group Workshop*.
12. Walker, B. N., (1997). Congruency Effects with Dynamic Auditory Stimuli: Design Implications. *Proc. ICAD'97*, pp. 7-11.
13. Yeung, E. S., (1980). Pattern Recognition by Audio Representation of Multivariate Analytical Data. *Anal. Chem.*, 52: 1120-1123.

ACKNOWLEDGEMENTS

This work was supported by the National Science Foundation, Grant # 9450019.

CONTACT

Nikolai A. Grabowski, or Kenneth E. Barner
Dept. of Electrical and Computer Engineering
University of Delaware, Newark, DE 19716
Tel: (302) 831-2405
Email: grabowsk@eecis.udel.edu
barner@eecis.udel.edu

A PORTABLE READING DEVICE WITH GUIDED FEEDBACK FOR LOCATING AND TRACKING TEXT

James T. Sears, BSEE and David A. Goldberg, Ph.D.
Ascent Technology, Inc.
Boulder, CO

ABSTRACT

The Independent Reading Assistant (IRA) is a portable reading device for use by the blind, the vision-impaired, the cognitively-disabled, and others. The voice-output device is designed to be used in daily living situations, including school, work, shopping, and home. This paper describes design features that allow users to intuitively locate and read text presented in a variety of daily situations.

BACKGROUND

The ability to read printed material is a key need in many aspects of daily living. Reading manuals and memos at work, text books at school, food labels at the store, and mail at home is not simply a convenience, but constitutes one of the requirements for truly independent living. Thus, a reading machine which travels with the user throughout the day and may be used wherever text is encountered is of clear value.

Conventional reading machines require a flatbed scanner system to capture text images, which are then transmitted to a computer for conversion to textual content and subsequent vocalization with synthetic speech. While computers have become smaller and more portable, flatbed scanners must always be larger than the material that they scan, and therefore are inherently bulky and heavy. Convenient portability requires the use of small scanners, which can be held in a user's hand, but these must necessarily capture correspondingly small images containing only sentence fragments.

STATEMENT of the PROBLEM

The use of a handheld reading device capturing incomplete text images poses a series of issues to system designers:

- How to facilitate users extracting information from large documents using only a small reading window?
- How can the device be made easy to learn and apply to widely varying reading needs?
- How to make the device portable enough to be used "on the go"?

RATIONALE

The mental image underlying the conception of the Independent Reading Assistant (IRA) is that of the user, index finger extended, feeling the presence of and reading small text fragments underneath their finger as it passes over the page. This is a wholly natural movement and one, we thought, which would be easy to learn and perform. While we could not put sensors directly on the finger, we designed a handheld mouse, across which the finger is extended, which operates intuitively in a similar fashion.

DESIGN AND DEVELOPMENT

The Independent Reading Assistant (IRA) is comprised of two major hardware elements -- a handheld reading mouse and a portable computer (see Fig. 1), for which the current design accomodates palmtops such as the Toshiba Libretto [a], which weighs 2.2 pounds and is about the size of a videotape case.

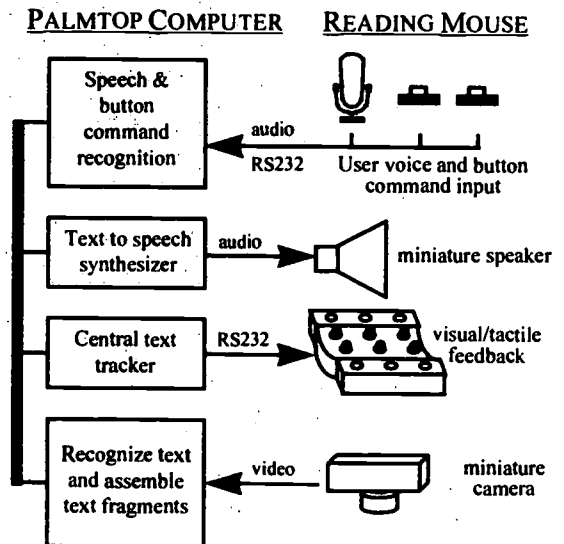

Fig. 1 - IRA system components

The mouse is approximately 3.5 inches long by 1.9 inches tall and 1.25 inch wide, and fits comfortably in the user's hand (see Fig. 2 below). The mouse contains a miniature CMOS

camera, which captures images of text underneath the camera within a text window, where the text is illuminated by LEDs located within the mouse.



Fig. 2 - User reading a bottle label with IRA. The right thumb is pressing a command button, the index finger lies on a tactile array of vibrating pins, and the speaker shows between the thumb and forefinger, pointed at the user.

In keeping with our rationale, we placed the text window beneath the tip of the index finger, which stretches across the top of the mouse. An effective reading device must be capable of rapidly exploring the spatial layout of text in order to identify pages and selections for reading. To enable this capability intuitively, we positioned an array of vibrating pins under the user's index finger. When text is detected under the text window, the vibrating pins are activated, providing the perception that the words are themselves vibrating. The job of locating or tracking text is then reduced to guiding the unit to keep the vibrations centered under the finger. Since many potential users hear and still have some residual vision, we augmented the tactile display with an easily visible LED array. To further increase the feedback to the user, allowing them to focus their attention on the text content, we positioned the output speakers within the handheld mouse so that sound emanates directly from the location that the words are being read.

We configured the device controls such that IRA requires only one hand to operate, leaving

the other hand free to hold or position the material to be read. This permits reading awkward objects like round or soft packaging, as well as reading while standing, which is useful at the medicine chest or while cooking or shopping (see Fig. 2 for an example of manipulating a bottle with one hand, while reading using IRA with the other hand).

In operation, the video information is transmitted back to the computer, where it is interpreted using optical character recognition (OCR) into text content. Because the image window is only approximately 1 inch square, any one image may not contain an entire word. Thus, the computer assembles words from the overlap of text fragments between images. Because images are received at approximately 6-10 frames a second, large amounts of overlap allow accurate assembly of large text sequences.

The computer additionally sends synthetic voice output signals to the speaker within the mouse. The output rate of text is adjusted in conjunction with the speed with which the user moves the mouse across the text (to the limits of speech intelligibility and the speed with which the computer can process incoming video images). Thus, as the user moves the mouse faster across the text, the rate of synthetic speech output increases.

A central text tracker within the computer software interfaces with the user through the tactile feedback array on the upper surface of the mouse. When operating in text locating mode, the text tracker finds the line of text most close to the center of the page, and vibrates the pins most closely associated with that line of text.

In vocalization mode, activated by pressing the button on the side of the mouse, the line closest to the vertical center of the text window is designated the vocalization track line, and this track line is followed in subsequent text images. The user keeps the track line centered by feeling the locus of vibration under his finger. The action is as simple as following a stimulus with your finger.

The number and arrangement of pins in the tactile array is under current investigation. The original tactile feedback device, consisting of a single linear array of pins, gave no information about the distribution of text in the horizontal dimension (e.g. is the mouse window over the beginning or end of a line?). A new tactile

feedback device has been designed with 2 columns of 3 pins having variable stimulation frequency and providing both horizontal and vertical information.

A number of modes of IRA use are being implemented in software, including modes for reading headlines, scanning for specific words (e.g. "Pay" on a utility bill), proofing medicine bottle instructions, and displaying images from the IRA camera on the palmtop computer screen. To support these different modes of operation, additional buttons and voice input are being implemented to allow rapid switching between different modes.

Finally, considerable attention was paid to the human and social feel of IRA. Many blind users do not want to be seen as unduly dependent on technology or have attention drawn to the fact that they are blind. This was instrumental in the decision to have the unit grasped discreetly in the hand, and to allow for earphones to assure total privacy of use. In feel and appearance, IRA is designed more as a clothing accessory than an electronic aid. The computer and mouse storage is cloaked within a handbag or belt pack and the cord between the mouse and the computer is designed to mimic the feel of cloth or leather rather than wire.

EVALUATION

A prototype version of IRA has been built and, instead of a palmtop computer, a desktop computer was used. IRA was tested with 17 geriatric subjects between the ages of 68 and 88 who became severely visually impaired after the age of 55. After a short training session of 25 minutes or less, subjects were tested for the ability to read isolated lines of text, and to demonstrate comprehension of the synthetic output speech.

All subjects demonstrated the ability to find text on a page, track a line of text, and understand the synthesized speech output. Furthermore, all subjects were able to handle the device to read text on a pill bottle. In qualitative discussions, users indicated comfort with the device, and many asserted that the device would significantly help them in their daily lives.

DISCUSSION

The use of IRA mimics the natural movement of following text you are reading with your index finger. In our trials, we found

that users were able to rapidly learn and operate IRA. The ease of learning is important, since the difficulty of learning complex technology appears to be an impediment to the spread of assistive technology, especially among older users [2].

A further advantage of IRA appears to be both the immediacy of feedback, allowing for rapid learning, and also the multi-sensory nature of the feedback. Thus, information about the location of text comes from the tactile array, colored LEDs, computer speech emanating from the handheld device, a soft buzzing sound of variable pitch generated by the tactile array, as well as the natural proprioceptive sensations regarding the position of the hand, the arm, and the fingers. This multiplicity of cues not only focuses the user, but also allows users with deficits in one or more senses to still use the device.

Second generation IRA devices using miniature Libretto computers will begin field testing in the spring of 1998.

REFERENCES

1. Kaczmarek, K.A., J.G. Webster, P. Bach y-Rita & W.J. Tompkins (1991) Electrotactile and Vibrotactile Displays for Sensory Substitution Systems. *IEEE Transactions on Biomedical Engineering* 38(1):1-16
2. Crews, J.E. and L. Luxton (1992) Rehabilitation teaching for older adults. In A.L. Orr (ed.), *Vision and Aging*. NY: American Federation for the Blind.

MANUFACTURERS

[a] Toshiba America Information Systems, Irvine, CA

ACKNOWLEDGEMENTS

This project was supported by the NIH Institute on Aging (Grant 1R43AG13363) and the Department of Education (Grant RW96014002).

James T. Sears JamesSears@IRAc.com
2301 Panorama Ave.
Boulder, CO 80304
(303) 541-9112 Fax: (303) 541-9117

SIG-09
Wheeled Mobility and Seating

REPOSITIONING THE ABLE-BODIED : EFFECT OF THE SHAPE CUSHION ON PRESSURE DISTRIBUTION

Aissaoui, R., Ph.D., Dansereau, J., Ph.D., Lalonde, N., MSc. & Lacoste, M., OT.

Chaire Industrielle CRSNG sur les aides techniques à la posture, Département de génie mécanique, École Polytechnique de Montréal, C.P. 6079, succ. Centre-ville, Montréal, Québec, Canada, H3C 3A7.

ABSTRACT

This paper reports on the effects of cushion shape when repositioning an able-bodied subject. It was found that a contoured foam cushion has a positive effect in simultaneously reducing the maximum pressure while maintaining the peak pressure gradient under a certain threshold.

BACKGROUND

Repositioning can be defined as the variation of user posture with respect to gravity by modifying the system tilt angle (STA) as well as the seat to back angle (SBA). Among the different reasons put forward in clinics is the fact that posterior tilt and seat-to-back angle may be used to prescriptively redistribute weight that is typically borne solely by the buttocks to the lower trunk (Ward, 1994). The effects of gross postural changes and tipping the wheelchair and its occupant have been investigated as potential alternatives to pressure relief. Bogie & Bader (1987) investigate the effects of varying seat recline angulation from 0° to 20° on interface pressure in the seated posture. They generally found that mean ischium pressure on a flat foam increased by 15 mmHg with respect to neutral posture with a fixed SBA=90°, and decreased by 15 mmHg when the backrest is freely reclined. Shields & Cook (1988) found a 10% decrease of the pressure around the ischial tuberosity on a hard surface by reclining the seat angle by 10°. However this was not statistically significant. Hobson (1992) found a decrease of 14% of the maximum pressure under the ischial tuberosity when tilting the chair by 20°, and an increase of 12% when the SBA is set to 120° for able-bodied subjects. Moreover, the peak pressure gradient increases by 5% for a

full-body tilt of 20° and decrease by 15% when reclining the backrest to 120° (Hobson, 1992). Henderson et al. (1994) found a reduction of 27% and 47% in maximum pressure when tipping the wheelchair backward by 35° and 65° respectively for spinal cord injury. Recently, Aissaoui et al. (1997) reported a reduction of about 40% for maximum seat pressure using a multi-layered flat-foam cushion (SBA=120°, STA=45°), while they observed that the peak pressure gradient remains under the $\pm 20\%$ with respect to the one measured in neutral posture. On the other hand, reduction of sitting pressure can be achieved by custom contoured cushion (Sprigle et al., 1990), total contour seat (Rosenthal et al., 1996), and contour shape optimization (Brienza et al., 1996). However, the main effect of these generic shaped cushions on pressure distribution has been tested in a seating upright posture. The purpose of this study is to investigate the effect of contoured foam cushions on pressure distribution when repositioning an able-bodied subject.

METHODS

Eight able-bodied subjects participated in this study (age :22-26 years; weight :67-100 kg; height : 1.73-1.90 m). A computerized simulator chair (Ringuette et al., 1997) was used to configure 24 different positions. The subject was positioned in such a way that the pelvis was in contact with the back while leaving a distance of 4 cm between the popliteal fossa and the front seat. The footrest was adjusted to have the thigh segment parallel to the seat in the neutral posture. The head was in contact with the headrest while the arms were comfortably placed on the thighs. The neutral posture was defined such as the STA=0° and SBA=100°. The slumped posture was defined as the sitting posture

similar to the neutral one except that the subject's pelvis was moved forward about 5 cm. Two cushions were used in this study, a 2 inch flat-foam (FF) and a generic contoured cushion ISCUS (Promed, Inc). Each subject adopts successively 24 positions for each cushion as indicated by numeral order in table 1. Seat interface pressure was measured by an FSA mat (Vistamed, Inc). The calibration of the seat mat was done before each subject's session. The subject maintains his posture for five minutes, after which pressure data was collected for 20 seconds at 1 Hz sampling frequency. The mean pressure (MP) in the total contact area, the maximum pressure (MPI) and the peak pressure gradient (PPG) around the ischial tuberosity were estimated for each configuration. The total contact surface (CS) was estimated by adding the number of active sensor (pressure > 5 mmHg).

Table 1. Representation of 24 positions in the simulator. (*):leg-rest at 45°. (°):Slumped posture

STA	0	15	25	35	45
SBA					
90	1	15	16	17	18
100	2-5-14- 19-22- 23°	6-10°	7-11°	8-12°	9-13°
110	3				
120	4-24*	20	21		

RESULTS & DISCUSSION

Generally, tilting the seat from 0° to 45° reduces the four parameters MP, MPI, PPG as well as CS more than when the SBA is modified from 90° to 120°. However, this reduction becomes more significant when the STA exceed 15°. For each cushion and with respect to neutral posture, the highest significant decreases in mean pressure were respectively equal to 38% and 35% for the FF and the ISCUS cushions (STA=45°, SBA=100°). The MPI, the PPG and the CS decreased significantly by (30%, 20%), (23%, 25%) and (10%, 10%) respectively for the FF and the ISCUS cushion. The leg-rest influenced more the PPG and the CS than the MP and the MPI parameters. In fact, for both cushion the MP decreased by 10%, while the PMI increased by 10%

when leg-rest was changed from 90° to 45°. However, this was not significant. Moreover, the CS decreased significantly by 20% while the PPG increased by 20%. Based on this data, the two cushions seem to behave similarly for the different positions adopted by the subjects. However, this data is relative to neutral posture for each cushion independantly. A large degree of variability was found within and between subjects when comparing to absolute values. Fig.1 shows the average PPG for 8 subjects and 24 successive positions. Although the standard deviations do not appear in fig.1, they are larger for the FF cushion. A threshold of 50 mmHg/inch could easily discriminate between the two cushions. This threshold corresponds to the maximum value of the PPG reported by Hobson (1992) for able-bodied subjects.

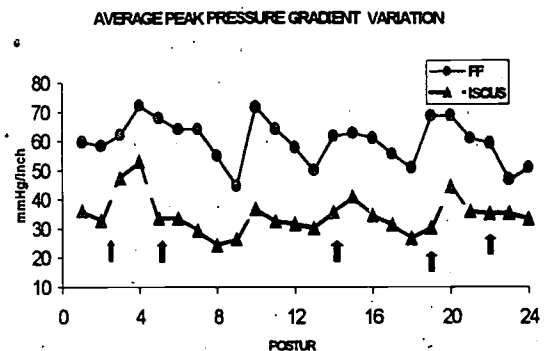

Fig1. Average PPG over 8 subjects for 24 positions. Vertical arrows indicate the neutral posture.

Many studies compared different cushions with respect to maximum pressure relief under the ischial tuberosity region (Bar, 1991; Hobson, 1992; Koo et al, 1996; Peters & Swain 1997). However, these authors report no relationship between the PPG and the MPI. Hobson (1992) noted that it seems reasonable to assume that if high pressure gradients are estimated by the sensor matrix, these gradients should, in some way, be related to high shear stresses in the supporting tissues; moreover knowing about cushion materials and postures that minimize these occurrences is vitally important. Fig.2 shows the relationship between the PPG and the MPI parameters for the cushion. It was found here that 87% of the

subject/position are below a threshold of 50 mmHg/inch for the PPG and 132 mmHg for the MPI when using the ISCUS cushion, whereas 58% of the subject/position belong to the opposite quadrant when using the FF cushion. The effect of shape cushions on pressure parameters is clearly shown in fig.2.

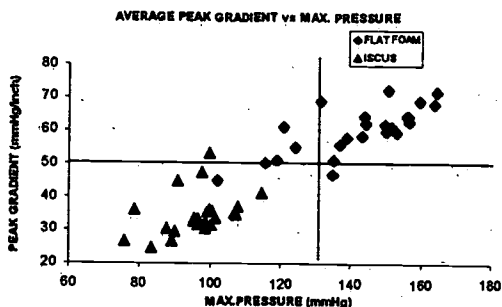

Fig2. Average PPG over 8 subjects versus MPI for 24 positions

From this study it appears that peak gradient pressure is as important as the maximum pressure parameter. Recently, Goossens et al. (1997) have tested the relationship between local shear stress and seat angle. They found that the resultant shear force tends to decrease with increasing seat angle. The results of Goossens's study showed no significant differences between the local shear stress under the ischial tuberosity for two postures (STA=0° and 8°). In our study, a significant reduction in peak pressure gradient appears when the STA exceed 15°. However, this study is limited to able-bodied subjects, further study must be done on disabled people to show the importance of the relationship between the PPG and MPI in comparing different cushions.

CONCLUSION

This study demonstrated the effect of cushion type on pressure distribution when repositioning an able-bodied subject. The relationship between the peak pressure gradient and the maximum pressure under the ischial tuberosity highlights the difference between the flat and the contoured foam cushions.

REFERENCES

- Aissaoui, R., Dansereau, J., Lemire, N., Latulippe, I. & Lacoste, M. (1997). Effect of repositioning on seat and back pressure measurements and posture of able-bodied subjects. *Int. Conf. On Wheelchairs and Seating*, Dundee (Scotland), septembre 8-12.
- Bar, C. (1991). Evaluation of cushions using dynamic pressure measurement. *Prosthetics & Orthotics International*, 15 :232-240.
- Bogie, K. & Bader, D.L. (1987). The biomechanics of seating - An initial study. In *International Series on Biomechanics*, volume 7-A, (Eds: de Groot, G., Hollander, A.P., Huijting, P.A. & van Ingen Schenau, G.J.), Free University Press, pp.498-503.
- Brienza, D.M., Karg, P.E. & Brubaker, C.E. (1996). Seat cushion design for elderly wheelchair users based on minimization of soft tissue deformation using stiffness and pressure measurements. *IEEE Trans. on Rehabil. Eng.*, 4(4) : 320-327.
- Goossens, R.H.M., Snijders, C.J., Holscher, T.G., Heerens, W.C. & Holman, A.E. (1997). Shear stress measured on beds and wheelchairs. *Scand. J. Rehab. Med.*, 29 :131-136.
- Henderson, J.L., Price, S.H., Brandstater, M.E. & Mandac, B.R. (1994). Efficacy of three measures to relieve pressure in seated persons with spinal cord injury. *Arch. Phys. Med. Rehabil.*, 75 :535-9.
- Hobson, D. A. (1992). Comparative effects of posture on pressure and shear at the body-seat interface. *J. Rehabil. Res. & Dev.*, 29(4) :21-31.
- Koo, T.K.K., Mak, A.F.T. & Lee, Y.L. (1996). Posture effect on seating interface biomechanics : Comparison between two seating cushions. *Arch. Phys. Med. Rehabil.*, 77 :40-47.
- Peters, E., Swain, I. (1997). Comparative evaluation of wheelchair cushions. *Int. Conf. On Wheelchairs and Seating*, Dundee (Scotland), septembre 8-12.
- Ringuette, J.P., Dansereau, J. & Trudeau, F. (1997). Adaptation of a clinical seating simulator into a research tool. *RESNA '97*, Pittsburg, june 20-24, pp. 222-224.
- Rosenthal, M.J., Felton, R.M., Hileman, D.L., Lee, M., Friedman, M. & Navach, J.H. (1996). A wheelchair cushion designed to redistribute sites of sitting pressure. *Arch. Phys. Med. Rehabil.*, 77 :278-282.
- Sprigle, S.H., Chung, K-C. & Brubaker, C.E. (1990). Reduction of sitting pressures with custom contoured cushions. *J. Rehabil. Res. Dev.*, 27(2) :135-140.
- Ward, D.E. (1994). *Prescriptive Seating for Wheeled Mobility. Voll : Theory, Application and Terminology*. HealthHealth International.

Acknowledgments

This project was supported by the NSERC (Natural Sciences & Engineering Research Council) of Canada and by Orthofab and Promed compagny.

DESIGN OF A TEST FIXTURE FOR WHEELCHAIR CUSHION TESTING

Allen R. Siekman, BS, Peter W. Axelson, MSME & Jamie H. Noon
Beneficial Designs, Inc.
Santa Cruz, California, USA

ABSTRACT

The Seating Interface Tester (SIT) was developed to provide a test fixture that simulates the anatomical properties of a seated individual. This will allow for a standardized method of testing wheelchair cushions in a controlled, repeatable manner. A mold of the buttocks and posterior thighs of an adult SCI male was taken. From this mold a gel material was cast around an appropriately sized pelvis/femur model. Seat interface pressure measurements obtained with this model were compared to the RESNA SIG17 "Sore Butts" test fixture and to the adult SCI male on several different cushions. Future evaluations of the SIT will involve comparisons with six additional subjects. This test fixture could be used in the development of standardized test procedures that would provide objective measurements of cushion performance for safety and comparison purposes.

BACKGROUND

Measuring the pressure distribution properties of seat cushions is necessary to optimize fit and function. Service providers use clinical observation, evaluation, pressure mapping systems, and other tools to determine the best match between product and consumer. Designers, researchers and manufacturers also use pressure mapping systems to evaluate and test new concepts, designs, and materials.

The most common methods used for cushion and interface pressure testing include the standard Indentation Load Deflection (ILD) tests [1] and pressure mapping with systems such as the Force Sensing Array (FSA) (Vista

Medical, Winnipeg, Canada). Research by Chow [2] and Sprigle [3] involved instrumented force testing with a gel interface. These studies focused on determining the effect of cushion shape on pressure distribution and examined the transmission of pressure through the gel interface. Neither of these studies used an interface that matched the soft tissue and skeletal shape of the human anatomy.

A RESNA special interest group (SIG17 "Sore Butts") designed a test fixture using PVC tubing, golf balls and foam covering to test the function of various cushions. The test fixture attempts to simulate the general shape and orientation of the skeletal support structure. Although it meets the low cost and easy reproduction needs of the SIG 17 project, it fails to provide realistic pressure distribution patterns.

STATEMENT OF THE PROBLEM

A uniform test fixture that simulates both the anatomical orientation and the soft tissue displacement of a seated individual is currently not available.

Matching the properties of the wheelchair cushion to the needs of the consumer is often carried out by the clinician, therapist or service provider. Pressure mapping systems used in combination with clinical observation and trial and error can provide very good results; however, this testing is user specific with the test subject (the consumer) used as their own control.

Testing the function of a wheelchair cushion in the design or development stage is more difficult since the goal is to develop a cushion

that works well for many individuals instead of a specific person. This requires numerous tests to chart the progress of the design or material changes.

RATIONALE

A standardized test fixture that simulates a human buttocks could be used to evaluate the performance of different seat cushions. Pressure measurements obtained with this test fixture would provide a better indication of the actual pressures experienced by a typical consumer. The results obtained with this test fixture would be objective, valid and comparable. Thus, the information could be used by consumers to compare products, by clinicians to select and prescribe appropriate cushions, and by researchers to evaluate the effectiveness of their designs.

DESIGN

The Seating Interface Tester (SIT) was produced by taking a negative mold of a wheelchair user, fitting a skeleton model into the mold and filling the mold with a gel material to simulate soft tissue. This mold assembly can be attached to a load/deflection test fixture for cushion testing.

In order to accurately recreate the forces that are transferred to a wheelchair cushion by a seated person, the test fixture must have a shape that matches human anatomy, correctly shaped and placed skeletal structure and a "soft tissue" covering with properties similar to human tissue. To test the fixture on cushions, it was also necessary to have the ability to load the cushion with the desired weight.

Shape – The shape of the buttocks and posterior thigh of a person who is a full-time wheelchair user is generally different than that of a person who ambulates. To match the shape of a wheelchair user, the mold was taken using a 35 year old male with a T6 spinal cord injury.

To obtain the mold shape without the weight-bearing deformity to soft tissue, the subject was suspended in a mold box which was then filled with a thin solution of alginate casting material. This aqueous solution provided some buoyancy and kept the soft tissue from "hanging" while the mold was formed. The resulting shape was quite uniform and did not have the compressed tissue areas often found in molds taken of seated individuals. The alginate mold was then filled with plaster which was smoothed and used to form a two-part mold necessary for the gel material and the skeletal insert.

Internal Skeletal Support – A model of a male pelvis with full femurs (MPL Inc., Gatesville TX) was used in the SIT. The skeleton model, cast from a 5'8"- 5'10" male, closely matched the subject used for the mold shape. The skeletal support was positioned in the fiberglass mold in appropriate alignment and held into position prior to pouring the gel (Action Products Inc., Hagerstown MD). The completed assembly was mounted on a load/deflection test fixture which allows instrumented pressure loads to be applied to the test cushions. Pressures are monitored with an FSA pressure measurement system.

EVALUATION

Using an FSA pressure measurement system and various wheelchair cushions, the pressure distribution characteristics of the SIT test fixture will be compared to the RESNA Sore Butts fixture. In addition, the pressures produced by the SIT will be compared to the pressure measurements obtained on the same cushions with the mold subject and six other individuals.

Three readings will be taken with each test fixture and each test subject. For each reading, the number of sensors included, the average pressure, maximum pressure and standard

deviation of the pressure measurements will be recorded.

DISCUSSION

Testing conducted with a standardized test fixture will enable researchers, designers and manufacturers to obtain objective, comparable information about the performance of a cushion. This information will benefit consumers and clinicians by providing the necessary data to make appropriate cushion selections.

Manufacturers and designers often explore changes in design, materials or the manufacturing process in an effort to improve product performance or to decrease manufacturing costs. While subject testing of these changes is still essential, they will be able to use these fixtures to provide objective comparable information about these changes in a controlled environment prior to subject evaluation.

Development of universal testing standards for seating is one of the next major steps in the evolution of service delivery. Development of seat cushion standards could establish minimum performance characteristics of seat cushions. The development of standardized test fixtures will enable a committee to develop such procedures. Standardized test fixtures are key components in the testing of products and in the development and refinement of concepts and materials.

The SIT test fixture developed is size specific and is not expected to produce pressure readings that match a person with substantially different body shape and mass. The test fixture is also relatively symmetrical and has no provision for pelvic obliquity or other postural/orthopedic deformity.

Further research is needed to refine and test the fixture and develop a series of devices that

simulate individuals ranging from a 5th percentile adult female through a 95th percentile adult male and pediatric sizes. Similar fixtures could also be fabricated to replicate pelvic and lower extremity abnormalities.

REFERENCES

1. Chow, W.W. (1974). Mechanical properties of gels and other materials with respect to their use in pads transmitting forces to the human body (Doctoral dissertation, University of Michigan, 1974). University of Michigan, 75-148.
2. Haddow, A. (1997). Wheelchair cushion designs for developing countries: Project Sorebutts, Proceedings of the RESNA 1997 Annual Conference (pp. 471-473). Arlington, VA: RESNA Press.
3. Sprigle, S. (1994). Uniaxial and hydrostatic loading at the core of a gel buttock model, Proceedings of the RESNA 1994 Annual Conference (pp. 266-268). Arlington, VA: RESNA Press.
4. Todd, B.A. (1997). Testing polyurethane foams for cushion design, Proceedings RESNA 1997 Annual Conference (pp. 225-227). Arlington, VA: RESNA Press.

ACKNOWLEDGMENTS

Funding for this research was provided by ComforTech Inc.

For further information:

Allen R. Siekman

Beneficial Designs, Inc.

5858 Empire Grade

Santa Cruz, CA 95060

Phone: 408-429-8447

Fax: 408-423-8450

e-mail: allen@beneficialdesigns.com

SKIN TEMPERATURE MEASUREMENT TO PREDICT INCIPIENT PRESSURE ULCERS

Maureen A. Linden and Stephen H. Sprigle

Center for Rehabilitation Technology

Helen Hayes Hospital

West Haverstraw, NY 10993

ABSTRACT

A Stage I pressure ulcer is defined as nonblanchable erythema of intact skin. Since erythema is difficult to assess in darkly pigmented skin, other factors are often used to identify Stage I ulcers in persons with dark skin. Elevated skin temperatures are accepted indicators of incipient ulcer formation. This study quantifies temperature differences between Stage I ulcers sites and nearby healthy tissue. Analysis of these differences shows that erythematous tissue may be warmer or cooler than the surrounding tissues. This is important in the assessment of damaged tissue.

BACKGROUND

The National Pressure Ulcer Advisory Panel (NPUAP) defines pressure ulcers as lesions caused by unrelieved pressure resulting in damage to the underlying tissue. Pressure ulcers occur in 9% of patients admitted to hospitals and 23% of nursing home residents. They represent the most expensive medical complication for spinal cord injury (1). Early detection of developing pressure ulcers is a key factor in reducing time and cost of wound healing.

The NPUAP characterizes four pressure ulcer grades or stages. Nonblanchable erythema of intact skin is considered a Stage I ulcer. Because it is difficult to discern erythema in darkly pigmented skin, the NPUAP advises that other factors, including increase in skin temperature, edema, induration, or hardness, may indicate the presence of a Stage I ulcer (1).

Barnett and Ablarde described the temperature response of healthy skin during

and after short durations of sitting. Video thermography measured skin temperature while subjects sat for varying durations and every 30 minutes after the bout of sitting. Both the maximum post-sitting temperature and the time to attain maximum temperature varied directly with seated duration (2). This study thermally characterized the reactive hyperemic response of healthy skin.

Thermography has also been used to characterize the hyperemic response of damaged tissue and predict the occurrence of pressure ulcers. Damaged tissue does not exhibit the characteristic temperature increase during reactive hyperemia observed in healthy skin. Therefore, a lack of temperature increase may identify damaged tissue (3). Newman and Davis did a prospective study relating skin temperature of admitted patients and subsequent pressure ulcer development (4). Subjects with persistent skin redness were excluded from the study as they were likely to be given more medical attention. Skin warmth was defined as an increase in temperature exceeding 1 °C (1.8 °F). Diffuse skin warmth without redness predicted pressure ulcer development using a Chi Square analysis.

RESEARCH QUESTION

The objective of this study was to evaluate temperature differences between areas of erythema and surrounding healthy tissue. Thermography studies have shown that skin warmth may indicate pressure ulcer development. Skin warmth is caused by the inflammation response of a pressure ulcer due to increased circulation to the tissue. In cases

where the microvasculature is damaged however, blood may stagnate in the interstitial tissue, causing a decrease in temperature. The stated project objective checks the validity of the theory that decreased skin temperature indicates tissue damage or necrosis.

METHOD

Dermatherm Perfusion Monitors were used to evaluate temperature differences between erythematic sites and the surrounding tissue in patients erythema. Dermatherm Monitors are single-use liquid crystal thermometers mounted to a non-latex based paper tape. The thermometers have a precision and accuracy of 0.5°F over the temperature range from 80 to 100°F with a response time of less than 15 seconds. Each strip costs \$1.00.

The temperature and appearance of erythematic and control sites were documented in forty-five subjects. Temperature strips were placed directly on 57 pairs of erythematic and control sites. The methodology did not control for time since it was meant to mimic the clinical use of thermometers by practitioners. Therefore, the time from pressure relief to temperature measurement varied according to the complexity of the transfer and positioning needed to expose the erythematic sites

Participants presented clinically with pressure induced erythema. In subjects with lightly pigmented skin, all areas of redness were monitored regardless of whether the erythema was caused by reactive hyperemia or a Stage I pressure ulcer. In subjects with dark skin pigment, erythema was indicated by skin discoloration near load-bearing bony prominences. The subjects were primarily non-ambulatory and had a broad range of disabilities including spinal injury, multiple sclerosis, and traumatic or diabetes-related lower limb amputations. All subjects gave informed consent.

RESULTS

The temperature differences between the erythematic and control sites were calculated for each of test pair. This data is presented in Table 1 and Figure 1. A negative temperature difference indicates that the erythematic site was cooler than the surrounding healthy tissue. There is a slightly positive average temperature difference, and the data range is equally distributed around zero. Twelve percent of the erythematic sites were the same temperature as the surrounding tissue to within the precision of the measurement system. Twenty-six percent of the erythematic sites were cooler than the control sites. A two-tailed paired comparison shows the temperature differences between the erythematic site and control site were statistically significantly different ($p < 0.05$).

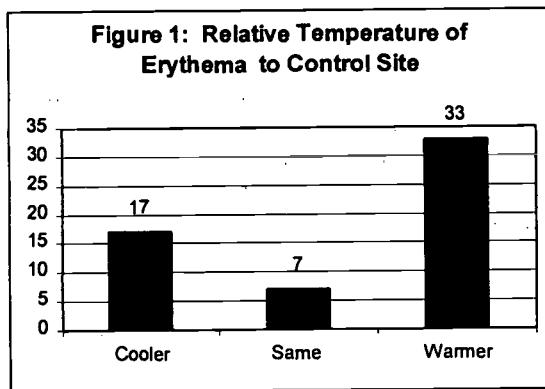

Mean ± SD	0.7 ± 2.2
Minimum	-5.0
Maximum	5.0
n	57

DISCUSSION

Analysis of temperature differences between erythematic site and surrounding skin showed that erythema may be either warmer or

cooler than the surrounding tissue. Fifty-seven percent of the erythematic sites had increased temperature. This result supports the commonly held belief that the causes of erythema, reactive hyperemia and Stage I pressure ulcers, involve physiological responses that can increase tissue temperature, increased perfusion and an inflammatory response, respectively. However, twenty-six percent (17) of the erythematic sites were cooler than the surrounding tissue. These cases may represent a different systemic responses for certain Stage I pressure ulcers.

Insight into the systemic response may be gained by examining the characteristics of the subject and tissue trauma in cases where the damaged tissue was cooler than healthy tissue. Thirteen sites represent traditional load-bearing over bony prominences. Two of the remaining sites were bony prominences with possible load history due to patient positioning problems. For seven cases, the subjects had documented circulatory pathology. Five cases appeared to have deep tissue trauma, characterized by loss of skin turgor or a purplish tone appearing beneath the skin surface.

The results of the project illustrate both usefulness and limitations of temperature measurements to identify areas of erythema, especially in people with darkly pigmented skin. A temperature difference can be used to indicate a skin integrity problem, but a lack of a difference cannot be used to indicate that no problem exists.

Further work in this area should investigate different temperature measurement systems. While the Dermatherm Perfusion Monitors offer a relatively rapid response, they have limited precision and concern exists over placing them on damaged or fragile tissue. Other surface thermometer instruments such as thermocouple or infrared systems offering higher precision and a more rapid response, non-contact instrument should be investigated.

REFERENCES

1. U.S. Department of Health and Human Services, "Pressure Ulcer Treatment: Quick Reference Guide for Clinicians." Agency for Health Care Policy and Research, AHCPR Publication Number 95-0653, December 1994.
2. Barnett RJ, Ablarde JA, "Skin Vascular Reaction to Short Duration of Normal Seating." *Arch Phys Med Rehabil* 76: 533-540.
3. Crenshaw RP, Vistnes LM, "A Decade of Pressure Sore Research: 1977-1987." *Journal of Rehabilitation Research and Development* 26(1): 63-74.
4. Newman P, Davis NH, "Thermography as a Predictor of Sacral Pressure Sores." *Age and Aging*, 10: 14-18 (1981).

ACKNOWLEDGMENTS

This study was funded by the National Institute on Disability Research and Rehabilitation grant number H133G5001896.

Maureen Linden
Center for Rehabilitation Technology
Helen Hayes Hospital
Rt. 9W
West Haverstraw, NY 10993
crthhh@mindspring.com

EFFECT OF TISSUE TYPE ON SEATING PRESSURE

Jonathan M. Owens, Beth A. Todd, Ph.D, and James F. Cuttino, Ph.D.
Department of Mechanical Engineering
University of Alabama, Tuscaloosa, AL

ABSTRACT

The effective elastic moduli of muscle and fatty layers were determined for able-bodied male and female subjects in the seated position. The male subject had a mass of 74 kg, and the female subject had a mass of 58 kg. The experimentally determined values of the elastic moduli and tissue thicknesses were entered into a finite element analysis program to determine more accurately the stresses and pressures generated on the human buttocks.

BACKGROUND

When a person sits for an extended period of time, he or she shifts as the pressure from the chair, bench, or floor begins to make them uncomfortable. Individuals who are insensate or have a motor disability may not be able to adequately redistribute the pressure by shifting. This can lead very quickly to tissue damage such as decubitus ulcers. Experimentation has been done on animals to determine what effect pressure has on underlying tissues, but human testing is very difficult (1). Finite element analysis offers another avenue to explore the interrelationship between pressure, tissue damage, and seating.

EXPERIMENTAL METHODS

Load vs. Displacement data was analyzed to determine the stiffnesses for the muscle and the fat tissue separately (2). This was done using data for a male with negligible body fat and a female with approximately equal amounts of muscle and adipose tissue in the buttocks. The two layers were modeled as springs in series where

$$k_{eff} = \left[\frac{1}{k_m} + \frac{1}{k_f} \right]^{-1} \quad (1)$$

and k_{eff} is the effective stiffness of fat and muscle, k_m is the stiffness for muscle, and k_f is the stiffness for fatty tissue. The effective

stiffness was measured from the female subject while k_m was measured from the male subject with the assumption that his body fat was negligible. Solving for k_f , Equation 1 becomes

$$k_f = \frac{k_m k_{eff}}{k_m - k_{eff}} \quad (2)$$

With the stiffnesses known, the moduli of elasticity could be determined with Equation 3.

$$E = k \frac{L}{A} \quad (3)$$

This equation states that elastic moduli for the fat and muscle layers are equal to the stiffness, k , multiplied by the thickness of the tissue, L , and divided by the area, A , of the probe used to take the load-deflection measurements (2).

An axi-symmetric model of a portion of a single buttock was developed after work by Chow and Odell (3). The model was generated with ANSYS/ED Version 5.3 on a Pentium class computer using 4-node axisymmetric-harmonic structural solid elements.

The finite element model includes the soft tissues under and around the ischial tuberosity with a rigid core representing the bony prominence. The rigid core consists of a vertical cylinder of radius 25 mm, length 50 mm, and a hemispherical end. The core is created by the use of displacement constraints placed along its interface with the soft tissue.

The dimensions of the model were chosen based on MRI data for each subject where the thickness of each of the male and female layers of muscle and fatty tissue was determined (4). On the male model, the thickness of the fatty layer was 13.7 mm while the muscle layer was

45.1 mm beneath the ischial tuberosity as shown in Figure 1. In contrast, in the female model, the fatty layer was 25.5 mm and the muscle layer was 15.6 mm beneath the ischial tuberosity. Both materials were given a Poisson's ratio of .49 such that the materials would be almost incompressible (3).

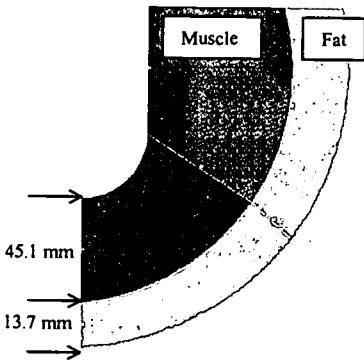

Figure 1. Male Model Tissue Layers

The male model was loaded with 29% of the subject's total body weight, which was determined to be 211 N (5). The female model was treated the same with a load of 167.5 N applied. Both loads were applied as a surface pressure on the lower quarter of the hemispherical surface to represent contact with a contoured cushion.

RESULTS

It was determined experimentally that k_{eff} equals 1.2 N/mm and k_m equals 1.8 N/mm. The value for k_f was calculated to be 3.6 N/mm. The elastic modulus for the muscle layer was calculated to be .54 N/mm² and that for the fatty layer was .42 N/mm².

Despite the different loading due to the weight differences and the varying layer thickness, both models resulted in similar internal stress distributions. The von Mises stress was plotted and is shown in Figures 3 and 4. The highest stress magnitude was 231 Pa for the male and 220 Pa for the female adjacent to the lower portion of the ischial tuberosity. The contact

surface stresses were low on both models and varied from 20 to 50 Pa.

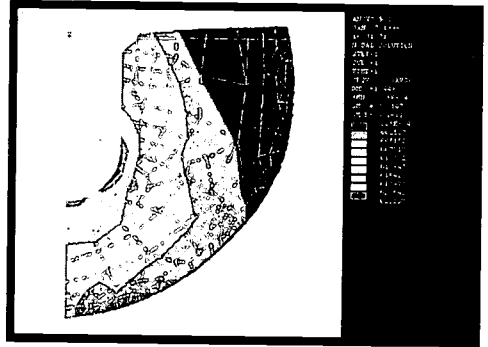

Figure 3. Male Finite Element Model Results

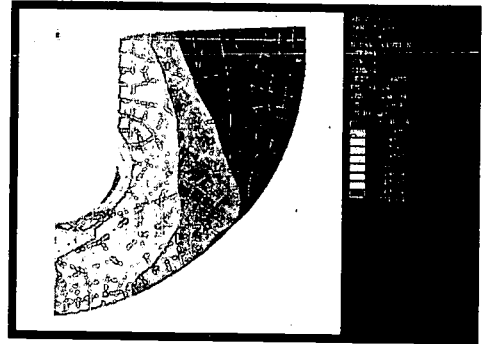

Figure 4. Female Finite Element Model Results

While the von Mises stresses were similar, there were some differences in the strain distributions. The male and female strains are shown in Figures 5 and 6.

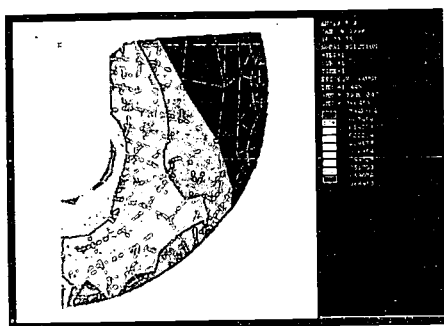

Figure 5. Male von Mises Strain

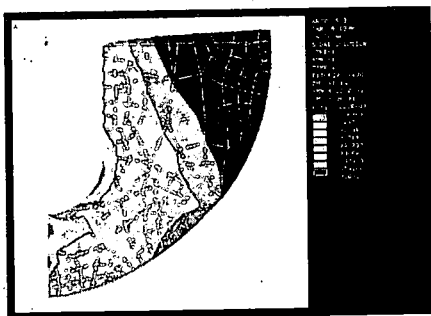

Figure 6. Female von Mises Strain

The male and female maximum strain values were .066 mm/mm and .061 mm/mm respectively. In both models, the maximums occur in the same area as the maximum stress, which would be expected. The female model also has a high strain area directly beneath the ischial tuberosity half way between the outer surface and the rigid core. This difference between the male and the female models is due to the thickness of the fatty layer. Another point of interest is that the surface strain on the male is higher than that of the female in the area of the fatty tissue. The highest surface strain of the male is .066 mm/mm while the surface strain on the female is only .014 mm/mm in the same region. This region is directly beneath the ischial tuberosity.

DISCUSSION

Similarities in the von Mises stresses throughout the two models were expected because the geometry and loads were similar. The interesting information gained is the

difference in the strain distributions in the two models.

The higher surface strain on the male model below the ischial tuberosity may be caused by the stiffness of the relatively thick layer of muscle above the fatty layer. Most of the deflection of the buttocks will be done in this fatty region.

The higher strain in the female model occurs beneath the ischial tuberosity at the interface of the muscle and the fatty layer. This too may be due to the fact that the stiffer muscle layer will be less pliable while the fatty layer will be more likely to move under load.

The results of these models show that it is desirable to separate the properties of the fatty and muscle layers to gain information on the behavior of the interface of the two layers. This behavior was not shown in the same model with constant material properties. The higher strain at the interface of the two layers did not exist in that test case.

REFERENCES

1. Sanders JE, Daly CH. Measurement of stresses in three orthogonal directions at the residual limb-prosthetic socket interface. *IEEE Trans Rehab Eng* 1993;1:79-85.
2. Todd, Beth A., Finite Element Analysis of the Stress Distribution within the Seated and Supine Human Buttocks, In Vivo, Doctoral Dissertation, University of Virginia, May 1992.
3. Chow, W.W. and E.I. Odell, "Deformation and Stresses in Soft Bodied Tissues of a Sitting Person", ASME Journal of Biomechanical Engineering, 100: 79-87, 1978.
4. Protz, Philip R., Jr., An Investigation of the Load-Bearing Tissues of the Human Buttocks Implementing Magnetic Resonance Imaging, Mater of Science Thesis, University of Virginia, August 1990.
5. Anthropometric Source Book, Volume I: Antropometry for Designers, NASA Reference Publication 1024, July 1978, pg. IV-31 - IV-39.

EFFICACY OF SEAT CUSHIONS IN PREVENTING PRESSURE ULCERS FOR AT-RISK ELDERLY NURSING HOME RESIDENTS: RESEARCH ISSUES

Mary Jo Geyer, David M. Brienza, Sheryl F. Kelsey, Patricia Karg and Elaine Trefler
Departments of Rehabilitation Science and Technology and Epidemiology
University of Pittsburgh, Pittsburgh, PA

ABSTRACT

This paper describes the major design and methodology issues identified and addressed during project development such as: accuracy and reliability in assessment of Stage I ulcers; validity and reliability of risk assessment; appropriate timing of intervention strategies; the use of alternative outcome measures in addition to interface pressure and the degree of customization appropriate for the seating intervention. These issues represent some of the challenges associated with seating and pressure ulcer research as well as those specific to the elderly, immobile nursing home (NH) population.

BACKGROUND

The scope of the problem of sitting-induced pressure ulcers in the immobile, elderly NH population is largely unknown. However, it is estimated that the US NH population includes 600,000 elderly wheelchair users (1) with a pressure ulcer prevalence of 17.4-28.0% (2) of which 15% are ischial ulcers (3). Despite Federal regulations requiring that all residents of nursing homes receive the care and supplies necessary to prevent the development or progression of pressure ulcers, this population is generally not evaluated for seating and positioning needs. Although commercial cushions are available, reimbursement is not routinely available for the seating evaluation or the cushions due largely to the fact that the efficacy and cost effectiveness of these interventions has not been sufficiently demonstrated in this population.

STATEMENT of the PROBLEM

This pilot study has been funded for the purpose of designing and testing the feasibility of a randomized clinical trial to determine the efficacy of various pressure-reducing cushions in

preventing pressure ulcers in at-risk, immobile elderly NH residents.

APPROACH

In November 1997 a national panel of seating experts was convened in association with this study. The following describes the issues identified and addressed by design and methodology.

Incidence and prevalence data is generally flawed due to inconsistency in defining pressure ulcer stages and the fact that Stage I pressure ulcers are unreliably assessed, especially in darkly pigmented skin. Therefore, everyone involved in data collection must be capable of accurately distinguishing pressure ulcers from other types of chronic wounds and care must be taken to ensure that Stage I ulcers are accurately recorded and not confused with a dermatitis or the normal hyperemic response.

In order to provide a more valid indication of the intervention efficacy, a comparison of pressure ulcer frequencies between individuals at-risk and those not at-risk must be made. Therefore the timing of the intervention strategy must coincide with periods of increased risk and must identify those at-risk in a valid and reliable manner. Data available regarding pressure ulcer risk factors identifies limited activity and mobility as key factors (2). The Braden Scale appears to have good reliability, includes two subscales for activity and mobility and has been tested for predictive validity in a NH population where it was found to have the greatest sensitivity and specificity with a cut off score of 18 (5). Evidence supports the use of risk assessment tools to target preventive measures for the highest risk groups.

Although available data suggest that the risk for pressure ulcers persists throughout a NH resident's stay, most pressure ulcers occur

within the first few days or weeks of admission. Braden and Bergstrom found that 80% of NH residents destined to develop pressure ulcers did so within the first two weeks of admission; 92% by the third week and 100% by the ninth week (4). It should be noted that most pressure ulcers develop during or immediately following acute care hospitalizations (2).

Numerous studies have been performed to determine the effectiveness of available wheelchair cushions in increasing comfort and/or reducing interface pressure (1). The assessment of the efficacy of cushions has been primarily limited to the use of criteria lacking in standardization and interface pressure measurement which, although convenient, has considerable limitations. Recent research suggests that interface pressure does not provide adequate information regarding the prophylactic performance of a particular cushion (7). Its reliability is further compromised by variability among measurement devices. Currently, controversy exists in the literature regarding the effectiveness of a few selected commercial cushions to provide increased comfort; lower interface pressures; and decrease incidence, severity or healing time of sitting-induced pressure ulcers in this population (6,7).

Currently, the degree to which a wheelchair may be adjusted to meet the seating needs of NH residents is largely dependent upon the skill and experience of the NH clinicians and the availability of chairs within the facility. While the quality of seating interventions is variable among institutions nation-wide, the consensus of the majority of clinicians is that it is largely inadequate. Previous studies have taken the approach of either using the wheelchair as assigned by the facility or providing individualized adjustment of the wheelchair and cushion by a seating specialist. Although providing a properly modified, highly adjustable chair would help to distinguish the effects of the chair from those of the cushion, the cost for a large scale clinical trial would be prohibitive. The intent of this study is to duplicate the current conditions of most facilities without compromising the effects of the cushions.

IMPLICATIONS

Experimental Design and Methods

Multiple nursing homes will be participating in this study. Forty subjects (male and female) will be cumulatively enrolled and followed until the first incidence of sitting-induced pressure ulcer or the end of the study (June 1999). Subjects will be randomized to one of two groups: 1) will receive a pressure-reducing cushion appropriate for his/her needs and a wheelchair of proper fit or 2) will receive a standard cushion of convoluted foam and a wheelchair of proper fit. All subjects will receive an initial seating and wheelchair assessment during which the fitting of the wheelchair cushion and the wheelchair will occur. This study will compare the efficacy of a wide range of commercially available cushions to the standard convoluted foam cushion. Interface pressure measurements will be used to guide seating modifications for a specific subject and to compare pressure data *post hoc* with the primary outcomes.

The primary study outcome will be sitting-induced pressure ulcer incidence. Skin assessments will be conducted weekly or as needed by the research team in addition to the daily inspection performed by nursing personnel. Facility staff will be recruited and trained in the staging of pressure ulcers and the recording of data on the skin assessment tool. Training will be conducted by a certified wound specialist until the interrater reliability reaches 0.95 and will be checked monthly to assure maintenance.

Consenting NH residents admitted to a facility following an acute care hospitalization who are age 65 and older with a Braden Score of ≤ 18 and a combined Braden subscale score for Mobility and Activity of ≤ 5 will be eligible for screening. Additional inclusion criteria: 1) being free of sitting-induced pressure ulcers and 2) requiring the use of a wheelchair for mobility and seating for ≥ 6 hours per day must also be met for subject selection. To initiate intervention to coincide with the highest risk period, potential subjects will be identified while hospitalized

Seat Cushions-NH Elderly

and will be assessed for seating needs on the day after admission to the NH. All subjects will receive their seating interventions within 48 hours of assessment.

DISCUSSION

We anticipate that this pilot project will:

- Demonstrate the feasibility of performing the clinical trial proposed
- Provide an estimate of the incidence rates of pressure ulcers in this population to predict the number of subjects needed for the full-scale trial with greater accuracy
- Provide further insight into the issues surrounding pressure ulcer development for this high risk population
- Develop a working Manual of Operations with sufficient detail to perform a successful multi-center clinical trial
- Provide a validated procedure that will be available for use by other researchers to implement a full-scale clinical trial on the effects of a specific pressure-reducing cushion or to perform a comparative evaluation of commercial devices
- Provide the basis to pursue funding for a clinical trial that will demonstrate whether or not the intervention of a pressure-reducing cushion is clinically-effective in reducing the incidence of pressure ulcers and cost-effective for the elderly, immobile nursing home population

REFERENCES

1. Shaw, CG and SJ Taylor. (1992) A Survey of Wheelchair Seating Problems of the Institutionalized Elderly. *Assistive Technology*, 3(1):5-10.
2. Allman, RM. (1997) Pressure Ulcer Prevalence, Incidence, Risk Factors, and Impact. *Clinics in Geriatric Medicine*, 13 (3):421-36.
3. Smith, DM. (1995) Pressure Ulcers in the Nursing Home.[Review]. *Annals of Internal Medicine*. Sept; 123(6):433-42.
4. Bergstrom, N and BJ Braden. (1992) A Prospective Study of Pressure Sore Risk Among Institutionalized Elderly. *Journal of the American Geriatrics Society*. Aug; 40(8):747-58.
5. Braden, BJ and N Bergstrom. (1994) Predictive validity of the Braden Scale for Pressure Sore Risk in a Nursing Home Population. *Research in Nursing & Health*. 17:459-70.
6. Lim, R., R Sirett, TA Conine, D Daechsel. (1988) Clinical Trial of Foam Cushions in the Prevention of Decubitus Ulcers in Elderly Patients. *Journal of Rehabilitation Research and Development*. Spring; 25(2):19-26.
7. Conine, TA., C Herschler, D Daechsel, C Peel, A Pearson. (1994) Pressure Ulcer Prophylaxis in Elderly Patients Using Polyurethane Foam or Jay® Wheelchair Cushions. *International Journal of Rehabilitation Research*. 17:123-37.

ACKNOWLEDGEMENTS

This pilot project is supported by the Department of Education NIDRR Field-Initiated Research & Demonstration Project (CFDA No. 84.133G) and the University of Pittsburgh Departments of Rehabilitation Science and Technology and Epidemiology. Additional thanks to the National Advisory Panel associated with this project.

Mary Jo Geyer mgeyer+@pitt.edu
5064 Forbes Tower, RST Department
University of Pittsburgh
Meyran Avenue
Pittsburgh, PA 15260
(412) 647-1289 FAX: (412) 647-1277
<http://pft5xx36.ft90.upmc.edu/RST/SSBL>

A METHOD FOR CONTOURED CUSHION DESIGN USING PRESSURE MEASUREMENTS

David M. Brienza and Patricia E. Karg
Seating and Soft Tissue Biomechanics Laboratory
University of Pittsburgh
Pittsburgh, Pennsylvania, U.S.A.

ABSTRACT

The interface pressure distributions between flat cushions and the buttocks of seated subjects were compared to custom cushion shapes to test the hypothesis that pressure measurements could be used to generate custom contours. The study used SCI (12) and elderly (30) subjects. Interface pressure was measured using a pressure mapping pad. Contour shape was measured using an electronic contour gage. Pressure and contour information were reduced using singular value decomposition. Polynomial regressions were performed on the values in the first singular vectors of the corresponding pressure and contour decompositions. Relationships best described by cubic polynomials were detected between pressure and contour, suggesting that interface pressure predicts contour.

BACKGROUND

Effective seat cushions are characterized by even pressure distributions and low shear forces. To achieve this condition, the support surface must envelop the buttocks. One method for achieving envelopment is to provide a seat support surface that is pre-contoured to a shape that is closely matched to an individual's buttocks [1]. Our purpose in performing this study is to develop a clinically feasible method for determining surface contours suitable for resilient foam cushions that achieve adequate envelopment of the buttocks. We know from previous studies that effective contours for high resiliency foam cushions can be determined from deflection measurements of flat, segmented foam or from spring-supported mechanical systems [2,3,4,5].

In clinical practice, deflection measurements require costly, non-portable, dedicated instrumentation [6], thus limiting the potential

for widespread use of the measurement systems. Pressure measurements, on the other hand, are much easier to obtain via commercially available pressure mapping systems. If the information from load-deflection measurements is available in the pressure measurements, pressure measurements could be used to design custom contoured seat cushions.

RESEARCH QUESTION

Our research investigates the hypothesis that pressure measurements can be used to generate custom contoured seat cushions equivalent to cushions generated with load-deflection measurement devices.

METHOD

The instrumentation used for this study were the electronic shape sensor (ESS) [6] and the force sensing array (FSA) (FSA Pad, Vista Medical, Manitoba, Canada). The ESS consists of an 11 by 12 array of support elements. The support elements are spring loaded and deflect downward in response to loads applied to the spherical tops of the elements. With a person seated on the device, the elements deflect downward until a force equilibrium is reached. The deflection of each spring-loaded support element is measured using linear potentiometers. The ESS is used in this study to generate the contour shapes that are compared to flat interface pressure distributions. Interface pressure distributions on flat foam cushions were measured using the commercially available FSA pressure mapping device (FSA Pad, Vista Medical, Manitoba, Canada.). The mapping device consists of a 15x15 array of force sensing resistors contained in a flexible material base. The cushions used were made from high resiliency, polyurethane, HR-45 grade foam with a 25% ILD rating in the range of 178-

222 N and a density of $448 \pm 16 \text{ N/m}^3$. Four inch and three inch thick cushions were used for the SCI and elderly subjects, respectively.

Thirty elderly subjects (17 female; 13 male) participated in the research study. The criteria for selection was that they were wheelchair users with an age of 65 years or greater and were free of sitting-induced pressure ulcers for the previous six months. Twelve SCI subjects (2 female; 10 male) also participated in the research study. The criteria for selection was that the subject was a wheelchair user with a spinal cord injury and free of sitting-induced pressure ulcers for the previous six months. The level of spinal injury varied over the range from C4-5 to L1-2 (6 cervical; 6 thoraco-lumbar).

Informed consent was obtained from each subject. Measurements of the subject's seating dimensions were used to adjust the backrests and footrests of the ESS to the appropriate positions. The subject first sat on the ESS and was positioned with assistance from the research team. The subject was positioned by centering the pelvis medial-laterally on the seat, attempting to level the pelvis and rotate it anteriorly to an upright position, placing the thighs in a relaxed position and parallel to the floor and relaxing while placing their hands in their lap and facing forward. Once positioned on the ESS, the resulting shape of the support surface was stored. The subject then sat on a flat foam cushion with the FSA mat between the cushion and his or her buttocks.

To reduce the complexity of comparing 2D arrays of data, we developed a data reduction and analysis technique based on singular value decomposition (SVD). Using SVD we are able to reduce the dimension of the data by more than half while retaining most of the information. The SVD of a data set reveals the dominant anterior-posterior (A-P) and medial-lateral (M-L) cross sectional shapes of the data, independent of their magnitudes. This allows for comparisons to be made between specific features of the data more accurately than if sample cross sections alone are used for comparison.

SVD was performed on the contour data measured on the ESS and on the interface pressure data measured on the flat foam cushion. Only the first singular vectors and the spectral norms were considered in the analysis. For each group, the components of the singular vectors representing the A-P cross sections and M-L cross sections for the contour data were compared to the corresponding data for the interface pressure. The interface pressure vectors were shifted to account for misalignment of the data.

Polynomial regressions were performed on the magnitudes of values in the first singular vectors of the pressure and contour data sets. This analysis was first carried out separately for the A-P and M-L cross section vectors, then with the data from the A-P and M-L vectors were combined. Beginning with linear regression, higher order terms were added to the regression model until the highest order term was no longer significant ($p \leq 0.05$). Correlation coefficients were computed for the spectral norms for each data set.

RESULTS

Third order polynomial regressions of the singular vectors' components for the ESS contour vs. interface pressure are shown in Fig. 1 for the combined A-P and M-L vectors for the elderly and SCI subject groups. In both cases, third order regression models were used to describe the relationship. R^2 for the best fit polynomials were 0.88 and 0.85 for the elderly and SCI groups, respectively. When the results for the A-P and M-L cross sections were analyzed separately, slightly stronger relationships for the A-P cross sections became apparent. R^2 for the A-P best fit polynomials were 0.93 for the elderly and 0.89 for the SCI. R^2 for M-L cross sections were 0.85 for the elderly and 0.83 for SCI.

The relationship between the magnitudes of interface pressure and deflection was analyzed by comparing the spectral norms of the pressure and deflection data. The relationship was best described by a linear regression. R^2

CONTOURED CUSHION DESIGN USING PRESSURE

values for the linear regressions were 0.55 for elderly group and 0.77 for the SCI group.

DISCUSSION

Our study suggests that contours for custom contoured seat cushions can be generated using pressure mapping data. The transformation involves decomposing the pressure data using SVD, extracting the first singular vectors corresponding to the A-P and M-L cross sections and the spectral norms, transforming the first singular vectors and spectral norms using the third order and linear relationships described in the previous section, then reconstructing the contour array from the resultant elements. Further research is necessary to validate the method.

REFERENCES

1. Chow WW, Odell EI. Deformations and Stresses in Soft Body Tissues of a Sitting Person. *J Biomed Engr.* 1978;100:79-87.
2. Chung KC. Tissue contour and interface pressure on wheelchair cushions. Dissertation, Charlottesville, VA: University of Virginia, 1987.
3. Sprigle SH, Faisant T, Chung KC. Clinical evaluation of custom-contoured cushions for spinal cord injured. *Arch Phys Med Rehabil* 1990;71:655-8.

4. Sprigle SH, Chung K-C, Brubaker CE. Reduction of sitting pressures with custom contoured cushions. *J Rehabil Res Develop* 1990;27(2):135-40.
5. Brienza DM, Karg PE, Brubaker CE. Seat cushion design for elderly wheelchair users based on minimization of soft tissue deformation using stiffness and pressure measurements. *IEEE Trans on Rehab Eng* 1996;4(4):320-327.
6. Brienza DM, Chung KC, Brubaker CE. Computer design and fabrication of custom contoured seating. *Med Des and Mat* 1991;1(1):32-41.

ACKNOWLEDGEMENTS

This work was supported by a grant from NIH, NCMRR, grant number R01-HD30161 and the Dept. of Ed, NIDRR grant number H133E0005.

David M. Brienza
Forbes Tower, Suite 5044
Pittsburgh, PA 15260

<http://pft5xx36.ft90.upmc.edu/RST/SSBL/>

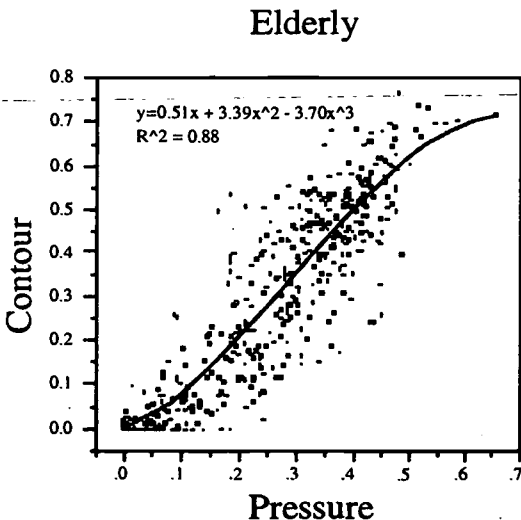

(a)

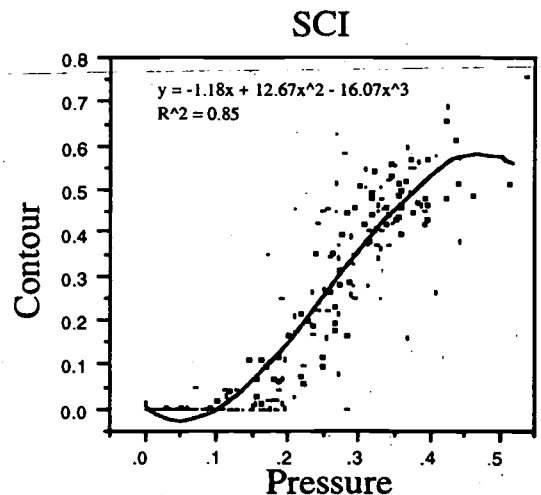

(b)

RELATIONSHIP BETWEEN WRIST BIOMECHANICS DURING WHEELCHAIR PROPULSION AND MEDIAN NERVE DYSFUNCTION

Sean D. Shimada^{2,3,4}, Michael L. Boninger^{1,2,3}, Rory A. Cooper^{1,2,3}, Mark A. Baldwin^{2,3}

¹Division PM&R, UPMC Health Care System, Pittsburgh, PA 15261

²Dept. Rehab. Science & Technology, University of Pittsburgh, Pgh, PA 15261

³Human Engineering Research Laboratories, VA Health Care System, Pgh, PA 15206

⁴Biomechanics Laboratory, California State University, Sacramento, 6000 Jst, Sacramento, CA 95819

ABSTRACT

There is a high incidence of carpal tunnel syndrome (CTS) among manual wheelchair users (MWUs). However, there is a lack of studies that have investigated the possible mechanisms that contribute to CTS in MWUs. A biomechanical analysis of 15 subjects propelling a wheelchair at 0.9 m/s (2 mph) was performed. Wrist flexion/extension moments and electrophysiological indicators of CTS were analyzed for possible correlation's.

The results revealed that both flexion and extension moments correlated with electrophysiological predictor variables. Without a possible outlier, flexion and extension moments continued to correlate with the electrophysiological predictor variables.

The results suggest that individuals who exhibit larger wrist flexion and extension moments may have a greater predisposition to median nerve abnormalities.

INTRODUCTION

Rehabilitation scientists have placed emphasis on the investigation of wheelchair propulsion because of the high incidence of secondary injuries among manual wheelchair users (MWUs). It is well accepted that MWUs are at greater risk for developing carpal tunnel syndrome (CTS) than the general population (1,2). Despite the agreement, no one has investigated the relationship between wrist biomechanics during wheelchair propulsion and CTS.

The *purpose* of this study was to investigate the relationship between wrist biomechanics during wheelchair propulsion and median nerve dysfunction. This will enable us to identify possible mechanisms that contribute to the development of CTS in MWUs.

METHODS

Subjects

A random sample of 15 experienced wheelchair users (9 males, 6 females) with traumatic spinal cord injuries (SCI) volunteered

for the study. The average age of the subjects was 34.9 years (SD=10.9 years). The level of SCI ranged from T-4 to L-1. The average years post-injury was 9.8 years (SD=5.0 years).

Biomechanical Analysis

A SMART^{Wheel} was placed on both sides of each subjects' wheelchair to measure three-dimensional pushrim moment data (3). The implementation of the SMART^{Wheel} did not change the camber or diameter of the subjects' normal pushrim or tire size.

A 60 Hz, three-dimensional camera system (OPTOTRAK, Northern Digital Inc.) was used to collect kinematic data. LED markers, used for kinematic analysis purposes, identified the lateral epicondyle, radial and ulnar styloid process, and the 3rd and 5th metacarpophalangeal joint on each extremity.

After informed consent was given, each subject pushed their own wheelchair at 0.9 m/s (2 mph), following an acclimation period. Kinematic and kinetic data were collected for 20 seconds after the subject reached steady state propulsion.

Nerve Conduction Studies (NCS)

Bilateral NCS were performed on all 15 subjects. Four specific electrophysiological variables were selected for this investigation; 1) median sensory amplitude (MSA), 2) median sensory latency (MSL), 3) median motor amplitude (MMA), and 4) median motor latency (MML). These variables have been reported to be sensitive indicators of CTS (4). An abnormal measure of any one of the indicators in the current investigation is suggestive of CTS.

Analysis

A local coordinate system was created in order to describe anatomic wrist motions (5). The moments measured from the SMART^{Wheel} were transformed into the anatomic wrist coordinate system. Wrist flexion and extension moments from each subject were analyzed for five propulsion strokes to obtain mean values.

MEDIAN NERVE DYSFUNCTION

The mean maximum wrist flexion and extension moments were selected based on possible mechanisms that contribute to CTS (1,6).

Each subjects' right and left mean maximum biomechanical wrist measures and electrophysiological predictor variables were averaged to obtain a single representative measure. An average of the right and left wrist measures were performed because there is a strong tendency for the sides to correlate with each other (4).

Wrist measures were tested against the electrophysiologic predictor variables, resulting in a Pearson correlation coefficient (r). A Fisher's r to z statistic were utilized to obtain the p -values associated with the correlation. A p -value less than 0.05 was considered statistically significant.

RESULTS

The correlation analysis revealed that flexion and extension moments correlated with the electrophysiological predictor variables. Table 1 reports the correlation coefficient (r) and p -values for the statistically significant findings.

Clinical Variable	Flexion Moment		Extension Moment	
	r	p	r	p
(n=15)				
MSA
MSL	0.571	0.025	.	.
MMA	-0.715	0.002	0.553	0.031
MML	0.564	0.027	.	.

Table 1 Biomechanical variables that correlated with the electrophysiological predictor variables.

A review of the electrophysiological predictor variables revealed that one subject may have strongly influenced the correlation between the biomechanical and electrophysiologic

Clinical Variable	Flexion Moment		Extension Moment	
	r	p	r	p
(n=15)				
MSA	.	.	-0.524	0.054
MSL	0.565	0.034	.	.
MMA	-0.685	0.005	0.648	0.011
MML	0.540	0.045	.	.

Table 2 Biomechanical variables that correlated with the electrophysiological predictor variables without outlier.

predictor variables. This subject was eliminated from the analysis to determine whether the outlier influenced the correlation analysis. The analysis revealed that the flexion and extension moments continued to correlate with the electrophysiologic predictor variables (Table 2). Figure 1 depicts a plot of the median motor amplitude plotted against the flexion moment.

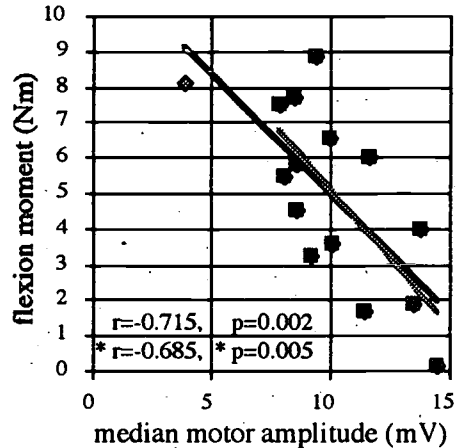

Asterisk (*) identifies r and p -values for the trendline without the possible outlier (gray line).

Figure 1 Scatter-plot depicting the median motor amplitude and flexion moment for 15 subjects.

DISCUSSION

Flexion Moment

The flexion moment measured at the wrist were found to correlate with the electrophysiologic variables. The largest correlation coefficient (r) was -0.685 with a p -value of 0.005. This was found when the flexion moment was paired with the median motor amplitude. This implies that larger flexion moments may contribute to the development of CTS in MWUs.

Smith *et al.* (7) reported that bending of the flexor tendons around the flexor retinaculum under tension may lead to chronic synovitis, contributing to the development of CTS. The continual contraction of the wrist flexors during wheelchair propulsion may repetitively impinge the median nerve against the flexor retinaculum. This impingement may become more severe as flexion angles and moments increase. This hypothesis can be supported by the association found between large flexion moments and electrophysiological indicators of CTS.

Extension Moment

Large extension moments at the wrist have been reported to contribute to the development of CTS. Seradge *et al.* (8) found that active wrist extension increased carpal canal pressures, while Werner *et al.* (6) found that isometric contraction of the wrist muscles also increased canal pressures. The investigations concluded that the increase in carpal canal pressure during active wrist extension injure the median nerve.

The extension moments measured in this investigation were found to correlate with the median sensory amplitude, median sensory latency, and median motor amplitude. This suggests that individuals who exhibit larger extension moments at the wrist may be predisposed to median nerve abnormalities. When the subject representing the possible outlier was eliminated from the analysis, the extension moment continued to correlate with the electrophysiological predictor variables. This finding further substantiates the claim that wrist extension moments may be used to identify individuals with abnormalities in the median nerve.

The results from this investigation indicate that both flexion and extension moments may contribute to the development of CTS in MWUs. It is hypothesized that these moments can not be avoided during wheelchair propulsion, predisposing MWUs to CTS. For the most part, the results of this investigation agreed with the literature. However, the sample size of this analysis was relatively small (15). Solid conclusions to the findings can not be directly stated. Nevertheless, the findings of this study can not be discounted.

CONCLUSION

This investigation can not make conclusions regarding whether the larger biomechanical measures identified as possible indicators of CTS were due to a causative or compensatory event. More specifically, were the biomechanical measures initially different, contributing to the development of CTS, or were the biomechanical measures an adaptation developed in order to cope with the symptoms associated with CTS. This investigation can not make this distinction. A longitudinal study is currently underway to determine whether the biomechanical measures associated with the electrophysiologic predictor variables were a causative or compensatory event.

The information resulting from this study may ultimately help prevent musculoskeletal and neurological wrist injuries in both MWUs and the working population (i.e. secretaries, manual laborers, garment makers).

REFERENCES

1. Gellman H, *et al.* Carpal tunnel syndrome in paraplegic patients. *J Bone & Joint Surg* 1988;70-A(4):517-519.
2. Aljure J, *et al.* Carpal tunnel syndrome in paraplegic patients. *Paraplegia* 1985;23:182-186.
3. VanSickle DP, Cooper RA, Robertson RN. SMARTWheel: Development of a digital force and moment sensing pushrim. *Proc 18th Annual RESNA Conf.* Vancouver, BC: 1995:352-354.
4. Boninger ML, *et al.* Upper limb nerve entrapments in elite wheelchair racers. *Am J Phys Med & Rehab* 1996;75(3):170-6.
5. Shimada SD, Boninger ML, Cooper RA. Biomechanical wrist analysis during wheelchair propulsion: A local coordinate system. *Proc 20th Annual RESNA Conf.* Pittsburgh, PA: 1997:254-256.
6. Werner CO, Elmquist D, Ohlin P. Pressure and nerve lesion in the carpal tunnel. *Acta Ortho Scand* 1983;54:312-316.
7. Smith EM, Sonstegard DA, Anderson WH. Carpal tunnel syndrome: Contribution of flexor tendons. *Arch Phys Med & Rehab* 1977;58:379-385.
8. Seradge H, Jia YC, Owens W. In vivo measurement of carpal tunnel pressure in the functioning hand. *J Hand Surg* 1995;20A(5):855-859.

ACKNOWLEDGMENTS

Partial funding for this research was provided by the U.S. Department of Veterans Affairs Rehabilitation Research & Development Services (Project #B686-RA), National Institutes of Health (NIH K08 HD01122-01, PO1 HD33989-01), and the Paralyzed Veterans of America.

Sean D. Shimada, M.S.
California State University, Sacramento
Department of Health and Physical Education
Biomechanics Laboratory
6000 J. Street
Sacramento, CA 95819

EFFECT OF VINYL COATED PUSHRIMS ON WHEELCHAIR PROPULSION KINETICS

Alicia M. Koontz, Michael L. Boninger, Mark A. Baldwin, Rory A. Cooper, Thomas J. O'Connor
Dept. of Rehab. Science and Technology, University of Pittsburgh, Pittsburgh, PA 15261
Human Engineering Research Laboratories, Highland Drive VA Medical Center, Pittsburgh, PA

ABSTRACT

Upper extremity pain and injury is commonly attributed to the high impact and repetitive forces exerted on the pushrim during wheelchair propulsion. The purpose of this study was to determine if the use of vinyl-coated pushrims could reduce potential injurious forces. Twelve wheelchair users were asked to push their personal wheelchair at 1.3 and 2.2 m/s under two conditions 1) with anodized pushrims and 2) with vinyl-coated pushrims while force and moment data from attached SMART^{Wheels} was collected. Summary mean variables: velocity, Fz, Fr, Ft, F, Mz, and stroke frequency, were calculated for each subject for 5 consecutive strokes. Significantly smaller resultant forces were found when vinyl-coated pushrims were used. We conclude that less force is required to propel forward when using vinyl-coated pushrims than when using anodized pushrims.

INTRODUCTION

Pain and upper extremity injury is common among manual wheelchair users. Shoulder-related injuries have been shown to be present in up to 51% of manual wheelchair users (3). In addition, the prevalence of elbow, wrist and hand pain has been reported to be 16%, 13%, and 11%, respectively (4).

Prolonged manual wheelchair use has been implicated as a cause of upper extremity pain and injury. During wheelchair propulsion, users must exert large forces in order to propel the chair forward. The component of force that is directed in towards the hub does not contribute to forward motion but is necessary in order to provide friction between the hand and the pushrim. Acting equal and opposite, this force is transmitted to the shoulder and is likely

a contributor to the development of rotator cuff tears and/or impingement syndromes (1).

The purpose of this study is to investigate the use of a vinyl-coated pushrim as a method of reducing injurious forces and moments. Padding for shock absorption has been shown to diminish the likelihood of neurovascular injury (2). The vinyl-coated pushrim has a higher coefficient of friction than a standard pushrim which may dampen the initial impact forces at the beginning of each stroke. As a result, the adapted pushrims may reduce the overall forces otherwise required to propel the chair and thereby improves the efficiency of propulsion. We hypothesize that the use of vinyl-coated pushrims will reduce the magnitude of the forces applied to the pushrim improving mechanical efficiency thus potentially reducing the likelihood of injury.

METHODS

Subjects. A convenience sample of twelve wheelchair users gave informed consent to participate in this study. The sample consisted of 6 males and 6 females with a spinal cord injury of T4 level or below.

Anodized and Vinyl-Coated Pushrims. The anodized pushrims were 1.88 cm in tube diameter with an overall diameter of 52.70 cm. Anodized rims were dipped in vinyl to provide for a padded, high friction gripping surface available from Sunrise Medical¹. The vinyl-coated pushrims measured 2.24 cm in tube diameter with an overall diameter of 53.66 cm.

¹ Sunrise Medical, Inc., Quickie Wheelchairs, 2842 Business Park Avenue, Fresno, CA 93727

EFFECT OF VINYL COATED PUSHRIMS

Kinetic Measurement System. Kinetic data was obtained using the SMART^{Wheel}, a force and torque sensing pushrim (5). The SMART^{Wheel} is used to measure three-dimensional forces and moments applied to the pushrim during wheelchair propulsion. Data from the SMART^{Wheel} was collected at 240 Hz and low-pass filtered at 30 Hz.

Experimental Protocol.

SMART^{Wheels} were attached to the subjects' own personal wheelchair. The subjects pushed on a wheelchair dynamometer. Prior to data collection, subjects were asked to propel their wheelchair to acclimate themselves to the experimental setup. Afterward, the subjects were asked to propel their wheelchair at two speeds 1.3 m/s and 2.2 m/s for two conditions 1) with anodized pushrims and 2) with vinyl-coated pushrims. Conditions were implemented in a random order. Force and moment data from the SMART^{Wheel} was collected for 20 seconds during each trial. Subjects rested between trials.

Data Analysis. As mentioned previously, three-dimensional forces (F_x, F_y, F_z) and moments (M_x, M_y, and M_z) were obtained from the SMART^{Wheel}.

The resultant force (F), radial force (F_r) and tangential force (F_t) were calculated from this data set and are

graphically represented in Figure 1. The resultant force, F, was defined as

$$F = \sqrt{(F_x^2 + F_y^2 + F_z^2)},$$

while the tangential force, F_t, was defined as $F_t = M_z/r$, where r is the radius of the pushrim.

The mechanical efficiency is the ratio of the force that contributes to forward motion over the resultant force, F_t^2/F^2 (1). The stroke frequency is defined as the number of propulsion strokes per second. Peak F, F_t, F_r, F_z, and M_z, and the mean velocity of the wheelchair were determined for each subject over the first five consecutive strokes.

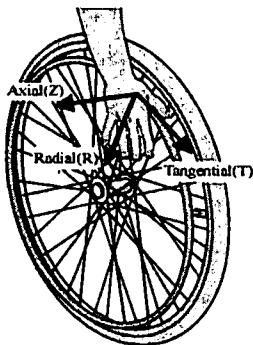

Fig.1 - Coordinate System

Statistical Analysis. A student's paired t-test was used to compare mean peak pushrim forces, M_z, mechanical efficiency, and velocity values for the two conditions. A p<0.05 was considered statistically significant.

RESULTS

The mean values for the right and left sides at both speeds were highly correlated (r>0.7). Therefore, a summary mean variable for each measure was calculated that averages the means for both sides and both speeds. The mean summary velocity, peak forces (F, F_t, F_r, F_z), M_z, mechanical efficiency, and stroke frequency for twelve subjects are reported in Table 1.

TABLE 1 - SUMMARY MEAN VARIABLES

Condition	Velocity (m/s)	F _z (N)	F _r (N)	F _t (N)	F (N) *	M _z (N/m)	$\frac{F_t^2}{F^2}$	stroke frequency
Anodized (n=12)	1.35 (0.07)	30.86 (20.34)	67.57 (22.14)	46.38 (22.06)	88.55 (24.35)	15.46 (7.35)	0.26 (0.13)	1.07 (0.17)
Vinyl (n=12)	1.43 (0.13)	26.36 (18.94)	62.76 (23.93)	43.95 (15.14)	79.85 (25.29)	14.65 (5.05)	0.29 (0.13)	1.09 (0.18)

*p<.05 represents statistically significant differences

There was no significant difference found when comparing the velocity of propulsion for both conditions (p>0.05). A significantly lower resultant force, F, was found

EFFECT OF VINYL COATED PUSHRIMS

for subjects using the vinyl-coated pushrims. No significant differences were detected for the other variables.

DISCUSSION

Manual wheelchair users are at a high risk for developing upper extremity injuries in part due to the large repetitive forces applied to the pushrim during wheelchair propulsion. Upper extremity injuries jeopardize independence and impact the overall functionality of the individual. For this reason, use of vinyl-coated pushrims were investigated as a method to reduce harmful forces that are presumed to be injury inducing mechanisms.

The results of this study reveal that the peak resultant forces were lower when vinyl-coated pushrims were used. Since propulsion velocity did not differ significantly between conditions, this decrease in force can not be attributed to variations in speed. While there was no significant change in tangential, radial and axial forces, an overall decrease in these variables must have occurred in order to result in a lower resultant force.

Use of the vinyl-coated rims may have reduced the frictional forces necessary to propel the wheelchair by improving the coupling of the hand to the pushrim. As a result, wheelchair propulsion is more efficient and performance is enhanced.

CONCLUSIONS

These findings strengthen the proposed hypothesis that vinyl-coated pushrims reduce the magnitude of the forces applied to the pushrim during wheelchair propulsion. This is most likely due to the improved coupling affect between the hand and the pushrim. Future studies should determine if long-term use of the adapted pushrim can reduce the incidence of injury. In the meantime, clinicians and

wheelchair users should consider incorporating this technology.

ACKNOWLEDGMENTS

Partial funding for this research was provided by the U.S. Department of Veterans Affairs Rehabilitation Research & Development Services (Project B689-RA), National Institutes of Health (NIH K08 HD01122-01), and the Paralyzed Veterans of America.

REFERENCES

1. Boninger ML, Cooper RA, Robertson RN & Shimada, SD (1997). Three-dimensional pushrim forces during two speeds of wheelchair propulsion. *Am J Phys Med Rehabil*, 76, 420-426.
2. McKenzie F, Stormont J, Van Hook P & Armstrong TJ (1985). A program for control of repetitive trauma disorders associated with hand tool operations in a telecommunications manufacturing facility. *Am Ind Hyg Assoc J*, 46, 674-678.
3. Nichols PJ, Norman PA & Ennis JR (1979). Wheelchair user's shoulder? Shoulder pain in patients with spinal cord lesions. *Scand J Rehabil Med*, 11, 29-32.
4. Sie IH, Waters RL, Adkins RH & Gellman H (1992). Upper extremity pain in the postrehabilitation spinal cord injured patient. *Arch Phys Med Rehabil*, 73, 44-48.
5. VanSickle, DP, Cooper RA & Robertson RN (1995). SmartWheel: Development of a digital force and moment sensing pushrim. *Proceedings of RESNA '95 Annual Conference*, Vancouver, BC, 15, 352-354.

Alicia M. Koontz
Human Engineering Research Laboratories
VAMC, Highland Drive
Pittsburgh, PA 15206

QUANTITATIVE ASSESSMENT OF THE VIBRATION EXPERIENCED BY WHEELCHAIR USERS DURING ACTIVITIES OF DAILY LIVING

Dehou Liu, Rory Cooper, Changfeng Tai, Andy Rentschler, Mike Dvorznak,
Michael Boninger, Jess Gonzalez

Human Engineering Research Laboratories

VA Pittsburgh Healthcare System, Pittsburgh, PA 15206

Department of Rehabilitation Science & Technology, University of Pittsburgh, PA 15261

Abstract

The quantitative measurement and analysis of vibration (acceleration) is a possible means of objectively evaluating wheelchair ride comfort and could lead to information about secondary injury during wheelchair propulsion. In this study, the acceleration during wheelchair driving over 8 different daily obstacles was analyzed. The resonance frequencies of wheelchair users were determined. The RMS of the wheelchair acceleration was calculated and compared to the ISO 2631. The acceleration power of the wheelchair and its user for the different obstacles were compared. The resonance frequency obtained here is lower than that of unimpaired human body exposed to vibration within wide frequency range. The RMS of the wheelchair acceleration exceeds several of the ISO boundaries.

Background

Although durability is a preferred quality in wheelchairs, additional qualities are required for high performance wheelchairs. For example early wheelchairs were durable, but very heavy. They required more energy to propel and more energy was transmitted from the frame to the wheelchair user, making them uncomfortable.

Static loads exist at the seat and back interface due to the wheelchair's reaction forces to the weight of the wheelchair user. The pressure distribution and postural support that results from these reaction forces can produce physiological changes in the wheelchair user's body including circulation occlusion, nerve occlusion, and ischemia [1]. Such changes are risk factors for pressure sore development, tissue necrosis, nerve

damage, and spinal deformity. Because wheelchair propulsion is a dynamic and complex activity, the quantitative investigation of wheelchair vibration (acceleration) is very important to understanding the causes of wheelchair user secondary injury. The intensity and frequency range of the vibrations experienced daily by the wheelchair and its user are still not available. In this study, the vibrations of wheelchair driving were assessed quantitatively.

Methods

Data Acquisition System

One accelerometer was mounted on the seat of the wheelchair to measure the acceleration induced by passing some simulated obstacles, and another accelerometer was mounted on a bite-bar held in the mouth of the subject to measure the acceleration of the head transmitted from the wheelchair. The accelerometers (Analog Devices ADXL05, $\pm 4g$'s) were mounted in a three-axis configuration in order to measure three dimensional accelerations, but only the vertical acceleration was analyzed in this paper. The acceleration signals were sampled at 200 Hz via a battery powered custom-designed data acquisition system based on a Motorola Microcontroller (MC68HC11A1) with 8-bit A/D converter [2]. The acceleration data were transmitted to an IBM-PC through RS-232 port at 38.4k baud for further analysis.

Experiment Protocol

The subject traversed obstacles designed to emulate those a wheelchair user would encounter during activities of daily living. The first obstacle

is four tiles used to make dimple strip guidance markers for the visually impaired. Each tile is 16.51-cm square. These squares are placed side by side so that the entire wheelchair passes over the tiles. The second obstacle is a piece of light-industrial carpet. The third one is a simulated door threshold 1.6-cm high, 91.4-cm by 25.4-cm's aluminum plate. After rounding the first corner, the subject climbed the fourth obstacle - a 1.27-m long ramp to a height of 5.0-cm. A 1.22-m platform allows the wheelchair to reach the equilibrium before traversing off the 5.0-cm simulated curb drop. The height of this drop was selected to correspond to the height of the ANSI/RESNA Curb Drop test. Next, the wheelchair passed over two squares of rumble strips. The subject then made the last turn and traversed over three sinusoidal bumps. Each is 91.4-cm with the heights of 2.5-cm, 5.1-cm, 7.7-cm. The time when the front caster touches an obstacle and when the rear wheel leaves the obstacle was recorded with the collected data. The subject propelled an instrumented wheelchair with three trials using his/her own cushion. In each experiment, either a Quickie II, E&J Metro, Kushall 1000 or the subject's own wheelchair was used.

Data Analysis

The data were divided into 8 sections according to the markers made in the experiment to study different obstacles (-Figure 1-).

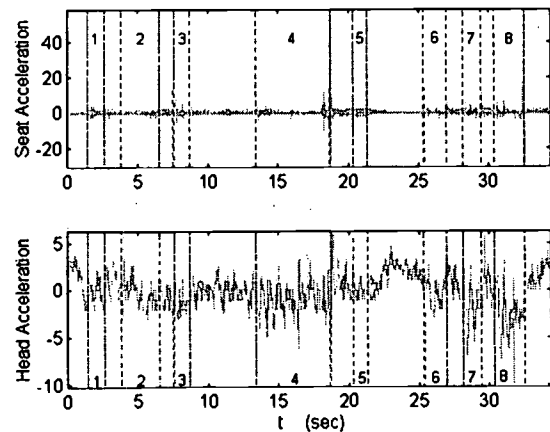

Figure 1. Acceleration signal during the course. The 8 obstacles are: 1, Dimple Strip; 2, Carpet; 3, Door Threshold; 4, Ramp; 5, Rumble Strip; 6, Bump #1; 7, Bump #2; 8, Bump #3

The PSD of the seat acceleration and the head acceleration for different obstacles were obtained via Welch's method. The resonance frequency of the wheelchair user was obtained from the PSD of the head acceleration. The power of the seat and head acceleration were also obtained by integrating the PSD of the seat and head accelerations. The root mean square (RMS) of the wheelchair vibration was calculated based on the ISO 2631/1 [3]. All results were obtained by averaging over 19 subjects (a total of 55 trials) to obtain a true representation of the vibration experienced by wheelchair user daily.

RESULTS

Figure 2 is the resonance frequency of the wheelchair user for 8 different obstacles. The average resonance frequency was 3.3 ± 1.34 Hz. This frequency is lower than the resonance frequency (4-8Hz) when an unimpaired human body is exposed to vibration within wide frequency range [3].

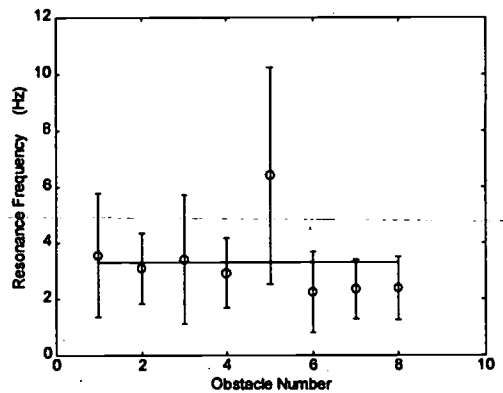

Figure 2. Resonance frequency when passing 8 different obstacles (8 obstacles corresponding to the definitions in Figure 1); + represents the resonance frequency for 8 obstacles, - - represents the average resonance frequency.

Figure 3 shows the power of the head and seat accelerations. For most obstacles, the power of head acceleration is larger than that of the seat. This may be because of the voluntary motion of the head of the subject during driving. But for obstacle 3 (door threshold) and obstacle 5 (

ramp), the power of seat acceleration is larger than that of head.

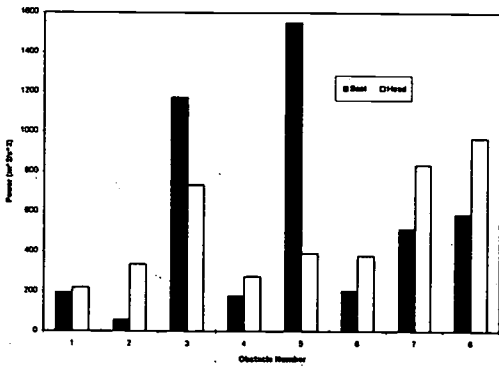

Figure 3. The power of head and seat acceleration for different obstacles (8 obstacles corresponding to the definitions in Figure 1)

Figure 4 is the RMS of the wheelchair acceleration averaged over the 19 subjects and 8 obstacles.

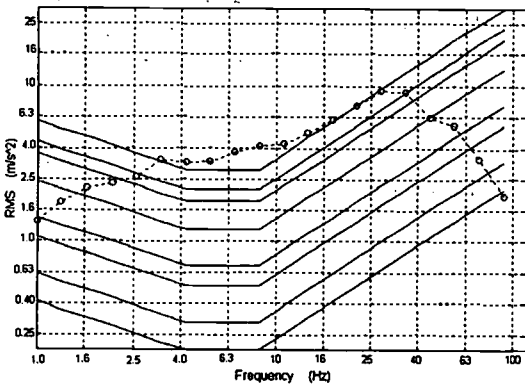

Figure 4. RMS of wheelchair acceleration and the fatigue-decreased proficiency boundary adopted from ISO 2631/1 for exposure time from 1 minute to 16 hours. The + represents the wheelchair data in this experiment

The RMS of the wheelchair acceleration exceeds several of the ISO boundaries. Of particular note is that it exceeds the 1 minute boundary within the frequency range of 3.15 Hz to 12.5 Hz.

DISCUSSION

A quantitative assessment of wheelchair vibration was presented. The vibration frequency and intensity daily experienced by wheelchair user were assessed. The daily experienced wheelchair vibration is larger than the ISO fatigue-decreased proficiency boundary. This suggests that new vibration reduction systems

should be designed for current wheelchair users and also suggests that new wheelchair ISO standards should be established to set the intensity boundary for wheelchair vibration to reduce wheelchair user secondary injury.

REFERENCE:

1. Viano D and Andrzejak D, Research Issue on the Biomechanics of Seating Discomfort: An Overview with Focus on Issue of the Elderly and Low Back Pain, *SAE Transaction*, #920130, 1992, pp. 122-131.
2. Vansickle D, Cooper R, Gonzalez J, Smart Accelerometer: A Device to Measure Three-axis Acceleration For the Purpose of Evaluating Wheelchair Ride Comfort, *Proceeding RESNA '97 Annual Conference*, Pittsburgh, PA, 1997, pp. 245-247.
3. Evaluation of Human Exposure to Whole-body Vibration - Part 1: General Requirements, *ISO 2631/1*, ANSI Press, Washington DC, 1985.
4. Vansickle D, Cooper R, Demonstration of a Methodology for Wheelchair Acceleration Analysis, *Proceeding of the 15th Annual International Conference of the IEEE-EMBS Society*, San Diego, CA 1993, pp. 1301-1302.
5. Vansickle D, Cooper R, Whole Body Dampening Properties of A wheelchair Rider, *Proceeding of the 16th Annual International Conference of the IEEE-EMBS Society*, 1994, pp. 498-499.

ACKNOWLEDGMENT

This work was partially supported by the Rehabilitation Research and Development Services, US Department of Veteran Affairs (B805-RA) and the National Institute on Disability and Rehabilitation Research, US Department of Education (HE133005).

Dehou Liu
 Human Engineering Research Laboratories
 VA Medical Center, 7180 Highland Drive, 151R-1
 Pittsburgh, PA 15206
 Tel: (412)365-4830
 delst18@pitt.edu



EFFECT OF A CUSHION ON WHOLE BODY ACCELERATION DURING WHEELCHAIR PROPULSION

Dehou Liu, Rory Cooper, Changfeng Tai, Andy Rentschler, Mike Dvorznak
Human Engineering Research Laboratories
VA Pittsburgh Healthcare System, Pittsburgh, PA 15206
Department of Rehabilitation Science & Technology, University of Pittsburgh, PA 15261

ABSTRACT

The subject propelled a wheelchair with cushion and without cushion while driving over the simulated obstacles. An accelerometer was mounted at the seat of the wheelchair. A second accelerometer was mounted on a bite-bar held in the mouth of the subject. The acceleration transfer function from the seat to the bite-bar was obtained via Welch's method. The system gain and -3 dB bandwidth were examined as objective measurements of comfort. The cushion reduces the vibration (acceleration) magnitude and frequency transferred from the wheelchair to human body.

BACKGROUND

It is difficult to evaluate a cushion only from the measurement of the seating pressure and shear force because the seating position strongly affects the measured results. Wheelchair propulsion is a dynamic activity, so the static measurement has limited ability for evaluation. In order to address these problems, an acceleration measurement system was designed to give a possible objective evaluation of the cushion during wheelchair propulsion.

When an obstacle is encountered during propulsion, loads are transmitted through the wheels and casters, the frame, the cushion, and through the wheelchair user. During a vertical acceleration resulting from such loads, the spinal column acts as a shock absorber, an energy absorber, and a transmission couple for vertical forces and vibrations. Vibration, especially vibration that is near the first human resonance frequency, can lead to spinal deformities, herniated discs, and chronic low back pain over time [1]. It is important to design wheelchair stiffness, damping characteristics and appropriate cushion to minimize such vibration transmission.

METHODS

Data Acquisition System

The whole body of the wheelchair user was modeled as an acceleration transfer system. The acceleration of the wheelchair induced by passing some obstacles was measured as the system input by an accelerometer mounted on the wheelchair seat, and the resultant head acceleration of the wheelchair user was measured as system output by mounting an accelerometer on a bite-bar held in the subject's mouth. The accelerometers (Analog Devices ADXL05, $\pm 4g$'s) were mounted in a three-axis configuration in order to measure three dimensional accelerations, but only the vertical acceleration was analyzed in this paper. The acceleration signals were sampled at 200 Hz via a battery powered custom-designed data acquisition system based on a Motorola Microcontroller (MC68HC11A1) with 8-bit A/D converter [2]. The acceleration data were transmitted to an IBM-PC through RS-232 port at 38.4k baud for further analysis.

Experiment Protocol

The subject traversed obstacles designed to emulate those a wheelchair user would usually encounter. The first obstacle is four tiles used to make dimple strip guidance markers for the visually impaired. Each tile is 16.51-cm square. These squares are placed side by side so that the entire wheelchair passes over the tiles. The second obstacle is a piece of light-industrial carpet. The third one is a simulated door threshold 1.6-cm high, 91.4-cm by 25.4-cm's aluminum plate. After rounding the first corner, the subject climbed the fourth obstacle --- a 1.27-m long ramp to a height of 5.0-cm. A 1.22-m platform allows the wheelchair to reach the equilibrium before traversing off the 5.0-cm simulated curb drop. The height of this drop was selected to correspond to the height of the ANSI/RESNA Curb Drop test. Next, the

wheelchair passed over two squares of rumble strips. The subject then made the last turn and traversed over three sinusoidal bumps. Each is 91.4-cm with the heights of 2.5-cm, 5.1-cm, 7.7-cm. The time when the front caster touches a obstacle and when the rear wheel leaves the obstacle was recorded with the collected data. The subject propelled a chair (Quickie) for three trials in two conditions: with cushion (standard foam cushion) and without cushion.

Data Analysis

The whole body acceleration transfer system is a time variant system because of the different seating positions and pushing styles when the subject encountered the different obstacles. We assume during each obstacle the acceleration transfer system is a linear time-invariant system with impulse response $h(n)$. Suppose that the input acceleration (seat acceleration) is $x(n)$, the output acceleration (head acceleration) is $y(n)$. So the system transfer function is

$$H(\omega) = \frac{S_{yx}(\omega)}{S_{xx}(\omega)}$$

Where $S_{yx}(\omega)$ is the cross-power spectral of $x(n)$ and $y(n)$, $S_{xx}(\omega)$ is the auto-power spectral of $x(n)$.

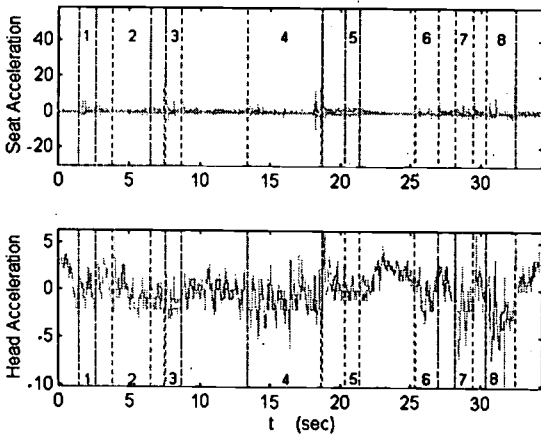

Figure 1. Acceleration signal during the course (trial 3 with cushion) passing 8 obstacles: 1, Dimple Strip; 2, carpet; 3, Door Threshold; 4, Ramp; 5, Rumble Strip; 6, Bump #1; 7, Bump #2; 8, Bump #3

The data were divided into 8 sections according to the marks made in the experiment to reflect the corresponding obstacle (Figure 1). The spectral estimates are based on Welch's method. The

acceleration transfer gain of the whole body was calculated by

$$G = \frac{\sum y(n)^2}{\sum x(n)^2}$$

for every obstacle. The -3 dB bandwidth and transfer gain were averaged over 3 trials.

RESULTS

Figure 2 is one sample of PSD of the seat acceleration and the head acceleration during bump

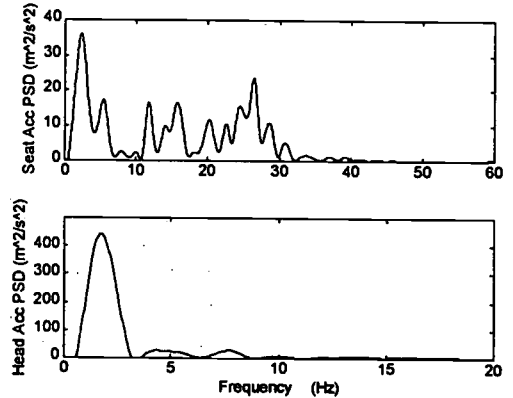

Figure 2. PSD of the acceleration during the bump #3 in the trial 3 with cushion.

#3 in trials 3 with cushion. The amplitude of head acceleration is much higher. This is because of the voluntary motion of the subject's head. The energy is usually below 40Hz for the seat and 15 Hz for the head. So the whole body acts like a low pass filter.

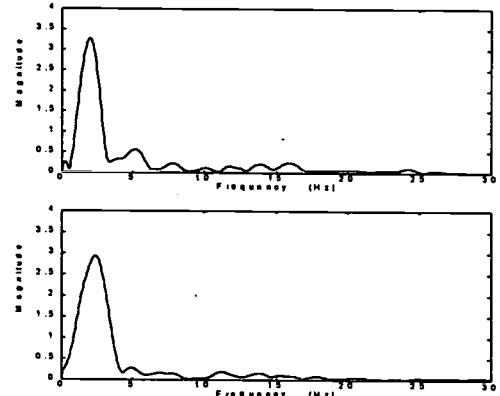

Figure 3. The gain of the transfer function of the whole body acceleration system for bump #3 in trial 3: top -- with cushion; bottom -- without cushion)

The transfer functions of the whole body acceleration system for the 8 obstacles were also

Cushion Effect on Whole Body Vibration

calculated. Figure 3 shows the magnitude frequency response of the system transfer function for bump #3 in trial 3 with cushion and without cushion. The -3 dB bandwidth for 8 obstacles with cushion is smaller than that without cushion (Figure 4). The acceleration transfer gains (G) was also reduced with cushion except for on carpet (Figure 5). When in the carpet, the input acceleration and output acceleration are both small, so the ratio is not accurate.

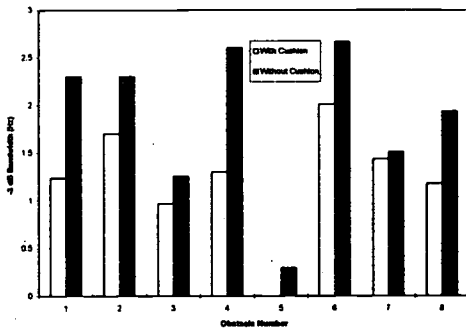

Figure 4. -3 dB band width of the whole body acceleration transfer system (8 obstacles corresponding to the definitions in Figure 1)

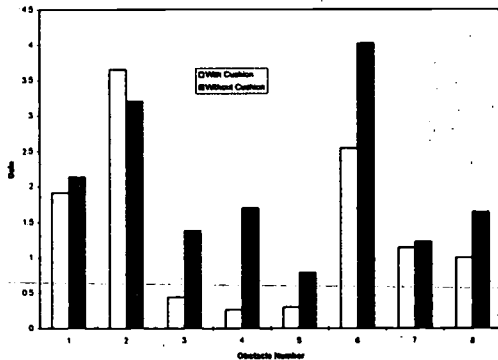

Figure 5. The energy transfer gain of the whole body acceleration (8 obstacles corresponding to the definitions in Figure 1)

From these results, we concluded that cushion reduced the vibration transmitted from the wheelchair to the human body (including magnitude and frequency).

DISCUSSION

A quantitative evaluation of the cushion function during the wheelchair propulsion is presented. The system response is obtained for the acceleration transfer from wheelchair to the subject's head during the propulsion. A future study can focus on:

same chair with different cushions. This system can be also used in the evaluation of the wheelchair: same cushion with different wheelchairs. It should be noticed that the measurement result may be also strongly affected by the seating position and propulsion style, and wheelchair user's pushing skill. This shortcoming can be overcome by repeated measurements.

REFERENCE:

1. Lawrence B, Cooper R, Robertson R, Boninger M, Gonzalez J, Vansickle D, Manual Wheelchair Ride Comfort, *Proceeding RESNA '96 Annual Conference*, Salt Lake City, UT, 1996, pp. 223-225.
2. Vansickle D, Cooper R, Gonzalez J, Smart Accelerometer: A Device to Measure Three-axis Acceleration For the Purpose of Evaluating Wheelchair Ride Comfort, *Proceeding RESNA '97 Annual Conference*, Pittsburgh, PA, 1997, pp. 245-247.
3. Vansickle D, Cooper R, Demonstration of a Methodology for Wheelchair Acceleration Analysis, *Proceeding of the 15th Annual International Conference of the IEEE-EMBS Society*, San Diego, CA 1993, pp. 1301-1302.
4. Vansickle D, Cooper R, Whole Body Dampening Properties of A wheelchair Rider, *Proceeding of the 16th Annual International Conference of the IEEE-EMBS Society*, pp. 498-499, 1994.

ACKNOWLEDGMENT

This work was partially supported by the Rehabilitation Research and Development Services, US Department of Veteran Affairs (B805-RA) and the National Institute on Disability and Rehabilitation Research, US Department of Education (HE133005).

Dehou Liu
Human Engineering Research Laboratories
VA Medical Center, 7180 Highland Drive, 151R-1
Pittsburgh, PA 15206
Tel: (412)365-4830
delst18@pitt.edu

EFFECTS OF CASTER TYPE ON WHEELCHAIR PROPULSION WORK REQUIREMENTS

W. Mark Richter, MSME; Logan G. Smith; Kenneth A. Chizinsky, MSBE;
Denise A. Chesney, MEBME; Peter W. Axelson, MSME
Beneficial Designs, Inc.
Santa Cruz, California, U.S.A

ABSTRACT

Wheelchair casters are available in a variety of sizes and styles. Caster size and style affect wheelchair performance characteristics. This study investigated the effects of caster type on the work required to propel a wheelchair along a straight path. Seven different casters were tested on six surfaces: grass, dirt, wood chips, two types of carpet, and a plywood ramp. The casters ranged from 3 in. to 8 in. in diameter and included both pneumatic and solid designs. Propulsion work was measured using ASTM PS 83 test methods. The results showed that the pneumatic casters required less work than the solid casters of the same size, and the 8 in. casters required less work than the 6 in. casters for both the pneumatic and solid designs.

BACKGROUND

A wide variety of caster types are available for use on wheelchairs. Each caster type has an effect on performance characteristics of the wheelchair such as ride comfort, obstacle climbing ability, ease of turning, and rolling resistance. Different casters may not perform equally on a particular surface type. Some casters are better suited for hard, smooth surfaces while others may perform best in softer surfaces and still others ideal for use on rocky or obstacle intensive environments. Objective measurements of these performance characteristics would serve to inform potential users as to which caster type was best suited for the activities and environment of anticipated use.

RESEARCH QUESTION

In an effort to provide one objective measurement of caster performance, how does caster type affect the amount of work required to propel a wheelchair along a straight path across various surface types?

METHODS

Seven different caster types were tested on six surfaces. The seven caster types were: 3 x 0.75 in. solid Rollerblade (3S), 5 x 1.25 in. solid (5S), 6 x 1.25 in. solid and pneumatic (6S,6P), 8 x 1.25 in. solid and pneumatic (8S,8P), and 6 x 3 in. semi-solid Zimbabwe wheel (ZB). Pneumatic casters were inflated to the maximum rated pressure. The standard caster fork was replaced by an adjustable length fork. The length of the caster fork was adjusted for each caster such that the height of the wheelchair frame remained constant. The six test surfaces evaluated were: a plywood ramp with a 7.1% (1:14) grade (R), cedar chips (CC), carpet with a 0.33 in. pile height without a pad and at a 1% grade (C1), carpet with a 0.75 in. pile height and a 0.25 in. pad (C2), level compacted dirt (D), and grass with an average grade of 2.5% and 1.5% cross slope (G).

The wheelchair propulsion work requirements were measured using the ASTM PS 83 test procedure [1]. A wheelchair was propelled in a straight line across a test surface using four uniform pushes. During propulsion, the torque applied to the pushrim was measured. The work required for propulsion was a product of the applied torque and the resulting angular displacement of the wheel. Five trials with

each caster type were performed on each surface.

A 16 in. width rehab wheelchair (Quickie 2 by Sunrise Medical) with 24 in. pneumatic rear tires and 20 in. pushrims was used as the test wheelchair. A SMART^{Wheel} [2], with the same dimensions as the rear wheels, was mounted onto the wheelchair and used to measure the torque applied during propulsion. The wheelchair weight with 8 in. pneumatic casters was 34 lbs.. A laptop computer and an external battery pack were mounted onto the wheelchair. The total weight of the wheelchair with the computer and power source was 54 lbs.. The wheelchair rider weighed 183 lbs. and was seated such that when statically measured, the front to rear weight distribution was 40/60 %.

The wheelchair was propelled 2 (+0.2, -0.0) m in 7 (+/- 1) seconds using four uniform pushes. Torque applied to the pushrim was recorded at 240 Hz and was then filtered. The average torque for each trial was found by numerically integrating the torque as a function of time and then dividing by the total trial time. Propulsion work for one wheel was determined by multiplying the average torque by the total angular displacement of the rear wheel. The total propulsion work was two times the work required for one wheel. The total propulsion work for each trial was then normalized per meter of distance traveled by dividing the total work by the total distance traveled. The average work per meter value was determined by averaging the five trials.

Statistical analysis was performed on the work per meter values to determine if changing the caster type significantly affected the results. A 95% confidence interval for the average work value for each caster type was calculated using an independent samples t-test. Differences between average work values were considered statistically significant if no overlap existed between the 95% confidence intervals.

RESULTS

The resulting average work per meter values for the ramp and cedar chips are shown in Figure 1, the two carpets in Figure 2, and grass and dirt in Figure 3. On cedar chips, the 3S caster was not able to roll and therefore unable to complete the test.

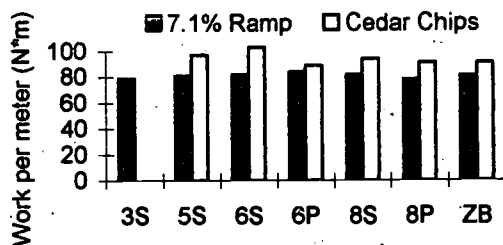

Figure 1. Work required on the ramp and cedar chips

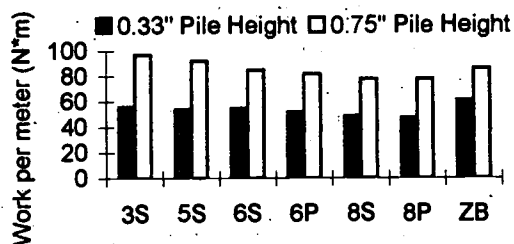

Figure 2. Work required on two carpet types

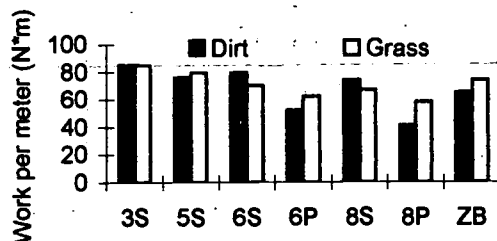

Figure 3. Work required on dirt and grass

Significant differences between the propulsion work required between any two caster types within the particular surfaces were found in 50% of the possible combinations. Caster comparisons found to be statistically significant for the six surface types are given in Table 1. There were no significant differences found

EFFECTS OF CASTER TYPE ON WHEELCHAIR PROPULSION WORK REQUIREMENTS

between casters 3S and 5S, nor between casters 5S and 6S. Caster 8P required significantly less work than caster 6S on all of the surfaces tested. Caster 6P required significantly less work than caster 6S on cedar chips and dirt, and caster 8P required significantly less work than caster 8S on dirt and grass. On the cedar chips and dirt surfaces, propulsion work requirements for the 6 in. pneumatic caster decreased by 13.4% and 33.4%, respectively from that required with the solid caster. Similarly, on the dirt and grass surfaces, propulsion work requirements for the 8 in. pneumatic caster decreased by 46.8% and 11%, respectively from that required with the solid caster. Thus, when significant differences occurred, the pneumatic casters required less work than the solid casters of the same size. On the majority of the surfaces, the 8 in. pneumatic caster required significantly less work than either of the 6 in. casters. The 8 in. diameter caster produced the lowest work requirements for the greatest number of surface types.

	6P	6S	8P	8S	ZB
3S	R,C1,C2, D,G	R,C2, G	C1,C2,D,G	C1,C2,D, G	C1,C2,D, G
5S	C2,D,G		C1,C2,D,G	C1,C2,G	CC,C1
6P		CC,D	R,C1,D,G	D	C1,D,G
6S			R,CC,C1,C2, D,G	C1,C2	CC,D
8P				D,G	C1,C2,D, G
8S					C1,C2

Table 1. Significant differences in average work values for the six surfaces

DISCUSSION

The results of this study offer an objective comparison between straight propulsion work requirements for various caster types. The results of this study only compare caster performance in straight propulsion. Straight propulsion work is one of many caster performance factors and should not be used

solely to select an appropriate cater type. Other factors such as ride comfort, obstacle climbing ability, and ease of turning should be considered. If another caster type performs adequately in straight propulsion work requirements for the surface types of anticipated use and it excels in other performance characteristics, it may be the best caster to choose. For future studies, the same experimental methods could be used to study the effects of caster type on propulsion work requirements during turning or maneuvering.

REFERENCES

[1] American Society for Testing and Materials (ASTM)(1997). ASTM PS 83-97 Provisional Standard for Determination of Accessibility of Surface Systems Under and Around Playground Equipment. West Conshohocken, PA:ASTM.

[2] Asato KT, Cooper RA, Robertson RN, Ster JF (1993). SMART^{Wheel} development and testing of a system for measuring manual wheelchair propulsion dynamics, *IEEE Transactions on Biomedical Engineering*, 40(12).

ACKNOWLEDGMENTS

Funding for this research was provided by the National Center for Medical Rehabilitation In the National Institute of Child Health and Human Development at the National Institutes of Health through SBIR Phase II Grant # 2 R44 8HD30979-02.

Whirlwind Wheelchair International of San Francisco State University provided the Zimbabwe wheels for this research.

Quickie Designs donated all other casters for this research.

Mark Richter
Beneficial Designs, Inc.
5858 Empire Grade
Santa Cruz, CA 95060

FINITE ELEMENT MODELING OF WHEELCHAIR SEAT CUSHIONS

Marie-Josée Dionne, B.Eng., Carl-Éric Aubin, PhD, Jean Dansereau, PhD
NSERC Industrial Research Chair on Seating Assistive Technology
École Polytechnique de Montréal, Dept of Mechanical Engineering, Montréal, Canada

ABSTRACT

A finite element model of a seat cushion was developed to study the combined effect of surface geometry and material properties in design of more appropriate seating devices. Two different cushion geometries were modeled. Mechanical properties of elastic foams were assumed isotropic and time independent. Different material hypotheses were tested and it was found that the best way to represent the behavior of the elastic foam material was with multilinear properties and geometric nonlinearities. Simulations of a real subject's pressure distribution applied on the model showed that different surface geometries and materials influence vertical deformation of the cushion.

BACKGROUND

The biomechanics of wheelchair seating is still not well documented especially the relation between seating materials, wheelchair user's comfort, interface pressures and development of decubitus ulcers. A cushion should be seen as a pressure-distributing device and a support surface [1]. To answer this purpose, two techniques were reported in the literature: use of custom contoured cushions [2] and use of components with different mechanical and physical properties [2-3].

OBJECTIVES

The overall objective is to develop a computer model of the seat in order to simulate different cushion geometries, kinds of foam, structures (foam overlaid or placed side by side) and types of load. Then, the model will be used to analyze the effects of these characteristics for the design of more appropriate seating devices. The specific purpose of this study is to create a preliminary

model of the seat and verify the relevance of using nonlinearities. The emphasis was put on the development of preliminary tests to characterize the mechanical behavior of elastic foams. A preliminary validation of the model was also performed.

METHOD

A finite element model of the seat cushion was created with ANSYS finite element package.

Geometry

Two different cushion geometries were modeled, each with one and two layers of foam. The first one, a standard rectangular cushion, was modeled with generic dimensions (435 mm x 435 mm x 90 mm). The second one, an ISCUS contoured cushion manufactured by Promed Inc, was measured using a 3D digitizer (Microscribe 3D, Immersion Corp).

Foam properties

The mechanical properties of different foams were introduced in the model using the Indentation Force Deflection curve following ASTM 3574-95 standard. Each specimen, a small block of 50 mm x 50 mm x 25 mm, was preflexed and tested between two parallel plates according to the procedure of the ASTM standard test C [4]. Five types of foams were investigated: Plastazote (PE), Super constructa foam (PE), Neocor (PU), Molded PU and Latex. Three specimens of each foam were tested. All testing was completed with a MTS Bionix Test System 858.

An elastic foam exhibits a complex behavior because of the combination of geometric and material nonlinearities. Three

different hypotheses were proposed to model this behavior. In all cases, the foam material was assumed isotropic and time independent. At first, we considered material and geometric linearities. Secondly, we maintained material linearity and we introduced geometric nonlinearities to take into account large strains (by updating the stiffness matrix at each step). A third simulation was made with geometric nonlinearities and multilinear material properties.

Meshing, seating load and boundary conditions

Each modeled cushion was meshed with 8-nodes isoparametric bricks. There was 3 layers of elements for cushions made of one material and 4 layers of elements for cushions made of two different materials (2 layers of elements per different material). A real pressure distribution of a normal subject (75 kg) in a seated position was measured using a Force Sensing Array device (FSA) from Vista Medical Ltd and was applied on the model. The pressures were applied by five small increments perpendicular to the top surface of the cushion. All nodes located on the bottom plane of the cushion were constrained from vertical and horizontal displacements to take into account the rigid support surface of the wheelchair.

Preliminary validation

A preliminary test bench, based on ASTM 3574-95 compression test C, was build to validate the model. The procedure was essentially the same as for the determination of the mechanical properties except that the size of the specimen was larger (200 mm x 200 mm x 76 mm). The experimental conditions were reproduced in the model by the application of an uniform pressure on the top surface of the modeled cushion.

RESULTS

Foam properties

The experimental stress-strain curves show two distinct regions that represent the two

first phases of the load deformation behavior of cellular foam. Figure 1 illustrate the values obtained for Neocor (PU). In the case, the experimental and multilinear stress-strain curves are mostly superimposed. The linear and multilinear curves represent an approximation of the mechanical properties that was used as input into the finite element model.

Properties of NEOCOR HR35

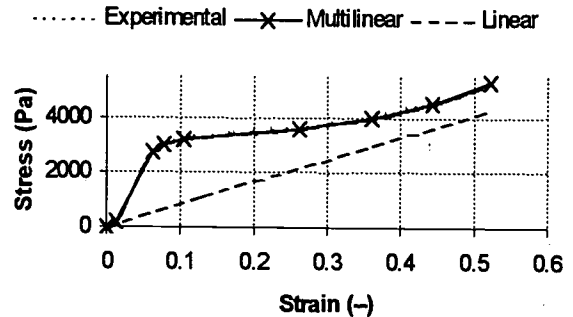

Figure 1: Modeled and experimental mechanical properties of foam

Preliminary validation

Figure 2 shows the resulting displacements of the flat cushion model with the different hypotheses of geometric and material nonlinearities. As we expect, the use of multilinear properties and geometric nonlinearities make the results closer to the experimental results than all other hypotheses.

Validation results

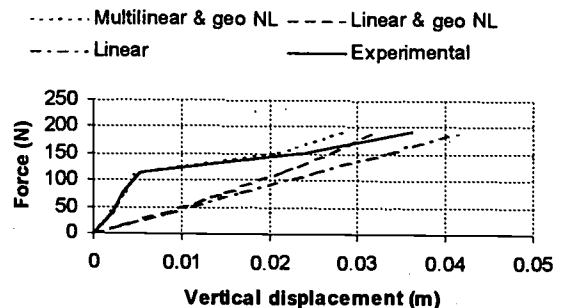

Figure 2: Validation results with Neocor HR35; geo NL: geometric nonlinearities

As the applied force increases, the cushion is more compressed and exhibit increasing stiffness at higher load (less displacement for same applied force). Activation of geometric nonlinearities into the finite element model can consider this phenomena.

Preliminary model

The simulations presented below were realized with the model that considers linear material properties and geometric nonlinearities. As demonstrated in figure 3, for the same material layout, a contoured cushion reduces the compression squash compared to a flat surface cushion of the same thickness. Using the same surface geometry (3a & 3b), the addition of one layer of more rigid foam reduces the squash in the case of flat surface cushion and do not significantly modify the squash in the case of a preformed contoured surface cushion such as the ISCUS (3c & 3d).

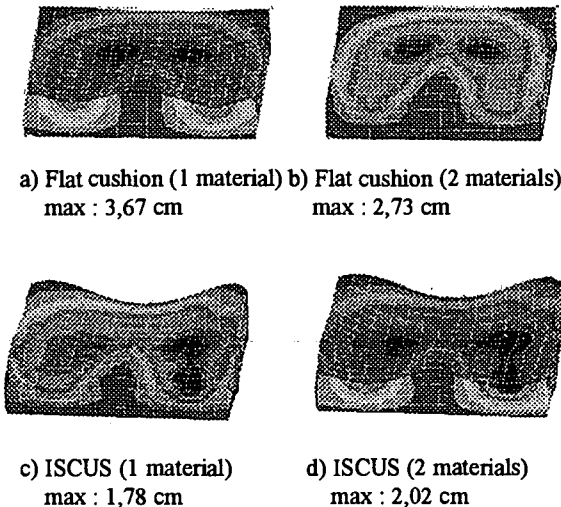

Figure 3: Vertical displacements obtained from simulations of a real subject pressure applied on different cushion models

DISCUSSION

Curve of mechanical properties obtained in this study such as the one shown in Figure 1 are similar than those obtained by Ferguson-Pell [3] and Todd [5]. It was also shown that the addition of geometric

nonlinearities increases the stiffness of the material under large strains. Next step is to model the behavior of the elastic foam with hyperelastic constitutive equations (i.e. Blatz-Ko (1962)). Hyperelastic materials are known to be conservative and do not depend on the load path. This behavior is typical of resilient foams used in this study. The preliminary results showed that different surface geometries and different material layouts influence the pressure distribution and support functions of the seat cushion.

WORK IN PROGRESS

Additional tests are in progress to improve this preliminary model. In order to refine the modeling approach, viscoelastic foams (like Temperfoam) and different foam structures (overlayed and placed side by side) will be included in a future version of the model. These model developments will permit to investigate and document the complex biomechanics of wheelchair seat cushion and their effects of different seating parameters.

REFERENCES

1. Ferguson-Pell et al. (1986), Development of a modular wheelchair cushion for spinal cord injured persons, *J Rehab Res & Dev*, Vol. 23, No 3, 63-76
2. Sprigle et al. (1990), Reduction of sitting pressures with custom contoured cushions, *J Rehab Res & Dev*, Vol. 27, No 2, 135-140
3. Cochran and Palmieri (1980), Development of test methods for evaluation of wheelchair cushions, *Bull Pros Res*, Vol. 17, No 1, 19-30
4. ASTM D-3574-95, Standard test methods for flexible cellular materials - Slab, bonded, and molded urethane foams, Philadelphia, PA, American Society for Testing and Materials (1995), 360-377
5. Todd et al. (1997), Testing polyurethane foams for cushions design, *Proc RESNA'97 Ann Conf*, 225-227

ACKNOWLEDGMENTS

This research was founded by NSERC (Natural Sciences and Engineering Research Council of Canada), Promed Inc. and Orthofab Inc.

Marie-Josée Dionne, M.A.Sc. student
NSERC Industrial Research Chair on Seating Assistive Technology, Departement of Mechanical Engineering
École Polytechnique de Montréal
Campus de l'Université de Montréal
CP 6079, Succ. Centre-Ville
Montréal, Québec, Canada, H3C 3A7

A mathematical method for comparison of contoured seating shapes

Yue Li, M.Sc.A, Rachid Aissaoui, Ph.D., Jean Dansereau, Ph.D.

Chaire Industrielle CRSNG sur les aides techniques à la posture

Department of mechanic engineering, Ecole Polytechnique de Montreal, Montreal, Quebec, Canada

ABSTRACT

This paper presents a new method for the comparison of seat geometry or contoured surface shape of cushion used in wheelchair. Two-dimensional geometric analysis of cushion shape was proposed as well as definitions of geometric parameters to describe intrinsic characteristics of curve shapes. Based on these parameters, a set of similarity index was developed. The analysis of three similar contoured foam cushions of different sizes and one seating support shape showed substantial differences between both types of shapes.

BACKGROUND

The primary role of a wheelchair cushion is to provide an effective platform from which the user may perform a wide range of tasks. For many users, the cushion performs a crucial function by reducing the concentration of pressure in soft tissues, thereby helping to prevent the formation of pressure sores.

Pressure measurements at the seating interface are routinely done in the selection and prescription of wheelchair cushions for users susceptible to pressure sores. There are, however, substantial limitations to the accuracy and significance of pressure measurements. Surface pressure distribution measurements are directly affected by the mechanical properties of underlying tissues. The high degree of variation in mechanical properties of gluteal tissues and structures makes it extremely difficult to determine what constitutes an optimal pressure distribution. (Levine et al., 1990). In that sense, contoured seating interface shapes becomes as important as interface pressure. In order to characterize the seating shape, it will be important to establish measurement methods for shape evaluation. The goal of this study is to develop

a procedure based on geometric parameters to characterize and compare different cushion shapes.

METHODS

In this study two types of seating shapes are considered: the first type is preformed shapes of contoured foam cushions, such as the ISCUS manufactured by Promed Inc having different dimensions: 15"x18", 17"x18", and 18"x18", which were manually measured by a 3D digitizer (MicroScribe-3DL, Immersion Corp); the second type is a seating shape contour obtained from an electronic shape sensor (ESS) [3].

A similarity index were developed based on a set of geometric parameters in order to quantitatively compare different contoured shapes.

Shape Measurements



In the acquisition of preformed cushion shapes, the digitized interval was determined to be the dominant factor effecting the fidelity of the reproduced shape. A technique to determine the optimal numbers of points (or the digitized interval) to be digitized along cross-sectional curves of preformed cushion have been developed in order to keep all geometric intrinsic characteristics of such curve. A limited number of digitized points along the curve (or wide digitized interval) will result in a lost of intrinsic shape definition and an attenuation of their features.

Three specific digitizing intervals used by other researchers were found in the literature: 1.2 inch (30 mm) [2], 1.7 inch (42.7 mm) [3], 2 inch (50 mm) [4].

In the present study, regularly spaced sample points along cross-sectional curves of cushions are considered. To determine the optimum digitizing interval, the following experiment was done. First, a preformed

18"x18" cushion (ISCUS) was measured over a 33x33 rectangular array of marked points on its surface (involving a digitized interval of 14 mm). It was then possible to obtain 33 cross-sectional curves in the antero-posterior axis of the cushion and another 33 cross-sectional curves on the lateral direction of the cushion. These curves could be classified into four typical shapes as shown in Table 1. Then, based on the digitized points on each curve, cubic splines were used to interpolate 200 points in order to generate reference curves for analysis.

The next step was to sample each curve by simulating different number of interpolated points (from 3 points to 30 points) and then compare the resulting curve to the reference curve. Differences between reference curve and the resulting curve were calculated at 200 different locations and mean value of differences were finally computed.

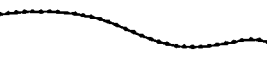
Typical curve	Description	optimum interval (mm)
curve I		45.0
curve II		32.1
curve III		37.5
curve IV		34.1

Typical curve I: posterior seat region; II: anterior seat region;
 Typical curve III: lateral parts of the cushion;
 Typical curve IV: front to back curve located merely in the middle part of the cushion.

Table 1: Digitized Interval.

Since seat cushions are formed in compliant materials, there is possible error in the digitizing process. There is also the intrinsic error associated to the digitizer itself. As reported by the manufacturer, the accuracy of the MicroScribe is 0.64 mm. To evaluate the action of digitizing, the cushion used in above the experiment was digitized four times on the same marked points and the resulting reproducibility was found to be close to 0.3 mm.

Then for each cross-sectional curve, there is a optimum number of sample points (or optimum interval) for which the mean error is smaller than 0.3 mm. The resulting minimum interval for the four typical cushion curves shown in table 1 is between 32.1 mm to 45.0 mm. So for digitization of preformed cushion shapes, a 40 mm digitized interval was used to acquire the geometry of the three preformed cushions used in present study.

Definition of intrinsic curve parameters

Six parameters were defined and calculated to describe the geometric characteristics of each cross-sectional curve (Figure 1). They were identified as local parameters (P1-P4) and global parameters (P5-P6):

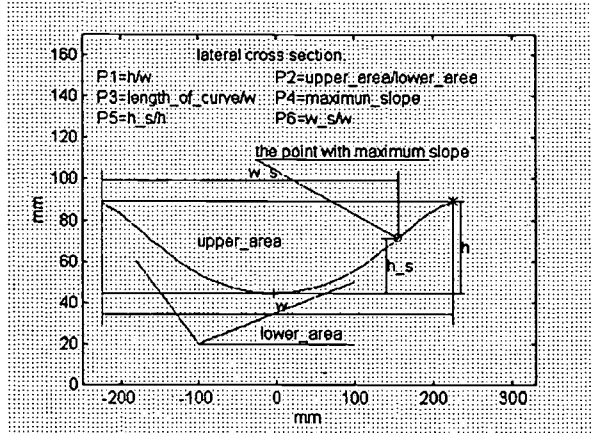

Figure 1: Local and global parameters

- P1: The absolute vertical height (h) divided by the absolute horizontal width (w).
- P2: The upper area divided by the lower area. Upper area is defined between the curve and the line passing through the upper point of the curve. Lower area is defined between the curve and the line passing through the lower point.
- P3: Length of the curve divided by the absolute horizontal width (w).
- P4: Maximum slope of the whole curve.
- P5: Height at location of the maximum slope (h_s) divided by the absolute vertical height (h).

P6: Horizontal distance from the location of the maximum slope to the left end-point (w_s) divided by the absolute horizontal width (w).

Similarity index

Similarity index (SI_i) was defined for each geometric parameter as follow:

$$SI_i = \frac{1}{n} \left(\sum_{j=1}^n \left| \min(P_{i,j}^A, P_{i,j}^B) \right| \right) / \left(\sum_{j=1}^n \left| \max(P_{i,j}^A, P_{i,j}^B) \right| \right)$$

where

n is the number of cross-sectional curves (33 in one case)

i is the parameter number (from 1 to 6)

j is the curve number (from 1 to 33)

A, B: different types of seating shape (here there are 4 types of seating shapes)

$P_{i,j}^A$: is parameter P_i of the j th curve for cushion A.

$P_{i,j}^B$: is parameter P_i of the j th curve for cushion B.

A global similarity index (GSI) was also defined as following:

$$GSI = \frac{1}{6} \sum_{i=1}^6 SI_i$$

The values of indexes are between 0 to 1. The more the value is close to 1, the more the shapes of two cushions are similar.

RESULTS & DISCUSSION

Similarity index	A=1* B=2	A=1 B=3	A=2 B=3	A=1 B=4	A=2 B=4	A=3 B=4
GSI	0.89	0.85	0.94	0.69	0.67	0.65
SI_1	0.90	0.78	0.87	0.43	0.39	0.34
SI_2	0.93	0.91	0.98	0.65	0.60	0.59
SI_3	0.99	0.95	0.95	0.89	0.89	0.84
SI_4	0.92	0.88	0.95	0.45	0.49	0.52
SI_5	0.96	0.96	0.92	0.86	0.90	0.83
SI_6	0.66	0.65	0.99	0.86	0.76	0.76

*Shape 1: 15"x18" ISCUS; Shape 2: 17"x18" ISCUS;
Shape 3: 18"x18" ISCUS; Shape 4: seating shape from ESS

Table 2: Similarity index

Results of similarity indexes for comparison between shapes are presented in Table 2. Results from similarity indexes show that shapes 1 and 2, and shapes 1 and 3 are quite similar, presenting GSI of 0.89 and 0.85 respectively. Similarity index is also stronger for shapes 2 and 3 with a GSI of 0.94. These high values confirm the fact that the preformed

shapes of the contoured ISCUS cushions are similar. In fact, these cushions are manufactured in the similar way and it is obvious that their shapes should be similar. The only difference on these cushions is the size which varies slightly from 15"x18" to 18"x18". Comparison between these cushion shapes and the seating shape acquired from ESS (shape 4) showed great difference from global similarity index (GSI) results (0.69, 0.67, 0.65 for comparison of shapes 1-4, shapes 2-4, and shapes 3-4 respectively). These differences came mainly from parameters P1 and P4 showing similarity indexes between 0.34 to 0.52. It seems that this seating shape is different from the ISCUS cushion shapes.

CONCLUSION

A new mathematical method based on similarity index calculated from intrinsic shape parameters of curves has been developed to compared seating and preformed cushion shapes. It has been found that this method is able to distinguish shapes from close geometry to shapes which are dissimilar. It is also possible to identify which parameters are mostly responsible of these dissimilarities. Validation of this new approach is in progress and will be tested in a large sample of different shapes in order to better characterize and compare seating interfaces.

REFERENCES

- Levine SP, Kett RL, Ferguson-Pell M: Tissue shape and deformation versus pressure as a characterization of the seating interface. *Assistive Technology*, 1990(b) :2:93-99.
- Chang SR, Son K, Choi YS: Measurement and three-dimensional graphic representations of Korean seatpan and seatback contours, *Int. J. Indu. Ergon.*, 1996 :18 :147-152.
- Brienza DM, Chung KC, Brubaker CE, Wang J, Karg TE, Lin CT: A system for the analysis of seat support surface using surface shape control and simultaneous measurement of applied pressures. *IEEE Trans Rehabil Eng.* 1996 :4:103-112.
- Sprigle S, Chung KC: Factors affecting seat contour characteristics, *J Rehabil Res Dev*, 1990 :27 (2) :127-134.

ACKNOWLEDGMENTS

Special thanks to D. Brienza who gave the ESS data. This research was founded by the NSERC (Natural Sciences and Engineering Research Council of Canada), Promed Inc, and Orthofab Inc.

REPEATABILITY OF A 3D POSTURAL EVALUATION METHOD IN SEATED POSITIONS.

LeBlanc R., Guyot C., Maltais C., Lacoste M., Dansereau J.
NSERC Industrial Research Chair on Seating Assistive Technology
Ecole Polytechnique de Montréal
Montréal, Canada

ABSTRACT

A 3D seated postural evaluation of wheelchair bound subjects has been developed by Maltais et al. (1,2). The purpose of the present study is to evaluate this method more thoroughly. Anatomical landmarks were identified and digitized in 3 different seated positions in order to assess the variability according to their 3D coordinates and their associated geometric parameters (Position I, tilt angle 0° , seat-to-back 100° ; position II, tilt 30° , seat-to back 100° ; position III, tilt 30° , seat-to-back 130°). Results show that the variability does not differ substantially according to the 3 seated positions. The greatest variability is found for the left greater trochanter with 8.8 mm in position I while the lowest is found for the left malleolus with 1.9 mm in position I. As for the geometric measurements, the trunk shift shows the highest variability in position III and the shoulder obliquity has the lowest variability in position II.

BACKGROUND

The need for reliable outcome measures is a well known concept in the field of seating. Unfortunately, efficient and non invasive methods to evaluate postural changes over time and the effect of seating systems on posture are scarce. A variety of technique have been utilized to represent 3D positioning in a stand up position (3, 4, 5). However, almost no data is available concerning the 3D postural evaluation in seated position.

In 1997, Maltais et al. presented a new method for this type of assessment using an accurate mechanical articulated arm to digitize in 3D anatomical landmarks on the trunk, pelvis and lower limb extremities for both side of the wheelchair user. For the need of their study, 23 anatomical landmarks were digitized. The data acquisition was done in the subject's wheelchair, in his usual posture. The method is somewhat simple to follow and seems to give

a fairly good way to quantify the subject's seated position. The purpose of the present study is to evaluate the intrinsic variability in the digitizing procedure. Sixty-eight anatomical landmarks were identified and digitized in 3 different seated positions. In a first time, the variability on the identification of the landmarks has been assessed according to their 3D coordinates. In a second time, the total variability of 69 pre-determined parameters has been calculated. For practical reasons, 20 anatomical landmarks and 13 parameters are presented in this paper.

METHOD/APPROACH

A total of 8 able-bodied subjects (2 males, 6 females) has been evaluated in three different seated positions imposed on a seating simulator (SEM by Promed Inc.) (6). In order to reach the landmarks located on the back of the subjects, the backrest has been divided in 10 removable horizontal sections. The 8 subjects were evaluated in position I which is represented by 0° of system tilt of and 100° of back recline. Of these 8 subjects, 4 were evaluated in position II (30° of system tilt and 100° of back recline) and the 4 other were evaluated in position III (0° of system tilt and 130° of back recline).

The twenty anatomical landmarks that have been identified once and digitized five times in a pre-determined sequence are presented in table 1.

A mechanical arm 3D digitizer (Microscribe 3D, Immersion Corporation) was used to record the 3D position of the landmarks with respect to a global wheelchair coordinates system where Y represent the gravitational axis, Z the anterior-posterior direction and X the cross product of Y and Z. The accuracy of the Microscribe 3D, as reported by the manufacturer, is 0.64mm (0.025") with a possible range of motion of 1.67m (66").

Table 1: Anatomical landmarks digitized with the mechanical arm

Anatomical landmarks
Greater trochanter (left and right)
Lateral femoral condyle (left and right)
Lateral malleolus (left and right)
Sternum (inferior and superior extremities)
Center of the clavicle (left and right)
Anterior superior iliac spine (A.S.I.S. left and right)
Superior iliac crest (left and right)
Acromion (left and right)
Inferior angle of the scapula (left and right)
Posterior superior iliac spine (P.S.I.S. left and right)

In order to quantify the posture of the subjects and observe the variability of the measurements, thirteen parameters were defined.

Pelvic obliquity: [1] Defined as the angle between the line joining the left and the right ASIS and the transverse plane (XZ). [2] Defined as the angle between the line joining the left and the right iliac crest and the transverse plane.

Pelvic rotation: [3] Defined as the angle between the line joining the left and the right ASIS and the frontal plane (XY). [4] Defined as the angle between the line joining the left and the right iliac crests and the frontal plane. [5] Defined as the angle between the line joining the left and right greater trochanter and the frontal plane.

Pelvic tilt: [6] Defined as the angle between the transverse plane and the plane described by the left and right ASIS and the left and right PSIS.

Trunk rotation: [7] Defined as the angle between the frontal plane and the line joining the left and right clavicle center.

Trunk shift: [8] Defined as the angle between the sagittal plane and the line joining the middle of the line between the right and left ASIS and the middle of the line between the inferior angle of the left and right scapula.

Shoulder obliquity: [9] Defined as the angle between the transverse plane and the line joining the left and right clavicle center.

Left[10] and right[11] knee angle: Defined as the angles between 2 lines joining the malleole, femoral condyle and greater trochanter projected on the sagittal plane (YZ).

Left[12] and right[13] hip angle: Defined as the angle between 2 lines joining the femoral condyle, the greater trochanter and the iliac crest projected on the sagittal plane.

The variability of each landmark was obtained by computing, for each subject, the mean 3D location of this landmark and by calculating the difference of each corresponding five digitized coordinates to this mean landmark location. A mean value over the number of subjects was finally calculated and reported in table 2.

The variability of each geometric parameters was evaluated using a similar approach.

RESULTS AND DISCUSSION

Table 2 presents the variability of the 3D positions for the 20 anatomical landmarks for the 3 different seated positions. For all 8 subjects in position I (0°-100°), the left and right greater trochanters and the left lateral femoral condyle show the largest variability. The smallest variability in this position is observed for the left and right lateral malleolus. In position II (30°-100°), the greatest variability is observed for the inferior extremity of the sternum while the smallest variability is for the position of the right anterior superior iliac spine. The right A.S.I.S. and the right and left lateral femoral condyles show the largest variability in position III (0°-130°) while the position of the center of the right and left clavicles have the two smallest variabilities.

Table 2: Variability of anatomical landmarks for the three different seated positions (N: number of subjects)

Landmark ID	Variability position I (mm) N = 8	Variability position II (mm) N = 4	Variability position III (mm) N = 4
Left greater trochanter	8.8	2.7	5.6
Right greater trochanter	8.2	4.7	4.5
Left lateral femoral condyle	8.5	4.0	5.8
Right lateral femoral condyle	4.3	---	6.3
Left maleola	1.9	5.4	---
Right maleola	2.5	---	3.5
Supra-sternal	2.8	2.9	---
Sub-sternal	5.2	6.6	3.9
Center of the right clavicle	4.1	3.7	3.0
Center of the left clavicle	2.7	3.0	2.9
Right A.S.I.S.	3.2	5.3	6.3
Left A.S.I.S.	3.8	2.6	4.1
Right superior iliac crest	5.7	3.5	4.8
Left superior iliac crest	5.2	5.3	5.5
Right acromion	4.3	3.9	5.6
Left acromion	3.1	3.8	5.7
Inferior angle of right scapula	3.8	3.8	5.2
Inferior angle of left scapula	4.5	4.2	4.8
Right P.S.I.S.	6.1	4.0	---
Left P.S.I.S.	5.4	3.7	---

Even though variabilities of more than 8 mm are observed, they do not go beyond what Maltais et al. found in their study (1, 2). Large

variability on the identification of anatomical landmarks is mostly due to the thickness of soft tissue over the bony structures. In specific positions, the repeatability of the identification of some anatomical landmarks seems to be better than what was found by Maltais et al., but globally, the 3 positions studied are quite equivalent.

Results in table 3 show the variability of the parameters for the 3 different positions. The largest measurement variability are found for the right and left hip angles in position I (0°-100°) and globally, all the other parameters show a variability less than 2 degrees.

Table 3: Variability of computed values of parameters measured in degrees. (N: number of subjects)

Parameters	Variability in degrees Position I N=8	Variability in degrees Position II N=4	Variability in degrees Position III N=4
Pelvic obliquity I	0.7	0.5	0.7
Pelvic obliquity II	1.0	1.0	1.2
Pelvic rotation I	0.9	0.8	1.1
Pelvic rotation II	1.4	1.0	1.3
Pelvic rotation III	1.3	1.3	1.2
Pelvic tilt	1.3	1.6	---
Trunk rotation	0.9	0.9	0.9
Trunk shift (lateral)	0.5	1.3	---
Shoulder obliquity	0.6	0.4	0.5
Left knee angle	1.1	0.9	---
Right knee angle	0.7	---	0.8
Right hip angle	3.2	---	---
Left hip angle	2.3	2.6	---

These results are consistent with those presented by Maltais et al. in 1997 (1, 2). It indicates that even if reproducibility errors are as high as 8mm on 3D coordinates of the greater trochanter landmarks, it does not affect greatly the repeatability of the geometric parameter measurements. In fact, this may be explained by the large distance between the right and left greater trochanters compare to the errors done in the identification of the anatomical landmarks.

CONCLUSION.

Results show that the different positions imposed to the subjects do not globally affect the variability of the measurements. They also show that the 3D postural evaluation method is an adequate and repeatable approach to obtain geometric parameter measurements even if some anatomical landmarks are often difficult to be accurately repeatable such as the greater trochanter.

REFERENCES

1. Maltais C., Dansereau J., Lacoste M. (1997) Variability of geometric measurements on wheelchair users. Proceedings of RESNA '97, Pittsburgh, Pennsylvania, pp. 211-213
2. Maltais C. (1997) *Mesure de paramètres géométriques et mécaniques de la position des personnes en fauteuil roulant.* Master degree Thesis, Institut de Génie Biomédical, École Polytechnique de Montréal 1997.
3. LeBlanc R., Labelle H., Poitras B., Rivard C.H., Kratzenberg J. (1996) Évaluation 3-D de la posture chez des adolescents normaux et scoliotiques. *Annales de Chirurgie*, 50(8), pp. 631-636
4. Mellin G. (1986) Measurement of thoracolumbar posture and mobility with a Myrin inclinometer. *Spine*, 11:759-762
5. Stokes I.A.F., Cobb L.C., Moreland M.S. (1985) Surface shap analysis of spinal deformity. *Automedica*, 6:71-83
6. Ringuette J.P., Dansereau J., Trudeau F. (1997) Adaptation of a clinical seating simulator into a research tool. Proceedings of RESNA '97, Pittsburgh, Pennsylvania, pp. 222-224

ACKNOWLEDGEMENTS

This study was funded by the NSERC (Natural Science and Engineering Research Council of Canada) and by Promed Inc. and Orthofab Inc.

Richard LeBlanc Ph.D.
 NSERC Industrial Research Chair on Seating Assistive Technology
 École Polytechnique de Montréal
 C.P. 6079, succ. Centre-ville, Montréal
 Québec, Canada, H3C 3A7
 Telephone: (514) 340-4711 extension 4977
 Fax: (514) 340-3261

CONSUMER CRITERIA FOR EVALUATING SATISFACTION WITH WHEELCHAIR SEATING AIDS: QUEST RESULTS

Rhoda Weiss-Lambrou¹, Camille Tremblay¹, Michèle Lacoste², Richard LeBlanc², Jean Dansereau²

¹École de réadaptation/School of Rehabilitation, Université de Montréal

²École Polytechnique de Montréal, NSERC Industrial Research Chair on wheelchair seating aids
Montreal, Quebec, Canada

ABSTRACT

The Quebec User Evaluation of Satisfaction with assistive Technology (QUEST) was used as the outcome measure for evaluating consumer satisfaction with a specific type of assistive technology, that is wheelchair seating aids. This paper presents the QUEST results on the relative importance attributed to each of the satisfaction variables by the 24 subjects of the study. Results revealed gender differences in the degree of importance attributed to certain variables as well as differences between subjects living at home and those living in an institution. The application of QUEST for wheelchair seating systems demonstrates this instrument's usefulness as an outcome measurement tool.

BACKGROUND

In the current context of quality assurance, cost-containment and consumerism, the need for meaningful and reliable outcome measures of assistive technology has become of foremost importance to all stakeholders [1,2]. The Quebec User Evaluation of Satisfaction with assistive Technology (QUEST) is a new outcome measurement instrument that was designed to evaluate user satisfaction and perceived importance of the dimensions of assistive devices [3]. The concept of satisfaction as defined in QUEST refers to a person's positive or negative evaluation of those distinct dimensions of the assistive device that are influenced by one's expectations, perceptions, attitudes and personal standards [3,4]. This definition is based on the principle that the relative importance of each variable needs to be determined by the user in order to correctly interpret the satisfaction data; the variables constituting QUEST are those criteria considered to most likely influence user satisfaction.

RESEARCH QUESTION

How do users of wheelchair seating aids rate the degree of importance they attribute to each of the satisfaction variables of QUEST?

METHOD

Sample

Twenty-four adults who owned a wheelchair seating aid were recruited from a Montreal rehabilitation facility. The sample consisted of 14 men and 10 women with a mean age of 47 years. Eleven subjects had multiple sclerosis, 3 subjects had cerebral palsy, 2 had muscular dystrophy and the remaining 8 had a diagnosis of another type. The sample had an average of 10 years experience with their wheelchair seating aid. All subjects had a modular type seating device integrated in a powered wheelchair. Thirteen subjects were living at home and 11 were living in long term care hospitals. All subjects had their seating device paid by the provincial health insurance program.

Procedure

The subjects were administered the 3 parts of QUEST: (a) General information questionnaire, (b) Rating of importance and (c) Rating of satisfaction. At the time of this study, QUEST consisted of 19 variables (unlike the current version with 24 items). Subjects were asked to rate the degree of importance he/she ascribes to each of the variables (using a 5-point importance scale, with 1 being "of no importance" and 5 being "very important") and then to rate the degree of satisfaction with each of the variables (using a 5-point satisfaction scale, with 1 being "not satisfied at all" and 5 being "very satisfied"). Each evaluation session took approximately 45 minutes and the same graduate student/researcher conducted all the QUEST assessments.

RESULTS

The results for the variables considered to be the most and least important (on the 5-point importance scale) are shown in Table 1. From the list of 19 variables, the five variables judged to be the most important were: comfort, repairs & servicing, safety, professional services, and the effectiveness of the wheelchair seating aid. The five criteria considered to be of least importance were the social (family and peer) support, the subject's motivation, the appearance of the seating system, its weight and the reaction (attitude) of others.

Most important	mean SD	Least important	mean SD
Comfort	4.96 0.20	Social support	4.10 1.15
Repairs/ servicing	4.83 0.38	Motivation	4.10 1.08
Safety	4.79 0.59	Appearance	3.54 0.98
Professional services	4.79 0.51	Weight	2.88 1.26
Effectiveness	4.75 0.53	Reaction of others	2.83 0.38

Table 1. Criteria considered to be the most and least important for users of wheelchair seating aids

From the list of 19 variables, only one was considered to be non-applicable by a significant number of subjects; the variable "cost" or affordability of the device was considered to be non-applicable for 8 of the 24 subjects (33%) primarily because the seating device was paid for by the provincial health care insurance; this variable was therefore not included in the statistical analyses.

Results of the Mann-Whitney test revealed significant differences ($p < 0.05$) when the sample was divided into groups according to sex and milieu (institutionalised vs non-institutionalised). Firstly, the female subjects ($n=10$) tended to assign a greater degree of importance to the following 3 variables than did

the male subjects ($n=14$): the dimensions of the device, the effort and the motivation required to use the seating device. Secondly, subjects ($n=13$) who were institutionalised accorded a greater degree of importance to the multi-purposefulness of the device, the social support and the reaction of others, than did those subjects ($n=11$) who were living at home. Lastly, no significant differences were found when subjects were divided into groups according to disability and according to the number of hours spent in their wheelchair seating aid.

DISCUSSION

This is the first research study that has applied QUEST with a specific type of assistive device. In a forthcoming publication, these results will be compared with the subjects' ratings of satisfaction with each of the variables.

Two prior studies have also generated consumer criteria for assistive devices [5,6]; the five most important criteria of these works are shown in Table 2 together with this study's results [7].

Batavia & Hammer [5]	Lane, Usiak & Moffatt [6]	Tremblay [7]
Effectiveness	Effectiveness	Comfort
Operability	Affordability	Repairs/ servicing
Dependability	Reliability	Safety
Affordability	Portability	Professional services
Personal acceptance	Durability	Effectiveness

Table 2. Comparison of consumer-based criteria for evaluating assistive devices

Although the Table highlights similarities in the consumer criteria across these three studies, two important differences can be noted. Firstly, in the present study the variable "cost" (or affordability) was not amongst the most important variables; the fact that 33% of our subjects considered this variable to be non-applicable suggests a difference in Canadian vs

QUEST results

American consumer opinion probably due to the differences in our service delivery systems of assistive technology. Secondly, the results of our study showed that for users of wheelchair seating aids, the variable "comfort" was considered to be the most important variable; we agree with Lane and colleagues [6] who reported that consumer criteria varies with the type of assistive device being evaluated. It can be assumed that the importance of comfort for users of wheelchair seating aids will not be the same for consumers of other types of assistive devices. For this reason, consumer criteria for different categories of devices need to be generated and once validated, can serve as a guideline for selecting the most appropriate technology for the person.

The results of the present study also revealed gender differences in the degree of importance attributed to certain variables as well as differences between subjects living at home and those living in an institution. These differences suggest the need for future studies examining how women and men differ in their satisfaction with and use of assistive devices as well as how consumer criteria and satisfaction might differ depending on where the person is living.

In conclusion, the application of QUEST for wheelchair seating systems demonstrates this instrument's usefulness as an outcome measurement tool. The psychometric properties of QUEST and its applications with different user groups and different types of devices are currently being conducted in Montreal as well as in several American institutes and in the Netherlands. The results of this work will provide a means of assessing user satisfaction and contribute to outcome assessment of the impact of assistive technology on function and quality of life of people with a disability.

REFERENCES

- [1] Trachtman, L. (1994). Outcome measures: Are we ready to answer the tough questions? *Assistive Technology*, 6, 91-92.
- [2] Smith, R.O. (1996) Measuring the outcomes of assistive technology: Challenge and innovation. *Assistive Technology*, 8, 71-81.
- [3] Demers, L., Weiss-Lambrou, R., & Ska, B. (1996). Development of the Quebec User Evaluation of Satisfaction with assistive Technology (QUEST). *Assistive Technology*, 8, 3-13.
- [4] Linder-Pelz, S. (1982). Toward a theory of patient satisfaction. *Social Science and Medicine*, 16, 577-582.
- [5] Batavia, A.I. & Hammer, G.S. (1990). Toward the development of consumer-based criteria for the evaluation of assistive devices. *Journal of Rehabilitation Research and Development*, 27 (4), 425-436.
- [6] Lane, J.P., Usiak, D.J. & Moffatt, J.A. (1996). Consumer criteria for assistive devices: Operationalizing generic criteria for specific ABLEDATA categories. *Proceedings of RESNA '96*, Salt Lake City, Utah.
- [7] Tremblay, C. (1998) Les aides techniques à la posture: Évaluation de la satisfaction des utilisateurs ["Seating aids: Evaluation of user satisfaction"]. Unpublished Master's thesis, Sciences biomédicales (réadaptation), Université de Montréal.

ACKNOWLEDGEMENTS

This paper was based on the Master's thesis of Camille Tremblay [7]; the study was conducted in the context of the research activities of the NSERC (Natural Sciences and Engineering Research Council of Canada) Industrial Research Chair on wheelchair seating aids. The authors wish to acknowledge the collaboration of the *Centre de réadaptation Lucie-Bruneau* and to thank the subjects of this study for their participation. A special thanks is extended to Jacques Corbeil, for his support and collaboration.

Prof. Rhoda Weiss-Lambrou
École de réadaptation, Université de Montréal,
C.P.6128, succ. Centre-ville, Montréal
Québec, H3C 3J7
(514)343-2186 Fax: (514)343-2105
e-mail: weisslar@ere.umontreal.ca

Postural Changes with Aging in Tetraplegia

Michael L. Boninger, M.D.^{1,2}, Tracy Saur, M.S., OTRL², Elaine Trefler, M.S. OTRL²,

Doug Hobson, Ph.D.², Ray Burdett, Ph.D.³, Rory A. Cooper, Ph.D.^{1,2}

¹Division of Physical Medicine and Rehabilitation, University of Pittsburgh

²Department of Rehabilitation Science and Technology, University of Pittsburgh

³Department of Physical Therapy, University of Pittsburgh, Pittsburgh, PA 15261

ABSTRACT

The objectives of this study were to determine differences in kyphosis and scoliosis in a group of newly injured individuals with tetraplegia and a group of individuals with tetraplegia who were further out from a traumatic spinal cord injury (SCI). A secondary purpose was to determine the association between kyphosis and scoliosis and pain, depression, and life satisfaction. The study used a cross-sectional, case-control design. Participants included; 10 individuals with new tetraplegia (NT); 10 individuals with old tetraplegia (OT); and 10 controls (C) without SCI. No differences were seen between the OT and NT groups with respect to age, height or weight. In addition, No significant differences were found between the NT and OT groups with respect to measures of kyphosis and scoliosis. Subjects with SCI had significantly higher measure of kyphosis and scoliosis than the C subjects. No correlation was found between pain and degree of kyphosis or scoliosis. This study indicates that seated kyphosis and scoliosis develop early and may not be progressive. No association was seen between pain and kyphosis or scoliosis in this relatively young sample.

INTRODUCTION

With increased longevity, secondary disabilities have become a major concern for individuals with spinal cord injury (SCI). One area of concern related to secondary disability is the spine. The prevalence of back pain among individuals with SCI has been reported to be between 32% and 83%.⁽¹⁾ Amongst professionals who provide wheelchair seating

components, it has long been accepted that specialized seating is needed to prevent the development of kyphosis and scoliosis. (2) It has generally been thought that increased kyphosis and scoliosis leads to pain and a reduced quality of life. Despite this widely held belief, there is little research to support this contention.

METHODS

Recruitment

Subjects were recruited through a database at a freestanding rehabilitation hospital. In order to qualify for the study individuals had to have a traumatic spinal cord injury resulting in tetraplegia. Two distinct groups were recruited: individuals 1 to 3 years post injury -- new tetraplegia (NT) and individuals 10 to 20 years post injury -- relatively old tetraplegia (OT). The control subjects (C) were recruited after the testing on individuals with tetraplegia was completed. Individuals matched with the tetraplegia groups for age, sex, height and weight were recruited. The control group only completed the postural assessment portion of the protocol.

Posture Assessment

All subjects were seated in a wheelchair design to allow unobstructed A-P and lateral radiographs to be taken. The seat to back angle was 90° and the seat tilt was 5°. The foot rests were positioned such that the knees were flexed to 70°. Each radiograph was read by a single investigator who was blinded to the group assignment. Scoliosis was measured using the Cobb technique.⁽³⁾ Kyphosis was measured using the technique described by Fon et al.⁽⁴⁾

Questionnaires

Each subject was given the Center for Epidemiological Studies - Depression Scale,(5) the Life Satisfaction Index A-A,(6) and the Craig Handicap Assessment and Reporting Technique .(7) In addition to asking yes/no questions related to back and arm pain, each subject was given the short form of the McGill Pain Questionnaire.(8)

Statistical Analysis

An independent sample t-test was used to compare differences between the groups. When there was no difference between the NT and OT groups they were combined into a single group and a t-test was used to look for difference between the combined group with tetraplegia and the controls. A Pearson's correlation was used to evaluate the relationship between questionnaire variables and scoliosis and kyphosis.

RESULTS

Using an independent sample t-test, no significant differences were found with regards to age, height, and weight between the NT and OT groups. In addition, no significant differences with respect to age, height, and weight were found between the combined and C groups. As expected, a significant difference was seen between the NT and OT group with respect to years out from injury (NT = 2.2 ± 0.8; OT = 13.1 ± 3.3).

No differences were found between the NT and OT groups in either measures of kyphosis or scoliosis. Individuals with tetraplegia were grouped together and an independent sample t-test was used to compare the C group to those with tetraplegia. The C group was found to have significantly less scoliosis and kyphosis than individuals with tetraplegia. The results are summarized in table 1.

Table 1: Postural measures: Mean is presented with standard deviation in parenthesis.

Measure	NT (n= 10)	OT (n = 10)	Control (n = 10)
Kyphosis (°)	43 (12.4)	41 (19.6)	32 (7.9)*
Scoliosis (°)	17 (12.1)	11 (4.2)	5 (3.8)*

* p < 0.05

Nine of the twenty subjects reported back pain and 10 of the 20 subjects reported upper extremity pain. No significant difference was seen in kyphosis and scoliosis in those reporting pain and those not reporting pain. No significant relationship between pain and radiographic measures was seen. A portion of this data is represented as a scatter plot in figure 1.

Figure 1: Scatter plot of kyphosis and scoliosis and pain – no correlation was found.

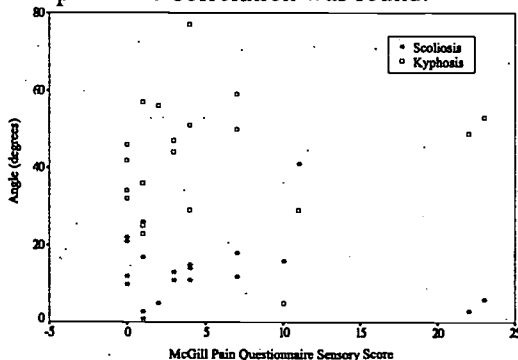

DISCUSSION

This is the first study to radiographically measure kyphosis and scoliosis in a group of individuals with tetraplegia. Not surprisingly individuals with tetraplegia were found to have a greater degree of seated kyphosis and scoliosis than a control group without paralysis. The seated measure of kyphosis for the control group were similar to standing kyphosis measures reported by Fon et al. for a comparable age group.(4) These similarities with previous studies provides reasonable

assurance that the seated position did not dramatically effect the angles measured.

This study did not find a greater degree of spinal curvature in individuals further out from an SCI. This contradicts what has generally been accepted by professionals involved in the seating and positioning. The study could have missed an effect because of a small sample size. Although this can not be ruled out as a possibility, it should be noted that no trend was seen. Another possible explanation for this finding is that our subjects were not far enough out from their SCI to develop progress spinal deformity. An important finding of this study is that individuals who were only two to three years out from and SCI had significant spinal deformity. It may be that a kyphotic and scoliotic posture are assumed early and are not progressive. If this is the case, early interventions is need to prevent problems later.

This study found no association between spinal deformity and pain, perceived function or depression. It is important to note that the our subject population was relatively young and all less than 20 years out from SCI. In addition, all subjects were recruited from a outpatient SCI follow-up clinic. If the population had included individuals who were more than 20 years out from injury, or who did not receive specialized routine care the results may have been different.

CONCLUSION

This study indicates that seated kyphosis and scoliosis develop early in individuals with tetraplegia and do not tend to progress during the first twenty years after SCI. No association was seen between pain or life satisfaction and kyphosis and scoliosis in this relatively young sample. Longitudinal studies are needed to determine if pain does become a problem in individuals with significant kyphosis and scoliosis as they age, and to more

definitively examine the progression of kyphosis and scoliosis with aging.

ACKNOWLEDGEMENTS

This work is supported by Grant # H133E30005 provided by NIDRR. Opinions expressed are those of the authors and should not be construed to represent opinions or policies of NIDRR

REFERENCES

1. C. Nepomuceno, et al., Pain in patients with spinal cord injury Arch Phys Med Rehabil, vol. 60, pp. 605-609, 1979.
2. R.A. Cooper. Rehabilitation Engineering Applied to Mobility and Manipulation, Bristol, UK and Philadelphia, PA: Institute of Physics Publishing, 1995.
3. B.N Weissman. The Lumbar Spine. In: Orthopedic Radiology, Anonymous Philadelphia: W.B. Saunders Company, 1986.pp. 288-294.
4. G.T. Fon, et al., Thoracic kyphosis: range in normal subjects AJR, vol. American Journal of Roentgenology. 134, pp. 979-983, May, 1980.
5. L.S. Radloff, The CES-D scale: A self-report depression scale for research in the general population Appl Psychol Meas, vol. 1, pp. 385-401, 1977.
6. B.L. Neugarten, R.J. et al., The measurement of life satisfaction J Gerontol, vol. 16, pp. 134-143, 1961.
7. G.G. Whiteneck, et al., Quantifying handicap: A new measure of long-term rehabilitation outcomes Arch Phys Med Rehabil, vol. 73, pp. 519-526, 1992.
- 8 R. Melzack, The short-form McGill Pain Questionnaire Pain, vol. 30, pp. 191-197, 1987.

Michael L. Boninger, M.D.
Human Engineering Research Laboratories
VAMC highland Dr., 7180 Highland Dr.
Pittsburgh, PA 15206

IDENTIFYING ELDERLY WHEELCHAIR USERS' NEEDS: RESULTS OF A FOCUS GROUP

Michèle Lacoste¹, Rhoda Weiss-Lambrou², Louise Demers², Richard LeBlanc¹, Jean Dansereau¹
¹École Polytechnique de Montréal, NSERC Industrial Research Chair on wheelchair seating aids

²École de réadaptation/School of Rehabilitation, Université de Montréal
Montreal, Quebec, Canada

ABSTRACT

The purpose of this preliminary study was to identify the seating and wheeled mobility needs of institutionalised elderly persons. A focus group process based on a modified version of the Nominal Group Technique [1] was conducted with eight health care practitioners who worked with the elderly. In response to five open-ended questions, the participants identified, prioritized and discussed the assistive technology needs of elderly persons with mobility impairments. The results revealed the eight most important seating and mobility needs of the elderly. The participants considered "comfort" to be the most important seating and mobility need and they described the many problems associated with the geriatric chair. The results of the study confirm the need for research and development of seating and wheeled mobility aids that will better meet the needs of elderly persons living in an institution.

BACKGROUND

Considering the current lifestyle of most individuals in their work, home and social environments, most people spend one third of their lives sitting. The older we get, the more we sit. The demand for better and more comfortable seating seems to be intensifying, especially among very elderly persons who spend most of their waking hours in seated positions. This situation is particularly true in nursing homes where an increasing number of elderly are relegated to a sitting existence [2]. Unfortunately, despite recent advances in seating and wheelchair technology, the majority of chair bound nursing home residents remain seated in either uncomfortable standard sling-seat folding chairs or in "geri-chairs" that prevent any independent attempts for mobility [3]. The way elderly persons are seated has a profound effect on how others perceive and interact with them. This in turn affects their

own sense of self esteem and well-being [4]. As the number of elderly persons living in nursing homes and long term facilities rises, the monies available to meet their seating and mobility needs decreases. It is therefore of critical importance to design, manufacture and provide seating and wheeled mobility aids that meet the needs of today's aging population.

RESEARCH QUESTION

What are the most important seating and wheeled mobility needs of elderly persons living in long term care facilities in the Montreal area?

Objectives

This preliminary study was conducted as an initial step toward the development, design and selection of wheelchair seating aids that will better meet the posture and mobility needs of the elderly. The specific objectives of the study were to:

1. identify the needs of institutionalised elderly persons in terms of seating and wheeled mobility;
2. determine the advantages and disadvantages of the most commonly selected seating and mobility aids that are currently used in institutions for the elderly, and
3. describe the context and conditions in which manual wheelchairs, geriatric chairs and positioning wheelbases are generally prescribed for elderly persons.

METHOD

Sample

Eight health care practitioners who worked in three Montreal long term care facilities were selected as participants of a focus group. The group included one doctor, four occupational therapists, two nurses and one part-time nursing aid (who was also a third year occupational therapy student); unfortunately, it was not possible to recruit any elderly persons or family members as participants. Five other

Elderly wheelchair users' needs

people were present: two moderators and three members of the research team.

Procedure

The participants attended a three hour session that was held in a conference room of a university teaching hospital for geriatric care. Three different types of geriatric chairs were on display to stimulate ideas and promote discussion. Five open-ended questions were presented to the group:

1. Based on your personal and professional experience with the elderly, what do you consider are their needs in terms of seating and wheeled mobility aids?
2. What are the advantages and disadvantages of the current seating and wheeled mobility aids provided to elderly persons living in an institution?
3. In what context and under what conditions are manual wheelchairs, geriatric chairs and positioning wheelbases prescribed for the institutionalised elderly?
4. Considering the needs of elderly persons, do you feel it is necessary to design and develop new seating and mobility aids?
5. In designing a new wheeled mobility aid for elderly persons, what features should characterise the ideal system that would best meet the present and future needs of the elderly?

A modified version of the Nominal Group Technique [1] was used for the first question. The participants were asked to identify the factors they considered to be important thereby generating an initial list of 23 seating and mobility needs for the institutionalised elderly. They were then asked to individually select from this list, the eight factors they considered to be the most important and to rank them in order of importance. Their written responses were collected and scored as follows; the need of greatest importance was assigned 8 points, the need of second greatest importance was given 7 points and so on; a maximum score of 64 points (8 participants X 8 points) was possible for the factor of greatest importance.

For the other questions, a more unstructured approach was used due to a lack of time; the participants expressed their opinions (one at a time) in turns and the moderators recorded the responses on flip charts. Approximately 30 minutes was required by the group to

completely exhaust each of the remaining four questions.

RESULTS

From the list of 23 factors identified by the participants (question #1), the eight seating and mobility needs considered to be the most important are provided in Table 1 together with their total score.

Seating & mobility needs	Score
1. comfort	64
2. security/safety	51
3. body alignment	35
4. ease of handling the client	29
5. frequent repositioning	25
6. adaptability to aging process	22
7. ease of manipulation of parts	12
8. easy propulsion by others	8

Table 1. Eight most important seating and mobility needs of institutionalised elderly

These results show that all participants considered seating and wheelchair "comfort" to be the most important factor. The second most important factor "safety/security" was identified not only as a need of the primary user but also for the nursing staff who positioned and transferred the clients. In the same way, "ease of handling the client" and "easy propulsion by others" were considered very important needs from both the primary and secondary user perspectives.

In response to the second question, the participants described the advantages and disadvantages of the seating and mobility aids used in their institution in somewhat general terms. Most of their criticism was targeted toward the geriatric chair which they described as being oversized, non accommodating, uncomfortable and unsafe; the elderly person is most often seated in a nonfunctional, asymmetrical or forward sliding, kyphotic posture.

The context and conditions under which manual wheelchairs, geriatric chairs and positioning wheelbases are prescribed (question #3), was reported to depend primarily on the nature and severity of the person's impairment and whether or not there was public funding

Elderly wheelchair users' needs

coverage. The manual wheelchair is generally selected for elderly persons who have enough trunk control to remain seated regardless whether or not they can self-propel the wheelchair; under certain terms and conditions, the cost of this type of mobility aid is paid by the provincial health insurance program. For persons with marked cognitive and physical impairments, the geriatric chair is usually provided because they are readily available in the facilities; the geriatric chair is not covered by the Quebec health care program. Although the positioning wheelbases are considered to be more advantageous than the geriatric chair, they are not prescribed as often as the participants think they should be, primarily because of the lengthy procedures required by the provincial health insurance program; in many instances, after several months wait for the mobility aid, the client passed away by the time the device arrived.

All participants felt that it was necessary to design and develop a new seating and mobility aid (question #4) that would better meet the needs of the elderly living in an institution. In response to the fifth and last question, the participants were unable to propose a design concept for the ideal seating and mobility aid. They did however explain that a new seating and mobility aid that met the needs identified at the beginning of the session, could be considered to be the ideal device.

DISCUSSION

From the participants' perspective, in a long term care facility, seating discomfort has a profound effect on the amount of nursing time spent with the elderly; to alleviate their discomfort, the elderly person has to be either repositioned in the (wheel)chair or transferred to bed. In both situations, the problem of seating discomfort has an impact on both the elderly person's well-being and on the practitioner's responsibilities. Finally, the many problems associated with the geriatric chair stress the need for outcome data on elderly persons' functional performance, seating posture and (dis)satisfaction with this mobility aid.

In conclusion, this is the first research study of its kind in Quebec and it constitutes an initial step toward a better understanding of the

seating and wheeled mobility needs of the elderly. The results emphasize the importance of seating comfort and highlight the many problems associated with the geriatric chair. Given the complexity of the problems addressed, this study confirms the need for better seating and wheeled mobility aids for elderly persons living in an institution.

REFERENCES

- [1] Deslauriers, J.P. (1987). *Les méthodes de la recherche qualitative*. Sillery, Québec: Presses de l'Université du Québec.
- [2] Redford, J.B. (1993). Seating and wheeled mobility in the disabled elderly population. *Archives of Physical Medicine and Rehabilitation*, 74, 877-885.
- [3] Jones, D., Lavelle, M., Semradek, J. (1994). Enhancing functional ability in chairbound nursing home residents. *Proceedings of the Canadian Seating and Mobility Conference*, Toronto, Ontario.
- [4] Khatri, A.R., McCullough, C. (1991). Addressing post prescription seating issues in long term care. *Proceedings of the Canadian Seating and Mobility Conference*, Toronto, Ontario.

ACKNOWLEDGEMENTS

This study was funded by the NSERC (Natural Sciences and Engineering Research Council of Canada) Industrial Research Chair on wheelchair seating aids, École Polytechnique de Montréal and by our Quebec industrial partners, Promed Inc. and Orthofab Inc. The authors wish to acknowledge the collaboration of the Institut universitaire de gériatrie de Montréal and to thank the participants of the focus group for sharing with us their valuable time and expert opinion.

Michèle Lacoste, occupational therapist
Research associate,
Chaire industrielle CRSNG sur les aides
techniques à la posture
École Polytechnique de Montréal
C.P. 6079, succ. Centre-ville, Montréal
Québec, Canada, H3C 3A7
Telephone: (514)340-4711 local 4298
Fax: (514)340-3261
e-mail: lacoste@meca.polymtl.ca

PRELIMINARY TEST METHODS FOR WHEELCHAIR SEATING COMPONENTS

Allen R. Siekman, BS, Peter W. Axelson, MSME,
Jamie H. Noon, Arne T. Folkedal, Ronald J. Wisnia
Beneficial Designs, Inc.
Santa Cruz, California, USA

ABSTRACT

As part of the movement to define and adopt standards for seating and positioning products, methodologies for testing these components need to be developed. Several test fixtures were designed and developed to objectively measure the durability and performance characteristics of wheelchair seating components. Further development of the test fixtures and protocols will allow designers, manufacturers and researchers the ability to obtain data that is objective, valid and comparable. The adoption of standardized test fixtures and protocols will enable a committee to proceed with the establishment of performance standards for seating and positioning devices.

BACKGROUND

In the United States, the testing of seating and positioning components for function, durability and safety has generally been conducted at the discretion of the manufacturer. One exception to this is flammability testing for which there is a national standard. Many state governments have more strict standards.

During the course of work on wheelchair standards, test fixtures and protocols have been developed that can be easily adapted to testing seating components. Test fixtures, such as the double drum fixture, can be used with little adaptation, while others clearly need to be developed.

The industry and consumers would benefit from the establishment of standardized testing of cushions, backrests and other positioning components just as they have benefited from wheelchair standards.

STATEMENT OF THE PROBLEM

Uniform test fixtures and test protocols that provide comparable, objective data on the performance, safety and durability of seating products are not currently available. The future development of seating performance standards will require the development of test fixtures and protocols. Although some fixtures developed for wheelchair testing can be adapted to test seating products, there is a need for test fixtures that are specifically designed for this purpose.

APPROACH

Areas that are routinely tested during development, research and product testing include: durability, pressure distribution, load and deflection characteristics, and safety. To accomplish these tasks, several test fixtures and protocols have been developed.

Durability Testing

Durability testing is multifaceted and may include analysis of materials, manufacturing procedures, wear and tear and exposure to environmental elements.

The main test fixtures that are in use for durability testing include: 1) a double drum tester, 2) a modified test dummy, 3) a repetitive

load test fixture 4) a load/deflection fixture and a seating interface test fixture.

Double Drum Tester

The double drum test fixture is used to accelerate the effect of loads on the seating components in the same way that wheelchairs are tested. (ANSI/RESNA WC/08 Static, Impact and Fatigue Testing). The purpose of the test is used to assess the strength of seat and back shells, mounting hardware and bracketry. This test also helps establish the durability and the fatigue resistance of the support and cushioning materials used in the manufacture of the product.

Using a 100 kg. test dummy, the seating products are subjected to 100,000 cycles on the two drum fatigue tester. Load vs. deflection measurements as well as physical inspection for wear or damage is completed before and after the two drum test.

The standard test dummy used in wheelchair standards testing has recently been modified for testing seating devices. The attachment of a more appropriately shaped seat interface section and the addition of articulating legs and feet has made this possible.

Modifications to the dummy followed the proposed ISO committee draft standard 7176-20:1996 for testing of stand-up wheelchairs. Inclusion of the buttocks, thigh and leg/foot assemblies allows for a more accurate distribution of forces onto the cushion surface. With existing test dummies abnormal wear to seat cushions often occurs.

Repetitive Load Tester

A test fixture has been fabricated that allows a repetitive load to be applied to the seating components. The repetitive load tester is used

to evaluate durability by applying controlled loads to the seat or backrest.

The load is produced by a pneumatic ram. The amount of force and the duration of load application is adjustable to meet the needs of the specified test.

When testing a seat cushion, a 100 kg. force is applied to the seat using an attached seating test fixture. Force is measured with a pressure transducer on the pneumatic ram and is maintained for 2 seconds on each cycle. The cushion is subjected to 50,000 cycles (estimate 4 pressure reliefs per hour x 16 hours use per day x 365 days per year = 23,360 cycles per year).

When testing a backrest, a 50 kg. force is applied to the backrest using an attached torso model. The force is maintained for 2 seconds on each cycle. The backrest is also subjected to 50,000 cycles.

Load/Deflection Test Fixture

Prior to fatigue and repetitive load testing, cushions are evaluated using a load vs. deflection process. A load/deflection test fixture has been fabricated that allows for the measurement of the cushion deflection at loads of 50, 100, 150, 200 and 250 pounds,

In addition, pressure distribution characteristics can also be measured using a FSA pressure measurement system (Vista Medical, Winnipeg, Canada).

The force is applied to the test cushion through an attached seating interface fixture. Until recently, the RESNA Sig17 "Sore Butts" fixture was used to interface with the test cushion. A new fixture, the Seating Interface Tester (SIT), has been developed to replace the Sig17 test fixture in these tests. The Seating Interface

Tester (SIT) was produced by taking a negative mold of a wheelchair user, fitting a skeleton model into the mold and filling the mold with a gel material to simulate soft tissue.

Using the FSA, three readings are taken with the test fixture at the appropriate loads. For each reading, the number of sensors included, the average pressure and standard deviation of the pressure measurements are recorded. Color printouts of the pressure mapping readings are also used to visually assess the cushion's ability to distribute pressure.

DISCUSSION

Development of seating and positioning standards is one of the next major steps in the evolution of service delivery. The development and adoption of universal test fixtures and test protocols which measure the characteristics of a seating component will enable a standards committee to begin developing seating standards.

Standardized test fixtures and product testing is necessary to objectively measure product safety, durability and performance. The development of standardized test fixtures and protocols will provide common tools for manufacturers, designers, researchers to compare test results and evaluate changes in design, materials or manufacturing techniques.

The test fixtures and protocols discussed here have been developed to meet the needs of research and testing projects. This information is presented in the hope that it will provide a seed for discussion and further development of test equipment and protocols.

REFERENCES

1. Haddow, A. (1997). Wheelchair cushion

designs for developing countries: Project Sorebutts, Proceedings of the RESNA 1997 Annual Conference (pp. 471-473). Arlington, VA: RESNA Press.

2. Technical Committee 173, Subcommittee 1. (1996). ISO/CD 7176-20: Determination of the performance of stand-up type wheelchairs. Geneva: International Standards Organization.

ACKNOWLEDGMENTS

Portions of this research were funded by ComforTech Inc.

For further information:

Allen R. Siekman

Beneficial Designs, Inc.

5858 Empire Grade

Santa Cruz, CA 95060

Phone: 408-429-8447

Fax: 408-423-8450

e-mail: allen@beneficialdesigns.com

MODELING THE DYNAMIC STABILITY OF AN OCCUPIED WHEELCHAIR

Christopher Bruno and Allen H. Hoffman, Ph.D.
Mechanical Engineering Department
Worcester Polytechnic Institute, Worcester, MA 01609

ABSTRACT

Wheelchair instability under dynamic conditions is a significant cause of injury. The varying conditions under which dynamic instability occurs has created a need for mathematical models to complement existing experimental studies. A user friendly computer model was developed for analyzing the stability of a manual wheelchair. Forward and rear stability were examined in the static case and in the dynamic situation where the wheelchair strikes an object that it can not roll over. The model showed good agreement with published experimental studies.

BACKGROUND

It is estimated that each year in the United States, over 36,000 people are injured seriously enough in wheelchair accidents to seek medical attention. Wheelchair stability is a significant factor in the majority of these accidents [1]. Forward and backward tips and falls are particularly prevalent among manual wheelchair users [2].

Dynamic stability has been primarily studied experimentally. These studies include: the effect of elevated footrests on forward stability [3], the effect of caster diameter on forward stability [4] and the effect of seat position on forward and rear stability [5]. Safety considerations generally confine experimental studies of dynamic stability to transient tip conditions. Even under these conditions, test subject reactions may not be typical of actual user reactions. Dummies are used to study full tip conditions. However, it is impractical to perform detailed experimental studies of the effect of parametric variations in wheelchair design or occupant positioning.

Past models of dynamics stability have tended to focus on wheelchair trajectories on nearly planar surfaces [6,7]. Little attention has

been given to the types of dynamic instabilities associated with the injury data.

RESEARCH QUESTION

Experimental studies, which focus upon single variables, have contributed significantly to the understanding of dynamic stability. However, the simultaneous variation of several parameters is not easily studied experimentally. There exists a need to develop mathematical models capable of predicting wheelchair stability under widely varying conditions.

METHODS

Static and dynamic stability depend upon the location of the center of mass of the wheelchair/occupant system. The system consists of three parts: the wheelchair frame, the occupant, and the wheels and casters. Tube elements in the wheelchair frame are modeled as line segments thereby creating a three-dimensional wire frame model. The center of mass of the wire frame can be calculated using composite parts techniques.

The human body model was developed using a 14-element model [8]. Each element is modeled as a line segment except for the hands and feet, which are modeled as points. The model assigns a mass and locates the center of mass of each segment. The lower body is assumed to be rigidly attached to the wheelchair. Inputting appropriate angles and lengths for the torso and arm segments specifies the configuration of the upper body. The moment of inertia of each segment is determined by approximating the arms and legs as cylinders, the head, hands and feet as spheres and the torso as a rectangular prism. These values are used to determine the center of mass and moment of inertia of the human model.

The location of the center of mass of the wheelchair frame/occupant system is then determined in the global coordinate system. The location of this mass center is adjusted by including the mass of the rear wheels in the case of forward stability and the mass of the casters in the case of rear stability. Forward and rear static stability are the angles through which the wheelchair can rotate about the front caster or rear wheel axis before the mass center falls outside the footprint of the wheelchair.

For the dynamic analysis, it is assumed that the wheelchair collides with an object that it cannot roll over. The system is assumed to be rigid and symmetric about the XY plane allowing for a two-dimensional analysis. Thus it is assumed that both wheels will strike the barrier at the same time. The model assumes that the interaction between the tire and the barrier acts as a spring-damper system. Values of the spring constant and damping coefficient of the tire are related to air pressure in the case of pneumatic tires and to the material properties in the case of solid or foam tires.

The system is initially translating on a horizontal surface and rotation will occur about the axle of the colliding wheel. The free body diagram of the system (Figure 1) is analyzed as a function of time for an initial impact velocity. The model equations were solved symbolically. The symbolic equations were developed into a computer program using finite difference

techniques. The program computed the solution at each time-step (.0005 seconds) by using the results of the previous steps.

RESULTS

The program was used to model a typical rigid lightweight wheelchair. Static stability results (Table 1) were compared to the experimental results of Trudel et al. [9]. Most other experimental studies did not contain sufficient information on many model parameters to allow comparisons.

The model was compared with the dynamic stability experiments of Majaess et al. [5]. This article focused on comparing stability values for different seat positions. The values for 'seat back' were used since this was the position of the seat during normal use. Majaess et al. [5] reported threshold velocities for "transient tip". The computer model was used to calculate the velocities for transient tip (assumed to be a rotation of 10-15 degrees) and for full tip (Table 2).

DISCUSSION

Forward and rear dynamic stability of an occupied manual wheelchair have been analyzed using a user friendly computer model. The model operates on a Windows based platform and is easily modified. Multiple wheelchair designs and occupant positions can be incorporated into the model. The structure of the model lends itself to the study parametric variations in design parameters. In the work reported here, a single commercially available lightweight wheelchair was modeled. Furthermore, the position of the occupant was assumed to remain fixed with respect to the wheelchair. Future development of the model could incorporate the motion of body segments of the occupant with respect to the wheelchair.

Comparing the model results to prior experimental studies is hindered by a lack of knowledge of all of the model parameters associated with the experimental studies. Nonetheless, the model predictions for static stability were within 1 to 4.3 degrees of those observed experimentally by Trudel et al. [9].

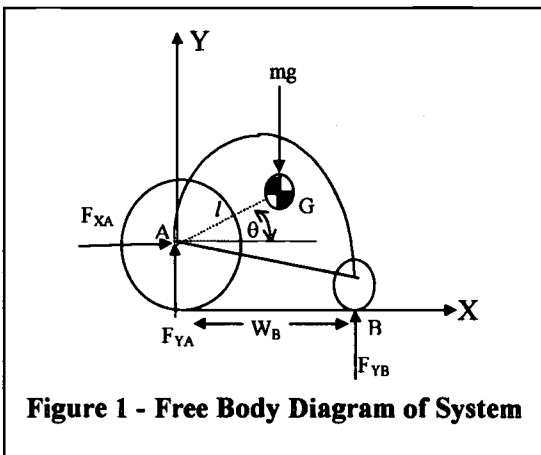

Figure 1 - Free Body Diagram of System

Modeling The Dynamic Stability Of An Occupied Wheelchair

Comparison of the dynamics stability results with those of Majaess et al. [5] is hindered by two additional factors. First, transient tip is not quantitatively defined in the experiments and second, the dynamics of the occupant are probably somewhat different in the experiment. Despite these uncertainties, the stability predictions compared very well when a forward tip of 15° and a rearward tip of 10° were used as transient tip values (Table 2).

The model has also been used to investigate dynamic stability in two additional situations: rolling forward over a drop off such as a curb and attempting to brake while rolling backward on a inclined surface [10].

REFERENCES

- [1] Kirby, R. L., "Wheelchair stability: important, measurable and modifiable", *Technology and Disability*. 1996; 5:75-80.
 [2] Gaal et al., "Wheelchair rider injuries: Causes and consequences for wheelchair design and selection", *J. Rehab Res and Dev*. 1997; 34:58-71.
 [3] Kirby et al., "Static and dynamic forward stability of occupied wheelchairs: Influence of elevated footrests and forward stabilizers," *Arch of Physical Med and Rehab*. 1989; 70:681-686.

- [4] Kirby et al., "Influence of caster diameter on the static and dynamic forward stability of occupied wheelchairs," *Arch of Physical Med and Rehab*. 1992; 73:73-77.

- [5] Majaess et al., "Influence of seat position on the static and dynamic forward rear stability of occupied wheelchairs," *Arch of Physical Med and Rehab*. 1993; 74:977-982.

- [6] Cooper R.A., "Stability of a wheelchair controlled by a human pilot," *IEEE Trans. Rehab Eng*. 1992; 1:193-205.

- [7] Collins T.J, Kauzlarich J.J., "Directional instability of rear caster wheelchairs," *J. Rehab Res and Dev*. 1988; 25:1-18.

- [8] Chandler, R.F. et al., "Investigation of inertial properties of the human body", NTIS No. AD-A016 485, 1975.

- [9] Trudel et al., "Effects of camber on wheelchair stability," *Proceedings of the RESNA '94 Conf*. 1994; 315-317.

- [10] Bruno, C., Development of a Mathematical Model to Investigate the Static and Dynamic Stability of a Wheelchair System, MS Thesis, Worcester Polytechnic Institute. 1997.

Christopher Bruno
 89 Circular St. #4
 North Attleboro, MA 02760
bruno@jcd.teradyne.com

<u>Static Stability</u>	<u>Experimental</u> from Trudel et al. [9]	<u>Program Results</u>	<u>% Difference</u>
Lateral	24°	23°	4.3%
Forward	27°	31.3°	13.7%
Rearward	13°	15.6°	16.6%

Table 1 – Comparison of calculated static stability versus experimental static stability. In the rear stability case, wheels are unlocked. Rear camber is -10°. Units are in degrees.

<u>Dynamic Stability</u>	<u>Experimental</u> <u>(Standard Deviation)</u> from Majaess et al. [5]	<u>Program Results</u> <u>Transient Tip</u>	<u>Program Results</u> <u>Full Tip</u>
Forward	3.12 (0.59)	3.37	5.7
Rearward	1.57 (0.16)	1.53	2.3

Table 2 - Comparison of experimental and calculated velocities for transient tip. Forward-calculated velocity yields 15° rotation, rearward calculated velocity yields 10° rotation. Calculated values for full tip are also presented. Units are in ft./sec.

A KINEMATIC METHOD FOR THE EVALUATION OF LATERAL STABILITY OF THE USERS PROVIDED BY WHEELCHAIR BACKRESTS

Frédéric Parent, Jean Dansereau, Heydar Sadeghi & Rachid Aissaoui.
École Polytechnique de Montréal, NSERC Industrial research chair on wheelchair seating aids
Montreal, Quebec, Canada

ABSTRACT

A kinematic method was developed to evaluate the lateral trunk stability provided by different wheelchair backrests during user's displacements in a motorized wheelchair. This method was applied on a non-disabled subject for two wheelchair backrests in order to demonstrate its feasibility. The subject had to drive a motorized wheelchair on an experimental inclined pathway. 3-D locations of reflective markers associated to anatomical landmarks on the trunk and the wheelchair were measured with the help of the Motion Analysis system. Preliminary results showed that the accuracy of this method is sufficient to evaluate and compare the stability effects produced by different wheelchair backrests.

INTRODUCTION

A large number of wheelchair users present lateral trunk instability. In order to improve function and prevent or manage trunk alignment problems, many wheelchair backrests were designed in such a way to provide adequate lateral trunk support. For the manufacturers and the clinicians, it is however difficult to objectively evaluate the quality of the lateral stability provided by a wheelchair backrest. In fact, most of the works in the field of seating address the issue of wheelchair stability [1,2,3]. Axelson & Chesney [4] have proposed a method to evaluate the forward and lateral stability offered by a new back support. Lateral trunk stability was assessed by measuring the maximum lateral distance reached by the subject with the dominant hand holding a weighted object without losing his balance. This approach however, does not provide information about the lateral stability provided

by the backrest itself during the user's displacements in his own wheelchair. The purpose of this study is to introduce a kinematic method to evaluate the lateral trunk stability provided by different wheelchair backrests when a user is driving a wheelchair on an experimental inclined pathway. In this study, two wheelchair backrests were tested on a non-disabled subject in order to demonstrate the feasibility of the method. A preliminary study on the variability of rigid body measurements along the pathway was also performed.

METHOD

An able-bodied subject (26 years, 87 kg) participated in this study. He was asked to drive a motorized wheelchair (Targa from Orthofab Inc.) at low speed (1.4 m/s) on a path composed of three sections: a 1m horizontal plane, a 1.75m twisted access plane and a 2m laterally inclined plane (figure 1). A transition zone of 0.5m was defined between the access and the inclined sections as shown on figure 1.

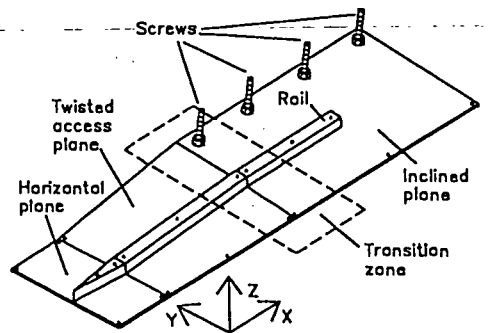

Figure 1. Schematic representation of the experimental pathway designed to allow lateral tilt of the wheelchair.

Tilt of the inclined plane was variable up to 15° by the adjustment of four screws. During the

experiments, the tilt angle was set to 10°. A rail on the experimental pathway and four little rollers fixed under the motorized wheelchair allowed the user to keep a linear direction along the path. Trials were done with two different backrests. The first one was the standard backrest installed on the motorized Orthofab's wheelchair. This backrest is composed of a 7.5 cm depth contoured lateral support located at the middle height of the backrest. The second backrest, the Perform (Orthofab Inc.), has also a contoured lateral support of 7.5 cm depth but mostly located in the upper part of the backrest. It was hypothesized that the Perform improves the lateral support in the upper part of the trunk in comparison with the standard backrest.

Along the experimental pathway, the Expert Vision System from Motion Analysis Corporation was used for the kinematic acquisition of anatomical landmarks on the subject and the wheelchair. For this study, two reflective spherical markers of 24 mm of diameter were placed over the anatomical landmarks of the shoulder (acromion processes, markers 1 and 2 on figure 2), two others on the trunk (sternal notch and xyphoid process, markers 3 and 4 on figure 2) and two others on the wheelchair (markers 5 and 6 on figure 2). Six high speed videos cameras were placed around the experimental pathway along an arc of about 180° to track all markers at 60 Hz. Distance between the access plane and the cameras was about 4 meters. Three-dimensional coordinates were obtained from ExpertVision software and around 190 frames were generated for each trial. The following parameters were then calculated along the path (figure 2):

Trunk lateral tilt (TLT)

Defined as the difference between the wheelchair tilt angle (computed in the frontal plane by the use of markers 5 and 6) and the angle between the Z axis and the vector passing through the markers 1 and 2, projected on the YZ plane.

Shoulder lateral tilt (SLT)

Defined as the difference between the wheelchair tilt angle and the angle between the Y axis and the vector passing through the markers 3-4, projected on YZ plane.

Trunk transverse rotation (TTR)

Defined as the angle between the Y axis and the vector passing through markers 1-2, projected on XY plane.

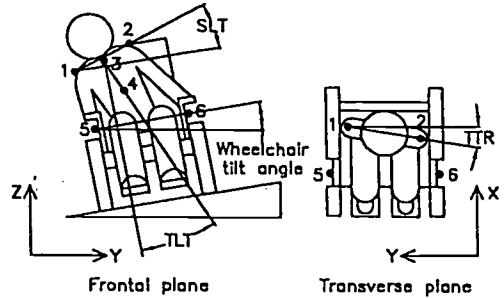

Figure 2. Geometrical parameters calculated with the user's trunk and shoulder landmarks.

The accuracy of these parameters depends on the intrinsic calibration errors associated to the Motion Analysis system as well as the markers visibility. In order to obtain preliminary results concerning the validity and the feasibility of the proposed evaluation method, the variability in length of three assumed rigid body segments (shoulder segment 1-2, sternum segment 3-4 and wheelchair width 5-6, figure 2) were calculated along the path. Also, assuming that the inclined plane section was constant at 10°, the variability of the wheelchair tilt angle (figure 2) was calculated along this section.

RESULTS

As shown in table 1, variability of segments 1-2 and 3-4 are lower than 2.7 mm while the segment 5-6 presents relatively high variability along the path (more than 8 mm). However, the variability of the wheelchair tilt angle is small.

Table 1. Length variability of three rigid body segments along the path (189 frames) and wheelchair tilt angle variability along the inclined section (66 frames).

	Perform trial	Standard trial
Segment 1-2	± 2.7 mm	± 2.4 mm
Segment 3-4	± 1.7 mm	± 1.2 mm
Segment 5-6	± 9.8 mm	± 8.0 mm
Wheelchair tilt	± 0.3°	± 0.2°

Figure 3 presents the results obtained from the experiments with the non-disabled subject. As shown on this figure, parameters calculated for the Perform backrest seem constant along the path in comparison with the standard backrest which presents abrupt changes in the transition zone. Figure 3 also shows that the values of the parameter TLT and SLT are quite similar for the two backrests along the path.

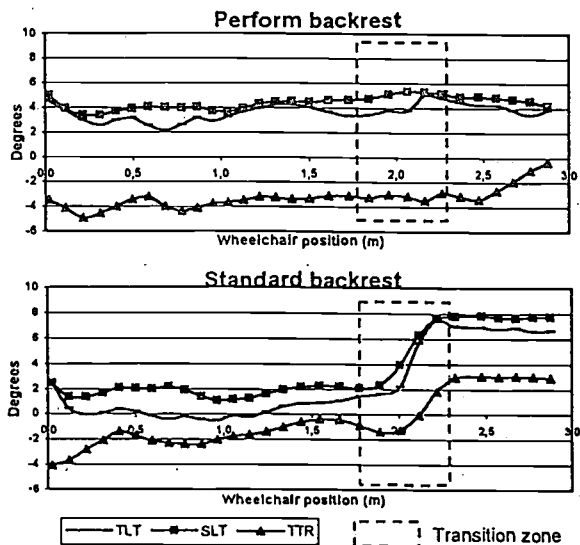

Figure 3. Evolution of parameters calculated for the two backrests with respect to the wheelchair position on the experimental pathway.

DISCUSSION

The aim of this study was to introduce a kinematic method to evaluate the lateral trunk stability provided by wheelchair backrests. The method proposed in this study seems adequate although it is still exploratory at this stage. Some changes need to be done in order to improve the accuracy of markers associated to the motorized wheelchair. Although the calibration was done with care, the distance between cameras and the access zone was high (over 4 meters). Therefore, the visibility and the tracking of some markers were difficult, implying possible sources of errors. Furthermore, wheelchair markers were each

tracked by only three cameras while other markers were tracked by at least four of them. This may explain higher variability for segment 5-6 compared to segments 1-2 and 3-4. However, variability of the wheelchair tilt angle is small, meaning that the high variability of the segment 5-6 does almost not affect parameter calculations. Results of this study demonstrated the feasibility of this new evaluation method when applied on a non-disabled subject. It was found that the Perform backrest provides better lateral trunk stability in the upper part of the trunk (it tends to maintain more efficiently the subject's trunk in place even if the wheelchair was tilted) when compared to the standard backrest for this specific subject. A pilot study has been started to evaluate the feasibility of the method and to deeply study the stability effect of different backrests on a group of disabled subjects.

REFERENCES

1. ANSI/RESNA WC/01 (1990). RESNA Standards, Wheelchairs: Determination of static stability.
2. Cooper R.A., Stewart K.J. & VanSickle D.P. (1994). Evaluation of methods for determining rearward static stability of manual wheelchairs. *Journal of Rehabilitation Research and Development*, 31(2):144-147.
3. Kirby R.L, Sampson M.T., Thoren F.A.V. & MacLeod D.A. (1995). Wheelchair stability: Effect of body position. *Journal of Rehabilitation Research and Development*, 32(4):367-372.
4. Axelson P.W. & Chesney D.A. (1996). Clinical and research methodologies for measuring functional changes in seating systems. *Proceedings of the International Seating Symposium, Vancouver*, 81-84.

ACKNOWLEDGMENTS

This research was funded by the NSERC (Natural Sciences and Engineering Research Council of Canada), École Polytechnique de Montréal, Promed Inc. and Orthofab Inc.

Frédéric Parent, M.Sc.A.

NSERC industrial research chair on wheelchair seating aids, École Polytechnique de Montréal, C.P. 6079, succ. Centre-ville, Montréal, P.Q., Canada, H3C 3A7. Fax: 514-340-3261 e-mail: parent@meca.polymtl.ca

BIOMECHANICAL COMPARISON OF WHEELCHAIR BASKETBALL PLAYERS AND NON-BASKETBALL PLAYERS

Thomas J. O'Connor, Michael L. Boninger, Mark Baldwin, Rory A. Cooper, Sean Shimada & Alicia Koontz

Dept. Rehab. Science & Technology, University of Pittsburgh, Pittsburgh, PA. 15261
Human Engineering Research Laboratories, Highland Drive VA Medical Center, Pittsburgh, PA. 15206

ABSTRACT

Six wheelchair basketball players and six wheelchair nonathletes were tested on a wheelchair dynamometer using their own wheelchairs and SMART^{Wheel}s fitted on both sides. Three-dimensional kinetic data were collected at a frequency of 240 Hz. Results show that there were no significant differences between the forces analyzed. A questionnaire was completed and all of the nonathletes reported some type of shoulder and wrist pain, while three of the nine basketball players reported no pain. Two of the three athletes that reported no pain used specialized wheelchairs for play. Future studies should investigate design features of these sports wheelchairs.

INTRODUCTION

With the improvements in medical technology and medicines, people with traumatic spinal cord injuries are surviving major accidents and living longer and more productive lives. Many participate in sports for exercise and recreation as a part of this productive life. The number of participants in wheelchair sports is increasing along with the number of individuals who are surviving spinal cord injuries (1). One of the sports that is growing in popularity is basketball. Basketball not only gives the players a competitive activity, but it also increases their activity level which helps to promote and maintain a healthier cardiovascular system and reduce the risk of obesity, diabetes, and osteoporosis (2 & 3). This is important because cardiovascular disease is a major health concern for individuals with a spinal cord injury.

Generally, one might think that a wheelchair athlete would report more shoulder and/or wrist pain and injuries because the wheelchair athlete is training more which can include wheeling, weight training and participation in other sports. This extra training does not include the wheeling and transfers that the individuals do for everyday living activities. Wheelchair basketball requires the arms to be in an overhead position quite frequently which might also contribute to the player developing shoulder pain. Using survey questionnaires, studies reported that wheelchair basketball players do acquire shoulder and wrist injuries during training and competition (4, 5, 6 & 7). Wheelchair basketball players need to impart large forces to the pushrim to propel their wheelchair which can cause injuries to the shoulder and wrist areas. Research has reported the extra training associated with basketball wheelchair, decreases the amount of shoulder and wrist pain and/or injuries they incur (1). This extra training might strengthen the shoulder and wrists thus minimizing the trauma during wheeling, transfers and everyday living activities.

Individuals who use a wheelchair for everyday mobility are more susceptible to shoulder impingement and wrist injury than individuals who use their legs for mobility. These types of injuries can be painful, but they might also cause greater problems. A shoulder or wrist injury might limit a wheelchair user's ability to propel their wheelchair and thus limit their mobility for everyday activities. They can become dependent for mobility or they might have to start using an electric powered wheelchair.

This study investigated whether there was a difference between the forces applied to the pushrim by wheelchair basketball players and non-basketball players, and if there was a difference in reported pain in the shoulder and wrist areas by these individuals.

METHODS

Subjects

Eighteen subjects, out of a database of 40 were selected for analysis in this study. All subjects had a spinal cord injury of T4 or below and gave written informed consent. Nine of the subjects were wheelchair basketball players and the other nine subjects reported that they did not participate in wheelchair sports. The nonathletes were chosen to provide an age and years out from spinal cord injury matched control group. The subjects ranged from 24 to 41 years of age. Table 1 shows mean age and mean years of wheelchair use. The SPSS for Windows was used for calculation of significant differences.

Table 1.

	Mean Age	Mean Yrs WC
BB Player	30.4±4.8	9.2±5.2
NON BB	32.9±7.1	10.9±4.6

Experimental Protocol

The kinetic data were collected using SMART^{Wheel}s and at 240 Hz. The individual's wheelchair was fitted with SMART^{Wheel}s on both sides. The wheelchair was then secured to a dynamometer. The SMART^{Wheel}s were triggered simultaneously and data were collected using an IBM compatible computer. The kinetic data were converted and analyzed using Matlab programs. The subjects answered a questionnaire about their wheelchair history and health prior to the testing.

Testing consisted of the subjects propelling their wheelchair at .89 and 1.79 m/s (actual recorded speeds were .97 and 1.68 m/s). The subject would propel up to the speed of

that trial and then maintain the speed. Data for each trial were collected for twenty seconds after the subject reached steady state.

The questionnaire was checked to see if the subject reported shoulder and/or wrist pain. Data analyzed were three-dimensional resultant, tangential, and radial forces for the right and left sides. The first five strokes were analyzed. The contribution of the tangential force to the resultant force (CTF) was calculated using Robertson et al's (8) formula:

$$CTF = F_t^2 / F^2$$

RESULTS

Three of the wheelchair basketball players reported shoulder and wrist pain, three reported wrist pain and three reported no pain in the wrist or shoulder areas. Four nonathletes reported wrist and shoulder pain, four reported wrist pain and one reported shoulder pain. Two of the three athletes that reported no pain also reported that they use a specialized wheelchair while playing basketball.

No significant differences were found for the forces that were analyzed between the two groups. The contribution of the tangential force to the resultant force (CTF) was also calculated and there was no significant difference. There was no significant differences between the pain categories.

DISCUSSION

The kinetic data showed that there were no significant differences between the basketball players and the nonathletes for the forces analyzed in this study. All the nonathletes reported some type of shoulder or wrist pain and one third of the athletes reported no pain in the shoulder or wrist areas. The nonathletes were older, but not significantly (32.9 vs. 30.4 years old) and their years of wheelchair use was longer, but not significantly (10.9 vs. 9.2 years). This study did not investigate what the athletes and nonathletes did for work or everyday living activities and what affect this might have on the incidence of

shoulder and/or wrist pain. The nonathletes might have jobs or hobbies that increase the possibility of them developing shoulder or wrist pain.

Four athletes reported that they used a specialized wheelchair for basketball but did not provide the camber angle. Two of these four athletes reported that they had no shoulder or wrist pain.

Future studies might investigate whether some of the design features of the specialized wheelchairs decreases the possibility of acquiring some type of shoulder or wrist pain. The athletes used for this study are not classified as elite level wheelchair basketball players so this might explain why two thirds of the group reported some type of pain. Future studies should include a larger number subject of participation.

ACKNOWLEDGEMENTS

The U.S. Department of Veterans Affairs Rehabilitation Research & Development Services (Project B689-RA), National Institutes of Health (NIK K08 HD01122-01) and the Paralyzed Veterans of America provided partial funding for this research.

REFERENCES

1. Curtis KA, McClanahan S, Hall KM, Dillon D, & Brown KF, (1986). Health, vocational, and functional status in spinal cord injured athletes and nonathletes. *Arch Phys Med Rehabil*, 67, 862-865.
2. Wyndam CH, (1979). The role of physical activity in the prevention of ischaemia heart disease: A review. *South African Medical Journal*, 56, 7-13.
3. Pollack ML, Wilmore JH, & Fox SM, (1984). *Exercise in health and disease: Evaluation and prescription for prevention and rehabilitation*. Philadelphia: WB Saunders Company.
4. Burnham RS, Higgins J, & Steadward RD, (1994). Wheelchair basketball injuries. *Palaestra*, Winter 1994, 43-49.
5. van der Woude LHV, Hendrich KMM, Veeger HEJ, van Ingen Schenau GJ, Rozendal RH, de Groot G, & Hollander AP, (1988). Manual wheelchair propulsion: effects of power output on physiology and technique. *Medicine and Science in Sports and Exercise*, 20(1), 70-78.
6. Nyland J, Robinson K, Caborn D, Knapp E, & Brosky T, (1997). Shoulder rotator torque and wheelchair dependence differences of National Wheelchair Basketball Association players. *Arch Phys Med Rehabil*, 78, 358-363.
7. McCormack DAR, Reid DC, Steadward RD, & Syrotuik DG, (1996). Injury profiles in wheelchair athletes: Results of a retrospective survey. *Clinical Journal of Sport Medicine*, 1, 35-40.
8. Robertson RN, Boninger ML, Cooper RA, & Shimada SD, (1996). Pushrim forces and joint kinetics during wheelchair propulsion. *Arch Phys Med Rehabil*, 77(9), 856-865.

Thomas J. O'Connor
Human Engineering Research Laboratories
VAMC Highland Drive, 7180 Highland Drive
151R-1, Pittsburgh, PA. 15206

VALIDATION OF DYNAMIC MODELS FOR POWER WHEELCHAIRS

Jason Young, B.E.Sc., William Cleghorn, Ph.D., Geoff Fernie, Ph.D.
Centre for Studies in Aging, Sunnybrook Health Science Centre, University of Toronto
Toronto, Ontario, Canada

ABSTRACT

Dynamic stability is an important safety issue in the design of power wheelchairs. Computer simulations allow visualization of complex motion and potentially dangerous scenarios, but must be thoroughly validated before the designer can utilize their predictions. A suggested series of tests for validation of 2D computer models is presented, based on current wheelchair research at the Centre for Studies in Aging. Both static and dynamic measures are included to help isolate the effects of centre of gravity position, suspension elements, and wheelchair user. Recommended testing methods and criteria for evaluating the model are discussed. Using this approach, the study has yielded excellent static results to date with dynamic results forthcoming.

BACKGROUND

The number of wheelchair-related accidents reported is increasing annually (Kirby, 1995), with 50% to 75% of these accidents resulting from tips and/or falls of the chair, the user, or both (Calder, 1990, Unmat, 1994). Outdoor obstacles and hazards encountered by the chair while in motion, such as inclines, ramps, curbcuts, surface transitions and sidewalks, account for a large proportion of these accidents. As a result, wheelchair stability has emerged as a major research issue with regards to user safety.

The majority of research to date in this area has focused on static analysis, largely with

respect to manual chairs. The study of power wheelchair dynamics has been limited to empirical testing of existing chairs against dynamic standards. In order to understand and predict dynamic behaviour from an analytical or design point of view, computer modeling is necessary.

Dynamic simulation using computer models offers tremendous advantages to the typical prototype development cycle, including optimization of design parameters, visualization of complex motions, and simulation of dangerous conditions without any danger to test subjects or equipment. This paper presents a suggested protocol for validation of 2D computer models used in predicting power wheelchair dynamic behaviour, and is based on validation studies of prototype models currently underway at the Centre for Studies in Aging.

STATEMENT of the PROBLEM

The temptation to rely on simulation results and/or safety limits without sufficient validation of a model may lead to incorrect predictions and/or faulty design. It is therefore imperative for the power wheelchair designer to establish a set of minimum criteria by which model predictions may be verified against observed experimental data for that specific wheelchair prototype. Once a certain level of confidence in the model has been established, the designer may then proceed to implement design changes based largely on those predictions.

APPROACH

An adequate dynamic model for power wheelchairs typically requires many inputs, including: mass distributions and moments of inertia (for wheelchair components and human segments); rotational constraints for human joints; tire elasticity and coefficient of restitution (as a function of tire pressure for pneumatic tires); static and dynamic coefficients of tire friction; motor output profiles; and spring/damper values for suspension elements (including cushioning and buttocks).

Consequently, the model must be validated under various conditions. Two such sets of test scenarios are presented and described below in Table 1. The initial round (static tests) ensures proper mass distributions and allows for fine-tuning of the centre of gravity position. The final round (dynamic tests) verifies that all other simulation inputs (spring/dampers, moments of inertia, motor output etc.) have been modeled appropriately to yield accurate dynamic predictions.

Table 1. Suggested static and dynamic test protocol for 2D validation of power wheelchair model

Test Description	Data to Record	Apparatus	Additional Notes
STATIC			
Weight distribution (level ground)	load at each wheel	force plate or recessed scale	test with & without occupant
Forward stability (downhill ramp)	uphill wheel liftoff angle, imminent tipping angle (ANSI/RESNA WC01)	platform & hoist	occupied case only; test with seat upright & full back
Rear stability (uphill ramp)	"	"	"
DYNAMIC			
Speed control (level ground)	average velocity at full & half speed settings	stopwatch & 5 m (16.5') track	to match speeds for collision testing
Forward Collisions* (level ground)	{x(t), y(t), y' max, y'' max} for each axle and centre of head	motion analysis system (PEAK etc.) or accelerometers**	test with full & under-inflated tires at full & half speed

* 3.8cm (1.5") high half round bump recommended
 ** must be able to measure up to 20 Hz vibrations

Since upper body control is required during these tests, the use of a live test subject is recommended over that of an ANSI test dummy. For static stability tests, tipping should be controlled, while for collision tests, obstacle height and/or speed should be kept well within safe conditions. The two sets of experiments should be conducted within a few days of each other to keep changes in subject mass below 2%. Before each set of experiments, the seating and footrest angles should be recorded, as well as the tire pressure (for pneumatic tires). Additional recommended test conditions are included in Table 1.

Regardless of the particular test conditions selected, the crucial element is to maintain congruence between the experiments and the simulation. The purpose of these tests is to validate the response of the model chair under known conditions, not to determine the safety limits of the chair.

Once the data have been analyzed and compared qualitatively to the final model simulation for each test scenario (keeping all model parameter constant during those simulations), a quantitative evaluation follows.

IMPLICATIONS

For the static tests, where centre of gravity location and stability angles are determined, it is possible to achieve as little as a ±5% difference between theoretical and experimental data. For the dynamic tests, differences of up to ±20% in vertical displacement, peak velocity and peak acceleration can be expected, even in refined wheelchair models. Judgment and caution must be exercised when using dynamic safety limit predictions even when there is good agreement between experimental and theoretical data, due

WHEELCHAIR MODELING

to unanticipated non-linear effects in the wheels, springs, and/or user near the instability point.

DISCUSSION

This study focused on 2D fore-aft static and dynamic stability for power wheelchairs. The approach developed is equally valid for all wheelchairs, regardless of configuration (e.g. manual or power, rear or front wheel drive, number and position of wheels and anti-tippers etc.). Similar test procedures can easily be developed to include lateral stability for multi-directional chairs and 3D models for analyzing cornering.

Using the above approach, a 2D validation study of a modeled centre-drive prototype wheelchair is currently being conducted by the authors using Working Model 2D dynamic software (v.4.0, *Knowledge Revolution, San Mateo, CA*) and the PEAK5 motion measurement system (*Peak Performance Technologies Inc., Englewood, CO*). To date, the study has yielded static predictions within $\pm 10\%$ of the observed data and reasonable dynamic predictions with quantitative comparisons forthcoming.

REFERENCES

"ANSI/RESNA Wheelchair Standards: Sample Evaluation and Guide to Interpreting Test Data for Prescribing Power Wheelchairs", Health Devices-NIH Publication, 22, 10:432-484, 1993.

Calder C.J., Kirby R.L. "Fatal wheelchair-related accidents in the United States", *Am J Phys Rehab*, 69:184-190, 1990.

Kirby R.L., Ackroyd-Stolarz S.A. "Wheelchair safety - adverse reports to the United States Food and Drug Administration", *Am J Phys Rehab*, 74:308-312, 1995.

Unmat S., Kirby R.L. "Nonfatal wheelchair-related accidents reported to the National Electronic Injury Surveillance System", *Am J Phys Rehab*, 73:163-167, 1994.

ACKNOWLEDGEMENTS

Funding for this research was provided by the Ontario Rehabilitation Technology Consortium (O.R.T.C.).

Jason A. Young
Centre for Studies in Aging
Sunnybrook Health Science Centre
2075 Bayview Ave.
Toronto, Ont.
M4N 3M5
csia@srcl.sunnybrook.utoronto.ca

COMPUTERIZED TRACKING USING FORCE- AND POSITION-SENSING JOYSTICKS

Daniel K. Jones^{1,2,4}, Steven Albright^{2,4}, Rory A. Cooper^{1,4}, Michael L. Boninger^{1,4}

HUMAN ENGINEERING RESEARCH LABORATORIES

¹Division of Physical Medicine and Rehabilitation, Department of Orthopaedic Surgery,
University of Pittsburgh Medical Center

²Department of Rehabilitation Science and Technology, University of Pittsburgh

³Bioengineering Program, University of Pittsburgh

⁴Veterans Affairs Pittsburgh Healthcare System
Pittsburgh, PA, USA

ABSTRACT

A computerized tracking system was developed to evaluate the use of devices for power wheelchair (PWC) control. A clinical study was conducted to compare a new, force-sensing joystick (FSJ) to a conventional, position-sensing joystick (PSJ). The manual performance of each joystick was measured for five inexperienced PWC users and five regular PWC users who have quadruplegia.

Subjects used a stationary PWC on a wheelchair dynamometer. Operating the PWC with each joystick, the subjects followed two-dimensional tracks displayed on a computer monitor. A moving icon displayed virtual motions of the PWC. The root mean square error (rmse) was computed as subjects followed a series of tracks.

A paired t-test ($p < .05$) showed no significant differences in the rmse between the two joysticks. Each subject demonstrated acceptable, comparable tracking performance using each joystick.

BACKGROUND

Joysticks provide two-dimensional, proportional signals that are well-suited for PWC control. The user pushes forward and backward to control speed, left and right to steer.

Conventional PSJs provide access to PWCs for many individuals,¹ but some people do not have the motor skills required to use PSJs. A

FSJ may provide a proportional-control alternative for people who cannot use PSJs.

The FSJ is a rigid, zero-throw device that measures the forces applied by the user. Previous investigators^{2,3} have evaluated FSJs for computer access, but little work has been done on the use of force sensors for driving PWCs.

Our lab has built a custom force-sensing joystick based on strain-gage technology.⁴ Prototype electronic circuitry translates the applied forces into conventional joystick signals. Because the FSJ is a new access device, there is a need to safely determine if a person can use a FSJ for PWC control prior to real-world driving.

OBJECTIVE

The objective was to determine if a person could safely use the FSJ to drive a PWC. To ensure that a person has sufficient motor skills to use the FSJ, we were interested in measuring the tracking performance, using a conventional joystick (Flight Link Controls) as a benchmark.

A broader goal was to develop a tool for assessment and training of new PWC access devices.

METHODS

Subjects

Five inexperienced PWC users and five subjects with quadruplegia gave informed consent to participate in the study. The

inexperienced PWC users served as a control group.

The subjects with quadraplegia, aged 32 to 50, had spinal cord injury or dysfunction at level C4-C6. Each used a PWC as their primary means of mobility, using a PSJ by hand.

Equipment

Each subject used a Quickie P300 power wheelchair, which was secured to a wheelchair dynamometer.⁵ Figure 1 shows the tracking system during a clinical test. The PWC was operated using the prototype FSJ and a standard PSJ. Each joystick had a similar housing and handle, and each joystick was mounted in a position preferred by the subject.

Software for this study was written in Borland C++. A PC recorded the speed of each wheel, computed the virtual position and

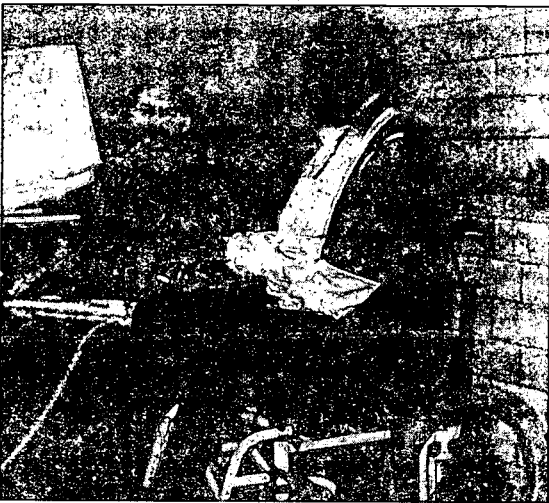

Figure 1. Computerized tracking on the wheelchair dynamometer.

orientation of the P300, and displayed an icon depicting virtual wheelchair motions in two dimensions.

Protocol

One of the joysticks was randomly selected to start. Each subject was asked to trace a 12 cm by 12 cm square track which was displayed

on a computer monitor, representing 6 m by 6m in real dimensions. Subjects traversed the square 3 times in the clockwise and counterclockwise directions. The protocol was repeated for the other joystick.

Analysis

Tracking errors were found by measuring the distances between the track and the virtual positions of the PWC. To measure the performance of each joystick, the root mean square error (rmse) was computed for each trial. For each subject, the average rmse was computed for three trials in both the clockwise and counterclockwise directions.

Acceptable performance was defined as having a rmse less than 58 cm, the width of the wheelchair. In addition, the maximum deviation should be less than two wheelchair widths.

RESULTS

All subjects used conventional handles except for one subject with quadraplegia. He could not use the knob handle, and so he used his own, T-shaped handle on each joystick.

Results are presented in Table 1 for each joystick. Subjects 1-5 were inexperienced PWC user, and subjects 6-10 had quadraplegia. A two-tailed, paired t-test ($p < 0.05$) indicated no significant difference between the two joysticks for the group. The average rmse was virtually the same for both joysticks.

The final column in Table 1 lists the joystick with the lowest rmse for each subject. Four of the subjects performed better with the FSJ than with the PSJ.

DISCUSSION

All subjects exceeded the performance criteria, indicating that it may be safe to proceed to a test driving course. The results show that the tracking performance of the FSJ was comparable to the PSJ.

In general, the inexperienced PWC users performed better than the subjects with

COMPUTERIZED JOYSTICK TRACKING

quadraplegia. However, the performance of subjects with quadraplegia was acceptable despite the fact that they were not using their personal PWC. Also, the seating system and joystick were different from those customarily used by each subject.

Table 1. Root mean square error during computerized tracking.

Subject	rmse (cm) for FSJ	rmse (cm) for PSJ	low rmse
1	17.1	10.6	PSJ
2	21.4	17.8	PSJ
3	30.2	40.4	FSJ
4	25.2	26.8	FSJ
5	14.7	10.2	PSJ
Avg of 1-5, \pm SD	21.7 \pm 6.2	21.2 \pm 12.7	
6	12.3	14.9	FSJ
7	34.3	31.1	PSJ
8	48.4	40.3	PSJ
9	35.2	29.1	PSJ
10	26.5	41.0	FSJ
Avg of 6-10, \pm SD	31.3 \pm 13.2	31.3 \pm 10.6	
overall avg \pm SD	26.5 \pm 11.0	26.2 \pm 12.2	

This study had some limitations. Because tests were conducted on a dynamometer, subjects did not move as they followed the paths on the computer screen. Several subjects indicated that they thought they would have performed better with a different joystick handle or with a different seating system. Nevertheless, each subject performed the same tracking tasks using each joystick on the same PWC and seating system.

These findings warrant further investigation of force sensors for PWC control. The FSJ

shows potential for proportional control of PWCs, especially for people who are unable to use PSJs. Further clinical studies are planned to measure the real driving performance of each joystick. A correlation of performance in computerized tracking and real driving will provide insight into the value of computerized tracking to assess new access devices.

REFERENCES

- [1] Cooper, R, "Rehabilitation Engineering Applied to Mobility and Manipulation," Institute of Physics Publishing, 1996.
- [2] Kondraske G, et al., A Computer-Based System for Automated Quantitation of Neurologic Function, *IEEE Transactions on Biomedical Engineering*, Vol. BME-31, No. 5, May 1984.
- [3] Rao S, et al., Evaluation of an Isometric Joystick as an Interface Device for Children with CP, *RESNA Annual Conference*, 1997.
- [4] Widman L, et al., Evaluation of an Isometric Joystick for Power Wheelchair Control, *RESNA Annual Conference*, 1993.
- [5] Shimada S, et al., Computer controlled wheelchair dynamometer, *IEEE/EMBS 17th Annual Conference*, 1995.

ACKNOWLEDGEMENTS

This work is supported by Grant #1738 from the Paralyzed Veterans of America Spinal Cord Research Foundation.

Daniel K. Jones, Ph.D., P.E.
Human Engineering Research Laboratories
VA Medical Center, 151R-1
7180 Highland Drive
Pittsburgh, PA 15206
(412)365-4828, FAX (412)365-4858
dkjones@pitt.edu

SEATING AND MOBILITY FOR A SPINAL MUSCULAR ATROPHY TEENAGER: A HONG KONG EXPERIENCE

Sandra Shum¹, Eric Tam², Victoria Leung¹, Simon Wong¹, Bill Cheng¹ and Jack Cheng³

¹Seating Clinic, Prince of Wales Hospital, Hong Kong

²Jockey Club Rehabilitation Engineering Centre, The Hong Kong Polytechnic University

³Department of Orthopaedics and Traumatology, The Chinese University of Hong Kong

ABSTRACT

Spinal muscular atrophy (SMA) children usually presents problems with decreased mobility and progressive spinal deformities. During adolescence, their seating and mobility problems are often complicated with obesity and their rapid body growth. This paper presents our experience in providing a 13-years-old SMA teenager with a low cost custom contoured seating system which aims to provide comfort and support to his body, and to maintain his independence in maneuvering his manual wheelchair.

INTRODUCTION

This 13 years old teenager was referred to the seating clinic presenting a kypho-scoliotic posture in a out-grown manual wheelchair. Mat assessment revealed an increased lumbar lordosis with the pelvis slightly side-tilted and rotated to the right in supine lying. In addition, a 20° right hip abduction was also observed. His pelvis was still mobile but already limited in some dimensions. This patient can barely maintain a hand-free sitting posture and has developed bilateral knee flexion contracture. His kyphosis was exaggerated in sitting with a prominent right thoraco-lumbar hump. During sitting, he weight-bearred on his right ischial tuberosity. It was found that his upper limb muscle power was grade 3 in proximal group and grade 4 in distal group. Figure 1a and b shows the patients posture during sitting.

Functionally, the patient was independent in self-care, including bed-to-chair transfer and can maneuver his wheelchair effectively on level ground and gentle slopes. The patient attended a residential school which was totally wheelchair accessible. However, the home environment for this patient was relatively limited, and the use of power mobility was not feasible. Psychologically, this patient did not like to seek help from others and would like to be as independent as possible.

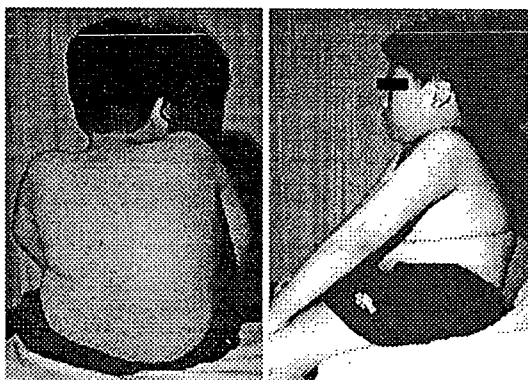

Figure 1a. Posterior view of patient in sitting

Figure 1b. Side view of patient in sitting

OBJECTIVES

The seating and mobility goals for this patient are to provide a seating system which can provide proper support to prevent or delay further deterioration of the 3-dimensionally deformed spine, and to preserve the functional independence of the patient, especially the ability for manual wheelchair maneuvering.

APPROACH

In order to provide adequate support for the kypho-scoliotic spine, three intervention options have been considered. This included the use of a spinal brace, the use of a three point supporting system which utilize one lateral pelvic support and two curved trunk supports, and the application of a total custom contoured body support. The advantage of using a brace is that the spinal deformities can be effectively controlled, but presented two concerns which were not accepted by the patient. These included the inability of self wearing, and the tolerance for long term wearing especially during a hot and humid day. Secondly, due to the obesity of the patient, lateral trunk supports cannot effectively position the body and would cause high localized pressure areas if a three point supporting system was being used. Therefore, our decision was to provide the

patient with a total custom contoured seating system.

METHOD

In view of the fact that the patient was in his adolescence where his body is rapidly growing, we envisage that his seating and mobility system would need to be constantly renewed until he reached skeletal maturity. Fortunately, our clinic has an associated "Wheelchair Bank" which can provide different sizes of mobility bases to accommodate the changing needs of these children on a loan bases. A light weight manual wheelchair was selected for this patient to ease his propulsion and to compensate for the additional weight that will be added by the new seating system.

In view of the funding limitations, the clinic team decided to fabricate the required custom contour body supports through the use of a newly designed "low cost" custom contour cushion fabrication system. A wooden shell was constructed to form the supporting frame of the seating system. The axle plate of the mobility base was reconfigured to create a seat tilting angle of 10° , so that the patient can effectively maintain his upright sitting posture. Velcro straps were then used to affix the seating system onto its mobility base. Finally, the configurations of the wheelchair were fine tuned to optimize the user's propulsion efficiency. Figure 2 shows the outlook of this seating and mobility system. Subsequently, upon the request of the patient, the fixed pommel was modified to become detachable in order to allow ease of toileting.

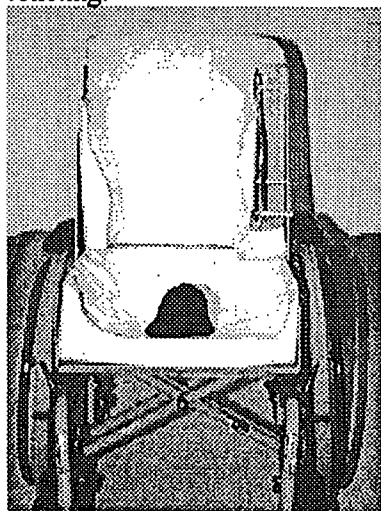

Figure 2. Outlook of the seating and mobility system

RESULTS

A follow-up session was conducted three months after the seating/mobility system was being used. The patient reported that he has adapted to the use of the new system and found that it was more comfortable than his previous wheelchair. He also regained his full independence in meeting his daily need, especially for bed transfer which he has experienced some difficulties during the initial period of using this new system. Further, we have evaluated his wheelchair propulsion ability in an indoor track of 10 meters long. It was found that at the initial use of this new system, his propulsion performance was decreased, but at the follow-up session, he has already regained the performance level as before. Figure 3a and b shows the sitting posture of the patient before and after the intervention.



Figure 3a. Sitting posture before intervention



Figure 3b. Sitting posture after intervention

DISCUSSIONS

Proper seating and positioning for SMA children are important to ensure their quality of life. There is no doubt that with early interventions, body deformities can be prevented or delayed. We have observed severe body deformities in some SMA patients attending our clinic, which greatly affected their cardiac-pulmonary functions. However, we also encountered difficulties in educating the parents to allow early seating and mobility interventions to be conducted when floor mobility became the only mobility function for their child.

Our experience at the seating clinic suggested that the use of spinal brace together with a suitable and correctly configured wheelchair can effectively provide the necessary body support

Seating and Mobility for a SMA teenager

and mobility for the young SMA children. However, for some of the total body involved type, the use of a modular contoured seating system could greatly facilitate care-taking for these children through proper seating.

For this 13-years-old teenager, we have observed that his wheelchair propulsion style involved a lot of trunk movements which brought his body out from the contoured back cushion. Although, he could reposition himself back to the contoured back support, the regained posture may not be optimal. This could lead to further deterioration of his spinal deformities. At present, the provision for using power mobility is still limited by his home environment, intermediate solution(s) to this patient's seating problem remain to be explored.

REFERENCES

1. Tam, E., Cheng, J. and Evans, J. (1997), Seating Children with Neuromuscular Disease - The Hong Kong Perspective, *Proceedings of the Thirteen International Seating Symposium, Pittsburgh, USA*, pp270-272.

ACKNOWLEDGMENTS

This work is supported by the Cathay Pacific Wheelchair Bank, the Jockey Club Rehabilitation Engineering Centre, the Hong Kong Polytechnic University and the Department of Orthopaedics and Traumatology, the Chinese University of Hong Kong.

Sandra Shum, PT
Seating Clinic
Prince of Wales Hospital
Shatin, New Territories
Hong Kong
Tel: 852-2632-3231
Fax: 852-2648-4230

DEVELOPMENT OF A SIMULATOR OF POWERED WHEELCHAIR

Takenobu INOUE*,M.S., Hideyuki HIROSE*,M.S.,PT, Yasuo SUDOH*,M.S.,
Kazunori HASE**,Ph.D.

*Research Institute, National Rehabilitation Center for the Disabled, Tokorozawa, Saitama, JAPAN

**National Institute of Bioscience and Human-Technology, Tsukuba, Ibaraki, JAPAN

ABSTRACT

This paper describes development of a simulator for powered wheelchair adaptation. This simulator has two screens and a moving platform. Computer graphics is displayed on the screens according to the operation of a driver. In addition, the moving platform generates realistic accelerations. This paper reports the results of an evaluation involving thirteen subjects. It was obvious that drivers of the simulator had virtual experiences that were similar in many ways to driving a powered wheelchair. However, three problems were identified. They were a tendency to motion sickness, absence of a side view and an unrealistic response of the joystick.

BACKGROUND

Independent mobility is an important factor in determining the quality of life. We gather information from each sense organ. However, if we can't move anywhere, the variety of this information is limited. If somebody pushes us in a manual wheelchair, we are less able to respond to sensory input and satisfy our curiosity. Independent mobility promotes a richer experience.

The powered wheelchair is a significant device for people with severe disabilities to ensure independent mobility. Recently, many kinds of input devices and programmable controllers have become available for powered wheelchairs.

Habasevich et al provided a powered wheelchair to 1-year old child based on the concept of "Interactive Shared Reality" [1]. Using such sophisticated devices offers disabled children the capability to start moving at a similar age to able-bodied children.

STATEMENT of the PROBLEM

The adaptation of wheelchairs to people with severe disabilities is very difficult and takes long time because many trials are needed. Inoue et al developed a head controlled powered wheelchair for a severely disabled child with cerebral palsy [2]. They identified suitable parameters for the child by measuring her head movement. However, to measure movement of severely disabled people during actual driving of a wheelchair is difficult. Additionally, there is a problem of safety.

RATIONALE

It is anticipated that a simulator would be very helpful when adapting a powered wheelchair to a severely disabled person. It would be easy to gather data safely.

Stredney et al developed a powered wheelchair simulator that consisted of a computer graphics in a workstation [3]. However, this device did not simulate the accelerations experienced when driving a real chair. The more severely disabled a person is, the more accelerations may confound the ability to control the chair.

DESIGN and DEVELOPMENT

The objective to design a simulator of powered wheelchair was to enforce an operator to make a virtual experience of driving a powered wheelchair.

Fig. 1 is a concept diagram of this system. Two computer screens, a chair, some switches and some measurement devices are on a moving platform. The platform is connected six servo linear actuators that work by electric power. Electric actuators were selected over hydraulic ones for ease of maintenance. The moving platform generates similar accelerations to real powered wheelchair. The upper computer screen shows forward scenes and the lower screen shows ground surface features. A Recaro Medical Seat is set on the moving platform. It ensures a stable sitting posture and also reclines. The moving platform and the computer graphics are controlled by a special computer. Experimenter operates this system from an operator's desk. Emergency switches are located at the operator's station and on the platform close to the driver.

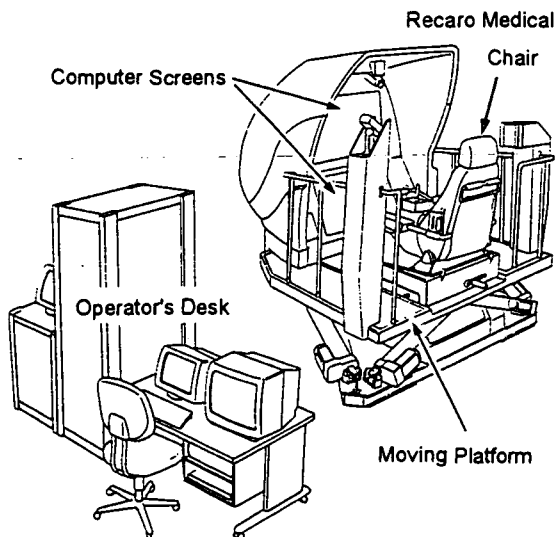

Fig. 1 The simulator of powered wheelchair.

This system has a mathematical model of a powered wheelchair in the computer. Since it is driven by torque of right and left driving wheels, it gets slower on an uphill slope and faster on a downhill slope. The model also turns downhill on a cross slope. Accelerations, decelerations, impacts of collisions and climbing curbs, maximum speed and maximum turning speed can be changed on the operating software.

A virtual driving course is prepared in the computer program. It has several situation as follows: figure 'S' road, crankshaft-shaped road, traffic signs, rail road crossing, pathway which has curb from a roadway, roadway with a cross slope, rough surface with bricks, 3 degree, 5 degree, 8 degree and 10 degree slope and a 5 degree cross slope. Some pedestrians and some bicycles come up on some pathways.

This system has three modes for driving: free driving mode, scenario mode and demonstration mode. In the scenario mode, arrows and audio indicate the next way to go. The complete scenario takes about 7 minutes. The demonstration mode automatically takes a driver on a pre-defined route.

EVALUATION

Thirteen subjects drove the simulator. Eight of them were experienced powered wheelchair drivers including six physiotherapists. Subjects who lacked experience driving powered wheelchairs were given the opportunity to drive a powered wheelchair before using the simulator. After driving the simulator, the subjects completed a questionnaire.

Seven subjects complained of motion sickness including two who experience severe sickness. Twelve subjects stated that it was much more difficult or more difficult to operate the simulator than to drive a real powered wheelchair. Two reasons for this added difficulty were noted by the subjects. One was a

lack of both side views, which was identified by twelve subjects. They complained that they couldn't determine where they should turn. The other cause was an unrealistic response of the joystick. Four subjects complained that the wheelchair sometimes went in different directions than they intended.

DISCUSSION

From the evaluation, three big problems were described, motion sickness, lack of side view and poor response of the joystick.

Motion sickness is caused by a complicated mechanism. Generally, difference between visual perception and equilibrium perception is said to be the primary contributing factor. Some subjects observed that the quick motion of the computer graphics when turning made them sick. More study of this problem is needed.

This system was not equipped with side screens because of a limitation of space. The low screen was expected to help a driver to realize when he/she should make a turn because it shows guide lines drawn on the road. With more practice a driver might be able to start turning at the exact point. However, driving this simulator feels different from driving real powered wheelchairs because of a lack of a side view.

The problem of the inappropriate response of joystick was due to inadequacies in the computer model of the castor wheels. Some modifications are needed.

The evaluation of this system was pointed out some problems. Some modifications will be done to solve these problems. In addition, an efficacy of this system will be identified through an adaptation of a powered wheelchair to a person with severe disability.

REFERENCES

1. Habasevich JR & Waldera KE, (1997). A developmental approach to functional positioning for young children. Proceedings of the RESNA '97 Annual Conference, 163-165.
2. Inoue T, Hirose H & Sudoh Y, (1994). Development of a head-controlled electric powered wheelchair for a person with cerebral palsy. Biomechanism, 12,303-314. (*in Japanese*)
3. Stredney D, Yagel R, Carlson W, Moeller T, Shih PW & Fontana M, (1997). Assessing user proficiency through virtual simulations. Proceedings of the RESNA '97 Annual Conference, 366-368

ACKNOWLEDGEMENTS

This simulator was produced by Mitsubishi Precision Co.,Ltd.

Takenobu Inoue
Research Institute, National Rehabilitation
Center for the Disabled
4-1 Namiki, Tokorozawa, Saitama, 359 Japan
Tel. +81-429-95-3100 Fax. +81-429-95-3132
e-mail: inoue@rehab.go.jp

A LOW COST CONTOUR COPIER FOR CUSTOM CONTOUR CUSHION FABRICATION

Eric W.C. Tam and C.F. Tin
Jockey Club Rehabilitation Engineering Centre
The Hong Kong Polytechnic University, Hong Kong

ABSTRACT

A low cost manual contour copier has been developed for the fabrication of custom contoured cushions in clinical settings. The copier utilizes a mechanical tracer to transfer the shaped contour from a vacuum consolidated bead bag onto a foam block using a standard trimmer. The time required for producing a contoured cushion is approximately 90 minutes. The operation of the system can be performed by most people with safety precautions. This paper presents the design and evaluation results of this machine.

INTRODUCTION

The importance of providing custom contour supports for individuals with severely physical deformities to increase comfort and improve their functional activities is well recognized. Over the years, rehabilitation professionals have developed different techniques to capture the shape of the body contour and duplicate its profile onto the supporting media. Among those, the use of vacuum consolidated bead bag for capturing the body contour; plaster impression to create the contoured mould and the use of "foam-in-place" to produce the required support were the most commonly used techniques adopted by seating clinics. With the advancement of CAD-CAM technology in the past decade, a number of dedicated equipment have been developed to fabricate custom contour seats in an effective manner. However, these dedicated CAD-CAM equipment were very expensive and in particular, the operation and maintenance of the CAM system would require a higher trained personnel to support. As a result, only the CAD system can be made available in the clinical setting, whereas the CAM system would need to be centrally located at the manufacturer's facility. Although this arrangement can help to maximize the utilization of the CAM facility and reduce the unit cost for each custom contour support, the delivery time would be comparatively longer. In addition, with such a remote production facility,

any on-site modification which is commonly required during fitting would become difficult.

OBJECTIVES

In clinical practice, children with neuromuscular diseases often require custom contour supports for proper positioning. During adolescence, body growth is rapidly changing. In order to prevent any further body deformities, seating intervention has to be provided within very short time after assessment. Although CAD-CAM seating has great potential in meeting the demand, the extended delivery time and the comparative expensive associated costs have limited its application for this particular group of patients. In view of this situation, the objective of this work is to design a "low cost" foam cushion fabrication system which can produce a custom contour cushion in within hours at the clinical setting.

DESIGN

Since the vacuum consolidated bead bag technique is the most commonly used clinical procedure for capturing body contour, our aim is to design an equipment which can directly carve out the identical contoured body support from a standard foam block. The design of this equipment is based on the concept of a "sign engraver", where on one side the contour bead bag is being traced with a tracer; on the other side, the foam block will be carved by a trimmer to form the exact contour. Figure 1 shows the outlook of this manual contour copier.

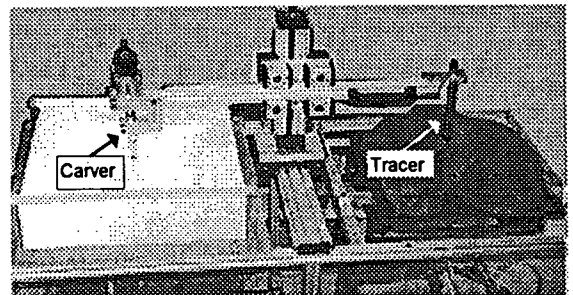

Figure1. The manual contour copier

108

The configuration of the contour copier consisted of a mobile base made with standard high density extruded aluminum profiles and a three-axis tracing/carving unit constructed with a manual driving ball screw unit and two roller guided sliding units. The tracer and the carving unit were mounted at each end of the longitudinal sliding element. The maximum stroke for the ball screw unit which controls the vertical movement of the tracing/carving unit is 125mm with 5mm increment. The longitudinal and cross movement for the tracing/carving unit is 523.5x523.5 mm. This would allow carving of a 508x508x127 (LxWxH) mm foam block. The carver is constructed with a standard trimmer (30,000 rpm) using a 1 inch carbide tipped trimmer bit with half round grooving as the carving head. Also the trimmer was modified to allow a cutting depth up to 127 mm. The tracer was constructed with a 25.4 mm diameter plastic ball knob fitted to allow rotation along its vertical axis. The cutting speed is set at 16,000 rpm and can be adjusted with a voltage controller. The on/off control of the carver is through a foot switch.

EVALUATIONS

In order to assess the performance, we have evaluated the crafting performance of the system. Three curve templates were created with arbitrary contours and their associated foam copies were fabricated using the new contour copier. In order to compare and evaluate the morphology of these foam copies, the contour of the templates were quantified using a linearly variable differential transformer (LVDT) digitizer at 10mm intervals. These information were then compared with the results obtained from the foam copies. The results were shown in Figure 2. The mean errors for the 3 curves are 4.81 ± 2.26 mm, 3.35 ± 2.76 mm and 3.12 ± 5.12 mm. In addition, we have also assessed the 3-D grafting performance of the system using a headrest as a standard. Figure 3 shows the outcome of the foam copy and its associated mesh reconstruction.

In order to evaluate the effectiveness of the system used in clinical situations, physiotherapists, occupational therapists and prosthetists and orthotists have been asked to operate the contour copier. It was revealed that even with only minimal instruction, all of them

can fabricate a contoured cushion by themselves in 90 minutes.

Comparison Between the Shape of Template 1 and the Shaped of the Foam Reproduced Using the Contour Copier

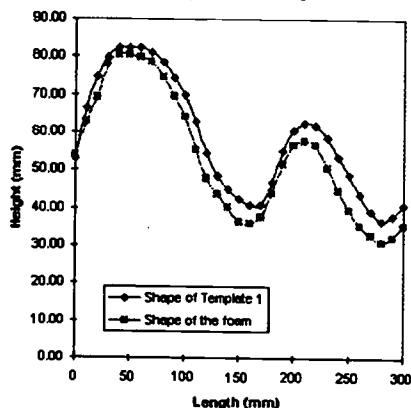

Comparison Between the Shape of Template 2 and the Shaped of the Foam Reproduced Using the Contour Copier

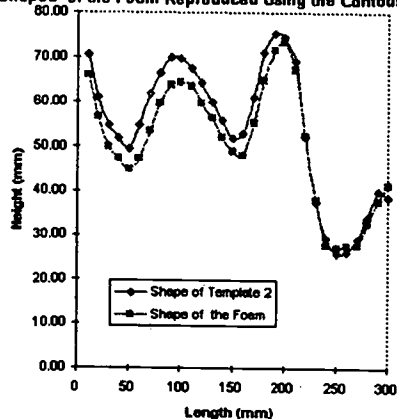

Comparison Between the Shape of Template 3 and the Shaped of the Foam Reproduced Using the Contour Copier

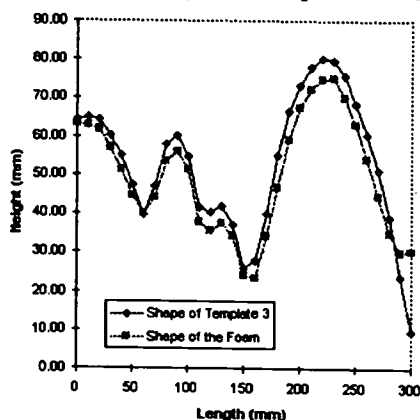

Figure 2. Shape comparison between curved templates and the associated foam copies

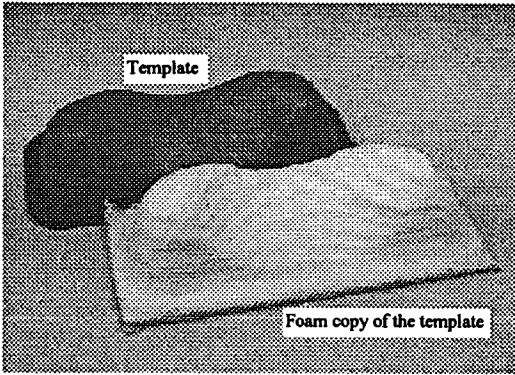

Figure 3a. Outlook of the headrest (Template vs. Foam Copy)

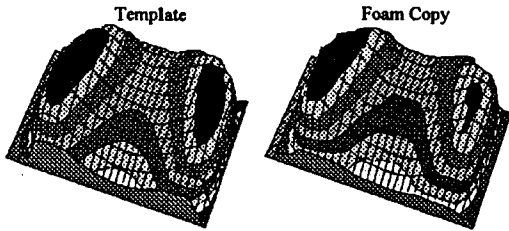

Figure 3b. 3-D mesh representations of the headrest

ACKNOWLEDGMENTS

This work is supported by the Royal Hong Kong Jockey Club (Charitable) Ltd. and the Hong Kong Polytechnic University.

Eric W.C. Tam
 Rehabilitation Engineering Centre
 The Hong Kong Polytechnic University
 Hunghom, Kowloon
 Hong Kong
 Email: RCERIC@PolyU.EDU.HK

DISCUSSIONS

The performance of the manual contour copier was proven to be effective in meeting the need for rapid fabrication of custom contour cushions during clinical sessions. The reproducibility of the contoured shape was acceptable, but limited by the size of the cutting head and the dexterity in controlling the tracer as it moves along the shaped contour surface of the vacuum consolidated bead bag. The capability of performing a direct shape transfer has greatly reduced the cost and time required for obtaining the necessary plaster cast and reduced the fabrication time from a few days to approximately 90 minutes. This improvement has allowed fitting and modification to be performed in one single clinic session. As compared to the modern CAD-CAM systems, this copier is more economical which only costs USD 5,000. Since the operation of the system is relatively simple, most people can participate in the cushion fabrication process. However, there are still limitations to the present design, including the capability for handling any possible "under-cuts" which may occasionally encountered in some body contours, the required fabrication time and a record of the three dimensional coordinates of the body contours.

REHABILITATION TECHNOLOGY AS ART: THE EFFECT OF AESTHETICS ON CONSUMER ACCEPTANCE

Alan J. Harp, Industrial Designer
Julius T. Corkran, Industrial Designer
Center for Rehabilitation Technology
Georgia Institute of Technology
Atlanta, Georgia

ABSTRACT

Rehabilitation Technology as art is an idea that is finally beginning to become prevalent in today's marketplace. For too long, assistive technology has been developed as an afterthought with no consideration to the aesthetic of the end result. The poorly designed product is rarely used nor accepted by the general public. The stigma of rehabilitation technology products will remain until the designers and engineers realize the ultimate importance of the art of the product. To illustrate that point, a product to product comparison will be drawn between a rehabilitation product and a typical consumer product.

BACKGROUND

Beginning at the 1939 World's Fair in Queens, New York, the public was introduced to the profession of Industrial Design. Industrial Design represents the ability to create products that will function well and be admired for their appearance. Norman Bel Geddes, Raymond Loewy, Walter Dorwin Teague, and Henry Dreyfuss brought the aesthetic to the industrial age while creating a new methodology for product design. No longer could a product merely perform a function, it must also be appealing to the eye. Ever since those days in 1939, this ideology has been taken to heart by the consumer public. It is now expected, even demanded, that the products we use be attractive as well as functional.

STATEMENT OF PROBLEM

Throughout the history of rehabilitation technology, very little thought has typically been given to the product's aesthetic. Too often, the solution to an assistive technology problem is treated as a Band-Aid or patch instead of a whole product. The functionally driven nature of this type of solution will typically perform well as designed, but will fail in the long run. When the end user is dissatisfied or even embarrassed by the look of the product, it will soon be relegated to the closet or the trash. Never will it be viewed as a product for general consumption. Frequently, the product is cumbersome, heavy, and unattractive, such as the standard hospital wheelchair. (Figure 1) Hence, it is looked upon as a simple utilitarian product which would only be used if required by circumstance.

Figure 1.

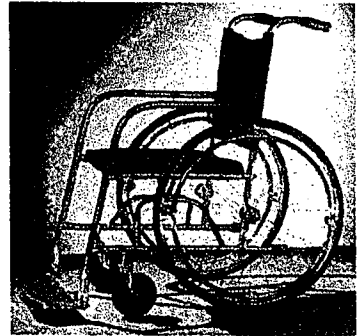

Likewise, the common passenger van of a decade ago had always been viewed by the consumer market as overtly practical and unappealing for personal use. One would only drive such a vehicle if moving, making

deliveries, or if required for wheelchair accessibility. (Figure 2)

Figure 2.

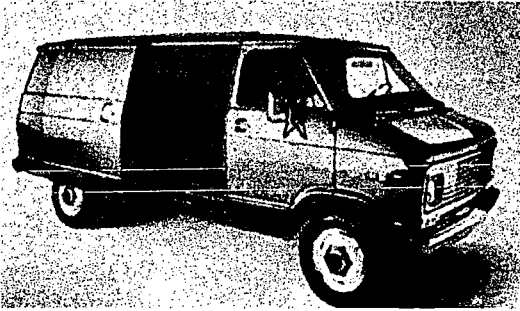

APPROACH

In recent years the market competition for wheelchairs has exploded as companies have finally begun to realize the importance of the aesthetic of design. Wheelchairs have become lightweight, colorful and sporty. (Figure 3) Consumers now have a voice in the style, function, price point and even color choice of their chair.

Figure 3.

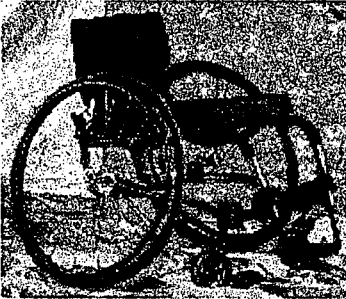

Similarly, automotive designers began to see the need for a van acceptable to a broader spectrum of the population. The minivan achieved this result as the aesthetic became more pleasing. (Figure 4) Just as with the wheelchair, vans are now available with many options in color, style, price point and function.

Figure 4.



Both of these products had remained stagnant in their respective design philosophies for years leading to a pervasive perception by the public. Both were viewed as basic, uninteresting products used only out of necessity.

IMPLICATIONS

As the aesthetic of the wheelchair became more pleasing, users have become more active in society. This was displayed in grand manner at the 1996 Paralympic Games in Atlanta. Thousands of spectators paid to watch hundreds of athletes in wheelchairs participate in races and other sporting events. This type of exposure to wheelchairs will have a long lasting effect on the design and acceptance of these products.

The visual quality of the wheelchairs in an event such as the Paralympics had the general public admiring the athlete as well as the chair. It was common to hear spectators comment on stylish look of a racing wheelchair. (Figure 5) This would be unheard of if the athletes had still been using the standard chrome hospital chairs.

Figure 5.

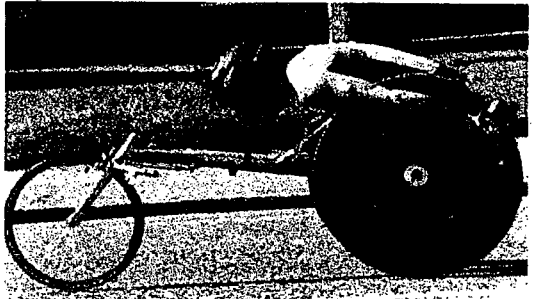

REHAB. TECH. AS ART

The minivan has become one of the top selling vehicles in the automotive market today. It is no longer looked upon as simply a delivery vehicle or work truck, but rather the desired family vehicle. This would never have happened had the designers continued to ignore the needs and desires of the consumer. People have families and possessions to transport, and they want to do it in comfort and style.

DISCUSSION

Curiously, the evolution of the wheelchair and van follow each other closely. The van has always been the vehicle of choice for wheelchair users due to its commodious nature. This pragmatic combination has only helped to accentuate the perception of both products.

As both products have become more aesthetically pleasing and desirable for their given functions; neither retain the same stigma suffered in the past. When the public views a van today, it no longer sees the utility box on wheels, but rather a vehicle found in their own driveway. Similarly, the wheelchair has become a product known for its sports prowess and attractiveness. It is now a product that, due to its aesthetic, no longer generates anxiety in the general public.

As new products are developed for the rehabilitation technology market, the designers must remember the perceptions of the public. If a product is unattractive, it will not be used to its fullest as compared to a functionally comparable product that is visually desirable.

REFERENCES

1. Papanek V, (1972). *Design for the Real World*. New York: Pantheon Books.

2. Pirkl J, (1988). *Guidelines and Strategies for Designing Transgenerational Products: A Resource Manual for Industrial Design Professionals*. Littleton, MA: Copley Publishing Group.

3. Lucie-Smith E, (1983). *A History of Industrial Design*. New York: Van Nostrand Reinhold.

4. Pulos A, (1988). *The American Design Adventure*. Cambridge, MA: The MIT Press.

ACKNOWLEDGMENTS

The Center for Rehabilitation Technology Design Group would like to thank its many clients for their enthusiasm, cooperation, input of ideas and patience while participating in the design of products for their use.

Alan Harp, Industrial Designer
alan.harp@arch.gatech.edu

Julius T. Corkran, Industrial Designer
danny.corkran@arch.gatech.edu

Center for Rehabilitation Technology
Georgia Institute of Technology
490 10th Street
Atlanta, Georgia 30318
(404)-894-4960
(404)-894-9320 FAX

SELECTING A RURAL OUTDOOR MOBILITY DEVICE

Rory A. Cooper, Ph.D. and Rosemarie Cooper, B.S.
Departments of Rehabilitation Science and Technology, and Physical Therapy
University of Pittsburgh, Pittsburgh, PA, 15261

Abstract

The goal of this study was to select a mobility device suitable for use in a rural home environment. The objective was to find an appropriate device to allow a person with paraplegia to have greater independence when performing tasks around a small horse ranch. Manual wheelchairs, electric powered wheelchairs, and all terrain vehicles were reviewed and tried. A Polaris Xplorer was selected.

INTRODUCTION

People with disabilities live in a variety of environments (e.g., rural, urban, suburban) and different climate regions (e.g., temperate, desert). The mobility needs of people are influenced by their living conditions. This effects the choice of wheelchair and other assistive devices. This study was motivated by the desire to identify a mobility device that would be useable by a person with paraplegia. The device was to be used to provide outdoor mobility in unstructured environments (e.g., horse trails, fire trails), and be suitable for performing outdoor chores (lawn mowing, snow removal). (1), (2)

It is important for people with disabilities to have choices when selecting living environments. Moreover, the ability to return home and resume activities of daily living that are similar to those pursued prior to disability are important for a person's well being. Some people with disabilities are also choosing to try living in more rural environments.

Research Question Identify or design a vehicle that could be used to provide outdoor mobility in unstructured environments. The vehicle must be safe and effective for people with paraplegia. The vehicle was to be used for outdoor

chores in a rural environment (e.g., snow removal, lawn/pasture mowing). It was also desirable to be able to use the vehicle for riding on and grooming horse trails.

METHODS

The methods consisted of four parts:

- (1) Survey of manual and electric powered wheelchair products that provide outdoor mobility in unstructured environments.
- (2) Survey of all terrain vehicles for accessibility to people with paraplegia.
- (3) Survey of accessories for both the wheelchairs and all terrain vehicles.
- (4) Purchase of an all terrain vehicle and testing.

While conducting this study, several products were test-driven by the investigators. The test drives were conducted at the RESNA annual conferences in 1996 and 1997, at the 1996 Paralympic Congress, and at the 1997 Reha International Show. Surveys were conducted by collecting product literature provided by the manufacturers. We also reviewed the professional literature including previous RESNA proceedings, and peer-reviewed journals.

The evaluation criteria were:

- (1) Cost
- (2) Durability
- (3) Functions/features
- (4) Accessibility
- (5) Outdoor mobility

Cost was evaluated based upon initial purpose price as well as lifetime maintenance costs. Durability was evaluated based upon ANSI/RESNA test

reports or consumer reports, depending upon the vehicle type. Durability was also evaluated by examining the design and construction of each vehicle. Function was evaluated by test driving the vehicles. The features were evaluated by compiling a list of the accessories and options that are available for each product. Accessibility was determined by ease of transfer, maintenance, and the ability to transport materials/tools. Outdoor mobility was determined by test driving the products, and by evaluating their design characteristics. The wheelchairs and all terrain vehicles evaluated as part of this study are listed in Table 1.

Table 1. Wheelchair and all terrain vehicles evaluated.

Manual Wheelchairs

Iron Horse
Permobil Boing
Kuschall
Cobra

Electric Powered Wheelchairs

Omega Trac
Invacare Storm
Sunrise Medical F55
Boulder
Chasswheel Four X

All Terrain Vehicles

Yamaha Grizzly 4WD
Kawasaki Prairie 400 4x4
Polaris Xplorer

RESULTS

The manual wheelchairs were unable to fulfill several of the key parameters. The manual wheelchairs had the lowest cost, and high durability. The cost for the manual wheelchairs was between \$2,000 to \$3,000. They were moderately accessible. Transfers were typically easy, with the exception of the Cobra. Maintenance demands were low, but there was little ability to transport tools. However, the manual wheelchairs have few features related to the functions desired for this study. The manual wheelchairs also provided low accessibility for unstructured environments. The Cobra provided the

highest accessibility. It is able to traverse reasonably rugged terrain, but it is difficult to propel. It worked best for downhill driving.

The cost of the power wheelchairs was highest among the three categories of products evaluated. The electric powered wheelchairs ranged in price from \$6,000 to \$12,000. There have been tremendous improvements made to outdoor mobility while using electric powered wheelchairs. The Invacare Storm, the Boulder, and the Sunrise F55 performed well on grass, and gravel surfaces. They were also able to climb slopes of about 10 degrees when the driver was able to lean. They are suitable for groomed walking trails. The electric powered wheelchairs were high in accessibility. Transfers were simple. High driver skill was required to operate the Four X. The Omega Trac was the only wheelchair that provided a means of carrying tools, and included a towing package for a small trailer. The Omega Trac and the Four X are able to traverse unfinished terrain of moderate severity (e.g., sand, side slopes, small stones).

The all terrain vehicles (ATV's) provide some unique features for providing outdoor mobility. (3)-(5) They have much more power and are capable of negotiating natural terrain. They also have high range on the order of 100 to 160 kilometers. The cost of ATV's ranges from \$4,000 to \$6,000. This places them between manual and electric powered wheelchairs. The accessibility of ATV's is moderate. They are difficult to mount, but they are well equipped for hauling tools. There also a large number of attachments available (e.g., mower decks, snow blowers, blades, trailers). (6) They can also easily transport a manual wheelchair. ATV's are rugged and can give many hours of operation when properly maintained. The performance and costs of the three ATV's selected for evaluation were similar. The Polaris Xplorer had three distinct advantages for people with paraplegia: all of the controls are hand operated; the engine is water cooled; and it is equipped

Selecting Outdoor Mobility

with an oil heater. These features help to extend vehicle life and provide higher reliability in cold climates.

Based upon this evaluation, the Polaris Xplorer was selected for purchase. The Xplorer was then used in various activities. The Xplorer was suitable for clearing snow, grooming horse trails, moving earth and gravel, and towing items. It also provided a recreational outlet on trail rides.

DISCUSSION

Manual chairs are lowest cost and would be useful for people who wish to stay on groomed trails with an occasional deviation onto natural terrain. Expert wheelchair users can traverse more severe terrain with assistance from people who are unimpaired. The Cobra provided excellent downhill recreational driving off-road.

The Omega Trac and the Four X provide moderate mobility over natural terrain. These electric powered wheelchairs provide a degree of outdoor independence that is highly desirable for some people with severe disabilities. Their high cost may be prohibitive for some people unless they are able to secure supplementary funding.

The ATV's must be purchased by the individual. In some cases, purchase may be made by a third party payer for some vocational uses. In other cases, the ATV may be tax deductible as an accessibility accommodation. The greatest difficulty in using an ATV is mounting and dismounting. The seat height may be in excess of 90 cm. This can be insurmountable for some people with disabilities. Transfers can be aided by using a platform and ramp or an overhead trapeze. Operation of the handle bars can require moderate strength when performing some activities. Arm strength and sitting balance will effect driving ability. For some individual the ATV seat may require modification to increase

sitting balance and provide greater pressure relief.

Testing of the Polaris Xplorer showed that it had excellent performance in crossing streams, climbing steep slopes, negotiating mud and driving through snow. It had high all year and all weather performance. It also extended the number of independent activities that a person with paraplegia was able to perform on a "gentleman horse ranch". The abilities and desires of the individual will have a significant effect on the appropriate choice of vehicle. In this case, the goal was to provide mobility and an increased ability to perform tasks around a "gentleman horse ranch".

REFERENCES

1. Pasternak MA, Axelson PW, Chesney DA, Wright WE, Longmuir PE, The universal trail assessment process, *Proceedings of the RESNA 96 Annual Conference*, Salt Lake City, Utah, pp. 432-434, 1996
2. Chesney DA, Axelson PW, Richter WM, A wheelchair work measurement method for assessing surface stability, *Proceedings of the RESNA 97 Annual Conference*, Pittsburgh, PA, pp. 509-511, 1997.
3. *Polaris All Terrain Vehicles*, Part #9914702, Polaris Industries, Inc., Minneapolis, MN, 1997.
4. *All Terrain*, Part # 99969-2256, Kawasaki Motor Corporation, U.S.A., 1997.
5. *ATV 1998*, Part # LIT-11111-11-98, Yamaha Motor Corporation, USA, 1997.
6. *All-Terrain Vehicle Accessories*, Cycle Country, Milford, IA, 1995.

Rory A. Cooper, Ph.D.
University of Pittsburgh
5044 Forbes Tower
Pittsburgh, PA 15261
TEL: 412-365-4850
FAX: 412-365-4858

THE DEVELOPMENT OF "OFFICE WHEELCHAIR"

Masatsugu Sakajiri and Shinich Okada (National Institute of Vocational Rehabilitation, Japan)
Hideyuki Hirose (National Rehabilitation Center for the Disabled, Japan)
Takashi Kinose (Tokyo Metropolitan College of Allied Sciences, Japan)
Toshihiro Kawai (Saitama Rehabilitation Center, Japan)
Takeshi Yatogo (Nihon University, Japan)
Shoji Ogino (Spinal Injuries Japan, Japan)
Chihiro Shimodaira (Takano Co., Ltd, Japan)

ABSTRACT

To support wheelchair users working at offices, a new office wheelchair was developed in consideration of sitting postures of wheelchair users.

INTRODUCTION

In Japan, many wheelchair users use compact wheelchairs at their offices because those wheelchairs are easy to fold and carry by cars. However they have difficulties in keeping their sitting postures while working for a long time. Some users may suffer from the bedsores or the low back pains. If a wheelchair ideal for office working is available, the efficiency and health conditions will be improved. Therefore we started to develop an "Office Wheelchair" in 1996.

Although many researches have been carried out previously concerning non-disabled workers, those on disabled workers were very few (1),(2).

The development of our "Office Wheelchair" proceeded through the three stages. First, the sitting postures of wheelchair users were measured using our posture measuring chair that we specially produced. Second, we designed "Office Wheelchair" based on those data. Third, a trial production of the "Office Wheelchair" was made.

This paper describes the measuring of the wheelchair user's posture and show the "Office Wheelchair" we designed.

MEASUREMENT

The posture measuring chair

Figure1 shows the posture measuring chair. The back consists of nine pieces to adjust to

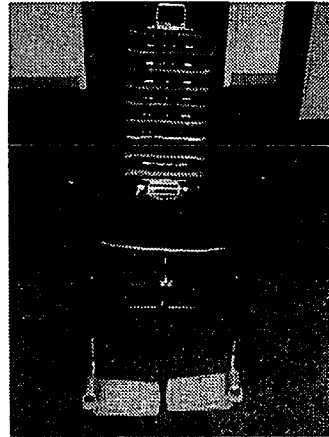

Figure 1. The posture measuring chair: the back is divided into nine pieces. The back of this chair is adjustable for subject's posture.

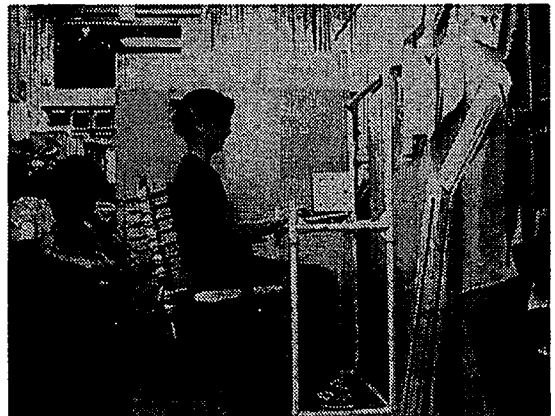

Figure 2. Measurement of a subject's posture.

the shape of the subject's backs. The seat angle is also adjustable.

Subjects

The subjects were twelve male and four female manual wheelchair users. Their ages ranged from twenty-one to forty-seven (an average age was thirty-one). All subjects had spinal cord injury. Fourteen subjects had jobs. Thirteen subjects were engaged in desk work and one in factory work.

The posture measuring

First, the sizes and angles of subjects' wheelchairs were measured. Then, the condition of the measuring chair was adjusted so as to simulate each subject's wheelchair. After adjusting, the condition of the measuring chair was changed to make him/her feel more comfortable. In order to get precise data, the posture images were videotaped. It took about 20 minutes to get data of each subject. The posture data of subjects were calculated using recorded video images. Figure 2 is a scenery of the measurement.

RESULTS

Posture data were calculated as shown in Figure 3. "O" represents an intersection of the back and the seat, "A" an intersection of the upper back line and the lower one, "a" the angle of the lower back, "b" the angle of the upper back, "OA" the length of the lower back, "AB" the length of the upper back, and "B" the neck.

The data concerning each posture on his/her own wheelchairs and on the posture measuring chair were as shown in Table 1.

		wheelchair	posture measuring chair
seat angle	average	10°	9°
	range	16~7°	8~2°
lower back length	average	257 mm	479 mm
	range	315~151mm	561~412mm
lower back angle	average	-82°	-65°
	range	-85~-79°	-79~-51°

Table 1. The posture data of the wheelchair and the posture measuring chair.

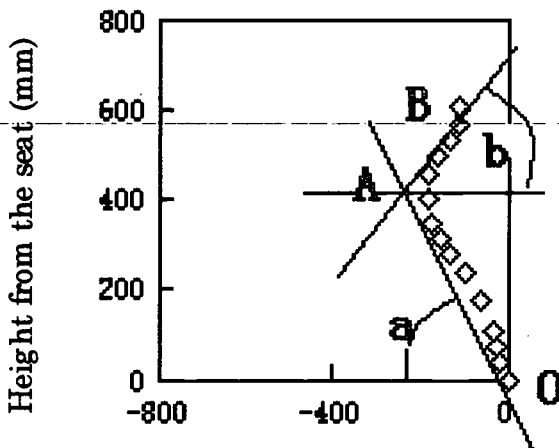

Displacement from the perpendicular line through the coccyx (mm)

Figure 3. The posture data of a subject, seen from right side of the subject. The markers \diamond represents the subject's back contour.

DISCUSSION

Comparison of both posture data implies the following facts. There were little differences in the seat angle between the measuring chair and each wheelchair. Concerning lower back, wheelchairs were about a half length of the measuring chair (an average of wheelchairs was 52% of the measuring chair).

The backs of wheelchairs were not long enough to support their trunks firmly because users hoped their wheelchairs to be compact and easy to handle at small space. On the other hand, the measuring chair was able to support the upper back. All subjects reported that their trunks were stable when they sat on the measuring chair. It indicated that the back which was long enough to support user's upper back was important to keep their posture firmly. In addition, some subjects commented that the armrests of the measuring chair supported their posture because the armrests were higher than the armrests of

The Development of an "Office Wheelchair"

users wheelchair. This comment suggests that higher position of armrests may be desirable to support user's posture.

THE DESIGN OF THE "OFFICE WHEELCHAIR"

The data on the posture of wheelchair workers was obtained. As a result, we obtained three concepts to be considered in design of "Office Wheelchair".

First, the back is to be divided into several pieces to adjust for user's optimal sitting posture. Second, to reduce fatigue of office working, the armrests to efficiently support the elbow efficiently is necessary. Third, to enable to the user reach at higher point (the copy machine and/or the shelf), the mechanism of lift is useful. The "Office Wheelchair" was designed for these concepts. The first trial product of "Office Wheelchair" is shown in Figure 4. The seat angle, the back angle, and the back shape are adjustable to each user's posture condition.

CONCLUSION

The office work posture of wheelchair users were measured using the posture measuring chair. Concerning lower back, the wheelchair was about a half length of the measuring chair (an average of wheelchair was 52% of the measuring chair). It indicated that the back long enough to support user's upper back was important to support their posture firmly. The higher position of the arm rest may support user's posture was indicated. Three concepts to design "Office Wheelchair" were obtained.

Future research

We are now evaluating this "Office Wheelchair". We are going to improve the "Office Wheelchair" by this evaluation. This wheelchair will increase user's efficiency, and useful for not only wheelchair users but also their employer.



Figure 4. The trial product of "Office Wheelchair".

REFERENCES

- (1) Ewa Nowak. Workspace for disabled people. *Ergonomics* 1989;2(4):18-37.
- (2) Betty Troy, Rory Cooper, Rick Robinson and Thomas Grey. An analysis of work postures of manual wheelchair users in the office environment. *Journal of Rehabilitation Research and Development* 1997;34(2):151-161.

ACKNOWLEDGMENT

"Flex mobile EFM-692" was used as the mobility and lifting system of our "Office Wheelchair" by kind permission of Euroflex System AB in Sweden.

Masatsugu Sakajiri

Department of Research on Employment of Disabled
National Institute of Vocational Rehabilitation
3-1-3 Wakaba, Mihama-ku, Chiba-city
261-0014 Japan

TEL: 81-43-297-9034 FAX: 81-43-297-9058

E-mail: msakajir@nivr.jaed.or.jp

FISHING AID FOR WHEELCHAIR RECREATION

Tanya G. Cole
University of Alabama
Department of Mechanical Engineering
Box 870276
Tuscaloosa, AL 35487-0276

ABSTRACT

Through client demand, there is a movement developing in the recreational side of assistive technology. The Mechanical Engineering Senior Design Class at the University of Alabama has recognized this and is developing products that meet the special needs of the disabled. In the Fall of 1997, the class consisted of ten teams, each of which designed, built, and tested a device that would allow someone in a wheelchair to fish with minor assistance. The device described in this report is a very compact and relatively inexpensive solution that allows the client to cast and reel independently. Both casting and reeling are powered by DC motors, and the casting motion itself is actioned by torsional springs.

BACKGROUND

There is a broad range of potential clients for recreational devices. The specified clients for this casting and reeling device were electric wheelchair occupants with minimal use of their upper extremities. Some particular clients only had a push/pull strength of approximately one lb. It was desired that the device would allow the user to cast and reel with as much independence as possible. The client also wanted a relatively low cost device that would be safe and durable.

STATEMENT of the PROBLEM

The task of our three person team was to design, build, test and demonstrate a wheelchair accessory that assists the occupant in casting and holding a fishing rod, as well as reeling in a fish. No permanent modifications were to be

made to the wheelchair, which was to remain fully functional. The resulting device had to be safe, stable, compact, removable, durable, independently powered, and easily operated by a wide range of potential users.

RATIONALE

The design criteria can be divided into five categories:

1. Cost: There was a \$350 limit per design/build team, not including the price of the wheelchair.
2. Safety: The wheelchair still had to conform to all applicable regulations and codes, as did the device.
3. Convenience: The device had to be easy to use and allow the user to quickly cast and reel using only minimal hand motion and force. The device had to fit a variety of commercially available wheelchairs.
4. Manufacturability: The device had to be easy and inexpensive to build and install.
5. Durability: Proof of durability was demonstrated by repeated testing and rigorous engineering analysis.

DESIGN

After brainstorming, the initial concepts were weighed against each other for the criteria discussed above. It was desired to keep the device as simple as possible while allowing the user to independently work the device.

The concept decided upon by the team was that of programmed motion of gears in conjunction with a motor and torsional springs. Torsional springs gave the casting motion desired. One of the two brass gears had been ma-

chined so that only 100° of the teeth remained on the gear. The machined gear was placed on the motor shaft so that it would turn continuously. The regular gear would slip when the machined portion of the program gear came in contact with the first gear, allowing the springs to cast the rod. Figure 1 shows the initial design concept.

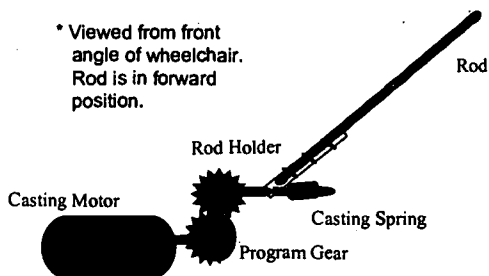

Figure 1. Initial Design Concept

In the actual design, the casting motor fit under the rod holder stop to conserve space. A photograph of the device without the top cover can be seen in Figure 2.

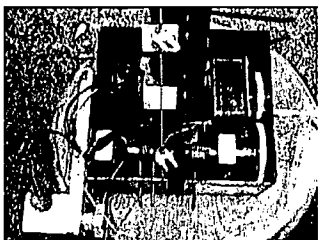

Figure 2. Top View of Device

With the initial calculations, it was predicted that the device would cast approximately 50 feet. For this to be accomplished, weight of the rod holder had to be minimized. Bearing friction also had to be considered. With factors such as these in mind, each component was designed and ordered.

The bearing holder, rod holder, button release mechanism, program gear, shaft, cover, reeling motor holder and couple, casting motor

mounting plate, and wheelchair attachments each had to be machined or altered.

Two motors were needed for the device: one for reeling and one for casting. The casting motor was a 12 Volt, 6 RPM, 50 in-lb DC motor. With the program gear design, it was required that this motor stop after one revolution. This was accomplished by way of a relay, a magnetic sensor, and a contact switch. A large metal washer with a 1/2 inch hole on the outer perimeter was epoxied to the side of the program gear which was attached to the motor. The magnetic sensor was attached to the casing of the device. As long as the sensor was on the washer, the motor would remain in motion. When the rotation of the gear and washer placed the hole in front of the sensor, the motor would trip off. The components involved in this aspect of the design can be seen in Figure 2. The wheelchair occupant only has to hold the large button that is shown in Figure 4 for a few seconds and the motor will begin to turn again for the next cast.

The 6 Volt reeling motor was much faster at 180 RPM with a torque of 40 in-lbs. Figure 3 clearly shows the reeling motor.

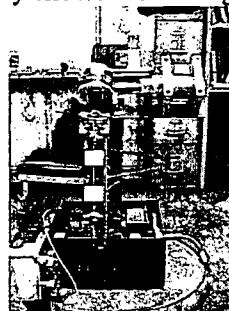

Figure 3. Back View with Reeling Motor

Variable speed was required of the reeling motor because it was used to set the hook in the fish's mouth with a quick jerk to the line, as well as reel in the line without a fish at a reasonable rate. This variable speed was achieved by use of a control box that contained a rechargeable 6 Volt battery and an easily con-

FISHING DEVICE

trolled toggle switch. This control box was carefully designed so that the user could move the switches with ease, and is shown in Figure 4.

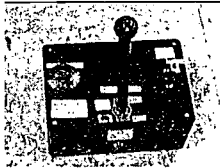

Figure 4. Control Box

DEVELOPMENT

One of the main problems with the device was the button release mechanism. It was found that the correct timing and pressures on the button were extremely hard to coordinate. A spring loaded hinge tied into place with a small steel cable provided the lowest cost and most consistent means of releasing the button. A sketch of this component can be seen in Figure 5.

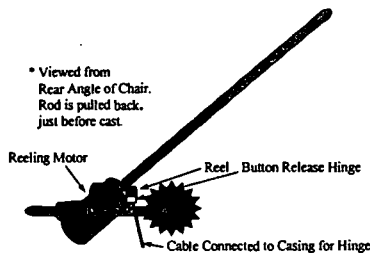

Figure 5. Button Release Mechanism

Figure 6 shows a side view of the device with the button release mechanism.



Figure 6. Side View of Device

EVALUATION

The completed mechanisms were evaluated by faculty, the mechanics, and the clients. Each judged the device on ease of operation, usefulness, cost, appearance, finished quality, engineering, and potential for commercialization.

DISCUSSION

Once the assembly of the design was complete, the testing phase of the project began. The team ensured durability by repeated trials of the mechanism. Through these trials, the mechanism was perfected and slight alterations were made as needed. The mechanism casted a maximum of 48 feet which was very consistent with the predicted results. The control box was very easy for the clients to use since all that was required from the clients was the minimal use of the casting and reeling controls. Many of the components were donated, so the team had a final cost of around \$150, which was well under budget. An emergency on/off switch was added to the mechanism for safety purposes. The device was very small (7 x 7.5 x 3 inches), such that it could fit in the back floorboard of a small car. Thus, it could be easily transported which was very convenient for the clients. The adjustable wheelchair attachment design, in Figure 6, also allowed the device to fit various wheelchairs.

ACKNOWLEDGMENTS

I would like to acknowledge Richard Skinner and Hoon Voon Liew, my teammates for the project, and the instructor, Dr. John Gershenson.

Tanya G. Cole
Mechanical Engineering Department
Box 870276
Tuscaloosa, AL 35487-0276

MODIFICATION OF A SIDE-BY-SIDE TANDEM BICYCLE TO ACCOMMODATE A PHYSICALLY CHALLENGED CHILD

Suzanne Miller, BA
Krista Williamson, MPT
University Hospital School
Iowa City, IA 52242-1011

ABSTRACT

This case study will show how a side-by-side tandem bicycle was modified to allow a young child with disabilities to participate in an outdoor activity. The modifications were based on the cognitive, social and physical needs of the subject. The original seat base was discarded and a new frame designed to hold a complete custom seating system. The drive chain was removed from the "passenger" side and a pulley system was designed to engage the child's foot pedals to exercise his legs. The pedal reach was modified to accommodate the patient's reduced leg movement.

BACKGROUND

The family of a severely physically challenged child, who was already receiving services for postural support for his manual and power wheelchairs, approached the occupational and physical therapy and rehabilitation engineering departments at University Hospital School about modifying a recreational bicycle for their child. Their son's physical disabilities limited his access to outdoor activities.

The child's diagnosis includes that of mixed quadriplegia, scoliosis, and intellectual impairment. He is limited in his range of motion, especially into hip and knee flexion and has undergone bilateral knee surgery secondary to recurrent patellar subluxation. Functionally, he requires total assistance when

transferring and is dependent in all his positioning, requiring custom postural support.

After speaking with the family, the company that manufactures the bicycle was contacted by phone. To their knowledge, no one had ever attempted to modify their product for the physically challenged. Based on the design specifications supplied by the company, we concluded that the modifications appeared possible.

The family, with the generous support of their community, purchased a Double Joy Rider tandem bicycle from Trailmate, Inc. of Sarasota, Florida.



APPROACH

Upon receiving the Joy Rider vehicle, a thorough examination of the design and

construction was made by the rehabilitation engineering department.

Due to the distance the family had to travel to Iowa City, as well as the complexity of the modifications, it was arranged with the family to make two visits to University Hospital School. The first visit involved taking body measurements and discussing the fabrication of the seating system that would be installed on the Joy Rider, as well as any modifications to be made to the frame.

The second visit would be to fabricate the custom cushions.

The modifications would fall into three main categories:

- 1) Designing a frame to hold a custom seating system.
- 2) Redesigning the drive system to allow the child to use the foot pedals only when desired.
- 3) Fabricating a postural support system.

DESIGN

1) Seat Frame

The right side was developed for the "passenger", as that was the easiest side to do physical transfers with this child.

The right plastic contoured seat was discarded. In order to mount our custom cushions, a frame was constructed. One inch square aluminum tubing, with 1/8" wall was chosen to construct the frame because it is lightweight but strong enough to support a 100 pound individual and the seating system.

The dimensions for the 18-inch wide seat frame were based on the available space in the Joy Rider frame and the child's body measurements. Because the child is only ten years old, room for growth was also desired. The physical and occupational therapist concluded that the seat to back angle should be opened to

110 degrees to allow for proper body positioning.

Receptacles were added to the bottom seat rail to hold adjustable arm rests. 14" long commercial pads were mounted on the tubular arm frame.

Holes were predrilled to allow for mounting of the cushions. The seat frame was then attached to the bicycle frame with 5/16" bolts.

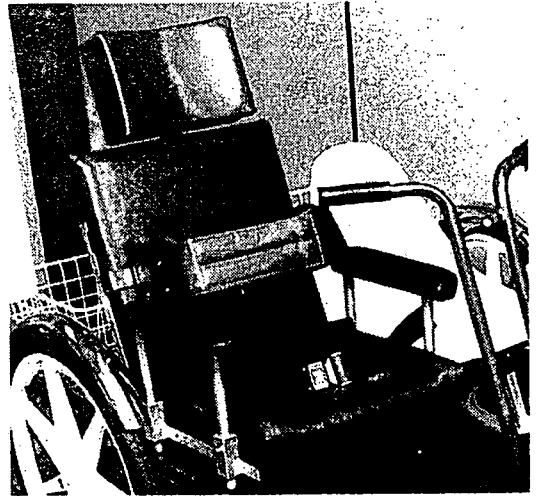

2) Drive System

The bicycle drive system consisted of two drive chains that worked in tandem. Pedaling on one side moved the pedals on the opposite side. Due to the child's inability to assist with propelling, as well as the need to allow him to rest his legs, the right drive chain was eliminated leaving the right pedals freewheeling.

The child's mother expressed the desire to be able to engage the passenger pedals at times to help exercise his legs. A dual pulley system was designed to allow her to engage/disengage at will. It was mounted on the center frame between the riders. Two and 1/4 inch pulleys were mounted in four places. A lever on the driver's side engaged the system. The

Modified Tandem Bicycle

driver is able to access the handle while remaining in his seat. This system had no effect on the drive gears. It did require a small amount of extra physical effort to propel the vehicle when the passenger pedals were engaged.

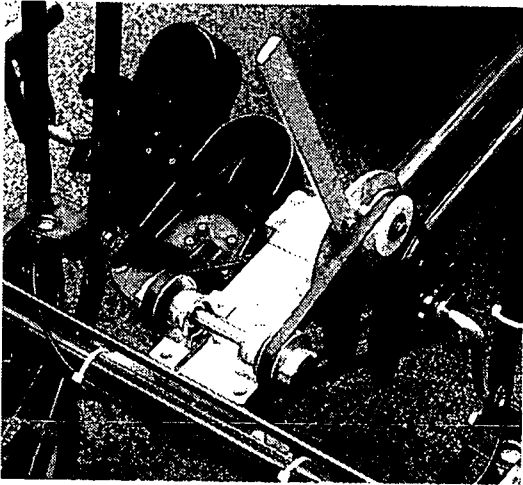

Because of the child's reduced leg movement, the circumference of the pedal rotation needed to be reduced by half. This was accomplished by cutting the pedal tubing and welding a coupling over the rejoined area for added strength.

3) Postural Support System

Custom seating systems fabricated at University Hospital School usually consist of wood, foam, and vinyl. For the seat cushion, a two inch layer of ethafoam is glued down over a baseboard. The dimensions of the client are etched on the ethafoam and an impression is carved out of the foam.

Once the contours are fitted, the ethafoam is covered with a one-inch layer of sunmate foam and a surface cover of vinyl is applied.

For this child, the therapists decided that a flat back with a contoured head support would be appropriate. Lateral

supports, a cummerbund, and a seatbelt were also added to give additional upper body support. Finally, molded shoe forms were added to the pedals to secure the feet.

DISCUSSION

The family reported that the modifications to the bicycle provided their son with the support he requires so he can be involved in their preferred recreational activity. They found it worked well on level surfaces, but inclines were difficult due to one rider propelling the bicycle. The pulley system was operating well and exercising his legs.

Unlike other bicycles that carry riders, the side by side seating allowed their son to communicate with the other rider on a face to face basis, allowing for improved social interaction.

ACKNOWLEDGEMENTS

Suzanne Miller s-miller@uiowa.edu
University Hospital School
Rehabilitation Engineering Department
100 Hawkins Dr.
Iowa City, IA 52242-1011
(319) 353-6416 Fax: (319) 356-8284

This project was supported by:

Christy Walloch, OTR, BCP

The University of Iowa Hospitals and Clinics,
Medical Instrument Department.

Special thanks to Spencer Harris and family of
Kirksville, Missouri.

THE ART AND SCIENCE OF COMPASSION IN PRODUCT DESIGN:
A PRONE STANDER WHICH SATISFIES
THE QUALITATIVE NEEDS OF CHILDREN AND PARENTS
AND THE QUANTITATIVE NEEDS OF THE THERAPIST

Mary Lou Tierney
Industrial Design Graduate Program
Georgia Institute of Technology
Atlanta, Georgia

ABSTRACT

The design and fabrication of a peer-level prone stander for children 25-40" in stature is presented. The benefits of early intervention therapy in the form of weight bearing are well documented. The design methodology is based on treatment of the "whole child". The design concept focuses on favorable product aesthetics to help parents and children overcome the emotional barrier to therapy. Other product enhancements include support systems which make the equipment as comfortable as possible for the child while aligning the body safely and securely. Adjustability mechanisms and overall use of the prone stander by parents and therapists is easy and intuitive. In addition to field testing, the design provides for the quantitative assessment and analysis of therapy. An early intervention weight-bearing program is successful when the physiological and emotive needs of the child are met. A content child facilitates active involvement of parents in a home therapy program.

BACKGROUND

While in a prone stander, the whole child is being considered and treated. Self-esteem, motor skills, independence, and cognitive learning are simultaneously addressed during therapy sessions. Duration of the standing program depends on whether the goal is bone development, acetabular development (bone shape), or contracture management. Early space flight observations by NASA provide other evidence supporting the positive effects of weight-bearing. The development of osteoporosis was observed in direct correlation with the degree of disuse. Clinical observations of children involved in weight-bearing programs took place over a three month period at Elaine Clark Variety Center for Special Needs Children, an early intervention facility in Atlanta, GA. Observations documented the length of time each child participated in weight-bearing, the number of different toys they played with during therapy, and their emotional state before, during and after each session. Given the child's young age, design of the prone stander addresses the needs of its three user populations: children, parents, and therapists. Within the context of a team approach to therapy, goals were established for each user group:

Children: Develop a more positive connotation of therapy through favorable product aesthetics and the mechanisms used to support the child

Parents: Promote therapy at home through ease of use, mainstream juvenile product appearance and efficient size for home use and portability

Therapists: Help develop physical therapy as a "scientific, as well as compassionate clinical field"¹ by providing indicators, integral to the design, which allow the therapist to make quantitative assessments of the child's progress

All of these goals were addressed in the design of a new prone stander. An initial prototype was developed and feedback from focus groups led to a the final design and the fabrication of a second prototype.

STATEMENT OF PROBLEM

The primary guiding principle of the project was to design a prone stander with a toy-like aesthetic for the small, developmentally dysfunctional child. Based on Hebb's theory of committed and associative tissue and Piaget's theory of development, implementation of an early intervention weight-bearing program is supported. A comprehensive analysis of prone standers currently on the market revealed that only 2 of the 15 prone standers researched accommodate a child as small as 25" in stature. Research mentions two criterion to determine when standing should begin: when the child is one year old or when the child attempts to pull up into a standing position. Young children, between 11 and 15 months old, most readily accept adaptive equipment of confinement, reducing the potential of device rejection. Three clinical studies of children focused on isolating reasons why weight-bearing was so problematic for them. All three children were between ages 2-3 years and exhibited behavior of rejection for the prone stander. For children, a void exists in the marketplace for a prone stander which properly positions the small, special needs child. Product's appearance and training the parents on how to properly use equipment and the posed the largest obstacles to home therapy. "Evidence is accumulating that the child's own parents are the best choice as caregivers to facilitate long-term gains."² For parents, the size and cost of prone standers can be prohibitive. Parents maintain a sensitive and heartfelt concern of the "contraption" aesthetic of prone standers.

210

PRONE STANDER

While the therapists clinical experience cannot be underestimated, the ability to quantify the child's progress encourages efforts to document and compare various strategies of intervention. For therapists, gaps in documenting human experimentation of early weight-bearing are common. No prone stander researched provided the therapist a way to document quantitative information of a prescribed standing program.

DESIGN AND DEVELOPMENT



Pre-test anthropometrics with a two-year old

The design follows an iterative process of sketches, study models, prototypes, and focus groups to develop the new prone stander. An analysis of current products is used as a guide in presenting the features of the new prone stander.

The Pod

The Pod of the prone stander is a comprehensive unit to which all positioning elements are integrated. It also represents the product's ability to be modular. The modular design optimizes the long term cost for the family as it can be modified to grow into a gait trainer as the child develops. Because of the child's familiarity with the device, the transition from one form of therapy to the other is anticipated to be smooth and uninterrupted. Two removable features of the pod are a sling and a tray. For sanitary reasons, this piece is washable. Removing the tray allows the child to engage in peer level and computer interaction.

Torso Stabilizer

The Torso Stabilizer represents a unique feature of the design. In case studies, straps caused the most emotional distress for children. These straps can cause friction and shearing forces and have been eliminated to prevent pressure sores and pinching of the skin. The prone stander utilizes two "cupped" forms, mimicking the parent's hands,

which provide adjustability for this element is 7.75" and will accommodate a chest breadth from six to ten inches.



Parent adjusting the tilting mechanism

Hip Stabilizer

The Hip Stabilizer assists in helping the child achieve full hip extension. The Hip Stabilizer swings down and out of the way to aid rear ingress and egress to the prone stander. This also reduces removable parts, a feature desired by the therapists and parents. The range of adjustability for the hip stabilizer is 7.00" vertically and pivots to compensate for different hip dimensions.

Tibia Stabilizer

Due to patellar instability, resulting in subluxation or dislocation, the point of support will be the tibia. The use of a nautilus shaped cushion will compensate for the differences in height and depth of contact which will occur at the tibia. For all users, the prone stander holds the "knee" position constant, with the other positioning mechanisms adjusting for this constant.

Foot Stabilizer

The Foot Stabilizer provides the basis for alignment of the body. It is also the structural member between the two halves of the pod. The rubber surface prevents foot slippage. The feet are positioned with adjustable blocks. The vertical range of adjustability is 3 1/2".

Cushioning

Those areas that bear body weight for prolonged periods or that bear unequally distributed pressure are at high risk for skin breakdown. The load bearing, heat and humidity-dissipating characteristics of foam, air-bladders, and gel cushions were investigated. Gel provided the best solution in this application.

Anthropometrics and Ergonomics

Anthropometrically, children 25-40" in stature correlates to the normative child population ages 6 months to 4.1/2 years. A representative sampling of anthropometric measurements of the special needs child population was

PRONE STANDER

analyzed. Based on these data and the fact that developmentally disabled children are typically smaller, the chronological age correlation is advanced approximately six months.

Task analysis of the loading and unloading procedures revealed appropriate ergonomic positions for controls. Knobs are distinguishable by touch and positioning of controls is optimized for reach. Integral to the design is a collapsible handle which, when extended, allows the adult to achieve a comfortable gait when pushing the prone stander, a feature desired by therapists and parents.

EVALUATION

To ensure that weight-bearing is occurring on the long extremities and not the support cushions, an in-shoe pressure measurement system will be used to calculate loads during weight-bearing. The pediatric inserts used in monitoring local loading consist of eighty-eight homogeneously distributed sensors.

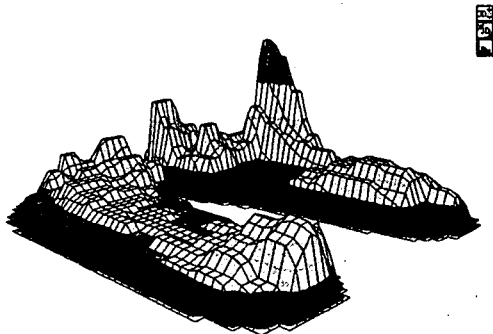

3-D image of average pressure distribution from three-year old test subject

DISCUSSION

A glance through patent searches, and it is clear that prone stander design is driven by function. Without compromising necessary functionality, this prone stander satisfies the qualitative needs of children and parents and the quantitative needs of therapist through product aesthetics. Long-term quantitative clinical evaluation is necessary to document the benefits of an early intervention weight-bearing program.

ACKNOWLEDGMENTS

Funding for this project was provided by the Georgia Tech Center for Rehabilitation Technology. Special thanks to

CRT staff who assisted with this project, especially Joe Koncelik, Alan Harp and Julius T. Corkran.

The pediatric insoles, utilized during field testing, were provided courtesy of Novel Electronics, Inc. I am grateful to Kevin Ford of Novel and Dr. Elizabeth Higbie, Professor of Physical Therapy at Georgia State University for their expert assistance in developing the quantitative testing protocol.

REFERENCES

- Campbell, Suzann K. *Pediatric Neurologic Physical Therapy*. New York: Churchill Livingstone, 1984.
- Dul, J., and B.A. Weerdmeester. *Ergonomics for beginners: A quick Reference Guide*, 9th ed. London: Taylor and Francis, 1993.
- Snyder, Richard G., Lawrence W. Schneider, Clyde L. Owings, Herbert M. Reynolds, D. Henry Golomb, and M. Anthony Schork. *Anthropometry of Infants, Children, and Youths to Age 18 for Product Safety Design*. Warrendale: Society of Automotive Engineers, 1977.
- Stuberg, Wayne. "Considerations Related to Weight-Bearing Programs in Children with Developmental Disabilities". *Physical Therapy* 72, no.1 (January 1992):35-40
- Whedon, G. Donald. "Disuse Osteoporosis: Physiological Aspects". *Calcified Tissue International*, 36,(1984):S146-S150.
- Mary Lou Tierney
Industrial Design Program
Georgia Institute of Technology
Atlanta, GA 30332-0155
Ph. 404•894•4874 Fax 404•894•3396
e-mail gt4487d@prism.gatech.edu

¹ Campbell, Suzann K. *Pediatric Neurologic Physical Therapy*. New York: Churchill Livingstone, 1984, 379

² Campbell, Suzann K. *Pediatric Neurologic Physical Therapy*. New York: Churchill Livingstone, 1984, 4.

TEMPERATURE CONTROL SHOWER UNIT

Ben Schaller, Christin Vance, Terry Baylis, Jason Grup, Seung-Jae Yi,
Gregory Nemunaitis*, Nagi Naganathan & Mohamed Samir Hefzy
Biomechanics Lab., Dept. of Mech. Ind. & Manuf. Eng., The Univ. of Toledo, Toledo, OH 43606
*Department of Physical Medicine, Medical College of Ohio, Toledo, OH 43699

ABSTRACT

This paper describes the design and development of a temperature controlled shower unit to be used by a paraplegic who is confined to a wheelchair and has little or no motor and sensory function below his arms. The unit which will be mounted in the shower will allow the paraplegic to interactively select and set his preferred water temperature. The design of this unit incorporates a thermal mixing valve that provides optimum temperature control, and a PID (proportional-integral-differential) controller that insures a constant water temperature throughout usage. The valve is operated by a motor which allows mixing cold and hot water within its body. A thermocouple measures the temperature of the mixed water and feeds it to the controller which provides a feedback input to the motor allowing valve rotation. An anti-scald valve was also incorporated into the system in order to prevent burns caused by scalding hot water that may result from system failure.

BACKGROUND

Paraplegics individuals confined to wheelchairs have very little motor and sensory function below their arms which represents a serious problem to these patients when they take a shower. Because of the loss of sensation in some parts of their bodies, they could, without knowing, injure themselves from scalding water. Also, these patients would need assistance to adjust the water mixture to keep a constant temperature while they are washing the parts of their bodies that they feel, and shower while seated at the back of the bath tub on the tub bench using a long handled shower head. With the use of a temperature controlled shower unit mounted inside the

shower's walls, these patients can set the water temperature to a desired amount without the physical assistance of another person, and take a shower comfortably and safely without risking injury from scalding water while sitting on a tub bench at the back of a tub.

STATEMENT of the PROBLEM

A patient requires a temperature control shower unit to be mounted inside his shower walls to allow him to take showers independently, comfortably and safely. The unit should satisfy the following requirements:

1. it should provide optimum temperature control
2. it should protect a user who does not feel that water is hot from scalding water
3. it should be safe
4. it should be easily installed
5. it should allow the patient to operate it independently
6. it should be affordable

RATIONALE

The temperature control shower unit was designed and constructed because a similar and affordable device was not commercially available to the patient.

DESIGN & DEVELOPMENT

The proposed design incorporates a thermal mixing valve that combine the output from hot and cold supply lines of water into a single outlet stream having a specified temperature. This temperature was controlled by adjusting the mixing valve using a control unit composed of a PID controller, a direct-coupled actuator

TEMPERATURE CONTROL SHOWER UNIT

and a thermocouple. Due to the wet environment, it was necessary for the control unit to operate at 24 volts and reduced amperage. This required using a transformer to step down the power from the standard 110 volt service to 24 volts. The system and its different components are shown in Figure 1.

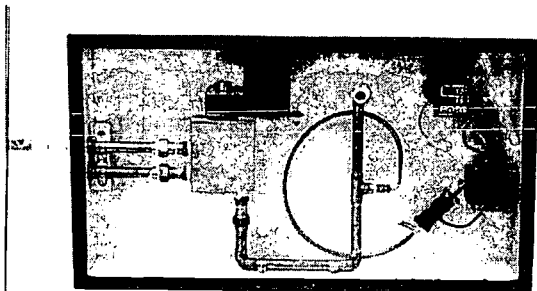

Fig. 1 Temperature control shower unit. The system includes: (1) motor; (2) mixing valve, (3) thermocouple, (4) PID controller, (5) transformer, (6) hot supply line, (7) cold supply line

The thermal mixing valve was designed to sustain up to 75 psi of water pressure and to operate between 45 and 200 degrees Fahrenheit, which accounts for all possible conditions present in a typical household water system, whether it is supplied municipally, or by a well with a pump. For simplicity, the system was designed to operate with a single motor where hot and cold streams are mixed within the body of the thermal valve. The valve is composed of body, stem, three o-rings and a stem-retaining nut. The stem is a 0.75 in diameter rod with two 0.5-inch holes drilled through, perpendicular to each other and offset axially 1.5 inches. The effect of the perpendicularity offset of the holes is to allow the motor to rotate the stem within the body of the valve 90 degrees. This allows the mix of the two inlet streams to vary from 100% cold flow to 100% hot flow with adjustable mixtures of hot and cold in between. The stem diameter is reduced to 0.5-inches to allow for a retaining nut to hold the stem in position inside the valve body. The stem-retaining nut is made of aluminum and has 0.50-inch hole through the center, to slide over the stem. The retaining nut is threaded on the outside edge, and threads

into the valve body to prevent the valve stem from moving in the axial direction. Three nitrile o-rings (operating temperature between -65 and 275 °F) were employed to seal the opening where the stem exits the body of the valve requiring thus three o-rings grooves to be machined into the valve stem. Two o-rings were used to prevent water from leaking out along the valve stem, and one o-ring to prevent leakage between the hot and cold streams.

A Watlow Series 965 PID controller (part number: 965A-3FA1-OORR) was employed to regulate the temperature. The motor was selected to allow for slow rotation which was required to reduce temperature fluctuation about the set point. A direct coupled actuator manufactured by Honeywell (part number: ML7161A1000) with a stroke range of either 45°, 60° or 90° was used. The motor, which takes 90 seconds to stroke 90°, was mounted to the shaft. As indicated earlier, a transformer was employed. Its rating of 40 watts was more than adequate for the system since the motor required 4.8 watts and the PID controller 2.0 watts. In order to measure the temperature of the mixed water, a 'T' type thermocouple (manufactured by Instrument Service & Equipment, Inc., part number: T20S28FS, model number: J20S28F) with a working range of 32°F to 662°F was selected. Flexibel romex wiring and connectors were employed in the final set-up. The thermocouple measured the temperature of the mixed water, fed it to the controller who in its turn compared it to the set temperature and acted accordingly. The controller caused the motor to turn in one direction or the other depending on whether more hot or more cold water is required in order to match the measured temperature with the set one.

A commercially available chrome plated brass anti-scald valve (manufactured by sacramento Plumbing Supply, Co., part number: SS-981) was added to the system. Since this valve is a small, it can be installed at any point between the gooseneck pipe and the hand held showerhead. The valve is designed to automatically shut off the water when the temperature reaches 114 ±5°F, a red reset button on the anti-scald valve can be pushed once the shower head is directed away from the body to flush the hot water from the pipes.

TEMPERATURE CONTROL SHOWER UNIT

Total expenses for material and supplies were \$500 with the controller and the motor being the most expensive items, costing \$266.00 and \$96.26, respectively.

EVALUATION

The system was tested to determine the time required to respond to a significant temperature change. Two types of tests were conducted. In both tests, the valve stem was oriented to 100% cold water flow, approximately 67°F. In the first test, the PID input temperature was set at 215 °F and the system responded by rapidly adding hot water. In 90 seconds, the water was shut off when it reached an average of 111.5 °F for two trials, which was within the designated rating of 114°F ± 5°F. In the second test, and in order to demonstrate how the PID controller determines the rate of temperature change and prevents temperature overshooting, the PID input temperature was set at 110°F. As the measured temperature approached the set temperature, the rate of temperature change decreased. In about 90 seconds, the system stabilized with an average 2.15 seconds per degree over two trials. Also, in all tests, it was verified that leaks were prevented.

DISCUSSION

An assistive device that improves the quality of life of a paraplegic has been developed and tested. The device, a temperature control shower unit, allows a patient to take a shower independently by setting and maintaining the water temperature to a desired value. The system also allows a patient that does not feel hot water to take a shower independently without being concerned of injury due to scalding. The temperature control shower unit can be used with a standard long handled shower head while the patient is seated on a tub bench at the back of the tub. The evaluation of the system has been conducted using the criterion for the assessment of Assistive Technology (AT) (1). These criterion require AT services to be functional, simple, easy to use, acceptable in appearance, affordable, and to provide independence.

A limitation of this system is that the mixing valve was designed to operate as a thermal mixing valve only; isolation or shutoff valves were not included in the design of the prototype. The system can be improved if isolation valves are to be used for both hot and cold supply lines to start and stop flow. Furthermore, some improvements could be achieved if the 60° range of rotation of the motor was selected (instead of the 90° range) along with changing the orientation of the holes in the valve stem. If the valve stem holes were less than 90° apart, the mixture would change more rapidly and it is believed that it would speed up the response time of the entire system.

REFERENCES

1. DeRuyter, F., "Evaluating Outcomes in Assistive Technology: Do We Understand the Commitment?", *Assistive Technology*, Vol. 7, No. 1, pp. 3-8, 1995.

ACKNOWLEDGEMENTS

This work was supported by grant BCS-9308700 from Aiding the Disabled Program of the Bioengineering Division of the National Science Foundation

Corresponding Author:
Mohamed Samir Hefzy, Ph.D., PE.
Professor and Director,
Biomechanics Laboratory
Dept. of Mech., Ind. & Manufacturing Eng.
The University of Toledo
Toledo, Ohio 43606
Tel: 419-530-8234
Fax: 419-530-8206
E-mail: mhefzy@eng.utoledo.edu

DEVELOPMENT OF A DYNAMIC PELVIC STABILIZATION SYSTEM

Jamie H. Noon, Denise A. Chesney, MEBME, Peter W. Axelson, MSME
Beneficial Designs, Inc.
Santa Cruz, California, USA

ABSTRACT

The Hip Grip is a dynamic pelvic stabilization system which is designed to maintain pelvic posture for wheelchair users while allowing desired pelvic movement. As the pelvis is the foundation for good seating, this device can be a key seating component for many wheelchair users. The Hip Grip incorporates rear, front, and side support of the pelvis in an adjustable unit which allows the pelvis to pivot forward about the hip joint within a desired range. The Hip Grip provides adjustable resistance to pelvic movement. This helps bring the pelvis back into its neutral posture after allowing a desired degree of movement. Approximately 20 wheelchair users will evaluate the specific parameters of the Hip Grip through a fitting and interview process to optimize the design to control pelvic movement and enhance upper body function. The results from this testing will be used to refine the design of the Hip Grip.

BACKGROUND

Maintaining proper pelvic posture and providing stability through the pelvis are critical to overall sitting posture. Freedom of movement can be enhanced by achieving a stable base of support (1). The optimum position for the pelvis is a slight anterior tilt (2). An effective pelvic support will prevent the pelvis from tilting posteriorly. A posterior pelvic tilt promotes rounding of the upper spine which can lead to deformity (3). For a pelvis which posteriorly tilts, the top of the pelvis must be blocked from moving back and the bottom of the pelvis must be stabilized from moving forward (4). With adequate proximal support, less support is required distally. Therefore, with increased stability of the pelvis, the user is less dependent upon additional supports in order to maintain a functional, upright sitting posture.

The neutral posture of the pelvis is a dynamic state which should be allowed to move, therefore, rigidly stabilizing pelvic position is not desirable (3). Currently available pelvic supports either do not control undesired pelvic movement, or lock the pelvis in a static, non-functional position. The subtle movements of the pelvis are critical to maintaining an active posture and should not be rigidly stabilized (3).

STATEMENT of the PROBLEM

Currently available pelvic stabilization devices do not move with the user and do not provide a dynamic force to help correct the users posture after allowing movement. Pelvic support devices which do not maintain contact with the pelvis when the user moves are less effective. Currently available devices do not support the pelvis from the front, back, and sides. A combination of devices, often from various sources, must be used to provide support in these areas. This increases the cost of the seating system, adds bulk and weight, and increases time required to install, fit, and adjust the system for growth. Potential hazards presented by improperly used pelvic supports include strangulation from sliding out of an ill-fitting system, and tissue damage due to high pressures from rigid anterior pelvic supports.

DESIGN

The Hip Grip is designed to be fit to the users pelvis in their neutral and balanced posture. Individually fitted contoured pads ensure comfort and reduce risk of tissue damage. The fitting adjustments allow for accommodation of orthopedic deformity such as pelvic rotation, obliquity, and posterior tilt. When the user moves the support surfaces move with the body, maintaining support throughout the prescribed range of movement.

DYNAMIC PELVIC STABILIZER

In the new design the Hip Grip consists of a padded rear shell, two padded front shells, lateral hip pads, a pivot mechanism, a fore-aft lock, and attachment hardware. (Figure 1).

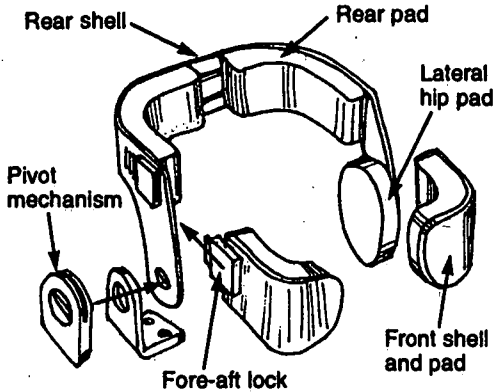

Figure 1. The Hip Grip

Rear shell. The rear shell supports the pelvis at the sacrum, the posterior superior iliac spines (PSIS's) and the sides of the pelvis. The width of the rear shell will be adjustable to provide a custom fit for each user.

Two front shells. The two front shells support the front of the pelvis at and around the anterior superior iliac spines (ASIS's).

Lateral hip pads. Lateral hip pads at the greater trochanter are designed to prevent the pelvis from sliding to the sides. (Figures 1 and 2).

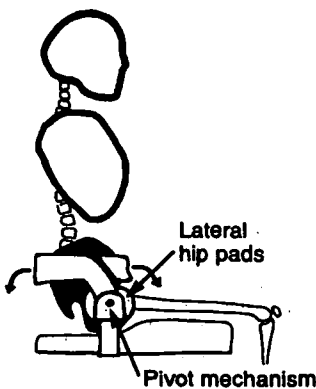

Figure 2. Pelvic movement with the Hip Grip

Pivot mechanism. A pivot mechanism allows anterior and posterior tilting of the pelvis. A separate adjustment for anterior and posterior tilt ranges allows adjustment of one independently of the other. Adjustable centering springs help return the pelvis back to a neutral position and provide dynamic resistance to pelvic movement.

Fore-aft lock mechanism. A fore-aft lock mechanism is used to lock the front shells onto the rear shell after the user is positioned in the wheelchair. An adjustable range ensures a close fit on a variety of users.

Attachment hardware. Three types of attachment hardware allow the Hip Grip to mount to seats, backrests, or wheelchair frames. Features to be optimized include: ease of installation and adjustment, compatibility with a variety of wheelchairs and seat systems, and adjustment range.

DEVELOPMENT

The design of the Hip Grip originated from years of clinical experience in wheelchair seating and dissatisfaction with commercially available pelvic positioning devices. A variety of custom and commercially available solutions were tried, but good pelvic control was not attainable for many clients, particularly those with strong extensor tone in the hips such as those with athetoid cerebral palsy. A common solution to address pelvic instability was to use a combination of components including: a Sub-ASIS bar, anti-thrust seat (ATS), and a supportive backrest. There continued to be problems with these solutions including bruising at the front of the hips and the user sliding out of position, resulting in a posteriorly tilted pelvis.

A proof of concept device was fabricated and tried by 5 able-bodied seating experts and 5 staff for their subjective feedback on its effectiveness in maintaining pelvic posture and to collect measurements related to the fit of the device.

DYNAMIC PELVIC STABILIZER

This test device consisted of a molded plastic shell which wrapped around the top of the pelvis, a mechanical pivot, and a strap to adjust the forward and rearward tilt of the pelvis. This device was mounted to a plywood base with 2 inches of foam to provide a seat surface. During these trials it was found that the rear portion of the shell provided good lumbo-sacral support. The device also reduced movement of the pelvis in obliquity, rotation, posterior tilt, lateral movement, and forward movement. It provided a stable base of support which enhanced upper trunk movement. It was observed that less work was required to balance the trunk and head over the pelvis.

EVALUATION

A minimum of 20 wheelchair users, both male and female, ranging in age from 5 to 70 years will participate in the brief clinical evaluation. The specific objectives of this evaluation process are to determine the effectiveness of the Hip Grip in controlling pelvic movement, reducing pressure on the pelvis, improving upper body function, and improving sitting posture as compared to currently available seating components. Anthropometric data and subjective feedback will also be collected in order to optimize design features.

DISCUSSION

Pilot testing indicates that this device will reduce unwanted pelvic movement while allowing movement within a desirable range. Upper body function of wheelchair users with a variety of disabilities will benefit from the use of this device. The Hip Grip provides stability through a direct mechanical link between the user and the wheelchair. This link will provide a stable base from which to perform functional tasks, such as reaching and bending, without risk of falling out of the wheelchair. The Hip Grip can also increase efficiency in wheelchair propulsion and user independence. There is a great deal of potential for use of this type of dynamic system in special seating.

REFERENCES

1. Trefler, E, Hobson, D.A., Taylor, S.J., Monahan, L.C., Shaw, C.G. (1993). Seating and mobility for persons with physical disabilities. Memphis: Therapy Skill Builders. (pp. 54-55).
2. Presperin, J. (1986) Deformity control. In Intagliata, S. (ed.) Spinal cord injury: A guide to functional outcomes in occupational therapy. Rockville: Aspen Publishers, Inc.
3. Ward, D.E. (1994). Prescriptive seating for wheeled mobility: Vol. I Theory, application, and terminology. Kansas City: Health Wealth International. (p. 56).
4. Cooper, D. (1991). Biomechanics of selected posture control measures. In Proceedings from the 7th International Seating Symposium. (pp. 37-41). Memphis.

ACKNOWLEDGMENTS

This project is funded by the National Center for Medical Rehabilitation Research in the National Institute of Child Health and Human Development at the National Institutes of Health through Small Business Innovation Research Phase I grant # 1R43HD36156-01

Jamie H. Noon
Beneficial Designs, Inc.
5858 Empire Grade
Santa Cruz, California, 95060

221

SIG-10
Electrical Stimulation

EVALUATION OF IMPLANTABLE ELECTRODE LEADS IN A GROWING LIMB

Brian T. Smith, June M. Akers, and Randal R. Betz
Research Department, Shriners Hospitals for Children
Philadelphia, PA

ABSTRACT

An implantable electrode leadwire system used to restore limb function to individuals with spinal cord injuries (SCI) was evaluated in a series of growing dogs to determine whether it could maintain its performance in the presence of growth. Thirty implantable electrodes were implanted in the forelimb muscles of six young dogs. The electrodes' leadwires were tunneled subcutaneously and anchored proximally in the shoulder with excess leadwire incorporated into the subcutaneous space to accommodate growth. Eight leadwires had some of this excess placed in pouches made from surgical membrane. Motor responses to the electrodes were tested before and after growth with tendon force transducers. Results indicated that extension of excess electrode leadwire was comparable to limb growth so that the motor responses of the associated electrodes remained unchanged with growth. The pouch enclosures were found to be unnecessary for facilitating leadwire expansion.

BACKGROUND

An eight-channel implantable functional electrical stimulation (FES) system developed by Peckham and colleagues [1] is currently undergoing extensive investigation as a means to improve limb function for those with spinal cord injuries (SCI) [1-3]. Due to the unknown affect of growth on this FES system, it is not available to growing children with SCI.

Yet, it would be advantageous to initiate FES in children with SCI while they are young to maximize their opportunity to use technology that could assist them in self-care, school, work and play activities. Further, positive results have been gathered using temporary, percutaneous electrode systems which support the utility of FES for children with SCI [4].

Accommodation of growth has been investigated for similar implantable devices such as cardiac pacemakers [5], diaphragmatic systems [6] and auditory prostheses [7]. Results using these devices in human and animal trials have generally indicated that they can accommodate growth using excess electrode leadwire. In some cases the excess leadwire is housed in a biocompatible pouch to facilitate leadwire extension by minimizing adhesions to surrounding tissue. Given the location of these various prostheses, these studies have not examined how excess leadwire could be configured to accommodate the extensive growth of the extremities.

In a previous animal study performed in our laboratory, it was shown that the implantable electrodes (without leads) associated with the FES system developed by Peckham [1] could provide consistent motor responses in the presence of growth [8]. The present study focuses on how excess leadwire should be configured within the subcutaneous space to prevent tension on the leads that could disrupt the electrodes from their appropriate locations and potentially alter their motor responses.

RESEARCH QUESTION

Using an animal model, can excess electrode leadwire be configured in the extremity such that it will unravel on demand with limb growth, allowing the corresponding implantable electrodes to maintain stable, repeatable motor responses?

METHOD

Fifteen epimysial (EP) and 15 surgically-implanted intramuscular (IM) electrodes [9] were implanted in forelimb muscles of six young dogs between 8-12 weeks old.

In the first three animals (Phase a), a total of twelve electrodes were implanted. For each dog, four electrodes were placed in the forearm and the proximal end of the lead was tied to the

scapula. Leads were at least 11 cm longer than needed and the excess lead was placed in the subcutaneous space of the upper portion of the forelimb. For six electrode leads, two in each dog, the excess was placed in the subcutaneous space in a loose configuration. For six leads this excess lead was placed in a 4 cm by 6 cm polytetrafluoroethylene (PTFE) pouch.

In a second set of three animals (Phase b), methods were modified to expose the electrode leads to greater limb growth. Dogs specially bred for long limb growth and conditioned to allow for surgery at an earlier age (8 to 10 weeks old) were used. To further approximate the clinical situation, the in-line connectors used with these electrodes in the implantable system were used to connect the electrodes to a proximal lead section. Eighteen total electrodes were implanted, evenly distributed between EP and IM designs. Six electrodes were implanted in each of these dogs. In two of these three animals, the proximal lead sections were sutured to the spinous processes. In the final animal, the electrode leads were connected to the implanted radio-frequency controlled stimulator. Approximately 30 cm of excess lead was placed in the subcutaneous space for each lead, divided between the shoulder and the forearm areas.

In each dog, one EP electrode was sutured to, and one IM electrode was inserted in, each of the target muscles. These target muscles were two lower forearm muscles, the ulnaris lateralis and the extensor digitorum communis, and an intrinsic muscle in the paw. Each electrode was implanted in a position that produced the greatest force before spillover to other muscles. Isometric recruitment characteristics for each forearm electrode were recorded intraoperatively using Z-shaped tendon force transducers placed on the tendon of both the muscle implanted with the electrode (target muscle) and the next muscle to be recruited by increasing stimulus pulse duration (spillover muscle). Two or three trials were run with each test electrode and the key measures (stimulus thresholds, peak force, and percent of peak force just before spillover) were averaged from these trials. As in the current human application of this system, the limb was casted for three weeks postoperatively to stabilize the muscle-electrode interface during fibrous tissue encapsulation. The cast was changed every 7 to 10 days during the cast period to

avoid interference with growth.

Radiographs were taken at two month intervals throughout the growth period to monitor the shape and progress of the excess lead. After one year, an explant procedure was performed and the measurements of the implant session were repeated. In order to compare motor responses that could be achieved in the mature dog to the performance of the original electrodes that were exposed to growth, new electrodes were implanted during the explant procedure to the same muscles and recruitment measures taken.

RESULTS

Table 1 shows the results of the average threshold and peak force measures for the EP and IM electrodes combined since statistically they did not perform differently. A multivariate analysis of variance (MANOVA) between the measures at implant, explant and for the new electrodes at explant, indicated that growth had a statistically significant effect ($p=0.044$) on motor responses. Follow-up ANOVA tests on the significant effect, indicated that growth affected the stimulus threshold alone ($p= 0.001$) and not the percentage of peak force attained ($p= 0.618$) before adjacent muscle activation.

Table 1: Target thresholds and percentage of peak force for both the EP and IM electrode designs for three situations: Implant (before growth), Explant (original electrode after growth), and New (new electrode implanted after growth to the same muscle).

EP and IM electrodes	Target Threshold (microseconds)	% of Peak Force Achieved Before Spillover Activation of Adjacent Muscle
Implant	3.6 +/- 2.2	80 +/- 21
Explant	9.2 +/- 9.2	84 +/- 19
New	5.6 +/- 4.6	80 +/- 20

Figure 1 shows the sum of all measured leadwire extension as compared to growth along the lead pathway. Growth in Phase a dogs was about 3 cm and in Phase b dogs about 14 cm. The measured lead extension was on average 80 percent of the measured growth. Some lead extension occurred outside of the regions measured, thus the measured extension does not fully add up to the amount of growth. Importantly, at explant there was no evidence of leadwire stretching. For the leadwire housed in pouches, extension occurred mainly from the

small amounts of excess outside the pouch rather than from that inside the pouch.

Growth and Lead Extension

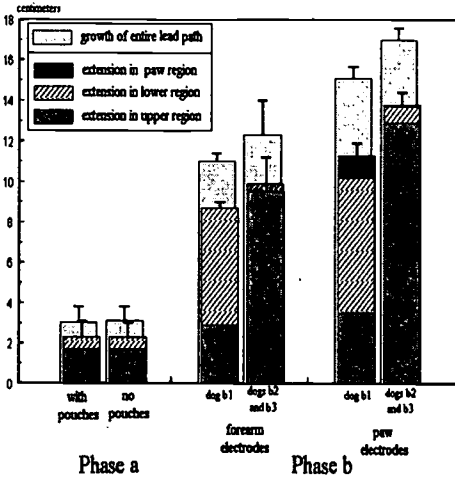

Figure 1: Growth and measured extension for the three regions along the leadwire path with averages and standard deviations for several subgroups of dogs and electrodes. Growth, in the offset lightly-shaded bars, is measured from the proximal leadwire anchor point to the electrode site. The measured extension is not expected to match growth precisely because only subsections of the lead were evaluated.

DISCUSSION

The results of this study suggest that for both the EP and IM electrode designs, excess electrode leadwire played out with growth such that the motor responses produced from the associated electrodes remained functional. In addition, the motor responses from new electrodes implanted in the mature muscles was comparable to that of the electrodes exposed to growth. Growth had an effect statistically on the target threshold values but the differences are not considered clinically significant and, in human application, can be accommodated easily through stimulation programming. Most importantly, the percentage of peak muscle force that could be attained before activation of adjacent muscles was not affected by growth.

The quantity of growth to which leads were exposed in this study (about 14 cm in phase b dogs) is comparable to that amount expected in the human applications of this electrode system [10]. For upper limb applications, the stimulator is placed in the chest and thus the leadwire for an electrode in the forearm must accommodate about 16 cm of limb growth

(humerus and proximal radius) which would occur in a boy from age seven to maturity. For lower limb applications, the stimulator is placed in the lower abdominal region and the leadwires would need to accommodate, from age 7 to maturity, about 5 cm of growth across the proximal femur for electrodes placed in thigh muscles. For muscles implanted below the knee, an additional 15 cm of growth would be anticipated.

REFERENCES

- [1] Kilgore KL, Peckham PH, Keith MW, Thrope GB, Wuolle K, Bryden A, Hart R, (1997). An implanted upper extremity neuroprosthesis. *J Bone Joint Surg*, 79-A(4):533-541.
- [2] Mulcahey, R.R. Betz, B.T. Smith, A.A. Weiss, and S.E. Davis, (1997). Implanted functional electrical stimulation hand system in adolescents with spinal injuries: An evaluation. *Arch. Phys Med Rehab*, 78:597-607.
- [3] Triolo RJ, Bieri C, Kobetic R, Polando G, Sharma M, Marsolais EB, Davis J, (1997). Installation and performance of a 16-channel implantable FES system for upright mobility. *Proc RESNA 1997 Ann Conf*. pp 310-312.
- [4] Mulcahey MJ, Betz RR, (1997). Upper and lower extremity applications of functional electrical stimulation: A decade of research with children and adolescents with spinal injuries. *Pediatr Phys Ther*. 9:113-122.
- [5] Sato G, Glenn WW, (1970). A Teflon envelope protection for cardiac electrodes in growing swine, *J Thor Cardiovasc Surg*. 59:830-836.
- [6] Weese-Mayer DE, Hunt CE, Brouillette RT, Silvestri JM, (1992). Diaphragm pacing in infants and children. *J Pediatrics*, 120(1):1-8.
- [7] Xu SA, Shepherd RK, Clark GM, Tong YC, Williams JF, (1993). An evaluation of expandable leadwires for pediatric cochlear implants. *Amer J Otolary*, 14(2): 151-160.
- [8] Akers JM, Triolo RJ, Betz RR, (1996). Motor responses to FES electrodes in a growing limb. *IEEE Trans Rehab Eng*, 4(4):243-250.
- [9] Memberg WD, Peckham PH, Keith MW, (1994). A surgically implanted intramuscular electrode for an implantable neuromuscular stimulation system. *IEEE Trans Rehab Eng*, 2(2):80-91.
- [10] Hensinger RN (1986). *Standards in pediatric orthopedics: tables, charts and graphs illustrating growth* (1st ed.) New York, NY: Raven Press.

ACKNOWLEDGEMENTS

This work was funded by Shriners Hospitals for Children Grant #9530.

Brian T. Smith, Research Department
 Shriners Hospitals for Children
 3551 North Broad Street
 Philadelphia, PA 19140 Phone: 215-430-4000

SHOULDER SUBLUXATION AND PAIN IN CHRONIC HEMIPLEGIA TREATED BY INTRAMUSCULAR ELECTRICAL STIMULATION

Maria E. Walker, M.S. candidate, David T. Yu, M.D., John Chae, M.D.,
Zi-Ping Fang, Ph.D., and Ronald J. Triolo, Ph.D.

Department of Biomedical Engineering
Case Western Reserve University, Cleveland, OH

ABSTRACT

The purpose of this study was to explore the effects of intramuscular electrical stimulation on shoulder subluxation and pain, as well as motor function and self-care skills in stroke survivors. Eight chronic hemiplegic subjects participated in a 6-week program of electrical stimulation to posterior deltoid and supraspinatus muscles. Stimulus was delivered via intramuscular electrodes with percutaneous leads. Radiology, goniometry, pain inventory and other measures evaluated the outcomes. Significant improvements in shoulder subluxation ($p=0.049$), range of motion ($p=0.012$), pain intensity and interference ($p=0.034$, $p=0.018$), motor function ($p=0.066$), and self-care skills ($p=0.034$) were observed post-treatment. Improvements were maintained after stimulation was discontinued.

BACKGROUND

Stroke is the leading cause of long-term disability among adults, occurring in approximately 500,000 individuals each year. Among the stroke survivors, hemiparesis is an apparent finding in three-quarters of the cases. Shoulder subluxation is a significant complication among the hemiplegic stroke survivors, occurring in 17% to 75% (7). The primary causes of shoulder subluxation are the absence of muscular support, the stretching of ligamentous structures, and the weight of the unsupported arm. A high incidence of shoulder pain is also reported among hemiplegic stroke survivors, occurring in up to 84% of all cases. Shoulder pain in hemiplegia is associated with decreased range of motion, poor motor recovery, decreased motivation, and failure to respond to rehabilitation (7).

The use of conventional methods of treatment for shoulder subluxation and pain is controversial. These treatment modalities include various types of slings and arm supports. Slings have shown to be effective in reducing subluxation and pain if prescribed correctly, but they place the arm in a non-

functional position. Furthermore, the immobilization of the arm may cause additional complications such as unwanted synergies and disabling contractures (6).

Electrical stimulation of the shoulder muscles has been researched as an alternative approach to prevent or treat subluxation. Previous pilot studies have found surface electrical stimulation to be effective in decreasing the degree of shoulder subluxation, reducing the degree of shoulder pain, maintaining joint stability, and speeding recovery of arm function (1,2). Though effective, surface stimulation is not widely accepted because of stimulation-induced pain, poor muscle selectivity, poor motor point localization, and poor repeatability in daily application of electrodes.

RESEARCH QUESTIONS

The goals of this study were to investigate the short-term and long-term effects of intramuscular electrical stimulation of the posterior deltoid and the supraspinatus muscles among chronic hemiplegic stroke survivors. The study hypothesized that four effects of this intervention would occur immediately following treatment; the degree of shoulder subluxation would decrease, the degree of shoulder pain would reduce, upper extremity motor function would improve, and self-care skills would improve. The final hypothesis explored whether the effects of treatment were maintained after stimulation was discontinued.

METHODS

Subjects

Eight chronic hemiplegic stroke survivors were enrolled in the study. All subjects were greater than 6 months post stroke with at least 2 months of neurological stability. It was also required that they had existing clinical shoulder subluxation greater than or equal to 1 fingerbreadth. The subjects' neurological status permitted them to serve as their own controls in a pilot pre-test, post-test study design.

Treatment Protocol

Intramuscular electrical stimulation was applied to the posterior deltoid and the supraspinatus muscles. These muscles were chosen based on previous electrical stimulation studies (1,2). Compared to surface stimulation, intramuscular stimulation provides better muscle selectivity and recruitment stability, while causing less stimulation-induced pain sensation. A CWRU-type intramuscular electrode with a percutaneous lead and a single helix of fluoropolymer-insulated stainless steel multistrand wire was employed. This design was chosen based on its high survival probability and ease of removal after a short time duration (4). A self-adhesive, carbon electrode served as a common anode. Current-regulated, charge-balanced, biphasic stimuli were used for consistent muscle recruitment and minimal tissue damage and electrode corrosion. The stimuli delivered 20 mA, 12 Hz, and a variable pulse-width of 10–200 μ sec.

The subjects received the stimulation treatment for 6 hours per day for 6 weeks as prescribed in previous studies (2). The subjects and their caretakers were responsible for turning the stimulation on and off, recording a log of stimulation times, and cleaning the electrode exit site. It was not required that the subjects stimulate for 6 hours continuously, but they were asked to be seated or standing during the stimulation with their arm extended at their side. The purpose was to stimulate the muscles against the weight of the arm. After the 6-week treatment, stimulation was discontinued, and the subjects were encouraged to voluntarily exercise their shoulder but no other treatment was used.

Outcome assessments

Outcome measures were performed three times during the study to assess status and changes. The assessments were performed prior to stimulation treatment (T1), at the completion of the 6-week treatment (T2), and 12 weeks after the completion of the treatment (T3).

Comparing anteroposterior radiographs of the affected and unaffected shoulder assessed shoulder subluxation. The subject stood, if able, or sat in an upright position with both arms extended at his sides with no support. The difference in the vertical distances of the affected and unaffected side was measured to quantify the degree of inferior subluxation. The vertical distance was that between the most

inferolateral point of the acromion and the central point of the humeral head (5).

Shoulder pain was assessed using pain-free, passive, shoulder lateral range of motion (SLROM) measured by a goniometer. The Brief Pain Inventory (BPI) subjective questionnaire was also used as a pain measure. BPI assessed the intensity and interference of pain in the subject's daily living.

Motor function of the upper extremity was evaluated using the Fugl-Meyer Measurement (3). The self-care section of the Functional Independence Measure (FIM) was used to assess the degree of disability. Each value of the FIM was based on history obtained from the subject and/or caretaker.

RESULTS

The medians of the preliminary data showed consistent trends in improvement of subluxation, pain, motor function, and self-care skills as displayed in Figure 1. The level of significance between the independent assessment periods of T1 to T2 and T2 to T3 were calculated based on Wilcoxon signed-rank, nonparametric statistics.

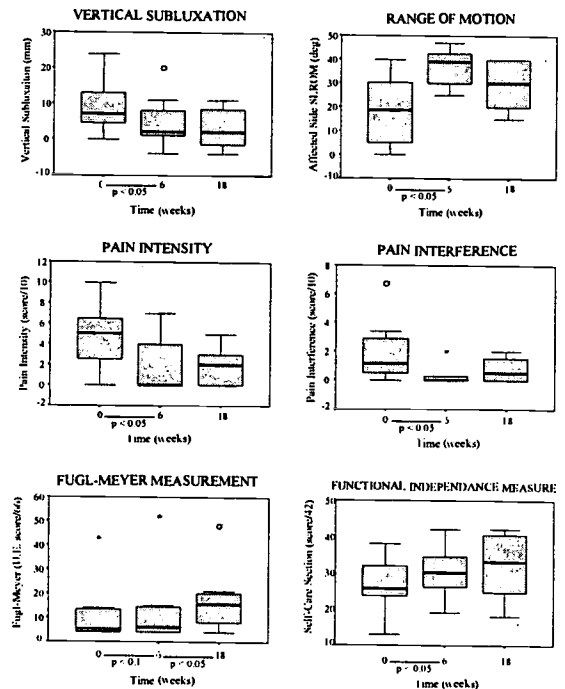

Figure 1. Results of all outcome measures

At post-treatment assessments (T2), all outcomes were shown to be significantly improved from the pre-treatment (T1) outcomes ($p < 0.05$) with motor function outcome at $p < 0.10$. At follow-up evaluations (T3), only the motor function outcome was shown to be significantly improved ($p < 0.05$). All other measures at follow-up were not significantly different than post-treatment; thus the effects of treatment were maintained.

Subject compliance reported through subject data logs was 86% of the total prescribed time. Results show that all eight subjects had a reduction in either subluxation or pain at the T2 assessment immediately following treatment. Half of the subjects had a reduction in both subluxation and pain at the T2 assessment. At the follow-up assessment, five subjects had maintained this reduction. In addition, half of the subjects had an improvement in upper extremity motor function at T2 and three-quarters had an improvement of self-care skills at T2. All of these subjects maintained these improvements. Among this small sample size, no correlations were found between the degree of subluxation and the other five outcome measures. Likewise, no correlation was found between the subjects' individual characteristics and their results.

DISCUSSION

Intramuscular electrical stimulation was shown to significantly reduce the degree of shoulder subluxation and pain and improve motor function and self-care skills immediately following treatment. These improvements were maintained for a 12-week follow-up period. The treatment was well accepted by the subjects and their caretakers. Intramuscular electrical stimulation was shown to be an effective alternative approach to conventional treatment.

Several assumptions were made regarding the selection of muscles for stimulation and the scheme of stimulation delivery. To optimize the intervention protocol, further studies are necessary. In addition, the outcome measures used were only adequate for attaining preliminary data to demonstrate the effects of the proposed treatment, but the technique for administering these measures needs to be standardized. Most importantly the position of the subject during x-ray needs to be normalized to ensure the quality and comparability of data

and to reduce the variability in magnification. Other areas to explore in a future larger-scale study would be the possible causal mechanisms of the observed effects and the possible correlations between patient's characteristics and the treatment outcome.

REFERENCES

1. Baker LL, Parker K (1986). Neuromuscular electrical stimulation of the muscles surrounding the shoulder. *Phys Ther*, 66:1030-1037.
2. Faghri PD, et al. (1994). The effects of functional electrical stimulation on shoulder subluxation, arm function recovery, and shoulder pain in hemiplegic stroke patients. *Arch Phys Med Rehabil*, 75:73-79.
3. Fugl-Meyer A, et al. (1975). The post-stroke hemiplegic patient: I. A method for evaluation of physical performance. *Scan J Rehabil Med*, 7:13.
4. Memberg WD, et al. (1993). An analysis of the reliability of percutaneous intramuscular electrodes in upper extremity FNS applications. *IEEE Trans Rehab Eng*, 1:126-132.
5. Prevost R, et al. (1987). Shoulder subluxation in hemiplegia: a radiologic correlational study. *Arch Phys Med Rehabil*, 68:782-785.
6. Van Ouwenaller et al. (1986). Painful shoulder in hemiplegia. *Arch Phys Med Rehabil*, 67:23-36.
7. Zorowitz RD, et al. (1996). Shoulder pain and subluxation after stroke: correlation or coincidence? *Am J Occup Ther*, 50: 194-201.

ACKNOWLEDGEMENTS

This research was supported by the NIH-PHS SBIR Phase I Grant awarded to NeuroControl Corporation (Dr. Zi-Ping Fang, principal investigator). The authors acknowledge the engineering support of Ronald Hart and Dr. P. Hunter Peckham, and the statistical assistance of Dr. Nel Sedransk and Scott Snyder.

Maria E. Walker mew@po.cwru.edu
NeuroControl Corporation
1945 East 97th Street
Cleveland, OH 44106
(216) 231-6812 FAX: (216) 231-2305

EVALUATION OF ADAPTIVE NEURAL NETWORK CONTROLLER IN CYCLIC MOVEMENT USING FUNCTIONAL NEUROMUSCULAR STIMULATION

JoAnne Riess and James J. Abbas
Center for Biomedical Engineering
University of Kentucky

ABSTRACT

Improvements in the control components of Functional Neuromuscular Systems (FNS) can greatly increase the functionality and energy efficiency of these systems (the control algorithm is the component that determines the stimulation). In this study, we evaluate the capabilities of an adaptive feedforward controller to determine a stimulation pattern for the quadriceps muscle group during cyclic movement.

In experimental evaluations on able-bodied subjects, the performance of the adaptive neural network controller under isotonic conditions was compared to a standard feedback controller over a 75-cycle trial. Results showed the adaptive controller automatically determined a stimulation pattern for the desired motion, altered the stimulation pattern in the presence of fatigue, and controlled the movement with better overall performance than a proportional derivative (PD) feedback controller.

BACKGROUND

Functional Neuromuscular Stimulation (FNS) systems activate paralyzed limbs by electrically stimulating motor neurons. These systems have been used to restore functions such as standing and stepping in people with thoracic level spinal cord injury. One major problem which limits the practicality of FNS systems is that stimulation patterns must be customized for each individual based on each person's specific injury, anatomy, and muscle condition. An adaptive control algorithm has been designed to automate this customization and perform on-line adaptation of stimulation levels to account for fatigue.

The adaptive Pattern Generator / Pattern Shaper (PG/PS) controller assessed in this study uses neural networks to alter the stimulation pattern transmitted to the muscle (Figure 1) and has been found to perform well in simulation and under isometric conditions (1, 2).

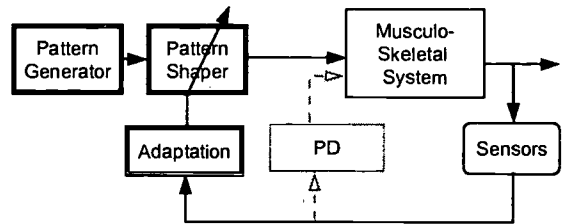

Figure 1: Block diagram of Pattern Generator/Pattern Shaper (PG/PS) controller. This adaptive feedforward controller uses neural networks to determine a stimulation pattern for cyclic contractions. The Pattern Generator produces a periodic signal at the frequency of the desired contraction. The Pattern Shaper adaptively filters the pattern before it is sent to the muscles. The PD feedback controller (gray dashed) uses an error signal to determine the stimulation levels.

RESEARCH QUESTION

The purpose of an FNS system is to restore function to paralyzed limbs in a manner that is safe, easy to use, and energy efficient. The objective of this study was to assess under isotonic conditions (when dynamic nonlinearities are present) the capability of the controller to adapt stimulation patterns for each person and to adjust them over time to account for fatigue. The performance of the controller in tracking an oscillatory movement trajectory was compared with the performance of a fixed parameter proportional derivative (PD) feedback controller for further evaluation of the PG/PS capabilities.

METHOD

The controllers were tested on 4 legs (both legs of two able-bodied subjects). The single-segment, single-muscle motion was generated by electrical stimulation of the quadriceps muscle groups. Evaluation on subjects with lower extremity paralysis will occur in a future study.

Stimulation:

Surface electrodes were placed on the anterior thighs of both the subjects' legs for single channel stimulation of the quadriceps muscle groups. Modulation of the stimulation pattern was accomplished by altering the pulse amplitude of the stimulation train. Both the sampling frequency and stimulation frequency of the trials were 20 Hz.

Desired Trajectory:

The desired trajectory for the experiment is a raised cosine seen as the dotted line in the top plot of Figure 2. The amplitude was 50° with a duty cycle of 60% and a period of 2.5 seconds.

Protocol:

In the study, either the PD or the PG/PS controller was utilized to determine the stimulation pattern for the trial. Motion tracking data and stimulation levels were collected for 75 cycles (approximately 3.5 minutes). 8 trials per controller per leg were collected over 2 days of testing. A 1-lb weight was placed on the ankle during 4 of the trials to evaluate the performance of each controller with a change in inertial properties of the leg.

RESULTS

PG/PS Performance Characterization

During each cycle, the stimulation levels were modified by the controller in an attempt to match the desired trajectory. Figure 2 shows the trajectory of the leg and the stimulation levels determined by the controller from the trial with the best PG/PS performance. When the peak stimulation level reached over 50% of the stimulation range, a noticeable change in output had occurred. By the 15th cycle, the error

between the actual trajectory of the leg and the desired trajectory was small (root mean square (RMS) error $< 10\%$) and the increase in peak stimulation per cycle had leveled off.

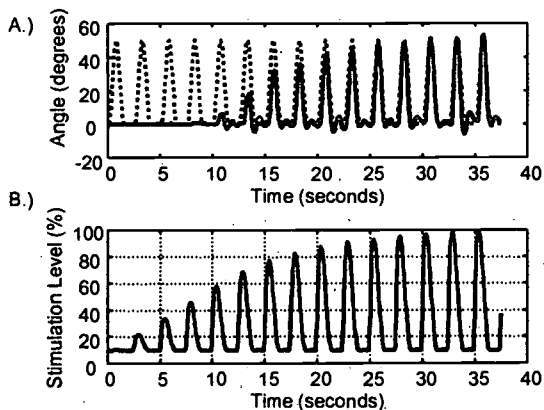

Figure 2: First 15 cycles of the best PG/PS controller from controller comparison trials (best is defined as the lowest mean RMS error over last 10 cycles of trial). Angle output and stimulation levels are shown. Note that the stimulation levels are shown as a percentage of the stimulation range determined for each subject.

Comparison of PG/PS and PD Controllers

To better assess the capabilities of the PG/PS controller, we compared the performance of the controller with that of a standard PD feedback controller. Figure 3 shows the first 5 cycles and the last 5 cycles of the best PD controller trial and the best PG/PS controller.

Figure 4 shows a comparison of the RMS errors of the best PD and PG/PS controller throughout the entire trial. Low RMS errors indicate a good performance. The PG/PS controller had high initial errors, but as the trial proceeded, the RMS error for the PG/PS controller continued to decrease (RMS error = 7%), while the PD controller oscillated about a fairly constant value (RMS error = 27%).

The average RMS error for each controller under unloaded and loaded conditions are seen in Figure 5. The PG/PS controller performed significantly better than the PD controller for

all muscles evaluated although there was no significant difference between the unloaded and loaded trials.

DISCUSSION

In this experiment, we evaluated the PG/PS controller with respect to automatic customization of a stimulation pattern and on-line fatigue adaptation. The PD controller was able to elicit an immediate response during the first few cycles of the trials (Figure 3) where as the PG/PS controller showed little movement. As the trial progressed, the adaptive controller was able to determine a stimulation pattern quickly and efficiently. This results in a good performance for the PG/PS controller.

Until a cure is found for paralysis, FNS offers a way to activate paralyzed limbs to improve health and offer different opportunities to people who cannot voluntarily move their lower extremity. The ability of the adaptive controller to automatically customize a stimulation pattern may contribute to a more practical FNS system.

REFERENCES

1. Abbas JJ, Chizeck HJ (1995). Neural Network Control of Functional Neuromuscular Stimulation Systems. *IEEE Trans BME*, 42, 1117-1127.
2. Abbas JJ, Triolo RJ (1997). Experimental Evaluation of an Adaptive Feedforward Controller for Use in Functional Neuromuscular Stimulation Systems. *IEEE Trans. Rehabilitation Engineering*, 5, 12-22.

ACKNOWLEDGEMENTS

This work was supported in part by a University of Kentucky fellowship and the Whitaker Foundation.

JoAnne Riess riess@cbme.uky.edu
 Wenner-Gren Laboratory
 Lexington, Kentucky 40506 - 0070
 (606) 257- 5941 Fax: (606) 257 - 1856

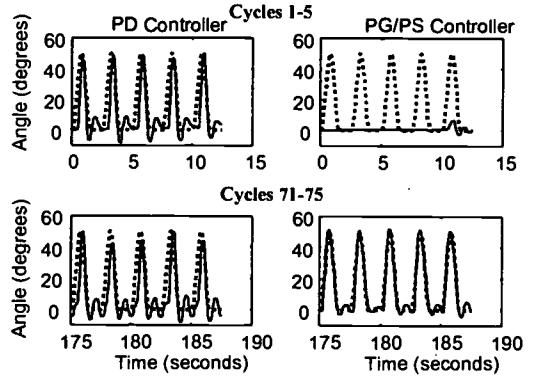

Figure 3: Example trials of the best PD Controller and the best PG/PS controller for the first 5 cycles and the last 5 cycles. Note as the trial continues, the PG/PS controller improves performance, but the PD controller (thin line) only maintains performance

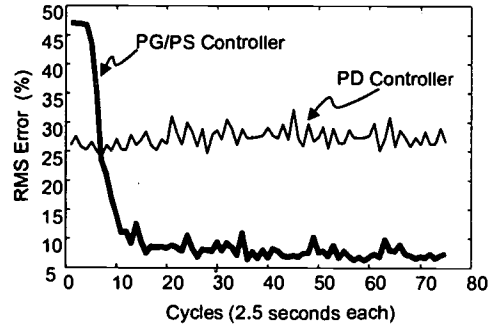

Figure 4: Example of RMS errors across cycles for both controllers seen in Figure 3. (The trials with the lowest mean RMS error over the last 10 cycles define best performance.)

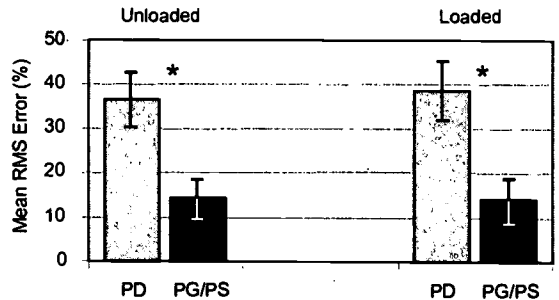

Figure 5: Mean RMS error +/- one standard deviation for all unloaded and loaded controller trials. Repeated-measures ANOVA showed that the PG/PS controller had a significantly (*, p-value < 0.05) lower RMS error than the PD controller.

N = 16 Trials (4 legs, 4 trials per leg in each condition)

Performance of Implanted Epimysial Electrodes in the Lower Extremities of Individuals with Spinal Cord Injury

JP Uhlir¹, RJ Triolo², R Kobetic³, M Wibowo¹

Department of Biomedical Engineering¹ and Orthopaedics², Case Western Reserve University
³Motion Study Laboratory, Cleveland VA Medical Center

ABSTRACT

This paper describes the recruitment properties of implanted epimysial electrodes in the lower extremity muscles of persons with low cervical to mid-thoracic level spinal cord injury (SCI). 24 epimysial electrodes have been implanted in various muscles of the lower extremities of three volunteers. In each person, the electrodes were connected to a CWRU/VA implantable receiver/stimulator (IRS-8) for use as a functional standing or stepping system. All electrodes remain functional after more than six months post-implant, with 18 electrodes in two subjects functional after more than one year. The electrodes exhibit stable thresholds and produce knee extension and hip flexion/extension moments adequate for standing and stepping with the implanted systems. The electrodes appear suitable for long-term clinical use in permanently implanted lower extremity neuroprostheses. Continual refinement of the current surgical procedure for electrode installation should result in improved specificity and strength of the stimulated responses.

BACKGROUND

The long-term performance of the CWRU epimysial electrodes are well documented in the muscles of the upper extremity [1, 2]. They have successfully provided individuals with mid-cervical level SCI with active palmar prehension and lateral pinch. To date, epimysial electrodes have been implanted in over 60 individuals world-wide as part of a hand grasp neuroprosthesis, and have been functional in one user for more than 10 years. Only one mechanical failure of an epimysial electrode has been reported in over 700 electrode-years of operation in these systems, and tissue responses from

implantation and chronic stimulation of these electrodes are medically acceptable [3].

The performance of epimysial electrodes in lower extremity (LE) muscles of persons with complete SCI has yet to be determined.

Previous attempts to implant epimysial electrodes of a different design into LE muscles of stroke survivors and persons with incomplete SCI have been encouraging [4]. Functional muscle contractions were obtained from epimysial electrodes with percutaneous leads. In 33 epimysial electrodes implanted in the hip and knee muscles of six individuals with partial paralysis, all generated contractions of greater force than with surface stimulation, and only one failure (breakage at the electrode exit site) was reported. The muscle forces generated by stimulation were sensation-limited in all these patients. The absence of sensory responses in the LE of individuals with complete SCI could therefore make them suitable candidates for an implanted neuroprosthesis employing epimysial electrodes and the IRS-8.

RESEARCH QUESTIONS

The goals of this study are to: 1) investigate the stability and performance of implanted epimysial electrodes in the LE muscles of individuals with long term SCI, and 2) determine whether these electrodes can reliably produce adequate joint moments for functional standing and stepping. Results should indicate the suitability of epimysial electrodes for permanent implantation in a clinical neuroprosthesis for LE function in persons with complete SCI.

METHODS

Three persons with SCI (injury levels C6-T10) volunteered for the study. Two were im-

PERFORMANCE OF EPIMYSIAL ELECTRODES IN THE LOWER EXTREMITY

planted with an IRS-8 for use as a functional neuromuscular stimulation (FNS) standing system, and one received two IRS-8's for use as a 16 channel FNS stepping system. A total of 24 epimysial electrodes have been implanted into various LE muscles of these individuals. More specifically, instrumented muscles include: the full Quadriceps (QUAD), Vastus Lateralis (VL), Sartorius (SART), Tensor Fasciae Latae (TFL), ischial portion of Adductor Magnus (PADD), Gluteus Maximus (GMAX), Hamstrings (HAM), and Tibialis Anterior (TA). In all volunteers, the trunk extensors were instrumented with surgically-implanted intramuscular electrodes because the segmental innervation of these muscles precluded the use of epimysial electrodes. In one subject, four implanted intramuscular electrodes were combined with four epimysial electrodes in an eight-channel standing system.

A two week period of bedrest after surgical implantation of the epimysial electrodes was required to promote encapsulation. An additional two weeks of restricted activity further promoted complete healing. Stimulation pulse width (PW) threshold measurements were taken at four weeks, and regularly thereafter to ascertain electrode stability.

Daily exercise was initiated by the eighth week, and continued for 24 weeks. Around 16-20 weeks post-implant, the moment generating capacities of the electrodes were measured using a Cybex II dynamometer. The QUAD and VL electrodes were tested isokinetically at 30°/sec using a 16% duty cycle. The SART, TFL, PADD, GMAX, and HAM electrodes were tested isometrically at six angles (0, 10, 20, 40, 60, and 90°) of hip flexion using a 20% duty cycle. The stimulation for all tests was a 20mA biphasic, charge-balanced, asymmetric, cathodic current pulse train at 30Hz. The PW for all tests was fixed at 200 μ S. The hip flexor and extensor electrodes were tested individually and in combination, with the knee fixed in extension. The order of stimulation was randomized

to minimize the effects of fatigue. The Cybex II signals were sampled at 100Hz, and digitized for off-line reduction.

RESULTS

To date, all 24 epimysial electrodes implanted in the LE muscles remain functional. This represents more than 24 electrode-years of operation with no mechanical failures. In one subject, all epimysial electrodes yield functional and repeatable moments more than 15 months post-implant. In another, functional and repeatable results are generated more than 13 months post-implant.

Stimulation PW threshold measurements show that roughly 80% of the implanted electrodes are stable at eight weeks post-implant, with the remainder stabilizing by the 18th week. Examples of these stimulation thresholds over time are given in Figure 1.

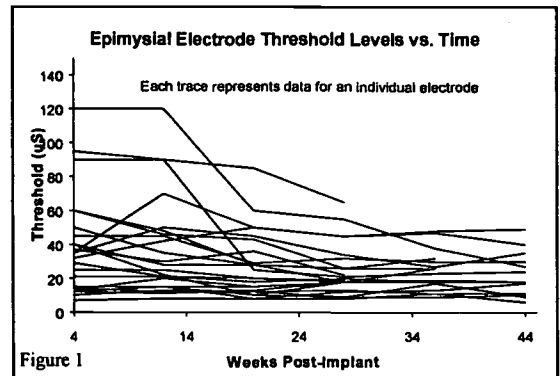

The peak moments generated by individual electrodes are shown in Figure 2. Simultaneous activation of multiple muscles in a functional group yield peak joint moments roughly equal to the sum of the individual peak moments. In all subjects, the simultaneous activation of hip extensors generates unilateral peak hip extension moments between 20 and 50Nm. Similarly, the simultaneous activation of hip flexors in the FNS stepping system generates unilateral peak hip flexion moments of 7 to 27Nm.

The knee extension moments generated by activation of the VL electrodes are roughly 60% of those generated by the full QUAD electrodes.

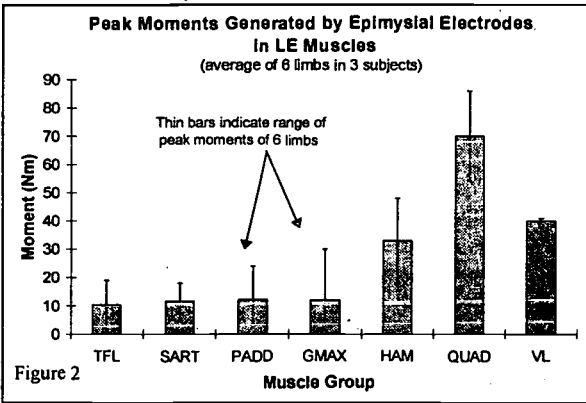

DISCUSSION

Surgical implementation of a totally implanted eight or 16 channel FNS systems utilizing epimysial electrodes has been demonstrated in three volunteers. Stimulated responses are stable and of sufficient strength for function. These preliminary data on epimysial electrode performance in the LE muscles are encouraging. Because these totally implanted FNS standing and stepping systems are providing function more than one year after implantation suggests that epimysial electrodes are an effective vehicle for delivering the stimulation signal to the target muscle.

Not apparent from Figure 2 are the large variations in moments produced by the same muscle in different limbs, even in the same subject. All electrodes show some asymmetry between limbs.

The activation of the full QUAD versus VL alone provides more knee extension moment for the sit-to-stand transition. One problem with this strategy, however, is the unavoidable activation of biarticular muscles (rectus femoris and SART) which act antagonistically to the hip extensor and QUAD electrodes. Activation of either degrades hip extension, and activation of SART degrades knee extension and ultimately compromises the standing posture.

There appears to be a position dependence in one of the two QUAD electrodes with hip flexion angle (the knee will only fully extend if the hip is extended). Some degradation in the

overall knee extension after continuous stimulation is also observed in the same electrode, suggesting that current spillover to SART overcomes the QUAD component and results in knee flexion after several minutes.

The unilateral knee and hip extension moments for rising from a chair with the aid of arms are in the range of 40Nm and 50Nm, respectively [5, 6]. Given these values, it is apparent from Figure 2 that the moment generating capacity of both knee and hip extensors needs improvement. Although the total hip extension moments from Figure 2 are similar to those reported by Waters [4], it is possible that larger hip and knee joint moments can result from continual refinement of the surgical approaches to optimize the electrode position relative to the target motor point.

REFERENCES

1. M.W. Keith et al., "Implantable functional neuromuscular stimulation in the tetraplegic hand." *J. Hand Surg.*, vol. 14, pp. 524-530, 1989.
2. K.L. Kilgore et al., "An implanted upper extremity neuroprosthesis: A five patient review." *J. Bone Joint Surg.*, vol. 79A, pp. 533-541, 1997.
3. J.M. Akers et al., "Tissue response to chronically stimulated implanted epimysial and intramuscular electrodes." *IEEE Trans. Rehab.*, vol. 5, no. 2, June 1997.
4. R.L. Waters et al., "Therapeutic electrical stimulation of the lower limb by epimysial electrodes." *Clin. Ortho.-Rel. Res.*, vol. 233, pp. 44-52, 1988.
5. T. Bajd et al., "Standing up of a healthy subject and a paraplegic patient." *J. Biomechanics*, vol. 15, no. 1, pp. 1-10, 1982.
6. A. B. Schultz et al., "Biomechanical analyses of rising from a chair." *J. Biomechanics*, vol. 25, no. 12, pp. 1383-1391, 1993.

ACKNOWLEDGMENTS

This work was supported by the Cleveland FES Center, the FDA Office of Orphan Product Development, the NIH and the Rehabilitation R&D Service of the Department of Veterans Affairs.

James P. Uhler
 Cleveland VAMC
 10701 East Blvd. (151A)
 Cleveland, Ohio, 44106

237

FUNCTIONAL ELECTRICAL STIMULATION APPLICATION¹ FOR AUGMENTATION OF GAIT IN ADOLESCENTS WITH INCOMPLETE TETRAPLEGIA

RL Finson, RR Betz, MJ Mulcahey, J Akers, D Bonaroti
Shriner's Hospitals for Children, Philadelphia Unit
3551 North Broad Street
Philadelphia, PA 19140

ABSTRACT

Two adolescents with incomplete tetraplegia underwent percutaneous implantation of intramuscular electrodes to deliver functional electrical stimulation (FES) for reciprocal gait augmentation. Both subjects presented similarly, with asymmetrical weakness in lower extremities, the majority of weakness within the L5-S1 myotome, and significant gait compromise resulting in limited household level ambulation. Electrode placement for each subject was unilateral in the weaker lower extremity. Stimulation was delivered using a 16 channel research grade portable stimulator. Prior to implantation of electrodes and following training in the use of the FES system, data were collected for each individual on strength, range of motion, gait analysis, and energy expenditure. Initial findings from these pilot subjects suggest that FES may have beneficial effects on physiologic and functional performance of upright mobility.

BACKGROUND

FES applications to restore stance and mobility in persons with spinal cord injury have been and remain the source of much interest in research (1). Most recent applications of implant FES technology for upright mobility have focused on restoring function in individuals with complete SCI (2).

Comparatively, little work has been done exploring the application of FES for upright mobility to children and adolescents with incomplete tetraplegia. Yet many of these children are able to stand and walk only with significant lower extremity bracing, high demands on the upper extremities, at slow velocities, and using abnormally high levels of energy (3,4,5). FES may provide an alternative for these children to improve gait and diminish energy expenditure during gait.

RESEARCH QUESTION

Can the use of FES delivered intramuscularly via percutaneous electrodes

impact positively on strength, range of motion, gait kinematics, spatiotemporal gait characteristics, and energy expenditure in adolescents with incomplete tetraplegia?

METHOD

Two subjects with incomplete tetraplegia participated in this pilot study. Subject 1 was a 12 year old who presented with C5-6 incomplete tetraplegia, 3 years post excision of a cervical spine astrocytoma. Primary areas of motor function loss were at C7-8 and L5-S1 in the right lower extremity. Due to upper extremity weakness of elbow extensors and finger flexors, she utilized a platform rolling walker primarily for physiologic and some household level walking. Her primary means of mobility in community and school was a wheelchair. Subject 2 was a 16 year old with C7 incomplete tetraplegia as a result of a C5-6 fracture sustained in a MVA, also 3 years post injury. Primary areas of weakness also were in the C7-C8 myotome in bilateral upper extremities and in the L5-S1 myotome in the left lower extremity. Subject 2 had previously undergone tendon transfers to restore volitional hand function in both upper extremities and as a result was able to utilize lofstrand crutches for limited ambulation for occasional household level gait.

Prior to FES, subject 1 ambulated using a reverse walker with bilateral forearm platforms and a right AFO. Utilizing muscle strength tests and EMG data from gait analysis of subject 1, the following gait characteristics were identified. Diminished activity of right pelvic girdle musculature (gluteus maximus, gluteus medius, and iliopsoas) along with bilateral hip flexion contractures translated into excessive pelvic motion in all three planes (sagittal, coronal, and transverse) and diminished right hip flexion/extension throughout the gait cycle. Poor right knee flexor activation resulted in diminished knee flexion in swing and contributed to excessive coronal plane pelvic motion. Absent muscle

activity at the right ankle complex resulted in severe foot drop and a resultant need for AFO.

Prior to FES, subject 2 ambulated using lofstrand crutches, left shoe lift, and a right AFO. Muscle strength tests and EMG from gait analysis revealed diminished activity of the left gluteus maximus and hip rotators, left hamstrings and quadriceps, and left ankle complex. These, combined with elevated extensor tone in the left leg, lead to the following gait deficits. Lateral shift of trunk to the right to assist in initiating left swing, pelvic instability and tendency toward anterior tilt consistent with proximal weakness, limited left knee flexion in swing and excessive hyperextension in stance, and severe left foot drop in swing phase of gait.

Both subjects were implanted with electrodes in hip extensors and hip abductors. Subject 1 was also implanted with an electrode to stimulate the peroneal nerve for a withdrawal reflex to facilitate stepping/swing during gait. Subject 2 was implanted with electrodes in the vastus lateralis and biceps femoris. Subject 2 also had an electrode placed near the L2 nerve root to stimulate hip flexion.

Following electrode placement, subjects underwent a 4 week strengthening program using FES for exercise. This was followed by gait programming and training with the FES system. Gait programming and training ranged from 1 week (Subject 1) to three weeks (Subject 2). Stimulation was delivered by a 16 channel research grade stimulator producing a biphasic asymmetrical current at a frequency of 20 Hz, an amplitude of 20 mA and pulse widths from 0-150 microseconds. Timing of stimulation was controlled during gait using force sensing resistors (FSR) incorporated into shoe orthoses and worn on the contralateral or "control" lower extremity.

FSR orthotics for both subjects were fabricated with four sensors, one each in the toe, medial mid-foot, lateral mid-foot, and heel. Placement of sensors in the orthotics was determined using a pressure mapping system placed in subjects shoes during gait. Areas of the foot with larger ranges of pressure were used as sensor locations. During stance of the "control" leg, as pressure transitioned first from the heel, to mid-foot and then to toe, feedback from the sensors was used to turn stimulation on or off for key gait events in the stimulated leg. Events detected were "anticipating" initial

contact, early and mid stance, and "anticipating" swing. In this way, the system was able to "anticipate" approaching gait events rather than react to events already occurring as when the sensors are placed in the shoe of the stimulated leg.

Data were collected on spatiotemporal gait characteristics, maximal ambulation distance and velocity, and energy expenditure prior to implantation. Then following training, after 3 months of home use, data were collected under "FES on" and "FES off" conditions.

RESULTS

Following FES training and 3 months of home use, both subjects exhibited carry over improvement in the step length of the leg receiving stimulation, cadence, velocity, maximum ambulation distance, and energy expenditure as compared to baseline measures. Data collected also indicated that for some of the measures, there was a direct benefit of FES walking as compared to non-FES walking. Summary data for the two subjects are shown in Tables 1 and 2.

Table 1: Results of Subject 1

(Shaded areas indicate clinically significant changes)

Measure	Base line	Post Training		3 Mo. Post Training	
	FES Off	FES On	FES Off	FES On	FES Off
R Step Length (cm)	54	43	50	61	56
Cadence (steps/min)	66	64	57	77	84
Velocity (meter/min)	14.1	16.0	16.3	36.5	37.1
Max Amb Dist. (meters)	92	92	92	213	268
Energy Expend (ml/kg/m)	N/T	0.62	0.68	0.57	0.63
Max Knee Ext @ IC (degrees)	-15	-5	-10	-20	-15
Max Hip Flex @ IC (degrees)	50	35	45	50	50
Max Knee Flex @ PS (degrees)	35	55	40	50	40
Max Hip Ext @ PS (degrees)	-20	-10	-10	-25	-25

IC - Initial Contact

PS - Pre-Swing

Voluntary muscle strength of subject 1 in two of the implanted muscles (gluteus maximus and gluteus medius) improved by at least one full muscle grade as did an increase of

PROM in subject 2's hip extension of the stimulated leg (from -5° to $+10^{\circ}$), suggestive of carry over effect of FES.

Positive effects of FES seen during gait analysis of subject 1 are improved stability of pelvis in coronal plane at terminal stance, less anterior tilt of pelvis, and less right hip adduction during stance and swing. No significant changes were noted at the knee and ankle in the sagittal plane although peak right knee flexion at toe off increased from 50° to 55° .

Positive effects of FES seen during gait analysis of subject 2 are less pelvic drop on right during left stance, diminished left hip abduction (or circumduction) during left swing, and increased left hip and knee flexion during swing. No significant changes were detected at the ankle

Table 2: Results of Subject 2

(Shaded areas indicate clinically significant changes)

Measure	Base line	Post Training		3 Mo. Post Training	
	FES Off	FES On	FES Off	FES On	FES Off
L Step Length (cm)	20	25	33	42	39
Cadence (steps/min)	33	32	39	37	38
Velocity (meter/min)	12.0	16.0	14.2	15.6	20.7
Max Amb Dist (meters)	43	85	89	159	145
Energy Expend (ml/kg/m)	1.09	0.78	0.86	0.66	0.55
Max Knee Ext @ IC (degrees)	+20	+20	+20	+10	+20
Max Hip Flex @ IC (degrees)	35	45	25	40	35
Max Knee Flex @ TO (degrees)	35	45	25	40	35
Max Hip Ext @ TO (degrees)	+5	+5	+10	0	+05

IC - Initial Contact

PS - Pre-Swing

DISCUSSION

FES applications for reciprocal gait augmentation in adolescents with incomplete cervical level SCI appear feasible. Sagittal plane motion at the hip and knee for both subjects and energy expenditure in subject 1 showed improvements with FES walking compared to no-FES walking. Velocity,

maximal ambulation distance, and energy expenditure are those aspects of gait which demonstrated the most benefit from baseline to 3 months post training in these pilot subjects. Following FES intervention, both subjects reported an increase in amount of time spent ambulating outside the home, both began to use system to perform limited ambulation (between classes) at school. Direct as well as carry over benefits of FES may both potentially emerge but additional research is needed to further explore and define applications and benefits of FES as an intervention in this population.

REFERENCES

1. Popovic DB. Functional Electrical Stimulation for Lower Extremities. In: Stein RB, Peckham PH, Popovic DB, editors. Neural Prostheses: Replacing Motor Function After Disease or Disability. New York: Oxford University Press, 1992:202-32.
2. Bonaroti D, Betz R, Akers J, Mulcahey MJ. Functional Comparison of FES and KAFO's in an Ambulatory Child with Complete Thoracic Level SCI. JSCM, 20(1) 1997, 147
3. Vogel LC, Lubicky JP: Ambulation in Children and Adolescents with Spinal Cord Injuries. J. Ped. Ortho. 15:510-516, 1995.
4. Perry JP: Gait Analysis. SLACK Inc., Thorofare, NJ, 1992.
5. Waters RL, Lunsford BR, Perry J, Byrd R: Energy-Speed Relationship of Walking: Standard Tables. J Ortho Res. 6: 215-222, 1988.

ACKNOWLEDGEMENTS

This study was funded by the Shriners's Hospitals for Children grant # 9530.

Rick Finson, MS, PT
Research Department
Shriners's Hospital for Children
3551 North Broad Street
Philadelphia, PA 19140
(215) 430-4000

EVALUATION OF THE FREEHAND SYSTEM IN ADOLESCENTS WITH TETRAPLEGIA

M.J. Mulcahey, Randal R. Betz, Lawrence C. Vogel, Michelle A. James, B.T. Smith
Research Department
Shriners Hospitals for Children, Philadelphia
Philadelphia, PA

ABSTRACT

The Freehand System, an eight channel functional electrical stimulation (FES) system designed to provide hand function, was implanted in eleven adolescents with C5 or C6 level spinal cord injuries (SCI). To date, nine adolescents have completed Freehand System training and were tested in their ability to perform either pre-selected or self-selected activities both with the Freehand System and their alternative method (ie: wrist driven flexor hinge orthosis or adaptive equipment). Data were also obtained on adolescents' preference of activity performance and, for self-selected activities, satisfaction of activity performance with the Freehand System. Data on 61 with-
out comparisons were obtained from fifteen activities. With Freehand System, the adolescents were independent in 7% of the comparisons. With the Freehand System, almost 90% of the ADL tested were performed either independently or with simple adaptive equipment. The Freehand System was preferred for performance in 61% of the comparisons and when asked if they were satisfied with the Freehand System for self-selected activities, 68% of the time adolescents answered "yes."

BACKGROUND

Surgical reconstruction techniques and FES systems have been refined over the past three decades to restore hand function to persons with SCI. Persons with low-level tetraplegia (C6-C8) are able to undergo surgical tendon transfers to restore multiple voluntary hand movements [1-3]. Outcomes of tendon transfers for active hand function in this group of persons with SCI include increased pinch and grasp force and greater independence in unilateral and

bilateral activities [4, 5]. For persons with mid-cervical injuries (C5-C6), options are limited for active hand function by tendon transfers because of the extent of paralysis. However, FES systems [6] are available to provide stimulated grasp and release enabling independent pursuit of self-care, avocational and vocational activities.

One FES system, the Freehand System, is an eight-channel device that uses a totally implanted stimulator and implanted electrodes [7]. The Freehand System combines surgical reconstruction to provide optimal hand placement and an efficient, balanced hand grasp and release. Implantation of the Freehand System involves suturing eight electrodes onto the paralyzed muscles. Typically, up to three electrodes are used to provide optimal hand placement (triceps, wrist extensors, pronator quadratus); the remaining electrodes are sutured onto the muscles necessary for hand grasp and release. The electrode leads are tunneled subcutaneously to the implanted stimulator that is sutured in the chest anterior to the pectoralis major muscle. Opening and closing of the hand is controlled in a proportional fashion with movements of the contralateral shoulder that are transduced by a position sensor [8]. "Locking" the hand in a desired position is achieved by a quick movement of the shoulder which allows the FES user to hold an object for prolonged periods (ie: a pen for writing) without maintaining a constant shoulder position [9]. Surgical reconstruction in the form of tendon transfers (if sufficient strength), tendon synchronizations, lengthenings and releases, and arthrodeses are performed to enhance the overall function of the limb, improve the posture of the hand during stimulation and eliminate the need for an orthosis [10].

RESEARCH QUESTION

There are three research questions: 1\What is the outcome of the Freehand System on adolescents' ability to perform activities of daily living (ADL)?; 2\ Do adolescents prefer using FES to perform ADL?; 3\ Are adolescents satisfied with FES during performance of ADL?

METHOD

Eleven adolescents with C5 or C6 level SCI underwent surgical implantation of the Freehand system and multiple augmentative soft tissue procedures including tendon transfers for voluntary elbow and wrist extension, flexor pollicis longus split tendon transfer or arthrodesis procedures to stabilize the thumb, an intrinsic tenodesis procedure, synchronization of the finger flexor or extensor tendons and biceps re-routing. Post-operative management consisted of a two-to-four week period of immobilization, tendon transfer training and stimulated exercise using the Freehand system. Each adolescent also underwent FES training during which time the adolescents were taught how to control their FES systems and how to employ them to independently perform a wide range of ADL. To date, nine adolescents have completed ADL training with the Freehand System and have undergone testing.

Adolescents were tested in either pre-selected or self-selected activities both with FES and their alternative method (ie: wrist-driven flexor hinge orthosis, adaptive equipment). For all adolescents an independence score was assigned to each activity using a five-point likert scale ranging from complete independence, defined as performance using one hand, to complete dependence, defined as performance with the assistance of another person. The test was administered at baseline (before FES implantation) and following FES training with and without the Freehand system. During post FES data collection, preference data were obtained on each of the tested ADL by asking the adolescents "which method (FES or alternative)

do you prefer to perform this activity?" For the self-selected ADL, adolescents were asked if they achieved their desired level of independence with the Freehand System.

RESULTS

Data on 61 with-without comparisons were obtained from fifteen different ADL; five adolescents were tested on six pre-selected ADL (30 trials) and the others were tested on self-selected ADL (31 trials). All of the adolescents were tested in eating, writing and brushing teeth; other activities included computer and telephone use, applying make-up, shaving and catheterization.

Without FES, the adolescents were independent in only 4/61 comparisons (7%). With the Freehand system, they were independent in 39/61 comparisons (64%) and required adaptive equipment in 15/61 comparisons (25%). Adolescents preferred using the Freehand system in 37/61 comparisons (61%). For the comparisons in which adolescents were asked "Did you achieve your goal with the Freehand System," 68% of the time they answered "yes".

DISCUSSION

The Freehand System was designed to restore stimulated hand function to persons with C5 or C6 level SCI who are unable to benefit from surgical reconstruction alone because of the extent of paralysis. In this study, eleven adolescents were implanted with the Freehand system and provided with stimulated grasp and release; all nine adolescents who have been tested to date have demonstrated positive outcomes on performance of ADL.

With FES, almost 90% of the ADL tested were performed either independently or with simple adaptive equipment (ie: straw, felt pen rather than Bic pen). For those with stimulated elbow extension and/or forearm rotation, modifications to the equipment (ie: positioning objects close to trunk or bending utensil handles)

Freehand System in Adolescents with SCI

were no longer necessary. Likewise, stimulated wrist extension stabilized the hand for function in the absence of a wrist orthosis.

In addition to being more independent with the Freehand System, for the majority of comparisons adolescents also preferred using the Freehand System over alternative methods and attained their desired level of function while using the Freehand System. In general, preference and satisfaction spoke more to the amount of effort required and the cosmesis of activity performance rather than independence. If performance of an activity was easier and "looked more normal" with the Freehand System, adolescents always preferred using the Freehand System. On the other hand, if there was not a difference in effort or cosmesis, adolescents typically preferred "getting by" without the Freehand System. These data are important considerations in goal setting, rehabilitation and assessment of outcomes of the Freehand System in home, school and work environments.

The ability of adolescents to use their hands to complete ADL without physical assistance, extensive modifications to the ADL objects and multiple pieces of adaptive equipment is important in their pursuit of autonomy. Coupled with providing brace-free hand function and requiring minimal effort during activity performance, the capabilities afforded by the Freehand System offers adolescents with C5 and C6 level tetraplegia an effective and cosmetically pleasing device to independently engage in ADL.

REFERENCES

- [1] Freehafer A, Kelly C, Peckham P, (1987). Planning tendon transfers in tetraplegia: "cleveland technique." In Hunter J, Schneider L, Mackin E (eds), *Tendon transfer surgery*. St. Louis: CV Mosby, 506-515.
- [2] Hentz VR, House J, McDowell C, Moberg E, (1992). Rehabilitation and surgical reconstruction of the upper limb in tetraplegia: an update. *J Hand Surg* 17A:964-967.
- [3] Freehafer A, Vonhaam A, (1974). Tendon

- transfers to improve grasp after injuries of the cervical spinal cord. *J Bone Joint Surg* 56A:951-959.
- [4] Hentz V, Brown M, Keoshian L, (1985). Upper limb reconstruction in quadriplegia: functional assessment and proposed treatment modifications. *J Hand Surg* 8A:119-131.
- [5] Freehafer A, (1991). Tendon transfers in patients with cervical spinal cord injury. *J Hand Surg* 16A:804-809.
- [6] Smith B, Gardner E, (1996). Functional electrical stimulation. In: Betz R, Mulcahey M, (eds), *The child with spinal cord injury*. Rosemont, IL: American Academy of Orthopaedic Surgeons, 731-750.
- [7] Smith B, Peckham P, Keith M, et al., (1987). An externally powered, multichannel implantable stimulator for versatile control of paralyzed muscle. *IEEE Trans Biomed Eng*, 34:499-508.
- [8] Kilgore K, Peckham P, Thrope G, Keith M, Gallagher-Stone K, (1989). Synthesis of hand grasp using functional neuromuscular stimulation. *IEEE Trans Biomed Eng*, 36:761-770.
- [9] Johnson M, Peckham P, (1990). Evaluation of shoulder movement as a control source. *IEEE Trans Biomed Eng*, 37:876-885.
- [10] Mulcahey M, Betz R, Smith B, Weiss A, Davis S, (1997). Implanted functional electrical stimulation hand system in adolescents with spinal injuries: an evaluation. *Arch Phys Med Rehab*, 78:597-607.

ACKNOWLEDGEMENTS

This work was funded by the Shriners Hospitals for Children and conducted at the Philadelphia, Chicago and Northern California Shriners Hospitals. Drs Albert Weiss and Michael Bednar and the OT Department at each of the Shriners Hospitals are acknowledged for their contributions. Hunter Peckham, Ph.D. and Mike Keith, M.D. are acknowledged for their pioneering work with the Freehand System.

M.J. Mulcahey, M.S., OTR/L
Shriners Hospitals for Children, Philadelphia
3551 North Board Street
Philadelphia, PA 19140
Phone: 215-430-4000

OUTCOME OF FUNCTIONAL ELECTRICAL STIMULATION IN THE REHABILITATION OF A CHILD WITH C5 TETRAPLEGIA

S.E. Davis, M. J. Mulcahey, R. R. Betz
Shriners Hospitals for Children
3551 North Broad Street
Philadelphia Pennsylvania

ABSTRACT

This pilot study reports the outcome of functional electrical stimulation (FES) and reconstructive surgery in the rehabilitation of a six-year-old female child with C5 tetraplegia. Study design was a single subject, before after trial measurement where data were collected at baseline (prior to) and following FES. Standardized physical and functional assessments were used to evaluate the effect of stimulated hand function and surgical reconstruction.

Following rehabilitation and FES training, the subject was able to perform activities with FES that previously required physical assistance. Her overall level of independence in ADL (activities of daily living) and age-appropriate skill abilities increased.

Additionally, based on standardized assessments, RD and her caregiver experienced increased level of satisfaction and performance on self-selected activities. Positive gains evidenced through this case study suggest the need to further investigate the utility of FES in young children with SCI.

BACKGROUND

For children with C5 motor level SCI, there are limited options to restore hand function (1). Functional electrical stimulation (FES) may offer an alternative to static and dynamic orthoses (2). With percutaneous and implanted FES systems, electrodes are placed at or near the motor point of the muscles required for grasp and release (3). In percutaneous systems, electrodes are hypodermically implanted and exit the skin, where they are connected to a portable stimulator via external cables (4,5). In totally implanted systems, electrodes and the stimulator are surgically placed under the skin and communicate with an external control unit through radio frequency (6). In both types of systems, control is accomplished voluntarily

through a control source such as a shoulder position transducer (5, 6).

When provided with hand function, adolescents with tetraplegia have demonstrated the ability to perform ADL (5, 6). Young children with tetraplegia are not only dependent on others to provide their basic self care, but also participation in play or learning activities are inhibited. By providing stimulated hand movement to young children with SCI, it may also be possible to expand their abilities to interact with the environment.

OBJECTIVE

The purpose of this investigation is to examine the impact and utility of FES hand function in a 6 year old child with C5 tetraplegia.

METHOD

Prior to FES, RD presented with bilateral internal rotation of 90° when positioned in shoulder abduction. Her right forearm rested in 100° of supination and lacked passive pronation range. Range limitations inhibited use of a universal cuff or dynamic splint for hand function.

To enable functional positioning of her arms, RD underwent external rotational osteotomies of both humeri and radial rotational osteotomy of her right forearm to release a supination contracture.

Implantation of 10 percutaneous electrodes to the right arm provided stimulated movement of wrist, finger and thumb extension; thumb adduction and abduction; finger and thumb flexion and; elbow extension. The electrodes exited her forearm at a common site and were connected via a cable to a research grade stimulator described elsewhere (7). Muscle response to electrical stimulation was programmed for both exercise and functional grasp.

Grasp was controlled through contralateral shoulder elevation and depression using a shoulder transducer switch.

Maintenance of hand position, to hold an object, was achieved by pressing a miniature button switch with her chin.

Physical and functional assessments, including range of motion, manual muscle testing, ADL abilities (8) and the Canadian occupational performance measure (COPM) (9) were used to evaluate the result of FES on functional ability. These were conducted prior to implantation and again following rehabilitation and FES training.

The ADL Abilities Test and COPM were used as both a training and testing tool. Six developmentally appropriate, standardized activities assessed functional ability in ADL. The activities were: coloring in a picture, eating with a spoon, computer access, brushing teeth, eating small food with hands and drinking from a cup with a handle. A scale ranging from physical assistance to independent performance using one hand was used to measure independence. Varying levels of independence between the two conditions included; self assistance, supervision, adaptive equipment and orthotic assistance.

Using the COPM, the client and her mother identified five goals: 1. self feeding with a fork, 2. self feeding with hands, 3. brushing teeth, 4. writing her name and 5. painting her fingernails. For each goal, satisfaction and performance were rated by the patient's mother using a Likert scale anchored between one (most negative) and ten (most positive) (9). These scores are then weighted by an importance score, which is ranked in the same manner.

Therapeutic intervention included FES training, activity grading, encouragement of independent problem solving, and adaptive modifications to promote access. All COPM training and testing were performed with FES. Rehabilitation and data collection were conducted by the primary author.

RESULTS

With FES, physical, functional and satisfaction data demonstrated positive change. Passive range in shoulder internal rotation in both arms improved from 150° to 70° on the right and from 125° to 100° on the left, enabling RD to bring her hand to her mouth. In her right forearm, hyper-supination range improved, from 115° to 30° and passive pronation improved from -22° to 90°. Overall strength increased at study completion at the shoulder bilaterally. Both

shoulder flexion and abduction strength increased from a 2+ to 3+ on the right arm. On

the left, shoulder abduction strength increased from a 2+ to 3+ and horizontal abduction strength increased from 1 to 3-. No decrease in strength was evidenced throughout.

As shown in Table 1, RD no longer required physical assistance (PA) in 3 of 6 ADL activities. For eating with a spoon, coloring with a crayon, and drinking from a cup all tasks were performed independently only using adaptive equipment (AE) during acquisition. Modifications to perform drinking included use of a small, 4 oz. handled cup. Because of insufficient pronation, for eating food with her hands, RD required PA during acquisition and for brushing teeth, required PA to access the right side of her mouth. For computer access, RD more easily performed this activity with a mouth stick, rather than using her hand to press individual keys. Overall, with FES, RD was more independent in bringing things to her mouth and holding them.

ACTIVITY	NO FES	FES
coloring/ crayon	PA	AE
eating/spoon	PA	AE
computer access	PA	PA
brushing teeth	PA	PA
eating/hands	PA	PA
drinking /cup	PA	AE

Table 1- ADL results post training without and with FES. Score depicts most dependent score for overall activity; shading indicates increased independence. PA= physical assistance, AE= adaptive equipment.

As shown in Table 2, all COPM scores increased. The total change in performance score was a 39.6 increase and total change in satisfaction score was a 49.6 increase following intervention.

The greatest increase in COPM scores occurred in satisfaction scores for eating with a fork and writing activities. Of performance scores, the greatest changes were in eating with a fork. The least change for performance and satisfaction was for painting fingernails.

Additionally with FES, RD not only was able to participate in tested and self-selected ADL, but demonstrated ability to play with toys, such as holding a doll and putting together

puzzles, which she was previously unable to do.

GOALS	Baseline		Post-Rehab	
	IxP	IxS	IxP	IxS
1.	20	10	80	90
2.	32	32	56	64
3.	16	16	48	48
4.	8	8	48	48
5.	6	6	48	54
	16.4	14.4	56	64

Table 2 - COPM results at baseline and post-rehabilitation. Key: I= importance, P= performance, S= satisfaction. See text for names of goals

DISCUSSION

With FES, RD was provided with the ability to interact with her environment in new and effective ways. Improved forearm rotation and proximal strengthening gained through rehabilitation and FES training both contributed to her ability to perform ADL. RD was able to engage in age-appropriate ADL using her hands, such as writing her name and feeding herself.

To use her FES system, RD switched her system on and off, opened, closed and maintained hand position independently. More importantly, she demonstrated that a young child with C-5 tetraplegia had the ability to use FES technology to improve upper extremity function and participate in age appropriate ADL.

Qualitatively, RD relied less on manipulating objects with her mouth when using FES. With FES, she was able to grasp objects tighter with her hand, producing less spills during feeding and drinking and exerting sufficient pressure for better results in brushing teeth and applying crayon onto paper. Evidence of this improvement is supported by positive change in COPM scores which indicated improvement of patient perceived opinion of satisfaction and performance for goal activities from baseline to post-rehabilitation.

Limitations inherent of the percutaneous system interface confine its application to research study. These factors include; complex set-up of stimulation for function, maintenance of percutaneous electrode sites exiting the skin and poor cosmesis of cables connecting electrodes to the stimulator.

Positive gains evidenced through this investigation suggest that FES can be beneficial to young children. Through this technology, children like RD may be able to benefit from use of an FES system by potentially contributing to the development of adaptive skills desirable for a more satisfying and independent future.

REFERENCES

- James, M. A., (1996) . Surgical treatment of the upper extremity: indications, patient assessment and procedures. In R. Betz & M.J. Mulcahey, *The child with spinal cord injury*. Rosemont: American Academy Orthopedic Surgeons.
- Mulcahey, M. J., (1996) . Upper extremity orthosis and splints. In R. Betz & M.J. Mulcahey, *The child with spinal cord injury*. Rosemont: American Academy Orthopedic Surgeons.
- Peckham, P.H., (1987) . Functional Electrical Stimulation: Current status and future prospects of application to the neuromuscular system in spinal cord injury. *Paraplegia*, 25, 279-288.
- Smith, B.T., Mulcahey, M. J., Triolo R.J., Betz, R.R., (1992) . The application of a modified neuroprosthetic hand system in a child with C7 spinal cord injury . *Paraplegia*, 30, 598-606.
- Mulcahey, M. J., (1994) . Functional neuromuscular stimulation: Outcomes in young people with tetraplegia. *Journal of the American Paraplegia Society*, 17, 20-35.
- Mulcahey, M. J., Betz, R. R., Smith, B. T., Weiss, A.A., Davis, S. E., (1997) . Implanted functional electrical stimulation hand system in adolescents with spinal injuries: An evaluation . *Archives of Physical Medicine and Rehabilitation*, 78, 597-607.
- Smith, B. T., Mulcahey, M. J., & Betz, R. R., (1996). Development of an upper extremity FES system for individuals with C4 tetraplegia. *IEEE Transactions in Rehabilitation Engineering*: 4-4, 264-270.
- Stroh K. C., Van Doren, C. L., Thrope, G., & Wijman, C. A., (1989) . Common object test: a functional assessment for quadriplegic patients using a FNS hand system . *Proceedings of the RESNA 12th Annual Conference*. New Orleans LA. 387-88.
- Pollack, N., Baptiste, S., Law, M., McColl, M.A., Opzoomer, A., and Polatajko, H. (1990) . Occupational performance measures: a review based on the guidelines for client-centered practice of occupational therapy . *Canadian Journal of Occupational Therapy*, 57-2, 77-87.

ACKNOWLEDGMENTS

This study was funded by the Shriners Hospitals for Children grant # 9530.

Sheryl E. Davis, OTR
 Research Department
 Shriners' Hospitals for Children
 3551 North Broad Street
 Phila PA 19140-4131
 215-430-4000

SELECTIVITY OF INTRAMUSCULAR STIMULATING ELECTRODES IN THE LOWER EXTREMITIES

May Q. Liu¹ and Ronald J. Triolo², Ph.D.
Departments of Biomedical Engineering¹ and Orthopaedics²
Case Western Reserve University, Cleveland OH

ABSTRACT

Functional electrical stimulation (FES) uses implanted electrodes to stimulate muscles paralyzed by spinal cord injury. FES often produces a phenomenon known as spillover. Spillover occurs when the stimulus intended for a particular muscle unintentionally activates another muscle, thus compromising the selectivity of the electrode. The purpose of this retrospective study is to determine the most common spillover patterns for intramuscular (IM) electrodes implanted in the lower extremities. Knowledge of these patterns will allow a surgeon implanting electrodes to better predict their ultimate selectivity and functional usefulness.

BACKGROUND

Persons with spinal cord injury often lose voluntary control of muscles below the level of injury. Functional electrical stimulation (FES) is currently being studied as a way to restore standing and walking abilities to persons with paraplegia.

The selectivity of an electrode can be difficult to control (3), and can be affected by a phenomenon known as spillover. Electrode spillover refers to any instance during which the stimulus intended for a particular muscle seems to be the direct cause of unintended stimulation of another muscle. This happens when the minimum stimulation level for the secondary muscle is reached before the optimum stimulation level for the primary muscle. The action of the secondary muscle may be synergistic or antagonistic with respect to the primary muscle's action, depending on the overall motion desired. Spillover usually occurs when an electrode is implanted at or near the branch of two nerves, or when an electrode drifts after implantation.

RESEARCH QUESTIONS

This study focused on determining when spillover can be expected to assist the primary muscle or when it might cause an antagonistic action and should be avoided. More specifically, the purpose was to determine if patterns of spillover exist, i.e., do electrodes implanted in particular muscles in the lower extremities

tend to spill over to certain muscles more frequently than to others. Furthermore, the relative frequencies of the spillover patterns were determined to help predict the outcome of future implant procedures. Finally, each pattern was classified as being helpful or counterproductive to standing and walking with FES.

METHOD

Data were collected from records of subjects who had participated in standing and walking FES programs at the Cleveland VA Medical Center in the last ten years. Each subject's record contained information on every electrode implanted, including threshold and maximum pulse durations, and comments on the muscle actions elicited. The threshold is the lowest pulse duration producing a just-noticeable contraction; the maximum pulse duration is that above which no further force is generated. This information had been updated periodically throughout each electrode's lifetime, providing a history that characterized its recruitment properties.

The records of ten subjects implanted with percutaneous intramuscular (IM) electrodes (4, 6) were examined. If data were recorded to show that an electrode was functional two months after implantation, the electrode was classified as "stable." Only data from a two to six month period following implantation were considered for each electrode. The data from this four month window reflected the electrode behavior at its peak performance and represented what can be expected from a stable system. Furthermore, this study focused only on electrodes implanted into the muscles used in standing and walking (3) except for the rectus abdominis, quadratus lumborum, gluteus minimus, adductor longus, and rectus femoris.

The information from all the records was combined and used to establish the most common patterns of spillover for each muscle. From the anatomy of the muscles and nerves of the lower extremity (1, 2) the most likely neural path of the spillover was determined. Finally, the possible advantages and disadvantages of

247

using each spillover pattern during standing and walking were analyzed.

RESULTS

Six-hundred and two electrodes were included in the study. Of those electrodes, 60% (358) were stable, while 30% (107) of the stable electrodes exhibited at least one episode of spillover. Some electrodes spilled over to more than one nerve or muscle. It was also found that 29 electrodes caused reflexes; reflex activation with IM electrodes has been previously noted (4). Results for selected muscles follow.

Vasti of the Quadriceps

Of the 74 stable quadriceps electrodes, 23 evidenced spillover. A significant number of these (22) spilled over through the femoral nerve; 11 stimulated the sartorius, causing abduction in several cases. Fourteen electrodes spilled over to the rectus femoris, which is usually undesirable because it causes hip flexion. Three electrodes spilled over to both the rectus femoris and the sartorius. One electrode caused internal rotation, possibly due to spillover through the superior gluteal nerve to the gluteus minimus or tensor fasciae latae.

Hamstrings (Figure 1)

These electrodes did not include those implanted specifically into the short head of the biceps femoris. There were 39 stable electrodes in the hamstrings, 15 of which showed spillover. All but one of these spilled over to the sciatic nerve. Seven of these electrodes recruited an unspecified muscle, while two others stimulated the posterior fibers of the adductor magnus. Four electrodes plantarflexed the ankle, presumably via the gastrocnemius and/or soleus, and two more caused an unspecified foot action -- probably also plantarflexion. Two electrodes in the hamstrings appeared to excite the superior gluteal nerve; one of them caused internal rotation, while the other abducted the leg. The gluteus minimus and/or tensor fasciae latae may have been activated in these cases. One electrode spilled over to the inferior gluteal nerve, stimulating the gluteus maximus.

Gluteus Maximus (Figure 2)

Of 35 stable electrodes in the gluteus maximus, 12 spilled over. Nine electrodes spilled over to the sciatic nerve; three of these activated an unspecified muscle. Three more stimulated the hamstrings. One electrode plantarflexed the ankle, probably via the gastrocnemius and/or soleus, while two more caused an

unspecified foot action. Again, this was probably plantarflexion. Four electrodes spilled over to the superior gluteal nerve, stimulating the gluteus medius.

Figure 1: Distribution of Spillover Electrodes for the Hamstrings (n=15)

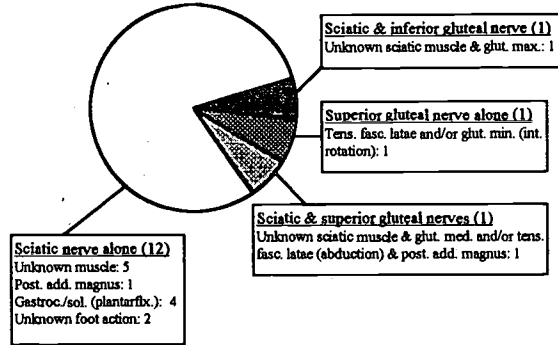
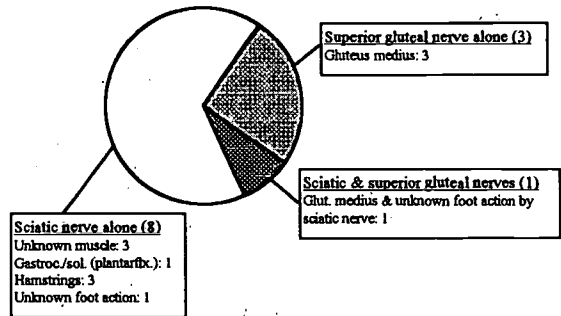

Figure 2: Distribution of Spillover Electrodes for the Gluteus Maximus (n=12)



Iliopsoas

Out of 12 stable electrodes, 8 spilled over to the lumbar nerve roots, which is where these electrodes were implanted. Three electrodes spilled over to the erector spinae, and the same number activated the abdominal muscles. Two more stimulated the quadratus lumborum. One of these also spilled over to the gracilis via the obturator nerve. Two electrodes activated the rectus femoris through the femoral nerve.

Reflex Response Results

Twenty-nine stable electrodes elicited various reflexes. Eight were also spillover electrodes. From the muscles discussed above, the quadriceps (5 electrodes), hamstrings (2 electrodes), and iliopsoas (1 electrode) were reflexive. However, the actual action caused by the reflex was rarely noted in the record books.

DISCUSSION

Implications for Using FES

Spillover patterns could affect electrode use in standing and walking with FES. Quiet stance involves several groups of muscles, while walking is clearly more complicated and requires various muscles in different phases (5). The spillover patterns from this study were grouped into helpful and unwanted patterns. The desirability of a spillover pattern may depend largely on the strength of the secondary action. However, even if an undesirable secondary action can be overcome by the primary muscle, it may take a great deal of metabolic energy to do so. Because walking is so complex, the advantages of using particular spillover patterns depend not only on the strength of the spillover action but also on the stage of the gait cycle.

Reflex Response

It is noteworthy that 15 of the 29 reflex electrodes were implanted in the lower leg muscles, implying that the lower leg may be more susceptible to reflex responses. Furthermore, 10 of the 29 reflex electrodes were in one subject, and 7 were from another. This suggests that there may also be a subject-related propensity for reflex response. Similarly to spillover, a strong reflex could affect the function and selectivity of an electrode.

Limitations of the Study

There are several limitations of this study. Because some subjects had more electrodes than others, any effects due to the anatomy of a few individuals may have affected a large portion of data. It should also be stressed that this study represents results from percutaneous intramuscular electrodes that may or may not be applicable to other electrode designs.

Conclusion

Even though an IM electrode is implanted into a particular muscle, it may be able to affect other muscles through nearby nerves. This spillover usually happens because of the proximity of another nerve or nerve branch and may

compromise the muscle selectivity of the electrode.

As predicted, several consistent and repeatable patterns of spillover and reflex activation emerged from this study. Some may be advantageous in standing and walking with FES, while others are undesirable. Surgeons and therapists using IM electrodes need to develop an understanding of these patterns and reflexes as this may lead to more success in predicting electrode function and selectivity in the future.

REFERENCES

1. Brash JC (1955). *Neuro-vascular hila of limb muscles*. London, England: E & S Livingstone, Ltd. 48-97.
2. Jenkins DB (1991). *Hollinshed's functional anatomy of the limbs and back*. Philadelphia, PA: W.B. Saunders. 187-301.
3. Kobetic R & Marsolais EB (1994). Synthesis of paraplegic gait with multichannel functional neuromuscular stimulation. *IEEE Trans Rehab Eng*. 2(2): 66-79.
4. Marsolais EB & Kobetic R (1986). Implantation techniques and experience with percutaneous intramuscular electrodes in the lower extremities. *J Rehab Res & Dev*. 23(3): 1-8.
5. Rose J & Gamble JG (1994). *Human walking* (2nd ed.) Baltimore, MD: Williams & Williams. 112-115.
6. Scheiner A, Polando G, & Marsolais EB (1994). Design and clinical application of a double helix electrode for functional electrical stimulation. *IEEE Trans Biomed Eng*. 41(5): 425-431.

ACKNOWLEDGMENTS

The authors wish to thank the staff of the Motion Studies Laboratory at the VA Medical Center in Cleveland for their assistance.

May Liu mql@po.cwru.edu
 Cleveland FES Center
 c/o Ronald Triolo, Ph.D.
 Case Western Reserve University
 11000 Cedar Road
 Cleveland OH 44106-3052
 Phone: (216) 791-3800

A COMPARISON OF THREE MECHANICAL INTERVENTIONS IN REDUCING LOWER LIMB EDEMA IN STROKE PATIENTS

Pouran D. Faghri, M.D., M.S., Christopher F. Hovorka, B.S., and William J. Pesce, D.O.
University of Connecticut, Department of Health Promotion & Allied Health Sciences, Storrs,
CT, and Hospital for Special Care, New Britain, CT

ABSTRACT

The affected leg of 10 hemiplegic CVA patients with a minimum of six months post-CVA were tested in this study. The effects of functional electrical stimulation (FES), sequential pneumatic compression device (SCD), leg elevation, and resting supine (control) on the lower leg volume and girth were evaluated. Leg volume was most reduced by FES, followed by control, leg elevation, and SCD. Compared to control, FES most notably reduced leg volume, followed by leg elevation and SCD. Leg girth was most consistently reduced at the proximal, middle and distal leg by FES. Leg elevation, control, and SCD treatments reduced leg girth more at the proximal and middle leg and least at the distal leg. Based on these findings, periodic FES-induced continuous contractions could be used as a preventive treatment to reduce edema in the affected lower limb of stroke patients.

BACKGROUND

In hemiplegic stroke, the accompanying paralysis can adversely affect vascular circulation causing numerous complications such as blood pooling due to immobility, edema, deep venous thrombosis, or pulmonary embolism. Common treatments include blood thinning drugs, leg elevation, or air compression sleeves to reduce edema. These treatments have side effects such as a predisposition to slow healing wounds, confinement to bed for positioning, or pressure sores to the limb. Functional Electrical Stimulation (FES) induced contraction in the lower extremity has recently been given attention as a useful alternative to medical treatments (1). Electrical stimulation increases the blood flow to the muscles receiving artificial stimulation (1,2,3). These studies show that the magnitude and frequency of FES-induced contractions may produce local hyperemia or decrease the blood volume in the limb. Impaired function of the calf muscle pump is responsible for venous hypertension,

leading to excessive accumulation of fluid and fibrinogen in the subcutaneous tissue, and results in swelling, lipodermatosclerosis, and finally ulceration. If blood flow is impaired particularly in the calf region, DVT or subsequent PE may develop. This is particularly important in patients who lose their muscle function due to paralysis. Periodic FES-induced continuous contractions may be used to activate the physiologic venous muscle pump and move the venous blood from the lower limb and reduce stasis (4). The purpose of this investigation was to evaluate and compare the effects of FES-induced intermittent contractions, SCD-induced intermittent compression, and continuous leg elevation on the lower limb edema of hemiplegic stroke patients.

MATERIALS AND METHODS

Subjects

Ten adult hemiplegic patients (seven male, three female,) participated in this study. All the subjects were free of any detectable cardiac conduction problem, a history of DVT or PE, and displayed less than moderate limb spasticity as defined by Ashworth (5). The mean \pm SE were for age 66.8 ± 2.08 years, height 168.26 ± 2.05 cm, weight 75.8 ± 3.43 kg. The affected leg (seven left, three right) was tested for each individual and all subjects had their stroke at least six months prior (22.6 ± 5.8 months). After signing an approved informed consent form, the subjects wore loose fitting gym shorts and participated in the experimental procedure.

Procedures

To screen for venous blockages, all subjects underwent a duplex Doppler ultrasound of both lower limbs prior to participation that was administered by a licensed sonographer and interpreted by a radiologist. Cleared subjects participated in each of four protocols where the subject's affected leg girth and volume were measured initially, after standing inclined to 45° in a tilt table for 10 minutes (to induce lower limb edema), and after administration of a

Reducing Lower Limb Edema

treatment. Treatments consisted of 30 minutes of: lying supine (control), leg elevation, SCD, and FES. Subjects participated in each of the four protocols only once on a single day and the order of each treatment was randomized.

Leg volume [a] was recorded by immersing each subject's affected leg in water 2.5 cm distal to the fibula neck and measuring the displaced water. Water temperature was maintained between 23-25 °C. Leg girth was measured using the Gulick tape measure [b] on each subject's affected leg at 25%, 50%, and 75% of the length from the ankle to knee.

The Respond Select Dual Channel Neuromuscular Electrical Stimulator [c] was used for FES-induced contractions. The stimulator has adjustments for stimulation intensity and stimulation timing. Medtronic Dual Lead Cables Model #86604000 [d] and Universal Bifurcating Wires #30108L [e] converted each single cable connection to a dual lead. PALS [f] reusable carbonized rubber skin surface electrodes were placed over motor points of the quadriceps, hamstrings, and calf (gastrocnemius-soleus and tibialis anterior). Two electrodes were placed over each muscle and the ES intensity was set to produce maximum muscle contraction without discomfort. The stimulator was programmed for: Channel 1 (calf stimulation) 11-sec ON, 60-sec OFF; Channel 2 (stimulating the quadriceps and hamstrings) 4-sec delay, 7-sec ON, 60-sec OFF. The programming enabled sequential contraction beginning at the distal leg that proceeded proximally up the leg and ended with co-contraction of the distal and proximal leg muscles.

The Intermittent Sequential Pneumatic Compression System [g] provides programmed leg compression for 11 seconds beginning at the ankle and progressing proximally to the thigh followed by a 60-sec period of deflation. An adjustable customized metal frame provided leg elevation.

RESULTS

Data were statistically analyzed using the SAS programming system (6). Descriptive statistics and the treatment means were compared.

Student t-tests were performed and significance was set at $p < 0.05$.

All treatments (including the control) produced a reduction in leg volume (Figure 1).

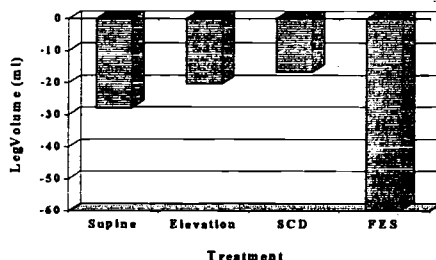

Figure 1. Effects of treatments on leg volume change after induced edema.

FES produced the greatest reduction in leg volume followed by control, leg elevation, and SCD.

When compared to the control, FES produced 213.8% of the volume reduction in the affected lower limb followed by leg elevation (72.94%), and SCD (59.9%) (Figure 2).

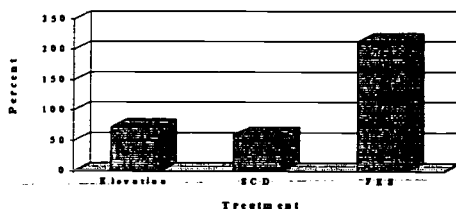

Figure 2. Percent change in leg volume of three treatments compared to supine.

The leg girth data shows that FES produced the greatest reduction overall at the distal leg (31 ± 15.82 mm), followed by the proximal leg (28 ± 10.44 mm) and middle leg (23 ± 19.94 mm) (Figure 3).

Compared to FES, leg elevation provided similar girth reductions at the proximal (29 ± 10.76 mm) and middle leg (27 ± 19.30 mm) followed by SCD which produced girth

Reducing Lower Limb Edema

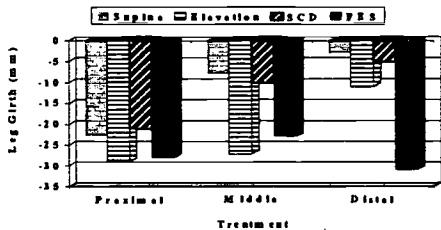

Figure 3. Effects of treatments on leg girth change after induced edema.

reduction primarily at the proximal leg (21 ± 8.86 mm). Leg elevation and SCD did not produce a notable reduction in leg girth at the distal leg.

Overall, only FES produced a consistent reduction among all three sections of the lower leg and reduced leg edema to a greater extent compared to leg elevation and SCD. Leg elevation and SCD produced their most notable reductions in girth at the proximal and middle leg.

DISCUSSION

All three mechanical interventions produced a reduction in edema, however this effect was more significant in the FES group. FES could be an effective system to reduce edema in stroke patients since it is lightweight and portable, induces direct contraction of the muscle, and maintains muscle integrity. In addition, the venous muscle pump is activated which mobilizes fluid within the limb. In this regard it may accelerate the recovery period. SCD and leg elevation do not induce direct muscle contraction and may exacerbate rehabilitation since they confine the patient to bed during their application which may adversely induce more edema or cause pressure sores to the limb due to prolonged positioning.

Conclusions

FES-induced contraction could be used to facilitate circulation and reduce limb edema in CVA patients. The timing and frequency of stimulation could be adjusted based on the symptom and the type of patients. Additional

studies are necessary to evaluate the long-term effects of FES on limb blood flow.

REFERENCES

1. Faghri, P.D. and Votto J.J. (1997). Circulatory responses to electrical stimulation of lower limb muscles of healthy subjects. *Proceed. of 20th Annual RESNA conference*, 271-273.
2. Babkin D., Timtsenko N. (1997). Notes from Y.M. Kots', Ph.D. (USSR) Lectures and laboratory periods. Canadian-Soviet exchange symposium on electrostimulation of skeletal muscles. Montreal, Quebec, Canada: Concordia University.
3. Cummings G. (1980). Physiological basis of electrical stimulation in skeletal muscle. *Certified Athletic Trainers Association Journal*, 3,7-12.
4. Pompe V.M., Hassani S., Faghri P.D., Glase R.M. (1995). Electrically-induced contractions vs. external compression for promoting venous return during hip and knee surgery. *Rehab Soc North Am*, 396-398.
5. Ashworth, B. (1964). Preliminary trial of carisprodol in multiple sclerosis. *Practitioner*, 192:540-542.
6. SAS Institute, (1994). *SAS User's Guide: Statistics. Version 6* (4th ed.), Cary, NC: SAS Inst.

MANUFACTURERS

- [a] Volumeters Unlimited, Phoenix, AZ.
- [b] Creative Engineering, Plymouth, MI.
- [c] Empi, Inc, St. Paul, MN.
- [d] Medtronic Inc., San Diego, CA.
- [e] Uni-Patch, Wabasha, MN.
- [f] Axelgaard Mfg. Comp. Ltd., Fallbrook, CA.
- [g] Kendall Health Care, Mansfield, MA.

ACKNOWLEDGEMENTS

This project was supported by a Rehabilitation Grant from Hospital for Special Care, New Britain, CT.

Pouran D. Faghri, M.D., M.S.
Department Head and Associate Professor
Health Promotion & Allied Health Sciences
University of Connecticut
358 Mansfield Road, U-101
Storrs, CT 06269-2102
(860) 486-0018; (860) 486-5378 (Fax)
Faghri@uconnvm.uconn.edu

Therapeutic application of neuromuscular electrical stimulation to improve tissue viability in persons with spinal cord injury.

Kath Bogie B.Sc., Ronald J Triolo Ph.D., John Chae MD
Rehabilitation Engineering Center
MetroHealth Medical Center
Cleveland, Ohio, U.S.A.

ABSTRACT

The therapeutic application of neuromuscular electrical stimulation (NMES) provides a technique to positively impact tissue viability characteristics such that the risk of tissue breakdown in paralyzed muscle can be reduced. The efficacy of NMES for prevention of pressure sores has been investigated.

Two subjects with spinal cord injury (SCI) were studied. Both subjects had electrodes implanted bilaterally into the gluteal muscles. Subject DN ceased long-term stimulation and was followed over a 6 month period. Subject GP commenced long-term stimulation and was followed over a 3 month period, with 2 months of routine stimulation. It was found that tissue viability status degraded in subject DN and showed some improvement in subject GP. Thus indicating that long-term NMES may decrease the risk of tissue breakdown, leading to pressure sores.

BACKGROUND

It is widely recognized that pressure sores are a major secondary complication of spinal cord injury which can have a extremely adverse effect on the quality of life of the individual. There is also a significant economic burden to be considered (1).

Historically, a variety of support media have been developed with the objective of preventing pressure sores by improving the distribution of external applied pressure. However, the incidence of pressure sores in the SCI population remains high (2).

Neuromuscular electrical stimulation has been employed primarily to improve functional abilities. However, it has also been observed that there is a concurrent increase in the strength and bulk of the paralyzed muscle receiving long-term stimulation. The primary site for tissue breakdown in the wheelchair user is in the region of the ischial tuberosities. The current study therefore assesses the effect of therapeutic NMES on the gluteal muscles using advanced implanted techniques.

RESEARCH QUESTION

The overall goal for this study is to develop an effective method for the long-term intrinsic improvement of tissue viability in paralyzed muscle using a novel application of the proven technique of implantable NMES technology. The primary question to be addressed by the current study is determination of the long-term effects of NMES on tissue viability status, specifically increased blood flow and bulk, in paralyzed gluteal muscles.

METHOD

Subject selection criteria for this study include complete motor and sensory spinal cord injury above the level of T12 and a significant history of pressure sores, sufficient to adversely affect daily living activities and/or the level of care required.

Baseline tissue characteristics are obtained through laboratory assessment prior to enrollment in the study. Tissue viability status is determined using transcutaneous gas

measurements (TINA TCM3, Radiometer Inc.) and interface pressure monitoring (Advanced Clinical Seating System, Tekscan Inc.). The subject sits in their wheelchair during the assessment.

Subject DN had a T5 complete lesion and had been involved in a standing/walking study utilizing implanted intramuscular electrodes for more than one year. The electrodes were then removed. Baseline assessment was made after he had ceased routine stimulation for approximately one month. Subsequent laboratory assessments of tissue gas levels and interface pressures were carried out monthly post-stimulation.

Subject GP had a C4 complete lesion. Percutaneous electrodes were implanted bilaterally into his gluteal muscles. Two electrodes were located over the gluteal nerve in each muscle, giving a 4-channel system (Figure 1). This approach is considered to optimize the recruitment of the gluteus maximus. All implanted material is caudal to the sitting region.

Figure 1: Supine view of electrode placement.

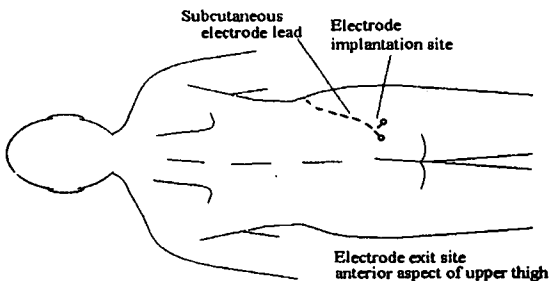

Following implantation, GP remained on complete bedrest for one week, followed by slow remobilization over the second week. This allows the electrodes to achieve good encapsulation, thus enhancing their longevity. Subject GP was then monitored for 6-8 weeks

without any stimulation in order to obtain control data. Weekly phone contact was maintained to ensure that he was monitoring skin status. Laboratory assessment of transcutaneous gas levels and interface pressures was carried out monthly. At the end of the non-intervention phase (Phase 1), a CT scan was taken to determine muscle cross-sectional area. The scans are performed with the subject lying supine. Transverse sections are taken across the gluteal region.

Subject GP then entered the intervention phase of the study (Phase 2). Stimulation is applied at night when the subject is in bed. Stimulation is applied at a frequency of 20Hz with a duty cycle of 2 seconds on, 8 seconds off. Increased muscle bulk can be produced by short stimulation periods however increased vascularisation is dependent on the number of muscle contractions. Thus maximal improvement in tissue viability is achieved with longer periods of stimulation. Subjects therefore receive the stimulation for one hour per day for the first week. Stimulation time is then increased by one hour every week to a maximum of six hours per day or to user tolerance if that is lower. Phase 2 conditioning stimulation is applied nightly for an 8-10 week period. Weekly phone contact was maintained throughout Phase 2, in addition to monthly laboratory assessments. Transverse CT scans of the gluteal region were repeated at the end of Phase 2.

RESULTS

Subject DN:

Mean seating interface pressures showed an increase of more than 10% over the 6 month study with a concurrent decrease in tissue oxygen levels (Figure 2). It was also found that peak pressure regions became more accentuated. The ischial region became more prominent and increased pressures were

observed in the sacral region at assessment 4 months post-stimulation.

Figure 2: Changes in tissue oxygen levels following withdrawal of NMES.

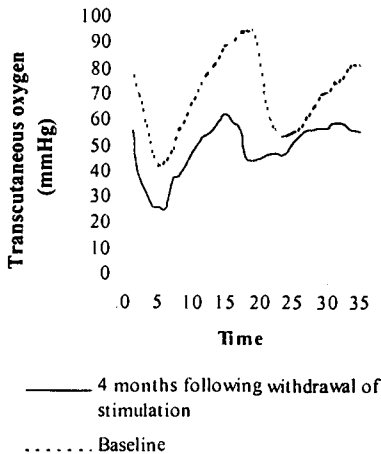

Subject GP

Tissue oxygen levels showed slight improvement as conditioning NMES was increased. Mean seating interface pressure showed a decreasing trend with exercise. Peak interface pressures also improved by approximately 10% with routine application of NMES.

DISCUSSION

The interface pressure and tissue oxygen assessments for these 2 subjects show a mirror image in tissue viability response over time, which can be related to neuromuscular electrical stimulation.

Ceasing regular application of NMES was found to produce a gradual deterioration in tissue viability, such that at 4 months post-stimulation significantly increased interface pressures were observed in the sacral region. Conversely, commencing routine application of NMES was found to produce a progressive

improvement in tissue viability status as the muscles become conditioned over time. These early findings imply that long-term use of NMES using implanted systems may improve the regional health of paralyzed muscle, thus reducing the risk of pressure sore development.

This study is continuing with further recruitment of persons with SCI who have a history of tissue breakdown.

REFERENCES

Book:

1. Graitcer PL, Maynard FM. (Eds.) Proc. 1st Colloquium on Prevention of Secondary Disabilities among people with spinal cord injury. Atlanta, GA: US Dept. Health and Human Services, Centers for Disease Control. p119, 1990.

Article:

2. Salzberg CA, Harmatz A, Byrne DW, D'Ariano G, Petro JA. Development of a computerized data base to evaluate pressure ulcers. *Decubitus* 3(3):29-36, 1990.

ACKNOWLEDGMENTS

This study has been funded by a grant from the Spinal Cord Research Foundation of the Paralyzed Veterans of America. The stimulator systems employed in the study were donated by NeuroControl Corp.

Kath Bogie
Rehabilitation Engineering Center
MetroHealth Medical Center
2500 MetroHealth Drive
Cleveland, OH 44109 U.S.A.

SIG-11
Computer Applications

TOWARDS TASK TRANSPARENCY: SCANNING TEXT SELECTION

G. Fraser Shein, Ph.D., P.Eng.

Bloorview MacMillan Centre & Institute of Biomedical Engineering, University of Toronto
Toronto, Ontario CANADA

ABSTRACT

This research explored a new view of transparent computer access for people who use switch-based scanning. Rather than mouse emulation through a scanning screen pointer, it was proposed to apply scanning to the underlying task and data. This is called *task transparency*. The work reported here demonstrates the application of this concept to selecting text. Three new strategies for positioning the insertion point by text scanning were evaluated through predictive analyses and experimentation. They were compared with each other and with a standard keystroke strategy. These strategies offered significant improvements in reducing key selections and switch activations.

BACKGROUND

Current access technology for people with disabilities is based on a concept called transparency. The general interpretation of transparency is that *an alternate access solution should emulate the input device(s) of a computer, i.e., keyboard and mouse, such that the target application is unaware that the input is not from the standard device(s)* [1]. Users with disabilities should then be able to equally access standard computers, operating systems, and applications. This approach may more appropriately be termed *device transparency*.

With respect to text entry, keyboard emulation with both direct and scanning access is generally effective because the keyboard function corresponds to the primary user task of entering text. This is not the case, however, for emulating mouse functions through scanning which generally involves some form of

scanning screen pointer. Indirect scanning mouse emulation is twice removed from most user tasks — by the indirect switch actions, and by the indirect pointing reference to the user task such as selecting an object or performing a command. The additional loss of directness detracts from the direct manipulation features of a graphical user interface and reduces the effectiveness of interaction. Controlling a scanning screen pointer for tasks such as text selection is often so difficult that users minimally edit text, or not at all.

I suggest that a scanning screen pointer is not necessarily required and further suggest that the current viewpoint of transparency diverts attention away from other potential access approaches because it focuses on device functionality. A new view of transparent access, called *task transparency*, is suggested. Task transparent design *involves allowing the user to directly access the underlying tasks and information without requiring the user to perform equivalent functions to the standard input devices*. With this view, scanning can be applied directly to the user task rather than higher-level pointing task [2].

RESEARCH QUESTION

This research sought new knowledge and understanding of the interactions that arise with a number of switch-based scanning strategies in a task transparent fashion. These strategies target the basic task of selecting text.

METHOD

Participants. The population that is being addressed includes those individuals who are constrained to switch-based scanning access

TASK TRANSPARENT TEXT SCANNING

methods. Within the experiment, however, twenty able-bodied individuals participated. Able-bodied subjects offered a practical means of accessing a sufficiently large pool of subjects with homogeneous physical skills to identify the key features of each strategy.

Text Selection Strategies

Strategy 1: Standard keystrokes. Text movement keys (characters, words, lines, or paragraphs) are repeatedly selected within an on-screen keyboard to move the text cursor until the target insertion point is reached. This strategy was used for comparison.

Strategy 2: Scanning text keys. The scanning method is applied to the task of moving the text cursor. When the user chooses a text movement key, the text cursor begins scanning by that increment. This is repeated with other text key increments until the target point is reached.

Strategy 3: Sequential scanning text keys. The scanning is applied to moving the text cursor using group scanning. The text cursor scans beginning with large movements followed by smaller movements until reaching the target point, e.g., by paragraphs, then by lines, words, and characters.

Strategy 4: Text scanning. This strategy differs from the others as it involves directly selecting insertion points by scanning across the text area rather than moving the text cursor. Paragraphs, lines, words, and characters are highlighted in succession until the target insertion point is selected. This approach allows the user to follow a consistent scanning selection rule, i.e., to focus on the target point and activate the switch whenever the target is highlighted, until the target point is selected.

Text Selection Test Application. A simplified pseudo-text application was designed and programmed under Microsoft Windows. A set of 25 random patterns of text blocks and targets was generated by the program. These patterns were representative of potential editing tasks

that might be faced in an actual word processor. The user task consisted of identifying the starting point of the selection, choosing an extend-selection key, identifying the end point of the selection, and choosing the stop extend-selection key to end the task.

Prediction of Error-Free User Performance. Analytic models to predict estimates of error-free performance were developed for the four selection strategies with respect to the total number of on-screen keys required, switch activations, and total time. Calculations were performed on the 25 selection tasks. The specific equations are provided elsewhere [2].

Experimental Design. A between-subjects design was employed utilizing four groups of five able-bodied participants. Each group used one strategy in five sets of trials. Each set of trials included 25 test trials of selecting text.

RESULTS AND DISCUSSION

The structure, design, and view of the selection task for each scanning strategy created different user demands that induced distinct performances. User demands included planning movements and choosing the appropriate on-screen keyboard key; attention to the task of scanning within and between the on-screen keyboard and the text area; choosing either the select or cancel switch as appropriate; and activating a switch within the assigned scan interval. Objective performance measures included specific strategies for moving to the beginning and end points of the text blocks through certain key selections (Figure 1); switch usage (Figure 2); overall time to complete the task (Figure 3); and errors.

All text scanning strategies were faster and less physically demanding than the standard keystroke strategy. The *scanning text keys strategy* significantly reduced the number of key selections and switch activations. It was easy to use and users had control over all text cursor movements. Time was reduced by

TASK TRANSPARENT TEXT SCANNING

approximately one-fifth. The *sequential scanning text keys strategy* further reduced physical demands. Planning and attention switching between the text area and on-screen keyboard were minimized. Time savings were, however, equivalent to the scanning text keys strategy. The *text scanning strategy* had similar efficiencies as the previous strategy. While this last strategy was easy to use, its time performance was less than expected.

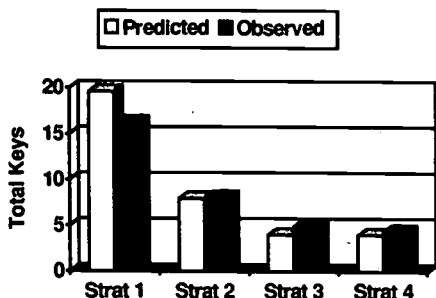

Figure 1: Avg. total on-screen keyboard keys required to accomplish each selection task

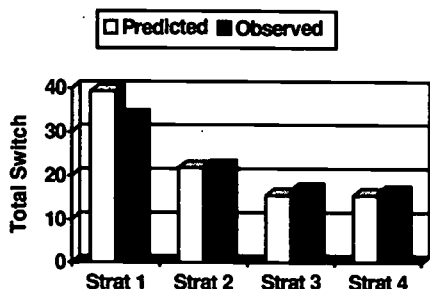

Figure 2: Avg. total switch activations

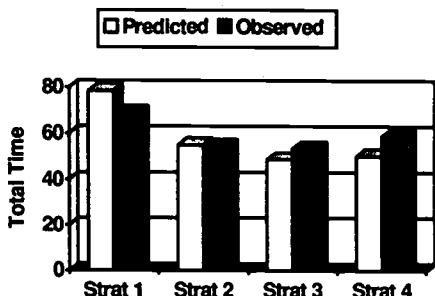

Figure 3: Average total task time

No one strategy is 'best.' Both approaches of moving the text cursor and scanning across the text are feasible. The costs associated with specific attention requirements, error correction, and inefficient scanning sequences suggest that further work be required to refine the strategies. Dramatically improving overall time performance (speed) remains an elusive goal for the text selection task. The most important contribution of this research within the context of computer accessibility is a new interpretation of transparent access. Task transparency opens the way for future access systems to be designed that are more appropriate to the abilities of the user rather than forcing the user to adapt to emulating functions that are beyond their ability.

ACKNOWLEDGMENTS

This research was supported by the Ontario Rehabilitation Technology Consortium and by the National Health Training Program of the National Health Research and Development Program, Health and Welfare Canada. M. Chignell, S. Naumann and M. Milner are thanked for their supervision.

REFERENCES

- [1] Cook, A. and Hussey, S. (1995). *Assistive Technologies: Principles and Practice*. St. Louis, MO: Mosby-YearBook, Inc.
- [2] Shein, F. (1997). *Towards Task Transparency In Alternative Computer Access: Selection Of Text Through Switch-Based Scanning*. Ph.D. Thesis, Dept. Industrial Engineering, University of Toronto, Toronto

ADDRESS

Dr. Fraser Shein, Ph.D., P.Eng.
Bloorview MacMillan Centre
350 Rumsey Road
Toronto, Ontario M4G 1R8
(416) 424-3855 x3538
e-mail: Fraser_Shein@msn.com

EVALUATION OF THE HALF-QWERTY® ONE-HANDED KEYBOARD SOFTWARE

Janis Krohe¹, Dishayne Garcia², and Mark McMulkin²

¹Rehabilitation Engineering Research Center, Cerebral Palsy Research Foundation of Kansas, Inc.

²Department of Industrial and Manufacturing Engineering, Wichita State University
Wichita, Kansas

ABSTRACT

Pilot tests of the Half-QWERTY® one-handed keyboard software developed by The Matias Corporation were performed with eight able-bodied subjects and one subject with Parkinson's Disease. Subjects performed 3, 15-minute practice sessions with the software, each followed by a 2-minute typing test. After roughly 50 minutes of typing, subjects achieved an average of nearly 11 wpm with 97% accuracy. At the end of the test session, some subjects experienced fatigue and discomfort. While the Half-QWERTY keyboard may be a viable alternative for the one-handed typist, the long-term effects of doubling the repetition demands on one hand should be considered.

BACKGROUND

The Half-QWERTY® one-handed keyboard software was originally developed by The Matias Corporation in an effort to manufacture a keyboard that could be worn by the user. Its use has since been extended to persons with disabilities and, according to the developer, specifically those with carpal tunnel syndrome, hand/arm injuries, hemiplegia, and blindness.

The Half-QWERTY typing technique is patterned after two-handed, touch typing methods used on a standard keyboard, except that it is performed using only one hand. With the software, one hand is positioned on the home row of the keyboard. All keys normally typed with that hand are typed in the same manner. Keys usually typed by the opposite hand are typed by holding down the spacebar and performing the same finger movement that would normally be done by the other hand.

Developers of the Half-QWERTY software report that trained touch typists can learn the Half-QWERTY technique in minutes with little or no retraining. In a study of 10 right-handed subjects who typed using their left hand, the developers reported that subjects were able to achieve an average of 13.2 wpm with over 84% accuracy after 50 minutes of practice (1).

RESEARCH QUESTION

The primary objective of this pilot study was to determine if subjects could quickly learn the Half-QWERTY typing technique. A second objective was to determine subjects' likes and dislikes of the product.

METHOD

Subjects

Eight able-bodied subjects participated in pilot tests of the Half-QWERTY one-handed keyboard software. Four subjects were males and four were females. Subjects' ages ranged from 20 to 62 years of age (Mean = 34.8 years, STD = 14.6). All subjects were touch typists of varying skill levels, with two-handed typing speeds ranging from 24 to 67 wpm (Mean = 39.8 wpm, STD = 16.6). All subjects were right-handed and, to permit comparison with previous studies, performed the one-handed tests using their non-dominant left hand. A 77-year-old male subject with Parkinson's Disease also participated in the study.

Materials and Apparatus

The equipment utilized in this study consisted of an IBM compatible computer with 101-key keyboard, Half-QWERTY one-handed

EVALUATION OF HALF-QWERTY KEYBOARD

keyboard demonstration software, Typing Tutor® IV typing software, typing exercises, video camera, video cassette tape, and tripod.

Procedures

Two-handed typing speed was determined for each subject using a typing test from the Typing Tutor IV software. After instruction on how to use the Half-QWERTY software, each subject began a 15-minute practice session with the software using only the non-dominant, left hand. During all sessions, the subject typed material taken from a typing textbook. All sessions using the Half-QWERTY software were videotaped to assist with data analysis.

After the first 15-minute practice session, the subject was timed for a 2-minute period to determine typing speed and accuracy using the Half-QWERTY software. The subject was then allowed to rest for two minutes. This test protocol was followed for two additional 15-minute practice sessions.

At the end of the test session, a usability questionnaire was administered to each subject. It consisted of nine questions rated on a 7-point scale and additional open-ended questions. The questionnaire was used to obtain user's perception on learning the Half-QWERTY typing technique, physical and mental demands of the software, difficulties encountered, and likes and dislikes of the product.

RESULTS

A summary of the group mean and standard deviation for one-handed typing speeds of the able-bodied subjects following each practice session is shown in Table 1. Mean typing accuracy for the group following Practice Sessions 1, 2, and 3 was 96.1%, 98.3%, and 97.0%, respectively.

Analysis of Variance (ANOVA) was performed on the data to determine the effect of practice session on performance. The results of the ANOVA (Table 2) indicate that session had a significant effect ($\alpha = 0.05$) on one-handed

typing speed. An ANOVA for one-handed typing accuracy (Table 3) shows that the difference in accuracy among practice sessions was not significant ($\alpha = 0.05$).

Table 1: Summary of One-Handed Typing Speeds (wpm) Following Each Practice Session (n=8)

Statistic	After Session 1	After Session 2	After Session 3
Mean	8.30	9.88	10.64
STD	1.20	1.90	2.30
Range	7.0 - 10.1	7.0 - 12.5	7.3 - 14.5

Table 2: ANOVA Table for One-Handed Typing Speeds with Practice Session as Treatment

Source of Variance	SS	df	MS	F	p
Subjects	61.29	7	8.76	11.10	p<0.0001
Session	22.74	2	11.37	14.41	p<0.0004
Error	11.04	14	0.79		
TOTAL	95.07	23			

Table 3: ANOVA Table for One-Handed Typing Accuracy with Practice Session as Treatment

Source of Variance	SS	df	MS	F	p
Subjects	81.29	7	11.61	0.56	p<0.7743
Session	18.25	2	9.12	0.44	p<0.6515
Error	289.08	14	20.65		
TOTAL	388.63	23			

Duncan's multiple range test was performed on practice session. Results indicated that one-handed typing speed was significantly higher after Session 2 than after Session 1. The difference in typing speed between Sessions 2 and 3 was not significant.

The results of the usability questionnaire indicated the group was divided on whether the Half-QWERTY technique was difficult to learn. The subjects tended to believe that using the Half-QWERTY keyboard was frustrating,

although many stated it was only frustrating at first and became less so with practice.

In general, the subjects were mostly in agreement that using the Half-QWERTY keyboard was physically fatiguing. Subjects were less in agreement on the mental demands of using the Half-QWERTY keyboard.

Some subjects had difficulty differentiating between using the spacebar to reverse the keyboard and using it to type spaces. Four subjects had difficulty with spacing, mostly typing extra spaces. One person consistently omitted spaces. The subject with Parkinson's Disease often typed extra spaces. This could be due to tremors indicative of the disability.

Features of the Half-QWERTY keyboard the subjects liked were that it makes use of the standard keyboard layout, is easy to understand how it operates, and is easier to learn than expected. One user liked the fact that it did not require users to "hunt-and-peck" with one hand.

Subjects also expressed some dislikes of the Half-QWERTY software. Four subjects believed their one hand was overworked, and felt fatigue, tightness, and/or pain at the end of the tests. Some subjects did not like the use of the spacebar as the modifier key of the layout. Finally, one person expressed concern that individuals who have experienced a stroke might have difficulty learning the Half-QWERTY technique. If so, this might seriously restrict the potential market for the Half-QWERTY keyboard.

DISCUSSION

The developers of the Half-QWERTY one-handed keyboard report that users can learn the Half-QWERTY typing techniques in a matter of minutes. In their study, subjects achieved an average of 13.2 wpm with over 84% accuracy after 50 minutes of practice (1). In the present study of able-bodied subjects, an average of almost 11 wpm with 97% accuracy was achieved after close to 50 minutes of practice.

One-handed typing speed improved significantly between 15 and 30 minutes of practice, indicating significant learning in a fairly short period of time. Accuracy was not affected by the increase in typing speed. Considering that the typists in the previous study were more skilled, with two-handed typing speeds averaging 58 wpm, the results of the present study do not appear to conflict with the developer's results.

Finally, the Half-QWERTY one-handed keyboard software does appear to be a viable option for the person who has use of only one hand and no cognitive impairments. Use of the software would be more attractive to the user who has had previous touch-typing experience, versus the "hunt-and-peck" typist, since it reduces the time required to learn an alternate typing technique. However, if the user does not possess touch-typing skills, the Half-QWERTY software would have little advantage over other one-handed keyboards or alternate input techniques, and the disadvantages could be seriously detrimental. Using only one hand doubles the repetition on the one hand now typing. Several of the subjects experienced fatigue produced by the increased load. In time, cumulative trauma disorders could develop if preventive measures are not taken.

REFERENCES

1. Matias, E., MacKenzie, I.S., and Buxton, W. (1996). One-handed touch-typing on a QWERTY keyboard. Human-Computer Interaction, 11, 1-27.

ACKNOWLEDGEMENTS

The authors wish to thank the subjects who gave freely of their time.

Janis Krohe
Cerebral Palsy Research Foundation of Kansas
5111 E. 21st Street N.
Wichita, Kansas 67208

THE KEYBOARD CHANNEL AS AN INVISIBLE COMMAND PATH: DESIGN OF A CONFIGURATION UTILITY

Cesar Marquez^{1,2}, Tom Nantais^{2,3}, Fraser Shein³

¹Universidad Iberoamericana, Mexico City, Mexico

²Lyndhurst Hospital, Toronto, ON, Canada

³Bloorview MacMillan Centre, Toronto, ON, Canada

ABSTRACT

A new low-level command software utility for Windows 95 is presented. This application uses the keyboard channel as an invisible command path, permitting keyboard emulators to pass commands into the computer. This paper addresses potential usability problems with this scheme by adopting a familiar keypad interface. The user interface of this utility was evaluated by twenty novice Windows users.

BACKGROUND

A new way to exploit programmable keyboard emulators is to program them to inject special codestrings that are translated into commonly used commands [1]. This translation function is accomplished by a software utility running on the computer. Whenever it detects a valid codestring in the incoming keystroke stream, it blocks the keystrokes and executes the command instead. The result is that users can access additional computer command functions directly from any existing device or software that is capable of injecting character strings into the computer. This includes most voice output communication aids, voice recognition systems, onscreen keyboards, abbreviation-expansion utilities, and hardware keyboard emulators.

In previous work [1], this concept was implemented to provide an alternate way of controlling a computer-based environmental control system (ECS) called the Proxi [2]. Suppose the user is typing in a word processor, and an abbreviation-expansion program is running in the background. Because abbreviation-expansion works by injecting an

expansion into the keyboard stream when it detects a valid abbreviation, it can be used as a source of codestrings. Consider an abbreviation "lo" that expands into a codestring resulting in the Proxi turning on the desk lamp beside the computer. If the user decides that she needs more light, she can just type "lo" into the word processor. The abbreviation-expansion program will detect the valid abbreviation and inject the codestring. The codestring interpreter utility would detect the valid codestring, translate it and issue it as a command to the Proxi. From the user's perspective, typing "lo" into any application turns on the lamp. The codestring utility extends the capabilities of keyboard emulators by providing a mechanism for them to trigger useful low-level computer command functions.

STATEMENT OF THE PROBLEM

A major difficulty with this scheme is configuration. Users need a way to specify a new command and assign it a unique codestring. The user then needs to program that codestring into the one or more keyboard emulators that will inject it. However, the codestring is invisible once programmed, and it has no conceptual relationship with the command it represents. This lack of directness presents a usability problem for the users who must configure the codestrings for use. Configuration can be especially awkward since codestrings are designed to be recognizable by a prefix and a suffix of special characters that are unlikely to occur together in regular computer use:

~!@1*%

RATIONALE

To be practical, the codestring utility must have a user-friendly front end to aid in configuration. It should display all of the active commands in an easily recognizable way, and offer each command's codestring upon request.

Because these commands tend to be discrete and self-contained, we decided that an on-screen keypad would be an appropriate visual representation. Besides providing this needed codestring display, the keypad would offer a familiar non-codestring method of executing the commands.

DESIGN

The keypad application is shown in Figure 1. Each file is capable of holding several pages. Each button represents a different command function. Command buttons and codestrings have a one-to-one relationship. There are also special buttons that link one page to another.

The program has two running modes: normal mode and edit mode. In normal mode, the user can access the functions by clicking on the buttons or by navigating with the arrow keys and pressing enter. To look up a codestring, the user simply navigates to the corresponding button, at which point the codestring is displayed in a text box (Figure 1). If this codestring is programmed into a keyboard emulator, the corresponding command would be invoked every time the codestring was injected. In edit mode, the user can create, delete or move buttons. New rows, columns and pages can also be created.

For demonstration purposes, a three-page keypad was created to reflect the typical environmental control commands available through the Proxi. Codestrings were obtained for every button. These codestrings were manually copied into an abbreviation-

expansion utility, and an onscreen keyboard with macro capabilities. Once programmed in this way, the commands could be invoked by sending the codestrings, without having to make the keypad application active.

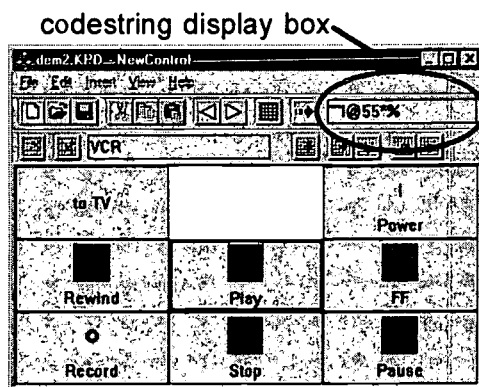

Figure 1: The keypad application. The play key with the thick border is the button with the focus. The codestring for the button with focus is displayed in the box on the top of the window.

EVALUATION

Twenty novice Windows users were asked to try the application. A brief explanation was given to each individual about the proper way of using the system. Examples of potential problems were also shown. Special emphasis was made to clarify the fact that it was the interface that was being tested and not the user.

Each participant was asked to perform a series of tasks that would expose the most important aspects of the interface. These tasks included creating and deleting control buttons, creating new pages, obtaining codestrings from the program and copying codestrings onto the clipboard. The number and type of errors that were made and the time that every person took to complete the list of tasks were gathered as relevant information.

After this, the person was asked to answer a series of questions designed to evaluate the usability of the program. The possible answers for the questions were arranged on a five-point scale ranging from "strongly agree" to "strongly disagree."

The majority of the persons involved in the evaluation agreed that the system was easy to learn and use. Most felt in command of the program at all times. It is important to mention though that over half of the individuals suggested that the configuration process needed to be shorter and less tedious.

DISCUSSION

These simple evaluations suggest that the system is likely to be perceived as intuitive by a range of inexperienced users. It is noteworthy, however, that a person using this system is still exposed to the codestrings and these are generally considered "hard to get familiar with."

The keypad application offers an open-ended interface in that new command functions can be added without having to recompile the software. Theoretically, there is no limit to the number of functions that a person could add to the system and, as stated in [1], these could include mouse emulation, file managing operations, Internet functions, etc.

REFERENCES

1. Nantais, T., Kobeh, G., & Shein, F. (1996). The keyboard channel as an invisible command path for alternate input devices. *Proceedings of the RESNA '96 Annual Conference* (pp. 310-312). Washington, D.C.: RESNA Press.
2. Hensch, M., & Adams, K., (1995). Proposal for an ECU standard protocol. *Proceedings of the RESNA '95 Annual Conference* (pp. 437-439). Washington, D.C.: RESNA Press.

ACKNOWLEDGEMENTS

This project was supported by the Lyndhurst Hospital Foundation. We would like to thank IBM Canada Ltd. and Madenta Communications Inc. for donation of equipment used in this project. We would also like to thank Prof. Ruth E. Mayagoitia for her valuable input.

Cesar Marquez
Assistive Technology Program
Lyndhurst Hospital
520 Sutherland Dr., Toronto, Ont., Canada
M4G 3V9

voice: (416) 422-5551 ext. 3048
fax: (416) 422-5216
E-mail: 104552.3234@compuserve.com

THE LEARN-ED DISTANCE TEACHING SYSTEM - RESULTS OF USE BY DISABLED STUDENTS

Nick Hine, Gillian Harper, William Beattie, John L. Arnott
MicroCentre, University of Dundee, Scotland

ABSTRACT

The LEARN-ED distance teaching system has been developed to allow students with a disability or temporary disabling condition to participate in higher education. The key feature of the system is that teaching activities and other live events can be relayed to students at different locations, and they can interact with those participating at the site of the live activity. This paper reports on the studies conducted at the University of Dundee to verify that the terminals used in the system can be suitably adapted to allow these students to participate in the live events.

BACKGROUND

A number of interactive distance education systems have been devised to allow students (including those with a disability) to participate in education when they can't be physically present in the teaching venue. [1] Where live access is provided, it invariably provides video showing the output of a document camera or a view of the same screen display that is visible to the students in the lecture room. Both of these solutions require a high bandwidth video image to give sufficient quality to show the details of the material being presented.

In late 1994 a consortium was set up with partners in Slovakia, Hungary and Austria, and was lead by a team from the University of Dundee in the UK. In considering access to lectures, the project team constructed a system based on an approach that uses desktop based Internet videophone links with lecture material being made available as HTML pages distributed using the World Wide Web (WWW). Control of the presentation of the lecture material on the terminals of the remote students is provided by the system.

Because the material is distributed as HTML pages, it can be transduced into another media or reformatted at the student's terminal. This process is almost impossible if the material were distributed as a live video stream. Furthermore, the system can be used in situations where the link between the local and remote sites is of relatively low bandwidth

(PSTN or primary rate ISDN).

RESEARCH QUESTION

The validity of the approach used in the LEARN-ED system has been studied extensively and reported in [3]. The key research question in this study was that the terminals used in the system could be adapted so that they could be used by students with disabilities

METHOD

Trials of the LEARN-ED system were carried out with individual motor-impaired students. Each trial followed the following method:

An introduction and a background questionnaire was administered to determine general background details and the level of prior computer experience.

An action script was used by the experimenter to direct the instruction of the participant through the process of starting the software, connecting to the lecture and using the system to listen to a short lecture, delivered by the second experimenter from a different room using the LEARN-ED system. After the short lecture, the shared Whiteboard facility was used to demonstrate potential tools for collaboration on documents in group project work.

At the end of the session the participant was asked for their feedback on usability of the system, particularly as it affected their ability to attend classes from a location other than the class location.

RESULTS

Each participant demonstrated the ability to carry out the scripted tasks required to use the system to attend a live event such as a lecture. Each participant also made the following comments:

PG: (Useful? 4/5) Found the system quite easy and enjoyable to use. She had some difficulty understanding what the other participants said when there was background noise. She reported that the system would be useful if she could attend lectures from home

THE LEARN-ED DISTANCE TEACHING SYSTEM

Subject	Age	Gender	Length of computer use	Computer use for education	Year of study	Main Subjects	Disability / Condition	Used WWW	Used CU-SeeMe
PG	20	Female	13 years	Daily	3rd	Applied Computing	Cerebral palsy	Yes	No
RC	21	Male	6 years	Daily	3rd	Business Admin.	Wheelchair user paraplegic	Yes	No
VT	22	Female	4 years	Daily	4th	Business and Computing	Fibromyalgia	Yes	No
TF	27	Female	2 years	Daily	2nd	History, American Studies, IT	Arthritis affecting hands, neck, knees, ankles	Yes	No

Table 1. Participant Details

when the weather makes travel difficult for her.

RC: (Useful? 3/5 to 4/5) Reported finding the system fairly easy to use. He was positive about the potential benefits of having such a system and enjoyed the experience. He thought that having such a system at home would be especially good for winters when the weather is poor so he would not miss classes. (Winter 1995-96 RC missed a week of classes due to winter weather combined with the remote location of his home)

VT: (Useful? 4/5) reported that she enjoyed the experience and felt that the system was a good idea. She thought that occasionally it would be useful to be able to attend a lecture from home or an alternative venue on campus because of the fatigue and other symptoms that accompany her condition.

TF: (Useful? 5/5, very useful) Reported that she felt self-conscious and found it difficult to talk loudly enough for audio transmission because of this. She liked the possibility of reviewing lecture notes at a later time and did not find listening to the lecture any more difficult than attending a lecture. She thought that the system could be helpful if her arthritic condition and level of mobility deteriorates.

CONCLUSION

In conclusion, this study has demonstrated the use of the specified LEARN-ED system with students with a variety of motor and speech impairments to participate in the live events of a Higher Education establishment. The event used was a short lecture about the project. Four participants used the system at individual sessions and gave positive subjective feedback

on the usefulness and usability of the system. In general, the participants thought that using the system to take part in live events such as lectures and tutorials could be useful to them in circumstances where physically attending classes was difficult.

REFERENCES

- [1] Harasim, L., Hiltz, S.R., Teles, L. & Turoff, M. (1995) Learning networks: a field guide to teaching and learning online Cambridge, MA: MIT Press
- [2] Hine N.A., Gordon I.A.S., Beattie W., Arnott J.L., McKinlay A., Kravcik M., Bebjak A., Moravcikova L, Arato A., Tolgyesi J., Giese P., Blasovszky B., Seiler F.P.: An interactive distance education service utilising the World Wide Web - a preliminary study, In Proceeding of the 8th Joint European Network and Computers Conference JENC 8, Edinburgh, 11-15th May 1997

ACKNOWLEDGEMENTS

We would like to thank the TIDE and COPERNICUS Offices of the European Commission for the funding of the LEARN-ED project, within which this work was being undertaken.

Nick Hine

MicroCentre, Department of Applied Computing, University of Dundee, Dundee, Scotland, DD1 4HN

FURTHER EXPLORATION OF ADAPTIVE ONE-SWITCH ROW-COLUMN SCANNING FOR TEXT ENTRY

Richard C. Simpson¹ and Heidi H. Koester²

¹Metrica, Inc., Houston, TX

²Koester Performance Research, Holland, MI

ABSTRACT

This paper describes a one-switch row-column scanning system that adapts its scan rate based on measurements of user performance. During an experimental evaluation, the system fully assumed the task of adjusting scan delay during text entry. Our results indicate that automatic adaptation has the potential to enhance text-entry rate without increasing task complexity.

BACKGROUND

Row-column scanning is a very slow method of communication. Options for increasing text entry rate include (1) dynamically changing the configuration of the row-column matrix or (2) using rate-enhancement techniques like word prediction, but evidence suggests that increased cognitive load imposed by these methods on the user can result in little or no improvement in text generation rate [1]. An alternative we are exploring is adapting a system's scan delay during run-time [2]. Our goal is to allow a scanning system to adjust its parameters "on the fly" (as opposed to the current practice of setting parameters during clinical assessments).

The underlying reasoning method used to make decisions in our system is a probabilistic technique known as Bayesian networks [3]. Figure 1 shows the Bayesian network used in our current system. The network compares the user's performance at the current scan rate to performance at the next faster and slower scan rates. Performance at faster and slower scan rates is estimated based on (1) the average change in text entry rate and errors observed at the faster (or slower) scan rate versus the current scan rate and (2) the amount of data these averages are based on (in terms of number of decision intervals at that scan rate). Future performance at the current scan rate is projected based on the current text entry and error rate and trend of these averages. The decision made by the network is based on the resulting probability that performance will be greatest using the current, next-faster, or next-slower scan delay.

The Bayesian network was implemented within a testbed row-column scanning system developed for this study. In the experimental system, there was one scan delay for both rows and columns and no additional delays before the first row or column. The system provided auditory and visual cues when an adaptation decision was made.

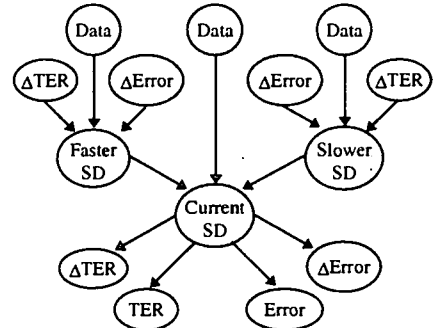

Figure 1. Bayesian network used to make adaptation decisions in row-column scanning system.

When the Bayesian network was active and the subject was entering text, the system recorded performance data over a predetermined time interval. At the end of each interval, the network used the recorded information to decide whether to raise, lower or maintain the current scan delay.

RESEARCH QUESTION(S)

The goal of the experiment described below was to empirically evaluate the Bayesian network's performance. The questions of interest were: (1) How did user performance when automatic adaptation was active compare to user performance when the user was in charge of setting the scan delay? (2) Which condition did users prefer? and (3) When automatic adaptation was active, how well did the network's behavior correspond with user's expectations?

METHOD

8 able-bodied subjects (6 male, 2 female) ranging in age from 23 to 56 participated in an experimental evaluation of the performance of the Bayesian network. Subjects were randomly divided into two groups based on whether the

network (Group 1) or the subject (Group 2) was in charge of adaptation decisions in the first trial.

All subjects were oriented as to the purpose of the trial and the operation of the system and practiced entering text into the system before data was recorded. Each subject completed a two-sentence training session with the system configured for manual or automatic adaptation depending on the subject's group membership. Subjects then entered text for a ten sentence trial in which every keystroke, error, and adaptation decision was recorded and time-stamped. Subjects then completed a second training session and ten-sentence trial in which the system was configured for the opposite experimental condition. In every training session and trial, the initial scan delay was set to 750 msec. After both trials were completed, subjects were asked to fill out a questionnaire detailing their subjective impression of each condition.

When automatic adaptation was active only the Bayesian network could make adaptation decisions while only the subject could make adaptation decisions under the manual adaptation condition. Both the network and the subject were restricted to changing the scan delay in 25 msec increments. The network made an adaptation decision every 10 seconds, but the subject had no limits on the number or frequency of adaptation decisions. Subjects changed the scan delay by pressing the up arrow key to scan faster (decrease the scan delay) and pressing the down arrow key to scan slower (increase the scan delay).

Adjusted text entry rate (ATER) and total errors were compared between conditions based on averages over each two-sentence block. Subjects' responses to the questionnaire were compared between groups and to the neutral answer (3.0). Several statistical analyses were performed, with a significant difference defined as a p-value less than 0.05.

Figure 2 shows the average ATER for both subject groups over both trials. Sentence blocks 1 through 5 correspond to the ten sentences of the first trial while sentence blocks 6 through 10 correspond to the ten sentences of the second trial. Repeated-measures ANOVAs were performed over blocks 1-5 and 6-10, with a between-subjects factor of adaptation condition and a within-subjects factor of sentence block. For blocks 1-5, adaptation

condition (automatic or manual) was not statistically significant ($p = 0.912$) while block was ($p = 0.018$). For blocks 6-10, adaptation condition was not significant ($p = 0.508$) nor was block ($p = 0.312$).

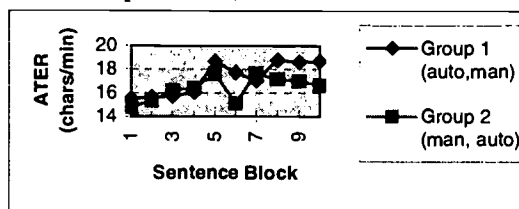

Figure 2. Average Adjusted Text Entry Rate for both groups over both trials.

Figure 3 shows the average total errors for both subject groups over both trials. Repeated-measures ANOVAs were performed over blocks 1-5 and 6-10. For blocks 1-5, adaptation condition was not significant ($p = 0.553$) and block was not significant ($p = 0.082$). For blocks 6-10, adaptation condition was not significant ($p = 0.260$) but block was significant (0.049). Interestingly, during the second trial subjects actually made more errors in later blocks.

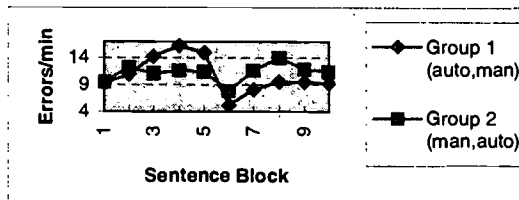

Figure 3. Average Total Errors for both groups over both trials.

There was not a significant difference between the total average response for any question and the neutral answer (3.0). The subjective data also did not demonstrate a significant difference for any question based on adaptation condition.

Figure 4 shows the scan delay over time from a single subject during a trial in which manual adaptation was active. This can be compared to Figure 5, which shows the scan delay for the same subject during the trial in which automatic adaptation was active. As can be seen from the figures, when subjects were in charge of changing the scan delay, they tended to perform changes in bursts with distinct pauses in between. When automatic adaptation was active, on the other hand, there was at least ten seconds between each change in scan delay.

DISCUSSION

Our goal is to develop a row-column scanning

system which can completely take over the task of setting the scan delay. The network did successfully assume full responsibility for the single parameter adjustment task and the presence of automatic adaptation neither hindered nor enhanced subject performance.

The results indicate that using the Bayesian network to control the scan delay did not cause a significant difference in text entry rate from an experimental condition in which subjects had complete control over scan delay. In addition, there was not a statistically significant difference between conditions for total errors. However, data suggests that some subjects made slightly more errors when automatic adaptation was active. This difference in errors will be examined further in future studies.

One possible explanation for the increased errors is people's preference for developing a scanning "rhythm," which automatic adaptation interfered with. Several subjects reported that their best performance came when the scan delay remained fixed at a given speed long enough for them to synchronize their actions to the scan delay. When automatic adaptation was active, the scan delay could change every ten seconds, which made synchronization more difficult. This does not mean that automatic adaptation is inherently flawed. However, it does indicate that changes should probably happen less frequently than they occurred during the experiment and that the notion of preserving the subject's rhythm should be incorporated into future enhancements of the system. One possible mechanism for

accomplishing this is to only make changes to the scan delay between sentences.

It is important to realize that the manual adaptation condition, as implemented within this experiment, represents an idealized situation that does not correspond to the typical row-column scanning scenario. First, we are unaware of any commercially-available row-column scanning system that makes changes in the scan delay as directly accessible as a single keystroke. In addition, the user of our manually adaptable row-column scanning interface needs to be able to consistently use three switches: one to make selections and two to change the scan delay. In reality, the average one-switch row-column scanning user is using a one-switch system because they find it difficult to operate multi-switch input methods. Hence, our target users are unlikely to find the option of direct manipulation of the scan delay as useful as the subjects that participated in the experiment.

REFERENCES

[1] Koester, H.H. and Levine, S.P. (1994). Learning and Performance of Able-Bodied Individuals Using Scanning Systems with and without Word Prediction. *Assistive Technology*, 6(1):42-53.
 [2] Simpson, R.C. and Koester, H.H. (1994). Adaptive One-Switch Row/Column Scanning for Text Entry. *Proceedings of RESNA Conf.*
 [3] Charniak, E. (1991). Bayesian Networks Without Tears. *AI Magazine*, 12(4):50-63.
 Rich Simpson rsimpson@traclabs.com
 TRACLabs; 1012 Hercules; Houston, TX 77598

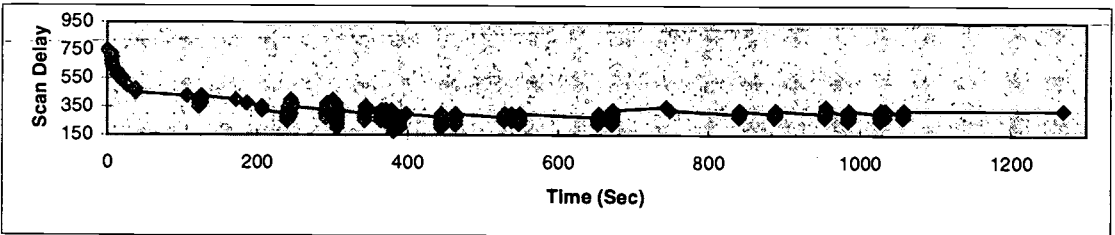

Figure 4. Scan delay for subject MM for a trial with manual adaptation active.

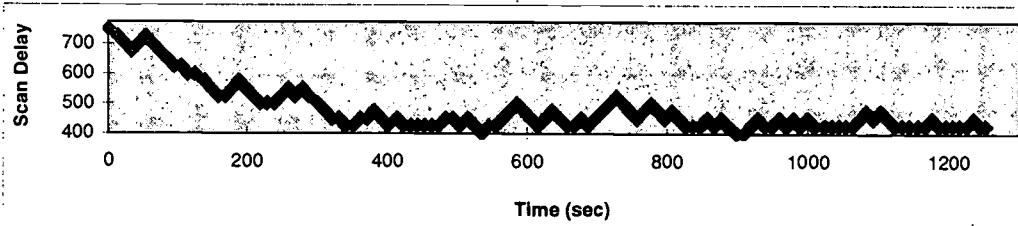

Figure 5. Scan delay for subject MM for a trial with automatic adaptation active.

AN ELECTRONIC MANUAL ON SPECIAL SEATING

Dominic P.K. Cheng
Rehabilitation Engineering Centre
The Hong Kong Polytechnic University
Hong Kong

ABSTRACT

A manual on special seating was written as a Windows 3.1 help file to serve as a teaching aid for a course on assistive technology. The rationale for why a help file is an appropriate format was detailed. This manual was intended to supplement other texts on special seating with its emphasis on the technology of cushion construction, production and evaluation spanning the full range from state-of-the-art to the do-it-yourself approach using international appropriate technology.

BACKGROUND

The author has been involved in the teaching of a postgraduate course on assistive technology for students mainly composed of allied health professionals. Like any other course that covers a wide range of topics, the breadth and depth of coverage of any one topic is limited by the number of contact hours and student effort hours. Exposure to the whole field can best be done through lectures while learning a particular topic in greater depth can be achieved through hands-on laboratory sessions, home assignments and small group projects. The author has chosen topics perceived to have a greater local need for more detailed coverage. Teaching aids, such as a personal communication board simulator (Cheng 1996), have been used as an attempt to compensate for the lack of real devices for teaching. The budding special seating services in this city have recently gained some momentum but at this stage there is still a large unsatisfied need and manual methods are used for the production of custom contoured

cushions. The author believes there is a need for better exposure to special seating in general and the technology of cushion construction, production and evaluation in particular. Out of forty-two contact hours for the course on assistive technology, fifteen hours are hands-on laboratory sessions with two on special seating during which students construct and evaluate a custom contoured cushion using foam slabs cut to contours as captured using a bead-bag. An electronic manual is thought to be a useful teaching aid to provide greater depth and breadth of coverage.

STATEMENT of the PROBLEM

To design and write an electronic manual on special seating that runs under Windows 3.1 and better.

RATIONALE

An authoring software is commonly used to write computer aided instruction projects because they are much easier to use for multimedia based applications as compared with a general purpose programming language such as Visual Basic. However, the purpose of this electronic manual on special seating is to disseminate information only without the need to monitor user response. In this regard, it only requires an easy to use format for ready retrieval of information. The Windows 3.1 help system more than satisfy this requirement with built-in search and other utilities such as copying and printing of selected items in addition to quick access of information using hypertexts and hypergraphics.

An Electronic Manual on Special Seating

This manual is compiled as a Windows 3.1 help file rather than one for Windows 95 for the following reasons:

- PCs are ubiquitous in this city and lots of them are still running Windows 3.1 out of choice or necessity (due to hardware limitations such as CPU type, available memory and harddisk capacity).
- Help files in the Windows 3.1 format can be viewed using Windows 95 but not the other way round.
- A manual in electronic form can easily be distributed and updated. It can be easily converted for printing if a hardcopy is required.
- Users can jump from one topic to another instantly—an advantage over any printed materials.
- Viewer for help files are built into all Windows operating systems—users do not have to install any extra software.
- All Windows users most likely have used the Windows Help which uses the same (help file) viewer.
- In this format, the manual can easily be incorporated as one of the help files in a specialist software on the provision of special seating.
- The last reason, but certainly not the least is that the author used Visual Basic 3 Professional edition to construct the communication board simulator and noticed it came with a Windows help compiler.

DESIGN

Topics available in the manual were shown in Fig. 1. Some subtopics were not shown in the figure for simplicity. Care was taken to use standard terminology (Medhat and Hobson 1992). While most topics on special seating were covered for completeness, the emphasis was on the technology of cushion construction, production and evaluation. The range of technology covered spanned from state-of-the-

art to DIY using international appropriate technology. For example, hi-tech commercial pressure mapping equipment were covered as well as a water-column manometer constructed using a party-balloon and a length of clear plastic tubing. Another example is the inclusion of topics on DIY low-cost or no-cost cushions using materials such as corrugated carton material or tree-leaves in addition to topics on how commercial cushions use a combination of pre-shaped contours and modern compliant materials to obtain desired cushion properties. This coverage was certainly very different from texts on special seating.

To make sure that the help file could work reasonably well with older PCs with limited hardware resources such as slow CPU and small storage capacity, all the picture files were converted into black-and-white format of appropriate resolution before incorporation in the Help file. By the same token, videos were not included in this version.

DISCUSSION AND DEVELOPMENT

This electronic manual will be used this coming term in a course on assistive technology during the two laboratory sessions on special seating and distributed to students for doing home assignments. The idea is to make sure the students recognize the pros and cons of the wide range of options available to achieve seating goals.

The manual will also be distributed to people providing special seating in this city for feedback and to foster mutual cooperation. The ultimate aim is to incorporate this manual (in the form of a help file) into an application for routine provision of special seating.

Special seating is inseparable with wheeled mobility but the latter was only mentioned briefly in conjunction with one of the main

objectives of special seating—position for function. Materials on wheeled mobility will be incorporated into the electronic manual when opportunities arise in the future.

Inclusion of videos and use of colour photographs are not necessary but desirable. Distribution in a CD-ROM format will then be necessary to handle the large file size.

REFERENCES

- Cheng, P.K. Dominic (1996) PC-Based Communication Board Simulator for Teaching, *Proceeding of RESNA '96*, USA, pp.328-330.
- Medhat M.A. and Hobson D.A. (1992) Standardization of Terminology and Descriptive Methods for Specialized Seating: A Reference Manual, RESNAPRESS, USA.

ACKNOWLEDGEMENTS

This work was supported by a Learning and Teaching Development Grant from The Hong Kong Polytechnic University.

Dominic P.K. Cheng
REC
The Hong Kong Polytechnic University
Hung Hom
Hong Kong
Email rcdpkc@polyu.edu.hk

Introduction

Terminology of special seating

Special seating solutions

- Principles of special seating
- Basic steps in the provision of special seating
- Commercial cushions
 - Passive cushions
 - Air, Foam, Gel, Combinations
 - Active cushions
- Low cost DIY (do-it-yourself) cushions
- Project Sorebutts
- Cushions using natural materials (Low or no-cost cushions)
- Commercial planar/contoured modular systems
- Custom contoured cushions
 - Manual methods of producing a custom contoured cushion/body support
 - Manual carving
 - Direct foam-in-place
 - Foam-in-place using a mold
 - Vacuum forming of thermoplastic shell with foam lining
 - Instant custom contoured cushions
 - CAD/CAM production of a custom contoured cushion/body support
 - Commercial systems
 - Signature 2000
 - PinDot Shape Sensor and SeatMaker
 - OttoBock Shape System
 - Research and development in universities
 - High-tech CAD/CAM
 - Low-cost CAD/CAM

Evaluation

- Interface pressure measurements
 - Electro-pneumatic, Electro-hydraulic, Resistive, Capacitive sensing
 - Manometer using a water column (DIY, very low cost)

Glossary

Fig. 1 Abridged contents of the electronic manual on special seating in the form of a Windows Help file

DEVELOPMENT OF INFRARED LIGHT HEAD POINTING DEVICE FOR PEOPLE WITH SEVERE PHYSICAL DISABILITY ON MANIPULATING PERSONAL COMPUTER

Takuro HATAKEYAMA*, Yoshiki KOIZUMI**, Yuichi UMEDA**

Masatoshi UCHIO**, Masao KASUGA***

* Yokohama Rehabilitation Center, ** Alps Electric Co., LTD.

*** Faculty of Engineering, Utsunomiya University
Japan

ABSTRACT

We developed an infrared light pointing device for people with severe physical disability for manipulating multimedia on a personal computer. This pointing device realizes a system which enables the mouse cursor to move according to the angle of movement of the head.

BACKGROUND

The rapid growth of the Internet, based on the recent advanced electronic technology and multimedia, has produced an environment in which everyone can easily use personal information processing equipment such as personal computers. Those people with severe physical disability take an increasing interest in using such equipment.

The authors have developed an infrared light pointing device which is designed to be operated by the user's head movements and puff & sip actions. We have obtained some results from using this device and would like to report our study.

STATEMENT OF THE PROBLEM

In these days, the Graphical User Interface (GUI) is becoming more and more popular as an operational interface on the personal computer. But, it is difficult for the people with severe physical disability to use the mouse. North American countries and Japan have been making efforts to develop various input devices of the personal computer for the people with severe physical disability(1)(2)(3).

As an example of the direct operation, such as manipulating the devices directly, the user presses the keyboard with a mouth stick. The user holds a stick itself or a mouthpiece attached to an end of the stick between the teeth. This operation gives heavy load to the teeth, and causes some bad effects such as an

irregular set of teeth. Most of indirect operations, such as manipulating the devices remotely, require that an additional device should be attached to the user. In some cases, the power supply cord and signal cables are needed. This might restrict the movement of the user with severe physical disability on an electromotive chair with the device attached. In addition, the user needs a helper for adjustments of the device position. This might increase the helper's workload and prevent the people with severe physical disability from being self-supporting.

CONCEPTION AND DESIGN

The system is based on the following eight designs. (1) To make most use of the remaining capabilities of the people with severe physical disability, (2) To reduce the operational load, (3) To give the user a sense of direct operation and increase operability, (4) To give no restrictions to the user's daily life, (5) To avoid the influence of surrounding light, (6) To produce a safe operating environment, (7) To allow the user to make position adjustments by himself/herself, (8) To be low-priced

DEVELOPMENT

System Configuration

The system configuration is shown in Figure 1. The system consists of a pointer, a controller and a personal computer. The pointer weighs approximately 90 grams. The distance between the pointer and controller is within a range of 30 cm and 2 m. Between the pointer and controller, dimensional angle sensing and data transmission are done using infrared light.

Dimensional Angle Sensing

The controller emits infrared light toward the user. The pointer measures a volume of

Head Pointing Device

infrared light from the controller. Based on this value, dimensional angles (horizontal and vertical) of the pointer are calculated. The results are sent to the controller through data transmission using infrared light. The on/off status of the air pressure switches is also sent to the controller.

Coordinates on the screen are derived from the data sent to the controller. The derived coordinates are sent to the personal computer through a serial interface, and are finally displayed and updated as the coordinates of the mouse cursor.

Position Adjustment Algorithm

In an operational concept of the system, two areas exist as shown in Figure 2. One of them is an area which is detected by the sensor. The other is a screen display area. The screen display area is contained in the sensor-detected area. The screen display area corresponds to a display area on the computer screen. In this paper, a resolution of 800 x 600 is set to this area. The sensor-detected area is about three times larger than the display area in both horizontal and vertical dimensions. In this paper, a resolution of 2048 x 2048 is set to that area. In a normal condition, the mouse cursor moves within the screen display area as the user's head moves. If any position adjustment of the cursor is necessary, that is, the user's operation center goes out of the scope of screen display, the cursor center is adjusted by moving the screen display area within the sensor-detected area.

EVALUATION

Methods

A target is displayed sequentially at ten pre-defined coordinates on the screen. The user is supposed to point to the target each time. The time required for this operation is measured. Target size: Large (9 x 9 mm), Medium (6 x 6 mm), Small (3 x 3 mm), *Repeat times: Large --> Medium --> Small ten times for each size, * Distance between the subject and display: 60 cm, * Subjects: A (high level cervical cord injured), B (cerebral palsy without spasticity or athetosis),

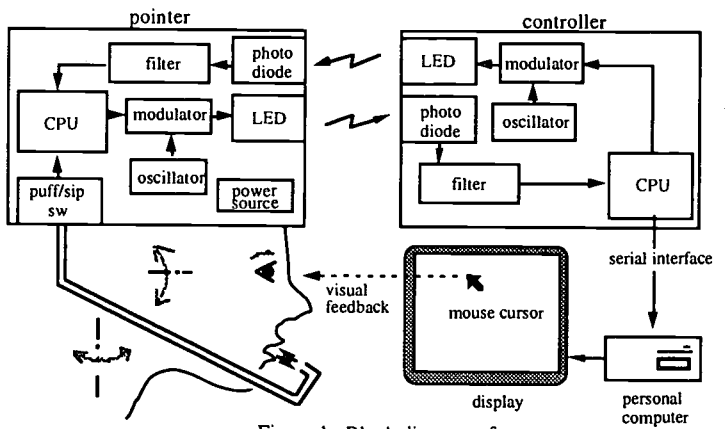

Figure 1. Block diagram of system

C (without disability), D (without disability).

Result

A mean time required for the operation of each target size is shown by subject in Figure 3. For any of the subjects, the operation time increases in inverse proportion to the target size. The difference in mean operation time among the subjects has nothing to do with

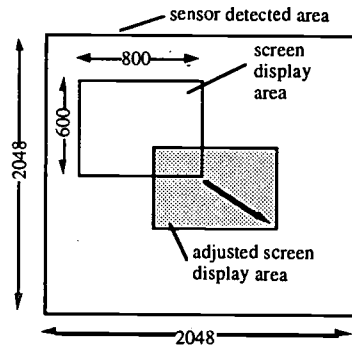

Figure 2. Concept of adjusting cursor position

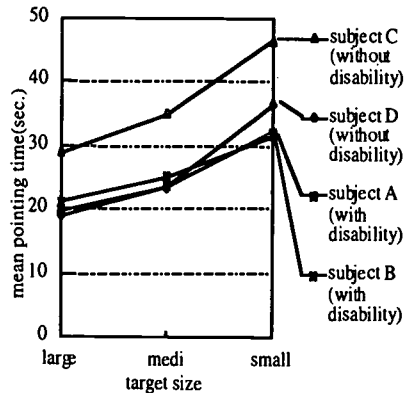

Figure 3. Relation between target size and mean pointing time

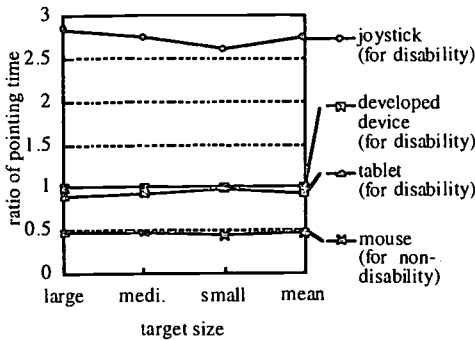

Figure 4. Relation between target size and ratio of pointing time of pointing devices (subject A:with disability)

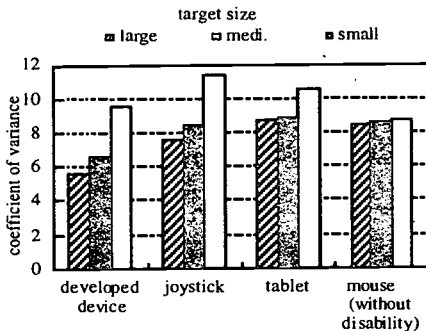

Figure 5. Relation between some pointing devices and coefficient of variance (subject A:with disability)

whether they are with disability or without disability. We think that a difference depends upon how familiar the subjects are with the device.

The pointing operation of the device is compared with other kinds of devices. This test is performed on Subject A only. See Figure 4 and 5. In Figure 4, the vertical axis shows the ratio of pointing time on an assumption that the value for the our pointing device is one. Figure 5 shows the relation between some pointing devices and their coefficients of variance. A coefficient of variance is used to find scattering. It is a percentage representation of the quotient of standard deviation divided by mean value. According to Figure 4, our pointing device is slightly different from others in operation time required. As the user becomes familiar with the device after he/she has used it for a certain time, the difference is expected to be smaller. According to Figure 5, there is no significant difference with other pointing devices although

the coefficient of variance increases as the target size becomes smaller. The coefficient of variance for our pointing device is slightly smaller than that for the mouse. We can safely say that our device has comparatively stable characteristics.

DISCUSSIONS

The time for pointing with our device for the people with disability is also improved by about twice compared with the case which the people without disability usually use the ordinary mouse. So, our device is considered to satisfy practical requirements.

Besides, we can expect that the operation time will be shortened to some extent as the user is accustomed to using the device.

One of our future tasks is to find a more hygienic method of programmatically interpreting the head movement instead of puff and sip switching. In addition, the power consumption for pointing should be reduced and the device should be made easier to use. Our device will be commercial available in 1998.

REFERENCES

1. Gunderson, J.: LONG RANGE SCREEN BASED HEADPOINTING; Proceedings of the 5th Annual Conference on Rehabilitation Engineering, pp. 134 - 136 (1982)
2. Per Krogh Hansen, David Dobson, James Wanner: FREE WHEEL - The cordless new head pointing device, ICAART 88 Proceedings, pp. 372 - 373 (1988)
3. Takuro Hatakeyama, Osamu Tanaka, Toshimitsu Nakagawa: THE KEYBOARD AND MOUSE EMULATOR, ICAART 88 Proceedings, pp. 418 - 419 (1988)

ACKNOWLEDGMENTS

This research and development is subsidized by the Development Project of Welfare Equipment for the people with disability of New Energy and Industrial Technology Development Organization (NEDO)

Takuro HATAKEYAMA
 QGA01654@niftyserve.or.jp
 Yokohama Rehabilitation Center
 1770 Toriyama-cho, Kouhoku-ku, Yokohama
 222 JAPAN
 Tel:+81-45-473-0666, Fax:+81-45-473-1299

USABILITY TESTING OF SOFTWARE FOR ASSESSING COMPUTER USAGE SKILLS

Heidi Horstmann Koester
Koester Performance Research
Holland, MI

William W. McMillan
Eastern Michigan University
Ypsilanti, MI

Background

We have developed an initial prototype of software for measuring the keyboarding and mouse usage skills of people with disabilities. This software, called Compass, allows an evaluator to assess an individual's computer input skills and compare performance across different devices and time periods. The main features of this prototype have been described elsewhere (Koester, 1997).

Research Goal

Usability testing has been employed throughout the project to identify user needs and evaluate how well our software meets those needs. The primary methods of gathering and incorporating user feedback into the development of the prototype are described below.

Defining Measurable Objectives

A key element of usability testing is to define measurable behavioral objectives that provide concrete usability benchmarks (Gould, 1988). To help formulate measurable objectives, a survey was developed which included questions on the respondent's background; goals and time spent in a typical client evaluation; interest in a quantitative assessment tool; rated importance of 23 different features of such a tool; and acceptable learning time, usage time, and cost. The survey was placed on a web site, and 37 computer access clinicians completed it.

Measurable objectives for learning time and evaluation time were defined from the survey responses. For learning time, 40% of responders were willing to spend 1-2 hours to learn the software. 35% deemed 31-60 minutes acceptable, with the remaining responses at 30 minutes or less. A reasonable target, then, was defined as a learning time of 31-60 minutes.

For evaluation time, the average responder said that they spent 31-60 minutes evaluating keyboarding and pointing skills under current practice. The majority (57%) were willing to spend a little longer on evaluations using the

Compass software, but the average response rounded down to "not longer", which suggests that a better target is that evaluations with the Compass system should not take longer than current practice. Our target for evaluation time, then, was defined at 31-60 minutes.

Usability Test #1

A usability test was conducted on an initial prototype of the Compass system, which incorporated a fairly complete evaluator interface, as well as early implementations of two keyboarding tests. The goals were to determine whether a typical user could meet the defined targets for learning and evaluation time, measure overall satisfaction with the software, and observe errors and misunderstandings.

Methods. Eight experienced clinicians participated. Each performed six pre-defined tasks with the system, which were printed out on paper for reference during the test. Short, dynamic help messages were available at the bottom of each screen, but otherwise there was no on-line help implemented in the system nor were there written instructional materials. Subjects were asked to try to solve any problems on their own, with the option of asking questions of the experimenter if they really felt stuck.

Each subject action and its associated time was recorded. Data were analyzed to determine for each task: the successful completion rate, the completion time, and the number and type of errors made. Any comments were also recorded for additional insight into possible problems. Subjects completed a post-test survey which assessed their level of agreement with 12 different statements about the prototype. Answers were on a 1 - 5 scale, from "strongly disagree" to "strongly agree." A score significantly greater than 3.6 is considered significant for positive survey questions, and a score significantly lower than 2.4 is considered significant for negative survey questions (Nielsen, 1995).

Before testing began, the specific objectives defined from the web survey were converted to measurable targets for the defined tasks in this test. For learning time, the target was independent use after a guided experience lasting 31 - 60 minutes. The six tasks were designed to take approximately one hour, with little or no help from the experimenter. A positive response to the post-test question of whether subjects "felt capable of using Compass with a client after this experience" was one indicator of successful achievement of the learning time goal. Other questions, asking whether Compass was "very easy to learn" and whether its use was "very frustrating", were additional indicators of perceived learning ease. A final set of indicators was that subjects should be able to complete Tasks 1 and 2 with no experimenter help, providing confidence that the basics of system use can be achieved quickly, and an overall completion rate of 100%, with no more than two interventions per subject by the experimenter.

For evaluation time, the target for assessment of keyboarding and pointing skills with the Compass system was 31-60 minutes. Since in this initial prototype, only keyboarding tests were implemented, the target was divided in half, to 16-30 minutes. Tasks 4-6 were designed to be a reasonable representation of an evaluation, requiring three runs of the Sentence test under three different configurations and interpretation of the resulting reports. Therefore, the primary criterion for achieving the evaluation time target was an average time under 30 minutes across Tasks 4-6. A secondary criterion was that Tasks 1 and 2, which represent single tests administered to a client, should each take less than 7 minutes to complete (allowing 4 tests to be administered within the target time). Two survey questions were additional indicators of satisfactory evaluation time ("Compass would take longer than my current assessment methods" and "It is worth the effort to use Compass").

Results. For learning time, five of the six measurable objectives were met. Subject responses on the questions of independent use, ease of learning, and frustration easily exceeded target levels. All subjects were able to complete the tasks successfully, with only two instances across all subjects in which the experimenter gave a small hint. Both of these hints were to

one subject on Task #2, so the objective of completing Tasks 1 and 2 without help from the experimenter was not fully met.

For evaluation time, five of the six measurable objectives were met. Subject responses on the question of whether use of Compass was worth the effort averaged 4.4, significantly greater than the target of 3.6. Subjects were less sure if use of Compass would take longer than current practice, with an average response of 2.0, which was not significantly different than 2.4. All measured time criteria were met. The average time for Tasks 4 - 6 was 14.8 minutes, which was significantly below the target level.

Subjects committed an average of 7.6 errors across the six tasks. In all but two instances, subjects were able to recover easily from their errors with no experimenter help. These errors were traced to 22 distinct usability problems. Nine of the problems occurred with a frequency greater than 50%. Most of these problems were related to Compass' ability to let the evaluator define and run a group of tasks with a client (in one or more sessions), as well as change the list of tasks or their configurations at any time. This feature was well-liked by evaluators, and is a key to Compass' power and efficiency in real-world use, but it does require the evaluator to manage a list of tasks and their configurations.

On the basis of these results as well as subjects' comments, the Compass interface was revised, to reduce or eliminate as many usability problems as possible. While these problems did not in general prevent subjects from reaching the behavioral objectives, they did represent opportunities for improving the interface.

Usability Test #2

Methods. A second usability test was conducted once the revisions to the Compass interface were complete and two new pointing tests were implemented. Ten participants were solicited from clinicians in the U.S. and Canada who had expressed interest in the Compass project. Participants evaluated the software by performing suggested and self-defined tasks and completed the post-test survey as well as some open-ended questions.

Data collection focused on survey question responses and qualitative feedback provided by

the evaluators. Since participants were geographically scattered, it was not possible to observe the time required for learning and evaluation. Therefore, measurable objectives for user satisfaction were defined as an average score significantly greater than 3.6 for "positive" survey questions and an average score significantly lower than 2.4 for "negative" survey questions. The qualitative feedback was carefully analyzed and collated to identify usability problems and other suggestions for enhancements to the system.

Results. Subjects in both usability tests completed the same post-test survey, and statistical analysis showed that responses were not significantly different for the two subject groups. Therefore, responses were collapsed across all subjects to gain the benefit of a larger subject pool.

Table 1 shows the average response to each survey question. Responses met the target level for 8 of the 12 questions, which suggests a relatively high level of user satisfaction overall. Responses to the other 4 questions indicate the following: subjects did not agree on whether use of Compass would take longer than current practice; the response time of the system could be improved; the client tasks could be made more motivating through the addition of color, animation, and other features; and planned additional keyboarding tasks should be implemented.

Discussion

These usability tests have provided invaluable information as we develop the Compass software. Quantifying even some user needs and verifying that the system meets those needs gives increased confidence that clinicians may ultimately find Compass to be a useful tool. Additionally, while beyond the scope of this paper, perhaps the richest source of information was the qualitative feedback provided by participants. Our next development cycle will focus on incorporating these clinician comments into the system.

References

Koester, H., McMillan, W. (1997). Software for Assessing Computer Usage Skills. *Proc. of RESNA '97*, 354-356.
 Gould, J. (1988). How to design usable systems. In *Handbook of Human-computer Interaction*. Elsevier Science Publishers.
 Nielsen, J. (1995). *Usability Engineering*. Boston: AP Professional.

Acknowledgments

This work was funded by the National Institutes of Health, grant #1R41-NS36252-01, as a Phase I STTR award to Koester Performance Research. Many thanks to the participating clinicians for their time and thoughtful insights.

Heidi Horstmann Koester
 368 Oak Harbor Ct.
 Holland MI 49424
 hhk@umich.edu

Survey Question	Ave. Response	95% C.I.	Met Goal?
It was very easy to learn how to use Compass.	4.1	[3.9, 4.4]	√
Using Compass was a very frustrating experience.	1.6	[1.2, 1.9]	√
I feel I am capable of independently using Compass with a client after this experience.	4.3	[3.7, 4.8]	√
The reports of the results were clear.	4.2	[3.7, 4.6]	√
Compass is very pleasant to work with.	4.2	[3.9, 4.5]	√
Compass would probably take longer to use than my current assessment methods.	2.3	[1.7, 2.8]	No
I am likely to use Compass routinely for client assessments.	4.2	[3.8, 4.6]	√
It is worth the effort to use Compass.	4.4	[4.1, 4.7]	√
The measures Compass provides are accurate indicators of a client's keyboarding skill.	3.8	[3.4, 4.2]	No
I understood how to do the client tasks (Single Letter, Sentence, Aim, and Menus)	4.3	[3.7, 4.9]	√
My clients would find the Compass tasks motivating.	3.3	[2.9, 3.8]	No
Compass seems to respond slowly.	2.8	[2.1, 3.5]	No

Table 1. Responses to post-test survey questions across the 16 subjects in Usability Tests #1 and #2.

MAKING THE INTERNET ACCESSIBLE TO THE VISUALLY HANDICAPPED

Djamel HADJADJ, Abdellah BOUZIDI, Dominique BURGER
INSERM-Creare, France

ABSTRACT

This paper describes the approach we have used to develop a non visual Web browser accessible to visually handicapped users in the frame of the BrailleNet project.

It proposes a method for adapting HTML documents in accordance to existing recommendations for HTML design. It describes the principles followed to create a multimodal user interface. A beta version of a Web browser based on Braille and speech has been released which aims at providing a very user-friendly and functional Internet interface to visually handicapped students from primary schools to universities. This work refers to recent software development techniques such as ActiveX.

BACKGROUND

Internet servers provide information via the unified HyperText Transfer Protocol (HTTP), and use the HTML language to describe the structure and content of the information delivered. In HTML, tags are used to identify different types or levels of information in the document. For instance, $\langle H_n \rangle$ is associated to headings, $\langle \text{IMG} \rangle$ identifies images, or $\langle \text{FORM} \rangle$ makes it possible to include forms composed of standard objects (Button, List box, Combo box, Check box, etc.) similar to those used in graphical interfaces.

Thus, this information is fairly easy to interpret and transform. For instance, the text browser LYNX [4] or the WAB proxy server [7] have taken advantage of these features. Both applications process HTML source documents and produce an adapted version. This is referred to as *filtering* in this paper.

The background of this paper is our experience of developing a Web browser for the

French BrailleNet project [1], 'Internet for the Education of the Visually Handicapped'.

METHOD

General architecture

Figure 1 shows the implementation of a non visual web browser. It is made of three modules: *Filter*, *Browsing Module* and *User Interface*. The *HTML Document* is an Internet Web server to which requests are sent using the HTTP protocol, a set of HTML files on a hard disk or a CD-ROM.

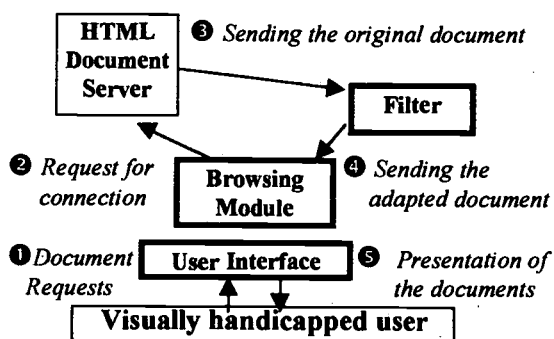

The user sends a document request via the interface. The Web module connects to the server. The server sends the HTML document to the filter, which adapts it and sends it to the Web module, the user can « read » the document via the user interface.

Figure 1 : General Integration scheme

WEB Module

The *Browsing module* can be a browsing component but also a complete Web application with the possibility to control it from an external software.

User Interface

In order to be user-friendly as graphical user interfaces are, the *User interface* shall combine visual, auditory and tactile interaction modes [2]. Essential functional data such as links shall

be perceived immediately by the user using dynamic braille display associated with auditory hints and the functionality to access them shall be simple enough. Taking into account the world wide dimension of Internet it has also to be able to easily switch from one language to another.

Filter

The HTML language is flexible enough to provide a variety of HTML elements clearly describing the structure of a document. Thus, a given semantic content can be presented in various HTML forms. This is the basis of any adaptation method based on processing HTML source code [6].

Adaptation of HTML Document

Several types of transformation can be made :

Simplifying

Some elements of little semantic value, such as tags concerning the size, style or colour text, can be simply removed. Images are also often removed when - unfortunately - no comment is provided to explain them.

Clarifying / Rephrasing

For instance, links can be presented with an added prefix (LINK) and/or the number of the link in the document and/or by delimiting it by "[]".

Restructuring

Even more drastic reformulation is sometimes needed to obtain a notion of the global structure of the document and for rapid navigation within the document. For instance, it is useful to provide a list of the links contained in a document, or a table of contents showing the headings of a document. This table of contents can be preceded by an anchor making it possible to bypass it. This type of adaptation of links implies the complete rebuilding of a document, since new links or anchors must be added.

Thus, in conclusion, different transformations can be used single or in combination for each

type of HTML element. Optimal solutions generally vary according to the user's preference or the display technique used.

Filtering components

Figure 2 shows the components used to build the filtering process. The filter processes source HTML documents and outputs adapted HTML documents .

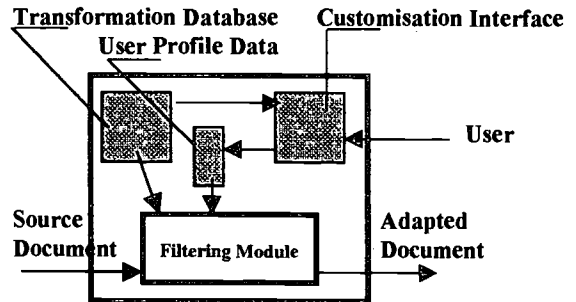

Figure 2 : Filtering components

Transformation Database

One or more transformation functions are invoked each time a tag is encountered. The process can be applied several times for each transformation. A database is built that defines the relationships between the various HTML tags and the transformation methods for the different HTML.

Customisation Interface

The document is adapted using the transformations appropriate to each type of HTML element. This is done by a customisation module whose user-interface allows or forbids certain combinations of functions, depending on the hardware/software used.

User Profile Data

The customisation parameters are saved in a data structure and used during filtering.

Filtering Module

The filtering module uses data provided by the database and the customisation module to process the HTML documents. Each elementary transformation can be broken down in three steps: *identification*, in which the HTML tag is

identified, *transformation* using one or more adaptation functions, and *replacement* in which the adapted sequence is inserted into the source document in place of the original one.

Implementation using high-level components

Microsoft ActiveX technology [5] offers a possible way to implement such browsing tools using sophisticated components whose functions are defined at a very high level. Powerful components can be controlled through rather simple software interfaces in this software development environment. For instance, Web Browser Objects can be used as HTML document servers. Software interfaces have then to be developed to make the filter communicate with these objects, and the HTML application communicate with the user interface [3]. It is even possible to co-operate with a complete application such as Microsoft Internet Explorer, since any ActiveX application is provided with a standard software interface based on OLE/COM techniques [5].

RESULTS & DISCUSSION

The architecture described here is the basis for developments that have been undertaken at INSERM as a part of BrailleNet [1]. A beta version of a Web browser has been released which aims at providing a very user-friendly and functional Internet interface to visually handicapped students from primary schools to universities. The proposed approach proved to provide a suitable framework for the development of Internet access products whose main features are full compatibility with current and previous HTML versions, and easy updating according as HTML develops by adding new data to the transformation database. This approach clearly separates the development work on the adaptation from the work on presentation and browsing.

Finally, it is to be hoped that standard browsers will become accessible through access products in the near future. This will mean that

specific functions are no longer available in the browsing product, and that adaptation filters will complement the standard Internet browsers. We therefore believe that the HTML adaptation problem will have to be completely solved within a well identified software component that other application can co-operate with. Recent trends in software development are encouraging in that direction. The use of high-level components alleviates much of the development work (for instance, developers do not have to take into consideration the problems linked to Internet connection and dialogue, or the basic functionality of applications). Therefore efforts can be concentrated on function and the user interface itself, to the benefits of the end user.

REFERENCE

1. BrailleNet, www.ccr.jussieu.fr/brailenet/
2. Burger D., Improved Access for the visually Handicapped, In: *IEEE transactions on rehab Engin.*, 1994, pp. 111-118
3. Hadjadj D., Agro R. & Burger D., Customising HTML by filtering, *3rd ERCIM Workshop User Interface for All*, 1997, pp. 219-224.
4. Lynx, <http://lynx.browser.org>
5. Microsoft, *ActiveX Accessibility Conference*, Birmingham-UK, 1996
6. The Web and Disabled People, www.w3.org/pub/WWW/Disabilities/
7. WAB: W3-Access for Blind And Visually Impaired, <http://inf.ethz.ch/publications/ea.html>

AKNOWLEDGEMENTS

This R&D project is supported by a grant of the *Fédération des Aveugles et handicapés visuels de France*.

Djamel Hadjadj dhadjadj@snv.jussieu.fr
INSERM-Creare U482, UPMC B23
9 Quai St Bernard, 75005 Paris, France
33 (0) 1 44 27 26 25 Fax: 33 (0) 1 44 27 34 38

AUTOMATED ALIGNMENT OF CONTOUR PAIRS: A HYBRID APPROACH WITH APPLICATIONS TO PROSTHETICS

BJ Hafner, SG Zachariah, JE Sanders
Department of Bioengineering, University of Washington
Seattle, WA 98195

ABSTRACT

The automated two-stage alignment algorithm is presented and its application to a series of bone contours described. The algorithm uses principle axes and centroid information to obtain an initial alignment, then minimizes a quantitative objective function to obtain the best possible alignment between the contours. It is currently being expanded for three-dimensional prosthetic applications for use in assessing shape differences of the residual limb and socket surfaces.

BACKGROUND

A quantitative method for computing three-dimensional shape differences in prosthetic sockets and limbs would be an invaluable tool for studying diurnal or lifetime shape changes of the residual limb. Similarly, such a method could also be applied to analyze variations in intersubject bone geometry. While the need for such an alignment program within the area of prosthetics is evident, only one such application has been noted in the literature (Lemaire, 1996).

Image alignment in other fields, notably neurology, has resulted in greater alignment accuracy using optimization methods to automatically align MRI and CT images (Pelizzari, 1989). It is hypothesized that by applying similar methods to residual limb and bone shapes, improved limb/bone alignment and shape change quantification will result. The following represents the development of an automated two-stage alignment algorithm for two-dimensional bone contours.

METHOD

Data Collection

The bone contour data was collected from x-ray computed tomography (CT) images (512x512, 8-bit grayscale) of the proximal leg of 18 adult subjects (Fig. 1, below).

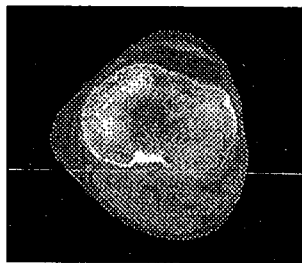

Figure 1 – CT Image of a Cross-Section of the Lower Leg Near the Proximal End of the Tibia

Using visual inspection, a similar cross-sectional image at the proximal end of the tibia was chosen from each individual's CT images. A density slice threshold was applied to each image using NIH Image¹ to differentiate the bone from the soft tissue on the basis of pixel grey-level. If required, manual correction was applied to correct any irregularities caused by grey level fluctuations or induced artifacts.

The thresholded images were then individually segmented to produce the bone contour and saved in cartesian coordinates. In order to reduce the size of the data and smooth the contour, the cartesian points were converted into B-spline format using a bespoke Matlab² routine. In addition to data reduction, the B-

¹ NIH Image, <http://rsb.info.nih.gov/ni-image/>

² Matlab, The Mathworks Inc., Natick, MA

spline format allows the ability to interpolate the coordinates at any point on the contour, which is required for the alignment algorithm presented below.

Alignment Program

The alignment program was designed as a two-stage alignment procedure incorporating principle axes alignment for rough initial alignment, and an optimization algorithm for detailed final alignment. The program compares two bone contours, one reference and one mobile. By process of an optimization cycle, the program calculates and minimizes a specified objective function describing the accuracy of the alignment of the two contours.

The initial alignment had to be of sufficient accuracy to ensure the optimization reached the global minimum. In order to perform rough calculations, each contour was segmented into 100 equally spaced (angular) points. Using these discretized contours, the centroid and first principle axis was calculated for each contour. The centroid of the mobile contour was then translated to the location of the reference contour and then rotated so that the principle axes aligned with that of the reference shape.

Starting with this position, the second stage returned to the B-spline form of the reference contour. At each point of interest on the discretized mobile contour, an optimization window is created (as shown in Fig. 2, below) at ± 8 degrees.

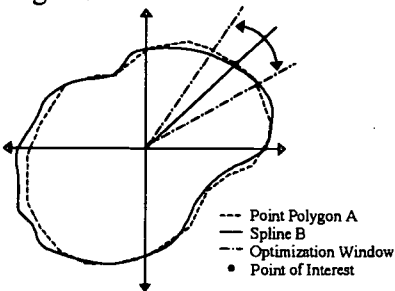

Figure 2 . . Final Optimization Process

The iterative optimization cycle calculated the sum of the squared distances from the point of interest to the closest location on the B-spline reference contour (with bounds provided by the above mentioned optimization window) and then minimized this sum. This objective function (also known as the error function) is described as follows:

$$Error = \frac{\sum_0^i d_i^2}{n}$$

Here, d_i corresponds to the minimum distance between each point on the mobile contour and the fixed contour and n corresponds to the number of points on the mobile contour.

The mobile contour was allowed four degrees of freedom in the algorithm: x translation, y translation, rotation about the centroid, and scaling. The optimization cycle simultaneously adjusted these values until a minimum objective value was reached, at which point the two shapes were said to be in the best possible alignment.

RESULTS

The bone contour alignment program was tested using 18 proximal tibia CT images from the collected data (see Fig. 3a).

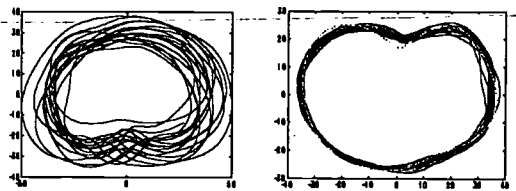

Figure 3 . Bone Contours (a) Before and (b) After Initial Alignment

The first contour (C1) was input as the reference contour, with the remaining 17 were input sequentially as mobile contours. The objective function was evaluated prior to alignment, after initial positioning, and after final alignment. As expected, the initial

positioning stage resulted in a very accurate fit (see Fig. 3b)

The final alignment produced an even better fit of each pair of aligned contours. The following chart (see Table 1) shows the objective function values at each stage of alignment and the resulting improvement of the final alignment over that of the initial alignment.

Table 1. Alignment Program Results

Bone Contour	Original Error	Error After Initial Positioning	Error After Final Alignment
1	22.0669	1.7349	1.6761
2	16.0070	1.6019	1.5721
3	5.2335	2.6583	2.6357
4	29.5571	2.9165	2.5753
5	5.7152	1.3890	1.3140
6	7.4918	2.2828	2.2703
7	4.2712	1.3165	1.3044
8	18.3540	3.5916	3.5701
9	15.4237	2.0575	2.0269
10	2.8189	2.7984	2.7584
11	13.2261	3.8705	3.7996
12	4.2970	3.4313	3.2300
13	19.6973	1.5202	1.4582
14	52.4501	9.3367	8.4601
15	6.8506	4.0158	3.8724
16	14.5550	2.1704	2.1494
17	4.8229	1.7548	1.6624
Average Reduction:	11.4348	0.1242	

As shown, in every case, the optimization program provided additional improvement, producing an optimal fit between bone contours. In order to verify the final results, each pair was transformed by hand and in no situation was an improvement in the objective function produced.

DISCUSSION

The data presented clearly shows that the above two-phase program is a powerful tool for automated alignment of two-dimensional bone contours, producing results more accurate than manual manipulation can provide. Of great interest is the accuracy not only of the final alignment, but of the initial alignment, based solely on the centroid and first principle axis of each contour. Such results minimize the computation required for further alignment and

ensures the optimization reaches a global minimum

Future work will include expansion of the alignment algorithm to three-dimensional bone shapes. By using a two-phase process similar to the one demonstrated above, we expect to obtain results far more accurate than methods used by previous investigators who have used only single-stage methods such as centroid (Lemaire, 1996) or landmark (Toennies, 1990) alignment. Such a tool could provide relatively quick and accurate registration using only a personal computer. This algorithm could be applied to a wide variety of prosthetics applications including residual limb-socket alignment, diurnal shape change measurements, and intersubject bone comparisons.

REFERENCES

- Pelizzari CA, et al., *J Comput Asst Tomogr*, 13(1): 20-26, 1989.
- Lemaire ED, and Johnson F, *IEEE Trans Rehab Engr*, 4(4): 303-309, 1996.

Toennies KD, et al., *IEEE Computer Graphics & Applications*, 52-62, May 1990.

ACKNOWLEDGEMENTS

This project was supported by the NIH Research Grant HD-31445 (NICHD) and the Whitaker Foundation.

Brian J. Hafner
Department of Bioengineering
University of Washington
Seattle, WA 98195
(206) 543-9379

MEDICATION DATABASE SYSTEM WITH INTEGRATED BAR CODE READER

Michael R. Tracey

School of Engineering, Graduate Program in Biomedical Engineering
The Catholic University of America, Washington, D.C.

ABSTRACT

75 million Americans over age 40 suffer from symptoms related to presbyopia. Indications and Directions for Over the Counter and Prescription medication are commonly outlined on the side of medication containers. This information is often printed in a very small font and is difficult for individuals suffering from presbyopia to read and understand.

A medication database that is accessed using a bar code reader provides a simple solution. Medication information would populate the database and would be displayed in a large type font with interactive displays for the user.

Integration of commercial technologies can provide powerful tools to all consumers, especially disabled consumers. The principles of Universal Design are incorporated into the system.

PROBLEM

As people age, they often begin to have difficulty focusing their eyes for reading or close work. This is called presbyopia and is the normal-aging of the eyes. It is a normal process that happens over a lifetime and usually does not effect people until after the age of 40. 75 million Americans over age 40 suffer from symptoms related to presbyopia.

Indications and Directions for Over the Counter and Prescription medication are commonly outlined on the side of medication containers. This information is often printed in a very small font making it difficult for individuals suffering from presbyopia to read and understand. Dangerous overdoses or dangerous combinations of medicines may result from ignored or misunderstood dosage information.

Other conditions and diseases effecting the vision of elderly individuals are Cataracts, Glaucoma and age-related macular degeneration. All can lead to a problem of reading small print on the side of medication bottles and packaging. Cataracts are the leading cause of blindness in people over 65 and impair more than 3 million Americans a year. Glaucoma is diagnosed in 95,000 new patients each year. (1)

Other common eye ailments are floaters, dry eyes, tearing, eyelid problems, and corneal diseases and conditions. These ailments effect people of all ages and may result in problems similar to those experienced by people suffering from presbyopia. (2)

PROBLEM SOLUTION

A simple solution to this problem combines bar code scanning technology with Personal Computer technology. Specifically, a database that maintains information about a particular medication and is accessed using a bar code reader. The information on dosage, indication and warnings would populate the database. Once retrieved the data would be displayed in a large type font with interactive displays for the user.

Three approaches are envisioned for providing this assistive technology. The *first* uses the Internet as the foundation for the system. The user would access a program on a home Personal Computer and scan in the bar code on the side of the medication bottle or packaging. This program would relate a product identification number (bar code) to an Internet site for that particular medication. Each product site would contain information about dosages, warnings, etc. and would require that

the medication manufacturer or a pharmacy maintain the information and sites.

A *second* approach would use a pharmacy-based system. The user's pharmacy would maintain a database that could be accessed in the store, a kiosk, or by remotely accessing the database from home via an emulation program for PC's. Again, the user would scan in the product information from the bar code to access product information. An advantage of this approach would be the ability for the user to renew prescriptions, confirm refills, etc. In this capacity the system would incorporate telemedicine characteristics for remote access to a pharmacist.

The *third* approach would develop a database for the user to maintain (directly or indirectly) on a home Personal Computer. This database would access the appropriate information when the bar code for a medication is scanned. The advantage of using this approach is the relative simplicity of the system. The system is not dependent upon manufactures' Internet sites or servers maintained by pharmacies.

METHODOLOGY

The approach used to develop a prototype system uses the *third* approach.

Commercially available bar code scanning technology is relatively unchanged since it was first introduced in the 1970's. At the time of introduction the technology was used only in manufacturing settings for product tracking and in retail for sales and inventory tracking. The optical pickup, or scanner, first projects light and then detects the reflection or absorption of light by the bars in the bar code. The spacing and width of the bars represent numbers or letters. In the United States the Uniform Product Code (UPC) has been standardized for all retail products. Manufactures must apply for a UPC for a product with the Uniform Code Council. The UPC format contains 12 digits and each series of digits contains information about the product. The UPC identifies the type

of product (i.e., pharmaceutical, medical), the manufacturer, and the particular product.¹

Bar code scanners are capable of interfacing with PC's in two ways; a hardware wedge or an RS-232 interface. Figure 2 depicts the two configurations of bar code scanning technology interfaces with Personal Computers.

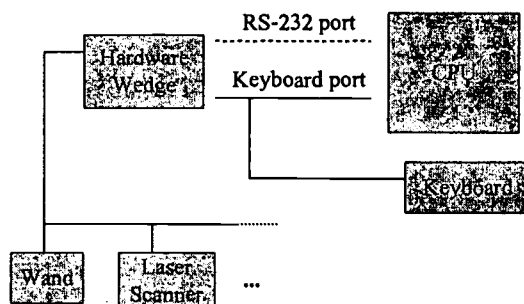

Figure 1 Bar Code Technology

Database development is relatively simple using commercially available relational database software. To take advantage of the Accessibility Options available on the MS Windows 95 operating system MS Access for Windows 95 is used to develop the database. No unique development methods are required to allow the database to accept information from the bar code scanner.

HOW THE DESIGN WOULD ULTIMATELY BE DEVELOPED AND USED BY THE DISABLED POPULATION

Depending upon the system concept used (as identified in the Problem Solution section) the development and use of this system will change. Using the system described in the Methodology section (home PC based system) the development of the system would be relatively simple. Using a commercially available database application the database could be created and populated by the user (directly or indirectly). Scanner technology is

¹ The European Article Numbering (EAN) contains an extra digit to identify the country of origin.

ready to interface with a Personal Computer (plug-and-play).

The system is capable of use by more than one person. For example a computer set-up in a common area of a medical care facility could contain the prescription information for a number of patients as well as extensive over-the-counter medication information.

LITERATURE REVIEW

The literature reviewed was commercially available data on bar code technology, human visual conditions and defects, and guidelines for design of computer systems for disabled persons. The majority of the data was accessed using the Internet.

The Industry/Government Computer Accessibility Task Force identified specific guidelines for the development of Assistive Technologies that incorporate computers. (4)

Recommendations for the design of systems for persons with disabilities were found in Cook & Hussy and the Trace Center's Internet site. These formed the basis for the detailed system requirements:

- Use large text.
- No color dependent options or bold text.
- Use few mouse type inputs.
- Use sound for error and correct inputs.
- Output audio and written information.
- Avoid flickering displays.
- Electronically available documentation.

PRELIMINARY DESIGN

A prototype database has been developed to demonstrate the feasibility of the system. The system is intended for home use on a PC with a PENTIUM Processor and MS Windows 95. MS Access for Windows 95 was used to develop the database and a Hewlett-Packard wand scanner with an RS-232 interface is used to scan medication bar codes.

Universal Design principles were incorporated into the system architecture. Universal Design is "The design of products and environments to be usable by all people, to

the greatest extent possible, without the need for adaptation or specialized design." (5).

Steps to developing a production version of this Assistive Technology would focus on development of a database using other database application. Should MS Access be used for a production development a read-only version of MS Access would be required to minimize the cost of the database to the user. The wand scanner used to demonstrate the capability worked well but requires a higher level of effort by the user than a laser type scanner. Laser scanners are more tolerant to user error but are more costly.

Integration of the Internet is introduced in this prototype but is not complete. Links to on-line medication databases and other medical information would make this Assistive Technology a more robust tool.

REFERENCES

1. *Aging and Your Eyes*, National Institute on Aging, U. S. Department of Health and Human Services Public Health Service, National Institutes of Health, 1995
2. *Learning To See The Inevitable Signs Of Aging Eyes*, The Better Vision Institute, Washington, D.C.
3. *Considerations in the Design of Computers to Increase Their Accessibility by Persons with Disabilities Version 4.2*, Industry / Government Computer Accessibility Task Force, Trace Center, 1988
4. *The Principles of Universal Design Version 2.0*, The Center for Universal Design, NC State University, 1997.

Michael R. Tracey mtracey1@juno.com
2520B South Walter Reed Drive
Arlington, VA 22206
(703) 578-4409

Scientific Instrument Access for Students with Disabilities

Douglas Loyd, Scot Schrager, and Kenneth Barner
Department of Electrical and Computer Engineering
Department of Computer and Information Sciences
University of Delaware, Newark, DE

ABSTRACT

Inaccessibility to appropriate scientific instrumentation discourages many college students with disabilities from entering scientific fields of study. This paper introduces research on the development of a software system to allow for improved access to instruments through alternative interface methodologies and remote access. Experimental software packages for are presented using LabVIEW™.

BACKGROUND

Laboratory instruments are intrinsic to scientific study. They are used for the control of devices, data storage, and data analysis. Indicators and graphic representations of data make it difficult for a student with a visual impairment to operate the instrument. Controls are often difficult for a student with physical disability to operate.

LabVIEW™, by National Instruments, is a software package that allows access and control of instrumentation via a computer. LabVIEW™ is the most widely used instrumentation software package in both universities and corporations. In fact, William D. Phillips, the 1997 Nobel Prize winner in Physics, used LabVIEW™ in his experiments in atom cooling.

We are using LabVIEW™ as the backbone for our accessible instrumentation software because of its extensive utilization and acceptance in both the academic and business communities. LabVIEW™ also has a large library of instrument drivers to which our accessible instrument methodologies can be applied. Previous research into accessible scientific instrumentation was directed toward

the development of a accessible device that would replace several simple laboratory instruments [1]. Our direction is to add accessibility to instruments via hardware and software, specifically desktop computers and LabVIEW™, that is already in wide use in scientific laboratories.

STATEMENT of the PROBLEM

The increasing use of software for instrumentation control presents both challenges and opportunities for students with disabilities.

The use of a software instrument interface to provide visual representations of an instrument, referred to as a Virtual Instrument (VI), introduces difficulties for individuals with visual impairments. VIs are commonly presented on a computer screen as a collection of knobs, buttons, dials, and switches for control and graphs and charts for data analysis.

Laboratory instruments also pose accessibility issues for students with physical disabilities. Labs are often inaccessible and instruments require fine manipulation of the myriad of buttons, knobs, switches and other controls.

RATIONALE

Although the visual nature of computer based instrumentation interface introduces problems, the ability of computers to produce sounds, such as synthesized speech, offer unique opportunities to overcome this obstacle faced by visually impaired users.

Computer connectivity, manifested through the Internet, allows for rapid communications where distance between points has become essentially irrelevant. The computer

down the hall has become nearly as accessible as one half way around the world. This offers to a student with physical disabilities the opportunity to operate an instrument via their own computer with its accessible offerings.

DESIGN

The accessible instrumentation package presented was designed using a Power Macintosh running system 7.5 and LabVIEW™ 4.0.

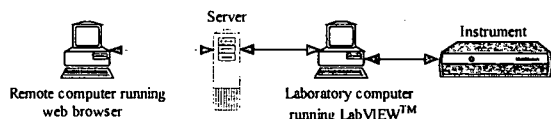

Figure 1. Accessible Instrument System

The system developed allows for two possibilities as illustrated in the above diagram. A computer running in the laboratory is connected to the instruments through a General Purpose Interface Board (GPIB). A visually impaired student can control the instruments and have audio feedback and key-based navigation, as described below. The computer in the laboratory can alternately be running as a server that a student operating a remote computer can access and operate the instruments.

To overcome the VIs Graphical User Interface (GUI) introduced limitations, alternative methodologies for output and navigation were developed. The Macintosh computer was chosen because of its built-in speech synthesizer and Musical Instrument Digital Interface (MIDI) output capabilities, packaged as part of the newer operating systems.

The first issue investigated was the need for the user to know the values of all the controls and indicators. Speech is used to alert the user to the changes in these values on the VI. The technique used is to detect changes by saving the current value in a local loop and

compare it with the next value. If there is a discrepancy a signal is generated to speak the new value.

The next issue to examine was the need for a visually impaired student to understand and analyze graphs, which are usually presented in a visual manner. An alternative method of graphing data elements was designed using the MIDI. Charts and graphs are stored in LabVIEW™ as an array of data elements, so these elements can easily be mapped into a series of MIDI tones. The elements can be mapped in various ways dependent on the intended use, or can be filtered to obtain a distinct audio representation of the entire graph. This control over how the data is graphed is given to the user. The user is also given control over what section of the data is graphed.

The last issue considered was the need for a non-visual form of control of the instrument. LabVIEW™ allows the use of a mouse to press buttons and turn knobs. An alternative method of navigation was designed using key-based menus. Instrument control is represented as a shallow hierarchy of menu choices. Each choice for any menu is mapped to a specific function key. Numeric values are entered using the numeric keypad. Every menu and sub-menu has a help file that the user can always access by pressing the F1 key. The help file is spoken by the speech synthesizer and tells the user what keys correspond to what menu choices for that specific menu. The user can also always exit a menu by pressing the escape key. For example, a function generator might have main menu choices of amplitude, frequency and modulation. The amplitude sub-menu would then allow the user control over the amplitude of the function. The function keys, the escape key and the numeric keypad accomplish keyboard navigation of the menu choices.

The conclusion of the design of the alternative output and navigation VIs leads to the next portion on the system. Through networking, computers can be used as front-end controllers, allowing instruments to be accessed remotely. Students with physical impairments can then operate a laboratory instrument using their own computer.

Data acquisition techniques and Common Gateway Interface (CGI) applications were developed to interface with laboratory instruments remotely, using National Instrument's Internet Developers Toolkit. Using these applications an Internet browser can send and receive data to and from a physical scientific instrument.

Using data acquisition, a VI reflects all the settings of the physical laboratory instrument. The Internet Developers Toolkit uses CGI to communicate with a VI through a web server.

User interaction is facilitated in a variety of ways. Each user is given a unique identity by which a communication link can be maintained. Careful coordination of web requests with user ID is necessary for accurate instrument representation. An image of the VI is sent to a web browser to display its current settings. Any change in the instrument's display automatically refreshes the current image displayed in the browser. A user can interact with the device by clicking on it. Clicking on the image either changes its settings or prompts the user for additional information through an HTML form.

The output of the VI to the web browser can take many forms. For example, a visually impaired student could operate the instrument by receiving textual descriptions of the VIs controls and using a screen reader to aid in the operation. Alternately, a student with a physical impairment could use a head-pointing device for

point and click operation of the remote instrument. A real-time remote instrument is limitless in applications.

DISCUSSION

The design of an alternative interface access software package with remote accessibility has one main goal. That is to encourage and enable students with disabilities to enter scientific fields of study.

This research is heading toward an entirely accessible laboratory that could be operated on location or remotely. The flexibility of the software developed and the abundance of scientific instrument drivers for LabVIEW™ lends itself to this. We are currently applying our methodologies to instruments that would be found in an introductory electrical engineering laboratory course. We have drivers with alternative audio output for the HP33120A 15 MHz Function and Arbitrary Waveform Generator, HP54603B 60 MHz Oscilloscope, and HP34401A Digital Multimeter. They are available at the Remote Instrumentation and Interface Access website:
<http://www.asel.udel.edu/sem/research/home.html>

PC versions of the software are also being developed.

REFERENCES

- [1] "The Microcomputer-based Laboratory Aid for Visually Impaired Students," D. Lunney and R.C. Morrison et al., IEEE MICRO, 3(4), 19 (1983).

ACKNOWLEDGMENTS

This work has been supported by the National Science Foundation, under grant #9450019. The authors would also like to thank Anna Phalngas for her feedback and support.

For more information contact Kenneth Barner at barner@udel.edu.

SIG-12
Rural Rehabilitation

292

ERGONOMIC RISK FACTORS AND TRACTOR MODIFICATIONS FOR FARMERS WITH SPINAL CORD INJURIES

Therese Willkomm, Ph.D. ATP
New Hampshire ATECH
The Alliance for Assistive Technology

ABSTRACT

The purpose of this paper is to describe the prevalence and frequency of tractor-related accidents and risk factors when modified equipment is used by operators who have spinal cord injuries and by co-workers who use the same equipment.

BACKGROUND

Each year over 300 farmers experience a spinal cord injury (SCI) (Hancock & Field, 1989). Many of these farmers choose to return to farming using equipment modifications such as tractor lifts and hand controls. In addition, co-workers often use the same equipment to complete essential farm tasks. Farming has been identified as the second most hazardous occupation; and tractors are a major cause of agricultural work-related fatalities, accounting for 150 to 300 occupational deaths annually (Bobick & Jenkins, 1992; Etherton et al., 1991; Murphy, 1990; Myers, 1989; National Safety Council, 1993). Unfortunately, there has been no research conducted on the tractor safety record of farmers with disabilities and the impact that their disabilities might have on the frequency and severity of tractor-related injuries. Further, due to the lack of commercially available tractor lifts and hand controls, the majority of tractors are modified by the farm family or a local machine shop, often without regard to established engineering principles.

METHODS

Twenty-one farmers from four Midwestern states and 20 co-workers were included in this

study. Farm visits were conducted on-site during the spring and summer of 1996. Each farmer and co-worker were interviewed to collect data on a prior history of secondary conditions that might affect tractor operations, as well as their history of tractor-related accidents or near misses that occurred when using the modified tractor. In addition, photographs and videotapes were used to document observed risks when using the tractor. Additional measurements of the tractor steps, doorway, and hand controls were gathered and compared to established ergonomic guidelines for tractors and hand controls. Observed and reported risks were analyzed and grouped into four categories: risk in using a tractor lift, risk in using a specific type of lift, risks in using hand controls, and risks to co-worker who use the same modified tractor.

RESULTS

Over 55 separate risks were identified as having the potential to cause an injury or illness to farmers with SCI who used a modified tractor or to co-workers who used the same tractor. The most frequent risk identified was the potential for bumping, scraping or catching one's feet or legs on the tractor or hand controls when getting on, off, or when operating the tractor (See Table 1).

Also, over 85 percent of the hand controls in the tractors exceeded the established ergonomic guidelines for maximum reaching distance in the transverse and sagittal planes.

293

Hand controls that could not be easily removed frequently interfered with foot and leg placement of co-workers (See Table 2). Co-workers who used tractors equipped with slings lifts mounted on the inside of the cab risked hitting their heads on an overhead diagonal track mounted in the ceiling of the cab. Furthermore, the workers who were required to assist the operator with SCI in getting in and out of the tractor, were at an additional risk of injury due to the physical and biomechanical demands placed on the worker (See Table 3).

Table 1: Frequency of Potential Risks Associated with Tractor Lifts in General (N=21)

Potential Risks Identified	N	%
Bump, catch, hit, or scrape of body when getting on or off the tractor	20	95.2
Lift uses winch motor which is not recommended for lifting humans	16	76.2
Placement of lift controls was difficult for the operator to see or reach	13	61.4
Lack of handholds when accessing the tractor seat	12	57.1
Assistance required when using the lift	9	42.9
The lift remote control must be held in ones hand when getting in or out of the tractor	9	42.9
The lift jumps, jerks, or bounces while the operator is being raised or lowered	7	33.3
Lift stops unexpectedly or does not stop when control switch is released	2	9.5

DISCUSSION

Ergonomic guidelines, different from those currently established for tractor operations, should be established for operators who have SCI due to unique individual needs, lack of upper body stability and reduced reaching capability. A bio-mechanical analysis would be required to determine the best ergonomic location of hand controls for each operator and their tractor. Furthermore, consideration must be given to co-workers prior to modifying the tractor in order to reduce the potential risk of injury among co-workers who use the same tractor.

Table 2: Frequency of Potential Risks with Each Hand Control (N=46)

Potential Risk	N	%
Hand control has sharp edges or pressure points	35	76.1
Exceeds maximum hand reach in the sagittal plane	34	73.9
Exceeds maximum hand reach in transverse plane	29	63.0
Diameter is less than 1 inches or greater than 1.75 inches	23	50.0
Hand control is not securely mounted	20	43.5
Push/pull force exceeds recommended optimum of 18 lbs	14	30.4
Length of control handle is less than 3 inches	10	21.7
Push/pull force exceeds recommended maximum of 31.5 lbs	10	21.7
Controls are pushed in a forward direction	9	19.6
One control is pulled rearward and the other is pushed forward	2	4.3

Table 3: Frequency of Potential Risks to Co-Workers (N=20)

Risks	N	%
Lift interferes with pathway to the tractor seat	13	65.0
Co-Worker required to assist operator with SCI	10	50.0
Hand control interferes with co-worker's foot placement	10	50.0
Accidental contact made with tractor lift	8	40.0
Door catch released	6	30.0
Controls interfere with pathway to seat	6	30.0
Co-Workers legs hit controls	5	25.0
Hand holds removed from tractor	3	15.0

REFERENCES

Bobick, T. G., & Jenkins, E. L. (1986). Agricultural-related fatalities. Advances in Industrial Ergonomics and Safety IV., 121-128.

Etherton, J. R., Myers, J. R., Jensen, R. C., Russell, J. C., & Braddee, R. W. (1991). Agricultural machine-related deaths. American Journal of Public Health. 81(6), 766-768.

Hancock, J. N., & Field, W. E. Farming following a spinal cord injury. (1989). Anonymous. Purdue University, West Lafayette, IN: Breaking New Ground. 6,

Murphy, D. J. (1992). Safety and Health for Production Agriculture. Penn State University: American Society of Agricultural Engineers.

Myers, J. R., & Snyder, K. A. (1995). Roll-over protective structure use and the cost of retrofitting tractors in the United States, 1993. Journal of Agricultural Safety and Health. 1(3), 185-197.

National Safety Council. Accident Facts. (1993). Anonymous. Itasca, IL: National Safety Council.

ACKNOWLEDGEMENT

This work was supported by the National Institute on Disability and Rehabilitation Research Switzer Fellowship ProjectNumber: H133F50020

Therese Willkomm, Ph.D. ATP
 New Hampshire ATECH
 The Alliance for Assistive Technology
 Five Right Way Path
 Laconia, New Hampshire 03246-1400
 (603) 528-3060
 e-mail: twillkomm@nhaat.mv.com

SIG-13
Assistive Robotics and Mechatronics

DUAL-AGENT USER INTERFACE FOR AN ASSISTIVE ROBOT

J.J. Wagner, M.S.M.E.,[†] H.F.M. Van der Loos, Ph.D.,[‡] L.J. Leifer, Ph.D.[†]

[†]Design Division, Department of Mechanical Engineering, Stanford University

[‡]Rehabilitation R&D Center, Palo Alto VA Health Care System, Palo Alto, CA

ABSTRACT

The greatest challenge in the design of interfaces to assistive robots is harnessing all the motion, manipulation and force-production capabilities of the robot itself, yet not place high technical demands on the operator to execute and create tasks. This paper describes a concept using a dual-agent approach to communication with the user in the context of a graphic user interface that allows operators to create, preview and execute motion sequences for the ProVAR workstation system.

BACKGROUND

This paper introduces the design of the user interface for ProVAR (Professional Vocational Assistive Robot), a robotic workstation for an office worker with high-level quadriplegia. ProVAR is based on the DeVAR system [Van der Loos & Hammel, 1997], whose interface consisted of voice I/O for task execution and robot movement control. Typical DeVAR tasks were loading CD-ROMs into a computer, administering medication, retrieving pages from a laser printer, and scratching an itchy forehead [Hammel, Loos & Perkas, 1992]. The initial ProVAR task set will not be different from DeVAR, but it will be expandable by the user through on-screen task design and preview. DeVAR programming could only be done by manually guiding the robot through trajectories using a teach box and inserting the new voice and screen commands in data files with an editor. ProVAR's current interface is an outgrowth of the earlier RoboGlyph prototype [Lees, 1994], which utilized task primitives arranged on a storyboard (see Figure 1).

ROBOGLYPH SAMPLE STORYBOARD

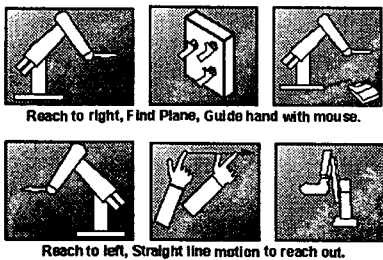

Figure 1: RoboGlyph Storyboarding Interface

STATEMENT OF PROBLEM

The difficulty in placing assistive robots in real workstation environments is the tension between robustness and simplicity of operation on the one hand and sophisticated technology for human-to-human, human-to-machine and machine-to-machine communication on the other. Both ProVAR's end users and the occupational therapists who will train them are likely to have little or no previous experience with robots and possibly even limited experience with computers, erecting a high barrier to adoption and use. Thus the goal is to create a non-threatening, self-enabling user interface for command of the robot by non-technical users. The difficulty in attaining this goal is compounded by the barriers on the human computer interaction placed by each end-user's particular physical and communication abilities.

In order to facilitate the initial training to use the system and to increase the likelihood of its continued use, the interface must take charge and draw in the user. For the ProVAR project, a character-based approach was adopted with two agents serving distinct roles. One character, called Pinocchio, is presented to the user as the robot itself, a PUMA 260 mounted on a track above the cubicle workspace (see Figure 2). The other character, Jiminey, is a smart "agent" that resides in the user interface computer. The function of the second agent is to help the user get Pinocchio (the "dumb" robot) to accomplish tasks when there are problems, such as incompletely defined tasks, obstacles in the robot's way, and partially-described objects that require more information to be manipulated properly. In reality, the user interface is one computer, but with two distinct personalities with which the user interacts.

This type of user interface must be combined with robot-environment interface that allows robust interactions between the gripper and the objects in the environment. If a task is defined as "Put the second videotape into the tapeplayer", then a force-based control algorithm is essential to assure proper completion. Pure position-based trajectory control would not be

Dual-Agent User Interface for a Robot

robust enough except in the simplest cases (like DeVAR's situation). The ProVAR challenge, then, is to define each interface (human-machine and robot-environment) and to develop the communications between them for a successfully integrated product.

APPROACH

The ProVAR system will be commanded by a graphic user interface (GUI) controlled by devices of the operator's choice. Nominally, control is via a head tracking system for cursor control and a voice recognition system for keyboard emulation. The GUI will entail both a familiar hierarchical menu bar as well as a three dimensional graphical representation of the user's work area. The user interface is being created using VRML and Java. VRML (Virtual Reality Modeling Language) and Java are new but rapidly maturing platform independent languages, designed specifically for use over an Internet mediated distributed application. VRML will provide the graphics engine that will display the simulated ProVAR work area.

Control of the VRML model and communications between the user interface and robot controller will be through a number of

Java applets. With the exception of the integration with a platform specific voice recognition system, the ProVAR system will be viewable by Macintosh, Windows/PC's, and Unix workstations. This VRML/Java architecture will allow prospective users of the system to readily test drive the ProVAR system from networked machine anywhere in the world.

IMPLICATIONS

The use of characters in the user interface was strongly influence by the work of Reeves and Nass, whose theory of Social Responses to Communication Technologies (SRCT) is nicely summarized their book The Media Equation [Reeves & Nass, 1996]. A central tenet of the book is that people's interactions with technologies such as computers are not merely similar to those they have with other human beings but are, on a fundamental level, identical. While most people, if asked, would maintain that they do not believe that computers have feelings or should be treated like people, their reactions and interaction with computers show the employment of the same social "rules" and expectations that are used in human-human interactions.

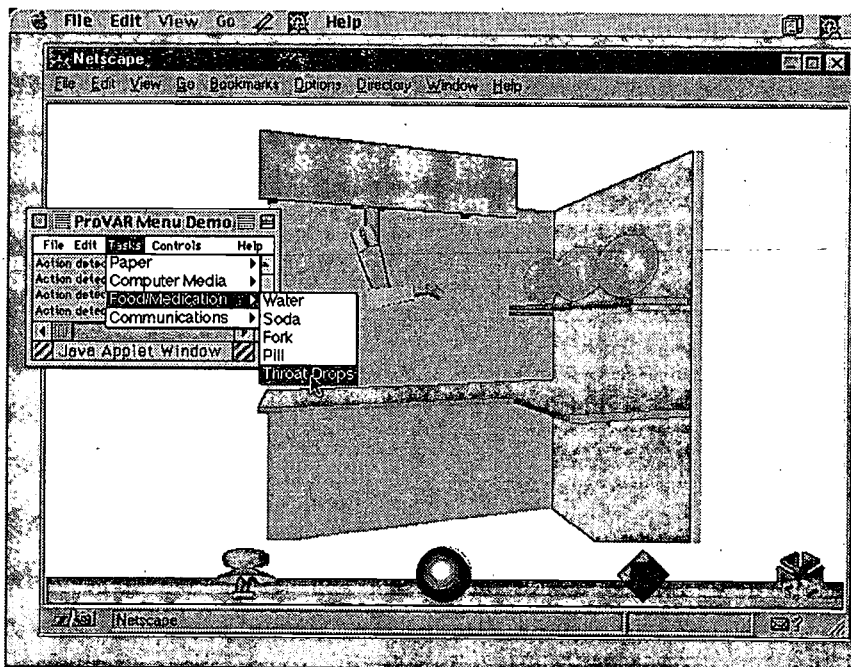

Figure 1. VRML Model of Robot Workstation

Dual-Agent User Interface for a Robot

One of the motivations for doing a division of entities was that by distinguishing two characters, users will have a greater tolerance for complex commands and errors. By siding with the user, the aiding agent will help engender a "team effort" to get the robot to do its tasks. Blame for mistakes and frustrating results can get shifted away from the user onto "someone" else, the robot. Likewise credit can get shifted to the user and to the aiding agent, creating a more positive feeling about the entire system. The agent could be passive, giving advise and helping with diagnostics, or be active, carrying out more complex tasks.

DISCUSSION

One of the concerns in planning this interface was determining whether the construction of a user interface that explicitly incorporates characters is too ambitious. Yet Reeves and Nass repeatedly assert that the user interfaces need not be very complex in order to engender a social response. It is "clear from the research...that very little information is needed to convince people that a personality is present" [Reeves & Nass, 1996, pg. 85]. The crucial element appears to be consistency, not complexity of character development. "In fact," Laurel explains, "when a minor one-dimensional character possesses only one or two actionable traits, audience members will impute elaborate histories and motivations as needed to make it believable. Whether the character is as simple as the Roadrunner or as complex as Hamlet, we take pleasure when, and only when, even the surprises in a character's behavior are causally related to its traits" [Laurel, 1993, pp. 145-146].

The adoption of this two-character model for a robot command user interface may not require much more effort than a "unified" robot interface, especially when one of the characters is the simple-minded robot fleshed out with an occasional wave of the robot's hand, and perhaps a little bit of speech (in its own voice): "Good morning," "My network is down - I can't hear anyone," "This feels too heavy for me to lift," etc.

One design integration task to be completed involves the multi-modality of the user input/outputs. ProVAR will have a large array of personal and environmental interface devices, including phone/fax connectivity, voice recognition and speech output, environmental control (ECU) and tongue touch keypad (TTK).

This multi-modality is especially important in light of the varying physical abilities of its users. While interface theory implies that it best to match modalities between computer and user, it will require some experimentation to determine how best to deal with situations when a user might simultaneously be using GUI, text-based and voice-based I/O. In any case, while the creation of a two-character interface may give robot control programmers a feeling of needless dissimulation, it should go far in reducing user frustration, and creating an engaging system that will be successful enough for commercial deployment.

REFERENCES

- Hammel, J., H.F.M. Van der Loos, Perlash, I. (1992). Evaluation of a Vocational Robot with a Quadriplegic Employee. *Archives of Physical Med and Rehabil*, 73(July), 683-693.
- Laurel, B. (1993). *Computers as Theatre*. Reading, MA: Addison-Wesley.
- Lees, D.S. (1994) *A Graphical Programming Language for Service Robots in Semi-Structured Environments*, Ph.D. Thesis, Department of Mechanical Engineering, Stanford University, CA
- Reeves, B. & Nass, C. (1996). *The Media Equation: How People Treat Computers, Television, and New Media Like Real People and Places*. New York: Cambridge University Press.
- Van der Loos, H.F.M. & Hammel, J. (1997). Engineering reasonable accommodation: the delivery and use of assistive technology in a vocational training program. *Technology and Disability*, 5(5), 371-382.

ACKNOWLEDGMENTS

This project is funded by a Merit Review development grant from the U.S. Department of Veterans Affairs Rehabilitation Research Service, with additional support from the Stanford University Center for Design Research.

ADDRESS

J. Joseph Wagner
Rehabilitation R&D Center, VAPAHCS
3801 Miranda Ave. #153
Palo Alto, CA 94304-1200
650-725-0168 Fax: (650) 493-4919
Email: joew@cdr.stanford.edu

QUANTITATIVE EVALUATION OF HUMAN-MACHINE INTERACTION WHEN USING AN ARM ROBOT

M. Mokhtari^{1,2}, M.S. Ph.D., N. Didi², Ph.D. student, A. Roby-Brami², M.D Ph.D.

¹ Institut National des Télécommunications
Evry Cedex, France

² INSERM-CREARE (U.483)
Paris, France

ABSTRACT

This paper describes the applications of recent motor control and sensory-motor learning theories to develop quantitative evaluation methods in order to analyze the different factors which influence the interaction of severely disabled with robotic devices. We focus on the motor behavior of the subject by evaluating both the **disability** and the **man-machine interaction**.

The needs of disabled people are highlighted by a quantitative evaluation of the upper arm mobility (reaching strategies and working space of the upper arm) which has been developed on the base of a 3D recording system which provides position and orientation of electromagnetic sensors.

In a second part, the use of an assistive robot manipulation is analyzed by a direct recording of man-machine interaction with the participation of disabled people. This method has been developed to optimize the use of home robots to perform daily living tasks.

INTRODUCTION

Patients with motor impairments have a reduced capacity of action particularly those with a pathology involving the four limbs (quadriplegia due to spinal cord injury or muscular dystrophy). The factors determining the ability of a person to act on his/her environment are related to his/her bodily impairment, to the skills he/she could acquire during the rehabilitation process and to the adaptive devices used.

The aim of this first part is to quantify the reduction of the working space of disabled and to evaluate residual motor capabilities in terms of displacement amplitude and orientation of the upper arm. This will next allow us to quantify the improvement gained either by the use of assistive aids or by any therapeutic operation.

The most precise description of the disability seems to be the essential preliminary to any study of the man-machine interface.

The persistence of the problems faced in the field of assistive technology is not due to an under-estimation of the ergonomic constraints (which are now recognized as being essential in the improvement of the man-machine systems), but to the fact that the ergonomic methods are too **qualitative** to be exploited [4]. The aim of our research work is to develop a **quantitative approach**

which provides readable data to the evaluators and is complementary to the qualitative approach.

EVALUATION OF THE DISABILITY

3D Movement Analysis

Recording of the upper arm movement permits to define precisely the motor capabilities of the disabled end-users and to study the motor strategies performed to compensate their disability. To match these objectives, it was necessary to develop an easy-to-use analysis method which allows to record the movement in 3D.

The measuring system is the Spatial Tracking System (STS) which relies on electromagnetic sensors (Polhemus). It permits the on-line recording of the relative position and orientation of up to four sensors relative to a fixed emitter which represents the reference frame (sampling frequency from 30 to 120 Hz depending to the number of sensors). This system permits to measure in continuous or discontinuous mode the position (X, Y, Z) and the orientation (Yaw, Pitch, Roll) of objects in an hemispheric area of about 1.5 m in diameter. The static accuracy of the sensors is 0.08 for the position and 0.15° for the orientation. The STS is connected to a PC via the serial link configured at a speed rate of 57600 Baud. The software has been developed using Borland C++ on Windows 95.

Methodology

A precise *evaluation of the disability* is important in order to evaluate the human factors involved in man-machine interaction. The measurement of the working space of the hand while pointing or reaching to remote targets seems to be particularly relevant in the case of quadriplegic patients whose heavy motor disability is a matter for technological assistance by robotics systems or home appliances. The recording of the motion of the working point (the hand) during a goal directed movement can be used to *quantify the actions* of the person on his/her environment. Recording of the hand sensor is used to define adaptive reaching and grasping strategies in hemiplegic patients [3].

Preliminary Results

The movements are recorded by fixing the STS sensors on different parts of the upper limb in such a way to minimize the error due to skin displacement and muscles contractions.

Three able-bodied people and eight quadriplegics patient having spinal cord injuries from the Rehabilitation Hospital of Garches have participated to this experimentation.

Two different tasks have been performed by each patient. The first one was a prehension task and the second protocol focused on reaching abilities

Prehension Strategies

We asked the users to perform prehension tasks of a cone situated on a calibrated working plane. The cone positions have been chosen in such a way that the whole prehension space was scanned.

With non-disabled people, the velocity profile of prehension gesture is stable and composed of a first velocity peak which correspond to the reaching movement, followed by a second velocity peak for the backward movement. They do not show a stop during the grasping (Fig. 1). With the disabled people the trajectories and velocity profiles of the reaching and backward movements are quite similar, but the grasping phase is particular to each patient. We found that the disabled people added an element of movement to grasp the cone. We notice also an increased movement of the trunk (Fig.2).

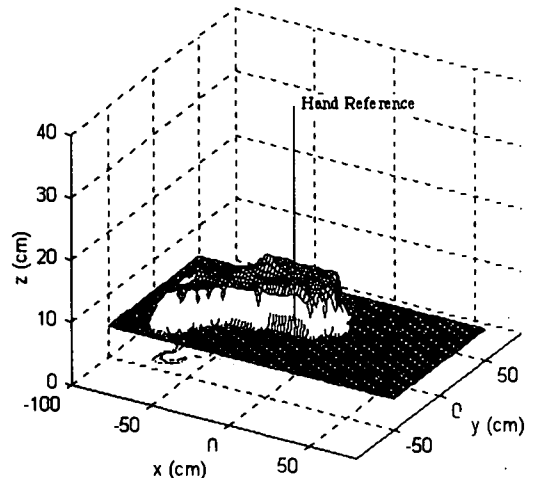

Fig.3 Pointing space of a quadriplegic person (left hand).

The projection of the pointing space on the horizontal plane is symmetric for the able-bodied person and shows a larger movement amplitude (Fig.4). In the case of disabled patients we observe an asymmetry and a reduction of his/her working space.

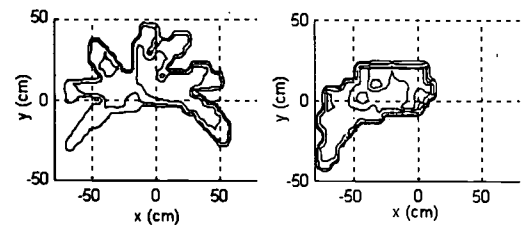

Fig.4 Horizontal Projection of the pointing space (left hand) of an able-bodied person (right) and a quadriplegic patient (left).

This method permits also to reconstitute the working space of the hand when a person performs prehension tasks.

During this experiment we have considered only the position of the hand without taking into account the movement of the shoulder or the elbow.

HUMAN-MACHINE INTERACTION

The development of a better method of man-machine interaction for patients who have reduced working space also needs precise analysis of the actions that are performed with existing devices. In order to favour accessibility and usability of interfaces, we have developed a method for the analysis of man-machine interaction.

Our method is based on a quantitative recording of the interaction which permit to have precise numerical data of the actions performed with one or many assistive aids during the learning phase and during the normal use. The application is based on the use of Manus arm robot which is mounted on a

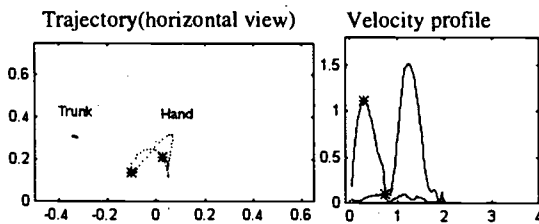

Fig.1 Hand and trunk trajectory (left) and velocity profile (right) of able-bodied person

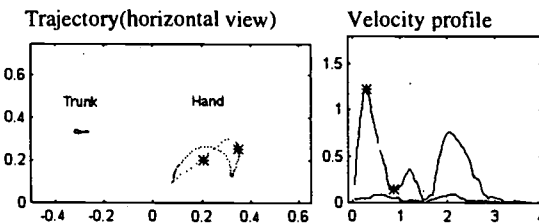

Fig.2 Hand and trunk trajectory (left) and velocity of a quadriplegic patient.

Working Space

To quantify the working space of quadriplegics people, we asked each patient to point at a maximum amplitude following different direction on the plane and in the space. Then we calculated the **pointing space** in the case of movements toward a target on the horizontal plane (Fig.3) and the **3D pointing space**. We emphasize that pointing space and **prehension space** should not be confused. We observed that the **prehension space** is smaller than the pointing space, due essentially to the orientation and folding down of the hand on the target.

wheelchair [1]. The objective is to evaluate the learning phase of the Manus and the strategies the user develop to perform a specific task with the help of Manus. The method consists on detecting and memorizing all the user actions on the keypad of the robot including the time parameter.

In the frame of man-machine interaction, an STS sensor was fixed on the end-effector of the robot and another one on the target-object. The position signals are obtained on line and so can be used to generate *visual and audio feedback* which help the user to know whether his action is closer or not from the target [2].

Results

Six disabled users from the rehabilitation hospital Raymond Poincaré of Garches participated in the experiment (4 with spinal cord injuries and 2 with muscular dystrophy). Four tasks has been performed by each user (gripping and drinking tasks). The figure 5 gives part of the sequence of actions (coded from 0 to 30) and according modes (coded from -3 to -6) to perform a specific task.

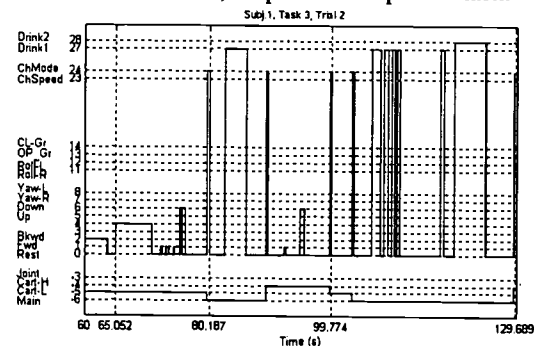

Fig.5 Representation of the different modes (arbitrary coded from -3 to -6) and actions (arbitrary coded from 0 to 30) performed by a quadruplegic patient

To evaluate the learning phase of the Manus we have considered the accumulated duration of the actions into four categories (Fig.6).

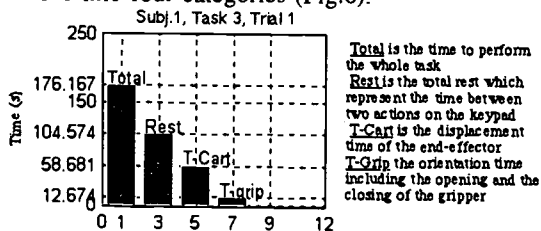

Fig.6 Analysis of the learning phase of Manus by quadruplegic patient

We observed that the users developed a strategy which consist on the orientation of the gripper in the beginning of the movement according to the target to minimize the number of actions, then reduced the T-grip time. The preliminary results showed that some actions which belong to different modes must be available in several modes to

minimize the switching time between modes. This kind of data is useful for the ergonomic design of the keypad interface.

CONCLUSION

In this study we have tried to take into account the different factors that could influence the man-machine interaction in the case of people having severe motor disabilities. This analysis is the first step of a technological development approach aiming to improve the assistive aids for disabled people to offer them a better quality of life and a better social and professional integration. To reach this goal, we developed a multi-disciplinary method based on recent theories on action mechanisms, motor control, and sensory learning. Our contribution consists on providing to the evaluators a method which permit to quantify both the disability and the ergonomical factors which can influence the learning and the use of man-machine interfaces. The application we presented which is based on the use of Manus arm robot showed the quantitative evaluation gives accurate data on the way the robot is used and on the difficulties encountered during the learning phase. An evaluation in real conditions at home of disabled is planned in collaboration with the French Muscular dystrophy Association (AFM) which has installed five Manus in families having a quadriplegic person due to a muscular dystrophy.

ACKNOWLEDGMENTS

The authors would like to thank C. Ammi from the INT, I. Laffont from the rehabilitation hospital Raymond Poincaré of Garches, J.C. Cunin and C. Rose from the AFM, for their help and support. Funds for this project are provided by the AFM and the Institut Garches.

REFERENCES

- [1] Kwee H., "Integrated control of Manus and wheelchair". In Proc. ICCOR'97. Bath Uni., UK. April 1997. P91-94.
- [2] Mokhtari M, Roby-Brami a, Laffont I, "A Method for Quantitative User Evaluation in case of Assistive Robot Manipulation". In Proc. RESNA'97. Pittsburgh, Pennsylvania. June 20-24, 1997. P420-422.
- [3] Roby-Brami A., Burnod Y., "Learning a new visuomotor transformation: error correction and generalization". Cognitive Brain research, 1995, 2: 229-242.
- [4] Senach B., "Evaluation ergonomique des interfaces homme-machine : Une revue de la litterature". Rapport de recherche INRIA. Prog. 8 Communication homme-Machine. N° 1180. Mars 1990.

M. Mokhtari
INT-INSERM
9, Quai Saint Bernard, Bat C.
75005 Paris
email: Mounir.Mokhtari@sny.jussieu.fr

CONTROL PROBLEMS IN ROBOTIC THERAPY FOR UPPER LIMB REHABILITATION: AN INITIAL INVESTIGATION

M Austin , J Cozens MD, A Plummer PhD, B Seedhom PhD
School of Mechanical Engineering and Rheumatology and Rehabilitation Research Unit
Leeds University , Leeds, England

ABSTRACT

There has been a recent increase in research into rehabilitation robots that assist patients to undertake therapeutic exercise. The demand for such robots is likely to increase as traditional physiotherapy is labour intensive and thus limited by funding. One of the major research questions is how to control the application of mechanical assistance in a therapeutic and safe manner. This paper presents initial developments of a controller for voluntary flexion/extension exercises of the elbow in the horizontal plane. Although the movement may not be of therapeutic value the work will identify the requirements and limitations of such a controller.

BACKGROUND

Physiotherapy and occupational therapy are major components of rehabilitation for patients with neurological disorder (e.g. stroke, multiple sclerosis, head trauma). This patient group often receives less treatment than prescribed despite the evidence of a dose-response relationship in conditions such as stroke[1]. Reduced patient recovery tends to lead to expensive outpatient home care costs. Active exercises form a significant part of many physiotherapy regimes to encourage motor relearning and increase joint range[2]. A robot that assisted such exercises could provide extra therapy and enable the therapist to supervise the treatment of several patients simultaneously.

Research has shown that responsive mechanical assistance can be applied safely to the upper limb. A group at the University of California has developed a device that actively assists subjects to undertake a voluntary

bimanual task[3]. The device has not been tested in a clinical situation. The MIT Manus robotic device has been developed at the Massachusetts Institute of Technology[4]. The robot assists the subject in a goal orientated upper limb movement, applying assistive force at the hand and wrist. This device has been used clinically and uses 'impedance control'.

RESEARCH QUESTION

To develop a controller for a responsive rehabilitation robot we must understand the dynamic interaction of the mechanical device with the neurological disordered human motor control system. The characteristics of the robot are easy to define, but the neurologically disordered human motor control system is not. The robot/patient system is also inherently nonlinear therefore traditional methods of developing control algorithms cannot be used. Thus experimental research and analysis is required to develop a method of control which responsively assists the movement without provoking muscle disorder such as spasticity.

METHOD

Experimental Apparatus: The pilot plant models a flexion/extension movement of the elbow in the horizontal plane (figure 1). The forearm is strapped onto the lever with the elbow joint aligned with the vertical axis of rotation and the upper arm fixed to the table. The lever is powered by a servo motor driven through a current amplifier and the torque is taken to be proportional to a motor drive signal. An angular potentiometer measures elbow angle and an accelerometer measures the angular acceleration. A force handle is attached to the lever to measure the force applied by a therapist assisting the movement. A semi-

circular array of light emitting diodes (LEDs) around the lever provided target lights. The control software was programmed in C++ on a pentium PC using the Window's environment.

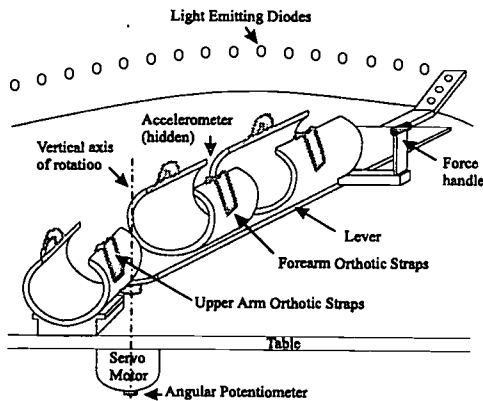

Figure 1: Experimental apparatus

Controller Design: A lead-lag controller has been developed (figure 2). The reference trajectory for a particular patient is generated from the trajectory achieved by the patient when guided by a physiotherapist. This is achieved by averaging ten physiotherapist guided flexion/extension movements. The dead zone allows for a specified error to occur before assistance is applied.

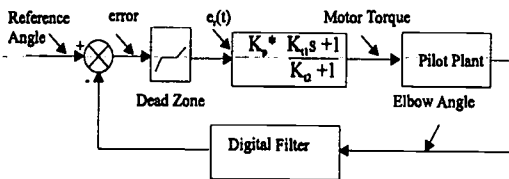

Figure 2: Lead-lag controller

Test Procedure: Ethical approval for this study was granted by a local ethical committee and all subjects participating gave informed consent. Post acute stroke subjects with stabilised neurological disorder, limited cognitive problems and full range of passive elbow movement were selected. A subject's upper limb was clinically examined using the MRC

power scale and the modified Ashworth Scale. The standard exercise was to undertake ten extension/flexion movement by pointing the lever to target lights at 70°/20° and 20°/70°.

RESULTS

The following are example test results for a 52 year old left side hemiplegic subject. The affected arm was clinically examined and found to have +1 tone rating for the flexors and 0 rating for the extensors using the Ashworth Scale. The MRC power scale ratings were 3 for the flexors and 4 for the extensors. When unassisted the subject's movement was often disjointed and oscillatory at the target light (figure 3). With physiotherapist's assistance the subject completed the whole movement in a single continuous controlled movement (figure 4). The torque trace shows that assistance was required particularly at the end of the extension movements, although the amount was relatively small (figure 5). It should be noted that physiotherapist assisted traces do vary. Therefore, when using the calculated reference trace, it is important that a band of error should be allowed before assistance force is applied.

Figures 6 & 7 illustrate motor assisted movement. They indicate that the physiotherapist reference trajectory is realistic, assistance was applied responsively and the subject initiated the movement. The results where obtained using controller constants $K_p = 0.1$, $K_{i1} = 0.1$, $K_{i2} = 0.2$, and dead zone = $\pm 5^\circ$.

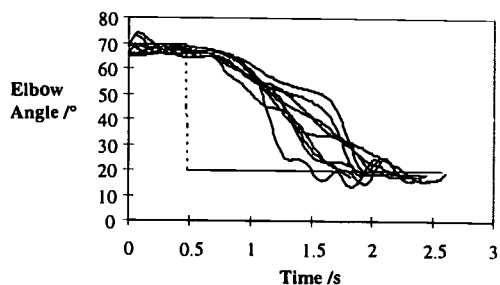

Figure 3: Actual (-) and target (--) elbow angle against time for ten unassisted extension movements

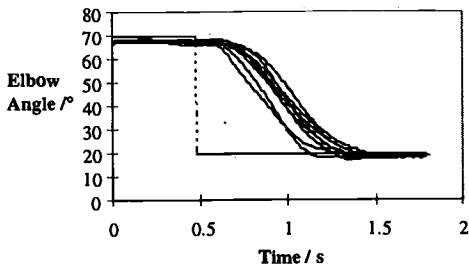

Figure 4: Actual (-) and target (--) elbow angle against time for ten physiotherapist assisted extension movements

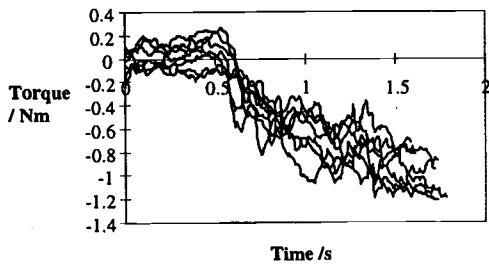

Figure 5: Torque applied to lever by physiotherapist during ten assisted extension movements

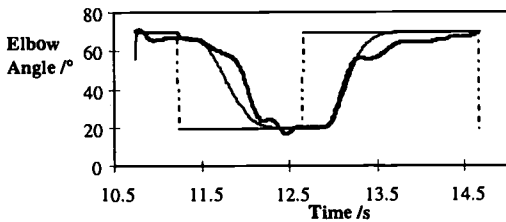

Figure 6: Actual (-), target (--) and reference (-) elbow angle against time for motor assisted extension and flexion movement

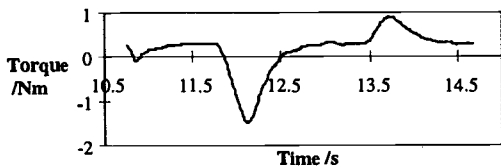

Figure 7: Torque applied to arm against time in figure 6

and use of upper body muscles significantly affect performance. This is reduced in testing by using a seat harness.

The use of a reference angle developed from a physiotherapist assisted exercise has been successfully implemented. The controller was developed to enable the subject to reach each target light and stay there as long as the light was illuminated. It therefore provided high low-frequency gain (i.e. when at the target light) and lower high-frequency gain (i.e. during the movement phase). Although successful at enabling subjects to reach the target light it was found to be too position dependent so the use of higher derivatives in the controller will be explored in the future.

REFERENCES

- [1] Sunderland, A; Tinson, D, J; Bradley, E, L; Flechter, D; Langton Hewer, R; Wade, D(1992), 'Enhanced physical therapy improves recovery of arm function after stroke. A randomised controlled trial.' *Jou. of Neurology, Neurosurgery & Psychiatry* 55:530-535
- [2] Carr, J; Shepherd, R, (1987). *A Motor Relearning Programme for stroke*, (2nd ed.) Butterworth-Heinemann
- [3] Lum PS, Burgar C, & Van der Loos M, (April 1997). 'The uses of a robotic device for post stroke movement therapy' *Proceedings of Intl. Conf. of Rehab. Robotics*, 107-110.
- [4] Hogan,N, Krebs,H,I Charnnarong,J; Srikrisha,P & Sharnn,A, (1993) 'MIT_Manus; A Workstation for Manual Therapy and Training II' *Proceedings of Telem manipulator Technology, SPIE The Intl. Society of Optical Engineering* 1833,28-34 Boston

ACKNOWLEDGEMENTS

We would like to thank the Engineering and Physical Sciences Research Council, the physiotherapists at St. Mary's Community hospital, Leeds and all the test subjects.
 M E Austin, menmea@leeds.ac.uk
 School of Mechanical Engineering, Leeds University, Leeds, England. LS2 9JT.
 Tel: 44 113 233 2170 Fax: 44 113 242 4611

DISCUSSION

An initial clinical evaluation of stroke subjects was found to be an unreliable indicator of their ability to perform this task. Also poor posture

AN ASSISTIVE CONTROL SYSTEM TO THE MANIPULATION OF THE MANUS ARM ROBOT

N. Didi, *Ph.D. student*, B. Grandjean, *Elec. Eng.*, M. Mokhtari, *Ph.D.*, A. Roby-Brami, *M.D. Ph.D.*
INSERM-CREARE U483
University Pierre & Marie Curie
Paris, France.

ABSTRACT

An Assistive Control System (ACS) has been developed to improve the manipulation of the robot arm Manus. Two more modes have been added to the actual Control Interface Configuration (CIC): the Point-to-Point Control Mode (PPCM) that allows a big amplitude movement between any point and some predefined points in the robot workspace and the Record Mode (RM) that allows to memorize the position and the space orientation of the robot end-effector. Also provided, an extra mode called Replay Control Mode (RCM) that can be run from a personal computer (PC) to replay off-line, a saved sequence of actions performed by the user during a task and a graphics user interface (GUI) to favor the use of the arm robot.

BACKGROUND

The clinical evaluations of Manus, last made in France by the APPROCHE association [1][4], have pointed out some problems due to the complexity of the control to perform certain tasks. Indeed, during the manipulation of Manus, the user has to develop strategies using different control modes and actions. He has in one hand, to learn how to orient the gripper in space according to what he perceives, and in the other hand to coordinate, in order to perform a task, the necessary command strategies. This requires a difficult and long training whether it is done by able-bodied or disabled people. Therefore, in collaboration with AFM and Exact Dynamics, we designed a library of pre-programmed global gestures to assist the end-user during the execution of certain tasks.

In addition to the two existing Cartesian Control Mode (CCM) and Joint Control Mode (JCM) the assistive control system described

here, offers three other modes PPCM, RM and RCM and generates historic data files that contain all the command actions (one action each time the button is pressed) performed during a given task.

As part of our research works, these data files are handled for the man-machine interaction studies and quantitative user evaluations of the Manus arm robot [5][6].

HARDWARE AND PERIPHERALS

The electronic system of the figure 1 we set up is composed of a PC 486DX4 and a Manus second generation (Manus II). The 4x4 Manus keypad is connected to the PC parallel port via the keypad interface. The communication between the PC and the Manus II control box is done through a CAN bus.

The Manus II is an improved design and hardware version of the Manus I. The vertical telescopic system was replaced by an external electric lever that allows the robot to move up and a little bit forward, the 5x7 LED array on the robot were removed and the control box now offers a CAN plug-in card. The control unit supports two input devices: the cited keypad and a two-axis joystick. Two pre-set mapping control modes CCM and JCM are available. The first one is designed to control the robot motion in Cartesian space whereas the second one allows a direct and separate control of the six arm joints.

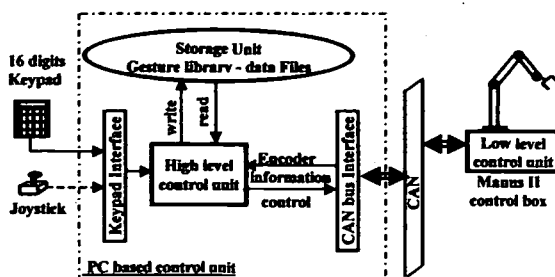

Figure 1: Hardware organization

SOFTWARE

The software is written in Borland C++ under MSDOS as a high control layer. It is actually running on a PC and is Manus II compatible. This software offers a new mode control organization as shown in figure 2 and an ergonomic GUI with Manus status feedback

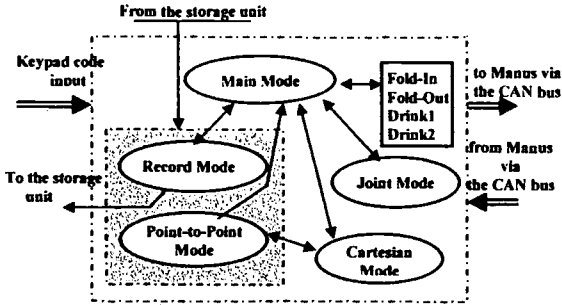

Figure 2: A new mode control organization

THE GESTURE LIBRARY

The first version of our gestures library includes twelve pre-programmed gestures and two user programmable gestures[3]. These are generated from the 4x4 Keypad input device. Each one is activated from the PPCM by pressing continuously on its corresponding button until the end of the movement. The arm stops at any moment if the button is released and continues otherwise. This fits the Co-autonomy concept control [2] where the decision and control are shared between the user and the robot arm. The user can also record two gestures using the RM.

The pre-programmed gestures cited here allow the user to reach approximately the target. The final gripping gestures are made by the end-user using the CCM.

POINT-TO-POINT CONTROL MODE

This mode is based on the Point-to-Point control. The gesture is performed between at least two known points of the robot workspace. Each point P_i represents a given robot arm configuration and is defined by the gripper position (x_i, y_i, z_i) and orientation $(yaw_i, pitch_i, roll_i)$. Thus each gesture G_i performed by the robot corresponds to a global movement that brings the end-effector from any arm

workspace position P_i to the predefined position P_{i+1} .

We have defined twelve final points as shown in the figure 3 corresponding to twelve final robot arm configurations. The points P_2, P_3, P_4, P_6 until P_{11} are in the same plan and form a vertical grid front of the user, P_1 is close to the user thorax, P_{12} corresponds to a preparation to a door opening gesture and P_5 to reach an object on the floor.

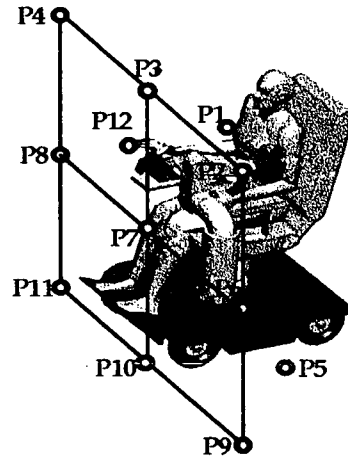

Figure 3: The twelve Manus workspace point distribution

RECORD MODE

In this mode the user has the ability to record different arm configurations. This allows the user to perform a repetitive task. This can be first performed by combining the CCM and PPCM. Once the target is reached the user can record the gripper operational coordinates (gripper position and orientation) and assign it to one of the keypad buttons. Later on, and from any gripper position and only if the user has not moved his wheelchair, he can come back, using the PPCM, to the recorded configuration.

REPLAY CONTROL MODE

In opposition of the two previous modes, this one runs from the PC and allows the evaluator to replay automatically a sequence of actions performed previously by the user.

The evaluation of this system is under work and the first preliminary results obtained with a valid and a representative person well familiarized with the ACS five Modes have pointed out how

this assistive method can improve the Manus manipulation. Figure 4 shows the gain in time to perform the task "serve and drink" using the ACS. The one minute gain is essentially due to the use of pre-programmed gestures. These induce far less user actions.

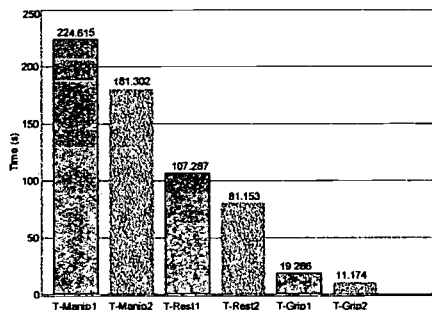

Figure 4: Action histogram performed during the task "serve and drink" using the ACS.

T-Manip1: total task duration with out the ACS.
 T-Manip2: total task duration with the ACS.
 T-Rest1: total duration between actions with out the ACS.
 T-Rest2: total duration between actions with the ACS.
 T-Grip1: total duration of gripper orientation actions.
 T-Grip2: total duration of gripper orientation actions.

CONCLUSION

In this paper we have described an Assistive Control System for Manus II which permits to assist the end-user during complex tasks. This system provides pre-programmed global gestures, in one hand to reduce the sequence of action the user has to memorize to manipulate objects and on the other hand to make the control of the arm more intuitive. For instance, grasping an object from the floor requires, with the CCM, different actions to orient and position the gripper according to the object whereas the same task can be performed by pressing only one key, i.e. one action with the PPCM. The direct consequence is the decrease of the task duration and of the effort provided by the disabled user. The PPM is the first step in our development approach; an improved pointing mode has to be implemented. It will give the opportunity to the end-user to refine his action during the execution of a global gesture. As proven in the case of robotic workstations where the automatic control is convenient, the RM for Manus permits to save

on-line positions and orientations of the end effector to execute automated tasks. The ACS could be integrated to the future Manus control box or set as a stand-alone control box. We plan to make this ACS supporting other input devices such as a joystick, space-mouse, and different type of keypads.

ACKNOWLEDGMENTS

The authors would like to thank Pr. B. Bussel from the rehabilitation hospital Raymond Poincaré of Garches, J.C. Cunin from the Association Française contre les Myopathies (AFM) and the Institut de Garches. N. Didi holds a grant from AFM and Institut de Garches.

REFERENCES

- [1] A. Bourel, Rapport évaluation APPROCHE, France. 1992.
- [2] R. Chatila, P. Moutarlier, N. Vigouroux, "Robotics for the Impaired and Elderly Persons", IARP Workshop on Medical Robots. Vienna, Austria. 1-2 Oct 1996.
- [3] N. Didi, "Méthode d'assistance à la télémanipulation de robots pour les personnes lourdement handicapées" Colloque INSERM-INRIA. INRIA Centre de Sophia Antipolis, France. 11-12 Dec 1997.
- [4] G. Le Claire, Résultats préliminaires de l'évaluation réadaptative de MANUS II, APPROCHE, France. avril 1997.
- [5] M. Mokhtari, A. Roby-Brami, I. Laffont, "A method for quantitative user evaluation in case of assistive robot manipulation", RESNA'97, Pittsburgh, Pennsylvania. June 1997 P420-422
- [6] M. Mokhtari, "Interaction Homme-Machine pour la compensation du handicap Moteur: Application à l'analyse quantitative de la télémanipulation", Ph.D. thesis. Dec. 1997.

N. Didi
 INSERM-CREARE (U483)
 UPMC, Bat C, 9, Quai Saint Bernard
 75005 Paris, France

DRIVER PERFORMANCE USING SINGLE SWITCH SCANNING WITH A POWERED WHEELCHAIR: ROBOTIC ASSISTED CONTROL VERSUS TRADITIONAL CONTROL

Holly A. Yanco
Artificial Intelligence Laboratory
Massachusetts Institute of Technology

and

James Gips
Computer Science Department
Boston College

ABSTRACT.

Single switch scanning is the access method of last resort for powered wheelchairs, primarily because drift is a significant problem. To correct a drift to the left or the right, the user must stop going forward, wait for the scanning device to get to the arrow for the direction of choice, click to turn the chair, stop turning, wait to scan to forward and then click to move forward again. Robotic assisted control can improve the ease and speed of driving using single switch scanning. Under robotic control, sensors are used to correct the drift problem and to avoid obstacles. The user is only required to give commands to change direction, for example "left" at an intersection.

BACKGROUND

Powered wheelchairs can be driven with a variety of access methods. The method of first choice is a joystick. If a person is unable to drive with a joystick, a multiple switch array such as a sip and puff system or a head switch array could be used. If a person can not use a multiple switch array, a single switch scanning device is used. Single switch scanning is the access method of last resort. With traditional powered wheelchairs, the need for frequent corrections to counteract drift and to move around obstacles makes driving difficult for single switch scanning users.

Work on robotic wheelchairs has resulted in systems that can navigate indoor environments by taking commands from the user and carrying out the commands safely using sensors on the robot (for example, [Levine et al., 1990] and [Miller, in press]). Most of the work on robotic wheelchairs does not address the issues of access methods; the primary focus is on the navigation system. While it is important to have a safe navigation system, it also is important to consider how a person will be able to use the system. Simpson and Levine [1997] studied voice control as an access method for the NavChair system. Yanco and Gips [1997] investigated eye control as an access method. In

this paper, we study single switch scanning as an access method for our robotic wheelchair system, Wheelesley, and compare these results to traditional control of a powered wheelchair with single switch scanning devices.

The wheelchair system [Yanco, in press] consists of a robotic wheelchair and a user interface. To provide robotic assistance, the wheelchair uses infrared, sonar and bump sensors and an on-board processor to avoid obstacles and to keep the wheelchair centered in a hallway. The robotic wheelchair makes the necessary corrections to the current heading whenever one or more sensors indicate that an obstacle or wall is getting too close to the wheelchair. The user gives commands through the user interface, which runs on a Macintosh Powerbook. The switch is a Prentke Romich rocking level switch which is connected to the Powerbook using a Don Johnston Macintosh switch interface.

For these experiments, the user interface consists of four large arrows and a stop button. The user interface was designed to look and function like a standard single switch scanning device. The interface scans to the forward arrow, the right arrow, the left arrow and the back arrow until the user selects a command by hitting a switch. The interface pauses at each possible selection for two seconds. Since all test subjects are able-bodied, the commands are latched. To stop driving or turning, the user hits the switch again. After the stop command is given, scanning starts again on the forward arrow.

RESEARCH QUESTION

Does robotic assistance improve driving performance compared to traditional manual control for a person using single switch scanning as an access method for a powered wheelchair?

METHODS

To determine the answer, we designed an experiment to test the performance of subjects

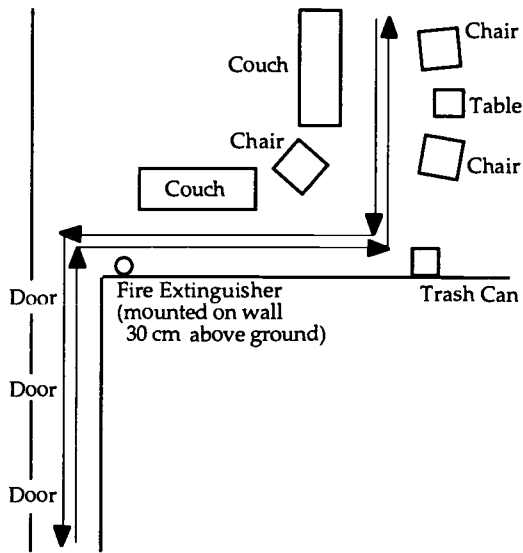

Figure 1: A diagram of the test course. Subjects drove the course four times in each direction, alternating driving methods after a round trip of the course. The course is 20 meters long, measuring along the outside edge of the course. Obstacles are couches, chairs, a table, a trash can, and a fire extinguisher mounted on the wall one foot above the floor. The three doors in the hallway were open or closed, determined by the office occupants.

under robotic assisted control and under traditional manual control. Fourteen able-bodied subjects (7 men and 7 women), ranging in age from 18 to 43, were tested.

At the beginning of a session, the subject was shown the wheelchair. Sensors that are used in robotic assisted control were pointed out and explained briefly. Safety measures, such as the power button, were discussed. Then the two driving methods were explained to the subject. After this introduction, the subject was seated in the wheelchair and the user interface was connected to the wheelchair. The single switch scanning interface was explained to the subject, who practiced using the interface first with the motors turned off.

Once the subject was comfortable with the interface, the session entered a practice phase in which the subject first tried robotic assisted control and then traditional manual control. The subject practiced both methods until he expressed an understanding of each control method; subjects usually spent about two minutes trying each method. All practice was done off of the test course, so that the subject

was not able learn anything that would assist him during the test phase.

The course was designed to include obstacles (several couches and chairs, a fire extinguisher mounted to the wall 30 cm above the ground, a trash can, and a table) and turns to the left and to the right. A diagram of the course is given in Figure 1.

The test phase consisted of four up-and-back traversals of the test course, alternating between the two control methods. Half of the subjects started with robotic assisted control and the other half started with traditional manual control. Each up-and-back traversal consists of two parts: running the course from the couch area to the hallway and then the return trip. The turn in the middle of the course is not counted as part of the run, as turning completely around in the middle of the hallway is not a normal driving occurrence. The total session time for each subject was approximately 45 minutes.

Most data collection was done by the computer which was running the user interface. The researcher only recorded the number of scrapes made by the chair. At the completion of the test, the user was asked to rank traditional manual control and robotic assisted control on a scale from 1 (worst) to 10 (best).

RESULTS

There were four experimental performance measures collected by the computer: (1) the number of clicks required to navigate the course, (2) the amount of time spent scanning to get to the necessary commands, (3) the amount of time spent moving or executing the given commands, and (4) the total amount of time spent on the course (scanning time plus moving time). Results are summarized in Table 1.

Data for each experimental measure was analyzed using an ANOVA test. The differences between robotic control and manual control were highly significant with $p < .0001$ for all measures. On average, robotic control saved 60 clicks over manual control, which is a 71% improvement. Total time for robotic assisted control was 101 seconds shorter than manual control on average, which is a 25% improvement.

The differences between the two trials were significant for clicks ($p = .003$) and for time spent scanning ($p = .015$). There was not a significant difference between trials for moving time or total time.

	Trial	Manual	Robotic
# of Clicks	1	90.2 (16.3)	25.6 (4.9)
	2	77.1 (9.8)	22.0 (3.3)
Scanning (seconds)	1	93.6 (20.3)	30.9 (8.3)
	2	81.1 (13.0)	25.2 (8.6)
Moving (seconds)	1	311.6 (36.4)	268.2 (21.5)
	2	316.6 (36.2)	277.1 (28.4)
Total Time (seconds)	1	405.1 (42.1)	299.1 (18.4)
	2	397.7 (43.7)	302.3 (32.5)

Table 1: Results of the experiments: the number of clicks, amount of time spent scanning for commands, amount of time moving and total time to complete the course. The first number for each method is the mean and the number in parentheses is the standard deviation.

The only performance measure not collected on the computer was the count of the number of scrapes. A scrape was recorded when the chair brushed along a wall or piece of furniture. Bumps with the bumper were also counted as scrapes. No subject hit a wall or an obstacle with great force. The average number of scrapes under manual control is 0.25. The average number of scrapes under robotic control is 0.18. These numbers are not significantly different.

Finally, the subjects were asked to evaluate the two driving methods by giving a score from 1 (worst) to 10 (best). The average score for traditional manual control was 3.5. The average score for robotic assisted control was 8.7. These scores are highly significant with $p < .0001$. No test subject preferred manual control over robotic control.

DISCUSSION

Subjects drove more efficiently and preferred to drive with robotic assisted control. Robotic control automatically adjusts for drift where manual control does not. When traveling down a long hallway under robotic control, a user can click on forward at the beginning of the corridor and does not need to do anything more until he wishes to stop or turn. Under manual control, the user must make many adjustments to compensate for drift.

Learning played a significant role between trials when counting clicks and scanning time. As the user became more comfortable with the system, he was able to judge more effectively when it was necessary make adjustments to the current course. There was no significant effect of learning on moving time and total time; since the speed is held constant throughout the

experiment, the user can not significantly reduce the amount of time required to travel the course between trials of the same control method. We plan to investigate how much improvement can be gained for the number of clicks and scanning time with continued learning.

Single switch scanning is a notoriously difficult way to drive a traditional powered wheelchair. Robotic wheelchairs could provide the means for single switch scanning users to drive their wheelchairs more efficiently. Continuing research using non-latched control and disabled subjects will help us to determine how much this method might assist these people.

REFERENCES

- [Levine et al., 1990] Simon P. Levine, Johann Borenstein, and Yoram Koren. "The NavChair control system for automatic assistive wheelchair navigation." RESNA Proceedings, pp. 193-194.
- [Miller, in press] David P. Miller. "Assistive robotics, an overview." In *Lecture Notes in AI: Assistive Technology and Artificial Intelligence*, V. Mittal, H. Yanco and J. Aronis, eds., Springer-Verlag.
- [Simpson and Levine, 1997] Richard C. Simpson and Simon P. Levine. "Development and evaluation of voice control for a smart wheelchair." RESNA Proceedings, pp. 417-419.
- [Yanco, in press] Holly A. Yanco. "Wheesley: a robotic wheelchair system for indoor navigation." In *Lecture Notes in AI: Assistive Technology and Artificial Intelligence*, V. Mittal, H. Yanco and J. Aronis, eds., Springer-Verlag.

[Yanco and Gips, 1997] Holly A. Yanco and James Gips. "Preliminary investigation of a semi-autonomous robotic wheelchair directed through electrodes." RESNA Proceedings, pp. 414-416.

ACKNOWLEDGMENTS

This research is supported at MIT by the Office of Naval Research under contract number N00014-95-1-0600 and the National Science Foundation under grant number CDA-9505200.

Holly A. Yanco
MIT Artificial Intelligence Laboratory
545 Technology Square, Room 705
Cambridge, MA 02139
holly@ai.mit.edu
<http://www.ai.mit.edu/people/holly/wheesley>

SIG-14
Job Accommodation

Design of a Horizontal Arm Support System

Sean Stephens (Primary Author), Davy Burhan, Regina Edwards, Bhruhu Pange
Department of Mechanical Engineering
The University of Texas at Austin, Austin, TX

ABSTRACT

There are many individuals with upper body motor disabilities that inhibit their ability to access and use keyboards or other key-press types of augmentative communication devices. These inhibitors can be categorized into strength and control issues. The team addressed these issues in designing and prototyping an assistive device to help these individuals in using a keyboard-like accessory. The team focused on assisting a primary customer whose motor disabilities are a combination of strength and control, while not precluding the needs of a more diverse customer base of people with more severe strength or control challenges.

BACKGROUND

People with disabilities primarily affecting their upper body motor skills find it difficult to work to their fullest cognitive potential. In many work environments, keyboard-like accessories are used to interact with PC's, other people, machinery, etc., often in a desk or table environment. These disabilities can, and often do, cause reductions in work efficiency and in the types of tasks the individuals are able to perform.

By decreasing the strength required to use a keyboard and increasing the control of the user, the individual becomes more independent and able to contribute in their work. The team designed an assistive device to allow users easier access to keyboard-like devices.

STATEMENT of the PROBLEM

Through discussion with several potential customers for the Horizontal Arm Support (HAS), the design team discovered

there were many aspects to the basic problem that needed to be addressed. Essentially, the HAS had to reduce the effort required by the user to access a keyboard and to assist the user's control while using a keyboard. However, there were several supporting requirements that were necessary for the HAS to accomplish the primary goal effectively.

To reduce the amount of strength required by the user, the team discovered two requirements. The HAS needed to support the arm against gravity and reduce the amount of friction in moving in the horizontal plane. These requirements were necessary because many users had trouble holding their arms up or overcoming the friction of sliding their arms across a surface.

Assisting the user in control while using a keyboard involved constraining the arm movement in some way. For some augmentative communication devices used by those with severe motor disabilities, the only movement required is front to back or side to side, but not both. Also, some users need assistance in controlling tremorous movements. The HAS must provide a way to limit these unwanted movements. Natural movement is important for the device for the user to feel in control, so the HAS needs to allow two axes of rotation; along the desk edge and perpendicular to the desk surface.

The team also determined some additional requirements to ensure a wide range of use. These included adjustable height for the movement plane, adjustment for different desk edge sizes, adjustment for different arm sizes, ease of setup, and ease of portability.

RATIONALE

The rationale, or methodology, of the design primarily followed that of Ulrich and Eppinger [1]. First the team developed a list of customer needs through interviews and needs analysis. A primary customer was chosen to assist in development of an in depth needs set and to provide a single customer contact. These needs were placed in a Quality Function Deployment (QFD) matrix. The team then added specifications to the QFD and determined relationships between the needs and specifications. The team found target values for the specifications through benchmarking products on the market that addressed the same needs set.

In the conceptual design stage, the team divided the problem into single task functional problems. Several solution principles for each problem were devised through brainstorming and benchmarking. The team developed nine concept variants for the HAS and through analysis settled on a final concept due to its superiority in reliability, unobtrusiveness, engineering stress analysis, and customer/expert preference.

The last stage of the design was the detail and prototyping phase. The team worked on several proof-of-concept prototypes to ensure the operation of each of the four modules. The results of this stage were a set of manufacturing plans and a beta prototype, which was tested with the primary customer.

DESIGN and DEVELOPMENT

The team designed the HAS, shown in Figure 1, to meet the needs stated above. The device consists of four modules, which are described below.

The HAS uses a splint to attach the device to the arm and provide support against gravity. We found many issues that were beyond our expertise, so we removed the splint from our design scope and enlisted the aid of a professional orthotist. The team attached

Velcro to the bottom to provide attachment to the Y-slider assembly.

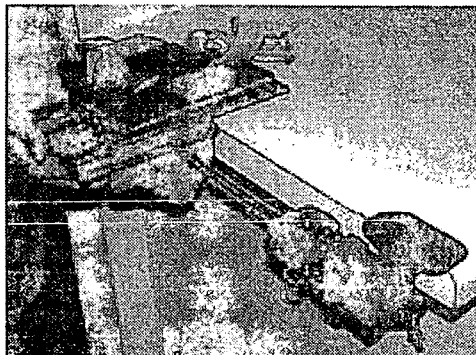

Figure 1: HAS attached to a standard counter.

The Y-slider assembly provides adjustability and attachment to the splint through a Velcro covered vee-block, which can be located on a plate to user preference. A lazy-susan is at the rear of the HAS between this top plate and the sliding plate, providing rotation in the plane of movement. A special rubber and Velcro strap is attached around the lazy-susan to wrap around the user's arm near the elbow. The strap keeps the device from falling, or rotating, backwards by providing a second support point at the rear of the arm. The sliding plate provides front to back movement through modified drawer sliders. The bottom plate attaches to the X-slider and has a hole through it, allowing the friction adjusting screw, from below, to contact the sliding plate.

The X-slider provides side to side movement through linear roller bearings on a steel rod. This assembly also provides frictional adjustments for each movement direction and an adjustable rotation stop to keep the device from rotating too far towards the user around the rod. The frictional adjustments are thumbscrews with felt pads on the end, which provide assistance in control for a wide range of users.

The clamp assemblies hold the rod in place through a wooden frictional clamp design. Attached to the rod clamp the height

adjustment mechanism uses two clevis pins and cotter pins to ensure both sides are level. All of this is attached to the back of two special clamps that were salvaged from a common drafter mechanism. These clamps hold the HAS to the desk edge.

EVALUATION and DISCUSSION

After the beta prototype was completed, the team tested the HAS with the primary customer. The test was done at her residence, so a desk surface was not available. However, the device did perform well for her at a counter in a secondary task of cutting apples. The team did find the device had a tendency to fall backwards, rotating at the rod. This occurred because the center of mass of the device and arm was behind the rotation point at the rod. That rotation with the rotation about the soft Velcro joint caused the splint to contact the front edge of the device. The combination of these effects made the device seem heavy because of poor mechanical advantage. To increase control and keep the splint aligned correctly, the team added a rubber and Velcro strap to go around the arm near the elbow. In a later demonstration of the device, the primary customer said that everything felt more stable and she did not have to work as hard.

The team made other observations suggesting improvements that could be made. Overall, the team felt the device met all of the customer needs, but some of the needs could have been met more effectively. Before this device is further manufactured, these improvements should be considered. After some continued use, the friction pad no longer tightened against the rod. Relocating the screw support $\frac{1}{4}$ " closer to the rod would allow the screw to tighten regardless of the condition of the frictional pad. Depending on the needs of other users, materials other than felt should be explored for the friction pads. Relocating the rod closer to the sliding plate and closer to the user's elbow will increase the stability of the

device, but this change will also require a redesign of the friction adjustments and the rotation stop. The team also noticed that the free rotation at the lazy-susan reduced the device's ability to dampen her tremors. To solve this the team suggests a friction adjustment be added to limit the free rotation if necessary. The height adjustment system is also unwieldy and should be improved for ease of use.

CONCLUSION

Through customer interviews and needs analysis, the team defined the true problem the HAS needed to address. Through a structured methodology, the team designed a device to meet these needs. By building a full prototype, the device performance was analyzed through actual customer use. From the analysis, the team made improvement suggestions for future manufacture of the HAS.

REFERENCES

1. Ulrich, K. T., Eppinger, S.D., *Product Design and Development*, McGraw-Hill, New York, 1995.

ACKNOWLEDGEMENTS

We wish to thank the following individuals: Meredith Frazier, our primary customer, for her patience in the many meetings we requested of her; Ray Joyce, Certified Orthotist, for his generosity in his time, materials, and knowledge; and Tracy Gilbert, Physical Therapist, for his assistance in clarifying the disability that Meredith has in terms we could all understand.

Sean Stephens (sean.s@mail.utexas.edu)
Department of Mechanical Engineering
The University of Texas at Austin
ATTN: Dr. Richard Crawford
ETC 5.160 / Mail Code C2200
Austin, TX 78712-1063

**UTILIZING ERGONOMIC PRINCIPLES:
A Case Study Accommodating an Individual with Cerebral Palsy**
Beth A. Loy, MS and Linda C. Batiste, MS
West Virginia University/Job Accommodation Network
Morgantown, WV

ABSTRACT

This paper is an excerpt from a case study investigating the use of ergonomic principles to accommodate individuals with various disabilities. The work addresses part of an investigation into the successful application of ergonomic principles to help increase worker productivity. The case study highlights one employee with cerebral palsy (CP) and examines a successful strategy for accommodation.

BACKGROUND

Technology in the area of ergonomics is growing rapidly with the increased concern for rising cases of cumulative trauma disorders (CTDs). Numerous assistive devices are available and marketed to accommodating individuals with CTDs. Many of these devices as well as the principles behind their design, however, have applications across disability areas. Ergonomic principles and the theory behind "proper" ergonomics can be successfully applied to individuals with other motor impairments, including CP.

OBJECTIVE

The objective of this case study is to share the process of accommodating an individual with CP in an office setting. Ergonomic principles were used to suggest assistive technology aids and devices. The principles were applied within the framework of an accommodation process. The use of this process and the application of the ergonomic principles are addressed in this paper. The authors:

- Identified key physical elements within the subject's job which are deemed as task problem areas;
- Developed a prioritized listing of potential intervention steps or activities; and

- Used the data obtained by this analysis to educate the subject and the employer as to potential actions which may reduce or eliminate barriers to performing job tasks.

METHOD/APPROACH

The authors made two site visits to the subject's office. The authors documented several areas of concern. During the site visits the employee was interviewed, was videotaped performing essential job functions, and allowed the authors to take anthropometric data. Measurements and pictures of the office setup were also recorded and taken.

The consultants applied an accommodation process used by the Job Accommodation Network (JAN). The process is a step-by-step method which identifies accommodation needs and possible solutions. Ergonomic adjustments and other accommodation ideas were suggested based on the authors' consulting experience and the following:

- Occupational Safety and Health Administration's Draft Ergonomics Protection Standard;
- American National Standard for Control of Work Related Cumulative Trauma Disorders, ANSI - Z365; and
- American National Standard for Human Factors Engineering of Visual Display Terminal (VDT) Workstations, ANSI/HFS 100-1988.

RESULTS

The individual is a professional who must answer the telephone, sort mail, and access the computer. The subject is a male, 5'7" tall, and 40 years old. He is unable to use a pen or pencil, has difficulty accessing his computer, is experiencing neck and shoulder pain, cannot independently access files or handle papers, and has problems using the telephone.

Utilizing Ergonomic Principles

The subject was using a keyguard to assist with computer access. Previous accommodation attempts had been made, including the use of a portable voice recognition device to transfer notes taken while completing off-site assessments, the use of open hanging files, and placement of binder pages in plastic sleeves.

Attempts at using voice recognition were unsuccessful due to the device's inability to recognize variations in voice and pitch fluctuations. Attempts at using open hanging files were also unsuccessful since the files were unable to withstand the subject's forceful motions. The use of binder pages placed in plastic sleeves to increase the individual's ability to grasp was helpful to the subject.

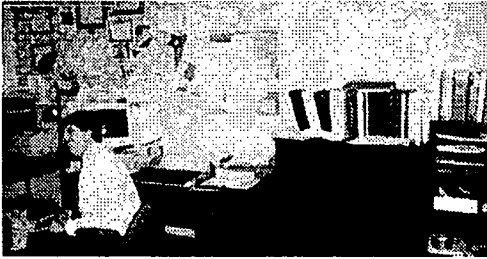

Subject's Work Area

Priority #1: Computer Access

- Subject had difficulty typing. He typed with his forefinger on his left hand and his forefinger and middle finger on his right hand. The subject considered this method of data entry inefficient.

Computer Access Accommodations

- Subject was recommended for an experimental project involving a new voice technology system designed by Integrated Wave Technologies. The voice recognition system was designed to accommodate voice and pitch fluctuations.

Priority #2: Workstation

- Subject was experiencing neck strain. The individual's VDT was placed at a 45 degree angle, at a height two inches below resting

elbow position, and beyond 30 inches from subject's sitting position.

- Subject reported eye fatigue. A 500 – 700 Lux glare was being projected from the window and overhead fluorescent lights onto VDT screen causing improper workstation lighting.
- Subject was experiencing shoulder pain. The subject's keyboard was placed approximately five inches above resting elbow position and his armrests were stationary, affixed three inches above resting elbow position.
- Subject reported back pain. Subject lacked lumbar support and was sitting for long periods of time. The subject was also continually moving his chair over a misaligned anti-fatigue mat and was performing excessive reaching in order to access materials.

Workstation Accommodations

- Place the VDT directly in front of the subject on a monitor arm within a 15 to 30 inch range
- Adjust the viewing angle of the VDT to the subject to between 15 and 25 degrees
- Move screen height to 40 inches from floor
- Place the CPU in a holder to the side of the subject's desk
- Place a glare screen over the computer screen, reducing glare to 250-300 Lux
- Attach a keyboard tray to the desk
- Adjust the keyboard tray so the subject's elbow angle is 90 degrees
- Place keyboard height between 25 and 30 inches above floor
- Adjust desk height to 30 inches above floor
- Replace existing chair with an adjustable chair that has lumbar support
- Adjust seat back angle to fluctuate between 100 and 120 degrees
- Adjust seat pan height to between 15 and 20 inches
- Place necessary materials to between 15 and 20 inches from mid-shoulder length

Utilizing Ergonomic Principles

Priority #3: Filing

- Subject had difficulty accessing file folders in filing cabinet. The individual did not have hanging files in his cabinets and separation of folders was difficult due to overloaded drawers.
- Individual had difficulty accessing open hanging files. He applied excessive force to the hanging files, causing the file to detach from its hanger and fall through the bottom of the file tray.

Filing Accommodations

- Add hanging files
- Decrease number of files in file cabinet
- Place one file folder per hanging file
- Add a bottom (possibly wooden or metal) to the open file with the slat touching the bottom of the hanging files to prevent folders from falling
- Change filing system to post office mail-type slots where slots would be placed against the wall and arranged horizontally

Priority #3: Paper Handling

- Subject reported difficulty manipulating paper, including opening, sorting, and filing incoming mail; manipulating pages placed in binders; and handling loose papers in file folders.

Paper Handling Accommodations

- Have an assistant open, sort, and file incoming mail
- Laminate pages of manuals or place the pages in plastic sleeves
- Laminate loose paper, place paper in plastic sleeves, or change filing system to post office mail-type slots

Priority #4: Telephone

- Individual had difficulty accessing the telephone. The individual used the phone extensively throughout the day. The telephone was located in an awkward position, causing the individual to bend and reach 25 inches from mid shoulder distance. The telephone was placed behind the keyboard on subject's desk.

Telephone Accommodations

- Convert the left top drawer of the individual's desk to a phone mount by placing a piece of wood on top of the drawer after the drawer has been pulled out from its resting position

Additional Suggestions

The individual was advised to sit close to desk, sit back in chair, avoid working with neck bent, take frequent breaks, rest forearms on chair arms, and maintain a neat workstation.

DISCUSSION

The consulting team attempted to remove or reduce awkward postures and motions while accommodating for the limitations associated with the individual's CP. The team selected accommodation ideas as they worked through an accommodation process. The team: 1. Defined problem areas; 2. Identified previous successful and unsuccessful accommodation attempts; 3. Identified new accommodation options; and 4. Discussed, summarized, and presented suggestions. The team also planned a follow-up consultation to assess effectiveness of the recommendations.

The approach used in this paper has resulted in accommodating an individual with CP using ergonomic principles and recommended standards. A process was illustrated that can be used in conjunction with these principles and others to accommodate individuals across disability areas.

REFERENCES

Kroemer, K.H.E. (March 1993). Fitting the Workplace to the Human and Not Vice Versa. *Ergonomics*, 56-60.

Lloyd, John D. (January 1997). Tutorial: Proper Setup for an Office Work Station. *Ergonomics Intelligence Report*, 7.

ACKNOWLEDGMENTS

This research was supported by the President's Committee on Employment of Persons with Disabilities. Beth A. Loy; JAN; WVU; PO BOX 6080; Morgantown, WV 26506-6080; Phone: 800-ADA-WORK; FAX: 304-293-5407 e-mail: bloy@wvu.edu

A QUANTITATIVE ECONOMIC MODEL FOR ASSESSING REASONABLENESS OF AN ACCOMMODATION

Don Malzahn, Ph.D., Joan Wagner, and Ban Yee Chee
Industrial and Manufacturing Engineering Department
Rehabilitation Engineering Center
Wichita State University
Wichita, KS 62260-0035

ABSTRACT

Since the passing of the Americans with Disabilities Act (ADA) people have struggled with the idea of a reasonable accommodation. The goal of this paper is to present a consistent way to evaluate reasonableness with a quantitative method.

BACKGROUND

With the passing of the ADA in 1990 a new world of opportunity was open to persons with disabilities. The world spanned from the home to the work place, the focus of this paper is in the workplace. Title I of the ADA prohibits employment discrimination on the basis of employees' disabilities. This is as long as the person with a disability is qualified for the position he or she seeks or holds and the person can perform the essential functions of the position with or without a reasonable accommodation (EEOC, 1992). Now the problem exists in defining what is a reasonable accommodation.

METHOD

The vagueness of the reasonable accommodation standard provides little help or guidelines for employers to comply with the ADA. Therefore, a quantitative method is needed to clearly specify the level of accommodation that would cause the employer an undue hardship (Dolatly, 1993). The quantitative method should also identify reasonable accommodation according to ability and type of industry of employers, and provide trade-off information between attributes that affect the reasonableness of an accommodation. This method should be simple and precise, and should provide more guidance and greater clarity in determining when an accommodation would impose an undue hardship. It could also specify certain levels as "uncertain".

An economic measure of undue hardship naturally breaks into two areas of concern, initial economic costs (IEC) and ongoing economic costs (OEC). Due to different "time values of money" it is reasonable for firms to differ in the trade-offs that they may make between current and future costs. The nature of accommodations also leads to the same two classes of costs; those that are one time expenses for an accommodation and those that are ongoing expenses.

Indices were developed for each of the cost factors. The IEC index was viewed as an indicator of what the firm could normally be expected to invest in capital for each employee. A reasonable estimate of this would be the capital consumed by the firm each year per employee. A good estimate of capital consumption is the depreciation rate of the firm's assets. The total Initial Economic Cost of the accommodation is then scaled by the annual depreciation per employee.

$$\text{Initial Econ Index} = \frac{\text{Initial Accom Cost}}{\text{Ann Depr} / \text{Total Payroll}}$$

A very capital intensive industry such as chemical production would be reasonably expected to be able to invest more in the first cost of an accommodation.

The OEC index was viewed as what a firm could be reasonably expected to incur as an ongoing cost of an accommodation. This would appear to be a function of the value that an employee contributes to the firm. A measure of contribution of personnel is the operating income of a firm per dollar of wages and salaries. If one assumes a fair market for high value adding employee skills, the pay received by the position being accommodated is a surrogate for the value contributed. It is reasonable to expect a firm with high operating

Reasonableness Model

income per payroll dollar to be able to afford higher ongoing costs for an accommodation because its employees make a relatively higher valued contribution. It is also reasonable to assume that it is reasonable to spend more in accommodating an employee with an extremely highly valued set of skills.

$$OEC\ Index = \frac{Ongoing\ Economic\ Cost}{\frac{Operating\ Inc / yr}{Payroll} * Ind\ Salary}$$

In order to determine the relationship between these indices and "reasonableness" a set of case studies was developed for a variety of index levels. These cases were then presented to rehabilitation engineers with experience in vocational rehabilitation engineering. Each engineer independently scored each case as to its degree of "reasonableness"

The information that they returned was then formulated in a full second order regression model. This used the following model:

$$E(y) = \beta_0 + \beta_1x_1 + \beta_2x_2 + \beta_3x_1x_2 + \beta_4x_1^2 + \beta_5x_2^2$$

where:
E(y) = Reasonable score of accommodation

Figure 1 presents the combinations of IEC and OEC that were judged to be Reasonable, Uncertain, or Not Reasonable. By calculating each index and plotting on the graph an estimate of the reasonableness of an accommodation can be estimated.

RESULTS

The Quantitative Economic Model was applied to several court cases to compare the outcome of the model to the outcome of the cases. Two of these are discussed in this paper.

Case A: Nelson v. Thornburgh

Three blind plaintiffs asked their employer to assume their cost to hire readers. The court held that the employer was obligated to provide the requested accommodation. With the necessary inputs the OEC Index was found to equal 0.173 and the IEC was equal to 0.0. From the graph this point falls in the reasonable region.

Case B: Gardner V. Morris

Gardner, a manic-depressive civil engineer, sought a transfer to a construction project in Saudi Arabia. The court ruled that accommodation was unreasonable because the cost of providing a physician and on-site laboratory facilities could cause undue hardship.

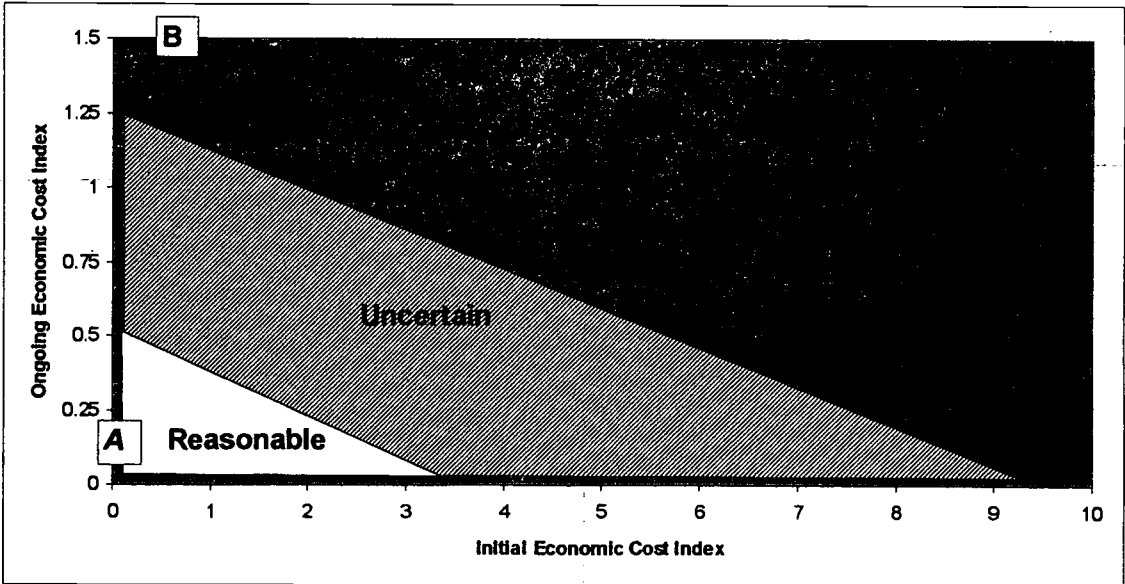

Figure 1. Accommodation Reasonableness as a function of the Initial Economic Cost Index and the Ongoing Cost Index

Reasonableness Model

The OEC index for this case is 1.91 and the IEC Index was 0.43.

Analysis of the court cases demonstrates that the Quantitative Model is consistent with court decisions. A problem in assessing the validity of this approach is that court cases are usually heard on the basis of "essential function" and not reasonableness. These cases do not provide the data required to calculate the indices.

There are other factors that impact the reasonableness of an accommodation such as safety and the degree of business disruption produced by the accommodation. We have also developed a model that assesses the degree of business disruption produced by an accommodation using a similar procedure.

CONCLUSION

A Quantitative Economic Model offers a solution to the question of what is a reasonable accommodation. Its primary purpose is to reduce the uncertainty and ambiguity when an accommodation is being considered. It explicitly considers the nature of the firm, the initial economic impact, and ongoing support costs. The reduction of uncertainty should provide greater opportunity for persons requiring accommodation

REFERENCES

Equal Employment Opportunity Commission (1992). A Technical Assistance Manual on the Employment Provisions (Title 1) of the Americans with Disabilities Act.

Dolatly, George C. (1993) The Future of the reasonable Accommodation Duty in Employment Practices. Columbia Journal of Law and Social Problems. 26(4), 523-553.

Nelson v. Thornburgh, 567 F. Supp. 369 (E.D. Pa. 1983), aff'd, 732 F.2d 147 (3d Cir. 1984), cert. denied, 469 U.S. 1188 (1985).

Gardner v. Morris, 752 F.2d 1271 (8th Cir. 1985).

ACKNOWLEDGEMENT

The authors would like to acknowledge the assistance of Tony Langton, Jan Galvin, Jerry Weisman, and Leonard Anderson. This research was partially supported by NIDRR grant H1333E30027-97.

Don Malzahn
Industrial & Manufacturing Engineering
Wichita State University
Wichita, KS 67260-0035
316 978-5906
malzahn@ie.twsu.edu

Learning from a Distance: Assistive Technology Training for Rehabilitation Counselors

Caren Sax
San Diego State University Interwork Institute
San Diego, CA

ABSTRACT

Distance learning has taken on new dimensions as technology advances to support more accessible avenues for student learning. Utilizing a range of instructional technologies, creative instructors can deliver learner-centered curricula and meaningful activities that relate to the students' daily experiences (Berge, 1996). While many remain skeptical of the quality of learning in a "virtual" classroom, those who have experienced this medium are finding it more interactive and motivating than they expected. San Diego State University's first cohort of rehabilitation counseling graduate students are joining the ranks of those in favor of distance education. Thirty-four California Department of Rehabilitation rehabilitation counselors are now enrolled in a 30-month masters degree program, including an eight-week course on rehabilitation technology. Students are learning via web-based instruction, desktop conferencing, videotapes, audiotapes, and more. They are enjoying the flexibility that their classes offer, and are becoming more comfortable communicating through their computers. In addition, they discovered that their own experiences and frustrations with mastering instructional technology provided valuable insights on how they are approaching the use of assistive technology in their work as rehabilitation counselors.

BACKGROUND

As a result of federal legislation, such as the Americans with Disabilities Act (ADA), the Individuals with Disabilities Education Act (IDEA), and the Reauthorization of the Tech Act, assistive technology information, products, and services are more readily available to individuals with disabilities. While access to information is improving, applying the information can be overwhelming. There is a continuing need to train both the users and the

providers of assistive technology in the areas of assessment, acquisition, funding, legal requirements, and evaluation (Behrman, 1995). All professionals who provide services to people with disabilities need a basic level of awareness and understanding in these areas. All too often, opportunities for individuals with disabilities are overlooked or rejected before the use of assistive technology is even considered.

Professionals must know the right questions to ask, and how to find available resources and appropriate expertise. Distance learning methods can provide access to this wealth of information. Planning and delivering instruction in a "virtual" classroom requires the same attention to individual learning styles that is necessary in a "real" classroom. Distance learning need not replace face-to-face contact. Rather, distance learning should enhance the relationship between instructors and learners.

CHALLENGE

Designing an assistive technology class for 34 California Department of Rehabilitation counselors who lived all across the state presented many challenges. Students who take a similar course on the SDSU campus have the advantage of meeting people who use assistive technology to access school, work, and community activities. The students on campus represent a number of disciplines (e.g., rehabilitation, special education, communication, engineering, physical and occupation therapy) who work on Tech Teams to design and construct assistive technology devices. The course is taught every semester for the full 16 weeks. The distance course, on the other hand, compressed learning into eight weeks while covering the same range of topics: legislative foundations, assessment, accessing resources, workplace modifications and ergonomics, communication devices and strategies, universal design, and advocacy. The activities and assignments in the distance class relied on students accessing local resources and

DISTANCE LEARNING

related directly to their job responsibilities. They turned in assignments as files attached to email messages, and their class participation was graded on the quality of their on-line submissions. Guest lecturers interacted with the students on-line rather than in person. The intro for each week's class was posted by Tuesday evening, and students logged on at their convenience from Wednesday morning to Saturday afternoon. Overall, the expectations for graduate level participation remained the same.

STRATEGY

The introductory session for the Rehabilitation Technology course was conducted via desktop computer conferencing. The students met at four locations across the state, each group gathering around a computer that was equipped with a camera and connections to the other sites. While the visual images were a bit time-delayed by a second or two, all the students at least saw each other, and met their "virtual" professor. The professor discussed the syllabus, expectations, and assignments by guiding everyone through the website together, sharing software across sites. All the materials had been sent in advance, including textbooks, supplemental articles, case study examples, and videotapes.

Each week's "weblecture" highlighted the readings and/or video for a specific topic area. A number of questions were then presented for the class on the website discussion board. Discussions were "threaded," that is, organized according to questions. Chat rooms and listservs were also set up for group work, so that students could work at the same time (synchronous) or at their convenience (asynchronous). The groups were responsible for compiling questions for the two guest lecturers. The guests were sent the list of questions in advance, in order to design their weblecture. Students were also provided information on accessing local resources and contacting local rehabilitation technology experts.

In addition to participating in class discussions, students were required to complete two assignments. The first assignment was to create a "webliography," an annotated listing of

websites describing a certain area of assistive technology, e.g., transportation, recreation, adl's. The second assignment was to complete a case study of an individual who might benefit from the use of assistive technology. Each student identified an individual with disabilities, completed a person centered assessment, and at least initiated the process of matching the person's needs with the appropriate technology (Scherer, 1996). Completed case studies included recommendations for specific technology devices, funding strategies, and follow-up plans once the technology was delivered to the individual. This assignment required the student/counselor to focus on one of their consumers who needed assistive technology.

RESULTS

The evaluations of the class indicated that the use of distance strategies were very effective for learning about assistive technology and applying this knowledge to everyday situations as a rehabilitation counselor. Comments by the students during and after the class are grouped into three categories: professional competence, personal confidence, and the development of a "learning community." All students referred to their increased level of professional competence. The students learned a great deal about how to provide better services to their constituents, and also served as valuable resources to one another. Many of the students had limited experience with recommending the use of technology to consumers prior to this class, and stated that completing the assignments helped them to increase their skills in this area. A primary emphasis in the course was to design better ways of including the individual with disabilities in the process. After experiencing the steps in matching people to appropriate technology, students claimed a better understanding of how to incorporate a person centered planning approach in considering technology throughout the entire rehabilitation process. In addition, the webliography assignment opened new avenues of resources that they never knew existed. At the end of the course, all the lists were compiled and each

DISTANCE LEARNING

student received their own copy of everyone's searches on disk.

The second category included references to their confidence level, particularly in the area of technology. Many of them commented that the struggles they faced in learning this new technology (e-mail, web discussion boards, desktop video) made them realize the frustrations that are often encountered by rehabilitation consumers when they are introduced to assistive technology. For example, when the discussion board was first introduced (about the third week of class), the students rebelled. Learning a whole new strategy for on-line interactions was overwhelming for many of them who were struggling with not only learning new course content, but also trying to master the use of distance technology for the first time. Through some careful negotiation and compromise, the students gave the board another chance and eventually mastered it. This experience caused many of the students to re-evaluate the expectations that they had for people with disabilities who were deciding on assistive technology devices. They learned first hand that it takes time to get used to new technology, assistive or otherwise.

The third area that most students referred to was the sense of a "learning community" that developed in the class. Members of the class created both professional and personal relationships that seemed to transcend the distance and the class parameters. As in any other class, people shared stories of births, deaths, promotions, and other accomplishments. They also discovered new opportunities for networking, based on their interactions with the guest lecturers and introduction to professional listservs. The level of discussion on-line was equal to, if not more in depth, than the discussions that occur in a typical classroom. The "virtual" ambience of the discussions was stimulating and challenging, but always respectful and supportive. When the students met face-to-face several weeks after the conclusion of the Rehabilitation Technology class, they greeted each other like long-lost friends. The students spent two days generating ideas and plans for implementing new programs based on what they were learning. They also had the

opportunity to share their new knowledge with the Department administrators and to discuss policy implications.

CONCLUSION

Distance learning can emphasize the best or the worst that education has to offer. Many years of impersonal correspondence courses and "talking heads" on television lecture classes demonstrated a good idea executed poorly. Providing interactive learning via computers takes planning and coordination, and instructors who are willing to spend the time creating a learning community. In this course, students developed personal and professional relationships and enhanced their abilities to perform their jobs more effectively. The key to success seems to be the same whether the course is face-to-face or on-line: ensuring that the content level is interesting, challenging, and applicable, and that the delivery is accessible, varied, and responsive to student needs.

REFERENCES

- Behrmann, M. M. (1995). Assistive technology training. In K. Flippo, K. Inge, & J. M. Barcus (Eds.), Assistive technology: A resource for school, work, and community (pp. 211-222). Baltimore: Brookes.
- Berge, Z. (1996). The role of the online instructor/facilitator. [On-line]. Available: http://star.ucc.nau.edu/~mauri/moderate/teach_online.html
- Scherer, M. (1996). Living in the state of stuck. Cambridge: Brookline.

ACKNOWLEDGMENTS

SDSU/California Department of Rehabilitation
US DOE Grant #H129E40006

Caren Sax, M.S.Ed.
San Diego State University Interwork Institute
5850 Hardy Avenue, #112
San Diego, CA 92182
619/594-7183, 619/594-8810 (fax)
csax@mail.sdsu.edu

Rehabilitation Technology in Supported Employment: Two Case Studies

Bernard Fleming, PhD, ATP, Wayne Thompson, BSEE, PE,
William Irvin, MS, CRC and David Matheis, BA
Human Development Institute
University of Kentucky, Lexington, Kentucky

ABSTRACT

Rehabilitation technology can have significant benefits for individuals participating in supported employment programs. This paper describes two individuals with significant disabilities who are competitively employed as a result of supported employment services combined with implementation of customized job modifications provided through a state agency-operated rehabilitation technology program.

BACKGROUND

Supported employment programs provide an opportunity for individuals with significant disabilities to achieve paid employment in integrated, competitive work settings where ongoing training and support is provided (Sowers and Powers, 1991). In spite of many successes, there remains a large number of individuals with significant physical and multiple disabilities who have yet to benefit from supported employment (Wehman et al., 1990). Among the promising strategies identified to benefit those individuals currently excluded from, or underrepresented in, supported employment programs is the application of rehabilitation technology (West, 1991).

OBJECTIVE

In the case studies described below, prior to implementation of custom job modifications, these clients were almost completely dependent on support from their job coaches and other employees. The objective of designing and fabricating the equipment described in this report was to enhance the ability of these individuals with significant disabilities to

independently, safely and efficiently perform their job tasks. Another significant result of the use of rehabilitation technology is that it has the potential to reduce job coach support and expenses. Finally, the devices designed for these individuals could be easily adapted for use in other job settings with many other individuals.

CASE STUDY #1

Problem: A young man with significant cognitive and physical disabilities was employed at a pet supply store. One of his job tasks was to count and bag a variety of pet treats for resale. This individual had great difficulty with the counting task. His error rate was high and productivity low. The job coach had tried numerous training strategies and low-tech counting aids but these approaches were unsuccessful. The use of counting aids and fixtures required too much physical manipulation and were not readily adapted to counting different numbers of pieces. Due to his physical disability, bagging the pieces also required assistance from the job coach.

Solution: A parts counting and bagging system was designed and fabricated. The device consisted of a two-foot long piece of 8 inch diameter PVC tubing that was mounted on a stand at a 30 degree angle. The pieces to be counted were dropped, one-by-one, into the upper end of the tubing. As they fell through the tubing, each piece interrupted an infrared light beam passing from an emitter mounted in the bottom of the pipe to a detector mounted in the top of the tubing (Omron amplified photomicrosensor, model EE-SPW301). The digital output signal from the infrared detector

was interfaced to an edge-triggered, one-shot circuit with a 0.2 sec. pulse width. This prevented multiple triggering of the counter. The pulse output signal from the one-shot circuit provided the input signal to the counter. The counter used was a model LIBC1E00 single preset counter with an LED display (Red Lion Controls, York, PA). This counter features input configuration programmability, a full complement of control inputs, programmable timed outputs (solid state and relay), and non-volatile memory. For this application, the counter was programmed to count up from zero and when it reached the preset count level (any number from 1 through 9999), the output was activated. At this time, the counter automatically reset to zero restarting the cycle. A manual reset was also provided. The relay output from the counter was activated at the preset value and used to turn on a visual and auditory signal to prompt the client that the desired count was reached. The amplitude and duration of the auditory signal could be varied. The plastic bag was held in place by simple pressure clips and could be easily attached and detached from the bottom end of the tubing.

Results: The counting system was custom designed and programmed to provide the client with an accurate and efficient device for independently counting and bagging pieces having a wide range of sizes and number. His productivity was significantly increased and counting errors were eliminated. The device substantially reduced the client's dependence on support from the job coach. With the cognitive and physical load minimized, the client also experienced less fatigue.

CASE STUDY #2

Problem: A young woman with significant physical limitations as a result of cerebral palsy was working in a library. Her job was to electronically check returned books back into the system by passing a bar code label on the outside back cover of the books under a laser

scanner. She was able to independently slide the books under the scanner, run them past a spine demagnetizer, and drop them into an output bin. There were two tasks that she was not able to do without full-time assistance from the job coach. First, she could not independently retrieve the books to be scanned from the input bin. The job coach handed her each book. Second, for books that scanned into the system normally, she simply pushed the book off the table into the output bin. When a book belonged to another library or some other special condition was detected, the bar code scanner demanded a keyboard response that she was unable to accurately perform. The job coach had to press the key for her. The goal was to allow the client to do the entire job independently thereby eliminating the need for support from the job coach.

Solution: A horizontal power belt conveyor was installed to serve as a book delivery system. It had a five foot bed length, 18 inch width, and slow speed of two inches/sec. A large "press to run" pushbutton was installed for the client. The end of the conveyor was positioned to deliver the books directly to the client's work area. With this system, the client could independently retrieve books from the conveyor. The books had been previously stacked on the conveyor by other library personnel prior to the client's work shift. As a stack of books was depleted, the conveyor pushbutton could be pressed and another stack could be delivered within reach. This system eliminated the need for the job coach to hand her each book individually.

Next, the existing single laser beam bar code scanner was replaced with a multi-beam laser scanner. Multi-beam scanners can decode bar codes held in any orientation. This modification reduced fatigue produced by excessive book manipulation which was required to orient the book in the necessary position to get a valid scan from the single beam scanner.

Finally, to enable the client to accurately press computer keyboard keys in response to detection of a special situation, a keyboard encoder was designed with three large, widely spaced pushbuttons. By pressing these large pushbuttons, she was able to emulate keyboard entries and accurately respond to the prompts. This encoder necessitated the replacement of the existing library computer terminal with an IBM-compatible computer running emulation software. Both the keyboard encoder and the multi-beam bar code scanner were interfaced to the computer via a keyboard wedge.

Results: The result of these modifications and adaptations was to enable the client to independently control the delivery of books to her work space, efficiently scan the bar codes with minimal effort, and easily respond to the computer when necessary. The client was then able to perform all job tasks with minimal support from the job coach or other employees.

DISCUSSION

The application of rehabilitation technology devices and services has the potential to enhance the employment opportunities of many individuals with significant disabilities who could benefit from supported employment programs. Although this paper has focused on the technical details of device design, fabrication and implementation, it should be noted that these activities are just one component of the entire process required to provide an effective job accommodation. Other necessary components of the process include: 1) review of data and on-site observation to determine specific problem areas, 2) evaluation of the total work environment, 3) consideration of simple adaptations and modifications to existing equipment, 4) job restructuring, 5) defining alternative strategies for modifying the specific job duties, 6) reviewing alternatives and strategies with the employer, co-workers, job coaches, and other rehabilitation professionals, 7) providing systematic

instruction, 8) collecting data to determine success of the accommodation, 9) long-term support and follow-through, including additional modifications and training, device maintenance and repair. (Callahan, 1990).

REFERENCES

Callahan, M. (ed.). 1990. UCPA (United Cerebral Palsy Association), *Getting the Job Done: A Manual for the Development of Supported Employment Services for Persons with Severe Physical Disabilities*, 2nd ed.

Sowers, J. and Powers, L. (1991). *Vocational Preparation and Employment of Students with Physical and Multiple Disabilities*. Brookes Publishing Co., Baltimore.

Wehman, P. et al. (1990). *Emerging trends in the national supported employment initiative: A preliminary analysis of 27 states*. Virginia Commonwealth University, Richmond, VA.

West, M. et al. (1991). *Supported employment and assistive technology for individuals with physical impairments*. *J. Vocational Rehab.* 1(2): 29-39.

ACKNOWLEDGEMENTS

The work described in this report was funded through the Kentucky Department of Vocational Rehabilitation and the Administration on Developmental Disabilities, University Affiliated Programs. Mr. Thompson is a rehabilitation engineer with the Kentucky Department for the Blind. Mr. Jeff Burleson was responsible for the mechanical fabrication of the counting system in Case Study #1.

Bernard P. Fleming, PhD, ATP
Rehabilitation Engineer/Project Director
Human Development Institute
University of Kentucky
Lexington, Kentucky 40506-0051
(606) 257-7225 (voice/TDD)
Email: flemingb@ihdi.uky.edu

SIG-15
Information Networking

<DISTANCE EDUCATION FOR POSTSECONDARY STUDENTS WITH DIVERSE NEEDS:
THE STATE OF THE ART AND SCIENCE>

<Al Cavalier, Ph.D>
<Department of Educational Studies>
<University of Delaware>
<Newark, DE 19716>

ABSTRACT

< Fueled by exciting technological advances and changing conceptions of a "university," distance education has developed enormously over the last decade. Distance education reduces -- and sometimes eliminates -- the barriers imposed by location, time, culture, language, and disability. As such, in concert with other assistive technologies it holds unprecedented potential to accommodate diverse needs and extend to people who traditionally have been underserved the opportunity to acquire advanced training and earn college degrees. This paper briefly explains distance education technologies, describes the current level of implementation nationwide, and highlights some threats to the full realization of this potential.>

BACKGROUND

< Definitions. *Distance Education* is a system and a process for providing instruction at a distance. Distance education occurs when (a) an instructor and student(s) are physically separated, (b) an educational institution is involved in the planning of curricula and the provision of student support services, and (c) educational media (i.e., voice, video, data, or print) are used to unite teacher and student and to carry course content across the instructional gap. Distance education includes *distance teaching*, the teacher's role in the process, and *distance learning*, the student's role in the process -- and the desired outcome of distance education (1, 7).

Distance Education Formats. Technology offers many options for providing education at a distance and there are numerous ways to categorize the different manifestations of distance education. I suggest that it is instructive to view this domain in terms of the nature of the channels by which information is exchanged between instructor and student. Viewed in this light, we can speak of five major formats for distance education:

- 2-way video/2-way audio -- sometimes

referred to as *2-way video interactive courses*. This synchronous format equips each site with a camera, microphones, and video monitors. Algorithms are used in digitizing the analog video signal into "compressed video" to eliminate redundant information and reduce channel bandwidth. The typical transmission systems are digital telephone lines and fiber optics. The instructor can see and hear all students and all students can see and hear the instructor and each other. This format provides the closest approximation to having the instructor and distance students "virtually" in the same classroom.

- 1-way video/2-way audio -- sometimes referred to as *satellite courses*. This synchronous format utilizes an orbiting satellite, an uplink antenna, and a downlink station. The instructor cannot see the students, but the students can see the instructor via video monitors and the instructor and students at all sites can talk to each other.

- 1-way video/1-way audio -- sometimes referred to as *videotape courses*. This asynchronous format requires a student to have access to a VCR and video monitor or TV. Videotapes of the instructor's lectures are typically sent directly to the student's home or place of work.

- 0-way video/2-way audio -- sometimes referred to as *audioconference courses*. This synchronous format typically utilizes telephone handsets or speaker phones for the instructor and students at all sites, and an audio bridge to connect all of the various telephone lines together. The course is conducted either totally or primarily via voice. The advantages of audioconference courses are extremely low cost and very common and easy-to-use equipment.

- 2-way print -- sometimes referred to as *correspondence courses*. This is the oldest format of distance education in which the instructor (or the instructor's institution) and the students interact asynchronously primarily by sending educational print materials back and forth.

<DISTANCE EDUCATION>

There is a sixth category of distance education that does not fit neatly into the scheme described above:

- computer-mediated courses -- sometimes referred to as *computer conference courses* (real time or delayed) and the newest variation, *web-based courses*. This format employs a computer network as the primary delivery medium and can be asynchronous or synchronous. Typically, instructors upload syllabi, lectures, and feedback into common computer files that everyone in the class can access. Students download the files, complete their assignments offline, and then upload them to the common files. Sometimes students and the instructor engage directly in online discussion threads. Because of the near-universal "reach" of the Internet, its ever-expanding capabilities for carrying voice, video, and data, and the ease of creating hyperlinks to rich and varied educational resources that include pictures and sound, web-based courses hold unprecedented opportunities for reaching students and for improving the quality of distance education. As the newest format, however, web-based distance education presents challenges that have not been encountered before -- in technical delivery, administration, and pedagogy (1).

In practice, each of the distance education formats listed above often includes a multitude of subsidiary formats to support the teacher-student exchange of information, e.g., fax, telephone, e-mail, snail mail. Synchronous distance education involves the simultaneous attention of all students and the instructor, i.e., their participation is in real time. Asynchronous distance education requires no simultaneity; students can choose their own individual times and often their own locations to learn. While synchronous education has the advantage of live interaction, asynchronous education is more flexible.>

STATEMENT of the PROBLEM

< We are rapidly becoming a society in which lifelong learning is both desired and required for effective participation as citizens and workers. People with disabilities have increasingly asserted their right to be participants in this process. Research estimates are between 6% and

13% of the current college student population that identify themselves as having a disability. This represents an increase of from 200% to 300% over the past decade (2). As this figure has increased, so has the pressure from consumers and the courts to improve accommodations and increase access. Distance education can be a very effective response to these needs.>

APPROACH

< Research on learning effectiveness shows that there are no significant differences between distance learning and more traditional methods -- sometimes distance learning is even better (4). The approach in this paper, however, is to highlight some of the major findings from two recently-published survey research reports on distance education implementation in higher education in the United States by the U.S. Department of Education (5) and by The Primary Research Group (3). For the first time, service providers and administrators have available hard data to guide their decision-making, including data on such issues as technologies employed, teacher strategies, student practices, degrees offered, student demographics, enrollments, course design, and profitability. Some highlights of the findings are:

- Approximately 33% of the institutions of higher education currently offer distance education courses, and another 25% plan to offer them within the next 3 years.
- About half (49%) of the institutions offer distance education classes to the student's home, 39% to branch campuses, 35% to other college campuses, 24% to elementary/high schools, 18% to work sites, and 10% to libraries.
- About 30% of the institutions offer degrees or certificates that can be completed by students exclusively via distance education courses.
- Two-way interactive video courses (57%) and videotape courses (57%) are the most frequently-used technology formats.
- Two-way interactive video (79%), other computer-based technology, e.g., Internet, (79%), and two-way online computer-mediated interaction during instruction (71%) are the technology formats that most schools would choose to add or increase in the next 3 years.

<DISTANCE EDUCATION>

- The percentage of institutions that indicated that the following goals are very important to their distance education programs are: increasing student access by making courses available at convenient locations (82%), increasing the school's access to new students (64%), increasing student access by more flexible time schedules for classes (63%), increasing school enrollment (54%), making educational opportunities more affordable for students (49%), improving the quality of course offerings (46%), meeting the needs of local employers (38%), reducing the school's per-student cost (20%).
- Approximately, 10% of the college distance education programs earn between 31% and 50% above costs, 25% operate with a profit margin between 11% and 30% above costs, 25% of such programs operate with a profit margin of less than 10% above costs, and 40% of college distance education programs operate at a loss.>

IMPLICATIONS

< Many universities have made a major commitment to outreach via distance education programs. While the findings highlighted above are informative and sometimes even surprising, conspicuous by their absence in both national surveys are any questions that directly address issues involving students with disabilities and their participation in and satisfaction with the distance education programs in institutions of higher education. This is unfortunate because efforts of this magnitude could provide valuable guidance to policy makers and program planners, direction to faculty, and leverage for consumers and consumer advocates. As distance education programs in higher education continue to grow at a rapid pace, there is a real danger that considerations for students with disabilities in the design, implementation, and support will be relegated to an afterthought, with all of the problems inherent in such retrofitting.>

DISCUSSION

< Strategic planning efforts for distance education in institutions of higher education must include consumers and professionals who are directly involved in services to students with disabilities. In overcoming some barriers to

accessing distance education opportunities, students can undoubtedly employ many of the existing assistive technologies, since many of the needs are in the areas of transforming information from one modality to another modality and of providing alternate access to computers. Because of the circumstances in which distance education is often conducted, however, this is often problematic. There are also some barriers that present unique challenges to specific distance education formats, such as closed captioning of 2-way interactive video and accessibility to web-based materials (6). Student support services, which have proven to be extremely important with all distance education formats, will prove to be essential for students with disabilities (1). Research in these and related areas is sorely needed.>

REFERENCES

1. Cavalier, A., et al. (1997). Distance education: A blueprint for action. Newark, DE: University of Delaware.
2. Henderson, C. (1991). College freshmen with disabilities: A statistical profile. Washington, DC: American Council on Education.
3. Moses, M., Moses, J., & Boas, G. (1997). The survey of distance learning programs in higher education. New York: The Primary Research Group.
4. Russell, T. L. (1997). The "no significant difference" phenomenon, as reported in 248 research reports, summaries, and papers. 4th Ed. Raleigh, NC: North Carolina State University.
5. U.S. Dept. of Education. (1997). The survey on distance education courses offered by higher education institutions. Washington, DC: National Education Data Resource Center.
6. Vanderheiden, et al. (1997). Unified web site accessibility guidelines. Madison, WI: University of Wisconsin-Madison.
7. Verduin, J. R., Jr. & Clark, T. A. (1991). Distance education: The foundations of effective practice. San Francisco: Jossey-Bass.>

<Al Cavalier cavalier@udel.edu
<302-831-6309 (voice), 302-831-4445 (fax)>

INTERNATIONAL TRAINING IN ASSISTIVE TECHNOLOGY

Dr Lloyd Walker
Dept of Occupational Therapy
James Cook University
Townsville, Qld, Australia

ABSTRACT

With the growing demand for training and professional development in the assistive technology field, an interactive multimedia external course has been developed in Australia. The potential exists to broaden the scope of all training in the field that can be delivered using flexible learning methods. This would permit cooperation between faculty at Universities around the world and access to training for students internationally, including countries without any formalised training in the field.

BACKGROUND

In 1992 a survey was conducted in North Queensland to ascertain what areas of interest there was in post graduate education associated with technology for people with disabilities. Return from the survey was particularly good with two areas of particular importance to respondents:-

- accessible courses - particularly for those in full time employment in rural areas
- university recognised standards - preferably leading to a formal qualification

For those working in the field of disability the area of particular concern was associated with the correct prescription and identification of technology - particularly high cost items such as communication equipment.

Flowing from the identification of need, a team of practitioners and educators in Australia began the process of development and production of a graduate diploma course. This course took its first students in early 1998.

TECHNOLOGY TO ENHANCE LEARNING

The concept of interactive multimedia which informed the development of these materials can be defined as "the use of a computer to present and combine text, graphics, audio and video with links and tools that navigate, interact, create and communicate"(4).

The last four components of this definition are very important: navigate, interact, create and communicate. These infer action on the part of the learner.

With the use of sound educational design, multimedia can be a very effective tool for learning as it has the flexibility and potential to provide students at all levels, particularly those from professional backgrounds, with a powerful tool for learning. In this approach the focus is on the student controlling the learning process and making decisions about which pathways are suited to their own personal needs. This system facilitates a deep approach to learning where students engage in a learning task with the intention of understanding or seeking meaning - rather than just memorising information (1,2). This is particularly important when dealing with a professional student group because professional decision making is dependent on a deep understanding and critical assessment of the information presented.

KEY FEATURES OF THE TRAINING

Of particular note is the flexible external delivery approach used. Students receive all their material on two CD-ROMs for the eight

subject Graduate Diploma. Study is conducted in the student's own time at home or work with only two residential periods required on campus. The course material includes communications systems to allow discussions, messages and tutorials to be conducted using the Internet.

Included on the CD-ROMs for the course are demonstration videos (Figure 1) and built in support systems for the student.



Figure 1: Video is included in the course material

THE INTERNATIONAL POTENTIAL

Flexible learning as outlined permits the student to live virtually anywhere. The package developed in Australia will encourage the student to make full use of the Internet - but it is not dependent on it. This was a major issue for those in more remote regions of the world. In some cases even power may be a luxury and paper based materials may need to be considered.

For most students however the Internet is readily available. The material as it presently exists is particularly flexible and has been written to a standard to allow new or revised subjects and material to be added. With access to the Internet, there is no longer a requirement for all members of faculty to be at the one institution. Several of the subject lecturers will be based in industry or other universities during the course and linked to students and each other by the Internet.

In extending the concept, discussions have already been held internationally on the

development of a "virtual library" of training materials not unlike that already developed in Australia. This concept would permit specialists to prepare training material that would then be available internationally. Various accredited Universities may then offer programs that award credit for subjects completed from the "virtual library" (eg the Graduate Diploma in Assistive Technology from JCU).

STUDENT BENEFITS

Tertiary education and continuing professional development in the all fields including rehabilitation and assistive technology are undergoing radical changes and becoming more "learner" focused (5). The field of assistive technology practice is relatively small when compared to the more mainstream professions. The funding available to sponsor training materials and courses is also limited, and most practitioners have only a modest disposable income.

The proposal being discussed has the potential to offer state of the art training to students wherever they are in the world. It also permits the faculty and Universities involved to reach a larger pool of students making specialist training areas economically viable.

With the advent of certification of practitioners, the internationalisation of training material offers the scope to ensure students around the world have access to leading edge training of the highest quality that is applicable world-wide. Students with disabilities (be they practitioners or just interested consumers) will also have greater access to training materials, and centres will have the scope to develop training packages specifically for consumers that can be taken in their own time and environment.

The cooperative efforts of the proposed library contributors may also have the ability to provide training and support into countries still to develop any extensive assistive

technology industry or services, let alone training services. The challenge would be to provide material relevant and accessible to students in these areas.

DISCUSSION

To date there has only been a limited amount of flexibly delivered material available to those interested in the broad field of assistive technology. The initiatives of EASI (3) and the Internet training opportunities offered by specialists in computer access are notable examples of the opportunities for flexible learning in this field.

With the advent of certification of professionals and the rapid changes taking place in the area of technology delivery, the time is ripe for cooperation not only nationally but internationally for the benefit of both practitioners and the Assistive Technology field as a whole.

REFERENCES

1. Alexander, S. (1995) Teaching and Learning on the World Wide Web. In Debreceny, & Ellis (eds) *Innovation and Diversity - the World Wide Web in Australia*. Lismore, Australia: Norsesearch Publishing.
2. Biggs, J. (1988). The Role of Metacognition in Enhancing Learning. *Australian Journal of Education*, 32(2), 127-138.
3. Equal Access to Software & Information (1997) On-line & On-site workshops. <http://www.rit.edu/~easi/workshops.html>
4. Hofstetter, F.T. *Multimedia Library*, McGraw Hill, New York, 1995.
5. Hobson, DA (1997) Integration of On-line Learning: Implications for Health & Rehabilitation Sciences. Dept of Rehabilitation Sciences & Technology, Uni. of

Pittsburgh.

<http://pft5xx36.ft90.upmc.edu/OLLGroup/OLLHTML/setpreface.html>

ACKNOWLEDGMENTS

The author acknowledges the support of staff from the University of Pittsburgh Dept of Rehabilitation Sciences & Technology and those involved in the development of the Graduate Diploma in Assistive Technology at JCU.

Lloyd Walker BEng PhD ATP
47 Banfield Dve
Mt Louisa Qld 4814 Australia
Tel: +61 7 4781 4931; Fax +61 7 4781 4018
Email: Lloyd.Walker@jcu.edu.au

***SIG-18
Tech Act***

THE POWER OF PARTNERSHIPS OR COLLABORATION AS A KEY TO COST CONTROL

Susan E. Garber, M.S., C.A.S.E.
Center for Technology in Education
Johns Hopkins University / Maryland State Department of Education

ABSTRACT

When the Center for Technology in Education (CTE) won the contract for our state's rural assistive technology outreach program, we knew that it could not be business as usual. A decreasing budget meant that we had to identify stakeholders who had both a desire for change and a willingness to contribute to that effort. CTE is working to achieve lasting systems change by building non-traditional partnerships and organizing activities that leverage the program's scarce resources.

BACKGROUND

For seven years, the Maryland Technology Assistance Program (MDTAP) operated a rural outreach program to serve the four western-most counties of the state. Western Maryland is an underserved region whose economy has been depressed by the exodus of several major employers. Residents have had to travel to a metropolitan area for most assistive technology services, such as evaluation or advanced training. MDTAP funds were used to staff an office and small demonstration center with a part-time assistive technology specialist, and, eventually, a support person. Trying to meet the varied needs of the population of an entire region with fewer than two people often mandated a "putting out fires" approach. While working feverishly to be consumer responsive, staff had few opportunities for comprehensive planning that could yield bonafide systems change and provide for the continued provision of services beyond Tech Act funding.

With only three years of declining funding remaining, MDTAP issued a request for proposals that incorporated the unmet needs of many groups in the region. The RFP included 12 diverse and complex items, such as outreach services to all ages and disability populations; provision of training; direct loan of AT devices; and development of funding for individuals to acquire technology and for program continuation. In addition, bidders were to develop a directory of local services, contribute to the statewide newsletter, develop resource materials, participate collaboratively with all other MDTAP projects, evaluate the project, and maintain a physical facility in the region.

Not surprisingly, getting responses was difficult, especially when the potential three years of funding declined from about \$75,000 to \$57,000 to \$38,000. CTE responded, but only after seeking and receiving the support of numerous local agencies and organizations.

CTE, a partnership of the Johns Hopkins University and the Maryland State Department of Education, has a history of working with underserved populations. From 1992 to 1995, CTE conducted a special grant-supported graduate program in AT for special educators and related service providers from Maryland's rural areas to train local experts and systems change agents within local education agencies.

OBJECTIVE

By responding to the RFP, CTE could continue its commitment to support the Johns Hopkins graduates in their systems change efforts and use our experience in building partnerships to benefit all disability populations of the region. As another "outside group," i.e., another

Power of Partnerships

program based in Baltimore, CTE had to gain the confidence of local representatives, but not create unrealistic expectations.

METHOD

CTE sought local partners who already had some knowledge of the potential benefits of AT for the population they represented; had ties with multiple organizations or agencies (i.e., were experienced at working together for the benefit of the "community"); and who comprehended that this was not a situation where struggling organizations could look for grant funds to support their groups. CTE had the expertise to help these groups meet their identified goals, but no additional money to provide to this project, which stretched beyond the Center's mission to assist children. Partners were sought who were interested in contributing their part to the common good, and who understood that systems change would only come from their own efforts.

APPROACH

If necessity is not the mother of invention, then surely insufficient funding is. CTE conducted an analysis of existing regional programs and institutions and sought to identify which program aspects could be undertaken, with minimal intrusion or cost, as part of an organization's regular work. CTE further sought to identify how it could contribute to the effort by coordinating other grants and contracts which benefited the region. Finally, CTE sought to understand how the activities in Western Maryland could best be supported by the resources of the central MDTAP program and any other components of the Tech Act.

RESULTS

Dissemination. Information dissemination is being done in several different ways. Highly trained CTE staff spend fractions of their time responding to calls to an 800 information

number at their office in Baltimore. A consultant from the Washington County Commission on Disability Issues fields calls about local services and assists with distributing project materials and publicity in local media. Time and mailing expenses for requests for information are minimized through a partnership with the region's public libraries. By expanding CTE's practice of regularly soliciting catalogs and pamphlets for distribution to members of the Maryland Assistive Technology Network (a group of education leadership personnel from throughout the state), large packets of materials were assembled to create "vertical files" of information for each branch library.

The region's public libraries have become key partners in other ways as well. While CTE originally proposed developing three topical displays to rotate among the libraries, librarians suggested creating resource reference albums for each main branch, due to the small size of some rural branches. Additional resource albums were placed in other project-supported facilities. In working with the library association, it was discovered that it already had a major grant to develop an on-line catalog of community services, thus eliminating the need to duplicate that procedure.

Regional Demo Centers in Existing Sites. Community Living, Inc. (CLI), a Frederick County program for adults with developmental disabilities, volunteered to house the small inventory which constitutes the regional "demonstration center." Citizens make appointments to see desired items, which can be shipped from central MDTAP in Baltimore. In exchange for providing the space and a staff member to respond to requests for demonstration or loan of items, CLI has ready access to devices for use by its clients. In this way, the expense of staffing the demo center full time is eliminated, and the collection can be used actively, rather than than the site being

Power of Partnerships

a "device museum." CTE also has been able to add repurposed equipment to this facility.

Wishing to distribute resources across the region but unable to start a new site, the project purchased computer accessories and software for placement with a Washington County child-oriented program. This creates a satellite site in a Parent Information and Training Center, which is housed in a special education facility. CTE coordinated the use of this facility for training through its contract with the state Infants and Toddlers Program.

A New Senior Demo Center. Numerous agencies in the Hagerstown area had identified the need for assistive technology training, services, and devices for the aging population and had established a grassroots coalition, the Western Maryland Assistive Technology Partnership (WMATP). CTE was able to work with this group to establish a multi-faceted program, which others may want to duplicate.

When electronic decision making software was used to reach consensus on the region's major training needs, this group and other participating partners concluded that training in how to work collaboratively was the top priority. CTE arranged with the UCP Systems Change Initiative to provide a full day of training on that topic. As a direct outcome, work groups were formed to establish a senior demonstration center and a 501c3 to assure continued funding. Trial use of a lounge in a Hagerstown Housing Authority building for seniors was obtained and a wonderful group of resident volunteers prepares and staffs the displays on a scheduled and by-appointment basis. The initial \$1000 worth of devices purchased by the project will be supplemented by vendors and a local home care pharmacy.

Establishing a 501c3. With CTE's help, the Washington County Commission on Aging, a major program partner, acquired \$30,000 through a grant and "tip jar money" to expand the program to include building modular ramps. Again, leveraging resources was a vital part of

the process. Using the Minnesota model eliminated the need to start the program from scratch, and establishing partnerships with several volunteer groups provided the needed manpower and storage space. Beyond that, with the help of central MDTAP, we created a 501c3, the Corporation for Assistive Technology, that will assure continued funding for these activities after the grant program ends.

DISCUSSION

Our experience has shown that the first step in developing low budget programs with the potential to create genuine systems change is to identify groups who are willing to contribute to, rather than take from, grant funded initiatives. This program shows that successful experience in partnering, a clear vision of what needs to be accomplished, and motivational leadership are the key factors in building an organizational framework for success. Finally, soliciting and recognizing the valuable input and contributions of volunteers are the capstones in such a community effort.

REFERENCES

- 1.) Flippo, Karen (1997) Creating Coalitions-Building Intradependence. Assistive Technology and Systems Change Project, UCPA.
- 2.) Tchang, Fred (1996) State-level Assistive Technology Associations: Cooperation and Collaboration on a Local Level. Proceedings of 19th Annual RESNA Conference.

ACKNOWLEDGEMENTS

This program is funded by Maryland TAP, a program of the Governors Office for Individuals with Disabilities.

Susan Garber SuGarCTE@jhunix.hcf.jhu.edu
Center for Technology in Education
2500 East Northern Parkway
Baltimore, MD 21214
410-254-8466 Fax: 410-254-8266

THE ABILITY PROGRAM: A PRIVATELY FUNDED STATEWIDE ASSISTIVE TECHNOLOGY INITIATIVE

Lawrence Trachtman, David Yoder,
Maggie Sauer, Mike Jones

The University of North Carolina at Chapel Hill

ABSTRACT

In 1995 the Kate B. Reynolds Charitable Trust awarded \$2.4 million to support the Ability Program, a statewide initiative to improve awareness of and access to assistive technology (AT) for adult North Carolinians with disabilities. This coordinated effort resulted in 11 funded projects, each using a different approach to deliver AT to persons in rural communities. An overall management, technical assistance, and evaluation program ensured coordinated use of the Trust's funds. This paper describes the development and implementation of the Ability Program in North Carolina.

BACKGROUND

Since the earliest provision of technology to rehabilitation patients over 50 years ago, a major shortcoming of AT services has been the lack of coordination among service delivery programs. During the late 1980s, states began recognizing the need for more coordinated efforts to deliver technology to persons with disabilities. Minnesota (1) and New York (2) were the first known attempts to develop statewide plans for improving AT service delivery. Other states also looked at systems approaches for statewide services (3, 4, 5), but at best these were only models tested on a very limited basis. In North Carolina, Project IMPACT was funded by the state's Council on Developmental Disabilities to improve and expand access to AT by building service delivery capacity (6). This project developed a service delivery model consisting of regional teams, local pilot projects, and statewide training and coordination. The project operated for 3 years and successfully established a

framework for a statewide model along with a few local programs that continued after state funding ended. Perhaps the best known attempt to coordinate AT services on a state level has been the federally funded Technology Related Assistance for Individuals with Disabilities Act (Tech Act) of 1988 and amendments in 1994. This large-scale effort has resulted in all 50 states and U.S. territories receiving federal funds to develop statewide, comprehensive consumer-responsive programs for providing AT to persons of all ages with disabilities, and to promote advocacy and systems change on behalf of consumers with disabilities (7). While this legislation has been successful in directing funds to states for planning and coordination activities, the long-term impact on developing sustained statewide AT services is still unknown. This paper describes the only known, privately funded effort to improve access to AT for individuals with disabilities statewide.

METHODS

The Kate B. Reynolds Charitable Trust of Winston-Salem, N.C. was created in 1947 to "Serve the health and medical needs of the people of North Carolina who may be in need of medical care or assistance for financial reasons." The goal of the Trust's Health Care Division is to "Increase the availability of health services to underserved groups." The Trust has an interest in rural areas of the state and sponsors projects focusing on health promotion and early detection/intervention.

In the summer of 1994 informal conversations began, to inform the Trust of AT efforts in North Carolina including Project IMPACT, the North Carolina Assistive Technology Project, and other public and

private initiatives, and to emphasize the ongoing need for improving coordination of statewide services. In December 1994, after subsequent conversations with Dr. Yoder and other state leaders, the Trust decided to sponsor a \$2.4 million statewide assistive technology initiative. This was only the third such directive supported by the Trust (the others being in health promotion and aging): Approximately \$400,000 would be used to administer the program (later awarded to UNC-CH), and \$2 million set aside on a competitive basis for individual project grants. The only parameters were that individual project funds be used to benefit adults in rural, underserved areas of North Carolina. The program administrators, subject to Trust approval, could determine any other project guidelines.

RESULTS

Approximately 20 consumer and provider representatives from across North Carolina met in January 1995 to help the Trust determine the needs of individuals with disabilities and potential applications of AT. Based on this focus group meeting, the Trust invited submission of a management proposal containing program guidelines and a timeline to a May board meeting. The proposal was approved and \$2.4 million was set aside to support the program.

The overall purpose of the Ability Program, as it was now called, was to "Enhance independent functioning to improve the quality of life of adult North Carolinians with disabilities through increased use of assistive technology." The program intent was to "Provide financial assistance for initiatives, including new and existing programs, that are designed to increase awareness and availability of, and access to, assistive technology for adult North Carolinians with disabilities." Objectives were to "improve living skills for more independent functioning, improve employment opportunities for independence, and provide avocational opportunities to develop leisure skills." Eligible applicants were public and

private nonprofit organizations in North Carolina providing services to adults with disabilities. Applicants were strongly encouraged to work directly with consumers with disabilities on project development, implementation and evaluation, and to coordinate services with other local providers. Preference would be given to projects that served adults living in rural areas or other groups underserved by current systems. Funding for individual projects would be up to \$200,000 over 2 years, and projects were expected to demonstrate the capacity to continue services beyond the initial grant funding.

A Request for Proposals was released statewide in May 1995 with a due date in July. Sixty-five (65) 3-page Letters of Intent were received and reviewed by a program Advisory Board consisting of consumer and provider representatives. Based on this review, 22 applicants were invited to submit complete 10-page proposals. A technical assistance meeting was held in August for potential applicants to help with their proposal development. Full proposals were received in September 1995 and again reviewed by the Advisory Board. A recommendation to fund 11 projects was made to the Trust for approval at its October Board meeting. The Trust approved all 11 projects and funding officially began in January 1996.

DISCUSSION

The 11 projects funded under the Ability Program represented a variety of service delivery approaches and covered almost all 100 North Carolina counties. They were based in universities, state agencies, nonprofit organizations, medical and rehabilitation centers, and consumer-run organizations. Most projects were awarded close to the full \$200,000 over the two year period. The projects included training and demonstration on low-cost home modifications, providing Internet access for people with disabilities statewide, adaptations for farmers with disabilities, training and job accommodations

for people with severe developmental disabilities, a regional AT demonstration center, technology loan programs for older individuals, equipment recycling, a financial loan program, mobile services, and equipment repair. Grant funding for the projects ended in December, 1997. At present the data is being analyzed and a final report will be submitted to the Trust in May, 1998.

Significant management support and technical assistance for grantees were provided by UNC-Chapel Hill as part of the overall Ability Program. This included centralized data collection, monthly progress reports, annual site visits, technical assistance meetings, regular telephone and e-mail communication, and a project newsletter. In addition, the management team (consisting of the project director, associate director, administrator and evaluator) met monthly to review progress and address any problems.

The Kate B. Reynolds Ability Program has been very successful both at the individual project and state levels. For projects, the grant funding directly helped individuals with disabilities acquire technology, and raised institutional and community awareness of the benefits of AT. Many of the projects were able to get local newspaper or television coverage of their work. In addition, as a result of this grant funding, many of the host institutions have made an ongoing commitment to retain staff and continue the projects. At least half of the 11 projects have a commitment for continuation. At the state level, the Ability Program helped forge new partnerships among organizations that serve people with disabilities. North Carolina now has more AT resources for adults with disabilities than existed 2 years ago. The data that was collected will also help demonstrate positive outcomes of AT services. Based on our success, we are hopeful that the Kate B. Reynolds Charitable Trust will consider funding for a second round of Ability grants.

REFERENCES

1. Governor's Report on Technology for People with Disabilities, State of Minnesota, June 1986.
2. A Final Report of the Task Force on Technology and Disabilities, New York State, October 1987.
3. Langton AJ & Trachtman LH, (1989) *Assessing the Availability of Program Resources and Future Needs within a State*. Electronic Industries Foundation, Washington, DC.
4. Kniskern J, (1991) A Systems Integration Model for Assistive Technology Resource Development. *Proceedings of the Third Touch the Future Conference*, Atlanta, GA.
5. Schoech D, Cavalier A, & Hoover B, (1993) A Model for Integrating Technology into a Multi-Agency Community Service Delivery System. *Assistive Technology*, 5(1): 11-23.
6. Trachtman LH & Sauer M, (1994) Project IMPACT: Development of a Statewide Service Delivery Model Through Local Capacity Building. *Proceedings of the RESNA 1994 Conference*, RESNA, Washington, DC.
7. Wobschall W & Cohen C, (1996) Interview with Carol Cohen. *Technology and Disability*, 5(3): 239-242.

ACKNOWLEDGEMENTS

We would like to thank the Kate B. Reynolds Charitable Trust for its support of the Ability Program, and recognize Mr. Ray Cope, Mr. Vance Frye and Mr. John Frank for their dedication to this project

Lawrence H. Trachtman
The Center for Universal Design, Box 8613
North Carolina State University
Raleigh, NC 27695-8613
919-515-3082
FAX: 919-515-3023
E-mail: trachtman@ncsu.edu

THE ABILITY PROJECTS: INCREASING ASSISTIVE TECHNOLOGY SERVICES TO ADULTS IN NORTH CAROLINA

Maggie Sauer, Mike Jones,
Lawrence H. Trachtman, David E. Yoder

University of North Carolina at Chapel Hill
CB #7120, Med School Wing E
Chapel Hill, NC 27599-7120

ABSTRACT

Providing resources to persons with disabilities, particularly adults, has become an increasingly difficult challenge. Individuals directing these programs must become innovative in their approach to a variety of issues; funding, system change, policy, and service delivery. The Ability Program was established by the Kate B Reynolds Charitable Trust located in North Carolina. Its 11 projects provide a variety of assistive technology services to adults across the state. This paper describes the development of these projects and the implications of their activities for the future of assistive technology (AT) services for adults with disabilities living in rural North Carolina.

BACKGROUND

As the theoretical and research base for AT service continues to expand, so does the need for effective service delivery and training models. A variety of models have been proposed to best provide AT services. (1-8) In North Carolina, several resources exist to support the use and development of AT for children ages birth to 21. Because less than adequate services existed for adults, the Kate B Reynolds Charitable Trust provided \$2.4 million to support 2 year projects across the state for adults with disabilities requiring the use of AT. Funds were administered by the Department of Medical Allied Health at the University of North Carolina at Chapel Hill. In

addition to providing information about adults with disabilities and AT, the Ability Program is helping to define the "issues" for this group of people and their communities. Most importantly, the Ability Program projects help "real" people solve "real" problems with the resources in their own regions. In other words, many of the adults served might have "fallen through the cracks" or given up because it just seemed too hard to navigate their way through "the system." A brief summary of these projects follows:

Bowman Gray School of Medicine - developed a loan closet of AT items for residents in Forsyth County and provides AT service and information as part of home health activities provided by Community Care Coordination Network at Reynolds Regional Health Center.

Charlotte Institute of Rehabilitation - developed a clearinghouse for donated recycled AT. The program has also modified a van to enable program staff to go into an 11 county region to provide assessments and make recommendations for AT in homes, communities or places of employment.

Partnerships in Assistive Technology- developed on-line services to rural communities statewide. The service includes grassroots technical support, training and materials to enable consumers and family members to access needed information and network with other consumers.

North Carolina State University- The North Carolina FarmABILITY Project helps farmers,

<THE NC ABILITY PROJECTS>

farm workers and agricultural family members of persons with disabilities by providing resources regarding AT applications on the farm, worksite assessments and technical assistance statewide.

Pathways for the Future, Inc.- Pathways has developed a Mobile Equipment Maintenance and Information Education Program designed to repair and maintain equipment, provide resource information and technical assistance to a seven county region in western North Carolina.

Southeastern Regional Rehabilitation Center (SRRC)- SRRC has established a demonstration center for AT access by professionals, consumers, family members and caregivers in the Cape Fear Region.

Programs for Accessible Living (PAL)- provided low-interest loans to consumers and/or family members for the purchase of AT. This program has been established in partnership with NationsBank and has given people with little or no credit history an opportunity to secure loans enabling them to return to or maintain employment, educational endeavors and live at home.

Region D Council of Governments Area Agency on Aging (AAA) - developed a program to deliver low-tech, low maintenance AT to elders with disabilities in seven western North Carolina counties. Loan closets have been developed in each of the seven counties' AAAs. The program is training the staff at the AAA offices to deliver AT services to elders.

Western Carolina Center- The Comprehensive Assistive Technology Services Program provided diagnostic, intervention planning and follow-up services to 12 western North Carolina counties. Services, technical assistance and information are provided in the community and at Western Carolina Center utilizing a mobile van program.

Center for Universal Design- This project promoted "low tech" AT and small-scale home modifications such as grab bars, hand rails, door hardware, bathing aids, more usable appliances (e.g., large button telephone) and home automation devices. These devices,

products, and installations are affordable, easily installed, and low maintenance, and can have a big impact on independent living and home safety.

APPROACH

A comprehensive program evaluation system was established to evaluate the effectiveness of the Ability Program in meeting its intended purpose. The system consisted of: 1) Processes - monthly reporting by each grantee of all activities relevant to the Program's objectives, and 2) Outcomes - an independent evaluation of the Program's impact on the functional outcomes of selected participants. The independent evaluation involves conducting in-depth follow-up interviews with 110 consumers served by the Ability Program grantees. These interviews are still underway.

RESULTS

Process data reported monthly by the grantees has been summarized through September, 1997. Between January 1996 and October 1997, grantees completed over 3,000 outreach activities (presentations, interviews and news releases, demonstrations or exhibits of AT, responses to information and referral requests), 752 training activities (workshops for consumers and providers, skill training sessions), and 6,668 AT service delivery activities (e.g., needs assessment, equipment loan, AT delivery or development, case advocacy/management, AT maintenance or repair).

Over 5,000 consumer training or service contacts were made. The average age of consumers served was 47, and over 18% of those served were aged 65 or older. Consumers from all 100 counties in North Carolina were served by the Program. Most consumers were living at home (68%); however, 22% resided in institutional settings (ICF/MR, nursing home). Over 60% of all training and service activities were provided to consumers residing in rural

<THE NC ABILITY PROJECTS>

areas (unincorporated areas and municipalities of less than 20,000 people). Thirty percent of consumers lived in rural locations of less than 100 people per square mile. Preliminary satisfaction data provided from service delivery and training activities indicate an average of 90% satisfaction for consumers and providers.

DISCUSSION

As described above, these projects vary in their intent and the type of service each provides. It has been challenging to provide data which quantifies the impact they have had in rural North Carolina. However, the projects have provided services to adults who had received very little or no service prior to their existence. Given the number of training/education and service delivery activities reported, the impact of the projects has been impressive. Moreover, the anecdotal information reported by adult consumers of the services has been extremely positive.

The success of each project was directly related to the knowledge and motivation of the project coordinator. Even if the coordinator had relatively little knowledge about assistive technology, the ability to seek out resources, organize project activities and most of all, work closely with consumers and family members to determine the focus and priorities of the project was key. The most successful projects were proactive in their solicitation to the community and partnered with a variety of groups to instill their activities in community life. Many have also been able to demonstrate a cost saving to the community for their services. This has resulted from the recycling of used equipment, providing opportunities for employment, and allowing adults to stay at home rather than in an institutional setting.

REFERENCES

1. Beukelman D, & Mirenda P, (1992). *Augmentative and Alternative Communication*, Baltimore, MD: Paul H. Brookes.
2. Church G, & Glennen S, (1992). *Handbook of Assistive Technology*, San Diego, CA: Singular Publishing.
3. Cohen C, (1986). Total habilitation and lifelong management. In SB Blackstone & D Ruskin (Eds), *Augmentative Communication: An Introduction*, Rockville, MD, ASHA Press.
4. Fisher P, Toszek M, Seeger BE, (1993). Technology for People with Disabilities: A Survey of Needs. *Assistive Technology*, 5.2, 106-118.
5. Schoech D, Cavalier A, & Hoover B, (1993). A Model for Integrating Technology into a Multi-Agency Community Service Delivery System. *Assistive Technology*, 5.1, 11-23.
6. Shane H, & Yoder D, (1981). Delivery of augmentative communication services: The role of the speech-language pathologist. *Language Speech and Hearing Services in Schools*, 12, 211-215.
7. Sauer M, Trachtman L, & Reinhartsen D, (1994). Project IMPACT: Innovative Methods for Providing Access to Technology. *Proceedings of the RESNA '94 Annual Conference*, RESNA, Washington, DC.
8. Yorkston L & Karlan G, (1986). Assessment Procedures. In SB Blackstone & D Ruskin (Eds), *Augmentative Communication: An Introduction*. Rockville, MD: ASHA Press

Maggie Sauer
University of North Carolina at Chapel Hill
CB #7120, Med School Wing E
Chapel Hill, NC 27599-7120
(919)966-9040

THE ACCOMMODATION STATION: AN INTERACTIVE EXHIBIT TO TEACH CHILDREN ABOUT ASSISTIVE TECHNOLOGY

Janet Weaver, B.S. and Robert Feyen, M.S.
Rehabilitation Engineering Program, Department of Biomedical Engineering
University of Michigan, Ann Arbor, Michigan

ABSTRACT

The "Accommodation Station" is a portable exhibit to be presented to students in area schools to increase awareness of assistive technology. The exhibit is four-sided and displays assistive technology around the themes of computer, home, recreation and school. A variety of high- and low-tech assistive technology devices are presented on each side to encourage student interaction, with a corresponding description of how the device might be useful to a person with a disability. Pictures of more complex devices will also be on the backdrop, as well as resource information.

BACKGROUND

The Accommodation Station was funded by a grant from TECH 2000 as a pilot project to promote systems change through public awareness with the intent that if it was successful it could be reproduced in other areas in the state. TECH 2000 is a state program whose mission is to increase awareness of assistive technology and to promote access to assistive technology devices, services and funding sources for all individuals with disabilities in the state of Michigan.

The Accommodation Station is being built through the collaborative efforts of the Washtenaw Community Assistive Technology Council (WCATC), the Ann Arbor Center for Independent Living (AACIL), and the University of Michigan Rehabilitation Engineering Program (UMREP). The WCATC

is an organization that consists of community volunteers that focuses on improving knowledge of and access to assistive technology in the Washtenaw community. The AACIL is a community-based center for education and advocacy related to disability issues, and the UMREP is a medical center-based service delivery and research program.

Each school year, numerous teachers in the community request that the AACIL present disability awareness issues to their students. The Accommodation Station would serve as an additional tool to effectively teach students about life with a disability.

Although the Station is targeted primarily for middle school aged children, the potential audience is all students within Washtenaw county. During the school year, the Station will be moved from school to school; at other times, it may be on display at local libraries or children's museums. The plan is for a presenter to meet with a group of students to discuss issues that people with disabilities confront on a regular basis, the roles that assistive technology can play in one's life, and tips for interacting with people who use assistive devices.

STATEMENT of the PROBLEM

Society has many negative attitudes toward people with disabilities and the assistive technology devices that they use. These include feeling sorry for individuals with disabilities, being afraid of them, or believing

ACCOMMODATION STATION

these individuals are not capable of taking care of themselves. Children need to be educated about disabilities and assistive technology. Our belief is that if children are familiar with these devices then they will be more accepting of people who use them, and this will carry over into an overall change in attitude towards people with disabilities.

RATIONALE

In order to reshape these attitudes, the awareness of today's youth regarding the abilities of those in the disability community must be raised through education. Furthermore, more young people with disabilities are being "mainstreamed" each year into the standard educational system. Although mainstreaming will hopefully increase awareness of some disability issues, it is possible that children will continue to isolate the child with a disability and not learn from the exposure. Ideally, the presenters of the Accommodation Station will be individuals with disabilities who use assistive technologies so that the students can view these adults as role models.

DESIGN

The Accommodation Station is a four-sided exhibit that displays assistive technology used by people with hearing, visual, communicative, mobility, and/or cognitive impairments. However, rather than focus on individual disabilities, each of the four sides concentrates on an area relevant to most students: computer, home, recreation, and school. Each side has a tabletop which is accessible to a pediatric wheelchair user and has various devices attached to it, each with a number.

On the backdrop there are questions or prompts to elicit thinking about how a person with a disability could accomplish a task. Each question has a flap that can be lifted up to show

a number that will correspond with a particular device. To encourage children to consider other solutions, these are mentioned as appropriate. For example:

Q. If you couldn't hit the keys on the computer keyboard with your hands, what could you do?

A. Use a mouthstick or headstick, or use Intellikeys or HeadMaster, or dictate to a friend.

For devices that are commonly used by individuals with disabilities but are too large to present, there will be a picture of the device with an explanation of why and how it is used. Some examples are service dogs, hand controls and adapted recreation equipment.

The frame consists of 1" O.D. PVC pipe and joints which are painted in primary colors. PVC pipe was chosen because it has relatively high strength-to-weight ratio, can be easily painted, is relatively cheap. Bolts are used to further secure the pieces together.

The overall structure is free standing and consists of four "side" units that are connected perpendicular one another, such that the backs of the units form a square. Each "side" unit consists of a rectangular structure with three sides and a tabletop surface.

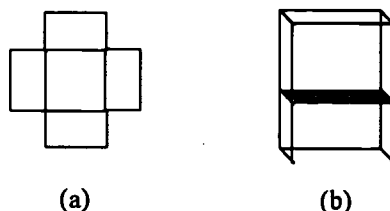

Fig. 1 (a) The top view of the frame set-up of the Station. (b) The frame of one side unit.

To improve the stiffness of the frame, panels have been added to the sides below the table. Since the station is intended to be portable, the long horizontal pipe and panels are removable (Figure 1) so that the exhibit can be collapse for transport. However, due to its size, the number of pieces and the amount of equipment, the

ACCOMMODATION STATION

Station requires a large vehicle (i.e. a van) to transport it and two people to set it up.

Designing the Station to be portable will allow more students to view the Accommodation Station, but is expected to take its toll on the overall frame and equipment. Although devices will be secured to the various panels to prevent loss or damage, funds have been allocated to replace the inevitable broken or lost equipment and frame components.

The major expense of the project was to purchase the high-tech assistive technology equipment. This equipment includes a notebook computer with adaptive software, large foot keyboard, mouse emulator, and text reader with speech output software. Most of the low-tech equipment was inexpensive or donated by local organizations, such as a talking alarm clock, built-up spoon handle, modified door knob, dedicated voice output device, head pointer. In addition, a pediatric wheelchair was donated to the project and accompanies the display.

EVALUATION

At each location, participants are asked to complete a questionnaire before interacting with the Station. Questions include:

1. What type of alarm clock could a visually impaired person use?
2. If you or a family member have a disability, from what community agencies can you receive services?
3. Name two ways you could communicate if you couldn't speak?
4. What are some sports you could play in a wheelchair?

Shortly after interacting with the exhibit a similar questionnaire is administered. The effectiveness of the exhibit will be evaluated by comparing the quality and number of correct answers between the two questionnaires.

DISCUSSION

Because of the diverse membership in the WCATC with regard to disability types and areas of service provision, choosing a variety of commonly used assistive technology was not difficult and care was taken to represent low-tech as well as high-tech options. Also, although a presenter initially accompanies the Station to a location, the Station may be left unattended up to a month at a time. Therefore, the display must not only be study, but also as self explanatory and interactive as possible.

By June 1998, the Accommodation Station will have been on display in at least one school or community location, such as a library or children's museum. The initial presentations should provide feedback of what can be improved over the summer. When not undergoing renovations during the summer, the Station may be exhibited at a summer school or shown to local girl or boy scout troops.

The Accommodation Station has excellent potential to engage children in activities that can educate them on many types of assistive technology with which they may come into contact with over their lifetime. Hopefully, can contribute to improving the attitudes in our current society towards people with disabilities.

ACKNOWLEDGMENTS

This project is supported by the WCATC, AACIL and UMREP through a special project grant given by TECH 2000 (#59430-009777-8421). Additional funds were donated by the Ann Arbor Community Foundation. The Station only exists because of the substantial effort put forth by all members of the WCATC.

Janet Weaver jweaver@umich.edu
1C335 University of Michigan Hospital
Ann Arbor, MI 48105-0032
(313) 936-7170 Fax: (313) 936-7515

SIG-19
Universal Access

EFFECTS OF WET SURFACE CONDITIONS ON WHEELCHAIR PROPULSION WORK REQUIREMENTS

W. Mark Richter, MSME; Logan G. Smith; Kenneth A. Chizinsky, MSBE;
Denise A. Chesney, MEBME; Peter W. Axelson, MSME
Beneficial Designs, Inc.
Santa Cruz, California, U.S.A

ABSTRACT

Current test methods determining surface accessibility do not specify whether the surface should be wet or dry and are routinely done in dry conditions. This study investigated the effects of wet conditions on wheelchair propulsion work requirements using the ASTM PS 83 playground surface test method. Nine different surfaces were tested dry and after 0.5 in. of water was applied. The surfaces included three engineered wood fibers, two common wood chips, chipped brush, shredded tire, dirt, and grass. Increases in the propulsion work requirements ranging from 28% to 92% were found in the grass and dirt surfaces when wet. The remaining seven surfaces showed no significant changes when wet. It is recommended that future accessibility testing consider surface water content.

BACKGROUND

The Americans with Disabilities Act Accessibility Guidelines (ADAAG) contain the current standards for buildings and facilities [1]. According to ADAAG, access routes must be firm, stable, and slip resistant. ADAAG does not define how these characteristics are measured or evaluated. In response to the lack of such standard test procedures, ASTM PS 83, a provisional standard test procedure for the determination of playground surface accessibility was developed [2]. ASTM PS 83 does not specify any surface wetness parameters to be adhered to during accessibility testing and is currently being done on dry surfaces. Since surface accessibility may change when exposed to various weather conditions, and since those surfaces will

continue to be used under some of those conditions, it is important to understand the effects these changes have on surface accessibility. One of the most common changes to a surface due to the weather is the introduction of water via rainfall.

RESEARCH QUESTION

Since many outdoor surfaces are exposed to rainfall, what effect does wet surface conditions have on the wheelchair propulsion work requirements for frequently used surface types?

METHODS

Nine test surfaces were investigated: grass (GS), dirt (DT), cedar chips (CC), bark chips (BC), chipped brush (CB), shredded tire (ST), and three different engineered wood fibers (E1,E2,E3). All surfaces were level surfaces except grass which had an average grade of 2.5% and cross slope of 1.5%. Each surface was installed according to manufacturers' instructions. Wet conditions were created by evenly distributing an average of 0.5 in. of water, over a 30 minute period of time. Water was applied using an oscillating yard sprinkler. The amount of water applied to the surface was measured using five rain gages placed evenly across the test surface. Testing began on each surface ten minutes after watering.

The wheelchair propulsion work requirements were measured using the ASTM PS 83 test procedure. A wheelchair was propelled both in a straight line and along a curved path across a test surface using four uniform pushes. During propulsion, the torque applied to the pushrim was measured. The work required for

propulsion was a product of the applied torque and the resulting angular displacement of the wheel. Five trials for both wet and dry conditions were performed on each surface. This procedure calls for the work required for each surface tested to be compared to the work required to negotiate a hard, smooth 7.1% (1:14) grade reference ramp. The propulsion work required to negotiate the ramp defines the upper limit of work for a surface to be considered accessible.

A 16 in. width rehab wheelchair (Quickie 2 by Sunrise Medical) with 8 in. pneumatic casters, 24 in. pneumatic rear tires, and 20 in. pushrims was used as the test wheelchair. A SMART^{Wheel} [3] with the same dimensions as the rear wheels was mounted onto the wheelchair and used to measure the torque applied during propulsion. The wheelchair weighed 34 lbs.. A laptop computer and an external battery pack were mounted onto the wheelchair. The total weight of the wheelchair with the computer and power source was 54 lbs.. The wheelchair rider weighed 183 lb. and was seated such that when statically measured, the front to rear weight distribution was 40/60 %.

The wheelchair was propelled 2 (+0.2, -0.0) m for the straight propulsion test and through 90 (+6, -0) degrees about a 31.1 cm radius for the turning propulsion test. In the turning propulsion test, the wheel to the inside of the turn was tethered from the hub of the wheel to the center of the curved path. The inner wheel traveled around the arc while in contact with a low friction turn guide test fixture. For the turning test, only the outer pushrim was used in propulsion. Each trial was completed in 7 (+/- 1) seconds using four pushes. Torque applied to the pushrim was recorded at 240 Hz and was then filtered. The average torque for each trial was determined by numerically integrating the torque as a function of time and then dividing by the total trial time. Propulsion work for one wheel was determined by multiplying the

average torque by the total angular displacement of the rear wheel. The total propulsion work for each trial was then normalized per meter of distance traveled by dividing the total work by the total distance traveled. In the case of straight propulsion the total work was two times the work required for one wheel. The average work per meter value for each surface was determined by averaging the five trials.

Statistical analysis was performed on the work per meter values to determine if the application of water significantly affected the results. A 95% confidence interval for the average work value in both the wet and dry conditions for each surface was calculated using an independent samples t-test. Differences between average work values were considered statistically significant if no overlap existed between the 95% confidence intervals.

RESULTS

The resulting average work per meter values for straight and turning propulsion are found in Figures 1 and 2, respectively. The average work per meter values resulting from negotiation of the 7.1% ramp in straight and turning propulsion were 78.2 N*m and 65.4 N*m, respectively. These values are noted as an accessibility reference line across Figures 1 and 2. On bark chips, the test rider was not able to complete the turning test in the dry conditions but was able to once the surface was wet.

Significant differences between the propulsion work required on a dry versus wet surface were found in only three of the 17 cases examined. These differences occurred during straight propulsion on the grass and dirt surfaces as well as during turning propulsion on the dirt surface. In all of the cases where significant differences were found, the propulsion work requirements increased for propulsion across a wet surface. Straight propulsion work

requirements increased by 92% on the dirt surface and 42% on the grass surface. Turning propulsion work requirements increased by 28% on the dirt surface.

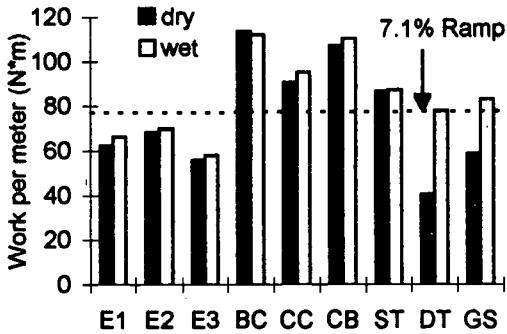

Figure 1. Work required for straight propulsion

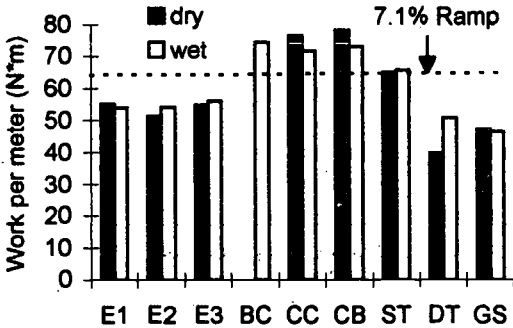

Figure 2. Work required for turning propulsion

DISCUSSION

The results of this study do not offer a clear pattern of changes in propulsion work requirements resulting from wet surface conditions. In the cases of the dirt and grass surfaces, more work was required to propel across the surface when wet. In the case of the bark chip surface, turning was impossible until the surface was wet. For the remaining surfaces, there were no significant changes in the amount of propulsion work required.

The results of this research show that, for some surfaces, propulsion work requirements change due to wet conditions and that those changes may result in a decrease in surface

accessibility. In the case of straight propulsion on grass, the work requirements increased from less than the 7.1% reference ramp to over this maximum value allowed. Since the potential for surface accessibility changes exists, and the need for surface accessibility remains a constant, it is recommended that future surface accessibility standards include testing under wet surface conditions.

REFERENCES

- [1] U.S. Architectural and Transportation Barriers Compliance Board (1991). Americans with Disabilities Act (ADA) Accessibility Guidelines for Buildings and Facilities, in the Federal Register, 36 CFR Part 1191.
- [2] American Society for Testing and Materials (ASTM)(1997). ASTM PS 83-97 Provisional Standard for Determination of Accessibility of Surface Systems Under and Around Playground Equipment. West Conshohocken, PA:ASTM.
- [3] Asato KT, Cooper RA, Robertson RN, Ster JF (1993). SMART^{Wheel} development and testing of a system for measuring manual wheelchair propulsion dynamics, *IEEE Transactions on Biomedical Engineering*, 40(12).

ACKNOWLEDGMENTS

Funding for this research was provided by the National Center for Medical Rehabilitation in the National Institute of Child Health and Human Development at the National Institutes of Health through SBIR Phase II Grant # 2 R44 8HD30979-02.

Mark Richter
Beneficial Designs, Inc.
5858 Empire Grade
Santa Cruz, CA 95060
(408)-429-8447

W3C Web Accessibility Initiative: Development of WWW Browser User Interface Guidelines

Jon Gunderson, Ph.D., APT
Division of Rehabilitation – Education Services
University of Illinois at Urbana/Champaign, USA

ABSTRACT

W3C Web Accessibility Initiative (WAI) is developing guidelines and standards to make WWW technologies more accessible to persons with disabilities. One set of WAI guidelines being developed is to define user interface features to improve the usability of browser technology by persons with disabilities. This paper outlines the basic concepts that are being used to develop the guidelines and major issues the guidelines will be addressing. The guidelines are a dynamic document and interested readers are encouraged to review the WWW sites listed at the end of this document for the most up to date information of WAI activities and how to participate in WAI discussions.

INTRODUCTION

World Wide Web (WWW) browsers are the windows to the universe of information available on the WWW. For information on the WWW to be available to all users, browsers need features that permit a wide range of user capabilities to see through these browser windows with equal clarity and control. Persons with disabilities and older persons with reduced capabilities need features that are often performed by able-bodied users in other ways. Many times when features have been added to other types of technology for the benefit of people with disabilities, the features have found general acceptance by able-bodied users. Able-bodied users find the features useful when they are temporarily impaired through disease or injury, are using a technology that impairs them (laptop and other mobile computer technology) or the user just prefers to use the new features. This document outlines the scope and principles that are being used to develop the browser guidelines and the types of features that provide a more flexible user interface.

In the following list of principles the meaning of "WWW document" includes not only HTML formatting elements, but also scripting languages, and other types of object based controls that provide interactive WWW page capability.

The general principles being used to improve accessibility:

- Providing users with greater control over the way documents are rendered on the screen (font size and type, foreground and background colors, spatial formatting...)
- Providing additional controls for navigation between and within WWW documents.
- Providing additional ways to summarize the document through alternative views of document information and through additional status line information.
- Providing orientation information to users about their location and the content of a WWW document.
- Improving the visibility of new interaction features so that all-users can benefit from their availability.
- Support the accessibility of popular browser technology through built-in access features and improved compatibility with assistive technologies, and support the development of specialized browsers designed to serve specific disability populations.

PRESENTATION ADJUSTMENT

Font and Color Specification: The ability to override author specified fonts and other formatting provides users with the means of displaying information using the fonts and colors that best match their capabilities.

CSS Override: The ability to turn off and modify author supplied cascading styles sheets (CSS) used for document formatting provides a means to disconnect the authors intended presentation of the information from the basic content of the information (the original intention of HTML). Users can use browser presentation controls or their own user defined style sheets to control the presentation of the content. This potentially will include the use of audio and Braille style sheets for speech and Braille output.

Alternative Representations: For some people with visual impairments the display of graphic images is not very useful. In this situation having the ALT text or the new LONGDESC attribute (HTML 4.0) of the image displayed instead is more useful. ALT text can provide a short description of the purpose of the image, while LONGDESC provides a URL to a detailed description of the image characteristics or information on what the image is trying to convey (for example the interpretation of a graph). The need for alternative representations of WWW documents is not limited to people with visual impairments. Persons with hearing impairments benefit from text descriptions and transcripts of audio files.

Alternative Views: One difficulty for persons with visual impairments with current browser technology is finding the main topics of a WWW document. One type of alternative view is to display only header elements so the user can see an outline of the main topics of the entire document. Other types of alternative views will also be useful. The user needs to be able to switch between views while maintaining their relative position in the document.

Browser Menus and Dialog Boxes: The ability to control the font size and background contrast in menus and dialog boxes is important for the entire browser to be accessible. Typically this is not thought of as an issue under the control of the browser developer, but could be a consideration for browser developers wanting to go the extra accessibility mile or the specialized browser developer looking to create a product for the print impaired.

NAVIGATION AND CONTROL

Navigation Commands: User actions for the selection of navigation commands needs to be more flexible, and additional navigation commands are needed to improve navigation between elements within WWW documents by persons with print impairments and people who cannot use a mouse. An example of a current navigation command is using the mouse to point at a link and selecting the link by pressing the mouse button. This and other types of navigation and control commands need to be selectable not only with the mouse, but also through the keyboard, toolbar, voice input or 3rd party assistive technology commands. A user can therefore select the type of input technique that matches their skills and preferences.

In addition to commands that are currently available in browser technology, new commands are need for navigation. These commands are not currently available in most browsers and are also part of improving user orientation to information in the document. The new commands provide a means to navigate the structural HTML elements of a WWW document. The following are examples of new commands that could be implemented:

Headers

- Move to previous header
- Move to next header
- Move to header from list

Forms

- Move to previous control
- Move to next control
- Move to control from list
- Change state of control (control dependent)

Tables

- Move to previous table
- Move to next table
- Move to table from list
- Move to next column
- Move to next row
- Present table row header on status line
- Present table column header on status line
- Find in table

Dynamic HTML (DHTML)

- Move to previous DHTML event
- Move to next element with DHTML event
- Activate event

ORIENTATION

Document Orientation: Information is needed, especially by persons with print impairments, to orient the user to where they are in a WWW document and their relationship to other WWW documents. This includes information on the size of the document and sizes of HTML structures within the document like tables and item lists, and a history of the documents visited by the user.

Document Summary Information: Summary information is needed to orient users to the size and type of structures that are within a document. This includes the document size in bytes, the number of headers, links and other significant HTML structures. This provides users with important information about function and features of the document.

Document Structural Information: As users navigate within a document, users need to have information on the type of HTML element or control that has the current focus. Some types of elements like controls and links in many popular browsers have a pseudo focus used for keyboard commands. The pseudo focus can be used by 3rd party assistive technology to identify the focus element to the user. There is no equivalent pseudo focus capability for most types of HTML elements or for dynamic HTML events in current browsers. Browsers need a way to indicate the focus for all HTML elements that can be recognized by 3rd party assistive technologies and also be salient on the standard visual display.

Dynamic HTML Event Notification: The introduction of Dynamic HTML essentially lets any HTML element respond to user actions. Most of these actions center on mouse pointing and button events, since this is the primary interaction technique used by able-bodied users. A WWW document can respond to an event as simple as moving the mouse over any HTML element presented on the display. The reliance on mouse events is only part of the problem. The other half of the problem is how to notify the user of the

results of executing an event (windows opening or closing, information disappearing or being made visible, etc...). There are an infinite number of possibilities and the user needs to know that they have activated an event and how the event changed the document.

VISIBILITY

The features built into browsers to improve accessibility need to be highly visible. Many users with disabilities do not have the specialized knowledge or access to skilled professionals to help them learn and use browser features that can improve their use of browser technology. Ideally it is important for able-bodied users to adopt the use of features useful to people with disabilities. In this way, able-bodied users can easily share the techniques with their peers with disabilities. One major way to improve visibility is to make accessibility features highly visible through menus, toolbars, specialized dialog boxes and both on-line and off-line documentation.

FURTHER INFORMATION

General Information about the W3C Web Accessibility Initiative, <http://www.w3c.org/wai>

Full draft of the Browser Guidelines, <http://www.als.uiuc.edu/InfoTechAccess/browser-gl.html>

ACKNOWLEDGMENTS

The development of browser user interface guidelines is supported by W3C member organizations, the National Science Foundation and the National Institute for Disability Research. The author would also like to thank members of the WAI browser guidelines and general interest working groups for their contributions in the development of the guidelines.

CONTACT INFORMATION

Jon Gunderson, Ph.D., APT
Division of Rehabilitation Education Services
University of Illinois at Urbana/Champaign
1207 S. Oak Street, Champaign, IL 61820

Voice: (217) 244-5870
Fax: (217) 33-0248
E-mail: jongund@uiuc.edu

CROSS-PRODUCT, CROSS-DISABILITY INTERFACE EXTENSIONS: EZ ACCESS

Gregg C. Vanderheiden, Ph.D.

Chris Law, M.S.

David Kelso, M.S.

Trace R&D Center

University of Wisconsin-Madison

ABSTRACT

Electronic products are being introduced at an increasingly rapid rate into our schools, workplaces, and daily living environments. Although individual adaptation or assistive technologies can be used to provide access to some of them, the number of different devices and the rate at which they are being introduced precludes this approach in general. Wherever possible, products should be designed to be directly accessible. In addition, it is important that the accessibility features on these different devices operate in similar manner, so that an individual does not have to learn a new access technique for each device. Proposed is a package of interface techniques called "EZ Access." Together, these techniques provide access for individuals with a very wide range of disabilities. They have also been designed to be flexible enough to apply to an extremely wide range of products, from cellular phones to ATMs to microwave ovens.

BACKGROUND

Increasingly, products are being designed with electronic interfaces (visual displays, sounds, small buttons, etc.) which can cause problems for individuals with low vision, blindness, reading, cognitive or physical disabilities. Appliances that used to be silent now emit sounds or even talk to the user, causing problems for people who cannot hear well or at all. Touchscreens have migrated from information kiosks to the front of household appliances, making the products impossible to use for individuals who are blind and rely on touch to locate and identify controls. Even products that have fixed tactile buttons often use LCD displays to change the meaning of the buttons, making them unidentifiable by people who are blind, and difficult to use for people who have difficulty reading. Finally, tiny and light-touch

buttons make some products unusable by individuals with physical disabilities. To address these problems, a standardized package of access strategies has been developed that can be built into mass-market products, providing cross-disability accessibility and usability.

THE EZ ACCESS APPROACH

EZ Access is a flexible but standard set of interface strategies for allowing people to access and use electronic devices even when they are operating under constrained conditions. The constrained conditions might result from their having a disability or from environmental factors.

For example, not being able to see a cellular phone might arise from having your eyes occupied while driving a car, or from being blind. Not being able to hear a multimedia information kiosk might be from using it in a mall during Christmas shopping, or from being deaf. Not being able to touch individual keys on a security keypad might be from having gloves on in winter, or from having a disability which affected your hand movement.

EZ Access provides the user with a means to adjust the way things work, so that you can use the senses and abilities you do have (or have available) to augment the ones you don't have. So, if you can't see a visual display, you make it audible; and if you can't hear an audible display, you make it visual; if you can't touch individual keys, you change the way the keys are activated.

POPULATIONS ADDRESSED

The EZ Access techniques allow direct access by individuals with a wide range of abilities/ disabilities, including individuals:

- Who have low vision;
- Who are blind;
- Who are hard of hearing;
- Who are deaf;
- Who have poor reach;
- Who have poor motor control;
- Who have difficulty reading;
- Who have difficulty remembering;

and (via the infrared link to assistive technologies) to individuals:

- Who are paralyzed;
- Who are deaf-blind.

TECHNOLOGIES ADDRESSED

The first application of the EZ Access techniques was on touchscreen kiosks. This application has been commercially transferred, and is now available in over 30 kiosks, including 2 Jobs kiosks in the Mall of America used by the Mall as well as Knight-Ridder newspapers.

Since that time, the techniques have been extended and generalized so that they can be applied across a much broader range of products. Designs and/or prototypes have now been developed for incorporating the techniques in:

- Touchscreen kiosks;
- "8-button" screen-based ATMs;
- Cellular phones;
- Business phones.

Designs are being worked on for:

- Stereos;
- Videocassette recorders (VCRs);
- Microwave ovens.

IMPLEMENTING EZ ACCESS

EZ Access is not necessarily complex or expensive to implement, but does provide a standard way for people with disabilities to use all manner of electronic devices, from microwave ovens, to cellular phones, to interactive multimedia kiosks, to coffee vending machines.

The process of implementing EZ Access will vary depending on the product and the company

that makes it. In many cases adding the techniques will entail adding functionality such as speech output or audio system interoperability. Changes may have to be made to adjust (or add to) existing software code in application, and some hardware may need to be added if it does not already exist on the device. However, in virtually all cases the standard means of operation for a device (for users who do not have disabilities) does not change.

HOW USERS INTERACT WITH EZ ACCESS DEVICES

Users can adjust the way the device operates (using EZ Access) via menus, shortcuts, or by having their preferred means of interaction stored on a personal card (for devices that accept cards, such as ATMs).

The EZ Access extensions provide a small number of powerful, flexible interface enhancements that together can provide great flexibility in how a user interacts with the product. The basic EZ Access components include:

- The ability to have any button that is touched (on a touchscreen or physical buttons) to be spoken aloud, as well as the ability to have any displayed text spoken.
- The ability to have all of the functions and displayed information presented as a list that can be navigated by sliding one's finger up and down the list, rotating a wheel, or operating up and down arrow keys.
- A mechanism that allows buttons to be highlighted but not activated when pressed, and only activated when a second "confirm" button is operated (or after a delay). Highlighting can take the form of a visual highlight or the auditory announcement or large text display of the name of the button.
- A built-in "Quick Help" feature that is activated if a button is pressed and held in various modes.
- The ability to have any auditory information presented on the visual display.
- The ability to have individual items in the above-mentioned list highlighted (visually

or auditorially) in sequence, allowing an individual with severe movement limitations to operate a system from a single button.

- An infrared port that can be used (in addition to other product functions) to allow a user to operate the device and/or display information on a separate assistive technology (such as an alternate keyboard or dynamic braille display).

These techniques can be used in combination to address the needs of a wide range of users. For example:

An individual with low vision could turn on the auditory highlighting feature along with the delay activation. They could then briefly touch the buttons on their phone, ATM, kiosk, microwave, etc., to have the names of the buttons read aloud. When they located the button they were interested in, they would simply press and hold it for a moment, and it would be activated. (This feature would also be very nice for individuals who can see fine, but who are trying to operate their stereo with stylistic dark lavender lettering on black keys located in a poorly lit corner.)

An individual having difficulty reading or who cannot read could use the same capabilities to operate the ATM, public fare machine, or microwave oven.

An individual with cognitive difficulties could use the Quick Help feature to understand the functioning of buttons with which they are not familiar (and most users could use the feature to figure out how to use the "conf" [conference] feature on their PBX phone).

An individual with a physical disability could use the audio highlight and confirm feature to operate even small keyboards that they would otherwise be unable to operate due to erroneously touched keys.

An individual who was blind could use the list function with the voice annunciation to access buttons on touchscreen kiosks, microwave ovens, or devices where the buttons either move or

change function over time. On 8-button ATMs, where the buttons are discernible but either unknown or change over time, they could also use the voice highlighting function.

An individual who was hard of hearing or deaf could use the visual presentation of audio information (as could everyone in noisy environments or in quiet environments such as libraries).

An individual who was not able to use the kiosk directly because of severe physical disability such as paralysis, or because they are deaf-blind, could use the infrared link to operate the device via an alternate keyboard or braille keyboard and display.

ACKNOWLEDGEMENTS

This project is funded in part by the National Institute on Disability and Rehabilitation Research of the Department of Education under grants number H133E30012 & H133E5002. The opinions herein are those of the grantee and do not necessarily reflect those of the Department of Education.

FOR MORE INFORMATION

More information on EZ Access is available at:

<http://tracecenter.org>

Gregg Vanderheiden
Trace R&D Center
Department of Industrial Engineering
College of Engineering
University of Wisconsin-Madison
Madison, WI 53706

WHY COMPANIES MIGHT ADOPT UNIVERSAL DESIGN: AN INITIAL REPORT FROM THE UNIVERSAL DESIGN RESEARCH PROJECT

James Tobias, MA, Inclusive Technologies

Gregg Vanderheiden, Ph.D., Trace R&D Center, University of Wisconsin-Madison

Katherine Vanderheiden, CPA, Trace R&D Center, University of Wisconsin-Madison

ABSTRACT

The success of universal design (UD) of products depends upon its adoption and implementation by mainstream companies with little background and understanding of the needs of people with disabilities. The National Institute on Disability and Rehabilitation Research (NIDRR) has funded a study on the adoption of universal design of products. This study is being undertaken with broad assistance from the universal design community. A major objective of the study is to identify specific factors within companies that facilitate or hinder universal design, as well as actions that can be taken by "outsiders" to improve the adoption of universal design.

INTRODUCTION

A working definition of universal design for purposes of this study is as follows:

Universal design is the process of creating products (devices, environments, systems, and processes) which are usable by people with the widest possible range of abilities, operating within the widest possible range of situations (environments, conditions, and circumstances).

Universal design has two major components:

1. Designing products so that they are flexible enough that they can be directly used (without requiring any assistive technologies or modifications) by people with the widest

range of abilities and circumstances as is commercially practical given current materials, technologies, and knowledge; and

2. Designing products so that they are compatible with the assistive technologies that might be used by those who cannot efficiently access and use the products directly.

Clearly, universal design is intended to be the province and responsibility of mainstream manufacturers and service providers, such as computer companies, architectural hardware manufacturers, and entertainment studios. These companies are quite different from assistive technology (AT) companies. AT companies are smaller, of course, and size can play an important role in how companies operate. More importantly, however, AT companies have as their core mission providing service to customers with disabilities. This pre-disposes some to adopt UD. For mainstream companies, often focusing on the "first 80%" of the mass market, these consumers are unfortunately often an afterthought. They may not be aware of or comfortable with "design ideologies" like universal design, nor do they often focus much attention on the needs of people with disabilities, for many reasons. How, then, can they be encouraged to adopt this principle? The Universal Design Research Project, a three year study, was designed to understand what is needed to encourage companies to adopt universal design for their products.

Its first objective is to understand why and how companies adopt universal design, and what factors are the most important in making this decision. In addition, factors which discourage or impede the adoption and successful practice of universal design are also being identified. The second objective is to determine what those outside of companies can do to support universal design within the companies. As resources allow, some mechanisms for developing this support will be piloted as part of the project.

METHODOLOGY

In its initial year, the major emphasis of this project has been conducting extensive interviews with individuals inside a variety of companies. A panel of seventeen experts in universal design, knowledgeable in a variety of industries, has assisted with identification of companies for interview, as well as with preliminary evaluation of the results.

A total of 22 companies were selected for interviews. The companies include large and small firms drawn from telecommunications, media and materials, "edutainment," computer, and built environment industry segments. One or more individuals within each company (sometimes representing different internal organizations) were interviewed using an instrument developed by the project team. The names of the companies and individuals interviewed are confidential, so the interview information has been summarized for analysis purposes.

In the second year of this project, a second round of interviews with the same companies and individuals will be conducted in order to confirm the initial results and to determine the relative importance of the factors and strategies identified.

INITIAL RESULTS

Although only the first round of interviews has been completed, certain early results are already fairly clear. So far few items have been identified that distinguish any industry segment from another. (Note that more results will be posted to the Center's website as they are developed.)

1. **Size.** Large companies that have succeeded in implementing UD share some characteristics: support from upper management, use of formal product development processes to institutionalize UD, and the use of cross-functional teams. Small companies tend to have "UD champions." They use informal information networks. Their flatter, more "empowered" organization frameworks require less authorization. Size alone does not appear to be predictive of UD adoption. Size does appear to pre-dispose companies to certain styles in their implementation of UD.
2. **Cost.** Virtually all interviewees mentioned cost as an element in their company's decisions. External UD advocates sometimes portray it as cost-free – "It's just good design that expands the potential market." The interviewees saw it as having some additional costs in design resources or manufacturing that were hard to justify, both internally in the struggle for resources and externally in the market. Would consumers see enough difference in value to pay an additional price? Even the *perception* of additional cost was important for them to manage.
3. **Regulation.** Companies that are regulated are more sensitive to UD and tend to adopt it as part of their regulatory and stakeholder strategies. This is also true of companies that are attempting to avoid becoming regulated. This additional motivation, coming as it does from a part of the company not associated with product design, can both add additional resources or moti-

vation and complicate the management of the issue.

4. **Research and Development.** Almost all interviewees wanted closer ties to organizations performing research and development in UD or accessibility. Specific comments were directed toward making research results easier to find, improved market research, and industry participation in the research agenda so that more economically viable products would result.
5. **Support from Outside.** Companies do not view themselves as isolated from their surroundings. Almost all interviewees had strong opinions on what people outside their company could do (or stop doing!) that would support their own efforts to implement UD. This finding supports the project's second objective of identifying specific outside support activities and piloting projects that address them.

Data collection and analysis is continuing.

DISSEMINATION

In addition to the industry interviews, the project has developed a database on universal design that is intended to be an industry resource. This database currently contains over 250 entries and includes books, reports, articles in journals, trade publications, and popular periodicals, and other media. The project's research team is currently in the process of obtaining electronic versions of as many public domain resources as possible related to universal design of products, and is also expanding the listing to include media and materials which, although not directly about universal design, would be useful to people working inside companies to promote or implement universal design.

Both the Universal Design Resource Database and other results of the Universal Design Research Project may be found on the Center's

web site, at the URL listed at the end of this paper.

CONCLUSIONS

If universal design is to be adopted across a broad range of mainstream companies, it must 'graduate' from a design ideology into a constellation of effective business practices. Those who are universal design advocates (both outside and within companies) can provide valuable lessons in how to accomplish this. The Universal Design Research Project is designed to help identify and offer organizational tools to new internal advocates and support for effective outside advocacy.

ACKNOWLEDGEMENTS

This project is funded by the National Institute on Disability and Rehabilitation Research of the Department of Education under Grant #H133A60030. The opinions contained in this publication are those of the grantee and do not necessarily reflect those of the Department of Education.

James Tobias
Inclusive Technologies, Inc.
334 Main Street, Suite 141
Matawan, NJ 07747

Gregg Vanderheiden
Katherine Vanderheiden
Trace R&D Center
Department of Industrial Engineering
College of Engineering
University of Wisconsin-Madison
Madison, WI 53706

The URL for the web site on this project is:
<http://tracecenter.org>.

STOVE MODIFICATION FOR CLIENT WITH TRAUMATIC BRAIN INJURY: HOW TO KEEP FROM BURNIN' YOUR BEANS

Alan J. Harp, Industrial Designer
Julius T. Corkran, Industrial Designer
Kim Adams, M.Sc. EE
Center for Rehabilitation Technology
Georgia Institute of Technology
Atlanta, Georgia

ABSTRACT

Cooking is an important function in nearly every person's life, whether it is simply reheating some leftover pizza or preparing a seven course meal. While working at a stove can be a relatively simple task, there always exists the possibility of a kitchen fire from overcooked food or forgotten buns in the oven. Knowledge, attention and a watchful eye will keep most kitchen experiences safe. However, for a cook who has experienced a traumatic brain injury, time at the stove can no longer be taken lightly. The following project depicts one solution to these safety issues.

BACKGROUND

The design team was presented with a client who had been involved in an on-the-job accident. The effects of the resultant traumatic brain injury included the conditions of narcolepsy, attention deficit disorder and amnesia. He did not experience any long term physical injuries in the accident.

The client lives with his wife and two children, where he is the primary cook for the household. The family lived in a manufactured home and had planned to purchase a newer, larger manufactured home. It was required by the homeowners insurance that, since the client was the primary cook for the family, a safe stove be installed.

STATEMENT OF PROBLEM

Returning home after physical recovery from his injuries, the client began to spend more time preparing meals for his family. However, the manifestations of his conditions prevented the safe usage of the kitchen equipment, specifically the stove and oven. While he retained the knowledge and physical skills required for cooking, it was not uncommon for him to walk away from the stove and forget that he was cooking. There were several occasions where the only reminder to him of his cooking would be the smell of burning food in the kitchen. This scenario presented an obvious safety problem to him and his family as they all desired to have him utilize his culinary skills.

APPROACH

A Hot Point #JBSO3 four-burner stove with integral oven was used as a base for the design modifications. (Figure 1) This model stove was standard equipment in the manufactured home which the client purchased.

Figure 1.

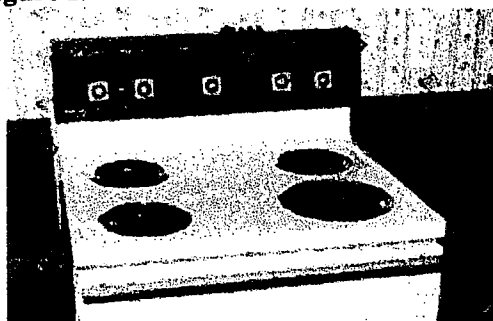

STOVE MODIFICATION

The intent of the project was that the range would retain its original functions and appearance while providing a safe cooking environment. A new face plate which mimics the original was designed to hold the modified controls. Graphics applied to the new face plate incorporate icons to relate each set of controls to the appropriate burner.

To attend to the safety issues dictated by the client's condition, it was determined that each burner and oven element would require individual timers and buzzers. The stove and oven controls were modified so that when the timers reached zero, the power to the respective burner would turn off and a loud buzzer would sound. The buzzer was chosen on its merit of providing a high volume sound. The client must be able to hear the buzzer throughout his home as it is possible he might have forgotten his cooking or fallen asleep while at the opposite end of the house.

The buzzer would continue until someone turned off the power switch to that element. Each of the stove elements are furnished with a timer that can be set in minute increments from 0-30 minutes. The oven timer is set to allow 1/4 hour increments from 0-3 hours. To continue cooking longer than the limit of the timer, the user must reset the timer to the additional time required, once the buzzer is activated.

Directions for use of the stove are printed on the control panel as a reminder to the cook. The directions read:

Instructions:

1. set temperature.
2. set cooking time.
3. turn on power.
4. when done, buzzer will sound.
5. turn power off.
6. turn temperature off.

It is important to note that the burner will not be activated until instruction 1-3 are followed. The

burner temperature and the cooking time may be set, but the element will not receive power until the switch for that burner is turned on. This method for setting the stove provides a built in fail-safe for its operation. The cook must know which burner he wishes to use, the temperature desired, how much time is required and that he must return to quiet the buzzer after the food is done.

The controls were placed in a vertical orientation on the control panel. (Figure 2) This design provides the cook with a convenient layout with which to follow the operating instructions. The upper control is the temperature, the middle is the timer and the bottom is the power switch. This placement helps to reinforce the proper manner in which to set the burner. Additionally, the timer has two lights which are activated when the unit is powered. A red light indicates to the user that the unit is receiving power. A green light flashes as the timer counts down. As the timer gets close to zero, the green light begins to blink faster reminding the cook that the time period is almost over.

Figure 2.

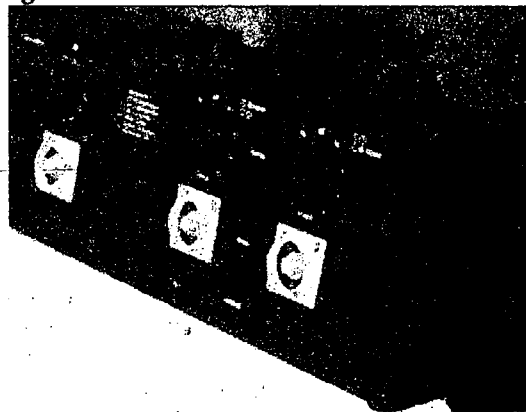

EVALUATION

After the modifications to the stove were complete, it was put through several iterations of testing. All burners were tested simultaneously to check for wiring safety and

STOVE MODIFICATION

function. Each burner was also allowed to run independently at full power for the maximum time allowed by the timer. These tests revealed no flaws in the wiring or function of the stove.

The client has had the modified stove in his home for two months and has reported no difficulties in the use of the stove. He was very pleased with the prospect of returning to his cooking duties.

DISCUSSION

Because the client retained the necessary skills for cooking there was no need to modify the function of the stove. The burners and the elements remain in their stock condition allowing for future replacement when elements burn out. Each set of controls is individually fused for safety. The fuses are located on the top of the control panel for easy access and replacement.

When performing initial research for this project, it was discovered that the stove manufacturers were curiously not interested in this idea. There is a belief that the functions added to this stove are not warranted for the general public. However, the response has been quite to the contrary when the idea has been demonstrated. Many realized the benefit of a simple safety device as a cut-off timer. This could prevent many tragic fires that were caused by a moment of inattention or forgetfulness.

Just as the microwave shuts itself off when the allotted time has passed, so could all stoves. With more research and a manufacturer's backing, this concept could be realized in the form of a computer control digital display for the burners. This concept would provide users with peace of mind as they set the time and temperature for their dinner, knowing that there would be little chance of overcooking or burning a dish.

ACKNOWLEDGMENTS

The Center for Rehabilitation Technology Design Group would like to thank the client for whom this project was designed for his patience and cooperation. Without his need and the funding provided by the Georgia Department of Administrative Services, this project would have never been realized.

Alan Harp, Industrial Designer
alan.harp@arch.gatech.edu

Julius T. Corkran, Industrial Designer
danny.corkran@arch.gatech.edu

Kim Adams, M.Sc. EE
kim.adams@arch.gatech.edu

Center for Rehabilitation Technology
Georgia Institute of Technology
490 10th Street
Atlanta, Georgia 30318
(404)-894-4960
(404)-894-9320 FAX

A LOSS FUNCTION APPROACH TO UNIVERSAL DESIGN

Don Malzahn, Ph.D., Rajiv Ramarajan, and Chandan Gokhale
Industrial and Manufacturing Engineering Department
Rehabilitation Engineering and Research Center
Wichita State University
Wichita, KS 67260-0035

ABSTRACT

A formal approach to universal design based upon quality loss function concepts is presented. The methodology explicitly considers the loss incurred by each user when a system is not designed to address their specific individual requirements.

BACKGROUND

Universal design is an emerging design methodology that attempts to develop systems that meet the needs of all users. This includes people with all levels of physical, sensory, and cognitive abilities (1, 2, 3, 4).

In order to rationally consider the specific characteristics that make a system accessible to a wider population, it is necessary to have a measure of 'universality.' This paper explores the potential of applying quantitative techniques used in modern systems design like the Taguchi methods of quality engineering to universal design.

APPROACH

Existing design methodologies evaluate system performance from an external frame of reference. This may be termed a 'corporate performance measurement', as each individual's performance is measured on a natural scale such as frequency, pounds, seconds, etc. This approach assesses the individual's suitability for using the system or product from the system's perspective. Typically systems are designed for use by 95% of the population. The problem is that the 5% who are not suitable for the system are always the same individuals. A more reasonable approach would be to measure the system's suitability to each individual.

The objectives of quantitative Taguchi methods used in systems engineering are to isolate optimum conditions where system performance is maximized (from the users' perspectives) and to control the amount of variability in system performance.

This approach is based on the concept of 'robust design', which states that a product or process is said to be robust when it is insensitive to the effects of variability, even though the sources of variability have not been eliminated. The principles of universal design are essentially based on a similar concept, the equity of use. Ideally, user performance should not be affected because of individual differences. Universal design also seeks to minimize physical and perceptual efforts while maximizing the system's tolerance for errors. The basic similarities in the two concepts of universal and robust design make the use of Loss Function Analysis, used in robust design, a suitable technique for quantifying universal design.

The quadratic Quality Loss Function was developed by Dr. Taguchi (5) to provide a better estimate of the loss incurred by manufacturers and consumers, as product performance deviates from its target value.

The quadratic loss function equation approximates the quality loss in a wide variety of situations;

$$L(z) = k(y(z) - m)^2$$

$L(z)$ is the loss due to deviation away from targeted performance as a function of the measured response, $y(z)$ of the product at design parameter level z ; m is the target value of the product's response; and k is the

economic constant called quality loss coefficient. At $y = m$, the loss is zero and the loss increases the further y deviates from m .

$$L(z) = \left(\frac{x(z)_{max} - x(z)}{x(z)_{max}} \right)^2$$

$L(z)$ is the loss experienced by an individual who is able to perform at a level $x(z)_{max}$ in an optimally configured system and at $x(z)$ when the design parameter under consideration is set at level z . If the person is able to perform at their personal best at the current design parameter level, $x(z) = x(z)_{max}$, then the loss is 0. If the person is not able to use the system at its current design level z then $x(z)=0$ and the loss $L(z)=1$.

DISCUSSION

The validity of using this loss function technique was examined as a means for deciding the slope of a ramp to be used by a wide range of persons with disabilities. Data from the study on ramp slope by Sanford et.al. from the Center for Universal Design (6). The measure of system performance (ramp design) was chosen to be the speed at which individuals were able to move on the ramp. The data used represented the varying ramp slopes collected from a sample of 171 subjects. This sample consisted of subjects with varying ability levels, and represented the disabled population distribution. They were divided into five categories based on the

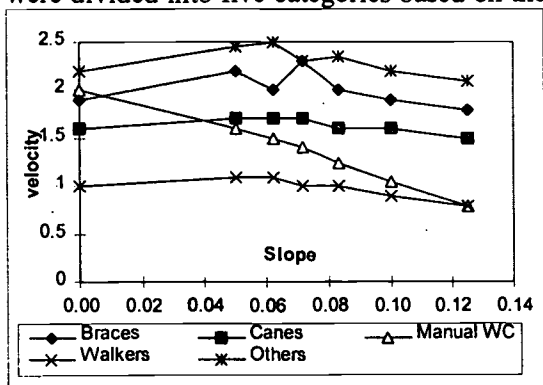

Figure 1. Velocity as a function of ramp slope.

assistive aid used: *braces*-17%, *canes*-45.6%,*manual wheelchairs*-11.7%, *walkers*-15%, and *others*-9.9%. ‘Others’ included participants who used electric wheelchairs, scooters, crutches, prosthesis, and no aid but with an activity limitation. The subjects were tested for speed of travel on a 30 foot ramp (Figure-1) over seven different slopes.(0, 1:20, 1:16, 1:14, 1:12, 1:10, and 1:08). The loss in performance was calculated for each of the subject groups over the different slopes (Figure-2). Note that in Figure 1 it appears that the ramp slope has minimal affect on speed. In Figure 2 the loss measure clearly shows the impact that changes in ramp slope have on manual wheelchair users..

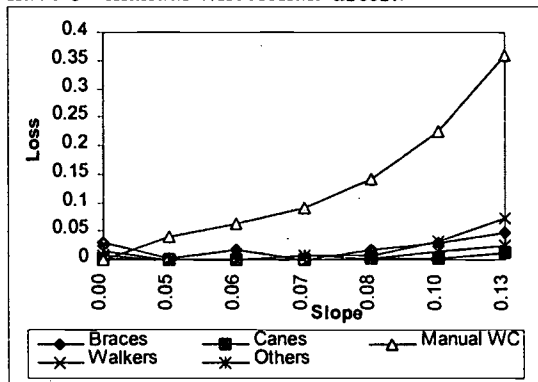

Figure 2. Loss as a function of ramp slope.

The distribution of speed for each slope is shown in Figure 3. Again this indicates that slope has little affect on performance. The distribution of losses for the population is show in Figure 4. We thus formalize a measure, with which we can decide, as to what must be a slope, if a certain percentage loss is considered permissible.

For example, for a commercial establishment with a high visitor flow, we might establish that a 95th percentile at a 2 % loss is acceptable and thus a slope of 1:20.(Figure 4) selected. Justifiably, for a less frequented or private establishment the percentile would be lower (assume 75th percentile) and the acceptable % loss higher

(assume 3%) this corresponds to a slope of 1:09. The different values of ramp slopes for each of the above cases can be directly read out of the plot. (0.05 and 0.112 respectively). Thus, design parameter levels may be established based upon system specifications.

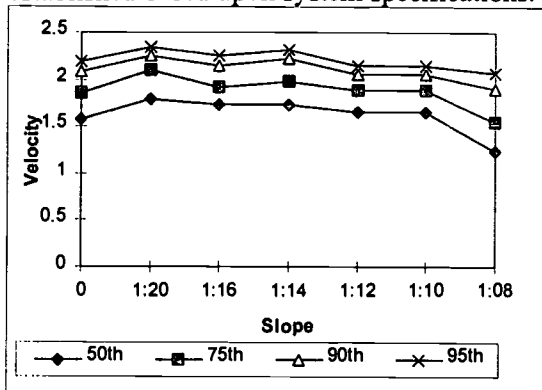

Figure 3. Distribution of velocity as a function of ramp slope.

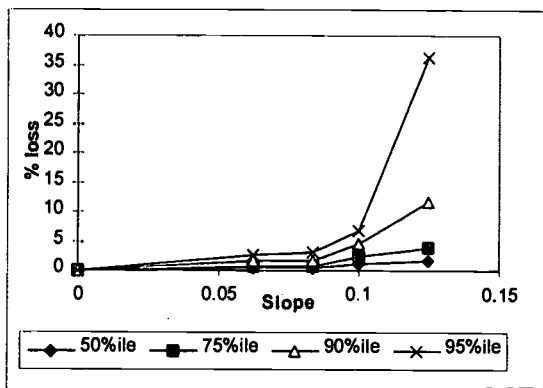

Figure 4. Distribution of loss as a function of ramp slope.

IMPLICATIONS

Loss function analysis gives a new perspective to system functional assessment that helps design systems that maximize performance while reducing sensitivity to the variations in performance across the user population. This has major implications for the built environment and mass produced assistive technology.

Some of the limitations with the use of loss function both in robust and universal design are:

1. There are inherent difficulties in measuring loss across multiple dimensions. That is, there is only one measure of system performance. In our example application, that was the speed of moving on the ramp.

2. It may be difficult to determine the $x(z)_{max}$ for each user. Although this would require the assessment of each individual on all possible system configurations, this value may be estimated for groups.

A loss function approach to universal design is an alternative to the "one person-one vote" criteria currently in use. It is a methodology that explicitly considers the relative impact of design options on individuals.

REFERENCES

1. Story, Molly Follete : "Achieving Universal Design" Quarterly Newsletter of the Center or Universal Design. Vol., Number 1, Fall 1997.
2. Connell, R. Betty; Jones, M.; Mace, Ron; Mueller, Jim; Mullick Abir; Ostroff, Elaine; Sanford, Jon; Steinfield, Ed; Story, Molly; Vanderheiden, Greg : "Principles of Universal Design" Quarterly Newsletter of the Center for Universal Design. Vol.1, Number 1, Fall 1997.
3. Clayton, Lewis: "Universal Design: everyone has special needs" - University of Colorado, Colorado, USA. 1996.
4. Mueller, J. : "Towards Universal Design: A Project on the Ergonomics of Disability" RESNA '89, Proceedings of the 12th Annual Conference, New Orleans, Louisiana, June 25-30,1989, Edited by J.J. Presperin. Resna Press, Washington DC. 1989
5. Ross, J. Philip : Taguchi Techniques for Quality Engineering - McGraw Hill, Inc.,1988.
6. Sanford, A. Jon; Story, Molly Follete; Michael, L. Jones : " An Analysis of the effects of Ramp Slope on People with Mobility Impairments" Asst. Technology 1997; 9: 22 - 23; RESNA 1997.

ACKNOWLEDGMENTS

The Authors would like to thank all the subjects who participated in this research. Funding for this research has been provided by National Institute on Disability Rehabilitation and Research (NIDRR) H133E30027-97.

TRAILS WEB SITE WITH UNIVERSAL ACCESS INFORMATION

Kathleen M. Wong, BA, Kenneth A. Chizinsky, MSBE Simone T. MacLeod, BA,
Wayne E. Wright, Peter W. Axelson, MSME, Denise A. Chesney, MEBME,
Beneficial Designs, Inc.
Santa Cruz, California, U.S.A.

ABSTRACT

Although people of various abilities enjoy traveling on trails, access information about trails can often be difficult to obtain and interpret. A trails Web site with universal access information has been developed to improve the availability of information on hiking trail characteristics that affect accessibility. The Web site allows Internet users to locate information about hiking trails by specifying search criteria that meet their specific access needs. The global connections of the World Wide Web offers trail users advance notice of trail environments so they can obtain any equipment or assistance they might need to safely enjoy their visit.

BACKGROUND

Other groups have developed several CD-ROMs, a database and a Web site to provide information about trails in an interactive, electronic format. However, these resources do not provide specific, objective information about trail characteristics that affect access.

Beneficial Designs developed the Universal Trail Assessment Process (UTAP) to assess the access characteristics of outdoor trails (1). The information gathered by the UTAP is processed into Trail Access Information (TAI). TAI includes grade, cross slope, maximum grade, obstacles, and trail width. It also includes information about landmarks such as waterfalls and obstacles such as drop-offs. This process is currently used nationwide by people trained through UTAP workshops. We have also developed a set of symbols and trail sign layouts to convey trail access information in attractive, easy to read formats. Trail maps contain a top view of the trail with descriptive text, grade profiles, surface type information, and symbols showing the sites of major obstacles.

Beneficial Designs also developed an interactive computer program capable of providing trail access information to park

visitors. Designed to be installed in a kiosk at visitor information centers, the program allows potential trail users to search for the type of trail they would like to hike. The user can then view a variety of information about each trail, including an overhead map, grade profile, surface types, scenic images along the trail, and images of trail obstacles.

STATEMENT OF THE PROBLEM

Approximately 16.1 million Americans have mobility or sensory limitations that affect their level of access to trails. (2) This number does not include people with temporary injuries or situations such as individuals with children in strollers that would limit their hiking ability. Many of these individuals enjoy visiting outdoor parks, forests, and recreational areas, but have difficulty obtaining information that describes the environmental conditions affecting trail access. As a result, many visitors are unable to select trails that meet their challenge requirements, do not prepare adequately for access by obtaining additional assistance or equipment, or do not hike at all. This situation can be frustrating for those who cannot reach a trail destination, and dangerous for those who become stranded due to unforeseen obstacles.

RATIONALE

By providing trail access information on a Web site, visitors can obtain objective access information about outdoor trails from a remote location. Remote access to trail access information will allow visitors more time to plan make better choices for their travel itineraries and obtain any equipment necessary to meet trail challenges safely. A Web site can provide detailed trail condition information to a large number of people rapidly and efficiently, reducing the need for users to locate and analyze travel guides and maps. A Web site can also help users find visitor accommodations, nearby

attractions, and other visitor services without obtaining sources such as newspapers or guidebooks. All trail users, including people with mobility impairments, families with small children, and others, would benefit from an easy means to obtain information about trail conditions before they reach the trail.

DESIGN

The format and content of the information provided by the Trails Web site is similar to the interactive kiosk. The difference lies primarily in the technology required for the Web site, and the opportunity for users to obtain the information remotely via the Internet. The Web site consists of a database containing access information about trails, and a search engine capable of handling search criteria from a user browsing the Web.

Users with a computer and Internet connection can access the site by entering the address on a Web browser. Once at the Trails Web site homepage, the user can search the database using a number of criteria (Table 1). Within these categories, users can also indicate specific search criteria such as "trails with < 10% average grade." The search program will then return the names of all trails found matching the search characteristics. If the user selects one of these trails, the search program will return a summary of the trail's access characteristics, scenic images of the trail, maps, park information, a grade profile and a summary of surface types. The user may elect to print-out or download this information. Each page has navigation buttons allowing the go to the homepage or the search page to initiate

another search at any time.

There are two current search interface prototypes. The first prototype, for expert users, displays a list of all possible search categories (Figure 2). The user can view a drop-down list for each category to select the search criteria. The second prototype allows the user to select one category from a list of all possible categories. Another page then displays the search criteria for the category as well as more information about the category to help the user make a choice. Once a category is selected, a new screen prompts the user to select the criteria for that category. Once a search criteria is selected, the original category list reappears to permit users to specify additional criteria or initiate a trail search. Both interfaces allow any or all of the search criteria to be used to locate trails.

Table 1. Some trails Web site search categories

Category	Example
trail name	Heron Falls
park, area name	Yosemite
trail location: county, state/province, country	Merced, CA, USA
jurisdiction	National Park Service
destination type	waterfall
trail length	2 miles
trail facility location, availability	w/c-accessible toilet
avg. grade	4%
max. grade	36%
avg. cross slope	2%
max. cross slope	6%
min. clearance width	17"
large obstacles: type, magnitude	boulder, 5' x 5' x 4'
min. vertical clearance	55"
surface firmness, type	dirt, firm

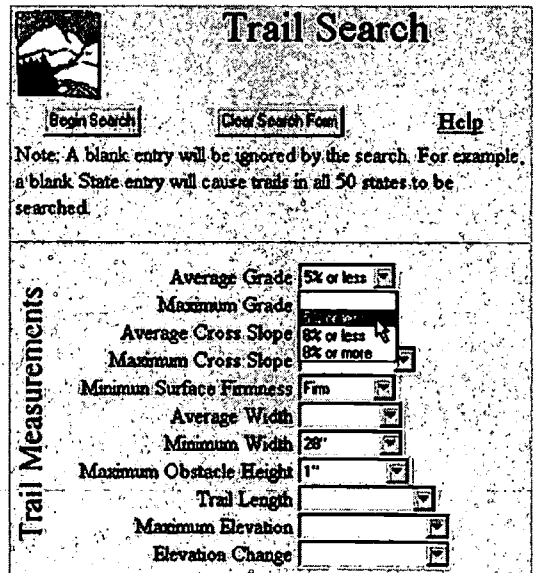

Figure 1. Expert user search screen

The trail database can be expanded by importing more from a text file into the master database from a remote computer. All information added to the database will be validated prior to uploading.

DEVELOPMENT

The user interface for the kiosk program was redesigned to accommodate the structure and capabilities of a Web site. New navigation bars, site links, layouts, graphics, and search screens were created in Hyper-Text Markup

Language (HTML) compatible with existing Web browser technology. Trail data was collected on approximately 70 trails and stored in the database. Claris Filemaker Pro 4.0 was used to store, search and serve results to web browsers.

EVALUATION

A wide variety of individuals evaluated the features, speed, ease of use, and content of several prototypes to demonstrate the site's effectiveness and optimize its design. Initially, the site was evaluated by company employees, all skilled computer users. Staff reviewers completed questionnaires to indicate their Web experience, the site's ease of use, and other feelings about their experience with the site. Staff reviewers followed a talking-out-loud protocol so the evaluator could note pleasing or frustrating aspects of the design as they were encountered. The site was improved after the initial evaluations based on the feedback provided.

After the internal evaluation, the site was made accessible to specific Web browsers. Users were requested to complete a brief questionnaire to provide feedback about the site. Representatives from the USDA Forest Service, the USDI Park Service, American Trails, and other land management and trails organizations visited the site via the Internet. While at the site, the representatives used a talking-out-loud protocol to evaluate the functionality and usability while on the telephone with investigators. A group of selected individuals will also be invited to evaluate the Web site to obtain input from a wide range of user groups, including wheelchair users, people who use canes, crutches, and walkers, families with young children, older people, mountain bikers, and people with visual impairments. All feedback obtained during the external evaluation period will be used to further refine the Web site.

DISCUSSION

Providing objective information on the degree of accessibility of outdoor trails will give millions of people with mobility limitations a tool to facilitate access to the outdoor leisure and recreation environment. Because Web site users can obtain the information quickly and easily

from any geographic location, they will better be able to plan trips and prepare for access. Because those who use the Web site will know what conditions to expect on trails, they will be less likely to be frustrated by unforeseen trail obstacles and adverse conditions, and more likely to enjoy their outing. Hikers who are better prepared to travel on trails are also less likely to become injured, lost, or endangered by their trip.

Once established, the Web site will be transferred to a dedicated server. Advertisements from visitor accommodations such as lodging, restaurants, and touring companies will eventually be solicited. These advertisements and links to related Web sites such as those of parks will be incorporated into the search data presented for trails located near these establishments. Local visitor accommodations such as restaurants will benefit from this opportunity to advertise their services and obtain business from Web site browsers.

REFERENCES

1. Axelson, P., Chesney, D., Longmuir, P., Pasternak, M., Wong, K., & Wright, W. (1997). Universal Trail Assessment Process Training Guide. Santa Cruz: PAX Press.
2. Pope, A.M., & Tarlov, A.R. (Eds.). (1991). Disability in America. Washington: National Academy Press.

ACKNOWLEDGMENTS

Funding for this research was provided by the U.S. Department of Education's Office of Special Education and Rehabilitative Services through Small Business Innovation Research Phase I Contract # RW97076011.

Development of the Interactive Computerized Information Trail Guides for Universal Access was funded by the U.S. Department of Education through Small Business Innovation Phase II Contract # RW95170006.

Kathleen Wong
Beneficial Designs, Inc.
5858 Empire Grade
Santa Cruz, CA 95060

PROPOSAL FOR A UNIVERSAL REMOTE CONSOLE COMMUNICATION (URCC) PROTOCOL

Gregg C. Vanderheiden, Ph.D.
David Kelso, M.S.
Laurie Brykman, B.S.
Trace R&D Center
University of Wisconsin-Madison

ABSTRACT

The Universal Remote Console Communication (URCC) Protocol is a new nonproprietary standard for allowing remote devices to control other products ("target devices"). The original work on the URCC protocol was carried out in an effort to develop an infrared link that could be used between public information systems (kiosks, ATMs, etc.) and assistive technologies. Targeting it in this fashion only, however, would result in rather limited deployment of the protocol, and therefore rather limited utility to people with disabilities. More recently, therefore, the URCC protocol has been targeted toward providing general-purpose remote console capability to any product using an infrared remote controller. The goal is to have the protocol supported on televisions, stereos, appliances, etc., as well as public information systems. The major advantage of using this protocol over other infrared protocols is the ability to create a much simpler, dynamic information display on the remote console.

INTRODUCTION

More and more electronic appliances and systems are being introduced into our homes and communities. However, current remote controls are fixed and uni-directional. They are also limited to just a small number of fixed functions for which there are standard codes.

The proposed URCC protocol is intended to provide a mechanism that would allow control by a very broad range of devices, including the assistive technologies that a person with a disability may already be using.

The URCC is a remote console protocol rather than just a remote control: that is, with an URCC compatible remote console the user can both view information from all of the displays on a target device as well as operate all of its controls. Target devices can be:

- televisions
- VCRs
- stereos
- kiosks
- telephones
- thermostats
- microwave ovens, or
- any other device that has electronic controls and displays

Remote consoles can be special hand-held devices designed specifically for this purpose. However, the remote console could also be:

- a laptop computer
- an electronic pocket calendar
- personal digital assistant (PDA) or
- any other electronic device with controls and a display of some type

The display on the remote console need not be a visual display; an entirely audio system could be used. In fact, a system could be built that could allow you to operate appliances directly over the telephone (you'd phone the "remote console," which would then allow you to interact with the target devices).

SIMPLE AND UNIVERSAL - NO PREPROGRAMMING

Since an URCC based controller gets the information about what controls are available on a target device from the target device itself, the URCC-based controller:

- does not have to be pre-programmed for different appliances
- can handle products (target devices) with any arbitrary number of buttons or controls (including the hundreds that might be on a touchscreen-based product)
- provides the exact name for each function (e.g., you never have to remember, as you do with some remote controls, that for Device 1 the button labeled "A" represents the control for turning on the sleep mode, but for Device 2 it represents surround sound).

The URCC Protocol is simple and straightforward, containing just a small number of powerful and versatile commands and data formats.

WORKS OVER IR OR OTHER MEDIUM

The URCC is a communication protocol, and as such can be used over any transmission medium: that is, it could be used over infrared, RF, or copper wire. The primary use of the URCC at this time, however, is envisioned as being in connection with the IrDA (Infrared Data Association) infrared protocol. In this capacity, it would allow individuals to use a single controller (a dedicated controller, or an electronic pocket organizer, or a laptop computer, etc.) with an IrDA port to control any URCC-compatible device (VCR, stereo, thermostat, kiosk, etc.).

It would also allow those individuals with disabilities who cannot use the displays and controls on the standard devices to use a special assistive technology as a remote console, al-

lowing them to access and use the standard devices.

TEXT AND GRAPHIC FORMATS

Flexibility is also provided in terms of the formats that can be used. Three URCC formats are currently proposed. Format 1 is text-based and presentation-mode independent: that is, it could be used with any size or type of display, including a purely auditory display. Format -2 allows for a product to send simple touchscreen-like console images to the remote console (in one or more resolutions) Format 3 allows photo realistic images to be used in image map like fashion.

FLEXIBILITY OF PRESENTATION

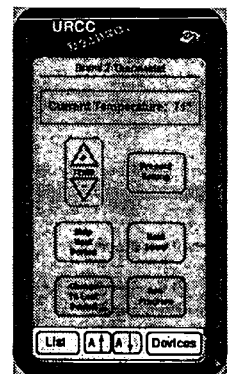
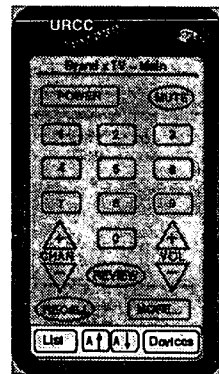

Controlling a television Controlling a thermostat

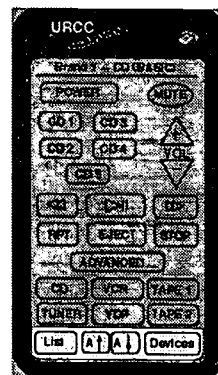

Controlling the CD portion of a stereo

As shown in the previous figures, the URCC protocol allows the remote console to display the buttons and controls specific to each particular product. The figures below shows what the display might look like for three different devices using the graphic (Format 2) presentation mode.

MULTIPLE LANGUAGE SUPPORT

URCC also allows devices to display different languages on the remote console to match different users.

ACKNOWLEDGEMENTS

This project is funded in part by the National Institute on Disability and Rehabilitation Research of the Department of Education under grants number H133E30012 & H133E5002. The opinions herein are those of the grantee and do not necessarily reflect those of the Department of Education.

FOR MORE INFORMATION

More information on the URCC Protocol is available at:

<http://tracecenter.org/world/urcc>

Gregg Vanderheiden
Trace R&D Center
Department of Industrial Engineering
College of Engineering
University of Wisconsin-Madison
Madison, WI 53706

SIG-20
Cognitive Disabilities & Technology

EFFECTIVE CUEING TECHNIQUES FOR PROMPTING PATIENTS WITH DEMENTIA DURING A WASHROOM TASK

Alex Mihailidis¹, Reinhard Schuller², Mary C. Tierney, Ph.D.¹, Geoff Fernie, Ph.D.¹
Sunnybrook Health Science Centre¹, Bloorview MacMillan Centre²
University of Toronto, Toronto, Ontario, Canada

ABSTRACT

We are conducting a study to determine the efficacy of using automated cueing to prompt patients with dementia, and determine the types of cues that are most effective in an automated device. This paper reports the results of the trials with the first subject. The subject had a higher success rate while washing his hands when these automated cues were provided, and the "workload" of the caregiver was reduced.

BACKGROUND

The ability for a person to care for his own washing needs is sometimes lost when he is suffering from dementia. Currently, if a person is unable to perform washroom tasks on his own a caregiver will remain in the washroom and provide verbal reminders. This sometimes causes a strain on the patient-caregiver relationship.

This relationship could be improved by removing the caregiver from the washroom while still providing the cueing and monitoring that is required by the patient. A prototype of an automated device has been developed. Before this device can be used, studies on effective cueing techniques and other relevant aspects are required.

Studies have been conducted with positive results on the use of cueing with patients suffering from dementia [1]. Research has also been conducted on the use of automated reminding devices for people with cognitive disabilities [2]. These studies concluded these devices are effective. The use of such automated devices in helping patients with dementia to complete activities of daily living (ADL) has not been reported. As well, the efficacy of a patient being prompted by a source

that is not located inside the washroom—i.e. by an automated cue, has not been studied. Finally, the types of cues that should be used to prompt patients with dementia (whether by an automated device or by a caregiver), have not been determined.

OBJECTIVE

The objectives of this project are to determine the efficacy of using automated cueing techniques with patients with dementia, and to determine the types of verbal cues that are most effective in assisting this population complete the hand washing process.

METHOD / APPROACH

Three long-term care patients with dementia participated in these studies—patients 21, 22, and 51. Subject selection was based on the results of surveys given to nine caregivers. The selected patients were administered the Mini-Mental State Exam (MMSE), and a second cognitive test that was devised—the Washroom Environment Identification Test (WEIT). This test was an adaptation of the Famous Faces Test [3], and attempted to test the patient's recognition abilities, with and without cueing, of items found in a washroom.

Task analysis was used to break down the handwashing task into nine distinct events—1) go to the sink; 2) turn the water on; 3) wet the hands; 4) use the soap; 5) put the soap down; 6) rinse soap off the hands; 7) turn the water off; 8) dry the hands; 9) leave the sink.

A single case experimental design was used. Each study involved two baseline phases, and two prompted phases—A₁-B₁-B₂-A₂, each conducted 3 times, once per day, for a total of 12 trials/days per patient. Phase A₁ was a

EFFECTIVE CUEING TECHNIQUES

baseline trial that tested the patient's ability to wash his hands, and observed the current workload¹ of the caregiver. Phase B₁ tested the cues that would be involved in a generic cueing device. Short commands using an unfamiliar voice was used for this phase. Phase B₂ tested the cues that would be involved in a personalized cueing device. These cues included the patient's name, were more detailed in the description of each task, and a familiar voice was used. Phase A₂ was another set of baseline trials.

For phases A₁ and A₂, the caregiver remained with the patient inside of the washroom and assisted him as necessary.

For phases B₁ and B₂, the cues were issued over a microphone-speaker system from outside of the washroom. The patient was monitored using a video camera set-up inside of the washroom. Also, for both phases a cue was repeated only once. If the subject did not respond after these two identical cues, the caregiver entered the washroom and assisted the patient with that particular task.

The subject's performance for each trial was evaluated using the following rating scale: 0 - completed task independently; 1 - completed task with first automated cue; 2 - completed task with second automated cue; 3 - completed task with cue from caregiver; 4 - completed task with physical interaction from caregiver; 5 - did not complete task. To obtain a subject's overall score for each phase, this scale was transformed into a success/failure proportion scale. Ratings of 0, 1, 2 were transformed into a score of 1 (success), and ratings of 3, 4, 5 were transformed into a score of 0 (failure).

RESULTS

The following are the results for Subject 21.

¹ Workload is the number of interactions the caregiver has with the patient when assisting him in the washroom.

The MMSE was only partially completed for Subject 21 because of poor vision. If perfect scores were given for the questions not completed, this subject would have scored a maximum of 12 out of 30. The WEIT was not administered to this subject because of visual limitations.

Using the proportion scale to rate the subject's performance for each trial, there was a noticeable improvement in his success rate when the automated cues were provided. The success/failure rates are presented in Table 1. A maximum rate of 27 successes per phase can be achieved (i.e. 9 tasks * 3 trials).

PHASE	A ₁	B ₁	B ₂	A ₂
Successes	16	24	21	17
Failures	11	3	6	10

Table 1 - Success/Failure Rates: Subject 21

During the baseline phases, Subject 21 exhibited a strong reliance on the caregiver.

During the prompted phases, the subject responded less to the personalized prompts that were issued by his caregiver than to the generic prompts that were issued by the researcher. The primary problem during the personalized phase was when the subject heard his caregiver's voice, he responded by saying "where are you...I can't see you." This caused him to become distracted from the task at hand, and the caregiver was required to enter the washroom.

The results from the final baseline trials indicated that carry-over, or learning on the part of the subject, was not a factor.

It was observed that the amount of time that the caregiver had to be present in the washroom was decreased with the generic and personalized automated cues. The average number of interactions between the caregiver and the subject during the trials is presented in Table 2.

EFFECTIVE CUEING TECHNIQUES

Phase	Audio cues	Physical interactions	Physical completions	Other
A ₁	3.7	1	0	0
B ₁	1	0.3	0	0
B ₂	2	0.3	0	0
A ₂	3.3	0.3	0	0

Table 2 - Caregiver Workload: Subject 21

The amount of time it took the subject to complete each task was logged. These data showed no relevant trends or information that could be used to prove the efficacy, or non-efficacy, of automated cueing.

Results with respect to visual cues indicated that the coloured objects used were not ideal for this particular subject. He was used to a white towel, and as a result he became confused at the sight of the brown towel used in the experiment, thinking it was a sweater.

DISCUSSION

Based on the results obtained thus far, it can be concluded that the use of automated cues is an effective means of assisting this individual with the handwashing task. There was a 29.6% improvement in the subject's success rate with the generic cues, and a 18.5% improvement in his success rate with the personalized system. As well, there was a noticeable decrease in the workload of the caregiver for both types of cueing. This decrease resulted in the caregiver spending less time inside of the washroom with the patient. This could improve the caregiver-patient relationship, and make the patient feel more independent.

The results indicate that a device that incorporates generic verbal prompts should be used, however, these generic cues should be more descriptive than they were in these studies.

Observations with respect to visual cues indicated the most important factor to consider is the consistency between the colours used

during the prompted phases with those that are familiar to the subject.

The WEIT needs further development. Other ADL assessment tests and scales, such as that developed by Tappen [4], may be more suitable because it has proven to be a good predictor of a patient's ability to complete ADL, and can be used to assess a patient's level of independence when completing these tasks.

The results provide important information with respect to automated cueing techniques, and showed that an automated device would be helpful for this particular subject. We must wait for tests on other subjects to be completed before being able to generalize these findings.

REFERENCES

1. Backman L., Memory functioning in dementia, Advances in psychology series, New York, 1992.
2. LoPresti E.F, et. al., "Electronic vocational aid for people with cognitive disabilities", RESNA Proceedings, Pittsburgh, pp. 514-516, 1997.
3. Hodges J., et. al., "Recognition of famous faces in Alzheimer's disease: A cognitive analysis", *Neuropsychologia*, v.31, n.8, pp.775-778, 1993.
4. Tappen R.M, "Development of the refined ADL assessment scale for patients with Alzheimer's disease and related disorders", *Journal of Gerontological Nursing*, pp. 36-42, 1994.

ACKNOWLEDGEMENTS

The authors thank Dr. W.L Cleghorn for his advice, and the caregivers and patients who participated.

Alex Mihailidis
 Centre for Studies in Aging,
 Sunnybrook Health Science Centre
 2075 Bayview Avenue
 North York, Ontario, Canada, M4N 3M5

PASSIVE WANDERING-DETERRENCE DEVICE FOR USE WITH COGNITIVELY DISABLED NURSING HOME RESIDENTS

Richard A. Dickinson and Jason T. Stauth (Members of the fictional design firm ElderTech¹)
Thayer school of Engineering
Dartmouth College
Hanover, NH, U.S.A.

Abstract

A device to passively deter wandering among cognitively disabled nursing home residents was developed. The device is a hinged door handle cover that fits over ADA approved door handles and effectively removes the visual cue of the door handle. Removing the door handle from the sight of wandering residents reduces their tendency to wander through a door and breach the privacy of other nursing home residents or otherwise wander into unsafe situations. Several prototypes of the device were constructed and tested in nursing homes to determine their effectiveness.

INTRODUCTION

Mrs. Jones, an elderly resident of a private nursing home, was awakened at 3:00 in the morning. She was startled to find a strange man wandering near her bed. She immediately called the nursing home staff. The nurses were relieved to find that their wandering patient was not hurt, but noted that this was his third time he had wandered into other residents' rooms.

Cases like this are common in the elderly community and will increase as the number of people with Alzheimer's Disease rises. By the year 2010, there are projected to be almost five million cases in the US, a figure that will expand to approximately 14 million by 2040.² Presently, 20% of the nation's Alzheimer's population lives in nursing homes, where wandering is reported to occur with as many as one in four members of this subpopulation of the cognitively disabled. According to a study conducted in an Alzheimer's unit of a 228 bed nursing home in the United States, dementia residents' daily schedules include approximately 9.5 hours of unstructured time each day during which they do not interact with staff. Within this time period, dementia residents spend around three to four hours sitting or wandering alone.

The American Alzheimer's Association defines wandering as "aimless or purposeful motor activity that causes a social problem such as getting lost, leaving a safe environment, or intruding on inappropriate places." People with this tendency to wander can get lost or hurt if they are not monitored or actively contained by their caregivers. In nursing homes, serious safety issues result from residents who wander into unsafe areas, handle unsafe objects or try to ingest inedible materials. "Nuisance problems for caregivers occur when residents rummage through the personal possessions of other patients, get into storage areas, walk away with nursing records and get into the bed of another resident even with the resident in it." Such incidents violate the privacy of other residents and leads to an atmosphere of anxiety among people living near

residents with Alzheimer's. The problem of wandering requires a good deal of attention from nursing home staff. Some patients regularly become lost within the facility, and they must be tracked down by the staff at any time during the night. In fact, about 50% of the care in nursing homes is provided to patients with Alzheimer's and related cognitive disorders. A device which aids in the care of CD residents could substantially reduce the overall cost in money and time of the management of the affected individuals. The Passive Wandering-Deterrence Device offers assisted-care facilities an effective, inexpensive way to reduce wandering while helping to improve the quality of life for their residents.

Description of Solution

Fig 1. a. Computer Rendering of the Plastic Prototype

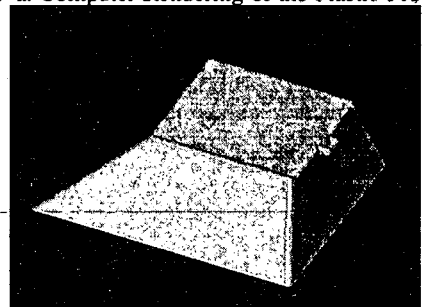

b. Schematic Diagram of the Device

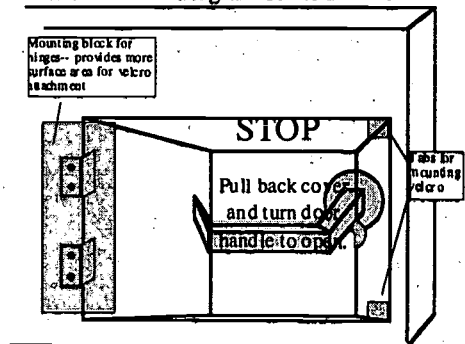

The concept involves creating a simple wooden shell that could be mounted on the surface of existing nursing home doors. It is comprised of four trapezoidal pieces and one rectangular top piece. The sides are placed at angles to both enhance the aesthetics and allow the cover to stay closer to the door in the open position. There are two subtle features which aid in opening the cover, a rib at one edge of the cover to aid in gripping the cover and a depression on the bottom of the handle that is hidden from normal view which also eases the opening of the door without adding a visual cue. Then the shell is hinged to a mounting plate, preferably a clear polycarbonate plastic. This type of plastic is preferred because it is rigid, robust, and clear which will help the durability and aesthetics of the product. The mounting plate will have three key-hole slots which will be mounted on another plastic plate with three screw heads pre-installed which will have a very sticky foam tape on the back to be attached to the door. This will ensure sturdy performance when installed, and also provide the staff with the option of removing the device in times when it is not needed. The cover will close by using the soft side of Velcro® on the edge of the cover attaching to the rough side of the Velcro® which will be on the door. It is both cheap and effective. Thus the primary goal of the door handle cover would be simply to enclose the door handle to defend against wandering residents who may be looking for a door that may be easily opened. Rather than using wrist or arm strength as a means of differentiating cognitively disabled residents from non-wandering residents and staff members, the product utilizes the differences in cognitive ability for its opening mechanism by removing the visual cue of the door handle. Another benefit of the device is that it only affects access to the door from the outside, a feature that allows residents to leave their rooms unhindered.

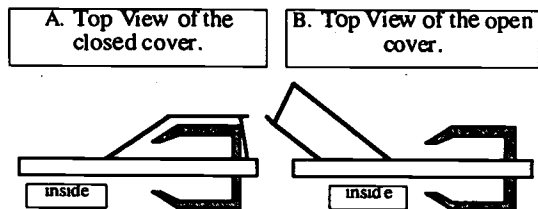

Experimental Analysis

ElderTech has conducted two related lines of investigation on the door handle cover. The first was in-situ testing of the suitability of the various prototypes in the actual nursing home environment. The second line of investigation has been centered around testing of materials and concepts in the Thayer School of Engineering. Each of these processes incorporated a great deal

of feedback from the other. For example, many new ideas were designed in response to problems pointed out by testing at a facility. These ideas were rapidly incorporated into prototypes and these revised models.

Many problems with initial prototype designs were identified through the testing process. The most apparent problem was that of durability; the first covers fatigued at the hinges or were forcefully removed by residents attempting to wander. However, more robust prototypes were developed that would stand up to the daily rigors of the nursing home.

Other problems were identified in the functional design of the door handle cover. Some of the early prototypes included a small tab on the opening side to aid in the opening of the cover. However, these models proved to be ineffective at deterring wandering because the tab provided wanderers a visual cue of how to open the cover. More subtle features to help in opening the cover were added, including a depressed hole on the underneath side of the cover hidden from view and a small rib that stretched across the opening side of the cover. Prototypes with these modifications proved to be much more effective at deterring wandering than those with the opening tab. Staff could easily pass through doors with the device installed on them, but wandering residents could not recognize how to operate the cover.

Several different shapes of covers were tested in the field. These shapes included everything from a simple rectangular box to an octagonal (stop sign) shaped and elongated trapezoidal-shaped model. The octagonal model was initially favored by some staff members because of the overt visual 'stop sign' cue. In testing, however, cognitively disabled residents were not always deterred by this cover; it actually tended to attract curious wanderers who attempted to pull off the cover and pass through the door. From this round of prototype testing, ElderTech learned that a more subtle cover would lead to fewer incidents of wandering.

The trapezoidal-shaped cover was favored by nursing home staff members, designed with a beveled rear face so that it would sit closer to the door while open. The fact that the cover had less of a projection from the face of the door proved to be an extremely important characteristic. The staff of the facilities frequently move in and out of resident rooms with large carts, and in two cases, test models without the beveled rear were damaged because they projected out too far from the face of the door on which they were installed.

To make the cover more aesthetically pleasing and less noticeable to potential wanderers, wooden door handle cover shells that matched the color and texture of the doors of the

nursing home facilities were constructed. According to the staff members at the two testing facilities, the blending covers helped to deter wandering without compromising the aesthetics of the assisted-living environment. A plastic model was designed through the use of a rapid prototyper, but was not well received nor did it work as effectively. Aside from concerns about its looks, the plastic cover did not deter wandering as well as the wooden shells; several staff members recorded finding residents "playing" with the plastic cover installed on doors while no similar incidents were reported with the wooden covers.

One question arose regarding the suitability of Velcro™ as a means of securing the cover. Velcro™ was tested, and the results showed a decline in holding strength with the number of times it is pulled apart, a decline that proved to be a limiting factor in attaching the cover to the face of the door. Nursing home staff members said they would not want to have to replace the velcro on the mounting plate more than once a year. Based on this feedback, ElderTech devised a new method of attaching the cover to the door that wouldn't require adding screws to the doors (this was another nursing home request). The solution was a slot mounting system that allowed for easy removal of the cover from the door.

To facilitate communication and feedback between the nursing homes and ElderTech, a survey was distributed. To more precisely gauge the magnitude of wandering, Eldertech asked staff members to estimate how many incidents of wandering occur within a facility per week. The responses collected indicated an average of 8.9 +/- 3.6 incidents of wandering per week. In order to determine how durable the material keeping the cover closed must be, ElderTech asked staff members how many approximate times per day that resident rooms were passed through excluding incidents of wandering. Around two thirds of the surveys indicated that rooms were passed through 5-10 times each day. In one year, this would lead to roughly between two to three thousand openings of the door handle cover. Asked to choose the optimal material for the cover shell from wood, plastic or metal, 90% of staff members selected wood. Finally, the last major quantitative question the survey posed was how much the facilities would be willing to pay for the cover device. Nearly all surveys indicated the Passive Wandering-Deterrence Device to be worth at least \$10 to \$15

Economic and Marketing Analysis

In order to select the final design of the passive wandering deterrence device and the material it will be made out of, ElderTech has

investigated the costs of two main alternatives: a cover made of polypropylene plastic, and one made of 1/4" birch plywood.

It was determined through contact with a plastics injection molding firm (G.W. Plastics, Bethel VT) that plastic manufacturing would only be economically viable in a large scale market. Wood manufacturing, on the other hand, was determined to be more economical in a small scale market.

In conducting market research, Eldertech has determined that a small scale operation would be more than adequate to provide for the needs of all possible buyers. Wood manufacturing is therefore a more viable option than plastic from an economic standpoint.

The variable costs to produce a wooden door handle cover are shown in table 1. The cost for labor per cover is an estimate that is based on the assumption that in an efficient production scheme, one man-hour could produce 6-10 covers. It is assumed that one man-hour would cost in the range of \$20.00. This leads to a conservative marginal labor cost of \$3.00 per cover.

Table 1. Table of the input costs

<i>Input Costs</i>	
<i>labor</i>	\$3.00
<i>wood per cover</i>	\$1.12
<i>hinge</i>	\$0.85
<i>glue</i>	\$0.05
<i>screws</i>	\$0.03
<i>plastic hole-cap</i>	\$0.02
<i>finishing</i>	\$0.25
<i>stickers</i>	\$0.08
<i>packaging</i>	\$1.25
<i>mounting plate</i>	\$0.19
<i>shipping</i>	\$3.00
total costs=	\$9.84
w/o shipping	\$6.84
47% markup	\$10.05
reasonable selling price	\$9.95
+ shipping and handling	

The costs for the materials have been researched and are accurate for a small scale production scheme. Shipping costs have been a concern but it is assumed that in the end, the product will be marketed so that the consumer pays the shipping fee separately from the price of the product. The overall variable cost of the door handle cover is \$9.84 with shipping included and \$6.84 without shipping.

Eldertech has estimated a final selling price of \$12.95 (\$9.95 plus \$3.00 shipping and handling). This is a fair 47% markup over production costs and should provide enough revenue to sustain production in the short term while making it profitable in the long term.

***Student Scientific
Paper Competition***

ESTIMATING POSTURAL DISTURBANCES CAUSED BY VOLUNTARY ARM MOVEMENTS

Kristin N. Werner, B.Sc., Ronald J. Triolo, Ph.D.,
Robert F. Kirsch, Ph.D., and Weifeng Zhao, Ph.D.
Departments of Biomedical Engineering and Orthopaedics
Case Western Reserve University, Cleveland, Ohio

ABSTRACT

The purpose for this study is to develop and validate a three-dimensional, inverse dynamic model of the upper extremity for estimating the types of reaction forces and moments that are generated at the shoulder during volitional arm movements. Experiments were conducted to validate the model under a variety of real-world conditions. The model's predictions appear to be consistent and accurate. These methods may be useful in a variety of rehabilitation applications, including the development of control strategies for maintaining balance while standing with functional electrical stimulation.

BACKGROUND

During volitional arm movements, postural disturbances are generated at the shoulder due to the weight and dynamics of the arm system. Although these disturbances can be quite large, the motor control strategies of the body are generally capable of maintaining stable posture. However, in the case of individuals with spinal cord injuries, the normal motor control pathways are destroyed, and the only way to activate the muscles required for standing is through functional electrical stimulation (FES).

The challenge of FES-assisted standing is to develop stimulation patterns, feedback mechanisms, and control strategies that are capable of rejecting postural disturbances. In order to accomplish this task, it is important to study the types of postural disturbances likely to be encountered during FES-assisted standing.

The focus of this paper is the development of a computer model to estimate the reaction forces and moments generated at the shoulder during arm movements. The model provides three-dimensional, dynamic analysis of movements, which is a departure from traditional two-dimensional or quasi-static upper extremity modeling techniques.

RESEARCH QUESTIONS

The accuracy of the inverse dynamics model of the upper extremity is a primary concern.

Since there is no way to directly measure reaction loads at the shoulder, the first question that must be addressed is whether or not external measurements (such as ground reaction forces) provide an adequate reference for comparison.

A second issue is the ability of the model to perform consistently under a variety of conditions. What effects do the loading conditions, movement rates, types of movements, and differences between subjects have on the accuracy of the model?

When the consistency and accuracy of the model have been established, its estimations of postural disturbances can be utilized and its usefulness in future research can be evaluated.

METHODS

Development of the Model

The right arm was modeled as two links, the upper and the lower arm. The lower arm includes both the forearm and the hand. Movements of the wrist were not modeled. The shoulder and the elbow were both modeled as gimbal joints, which allow three rotational degrees of freedom. An object held in the hand was represented as an additional link, with its own mass and inertial properties, attached to the hand by a zero degree of freedom "weld" joint.

Values for the masses and inertial properties of the arm segments were obtained by applying regression equations developed by McConville *et al.*(1), and the center of mass locations were scaled from their published average values. For masses held in the hand, the inertia matrices were calculated using standard mathematical equations for homogeneous bodies(2).

Kinematic information describing the position, angular velocity, and angular acceleration of each segment over the course of a movement was obtained with an Optotrak optoelectronic system (Northern Digital, Inc.). The three-dimensional Optotrak coordinate data was filtered and processed using routines developed in MATLAB (The MathWorks, Inc.).

The equations of motion for the arm system were generated using the SD/FAST software

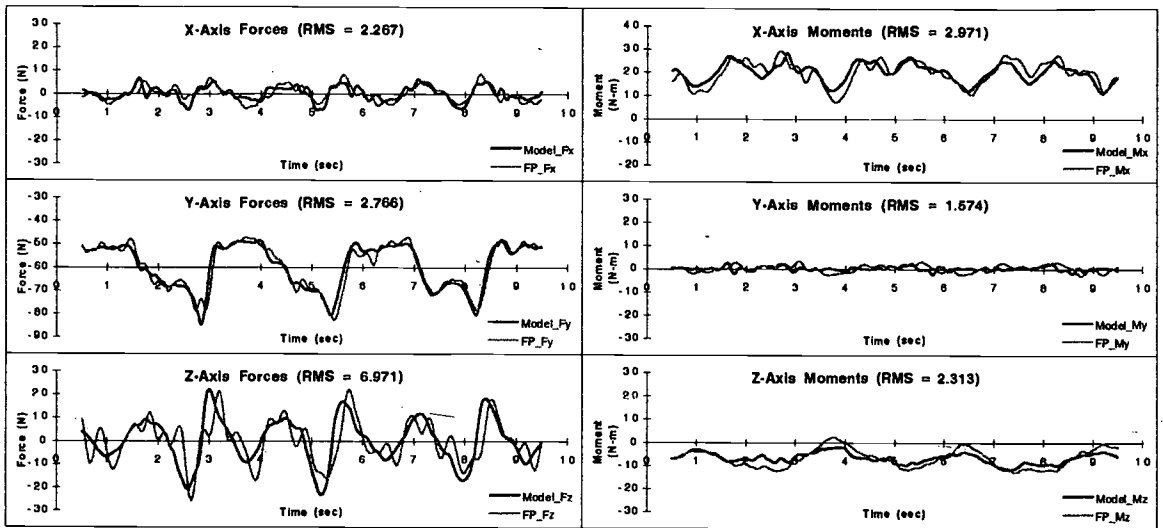

Figure 1 - Validation results for a fast, loaded coronal movement trial.

package (Symbolic Dynamics, Inc.). SD/FAST employs Kane's formulation(3) to generate specialized functions based on the system geometry. A master program was written to set the segment parameter values, prescribe the arm movements, and calculate the inverse dynamics of the system via the SD/FAST functions. The outputs from the program are the three-dimensional reaction forces and moments acting on the body at the shoulder joint.

Experimental Protocol

Six able-bodied subjects (five males and one female) ranging in age from 23 to 39 participated in the experiments. Three sets of tasks (two unimanual and one bimanual) were performed by each subject. For the first set, the subject was instructed to move his or her arm in each of the three anatomical planes, with the elbow held in full extension. Each of the three planar movements was performed under four conditions-- slow unloaded, slow loaded, fast unloaded, and fast loaded. The load was a five pound (2.268 kg) weight held in the hand. A metronome was used to help the subject achieve a uniform movement rate. For the second set of unimanual tasks, the subject was instructed to make random, self-paced movements that included elbow flexion and extension. Loaded and unloaded trials were conducted, using the same five pound weight.

The subject was seated during both sets of unimanual tasks and was requested to prevent

movement of his or her head and trunk. The subject's chair rested on two biomechanics force platforms (Advanced Mechanical Technology, Inc.). The voltage outputs from the force platforms were filtered and transformed in MATLAB to find the reaction loads at the shoulder.

The third set of tasks was chosen to represent a typical functional activity. The subjects were instructed to repeatedly move a weight from the surface of a table to one of two shelves using both hands. The weight was held in the mid-sagittal plane, and the movements were assumed to be perfectly symmetrical, with each arm supporting half of the weight.

RESULTS

The output of the model and the force platform data for a fast, loaded coronal movement are shown in Figure 1. The X-axis points in the direction that the subject is facing, the Y-axis points upward, and the Z-axis points laterally. Since the arm is moving in the YZ-plane, the predominant forces occur in those directions, and the greatest moment occurs about the X-axis, which is the axis of rotation of the arm system. The Y-axis forces are offset by approximately 60 N due to the weight of the arm segments and the load held in the hand.

The results from one of the bimanual trials is shown in Figure 2. The top chart shows the heights of the arm segment landmarks with respect to the table surface, while the middle and

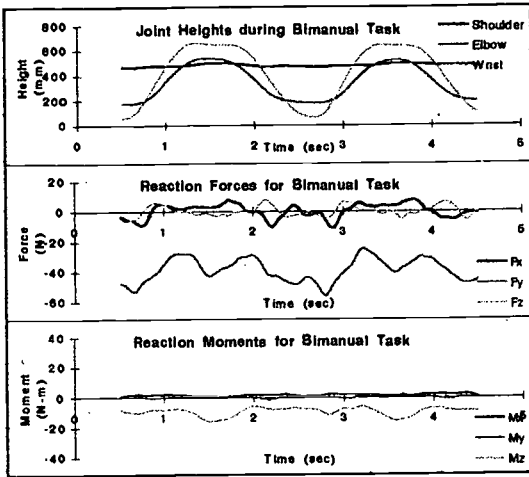

Figure 2 - Postural disturbances resulting from a bimanual task

bottom charts show the resulting reaction forces and moments respectively. The Y-axis forces are offset by the weight of the arm and load combination, which is approximately 40 N for this subject. Since the movement is performed predominantly in the sagittal plane, the greatest forces occur in the X and Y planes, while the largest reaction moments are generated about the axis of rotation, which is the Z-axis for this movement.

For each trial condition, the root mean squared (RMS) difference was calculated between the model outputs and the reaction loads derived from the force platform data. The overall correlation between modeled and recorded disturbances was very good, with average RMS values of 2.40 N for the reaction forces and 1.52 N-m for the reaction moments. Figure 1 includes the RMS values of the data sets shown.

The RMS values were generally higher for fast and loaded movements than for slow, unloaded movements. This is not unexpected, since the values of the reaction loads also increase under these conditions.

DISCUSSION

A three-dimensional inverse dynamics model of the upper extremity was constructed that consistently predicted the reaction forces and moments at the shoulder in response to voluntary arm movements. The model was validated experimentally which resulted in good agreement between the shoulder forces predicted

by the model and those estimated from external measurements. This model can become a useful analysis tool for many rehabilitation applications, such as wheelchair propulsion and seated or standing balance during activities of daily living.

The variability between subjects in the validation experiments was significant, with the RMS values from one particular subject consistently twice as great as those of the other subjects. This variability is most likely caused by failure of the subject to maintain a consistent body posture during the arm movement trials. For the other five subjects, the RMS values were generally within one standard deviation of the average values, which suggests that, when movements of the head and trunk are minimal, the model performs equally well for all subjects.

Future plans for this research include a broader study of the types of disturbances that are generated by typical arm movements, including reactions to unexpected changes in load. The bimanual applications may be expanded by creating a similar model of the left arm. Finally, a catalog of postural disturbances can be compiled for use with a musculoskeletal computer model to assist in the development of FES control systems that allows free use of both hands while standing.

REFERENCES

1. McConville JT, Churchill TD, Kaleps I, Clauser CE, & Cuzzi J (1980) *Anthropometric Relationships of Body and Body Segment Moments of Inertia*. AFAMRL-TR-80-119, Wright-Patterson Air Force Base, Ohio.
2. Greenwood DT (1988) *Principles of Dynamics* (2nd ed.) Englewood Cliffs, NJ: Prentice-Hall, Inc.
3. Hollars MG, Rosenthal DE, & Sherman MA (1994) *SD/FAST User's Manual*. Mountain View, CA: Symbolic Dynamics, Inc.

ACKNOWLEDGMENTS

This work was supported by the NIH Neuroprosthesis Program, Contract NO1-NS-6-2351 and the VA Center of Excellence in FES.

Ronald J. Triolo, Ph.D.
 Cleveland FES Center, Suite 230
 11000 Cedar Road
 Cleveland, OH 44106-3052
 (216) 791-3800 x4698

A Relationship between Pushrim Kinetics and Median Nerve Dysfunction

Mark A Baldwin^{2,3}, Michael L Boninger^{1,2,3}, Sean Shimada^{2,3}, Rory A Cooper^{1,2,3}, Tom O'Connor^{2,3}

¹Division of PM&R, University of Pittsburgh Medical Center, Pittsburgh, PA 15261

²Dept. of Rehab. Science and Technology, University of Pittsburgh, Pittsburgh, PA 15261

³Human Engineering Research Lab, Highland Dr. Veterans Affairs Medical Center, Pitt., PA 15206

ABSTRACT

The purpose of this study was to compare kinetic parameters of wheelchair propulsion between experienced wheelchair users with and without evidence of median mononeuropathy, an indicator of carpal tunnel syndrome.

Bilateral kinetic data was collected with SMART^{Wheel}s on thirty-one subjects who propelled their own wheelchairs at two speeds while secured to a dynamometer. Nerve conduction studies of each subject were used to place them in either the group with or without evidence of median mononeuropathy. The peak radial, axial, tangential and resultant forces, the efficiency, and the propulsion frequency were compared between the two groups.

Significantly higher peak radial and resultant forces along with stroke frequency were found in the group with evidence of median mononeuropathies. Reducing these forces and stroke frequency could lead to a reduction of carpal tunnel syndrome in manual wheelchair users.

INTRODUCTION

The prevalence of Carpal Tunnel Syndrome (CTS) has been reported to be as high as 63% in manual wheelchair users (MWUs). (1) Although there have been many studies investigating pushrim kinetics during wheelchair propulsion and many investigating nerve dysfunction as a result of wheelchair propulsion, none to date have performed the two in a single study. The purpose of this study was to determine the kinetic parameters of wheelchair propulsion that may differ between MWUs with and without median nerve dysfunction. We hypothesized that people with

evidence of median mononeuropathy (MMN+) propelled their wheelchairs with higher peak forces, greater stroke frequency, and decreased efficiency than those without median mononeuropathy (MMN-). Analyzing the difference in propulsion between these two groups could lead to recommendations in propulsion technique or wheelchair setup that would reduce the risk of developing CTS.

METHODS

Subjects

Thirty one (22 male and 9 female) experienced MWUs with a spinal cord injury at T-4 or below volunteered for, and gave written consent to participate in this study.

Nerve Conduction Study Data

Nerve conduction studies (NCS) were performed bilaterally by a board-certified technician using standard techniques. Median motor and sensory nerve evaluation was performed using a motor distance of 8cm and sensory distance of 14cm. Temperature was monitored throughout the trials and maintained above 32°C.

Kinetic Data Collection

Prior to kinetic data collection, subjects were secured in their own wheelchairs to a wheelchair dynamometer with appropriate rolling resistance. Bilateral kinetic data was collected during 2mph and 4mph speed trials from the force and torque sensing pushrim of the SMART^{Wheel} (2,3). Kinetic data was collected for twenty seconds after the subjects reached steady state speeds. Three-dimensional forces applied to the pushrim in the radial, tangential, and axial directions (F_r , F_t , F_z) were recorded on each side, as shown in

Figure 1. The kinetic data from the SMART^{Wheel} was collected at 240 Hz and filtered with a 20 Hz, 12th order Butterworth low-pass filter. (4)

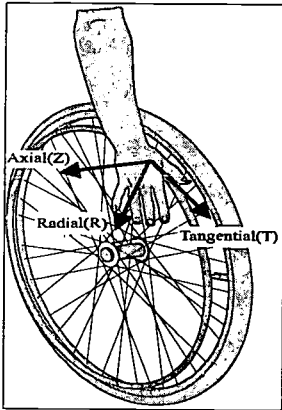

Figure 1: Pushrim coordinate system for kinetic data collection.

ANALYSIS

Nerve Conduction Study Data

For the purpose of this study, the subjects were separated into either the MMN+ or MMN- groups based on the results of their NCS. Four NCS parameters were compared with normative values for each hand. The four parameters were the median motor and median sensory nerve amplitudes and latencies. With the two hands as separate entities and using the four parameters applied to each hand, eight independent variables were used to separate subjects into the two groups. Subjects with two or more abnormal variables were considered MMN+ while all others were considered MMN-.

Kinetic Data

The peak tangential, radial, and axial forces of the first five strokes were used for analysis on each subject. Using these pushrim forces, the resultant force (F), defined as $F = \sqrt{F_r^2 + F_t^2 + F_z^2}$, (1) the contribution of tangential force to resultant force (CTF), defined as

$$CTF = F_t^2 / F^2, \quad (2)$$

and the stroke frequency were all calculated and compared between the two groups. To eliminate affects of noise on the CTF at the beginning and end of each stroke, only the top 80% of the resultant and tangential forces were used to calculate the CTF.

RESULTS

The mean age of the subjects and years post injury for the MMN- group (n=18) was 32.6 and 10.1 years respectively, while the MMN+ group (n=13) was 39.5 and 12.7 years respectively. At a confidence level of p<0.05, there was no significant difference in these two variables between the two groups. Pearson correlation coefficients were high (r>0.8) for each kinetic parameter between hands and across both speeds. Thus, the forces, CTF, and stroke frequency were averaged between both hands and across speeds for each subject. Average peak forces and stroke frequency over the first five strokes were calculated and are shown in Table 1.

Table 1: Kinetic Parameters for Wheelchair Propulsion

Groups	Velocity of Propulsion (m/s)	F (N)	F _r (N)	F _t (N)	F _z (N)	CTF (F _t ² /F ²)	Stroke Freq.(Hz)
MMN+	1.31 (0.09)	104.7 (25.91)	83.3 (22.9)	48.53 (13.88)	39.51 (26.17)	0.26 (0.11)	1.22 (0.24)
MMN-	1.31 (0.13)	75.76 (21.78)	56.93 (18.46)	38.86 (20.23)	30.56 (16.9)	0.26 (0.13)	1.05 (0.13)

(*) indicates sig. diff. at confidence level p<0.05; numbers in parenthesis are standard deviations

At a confidence level of p<0.05, significant differences between the MMN+ and MMN- groups were found for resultant force, radial force, and stroke frequency.

DISCUSSION

Individuals who use manual wheelchairs as their main source of mobility have a high risk of upper extremity injury due to overuse of the anatomical structures

involved in wheelchair propulsion. This study found that MWUs with MMN at the wrist propelled their wheelchair with greater force and increased stroke frequency.

In looking at these results, one must consider whether the median nerve dysfunction caused increased propulsion forces, or the subject's propulsion technique caused the development of the MMN. Burnham et al. found that 23% of a group of wheelchair athletes had nerve entrapments by clinical criteria (prevalence of hand numbness, pain, or weakness), while 64% of the same group had nerve entrapments by EDX criteria. (5) Burnham's results suggest that subjects who electrodiagnostically may be MMN+, may not have symptoms that could cause them to propel with larger forces. Therefore, it is likely that the differences in radial and resultant forces between the two groups are not a result of the MMN, but possibly the cause.

It is also important to notice that the tangential and axial forces along with the efficiency (CTF) did not differ significantly between the two groups. This would suggest that larger, non-propulsive radial forces might be a cause behind the development of median nerve dysfunction. In addition, the significant increase between groups in stroke frequency to achieve the same speed may also cause median nerve dysfunction.

CONCLUSIONS

This study suggests that reducing non-propulsive forces and stroke frequency during wheelchair propulsion may reduce the chances of developing nerve dysfunction and eventually CTS. Future studies need to incorporate

kinematics to further analyze wrist kinetics in a local coordinate system.

ACKNOWLEDGEMENTS

The U.S. Department of Veterans Affairs Rehabilitation Research & Development Services (Project B689-RA), National Institutes of Health (NIH K08 HD01122-01) and the Paralyzed Veterans of America provided partial funding for this research.

REFERENCES

1. Aljure J et. al., (1985). Carpal tunnel syndrome in paraplegic patients. *Paraplegia*, 29, 182-186.
2. Asato KT et. al., (1993). SMART^{Wheel}: Development and testing of a system for measuring manual wheelchair propulsion dynamics. *IEEE Transactions on Biomedical Eng.*, 40, 1320-1324.
3. VanSickle DP, (1995). SMART^{Wheel}: Development of a digital force and moment sensing pushrim. presented at the 18th Annual RESNA Conference, Vancouver, BC.
4. Cooper RA, (1997). Frequency analysis of 3-dimensional pushrim forces and moments for manual wheelchair propulsion. *Automedica*, in press, 1997.
5. Burnham R et. al. (1994). Upper Extremity Peripheral Nerve Entrapments Among Wheelchair Athletes: Prevalence, Location, and Risk Factors. *Archives of Phys. Med. and Rehab*, 75, 519-524.

Mark A. Baldwin
Human Engineering Research Laboratories
VAMC Highland Dr, 7180 Highland Dr.
Pittsburgh, PA 15206

SIGNAL TO NOISE RATIO BASED SORTING OF VOLUNTARY EVENT RELATED POTENTIAL AVERAGES FOR ASSISTIVE TECHNOLOGY APPLICATIONS

M. M. Rohde, S. L. BeMent, S. P. Levine, J. E. Huggins, and R. K. Kushwaha
Biomedical Engineering Department, University of Michigan
1301 Beal Ave, Ann Arbor MI 48109-2122

ABSTRACT

A method of sorting constituents of an average signal based on a running signal to noise measure is proposed. Its performance is examined with simulated data that includes four different types of experimental data corruption. The proposed method is able to reject bad constituents of the average for the simulated data.

BACKGROUND

Many forms of assistive technologies (AT) require some type of training. This training may require repetitions of a test response signal to define template signals that are representative of the true signal. A common example of this type of assistive technology is voice recognition systems. Another example, the one we will focus upon here, is the University of Michigan Direct Brain Interface (DBI) that is under development as an AT interface for patients with severely reduced communicative abilities.

The UM DBI is based on cross correlation of an exemplary cortical template signal with electrocortical (ECoG) signals recorded in specific parts of the human brain in order to identify voluntary event related potentials (VERP). The template is a time locked average of event related cortical potentials recorded during voluntary activities [1,2]. Experience has suggested that an average template based on all test responses may not generate the best template waveform for this DBI. Some responses vary noticeably from the average result, and thus should not be included in the final average template. We present a method by which a running SNR measure is used as the

basis upon which to identify and eliminate corrupted constituents in VERP templates.

RESEARCH QUESTION

Can a running SNR estimator-based sorting method that eliminates uncharacteristic constituents improve the template quality and thus yield better DBI detection characteristics?

METHODS

In developing the template for use in the DBI, VERPs are isolated by means of a trigger signal from continuous ECoG recordings and used to form the average VERP [1,2]. A running SNR estimate [3] is computed as each candidate constituent is added to the running average. Constituents that cause a decrease in the running SNR are removed and those that maintain the SNR level or increase it are retained. The ensemble of accepted constituents becomes the "sorted" average. The first five constituents in each computation are not sorted because of initial instability in the SNR estimator. Subsequently, these five constituents are individually compared to the rest of the trials using the running SNR estimator and sorted in a manner similar to the others. An example template and its corresponding SNR estimate before and after sorting are shown in Figure 1.

Simulated data with known characteristics were created to examine the dynamic performance of this method. It was hypothesized that inherent in VERP isolation are four corruptions in addition to baseline noise levels: temporal shifting from activity uncertainty, outlier VERPs that differ from the typical responses, accidental triggers when no activity occurred,

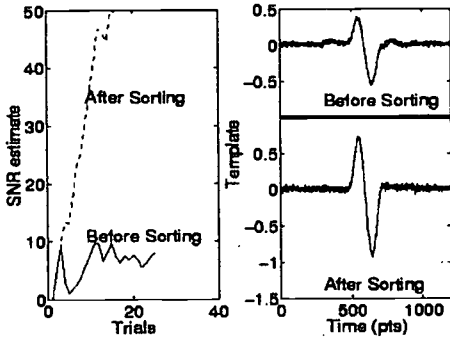

Figure 1 – Example of SNR estimate and template before and after sorting. A data set with temporal shifting was used. Note the "sidelobe" distortion of the template before sorting.

and bursts of contaminating noise in the recording. One cycle of a 1 Hz. sine wave was used to simulate an underlying low frequency VERP. White gaussian noise was added to yield a set of data similar to actual ECoG recordings. The number of constituents effected by the four corruption types, designated the severity level, was determined by randomizing the occurrence of corrupting factors in each set of simulated VERPS. The test sets were composed of 25 data traces with 25 simulated VERPs in each. A test set was made for each of the four corruption types at 5 severity levels (uniform probabilities of 0, 20, 40, 60, 80%) and at three known baseline SNR levels (0.1, 1.0, 10.0) for a total of 60 sets.

The temporal (trigger) shifting condition was simulated by temporally shifting individual constituents relative to their corresponding event trigger based on a gaussian distribution centered at the true event trigger time with a variance of 1 sec. The outlier corruption condition was simulated with an inverted sine wave cycle to represent a worst case condition — a dissimilar constituent that effectively cancels a coherent true constituent when averaged. Replacing the underlying sine wave VERP with zero values simulated the accidental trigger condition. The "burst" of extra contaminating noise condition was simulated by introducing white, gaussian, zero

mean noise one order of magnitude higher than the baseline level into an individual constituent.

The SNR based sorting method was applied to 25 sets of 25 VERPs for each of these four test conditions. In each case a comparison was made between the sorted results and the true character of the data. Correct classification occurred whenever accidentally triggered, noise corrupted, or outlier constituents were rejected. For the case of temporal shift, rejection was defined to be correct if the constituent was shifted by more than ± 10 milliseconds.

RESULTS

The application of the sorting method to the simulated test data yielded the results shown in figure 2. The sorting is clearly ineffective at the SNR value of 0.1 for all conditions. This is consistent with the concept that lower SNRs require longer settling times for the estimator and thus more constituents. As the SNR increases, however, the performance improves.

As expected, when the probability of outlier constituents increases, the ability to sort decreases. However, correct classification in

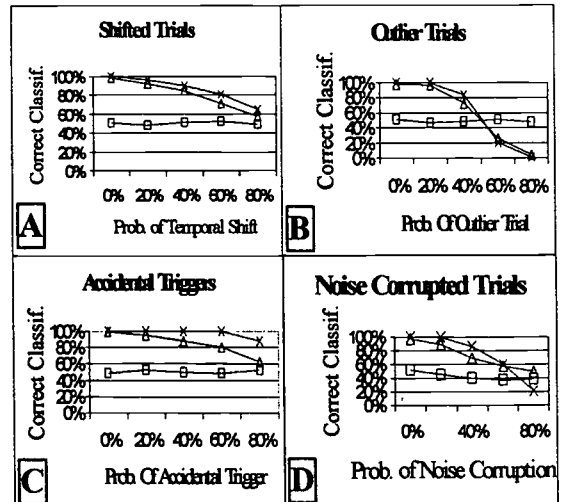

Figure 2 – Results of sorting method applied to simulated data. The lines are coded as follows: true SNR 0.1 "□", true SNR 1.0 "△", and true SNR 10 "x".

the 80-90% range was achieved with up to 40% probability of shift and 40% probability of accidental trigger. In the outlier case the graph shows a sharp performance change in the 40-60% probability range, which is expected because as the number of outlier constituents becomes greater than half of the total number, the SNR estimator and the sorting method should lock onto the outlier constituent shape. The probability of outlier constituents reaching 100% would cause the classifier to yield 0% correct classification if it is working properly.

DISCUSSION

The proposed sorting method was able to effectively remove uncharacteristic constituents when applied to the simulated data. The four uncharacteristic signals simulated represent our attempt to mimic variations that could exist in human VERP recordings. The method was able to correctly identify these constituents even at relatively high (20-40%) severity levels. It was also found to be effective only at higher SNR levels, and fortuitously the majority of the human ECoG templates with favorable detection characteristics lie in an estimated SNR region of 1 or more.

The true measure of the method's usefulness, however, lies in whether the sorted templates enhance the detection characteristics of an interface. Our future work includes comparing the detection characteristics of sorted and unsorted templates with both simulated and real data sets. The simulated data will contain mixtures of the four corruption types as well as the addition of VERPs without the corresponding trigger (introducing false positives). The human VERP data will be drawn from previous and future experiments. The results of such a test are not obvious as an unsorted "aggregate" template may allow more flexibility in the detection than the more specific, sorted template.

The UM DBI could be helped by the proposed method in two ways. The first, hypothesized

earlier, is that a sorted template could enhance the detection of human VERP data. The second exciting area is that the proposed method could be used to provide feedback to subjects during VERP experiments. If subjects can be trained to produce similar, repeatable VERP signals, the utility of the DBI and other AT applications based on such signals would increase dramatically.

Similar feedback could be used while training voice recognition systems. Feedback on the consistency of speech samples could help users to discover the most comfortable and repeatable response. The user and system would become a closed loop system during the training process, which should result in more robust performance.

There are potentially other AT applications that could benefit from the proposed method. While it is certainly only in its most preliminary stages, it is the author's hope that the method will eventually prove a viable and useful tool for rehabilitation engineers – and therefore help real people.

REFERENCES

1. J.E. Huggins et al., (1996). Detection of Event-Related Potentials as the Basis for a Direct Brain Interface. *Conf. Proc. RESNA-96*, 489-491.
2. S.P. Levine et al., (1996). Intracranial Detection of Movement-Related Potentials for Operation of a Direct Brain Interface. *IEEE EMBS Eighteenth Annual Conf. Proc.*, 2.7.1-3.
3. O. Özdamar and R. Delgado, (1996). Measurement of Signal and Noise Characteristics in Ongoing Auditory Brainstem Response Averaging. *Ann. Biomed. Eng.*, 24, 702-715.

ACKNOWLEDGMENTS

The authors appreciate the generous assistance of the Whitaker Foundation and the NIDRR.

THE EFFECT OF STIMULATED HIP EXTENSOR MOMENT ON THE LOADS IMPOSED ON THE ARMS DURING STANDING WITH FES

Michael A. Wibowo¹, Ronald J. Triolo², James P. Uhler¹, Rudi Kobetic³

¹ Department of Biomedical Engineering, and ² Orthopedics, Case Western Reserve University

³ Motion Study Laboratory, Cleveland VA Medical Center

ABSTRACT

The overall goal of this study is to understand how the hip extension moment produced by Functional Electrical Stimulation (FES) affects the loads imposed on the arms during upright posture. A biomechanical model of quiet standing was used to predict the effects of hip angle and stimulated hip extension moment on the arm support required to maintain balance. Two individuals with complete thoracic spinal cord injuries (SCI) stood with continuous stimulation to the knee and trunk extensors while hip extension activation varied. The vertical loads placed on a set of parallel bars by the arms and on a force plate by the feet during standing were measured. Results suggest that the loads imposed on the arms during quiet standing are highly dependent upon the extension moments at the hip, as well as and the hip flexion angle. These findings imply that the stimulation of hip extensor(s) that produces the largest moment should result in the least weight placed on an assistive device by the arms.

BACKGROUND

Observation of FES-induced standing indicates a deficiency in the hip extension moment required to maintain stability during standing, which leads to a slight-hip-flexed posture. The lack of moment is compensated by the use of the upper extremities for support via crutches, walkers, or parallel bars, to prevent the trunk from bending forward and to provide postural stability and balance. The focus of this study is to understand how the extension moment produced at the hip affects the load imposed on the arms through an assistive

device during quiet standing. The ultimate goal is to develop a FES system for standing that allows the user to release the hands from an assistive device and to manipulate objects in the environment.

RESEARCH QUESTION

The research questions to be addressed are :

- 1) Does maximizing hip extension moment minimize the effort exerted by the arms on an assistive device during FES-induced standing and
- 2) What are the effects of hip posture on arm support loads or the hip moments required to maintain upright posture. The proposed solution to the above questions involves comparing the moment generating capacities of various hip extensor combinations to the measured loads on the arms while standing with FES.

METHOD

The research questions were assessed in computer simulation, as well as through

Figure 1 : Six-Segment Model of Human Standing

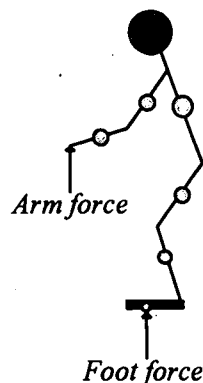

experimental measurements of the loads imposed on the arms while standing with different hip extensor muscles. A planar static 2-D model of the human skeletal system in the sagittal plane was developed based on the body parameters of a 1.80 m, 73.42 kg healthy, able-bodied male [1,2]. The model consisted of six rigid-body segments

which are connected by frictionless hinge joints. Conditions under which the simulation was performed are: 1) the knee joints are fully-extended, 2) the ankles are rigid and restrained from plantar-dorsi flexion movement, and 3) the arms are directed downward perpendicular to the floor and parallel to the gravitational vector. The model is represented schematically in **Figure 1**.

The simulations calculated the required load on the arms as a function of the hip extension moment at different hip angles.

Two well-conditioned individuals with mostly thoracic SCI and stable chronically indwelling intra-muscular or surgically implanted epymisial electrodes stood with FES between two parallel bars instrumented with strain gages to measure the loads on the arms [3]. In addition, a biomechanical platform (AMTI) measured the loads on the feet. *Erector Spinae*, *Quadriceps*, and different hip extensors were activated with a constant 20 mA, charge-balanced, asymmetrical, bi-phasic waveform at either 20 or 33 Hz. The lower frequency minimized fatigue during prolonged standing while the higher frequency maximized moments during the sit-to-stand transition. During the sit-to-stand transition and the 1st time interval, all hip extensors were stimulated up to the maximum pulse durations before spill-over to an adjacent muscle or unwanted reflex activation. In the 2nd interval, either no hip extensors or only a set of hip muscles was stimulated. This sequence was repeated 11 times. In successive intervals, the hip muscles activated by FES were randomly varied to generate different hip moments. The hip flexion angle during each standing trial was measured by a goniometer.

The moment generating capacity of any hip extensor combination was measured prior to the standing experiment on a CYBEX II dynamometer. The load on the arms while standing with various hip extensor combinations were averaged across trials. The

decreasing loads imposed on the arms due to activation of the hip extensors were computed by subtracting the arm loads while standing with no hip extensors.

RESULTS

Upward forces applied at the wrist joint create an extension moment around the hip. Simulation results indicate that the imposed loads on the arms and the exerted extension moment at the hip needed to remain upright increased as the hip flexed. In addition, increasing exerted hip moment was found to be proportional to the decrease in arm loads. The proportionality was determined by the postural hip angle. The simulation results at 10°, 15°, and 20° of hip flexion are shown as open symbols in **Figure 2**.

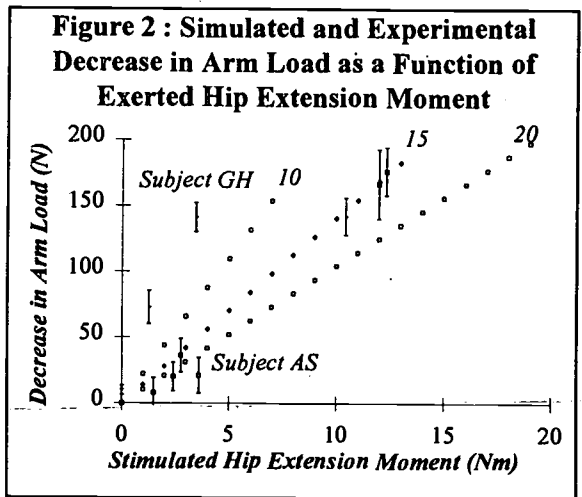

Experimentally, arm loads decreased as the exerted moment at the hip increased for any combination of stimulated hip extensor muscles as shown in **Figure 2**. Muscle combinations which produced higher moments yielded standing with the most decrease in the load on the arms compared to standing with no stimulated hip extensors. A simple curve-fitting was performed for each subject independently due to the differences in their standing posture. A straight line which gives the smallest error

was fitted through the origin. The best fit for subject GH was given by *Eq. 1* which produced an r^2 of 0.21. Similarly, the best fit for subject AS was given by *Eq. 2* which produced an r^2 of 0.97.

$$F = 16.84 M \quad (\text{Eq. 1})$$

$$F = 13.61 M \quad (\text{Eq. 2})$$

where F is the decrease in arm load (N), and M is the isometric moment exerted at the hip (Nm). The positive slope implies the magnitude of the decrease in load imposed on the arms should increase for increasing exerted hip extension moment.

In addition, the measured hip angles of standing posture for subject GH were between 10° and 15° . The slope of decreasing arm loads vs. hip extension moment derived from the simulation were 22.0 and 14.0 for 10° and 15° , respectively, bounding the experimental slope for subject GH. Similarly, the measured hip angles of standing posture for subject AS were between 15° and 20° . The simulated slope of decreasing arm loads vs. hip extension moment curve were 14 and 10.4 for 15° and 20° , respectively.

DISCUSSION

The simulation results of the static human standing model predicts that the active hip extension moment determines the load on the arms. Increasing the moment decreases the load imposed on the arms. The results confirm that the standing performance strongly depends on the extension moment generated by the hip muscles. Standing with a specific hip extensor combination that produced more extension moment decreases the load on the arms. Consequently, stimulation of hip extensor(s) which produces the most extension moment should yield to standing with the least amount of loads imposed on the arms.

The effect of hip extension moment on the arm load was determined by the hip flexion angle assumed while standing. The proportionality between the decreasing load on

the arms and the increasing hip extension moment derived from the simulation results agrees with the findings from the standing performance test on SCI individuals.

In order to decrease the load imposed on arm support devices and to eventually free the arms from support devices during standing, the first effort should be devoted to increasing the moment generated by electrically activated hip extensors. The second effort should be directed to improving the posture in terms of hip flexion angle in FES-induced standing.

REFERENCES

1. Dempster, (1955). Space requirements of the seated operator, USAF, WDAC. Technical Report, 55-159, Wright-Patterson Air Force Base, Ohio.
2. Drillis & Contini, Body segment parameters, Technical Report, 1166.03, New York University, New York.
3. Jin & Chizeck, (1992). Instrumented parallel bars for three-dimensional force measurement, *Journal of Rehabilitation Research and Development*, 29(2), 31-38.
4. Jin & Kobetic, (1997). Rail supporting transducer posts for 3-D force measurement, *IEEE Transaction on Rehabilitation Engineering*, 5(3).

ACKNOWLEDGMENTS

This work was supported by the Neuro-prosthesis Program of the NIH, Contract N01-NS-6-2351, the Rehabilitation R&D Service of the Department of Veterans Affairs, and the Cleveland FES Center.

Michael Ari Wibowo
10701 E. Boulevard (151A)
Cleveland, Ohio 44106

DELAYING THE ONSET OF FNS INDUCED MUSCLE FATIGUE: A STUDY OF MUSCLE FIBER RECRUITMENT DURING INTRAMUSCULAR STIMULATION

Kan Singh, Anne C. Dupont, Frances J.R. Richmond

Department of Physiology, Queen's University, Kingston, Ontario, Canada

ABSTRACT

Functional neuromuscular stimulation (FNS), the use of electrical stimulation to activate paralyzed or paretic muscle, has the potential to provide stroke and spinal cord injured persons with a significant improvement in their quality of life. However, the current application methods result in the rapid onset of muscle fatigue. This paper compares electrical stimulation using an intramuscular (IM) electrode with a nerve cuff (NC) electrode to determine differences in muscle-fiber recruitment and loss of force due to fatigue. The electrodes were implanted acutely in feline medial gastrocnemius (MG). Physiological tests of force development and histological evaluation of glycogen depletion provided information about muscle performance and recruitment of different fiber types. Force decrement due to fatigue was reduced with the IM electrode compared to the NC electrode. Predominantly fast glycolytic fatiguable (FF) fibers were recruited by the NC electrode whereas a more representative mix of three fiber types were recruited following IM stimulation.

BACKGROUND

Therapists using FNS have been frustrated by the problem of rapid fatigue onset due to the heightened energy cost of FNS-activated movements (1). This phenomenon is likely due to "recruitment reversal" that can occur during the stimulation of large nerve bundles. This unphysiological pattern of recruitment, in which the FF muscle fibers are recruited first, is due to the larger diameter of the FF motor axons than those serving more oxidative fiber types.

In recent studies using a novel IM

electrode (figure 1), muscles appeared to demonstrate a more even pattern of recruitment amongst mixed populations of slow oxidative fatigue resistant (SO), fast oxidative-glycolytic fatigue resistant (FR) and FF fiber types (2). An electrode capable of recruiting in such a non-selective way would reproduce the pattern of physiological recruitment used by the CNS. Clinically, it would be reasonable to assume that muscles stimulated using such an electrode would not fatigue as rapidly as they do with NC stimulation.

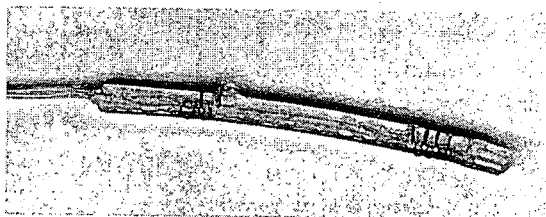

Figure 1. The IM electrode used in these studies consisted of a silicone tube. Two wires were passed through and wrapped around the tube to act as the anode and cathode.

RESEARCH QUESTION

These experiments were conducted in order to determine if IM stimulation could activate a more representative mix of muscle fibers than NC stimulation.

METHODS

Six cats ranging in weight from 2.7 to 5.4 kg were anesthetized deeply with chloralose urethane or sodium pentobarbital; the anesthetic level was maintained to abolish withdrawal reflexes. The MG was dissected and its tendon was attached to a force transducer whose output signals were displayed on an oscilloscope and recorded

FNS FIBER RECRUITMENT

using a Macintosh computer. The MG of one leg was implanted with an IM electrode and a NC was implanted on its nerve. The other MG was implanted only with a NC electrode. The maximal twitch force of each muscle was determined using NC stimulation. The stimulus intensity on the control (NC only) leg was adjusted to achieve 20 % of the maximal twitch force. On the leg implanted with the IM electrode, the current delivered by the electrode was increased until 20 % of the maximal twitch force was achieved. The muscles were intermittently stimulated at 40 pps according to Burke (3). The muscles were cut into blocks, frozen in liquid nitrogen, and cut into sections which were stained for mATPase activity (alkaline pH), H&E, and glycogen content using the PAS reaction. The fiber types of depleted fibers were determined from adjacent PAS and mATPase stained sections and proportions of different types of depleted fibers were analyzed.

RESULTS

The results of the fatigue tests are shown in figure 2. A rapid and significant drop was observed in the force developed by the muscle stimulated with the NC. In most cases the force dropped to 20 % of the initial intermittent stimulation force within 120 s and continued to decline until a plateau of less than 10 % of the initial force was reached. In contrast, the muscle stimulated with the IM electrode had a more gradual decline in force; 20 % of the initial force was reached after 300 s. That level of force was maintained for up to 2 hours of stimulation.

Histological examinations revealed that primarily FF fibers were depleted as a result of NC stimulation (figure 3). Stimulation with the IM electrode depleted fiber types more evenly. The depleted fibers were concentrated in a subregion of the muscle near the IM electrode.

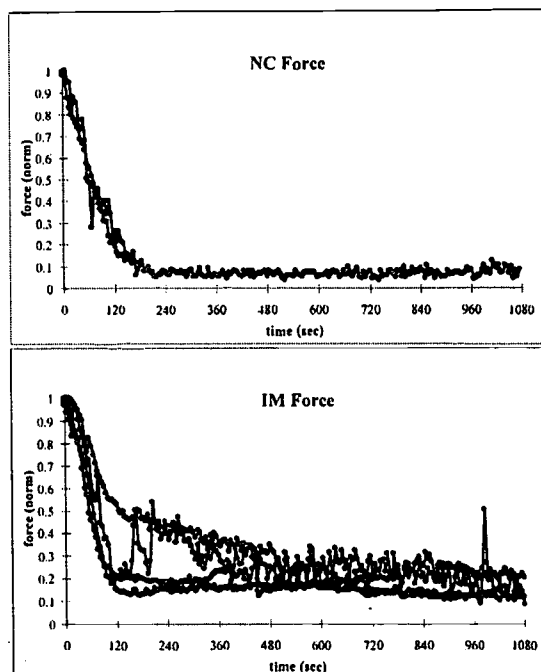

Figure 2. Results of the muscle fatigue tests using the NC electrode (top) and the IM electrode (bottom).

DISCUSSION

The results of these experiments demonstrate that IM stimulation can result in the recruitment of a higher proportion of SO and FR fibers than NC stimulation.

The distribution of these fibers was found to be distinctly regionalized. The regionalization is likely to occur because the electrical pulses activate terminal branches of motor axons closest to the electrode.

The lack of preferential recruitment may suggest that preterminal diameters of motor axons supplying different fiber types are more homogenous than diameters of fibers in the main nerve bundles.

The problem of fatigue during the use of FNS has been recognized as a limitation of the therapy (4). Several investigators have attempted to remedy this problem, but the successes have been outnumbered by the failures. Fang and Mortimer (5) have attempted to use an alternative waveform

FNS FIBER RECRUITMENT

which activates the SO fibers by using a differential neural blocking process. Although this method was successful in postponing fatigue in cat muscle, its use has been limited to experimental settings.

Boom and colleagues (6) have shown that the use of intermittent stimulation of muscle compartments can significantly increase the time to fatigue. Such intermittent compartmental stimulation may be achieved by the implantation of IM electrodes into different muscle parts. By cycling stimulation amongst compartments in which SO and FR fibers are recruited in higher proportions, it may be possible to reduce fatigue and to stabilize the production of modest forces over a relatively long period of time.

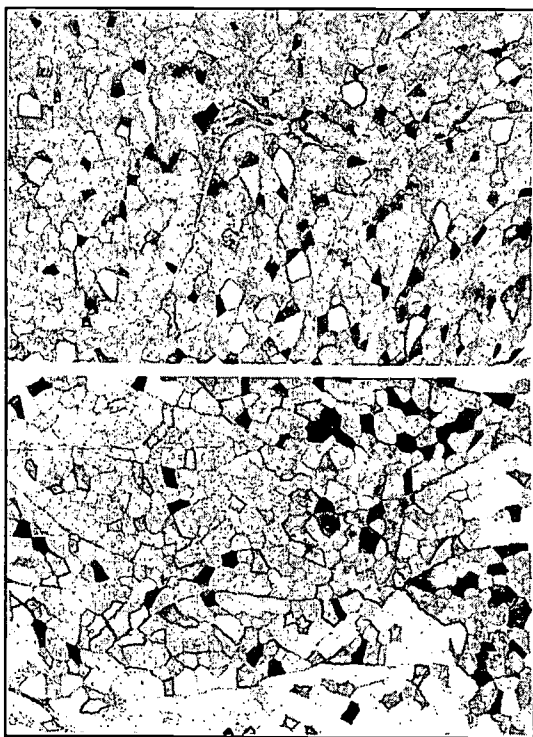

Figure 3. Photomicrographs of muscle tissue following the PAS reaction for the determination of glycogen content. Sections of muscle stimulated with a NC (top) and from muscle stimulated with the IM electrode (bottom) contain white fibers which are depleted of glycogen and are presumed to have been stimulated.

REFERENCES

1. Phillips CA (1991). *Functional electrical rehabilitation: technological restoration after spinal cord injury*. New York, NY: Springer Verlag.
2. Cameron T, Richmond FJR, Loeb GE, (1998). Effects of regional stimulation using a miniature stimulator implanted in feline posterior biceps femoris. *IEEE Transactions on Biomedical Engineering*. (In Press).
3. Burke RE, Levine DN, Tsairis P, & Zajac FE, (1973). Physiological types and histochemical profiles in motor units of the cat gastrocnemius. *Journal of Physiology*, 234, 723-748.
4. Kralj AR, Badj T (1989). *Functional electrical stimulation: standing and walking after spinal cord injury*. Boca Raton, FL: CRC Press.
5. Fang Z, Mortimer JT, (1991). A method to effect physiological recruitment order in electrically activated muscle. *IEEE Transactions on Biomedical Engineering*, 38, 175-179.
6. Boom HBK, Mulder AJ, Veltink PH, (1993). Fatigue during functional neuromuscular stimulation. *Progress in Brain Research*, 97, 409-418.

ACKNOWLEDGMENTS

This work was supported by the Medical Research Council of Canada and the A.E. Mann Foundation.

Kan Singh
Department of Physiology
Botterell Hall, Room 425
Queen's University
Kingston, Ontario, Canada
K7L 3N6
email: kan@biomed.queensu.ca

***Paralyzed Veterans of America (PVA)
Student Design Competition***

1998 Paralyzed Veterans of America (PVA) Student Design Competition

The PVA Student Design Competition recognizes the exemplary work of students in the many disciplines comprising the field of Assistive Technology. This year, entries were received from students with backgrounds in biomedical engineering, electrical engineering, mechanical engineering, computer science, industrial design, occupational therapy, physical therapy, social work, and special education. The collaborative work of these disciplines, present on virtually every paper, shows that the interdisciplinary nature of Assistive Technology is being taught, and put into practice, at the academic level.

Entries also covered the gamut of environments in which Assistive Technology can be applied: home, school, work, recreation, and therapy settings. The value of consumer input in the design process was very evident.

Designs were judged with respect to the following criteria:

- Technical competence
- Creativity and innovation
- Relevancy to real societal needs
- Clinical testing and user input
- Manufacturability
- Safety/durability
- Cost effectiveness
- Marketing potential
- Aesthetics of final design
- Consumer appeal

Award winners have made a special effort to bring their designs to the Conference. Please visit the Student Design Competition display, and see the talent and energy that will come to the field in the near future.

Many thanks are in order for the strong and consistent support provided by the Paralyzed Veterans of America (PVA). Through this support, PVA helps ensure that individuals with disabilities will have access to the cutting edge technology provided by skilled professionals. At PVA, Ms. Joan Napier is not only an advocate for the Student Design Competition, but an active part of the review and award process. Her work in this area was of great assistance and I look forward to her continued participation.

As with many other RESNA activities, Ms. Susan Leone provided much help, guiding the process along, keeping things on schedule, and providing advice when questions came up. Her efforts were much appreciated.

The difficult process of analyzing the designs was carried out with skill by an interdisciplinary panel, who generously devoted the time essential for a thorough and fair review. PVA and RESNA are indebted to them.

This year's competition was no doubt helped by the work of previous Chair David Law, and those who have chaired the competition before him, by setting a standard for a high quality and impartial process.

Finally, thanks must go out to all students who submitted entries. Although only five designs could be selected for the Award, the hard work put in by all students illustrates that the future of Assistive Technology is bright.

Glenn Hedman, ME ATP
Chair, PVA Student Design Competition

RESNA '98 • June 26 - 30, 1998

DESIGN OF A RAIN PROTECTION DEVICE FOR PERSONS USING MANUAL WHEELCHAIRS

Eric Hatcher, Amit Muraleedharan
Department of Mechanical Engineering
Sujatha Hampton

Department of Special Education
Tam Perry

School of Social Work
The University of Texas at Austin, Austin, Tx

ABSTRACT

Rain is a common nuisance for people using wheelchairs. Many commercial producers have marketed products that provide rain protection. Yet none of these solutions address the needs of people using manual wheelchairs for a price less than \$100. The design team developed a rain protection device that directly meets customer needs for substantially less than current solutions. This device is unobtrusive in appearance, intuitive to use, and flexible in its application

BACKGROUND

A person with a wheelchair has few options when rain starts to fall. Their manual wheelchair requires nearly full upper body mobility to navigate. The individual can little afford to use a hand to hold an umbrella or spend the time required to activate many of the solutions out on the market today.

Currently, a person using a wheelchair can purchase a rain protection device for between \$100 and \$400. These solutions range from extra large ponchos to power assisted convertible overhead canopies. Yet the design team discovered from numerous interviews with individuals using wheelchairs that these solutions were inadequate for their needs.

STATEMENT OF THE PROBLEM

The individuals interviewed emphasized several important needs relating to a rain protection device. Such a device should be: 1) Easy and Efficient to use, 2) Adjustable and Flexible to differing customer usage requirements, 3) Aesthetically Pleasing, and 4) Beneficial to a customer's independent lifestyle. Present solutions meet almost none of these customer requirements. The design team worked toward a solution that would meet these needs in a cost-effective manner while providing a maximum amount of rain protection for the user.

METHODOLOGY

Other commonly available solutions were obviously produced without close attention to customer needs. Therefore, any further attempts to solve the problem of rain protection would benefit greatly from a structured design approach that emphasizes the importance of the customers. The authors of this paper used a combination of the methodologies presented in Ulrich and Eppinger [1], and Paul and Beitz [2].

The first step in this composite methodology is to develop a Quality Function Deployment (QFD). From customer interviews the team developed a comprehensive list of needs ranked by importance. In the QFD these needs were directly related to specific design specifications. With the QFD, the team focused on isolating key quantifiable design specifications to maximize customer satisfaction [3].

Next, the team performed a functional analysis to develop ways to meet the various customer requirements. Specific concern was paid to issues of safety and reliability. The device would commonly be used in windy and wet environments where there is a potential for danger to the customer. From a functional development the team required the product to be failsafe. The product would have to alert the user of potential failure or fail in such a way as to not threaten the user or those around the user in any way.

From the functionality that the team developed numerous conceptual solutions where produced to meet customer needs. Using follow-up interviews and empirical testing the final design was narrowed down from 13 original designs. The final concept, shown in Figure 1, utilizes an unobtrusive platform (the wedge) that fits between the cushion and the sling seat of the wheelchair. The platform connects to an adjustment arm that holds a normal, user-determined umbrella.

DESIGN

As a first test of the final design, the team constructed a proof-of-concept prototype to examine issues of geometric design, ergonomics, and overall compactness. Analysis of the proof-of-concept

prototype, shown in Figure 2, led to advances in the collapsibility and ease of use of the device.

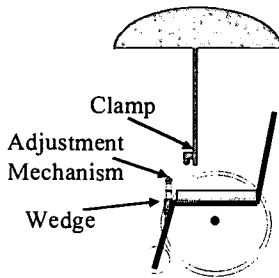

Figure 1. The final concept allows the user to choose their own umbrella

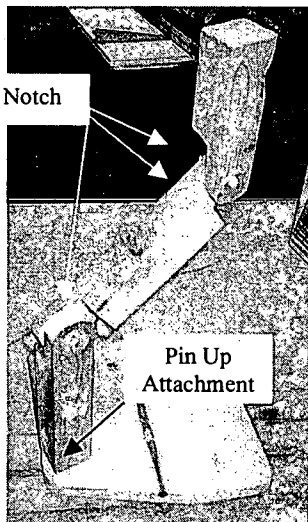

Figure 2. The proof-of-concept prototype utilized notched links in the adjustment arm and a “pin up” design in the wedge.

From the team’s analysis two major issues were raised in the proof-of-concept prototype. Interference in the joints prevented the device from collapsing any more than to a lazy “N” shape. Furthermore, the design of a pin attachment between the adjustment arm and the wedge that faced upwards required a “blind” assembly operation on the part of the user. To solve these problems in future prototypes the team designed joints that separated the links to rotate in parallel planes preventing the interference demonstrated in the proof-of-concept prototype. Additionally the team converted the attachment mechanism from a “pin up” to a “pin down” design. This last design change required the wedge to house the pin sleeve in a way that would not hinder the user’s leg space.

After analyzing the proof-of-concept model, the team developed a comprehensive prototype, shown in Figure 3. Preliminary testing showed that the prototype met all of the design specifications. The new joints demonstrated superior collapsibility and performance over the proof-of-concept model, as shown in Figure 4. However the production of the wooden wedge proved to be very time intensive. Additionally, empirical testing of the design showed that the quality of manufacturing techniques used affected the product’s performance significantly [4]. For optimal performance the design required moderate tolerances between parts; components needed to fit together smoothly with only a little give.

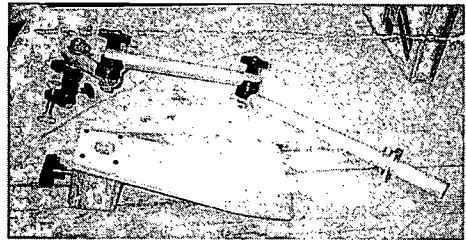

Figure 3. The Alpha prototype used a wooden wedge to keep the overall weight minimal.

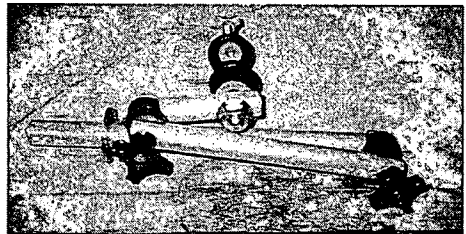

Figure 4. By sizing the lengths of the links the collapsibility of the design can be improved even more.

The final prototype, shown in Figure 5, featured a new aluminum wedge with a slimmer profile to enhance the appearance and comfort under the cushion. The final prototype, called the beta prototype, was manufactured using tolerances of ± 0.005 inches. This close tolerancing led to an overall improvement in performance and appearance caused by a smooth and tight fit between parts.

EVALUATION OF DESIGN

The team had to resolve numerous issues before the beta prototype could be completed. Each prototype involved a great deal of engineering analysis, material selection, manufacturing design, cost analysis, and safety concerns.

The design utilized five independent joints to provide the user with most of the same movements provided by the human arm. The five joints required

the greatest amount of design effort to ensure the proper strength and prevent any slipping. Any loss of strength in the joints might allow the umbrella to swing suddenly and endanger the user. To prevent this the product was designed to be extremely robust. The joints, as well as the materials for the entire device, were chosen with this idea in mind. In wet conditions where the wind gusts frequently at 55 mph, the design should last more than 20 years. Additionally an umbrella the user chooses will likely fail long before the device ever gives way. Even if the user's umbrella fails, the device will keep the broken umbrella in a safe position (away from the user) until the user can take the broken umbrella down.

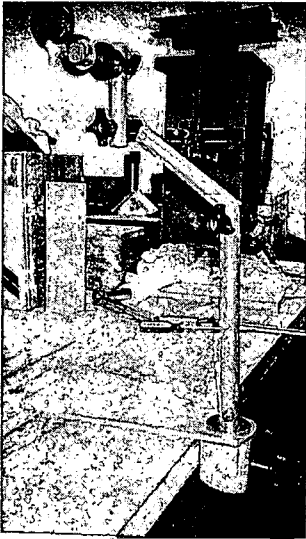

Figure 5. The Beta prototype's aluminum wedge was half the thickness of the wedge used in the Alpha.

The appearance of the design was chosen to minimize its conspicuousness. Interviews with customers showed that they were heavily concerned with how others would perceive the device. The team designed the product to make it as invisible as possible for the user. The wedge slides mostly under the cushion of the wheelchair with the sleeve fitting neatly behind the user's legs. To the average pedestrian, the wedge goes unnoticed. Similarly, the adjustment arm collapses to fit easily in a backpack, briefcase, or underslung basket.

The beta prototype cost the team \$70 to produce. However, large-scale manufacturing and additional manufacturing design would reduce the cost to around \$30 or \$40. This is less than half the cheapest solution available currently. Even in prototyping the device was still \$30 less than any market solution.

The truest test of the design is how the customers perceive it. During the prototyping stage of the design the team frequently interviewed two customers, Mike Gerhardt and Tom Billings. From their interviews the product was designed to their precise requirement. The result was a device that either met or exceeded expectations. When asked to evaluate the design relative to other solutions currently available, Mr. Gerhardt claimed the beta prototype was a great improvement. The new design was easier to use, inexpensive, and better looking than anything available. Should the device find commercial backing our customers are enthusiastic that the device will be extremely successful in enhancing the lifestyles of many people using manual wheelchairs.

ACKNOWLEDGEMENTS

The team would like to express its thanks to Mike Gerhardt and Tom Billings for their frank observations and suggestions. Additionally we are thankful to Dr. Richard Crawford of the Department of Mechanical Engineering, Mary McCarthy of the School of Education, and Jerry Jackson of 3M for their invaluable advice and weekly reviews. Lastly, we would like to thank the members of the other prototyping design teams that contributed to the project during the weekly project design reviews.

REFERENCES

- [1] Ulrich, Karl T. and S. D. Eppinger, *Product Design and Development* (New York: McGraw-Hill, Inc. 1995).
- [2] Pahl, G., and W. Beitz, *Engineering Design*, (Berlin: Springer-Verlag, 1977).
- [3] Otto, Kevin N. "Forming Product Design Specifications" *1996 ASME Design Engineering Technical Conferences and Design Theory and Methodology Conference*, (Irvine, CA, August 18-22, 1996).
- [4] Schey, John A. *Introduction to Manufacturing Process*, Second Edition (New York: McGraw-Hill, Inc. 1987).

Eric Hatcher
 2015 Cedar Bend Drive #602
 Austin, Texas 78758
akasha@utxsvs.cc.utexas.edu
 (512)-832-4117

OUTDOOR EXPLORATION FOR INDIVIDUALS WITH DISABILITIES USING THE ADAPTED HIKING CHAIR

Amy N. Arneson, OTS
Brain K. Held, OTS
University of Puget Sound
School of Occupational Therapy
Tacoma, Washington, U.S.A.

ABSTRACT

There appears to be a lack of opportunities in outdoor adventure for people with disabilities. Although the Americans with Disabilities Act (ADA) advocates equal opportunity and environmental access for all citizens, the current controversy over paving park trails and the slow process of making trails accessible limit opportunities for individuals with disabilities to be included in outdoor recreation. In response to one individual's desire to participate in outdoor adventure activities, the authors devised the Adapted Hiking Chair (AHC). The AHC provides individuals who are non-ambulatory with the opportunity to participate in outdoor recreation activities such as hiking and backpacking while preserving park trails.

BACKGROUND

The authors' friend, Nicole, visits the Pacific Northwest annually. During one of her visits, Nicole commented, "I have been in a wheelchair all of my life and have never been out in the forest before. I love being outdoors, but I feel like my options are limited by the places I can access in my power chair" (personal communication, Fall 1996).

Like many individuals with disabilities, Nicole's outdoor recreation opportunities are few. Her closest encounters with nature are limited to the places she can access by car or in her power wheelchair. If given the opportunity to participate in hiking or backpacking, with appropriate equipment to meet her needs, Nicole stated she would add these to her list of recreation activities (personal communication, Spring 1997).

Nicole's desire is not unique among those with disabilities. Robb and Ewert (1987) report that there exists a lack of opportunity in outdoor recreation for the disabled. In their study of trail setting preferences, Moore, Dattilo, and Devine (1996) report that people with and without disabilities are more similar

than different in their preference for outdoor recreation. In addition, Ingram (as cited by Moore et al, 1996) "noted no correlation between physical, sensory, or cognitive abilities of individuals and their desire for solitude, beauty, challenge, risk, discovery, or adventure in the outdoor environment" (pg. 28).

While the ADA theoretically creates an atmosphere of accessibility for individuals with disabilities, the current strategies available for those with disabilities to participate in outdoor recreation are limited. Through creative problem-solving, these barriers to outdoor adventure may be overcome.

STATEMENT of the PROBLEM

Applying universal design concepts to outdoor recreation sparks controversy. Able-bodied nature-lovers may fear that "accessible" is synonymous with paving all trails to ensure equal access. While some existing trails may allow for mountain peak experiences for individuals in manual wheelchairs, such as the expedition to Guadalupe Peak by the Paraplegics on Independent Nature Trips (POINT) climbers (Kerr, 1997, A-Hiking), options for those in power wheelchairs are even more limited. For people of all abilities to enjoy outdoor adventure activities, there needs to be a solution that can preserve existing trails while providing the outdoor experience for those unable to access it independently.

RATIONALE

The AHC is one way to engage in recreational activities such as hiking, backpacking, and camping, while preserving the trails. After sharing Nicole's frustration at being excluded from weekend hikes, the authors devised a homemade adapted device to take their friend backpacking. The AHC has been modified since that first trip to accommodate a wide variety of needs for individuals with disabilities.

ADAPTED HIKING CHAIR



DESIGN

The AHC allows individuals who are non-ambulatory to experience the splendors of the backcountry while seated securely between two hiking partners. This device easily attaches to external frame backpacks worn by the two hiking companions. Two six-foot fiberglass poles with sections of pipe foam and hose clamps make up the frame of the device. The poles are suspended from the sides of the backpacks by webbing straps (adjustable to the height of the carriers' hips). These straps are secured to the backpacks via the pre-existing pins on the packs. If the location of these pins do not allow the poles to hang at a comfortable height, new holes may be drilled and extra pins can be purchased.

A light-weight seat with a sturdy metal frame is suspended from the parallel poles by varying lengths of webbing. The tilt of the seat can be adjusted to accommodate the needs of the passenger. A VariLite seat cushion provides comfort and hip stability, and adds only minimal weight. The seatbelt and H-strap prevent forward weight-shifts, while the padded poles provide lateral stability. The feet rest in a nylon pocket suspended from the seat and poles, bringing the knees and hips into varying degrees of flexion (can be adjusted to meet individual needs). (see above photo).

DEVELOPMENT

The original AHC required the two hiking partners to wear a large piece of webbing twisted in a figure-8 around their shoulders. A wooden frame of grooved 2x4's then rested directly on the webbing. While this design allowed the partners to rotate their bodies independently of the wood frame to negotiate switchbacks and turns, the straps eventually put too much pressure on their shoulders. Suspended from the boards was a custom-built recumbent bike seat. Because the seat was shallow, a rock climbing harness was added to support the passenger's legs. In addition, the seat back angle of approximately 130° caused increased extensor tone in the trunk and hips. An old life jacket and pillow were used to increase hip flexion and provide symmetrical weight-bearing through the hips (see photo below).

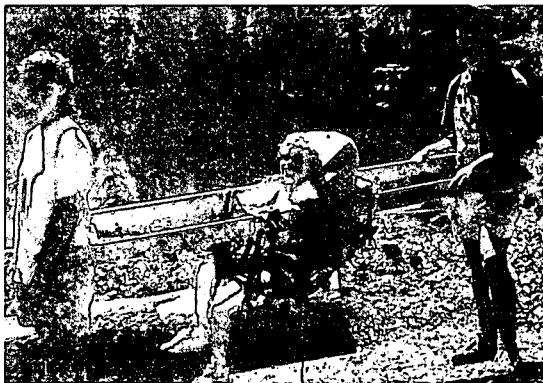

With this makeshift device, Nicole (the author's friend) enjoyed her first trip into the backcountry. "It was a totally awe-inspiring experience. There's nothing like being on the trail, looking around you and seeing God's magnificent creation! It's refreshing to know that disabled people [sic] will have a way of experiencing another one of life's great pleasures" (personal communication, Fall 1997). Nicole's primary complaint was the occasional rubbing of her shoulders on the wooden frame.

Several different ideas were explored when improving the original AHC. One of these ideas included bolting the boards directly to external frame backpacks. Unfortunately, the rigidity of the bolted frame did not allow the carriers to maneuver turns and switchbacks safely or with ease. The present design

ADAPTED HIKING CHAIR

combines the stability and weight-bearing qualities of the backpacks with the flexibility and rotation afforded by the webbing straps and fiberglass poles. The materials used are light weight, durable, and fully adjustable to accommodate a wide variety of unique individuals.

EVALUATION

When evaluating the Adapted Hiking Chair, there are advantages and considerations that both the passenger and the hiking partners should contemplate.

Advantages:

1. All of the products used for the AHC are commercially available.
2. The AHC is lightweight (less than 10 lbs).
3. The hiking partners can carry supplies in the backpacks.
4. The AHC is fully adjustable and can be used with almost any external frame backpack.
5. The hiking partners are close to the passenger to assist with any needs. The compactness of the design also allows for better maneuverability around turns.
6. The AHC disengages quickly and easily from the backpacks in the event of an emergency.

Considerations:

1. The AHC is best suited for individuals under 150 lbs. and for those whose torsos fit between the poles.
2. Although the poles remove from the webbing straps easily, straps which are not permanently fixed to the poles may dislodge more readily in the event of a trip or fall.
3. The H-strap on the AHC is for safety, not for postural concerns. Tightening the H-strap too tightly will pull the passengers into kyphosis. (For those who need increased postural control, the H-strap should be anchored off a rigid, high back to improve the line of pull.)
4. Unlike many assistive devices that depend upon computer technology, safe use of the AHC depends upon the availability, physical fitness and health of the hiking companions. While many may see this as a liability and dismiss this device as dangerous, it is important to remember that outdoor adventure presents a potential risk for everyone, whether able-bodied or disabled.

DISCUSSION

Nicole and her hiking partners, the authors, thoroughly enjoyed their time together on Nicole's first backpacking trip. The original AHC accommodated Nicole's challenging postural concerns, was easy to transport, and was relatively lightweight. The improved AHC design enhances ease of use by the hiking partners and quality of fit for a wide variety of unique individuals. It is important that people with disabilities be given realistic and feasible opportunities for outdoor exploration. The AHC is one way for individuals with disabilities to access outdoor recreation without paving over park trails or waiting for trails to be made wheelchair accessible. Whether your outdoor adventure takes you to the peaks of the Cascade Mountains or to the sands of Death Valley, the Adapted Hiking chair provides an opportunity for individuals with disabilities to reach a pinnacle in outdoor adventure.

REFERENCES

1. Kerr, T. (1997). The mountain trek heard 'round the world. ADVANCE for Occupational Therapists, 13(38), 15&54.
2. Moore, R., Dattilo, J., & Devine, M.A. (1996). A comparison of rail-trail preferences between adults with and without disabilities. Adapted Physical Activity, 13(1), 27-37.
3. Robb, G.M., & Ewert, A. (1987). Risk recreation and persons with disabilities. Therapeutic Recreation Journal, 21(1), 58-69.

ACKNOWLEDGEMENTS

This project was developed in part for:
OT 466/666 (Assistive Technology)
Prof. Yvonne Swinth, Ph.D., OTR/L
University of Puget Sound
Tacoma, Washington, U.S.A.

In addition, the authors would like to acknowledge the support, expertise, and donations of the following: Bob Ghent, MPT, Jim Hagglin, Steven Nash, Duane Rhodes, Steve Shores, MOT, OTR/L, Ron Stone, MOT.

Amy Arneson
1804 N. Union
Tacoma, WA 98406
e-mail: aarneson@ups.edu

VOICE ACTIVATED ENVIRONMENTAL CONTROL UNIT

Gregg Browinski, Douglas Thompson, Sean O'Connell

Assistive Technology Program, Electrical and Computer Engineering Department

University of Massachusetts at Lowell

Lowell, MA, U.S.A.

ABSTRACT

Voice activated applications have become increasingly more prevalent with recent advances in the field of voice recognition technology. The design and implementation of a versatile, fully functional voice activated environmental control unit is detailed. A full evaluation of the system as it is installed and in use by a quadriplegic is given.

BACKGROUND

Research in the field of computer aided voice recognition began in earnest in the early 1970s¹. Progress in the field was slow at first. The complexities associated with the wide range of inflection and utterances produced by humans proved to be a large obstacle at first². The past 10 years, however, have seen an explosion of research and subsequent advancement. Private research aimed at creating products for the consumer market and a 2000-fold increase in computing power have transformed the concept of voice activation from a space age fantasy to today's reality³.

Sam Afroh is someone who can immediately benefit from these recent developments. An automobile accident six years ago left Sam paralyzed from the neck down. Though he does have enough mobility in his arms to operate a motorized wheelchair, his quadriplegia has stripped him of his finer motor skills. A team of three UMass/Lowell students was introduced to Sam by the Electrical Engineering Department's Assistive Technology Program (ATP).

STATEMENT OF THE PROBLEM

The team's goal was to design and realize a flexible voice driven system able to

control the environment within Sam's apartment. The system would be developed under close collaboration with Sam and would need to be reliable and safe while remaining cost-effective.

RATIONALE

The preliminary phase consisted of a series of meetings with Sam to determine his needs and establish a set of objectives. The television, lights, and heating system were eventually stated as devices that the system would control. These would be controlled under the provision that they remain detached and operable in the normal fashion should the need arise.

Further discussions concerned the operation of the system. An intuitive interface with the ability to provide feedback to the user was deemed highly desirable. It was also agreed upon that system operation should not require Sam to be in any one location, but should be available from anywhere within his apartment.

The system itself would be divided into three distinct components: the voice recognition (VR) engine, a controlling platform, and the hardware.

Three traits were essential to the VR engine. It was to be fast, accurate, and customizable. Most engines come packaged with a dictionary of tens of thousands of words that can be recognized. As only a small subset of those would be needed for the project, the flexibility of the engine was paramount.

The controlling portion of the system would represent the visual and audible interface to the user in addition to serving as the arbitrator for the entire system. It would be

fast, modular for easy modification, and standardized. It was decided that the controller would be written in the Visual Basic (VB) programming language. VB's standard Window's interface, versatility, and quick turn around time outweighed the slight performance edge of any compiled languages.

The hardware portion would have to be linked to Sam's present devices but not interfere with their current modes of operation. A standard Universal or All-in-One remote control would provide access to his TV while X-10 technology would control his lights and any other plug-in devices. Both options represented safe and economical means of controlling the devices in Sam's apartment.

DESIGN

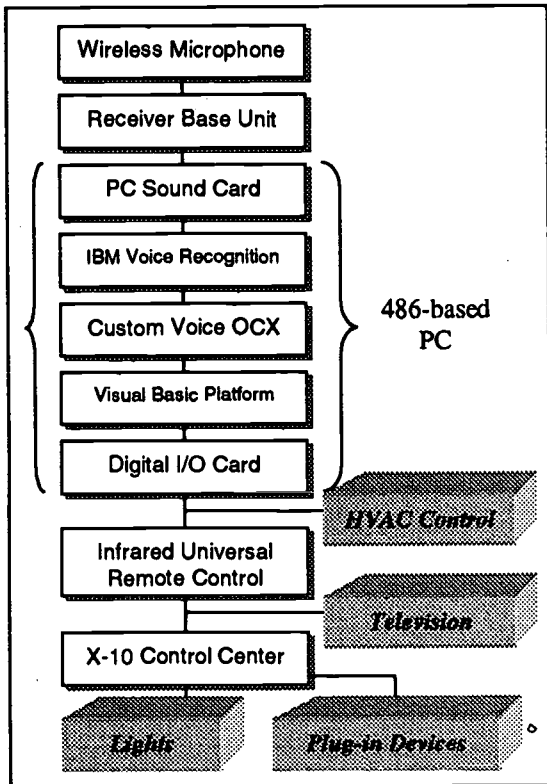

Figure #1 – Block Diagram of System

The system receives its voice input from a head worn wireless microphone. This allows Sam the freedom to move about in his apartment while maintaining control of the system. A RF link connects the microphone to the base unit, which is then channeled into a standard PC sound card.

From here, the VR engine, IBM's Voice Type Application Factory, interprets the speech and returns the associated text to the VB program through a third party Custom Control or OCX. The VB program, essentially a state machine, then either changes state or writes a sequence of bits out to a digital I/O card.

Each external device has a pattern of bits, or ID, associated with it. For the remote, each bit pattern specifies a single button. Sam's ventilation system is controlled by a series of logic gates and relays whereas his lights and television are controlled through the interfaced universal remote control. Using "Plug 'n Power" or X-10 technology, lights and outlets can be toggled while the remote communicates directly with the TV once the correct manufacturer's code has been entered.

DEVELOPMENT/EVALUATION

In keeping with the modularity of the overall design, the VR portion used *context files*, listings of acceptable words, for each program state. The effects of this on the VR were twofold. Restricting the number of possible matches resulted in simultaneously improving its accuracy and speed.

The VB program was modular in its series of drop-down menus. To promote usability, the menus reflected the layout of Sam's apartment. Each room had a corresponding drop-down menu containing a list of the devices in that room. This had the effect of shortening the user's learning curve by "personalizing" the menus and program flow.

The universal remote was attached to the digital I/O card via an RS-232 cable. After determining the pin-out from the remote's

controlling IC for each button, the sequences were hard-coded into the VB program. Switching relays were used to simulate the pressing of the buttons. The "Plug 'n Power" button accessed the X-10 control center, which toggled the individual X-10s directly.

After testing each component individually, the three were integrated into the finished system. Due to the close collaboration with Sam throughout the design process installation proceeded smoothly but for one oversight. The problem stemmed from the need to control Sam's cable converter box in conjunction with his television set. This affected initial power up of the television as well as all channel manipulations as they now needed to be transmitted to the cable box. Volume control still resided with the television.

The decision to ensure that the hardware was not proprietary proved essential here as the versatility of the design was demonstrated. Communication with the cable box was established once the manufacturer's code for frequency transmission was obtained from the remote manual. Thereafter, the interfaced remote communicated with the cable box exactly as it would have done with the television, necessitating no architectural modifications and only minimal coding change.

DISCUSSION

The highlights of the design can be grouped into four main categories: power, flexibility, usability, and cost-effectiveness.

The power of the system lies in the use of voice recognition. Any individual without a severe speech impediment can use it. It gives the user's voice the ability to accomplish what their bodies cannot. The devices controlled by this system are just a subset of those currently being developed to use voice recognition. Home security systems, mechanized doors and curtains, and thermostats are all now available for voice activation with new products continually being developed.

The versatility of the system was proven upon its installation at Sam's. The modularity built into the VB program and VR engine ensure that any modifications can be made quickly and without affecting current system operation.

User-friendliness was a factor in the design from the very beginning. The wireless microphone gives the user freedom of movement within their home while visual and audible prompts are relayed back during operation to enhance user awareness. The VR engine has up to a 95% successful recognition rate, but if the engine makes any mistakes, they can be undone by a spoken RESET command available in all contexts.

Although the system requires a PC for operation, the 486 based machine used in the initial system had recognition times of nearly one second and an overall response time of just over two seconds. Commercially available systems with comparable functionality may cost \$5000 and up, whereas the total component cost for this design was slightly under \$1200.

REFERENCES

1. Wilpon, J. (1994). *Voice Communication between Humans & Machines*. New York, NY, National Academy of Social Insurance.
2. Markowitz, J. (1996). *Using Speech Recognition* (1st ed.). Upper Saddle River, NJ, Prentice-Hall PTR.
3. Patterson, D., J Hennessy (1994). *Computer Organization and Design*. San Francisco, CA, Morgan Kaufmann Publishers, Inc.

ACKNOWLEDGMENTS

Project supported by The Assistive Technology Program, which is sponsored in part by grants from the National Science Foundation and corporate sponsors. Thanks also go out to Douglas Thompson and Sean O'Connell for devoting their time and helping this project come to fruition.

DESIGN OF A WHEELCHAIR-ACCESSIBLE SHELVING SYSTEM

David Thompson
Ravindra Upadrashta
Shawn Siegel
University of Texas at Austin
Austin, TX
USA 78712

ABSTRACT

The aim of this project was to design and prototype a device that would give people in wheelchairs access to storage as efficient as bookshelves. Eight people, with mobility constraints or those working with a person with mobility constraints, participated in the customer survey. The resulting device is an carriage that can be attached to shelving. The carriage is used to fetch bins from the shelving and bring the bin to a comfortable access point.

BACKGROUND

No one likes standing on tip-toe or crawling on the ground to reach a book. However, most people can when pressed. For those that cannot, bookshelves can be distressing encounters. Still, almost everyone needs bookshelves or the like to store and organize books and other small objects. This is because shelves make such efficient use of space, effectively letting piles grow much higher than would be normally stable. Thus, the task we undertook this semester was to design and prototype a device that would give people in wheelchairs access to storage as efficient as bookshelves.

As was hinted above, the customers we could consider for this device are a much larger group than those in wheelchairs. For example, many elderly have limited flexibility and cannot reach all of the shelves on a bookshelf. However, we considered people in wheelchairs our primary customers.

STATEMENT of the PROBLEM

The functionality of shelves we are interested in achieving is storage, display, and retrieval of objects. While display is not an immediately obvious function of shelving, it is critical because it allows for comfortable navigation of a large number of objects.

RATIONALE

With the problem defined we now turn to the constraints and assumptions of the project. The main assumption is that either the user or the objects must be moved since we are dealing with a limited access space. Moving the user would require large amounts of power and make at least some users uncomfortable. In addition, we assume that the objects to be stored would fit on nominal bookshelves.

We also placed constraints on acceptable designs: First, the device cannot require supervision or assistance; the main purpose of wheelchair-accessible shelving is to increase independence. Secondly, the device must be assembled and, to most extents, manufactured using common tools. The purpose of this is to allow easy assembly, adjustment, and maintenance. With these preliminary decisions made, we can begin the design process.

DESIGN AND DEVELOPMENT

The design of the shelving system followed an organized process set forth by Ulrich & Eppinger(1995) and Pahl & Beitz(1977). The design process was created to reduce the amount of time required to complete a design, to help yield the best possible design by considering as many alternatives as possible, and to keep the design focused on what the customers want. The first steps in the process involve interviewing customers and ranking the importance of the needs they mention. In rough order of importance, the most important needs are that the device

- must provide access to the items at the right height and allow the wheelchair as close as possible, so that heavy items can be handled.
- must not be obtrusive or block any paths by the shelves.

WHEELCHAIR ACCESSIBLE SHELVING SYSTEM

- must hold at least book-sized items and smaller, but larger items are not extremely important.
- should be inexpensive.
- should withstand regular, heavy use.
- should retrieve items quickly.
- should fit in place of or onto existing shelves.
- should not damage fragile objects.
- should retrieve several items at a time.
- should be manually powered or must at least have manual override.
- should be useful at both home and work.

From these needs, the design's function is mapped out at an abstract level. This description of the device doesn't include any references to *how* a task is completed, just what the task is and what inputs it relies upon. The design team then comes up with several different ways of how to accomplish each task and "glues" these together to form several concepts for how the device might physically operate. For the shelving system, three concepts were generated.

The first concept moves items on the left half of the shelves up until they reach the top and then over to the right side and down. At the bottom the items are shifted back to the left side to repeat the journey. This way, all of the items are eventually circulated around to the correct height. The second concept rotates an entire shelf on a pole placed at one end of the shelving system and then slides the shelf down the pole for access. The third concept requires that all the items are stored in bins placed on the existing shelves. A moving carriage is then positioned in front of a bin and pulls the bin off the shelf. The carriage is then lowered to allow access to the items in the bin.

The concepts are then evaluated by modeling how well each one fits the customer requirements. The third concept proves to be the best by a small margin because it does not require as much work to be done by the user, since only one bin is being lifted at a time. The primary customer was contacted with the results to make sure that the design decisions met with his approval.

The second interview with our primary customer went well; there was no objection to using bins as long as the items inside are still visible. Since clear bins are available, this is not a problem.

The design, shown in Figures 1 and 2, uses two vertical poles to guide the carriage vertically; wire rope runs from a crank case at the bottom of the poles, over the top, and to the carriage. The crank handle at the bottom is used to move the carriage up and down. The poles, carriage, and crank all move horizontally on runners at the top and bottom shelves. The top runner holds a counterweight to keep the poles from applying large vertical loads to the bottom runner. The top runner has stops at each end and is further kept from leaving the top shelf by a safety wire attached to the wall. In the event that a heavy load is applied to the carriage, the pulleys that hold the wire rope at the top and bottom will collapse, allowing the carriage to move down several inches. If this does not diminish the load, the guide poles will come loose from the top runner.

The carriage has side panels to keep objects from falling. The bottom of the carriage is a set of rollers that can be turned from below with a rope that hangs from the rear of the carriage. The rollers serve to pull bins, which protrude slightly past each shelf edge, off of the shelves.

OPERATION

The device operation consists of several simple steps. To retrieve a book, the carriage and guide poles are rolled horizontally to an alley on the shelves where there are no bins protruding. The carriage is then raised to the correct shelf with the hand crank and rolled to the correct bin. The rope on the carriage is then pulled to move the bin off of the shelf. A latch is provided on the crank case to keep the carriage from moving vertically while this is done. Once the bin is in the carriage, the carriage may be rolled back to the alley where it was raised and then lowered to rest on the crank case for access. Storing items is the same operation in reverse.

WHEELCHAIR ACCESSIBLE SHELVING SYSTEM

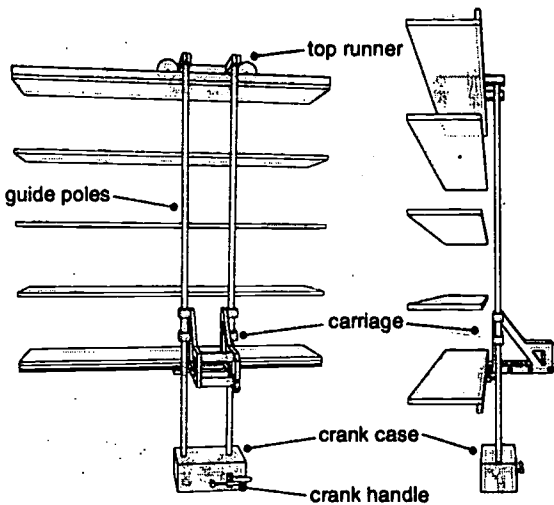

Figure 1 The final design.

CONCLUSIONS

The shelving system in its current form meets all the specifications set forth by the customers. Although some joints are not as smooth as we had hoped, we are confident that with access to more accurate tools, these problems can be eliminated. In addition there are several tasks that would enhance the utility and breadth of applicability of the device.

Because we were aimed at one primary customer, the device is designed to fit one type of shelving (wall-hanging). The design could easily be expanded to fit a variety of shelves. Another feature to add would be a small section of shelving that would rotate and allow the carriage to be stowed against the wall so that it does not protrude from the shelves when not in use.

REFERENCES

G. Pahl and W. Beitz., Engineering Design. Springer-Verlag 1977.

Karl T. Ulrich and Stephen D. Eppinger., Product Design and Development. McGraw-Hill 1995.

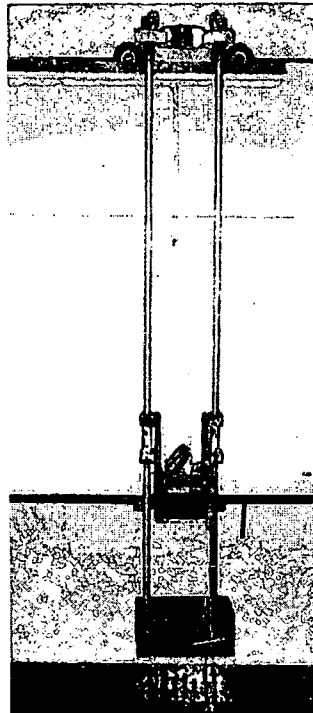

Figure 2 The prototype.

ACKNOWLEDGEMENTS

The authors would like to thank Tom Tyree of the University Affiliated Program for his patience and optimism.

David C. Thompson
University of Texas at Austin.,
Department of Mechanical Engineering
ETC 4.134., Mail Code C2200.,
Austin., TX 78712
USA.

DESIGN OF AN EXERCISE ARCADE FOR CHILDREN WITH DISABILITIES

Gary L. Downey
Michael J. Rosen, Ph.D.
The University of Tennessee-Memphis
Memphis, Tennessee, USA

ABSTRACT

Boing! is an "exercise arcade" that provides fitness, fun and social interaction primarily for children with disabilities. It offers aerobic, resistance and range of motion exercises with the appeal of a video arcade by use of a single bungee cord and transducer mounted overhead. The motion of the bungee cord, attached to the child's harness or limb, is sensed by the transducer. A computer reads the transducer signal and rewards the child with sounds, graphics, games, and video clips according to the Director™ software as specific exercise goals are achieved.

BACKGROUND

Children with disabilities are often limited in their purposeful movements and their participation in recreational and physical activities with typical children. These limitations diminish their fitness level and self esteem. Unlike typical preadolescent children who maintain their health through everyday activity, children with disabilities may need time with a special exercise device which can provide a leveled playing field. This opens the door for social interaction among friends and family.

Boing!, an "exercise arcade", began as the project for *Product Design For People With Disabilities (PDPD)*, a hands-on design course conducted in the Spring of 1996 at the University of Tennessee-Memphis. It has now been completely redesigned as the subject of a master's thesis.

STATEMENT of the PROBLEM

No affordable and flexible device developed to meet the physical activity

requirements of children with disabilities is currently on the market. The goal of this design project was to define the fitness needs of a population of children with disabilities and design and prototype an exercise device that met those criteria.

RATIONALE

A product motivating exercise with fun could improve the fitness of children with disabilities. To date the **Boing!** thesis project has focused on the needs of children with cerebral palsy (CP). However, the **Boing!** concept is not limited to CP; additional "gamercises" which meet the needs of other populations could easily be developed.

Numerous studies have shown that when children with CP participate in exercise their fitness level improves considerably. The outcome of the '94 *PDPD* course showed that a child with athetoid spastic CP obtained a noticeable increase in the strength of her legs and ankles and was more capable of holding her head and torso erect as a result of utilizing a custom made walker (Durham-Read, 1995). Damiano found that children with CP who participated in a bilateral quadriceps-strengthening program could increase the strength of their quadriceps to the point where they did not differ statistically from the norm (Damiano et al., 1995).

Other studies have shown that children with CP can increase their aerobic capacity by physical training. Peak oxygen uptake values improved by 8% (Bar-Or et al., 1976), and heart volume increased an average of 5% (30mL) (Lundberg et al., 1967).

Boing!

DESIGN

The **Boing!** frame consists of three main pieces fabricated from steel tubing. The circular base is 68 inches in diameter and supports two parabolic arches. These arches are 78 inches high and are connected at their apexes.



An optical mouse transducer senses the motion of the bungee cord and relays the positional data to the computer. The transducer is inside a vertical housing which is attached to the apex of both arches. Although the transducer travels vertically, motion of the bungee cord in

any direction can be detected by the use of a 360° pulley system. The pulley system consists of four rollers mounted on the inside of a square housing and an articulating mounting arm which secures the housing to the **Boing!** frame.

The code for three gamercises – aerobic, resistance and range of motion – was written by Dr. Stan Cronk at the University of Tennessee Rehabilitation Engineering Program using Director™ software. The aerobic gamercise, *Picture Show*, asks the child to move from a seated position to a standing position inside the frame while wearing a chest strap connected to the end of the bungee cord. As the child stands up, the transducer sends a signal to the software to produce a noise (e.g. belches, whistles, “yahoos!”). After the noise has occurred, pieces of a picture are revealed on the computer monitor. When the picture is revealed completely, the child is awarded a brief video clip. The object of *Cactus Gulp*, the resistance gamercise, is to move a watering can at the same pace as a moving cactus. The can is moved as the child performs leg extensions

inside the frame. The end of the bungee is passed through the pulley system to redirect bungee motion and is then attached to a padded leg cuff. Once the cactus grows to the therapist-specified height, the child is rewarded with a video clip. During the range of motion activity, *Balloon Pop*, the child sits inside **Boing!** trying to reach an adaptive single switch. Use of an articulating mounting arm allows the switch to be positioned anywhere within the frame volume. As the child contacts the switch, the transducer senses a mouse click and relays the information to the software. A soft pop is heard as the screen displays a slowly popping balloon. After a specified number of repetitions the child is rewarded with a video clip. All three games are accessed through one main screen where the variables can be specified by the therapist. Gamercise difficulties can be adjusted to allow a child with disabilities to compete with a friend or family member who may not have a disability.

DEVELOPMENT

Four major areas were examined during **Boing!** development, beginning with client requirements. Ms. Melanie Moore, a pediatric physical therapist at the Germantown Campbell Clinic, was consulted about the most common exercises for children with CP. Among her top exercises were “crossing the midline” (range of motion), “quadriceps contraction” (resistance) and “sit to stand” (aerobic).

Flexibility of **Boing!** was also a necessity. **Boing!**'s software allows a therapist to customize the gamercises according to the needs of the child. **Boing!**'s flexibility also includes the development of a 360° pulley which allows the child to receive feedback by moving any limb in any direction.

The third area examined was cost-effectiveness. The frame design depended on finding an affordable and easily manufacturable material with a sufficiently high strength to weight ratio. Although its strength to weight

Boing!

ratio was lower, steel was chosen over aluminum because of the labor intensive cost involved in bending an arch out of aluminum. The final cost for **Boing!** was \$3400.

Aesthetics was the final major area examined. The original class prototype was very sterile and industrial looking. Now **Boing!** not only looks fun and playground-like, but its arch configuration increases the frame's strength-to-weight ratio.

EVALUATION

An informal survey is being conducted at the Campbell Clinic during a continued clinical trial of **Boing!**. Results to date are very favorable. **Boing!** has received a 100% favorable response on items such as aesthetics, stability, sturdiness, game learnability, sustaining the child's interest, appeal to children without disabilities, and physical benefit to the user. **Boing!** also received high marks for having a toy-like appearance and for child's comfort level during use. The user's reactions to **Boing!** are very positive evoking comments like "Wow!," "Love it!," "Keep going!" and "Do it again!"

DISCUSSION

The next design evolution should include an increase in the interior volume of the frame so the therapist will have adequate room to enter inside with the user. The *Cactus Gulp* resistance gamercise should be overhauled to create a more intuitive mapping scenario as well as an interface that is easier to set up. The therapists are also requesting a screen option allowing them to select the type of video clips seen so they can customize according to the user's preferences. Some of the therapists have also requested an additional harness similar to a life jacket that will provide increased support for users that require it.

Boing! has earned reviews in *Memphis Health Care News* and *The Memphis Business Journal* while attracting companies interested in

its production. A United States patent is being pursued by The University of Tennessee Research Corporation. Further development of **Boing!** continues at The National Rehabilitation Hospital in Washington D.C.

REFERENCES

- Bar-Or O, Inbar I, Spira R, (1976). Physiological effects of a sports rehabilitation program on cerebral palsied and post-poliomyelitic adolescents. *Medicine and Science in Sports*, 8(3), 157-161.
- Damiano DL, Vaughan CL, Abel MF, (1995). Muscle response to heavy resistance exercise in children with spastic cerebral palsy. *Developmental Medicine and Child Neurology*, 37, 731-739.
- Durham-Read K, (1995). *Design of a Mobility Device for Children with Athetoid-Spastic Cerebral Palsy*. Memphis, TN: The University of Tennessee-Memphis.
- Lundberg A, Ovenfors CO, Slatin B, (1967). Effect of physical training on school-children with cerebral palsy. *Acta Paediatrica Scandinavica*, 56, 182-188.

ACKNOWLEDGMENTS

Funding for **Boing!** has been provided by The Crippled Children's Foundation. We would like to thank Dr. Stan Cronk for his diligent code writing and the University of Tennessee Rehabilitation Engineering Program for the use of equipment and facilities. We would also like to thank Ms. Melanie Moore for her consultation and clinical trial provision.

Gary L. Downey
The Capper Foundation
3500 SW 10th Avenue
Topeka, KS 66604
(785) 272-4060
downey@capper.org

Author Index

- Abbas, J.J., 220
Adams, K., 352
Aissaoui, R., 110, 146, 167
Akers, J.M., 214, 226
Albright, S., 176
Arneson, A.N., 396
Arnott, J.L., 255
Asghar, M.W., 103
Aubin, C.E., 143
Austin, M., 292
Axelson, P.W., 113, 140,
161, 209, 350, 358
Bahrain, K.H.K., 66
Bain, B.K., 57
Baldwin, M.A., 128, 131, 170, 378
Ball, L., 44
Barner, K.E., 103, 278
Batiste, L.C., 305
Baylis, T., 206
Beattie, W., 255
BeMent, L., 381
Bertocci, G., 34, 37, 40
Betz, R.R., 214, 226, 229, 232
Blaise, B., 75
Bogie, K., 241
Bonaroti, D., 226
Boninger, M.L., 128, 131,
134, 155, 170, 176, 378
Bouzidi, A., 269
Brennan, D., 78
Brienza, D.M., 122, 125
Browinski, G., 399
Brown, M., 78
Bruno, C., 164
Brykman, L., 361
Burdett, R., 155
Burger, D., 269
Burhan, D., 302
Carlberger, J., 50
Cavalier, A., 318
Chae, J., 217, 241
Chee, B.Y., 308
Cheng, J., 179
Cheng, B., 179
Cheng, D.P.K., 260
Chesney, D.A., 140, 209, 340, 358
Chizinsky, K.A., 140, 340, 358
Chow, D.H.K., 72
Cleghorn, W., 173
Cole, T.G., 197
Cooper, R.A., 128, 131, 134,
137, 155, 170, 176, 191, 378
Cooper, R., 191
Corkran, J.T., 188, 352
Cozens, J., 292
Cress, C.J., 44
Cuttino, J.F., 119
Cuyot, C., 149
Dang, T., 75, 78
Dansereau, J., 110, 143, 146,
149, 152, 158, 167
Davis, S.E., 232
Davis, K., 20
Demers, L., 158
Dhalla, I.A., 63
Dickinson, R.A., 369
Didi, N., 289, 295
Dionne, M.J., 143
Downey, G.L., 405
Drastal, S.D., 57
Dunn-Gabrielli, S., 60
Dupont, A.C., 387
Dvorznak, M., 134, 137
Edwards, H.C., 8
Edwards, M.M., 8
Edwards, R., 302
Edyburn, D., 17
Esteireiro, J., 34
Faghri, P.D., 238
Fang, Z.P., 217
Ferguson-Pell, M., 20
Fernie, G., 173, 366
Feyen, R., 335
Finson, R.L., 226
Fleming, B., 314
Folkedal, A.T., 161
Fridie, S.E., 20
Garber, S.E., 326
Garcia, D., 249
Garg, A., 11
Geyer, M.J., 122
Gips, J., 298
Gokhale, C., 355
Goldberg, D.A., 106
Goldthwaite, J., 88
Gonzalez, J., 134
Grabowski, N.A., 103
Grandjean, B., 295
Grow, P., 11
Grubbs, R.L., 95
Grup, J., 206

Gryfe, P., 54
 Gunderson, J., 5, 343
 Habdank, K., 63
 Hadjadj, D., 269
 Hafner, B.J., 272
 Hammel, J., 14
 Hampton, S., 393
 Harp, A.J., 188, 352
 Harper, G., 255
 Hase, K., 182
 Hatakeyama, T., 263
 Hatcher, E., 393
 Hefzy, M.S., 206
 Held, B.K., 396
 Heller, T., 14
 Hershler, C., 63
 Hine, N., 255
 Hirose, H., 182, 194
 Hobson, D., 37, 155
 Hoffman, A.H., 164
 Hovorka, C.F., 238
 Huggins, J.E., 381
 Hunnicutt, S., 50
 Inoue, T., 182
 Irvin, W., 314
 James, M.A., 229
 Jinks, A.F., 47
 Jones, M., 329, 332
 Jones, D.K., 176
 Jutai, J., 54
 Karg, P., 37, 40, 122, 125
 Kasuga, M., 263
 Kawai, T., 194
 Kelsey, S.F., 122
 Kelso, D., 346, 361
 Kenney, D.E., 60
 Khalsa, A., 82, 85
 King, P., 11
 Kinose, T., 194
 Kirsch, R.F., 375
 Kobetic, R., 384
 Koester, H.H., 257, 266
 Kohler, J.A., 92
 Koizumi, Y., 263
 Kon, B.D., 92
 Koo, T.K.K., 72
 Koontz, A.M., 131, 170
 Krohe, J., 249
 Kushwaha, R.K., 381
 Lacoste, M., 110, 149, 152, 158
 Lalonde, N., 110
 Law, C., 346
 LeBlanc, R., 149, 152, 158
 Leifer, L.J., 286
 Letechipia, J.E., 29
 Leung, V., 179
 Levine, S.P., 381
 Li, Y., 146
 Linden, M.A., 69, 116
 Liu, D., 134, 137
 Liu, M.Q., 235
 Logie, H., 57
 Loy, B.A., 305
 Loyd, D., 278
 Luebben, A.J., 8
 Luncher, J., 75
 MacLeod, S.T., 358
 Maltais, C., 149
 Malzahn, D., 66, 308, 355
 Mancil, G.L., 100
 Marquez, C., 252
 Matheis, D., 314
 McMillan, W.W., 266
 McMulkin, M.L., 66, 249
 Mihailidis, A., 366
 Milchus, K., 88
 Miller, S., 200
 Mokhtari, M., 289, 295
 Morgan, S.C., 63
 Mulcahey, M.J., 226, 229, 232
 Muraleedharan, A., 393
 Naganathan, N., 206
 Nantais, T., 252
 Naumann, S., 72
 Nead, C., 57
 Nemunaitis, G., 206
 Ng, K.K.T., 72
 Noiseux, J., 75
 Noon, J.H., 113, 161, 209
 O'Connell, S., 399
 O'Connor, T.J., 131, 170, 378
 Ogino, T., 194
 Okada, S., 194
 Owens, J.M., 119
 Pange, B., 302
 Parent, F., 167
 Perry, T., 393
 Pesce, W.J., 238
 Plummer, A., 292
 Ramarajan, R., 355
 Rentschler, A., 134, 137
 Richmond, F.J.R., 387
 Richter, W.M., 140, 340
 Riess, J., 220
 Ringaert, L., 26
 Riordan, B., 69
 Rivers, E.A., 2
 Roby-Brami, A., 289, 295
 Rohde, M.M., 381
 Romilly, D.P., 63

Rosen, M.J., 405
 Ross, D.A., 100
 Sadeghi, H., 167
 Sakajiri, M., 194
 Sanders, J.E., 272
 Sauer, M., 329, 332
 Saur, T., 155
 Sax, C., 311
 Schaller, B., 206
 Schrager, S., 278
 Schuller, R., 366
 Sears, J.T., 106
 Seedhom, B., 292
 Shein, G.F., 246, 252
 Shimada, S., 128, 170, 378
 Shimodaira, C., 194
 Shum, S., 179
 Siegel, S., 402
 Siekman, A.R., 113, 161
 Simpson, R.C., 257
 Singh, K., 387
 Smith, B.T., 214
 Smith, J.B.T., 229
 Smith, L.G., 140, 340
 Smith, R.O., 11, 17
 Sprigle, S.H., 69, 116
 Stanger, C., 82, 85
 Stanley, M.K., 17
 Stauth, J.T., 369
 Stephens, S., 302
 Sudoh, Y., 182
 Tai, C., 134, 137
 Tam, E.W.C., 73, 185
 Thomas, C., 34
 Thompson, D., 399
 Thompson, D., 402
 Thompson, W., 314
 Tierney, M.C., 366
 Tierney, M.L., 203
 Tin, C.F., 185
 Tobias, J., 349
 Todd, R.L., 23
 Todd, B.A., 119
 Tracey, M.R., 275
 Trachtman, L., 329, 332
 Treffer, E., 122, 155
 Tremblay, C., 152
 Triolo, R.J., 217, 223, 235, 241, 375, 384
 Troy, B.S., 60
 Uchio, M., 263
 Uhler, J.P., 223, 384
 Umeda, Y., 263
 Upadrashta, R., 402
 Usiak, D.J., 95
 van Roosmalen, L., 40
 Van der Loos, H.F.M., 286
 Vance, C., 206
 Vanderheiden, G.C., 346, 349, 361
 Vanderheiden, K., 349
 Vogel, L.C., 229
 Wagner, J.J., 286
 Wagner, J., 308
 Walker, L., 321
 Walker, M.E., 217
 Weaver, J., 335
 Weiss-Lambrou, R., 152, 158
 Werner, K.N., 375
 Wibowo, M.A., 223, 384
 Williamson, K., 200
 Willits, M., 60
 Willkomm, T., 282
 Wisnia, R.J., 161
 Wong, S., 179
 Wong, K.M., 358
 Wright, W.E., 358
 Yanco, H.A., 298
 Yap, R., 60
 Yatogo, T., 194
 Yi, S.J., 206
 Ying, G.S., 14
 Yoder, D., 329, 332
 Young, J., 173
 Young, T., 34, 40
 Yu, D.T., 217
 Zachariah, S.G., 272
 Zhao, W., 375

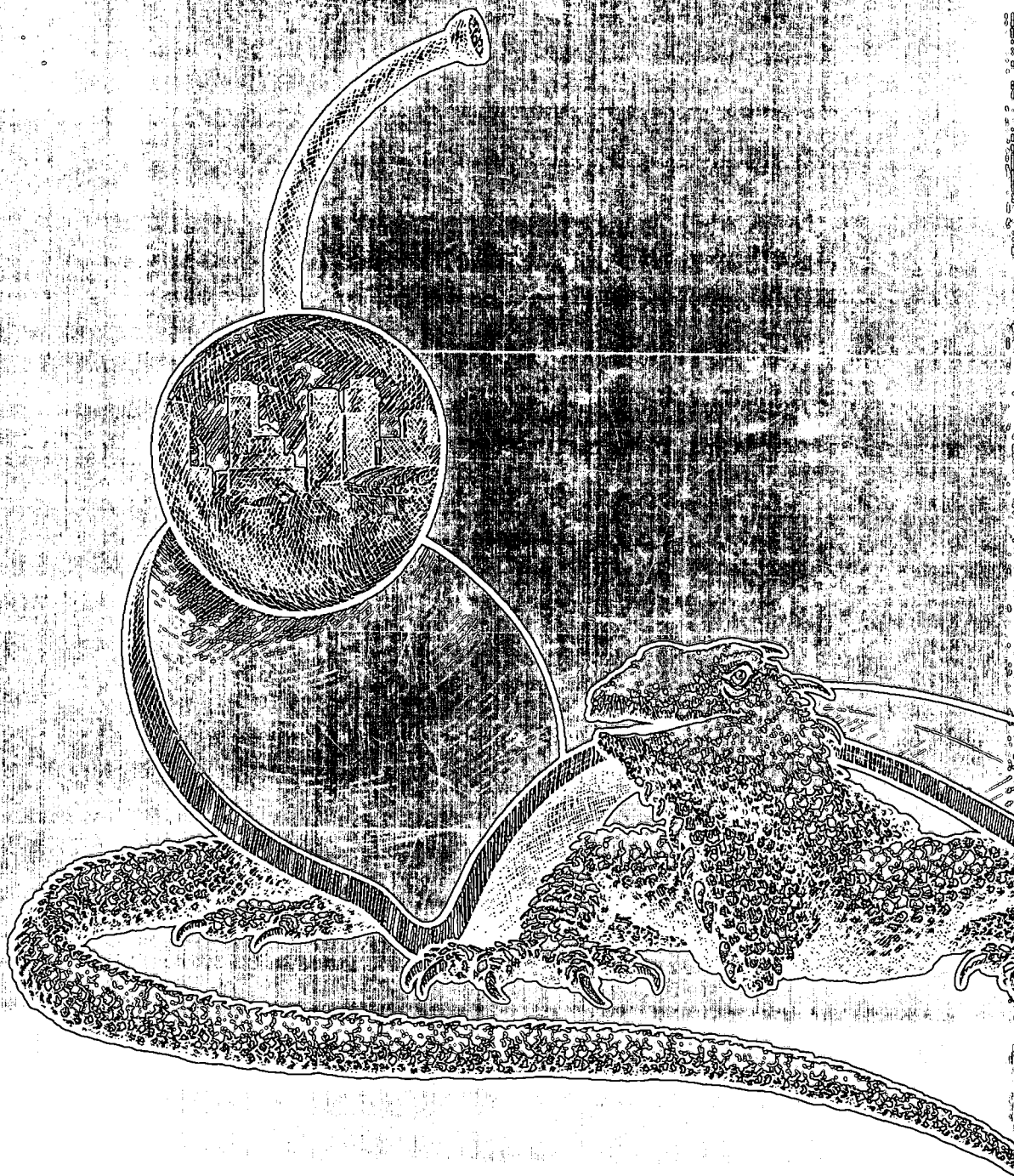



U.S. Department of Education
Office of Educational Research and Improvement (OERI)
National Library of Education (NLE)
Educational Resources Information Center (ERIC)



NOTICE

REPRODUCTION BASIS



This document is covered by a signed "Reproduction Release (Blanket) form (on file within the ERIC system), encompassing all or classes of documents from its source organization and, therefore, does not require a "Specific Document" Release form.



This document is Federally-funded, or carries its own permission to reproduce, or is otherwise in the public domain and, therefore, may be reproduced by ERIC without a signed Reproduction Release form (either "Specific Document" or "Blanket").