

DOCUMENT RESUME

ED 447 957

PS 029 066

TITLE The EPA Children's Environmental Health Yearbook Supplement.
INSTITUTION Environmental Protection Agency, Washington, DC. Office of Children's Health Protection.
REPORT NO EPA-100-R-00-0018
PUB DATE 2000-08-00
NOTE 220p.; For the health yearbook, see PS 029 064.
PUB TYPE Reports - Descriptive (141)
EDRS PRICE MF01/PC09 Plus Postage.
DESCRIPTORS *Child Health; *Children; *Environmental Education; Environmental Influences; *Environmental Research; Program Descriptions; Research Projects
IDENTIFIERS Environmental Health; *Environmental Protection Agency

ABSTRACT

Through their environments, children are exposed to a wide variety of substances that provide a risk to children's health. This report provides information to the public on the work of the Environmental Protection Agency (EPA) related to children's health protection, summarizing initiatives undertaken since the publication of "The EPA Children's Environmental Health Yearbook" in 1998 and updating some ongoing projects. Recent national accomplishments of the EPA are described, including the Centers of Excellence in Children's Environmental Health Research, the Workshop of Valuing Children's Health Effects, and the Child Health Champion Campaign. Initiatives are summarized in the following areas: (1) asthma and other respiratory effects; (2) childhood cancer; (3) developmental and neurological toxicity; (4) health effects of pesticides; (5) potential risks from contaminated water; (6) predicting health risks to children; (7) protecting children worldwide; (8) environmental education related to children's health; and (9) enhanced community right-to-know activities. The report also contains an updated list of Children's Health Resources. (Most chapters contain references.) (KB)



The EPA Children's Environmental Health Yearbook Supplement

U.S. DEPARTMENT OF EDUCATION
Office of Educational Research and Improvement
EDUCATIONAL RESOURCES INFORMATION
CENTER (ERIC)

X This document has been reproduced as
received from the person or organization
originating it.

Minor changes have been made to
improve reproduction quality.

• Points of view or opinions stated in this
document do not necessarily represent
official OERI position or policy.

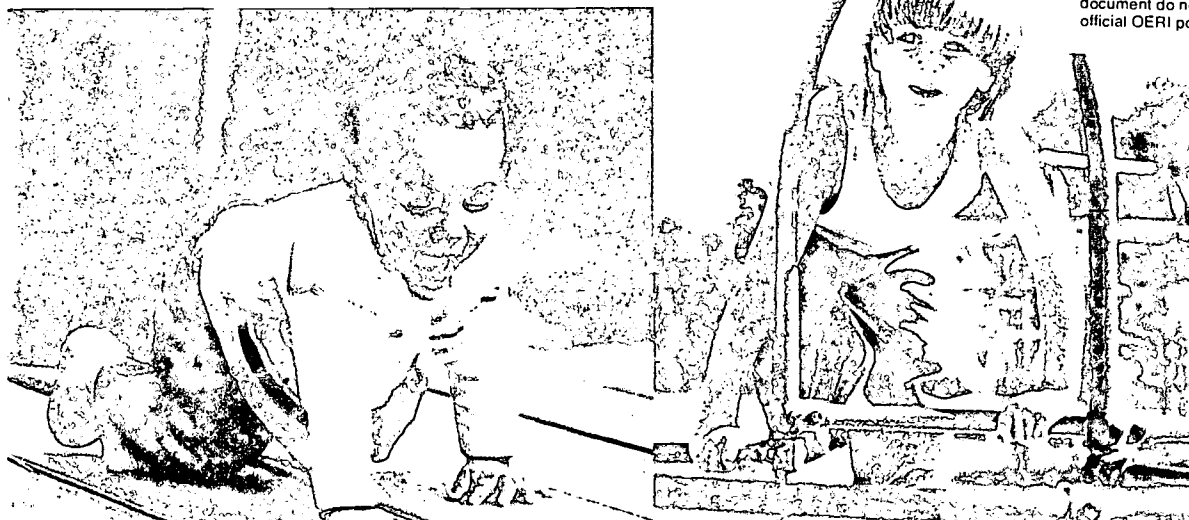

*"Ensuring our children a safe,
healthy environment is of
paramount importance, and we
will do it with strong actions,
guided by sound science."*

—Vice President Al Gore

BEST COPY AVAILABLE

029066

The EPA Children's Environmental Health Yearbook Supplement

United States Environmental Protection Agency
Office of Children's Health Protection, MC 1107
Washington, DC 20460-0001

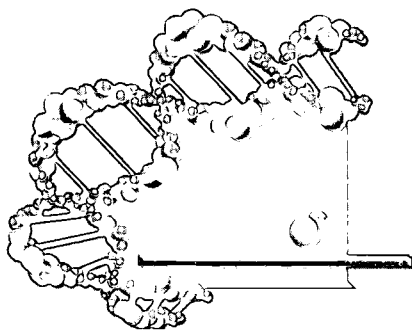

CONTENTS

Chapter 1 Introduction	6
Purpose of this Supplement	7
Children's Environmental Health Protection: Highlights of EPA's Recent National Accomplishments	7
Centers of Excellence in Children's Environmental Health Research	7
Children's Environmental Health and Safety Inventory of Research	10
Institutionalizing Children's Health Protection in EPA's Rule Making	10
Federal Advisory Committee on Protection of Children's Environmental Health	10
Reviewing Existing Regulations and Standards	11
Workshop on Valuing Children's Health Effects	11
Child Health Champion Campaign	11
Incorporating Children's Environmental Health Into Youth-Based Organizations	14
Targeting Criminal Violations that Threaten the Health and Safety of Children	15
State Profiles - Children's Environmental Health	15
Promoting Children's Environmental Health with Pediatric Chief Residents	15
Action to Eliminate Major Uses of the Pesticide Dursban to Protect Children and Public Health	15
Tips to Protect Children from Environmental Threats	16
References	18
 Chapter 2 Asthma and Other Respiratory Effects	 20
Improving Indoor Air Quality	20
Improving Outdoor Air Quality	22
EPA Projects on Asthma and Other Respiratory Effects	23
Indoor Air Quality Tools for Schools	23
Environmental Tobacco Smoke (Secondhand Smoke)	29

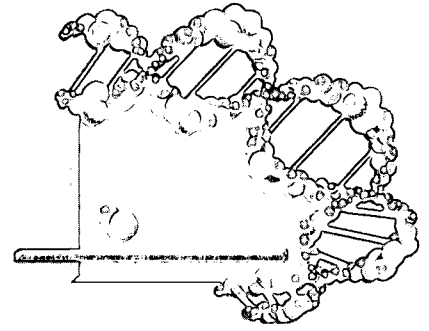

Indoor Air General Outreach and Interventions	33
Research on Indoor Air Quality and Asthma and Other Respiratory Illness Among Children	45
Outdoor Air Quality	51
Research on Outdoor Air Quality and Asthma and Other Respiratory Illness Among Children	52
References	55
Chapter 3 Childhood Cancer	56
EPA Projects Related to Cancer	57
Radon	57
Asbestos	58
Ultraviolet (UV) Light	59
Research on Childhood Cancer	61
References	63
Chapter 4 Developmental and Neurological Toxicity	64
EPA Projects on Developmental and Neurological Toxicity	65
Lead	65
Endocrine Disruptors	86
PCBs	86
Mercury	87
Other Research	88
References	93
Chapter 5 Health Effects of Pesticides	94
EPA Projects on Health Effects of Pesticides	95
Strengthened Standards and Better Public Information	95
Support for Integrated Pest Management	98

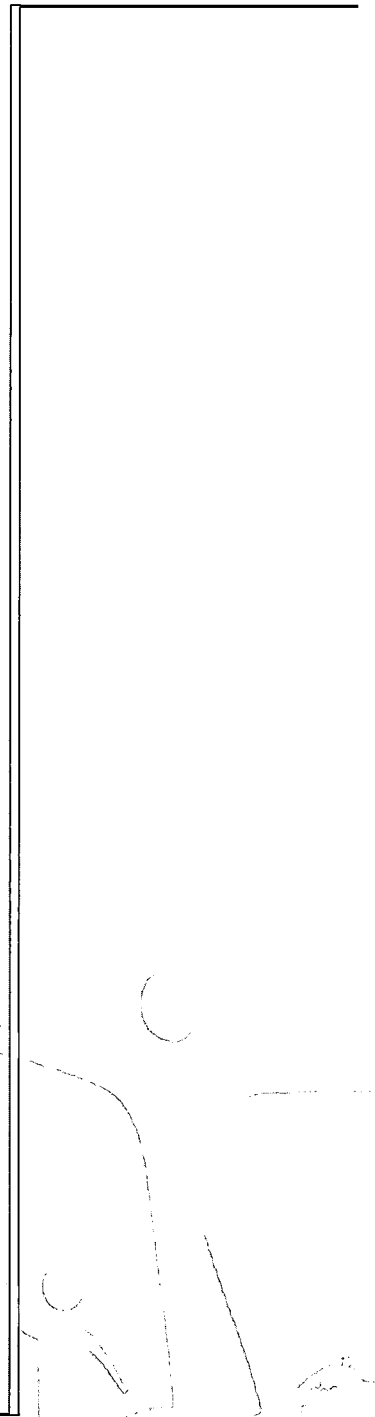

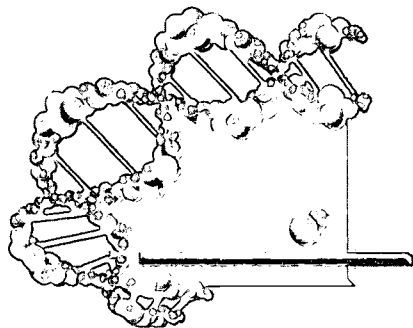

Expanded Enforcement Efforts	100
Understanding Risks to Children's Health	102
References	111
Chapter 6 Potential Risks from Contaminated Water	112
EPA Projects on Contaminants in Water and Fish	113
Contaminants in Water	113
Contaminants in Fish	118
References	119
Chapter 7 Predicting Health Risks to Children	120
EPA Projects to Improve Risk Assessment	121
Water	121
Hazardous Waste	122
Exposure	126
Cumulative Risk	134
Chapter 8 Protecting Children Worldwide	136
EPA International Projects	137
Asthma and Other Respiratory Effects	137
Developmental and Neurological Toxicity	139
Health Effects of Pesticides	141
Potential Risks from Contaminated Water	142
Chapter 9 Environmental Education Related to Children's Health	144
EPA Environmental Education Projects	144
Health Care Providers	144

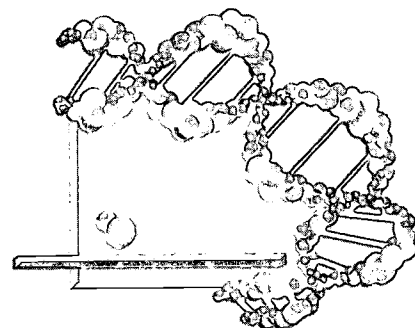

Pediatric Centers	145
Other Environmental Education Projects	146
Chapter 10 Enhanced Community Right-to-Know	158
EPA Community Right-to-Know Activities	159
Chapter 11 Children's Health Resources	162
Contacting EPA	162
EPA Headquarters	162
EPA Regions and Regional Children's Environmental Health Coordinators	163
Obtaining EPA Publications	169
EPA Materials, Tools, and Internet Resources Related to Children's Health	171
Inventory of Children's Health Research Projects	171
Asthma and Other Respiratory Effects	171
Childhood Cancer	179
Developmental and Neurological Toxicity	185
Health Effects of Pesticides	191
Potential Risks from Contaminated Water	195
International Activities	202
Environmental Education	202
Enhanced Community Right-to-Know	207
Other Federal Agencies with Programs Related to Children's Environmental Health	209
Index: EPA Program Offices and EPA Regions	211

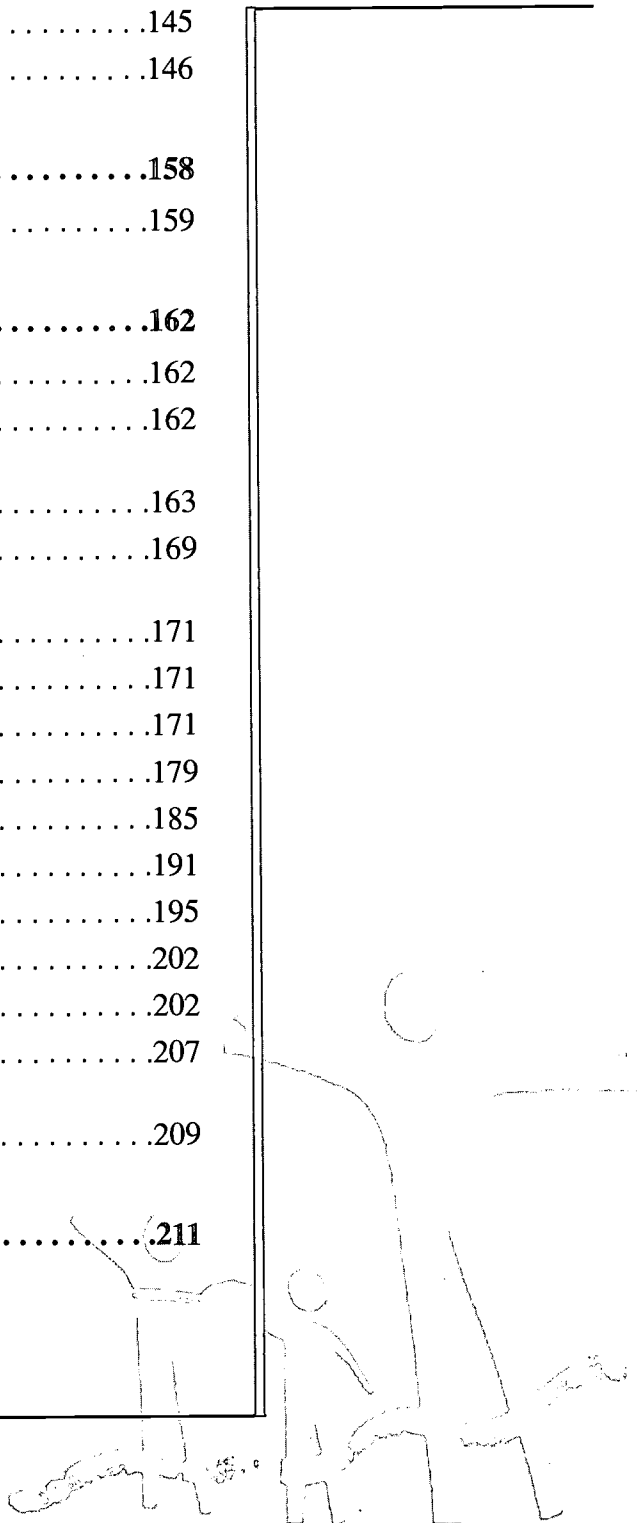

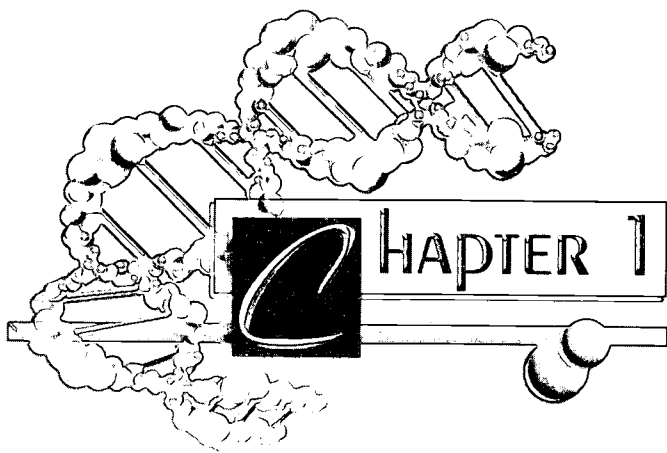

INTRODUCTION

Through their environments, children are exposed to a wide variety of substances that can affect their health. Environmental risks are a potential concern for children in all geographic areas and from all walks of life. For example:

- Poor indoor and outdoor air quality is linked with an increased risk of respiratory illnesses, especially asthma, in children.(1)
- Nearly 12,400 children and adolescents under the age of 20 are diagnosed with cancer each year in the United States. Approximately 2,300 children and adolescents die of cancer each year.(2) Brain tumors and leukemia, the most prevalent forms of the disease in children, have been linked with pesticide use in and around the home.(3,4,5,6,7)
- Lead, a heavy metal that can harm a child's brain, kidneys, and other systems, remains one of the most pervasive developmental toxic substances in America.(8,9)
- Children and women of childbearing age may be at increased risk, compared to other groups, from exposure to contaminated fish and disease-causing organisms in sewage-contaminated water.(10)
- In recent decades, about 50,000 synthetic chemicals have been produced in the United States, and many of these substances have dispersed into the environment.(11)

Children may have a special vulnerability to certain toxic substances, for a variety of reasons. Pound for pound of body weight, children breathe more air, drink more water, and eat more food than adults. In addition, their behavior patterns, such as playing close to the ground and engaging in hand-to-mouth activities, can increase their exposure to potential toxic substances in the environment. Damage to developing organ systems may carry lifelong consequences.(12,13)

Protecting children's health against environmental threats is among the Clinton administration's highest priorities. In April 1997, President Clinton signed the Executive Order on the Protection of Children from Environmental Health Risks and Safety Risks. This Executive Order requires all federal agencies to assign a high priority to addressing health and safety risks to children, coordinate research priorities on children's health, and ensure that their standards take into account special risks to children.

In May 1997, EPA Administrator Carol M. Browner established the Office of Children's Health Protection (OCHP) to support the Agency as it implements the

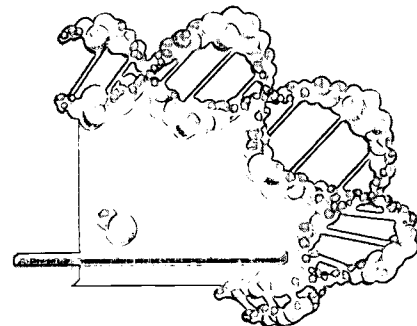

President's Executive Order, as well as EPA's National Agenda to Protect Children's Health from Environmental Threats. The mission of OCHP is to make the protection of children's health a fundamental goal of public health and environmental protection in the United States.

PURPOSE OF THIS SUPPLEMENT

In June 1998, EPA published *The EPA Children's Environmental Health Yearbook*, a compilation of EPA (Headquarters and Regional Office) activities on children's health. The document provides information to the public and serves as a tool to identify the Agency's work in children's health protection. The Yearbook includes sections on asthma and other respiratory effects, childhood cancer, developmental and neurological toxicity, health effects of pesticides, and potential risks from contaminated surface water and ground water. Additional chapters describe improvements in predicting health risks to children, highlight international activities to protect children, identify educational programs addressing issues of children's health, and describe EPA's expansion of individuals' and families' right to know about environmental hazards. The final section directs readers to additional EPA resources for more information.

Since the Yearbook's publication, EPA has undertaken a number of new initiatives and many additional projects focused on protecting children's health from environmental risks. This Supplement provides a summary of new projects and updates to some ongoing projects already described in the Yearbook. It also includes a complete, updated list of Children's Health Resources for further information.

CHILDREN'S ENVIRONMENTAL HEALTH PROTECTION: HIGHLIGHTS OF EPA'S RECENT NATIONAL ACCOMPLISHMENTS

CENTERS OF EXCELLENCE IN CHILDREN'S ENVIRONMENTAL HEALTH RESEARCH

On October 10, 1998, the Vice President announced the establishment of eight research centers dedicated solely to the study of children's environmental health hazards. A strong feature of these centers is the combination of clinical research and community interventions. The centers are jointly funded by EPA and the Department of Health and Human Services (DHHS).

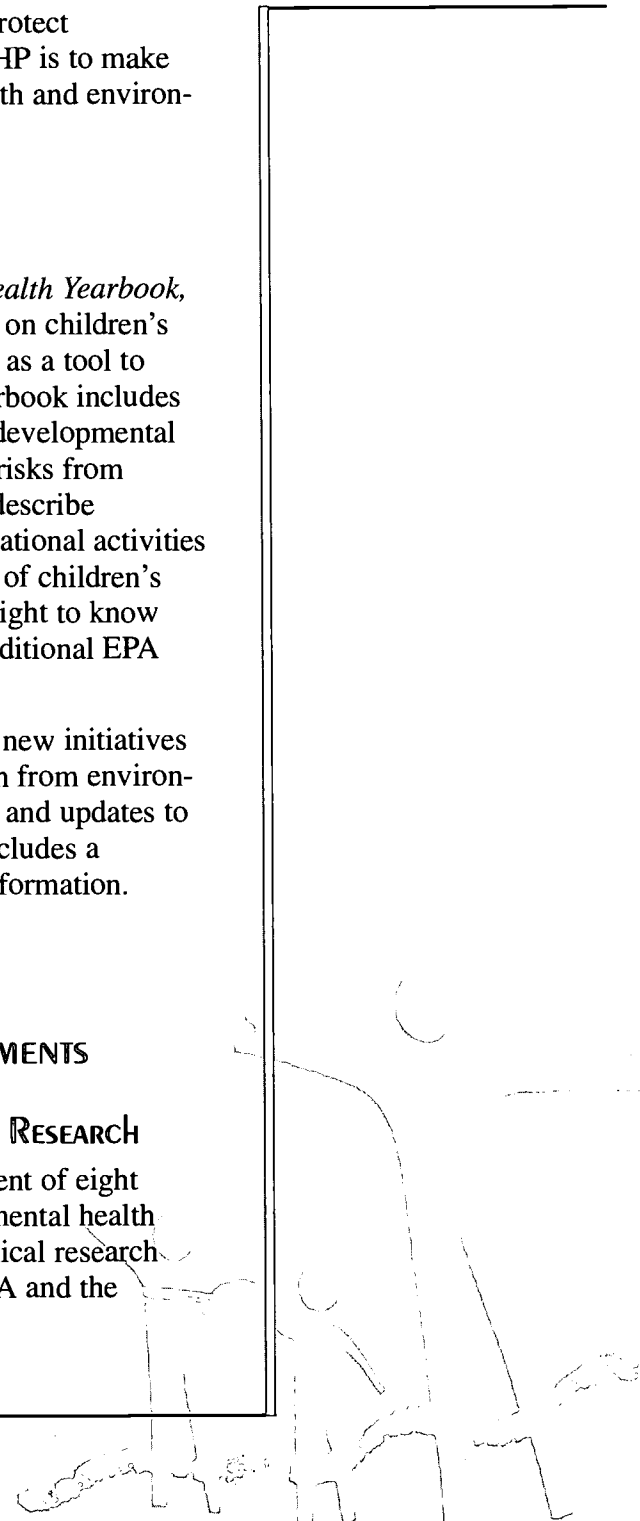

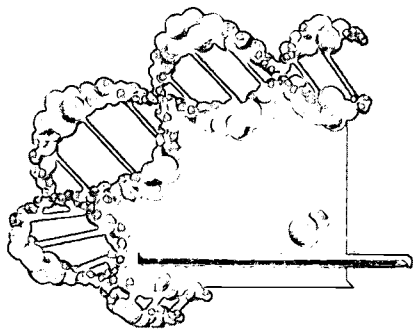

***University of Southern California, Department of Preventive Medicine
Los Angeles, California***

The University of Southern California Department of Environmental Health is investigating the relationship of secondhand tobacco smoke and other environmental health threats to the development of asthma in children. In partnership with Concerned Citizens for Central Los Angeles, Communities for a Better Environment, and Mothers of East Los Angeles, the Center is conducting research in Los Angeles communities to develop tools for health and environmental officials to better protect children's health.

***University of Iowa, College of Medicine
Iowa City, Iowa***

The College of Medicine at the University of Iowa is investigating respiratory illness in children from rural communities. Together with the Keokuk County Rural Health Study, researchers are examining causes of asthma in children living in rural Keokuk County and developing a multi-component approach for reducing levels of respiratory illness among children in rural areas.

***University of Michigan, School of Public Health
Ann Arbor, Michigan***

The University of Michigan School of Public Health is studying environmental factors that contribute to pediatric asthma. Working with the Kettering/Butzel Health Initiative, Detroit Health Department, Warren/Conner Development Coalition, Butzel Family Center, Latino Family Services, and United Community Housing Coalition, researchers are conducting assessments of asthmatic children in Detroit and using findings to develop initiatives to reduce asthma among inner city children.

***Johns Hopkins University, School of Medicine
Baltimore, Maryland***

The Johns Hopkins University Hospital School of Medicine is examining the role of air pollutants, such as particulate matter, environmental tobacco smoke, and ozone, in rising asthma rates among inner city children. By studying students in Baltimore City Schools, researchers will determine how exposures to environmental pollutants and allergens relate to asthma and will develop new ways to protect children from environmental health risks.

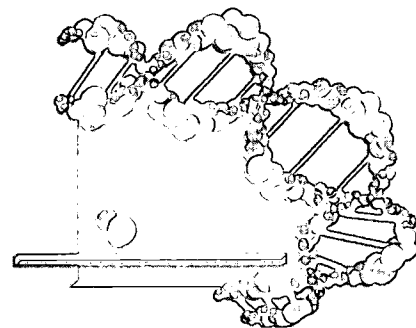

***University of California at Berkeley, School of Public Health
Berkeley, California***

The School of Public Health at the University of California at Berkeley is evaluating the impact of pesticide exposure on children's growth and development. Working with La Clinica de Salud del Valle de Salinas and La Natividad Medical Center, the school is studying the effects of pesticide exposure in children of the agricultural community of Salinas, California, and developing methods to protect children from health risks associated with pesticides.

***University of Washington, Department of Environmental Health
Seattle, Washington***

The University of Washington Department of Environmental Health is conducting research on the special vulnerability of children to health risks from pesticides. In conjunction with the Washington State Migrant Council, this Center is implementing research and intervention projects among children of farm workers in the state's Yakima Valley to provide local, state, and federal officials with new tools and approaches for improving the health of children in agricultural regions across the nation.

***Mount Sinai School of Medicine
New York, New York***

The Mount Sinai School of Medicine is undertaking research to identify, characterize, and prevent developmental effects among inner city children resulting from exposures to pollutants that occur in their diets and homes. In cooperation with East Harlem Community Health Committee and the Boriken Neighborhood Health Center, Mount Sinai is developing both direct and indirect methods for reducing household exposures to pollutants and will attempt to apply these methods broadly across East Harlem.

***Columbia University, School of Public Health
New York, New York***

The Columbia University School of Public Health is investigating the relationship between environmental pollutants, such as particulate matter and environmental tobacco smoke, and the incidence of asthma among inner city children. Working in partnership with West Harlem Environmental Action, Inc. and the New York State Department of Health, this Center is developing and evaluating a community-wide

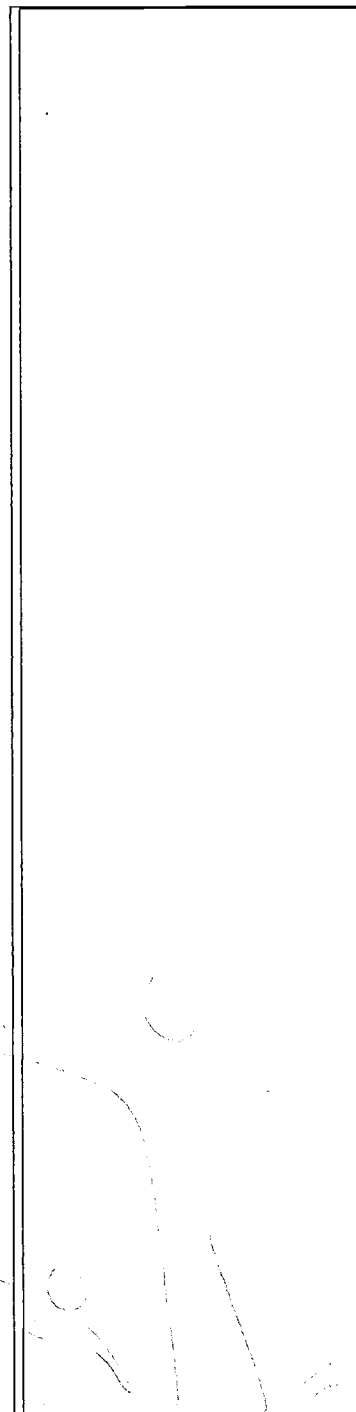

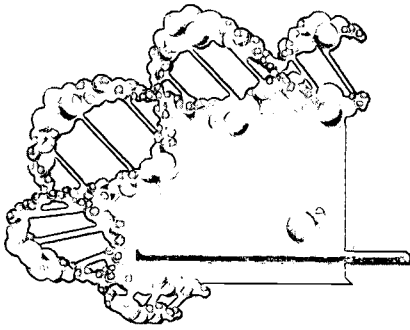

intervention to increase the awareness of environmental hazards and educate community members to prevent and reduce them.

Information on the Centers can be found on the Internet at <http://www.epa.gov/children/three.htm>, or contact Chris Saint, Office of Research and Development, 202-564-6909.

CHILDREN'S ENVIRONMENTAL HEALTH AND SAFETY INVENTORY OF RESEARCH

The Children's Environmental Health and Safety Inventory of Research (CHEHSIR) is a database of federally funded or sponsored research on environmental health risks and/or safety risks that may uniquely or disproportionately affect children. The database was created as an interagency effort under the President's Task Force on Environmental Health and Safety Risks co-chaired by EPA and DHHS. The inventory is available to all federal agencies, researchers, and the public through the Internet at <http://www.epa.gov/chehsir>. The current database contains information from six departments/agencies and represents 532 research projects. The entire database will be moved to the National Library of Medicine.

INSTITUTIONALIZING CHILDREN'S HEALTH PROTECTION IN EPA'S RULE MAKING

In November 1998, EPA published a final Guidance for Rule Writers to help them comply with Executive Order 13045, "Protection of Children from Environmental Health Risks and Safety Risks." This Guidance includes advice to EPA risk assessors and managers who are developing regulatory standards that are specifically targeted at pregnant women, infants, and children. In developing standards, EPA now consistently seeks out data on hazards, exposures, and dose-response functions that may indicate disproportionate risks to children.

FEDERAL ADVISORY COMMITTEE ON PROTECTION OF CHILDREN'S ENVIRONMENTAL HEALTH

EPA has established a balanced, broad-based external Advisory Committee, chartered under the Federal Advisory Committee Act, on children's environmental health. This Committee includes participants from industry, pediatric medicine, science/academia, nursing, environmental organizations, citizen organizations, federal, state/local/tribal government, environmental justice communities, community organizations, economists, and citizens-at-large. The Committee is EPA's way of

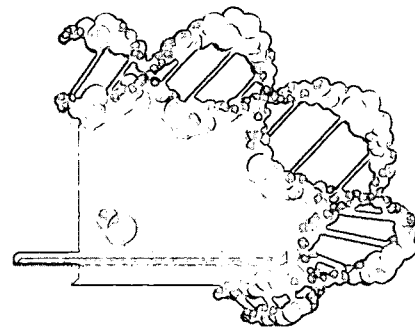

obtaining outside expert advice from the perspective of children's health protection on a variety of issues, including evaluation of EPA standards regarding children's health protection from environmental risks, economic benefits analysis, communications and outreach, and science. The full Committee has convened nine times since December 1997.

REVIEWING EXISTING REGULATIONS AND STANDARDS

OCHP, together with the EPA's program offices and the Office of General Counsel, and in response to public comments and recommendations of the Children's Health Protection Advisory Committee, identified eight regulations and regulatory areas for review. These were published in the February 3, 1999, *Federal Register*. EPA is currently reviewing the following regulations:

- Chloralkali plants national emission standard for hazardous air pollutants.
- Organophosphate pesticides tolerances for methyl parathion, chlorpyrifos, and dimethoate.
- Atrazine tolerance and maximum contaminant level.
- Farm worker protection standard.

WORKSHOP ON VALUING CHILDREN'S HEALTH EFFECTS

In March 1999, EPA and the National Science Foundation sponsored a workshop on valuing children's health effects. The workshop brought together leading economists to share and discuss ideas on this issue. Currently there is little information on how to value children's health when conducting benefit/cost analyses. In preparation for the workshop, EPA commissioned several research papers. These papers, along with the information generated at the workshop, will be used to develop a Children's Health Valuation Handbook.

CHILD HEALTH CHAMPION CAMPAIGN

On May 21, 1998, the First Lady announced a new EPA pilot program, the Child Health Champion Campaign, designed to empower local citizens and communities to protect their children from environmental health threats. Eleven communities are involved in the Campaign pilot. Each community assessed and prioritized potential

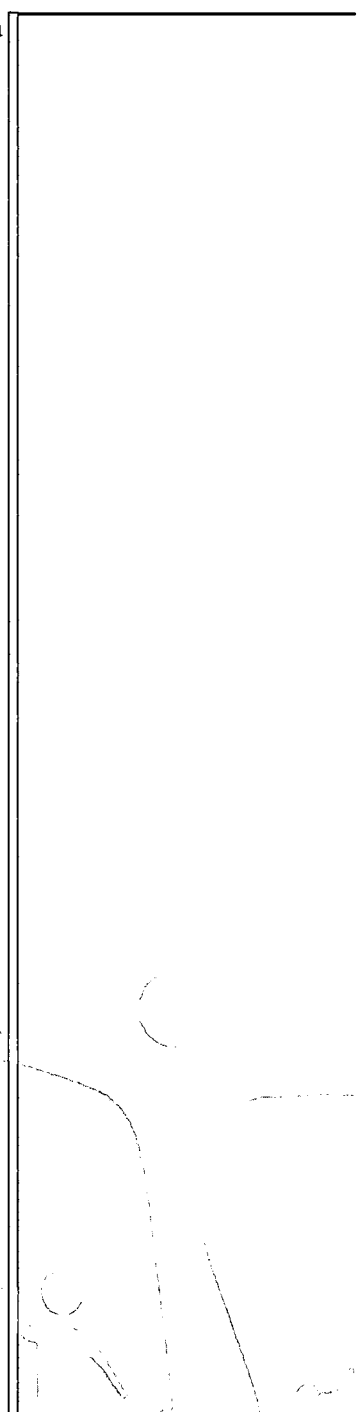

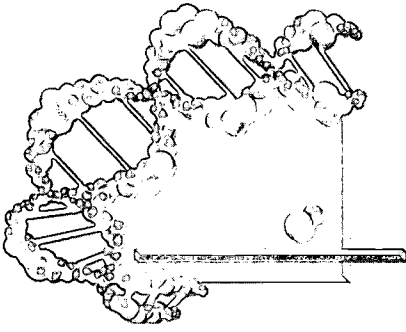

environmental hazards to children, set community-specific goals for selected hazards, and established action plans to meet each of the goals. The communities are now in the implementation phase of the program. A national evaluation of the pilot is being conducted.

Manchester, New Hampshire (EPA Region 1)

Through the Child Health Champion program, local organizations in this community are promoting awareness of several key issues affecting children's health, including lead poisoning, asthma, and the dangers of secondhand smoke. One grantee, the Way Home, is conducting home visits to identify children at risk for lead poisoning and asthma and to provide education on preventive measures. (EPA contacts: Alice Kaufman, 617-918-1064, or Pat Hamlin, 617-918-1584)

Ironbound Section, Newark, New Jersey (EPA Region 2)

The Ironbound Community Corporation (ICC) coordinates Region 2's Child Health Champion project, which focuses on the environmental causes of asthma. ICC has recruited and trained residents to become "Asthma Busters," who are conducting education in the community on asthma. Other education and outreach efforts, including an Asthma Information and Referral Service, also are under way. (EPA contacts: Rachel Chapat, 212-637-4001, or Terry Ippolito, 212-637-3671)

Anacostia Section, Washington, DC (EPA Region 3)

This Region's Community Team is focusing on indoor air pollutants as triggers for asthma and other illnesses. Several outreach tools—children's workbook, children's television program, and interactive website—are being designed to reach children and parents through schools and a public housing project. (EPA contacts: Gail Tindal, 215-814-2069, or Dan Welker, 215-814-2744)

Prichard, Alabama (EPA Region 4)

The Prichard, Alabama, Community Team selected childhood asthma and lead poisoning as the environmental health hazards of greatest concern. The team has developed partnerships with the elementary schools for this initiative. A database on the effects of asthma is being compiled from the schools and local health care providers. Interventions include the establishment of a children's environmental health repository and hotline, implementation of the *Indoor Air Quality (IAQ) Tools for Schools* program in all public and private schools, coordinating community integrated pest management (IPM) programs, establishing satellite learning centers with programs addressing children's environmental health hazards, and conducting

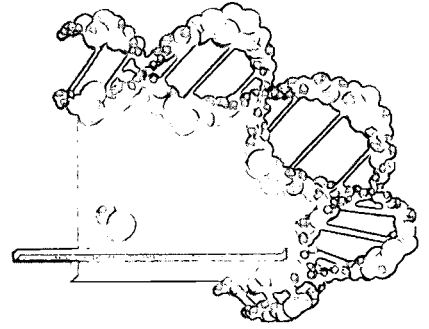

asthma screening, lead poisoning testing, and child health education activities. (EPA contacts: Wayne Garfinkel, 404-562-8982, or Al Hanke, 404-562-8954)

Near South/North Side Sections, Milwaukee, Wisconsin (EPA Region 5)

The Milwaukee Team is focusing on asthma and indoor air quality in homes and schools. A variety of activities are planned or under way, including distribution of an Asthma Care Plan, indoor air quality assessments in schools, an Asthma in the Air video, home visits, and an Awesome Asthma School Days program. (EPA contacts: Jeanette Marrero, 312-886-6543, or Afif Marouf, 312-353-5550)

Cherokee Nation, Talequah, Oklahoma (EPA Region 6)

This team is tackling the problem of contaminated drinking water, a problem that affects two-thirds of the drinking water sources tested. The Cherokee Nation has set a goal of providing clean drinking water to approximately 1,000 children under the age of 16 (10 priority area water systems) within 3 years. Activities include conducting public education and outreach as well as taking steps to prevent bacterial contamination of drinking water. (EPA contacts: Evelyn Daniels, 214-665-7543, or Steffanie Crossland, 214-665-6684)

New Madrid County, Missouri (EPA Region 7)

The New Madrid County Tri-Town Project has identified three priorities for protecting children's health: lead, asthma/allergies, and water. Community leaders presented project goals at a well-attended kick-off meeting, and resource centers are being established in each of these communities. (EPA contact: Althea Moses, 913-551-7649)

Chippewa Cree Tribe, Rocky Boy's Reservation, Montana (EPA Region 8)

The Chippewa Cree Child Health Champion Team is conducting a wide variety of activities on children's health issues. Examples include blood-lead testing through local schools; presentations for Earth Day on such subjects as lead, water pollution, dam safety, and pesticides; and educational activities on environmental health hazards at the annual Rocky Boy Pow-Wow. (EPA contact: Jennifer Wintersteen, 406-441-1130)

Nogales, Arizona (EPA Region 9)

In the City of Nogales, located on the U.S.-Mexico border, Region 9 established a Child Health Champion Community Team composed of representatives from

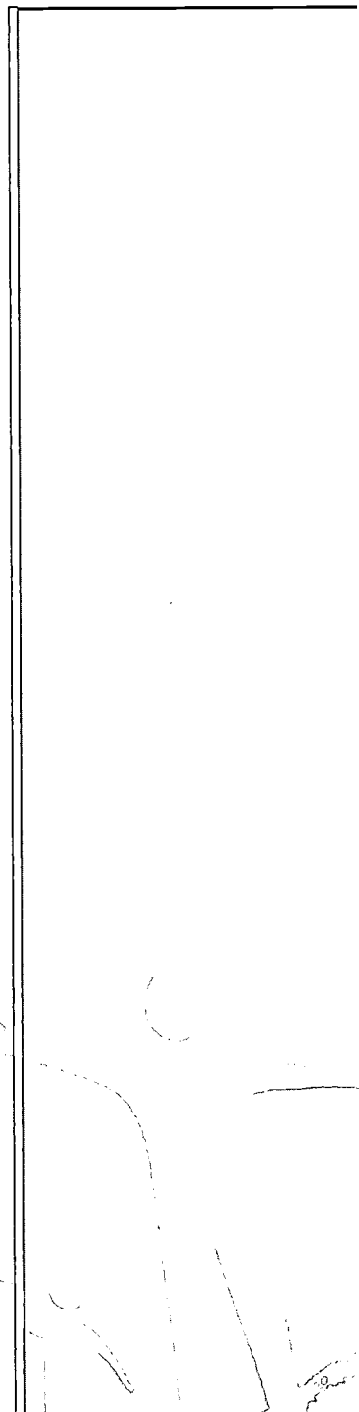

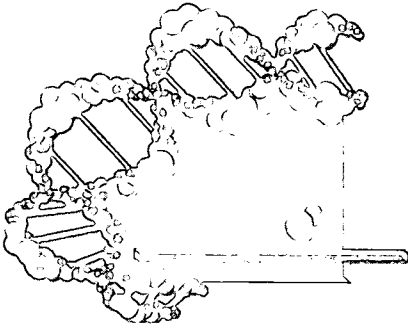

community organizations, government agencies, businesses, and citizen groups. The project focuses on controlling indoor air quality, reducing exposure to outdoor air on poor air quality days, reducing the number of visits to the school nurse due to upper respiratory illness, and reducing particulate matter by working with businesses to pave dirt areas. (EPA contact: Lorena Lopez, 619-235-4768).

East Side/Pico Section, Los Angeles, California (EPA Region 9)

The Los Angeles Child Health Champion (CHC) pilot, "KICK Asthma L.A." (Keep Improving Control of Kids' Asthma L.A.), is focused on children in East Los Angeles, a mostly Hispanic, economically disadvantaged community. The Community Team formed a collaborative partnership among local government agencies, public health organizations, and community-based organizations to KICK asthma and build community capacity for addressing problems of asthma and creating a model program for children's asthma education. As a direct result of the program, the community hopes to decrease school absenteeism due to asthma-related illness, increase adoption of healthy home measures to decrease asthma triggers, and increase community awareness about asthma. (EPA contact: Clarice Gaylord, 619-235-4767).

Toppenish, Washington (EPA Region 10)

The Yakima Valley Farm Workers Clinic is focusing on air pollution triggers of asthma in children under age 5. Interventions include home visits, training of child-care providers, support groups for parents, and broad-based community education. (EPA contact: Dan Robinson, 509-575-5845)

INCORPORATING CHILDREN'S ENVIRONMENTAL HEALTH INTO YOUTH-BASED ORGANIZATIONS

EPA is working with the Academy for Educational Development to incorporate children's environmental health into the fabric of youth-based organizations. Five national organizations, representing thousands of children and youth, have agreed to participate. An event showcasing the efforts of these groups is planned for September 2000. In addition, EPA is working with the Groundwater Foundation to hold a Youth Summit of Environmental Health in November 2000. (EPA contact: Ted Coopwood, 202-260-3410).

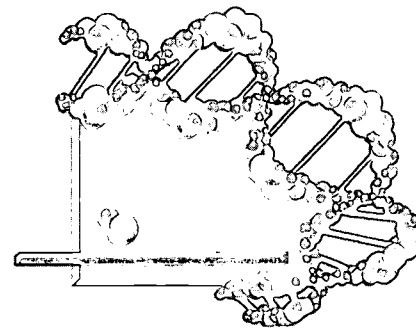

TARGETING CRIMINAL VIOLATIONS THAT THREATEN THE HEALTH AND SAFETY OF CHILDREN

Through the Children First Initiative, EPA's Criminal Investigation Division (CID) has expanded its response to the significant health threats that children continue to face from environmental hazards. This initiative identifies criminal environmental violations in which children are adversely affected or put at undue risk. At the end of fiscal year 1999, the number of Children First cases increased to 143 criminal investigations nationwide. This increase can be linked to CID's continuous pursuit of these violators and continuing educational efforts among their partners in state and local law enforcement. Individual criminal fines totaling \$271,189; restitution totaling \$389,998; 97 years of imprisonment; and 86.9 years of probation have been imposed on 75 individual defendants. Seventeen corporate defendants have been sentenced to pay a total of \$22,783,000 in criminal fines; \$4,150,000 in restitution; and 23 years of probation.

STATE PROFILES - CHILDREN'S ENVIRONMENTAL HEALTH

The Association of State and Territorial Health Officials is working in partnership with the Environmental Council of the States to profile state children's environmental health data and activities. The goal of the project is to highlight successful efforts to reduce hazards to children, provide state-by-state data on specific children's environmental health issues, and identify gaps in information. (EPA contact: Liz Blackburn, 202-260-7935).

PROMOTING CHILDREN'S ENVIRONMENTAL HEALTH WITH PEDIATRIC CHIEF RESIDENTS

EPA is supporting an educational session facilitated by the American Academy of Pediatrics to heighten awareness of pediatric environmental health issues in residency training programs. The session targets Chief Pediatric Residents because of their leadership in those programs. (EPA contact: Liz Blackburn, 202-260-7935).

ACTION TO ELIMINATE MAJOR USES OF THE PESTICIDE DURSBAN TO PROTECT CHILDREN AND PUBLIC HEALTH

In June 2000, the EPA and the manufacturer of Dursban agreed to eliminate this pesticide for nearly all household purposes. Dursban, also known as chlorpyrifos, is

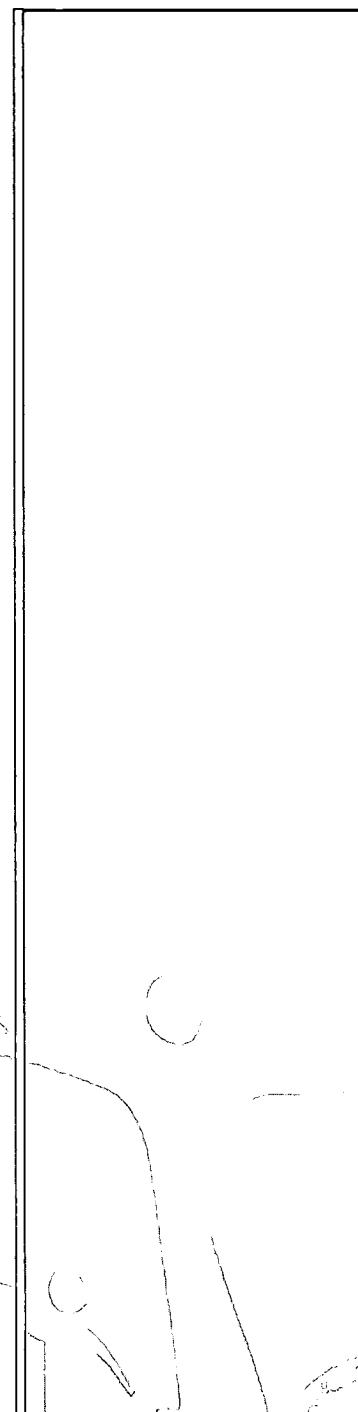

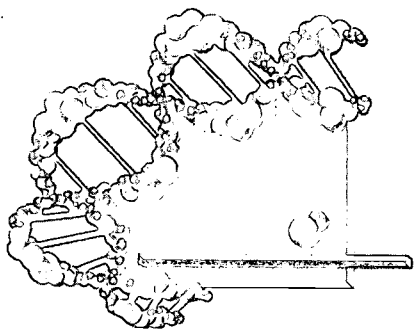

the most widely used household pesticide product in the United States. Chlorpyrifos belongs to a family of pesticides called organophosphates which can affect the nervous system. The agreement will:

- Stop production of and phase out all home, lawn, and garden uses.
- Stop production of and phase out the vast majority of termite-control uses.
- Significantly lower allowable pesticide residues on several foods regularly eaten by children.

EPA took this action under the Food Quality Protection Act (FQPA), which was passed unanimously by Congress in 1996. The FQPA requires a systematic review of all pesticides to ensure that they meet the tough new safety standards which, for the first time, must be protective of children, who are among the most vulnerable to adverse health effects from pesticide residues.

TIPS TO PROTECT CHILDREN FROM ENVIRONMENTAL THREATS

Because there are many things that parents and other caregivers can do to protect children from environmental risks, EPA developed relatively easy-to-follow, effective "tips," which are being widely distributed. Tips are available on both magnets and flyers and in English and Spanish. The National Safety Council produced a half-hour television program based on the tips which aired on Bravo and CNBC and is now available on video. The television program was viewed by an estimated 2 million people. A Spanish-language radio series based on the tips is being broadcast and will reach an estimated 75 percent of the U.S. Latino population.



Protect Children from Environmental Threats

Help children breathe easier



Help children breathe easier

- Don't smoke or let others smoke in your home or car
- Keep your home as clean as possible. Dust, mold, certain household pests, secondhand smoke, and pet dander can trigger asthma attacks and allergies.
- Limit outdoor activity when air pollution is bad such as on ozone alert days.



Protect children from lead poisoning

- Wash children's hands before they eat and wash bottles, pacifiers, and toys often
- Wash floors and windowsills to protect kids from dust and peeling paint contaminated with lead - especially in older homes
- Run the cold water for 30 seconds to flush lead from pipes
- Get kids tested for lead - check with your doctor
- Test your home for lead paint hazards if it was built before 1978

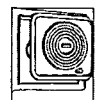

Protect children from carbon monoxide (CO) poisoning

- Have fuel-burning appliances, furnace flues and chimneys checked once a year
- Never use gas ovens or burners for heat and never use barbecues/grills indoors or in the garage
- Never sleep in rooms with unvented gas or kerosene space heaters
- Don't run cars or lawnmowers in the garage
- Install a UL approved CO detector in sleeping areas



Keep pesticides and other toxic chemicals away from children

- Put food and trash away in closed containers to keep pests from coming into your home
- Don't use pesticides if you don't have to - look for alternatives
- Read product labels and follow directions
- Use bait & traps instead of bug sprays when you can and place the bait & traps where kids can't get them
- Store where kids can't reach them and never put in other containers that kids can mistake for food or drink
- Keep children, toys & pets away when using pesticides and don't let them play in fields, orchards and gardens after pesticides have been used.
- Wash fruits and vegetables under running water before eating - peel them when possible



Protect children from too much sun

- Have them wear hats, sunglasses, and protective clothing
- Use sunscreen on kids over 6 months and keep infants out of the sun
- Keep them out of the mid-day sun - the sun is most intense between 10 and 4



Safeguard them from high levels of radon

- Test your home for radon with a home test kit
- Fix your home if your radon level is 4 pCi/L or higher. If you need help call your state radon office or 1-800-644-6999



Protect children from contaminated fish and polluted water

- Call the local or state health department to learn about any local advisories for limiting the amount of fish to be eaten or beach closing
- Take used motor oil to a recycling center and properly dispose of toxic household chemicals
- Find out what's in your local drinking water - call your local water system for your annual drinking water quality report or, if you have a private home drinking water well, test it every year

Get involved

Call toll free 1-877-590-KIDS for more information or check out EPA's Web site at www.EPA.gov/children



EPA Office of Children's Health Protection

EPA/100/F-00/008

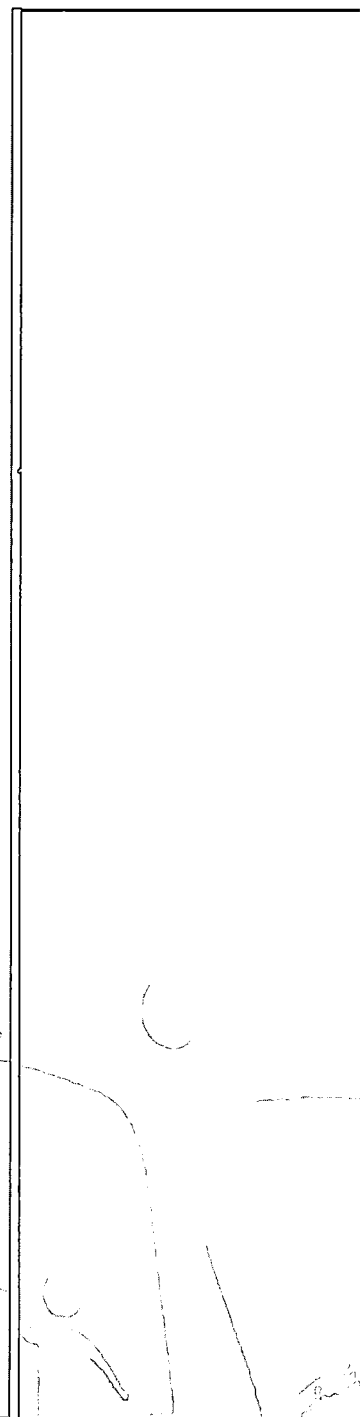
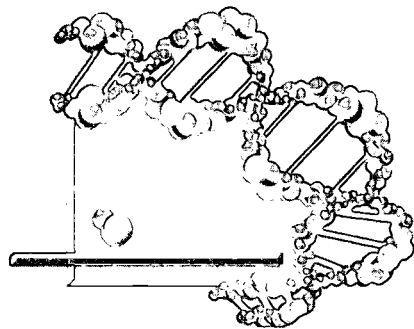

BEST COPY AVAILABLE

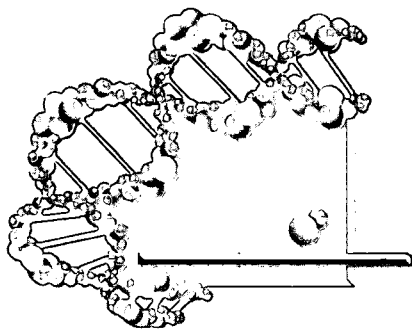

REFERENCES

1. Bates, D.V. 1995. The Effects of Air Pollution on Children. *Environmental Health Perspectives*. Volume 103 (Supplement B), Pages 49-53.
2. National Institutes of Health. September 1999. Cancer Incidence and Survival among Children and Adolescents: United States SEER Program 1975-1995. NIH Publication Number 99-4649.
3. NCI. 1997. SEER Cancer Statistics Review, 1973-1994. U.S. Department of Health and Human Services, National Cancer Institute. NIH Publication Number 97-2789, Page 457.
4. Devesa, S.S., W.J. Blot, B.A. Miller, R.E. Tarove, and J.F. Fraumeni, Jr. 1995. Recent Cancer Trends in the United States. *Journal: National Cancer Institute*. Volume 87, Pages 175-182.
5. David, J.R., R.C. Brownson, R. Garcia, B.J. Bentz, and A. Turner. 1993. Family Pesticide Use and Childhood Brain Cancer. *Archive of Environmental Contamination and Toxicology*. Volume 24, Pages 87-92.
6. Gold, E., L. Gordis, J. Tonascia, and M. Szklo. 1979. Risk Factors for Brain Tumors in Children. *American Journal of Epidemiology*. Volume 109, Pages 309-319.
7. Olshan, A.F., N.E. Breslow, J.M. Falletta, S. Grufferman, T. Pendergrass, L.L. Waskerwitz, W.G. Woods, T.J. Vietti, and G.D. Hammond. 1993. Risk Factors for Wilm's Tumor: Report from the National Wilm's Tumor Study. *Cancer*. Volume 72, Pages 938-944.
8. ATSDR. 1997. Healthy Children—Toxic Environments. Report of the Child Health Workgroup. U.S. Department of Health and Human Services, Public Health Service, Agency for Toxic Substances and Disease Registry.
9. CDC. 1997. Update: Blood Lead Levels—United States, 1991-1994. *Morbidity and Mortality Weekly Report*. Volume 46, Number 7, Pages 141-145.

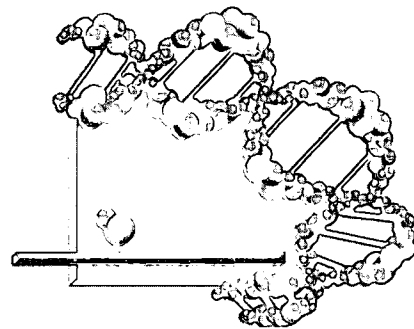

10. EPA. 1997. Should I Eat the Fish I Catch? Publication Number EPA 823-B-97-009. U.S. Environmental Protection Agency.
11. SOCMA. Undated. Fact Sheet: The Batch Chemical Industry. Washington, DC: Synthetic Organic Chemical Manufacturers Association.
12. NRC. 1993. Pesticides in the Diets of Infants and Children. National Research Council. Washington, DC: National Academy Press.
13. ILSI. 1992. Similarities and Differences between Children and Adults: Implications for Risk Assessment. International Life Sciences Institute. Washington, DC: ILSI Press.

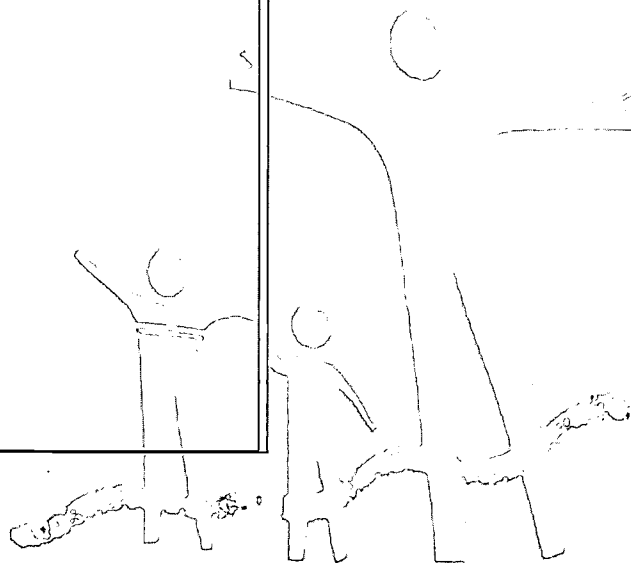
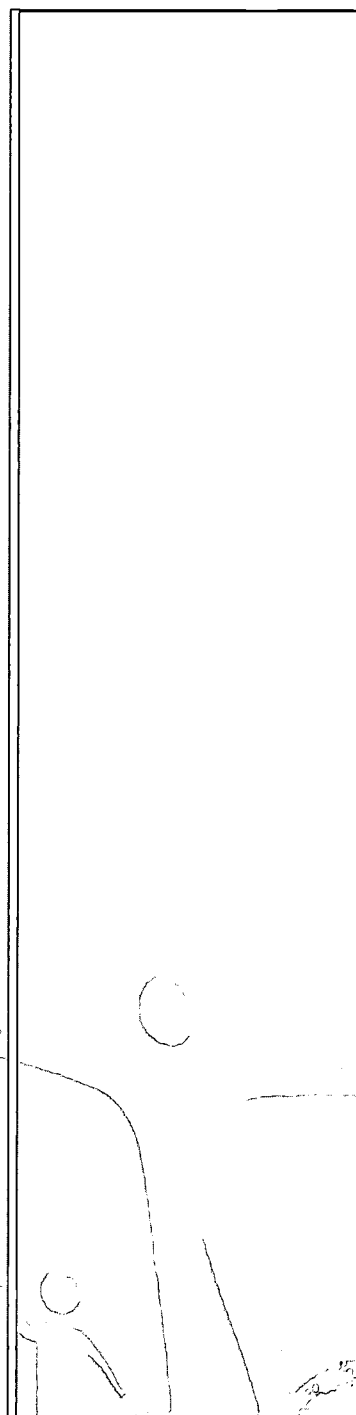

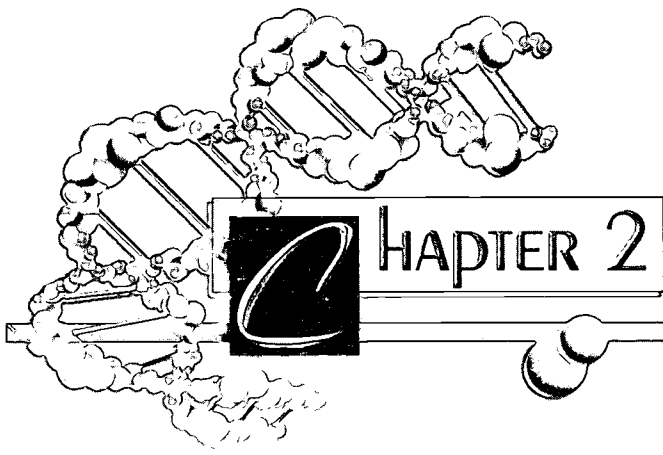

ASTHMA AND OTHER RESPIRATORY EFFECTS

Asthma, a serious lung disease, is the leading chronic illness among children in the United States. The number of children with asthma in the United States has more than doubled in the past two decades, from 2.3 million in 1980 to an estimated 5 million in 1998. The number of deaths attributed to asthma in children 18 and under also has increased, from 84 in 1977 to 280 in 1995. Minority children experience a disproportionately high impact from asthma. Asthma accounts for 10 million lost school days a year. In 1998, the cost of asthma to the U.S. economy was estimated to be \$11.3 billion, accounting for about 1 percent of all health care expenditures in the United States.(1,2,3,4,5,6)

Asthma is a narrowing of airways in the lungs that produces difficulty in breathing and can severely restrict the ability of a child to live a normal life. Poor indoor and outdoor air quality has been linked with asthma symptoms as well as with other respiratory problems, such as an increased frequency of respiratory infections, bronchitis, and pneumonia in children.(5) There is substantial evidence that environmental exposures (including cigarette smoke, smog, and allergens, such as pollens, dust mites, mold, and cockroaches) can trigger asthma attacks in children who have a genetic or acquired predisposition to the disease.(7)

In 1999, the President's Task Force on Environmental Health Risks and Safety Risks to Children released a comprehensive national strategy (*Asthma and the Environment: A Strategy to Protect Children*, <http://www.epa.gov/children/asthma>) to reverse the increasing rates of asthma among U.S. children. EPA played a leadership role in developing the strategy. The Agency is developing a program to combat the rising prevalence of asthma in the United States, with a focus on improving indoor and outdoor air quality. Over the next several years, the Agency will expand its research and public information initiatives to address indoor and outdoor asthma triggers. Some of these initiatives are described below.

IMPROVING INDOOR AIR QUALITY

Avoidance of asthma triggers in the environment, along with proper medical management and self-monitoring of symptoms, can substantially reduce the frequency and severity of asthma attacks. EPA's Indoor Air Quality (IAQ) program is focused on reducing the exposure of asthmatics—especially children with asthma—to indoor asthma triggers in homes, schools, and childcare facilities through a multi-faceted program that emphasizes public education and outreach, training, and extensive partnerships with the public and private sectors.

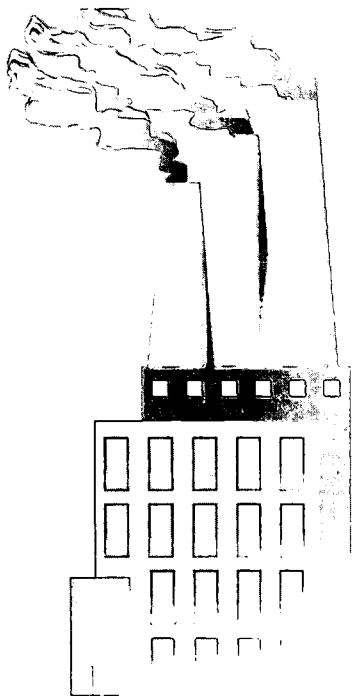

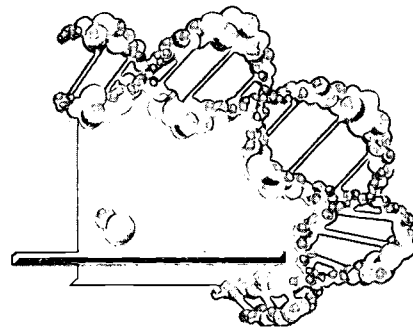

Goals of the Asthma and the Environment Strategy

- By the year 2005, the number of households in which children are regularly exposed to secondhand smoke will be reduced to 15 percent (compared to 29 percent in 1994).
- By the year 2010, asthma hospitalization rates in children will have fallen to no more than 10 hospitalizations per 10,000 people (compared to 50 for children 0 to 4 years old and 18 for children 5 to 14 years old in 1992-1994).
- By the year 2010, emergency department visits will be reduced to no more than 46 per 10,000 people (compared to 121 for children 0 to 4 years old and 81 for children 5 to 14 years old in 1992-1994).
- By the year 2010, no more than 10 percent of children with asthma will experience activity limitations (compared to 22 percent for the overall population in 1992-1994).

To establish a sound scientific basis for its indoor environments asthma program, EPA requested that the Institute of Medicine of the National Academy of Sciences conduct a comprehensive assessment of the relationship between indoor air pollution and asthma. Released in January 2000, *Clearing the Air: Asthma and Indoor Air Exposures* confirms the importance of addressing indoor environmental triggers as part of a comprehensive asthma management program.

EPA works to educate parents, health care professionals, school administrators, facility managers, and many other audiences about practical steps they can take to improve the indoor environments where children spend time. A new national media campaign, educational materials, such as the new brochure, *Clear Your Home of Asthma Triggers: Your Children Will Breathe Easier*, a comprehensive new asthma Web site (<http://www.epa.gov/iaq/asthma/>), and co-sponsorship of major events, such as Asthma Awareness Day on Capitol Hill help to get the word out. The cornerstone of EPA's national strategy, however, is a network of more than 30 national partner organizations and more than 1,000 collaborative partner organizations in communities across the nation.

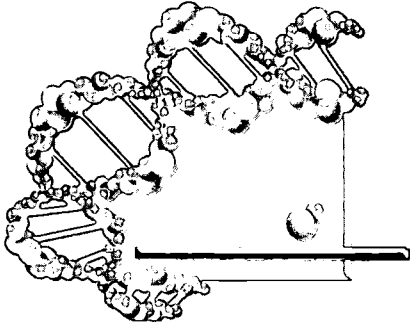

Through these partners, EPA continues to promote the *IAQ Tools for Schools* program, which empowers schools to prevent and resolve IAQ problems. Of particular note, EPA is working with the National Association of School Nurses to train thousands of school nurses in strategies for reducing children's exposures to asthma triggers and indoor pollutants.

EPA continues to work with the American Lung Association to implement the *Open Airways* program for inner city minority children who have higher-than-average asthma rates. EPA also is collaborating with partners, such as the DHHS, the Consumer Federation of America Foundation, the American Medical Association, and the American Academy of Pediatrics to educate the public about the dangers posed to children by environmental tobacco smoke (ETS), also known as secondhand smoke.

EPA has partnered with a number of health organizations to develop interventions that can reduce exposures to asthma triggers in the indoor environment. The Agency also is assisting community groups in efforts to publicize effective intervention strategies, especially in the low-income, inner city communities where asthma is most prevalent. In addition, EPA is conducting various research studies to measure the effectiveness and benefits of asthma interventions.

IMPROVING OUTDOOR AIR QUALITY

EPA's efforts to control outdoor air pollution are focused on protecting everyone, including children, from the harmful effects of ozone, particulate matter, and toxic substances. The Agency develops standards that set safe limits for the most prevalent air pollutants, and works with the states to implement those standards. Recently, the Clinton administration issued a strengthened air standard for ozone to protect the health of asthmatics and children and established new standards for fine airborne particles. The Agency estimates that the new standards will provide new health protections to 125 million Americans, including 35 million children. However, in May 1999 a federal appeals court ruled that these standards are unconstitutional. In January 2000 the U.S. Department of Justice filed a petition seeking Supreme Court review of the decision.

In addition to conducting these regulatory efforts, EPA is studying the impacts of outdoor air pollutants on the physical development of children and the characteristics of children that make them more susceptible to the effects of air pollution.

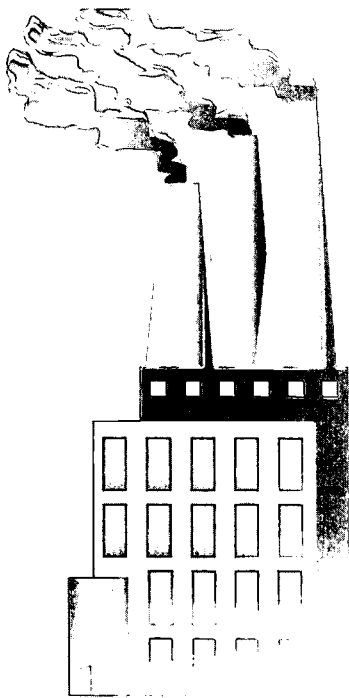

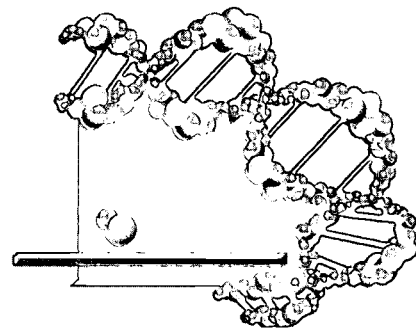

EPA PROJECTS ON ASTHMA AND OTHER RESPIRATORY EFFECTS

Indoor Air Quality Tools for Schools

Title: IAQ Tools for Schools

Description: EPA has developed *IAQ Tools for Schools*, an easy-to-use guide intended to empower schools to prevent and resolve IAQ problems at little or no cost using simple activities and in-house staff. More than 30,000 *IAQ Tools for Schools* kits have been distributed nationwide since 1996. The program is directed from EPA headquarters through agreements with a number of associations (see below). EPA's regional offices have active implementation programs as well.

Partners: National Parent-Teacher Association, American Association of School Administrators, National Association of City and County Health Officials, American Lung Association, National Education Association

Contact: Office of Air and Radiation, Michele Guarneiri, 202-260-9099

Title: Working with Partners to Improve Indoor Air Quality in Schools

- National Education Association

The National Education Association Health Information Network (NEA HIN) and EPA are supporting NEA's 2.2 million members in improving the management of IAQ in schools and homes. Through NEA's training program, NEA members and union liaisons are trained in school IAQ management. Trainees and workshop participants are currently working with school districts and schools to implement EPA's *IAQ Tools for Schools*. Contact Office of Air and Radiation, Jennifer Keller, 202-564-9338.

- American Association of School Administrators

EPA is working with the American Association of School Administrators (AASA) to enable schools to prevent and

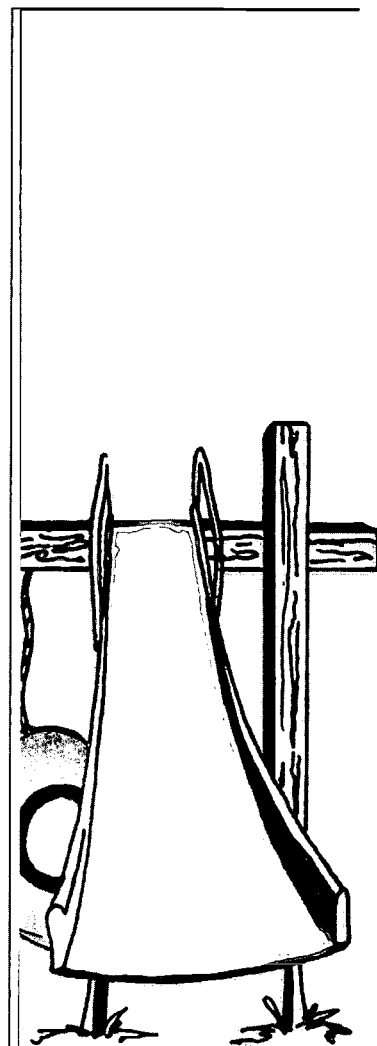

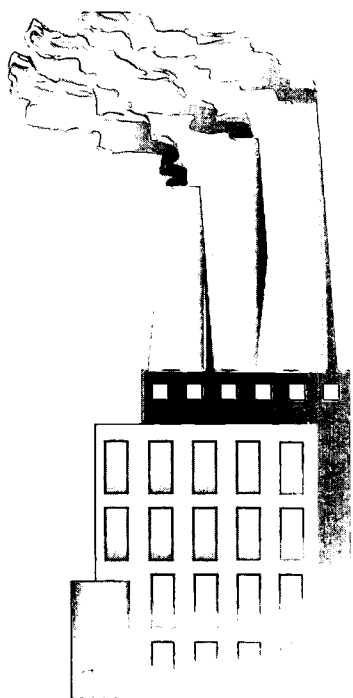
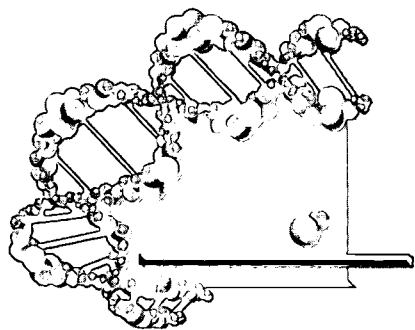

resolve IAQ problems using the *IAQ Tools for Schools Action Kit*. This project includes training courses, IAQ sessions during workshops and conferences, and articles in newsletters to educate administrators about IAQ problems and solutions, as well as how to implement an IAQ program using in-house school staff. AASA will conduct periodic surveys during the project to assess the administrators' understanding of IAQ and how they resolve problems. Contact Office of Air and Radiation, Paula Selzer, 202-564-9361.

- National Parent-Teacher Association

The National Parent-Teacher Association (NPTA) and EPA are working cooperatively to support the participation of more than 6.5 million NPTA members in the environmental management of homes, schools, communities, and ecosystems. NPTA's program has centered around environmental awareness, including training NPTA leaders on school indoor air quality, air pollution, water pollution, drinking water quality, hazardous materials, emergency planning, radon exposure, pesticides, solid waste, and lead poisoning. NPTA also publishes *Our World Newsletter* and sponsors Earth Week activities and literature. Contact Office of Air and Radiation, Michele Guarneri, 202-564-9099.

- Urban Schools IAQ Project

The National Association of County and City Health Officials (NACCHO), working cooperatively with EPA, will offer *IAQ Tools for Schools* pilot training courses in low-income urban communities. The courses are designed to encourage partnerships between local environmental justice organizations (or organizations with similar community concerns) and local public health and school officials. NACCHO has planned the training to promote awareness of IAQ problems in schools, management of IAQ, and strategies for managing asthmatic

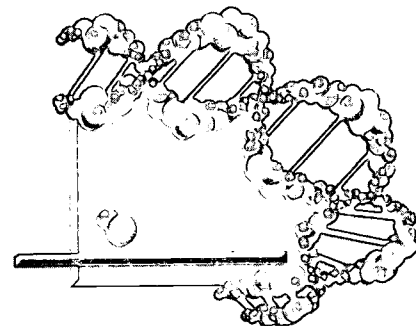

children's exposures to indoor asthma triggers. Contact Office of Air and Radiation, Laura Kolb, 202-564-9348.

- Training School Nurses on *IAQ Tools for Schools* and Asthma

The National Association of School Nurses (NASN) and EPA are working together on improving IAQ and addressing asthma triggers in schools. School nurses across the country have been trained on *IAQ Tools for Schools* and are conducting "train the trainer" workshops in their school districts. NASN also is developing asthma modules that school nurses can deliver during staff meetings, PTA meetings, and health classes to educate school communities about the seriousness of asthma and environmental triggers. The modules will incorporate *IAQ Tools for Schools* information and action items for reducing exposures to asthma triggers and indoor pollutants. Contact Office of Air and Radiation, Kim Smith, 202-564-9443.

- School Intervention Study

The School Intervention Study will provide a measure of the effectiveness of *IAQ Tools for Schools* in improving the management of school buildings for better IAQ. Success measures include activities to prevent problems, changes in staff symptoms and perceptions of indoor air quality, reduced pollutant levels, and improved ventilation systems. Before-and-after testing is being conducted in several schools and costs will be monitored over a 1-year period. Results are expected in FY 2000. Contact Office of Air and Radiation, John Girman, 202-564-9317.

- American Lung Association *Open Airways*

The American Lung Association is promoting EPA's *IAQ Tools for Schools* along with their *Open Airways* curriculum, which teaches asthmatic elementary school children to manage their own asthma. The program focuses on inner city children in areas with higher-than-average asthma rates. The American

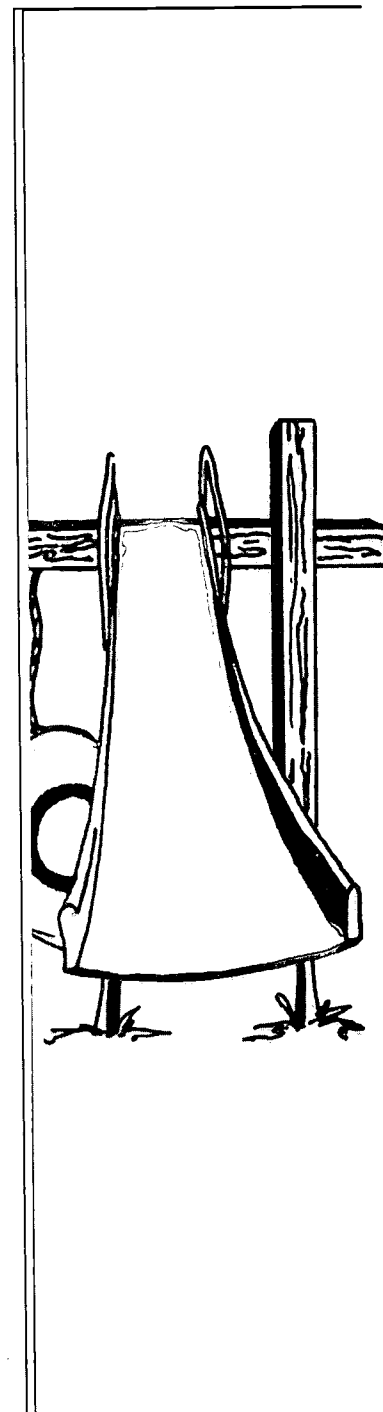

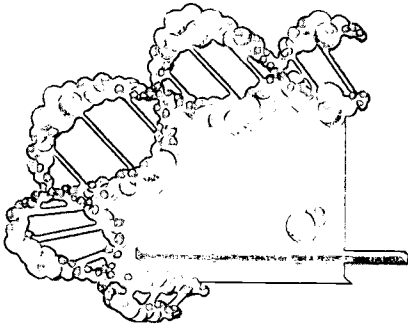

Lung Association is developing an integrated training program in which 15 master trainers will train 250 other trainers, who will then train 5,000 local volunteers. Project directors estimate that this combined program will result in 25,000 children graduating from *Open Airways* and 1,500 schools fully implementing the *IAQ Tools for Schools* guidance. The program has enhanced asthma management skills of children and their parents, reducing the frequency of asthma attacks. Several Regions are translating *Open Airways* into Spanish. Additionally, all local American Lung Associations will begin programs to implement EPA *IAQ Tools for Schools* in FY 2000. Contact Office of Air and Radiation, Tracy Enger, 202-564-9484.

Title: EPA Regional School-Based Programs to Improve Indoor Air Quality

Region 1: Region 1 and its partners (including Harvard School of Public Health, Tufts University School of Medicine, Massachusetts Public Health Association, and the American Lung Association) have sponsored numerous workshops introducing the *IAQ Tools for Schools* program to various segments of the education community. The New England Coalitions for Occupational Safety and Health have worked with schools to assist them in implementing the program; over 60 New England schools are implementing *IAQ Tools for Schools*. Contact Eugene Benoit, 617-918-1639, or Mary Beth Smuts, 617-918-1528.

With EPA funding, staff of the State of Vermont Department of Health trained a teaching professional representing the pilot supervisory union in basic issues related to indoor air quality and ventilation. After the training, initial concerns were addressed by the school at the local level, and an indoor air quality management plan was developed. The indoor air quality coordinator incorporated the new knowledge into the supervisory union's health education curriculum. Contact Kristen Conroy, 617-918-1069.

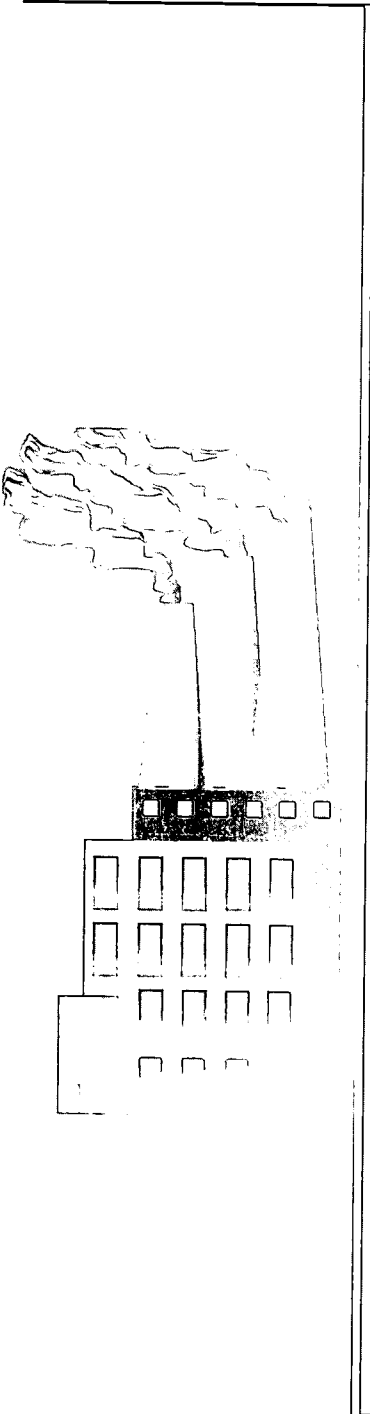

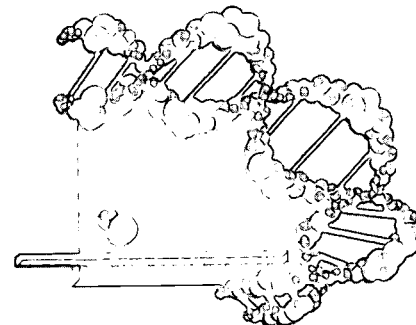

Region 4: Region 4 and the University of Tulsa presented 10 1-day workshops to educate school officials on the *IAQ Tools for Schools Action Kit*. (Approximately 1,400 kits were previously distributed to school officials in the region.) Around 50 school officials attended each workshop. Contact Henry Slack, 404-562-9143.

EPA funded a pilot project to deliver the American Lung Association's *Open Airways* curriculum to children with asthma in a rural Florida county, while implementing the *IAQ Tools for Schools Action Kit* at their school. EPA is also funding an American Lung Association effort in northern Florida to promote the kit at schools in a poor, rural county, and to offer *Open Airways* to children at the schools. In a separate effort, Region 4 and the University of Tulsa offered courses in Florida, Georgia, and North Carolina on topics including biological contaminants, asthma, and allergen control. Contact Henry Slack, 404-562-9143

Region 5: The Marion County, Illinois, Health Department is working with schools to implement the *IAQ Tools for Schools Action Kit* and is studying the kit's effectiveness. In addition, staff from Region 5 are providing onsite technical assistance to help schools implement the kit. Contact Helen Tsiapas or Sheila Batka, 312-886-6053.

The *IAQ Tools for Schools* program also is being implemented in a Minnesota school that serves a high percentage of children from Native American tribes. EPA is conducting *IAQ Tools for Schools* overview sessions for tribes in Wisconsin, Minnesota, and Michigan during 1999 and 2000. EPA also held a 1999 meeting with the Indian Health Services to discuss children's issues, *IAQ Tools for Schools*, and the potential for partnerships between the tribes and Region 5. Contact Jeanette Marrero, 312-886-6543, or Sheila Batka, 312-886-6053.

The Chicago Health Corps is working to initiate the Clean Air for Good Health in Schools Campaign within five Chicago public schools. This project will raise awareness of indoor air quality among teachers and building maintenance staff and improve the quality of the indoor environment in schools. The Chicago Health Corps will initiate an environmental assessment in the schools

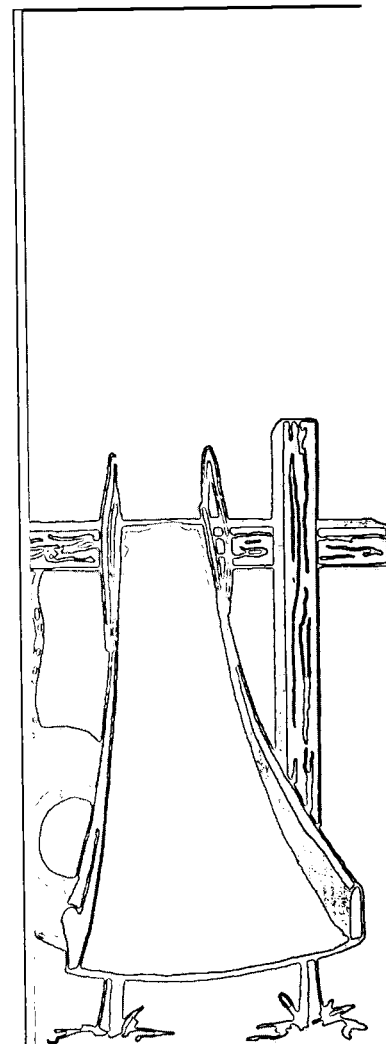

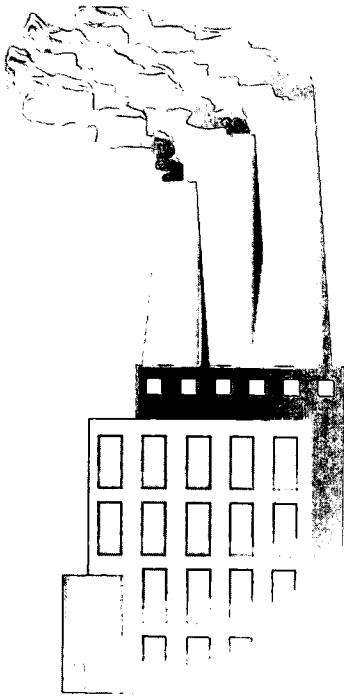
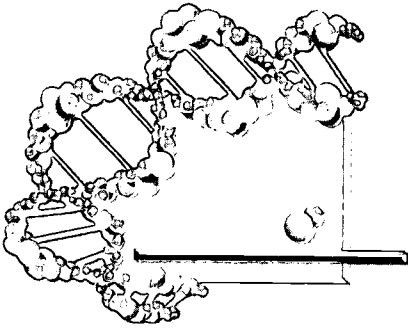

and provide recommendations for revising current maintenance policies. Contact Jeannette Marrero, 312-886-6543, or Sheila Batka, 312-886-6053.

EPA provided a grant to the Michigan School Indoor Air Coalition, headed by the American Lung Association of Michigan, to improve IAQ in Michigan schools. Contact Helen Tsiapas, 312-886-7901, or Sheila Batka, 312-886-6053.

EPA also provided a grant to the Wisconsin Department of Health and Family Services to increase awareness and implementation of energy-efficient and healthful IAQ practices in Wisconsin schools. Contact Sheila Batka, 312-886-6053, or Julie Magee, 312-886-6063.

Region 7: Region 7 completed *IAQ Tools for Schools* walk-throughs at schools in Jefferson City, Missouri; Lincoln, Nebraska; and Liberty, Missouri, as part of demonstration projects. Representatives discussed the *Tools for Schools* program at the Regional IAQ meeting and Regional Tribal Operations Committee Annual meeting, and hosted a Tribal *Tools for Schools* workshop/school walk-through in South Sioux City, Nebraska. The Region also completed presentations at *IAQ Tools for Schools* workshops in Lincoln and Omaha, Nebraska, and at the Kansas Schools Nurses Conference in Wichita, Kansas; distributed 10 *Tools for Schools* kits at the Back to School With New Ideas Seminar; and supplied the Kansas City/St. Joseph Catholic Diocese with 54 kits for their schools. Finally, Region 7 participated in the *IAQ Tools for Schools* Stakeholder Meeting in Washington, DC. Contact Michael Marshall, 913-551-7604.

Region 8: Region 8 is piloting the *IAQ Tools for Schools* program in several school districts in Colorado and continues to offer workshops to school personnel throughout the region. Contact Megan Williams, 303-312-6431.

Region 9: Region 9 is conducting a multi-pronged program to encourage schools to adopt *IAQ Tools for Schools*. The Region 9 team has trained more than 800 school district personnel and is now focusing on individual pilot schools within selected districts. Partners include state agencies, educational organizations, and the American Lung

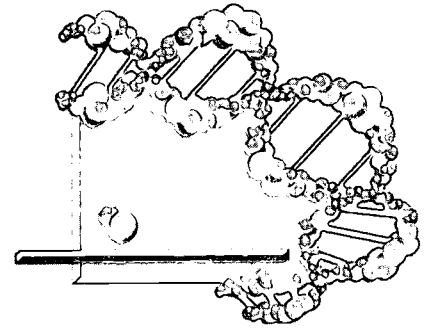

Association, which has created a pilot "Mentor" program with the American Industrial Hygiene Association. Contact Barbara Spark, 415-744-1132.

Region 10: Region 10 coordinates and supports the *IAQ Tools for Schools* program to conduct training and school walk-throughs in Washington, Oregon, Idaho, and Alaska through small grants to the Idaho Health Division, the Oregon State University Cooperative Extension Energy Program, the University of Alaska (Fairbanks) Cooperative Extension Energy Program, and the Washington State University Cooperative Extension Energy Program. Each of these agencies has committed to conducting at least four school walk-throughs and *IAQ Tools for Schools* training in each of their states. Contact Brook Madrone, 206-553-2589.

ENVIRONMENTAL TOBACCO SMOKE (SECONDHAND SMOKE)

Title: Environmental Tobacco Smoke Media Campaign

Description: EPA is conducting a multi-year, national campaign to motivate parents to keep their homes smoke-free. The first wave of this campaign includes three products: 60- and 30-second television spots, 60- and 30-second radio spots, and print public service announcements (PSAs) of various sizes for newspapers. These products were distributed directly to more than 1,000 television stations, 500 cable stations, 5,400 radio stations, and 1,500 major daily newspapers. One of the PSAs was the second most frequently aired PSAs in the country, appearing in 80 percent of U.S. television households with an unusually high number of prime-time airings. EPA has also equipped its local and national partners, such as National Association of City and County Health Officials and American Lung Association affiliates, as well as a national network of tobacco control experts, with materials to market the PSAs to media outlets in their states and communities.

Contact: Office of Air and Radiation, Wendy Kammer, 202-564-9152

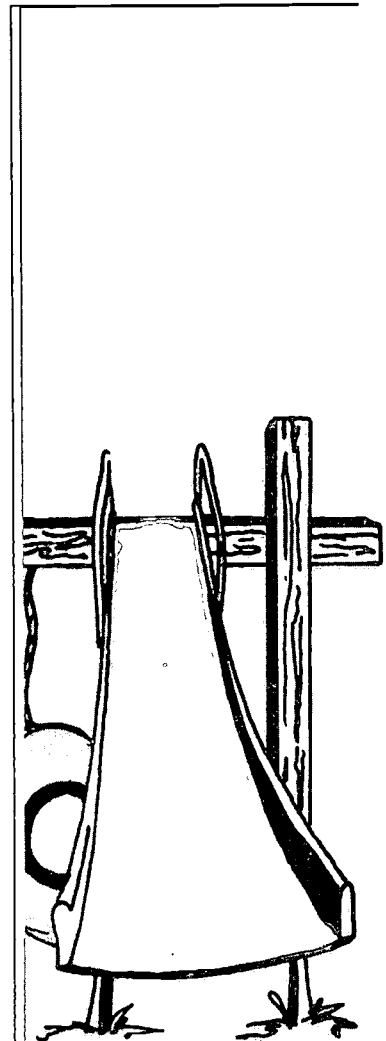

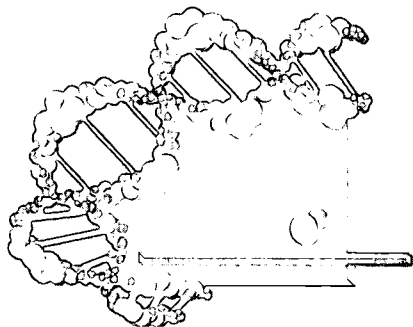

Title: Reducing Exposure to ETS through Child Care Outreach

Description: EPA is implementing training developed by the Pennsylvania Chapter of the American Academy of Pediatrics (AAP-PA) in at least five state systems this year. The program trains childcare center operators on the risks to children from exposure to ETS at home. The AAP-PA has provided professional credits to 160 providers who passed an exam and implemented this program, resulting in an estimated 1,920 families who have reduced their children's risk from ETS.

Partners: American Academy of Pediatrics, Pennsylvania Chapter; National Resource Center for Health and Safety in Child Care

Contact: Office of Air and Radiation, Alison Freeman, 202-564-9455

Title: Community-Based Pediatrician Outreach

Description: The American Academy of Pediatrics is collaborating with EPA to promote a secondhand smoke speaker's kit for pediatricians to use in community-based reduction efforts. The kit includes 35mm slides, speaker's notes, and other public information materials designed to communicate the health risks associated with children's involuntary exposure to secondhand smoke. More than 1,300 pediatricians have obtained the secondhand smoke speaker's kit since it was developed 3 years ago. To meet the high number of requests for the kit, AAP plans to post the kit on their Web site, <http://www.aap.org>, in the near future.

Contact: Office of Air and Radiation, Kim Smith, 202-564-9443

Title: Hispanic Health Project

Description: The National Council of La Raza (NCLR) and EPA are working on a two-part Hispanic Health Project. The first part is the "Smoke-Free" homes campaign, which provides ETS training for members of community-based organizations who then provide training and counseling on ETS and secure "smoke-free" homes pledges from

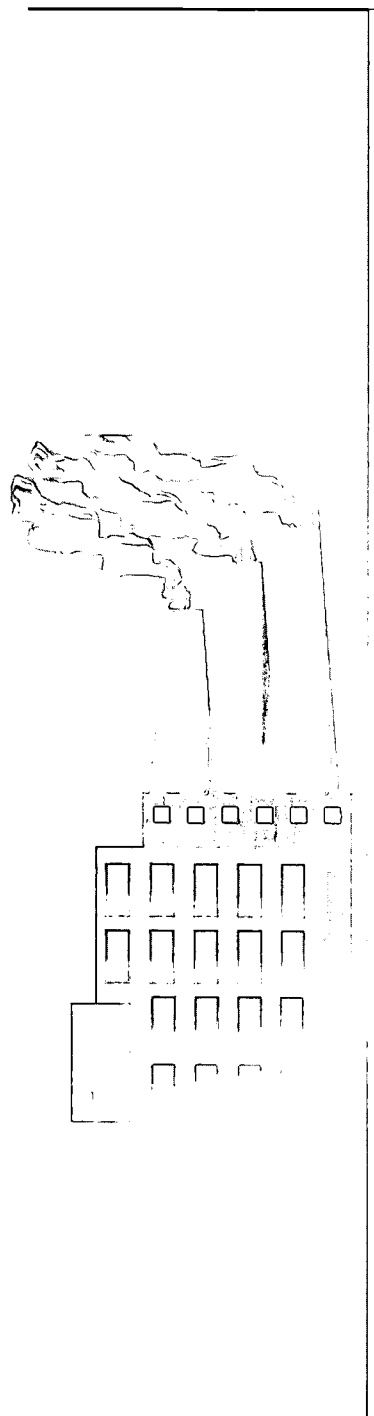

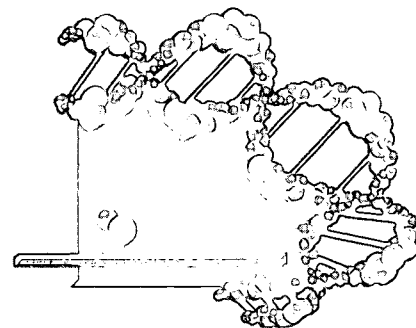

other community members. The second part of the Hispanic Health project provides training to lay health educators in low-income and minority communities on asthma, ETS, and other health-related topics.

Contact: Office of Air and Radiation, Laura Kolb, 202-564-9438

Title: Outreach Campaign on Secondhand Smoke and Children

Description: Surveys show that 35 percent of children under age 6 in EPA Region 4 live in a home that allows smoking indoors. To reduce these percentages, EPA is conducting outreach on secondhand smoke and children in two states. In Kentucky, Region 4 funded the American Lung Association of Kentucky's "Smoke Outside . . . Please" campaign, which features a poster and other materials that have been distributed in physicians' offices, buses, and other venues. Region 4 also funded efforts by the Tennessee Clearinghouse of the Tennessee Alcohol and Drug Association to develop public service announcements urging people to smoke outside.

Contact: Region 4, Henry Slack, 404-562-9143

Title: Grant to Cuyahoga County Board of Health, Ohio

Description: EPA awarded a grant to the Cuyahoga County Board of Health on behalf of the Greater Cleveland Asthma Coalition. The purpose of the grant is to reduce exposures to ETS among Cleveland's children, especially in minority populations.

Contacts: Region 5, Helen Tsiapas, 312-886-7901, or Sheila Batka, 312-886-6053

Title: Indoor Air Environment Program for Children

Description: Region 7 provided information to reduce smoking in homes where children 6 years old or younger reside. Using an IAQ grant, Region 7 worked with the American Lung Association of Western Missouri

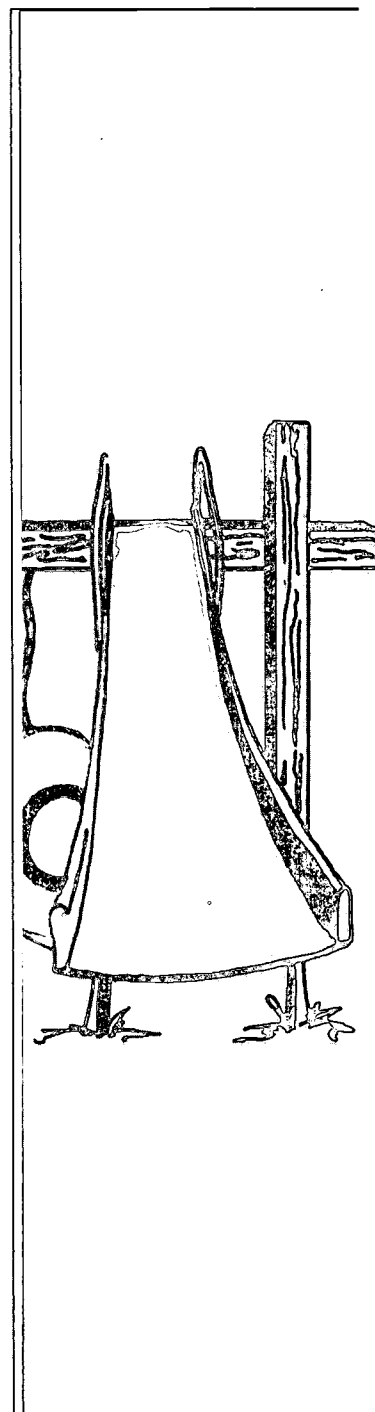

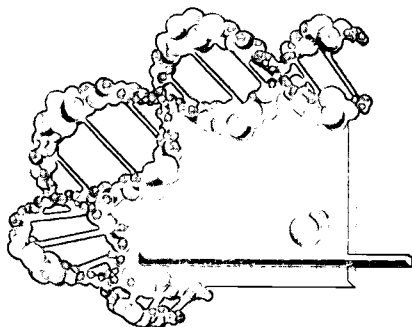

to develop their ETS program for pregnant women. The issue of smoking in homes with children was discussed during a Regional IAQ meeting. The Region met with the Iowa Department of Education in an effort to get EPA's "Environmental Tobacco Smoke Day Care Center Program" included in the Iowa childcare certification requirements. Copies of the ETS speaker's kit were sent to American Lung Association chapters in Kansas and Missouri and to the state indoor air programs.

Contact: Region 7, Robert Dye, 913-551-7605

Title: ETS Outreach Project

Description: In cooperation with the American Lung Association, Region 8 is providing outreach materials to health care professionals and to the general public on the health risks associated with childhood exposure to secondhand smoke.

Contact: Region 8, Kathleen Craig, 303-312-6031

Title: Environmental Tobacco Smoke Outreach

Description: Region 10 and the American Lung Association of Washington (ALAW) conducted ETS outreach efforts in Washington hospitals and clinics. The outreach consisted of interviewing and counseling parents of children discharged from hospitals and treated in clinics for asthma exacerbations. Parents who smoked were counseled regarding ETS as an asthma trigger and the importance of not smoking around their children. In addition, ALAW developed a manual that could be used by nurses and other clinic or hospital staff to provide this counseling. Distribution of these manuals, along with training in their use, has taken place in 10 hospitals and clinics throughout the state. Region 10 also worked with the Bellingham Opportunity Council to provide ETS and asthma outreach and education to childcare providers and parents, targeting low-income and minority communities in northwest Washington.

Contact: Region 10, Mike Letourneau, 206-553-1687

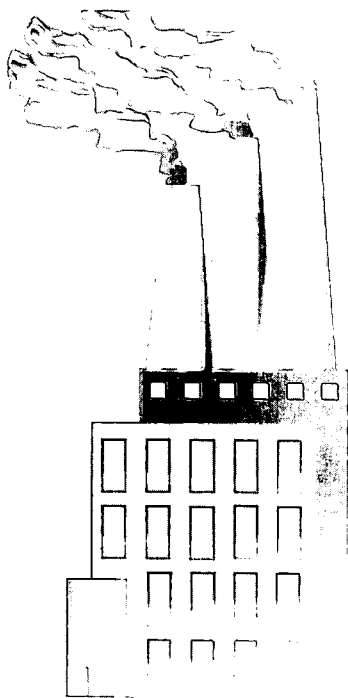

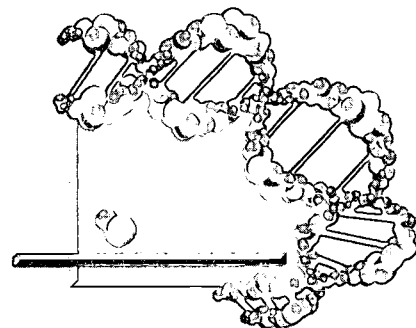

INDOOR AIR GENERAL OUTREACH AND INTERVENTIONS

Title: Asthma Media Campaign

Description: EPA is working to develop and promote a mass media campaign designed to raise awareness that controlling indoor environmental triggers is an integral part of managing asthma. The multi-level campaign targets the general public, the health community, care-givers of children with asthma, and people with asthma.

Partners: Department of Health and Human Services, National Institutes of Health

Contact: Office of Air and Radiation, Kristy Miller, 202-564-9441

Title: Asthma Case Studies

Description: The National Association of County and City Health Officials, in cooperation with EPA, is developing multi-disciplinary asthma case studies for local health departments and other health professionals. The case studies will concentrate on local health department asthma control and prevention programs, specifically highlighting programs that target children under 6 and low-income urban communities. The case studies will document and describe successful community asthma interventions that can be used as templates for other communities to replicate, with the aim of increasing awareness and implementation of local programs for the control and prevention of asthma.

Contact: Office of Air and Radiation, Laura Kolb, 202-564-9438

Title: Increasing Indoor Air Action in American Asian and Pacific Islander (AAPI) Communities

Description: EPA is working cooperatively with the Association of Asian Pacific Community Health Organizations (AAPCHO) to reduce indoor air-related health risks in AAPI communities. AAPCHO is developing a culturally and linguistically appropriate asthma health education

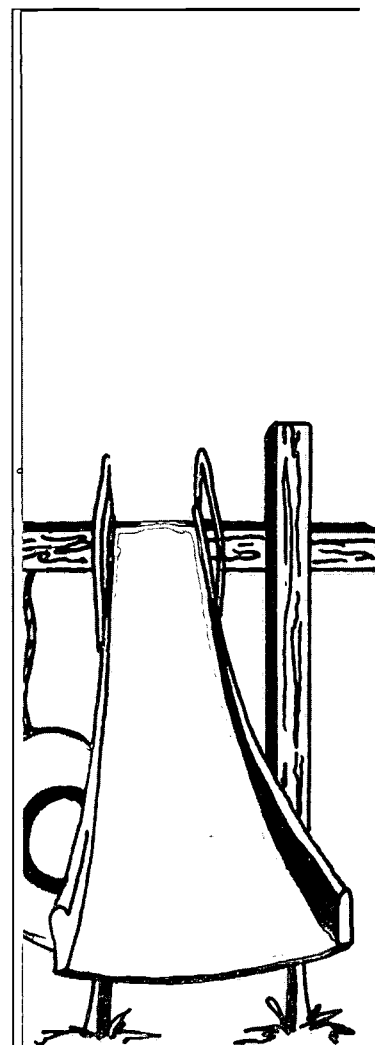

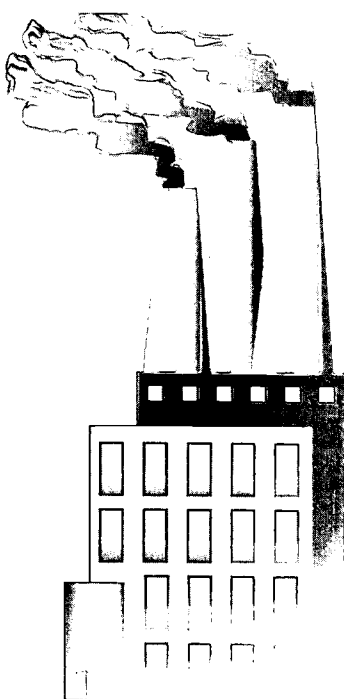
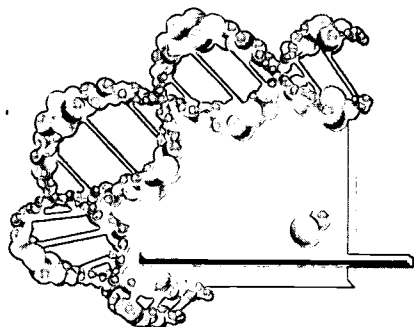

pamphlet for three Asian languages—Chinese, Korean, and Vietnamese—based on EPA's new brochure *Clear Your Home of Asthma Triggers: Your Children Will Breathe Easier*. AAPCHO is also providing technical assistance and support to three AAPI community-based mini-grant recipients during implementation of their indoor air activities, and is producing a four-language (English, Chinese, Vietnamese, Korean) wall calendar featuring catchy and positive messages about clean air in the home.

Partners: Association of Asian Pacific Community Health Organizations
Contact: Office of Air and Radiation, Paulina Chen, 202-564-9031

Title: Asthma and Allergy Essentials for Childcare Providers

Description: EPA is working cooperatively with the Asthma and Allergy Foundation of America to make childcare settings safer for, and more accessible to, children with asthma by (1) implementing the best-practice standards set forth in the newly released Pediatric Asthma Guidelines to ensure safe, healthy childcare for every child, and (2) improving policies and procedures for access to quality childcare for children with asthma and allergies as an essential part of each child's disease management program. This project involves training licensed providers of childcare in appropriate asthma and allergy management and environmental control.

Partners: Asthma and Allergy Foundation of America
Contact: Office of Air and Radiation, Brenda Doroski, 202-564-9764

Title: Asthma Collaborative Program

Description: The Bureau of Primary Health Care (BPHC) of the Department of Health and Human Services provides financial support to more than 1,000 Community Health Centers and School-Based Health Centers that provide medical services to low-income and minority underserved populations, many of whom do not have health insurance. EPA is working with BPHC to incorporate appropriate indoor

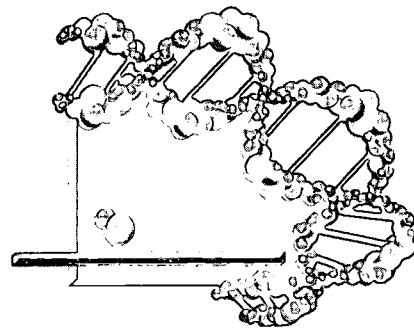

environmental trigger information into a new Breakthrough Series Asthma Collaborative program designed to help the centers improve health services for children and adults with asthma.

Partners: More than a dozen public and private sector partners, including federal agencies, private foundations, and pharmaceutical companies.

Contact: Office of Air and Radiation, Sheila Brown, 202-564-9439

Title: Early Intervention and Treatment of Asthma

Description: EPA is working cooperatively with the American Respiratory Care Foundation to educate pediatric asthma patients in the emergency room setting about environmental triggers for asthma and appropriate intervention techniques. The goal of the project is to reduce children's exposure to indoor asthma triggers and reduce asthma episodes and future emergency room visits. The project is being done in collaboration with Rainbow Babies and Children's Hospital, University Hospital of Cleveland, and Youngstown State University.

Partners: American Respiratory Care Foundation of the American Association for Respiratory Care

Contact: Office of Air and Radiation, Tracey Mitchell, 202-564-9446

Title: National Civil League Coalition Building Training

Description: As part of a continuing effort to educate communities in southeastern Connecticut about the potential dangers of indoor air pollution, the Southeastern Connecticut Indoor Air Quality Coalition held a 1-day forum on coalition building. The forum built upon concerns about children's exposure to ETS; efforts to reduce the number of children who become ill due to asthma; and outreach to hospitals, clinics, schools, and communities on issues of IAQ and health concerns.

Partners: Southeastern Connecticut Indoor Air Quality Coalition

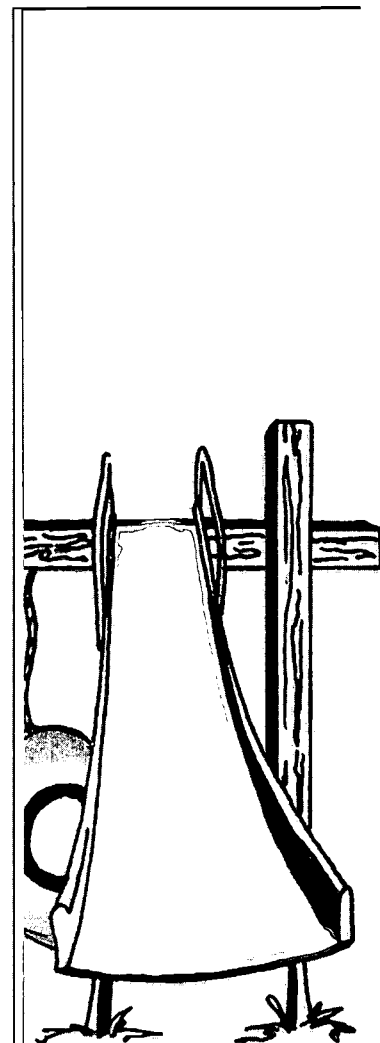

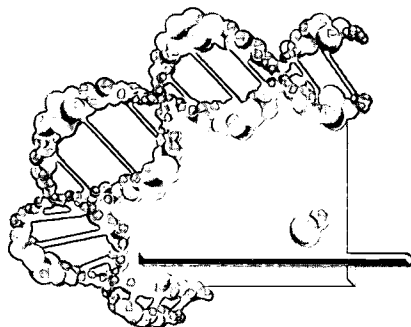

Contact: Region 1, Mary Beth Smuts, 617-918-1528

Title: ZAP Asthma Community Conference

Description: This 1-day conference in Boston featured a speaker from Atlanta, Georgia, who provided information on the ZAP Asthma Community Project. The conference focused on strategies for changing the emphasis on asthma from treatment to prevention.

Partners: Urban Asthma Coalition, Tufts University School of Medicine

Contact: Region 1, Mary Beth Smuts, 617-918-1528

Title: Urban Asthma Community Conference and Coalitions

Description: EPA co-sponsored this conference on urban asthma, held at a local community college in Boston, so as to be readily accessible to the inner city community. A panel of experts addressed diagnosis and management of asthma, as well as asthma prevention. The emphasis was on education and how citizens can maneuver through the health care system to receive thorough treatment. Numerous Environmental Asthma Community Coalitions have been working throughout New England on home and school education evaluations to control environmental asthma triggers. In addition, the Asthma and Allergy Foundation of New England developed a series for childcare providers on controlling environmental asthma triggers.

Partners: Alternatives for the Environment, Boston Medical Center, Citizens Energy Corporation, Dudley Street Neighborhood Initiative, Environmental Diversity Forum, Roxbury Community College, Urban Asthma Coalition, Asthma and Allergy Foundation of New England

Contact: Region 1, Mary Beth Smuts, 617-918-1528

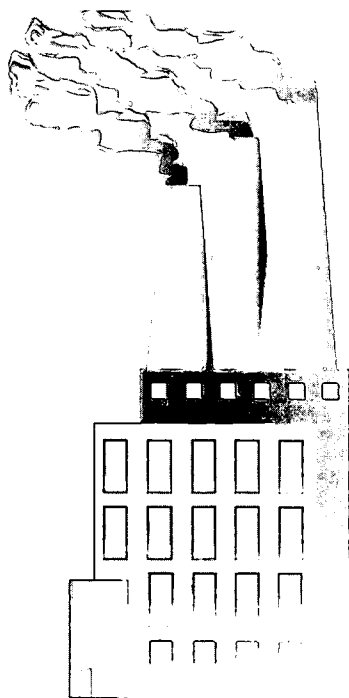

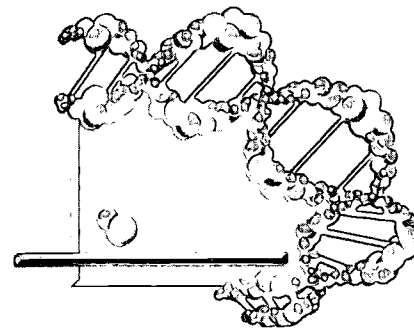

Title: Puerto Rico Department of Health—Asthma Coordinator

Description: In 1996, EPA sponsored an asthma workshop in Cataño, Puerto Rico, to discuss the high rate of asthma prevalence in Puerto Rican children and to determine the most productive course of action for combating asthma. The workshop identified a number of urgent needs, including the need for an asthma study examining the importance of indoor allergens in Puerto Rico (see project description below). Because the Puerto Rico Department of Health had no staff available to dedicate to asthma issues, EPA granted funds for 1 year to support an asthma coordinator, whose task is to implement the recommendations of the Cataño Workshop and to help conduct an asthma study.

Contact: Region 2, Rachel Chaput, 212-637-4001

Title: Integrated Pest Management in Urban Low-Income Housing Projects

Description: Hunter College's Center for Environmental and Occupational Health, in conjunction with the New York City Department of Health, is working with the New York City Housing Authority to implement integrated pest-management (IPM) strategies in low-income housing projects in East Harlem. The goal of the effort is to achieve sustainable reductions of cockroaches and rodents, both of which produce allergens that can cause or aggravate asthma. The team assembled to do the work is from the immediate community.

Contact: Region 2, Rachel Chaput, 212-637-4001

Title: Educational Photoliterature as a Means to Reduce Cockroach and Rodent Infestations Without Pesticides in a Low-Income Setting

Description: EPA Region 2 is developing a community-based educational photoliterature (photos with simple text) that describes integrated pest management (IPM) techniques for reducing cockroach and rodent infestations in inner city housing. Cockroaches and rodents produce

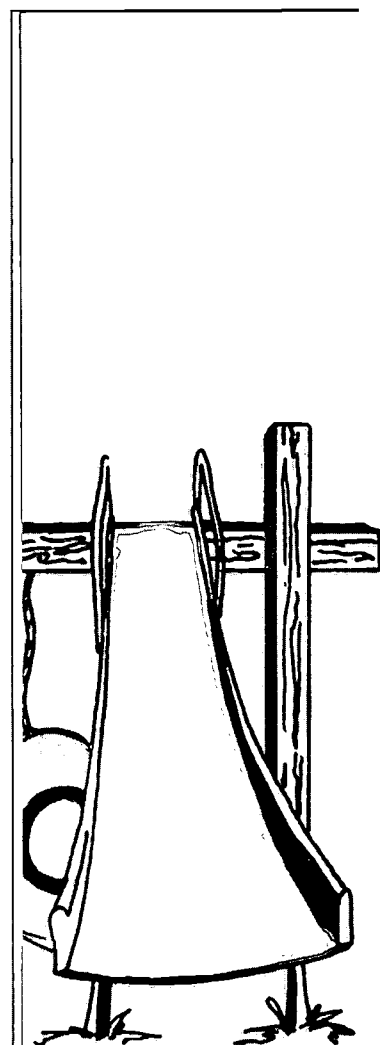

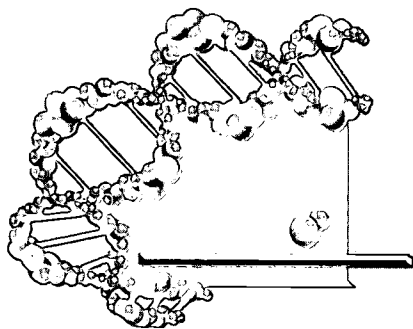

allergens that can cause or aggravate asthma in sensitive populations, especially children. The local community has been involved from the outset in the development of the photoliterature, learning about pest infestations and their association with asthma, developing a storyline to educate community members about IPM techniques, and helping to produce the photoliterature.

Contact: Region 2, Rachel Chaput, 212-637-4001

Title: Asthma Education in East Harlem

Description: The Boriken Neighborhood Health Center will conduct bilingual asthma education in East Harlem, which has been documented to have the highest asthma mortality rate in the nation. Boriken will work in partnership with the new EPA/DHHS Children's Health Center, recently established at the Mount Sinai Medical Center, to deliver education that focuses on environmental triggers and proper medical management of asthma.

Contact: Region 2, Rachel Chaput, 212-637-4001

Title: Fighting Asthma in HUD Housing

Description: EPA has awarded a grant to the New York City Housing Authority (NYCHA), which is part of the U.S. Department of Housing and Urban Development (HUD) housing program, to conduct an asthma educational program for residents of the city's public housing. The educational program will use NYCHA's 115 community centers as the primary venue for reaching this population. A series of posters will be developed and displayed, communicating critical messages about the environmental control of asthma. In addition, NYCHA will work with Hunter College's Center for Environmental and Occupational Health to offer educational workshops about asthma for public housing residents.

Contact: Region 2, Rachel Chaput, 212-637-4001

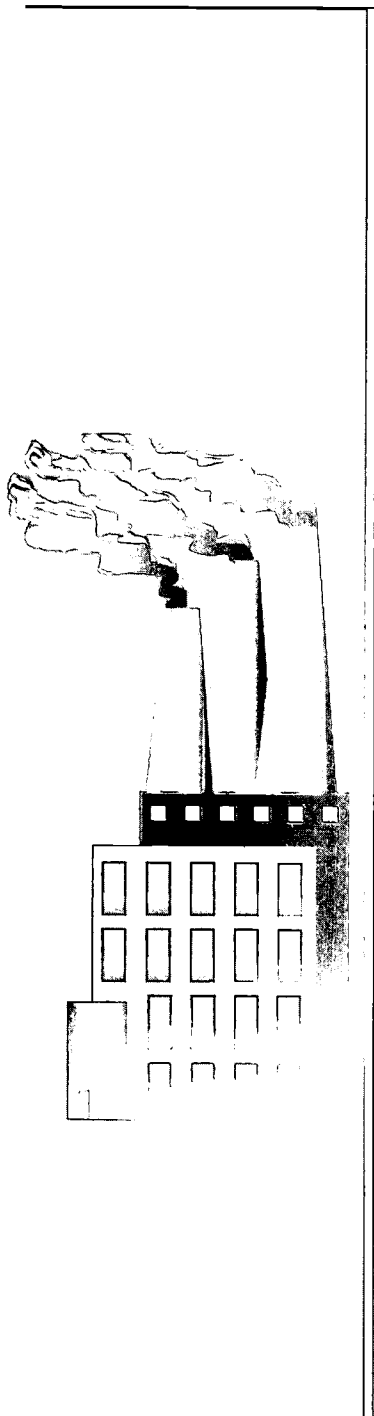

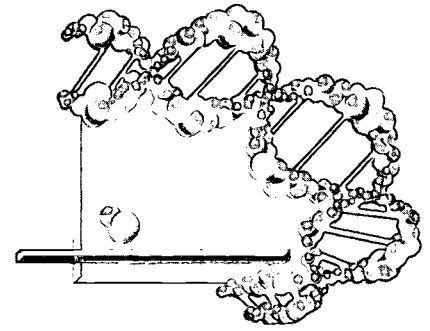

Title: Clinical Directors Network Asthma Intervention Project

Description: The Clinical Directors Network (CDN) is a nonprofit association of primary care providers who practice in low-income areas across the country. The goal of this project is to develop and refine two interventions which, at moderate cost, can improve asthma health outcomes. The two interventions, one clinical and one environmental, will be compared against "high-quality usual care." The resulting structure, or module, could then be used in CDN-associated low-income clinics in other regions, with refinements for local variations in the relevant environmental triggers.

Contact: Region 2, Rachel Chaput, 212-637-4001

Title: Camden-Rutgers University Asthma Project

Description: This project will focus on building the capacity of residents and community groups in Camden and Philadelphia to confront two health problems that are strongly associated with treatable environmental factors: lead poisoning and asthma. Both Camden and Philadelphia have populations of predominantly impoverished, minority families in which many children are at risk from these health problems. This project will identify children at risk through cooperative agreements with health professionals (e.g., school nurses and maternity care givers). Environmental management teams, composed of community residents who have been specifically trained for this purpose, will visit the families of identified children and provide education and intervention for lead and asthma. Followup visits will assess the effectiveness of training and allow evaluation of the program. The project has a 1-year goal of impacting 400 families in Philadelphia and 600 families in Camden.

Contact: Region 2, Rachel Chaput, 212-637-4001

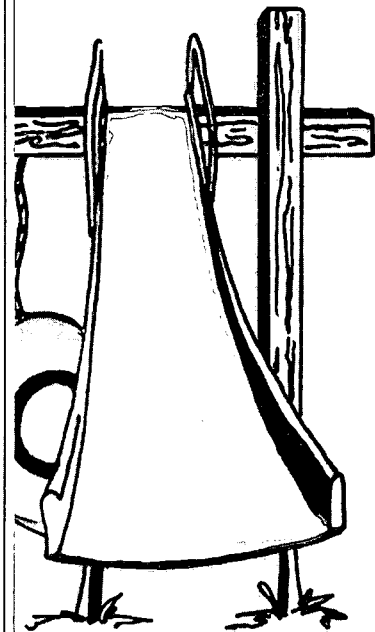
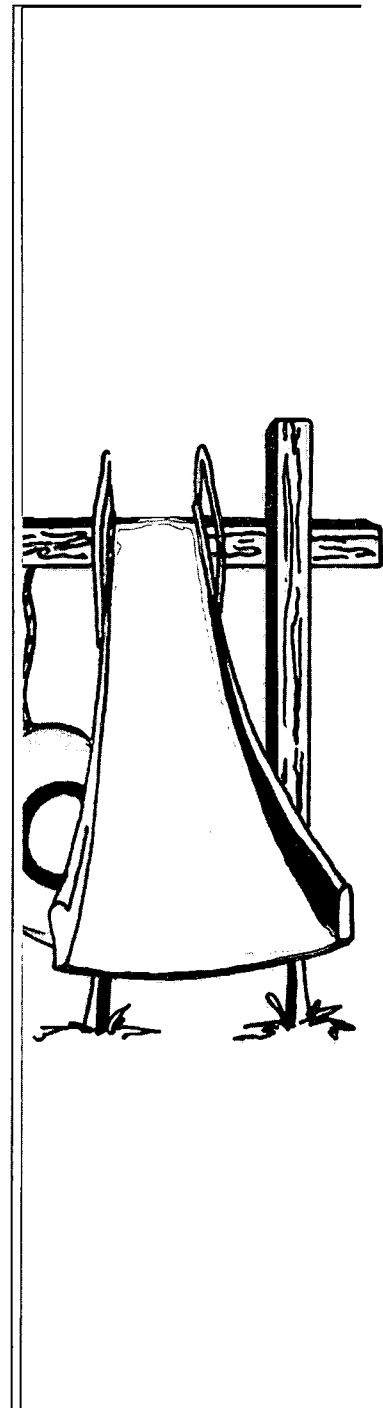

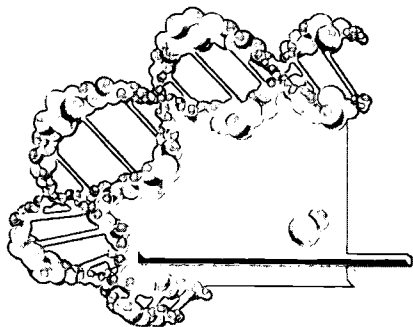

Title: English/Spanish Video on Reducing Indoor Asthma Triggers in Inner City Dwellings

Description: Due to a number of factors, including dilapidated housing stock, low-income urban populations often experience disproportionate exposures to various indoor environmental asthma triggers (e.g., cockroach allergens, molds). The same populations can also experience disproportionate exposures to pesticides used to target the roaches. Research has shown that these inequities are correlated to some extent with the extremely elevated rates of asthma found in these populations. Regions 2 and 7 are collaborating on developing an instructional video to give low-income urban populations techniques to reduce their exposure to these substances. The video will be translated into Spanish.

Contact: Region 2, Rachel Chaput, 212-637-4001

Title: Indoor Asthma and Allergen Control

Description: EPA Region 4 and the University of Tulsa are presenting several 2-day training courses to educate public health officials on indoor asthma and allergen control measures.

Contact: Region 4, Henry Slack, 404-562-9143

Title: Seminar Series on Asthma

Description: The Region 5 Children's Health team and the Air Division's Asthma Workgroup conducted four seminars on asthma, featuring expert speakers from the Chicago area. The seminars covered a range of topics, including the effect of environmental exposures on asthma hospitalizations, triggers and medications for asthma, use of the *Open Airways* curriculum in schools, and the Ozone Action Day Program.

Contacts: Region 5, Afif Marouf, 312-353-5550, Fayette Bright, 312-886-6069, or Jeanette Marrero, 312-886-6543

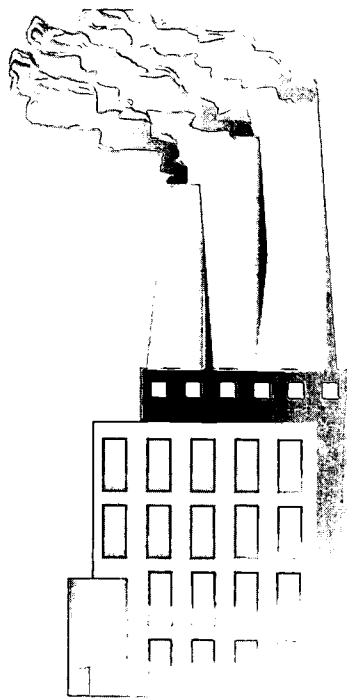

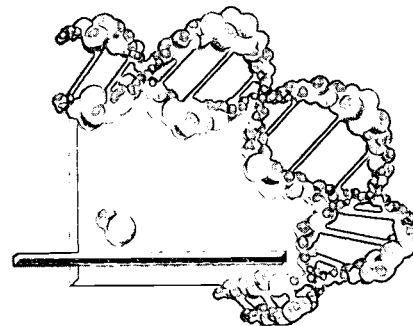

Title: Community Partnership to Improve the Lives of Asthmatic Children in Chicago

Description: EPA and the DHHS are working together on this community-based project to decrease asthma mortality and morbidity in Chicago. The DHHS will develop a model to reduce exposures in the indoor environment by educating people about asthma triggers and helping them change their behavior. The project is expected to lower children's exposures to asthma triggers, thereby reducing asthma episodes.

Contacts: Region 5, Fayette Bright, 312-886-6069, or Randy Cano, 312-886-6036

Title: Managing Asthma in the Childcare Setting

Description: With EPA funding, the American Lung Association (ALA) of Illinois conducts train-the-trainer sessions for childcare providers in the East St. Louis metropolitan area. Using the Children's Television Workshop's "A is for Asthma" video, the ALA educates the providers about the environmental factors that trigger asthma attacks in young children. The preschoolers then learn from their childcare providers how to prevent or manage their asthma attacks.

Partners: American Lung Association of Illinois

Contact: Region 5, Suzanne Saric, 312-353-3209

Title: Childhood Asthma and Allergies Conference

Description: Region 6 hosted a 3-day Childhood Asthma Conference in May 2000 in Dallas, Texas, to address the prevention and treatment of childhood asthma. The target audience for the conference includes practicing health care professionals and organizations involved in the prevention of asthma triggers. The unique aspect of this conference is that it brings together health care professionals and indoor environmental engineering control professionals for a 2-day exchange of ideas and information about the best available control

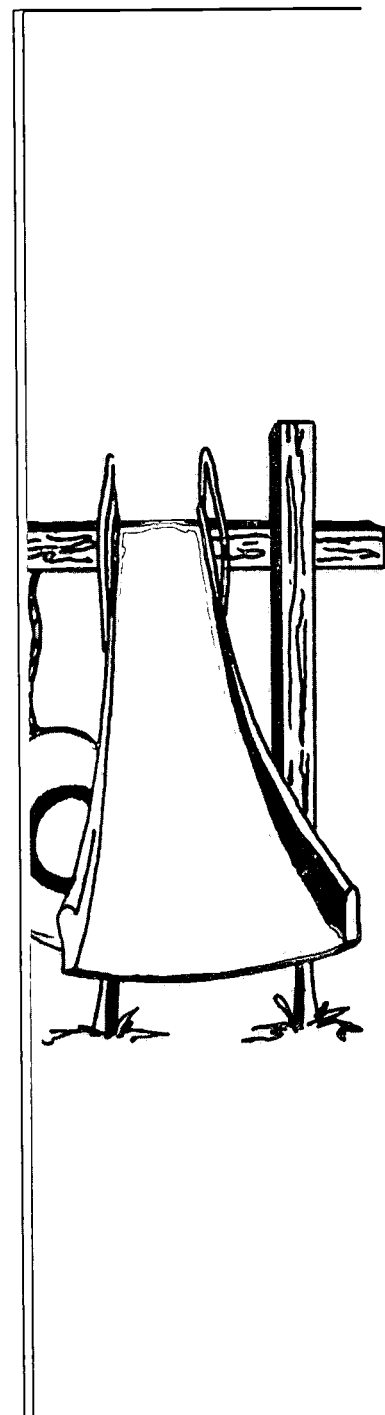

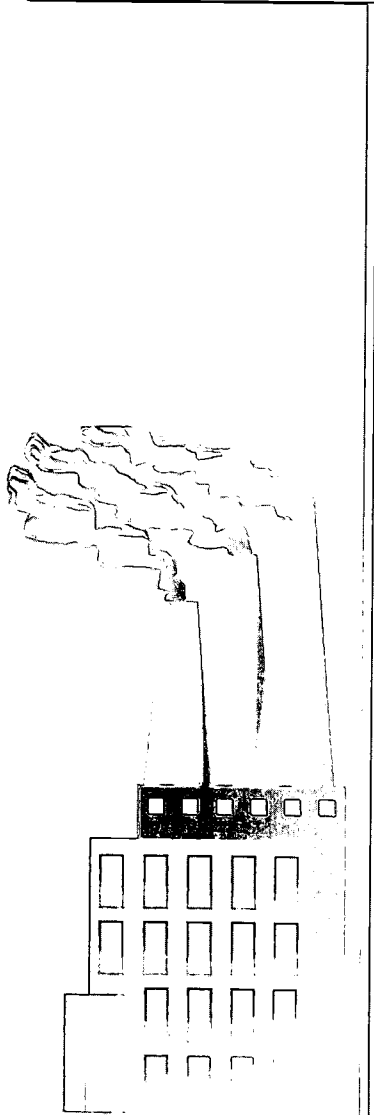
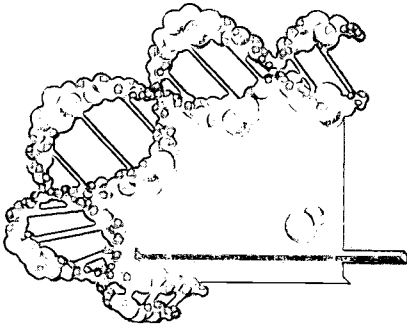

and treatment technology for the prevention, control, or management of asthma episodes in children.

Partners: University of Texas Southwestern Medical Centers (Dallas and San Antonio), Harris Methodist Health Plan, Centers for Disease Control and Prevention, National Institute of Environmental Health Sciences (NIEHS), U.S. Public Health Service, University of Tulsa, University of Washington

Contact: Region 6, Evelyn Daniels, 214-665-7543

Title: Environmental House Calls

Description: The South Texas Environmental Education and Research (STEER) initiative of the University of Texas Health Science Center at San Antonio offers physicians-in-training and other students in the health professions a unique 1-month border environmental health elective. STEER developed a pilot program of structured environmental house calls that students conduct, under the guidance of training professionals, by visiting homes of children with asthma in Laredo, Texas. Laredo, a U.S.-Mexico border community, has one of the highest rates of poverty and unemployment among U.S. cities. The goals of the project are to (1) give a poor, minority population an opportunity to improve environmental conditions that adversely affect the health of their children, (2) train physicians and nurses in environmental medicine, and (3) address the rising prevalence of asthma.

Partners: University of Texas Health Science Center at San Antonio

Contact: Region 6, Evelyn Daniels, 214-665-7543

Title: Colorado Asthma Summit

Description: EPA has provided funding to hold a statewide Asthma Summit in Colorado. This summit will bring together the public and private sectors to discuss and evaluate the high rate of asthma in Colorado and identify key areas that need attention.

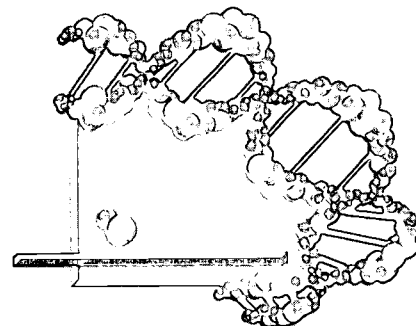

Partners: The American Lung Association of Colorado
Contact: Region 8, Whitney Trulove-Cranor, 303-312-6099

Title: Girl Scouts Asthma Awareness Badge

Description: Region 8 is working with the Agency for Toxic Substances and Disease Registry and the Mile-Hi Girl Scout Council to develop a badge program on asthma. The program will allow Girl Scouts to earn a badge for community health education activities related to asthma.

Partners: Agency for Toxic Substances and Disease Registry, Mile-Hi Girl Scout Council

Contact: Region 8, Alicia Aalto, 303-312-6967

Title: Neighbor to Neighbor Indoor Air Quality: Environmental Justice Education Program

Description: Region 10 is collaborating with the Community Coalition for Environmental Justice (CCEJ) of Seattle, Washington, on this program, which will implement the tool recently developed by CCEJ entitled *Creating Indoor Air Quality Programs in Low-Income Communities and Communities of People of Color: An Organizer's Handbook*. Using the handbook to implement a community-based education model, CCEJ will conduct workshops to train community members about indoor air contaminants and the health effects of exposures to indoor air pollution as well as other topics.

Contact: Region 10, Brook Madrone, 206-553-2589

Title: Master Home Environmentalist Program

Description: Region 10 is working with the American Lung Association of Washington (ALAW) in Seattle, Washington, to provide a 40-hour training course to community volunteers on key issues of indoor air pollution, and in community outreach skills and cultural diversity.

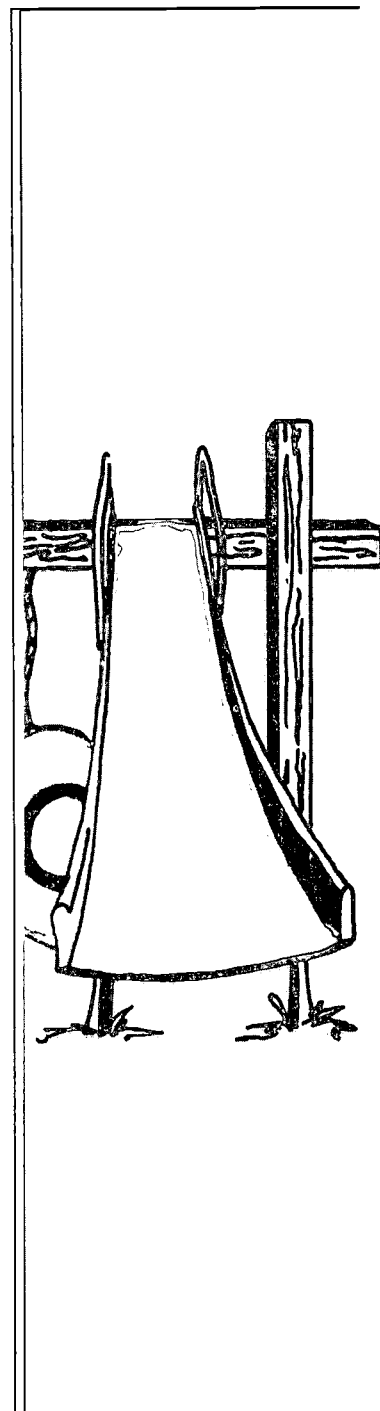

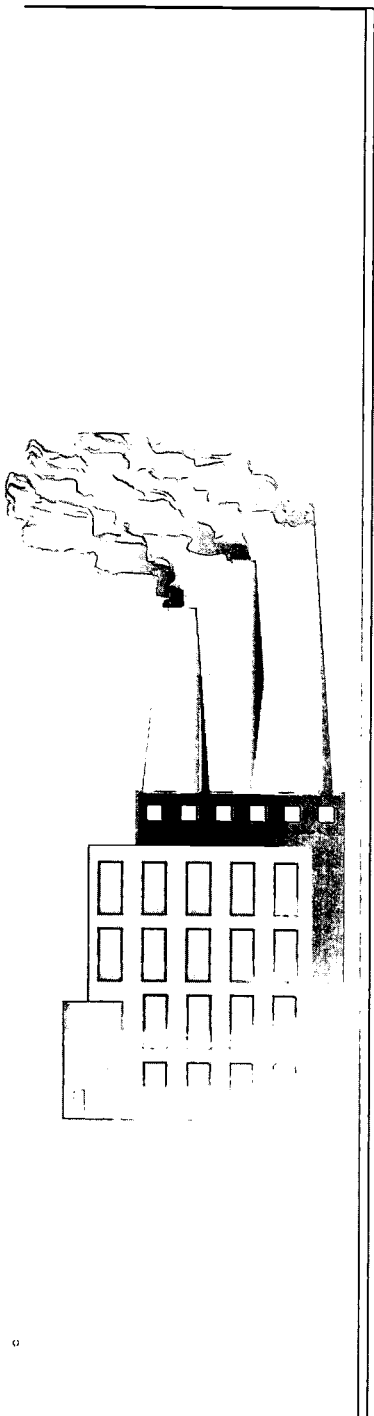
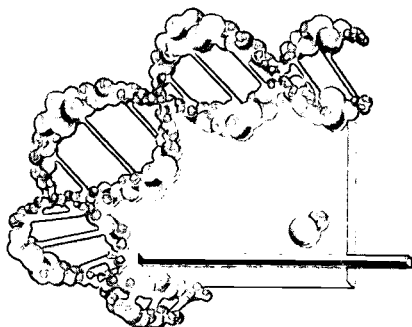

The training includes lectures on indoor air pollutants and their health effects, including a section on asthma and asthma triggers. The volunteers use a comprehensive training manual that focuses on conducting home environmental assessments using the Home Environmental Assessment List (HEAL), a comprehensive survey of indoor air conditions. Volunteers are working with residents to devise action plans that address the major concerns identified in the HEAL. ALAW is also working to address disproportionate health impacts of indoor pollutants on adults and children in low-income and minority communities. The training and home assessments also address the issue of lead poisoning in children.

Contact: Region 10, Barbara Ross, 206-553-1985, Brooke Madrone, 206-553-2589, or Dan Robison, 509-575-5845

Title: Community Outreach on Indoor Air and Asthma

Description: Region 10 works with several coalitions to address asthma and indoor air quality issues. One of these is the King County Asthma Forum, a coalition of public health agencies, local government, and nonprofit and community-based organizations including grassroots environmental justice organizations. This coalition addresses the increasing rates and morbidity of asthma in the Seattle-King County area. Region 10 also works with the Indoor Air Coalition (Puget Sound). This group's current activities include the Little Lungs Breathing Project, a project of the Seattle Chapter of the American Lung Association. The project focuses on identifying asthma triggers and other sources of indoor air pollution that can result in illness in children enrolled in childcare centers.

Contact: Region 10, Brooke Madrone, 206-553-2589

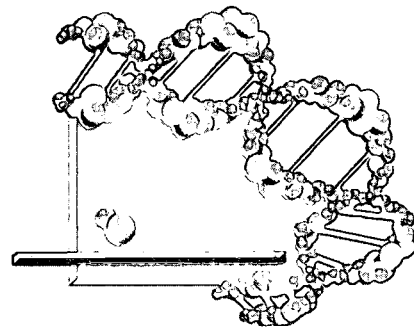

RESEARCH ON INDOOR AIR QUALITY AND ASTHMA AND OTHER RESPIRATORY ILLNESS AMONG CHILDREN

Title: Clearing the Air: Asthma and Indoor Air Exposures

Description: The National Academy of Sciences (NAS) Institute of Medicine conducted a review of available literature to determine the specific effects of indoor pollutants on asthma illnesses and deaths. The report, released in January 2000, includes both a general evaluation of asthma and indoor air quality and an analysis of the effects of individual indoor air pollutants on asthma, with special consideration for children. The report recommends the best methods to reduce exposures to indoor air pollutants that can cause or trigger asthma episodes, and also makes recommendations for additional scientific research in these areas. EPA will use the information to improve public outreach, including teaching children, parents, and school administrators about the benefits of reducing exposures to asthma triggers in homes and schools. The report is available online at <http://www.nap.edu/books/0309064961/html>.

Contact: Office of Air and Radiation, Pauline Johnston, 202-564-9425

Title: Direct and Indirect Costs of Asthma and the Potential Benefit of Education and Intervention

Description: EPA is conducting a study of the national costs of asthma and the factors that prompt some hospitals and health plans to sponsor asthma education programs. The study estimates the national costs of asthma and the distribution of these costs, and estimates the savings to the nation from meeting the proposed Healthy People 2010 asthma objectives. The study also reviews the state of knowledge about asthma triggers and their control, reviews several hospital- and health plan-sponsored asthma education programs, and assesses the cost-effectiveness of some of these programs.

Contacts: Office of Policy, Economics and Innovation, Nicole Owens, 202-260-9514, or Lanelle Wiggins, 202-260-2692

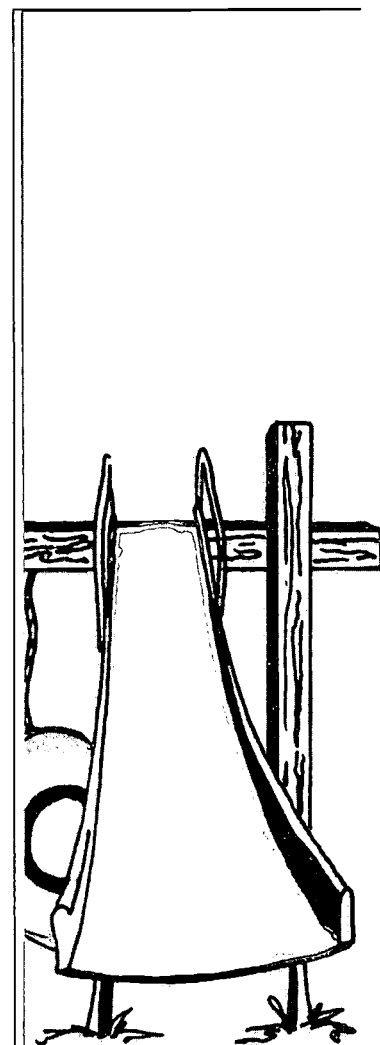

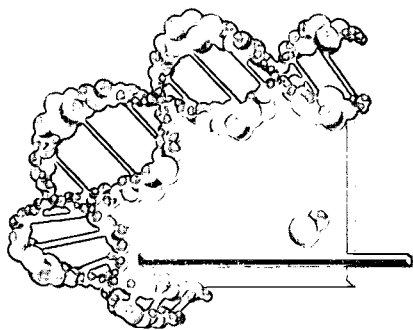

Title: Increased Vulnerability of Neonates to Naphthalene and Its Derivatives

Description: Epidemiologic studies implicate maternal cigarette smoking as a cause of a number of childhood respiratory diseases, though the impact of other environmental contaminants on lung disease in infants is not known. Recent studies with laboratory animals have demonstrated that newborns are much more susceptible to lung injury from certain environmental toxicants than are adults. This project, which is a series of studies, focuses on the fundamental differences between the developing cells in a newborn's lung and the fully developed cells in an adult's lung. These studies focus on the effects that a specific group of chemicals—naphthalene and its derivatives—have on the lungs of adult and newborn rats, in an attempt to understand why adults and newborns show different susceptibilities to the chemicals.

Contact: Office of Research and Development, Chris Saint, 202-564-6909

Title: Meeting of Hispanic Biomedical Association

Description: The Collaborative Study Group on Genetic-Environmental Interactions in Asthma held a 1999 meeting in New York City to define the genetic and environmental factors that need to be considered in studies involving the development of asthma in Puerto Ricans. The participants assessed available approaches for the study of genetic-environment interactions in asthma, and identified the best sample size and type, and the best methodology, for studying the genetic and environmental factors involved in the development of asthma in Puerto Ricans. The meeting contributed to better understanding the type and nature of environmental factors triggering asthma in Puerto Ricans and its relationship to their genetic makeup. A report on this subject will be published.

Contact: Region 2, Rachel Chaput, 212-637-4001

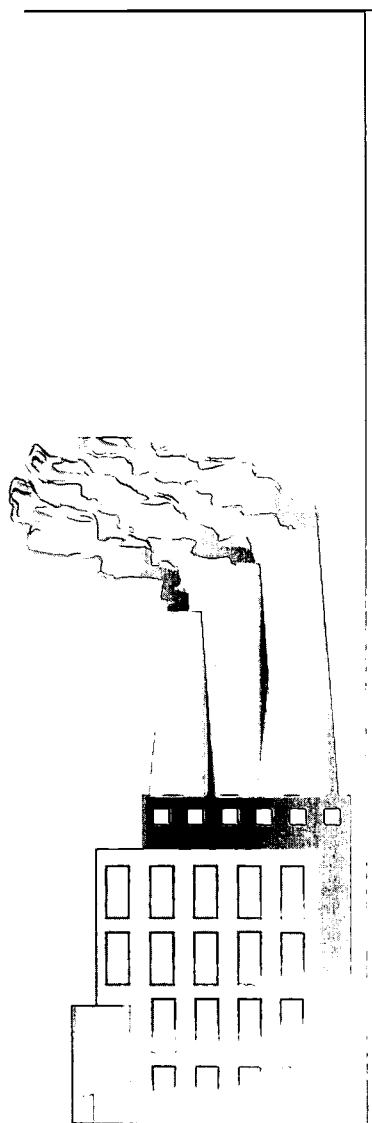

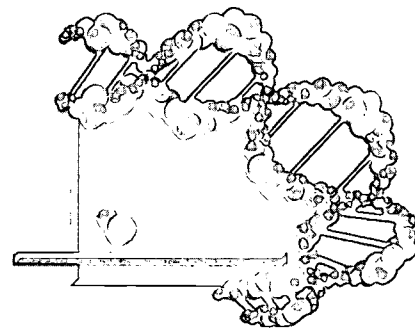

Title: Asthma Intervention Study in Hunts Point

Description: Researchers from the Jacobi Medical Center, in cooperation with the New York City Department of Health's (DOH's) Asthma Initiative, will assess the effectiveness of asthma interventions in 30 homes. The DOH will perform intensive asthma education in these homes (which all contain at least one asthmatic child), including education about asthma, medications, environmental triggers, and remediation of environmental triggers. The researchers from the Jacobi Medical Center will perform evaluations in all 30 homes, analyzing the dust samples for allergen levels at the beginning of the project, the midpoint, and the end. The researchers will also collect some limited asthma morbidity data at each visit.

Contact: Region 2, Rachel Chaput, 212-637-4001

Title: Montefiore Medical Center Asthma Intervention Project

Description: Montefiore Medical Center is conducting an asthma intervention study using its Safe House, a low-allergen controlled setting. There are three groups of participants, all severe asthmatics. The first group is being moved temporarily into the Safe House, while their homes are mitigated and cleaned to reduce allergens related to asthma. This group also will receive family counseling. The second group remains in their own homes but receives the same professional cleaning services. The third group receives the current standard of care—drug treatment. Symptoms and allergen levels in dust will be analyzed at specific points in time throughout the intervention.

Contact: Region 2, Rachel Chaput, 212-637-4001

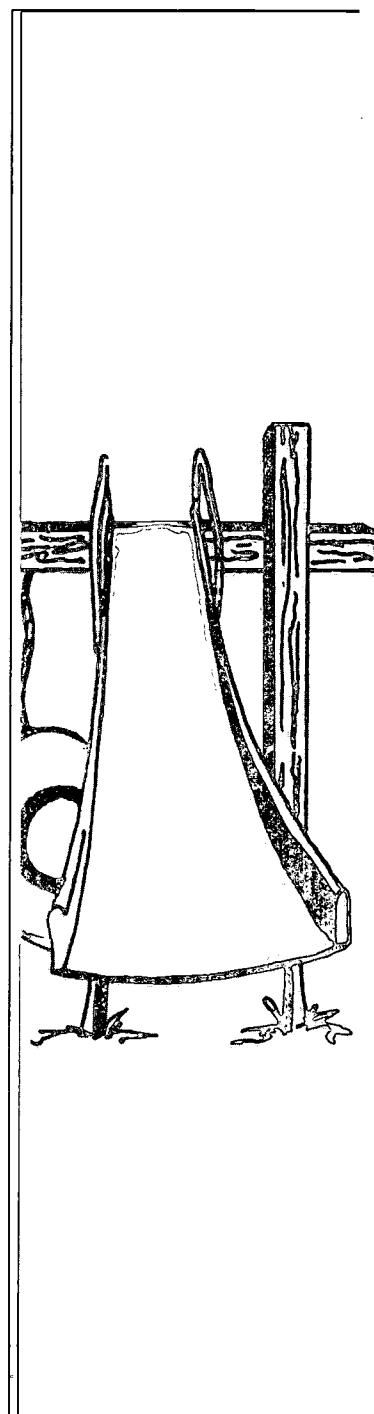

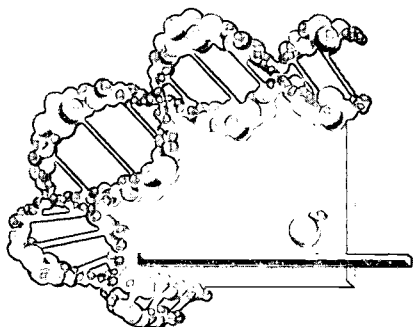

Title: Allergen Levels in Homes of Native Americans

Description: Preliminary data for the St. Regis Mohawk Tribe, a Native American nation located in New York state, indicate that asthma prevalence has risen in this population over the past decade, as in the nation at large. EPA Region 2 is providing funding for a study involving a small cohort of households, half with and half without asthmatics. Questionnaires will be completed by the families. Dust will be collected from these households and analyzed for the standard dust mite allergens and a general mold count. These data will allow researchers to compare tribal members' environmental exposures with those for groups whose environmental asthma has been more thoroughly studied.

Contact: Region 2, Rachel Chaput, 212-637-4001

Title: Indoor Allergens Study in Puerto Rico

Description: EPA Region 2 has funded an environmental allergen study in Puerto Rico, in cooperation with the University of Ponce Medical School. Measurements of the standard environmental allergens (dust mites, cockroaches, cats, etc.) will be made in the homes of asthmatic children, along with measurements of heavy metals and other substances of interest. The measurements will be complemented by an IAQ survey in the homes, and allergenic skin testing for the asthmatic children. This project will provide information on the levels of known allergens and irritants in this tropical environment, and will examine associations with the asthmatic children's allergic profiles. Asthma rates in children in Puerto Rico have been shown to be extremely high, and this project will provide further information on the environmental triggers critical to asthma in Puerto Rico.

Contact: Region 2, Rachel Chaput, 212-637-4001

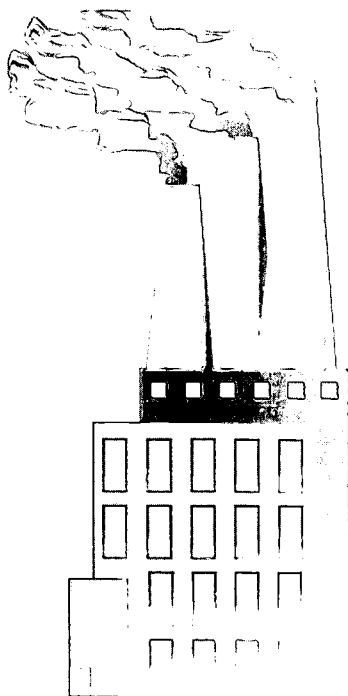

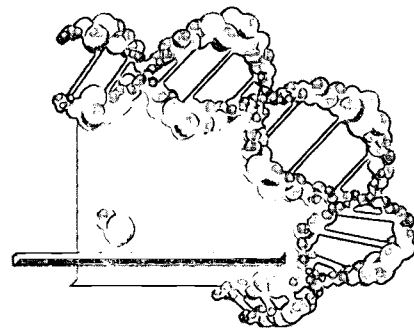

Title: School Intervention Project—Headquarters/Springfield School Indoor Air Risk Factors Study

Description: This study collected baseline measurements on pollutants and other indoor environmental factors in schools to assess the general state of schools' IAQ. The study monitored the levels of particulate matter, volatile organics, and biologicals, as well as ventilation conditions and comfort parameters. Monitoring continued for 1 week, both inside and outside the schools.

Contact: Region 5, Sheila Batka, 312-886-6053

Title: Asthma Risk Factor Study of Chicago Public School, Before and After Implementation of an Integrated Pest Management Program

Description: This study is focusing on the indoor environmental risk factors associated with asthma in Chicago-area school children. The study, which is being conducted at a Chicago public school, tested indoor environmental factors, such as general comfort, bioaerosols, particulates (PM2.5 and PM10), and dust allergens. A visual inspection of the heating, ventilation, and air conditioning system also was conducted. This year, an IPM program will be implemented at the school.

Contact: Region 5, Sheila Batka, 312-886-6053

Title: Indoor Biological Risk Factors for Asthma in School Age Children

Description: The Arkansas Department of Health (ADH) Division of Epidemiology will perform a study of homes and schools of asthmatic children in order to determine methods or approaches for reducing risk from exposure to biological agents. Asthmatic children will be identified from kindergarten through the sixth grade in selected Arkansas communities.

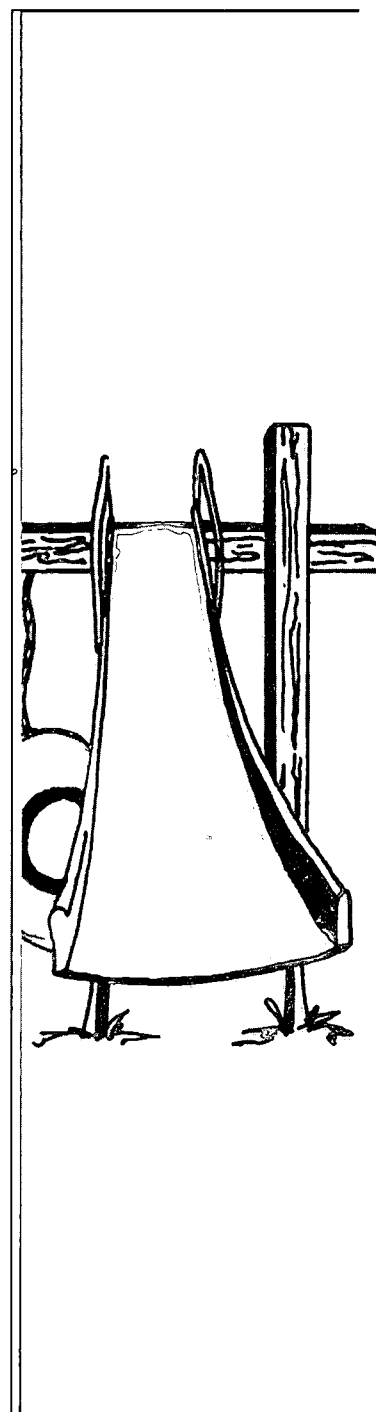

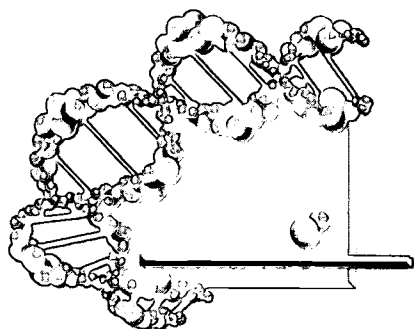

Partners: Arkansas public school systems; Parent-Teacher Associations; Statewide Educational Cooperatives; American Lung Association, Arkansas Chapter; Arkansas Department of Education

Contact: Region 6, Mike Miller, 214-665-7550

Title: Indoor Environmental Intervention Study in Grade Schools and Childcare Centers to Reduce Childhood Asthma Symptoms

Description: Region 8 and the University of Colorado at Boulder will conduct an intervention study to examine ways to reduce exposure to certain indoor environmental asthma triggers in schools and childcare centers in the Denver area.

Partners: University of Colorado Department of Mechanical Engineering, EPA Radiation and Indoor Environments National Laboratory

Contact: Region 8, Megan Williams, 303-312-6431

Title: Seattle Healthy Homes Project

Description: This 4-year study, funded by the National Institutes of Environmental Health Sciences (NIEHS), is designed to improve indoor environmental quality and reduce asthma morbidity. EPA and the project's Science Advisory Committee helped identify important intervention focus areas around control of asthma triggers, asthma self-management, and development of measurement tools.

Contact: Region 10, Brooke Mardone, 206-553-2589

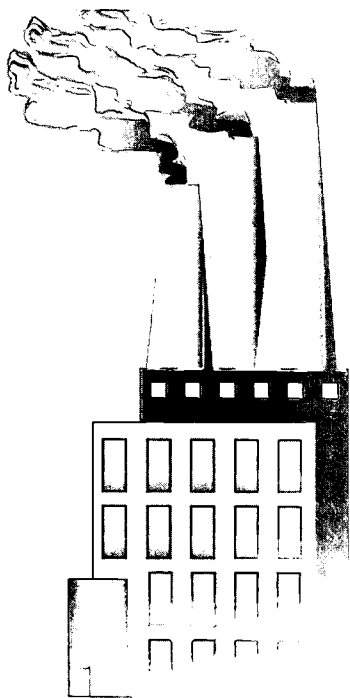

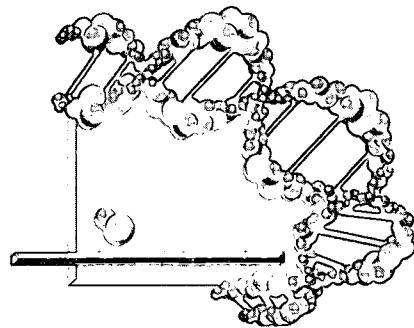

OUTDOOR AIR QUALITY

Title: Let Kids Lead

Description: This pilot program enables youth to become involved in transportation choices that improve air quality and quality of life in their communities. The program makes resources available to communities across the country who want to encourage youth to participate in transportation problem-solving. The program is administered through a partnership with the Academy for Educational Development, a national nonprofit organization. Its Web site is www.letkidslead.org.

Partners: Academy for Educational Development, American Lung Association of Gulfcoast Florida, Mid-America Regional Council, Alternatives of Community and the Environment

Contact: Office of Air and Radiation, Connie Ruth, 734-214-4815

Title: Community-Based Environmental Monitoring with the Toppenish School District and the Yakama Nation

Description: Region 10 is working with the Toppenish, Washington, School District and the Yakama Nation on an air quality education project with area schools. EPA is providing indoor and ambient air monitoring equipment along with training and short-term technical support. The school district is developing an environmental education curriculum focused on air quality. As part of the curriculum, both students and teachers will engage in air quality monitoring in and around their school. EPA will provide technical support in the short term and the Yakama Nation's air program will support the effort in the long term.

Contact: Region 10, Dan Robison, 509-575-5845

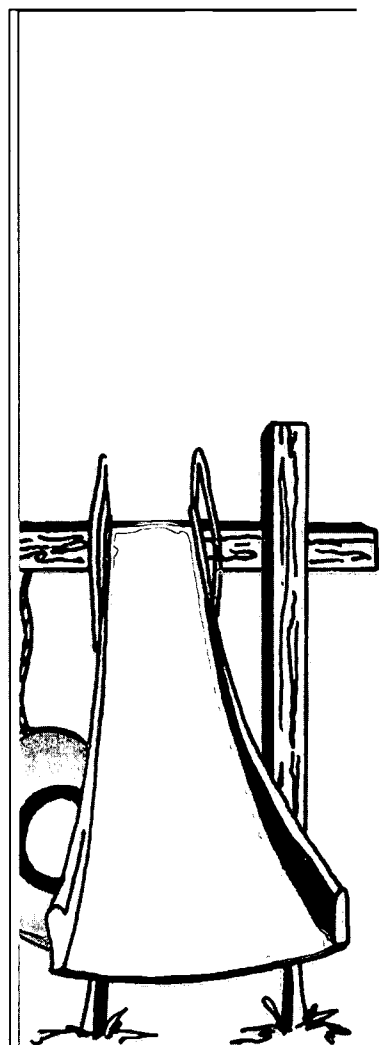

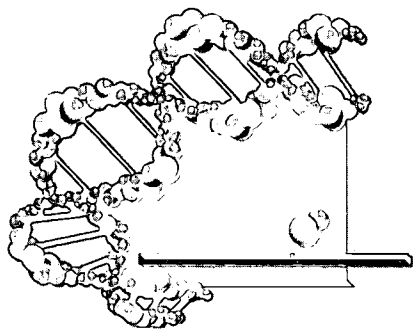

RESEARCH ON OUTDOOR AIR QUALITY AND ASTHMA AND OTHER RESPIRATORY ILLNESS AMONG CHILDREN

Title: Childhood Susceptibility to Air Pollutants

Description: A collaborative study is under way to determine whether children are more susceptible than adults to nasal metaplasia (abnormal cell changes) and whether biochemical tests can detect effects of exposure to high ambient ozone and PM10 pollutants in Mexico City. A separate study deals with a comparison of the dose of ozone delivered to the lungs of infant versus adult rats.

Contact: Office of Research and Development, Linda Birnbaum, 919-541-2655

Title: Oro-Nasal Ventilation Pattern in Children and Associated Fine Particulate Matter Deposition

Description: The objective of this project is to determine how a child's breathing rate ("ventilation rate") changes at various levels of activity, and at what point children switch their mode of breathing from nose to mouth-and-nose (the "oro-nasal switching point"). These parameters are key determinants of both inhaled particle deposition and gas uptake in the respiratory tract. These parameters have been characterized for a limited number of adult subjects. This study will produce the first data on these important ventilation parameters in children.

Contact: Office of Research and Development, Annie Jarabek, 919-541-4847

Title: Exacerbation of Asthma among Inner City Children

Description: EPA and the National Institute of Allergy and Infectious Diseases support a comprehensive indoor and outdoor monitoring program of particulate matter and co-pollutants in conjunction with the Inner City Asthma Study (ICAS). The ICAS study is examining

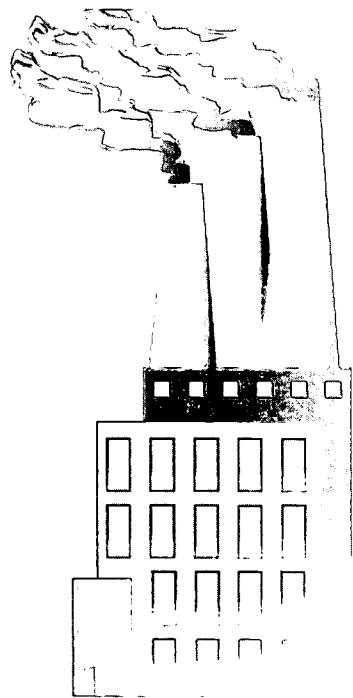

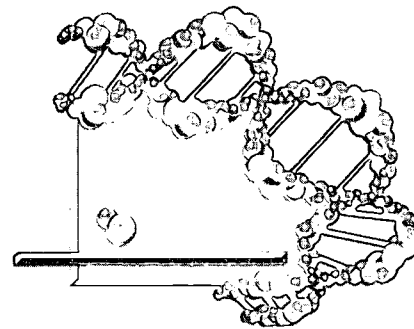

respiratory symptoms and pulmonary function levels among 1,022 inner city children with moderate to severe asthma, residing in seven U.S. communities.

Contact: Office of Research and Development, Hillel Koren, 919-966-6200

Title: Acute Respiratory Health and Ambient Air Quality in the Paso del Norte Airshed

Description: The objective of this epidemiologic study, developed by a group of public health professionals in Chihuahua, Mexico, is to determine if there is an association between air quality and pediatric respiratory health. The study area is the Paso del Norte airshed, an area of approximately 300 square miles in the Rio Grande River valley, incorporating parts of Mexico, Texas, and New Mexico. Researchers are looking for associations between daily levels of air contaminants, pollens, and meteorologic variables and daily counts of hospital emergency room visits for asthma and asthma-related illnesses by children aged 1 to 17 who live in the study area. The study is looking at data collected in 1994 and 1995.

Contact: Office of Research and Development, David Otto, 919-966-6226

Title: Mechanisms of Age-Dependent Ozone-Induced Airway Dysfunction

Description: Acute exposure to ozone causes airway hyper-responsiveness (AHR), a defining feature of asthma. Though ozone may be a particularly important respiratory hazard for children, the mechanism for ozone-induced AHR has not been established. The purpose of this project is to examine age-related changes in ozone-induced AHR in mice and to determine the mechanistic basis for observed changes.

Contacts: Office of Research and Development, Chris Saint, 202-564-6909

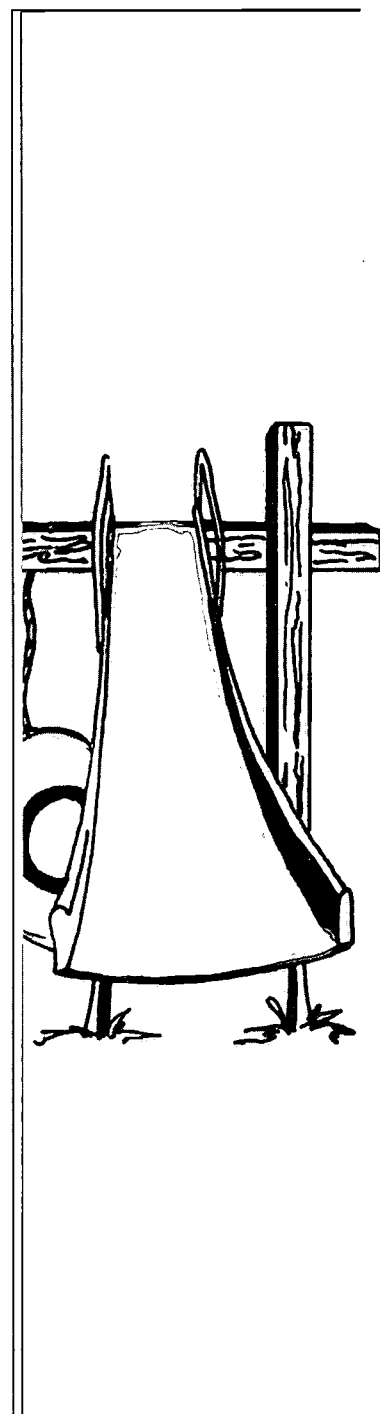

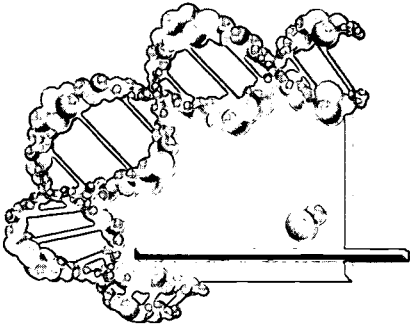

Title: Deposition of Air Pollutants in the Developing Human Lung

Description: Using a validated mathematical model for computing air deposition, researchers are studying total deposition within the whole lung, its relative compartmental distributions, and its localized patterns. This model also is being applied to predict the deposition of inhaled particles in the developing human lung.

Contact: Office of Research and Development, Linda Birnbaum, 919-541-2655

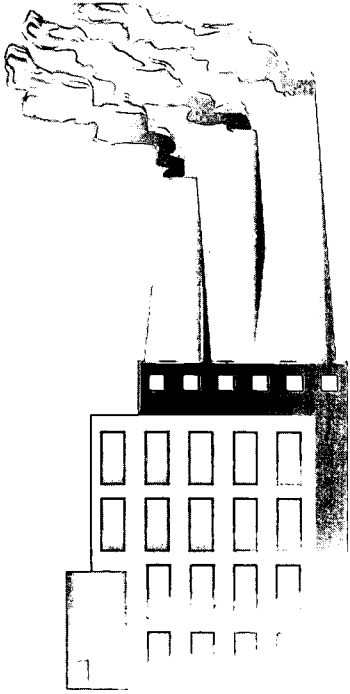

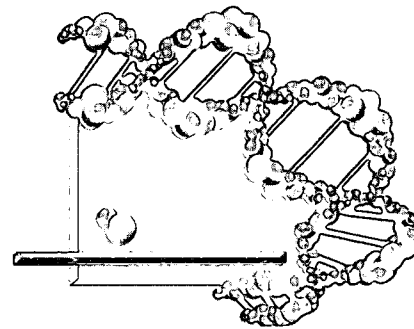

REFERENCES

1. The President's Task Force on Environmental Health Risks and Safety Risks to Children. 1999. Asthma and the Environment: A Strategy to Protect Children. Available at <http://www.epa.gov/children/asthma>.
2. Halfon, N., and P.W. Newacheck. 1993. Childhood Asthma and Poverty: Differential Impacts and Utilization of Health Services. *Pediatrics*. Volume 91, Pages 56-61.
3. CDC. 1996. Asthma Mortality and Hospitalization among Children and Young Adults, 1980-1993. *Morbidity and Mortality Weekly Report*. Centers for Disease Control and Prevention. Volume 45, Number 17, Pages 350-353. May 3.
4. ALA. 1997. Asthma in Diverse Communities. American Lung Association, Washington, DC.
5. Bates, D.V. 1995. The Effects of Air Pollution on Children. *Environmental Health Perspectives*. Volume 103 (Supplement B), Pages 49-53.
6. National Institutes of Health/National Heart, Lung and Blood Institute. October 1998. *Morbidity and Mortality: 1998 Chartbook on Cardiovascular, Lung and Blood Diseases*.
7. ALA. 1997. *When You Can't Breathe, Nothing Else Matters*. American Lung Association, Washington, DC.

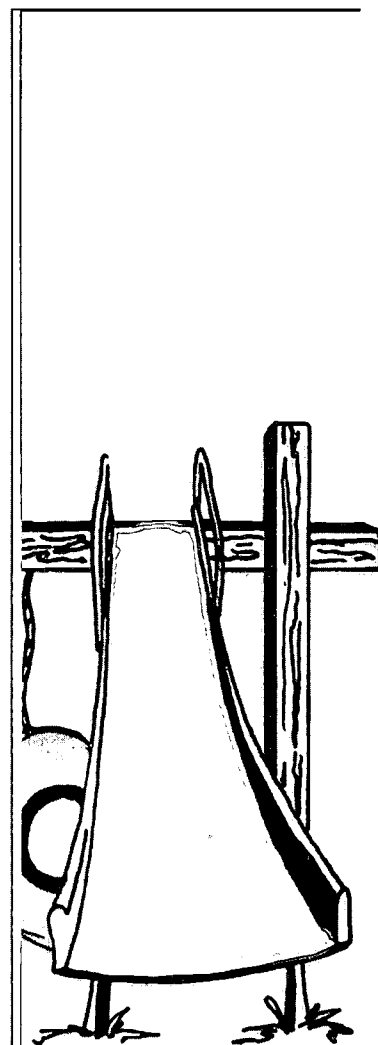

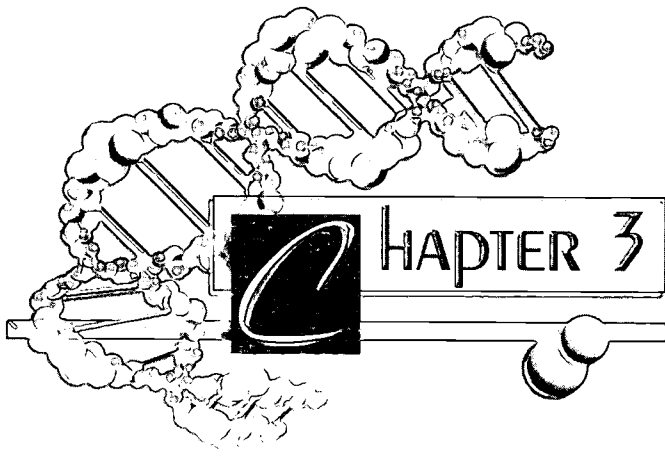

Childhood CANCER

According to the National Institutes of Health (NIH), cancer among children is a substantial public concern:

Each year in the United States, approximately 12,400 children and adolescents younger than 20 years of age are diagnosed with cancer. Approximately 2,300 children and adolescents die of cancer each year, which makes cancer the most common cause of disease-related mortality for children 1-19 years of age. (For this same age group, cancer ranked fourth as a cause of death behind unintentional injuries, homicides, and suicides).(1)

The NIH also reports that the overall cancer incidence rate increased from the mid-1970's, but rates in the last decade have been fairly stable. The incidence of leukemia among children younger than 15 years of age has shown a moderate increase (0.9% per year) in the past 20 years. Central nervous system cancer rates have increased from 1975 to 1995 (1.5% per year), though this trend has been the subject of considerable debate concerning the roles of environmental exposure and/or improvements in diagnostic technology.(1)

Certain toxic substances and radiation in the environment have the potential to initiate or accelerate the cell changes that lead to cancer. Examples of environmental factors that may be associated with cancer are environmental tobacco smoke, radon, asbestos, ultraviolet light, certain hazardous wastes, and some pesticides.(2,3,4)

EPA has an active program to address environmental threats that may contribute to childhood and adult cancer. EPA works with state and local governments, schools, and nonprofit organizations to reduce elevated radon levels in schools and homes. Through these partnerships, EPA has promoted radon awareness, voluntary testing programs, radon-resistant building practices, and methods to lower radon levels.

The Agency provides education and technical assistance to school districts to inspect school buildings for materials containing asbestos and to take followup actions. EPA also engages in outreach programs to educate students, teachers, and the general public about the potential damage ultraviolet radiation may cause to children's skin. A new EPA program, the SunWise School Program, offers students innovative learning opportunities, including monitoring daily UV levels (both forecast and actual), participating in cross-curricular classroom activities, and enhancing school sun-safety policies and practices.

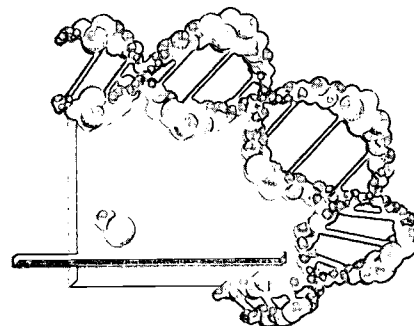

EPA has recently developed a list of chemicals and environmental hazards that pose the greatest risk to children's health at or near Superfund sites. The Agency is using this list to protect the health of children who live near hazardous waste sites. EPA also is conducting research to determine how much exposure children receive to toxic substances in the environment, and is developing methods and techniques to assess the effects of exposure to the body.

EPA PROJECTS RELATED TO CANCER

Radon

Title: Radon Mitigation for School Maintenance Personnel

Description: EPA Region 4, working with the Kentucky and Tennessee Radon Programs and the Southern Regional Radon Training Center, sponsored two courses designed to train school maintenance personnel on how to mitigate radon problems in their own schools. Radon mitigation techniques were applied at the host schools as part of the course. The course at the Western Kentucky University campus included mitigation of a building on the National Register of Historic Places. Representatives from numerous surrounding school districts participated.

Contact: Region 4, Patsy Brooks, 404-562-9145

Title: Radon Outreach

Description: Region 7 conducted a variety of radon outreach activities related to real estate transactions. It promoted real estate disclosure laws and radon testing, and handled more than 250 telephone calls about radon. The Region worked with several states to review a draft Radon and Real Estate fact sheet. Nebraska used radon grant funds from EPA to host six radon and real estate courses involving 116 brokers, real estate agents, and appraisers. The region also promoted radon-resistant new construction (RRNC). RRNC information was displayed in the Regional Office during national Radon Action

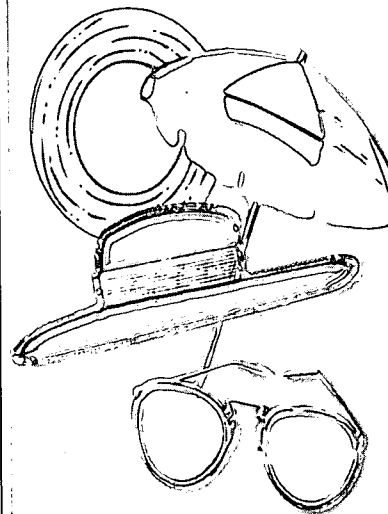

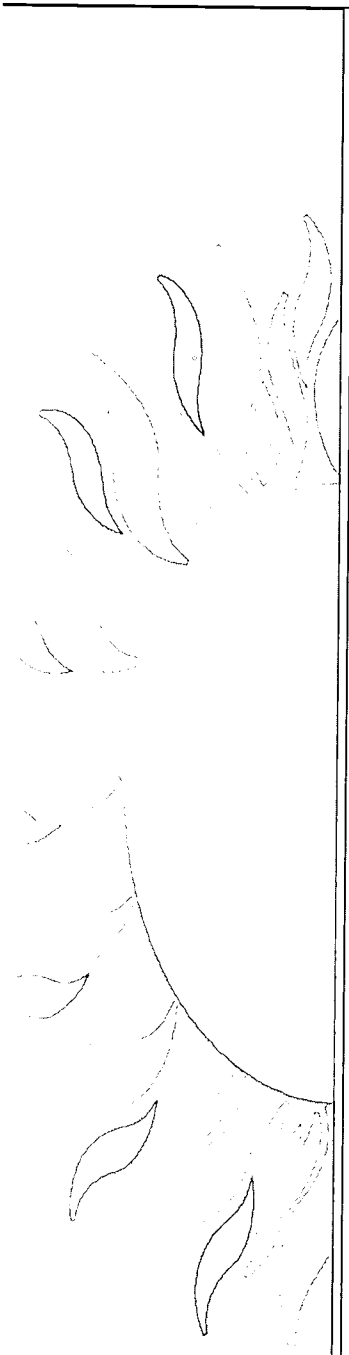
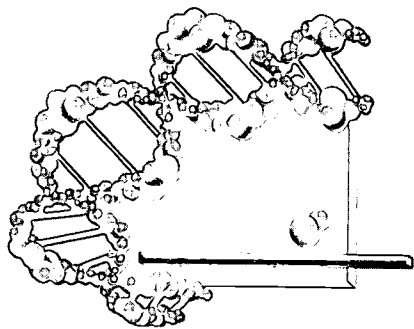

Week. Using EPA grants, Nebraska hosted a RRNC workshop. Kansas assisted technical schools and high school vocational programs in building radon-resistant homes. Region 7 also developed an IAQ and Radon Training Calendar that includes training courses offered by states, and conducted a number of briefings.

Contact: Region 7, Steve Chambers, 913-551-7260

Title: Radon Outreach/Community Projects

Description: All of the states in Region 8 (Colorado, Montana, South and North Dakota, Utah, and Wyoming) have active radon programs. These programs' objectives include (1) promoting radon-resistant building practices for new homes; (2) testing and mitigating radon problems in existing homes; and (3) outreach to nonprofit organizations, the medical community, and local schools. An ongoing effort is being made in each state to form partnerships with local governments, the American Lung Association, and realtors. Progress in these areas has led to healthier environments for families with children. In addition, Region 8 has provided funding for many tribes to test and mitigate tribal homes and schools.

Partners: The Western Regional Radon Training Center; American Lung Association; state and local governments, including Departments of Health and Departments of Environmental Quality

Contact: Region 8, Kathleen Craig, 303-312-6031

ASBESTOS

Title: Asbestos-in-Schools Rule

Description: EPA continues to monitor the requirements of the Asbestos-in-Schools Rule (1982, 1987) and to enforce standards that protect children against asbestos hazards. The rule includes requirements for preschools and childcare centers to protect younger children. EPA provides funds to 26 states to carry out asbestos and other inspections. States refer violations to the appropriate EPA regional office

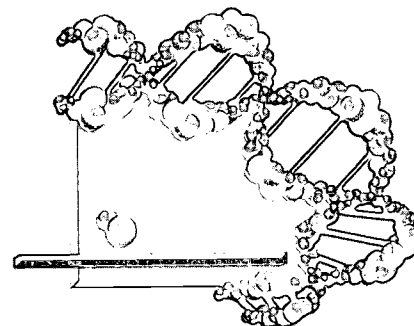

for enforcement. Contact EPA Headquarters: Jack Neylan, 202-564-5033, or Karen Taimi, 202-564-5046. Examples of activities to promote the Asbestos-in-Schools Rule follow.

Region 1: EPA staff mailed letters to all school superintendents in Region 1, reminding them of their asbestos management responsibilities under the Asbestos Hazard Emergency Response Act. Letters were also mailed to state PTA contacts for use as meeting discussion items or in their newsletters to members. Articles on current information concerning asbestos will be prepared for distribution to school newsletters. In cooperation with the National Conference of State Legislatures, Region 1 developed an asbestos compendium CD-ROM, a collection of statutes, regulations, vinyl asbestos tile (VAT) policies, and Web sites for the states and regulated community. Contact James M. Bryson, 617-918-1524.

Region 9: Region 9 developed a newsletter on asbestos issues and sent copies to school districts. Region 9 staff participate in refresher training courses targeted for school personnel and their consultants. Contact Pat Maravilla, 415-744-1122.

Title: Asbestos Outreach and Technical Assistance

Description: Region 7 provided technical assistance to regulated and unregulated communities and to tribal, state, county, city, and other federal governmental agencies via telephone, workshops, direct response to written inquiries, and mailings. The Asbestos team responded to more than 850 phone inquiries in FY 1999.

Contact: Region 7, Greg Crable, 913-551-7391

ULTRAVIOLET (UV) LIGHT

Title: SunWise School Program

Description: SunWise is a comprehensive environmental and health education program for elementary and middle schools. SunWise Partner Schools participate in classroom, school, and community projects that teach them about the health risks of overexposure to the sun, as

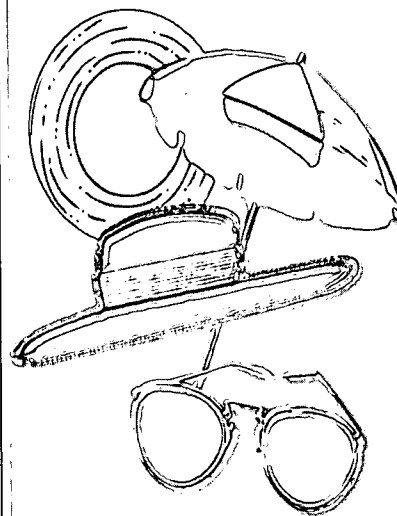

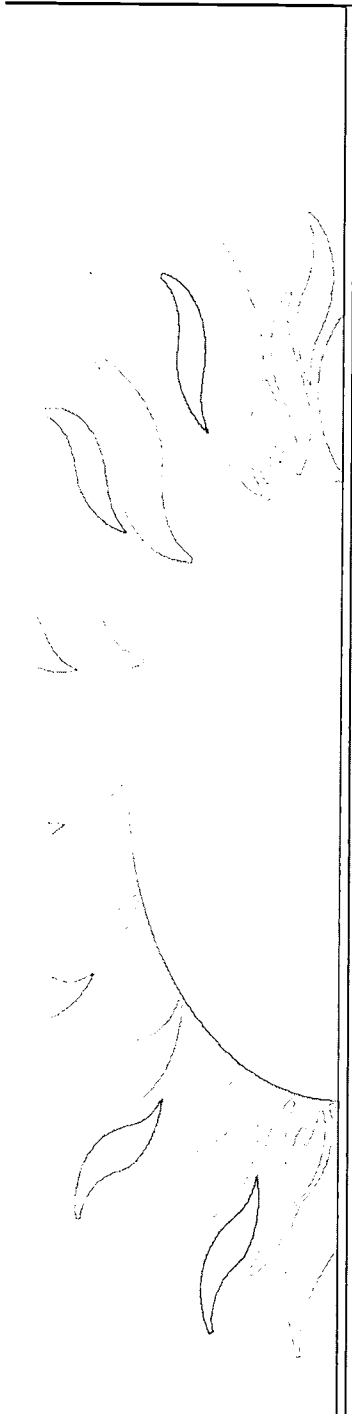
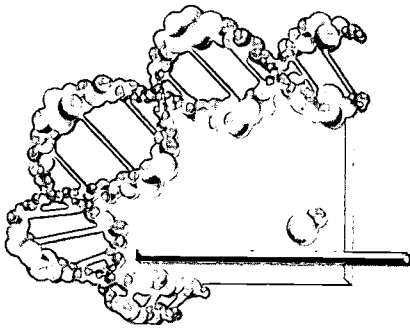

well as the science behind UV radiation and ozone depletion. SunWise schools participate in a wide range of activities, such as reporting daily UV ground and forecast data on the SunWise Web site, participating in cross-curricular classroom activities, enhancing school sun-safety policies and practices, and sponsoring guest speakers and partnerships. All program materials are provided to teachers free of charge.

Contact: Office of Air and Radiation, Maura Cantor, 202-564-9096, or visit the SunWise Web site at <http://www.epa.gov/sunwise>.

Title: Ozone Depletion Art Project

Description: The Ozone Depletion Art Project uses the Internet to motivate students to learn about ozone depletion, UV radiation hazards, and ways to reduce sun exposure. Using an EPA Web site (<http://www.epa.gov/ozone/art>), teachers and their students learn more about ozone depletion and UV exposure precautions. They submit drawings on the ozone layer (how it protects us from UV radiation), ozone depletion (how ozone-depleting substances harm the ozone layer), how UV radiation is measured, and how we can protect ourselves from the sun's UV rays. EPA has received more than 200 drawings so far. EPA also responds to approximately 50 questions and comments per month from students and teachers.

Contact: Office of Air and Radiation, Christine Dibble, 202-564-9147

Title: SunWise

Description: A SunWise display was created for EPA Region 3's Public Information Center, where numerous school groups came to learn about the dangers of UV radiation. In addition, 20 SunWise videos and information were sent to requesting schools for use as part of their health curriculum. The SunWise team participated in several health fairs and modified the EPA Region 3 Web site to include information on the SunWise Program.

Contact: Region 3, Fran Dougherty, 215-814-2083, or Christina Schulinkamp, 215-814-2086

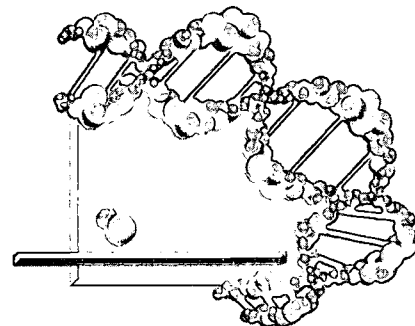

RESEARCH ON CHILDHOOD CANCER

Title: Assessment of Genetic Alterations in Newborns and Adults

Description: Specific chromosomal alterations are associated with specific human tumors. This research addresses the question of whether the frequencies of certain chromosome alterations are similar in newborns and adults or lower in children in the absence of known exposures. In addition, the response in the laboratory of cells from children and adults to specific exposures will be considered.

Contact: Office of Research and Development, Robert Kavlock, 919-541-2771

Title: Fetal Metabolism of Aflatoxin B1 and Susceptibility to Childhood Cancer

Description: The initial peak of cancer incidence occurs during the first 5 years of life, and available evidence indicates that a primary risk factor for childhood cancer involves prenatal exposure to cancer-causing agents. The rapid changes that occur during fetal development may result in critical windows of susceptibility to toxic injury. The objective of this research study is to understand the genetic and developmental risk factors associated with a specific dietary carcinogen (Aflatoxin B1) that can be transferred to the fetus through the placenta. The researchers also hope to identify particularly sensitive age groups and windows of developmental susceptibility to prenatal carcinogen exposure. Once risk factors and critical susceptibility windows are identified, then appropriate risk avoidance or minimization strategies can be employed.

Contact: Office of Research and Development, Chris Saint, 202-564-6909

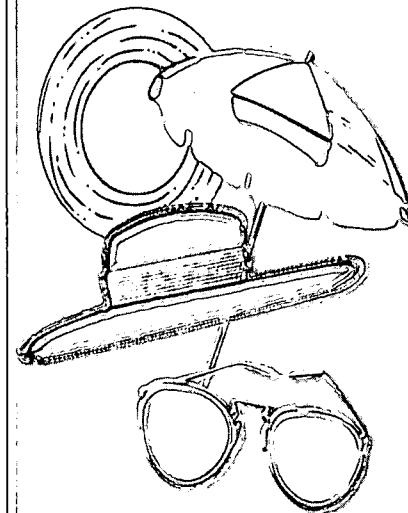

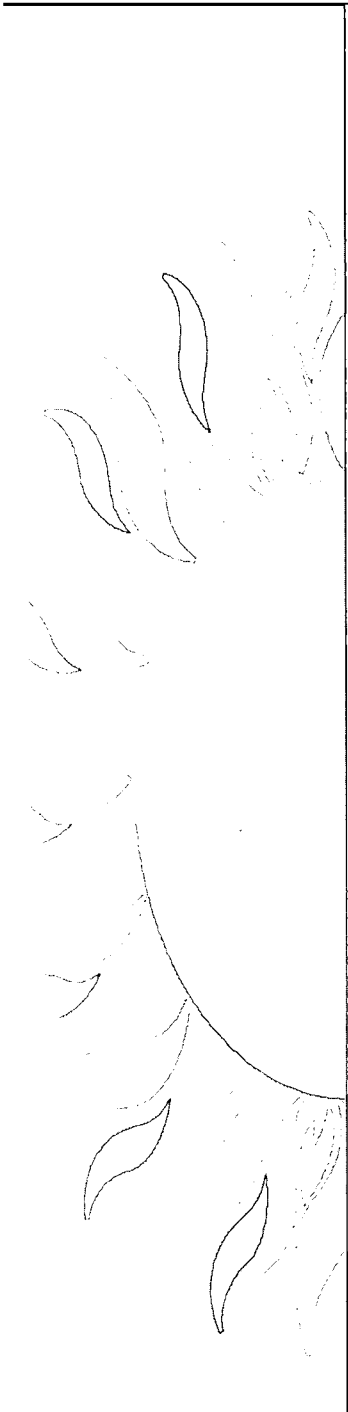
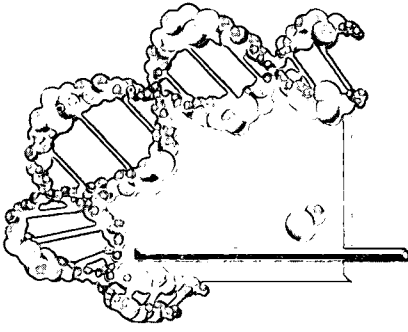

Title: Environmental Justice and Children's Health Data: Investigating Potential Relationships with Spatial Data

Description: Region 8 has initiated a project to combine current geographic information system (GIS) data on environmental justice with child health data in an effort to investigate potential relationships between exposure to environmental hazards and patterns of disease in Colorado. In particular, the program will evaluate several types of cancer and blood lead levels.

Partners: Colorado Department of Public Health and Environment

Contact: Region 8, Jan Buhmann, 303-312-6557

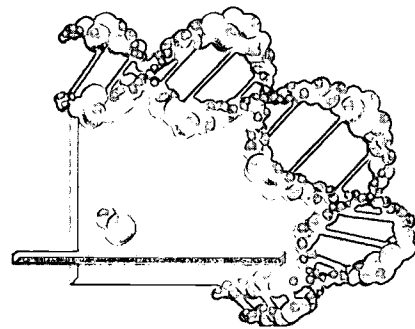

REFERENCES

1. National Institutes of Health. September 1999. Cancer Incidence and Survival among Children and Adolescents: United States SEER Program 1975-1995. NIH Publication Number 99-4649.
2. Zahm, S.H., and S.S. Devesa. 1995. Childhood Cancer: Overview of Incidence Trends and Environmental Carcinogens. Environmental Health Perspectives. Volume 103 (Supplement 6), Pages 177-184.
3. Weinstein, I.B. 1988. The Origins of Human Cancer: Molecular Mechanism of Carcinogenesis and Their Treatment. Cancer Research. Volume 48, Pages 4135-4143.
4. NRC. 1993. Pesticides in the Diets of Infants and Children. National Research Council. Washington, DC: National Academy Press.

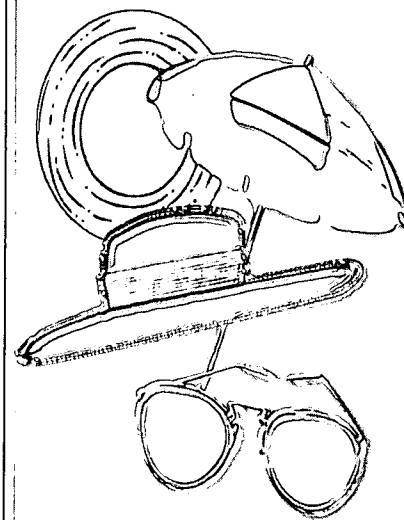

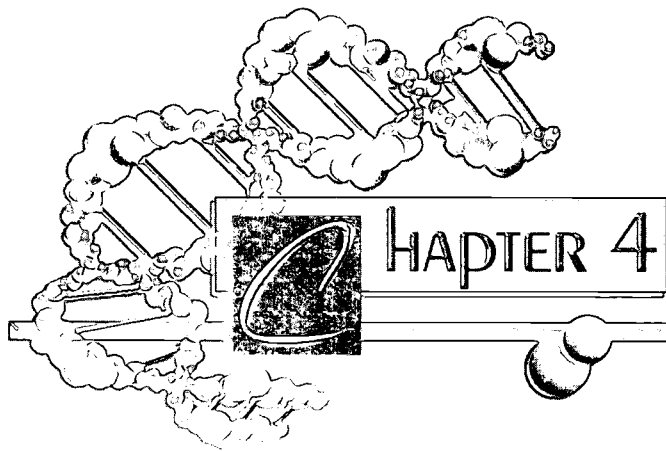

DEVELOPMENTAL AND NEUROLOGICAL TOXICITY

Exposures to neurotoxic substances (substances that can damage the nervous system) may have only temporary effects on adults, but may cause permanent damage to a child's developing nervous system, especially the brain.(1,2) Neurotoxic substances, such as heavy metals, solvents, pesticides, and polychlorinated biphenyls (PCBs), may have harmful effects on brain function, including intelligence and behavior, and interfere with the normal workings of the entire nervous system.(3,4,5,6)

Lead is one of the most pervasive developmental toxic substances in the United States today.(7,8) To prevent lead exposures in children, EPA and other federal agencies enforce regulations on the use and removal of lead-based paint, promote public education on the health risks posed by lead-based paint, and conduct research on lead poisoning and on the impact that lead-contaminated hazardous waste sites may have on children. To minimize children's exposures to lead via drinking water systems, the Safe Drinking Water Act controls lead levels at the tap, as well as the lead content in solder, water pipes, and plumbing fixtures.

EPA has completed a report to Congress on mercury and is studying the adverse health effects of mercury on nervous system development in children. EPA has begun a public education program to prevent mercury poisoning.

The Agency is developing a multi-year research strategy on endocrine (hormone) disruptors and is coordinating research throughout the federal government. The Endocrine Disruptor Screening Program focuses on providing methods and procedures to detect and characterize endocrine activity of pesticides, commercial chemicals, and environmental chemicals. EPA continues to conduct research on methods to assess reproductive, embryo, and fetal toxicity. In addition, EPA routinely conducts risk assessments of reproductive and developmental effects.

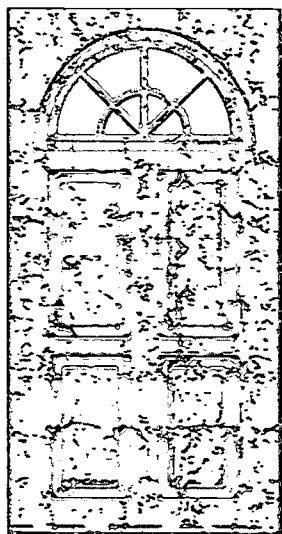

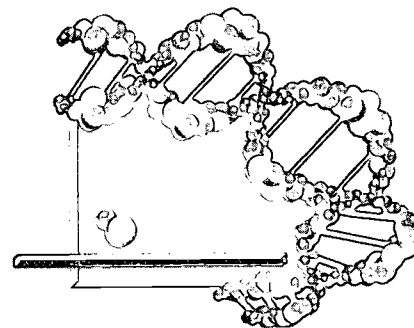

Goals of Eliminating Childhood Lead Poisoning: A Federal Strategy Targeting Lead Paint Hazards

- By 2010, eliminate lead paint hazards in housing where children under six live. This goal can be accomplished through the following:
 - Federal grants and leveraged private funding to identify and eliminate lead paint hazards in order to produce an adequate supply of lead-safe housing for low-income families with children.
 - Outreach and public education to increase awareness of lead hazards and how to address them.
 - Enforcement of lead safety laws and regulations.
- By 2010, elevated blood lead levels in children will be eliminated through:
 - Increased compliance with existing policies concerning blood lead screening.
 - Increased coordination across federal, state, and local agencies responsible for outreach, education, technical assistance, and data collection related to lead screening and abatement.

EPA PROJECTS ON DEVELOPMENTAL AND NEUROLOGICAL TOXICITY

LEAD

Title: Eliminating Childhood Lead Poisoning: A Federal Strategy Targeting Lead Paint Hazards

Description: The strategy Eliminating Childhood Lead Poisoning was developed by an interagency work group of the President's Task Force on Environmental Health Risks and Safety Risks to Children. The vision of the strategy is to eliminate lead poisoning in children in the United States. The goals focus on: 1) eliminating lead paint hazards in housing where children under age 6 live; and 2) early intervention for at-risk children.

Contact: Office of Children's Health Protection, Joanne Rodman, 202-260-7778

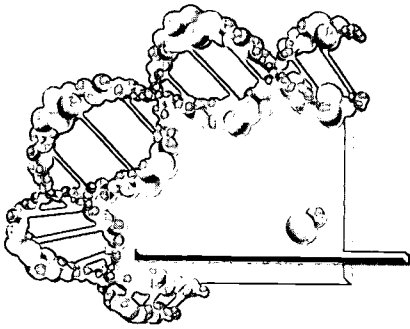

Title: Identification of Lead Exposure and Risk Reduction

Description: Pediatric lead exposure is a significant health concern along the U.S.-Mexican border. Researchers are conducting lead screening investigations at three sites: Tijuana, Mexico; the Chihuahua-New Mexico border; and the Sonora-Arizona border. The Sonora-Arizona study was recently completed. The study concluded that blood lead levels of children in the tested area do not appear to be a major public health problem. The low prevalence of elevated blood lead levels demonstrates the success of lead-reduction programs in the community.

Contact: Office of Research and Development, Chris Saint, 202-564-6909

Title: Environmental Lead Risks

Description: The aim of this research is to evaluate and refine tools for assessing risks from environmental lead. A principal focus is on exposures of young children to lead in soil and house dust. The results also will be applicable to assessment of risks from airborne lead, lead in drinking water, and lead in food. Another research focus is the application of direct statistical modeling of epidemiologic data on blood lead levels to evaluate environmental risks. EPA also provides technical support in lead risk assessment and risk characterization for the states and other organizations. (Web address: <http://www.epa.gov/superfund/programs/lead/index.htm>).

Contact: Office of Research and Development, Paul White, 919-541-0238

Title: Public Education and Outreach Grants

Description: In FY 1998, EPA awarded grants under the new Lead Poisoning Prevention and Lead Hazard Awareness Public Education and Outreach Grant Program. Their purpose is to provide public education and outreach that increases awareness of lead-based paint

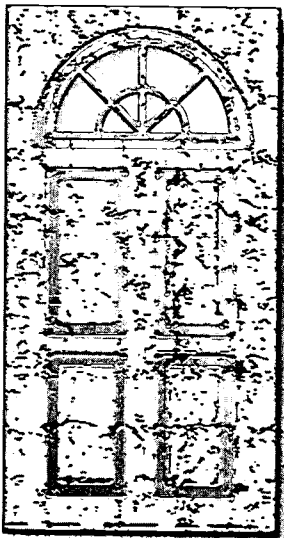

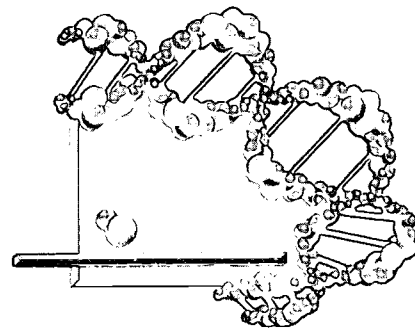

hazards and promote lead poisoning prevention among those at risk, including primarily low-income, minority communities located in large metropolitan areas or communities with predominantly older housing. Children living in these communities are at risk for elevated levels of lead exposure. Nine projects across the country received funding this year totaling approximately \$459,000.

Contact: Office of Prevention, Pesticides, and Toxic Substances, Megan Carroll, 202-260-7269

Title: The National Cinema Outreach Pilot Project

Description: In December 1998 and January 1999, EPA piloted the National Cinema Outreach Project to provide lead hazard awareness information on theater screens. This nationwide program was piloted in 17 states, 57 cities, 510 screens, with 1530 screenings each day, or 45,900 viewings each month. The slides featured medical backgrounds with different messages ("Protect Your Children From Lead Poisoning," "Grow Them Up Healthy," and "Get Your Child Tested Today") and the 1-800-424-LEAD number and the Lead Web site. It is estimated that the lead hazard awareness messages were viewed by one-half million people.

Contact: Office of Prevention, Pesticides, and Toxic Substances, Susan Laing, 202-260-0248

Title: Environmental Justice Grant: Lead Action Collaborative, Boston, Massachusetts

Description: The Lead Action Collaborative is a partnership of nonprofit organizations, foundations, and public agencies whose goal is to significantly and comprehensively reduce the incidence of childhood lead poisoning in Boston's high-risk neighborhoods. The Collaborative provides centralized support, technical assistance, and training to community-based organizations. The project strengthens

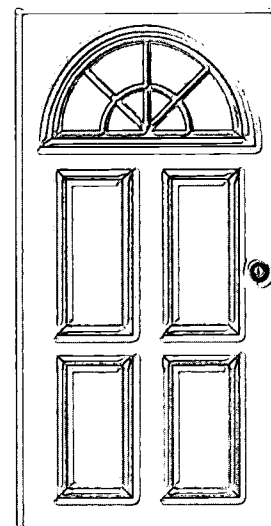

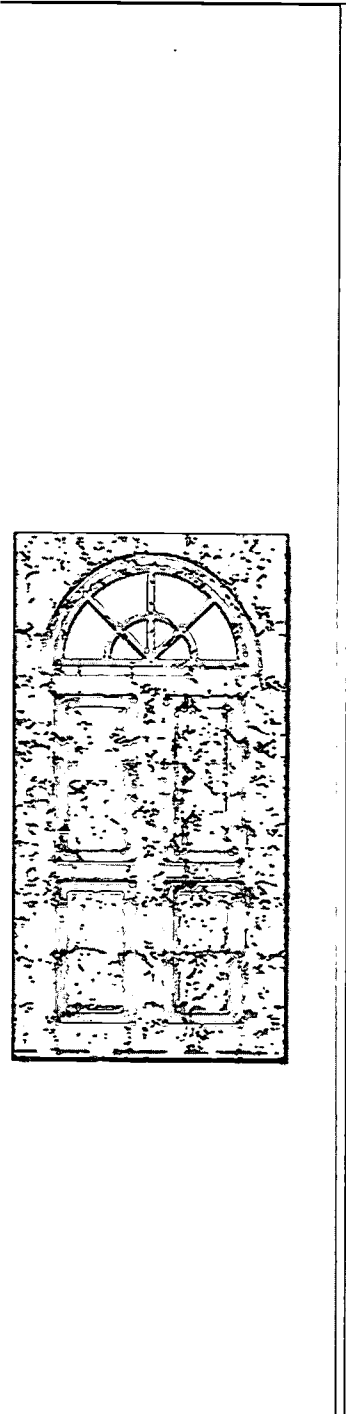
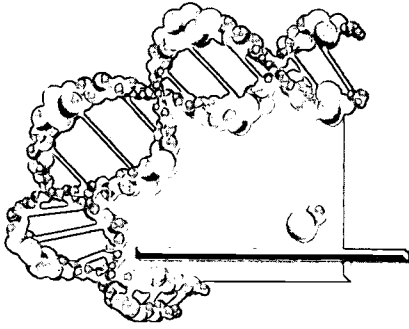

communication and fosters collaboration and resource sharing among grassroots organizations, nonprofit organizations, and public agencies through community forums, briefings, and workshops.

Partners: Lead Action Collaborative, public and private organizations in Greater Boston

Contact: Region 1, Katie Mazer, 617-918-1523

Title: Consortium of North East States and Tribes (CONEST)

Description: CONEST was developed through the efforts of the Region 1 Lead Program in 1991. The Consortium developed the first interstate and intertribal Memorandum of Understanding in the country outlining state and tribal lead program standards for training accreditation and auditing, contractor licensing, tracking, and third party examination requirements.

Partners: Region 1 and Region 2 states, Region 1 tribes

Contact: Region 1, James M. Bryson, 617-918-1524

Title: New England Lead Coordinating Committee (NELCC)

Description: NELCC is a collaboration of government agencies and nonprofit groups throughout New England, working in collaboration with public, private, and nonprofit health and housing organizations to develop and strengthen a coalition for lead poisoning prevention in New England. NELCC coordinates the "Keep It Clean" campaign, which informs "do-it-yourself" home renovators, contractors, and those who employ contractors about the risk of lead poisoning in children and adults during the renovation and repainting of older homes, and creates a link between consumers and hardware store employees.

Partners: Consortium of North East States and Tribes, state and local departments of health and/or environment, Centers for Disease Control and Prevention, U.S. Department of Housing and Urban Development

Contact: Region 1, Katie Mazer, 617-918-1523

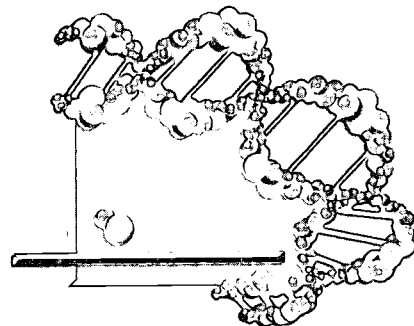

Title: Tribal Based Environmental Protection (TBEP) Program

Description: The Tribal Based Environmental Protection Program was developed as part of the Consortium of North East States and Tribes Memorandum of Understanding. Each tribal member has applied for program authorization from EPA under sections 402 and 404 of the Toxic Substances Control Act (TSCA) for their respective state and tribal lead licensing and enforcement activities. The main goal of TBEP is "protection of our most valued natural resource, our children . . ."

Contact: Region 1, James M. Bryson, 617-918-1524

Title: Environmental Monitoring for Public Access and Community Tracking (EMPACT) Lead Safe Yard Program

Description: This federally funded EPA project focuses on Boston's low-income Spanish- and Haitian-speaking neighborhoods. EMPACT conducts environmental monitoring of lead in soils, delivers time-relevant lead in soil data and interpretation to residents, provides public access and community tracking, and carries out low-cost landscaping and other soil remediation measures.

Partners: Bowdoin Street Health Center, Dudley Street Neighborhood Initiative, Boston University School of Public Health, Garden Futures, graduates of the Boston Urban Gardeners' City Gardener Certificate Program

Contact: Region 1, Rob Maxfield, 781-860-4640

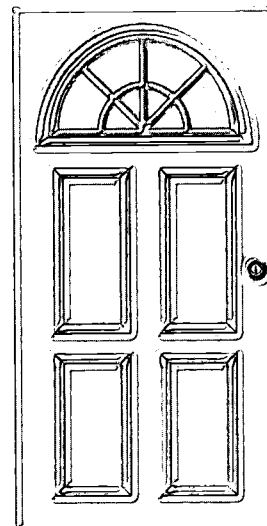
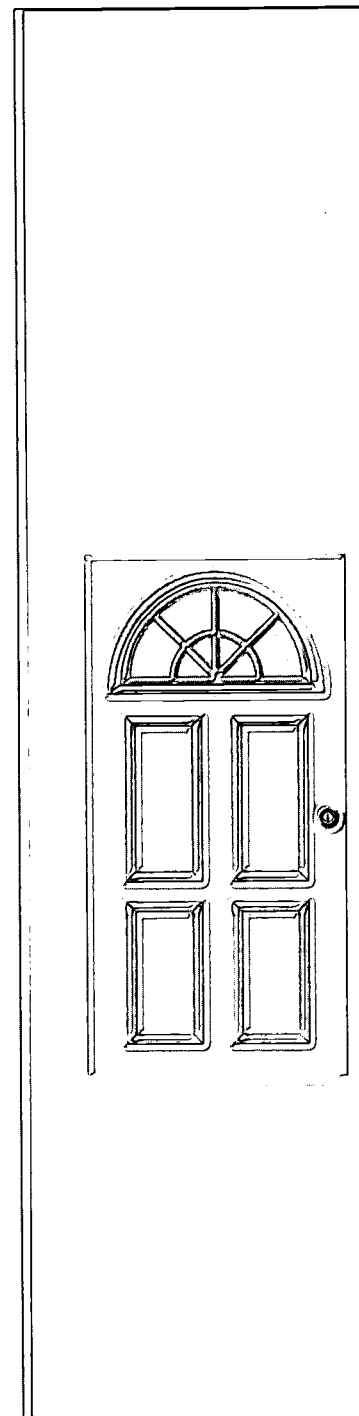

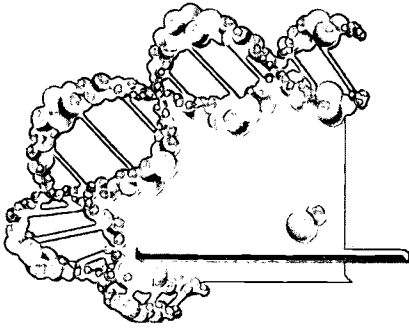

Title: EPA National Lead Poisoning Prevention and Lead Hazard Awareness Public Education and Outreach Program: Crittenton Hastings House, Boston, Massachusetts

Description: Crittenton Hastings House addresses the needs of young people who are low-income, pregnant, parenting, or at risk for early pregnancy and who live in areas where most severely lead-poisoned children are found. Working in collaboration with Boston organizations, Crittenton provides children and families with information regarding lead hazards and lead poisoning prevention to decrease the number of children at risk of lead poisoning, increase the number of children who receive regular blood screening, and increase awareness of tenant rights and landlord responsibilities regarding lead paint removal.

Contact: Region 1, Katie Mazer, 617-918-1523

Title: EPA Supplemental Environmental Projects (SEP), Providence, Rhode Island

Description: EPA has provided nearly \$400,000 in Rhode Island to remove lead from dozens of childcare facilities. Funding was made available from an EPA federal enforcement action against the Rhode Island Department of Transportation for the improper storage of large amounts of hazardous waste.

Partners: Rhode Island Department of Public Health

Contact: Region 1, Amelia Katzen, 617-918-1869

Title: Keep It Clean Campaign, Video, Posters, Billboards

Description: Region 1 conducted a lead awareness campaign targeted to homeowners and stores. The goal is to educate hardware stores to provide lead-safe tools and advice to consumers. The tools include an 8-minute video, pamphlets, and billboards.

Partners: Region 1 states, local hardware stores, Tufts University

Contacts: Region 1, James M. Bryson, 617-918-1524, or Katie Mazer, 617-918-1523

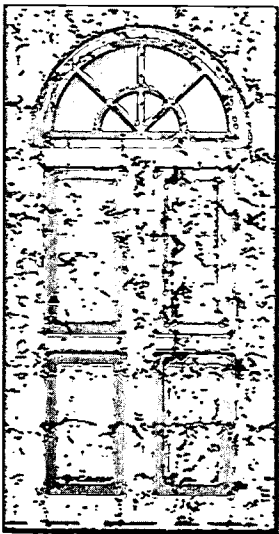

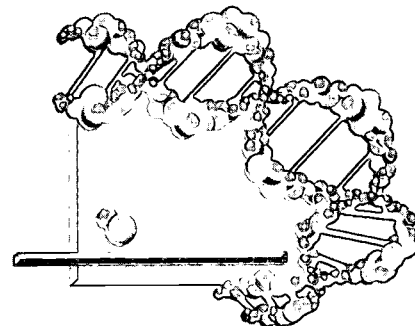

Title: Providence, Rhode Island, Mayor's Safe Housing Lead Task Force

Description: The Providence Safe Housing Lead Task Force is charged with establishing a comprehensive strategy for protecting Providence children and improving Providence housing. The Task Force has produced a master plan, *A Healthier and Brighter Future for the Children of Providence: A Strategic Framework for Healthy Children and Well-Maintained, Lead-Safe Housing in Thriving Neighborhoods*.

Partners: Providence public and private partners

Contact: Region 1, Kristi Rea, 617-918-1595

Title: IMPACT CD-ROM Technology

Project: An Interactive Module For Lead Awareness Course Technology (IMPACT) manual was designed to train those conducting renovation, remodeling, and painting. The manual is used in conjunction with the interactive CD-ROM, which is a 6-hour self-study course for vocational technical high school/college students who are future painters, carpenters, home renovators, etc.

Contact: Region 1, James M. Bryson, 617-918-1524

Title: Lead Safe Renovation Training - Interactive CD-ROM

Description: An interactive CD-ROM was developed for painters, home owners, and renovators. Video clips of "right" and "wrong" renovation activities are used with a 16-hour worker and an 8-hour supervisor training.

Partners: Consortium of North East States and Tribes, Massachusetts Department Workforce Development

Contact: Region 1, James M. Bryson, 617-918-1524

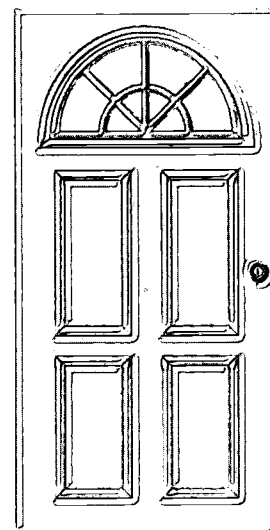

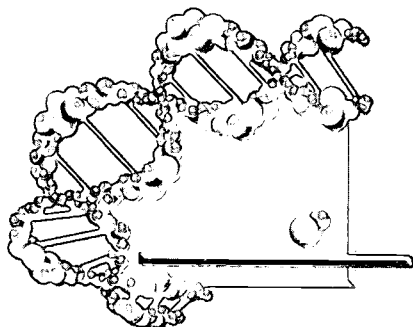

Title: First Steps: Childcare Provider/Parent Lead Awareness Manuals, Video, and CD-ROM

Description: The First Steps Program is designed as a primary prevention program for childcare providers to provide a lead safe training messages to parents with young children. It also allows childcare providers to earn Continuing Education Units (CEUs) that can be used to meet regulatory or professional requirements. A three-volume manual for the program includes *What You Should Know About Lead Poisoning: A Manual for Child Care Providers* (English); *Lo Que Debe Saber Acerca de la Intoxicacion por Plomo* (Spanish); and *Little Moccasins, a Lead Poisoning Prevention Manual and Video for Tribal Day Care Providers and Families* (Native American version).

Partners: Tribal Based Environmental Protection Committee, Houlton Band of Mauseet Indians, Phil Quint

Contact: Region 1, James M. Bryson, 617-918-1524

Title: Urban Environmental Initiative (UEI) Cooperative Agreement: Urban Revival, Inc., Prevent Lead Poisoning Project

Description: UEI is a Region 1 pilot program to address environmental and public health problems in urban areas. UEI facilitates community-based environmental protection in Boston, Massachusetts; Providence, Rhode Island; and Hartford, Connecticut. This project focuses on coordination of lead paint poisoning prevention and housing education outreach across multiple neighborhoods in Boston and East Boston with linguistically and culturally appropriate information and education.

Partners: The Tenant Action Network, comprising City Life/Viva Urbana, East Boston Ecumenical Community Council, and the Massachusetts Tenants Organization

Contact: Region 1, Katie Mazer, 617-918-1523

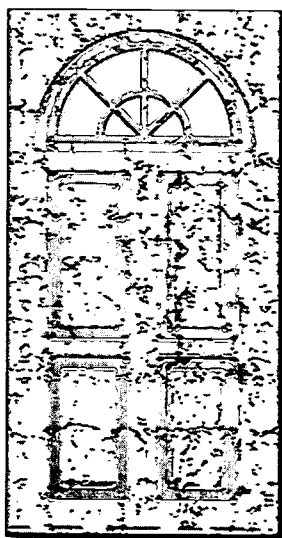

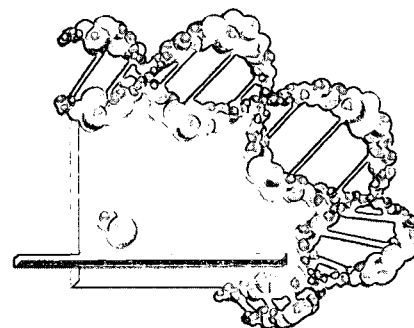

Title: Time Related Environmental Numeric Health Data System (TRENHDS) CD-ROM

Description: TRENHDS is an environmental and health tracking program on a GIS mapping platform. TRENHDS can map, track, and overlay environmental sample sites with health problems on a map to identify clusters. The system can be installed on laptops and is user friendly. It is currently developed for tribes in the Northeast.

Partners: Tribal Based Environmental Protection Committee, Trevor White, Passamaquoddy Indian Township

Contact: Region 1, James M. Bryson, 617-918-1524

Title: UEI Cooperative Agreement: Lead Poisoning Prevention Awareness Program for Childcare Providers

Description: The Hartford, Connecticut, Department of Public Health trained Community Environmental Educators to teach lead poisoning prevention to Hartford childcare centers located in areas of high risk for lead poisoning. The training uses the *First Steps* lead awareness manuals to provide materials for Spanish-speaking, English-speaking, and Native American childcare providers.

Partners: Connecticut Department of Public Health, Connecticut Cooperative Extension; Houlton Band of Maliseet Indians, Houlton, Maine; Hartford Department of Public Health

Contact: Region 1, Katie Mazer, 617-918-1523

Title: UEI Cooperative Agreement: Codman Square Lead Poisoning Prevention Initiative

Description: This project developed a lead poisoning prevention program that will serve as a model for high-risk, low-income African-American neighborhoods in other cities. The UEI grant money made possible the completion of planning, materials development, recruitment, and training essential to implementing an effective community action for

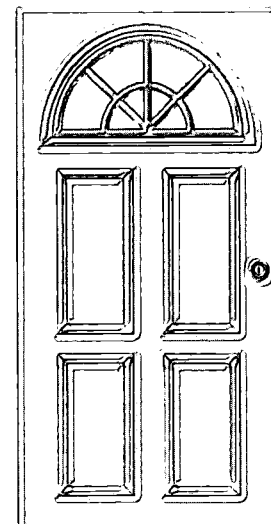

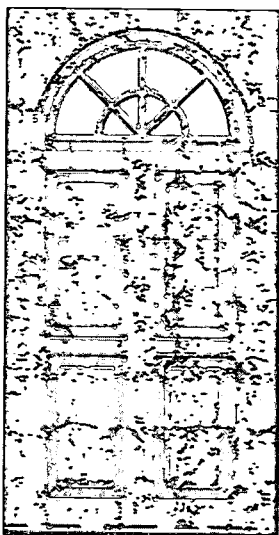
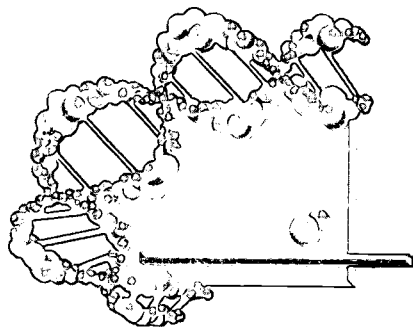

the primary prevention of childhood lead poisoning initiative in the high-risk neighborhoods of Boston.

Partners: The Medical Foundation of Boston and its Massachusetts Prevention Center in Codman Square, National Center for Lead Safe Housing

Contact: Region 1, Katie Mazer, 617-918-1523

Title: UEI Cooperative Agreement: ReVision House, Roxbury, Massachusetts

Description: ReVision House, a residential program for homeless young mothers and their children, designed and implemented an environmental education curriculum that included lead paint poisoning prevention, urban gardening, urban fish farming, and vocational training. Participants converted the porches of their triple-decker home to a thriving greenhouse and fish farm.

Partners: ReVision House, Garden Futures, Boston Urban Gardeners, Roxbury Community College, New England Aquarium

Contact: Region 1, Katie Mazer, 617-918-1523

Title: Healthy Beginnings: Lead Safe Families

Description: Healthy Beginnings is a set of user-friendly curriculum materials used as classroom resources for teachers of English as a second language. Healthy Beginnings teaches basic life and language skills to recent immigrants; interwoven into the language development skills are steps to identify and prevent childhood lead poisoning. Although they were developed for use in Region 1, the materials are currently in use in 27 states.

Contact: Region 1, Katie Mazer, 617-918-1523

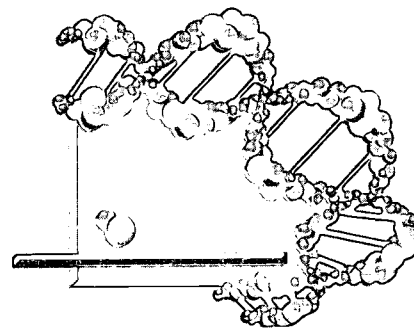

Title: Lead Suite CD-ROM

Description: An interactive CD-ROM provides turn key software to run a lead program. The CD contains tracking, testing, teaching, regulations, and guidance documents.

Partners: Tribal Based Environmental Protection Committee - Houlton Band of Maliseet Indians, Phil Quint

Contact: Region 1, James M. Bryson, 619-918-1524

Title: Camden-Rutgers University Asthma Project

Description: This project will focus on building the capacity of residents and community groups in Camden and Philadelphia to confront two health problems that are strongly associated with treatable environmental factors: lead poisoning and asthma. Both Camden and Philadelphia have populations of predominantly impoverished, minority families in which many children are at risk from these health problems. This project will identify children at risk through cooperative agreements with health professionals (e.g., school nurses and maternity care givers). Environmental management teams, composed of community residents who have been specifically trained for this purpose, will visit the families of identified children and provide education and intervention for lead and asthma. Followup visits will assess the effectiveness of training and allow evaluation of the program. The project has a 1-year goal of impacting 400 families in Philadelphia and 600 families in Camden.

Contact: Region 2, Rachel Chaput, 212-637-4001

Title: Environmental Education Project

Description: This EPA-funded project is coordinated by the Childhood Lead Poisoning Prevention Program (CLPPP) of the City of Philadelphia Department of Public Health. CLPPP provides free public workshops on safe methods of reducing lead hazards at various sites throughout the city, such as home repair supply stores. Workshops

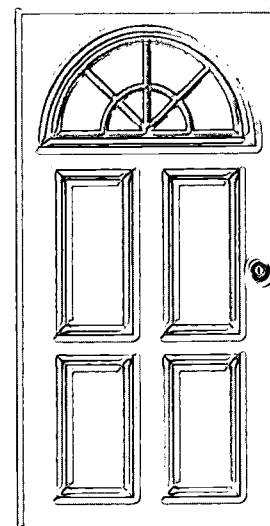

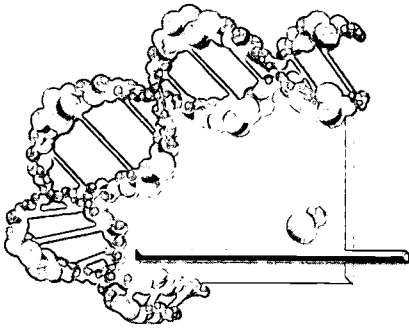

held at paint and hardware stores teach both staff and customers how to abate lead hazards in their own homes, in a manner that ensures the safety of the residents. All program materials are designed to be understood easily by the "average person."

Partners: City of Philadelphia Department of Public Health, Pennsylvania
Contact: Region 3, Nan Ides, 215-814-5546

Title: Lead-Safe Babies Project

Description: This project is being funded by the Children's Health Program to educate new mothers in high-risk areas of North Philadelphia about the dangers of lead poisoning to their babies. Specially trained outreach workers are visiting new mothers in their homes and showing them how to take preventative measures to protect their newborns. This intervention has been successful in reaching what is, traditionally, a hard-to-reach population. Of 45 new mothers identified in the target area, 44 of them (98%) have agreed to participate in the program and have already been visited once by the outreach specialists. This extraordinarily high level of participation is likely due to the use of outreach workers who are from the community who are trained and supported by the highly respected, nurse practitioner-led neighborhood health clinics. Follow-up visits will be made to the homes to reinforce practices and encourage mothers to have their babies tested for lead when they reach 9 months of age. The City of Philadelphia will provide free testing and the Regional Nursing Centers Consortium will assess and report on the results next year.

Partners: Regional Nursing Centers Consortium and Philadelphia's Department of Public Health

Contact: Region 3, Gail Tindal, 215-814-2069, or Dan Welker, 215-814-2744

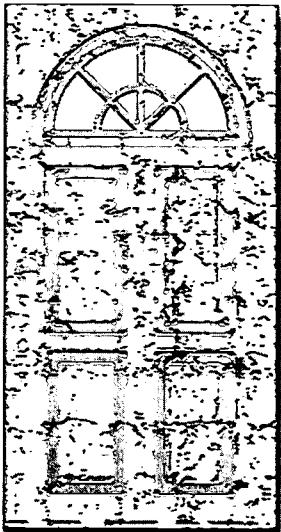

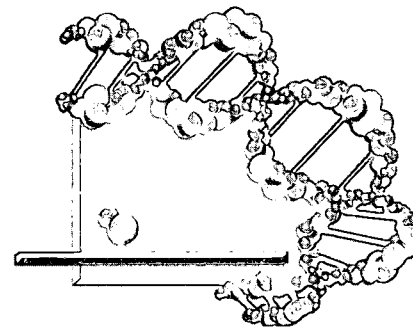

Title: Reducing Exposure to Lead in Drinking Water in Philadelphia's School District

Description: During 1999, EPA determined that there may be a potential health risk at a few schools due to lead leaching from some of the plumbing fixtures. In the beginning of 2000, the Philadelphia School District signed an agreement with the Health Department to (1) immediately institute daily flushing activities; (2) test all sources of drinking water for lead in schools; and (3) take corrective action wherever elevated lead levels are found. EPA Region 3 is providing ongoing technical assistance to the city and the school district. This project is especially important because (1) Philadelphia exceeds the national level for elevated blood lead levels in children and (2) the Philadelphia School District is the fifth largest in the country. This project, which will last a year or two, will test all potable water sources in approximately 295 buildings that the Philadelphia School District owns or operates and correct any lead plumbing problems.

Contact: Region 3, Marie Holman, 215-814-5463, or Karen Johnson, 215-814-5445

Title: Lead Umbrella Workshop

Description: EPA funded a 1-day lead information and education workshop for parents, representatives of local governments, policy makers, health providers, representatives of tenants' interests, members of religious communities, and education and childcare providers. The workshop addressed the issue of lead poisoning in children. Experts in lead education conducted the workshop, reinforcing their efforts with printed materials. As a followup to the workshop, a coalition (the Lead Umbrella) was created to develop a comprehensive plan to educate members of communities affected by the issue and work to eliminate childhood lead poisoning in the community of Birmingham.

Partners: Citizens' Lead Education and Elimination Project, Alabama

Contact: Region 4, Janie Foy, 404-562-4300

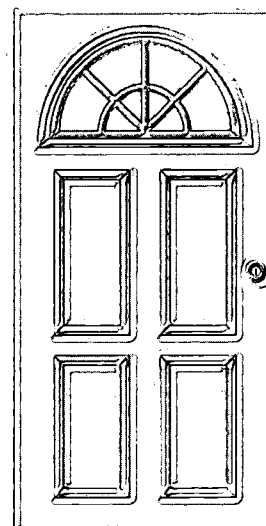

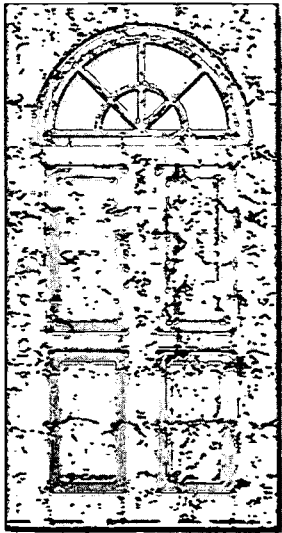
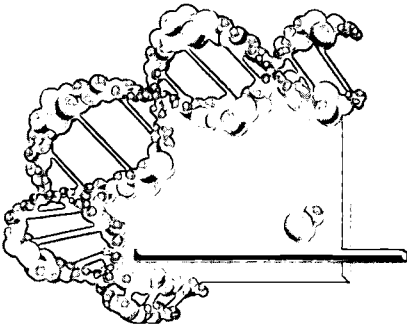

Title: Elevated Blood Lead Levels - Region 5 States

Description: Region 5 has finalized a report entitled *County and Zip Code Blood-Lead Data for Children Under Six Years of Age Testing Above Ten Micrograms Per Deciliter in Region 5 States*. This study, compiled in cooperation with all six state health departments, presents data on the numbers of reported cases of children with elevated blood lead levels across the region, broken out by county and zip code, and displayed on geographic information system (GIS) maps. The Region has also completed lead assessments in each of its five Geographic Initiative Areas in conjunction with community-based programs and organizations. The GIS maps and the community lead assessments are being applied to help target program efforts toward those areas of greatest need.

Contact: Region 5, Phil King, 312-353-9062

Title: Outreach to Migrant Farm Worker Health Promoters on Reducing Lead Exposure Risks to Children

Description: In August 1999, EPA staff conducted lead exposure risk reduction training in Spanish for health promoters of the Community Health Partnership of Illinois. The health promoters are current or former migrant farm workers who now also work as health educators among the migrant farm worker community in the area around Momence, Illinois.

Contact: Region 5, Edward Master, 312-353-5830

Title: Environmental WATCH Small Grants

Description: Region 5 issued small, community-based grants that promote children's environmental health and pollution prevention to organizations that participated in the Environmental Workshop on Actions to Take for Children's Health (WATCH). In the area of lead poisoning awareness and prevention, the organization—Improving Kids' Environment in Indiana—received funding for a Lead Poisoning and

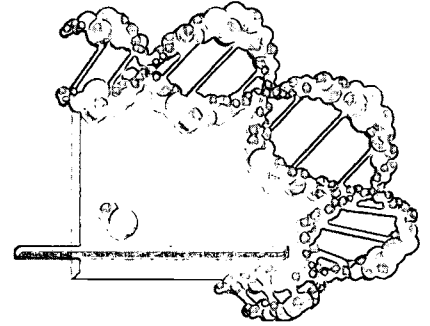

Pollution Prevention project. As part of the project, cooperative agreements will be developed with paint suppliers who will teach homeowners about lead hazards. The Oak Park Health Department in Illinois will carry out lead poisoning awareness and training of code enforcement officers and building inspectors.

Contact: Region 5, Holly Wirick, 312-353-6704

Title: Lead Poisoning Prevention and Control Training

Description: In September 1999, Region 6 awarded a grant to the Deep South Center for Environmental Justice, located at Xavier University. This grant will help to develop a community "train the trainer" program for lead poisoning awareness. Fifty community leaders will be trained on the hazards of lead-based paint, who then will organize several community forums to train residents on how they can protect their children from lead poisoning. Two Environmental Justice communities in the New Orleans area will be targeted for this program.

Partners: Deep South Center for Environmental Justice at Xavier University

Contact: Region 6, Paula Flores-Gregg, 214-665-8123

Title: TSCA Section 406(b) Pre-Renovation Notification Rule

Description: EPA Region 6 has been actively working with trade associations, hardware stores, local governments, and state government agencies to spread the word about the Federal Pre-Renovation Notification Rule. Region 6 has begun mailing thousands of letters directly to renovation and remodeling contractors in rural areas throughout the region to notify them about the requirements of the rule and where they can obtain information on how to comply with the rule.

Contact: Region 6, Jeff Robinson, 214-665-7577

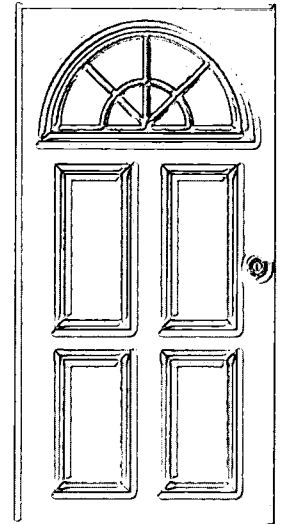

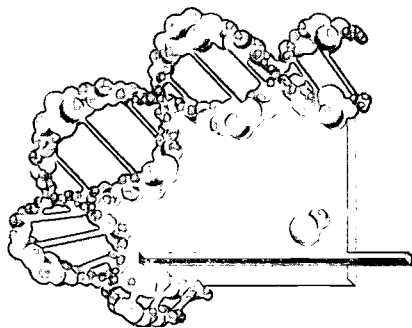

Title: Region 7 Lead-Based Paint Activities

Description: Region 7 conducted a variety of lead outreach and technical assistance activities. It provided technical assistance to states, tribes, regulated communities, and concerned citizens, including participating in 34 outreach meetings for landlords, not-for-profit groups, childcare centers, and health fairs.

- It conducted quarterly meetings with the states and tribes to provide updates on federal, state, and tribal programs, and to discuss issues and resolutions on a regional level.
- It provided compliance assistance to trainers regarding a new Accreditation, Training, and Certification Rule. It worked closely with four tribes that conduct ongoing lead hazard reduction programs.
- It presented a "brown bag" outreach session to Region 7 employees on disclosure requirements for sale or lease of residential property.
- It conducted outreach to childcare centers, county health departments, WIC programs, and other regional offices.
- It participated in home shows, health fairs, Earth Day activities, and other environmental outreach activities; conducted mass mailings on all of the new lead regulations, and developed a Web page to discuss lead regulations with the regulated community and supply links to other agencies that have federal lead program responsibilities.
- In efforts to reduce children's blood lead levels, Region 7's Superfund program has removed lead-contaminated yard soil from a total of 1,600 homes and childcare facilities in Southwest Missouri and Southeast Kansas. The program plans to remove lead-contaminated soil from nearly 100 homes and childcare facilities in Omaha, Nebraska in FY 2000.
- In St. Francois County Missouri, EPA, HUD, the State and County Health Departments, and area mining companies have partnered to address the multiple exposure routes of lead (e.g.,

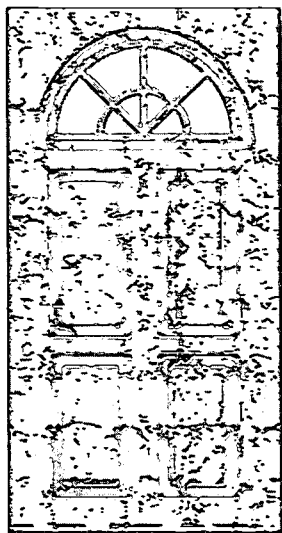

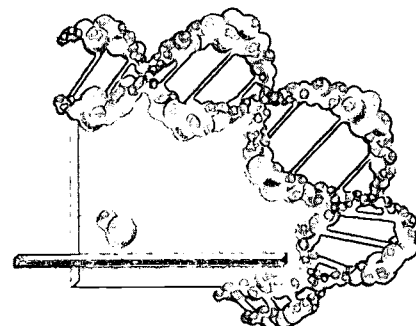

paint, dust, yard soils, etc.) in homes of children with elevated blood levels. At homes where EPA is considering the cleanup of yard soils, the Missouri Department of Health, using funds from a HUD grant, and the mining companies are addressing interior lead cleanup, thus providing a holistic approach to reducing blood lead levels in children.

- Jasper and Newton counties (in Missouri) are developing a joint Environmental Master Plan to address environmental problems in the region on a holistic basis. This plan is being developed as a direct result of the community's involvement in Superfund lead cleanup and the heightened concern for limitations on development due to environmental problems.

Contact: Region 7, Mazzie Talley, 913-551-7518

Title: Local Lead Awareness Campaign

Description: EPA funded this project to raise awareness of the hazards of lead poisoning and the necessity of screening children age 6 and under. The project changes the approach to the management of cases of exposure to implement intervention at the community level. It targets the population of children at risk through prevention, rather than confining itself to the care of the individual child suffering from lead poisoning. Key partnerships with local media increase the number of people the program can reach.

Partners: Cerro Gordo County Department of Public Health, Iowa; KLSS radio; KISS-TV

Contact: Region 7, Lori Walker, 913-551-7926

Title: Region 9 Lead Poisoning Prevention

Description: The Region 9 Lead Program has developed partnerships with state and local children's health programs and community advocacy groups, allowing the region to better focus efforts on reducing lead hazards for children at greatest risk (lower income families in older

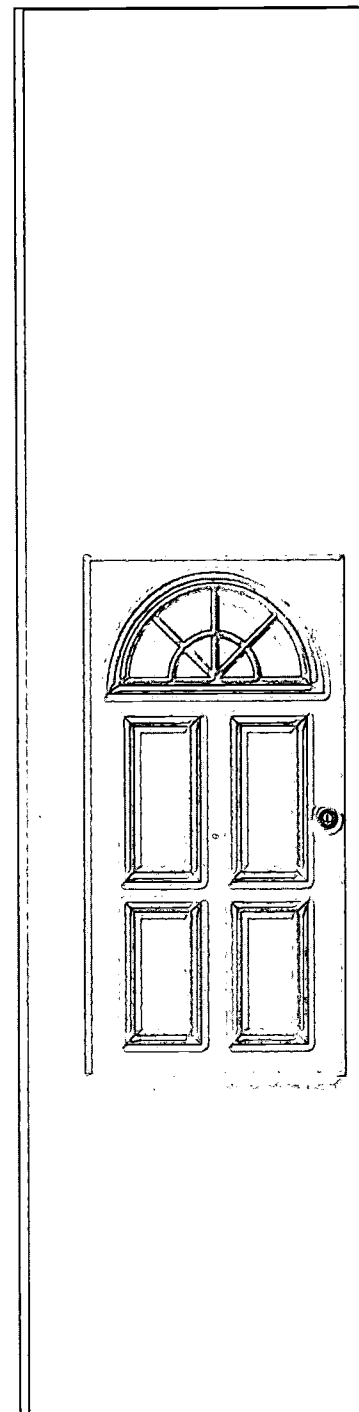

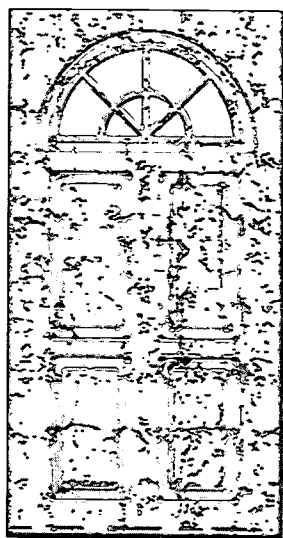
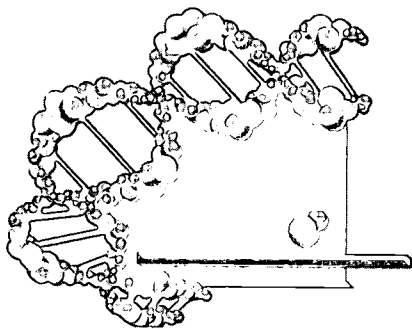

housing). The Region continues to conduct extensive outreach on the issues of childhood lead poisoning, the regulatory requirements in the lead-based paint disclosure rule, the remodeling notification rule, and the training and certification regulations. The Region established lead training and certification programs in Arizona, Hawaii, and Nevada.

Contact: Region 9, Paula Bisson, 415-744-1128

Title: Community-Based Lead Projects in Oregon

Description: Region 10 works with the Oregon Health Division to support community-based lead screening projects and environmental investigations. This program focuses on two activities: (1) blood lead testing for children at risk for lead poisoning who are without resources to pay for this testing and (2) reimbursement of county health departments for environmental investigations for children with high blood lead levels. These funds are projected to cover the cost of 350 to 460 blood lead tests, 15 to 16 environmental investigations, and 32 sets of environmental samples.

Contact: Region 10, Barbara Ross, 206-553-1985

Title: Urban League Lead Outreach Program

Description: Region 10 is working with the Urban League of Portland to expand the Urban League's lead outreach program to Portland's other distinct, at-risk communities: Spanish-language, recent immigrant, and labor communities. The overall goals are to encourage informed communities to access public-sector and other community-based programs, and to be involved in the policy decisions and development of strategies for lead poisoning prevention.

Contact: Region 10, Mike Letourneau, 206-553-1687

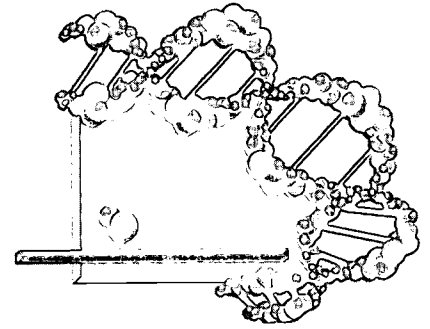

Title: Lead Hazard Reduction Act Compliance, Oregon

Description: Region 10 collaborated with the Oregon Health Division (OHD), The Urban League of Portland, the Oregon Environmental Council (OEC), the Environmental Justice Action Group (EJAG), the Coalition of Black Men (COBM), Physicians for Social Responsibility (PSR), the U.S. Department of Housing and Urban Development, Oregon Legal Services (OLS), the City of Portland Bureau of Environmental Services (BES), the Oregon Child Development Coalition (OCDC), and the Multnomah County Health Department to support compliance with the Lead Hazard Reduction Act and to develop a Statewide Comprehensive Plan for Oregon.

Contacts: Region 10, Barbara Ross, 206-553-1985, or Kirstin Andersen, 206-553-0244

Title: "Runs Better Unleaded" Bus Campaign

Description: Region 10 ran a bus advertising campaign in Portland and Yakima from September 1 through October 31, 1999. The campaign encouraged parents to call the Lead Hotline (1-800-424-LEAD) or access the EPA lead Web site (<http://www.epa.gov/lead>) for information on preventing childhood lead exposure. The EPA posters depicted children playing, with the text "Runs Better Unleaded" superimposed. Plans are under way to repeat this campaign with Spanish-language posters.

Contacts: Region 10, Barbara Ross, 206-553-1985, or Robert Jacobson, 206-553-1203

Title: Tri-Regional Lead Conference

Description: Representatives of western states and tribes met in mid-October 1999 in Portland, Oregon, to discuss lessons learned in implementing state and tribal lead programs. States and tribes represented included Oregon, Idaho, Washington, California, Hawaii, Utah,

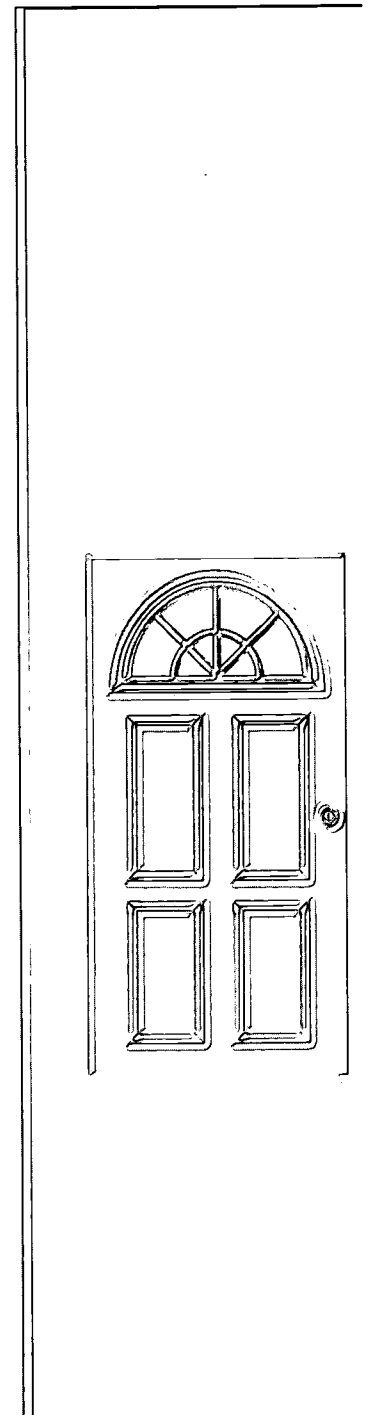

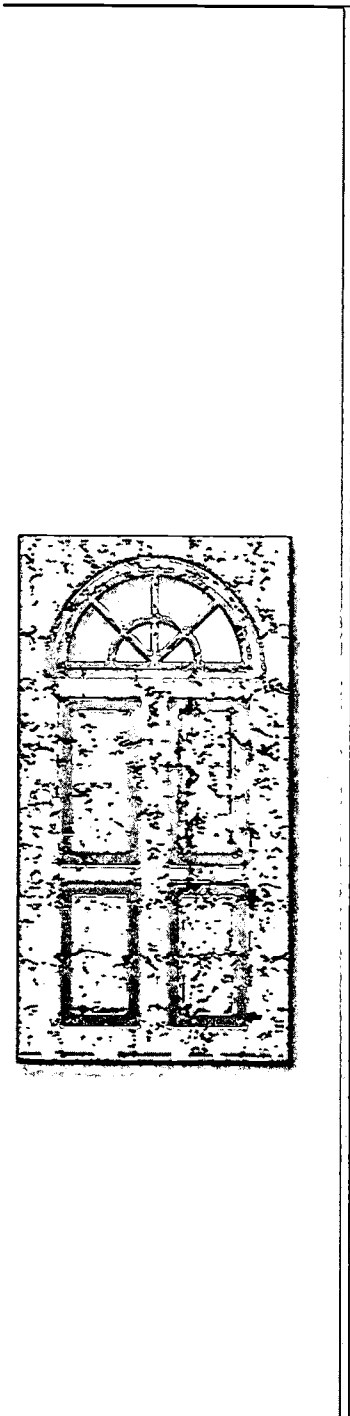
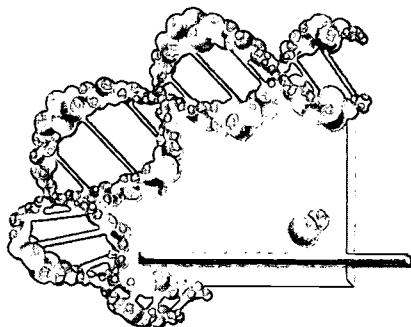

Crow, Umatilla, Colville, Yankton Sioux, Blackfeet, Chippewa Cree, and Flandreau Santee Sioux. In addition, private lead consultants, painting contractors, training providers, and EPA Regional and headquarters staff were in attendance.

Contacts: Region 10, Barbara Ross, 206-553-1985, or Kirstin Andersen, 206-553-0244

Title: Advance Notice of Funds Available for Lead Grant Program for Indian Tribes

Description: Region 10 staff have been working to notify tribes in Alaska, Idaho, Oregon, and Washington about new grant funds available exclusively for Indian tribes. The primary purpose of this grant program is to fund tribal blood lead screening of children and educational outreach activities to encourage Indian tribes to consider continuing such activities in the future. EPA plans to award 25 to 50 grants for amounts in the range of \$15,000 to \$50,000 each.

Contact: Region 10, Barbara Ross, 206-553-1985, or Kirstin Andersen, 206-553-0244

Title: Focused Outreach to Realtors

Description: Region 10 mailed compliance assistance letters with information about the Disclosure Rule to approximately 700 real estate firms in the region. In the letter, it was stated that Region 10 is conducting Disclosure Rule inspections, and that the real estate firm may be subject to the rule. Additionally, Region 10 staff exhibited and presented information about lead paint hazards at the Portland Home Show, the Portland Home and Garden Show, the Federal Facilities Conference, the Nisqually Indian Health Fair, the Washington Council of Painting and Decorating Constructors, the Lead Summit Meeting, the National Association of Real Estate Property Managers, the Washington Realtors Convention, the Shoshone County Realtors, the Peoples Coalition in Silver Valley, the Real

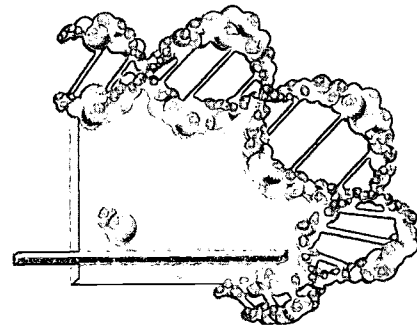

Estate Conference in Silver Valley, the King Dome Home Show in Seattle, and the Puyallup Home Decorating and Remodeling Show.

Contact: Region 10, Barbara Ross, 206-553-1985

Title: Preventing Lead Exposure in Northern Idaho

Description: Region 10 has been working with the Agency for Toxic Substances and Disease Registry, the State of Idaho, and the Panhandle Health District to prevent childhood exposures to widespread lead contamination in soil resulting from decades of lead production in Northern Idaho. Sampling is conducted at residences, schools, childcare providers, and parks. Results from a 1999 survey indicate that blood lead levels continue to decline at the Bunker Hill Superfund Site, but remain unacceptably high in the communities upstream of Bunker Hill. The Panhandle Health District has followed up with all of the families of children with elevated blood lead levels. Lead-contaminated soil was removed and replaced with clean soil at 26 residential properties, three schools, and one park. Water filters were installed at 10 homes with high levels of lead in their drinking water; future plans include providing safe, municipally supplied water to these homes. Lead-contaminated recreational sites also have been identified and remediation efforts are under way.

Contacts: Region 10, Roseanne Lorenzana, 206-553-8002

Title: Yakima County, Childhood Lead Poisoning Reduction Program

Description: EPA has provided funding to the Washington State Department of Health to supplement its work on education of low-income and minority homeowners on how to reduce lead poisoning of children. Part of the funds will be to print copies of a Spanish-language fotonovella, a picture book that shows ways a family can reduce lead exposure to children. The bulk of the funding will go toward development of PSA radio spots for airing on an all-Spanish radio station in Granger, Washington.

Contact: Region 10, Dan Robison, 509-575-5845

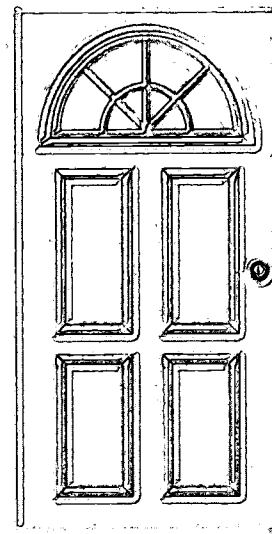

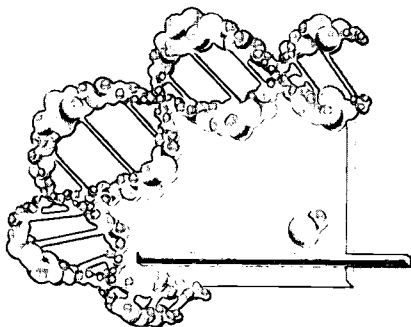

ENDOCRINE DISRUPTORS

Title: Endocrine Disrupting Chemicals Theme

Description: Researchers have identified and are investigating several Endocrine Disrupting Chemicals (EDCs) that primarily target the reproductive systems of developing (i.e., in pregnancy, perinatal, or pubertal stages) and adult animals. The goals of this research include identification of molecular mechanisms of toxicant action.

Contact: Office of Research and Development, David Otto, 919-966-6226

Title: Receptor and Signal Transduction Pathways in Developmental Toxicity

Description: Environmental estrogens and endocrine disruptors interfere with reproduction and development through mechanisms that involve altered expression and/or function of steroid receptors and endocrine hormones that bind to these receptors. These agents can also produce deleterious biological responses through effects on gene cascades that regulate and/or respond to endocrine signaling. EPA is investigating these mechanisms of developmental toxicity.

Contact: Office of Research and Development, Linda Birnbaum, 919-541-2655

PCBs

Title: PCBs in Schools

Description: Region 10 is collaborating with the Oregon State School Boards Association to address the hazards of PCBs in schools, specifically PCB regulations applicable to the storage, treatment, and disposal of fluorescent light ballasts. A case study based on four 1999 PCB inspections in the West Linn-Wilsonville School District is being used as a teaching tool in conjunction with a newly developed informational brochure entitled *Safe and Correct Handling of PCBs*

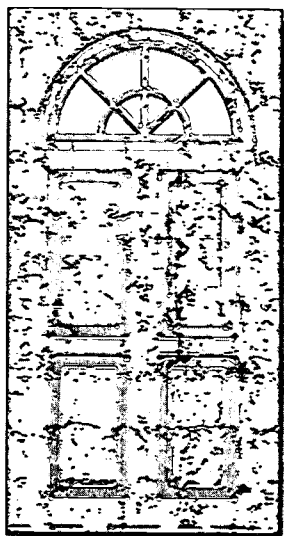

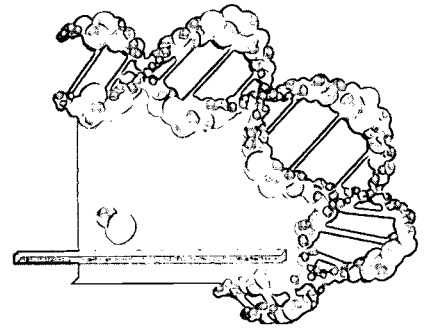

Your Responsibility. Region-wide outreach on PCBs in schools is planned for later this year.

Contact: Region 10, Dan Duncan, 206-553-6693, or Gretchen Schmidt, 206-553-2587

MERCURY

Title: Environmental WATCH Small Grants

Description: Region 5 issued small, community-based grants that promote children's environmental health and pollution prevention to organizations that participated in the Environmental Workshop on Actions to Take for Children's Health. The Fond du Lac Band of Chippewa, Minnesota, was funded to conduct a thermometer exchange with residents to replace mercury thermometers with mercury-free thermometers. This will complement activities to prevent illegal dumping of solid waste.

Contact: Region 5, Holly Wirick, 312-353-6704

Title: Elemental Mercury Exposures in Children: A Workshop to Examine the Scope of the Problem and Opportunities for Prevention

Description: On June 23, 1999, Region 5 and the Agency for Toxic Substances and Disease Registry (ATSDR) sponsored a 1-day workshop, "Elemental Mercury Exposures in Children: A Workshop to Examine the Scope of the Problem and Opportunities for Prevention." The specific goals of the workshop were to (1) share and compile current information on the potential sources that have resulted in exposure or the potential for elemental mercury exposure in children; (2) identify what is being done in the region to prevent acute exposure to mercury; and (3) determine how EPA, ATSDR, state health and environmental agencies, and their partners can further reduce the potential for elemental mercury exposure to children. Speakers represented a wide range of experts from state health, environmental, and agricultural agencies, as well as physicians from the Children's Center for Environmental Health at Cook County

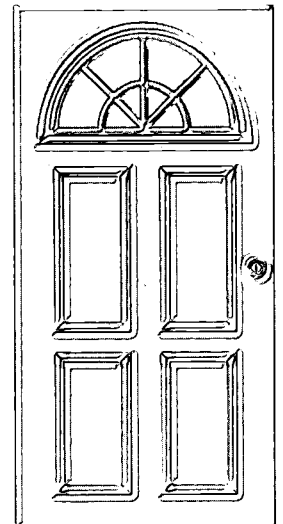

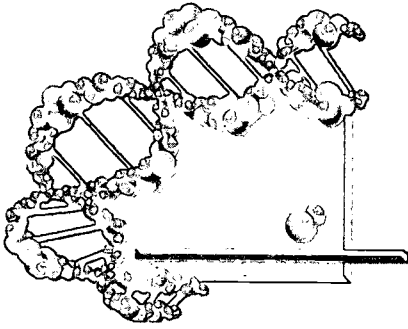

Hospital, Chicago, Illinois. Attending the workshop were more than 60 people, including representatives of state and local health and environmental agencies, industry (American Drugstores), and poison control centers.

Contact: Region 5, Colleen Olsberg, 312-353-4686

OTHER RESEARCH

Title: Developmental and Reproductive Toxicology (DART) Database

Description: An Interagency Agreement among EPA, the National Institute of Environmental Health Sciences, the National Center for Toxicological Research, and the National Library of Medicine supports the further development of the National Library of Medicine's DART database. DART contains references to and abstracts of published literature on agents that may cause birth defects and other developmental disorders. DART contains approximately 37,000 references. Including an earlier reference source, nearly 80,000 references to the developmental toxicity literature from 1959 to the present are available. In addition to references on drugs and environmental chemicals, DART contains information on biological and physical agents that have been tested for developmental and reproductive toxicity.

Contact: Office of Research and Development, Jim Cogliano, 202-564-3269

Title: Heat Shock Model (Mechanisms) for Developmental Toxicity

Description: This project is part of a larger collaborative effort among EPA and three academic institutions to develop biologically based dose-response models for developmental toxicity effects. Recent studies in this effort have begun to examine the cellular events that control the developmental process, including genetic expression, cell growth and cell death, and protein synthesis. The current project extends these findings by further defining the cellular responses and their relationship to developmental problems.

Contact: Office of Research and Development, Gary Kimmel, 202-564-3308

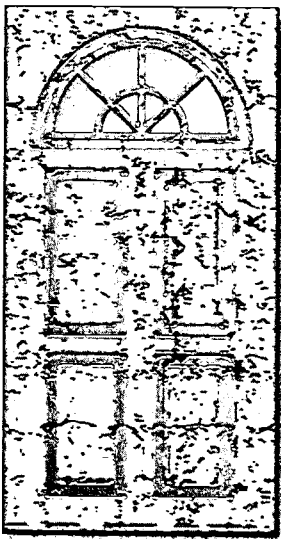

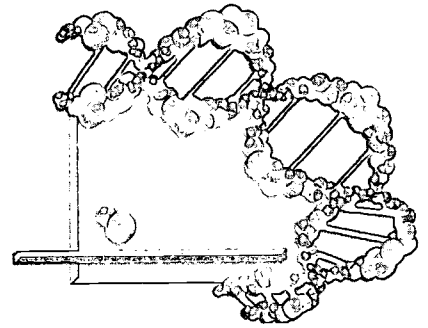

Title: Biologically Based Dose-Response Modeling of Developmental Toxicity

Description: This research focuses on developing models to describe in quantitative terms the relationship between biological processes and the development of adverse developmental outcomes. These models consider the physiologic and mechanistic factors that lead to adverse outcomes and evaluate the effects of varying route, dose, dose-rate, etc. This research is anticipated to advance the scientific basis for human health risk assessment.

Contact: Office of Research and Development, Robert Kavlock, 919-541-2771

Title: Texas Neural Tube Defect Project

Description: This is a 4-year case-control study of risk factors for neural tube defects (NTDs) in 14 counties along the Texas-Mexico border. An anticipated outcome of this project is the identification of unique biological indicators of environmental exposure, genetic susceptibility, and gene-environment interaction that lead to the development of NTDs in a Hispanic high-risk population.

Contact: Office of Research and Development, David Otto, 919-966-6226

Title: Cellular and Molecular Markers of Developmental Neurotoxicity

Description: This project will improve testing for developmental neurotoxicity, by developing a number of cellular and molecular markers that can be used to identify hazardous substances. This project uses proteins found in nervous system cells as indicators of neural damage or alteration in critical phases of nervous system development. The effects of known developmental neurotoxins on selected cellular/molecular processes at critical periods of development will be determined.

Contact: Office of Research and Development, Hugh Tilson, 919-541-2671

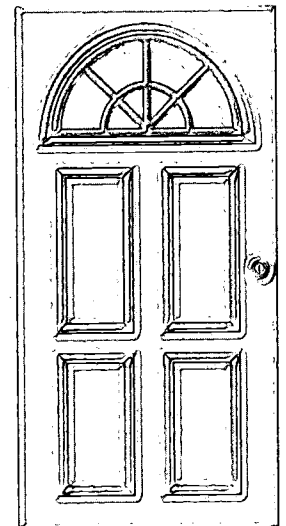

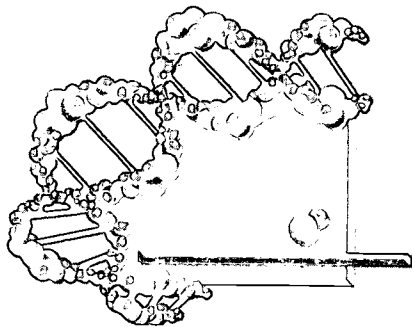

Title: Environmental Exposures and Human Neurological Function

Description: Valid tests of sensory, motor, cognitive, and affective functions are needed to determine the neurotoxic potential of environmental exposures. This project involves the development, modification, and validation of behavioral and nerve cell tests and test methods for evaluating effects of nerve cell neurotoxins on neurological function in children and adults.

Contact: Office of Research and Development, Hugh Tilson, 919-541-2671

Title: Role of Apoptosis in Developmental Toxicity

Description: The goal of this research project is to better understand the mechanism responsible for apoptosis (cell death) in the embryo. The current focus is on the role of reactive oxygen species (ROS) as a possible inducer of apoptosis. Because of the relationship between the regulation of cell cycle and the induction of cell death, an important component of this research will focus on cell cycle changes produced in the embryo.

Contact: Office of Research and Development, Robert Kavlock, 919-541-2771

Title: Improved Evaluation of Gamete Function

Description: New and more specific reproductive endpoints, including direct measures of sperm motion and structure, are now requirements specified in the new EPA Harmonized Reproductive Test Guidelines. This research aims to improve methods for these measures, with emphasis on using advanced computer technology to make these measures more objective and practical.

Contact: Office of Research and Development, Robert Kavlock, 919-541-2771

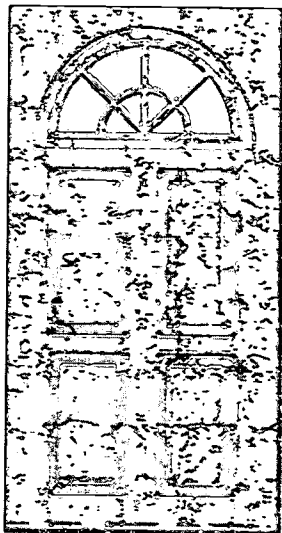

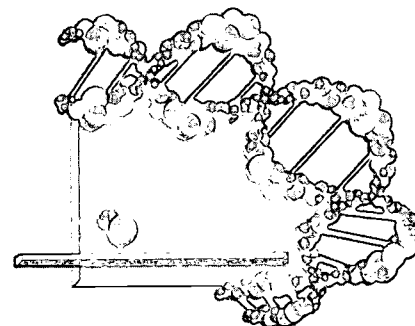

Title: Molecular Characterization of a Biological Threshold in Developmental Toxicity

Description: The goal of this research is to characterize, in molecular terms, the biological basis of a threshold (a minimum level that causes effects) in developmental toxicity. The data generated will be incorporated into computer simulations to help risk assessors predict when a prenatal environmental exposure might trigger birth defects.

Contact: Office of Research and Development, Chris Saint, 202-564-6909

Title: Using Biomarkers of Exposure and Neurobehavioral Test Batteries to Assess Children's Neurological Vulnerability to Residential Exposure to Tetrachloroethene (Perc)

Description: EPA considers perc a problematic pollutant in urban areas. The objectives of this study are to (1) assess perc exposure and neurological vulnerability of children and adults by measuring personal air and indicators of dose in exhaled breath, blood, and urine; (2) determine the relationship between environmental perc concentrations and biological indicators of dose; (3) assess behavioral functions in the exposed and unexposed groups; and (4) determine if dose-response relationships exist between the environmental and/or biological measures of exposure and neurological effects. The research will take into account age, gender, and activity levels. The data can be used to assess and compare neurological risk of perc exposure in children and adults, evaluate susceptibility to support human health risk assessment for perc neurotoxicity, and establish/assess a reference concentration (RfC) for perc.

Contact: Office of Research and Development, Chris Saint, 202-564-6909

Title: Childhood Risk Assessment at Superfund Sites

Description: The Region 3 Superfund Program has been concerned about the potential health effects that hazardous waste sites may have on sensitive subpopulations—including children. Risk assessments

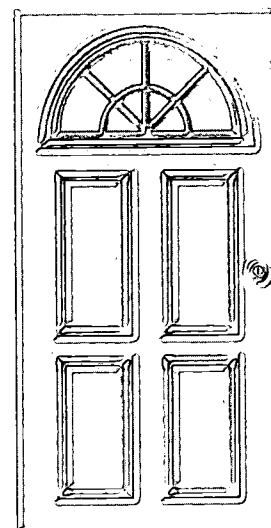

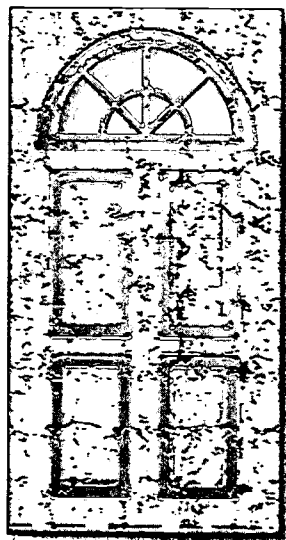
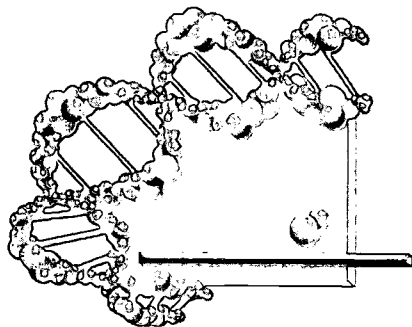

which are designed specifically for children are routinely performed. These assessments include a consideration of factors which identify children as being different from adults, such as body weight, inhalation rate, their proximity to the ground, and food and water intake. Potential routes of exposure to hazardous waste which might be specific for children are also considered, including playing in dirt and wading in surface water. The health effects of lead are analyzed with models specifically designed to predict blood lead levels in children under six years of age. Teenage children are also routinely considered in the event that they may play, ride bikes, etc. on accessible hazardous waste sites. Frequently, the decision to clean up a site is based on potential risks to children. As a result of these measures, the Region is confident that children's health has been protected at the hundreds of Superfund sites that have been cleaned up so far and that the Region's actions will continue to be protective of children.

Contact: Region 3, Lynn Flowers, 215-814-3115

Title: Shoalwater Bay Indian Tribe Reproductive Health

Description: In 1992, Region 10 learned that over 90 percent of pregnancies in the Shoalwater Bay Indian Tribe between 1990 and 1992 had ended in miscarriage, stillbirth, or infant death within the first year of life. In 1993, a Health Advisory Board was formed for the tribe, consisting of physicians, toxicologists, epidemiologists, and other health professionals. To investigate a possible environmental cause, a special team of Region 10 scientists and field staff gathered information, conducted onsite investigations, and analyzed samples. Results of the research were published in an EPA document, *The Shoalwater Bay Reservation: A Limited Environmental Assessment 1994-1995* (EPA Publication 910/R-96-013). As a result of the EPA study, the tribe is receiving high-level attention by relevant health professionals and epidemiologists. In addition, the tribe has been able to fund and build a new health clinic which has greatly improved the level of medical care for all tribal members. Through funding from EPA and

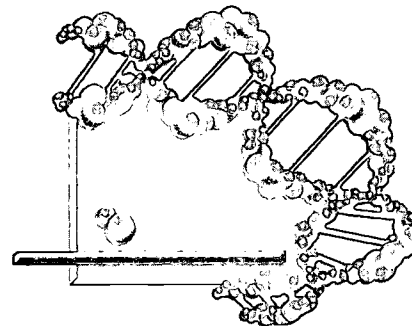

others, the Shoalwaters also have recently developed their own environmental laboratory.

Partners: Centers for Disease Control and Prevention, University of Washington School of Medicine, Indian Health Service, Agency for Toxic Substances and Disease Registry, American Medical Association, Washington State Department of Health

Contact: Region 10, Roseanne Lorenzana, 206-553-8002

REFERENCES

1. NRC. 1993. Pesticides in the Diets of Infants and Children. National Research Council. Washington, DC: National Academy Press.
2. Needleman, H.L., and C.A. Gastonis. 1990. Low-Level Lead Exposure and the IQ of Children: A Meta-Analysis of Modern Studies. *Journal of American Medical Association*. Volume 263, Pages 673-678.
3. Bellinger, D., A. Leviton, and C. Wateraux. 1987. Longitudinal Analysis of Prenatal and Postnatal Lead Exposure and Early Cognitive Development. *New England Journal of Medicine*. Volume 316, Pages 1037-1043.
4. Needleman, H.L., A. Schnell, and D. Bellinger. 1990. The Long-Term Effects of Exposure to Low Doses of Lead in Childhood: 11-Year Follow-Up Report. *New England Journal of Medicine*. Volume 322, Pages 83-88.
5. McLaughlin, J.G., R.W. Telzrow, and C.M. Scott. 1980. Neonatal Mercury Vapor Exposure in an Infant Incubator. *Pediatrics*. Volume 66, Number 6, Pages 988-990.
6. Maker, E.L., T.J. Smith, and P.L. Landrigan. The Neurotoxicity of Industrial Solvents: A Review of the Literature. *American Journal of Industrial Medicine*. Volume 8, Pages 207-217.
7. ATSDR. 1997. Healthy Children—Toxic Environments. Report of the Child Health Workgroup. U.S. Department of Health and Human Services, Public Health Service, Agency for Toxic Substances and Disease Registry.
8. CDC. 1997. Update: Blood Lead Levels—United States, 1991-1994. *Morbidity and Mortality Weekly Report*. Center for Disease Control and Prevention. Volume 46, Number 7, Pages 141-145.

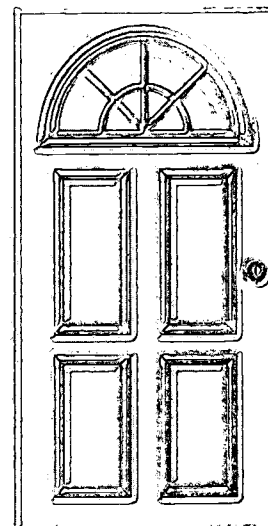

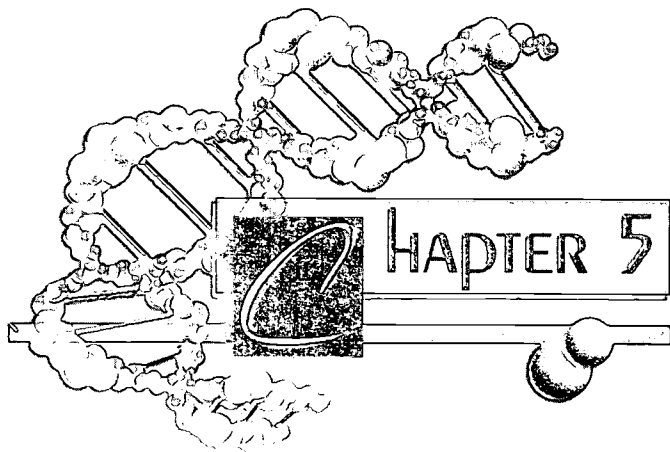

HEALTH EFFECTS of PESTICIDES

Pesticides are a concern for children because of their widespread use and children's special vulnerabilities. Children can be exposed to pesticides in their diets and drinking water, or through activities at home, play, and school. Potential health effects of pesticide exposure include cancer, acute and chronic injury to the nervous system, lung damage, reproductive dysfunction, and possibly dysfunction of the endocrine and immune systems.(1,2)

The 1996 Food Quality Protection Act (FQPA) includes specific regulatory requirements to protect susceptible members of the population, including children, from pesticide residues in food. EPA regulates pesticide residues in food through a system of standards called food tolerances. Under FQPA, the Agency will reassess approximately 10,000 existing pesticide tolerances and will focus first on those pesticides that pose the greatest hazards.

EPA has announced cancellation agreements and risk reduction strategies to increase protections for American families and their children from risks posed by two of the oldest, most widely used chemical compounds that remain in use as pesticides today. EPA is eliminating use of methyl parathion on all fruits and many vegetables. The Agency is reducing application rates of azinphos methyl and requiring practices that will result in significant reductions in allowable residues on apples, pears, and peaches. The Agency also recently announced an action to eliminate major uses of the pesticide Dursban.

EPA is calling for new studies of neurological and developmental effects on hundreds of pesticides to better understand their effects on children. These studies will allow EPA to evaluate pesticides more protectively than ever before.

In addition, EPA has committed to a number of activities to spread the word about adverse effects of pesticide exposure on children below the age of 12 who work in agriculture or are otherwise present in pesticide-treated fields. These activities include:

- Using community mentors and parents to communicate pesticide health and safety concepts to farm worker children at the Young Workers Academy in Brownsville, Texas, a pilot project which can serve as a national model.
- Expanding earlier efforts with the Hispanic Radio Network to convey information to Spanish-speaking agricultural workers.
- Increasing pesticide safety training through cooperative efforts with AmeriCorps and existing grants to develop pesticide health and safety curricula in elementary schools.

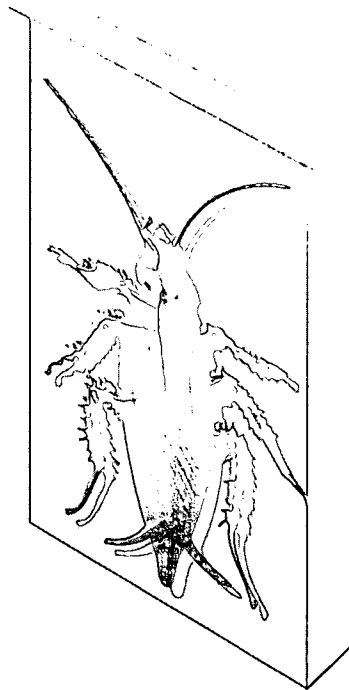

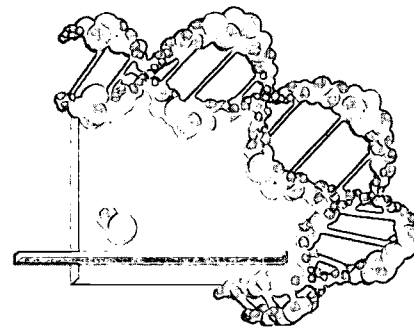

- Exploring the possibility of requiring label-specific language prohibiting children (age specified) in pesticide-treated fields, as well as label language specifying the full range of potential health effects of concern.

It is important to fully assess whether farm worker children are currently at risk from pesticide exposure and, if so, to properly address that risk. This is being carried out in a number of ways, including:

- Conducting a national assessment of the Worker Protection Standard with the help of non-governmental stakeholders.
- Examining information EPA has collected for other purposes to determine if it might be relevant to learning about exposure of children in agricultural settings.

EPA PROJECTS ON HEALTH EFFECTS OF PESTICIDES

STRENGTHENED STANDARDS AND BETTER PUBLIC INFORMATION

Title: Proposed Labeling Restriction for Insect Repellents used on Infants and Children

Description: On May 10, 2000, EPA proposed restrictions on the labeling of insect repellents marketed for use on infants and children. The proposed changes are part of a draft Pesticide Registration (PR) Notice, which will be available on EPA's web site at www.epa.gov/pesticides/biopesticides. The Agency is concerned that packaging and labeling specifically targeted to children (e.g., "for children" or "for kids") may encourage inappropriate handling and use by children. In many cases, such labeling contradicts directions or precautions on the same product labels (usually in much smaller print) that prohibit such handling and use by children. EPA believes that labeling targeted for infants and children may be misleading to parents because these products are not formulated differently for children than they are for adults.

EPA is also proposing restrictions on the use of food fragrances and colors in insect repellents. The Agency is concerned that insect repellents made with food fragrances and colors (e.g., grape, water-



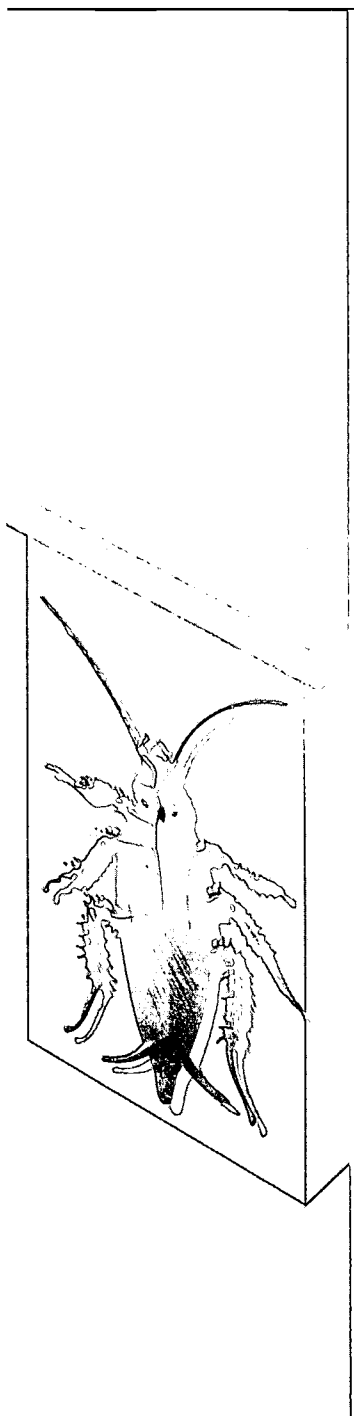
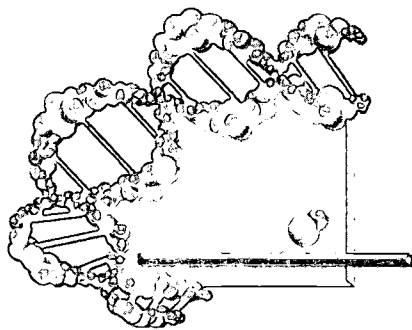

melon, orange) and packaged with graphics of the same food may encourage children to eat the product. The draft PR Notice outlines the proposed procedure and time frame for registrants to make changes to the labels of currently registered insect repellents with claims targeting use on infants and children, and to reformulate products that contain food colors or fragrances. Under this policy, EPA would not allow registrants to sell or distribute products that do not follow these restrictions as of March 1, 2001, and existing stocks may be sold or distributed by others only until March 1, 2003. A *Federal Register* Notice announcing the availability of the PR Notice is also available on EPA's Web site at the above address. A final PR Notice is expected by the end of 2000.

Contact: Office of Prevention, Pesticides, and Toxic Substances, Robyn Rose, 703-308-9581

Title: Cockroaches, Kids and Asthma Video

Description: EPA developed a video with the American Lung Association for the "Open Airways" program on how cockroaches can trigger asthma in young children, and how to prevent cockroaches from entering the home.

Contact: Office of Prevention, Pesticides, and Toxic Substances, Ralph Wright, 703-308-3273

Title: One Way to Increase the Commitment: Conference on the Food Quality Protection Act

Description: The March 1999 conference was designed for food producers, commodity groups, state and federal regulators, and others focused on issues, such as pesticide-related risk assessments, implementation of the Food Quality Protection Act, and data needs. Panel discussions were held on such topics as crop profiles, the U.S. Food and Drug Administration's monitoring program, and the impact of pesticides on drinking water and university activities.

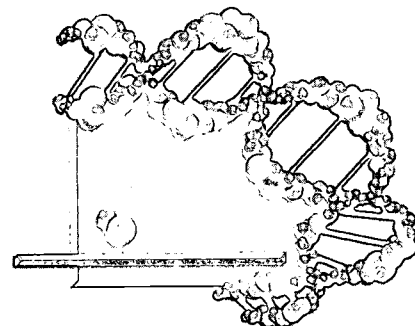

Partners: University of Massachusetts Extension, Massachusetts Department of Food and Agriculture, other New England state cooperative extension systems and pesticide regulatory agencies.

Contact: Region 1, Rob Koethe, 617-918-1535

Title: Bilingual (English/Spanish) Pesticide Safety Bingo Game

Description: During FY 1998, Region 6 developed an Urban Initiative project to reduce the misuse of pesticides among urban, inner city, and non-English-speaking groups. The resulting product is the Bilingual (English/Spanish) Pesticide Safety Bingo Game for elementary school children. In March 1999, the Bingo Game was pilot-tested in the Dallas Metroplex area in elementary schools (grades 1 through 6). Following game participation, students showed a 97 percent retention rate of material presented. Once demonstration game packets are completed, the game will be provided to Region 6 State Education Agencies for their review and approval. Region 6 anticipates eventual incorporation of the Bingo Game into the states' supplemental school curricula.

Partners: Texas School Systems, Parent-Teacher Associations, Texas Education Agency

Contact: Region 6, Sarah Perham, 214-665-2752

Title: Determining the Effectiveness of a Pesticide Risk Reduction Program for Migrant Farm Workers in Colorado

Description: This project is an evaluation of pesticide safety training provided to farm workers, which includes information about how to prevent exposure to children and other family members. The evaluation used a structured interview and observations of work practices to determine how training influenced the knowledge and behavior of migrant workers related to pesticide safety.



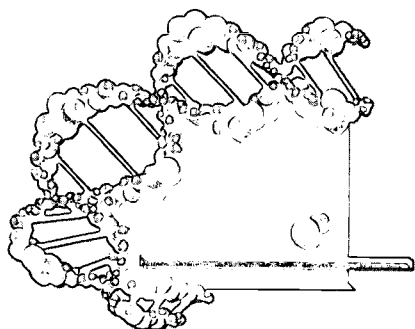

Partners: Colorado State University Department of Environmental Health
Contact: Region 8, Debbie Kovacs, 303-312-6020

Title: Farm Worker Safety in San Luis Obispo, California

Description: The Environmental Center of San Luis Obispo (ECOSLO) will work to minimize environmental health risks facing farm workers and to facilitate and improve communication and coordination among the county's environmental health stakeholders and farm worker support groups. Three hundred farm workers and their families will be surveyed to provide information to regulatory officials, public agencies, and nonprofit service organizations on household hazardous materials and pesticide use. Survey participants will be drawn from Migrant Head Start, Promotoras Comunitarias (a nonprofit support program for Latina women), and FUERZA (a county nonprofit Latino support organization).

Contacts: Region 9, Raymond Chavira, 415-744-1926, or Norman Calero, 415-744-1586

SUPPORT FOR INTEGRATED PEST MANAGEMENT

Title: IPM in School Projects

Description: Through EPA's Pesticide Environmental Stewardship Program (PESP) Grant, the University of Florida Web site (<http://www.ifas.ufl.edu/~schoolipm/>) was designed to assist schools and other organizations develop pesticide stewardship programs. In addition, a National Directory of IPM in School Web site (<http://www.epa.gov/reg5foia/pest/matilla/ipm.html>) has been created to assist individuals with finding specific information about each state IPM program, as well as appropriate IPM state contacts. The IPM in Schools Web site is at <http://www.epa.gov/pesticides/ipm>.

Contact: Office of Prevention, Pesticides, and Toxic Substances, Sarah Roman, 703-305-5475

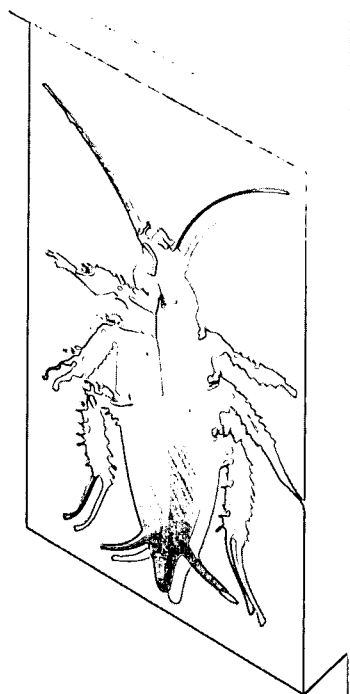

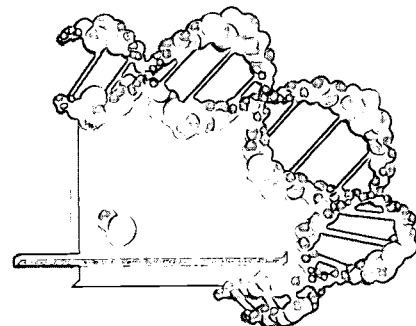

Title: IPM in Schools Training/Workshops

Description: EPA is considering the need to institute national training requirements for any applicators who apply pesticides in certain sensitive areas, such as schools and hospitals. A Pesticide Regulators Education Program (PREP) training course on IPM in schools was held in April 1999. The course is being repeated in mid-April in East Lansing, Michigan. A national workshop on IPM/Schools Implementation was sponsored by EPA in March 1999.

Contact: Office of Prevention, Pesticides, and Toxic Substances, Jim Boland, 703-308-8738

Title: Educational Photoliterature on Pesticide Misuse

Description: An integrated pest management specialist from the New York State Department of Health will develop a photoliterature document to educate low-literacy urban populations on the dangers of misusing pesticides. This document will be translated into Spanish and Chinese to help the Region reach more of the population in need.

Contact: Region 2, Rachel Chaput, 212-637-4001

Title: Pesticide Regulatory Education Program

Description: EPA Region 5 sponsored a Pesticide Regulatory Education Program (PREP) in Detroit in April 1999 to educate state regulators on IPM in schools. EPA also created a Web page to provide easy public access to a list of state authorities on IPM in schools for each of the Region 5 states.

Contact: Region 5, Don Baumgartner, 312-886-7835

Title: Environmental WATCH Small Grants

Description: EPA issued small, community-based grants promoting children's environmental health and pollution prevention to organizations that participated in the Environmental WATCH. The City of Milwaukee



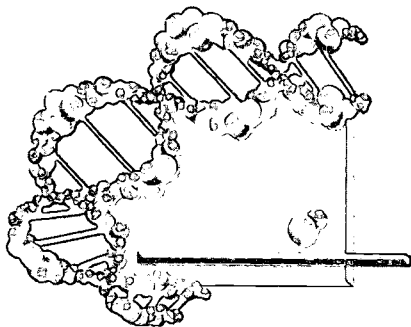

Health Department received funding for an Integrated Pest Management in Schools project.

Contact: Region 5, Holly Wirick, 312-353-6704

Title: Reducing Use of Pesticides in Schools

Description: EPA Region 9 has awarded a \$30,500 grant to the Pajaro Valley Unified School District to assist them in reducing the use of chemicals for pest management on school grounds. The District has assembled a committee of parents, teachers, and district staff to work with EPA to find alternative methods for controlling indoor and outdoor pests at all school sites. The committee is holding meetings at each site to explain IPM and to gain support for the project. Information developed in this project should be useful for other districts in the region.

Contact: Region 9, Mary Grisier, 415-744-1095

Title: IPM in Schools

Description: The IPM in Schools program offers a variety of resources to schools concerned about using pesticides and herbicides on school property. The program offers small grants to schools to facilitate the implementation of IPM programs. The program also provides speakers, educational videos and publications, and training courses for grounds and maintenance personnel.

Contact: Region 10, Don Priest, 206-553-2584

EXPANDED ENFORCEMENT Efforts

Title: The National Urban and Residential Pesticide Control and Enforcement Program (Urban Initiative)

Description: According to data collected from the American Association of Poison Control Centers, in 1998 alone, an estimated 73,260 children were involved in common household pesticide-related poisoning

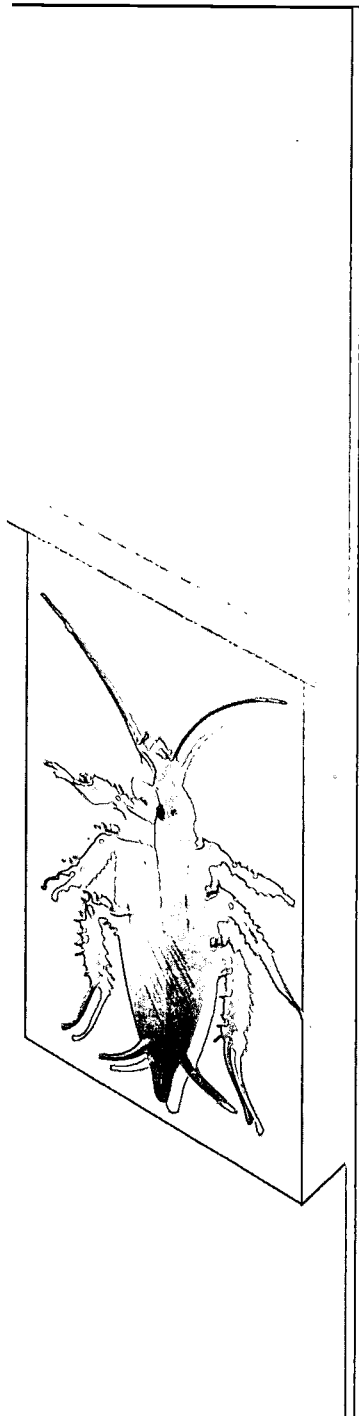

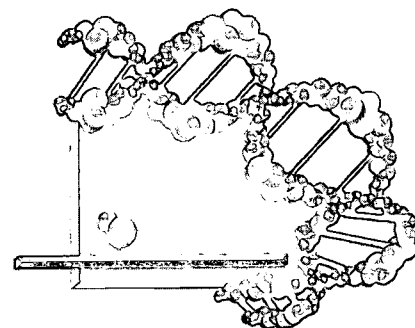

exposures in the United States. Through the Urban Initiative, EPA and other partner agencies and organizations work cooperatively to communicate health risks and prevent human and environmental harm by deterring the illegal misuse of agricultural pesticides in urban settings. Since this initiative is national in scope, educational tools will be developed for numerous audiences including pre-kindergarten through high school students. Communication strategies also will be developed with organizations, such as parent-teacher associations, church groups, 4-H, and other youth-oriented programs. The program also helps identify misuse of methyl parathion or other restricted-use pesticides and initiate appropriate enforcement action. Approximately 44 state and local arrests and two federal criminal convictions in Region 4 resulted from actions associated with the misuse of pesticides.

Contact: Region 4, Randy Dominy, 404-562-8996

Title: Reducing Pesticide Misuse

Description: EPA is working with state partners to develop an enforcement and public outreach strategy to eliminate the import, sale, and use of insecticidal chalk, a product that looks like ordinary blackboard chalk. An educational brochure highlighting the hazard to children has been developed and distributed, and has been translated into Spanish, Vietnamese, and Chinese. EPA also has initiated a compliance assistance campaign to educate school maintenance personnel about the importance of using registered products only and of following label directions for safe use. EPA has filed civil complaints against two companies selling insecticidal chalk and three companies selling unregistered moth repellents, and has issued a press release to publicize the risks to children.

Contact: Region 9, Kay Rudolph, 415-744-1065



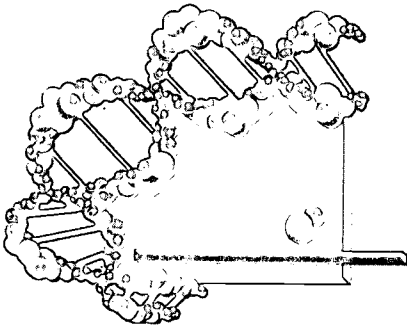

UNDERSTANDING RISKS TO CHILDREN'S HEALTH

Title: Study of Exposure and Body Burden of Children of Different Ages to Pesticides in the Environment

Description: This study will examine exposure to various pesticides (chlorpyrifos, diazinon, malathion, and atrazine) and the resulting doses experienced by children and adults from both rural and urban homes. The main objective is to test the hypothesis that children have significantly higher environmental exposures and resulting doses than do adults living in the same homes. The study will test whether the distribution of exposures for children living in urban environments is different from that for children living in rural environments.

Contact: Office of Research and Development, Chris Saint, 202-564-6909

Title: Ingestion of Pesticides by Children in an Agricultural Community on the U.S.-Mexico Border

Description: An environmental measurement and correlation study will be conducted in the area of Laredo, Texas, on the Rio Grande River. Researchers will test hand rinses of the children and house dust for pesticides and will measure pesticides and their metabolites in urine samples of the children. Observations of children's behavior (hand to mouth, hand to object, hand to surface, and object to mouth) will be made to evaluate the possible ingestion of pesticides from environmental sources. The information obtained in this study will be used to reduce the uncertainty in risk assessments for children and improve exposure measurements for children of different ages. The results will identify the magnitude of potential environmental risks to a minority population.

Contact: Office of Research and Development, Chris Saint, 202-564-6909

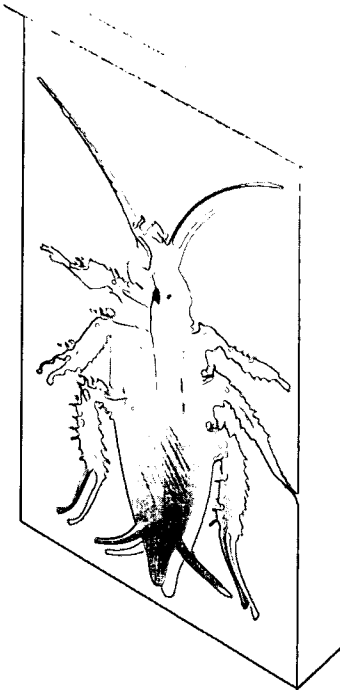

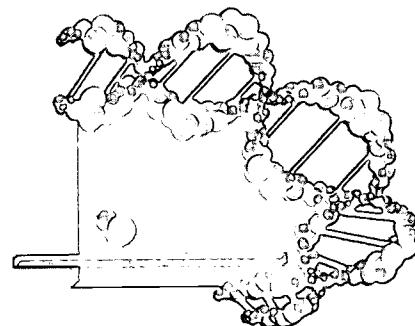

Title: Exposure of Children to Persistent Organic Pollutants and Pesticides

Description: This research is a larger-scale extension of several recently completed pilot studies on preschool children's exposure to persistent organic pollutants. The aim is to obtain scientifically valid, statistically robust information that describes these children's exposures. In this study, researchers are investigating the total exposures to persistent organic compounds of pre-elementary school children through ingestion, inhalation, and dermal absorption.

Contact: Office of Research and Development, Nancy Wilson, 202-260-1910

Title: NAFTA Border Project: Pesticides and Kids

Description: The purpose of this project is to describe the relationship of health outcomes in children along the U.S.-Mexico border with repeated pesticide exposures via multiple sources and pathways. Researchers will develop predictive models based on links between health outcomes, biological indicators, and exposure data. It will be possible to use this knowledge to design appropriate intervention strategies to reduce the risk associated with pesticide exposure. Research will be conducted in the U.S.-Mexico border states of Arizona, California, New Mexico, and Texas as part of the Environmental Health Workgroup of the Border XXI Program.

Contact: Office of Research and Development, Stephen Hern, 702-798-2594

Title: Microenvironmental Methods for Residential Exposure to Pesticides

Description: This research involves developing and testing methods for estimating residential exposure to pesticides, with special emphasis on small children. These methods are needed to accurately determine dermal and nondietary oral exposures of infants and toddlers, and are critical to understanding total human exposure. The research also will improve understanding of transport routes and mechanisms for movement of pesticides from the outdoors to the indoor environment. The long-term objective is to contribute to better



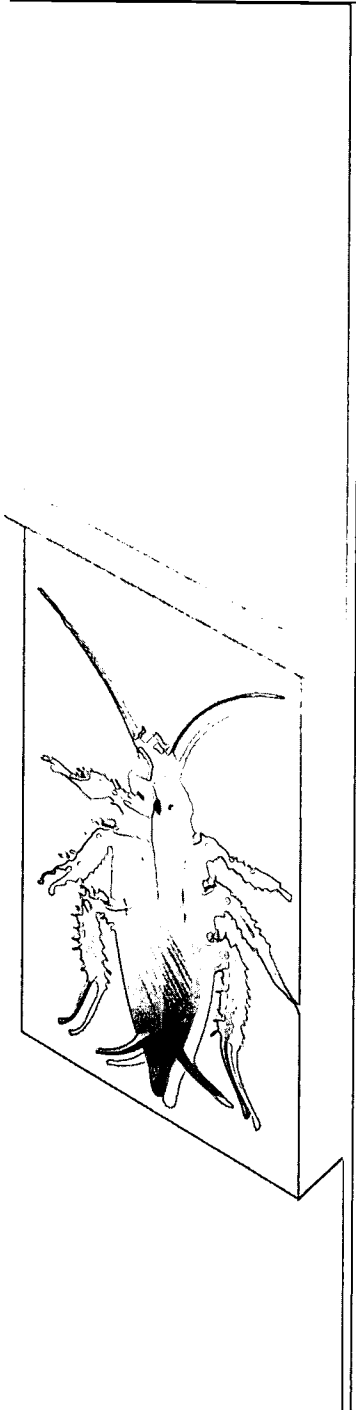
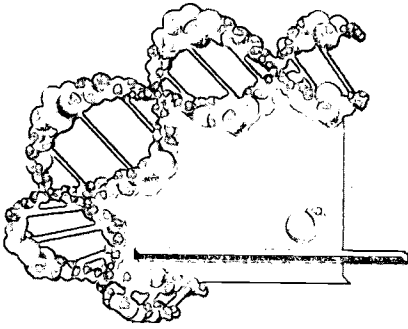

understanding of residential exposure to pesticides, especially for small children. The short-term objective is to assist in the development of guidelines for the assessment of residential exposure to pesticides.

Contact: Office of Research and Development, Bob Lewis, 706-355-8629

Title: Exposure of Children to Pesticides and Toxics

Description: The Food Quality Protection Act requires that multimedia, multi-pathway exposures be considered when setting food tolerances for pesticides. FQPA also requires that an emphasis be placed on exposures to infants and children. The overall goal of this task is to identify those pesticides, pathways, and activities that represent the highest potential exposures to children and to determine the factors that influence these exposures. The research will be used to develop methods, data, and models for evaluating aggregate exposure to pesticides and toxic chemicals. For infants and children, methods will be developed to account for important activities that take place in home, school, and childcare settings.

Contact: Office of Research and Development, Linda Sheldon, 919-541-2205

Title: Exposure of Children to Pesticides in Yuma County, Arizona

Description: The goal of this study is to determine whether children living in Yuma County have greater pesticide exposure than people living elsewhere in Arizona and whether the pathways of exposure are the same. The specific aims of the project are to (1) measure pesticide concentrations in water, air, and soil; (2) evaluate and compare routes of exposure; (3) employ biological methods and screening techniques as measures and predictors of exposure; (4) compare pesticide exposure among children to adults and children living elsewhere in Arizona; (5) develop a model for assessing exposure and risk among children; and (6) assess the potential for health care providers to carry out risk reduction activities.

Contact: Office of Research and Development, Chris Saint, 202-564-6909

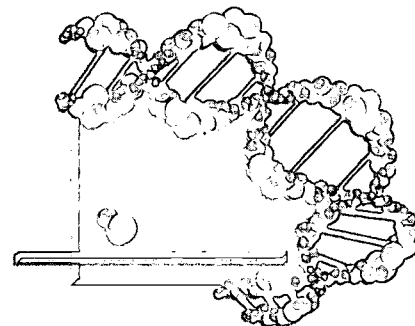

Title: Vulnerability of Young Children to Organophosphate Pesticides and Selected Metals Through Intermittent Exposures in Yuma County, Arizona

Description: The goal of this project is to accurately determine the routes and amounts of exposure to organophosphate pesticides and metals for young children. Researchers will measure rates of dermal contact, and hand-to-mouth and mouthing activity among children using videotape. They will evaluate media contacted by children (air, house dust, hands) for concentrations of pesticides commonly used in the area (including chlorpyrifos, diazinon, and malathion), as well as lead, manganese, and other metals. Urine assays for specific pesticide metabolites will be evaluated and compared to environmental concentrations. The study is expected to enhance exposure assessment models and help identify factors that minimize exposure.

Contact: Office of Research and Development, Chris Saint, 202-564-6909

Title: Exposure of Children to Pesticide Residues

Description: This project will address exposure and epidemiologic measures of children's health in relation to pesticide exposure. Proposed pilot studies include an exposure survey of school-aged children to determine if proximity to agricultural fields is associated with higher prevalence of pesticide urinary metabolites, surveillance for pesticide poisoning clusters, and studies of birth weight and infant mortality.

Contact: Office of Research and Development, Michael Dellarco, 202-564-3239

Title: Interactions and Mechanisms of Pesticide Mixtures—Children's Risk

Description: This project focuses on the effects of exposure to pesticide mixtures among animals in different age groups. The research will provide



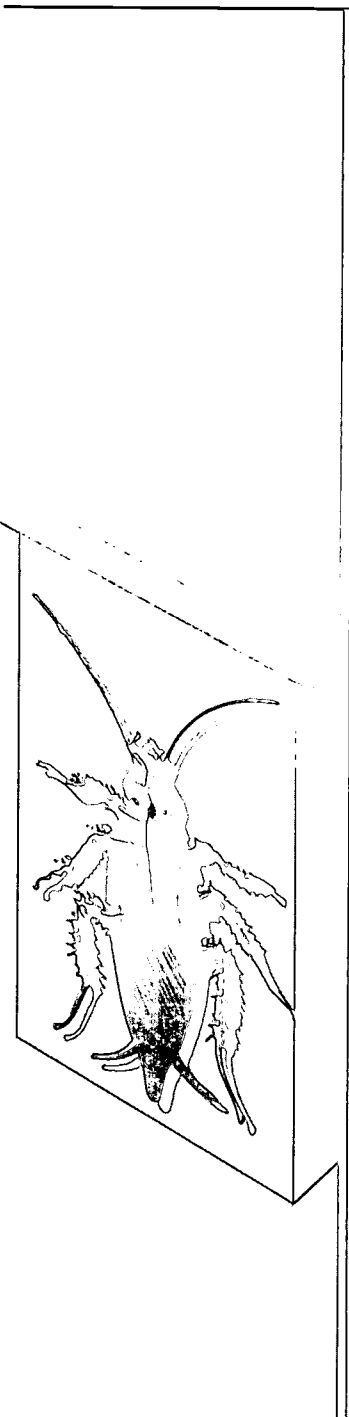
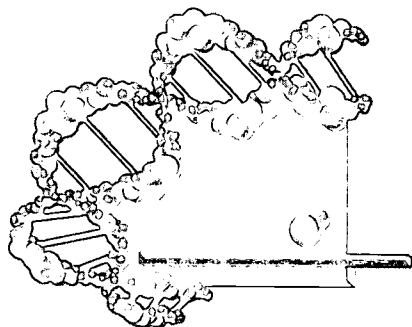

new data on the methods of pesticide interactions, biological measures of effects, and susceptibility for pesticide mixtures. The dose-response data obtained can be used for extrapolation from animals to humans for conducting risk assessment.

Contact: Office of Research and Development, Femi Adeshina, 513-569-7147

Title: Pesticide Interactions Affecting Fate and Transport and Children's Risk

Description: This project will develop a model to estimate internal dose from intermittent exposures to multiple herbicides. Researchers will develop a procedure for cumulative health risk assessment for reproductive toxicity.

Contact: Office of Research and Development, Rick Hertzberg, 404-562-8663

Title: Long-Term Potentiation as a Model System for Cognitive Function

Description: This research focuses on the alterations in cell function that accompany neurotoxic exposure and effects on intellectual function. The results could lead to improved, cost-effective test methods to examine the potential adverse effects of pesticides on learning and memory.

Contact: Office of Research and Development, Hugh Tilson, 919-541-2671

Title: Pilot Study of Symptomatic Young Children for Pesticide Exposure

Description: This study will test methods to determine whether children's nonspecific illnesses may be associated with exposure to organophosphate pesticides. Approximately 150 children age 2 to 5 in agricultural communities in Southern California and North Carolina with specific symptoms will be assessed for recent pesticide exposure and elevated cholinesterase levels.

Contact: Office of Research and Development, Hillel Koren, 919-966-6203

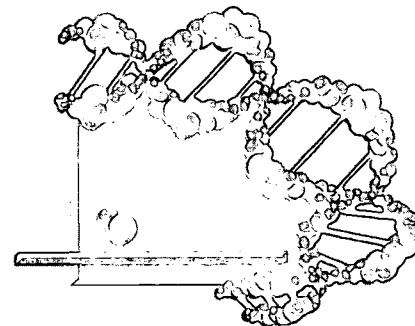

Title: Pilot Study of Immunologic Effects of Pesticide Exposure in Infants

Description: This study will test methods for evaluating the association between estimated insecticide exposure and immunologic, developmental, and enzymatic outcomes. The study will use exposure assessment methods and clinical sample collection to decide if it is practical to include these components in a longitudinal study of a larger group.

Contact: Office of Research and Development, Hillel Koren, 919-966-6203

Title: Biochemical Effects of Pesticides on the Central Nervous System

Description: This research will determine if the adverse effects of exposure to certain pesticides during development of the central nervous system are different from effects observed following adult exposure. The overall objective of this project is to determine empirically the age-related differences in sensitivity to cholinesterase inhibitors. The research will help support the application of a safety factor for children's health for cholinesterase-inhibiting compounds.

Contact: Office of Research and Development, Hugh Tilson, 919-541-2671

Title: Cognitive Effects of Pesticide Exposure During Development

Description: This research project will evaluate the cognitive and neurochemical effects of pesticides on memory, learning, and behavior following developmental or adult exposure of rodents. Immediate and long-term effects will be evaluated and attempts will be made to associate behavioral changes with underlying alterations in brain cholinesterase activity. The overall objective is to determine age-related differences in response to pesticides that inhibit enzyme activity. This research will help support the application of a safety factor for children's health for cholinesterase-inhibiting pesticides.

Contact: Office of Research and Development, Hugh Tilson, 919-541-2671



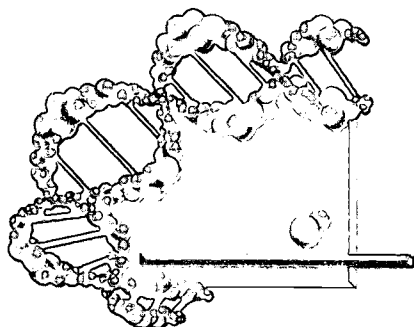

Title: Identifying the Mode and Mechanism of Action of Atrazine on Endocrine Function in the Female Rat

Description: The chlorotriazines, a class of pesticides, have been under Special Review in EPA's Office of Pesticide Programs since November 1995 because of their widespread use, and because they have been reported to induce mammary gland tumors. Several laboratories are conducting research to expand knowledge of the reproductive effects of these compounds and identify the mechanism through which these agents have their primary effect on endocrine function.

Contact: Office of Research and Development, Robert Kavlock, 919-541-2771

Title: The Effects of Pesticides on the Immune System and Allergic Response

Description: Researchers are examining the impact of exposure to pesticides on the development of allergy to house dust mites in adult and young animals to test two hypotheses: (1) that pesticide exposure promotes development of allergic sensitization, and (2) that this effect is greater in young than in mature rodents. Allergic sensitization is being evaluated using immune parameters, lung inflammation, and pulmonary hyperreactivity.

Contact: Office of Research and Development, Linda Birnbaum, 919-541-2655

Title: Perinatal Exposure of Rats to Toxic Chemicals and Pesticides and the Effects on Immune Function Development

Description: In this study, researchers are evaluating immune function and lymph cells at various ages following perinatal exposure to pesticides or toxic chemicals. This will determine if developmental exposure results in persistent alterations in the immune system.

Contact: Office of Research and Development, Linda Birnbaum, 919-541-2655

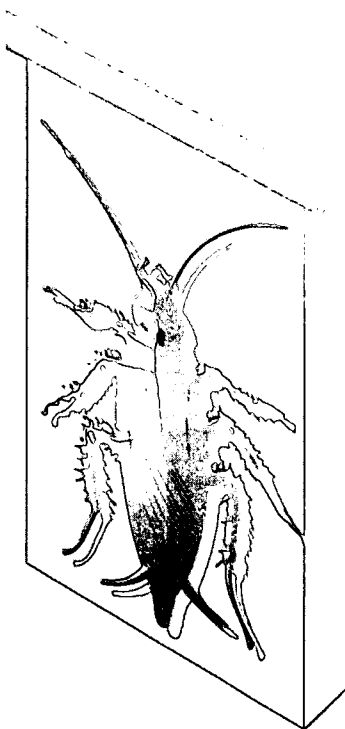

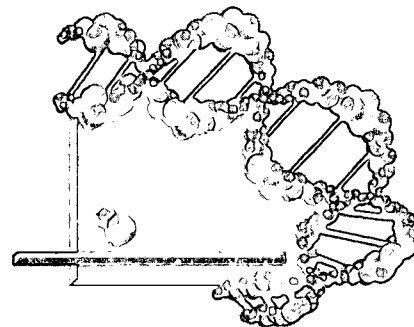

Title: A Study of Childhood Pesticide Poisoning in the Lower Rio Grande Valley

Description: This study will investigate pesticide poisoning reports in children 6 years of age or younger in the Lower Rio Grande Valley and selected non-border counties in Texas. The study will evaluate whether these children are at an increased risk for pesticide poisoning, identify risk factors associated with childhood poisoning, and develop intervention/prevention strategies for reducing pesticide poisoning in this population.

Contact: Office of Research and Development, David Otto, 919-966-6226

Title: Non-Occupational Pesticide Illness Surveillance

Description: This is a study in Texas to determine illness associated with the non-occupational exposure to pesticides. The goals are to better direct intervention efforts, identify risk factors, and determine the feasibility of expanding the program to other border states. This study includes both adults and children.

Contact: Office of Research and Development, David Otto, 919-966-6226

Title: Pesticide Exposure and Health Effects in Young Children along the U.S.-Mexico Border

Description: Researchers are examining the risks and possible health effects from persistent exposure to pesticides via multiple sources and pathways in children living along the U.S.-Mexico border. A three-phase approach is being used. In Phase I, pesticide usage and associated health data along the border were reviewed. Geographic information systems are being used to identify agricultural areas to aid in the study design. A workshop on health effects assessment in young children was held to review health endpoints appropriate for use in the project. In Phase II, infants and young children in Yuma, Arizona, and Imperial County, California, will be screened for evidence of pesticide exposure. Phase III will include a more



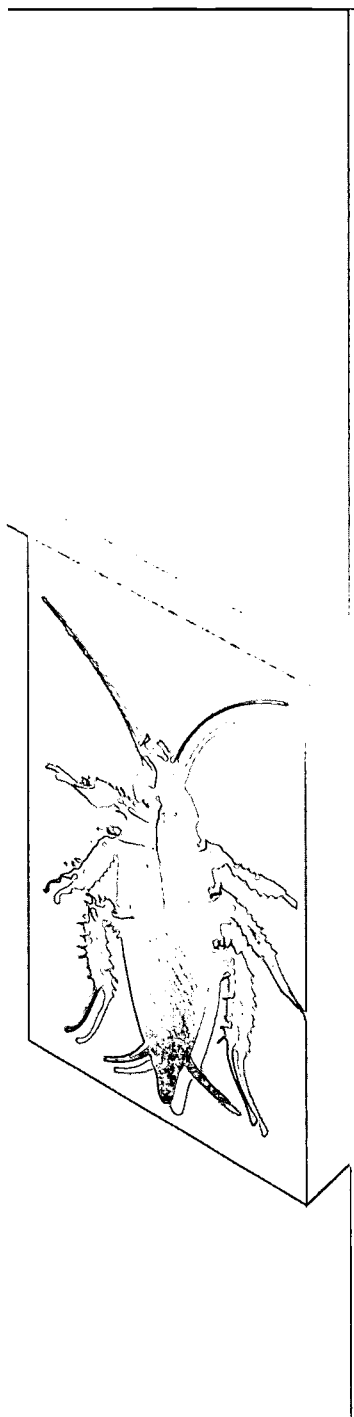
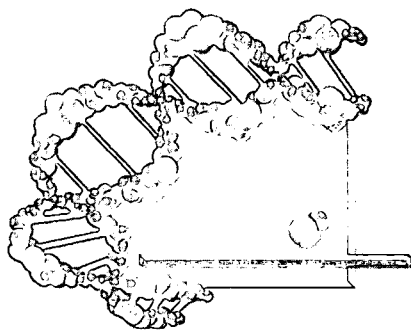

complete monitoring of children classified as "high-end exposures" in Phase II. An epidemiologic study will be linked to these efforts to examine specific hypotheses about the impact of pesticide exposure on health status/outcome of children.

Contact: Office of Research and Development, Hal Zenick, 919-541-2671

Title: Neurobehavioral Characterization of Susceptible Populations and Pesticide Neurotoxicity

Description: There is concern that neurological development of children may be adversely affected following exposure to pesticides. This project involves dose-response and time-course comparisons of the behavioral and biochemical effects of cholinesterase-inhibiting pesticides as a function of age (using rats at ages representing toddlers, pre-adolescents, and young adults) and gender. These studies will examine the effects of pesticide exposure using a battery of neurological tests at various times after acute exposure. This research will provide direct support for the application of applying a safety factor for children's health.

Contact: Office of Research and Development, Hugh Tilson, 919-541-2671

Title: Metabolic Basis for Age-Dependent Effects of Pesticides

Description: Several studies have found that younger animals are more sensitive to the toxic effects of pesticides, particularly pesticides that inhibit acetylcholinesterase. This project examines factors that may be responsible for differences in the sensitivity of young versus adult animals to high-volume, high-use cholinesterase-inhibiting pesticides. Once identified, the factors contributing to the differential age sensitivities will be applied to predict changes in children. This work will address the applicability of applying a safety factor for children in risk assessments for this class of pesticides.

Contact: Office of Research and Development, Hugh Tilson, 919-541-2671

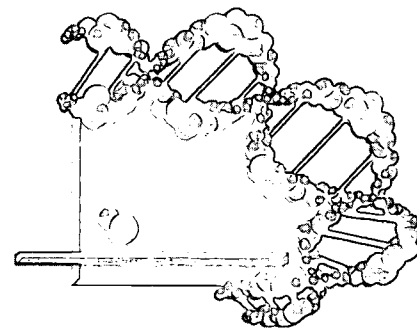

Title: Assessment of Urban Residential Exposure to 2,4-D

Description: This study will examine actual exposure to 2,4-D of Ft. Collins, Colorado, residents and their children through biomonitoring at two different times of year. The study will also correlate actual exposure with perceived exposure and possible sources of exposure in the urban or residential setting.

Partners: Colorado State University Department of Environmental Health

Contact: Region 8, Debbie Kovacs, 303-312-6020

Title: Pesticides at the Border

Description: EPA Region 9 is participating on the San Diego Advisory Committee for the California Department of Health Services (CDHS) outreach project. Their report, *Pesticide Use in California*, analyzed pesticide use levels around schools in Imperial and San Diego Counties. CDHS collected information about pesticide use along the U.S.-Mexico Border as part of an EPA research effort on pesticides' health effects in children at the border. EPA published a brief summary of the findings, and CDHS published a more detailed report. CDHS is planning an outreach effort to educate the public about the report, and has established Advisory Committees in both Imperial and San Diego Counties to work on outreach strategy. The group hopes to contact land use planners and city officials to encourage them to use this information in land use planning decisions, particularly in the siting of schools and childcare centers.

Contact: Region 9, Kay Rudolph, 415-744-1065



REFERENCES

1. Zahm, S.H., and S.S. Devesa. 1995. Childhood Cancer: Overview of Incidence Trends and Environmental Carcinogens. *Environmental Health Perspectives*. Volume 103 (Supplement 6), Pages 177-184.
2. Goldman, L.R. 1995. Children—Unique and Vulnerable: Environmental Risks Facing Children and Recommendations for Response. *Environmental Health Perspectives*. Volume 103 (Supplement 6), Pages 13-18.

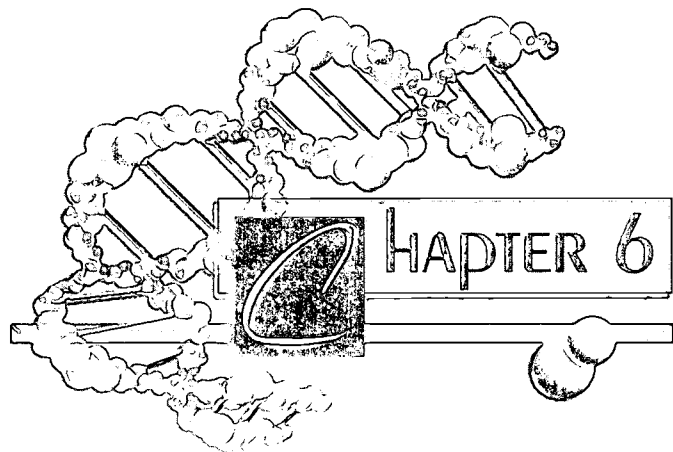

POTENTIAL RISKS FROM CONTAMINATED WATER

Contaminants in drinking water and surface water are a potential health threat to children in the United States. Drinking water in the United States is safe for most healthy adults and children, and contamination of drinking water is rare. However, outbreaks of waterborne illness, such as that caused by *Cryptosporidium*, may occur. Swimming in sewage-contaminated surface water may result in contact with organisms that cause hepatitis, gastrointestinal illness, fever, and ear infections. Bodies of water and their sediments also may be contaminated with toxic substances, such as PCBs and heavy metals.(1,2,3,4,5,6) If women of childbearing age and children eat fish from these waters, the contaminants may cause serious health effects, such as cancer, birth defects, and nervous system damage.(7)

To protect drinking water, EPA is currently developing more stringent standards that will further reduce the rate of waterborne illnesses. The Safe Drinking Water Act calls for better regulatory science, including an analysis of contaminants' health effects to children. The Act provides for special consideration of the risks to susceptible members of the population, such as children, in determining which contaminants to regulate. EPA is conducting several studies to determine the potential health effects in children from drinking contaminated water. The results will allow EPA to better document the susceptibility of children to microbial and chemical contaminants and respond appropriately.

To protect surface water, EPA regulates discharges of contaminated waste under the Clean Water Act. Under this Act, any point-source discharge is prohibited unless authorized by a permit. Through the permit process, EPA and the states control chemical and other discharges to surface waters. EPA also manages the Beach Health Program. EPA works with local officials and groups to inform the public about contamination at beaches and thus reduce children's exposure. Finally, EPA, along with state and tribal health departments, is improving the effectiveness of fish consumption advisories, which if followed help reduce health risks to children who eat fish and to the fetuses of pregnant women who eat fish.



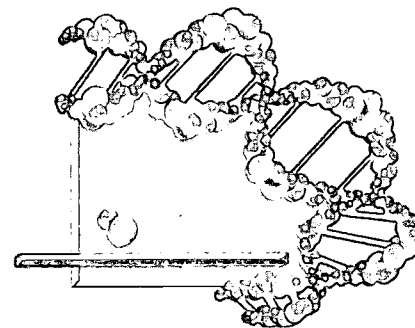

EPA PROJECTS ON CONTAMINANTS IN WATER AND FISH

CONTAMINANTS IN WATER

Title: Children and Drinking Water Standards Brochure

Description: A question many people have on their minds is, "Should I be concerned about the tap water my children are drinking?" This brochure contains information on contaminants to which children may be particularly sensitive, their sources, and what to do if their water contains high levels of these contaminants. It also tells readers where to get information on their local drinking water quality. The brochure explains how national standards contribute to drinking water safety, and helps readers make informed, reasonable choices about the water they and their children drink.

Contact: Office of Water, Sherri Umansky, 202-260-0432

Title: Chronic Arsenic Exposure and Reproductive Effects from Drinking Water

Description: This study is investigating the relationship of chronic exposure to arsenic and reproductive outcomes. University of Kentucky researchers will analyze existing data obtained from official and hospital records and try to confirm preliminary findings that arsenic exposure is associated with certain congenital anomalies. They also will investigate general fetal, neonatal, and maternal mortality and morbidity. A prospective study will investigate the association of arsenic exposure and specific outcomes, including low birth weight, prematurity, and pre-eclampsia. The researchers will assemble a cohort of pregnant women recruited in their second or third trimester of pregnancy and study them until the birth of their children. The researchers also will measure maternal urinary arsenic levels as an indicator of exposure from maternal ingestion of arsenic. They will

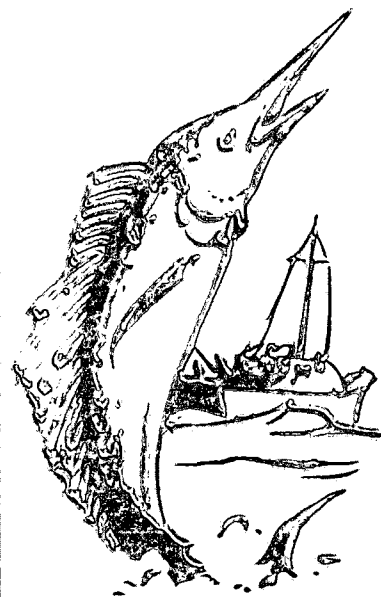

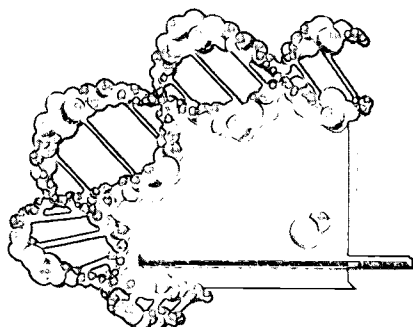

measure newborn hair arsenic concentrations as an indicator of fetal exposure through placental transfer.

Contact: Office of Research and Development, Herman Gibb, 202-564-3334

Title: Evaluation of Arsenic Metabolic Profiles in Adults and Children

Description: EPA is studying populations exposed to arsenic in drinking water to determine arsenic metabolic profiles in urine. Children and adults are being studied to determine if there is any difference in metabolism related to age or differences in ingestion habits.

Contact: Office of Research and Development, Hillel Koren, 919-966-6203

Title: Disinfectant Byproducts and Birth Defects

Description: This collaborative project with the National Center for Environmental Health at the Centers for Disease Control and Prevention is examining the potential association of neural tube defects and cardiac defects with exposure to disinfectant byproducts in drinking water.

Contact: Office of Research and Development, Hillel Koren, 919-966-6203

Title: Community Intervention Studies for Drinking Water

Description: This study looks at communities before and after changes or improvements in drinking water supplies or treatment. The study monitors families with children between the ages of 2 and 10 for the incidence of microbial enteric disease.

Contact: Office of Research and Development, Hillel Koren, 919-966-6203



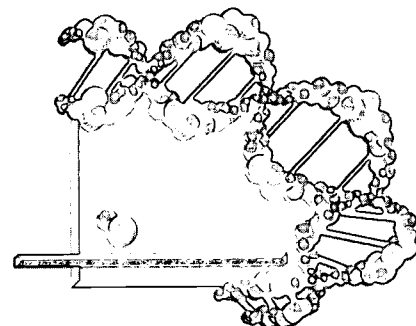

Title: Exposure of Children and Susceptible Populations to Chemicals in Drinking Water

Description: Researchers on this project are analyzing data collected in the National Human Exposure Assessment Survey (NHEXAS) to determine whether such data can be used to improve the accuracy of drinking water risk assessments and to identify specific subpopulations at risk. Chemicals of interest include selected metals, pesticides, and volatile organics.

Contact: Office of Research and Development, Michael Dellarco, 202-564-3239

Title: Microbial Disinfectants and Disinfection Byproducts

Description: EPA has promulgated the first two of a group of rules that strengthen control of microbial pathogens, including *Cryptosporidium*, while simultaneously reducing risk from potentially cancer-causing byproducts that form when disinfectants come into contact with organic material in water. These rules are collectively known as the Microbial-Disinfectants and Disinfection Byproducts (M-DBP) Rules. The new rules, the Interim Enhanced Surface Water Treatment Rule and Stage 1 Disinfectants and Disinfection Byproducts Rule, were promulgated December 1998. Water systems will be required to comply with the new standards by January 1, 2002. Future standards will continue to address the "risk-risk balance" between protecting against microbial contaminants and the byproducts of chemical disinfection. Children are among the sensitive subpopulations considered, and therefore will be protected by these regulations.

Contact: Office of Water, Jennifer McLain, 202-260-0431, or Dan Schmelling, 202-260-1439



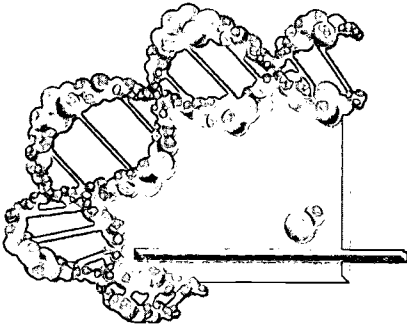

Title: Non-PRASA (Puerto Rico Aqueduct and Sewer Authority) Initiative

Description: There are 234 community public water systems in Puerto Rico that are not in the PRASA system. Typically, these systems are owned and operated by the community, serve poor rural communities of fewer than 500, and are not incorporated; some provide no treatment while others provide less than effective disinfection. Most systems violate the coliform Maximum Contaminant Level and thus fail to comply with U.S. drinking water standards. This initiative is designed to increase public awareness of the need for safe drinking water, provide basic disinfection, and improve overall drinking water quality for the individuals served by these systems. EPA's strategy includes public education, curriculum development, technical assistance, financial assistance, and enforcement.

Contact: Region 2, Jose Font, 787-729-6826

Title: Safe Drinking Water Branch Compliance Workshops

Description: Contamination of drinking water by nitrate and bacteria can pose a particular threat to infants. During the past year, Region 5 and Ohio's EPA staff conducted a series of seven compliance workshops directed at small drinking water treatment systems that were in violation of nitrate and total coliform monitoring regulations. Representatives of 58 systems attended the workshops and signed bilateral compliance agreements to conduct the required monitoring and notify the public of their previous failure to test drinking water. Timely monitoring will ensure that if there is a health threat, it will be identified and corrected.

Contact: Region 5, Holly Wirick, 312-353-6704

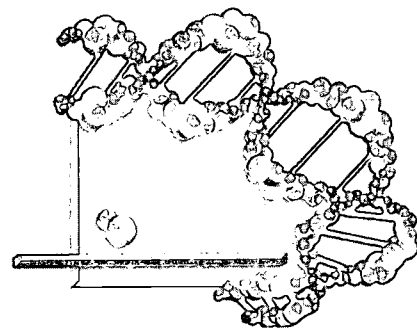

Title: Reduction/Elimination of Persistent Toxic Substances in Great Lakes

Description: EPA's Great Lakes National Program Office and Region 5 continue to work with several partners to eliminate the releases of specified persistent toxic substances to the Great Lakes Basin. The strategy targets PCBs, DDT, mercury, dioxins, and certain canceled pesticides for percentage reductions within a 10-year time frame on the path to virtual elimination of these substances.

Partners: Environment Canada, Great Lakes states, industries, tribes, environmental groups, non-government organizations.

Contact: Region 5, Rita Cestaric, 312-886-6815

Title: Water Awareness Program

Description: Region 6 is developing a risk-based children's health initiative to target outreach efforts and technical assistance for communities with degraded water quality and impaired recreational use. The Region uses GIS data to obtain a geographic focus for water-related children's health activities. The risks are analyzed using child demographics, degree of vulnerability, and degree of impact. The Region has developed a series of children's educational games, interactive activities, and children's health displays as part of the communication/outreach strategy for selected areas.

Contacts: Region 6, Paula Flores-Gregg, 214-665-8123, or Laura Talbot, 214-665-6678

Title: Protecting Drinking Water Supplies

Description: Region 10 is working with Valley Family Health Care, Inc., in Payette, Idaho, to address improper disposal and illegal dumping of chemicals and sewage that impact farm workers, Hispanic migrant

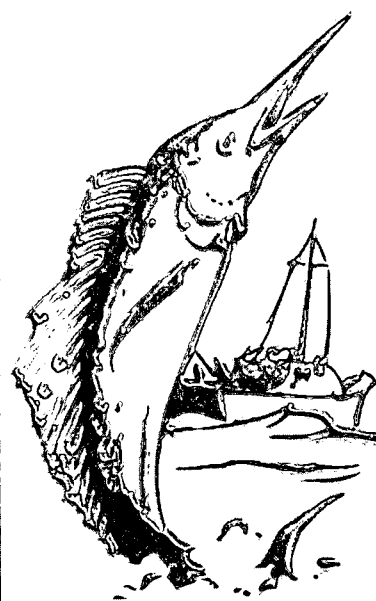

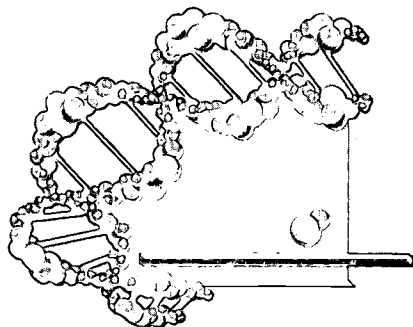

and seasonal farm workers, family members, children, and young adults. The program participants are educated about contaminated drinking water, improper methods of storing or consuming drinking water, and other activities that can further contaminate water supplies. The expected results are that program participants will understand how to protect themselves from exposure to pesticides and other chemicals.

Contact: Region 10, Cecila Contreras, 206-553-2899

CONTAMINANTS IN FISH

Title: Non-Commercial Fish Consumption Kit for Health Care Providers

Description: EPA, in partnership with the Agency for Toxic Substances and Disease Registry, is developing materials to assist health care providers assess and educate clients who consume non-commercial fish.

Contact: Office of Water, Jeff Bigler, 202-260-1305

Title: Fish Advisories

Description: EPA Region 2 has been actively involved in the public communication of fish advisories in the states of New York and New Jersey for the past 3 years. The communication takes the form of flyers (some translated into other languages), public service announcements, and consultations with local health care providers, most particularly prenatal and neonatal clinics. The bodies of water most involved are the Hudson River, the New York/New Jersey Harbor, the Passaic River, the Niagara River, and the Great Lakes. The advisories communicate information about contaminants in fish to particular populations at risk: sustenance anglers, pregnant and nursing women, and children.

Contact: Region 2, Ann Rychlenski, 212-637-3672



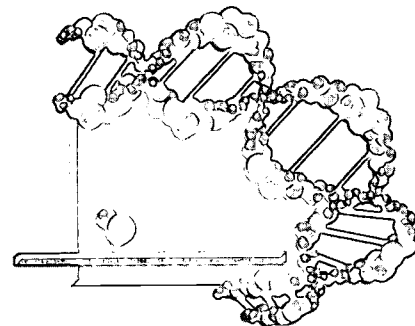

REFERENCES

1. ATSDR. Toxicological Profile for PCBs. U.S. Department of Health and Human Services, Public Health Service, Agency for Toxic Substances and Disease Registry.
2. ATSDR. Toxicological Profile for Arsenic. U.S. Department of Health and Human Services, Public Health Service, Agency for Toxic Substances and Disease Registry.
3. ATSDR. Toxicological Profile for Mercury. U.S. Department of Health and Human Services, Public Health Service, Agency for Toxic Substances and Disease Registry.
4. ATSDR. Toxicological Profile for Lead. U.S. Department of Health and Human Services, Public Health Service, Agency for Toxic Substances and Disease Registry.
5. ATSDR. Toxicological Profile for Chromium. U.S. Department of Health and Human Services, Public Health Service, Agency for Toxic Substances and Disease Registry.
6. EPA. 1997. Before You Go to the Beach. Publication Number EPA 820-K-97-001. U.S. Environmental Protection Agency.
7. EPA. 1997. Should I Eat the Fish I Catch? Publication Number EPA 823-B-97-009. U.S. Environmental Protection Agency.

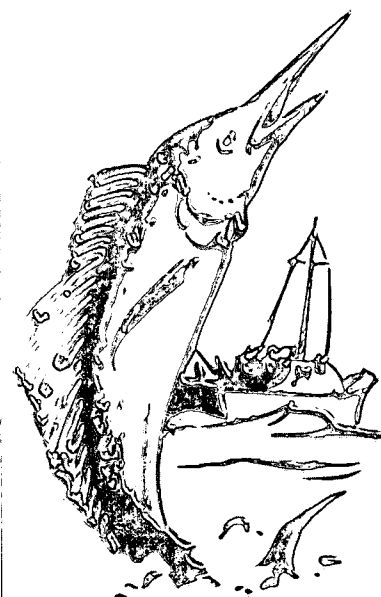

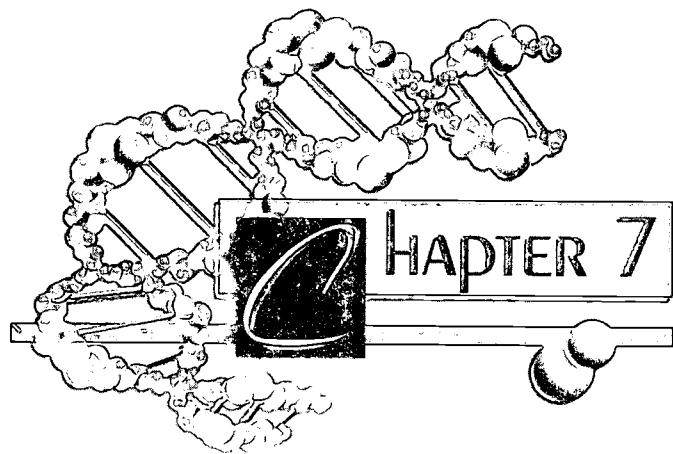

PREDICTING HEALTH RISKS TO CHILDREN

EPA uses risk assessment to identify and judge the severity of potential harmful effects to humans or ecosystems from exposure to environmental hazards. Risk assessment is a complex, analytical process involving expertise in chemistry, biology, ecology, statistics, medicine, and other disciplines.

For drinking water, EPA is working to ensure that the developmental studies used to determine national drinking water standards are designed to evaluate lifetime effects from exposures by infants and children during their formative years. To better protect children and adults from swimming-related illnesses, EPA is addressing limitations of current methods to measure, monitor, and communicate recreational water quality. In the area of hazardous waste, EPA's Superfund program analyzes possible risks to children from exposure to hazardous waste sites. EPA uses several exposure factors in the risk calculations that apply to children, including body weight, inhalation rates, and ingestion rates to account for age-specific activities, such as playing in soil.

A number of current EPA studies are under way to better characterize childhood exposures, identify subpopulations that may be at risk, and improve exposure estimates for infants and children to toxic substances, such as pesticides, lead, and toxic molds. EPA is identifying critical periods in a child's development when exposure can pose the greatest risks, and is determining the mechanisms that may increase or decrease the likelihood of adverse outcomes in children compared to adults. Finally, EPA is developing better risk assessment methods to account for combined exposures to a variety of substances and multiple routes of exposure. For instance, an individual may be exposed to lead from several sources, such as contaminated drinking water, lead-based paint, and airborne lead in densely populated or industrial areas. The exposures from all sources could be combined into one measure for an assessment of combined risk to children.

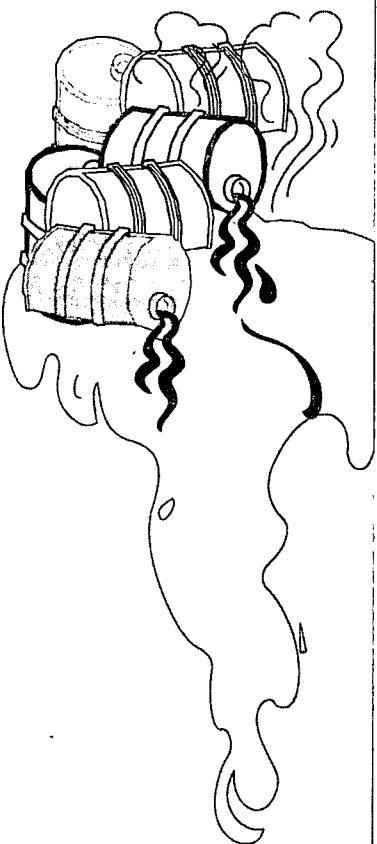

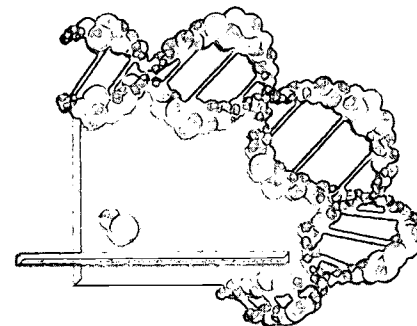

EPA PROJECTS TO IMPROVE RISK ASSESSMENT

WATER

Title: Genetic Damage Associated with DBPs

Description: In this project, researchers will address the differences in the distribution and metabolism of specific disinfectants/disinfection byproducts (DBPs) among individuals and between adults and children. Estimates of these differences will be analyzed using models constructed for adults and children. The cytochrome P-450 enzymes in the liver are the focus of this study, because they are responsible for a number of metabolic reactions that increase the toxicity of low-molecular-weight compounds.

Contact: Office of Research and Development, John Lipscomb, 513-569-7217

Title: Rapid Scientific Methods for Measuring the Quality of Bathing Beach Waters

Description: Researchers are developing new ways to measure the quality of recreational water and to address some of the limitations of current methods that measure the density of *E. coli* or *Enterococci* bacteria. Their methods make use of genetically engineered microbes, nucleic acid probes, and immunological methods. The methods can quantitatively measure water quality indicators and can produce rapid results without complex instruments. If successful, these methods will provide water quality data in a timely manner and help protect adults and children from swimming-associated illnesses.

Contact: Office of Research and Development, Kristen Brenner, 513-569-7317

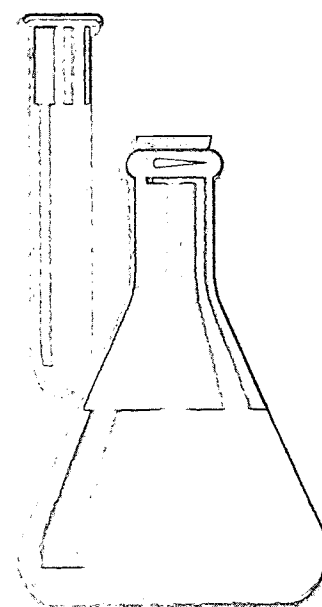

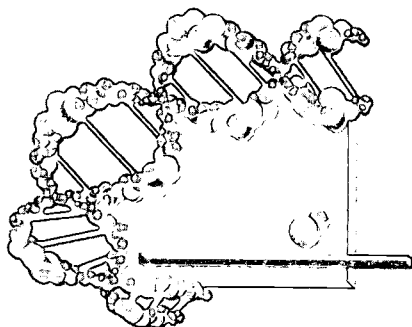

Title: Bathing Beaches Monitoring Protocols and Communicating Swimming Activity Risk to the Public

Description: Current EPA-recommended monitoring practices for bathing beach water quality have some limitations in their ability to protect the people who are most at risk from swimming-associated illness, particularly children. Researchers are addressing these limitations by developing a scientifically defensible monitoring protocol for bathing beach water that accounts for spatial and temporal variability, has national applicability, and can be translated into a simple system that the public can use to make personal decisions about risks associated with swimming and other recreational water activities. The use of this protocol will ultimately result in greater protection of adults and children from swimming-associated illnesses.

Contact: Office of Research and Development, Kristen Brenner, 513-569-7317

HAZARDOUS WASTE

Title: Development of Guidance on the Use of Probabilistic Analysis in Risk Assessment at Superfund Sites

Description: The Superfund program's risk assessment process is used to evaluate potential cancer risks and other hazards to children from exposure to hazardous waste sites placed on the National Priorities List. EPA has developed a document that provides technical guidance on the application of probabilistic analytical methods to human health risk assessment, including risks to children. Probabilistic analysis is a useful tool to characterize and quantify variability and uncertainty in risk assessment. Risk assessors select exposure factors that predict the potential risks of children living near a Superfund site. Risk information is used to evaluate the potential need for site cleanup.

Contact: Office of Solid Waste and Emergency Response, S. Steven Chang, 703-603-9017



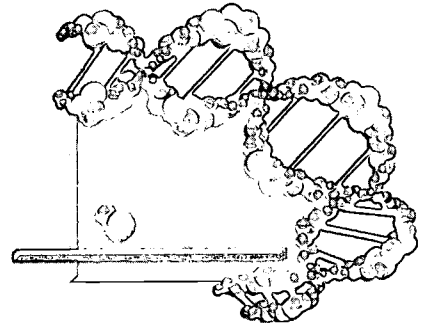

Title: Community Involvement in Superfund Risk Assessments

Description: EPA's Superfund program staff is improving the way in which risks to children and adults are assessed by enhancing the role of community involvement in risk assessment. EPA has developed a series of new learning tools for both EPA staff and the public. A guidance document provides suggestions to risk assessors for involving communities in planning a risk assessment, identifying sites to sample, and describing how people could be exposed to a Superfund site. Information and fact sheets for the public describe risk assessment in clear terms and illustrate how people's knowledge about a site and their community can help EPA with risk assessment. Educational videotapes, developed with the help of people across the country who live near hazardous waste sites, help communicate how EPA assesses risks and the ways in which people can help improve site assessments in their communities.

Contact: Office of Solid Waste and Emergency Response, Jayne Michaud, 703-603-8847

Title: Superfund Basic Research Program

Description: EPA supports children's health research through the Superfund Basic Research Program (SBRP) administered by the National Institutes of Environmental Health Sciences through an interagency agreement. In FY 1999, EPA committed \$37 million to the SBRP. The basic research funded by EPA helps to reduce uncertainties in risk estimates and allows the agencies to better protect children and susceptible communities. Children's health research helps us understand the impact of chemical exposures on children during critical periods of vulnerability. Examples of research supported by this program include studies on the influence of in utero PCB exposures on infant development and molecular epidemiology of childhood leukemia.

Contact: Office of Solid Waste and Emergency Response, Jayne Michaud, 703-603-8847

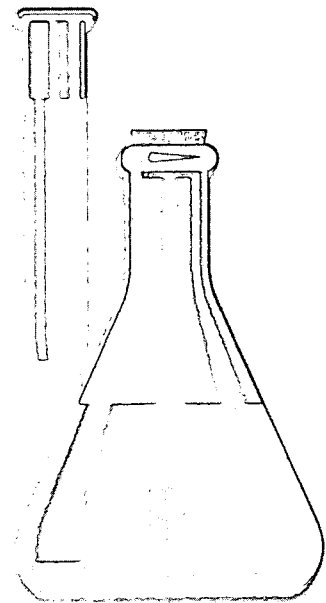
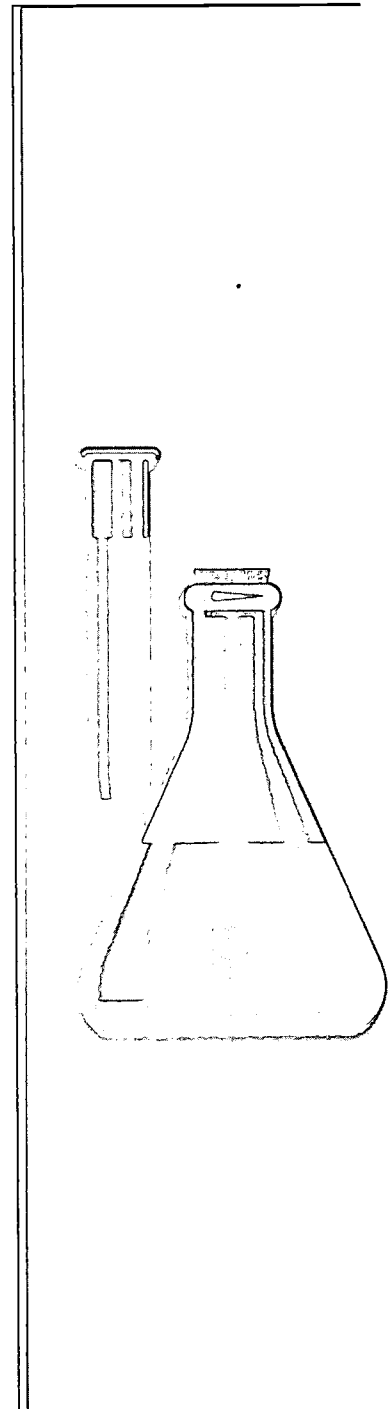

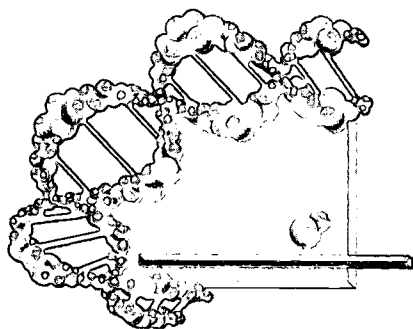

Title: Office of Solid Waste Risk Assessments

Description: EPA's Office of Solid Waste recognizes the importance of evaluating children's health risks as part of risk assessments supporting Resource Conservation and Recovery Act (RCRA) hazardous waste regulations. EPA routinely uses information on childhood exposure to assess child health risks associated with exposure to hazardous waste. Recently published EPA rulemakings in which risks to children are explicitly considered include final standards for controlling hazardous air pollutants emitted from hazardous waste incinerators, proposed standards for the management and beneficial use of cement kiln dust, and proposed hazardous waste listing determinations for dye and pigment production wastes and wastes from the production of chlorinated aliphatic chemicals. EPA also acknowledges the uncertainties involved in assessing health risks to children as part of its regulatory efforts, noting that methodologies for estimating environmental threats to children's health are relatively new, are currently being debated within the scientific community, and will continue to evolve and improve.

Contact: Office of Solid Waste and Emergency Response, Charlotte Bertrand, 703-308-9053

Title: Determining Potential Exposure of Children near Superfund Sites

Description: EPA's Superfund program staff evaluates potential risks to children from exposure to hazardous waste sites. These evaluations include assessing risks through ingestion of soil and inhalation, as well as risks to children trespassing onto abandoned hazardous waste sites. Risk assessors make appropriate changes to body weight, inhalation rates, and ingestion rates to account for age-specific activities when assessing risks to children. To assess potential risks to children from lead exposure, risk assessors use the Integrated Exposure and Uptake Biokinetic model for children 6 years old and under. The model predicts changes in blood lead levels in the population and this information is used to evaluate the potential need for remediation.

Contact: Region 2, Audrey Galizia, 212-637-4352



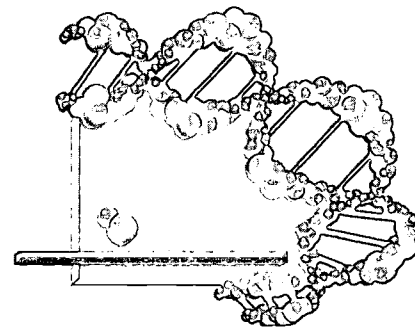

Title: Vega Baja Solid Waste Disposal

Description: The Vega Baja landfill site is an inactive, unlined landfill, located in a rural area of Río Abajo Ward, Puerto Rico. Open burning occurred on the landfill between 1948 and 1979. Approximately 200 dwellings are located on 11 acres of the site. The Puerto Rico Environmental Quality Board conducted sampling to explore possible lead hazards in soil, tap water, and homegrown fruits and vegetables. Also, the Puerto Rico Department of Health tested blood lead levels of young children living in the Vega Baja site. Results revealed no indication of health concerns. Future planned activities include collection of indoor dust samples from homes at the site.

Contact: Region 2, Audrey Galizia 212-637-4352

Title: Children's Exposure Priorities at/near Superfund Sites

Description: Region 5's Superfund Division has developed a priority list of those chemicals and environmental hazards commonly encountered at or near Superfund sites that pose the greatest risk to children's health. This list will be used by policymakers to allocate resources and implement appropriate actions for protecting children's health at or near Superfund sites. It will also be used to develop strategies for protecting children's health (e.g., developing outreach campaigns, incorporating the chemical list in site investigation). This list will be updated as new information becomes available.

Contacts: Region 5, Afif Marouf, 312-353-5550, or Ben Maradkel, 312-886-2064

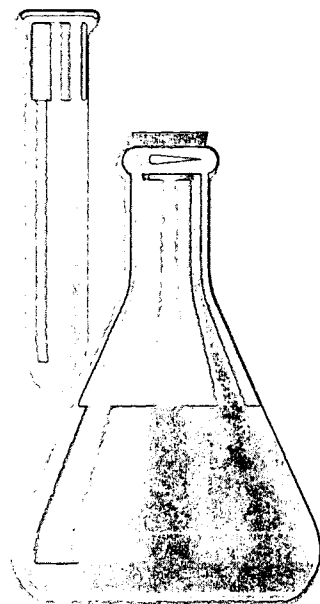
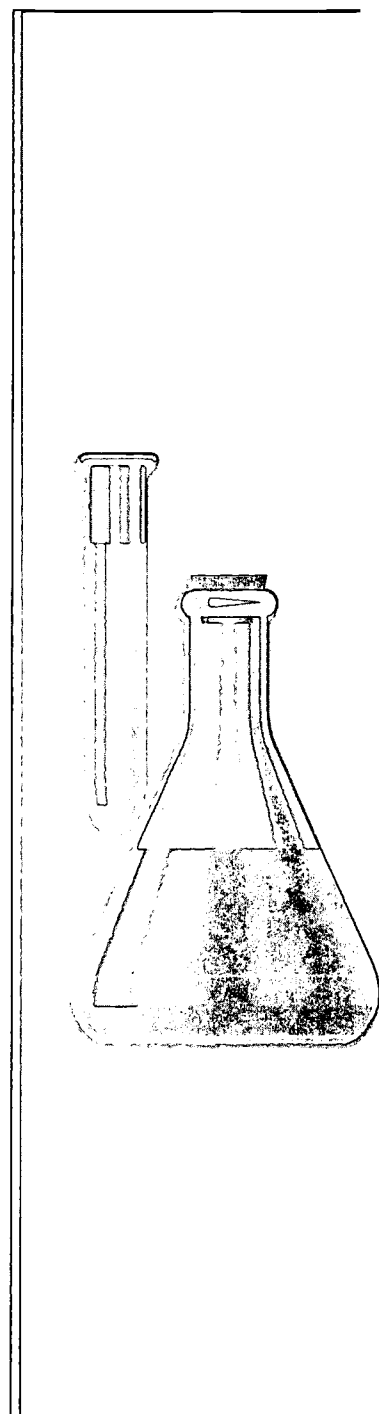

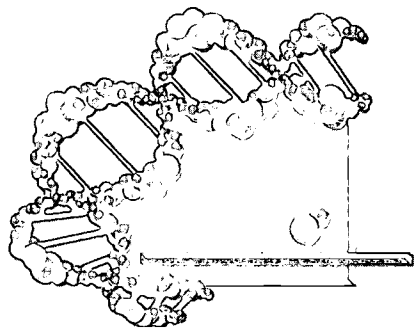

EXPOSURE

Title: Human Exposure-to-Dose Models: Models and Modeling Methods for Assessing Human Exposure and Dose to Toxic Chemicals and Pollutants

Description: This project aims to strengthen the general scientific foundation of EPA's regulatory risk assessment, management, and policy processes by developing state-of-the-art mathematical modeling and solution methods to describe the relationship between exposure and dose. Differences in physiology, metabolism, and anatomy may create alterations in absorption and hence risk among adults, children, and infants. One result of this research will be to produce a modeling framework and an integrated group of models that can be easily modified for a variety of exposure assessment and risk characterization problems.

Contact: Office of Research and Development, Jerry Blancato, 702-798-2456

Title: Dietary Exposure of Children

Description: The purpose of this research is to develop a protocol and model for assessing a young child's combined dietary intake of pesticides or other environmental contaminants, including those "inherent" in their foods as well as those that contaminate their foods during the eating process (from hands, surfaces, etc.). Laboratory testing is being conducted to characterize surface transfer coefficients and related factors. Video analysis is helping the researchers analyze contacts between foods and surfaces. Field testing will validate protocols and measure dietary intakes of small children.

Contact: Office of Research and Development, Maurice Berry, 513-569-7284



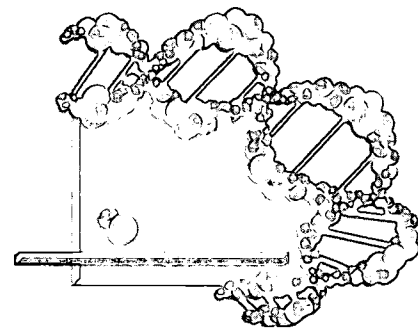

Title: Developing Risk Assessment and Risk Management Models for Exposure of Children to Toxic Mold, Using *Stachybotrys chartarum* as the Model Mold

Description: The health effects caused by exposures of children to indoor molds are complex and controversial. This proposed research project will attempt to further our ability to assess and manage the risks associated with such exposures using a combination of aerobiologic, epidemiologic, and modeling approaches. *Stachybotrys chartarum* will serve as a model subject of the investigation for several reasons: it is common in water-damaged buildings, it produces a series of well-characterized and particularly potent toxins, and exposure to it has been implicated in infant deaths from a disease known as pulmonary hemosiderosis (PH). The project will bring to bear new and rapid methods for the quantitative analyses of the spores and toxins of this organism, and will attempt to correlate the occurrence of PH disease with levels of exposures to these agents in a defined population of potentially at-risk infants in the Cleveland, Ohio, metropolitan area.

Contact: Office of Research and Development, Steve Vesper, 513-569-7367

Title: Multipathway Exposure Modeling of Children and Adults to Pesticides and Toxics

Description: The goal of this research is to develop a mathematical model to estimate exposure and absorbed dose to pesticides by children and adults. Because young children are potentially at higher risk for greater exposures to pesticides, this research emphasizes exposures to children. Exposures to other toxics in the environment will subsequently be investigated using a multimedia/multipathway modeling framework similar to that being developed for pesticide exposures. Initially, a probabilistic exposure model for chlorpyrifos will be modified. This model characterizes both uncertainty and variability in input distributions and exposure factors. Additional microenvironments and pathways that are important for children's exposure to

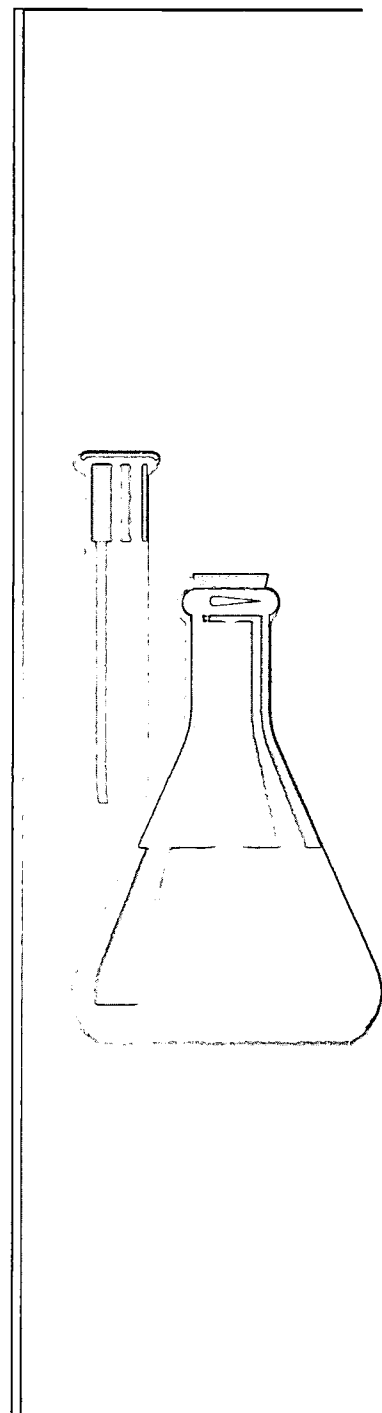

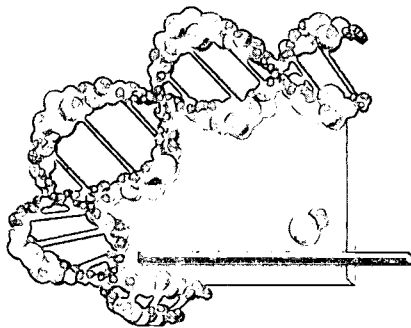

pesticides, including the dermal exposure pathway and gastrointestinal absorption, will be incorporated into the new model.

Contact: Office of Research and Development, Haluk Ozkaynak, 919-541-5172

Title: Workshop to Identify Critical Windows of Exposure for Children's Health

Description: A workshop was held in September 1999 in Richmond, Virginia, to develop a "time line" of critical periods of development, and identify the health effects that could result from exposures during those times. The time line describes key exposure periods within human development for selected health outcomes. Exposures may occur pre-conceptionally (to either parent), prenatally, and postnatally. Endpoints of interest for this project include developmental outcomes identified at birth, asthma, cancer, neurologic/behavioral effects, reproductive system effects, cardiovascular effects, diabetes, and effects on general growth.

Contact: Office of Research and Development, Sherry Selevan, 202-564-3312

Title: Childhood Exposure Factors Handbook

Description: This handbook is a compilation of statistical data on child-specific exposure factors. The handbook includes data on sociodemographic factors that affect exposure. A computer model will be developed to access the applicable databases and calculate exposure using user-defined exposure scenarios.

Contact: Office of Research and Development, Jacqueline Moya, 202-564-6245

Title: IEUBK Model Expansion

Description: The Integrated Exposure Uptake Biokinetic (IEUBK) Model for Lead in Children (version 0.99d), released in March 1994, has been widely accepted in the risk assessment community as a tool for

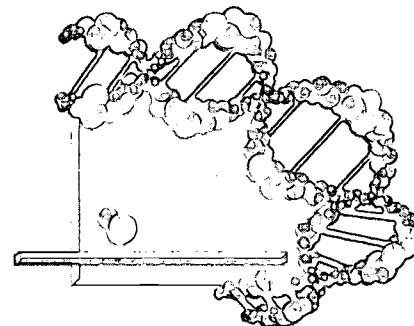

implementing the site-specific risk assessment process for childhood lead exposure. The model has four components, or modules: exposure, absorption/uptake, biokinetics, and statistical output. There is a need to expand the model to include adult exposure and to add several features not currently available. In FY 1998, the exposure module was expanded to a full age range (0 to 84 years) and revised to incorporate several new model features and user options. The uptake and biokinetic modules will be expanded in the same manner. Each of the modules will undergo a limited circulation for review and comment, to be completed during FY 2000. In FY 2000, the all-ages lead model will be released for scientific review and evaluation.

Contact: Office of Research and Development, Robert Elias, 919-541-4167

Title: EPA's Contribution to Children's Assessment in NHANES IV

Description: EPA is helping to support data collection through the Centers for Disease Control and Prevention in the National Health and Nutrition Examination Survey (NHANES) directed towards children between the ages of 6 and 19 years. For approximately 1,100 adolescents and young adults ages 12 to 19, the serum levels of the following persistent organochlorines will be tested: B-HCH, chlordane, DDT metabolites, dieldrin, heptachlor/HE, hexachlorobenzene, lindane, mirex, oxychlordane, PCBs, toxaphene, and trans-nonachlor. These individuals will also be tested for thyroid function. For approximately 800 children ages 6 to 11 and 800 adolescents ages 12 to 19, the following high-priority pesticides will be tested in the urine: chlorpyrifos; diazinon; permethrin; 2,4-D; ortho-phenyl phenol; and methyl parathion. EPA also is supporting the blood and urine collection procedures and the administration of research related to potential exposures to these chemicals. Sample collection is taking place in 1999 to 2000, and results are expected in 2001.

Contact: Office of Research and Development, Sue Perlin, 202-564-3284

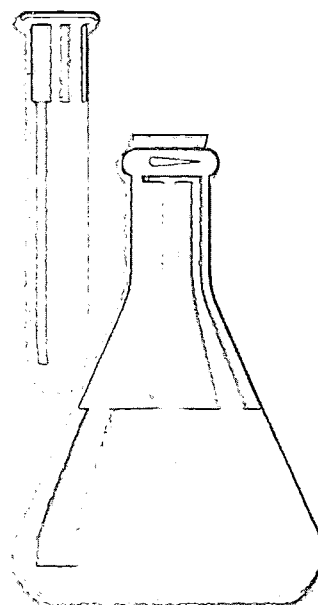
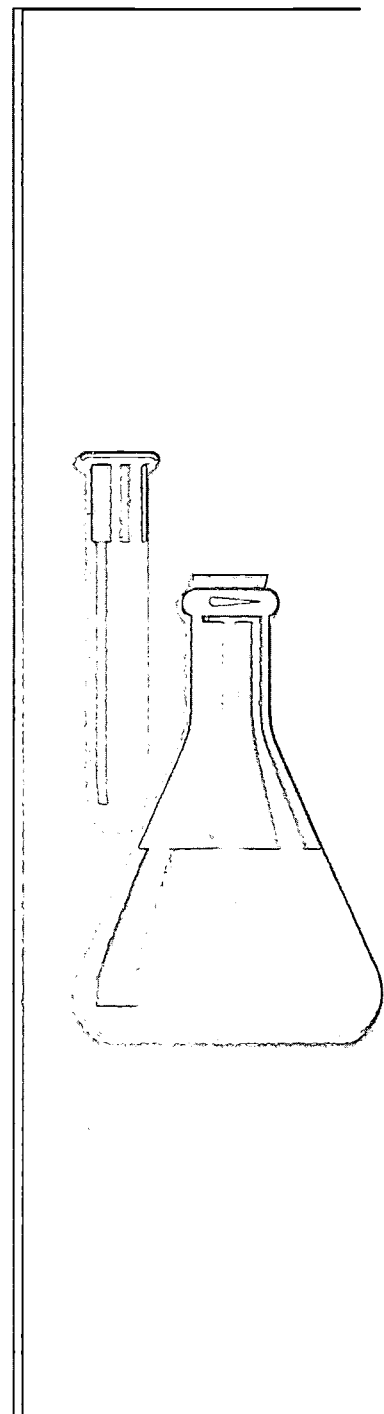

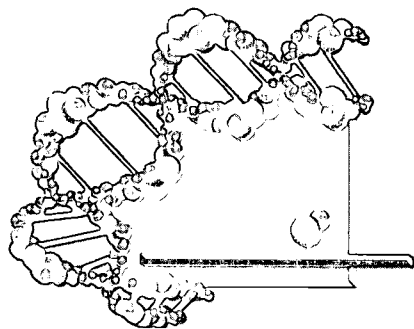

- Title:** Children's Risk: Summary Statistics of Selected Data Elements of NHANES III
- Description:** As part of the National Health and Nutrition Examination Survey (NHANES), this project generated databases and descriptive data on a variety of exposures and health characteristics as a first step in identifying topics for further exploration. The project report includes tables of data by gender, age, and race/ethnicity.
- Contact:** Office of Research and Development, Sherry Selevan, 202-564-3312
- Title:** Evaluation of Methods to Scale Pharmacokinetic Parameters between Adults and Children
- Description:** This project will analyze the pharmacokinetic differences between adults and children based on existing studies and will characterize the variability of pharmacokinetic parameters among children within given age groups.
- Contact:** Office of Research and Development, William Pepelko, 202-564-3309
- Title:** Ethnic and Minority Highly Exposed Children's Populations
- Description:** This project examines and documents differences in exposure to environmental contaminants in children of different racial, ethnic, and socioeconomic groups.
- Contact:** Office of Research and Development, Sherry Selevan, 202-564-3312
- Title:** Children's Environmental Health and Safety Inventory of Research
- Description:** The Children's Environmental Health and Safety Inventory of Research (CHEHSIR) is an Internet-accessible database of federally funded or sponsored research on environmental health risk and/or safety risks that may uniquely or disproportionately affect children.

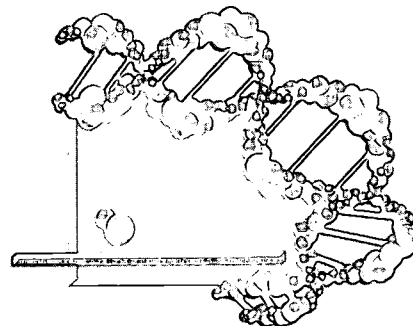

The database was created as an interagency effort co-chaired by EPA's National Center for Environmental Assessment (NCEA) and the DHHS National Institute of Environmental Health Sciences (NIEHS). The database is available at <http://www.epa.gov/chehsir>.

Contact: Office of Research and Development, Bruce Rodan, 202-564-3329

Title: Protective Mechanisms Theme

Description: The developmental processes of gametogenesis and embryogenesis are protected from the effects of toxicants by a variety of biological mechanisms. This research focuses on identifying and characterizing protective mechanisms dependent on heat shock proteins (HSPs) and/or glutathione (GSH). The research will determine specific biological mechanisms potentially relevant to a wide range of reproductive and developmental exposures. Results from these experiments will help define thresholds in dose-response studies, validate biomarkers of response as useful components of predictive dose-response models, and provide information for identifying susceptible subpopulations.

Contact: Office of Research and Development, Robert Kavlock, 919-541-2771

Title: North Carolina Birth Cohort Study

Description: This long-term project, still under development, will establish a cohort of children starting during gestation and follow them for the next 20 years. Researchers will examine several exposure issues (pesticides, persistent organochlorines, indoor and ambient air pollutants, and drinking water contaminants) while measuring age-appropriate health endpoints (developmental, immunological, neurological, and respiratory). Counties selected for study will be representative of both urban and rural environments and provide racial diversity.

Contact: Office of Research and Development, Hillel Koren, 919-966-6203

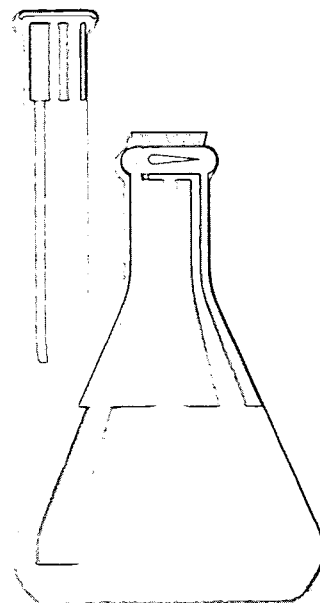
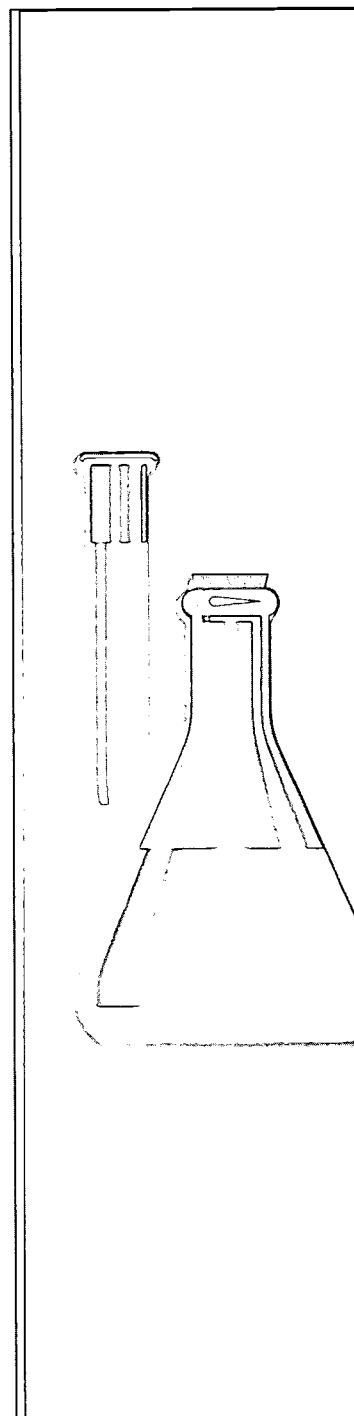

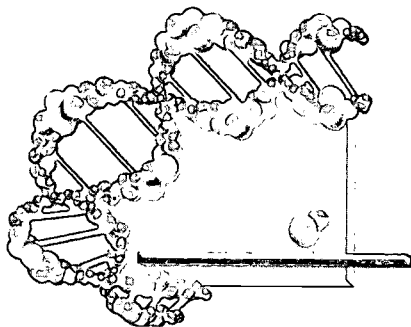

Title: A Survey of Health and Environmental Conditions along the Texas-Mexico Border

Description: This study will establish a baseline of environmental health conditions along the Texas-Mexico border. The results will be used to assess the need for environmental health education, environmental monitoring, and promotion of targeted health services. The results are also expected to lead to active surveillance for health conditions related to environmental exposures, such as hepatitis A, pesticide poisoning, lead poisoning, and asthma. The study will involve the collection of existing demographic, environmental, and health data from 2,100 randomly selected households in the principal population areas along the border.

Contact: Office of Research and Development, David Otto, 919-966-6226

Title: Preparing Maps of Region 4 Depicting Environmental, Health, and Demographic Characteristics

Description: This project is designed to determine how and if existing environmental, demographic, and health data can be utilized to identify potential relative risks from environmental factors to children's health in Region 4. The areas of concern for the initial evaluation include asthma, disorders caused by neurological/developmental toxicants, childhood cancer, waterborne diseases (biological pathogens), and acute responses to environmental contaminants (not including accidental poisonings).

Contact: Region 4, Wayne Garfinkel, 404-562-8982



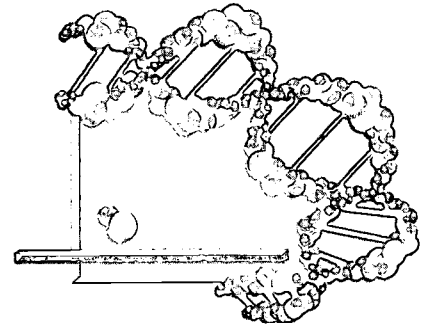

Title: Environmental Pollutant Exposures in Children (EPEC) Project

Description: The EPEC workgroup is compiling exposure information for a list of environmental pollutants that have potential health impacts for children in Region 5. The purpose of this project is to assess exposure of children to environmental pollutants, including benzene, dioxins, formaldehyde, lead compounds, mercury compounds, nitrates/nitrites, pesticides, polyaromatic hydrocarbons, polychlorinated biphenyls, toxaphene, trichloroethylene, and vinyl chloride. This project will reduce data gaps in knowledge about childhood exposures to environmental pollutants by addressing such questions as: does exposure to environmental pollutants represent a health concern for children? If so, what are the pollutants of concern and what are the health concerns?

Contact: Region 5, Colleen Olsberg, 312-353-4686

Title: Site Assessment in Response to Cancer in Children: McFarland, California

Description: McFarland is a small, largely Hispanic, agricultural community in California's Central Valley. For the past 21 years, it has had an increased rate of childhood cancers documented by the California Department of Health Services. EPA is sampling and analyzing drinking water, soil, and air for releases of hazardous substances associated with past industrial and agricultural practices to determine current environmental conditions and identify any issues that may be of concern to children's health. Two rounds of sampling of drinking water, including home faucets, and soil sampling have been completed. EPA is continuing with plans for air monitoring in the year 2000.

Contacts: Region 9, Mark Calhoun, 415-744-2376, or Elizabeth Adams, 415-744-1704

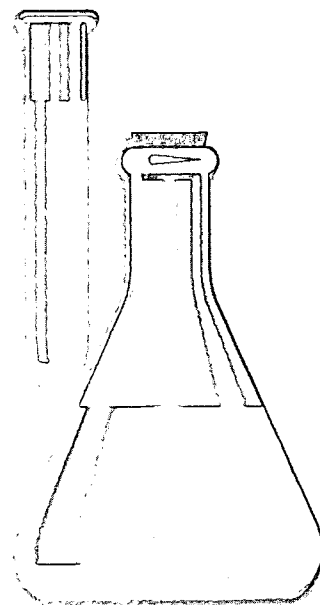
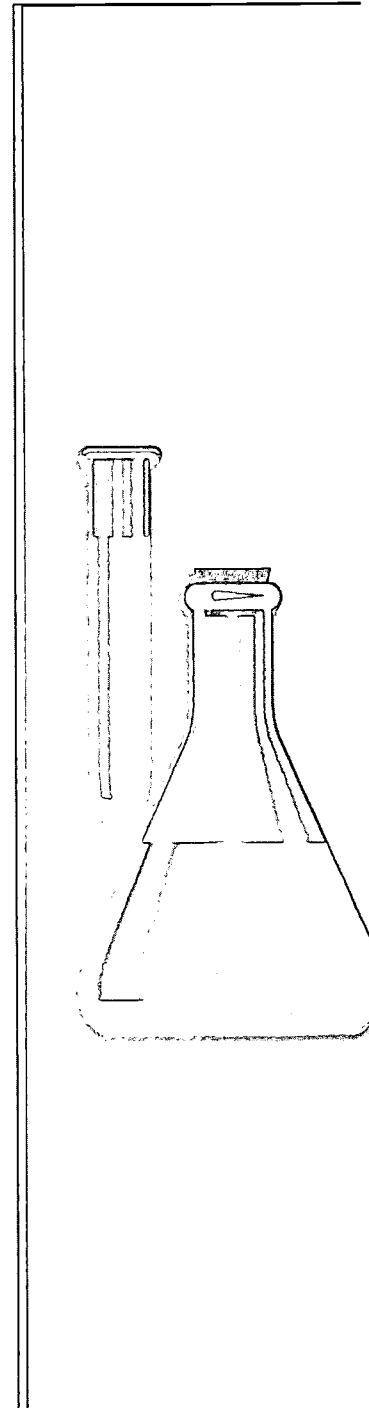

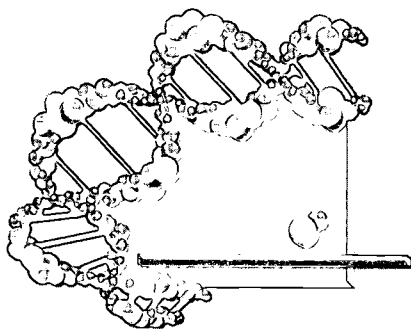

Title: West Oakland Urban Pilot Project

Description: West Oakland is a predominately minority community with mixed-use zoning. It includes many residences located near industrial activities, and many children are living next door to high-hazard facilities. EPA is engaged in several efforts to assess the environmental conditions and help build the community's capacity to respond to and advocate for environmental issues. EPA Region 9 arranged for an initial round of blood lead testing in the South Prescott neighborhood of West Oakland.

Contact: Region 9, Carla Moore, 415-744-1938

Title: Defensible Space Project

Description: The African American Development Association was given a grant to fund the "Defensible Space Project." The project goal is to assess and map all of the known polluters and storage facilities and their locations with respect to sensitive receptors, such as schools or other places where children gather. The project will provide an environmental snapshot of West Oakland and will be useful for many aspects of community planning and building. It will also support efforts to determine whether there is a correlation between public health and the location of industrial facilities.

Contact: Region 9, Carla Moore, 415-744-1938

CUMULATIVE RISK

Title: Assessment of Chemical Mixtures

Description: Children are frequently exposed in the environment to multiple chemical mixtures. However, little is known about the age-dependent response to chemicals with similar modes of action. This project examines the effects of chemical mixtures on various neurochemical and functional measures in rodents of different ages. The overall objectives of the project are (1) to assess the principle of additivity as it relates to the effects of environmentally relevant chemicals in

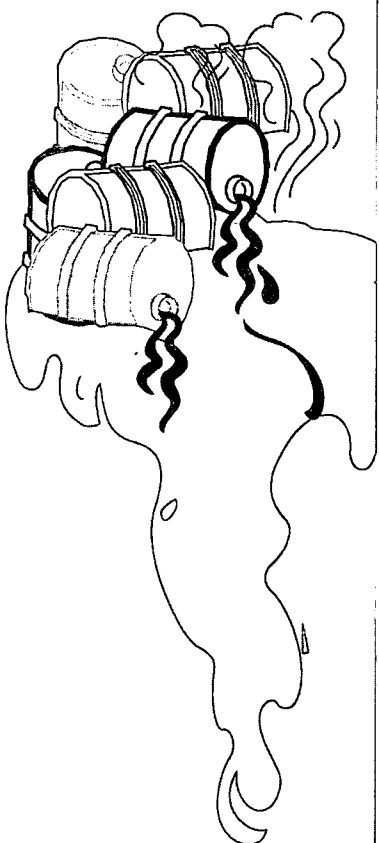

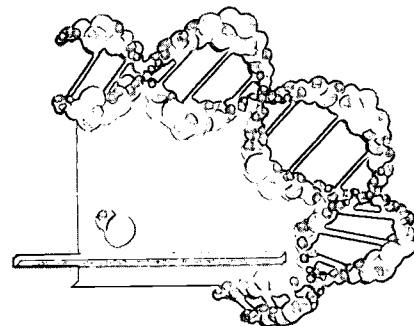

the brain, and (2) to determine if additivity varies as a function of age. This research addresses the problem of cumulative toxicity, in which children are exposed to many chemicals with similar modes of action.

Contact: Office of Research and Development, Hugh Tilson, 919-541-2671

Title: Update on Chicago Cumulative Risk Initiative (CCRI) Project

Description: This project, which examines complex exposures in urban industrial areas around Southeast Chicago and Northwest Indiana, has entered its second phase. Argonne National Laboratory is currently conducting a project to evaluate cumulative hazard impacts on children.

Contact: Region 5, Cheryl Newton, 312-353-6730

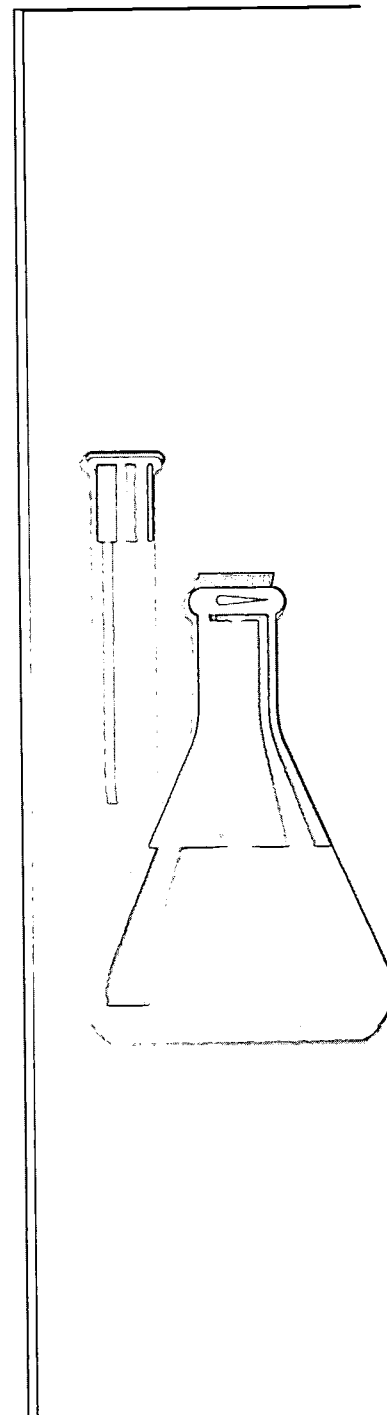

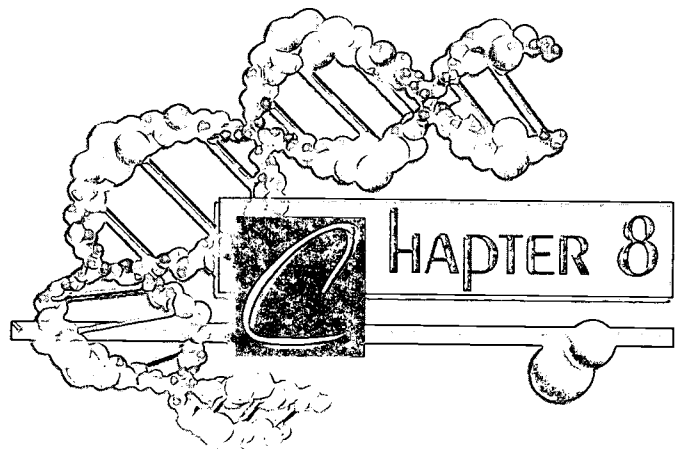

PROTECTING CHILDREN Worldwide

EPA's leadership in building international cooperation and technical capability is an essential part of the U.S. role in promoting children's environmental health in international organizations and other nations. The *1997 Declaration of the Environment Leaders of the Eight on Children's Environmental Health* was adopted unanimously at a summit hosted by EPA Administrator Carol Browner in May 1997. Seven specific areas for international collaboration were identified:

- Improving environmental science and risk assessments by using more explicit scientific knowledge of children's characteristics.
- Reducing blood lead levels in children to below 10 micrograms per deciliter and reducing child, infant, and maternal exposure to lead.
- Improving access worldwide to microbiologically safe drinking water.
- Reducing air pollution.
- Reducing children's exposure to environmental tobacco smoke.
- Increasing and coordinating scientific research on endocrine (hormone) disrupting chemicals.
- Taking decisive international action to confront the problem of global warming.

EPA is coordinating U.S. efforts to put into action the steps called for in the Declaration. The Agency is working with other countries of the Eight, as well as other international organizations, to further the goals of the Declaration.

In August 1998, EPA helped to fund and participated in the First International Conference on Children's Health and the Environment. This conference provided an international forum for the latest research findings in pediatric environmental health, identified opportunities to minimize childhood exposure to environmental contaminants worldwide, and initiated a review of future research in the field of children's environmental health.

In June 1999, EPA led a U.S. delegation to the World Health Organization's (WHO's) Third Ministerial Conference on Environment and Health. The Conference included more than 900 participants, including 72 ministers of environment and health. The *London Declaration*, adopted by 50 countries from the WHO European Region, affirmed the countries' commitment to specific measures that will reduce the harmful effects of environmental degradation on human health. The member states agreed to give greater emphasis in all relevant programs to the need

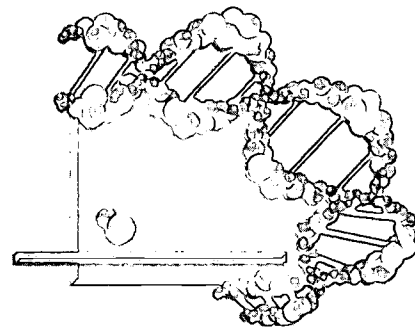

to prevent exposure of children to environmental threats, recognizing the special vulnerability of children and reproductive health to environmental threats. They agreed to endorse the priorities highlighted at the Conference: preventive strategies for asthma and allergies, childhood accidents and injuries, environmental tobacco smoke, and areas of emerging concern about effects of the environment on children's health.

EPA INTERNATIONAL PROJECTS

ASTHMA AND OTHER RESPIRATORY EFFECTS

Title: Particulate Matter Epidemiology in Children

Description: This is a project to analyze and publish reports of an epidemiologic study of children's and adult's respiratory health in relation to particulate matter (PM) exposure in the four Chinese cities of Chongqing, Guangzhou, Lanzhou, and Wuhan. Reports from this study will describe how exposure to size-specific ambient PM and indoor coal smoke affect the prevalence of respiratory illness and symptoms in children and their parents. The reports will also describe the effect of these exposures on the long-term growth of spirometric lung function in the children.

Contact: Office of Research and Development, Robert Chapman, 919-541-4492

Title: China Urban Respiratory Health Study

Description: The four Chinese cities of Chongqing, Guangzhou, Lanzhou, and Wuhan exhibit a very wide range of ambient particulate matter levels. Under the China-U.S. Environmental Protection Protocol, China and the United States are cooperating in a longitudinal study of respiratory health status and changes in respiratory health in relation to air pollution exposure in these cities. The health outcomes being measured are the frequency and severity of respiratory illnesses and symptoms in children and adults, as determined by a

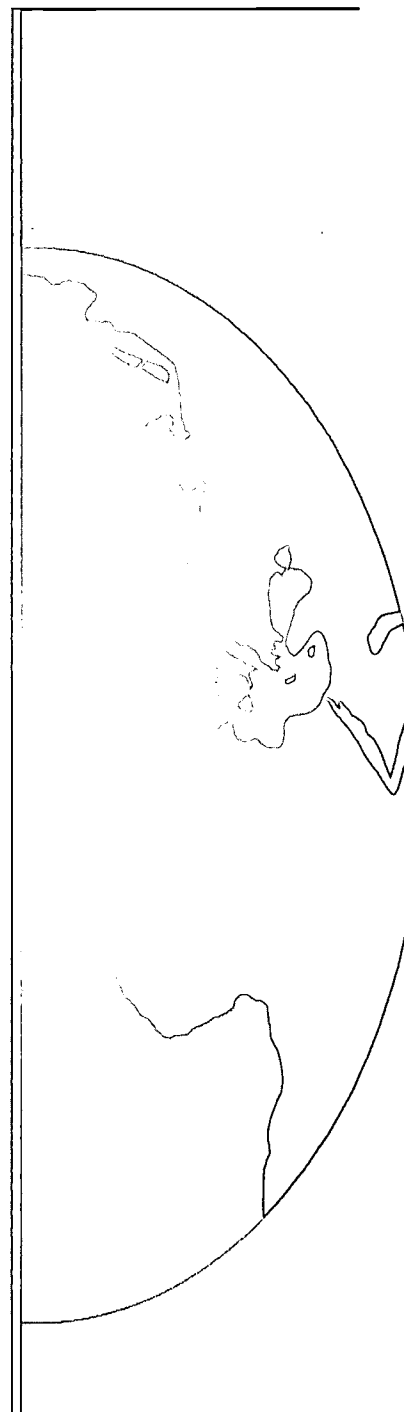

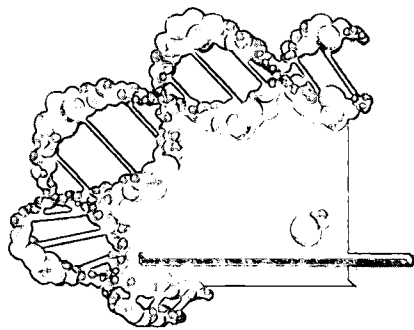

standardized questionnaire, and the growth of ventilatory lung function in children, as determined by twice-yearly spirometric lung function testing in elementary school children.

Contact: Office of Research and Development, Robert Chapman, 919-541-4492

Title: Children's Lung Function Study in China

Description: This U.S.-China cooperative study in four Chinese cities will determine long-term effects on children's lung function caused by several air pollutants, including (1) ambient acid aerosols, particulates, and sulfur oxides; and (2) indoor air pollution (coal smoke, environmental tobacco smoke). The study also examines the effects of changes in ambient pollution levels on children's lung function. Pilot study results have shown a clear association between particulate matter exposure and long-term reduction in elementary school children's lung function. The Children's Lung Function Study in China is ongoing and expanded as of 1999. The expansion will assess changes in respiratory health status in relation to changes in outdoor and indoor air pollution exposure over a 7-year interval (1994 to 2001).

Partners: China National Environmental Protection Agency, Robert Wood Johnson Medical School, New Jersey

Contact: Office of International Activities, Marianne Bailey, 202-564-6429

Title: U.S.-Canada Air Quality Agreement

Description: This agreement covers priority air pollutants and involves reducing smog pollution of the Midwest-Eastern regional airshed. It involves federal, provincial, and state governmental cooperation and significant public and private stakeholder involvement. EPA and Environment Canada also review, assess, and report on ground-level ozone and its effects through joint biennial progress reports.

Partners: Environment Canada, others

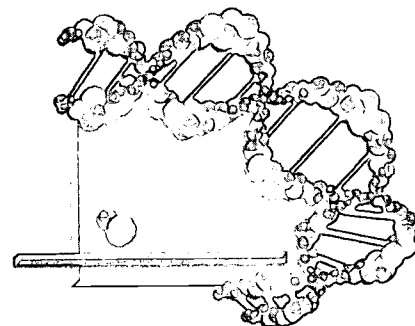

Contact: Office of Air and Radiation, Laurel Schultz, 919-541-5511

DEVELOPMENTAL AND NEUROLOGICAL TOXICITY

Title: The Effects of Lead in Children and Adolescent Development

Description: EPA scientists are working with the National Institute of Occupational Health (NIOH) in Ahmedabad, India, to study the health effects of lead, specifically on growth and puberty in children. The project is evaluating the effects of lead in a high traffic area of Ahmedabad, as well as the effects of a lead smelter in Calcutta. The project looks at multipathway exposure, dose, and health effects in children.

Contact: Office of Research and Development, Gary Kimmel, 202-564-3308

Title: Alaska Native Cord Blood Monitoring Program

Description: This program is designed to monitor the levels of selected heavy metals and persistent organic pollutants in umbilical cord blood and maternal blood of indigenous groups of the Arctic, with an initial focus on Alaska Native American populations. The project will take 50 percent of the samples from the Inuit population and 50 percent from the Yupic population. Expansion of the project to other populations is under consideration.

Partners: Centers for Disease Control and Prevention, State of Alaska, Tribal Agencies, others

Contact: Office of International Activities, Seth Low, 202-564-6414

Title: National Strategy for Lead Risk Reduction in Russia

Description: A Russian federal strategy was prepared with U.S. expert support to address sources of lead risk identified in 1996 by Russian experts. U.S. assistance will continue in identifying effective economic

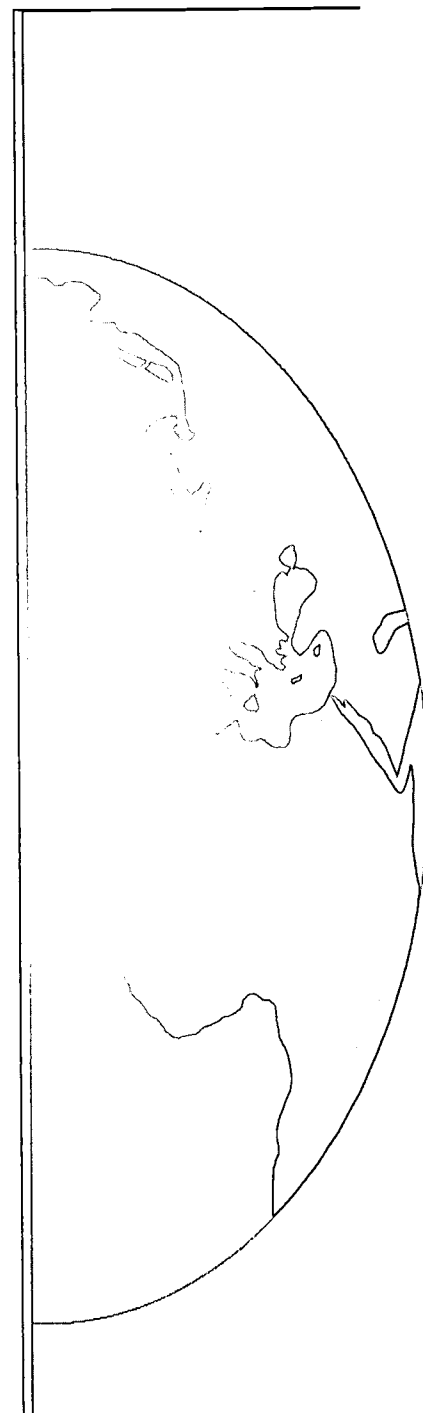

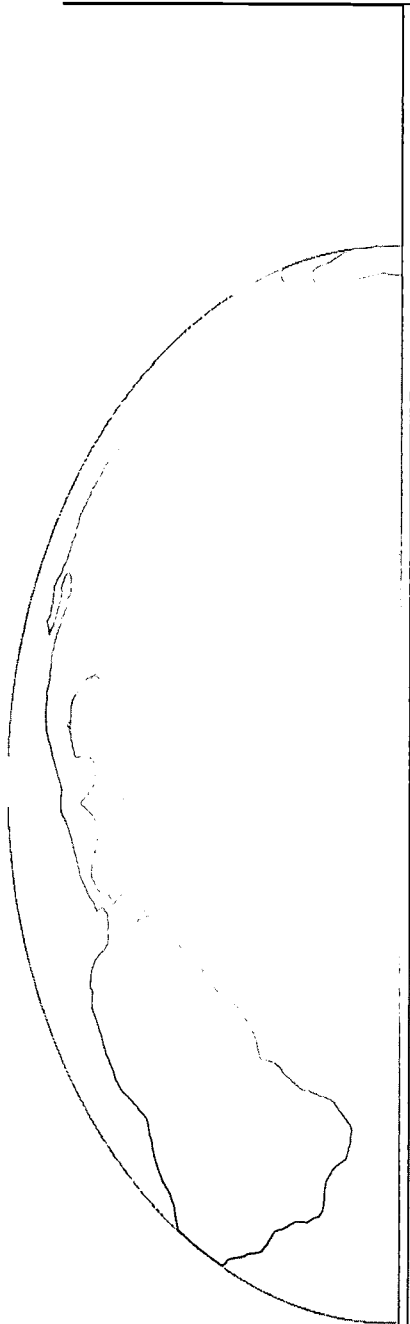
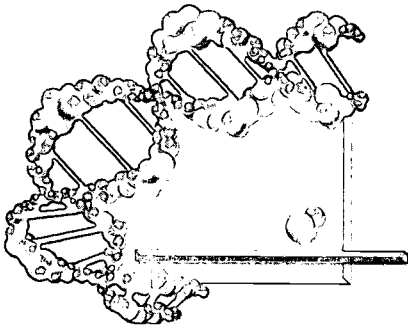

mechanisms to reduce lead exposure in key sectors and incorporate lead risk reduction measures into regional economic planning, industrial restructuring schemes, and privatization guidelines.

Partners: U.S. Agency for International Development, Centers for Disease Control and Prevention

Contact: Office of International Activities, Sylvia Correa, 202-564-6443

Title: Children's Blood Lead Level Screening in Russia

Description: This is the first study of pediatric blood lead levels in Russia. After findings of an initial survey of the City of Saratov were presented in January 1997, the United States and Russia agreed to repeat the study in other Russian cities to establish a baseline for measuring results of lead reduction activities. In 1998, EPA, the Centers for Disease Control and Prevention, and the Russia Ministry of Health investigated three additional Russian cities, Ekaterinburg, Krasnouralsk, Volgograd. Data will be used to characterize the overall lead exposure problem in Russia.

Partners: Centers for Disease Control and Prevention

Contact: Office of International Activities, Sylvia Correa, 202-564-6443

Title: Mobile Source Training/Lead Phase-Out Training

Description: Working with international organizations, EPA has developed a training program designed to encourage the phase-out of leaded gasoline and reduce motor vehicle pollution. The course has been delivered in two Latin American countries, two Chinese cities, the English-speaking Caribbean countries, and central and eastern Europe. It has been partially credited with China's subsequent commitment to phase lead out of gasoline by 2000. Additional deliveries are planned for Asia and sub-Saharan Africa.

Partners: World Health Organization, Pan American Health Organization, World Bank

Contact: Office of International Activities, Sylvia Correa, 202-564-6443

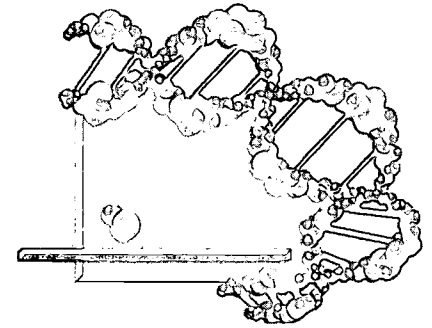

Title: Epidemiologic Survey of Lead Exposure of Children in Tijuana, Mexico

Description: An epidemiologic study of blood level concentration, lead use, and socioeconomic and demographic factors will be conducted for children, ages 2 to 6, in Tijuana. The study will evaluate associations between blood lead concentration in children and potential sources of lead exposure at the neighborhood and household levels. As part of this project, a blood lead testing laboratory will be established in Tijuana. Information derived from this study will be used to establish public health priorities and to plan public health programs for lead surveillance and control in Tijuana.

Partners: Centers for Disease Control and Prevention

Contact: Region 9, Winona Victory, 415-744-1021

HEALTH EFFECTS OF PESTICIDES

Title: Pesticides Management Project in Central America

Description: This program assists governments of Central American countries to regulate, monitor, and ensure safe use of pesticides. The national program focuses on building capacity to develop regulations for pesticide handling, storage, and use. The community-level program targets agricultural workers and public health and safety issues related to pesticide use. It focuses on using protective equipment, safe pesticide handling and application, container disposal, and avoiding pesticide contamination of drinking water.

Partners: U.S. Agency for International Development

Contact: Office of International Activities, Pam Teel, 202-564-6424

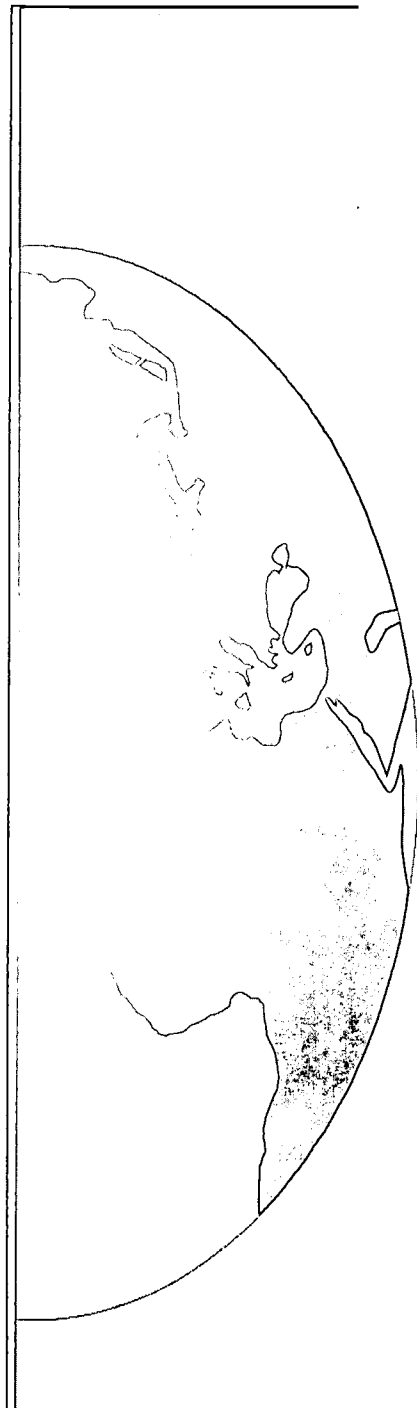

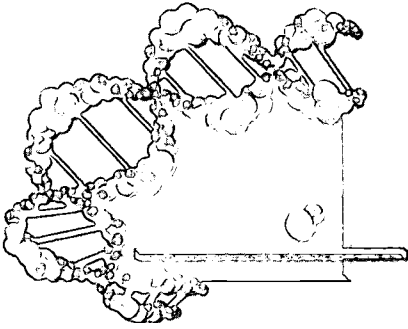

POTENTIAL RISKS FROM CONTAMINATED WATER

Title: U.S.-Canada Great Lakes Water Quality Agreement (GLWQA)

Description: Under this agreement, EPA and Environment Canada review, assess, and report biennially on ecosystem and health protection including discharges of toxic substances and their effects in the Great Lakes basin. A GLWQA Binational Strategy signed in April 1997 lists targeted persistent toxics and sets ambitious discharge reduction goals to better protect women of childbearing age, pregnant women, and children. These provisions are particularly targeted to minority cultures dependent upon family subsistence fishing and to other people who depend on fish from the Great Lakes for food.

Partners: Environment Canada, others

Contact: Region 5, Rita Cestanic, 312-886-6815

Title: Microbiologically Safe Drinking Water Laboratory Capacity in Latin America

Description: Illness associated with contaminated drinking water and inadequate sewage management poses serious threats to public health throughout the Americas, and disproportionately afflicts children. EPA will provide technical assistance from its national laboratories to help convert the Pan-American Health Organization's training laboratory in Lima, Peru, to a microbiological drinking water reference laboratory serving all of Latin America. Technical expertise, technology transfer, and training will be provided to assist with monitoring programs and certifying compliance with World Health Organization drinking water quality guidelines.

Partners: World Health Organization, Pan-American Health Organization

Contact: Office of International Activities, Stephanie Adrian, 202-564-6444

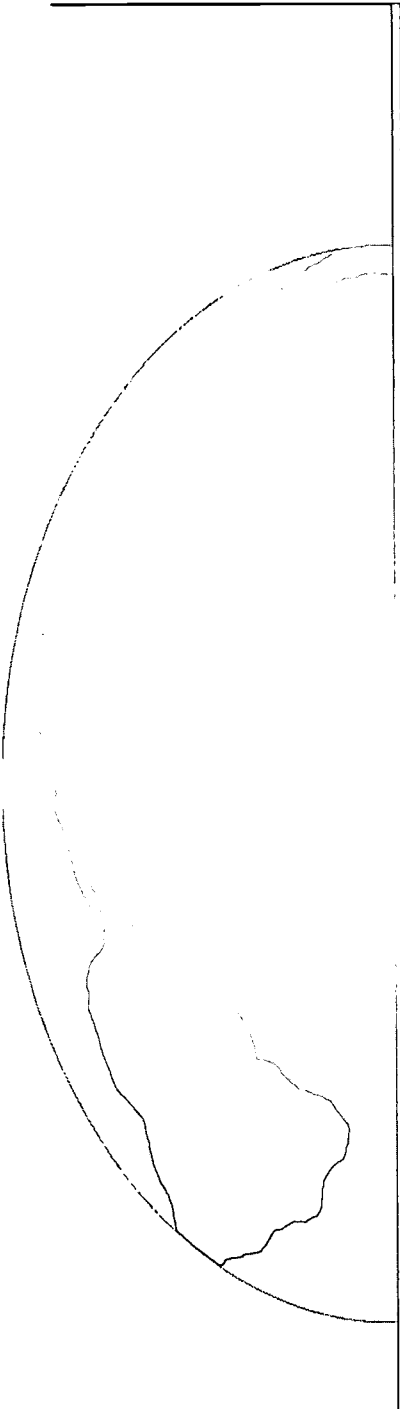

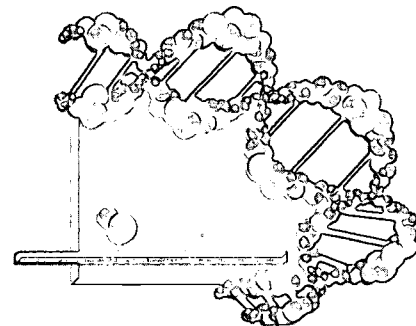

Title: Municipal Water Management in Latin America

Description: This project seeks to improve human health and child survival in Latin American and Caribbean countries through better access to microbiologically safe drinking water. Activities include training Peace Corps volunteers on ways to improve drinking water supplies, protect watersheds, and improve community sanitation and wastewater treatment practices.

Partners: U.S. Peace Corps

Contact: Office of International Activities, Stephanie Adrian, 202-564-6444

Title: The Central American Small Community Wastewater Treatment Project

Description: This project focuses on the use of appropriate wastewater treatment technologies to reduce microbiological contamination of water used for household purposes and to ensure safer water for communities downstream.

Partners: U.S. Agency for International Development

Contact: Office of International Activities, Stephanie Adrian, 202-564-6444

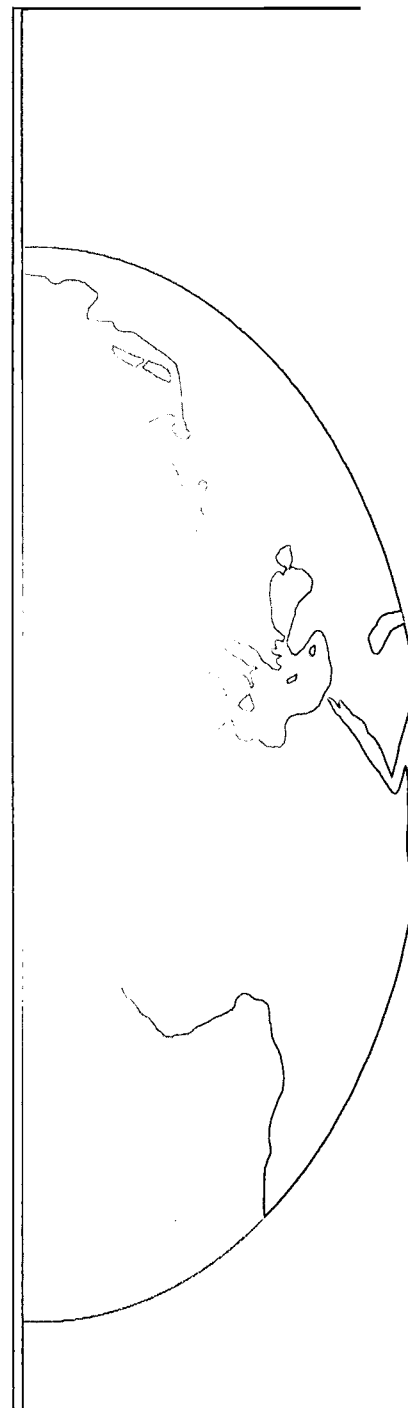

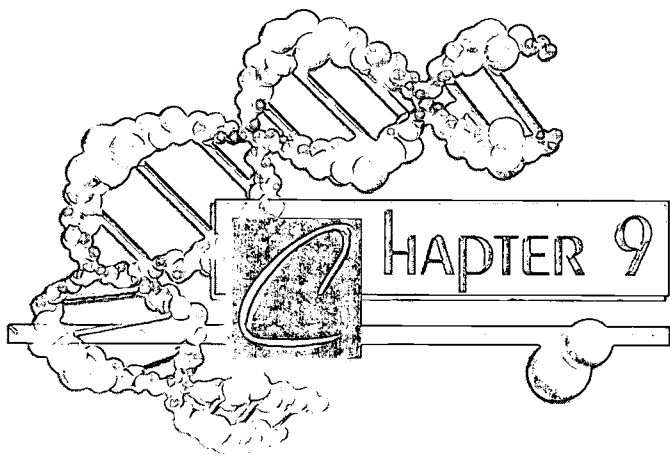

ENVIRONMENTAL EDUCATION RELATED TO CHILDREN'S HEALTH

As part of its *National Agenda to Protect Children's Health from Environmental Threats*, EPA is committed to expanding educational efforts with health and environmental professionals to identify, prevent, and reduce environmental health threats to children.

Some EPA-sponsored environmental education programs teach children about environmental health issues of particular interest to them and their families. Other programs provide skills and knowledge that parents, educators, and community leaders can use to help protect children from environmental health risks. The principles of environmental justice—that all people must have the opportunity to live in a healthy environment and that environmental laws apply without discrimination based on race, ethnicity, culture, or economic status—guide EPA's efforts to promote improved access to information and educational programs for poor and disadvantaged communities.

EPA ENVIRONMENTAL EDUCATION PROJECTS

HEALTH CARE PROVIDERS

Title: Environmental Health Workshops

Description: The East Texas Area Health Education Center (AHEC), in cooperation with the University of Texas Medical Branch at Galveston, designed a workshop curriculum to promote an increased awareness among health care providers of the unique problems associated with the exposure of children to hazardous substances in the environment and enhance skills important for the diagnosis and treatment of exposed children. The curriculum will be used to present five hands-on workshops to health care providers in Texas, including U.S.-Mexico border cities.

Partners: Agency for Toxic Substances and Disease Registry, Area Health Education Centers, University of Texas Medical Branch at Galveston, Centers for Disease Control and Prevention, Health Resources and Services Administration

Contact: Region 6, Evelyn Daniels, 214-665-7543

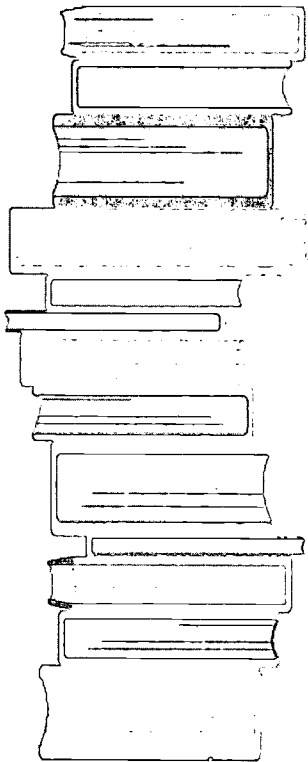

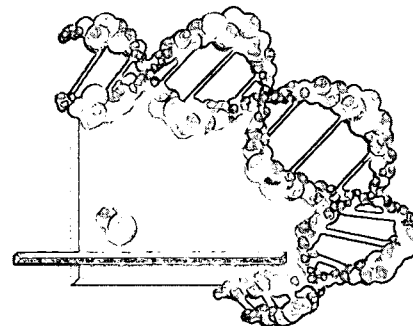

Title: Community-Based Training for Lay Health Promoters (Promotores) and Primary Care Clinicians

Description: By means of an interagency agreement between EPA and the Health Resources and Services Administration, a contract was awarded to the Farm Worker Justice Fund to implement community-based training for lay health promoters (promotores) and primary care clinicians along the U.S.-Mexico border. The training is aimed at preventing exposure to environmental health hazards and promoting early recognition and treatment of environmentally related illness, especially with regard to children. The training will take place in four locations along the border in Regions 6 and 9, and at least 200 persons are expected to be trained.

Partner: Health Resources and Services Administration

Contact: Region 6, Nelda Perez, 214-665-2209

PEDIATRIC CENTERS

Title: Pediatric Environmental Health Speciality Unit

Description: EPA and the Agency for Toxic Substances and Disease Registry (ATSDR) have established a Pediatric Environmental Health Speciality Unit (PEHSU) in Region 4 at Emory University. The PEHSU will provide medical education, expert consultation, and training to evaluate the potential adverse health impacts to young children exposed to environmental contaminants. The Unit will serve as a resource for pediatricians, other health care providers, parents, teachers, the public, and EPA and ATSDR staff nationwide. The Unit will also focus on pediatric environmental medicine as well as clinical specialty referrals for children.

Contacts: Region 4, Wayne Garfinkel, 404-562-8982, or Delores Rodgers-Smith, 404-562-8688

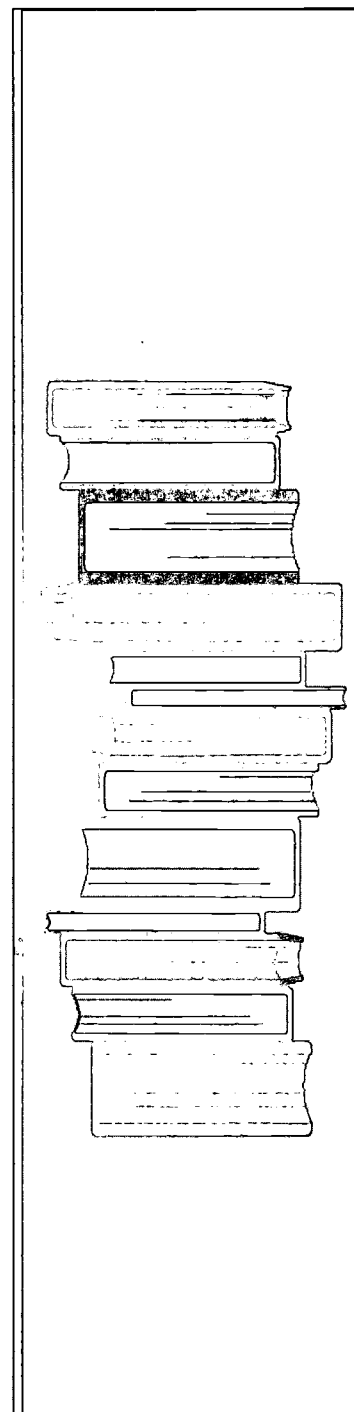

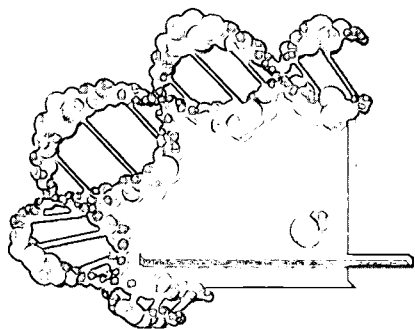

Title: Center for Children's Environmental Health at Cook County Hospital, Chicago, Illinois

Description: The Center for Children's Environmental Health, established in May 1999, provides professional training, clinical services, consultation, diagnostic evaluation, technical assistance, and data collection in the area of pediatric environmental health and illness in Region 5. The Center is jointly funded by EPA and the Agency for Toxic Substances and Disease Registry. Cook County Hospital is the primary provider of pediatric health services for indigent children in the Chicago area. This allows the Center to focus on the environmental health needs of disadvantaged children at increased risk of environmental exposures, while providing services regionwide. The Center will also implement an EPA-supported Environmental Exposure Questionnaire. The Center will be able to provide geographically specific data on environmental health problems to help EPA target intervention, prevention, and outreach activities more effectively.

Contact: Region 5, Edward Master, 312-353-5830

OTHER ENVIRONMENTAL EDUCATION PROJECTS

Title: Environmental Justice in the "Hood" 1999

Description: For the fourth year, EPA has co-sponsored this popular and growing symposium to gather activists and residents from the Massachusetts communities of Chelsea, Chinatown, Dorchester, East Boston, Jamaica Plain, Mattapan, Roxbury, South Boston, and the South End to discuss current issues surrounding environmental justice. This year's event was held on April 10, 1999, at Roxbury Community College in Boston. Topics included lead in homes and yards, urban air toxins, issues surrounding exhaust fumes from MBTA buses, and environmental hazards indoors. All of these concerns directly affect the health of urban children and their families.

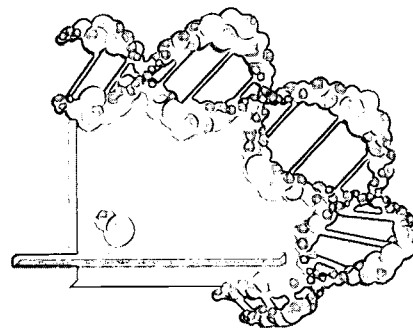

Partners: ACE, Bowdoin Street Health Center, Dudley Street Neighborhood Initiative, Egleston Square Neighborhood Association, Neighborhood of Affordable Housing, Neighborhoods Against Urban Pollution, Roxbury Community College.

Contacts: Region 1, Kristy Rea, 617-918-1595, or Lois Adams, 617-918-1632

Title: An Afternoon with UEI: Community Gardens/Urban Agriculture

Description: EPA's Urban Environmental Initiative (UEI) hosts a number of seminars that highlight the efforts of many of EPA's partners. An April 28, 1999, workshop in Boston focused on the positive health and social effects that community gardens and urban agriculture have on urban neighborhoods. Not only are the gardens a source of civic pride and a chance to reclaim abandoned or vacant lots and turn them into a "sea of green," but they provide a safe place for children to spend time and enhance their awareness of the beauty of nature and the importance of their environment. Community gardens can also provide a safe source of food and nutrition for communities with limited finances.

Contacts: Region 1, Kristy Rea, 617-918-1595, or Lois Adams, 617-918-1632

Title: Healthy Schools: Designing, Renovating, and Maintaining Our School Buildings

Description: EPA participated in a statewide conference at Clark University in Worcester, Massachusetts, on June 2, 1999, to explore the current best practices for designing and maintaining healthy buildings for the education of children in Massachusetts. Also explored were ways to renovate existing schools in a manner that is safe and reduces adverse health effects to children, teachers, and construction workers. Participants learned how to reduce toxins and health hazards in schools, and learned about the importance of community and civil rights. Follow-up surveys and workshops are being scheduled to continue the Healthy Schools Network.

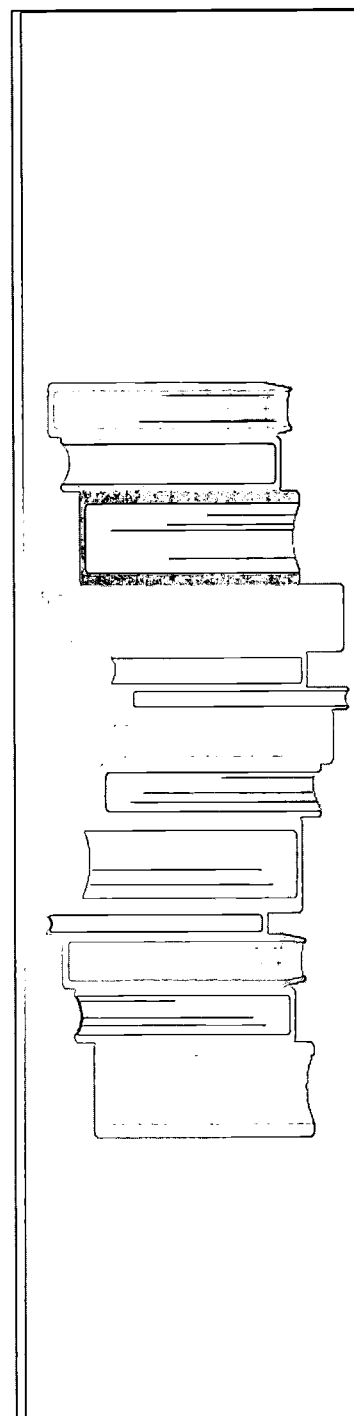

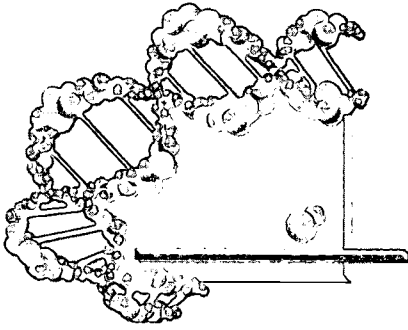

Partners: Massachusetts Healthy Schools Network, Massachusetts Medical Society, Massachusetts Public Health Association, Massachusetts Teachers Association, U.S. Department of Education Office for Civil Rights, Massachusetts Coalition for Occupational Safety and Health

Contacts: Region 1, Mary Beth Smuts, 617-918-1528

Title: Urban and Environmental Initiative

Description: Region 1's Urban Environmental Initiative (UEI) works aggressively to identify and solve local environmental and environmental health issues in Providence, Hartford, and Boston. UEI program managers are incorporating children's environmental health issues into local community planning efforts. The initiative includes programs to address asthma and lead poisoning in these key New England urban centers.

Contact: Region 1, Lois Adams, 617-918-1632

Title: Education about Asthma, Environmental Tobacco Smoke, and Lead

Description: Region 2 provided \$15,000 to a community group called West Harlem Environmental Action (WE ACT), located in Harlem, New York. WE ACT will conduct education in childcare centers and other relevant locations in Harlem, Washington Heights, and other low-income parts of the city regarding asthma, environmental tobacco smoke, and lead.

Contact: Region 2, Rachel Chaput, 212-637-4001

Title: Asthma and Lead Abatement Training and Education (ALATE), Camden, New Jersey, and Northern Philadelphia, Pennsylvania

Description: This project, funded at \$287,635, is designed to build the capacity of residents and community groups in Camden and Philadelphia to confront and reduce the problems of lead poisoning and asthma.

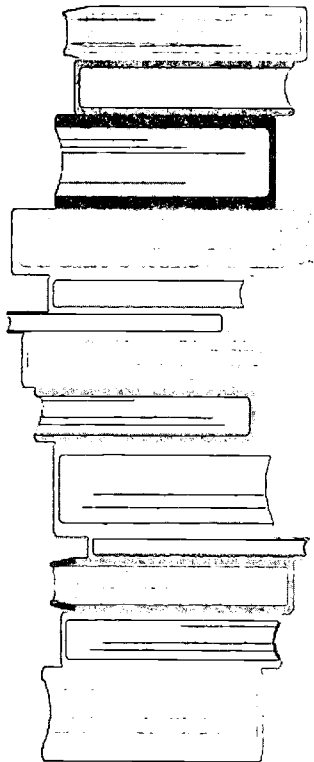

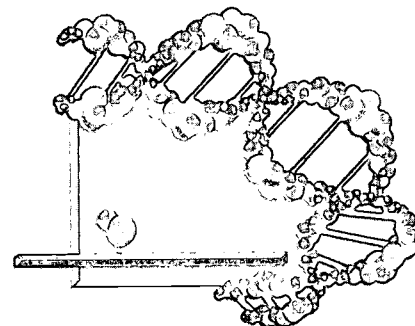

ALATE trains selected community residents (adults and high school students) to educate care givers about the hazards of exposure to lead and asthma-inducing allergens. The program also aims to educate care givers about the importance of screening and followup care for children at risk of lead poisoning and asthmatic episodes. ALATE hopes to develop mechanisms to promote healthy home environments for all community members and increase public awareness of the hazards of lead poisoning and asthma for all people, especially young children. ALATE also intends to work for housing and health care policies that effectively protect children from the hazards of lead poisoning and asthma.

Contact: Region 2, Maureen O'Neill, 212-637-5025

Title: Environmental Education Grants

Description: EPA is in its sixth round of awards of Environmental Education grants, authorized under section 6 of the National Environmental Education Act of 1990. In 1998, Region 2 awarded \$196,000 in grants.

Contact: Region 2, Terry Ippolito, 212-637-3671

Title: Environmental Justice Grants

Description: Since 1994, the Environmental Justice Small Grants Program has awarded grants to nonprofit grassroots organizations. During FY 1998, \$240,000 in grant funds were awarded to organizations that targeted children's health issues, primarily the prevention of lead-paint poisoning.

Contact: Region 2, Melva Hayden, 212-637-5027

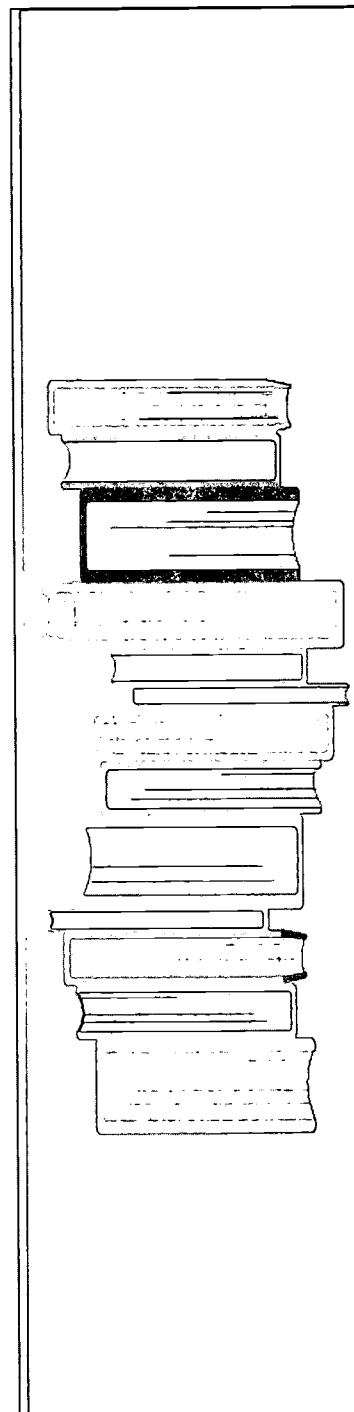

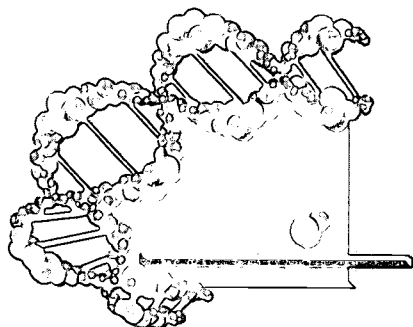

Title: Getting a Head Start on Environmental Education

Description: This EPA-funded project provides education in environmental health for teachers and parents of preschool children who live in the vicinity of the highly contaminated San Jose lagoon in the San Juan Bay Estuary. Two eight-part workshops target teachers, health professionals, and parents. Participants develop educational materials (suitable for a tropical environment) that teach children how pollution, environmental health, and human behavior are connected. Activities include identification of specific risk factors and behaviors in the participants' immediate communities and development of a guide that focuses on health issues relevant to nearby communities and Head Start centers. Staff of Head Start programs develop activities to help children form healthy habits.

Partners: Technological College of the Municipality of San Juan, Puerto Rico

Contact: Region 2, Terry Ippolito, 212-637-4445

Title: Newark Asthma and Lead Poisoning Education and Risk Reduction Project

Description: This EPA-funded project reaches 1,000 parents and care givers of young children, teaching them about risk reduction and better management of chronic conditions related to asthma and lead poisoning. Through the program, 12 participants in the Youth Corps/School-to-Work program and 16 members of Volunteers In Service to America (VISTA) are being trained to work with the parents and care givers, encouraging them to adopt practices in the home that can help reduce the risks of asthma and lead poisoning. The International Youth Organization (IYO) uses its network of childcare centers, elementary schools, block clubs, tenant associations, and community centers in Newark's Enterprise Community target area to reach its intended audience and educate people about important indoor air quality issues that affect children's health.

Partners: International Youth Organization, New Jersey

Contact: Region 2, Terry Ippolito, 212-637-4445

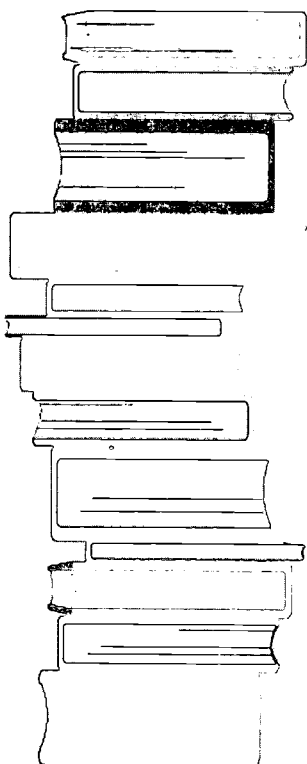

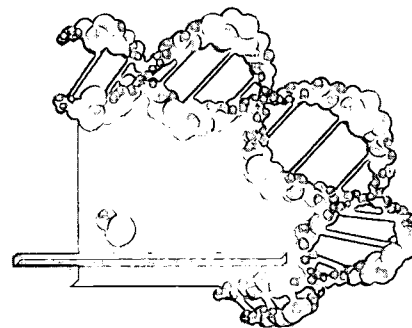

Title: Children's Pesticides, Asbestos and Lead (PAL) Initiative

Description: The Children's PAL Initiative, begun in 1998 in Baldwin County, Georgia, is a community-based outreach and education program designed to minimize children's exposures to environmental health hazards like lead-based paint, pesticides, secondhand smoke, radon, polychlorinated biphenyls, and asbestos. The program is designed to use resources in the community and government to help empower families and neighborhoods to take better care of their children's environment. A multi-agency steering team made up of representatives from federal, state, and local agencies that address children's health issues provides direction and guidance to the citizen's advisory panel.

Emory University's Rollins School of Public Health has been working with Region 4 to implement this initiative and conduct an assessment to provide community-specific information on children's environmental health issues. The community-specific data will help establish community-tailored interventions to address the environmental health hazards to children. As a result of the relationships established with the local government, health care, education, inter-faith organizations, and communities, interventions have been well received and supported by the community. These interventions used new environmental health outreach and education material. Students from the School of Health and Sciences at Georgia College and State University are participating in the educational outreach activities. Emory University's Rollins School of Public Health has presented information on the children's environmental health education interventions developed from this project at national clinical and public health conferences.

Contacts: Region 4, Wayne Garfinkel, 404-562-8982

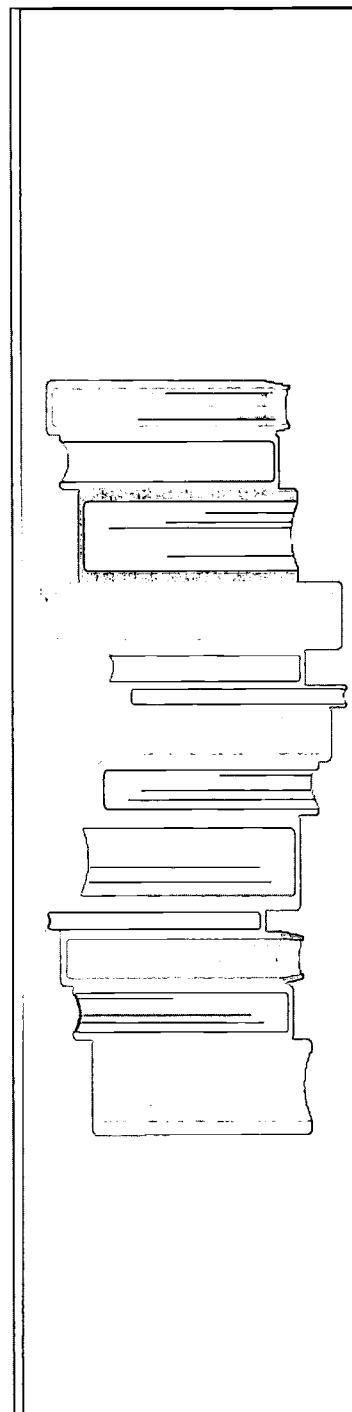

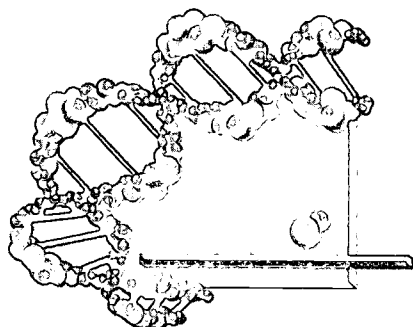

Title: Second Annual Region 5 Children's Environmental Health Conference

Description: Region 5 organized its second annual Children's Environmental Conference, held in July 1999. This year's event, called the Workshop on Actions to Take for Children's Health (WATCH), focused on helping communities learn about prevention, intervention, education, and collaboration efforts to reduce environmental health risks to children. The workshop was attended by more than 220 community organization representatives, health care providers, educators, tribal members, and representatives from local, state, and federal agencies. More than 50 speakers discussed a variety of topics, including prevention of asthma, pesticide exposures, and lead and mercury poisoning; safe drinking water; educating tribal health care professionals; community coalition building; and training health care providers about environmental health issues. Workshop attendees identified actions needed to protect children's environmental health at the local level.

Contact: Region 5, Holly Wirick, 312-353-6704

Title: Pollution Prevention Educational Demonstrations

Description: Pollution prevention educational demonstrations, involving activities from the Pollution Prevention Education Toolbox, were conducted for numerous educator, student, and general audiences at Chicago public schools and other Chicago-area schools, national and regional conferences, tribal events, and environmental festivals. The Pollution Prevention Toolbox can be downloaded from the EPA Region 5 Pollution Prevention Home Page at <http://www.epa.gov/region5/waste/p2pages/toolbox.htm>.

Contact: Region 5, Dolly Tong, 312-886-1019

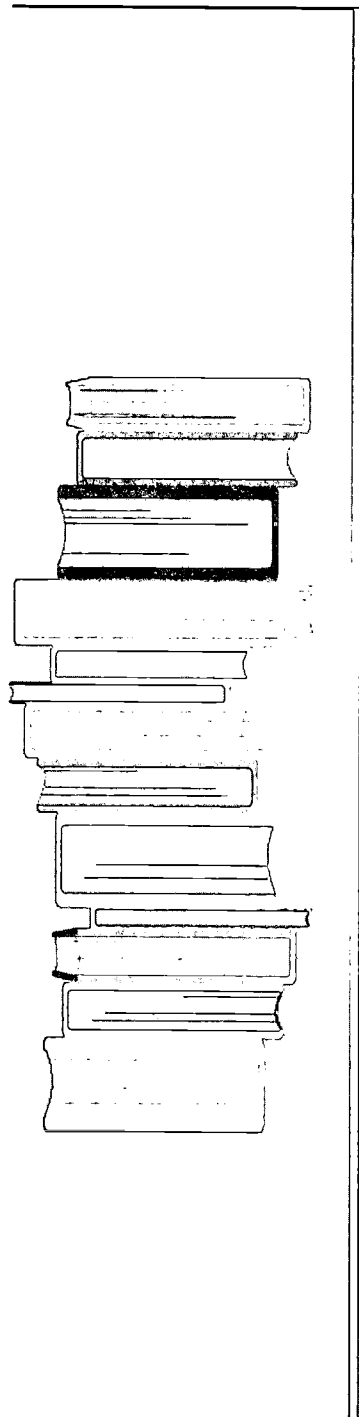

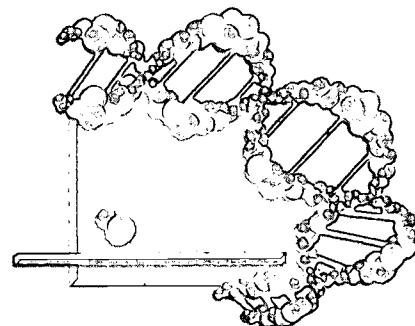

Title: Environmental WATCH Small Grants: Operation Clean Sweep

Description: Region 5 issued small, community-based grants promoting children's environmental health and pollution prevention to organizations that participated in the Environmental WATCH. As part of "Operation Clean Sweep," the Campfire Boys and Girls of Chicago has been funded to create a self-reliance class to teach parents and children about environmental health risks.

Contact: Region 5, Holly Wirick, 312-353-6704

Title: Children's Video: "*E-Hazards*"—*They're Out There . . .*

Description: Children can join investigators Lana and Wolf on a mission to identify environmental hazards in a neighborhood just like their own. Complete with whiz-bang gadgets, mischievous characters, and the latest information for kids, this tale is told in "X-Files" fashion, full of mystery, discovery, and humor. As kids enjoy this video, they will become more aware of how to protect themselves from everyday environmental hazards in and near their homes.

Contacts: Region 6, Paula Flores-Gregg, 214-665-8123, or Laura Talbot, 214-665-6678

Title: Children's Health Booklet: "*E-Hazards*"—*They're Out There . . .*

Description: This information booklet links with the video described above, offering additional precautions and health information, as well as useful Web sites, hotlines, and other information to parents and educators.

Contacts: Region 6, Paula Flores-Gregg, 214-665-8123, or Laura Talbot, 214-665-6678

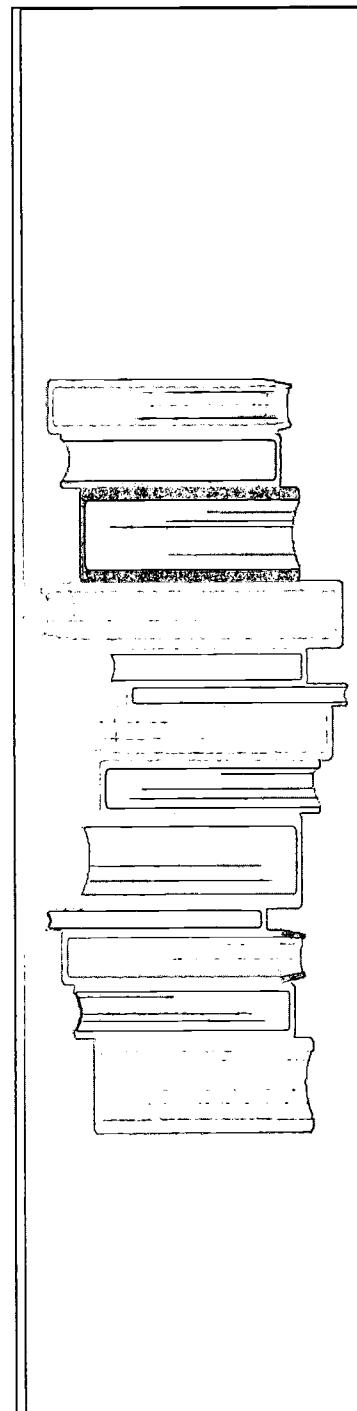

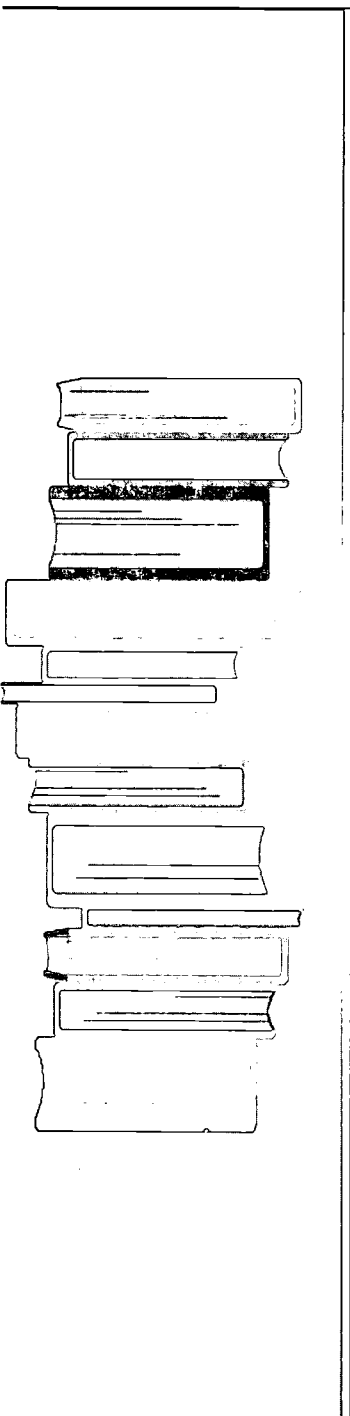
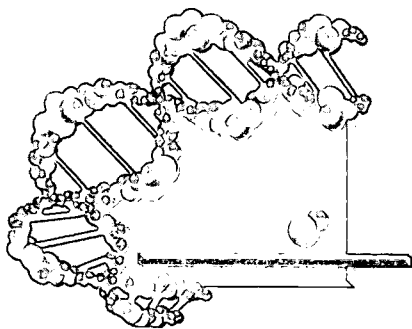

Title: Educating Parents about Environmental Dangers to Children

Description: Chance, Inc., reaches an under-served segment of ethnically diverse, low-income families participating in traditional financial service needs programs. With EPA funding, as part of their home visit program, Chance is educating their clients about environmental health issues, including pest control, pesticide use, lead poisoning, poisoning from gas heaters, radon, mercury, asbestos, secondhand smoke, and poisonous plants.

Partners: Chance, Inc., Texas

Contact: Region 6, Jo Taylor, 214-665-2204

Title: Healthy Environments and Living Places (HELP) for Kids

Description: This community-based children's health project trains residents to perform indoor environmental assessments of homes, home-based childcare, and schools. Indoor environmental risks that children are exposed to are identified, and recommendations are made for risk reduction. All environmental media are included; however, the project centers on issues that are within the control of the care giver. Environmental risks to be evaluated include lead-based paint, radon, environmental tobacco smoke, pesticides, carbon monoxide, hazardous household chemicals, and asthma triggers.

Partners: American Lung Association of New Mexico, City of Albuquerque Environmental Health Department, Albuquerque Community Health Partnership, Sawmill Advisory Committee, University of Tulsa

Contact: Region 6, Mike Miller, 214-665-7550

Title: Childhood Asthma and Allergies Conference

Description: Region 6 hosted a 3-day Childhood Asthma Conference in May 2000 in Dallas, Texas, to address the prevention and treatment of childhood asthma. The target audience for the conference includes practicing health care professionals and organizations involved in the

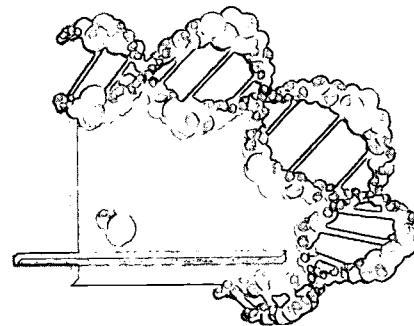

prevention of asthma triggers. The unique aspect of this conference is that it brings together health care professionals and indoor environmental engineering control professionals for a 2-day exchange of ideas and information about the best available control and treatment technology for the prevention, control, or management of asthma episodes in children.

Partners: University of Texas Southwestern Medical Centers (Dallas and San Antonio), Harris Methodist Health Plan, Centers for Disease Control and Prevention, National Institute of Environmental Health Sciences (NIEHS), U.S. Public Health Service, University of Tulsa, University of Washington

Contact: Region 6, Evelyn Daniels, 214-665-7543

Title: Environmental Education in the Paris School District

Description: With EPA funding, the Edgar County Public Health Department and Southeast Missouri State University work with teachers and students in the Paris School District to provide training and resources for the implementation of an environmental education program that features the investigation of an ecosystem adjacent to the city's drinking water source. The program establishes and implements an innovative multidisciplinary science education and research program that includes both classroom and field components for 1,000 students in grades 6 through 12.

Partners: Edgar County Public Health Department, Missouri

Contact: Region 7, Lori Walker, 913-551-7926

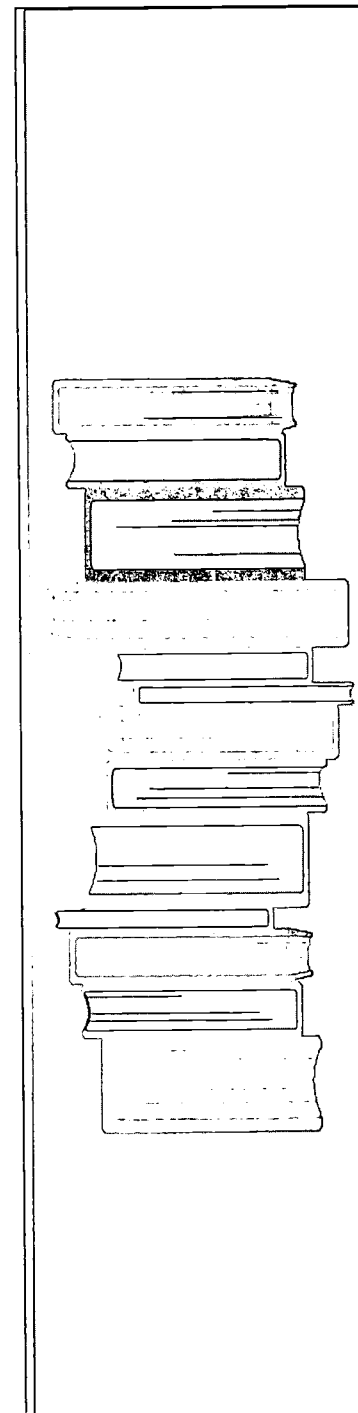

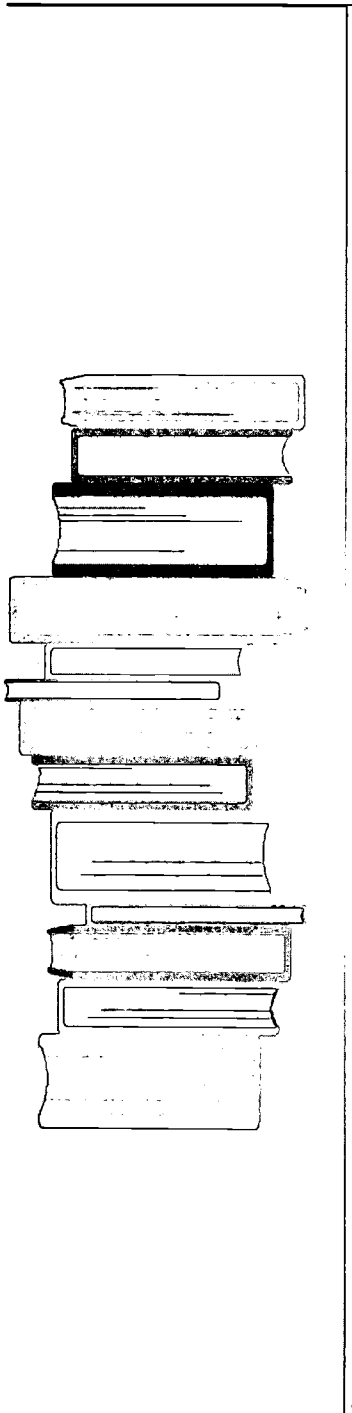
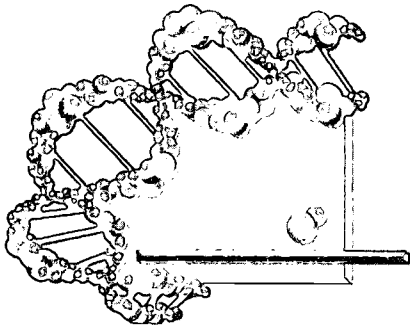

Title: Children's Health Forum

Description: Region 8 and the Colorado Department of Public Health and Environment held a children's health forum in May of 1999. The purpose of the forum was to help bridge the gap between environmental and health officials on issues relating to asthma, pesticides, and lead. Bringing these groups together built awareness of efforts occurring throughout the State of Colorado and promoted better collaboration and more efficient use of resources.

Contact: Region 8, Whitney Trulove-Cranor, 303-312-6099

Title: Children's Health Display

Description: Region 8 developed a Children's Health Display that has been used for several events in Colorado, including the Globeville Community Health Fair, Asthma Awareness Day, the Girl Scouts Tri-S'more Health Fair, and the National Right-to-Know Conference.

Contact: Region 8, Whitney Trulove-Cranor, 303-312-6099

Title: Hazardous Materials Awareness and Preparedness Training

Description: The Oakland, California, Fire Service Agency was awarded a \$20,000 grant to develop and implement this program. The Fire Department has prepared a workbook that includes maps of the neighborhoods of West Oakland. It has also been training community members to read hazardous material placards, set up emergency command posts, and respond appropriately in case of a hazardous material emergency. This training includes instruction on which chemicals are most harmful to young children and people with respiratory difficulties.

Contact: Region 9, Carla Moore, 415-744-1938

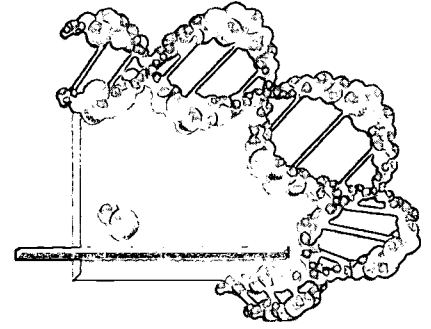

Title: Environmental Health Resources for Schools

Description: To provide schools with "one-stop shopping" for EPA's environmental health resources and programs, Region 10 has recently coordinated school outreach dealing with children's health issues. A mailing has been sent to every school district in the region outlining the programs and resources available to them from EPA to support their work in children's environmental health protection and providing additional information on their responsibilities to protect children's health. Additionally, Region 10 has launched a new web page on which this information is consolidated and is updating the popular *Environmental Hazards in Schools* manual.

Contact: Region 10, Pam Emerson, 206-553-1287

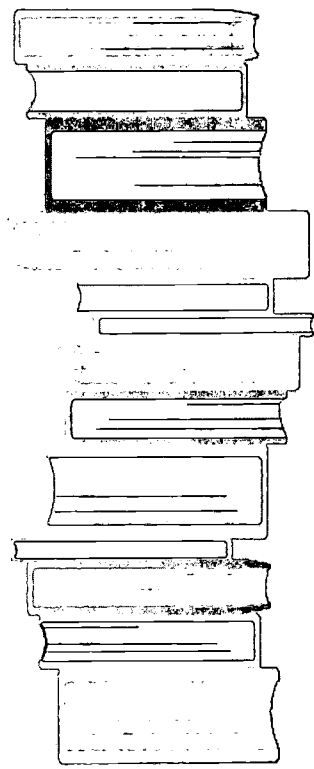
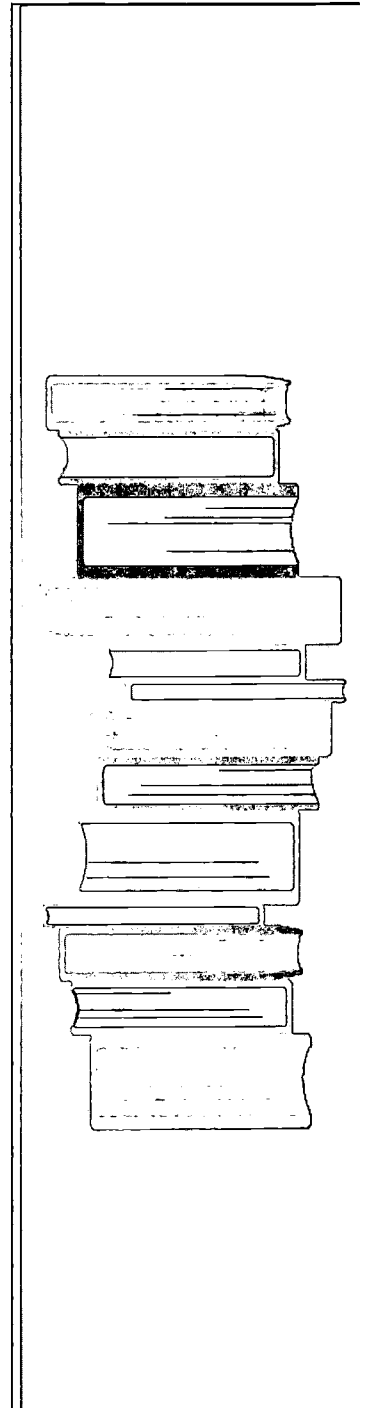

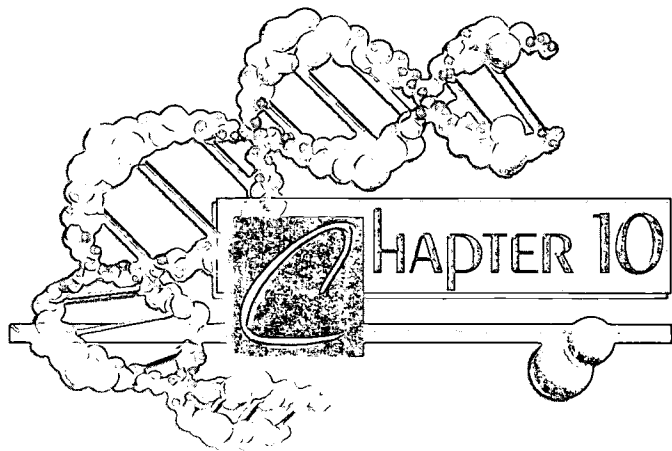

ENHANCED COMMUNITY RIGHT-TO-KNOW

EPA is enforcing the requirements of the Emergency Planning and Community Right-to-Know Act and is vigorously expanding public access to Agency information on pollution. With this information, parents can help prevent pollution in their neighborhoods and protect the health of their communities' children.

The Toxics Release Inventory (TRI) is a national database that provides the public with annual information on the environmental release of more than 600 toxic chemicals commonly used by industry (www.epa.gov/tri). More than 31,000 industrial facilities across the country are required to provide EPA with reports on the types and amounts of chemicals they release to the air, land, and water. Hazardous emissions have been reduced by 61 percent since 1987. EPA will use the TRI program to ensure that parents, teachers, and health care providers are aware of potential sources of contamination that may affect children's health.

Other regulatory requirements provide for the public's right to know about toxic substances to which people may be exposed. For example, the Safe Drinking Water Act Amendments of 1996 contain extensive provisions for consumer involvement. The provisions are founded on the principle that, before they turn on their taps, consumers have a right to know what is in their drinking water and where the water comes from. The Food Quality Protection Act (FQPA) includes special right-to-know provisions that provide more public information about risks from pesticides on foods. Such information can be the means for consumers to make more informed decisions.

On the eve of Earth Day 1998, Vice President Gore announced the Chemical Right-to-Know Initiative (ChemRTK), calling on EPA and industry to address immediately the massive gap in information on industrial chemicals. He also committed EPA to "...review and report on what new testing may be needed to assess the special impact industrial chemicals may have on children." An EPA study revealed that less than 7 percent of the 2,800 high-production-volume (HPV) chemicals have a full set of baseline testing data publicly available, and almost half of the HPV chemicals have no data publicly available. The ChemRTK Initiative is being implemented by a combination of voluntary and regulatory programs. A major component of the initiative, the HPV Challenge Program, encourages industry to voluntarily sponsor chemicals to provide data.

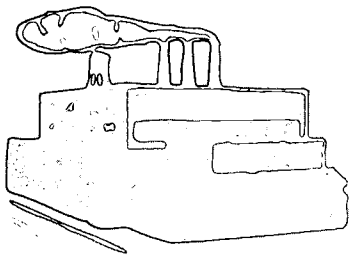

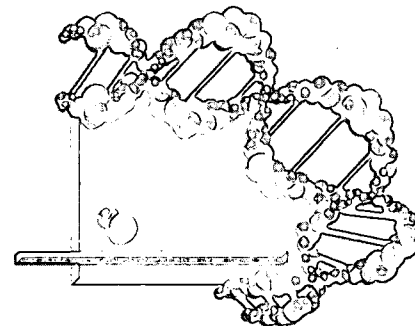

At the core of ChemRTK is a commitment to making data available to the public in a form that is easy to access, use, and understand. More than 200 companies and 50 industry consortia have committed to sponsor more than 1,250 chemicals in the HPV Challenge Program.

EPA COMMUNITY RIGHT-TO-KNOW ACTIVITIES

Title: Children's Health Chemical Testing Program

Description: The Children's Health Testing Program is a component of the Chemical Right-to-Know (ChemRTK) Initiative. EPA has begun a stakeholder dialogue to design and develop a voluntary program to test commercial chemicals to which children have a high likelihood of exposure.

Contact: Office of Prevention, Pesticides, and Toxic Substances, Catherine Roman, 202-260-8155

Title: Pre-Renovation Information Rule

Description: The Pre-Renovation Information Rule, published in June 1998, requires renovators to provide a lead hazard information pamphlet to owners and occupants of pre-1978 housing before beginning work. In addition, the rule requires notification on the nature of the renovation activities in certain circumstances involving multi-family housing. This rule ensures that owners and occupants of target housing are provided with information about potential hazards of lead-based paint exposure before certain renovations are begun. The rule went into effect on June 1, 1999.

Contact: Office of Prevention, Pesticides, and Toxic Substances, Dayton Eckerson, 202-260-1591

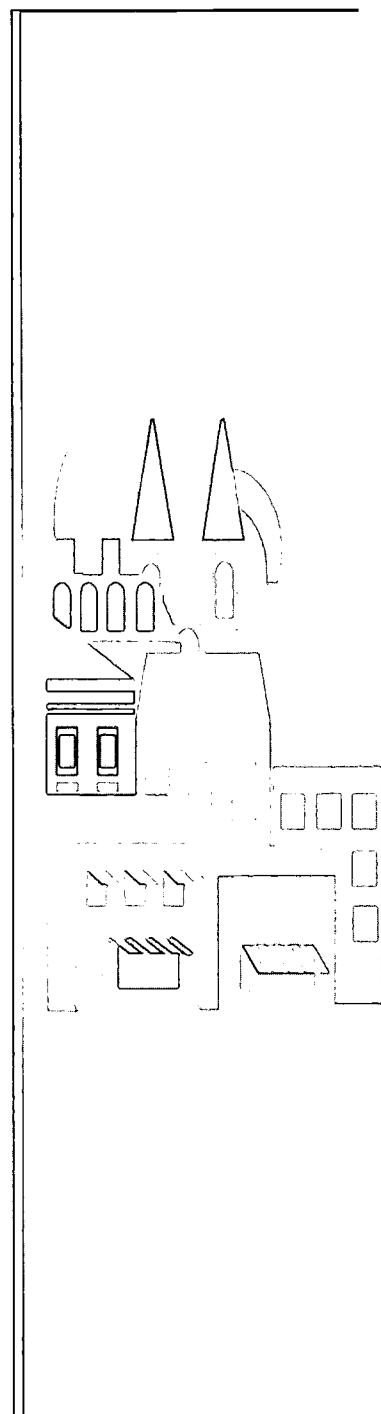

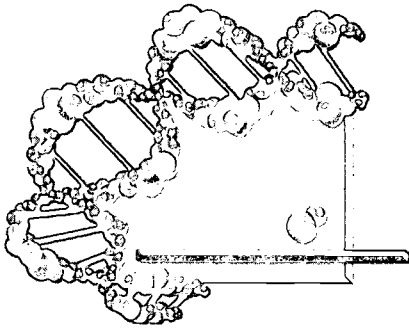

Title: Lower Threshold for Lead TRI Reporting

Description: In August 1999, EPA issued a proposed rule to lower the threshold for reporting of lead releases to TRI. Currently, facilities are not required to report their lead and lead compound releases to the air, water, and land unless they manufacture or process more than 25,000 pounds annually or use more than 10,000 pounds annually. These high thresholds severely limit the reporting of lead and lead compounds. Under the proposed rule, the reporting thresholds would be lowered to 10 pounds per facility per year and would substantially increase the amount of information made available to the public through TRI by about 13 percent, or 15,000 reports.

Contact: Office of Prevention, Pesticides, and Toxic Substances, Dan Bushman, 202-260-3882

Title: TRI Education Product

Description: EPA developed teaching materials for junior and senior high school students on TRI through a grant with the National Science Teachers Association. The materials, developed by science and social studies teachers, introduce and encourage the use of large databases as an educational tool in the classroom. EPA sponsored this effort to provide a greater understanding of the usefulness of TRI data and to help make environmental information in general more relevant for educational purposes. The materials include a TRI CD-ROM and user's manual, *The Toxics Release Inventory Teachers Guide, Getting Started* (a road map of ideas for how to introduce environmental education in the classroom), and *EPA's Guide to Environmental Database Basics*.

Contact: Office of Prevention, Pesticides, and Toxic Substances, Georgianne McDonald, 202-260-4182

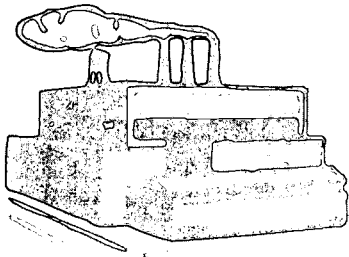

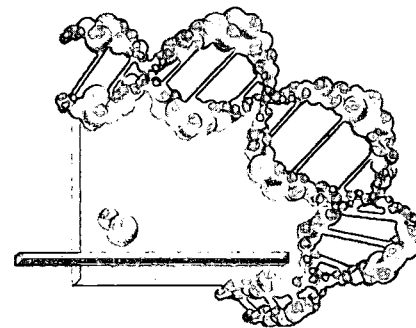

Title: Drinking Water Quality Reports

Description: In 1999, for the first time, EPA required water suppliers to provide annual drinking water quality reports to their customers. Water systems were required to deliver the first annual reports by October; starting in 2000, they will send them by July. Each report provides consumers with the following essential information about their drinking water: the lake, river, aquifer, or other source; the level (or range of levels) of the contaminants found in local drinking water; EPA's health-based standard for comparison; the likely source of contaminants found in the drinking water supply; the potential health effects of any contaminant found in violation of an EPA health standard; and phone numbers to call for more information. Reports may be obtained by calling the local water supplier. Many reports are available on the Internet through EPA's Local Drinking Water Information page at <http://www.epa.gov/safewater/dwinfo.html>.

Contact: Office of Water, Rob Allison, 202-260-9836.

Title: The Children's Healthline

Description: Created by the Region 3 Children's Health Program, this electronic newsletter attempts to educate the public on various environmental health issues. Insight from EPA experts and medical practitioners is often included in the newsletters. The dangers of UV exposure from the sun, lead from renovation activities, and asthma from indoor air triggers were featured in the most recent editions. A new Region 3 Children's Health website was created to make the Healthlines available to a larger audience; it can be found at www.epa.gov/reg03esd1/child-health/index.htm

Contact: Region 3, Gail Tindal, 215-814-2069 or Dan Welker, 215-814-2744

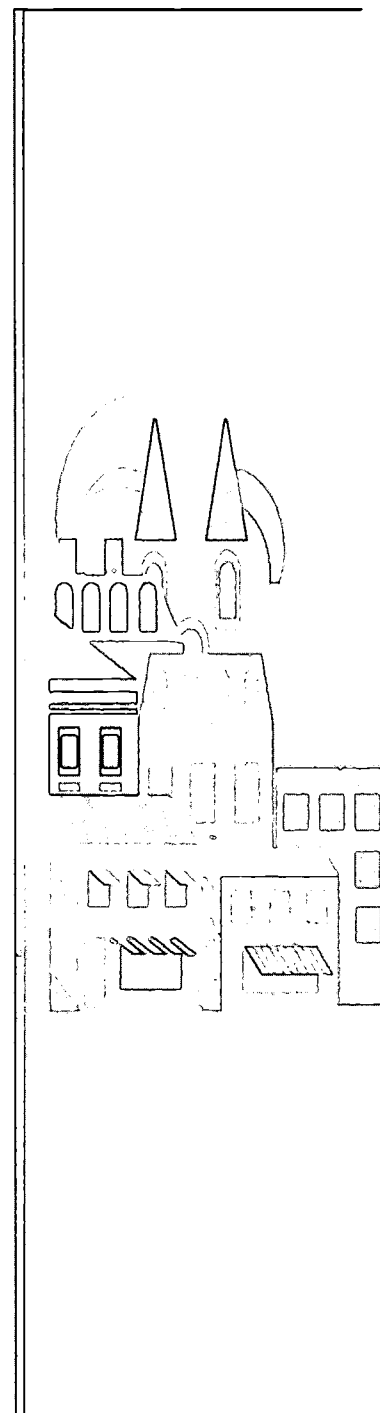

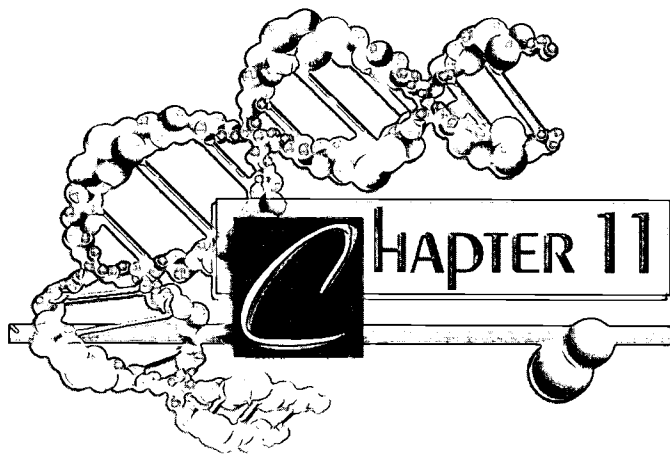

CHILDREN'S HEALTH RESOURCES

This chapter contains sources of additional information, lists of EPA publications related to children's health topics, and references for hotlines and Internet resources. Most of the resources listed below focus specifically on children or issues of primary importance during the developmental years. Others address EPA efforts to protect the environment where children live, learn, and play. The listing is not intended to be exhaustive, but to allow readers to better understand how to protect children's health.

CONTACTING EPA

For additional information on the EPA children's environmental health projects inventoried in this document, you may call the individuals listed as contacts for each project. For additional children's environmental health information at EPA, address all correspondence using the following addresses and telephone numbers:

EPA HEADQUARTERS

Environmental Protection Agency
Office of Children's Health Protection
Ariel Rios Building, MC 1107
1200 Pennsylvania Avenue, N.W.
Washington, DC 20460-0001
Phone: 202-260-7778
Toll Free Number: 877-590-KIDS
Internet: <http://www.epa.gov>
Children's Health home page: <http://www.epa.gov/children>

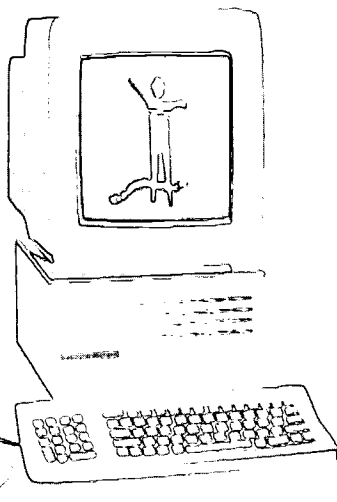

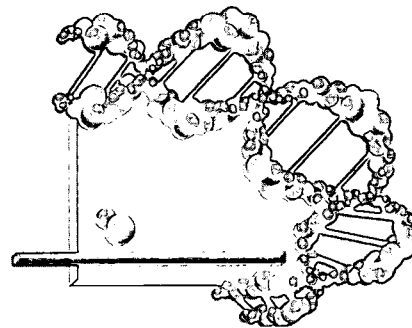

EPA REGIONS AND REGIONAL CHILDREN'S ENVIRONMENTAL HEALTH COORDINATORS

Region 1

(Maine, New Hampshire, Vermont, Massachusetts, Rhode Island, Connecticut)

U.S. Environmental Protection Agency
One Congress Street, Suite 1100
John F. Kennedy Building
Boston, MA 02114-2023
Phone: 617-918-1111
Toll-free (within Region 1): 888-372-7341
Fax: 617-918-1029
Internet: <http://www.epa.gov/region1>

Coordinator: Alice Kaufman
Mail Code: (RAA)
Phone: 617-918-1064
Fax: 617-918-1029
Email: kaufman.alice@epa.gov

Region 2

(New York, New Jersey, Puerto Rico, Virgin Islands)

U.S. Environmental Protection Agency
290 Broadway
New York, NY 10007-1866
Communications Division: 212-637-3660
Internet: <http://www.epa.gov/region2>

Coordinator: Maureen O'Neill
Mail Code: Office of the Regional Administrator
Phone: 212-637-5025
Fax: 212-637-4943
Email: oneill.maureen@epa.gov

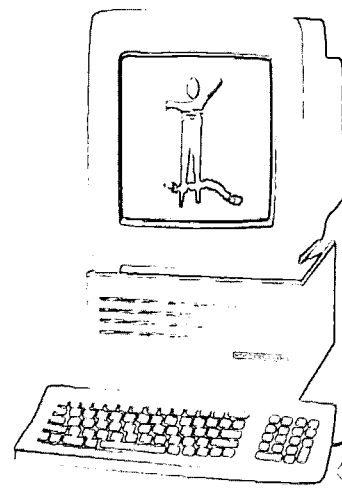
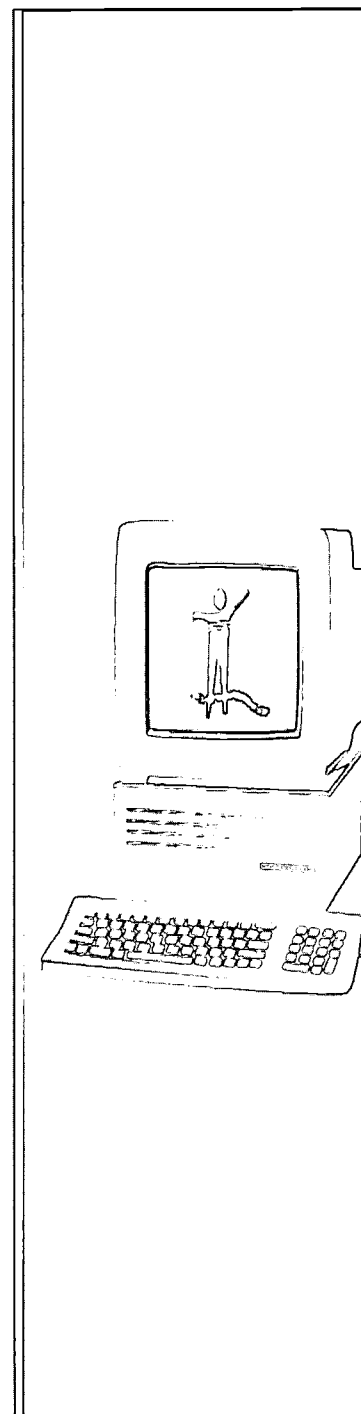

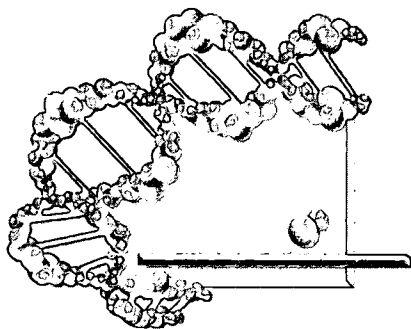

Region 3

(Pennsylvania, Delaware, District of Columbia, Maryland, Virginia, West Virginia)

U.S. Environmental Protection Agency
1650 Arch Street
Philadelphia, PA 19103-2029
Phone: 215-814-5000
Fax: 215-814-5103
Customer Service Center: 800-438-2474
Internet: <http://www.epa.gov/region3>
E-mail: r3public@epa.gov

Coordinator: Gail Tindal
Mail Code: (3WC00)
Phone: 215-814-2069
Fax: 215-814-2782
Email: tindal.gail@epa.gov

Alternate Coordinator: Dan Welker
Mail Code: (3ES10)
Phone: 215-814-2744
Fax: 215-814-1782
Email: welker.dan@epa.gov

Region 4

(Kentucky, Tennessee, North Carolina, South Carolina, Mississippi, Alabama, Georgia, Florida)

U.S. Environmental Protection Agency
61 Forsyth Street, S.W.
Atlanta, GA 30303-3104
Phone: 404-562-9900
Toll-free: 800-241-1754
Fax: 404-562-8174
Public Affairs and Information: 404-562-8327
Internet: <http://www.epa.gov/region4>

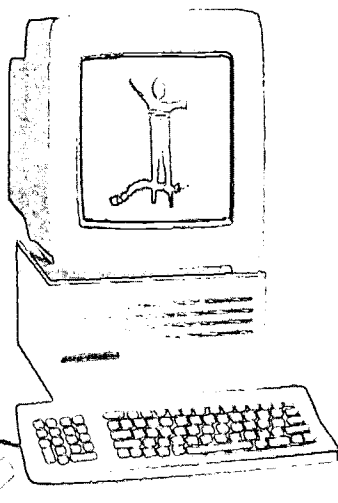

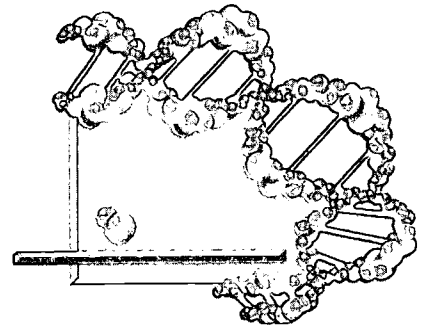

Coordinator: Wayne Garfinkel
Mail Code: (4AT-TS)
Phone: 404-562-8982
Fax: 404-562-8972
Email: garfinkel.wayne@epa.gov

Region 5

(Minnesota, Wisconsin, Illinois, Michigan, Indiana, Ohio)

U.S. Environmental Protection Agency
77 West Jackson Boulevard
Chicago, IL 60604-3507
Phone: 312-353-2000
Fax: 312-353-4135
Toll Free Number: 800-621-8431
Internet: <http://www.epa.gov/region5>

Coordinator: Maryann E. Suero
Regional Team Manager
Mail Code: (T-13J)
Phone: 312-886-9077
Fax: 312-886-9697
Email: suero.maryann@epa.gov

Alternate Coordinator: Colleen Olsberg
Mail Code: (DRP-8J)
Phone: 312-353-4686
Fax: 312-353-4788
Email: olsberg.colleen@epa.gov

Region 6

(New Mexico, Texas, Oklahoma, Arkansas, Louisiana)

U.S. Environmental Protection Agency
Fountain Place 12th Floor, Suite 1200
1445 Ross Avenue
Dallas, TX 75202-2733
Phone: 214-665-2200

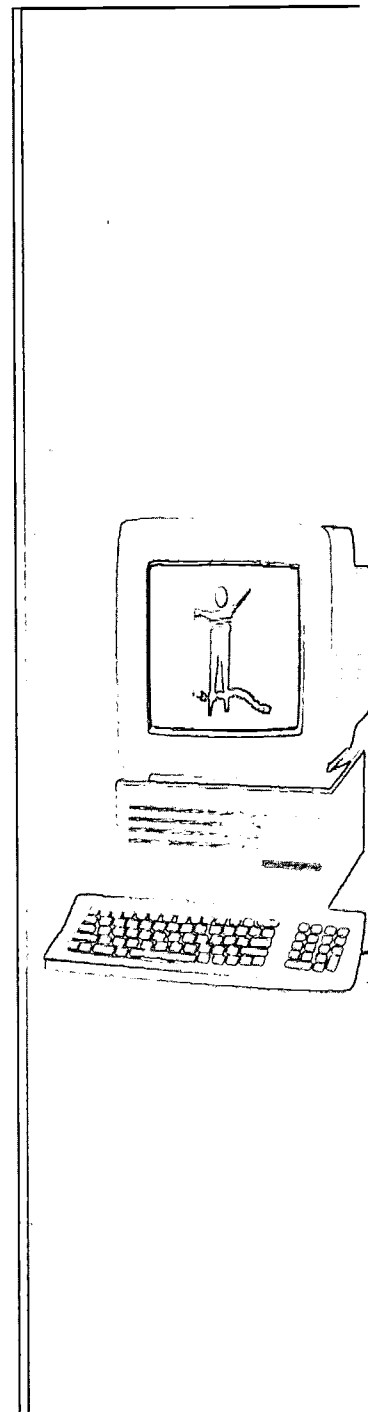

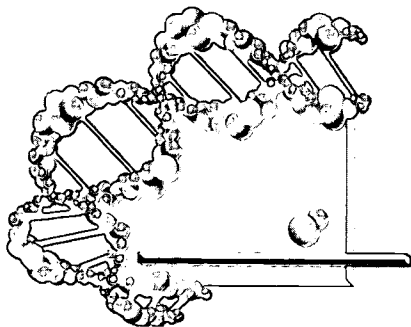

Toll-free (within Region 6): 800-887-6063
Fax: 214-665-7113
General Information: 214-665-2200
Internet: <http://www.epa.gov/region6>

Coordinator: Evelyn G. Daniels
Mail Code: (6PD-T)
Phone: 214-665-7543
Fax: 214-665-6762
Email: daniels.evelyn@epa.gov

Region 7

(Nebraska, Kansas, Iowa, Missouri)

U.S. Environmental Protection Agency
901 North 5th Street
Kansas City, KS 66101-2798
Phone: 913-551-7003
Fax: 913-551-7467
Toll Free Number: 800-223-0425
Internet: <http://www.epa.gov/region7>

Coordinator: Lori Walker
Mail Code: (POISPLMG)
Phone: 913-551-7926
Fax: 913-551-9926
Email: walker.lori@epa.gov

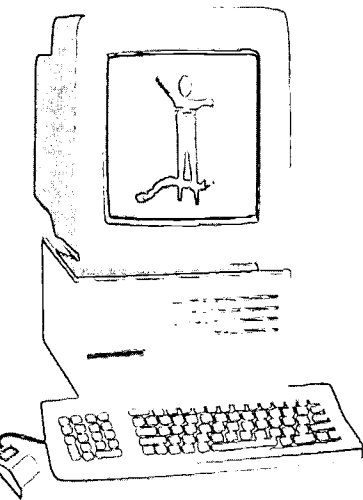

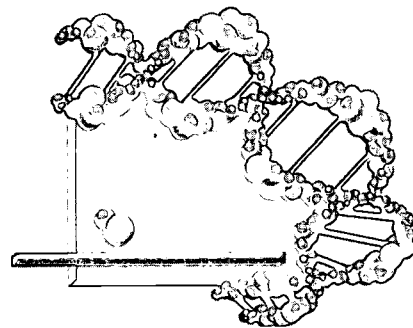

Region 8

(Montana, North Dakota, Wyoming, South Dakota, Utah, Colorado)

U.S. Environmental Protection Agency

999 18th Street, Suite 500

Denver, CO 80202-2466

Phone: 303-312-6312

Fax: 303-312-6339

Environmental Information Service Center: 800-227-8917

Internet: <http://www.epa.gov/region8>

E-mail: r8eisc@epa.gov

Coordinator: Alicia Aalto

Mail Code: (8P-AR)

Phone: 303-312-6967

Fax: 303-312-6064

Email: aalto.alicia@epa.gov

Region 9

(California, Nevada, Arizona, Hawaii, Guam, American Samoa)

U.S. Environmental Protection Agency

75 Hawthorne Street

San Francisco, CA 94105-3901

Phone: 415-744-1305

Fax: 415-744-2499

General Public Inquiries: 415-744-1500

Internet: <http://www.epa.gov/region9>

E-mail: r9.info@epa.gov

Coordinator: Jean Circiello

Mail Code: (SPE-1)

Phone: 415-744-1631

Fax: 415-744-2360

Email: circiello.jean@epa.gov

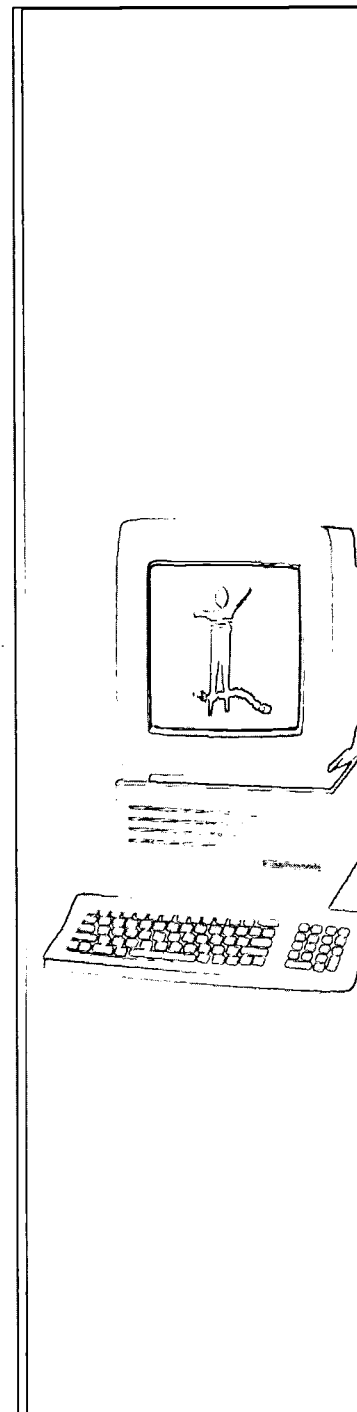

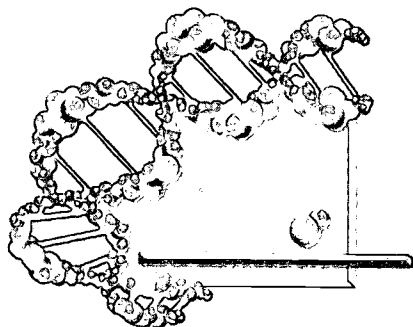

Region 10

(Washington, Oregon, Idaho, Alaska)

U.S. Environmental Protection Agency

1200 Sixth Avenue

Seattle, WA 98101-3188

Phone: 206-553-1200

Fax: 206-553-0149

Toll Free Number: 800-424-4372

Internet: <http://www.epa.gov/region10>

Coordinator: Pam Emerson

Mail Code: EXA-142

Phone: 206-553-1287

Fax: 206-553-1049

Email: emerson.pamela@epa.gov

EPA also operates a number of hotlines and clearinghouses. Those that offer publications and information relevant to topics covered in this report are listed in the appropriate sections below. For information on other EPA offices, locations, public information centers, hotlines, and clearinghouses, check the EPA home page or call the regional office nearest you.

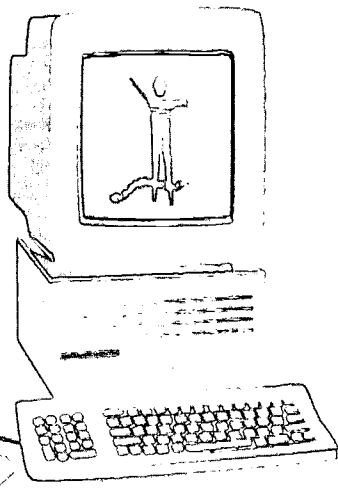

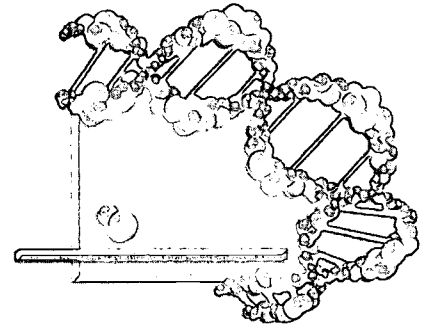

OBTAINING EPA PUBLICATIONS

EPA is making important progress to provide the public with information to protect children's health. The following tables list Web addresses for obtaining EPA information and direct links to other resources available on the Internet. It is also possible to call or write EPA to request copies of documents. General sources of EPA documents include:

- The National Service Center for Environmental Publications (NSCEP) is a central repository for EPA documents, with over 5,500 titles in paper and electronic format available for distribution (at no cost to the public). Individuals can browse and search EPA's National Publications Catalog, and order EPA Publications online or by telephone at 800-490-9198. The EPA publication number (e.g., EPA 999-F-99-999) is used to identify the resource being requested.

NSCEP
National Service Center for Environmental Publications
P.O. Box 42419
Cincinnati, OH 45242-2419
Phone: 800-490-9198
Local and Government Employees: 513-489-8190
Fax: 513-489-8695
Internet: <http://www.epa.gov/ncepihom>
E-mail: ncepimal@one.net

Some documents not available free of charge through NSCEP can be obtained for a charge through the National Technical Information Service (NTIS) or the Government Printing Office (GPO).

- NTIS is a central resource for government-sponsored U.S. and international scientific, technical, engineering, and business-related information. As a self-supporting agency of the U.S. Department of Commerce, NTIS covers its business and operating expenses with the sale of its products and services. For EPA publications, NTIS indexes publications by their EPA publication number, complete title, and by an NTIS product number. NTIS accepts VISA, MasterCard, American Express, and Discover.

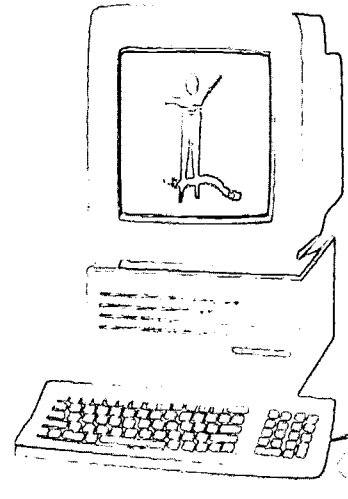

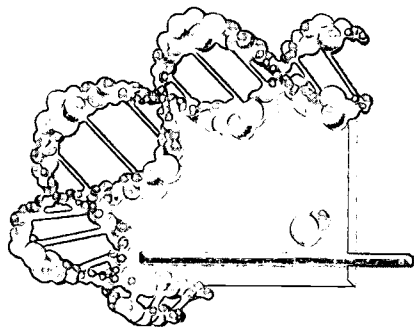

NTIS

National Technical Information Center
5285 Port Royal Road
Springfield, VA 22161-0002
Phone to Order: 800-553-6847 or 703-605-6000
Fax: 703-605-6900
E-Mail Online Ordering: orders@ntis.fedworld.gov
Internet: <http://www.ntis.gov>

- Documents available from the U.S. Government Printing Office (GPO) can be obtained for a fee by calling or writing to the address below. GPO also accepts VISA and MasterCard. Place orders by title or appropriate order number.

U.S. Government Printing Office
Superintendent of Documents
PO Box 371954
Pittsburgh, PA 15250-7954
Phone: 202-512-1800
Fax: 202-512-2250
Internet: https://orders.access.gpo.gov/su_docs/sale/prf/prf.html

Additional publications and interlibrary loans of EPA documents are available through the EPA library system. The EPA Headquarters Information Resources Center provides access to EPA information for U.S. and international requests, and has a range of information services consisting of environmental and related subjects, including online searching of commercial databases. The focus of the EPA collection is on environmental regulations, policy, planning, and administration. The library also maintains a large collection of EPA documents on microfiche and in hard copy. Libraries also are located in EPA regional offices and laboratories across the country. For information contact:

Headquarters Information Resources Center
Environmental Protection Agency
Ariel Rios Building
1200 Pennsylvania Avenue, N.W.
Mail Code 3404
Washington, DC 20460-0001
Phone: 202-260-5922
Fax: 202-260-5153
E-mail: library-hq@epa.gov
Internet: <http://www.epa.gov/natlibra>

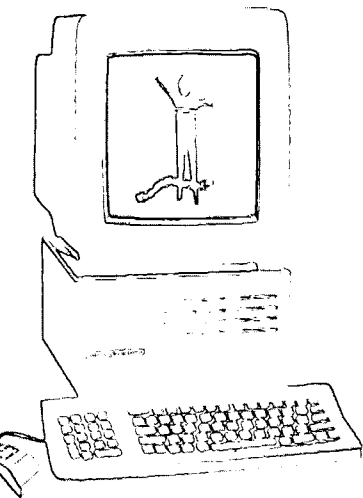

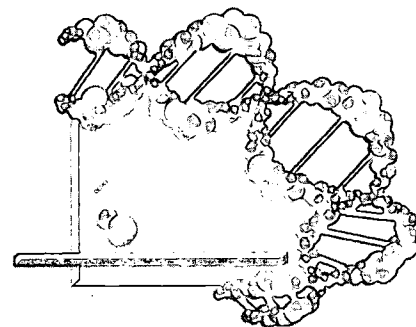

EPA MATERIALS, TOOLS, AND INTERNET RESOURCES RELATED TO CHILDREN'S HEALTH

This section contains information resources specific to the health effects and environmental contaminants addressed in the Children's Environmental Health Yearbook Supplement. Under each topic, general resources—such as hotlines and clearinghouses—are listed first, followed by an alphabetical listing of relevant EPA publications. For each document, one or more sources for obtaining the information is indicated in the right-hand column. Sources may be one of the major document distribution centers or EPA offices listed above, an Internet site address, or one of the topic-specific clearinghouses or hotlines. A specific individual contact and telephone number are provided where needed.

INVENTORY OF CHILDREN'S HEALTH RESEARCH PROJECTS

The Children's Environmental Health and Safety Inventory of Research (CHEHSIR) is an Internet-accessible database of federally funded or sponsored research on environmental health risk and/or safety risks that may uniquely or disproportionately affect children.

<http://www.epa.gov/chehsir>

ASTHMA AND OTHER RESPIRATORY EFFECTS

INFORMATION RESOURCES FOR INDOOR AIR QUALITY

Indoor Air Quality Information Clearinghouse (IAQINFO)

P.O. Box 37133

Washington, DC 20013-7133

Phone: 800-438-4318; local 703-356-4020

Fax: 703-356-5386

E-mail: iaqinfo@aol.com

Internet: <http://www.epa.gov/iaq/pubs>

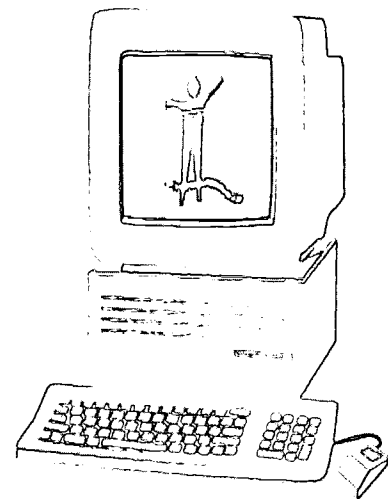

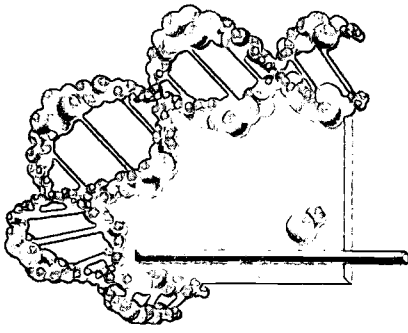

Indoor Air Quality Publications and Sources	
Publication	Source
A is for Asthma (video)	Region 5, Suzanne Saric, 312-353-3209
Asthma and the Environment: A Strategy to Protect Children	NSCEP http://www.epa.gov/children
Carpet and Indoor Air Quality Fact Sheet (EPA 402-F-94-011 October 1992, IAQ-0040)	IAQINFO
Children and Secondhand Smoke (EPA 402-F-99-003)	NSCEP
Clearing the Air: Asthma and Indoor Air Exposures	http://www.nap.edu/books/0309064961/html
Clear Your Home of Asthma Triggers: Your Children Will Breathe Easier (EPA 402-F-99-005)	NSCEP
Creating Indoor Air Quality Programs in Low-Income Communities and Communities of People of Color: An Organizer's Handbook	Region 10, Brooke Madrone, 206-553-2589
Flood Cleanup: Avoiding Indoor Air Quality Problems Fact Sheet (EPA 402-F-93-005, August 1993, IAQ-0061)	IAQINFO
How Healthy Is the Air in Your Home? A Room-by-Room Checklist for Your Home's Indoor Air Quality (EPA 402-F-97-001)	IAQINFO
IAQ Tools for Schools Action Kit EPA (402-K-95-008)	All except the problem solving wheel and video available at: http://www.epa.gov/iaq/schools GPO sells the complete kit and extra wheels. (GPO# 055-000-00563-0)

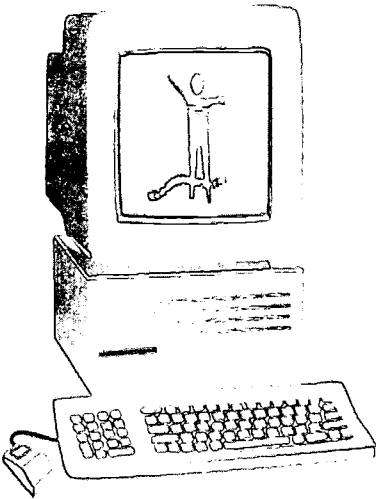

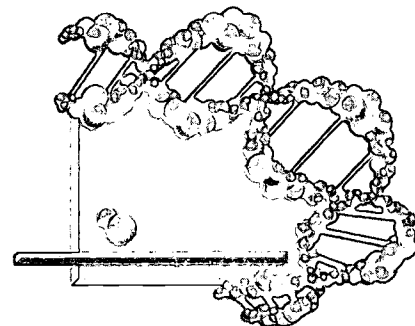

Indoor Air Quality Publications and Sources (continued)

Publication	Source
IAQ Tools for Schools Taking Action and Ventilation Basics (video) EPA 402-V-98-001	IAQINFO
Indoor Air Pollution: An Introduction for Health Professionals (EPA 402-R-94-007; GPO 1994-523-217/81322)	IAQINFO
Indoor Air Quality Basics for Schools Fact Sheet (EPA 402-F-96-004, October 1996, IAQ-0095)	IAQINFO
The Inside Story: A Guide to Indoor Air Quality (EPA 402-K-93-007, April 1995, IAQ-0009)	IAQINFO
Protect Your Family and Yourself from Carbon Monoxide Poisoning (EPA 402-F-96-005, October 1996) in Spanish (EPA 402-F-97-004, July 1997)	IAQINFO This fact sheet also is available in Vietnamese (EPA 402-F-96-005C), Chinese (402-F-96-005A), and Korean (402-F-96-005B)
Residential Air Cleaners Fact Sheet (EPA 20A-4001, February 1990, IAQ-0007)	IAQINFO
Sick Building Syndrome Fact Sheet (EPA 402-F-94-004, April 1991, IAQ-0004)	IAQINFO
A Special Alert for People with Asthma in the Northeast Ohio Area (EPA 905-K-001, May 1997)	Region 5, Indoor Air Coordinator, 312-353-2205

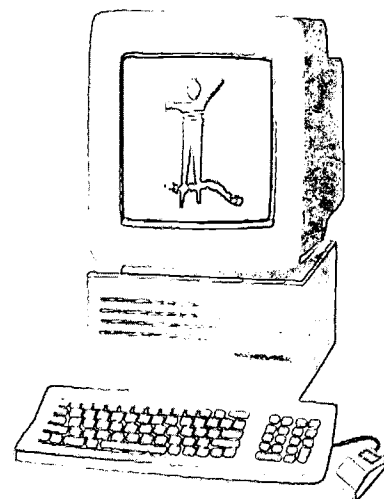

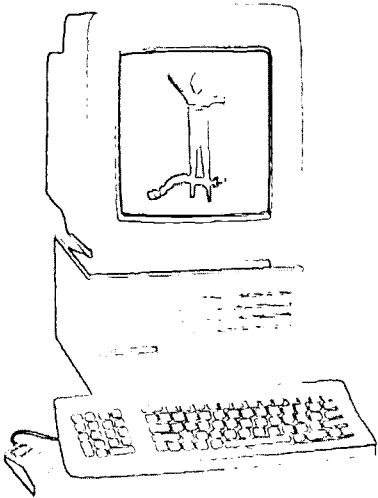
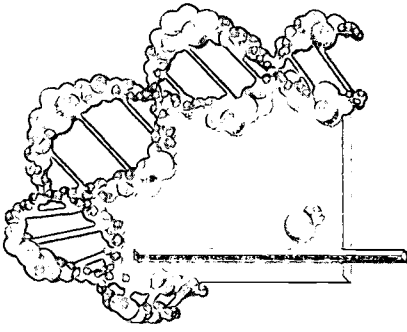

Indoor Air Quality Publications and Sources (continued)

Publication	Source
A Special Alert for People with Asthma in the Greater Cincinnati, Northern Kentucky Metropolitan Area (EPA 905-K-002, May 1997)	Region 5, Indoor Air Coordinator, 312-353-2205
A Special Alert for People with Asthma in the Greater St. Louis Metropolitan Area (EPA 905-K-003, May 1997)	Region 5, Indoor Air Coordinator, 312-353-2205
A Special Alert for People with Asthma in the Chicago Metropolitan Area and Northwest Indiana (EPA 905-K-004, May 1997)	Region 5, Indoor Air Coordinator, 312-353-2205
A Special Alert for People with Asthma in Southeast Wisconsin (EPA 905-K-005, May 1997)	Region 5, Indoor Air Coordinator, 312-353-2205
Use and Care of Home Humidifiers Fact Sheet (EPA 402-F-91-101, February 1991, IAQ-0008)	IAQINFO
Ventilation and Air Quality in Offices Fact Sheet (EPA 402-F-94-003, July 1990, IAQ-0003)	IAQINFO
What You Should Know about Combustion Appliances and Indoor Air Pollution (EPA 400-F-91-100)	IAQINFO

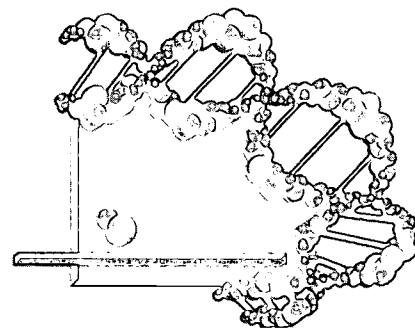

INFORMATION RESOURCES FOR OUTDOOR AIR POLLUTION

Office of Air and Radiation
 Office of Mobile Sources
 2565 Plymouth Road
 Ann Arbor, MI 48105-2498
 Phone: 734-214-4207
 Internet: <http://www.epa.gov/OMSWWW/consumer.htm>

National Vehicle and Fuel Emissions Laboratory (NVFEL)
 2000 Traverwood Drive
 Ann Arbor, MI 48105-2195
 Phone: 734-214-4200
 Fax: 734-214-4525
 Internet: <http://www.epa.gov/OMSWWW/01-nvfel.htm>

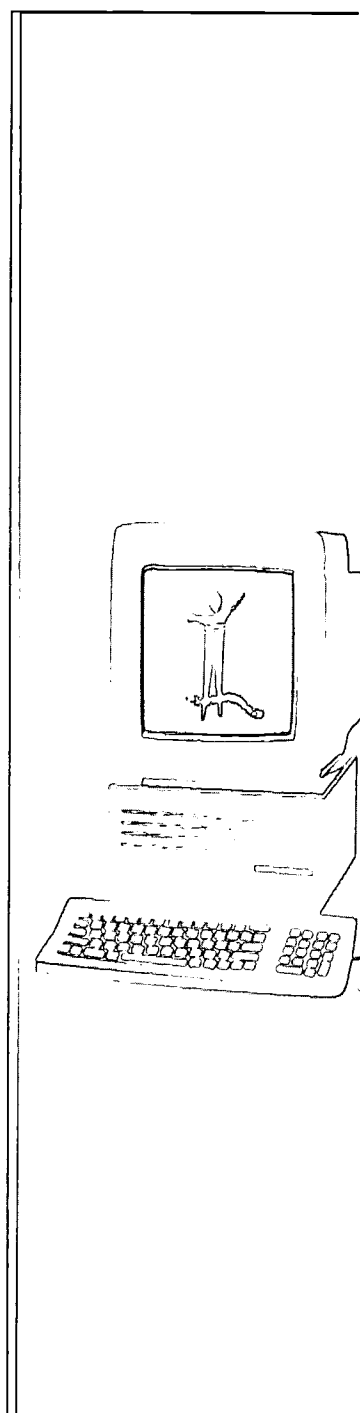

Outdoor Air Quality Publications and Sources

Publication	Source
Air Toxics from Motor Vehicles (EPA 400-F-92-004, Fact Sheet OMS-2, August 1994)	NVFEL or http://www.epa.gov/OMSWWW/consumer.htm
Automobile Emissions: An Overview (EPA 400-F-92-007, Fact Sheet OMS-5, August 1994)	NVFEL or http://www.epa.gov/OMSWWW/consumer.htm
Automobiles and Carbon Monoxide (EPA 400-F-92-005, Fact Sheet OMS-3, January 1993)	NVFEL or http://www.epa.gov/OMSWWW/consumer.htm

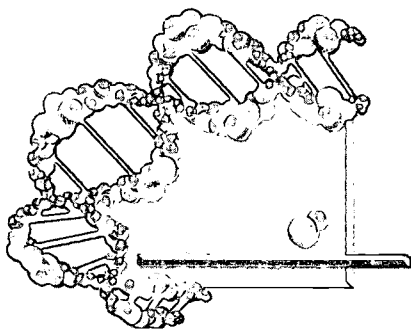

Outdoor Air Quality Publications and Sources <i>(continued)</i>	
Publication	Source
Be a Grower Not a Mower Fact Sheet (EPA 420-F-96-018)	NVFEL or http://www.epa.gov/OMSWWW/consumer.htm
Boating Pollution Prevention Tips Fact Sheet (EPA 420-F-96-003)	NVFEL or http://www.epa.gov/OMSWWW/consumer.htm
Car Owners: Protect the Environment and Your Health	NVFEL or http://www.epa.gov/OMSWWW/consumer.htm
Don't Tamper With Emissions Controls! (EPA 420-F-93-004)	NVFEL or http://www.epa.gov/OMSWWW/consumer.htm
Commute Alternative Brochure (EPA 420-F-95-011)	NVFEL or http://www.epa.gov/OMSWWW/consumer.htm
Commute Alternative Poster (EPA 420-H-95-002)	NVFEL or http://www.epa.gov/OMSWWW/consumer.htm
Control of Emissions from Nonroad Engines Fact Sheet (EPA 420-F-96-009)	NVFEL or http://www.epa.gov/OMSWWW/consumer.htm
Health and Environmental Effects of Particulate Matter, July 1997	http://tnwww.rtpnc.epa.gov/naaqsfm/pmhealth.htm
Nonroad Engines and Air Pollution: An Overview (EPA 420-F-94-003)	NVFEL or http://www.epa.gov/OMSWWW/consumer.htm

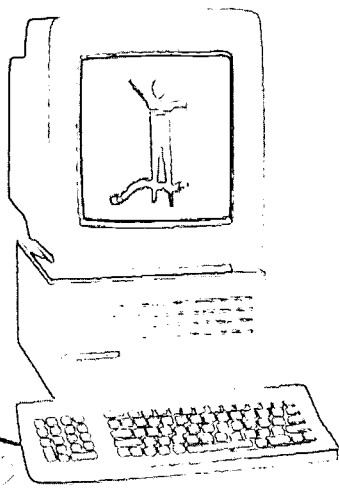

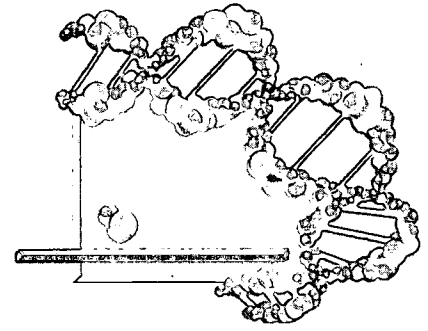

Outdoor Air Quality Publications and Sources (continued)

Publication	Source
Tips For Reducing Fuel Spillage Fact Sheet (EPA 420-F-96-002)	NVFEL or http://www.epa.gov/OMSWWW/consumer.htm
Tips to Save Gas and Improve Mileage (EPA 420-F-94-004)	NVFEL or http://www.epa.gov/OMSWWW/consumer.htm
What You Can Do to Reduce Air Pollution: A Citizens Guide to What Individuals and Communities Can Do to Help Meet the Goals of the Clean Air Act Amendments of 1990 (EPA 450-K-92-002)	NSCEP: http://www.epa.gov/ncepihom
Your Car or Truck and the Environment: An Environmental Guide for Owners and Drivers of Cars, Trucks, and Other Motor Vehicles (EPA 420-K-93-001)	NSCEP: http://www.epa.gov/ncepihom
Your Car and Clean Air: What YOU Can Do to Reduce Pollution (EPA 400-F-93-002, Fact Sheet OMS-18, August 1994)	NVFEL or http://www.epa.gov/OMSWWW/consumer.htm
Your Yard and Clean Air (EPA 420-F-94-002, September 1996)	NVFEL or http://www.epa.gov/OMSWWW/consumer.htm

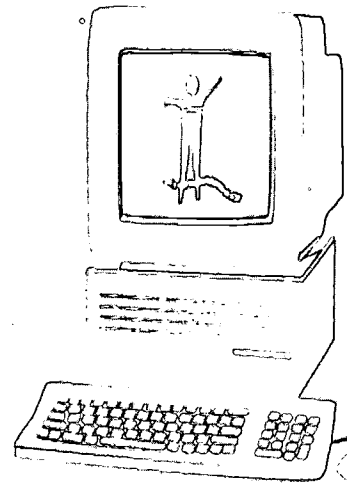

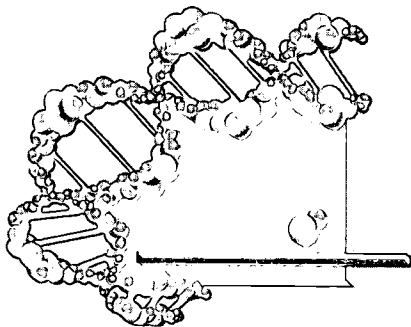

INFORMATION RESOURCES FOR GROUND-LEVEL OZONE

Office of Air and Radiation
 Office of Air Quality Planning and Standards, Mail Code MD-10
 Research Triangle Park, NC 27711
 Phone: 919-541-5616
 Ground Level Ozone home page: <http://www.epa.gov/oar/oaqps/gooduphigh/>
 AIRLinks: <http://www.epa.gov/airlinks>

REGION 1

New England's Air Quality Hotline: 800-821-1237
 Anne Arnold, Air Quality Planning Unit, Office of Ecosystem Protection,
 617-918-1047
 Ground Level Ozone Information Web Page:
<http://www.epa.gov/region1/eco/ozone/>

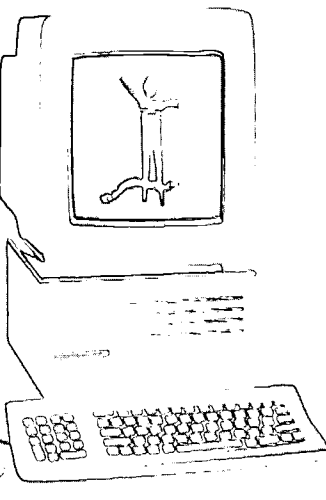

Ground Level Ozone Publications and Sources

Publication	Source
Automobiles and Ozone (EPA 400-F-92-006, Fact Sheet OMS-4, January 1993)	http://www.epa.gov/OMSWWW/consumer.htm
Ground-Level Ozone Air Quality Guide	Region 1, Anne Arnold, Air Quality Planning Unit, Office of Ecosystem Protection, 617-918-1047
Health and Environmental Effects of Ground-Level Ozone Fact Sheet, July 1997	http://www.epa.gov/ttn/oarpg/naaqsfm/o3health.htm

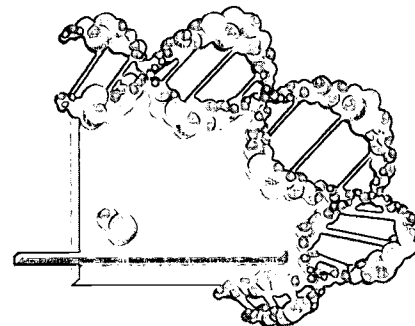

Ground Level Ozone Publications and Sources <i>(continued)</i>	
Publication	Source
Ozone Action Day Information	Region 5, http://www.epa.gov/region5/air/naaqs/o3info.htm
Ozone Action Days: A Special Alert for People with Asthma and Other Respiratory Problems (EPA 905-F-95-001, May 1995)	Region 5, http://www.epa.gov/ARD-R5/naaqs/o3asthma.htm

Childhood CANCER

INFORMATION RESOURCES FOR RADON

Indoor Air Quality Information Clearinghouse (IAQ Information)
 Radon Information Clearinghouse
 Phone: 800-SOS-RADON
 IAQ Radon Publications Web Site: <http://www.epa.gov/iaq/radon/pubs/index.html>

Radon Publications and Sources	
Publication	Source
A Radon Guide for Tenants	IAQ Radon Pubs Web Site Radon Information Clearinghouse
All About Radon (coloring book; English and Spanish)	Region 7, http://www.epa.gov/region7/kids/aar.htm

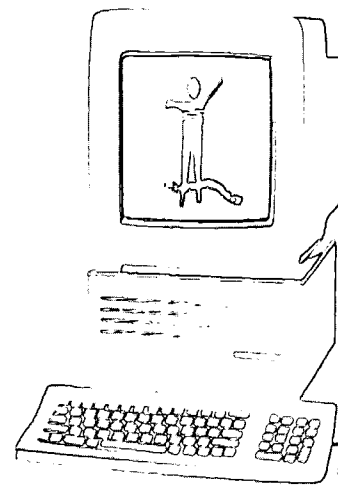

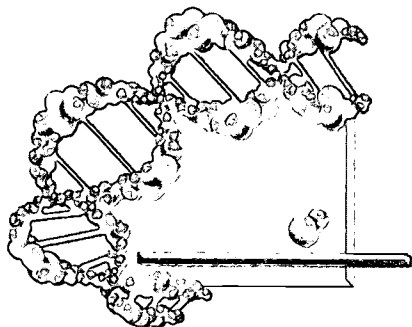

Radon Publications and Sources (continued)	
Publication	Source
Baby Radon Public Service Announcement, 1995	IAQINFO
Basic Information on Radon Resistant New Construction (pamphlet)	http://www.epa.gov/iaq/construc.html
Citizen's Guide to Radon: The Guide to Protecting Yourself and Your Family from Radon, Second Edition (EPA 402-K-92-001, September 1994) (in Spanish: EPA 402-K-93-005, September 1993)	IAQ Radon Pubs Web Site Radon Clearinghouse Information NSCEP
Consumer Federation of America Radon Public Service Announcement (video)	IAQINFO
Consumer's Guide to Radon Reduction: How to Reduce Radon Levels in Your Home (EPA 402-K92-003, August 1992, GPO Order Number ISBN: 0-16-036255-5)	IAQ Radon Pubs Web Site Radon Information Clearinghouse GPO
Dust Particles-Radon Public Service Announcement, 1996 (in English and Spanish)	IAQINFO
Home Buyer's and Seller's Guide to Radon (EPA 402-R-93-003, March 1993)	IAQ Radon Pubs Web Site Radon Information Clearinghouse GPO
Lung Radon Poster	IAQINFO

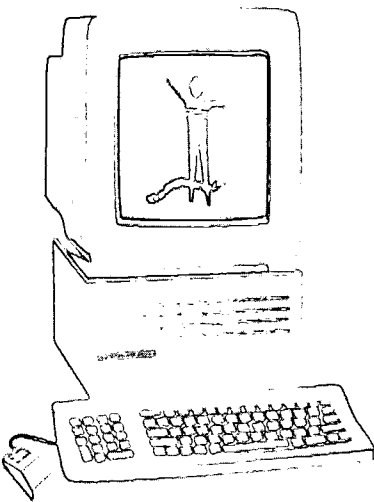

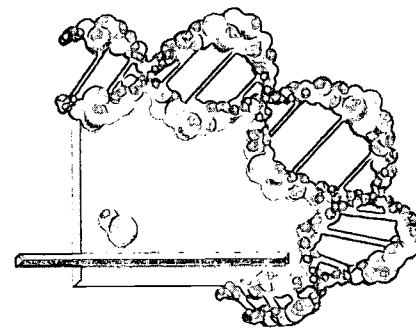

Radon Publications and Sources (continued)

Publication	Source
My Radon Coloring Book	Region 7 http://www.epa.gov/region7/kids/mrcb1.htm
Radon Measurement In Schools: Revised Edition Booklet (EPA 402-R-92-014, July 1993)	IAQ Radon Pubs Web Site Radon Information Clearinghouse
Radon Measurement in Schools, Self-Paced Training Workbook (EPA 402-B-94-001)	NSCEP
Radon in Schools Brochure, Second Edition (EPA 402-F-94-009, October 1994)	IAQ Radon Pubs Web Site Radon Information Clearinghouse
Radon Resistant New Construction in Homes (brochure)	IAQ Radon Pubs Web Site Radon Information Clearinghouse
Radon: Risks and Realities (August 13, 1996)	IAQINFO
Radon Video (also available in Spanish)	IAQINFO
Reducing Radon Risks (EPA 520-1-89-027, September 1992)	IAQ Radon Pubs Web Site Radon Information Clearinghouse
Reducing Radon in Schools: A Team Approach (EPA 402-R-94-008, April 1994)	IAQ Radon Pubs Web Site Radon Information Clearinghouse
The Radon Student Activity Book	IAQINFO

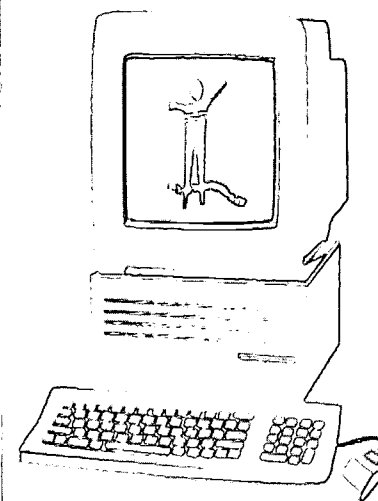

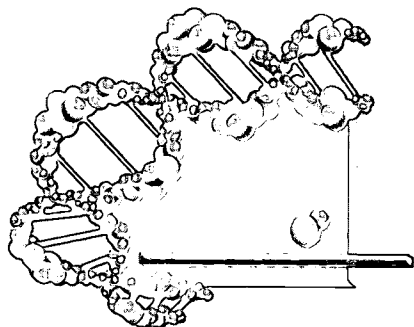

INFORMATION RESOURCES FOR ASBESTOS

Toxic Substances Control Act (TSCA) Hotline

Phone: 202-554-1404

Fax: 202-554-5603

E-mail: tsca-hotline@epa.gov

Asbestos Publications and Sources	
Publication	Source
Asbestos Hazard Emergency Response Act Q & A (EPA 745-K-93-023)	TSCA Hotline
Asbestos in the Home: A Homeowner's Guide (EPA 910-K-92-001, August 1992)	TSCA Hotline
Asbestos in Your Home (brochure, EPA 745-F-93-006)	TSCA Hotline
Asbestos Fact Book (EPA 745-K-93-016)	TSCA Hotline
Asbestos in Schools: Evaluation of Asbestos Hazard Emergency Response Act (fact sheet, EPA 745-F-91-100)	TSCA Hotline
Asbestos in Schools: Evaluation of Asbestos Hazard Emergency Response Act (summary report, EPA 745-K-91-101)	TSCA Hotline
Advisory to the Public on Asbestos in Buildings (EPA 745-K-93-014)	TSCA Hotline
The ABCs of Asbestos in School (information packet, EPA 745-K-93-017)	TSCA Hotline
Proposed Rule on Friable Asbestos Containing Materials in School Buildings: Health Effects and Magnitude of Exposure (support document, EPA 560-12-80-003)	TSCA Hotline

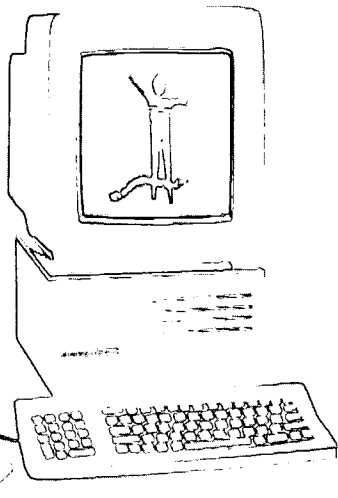

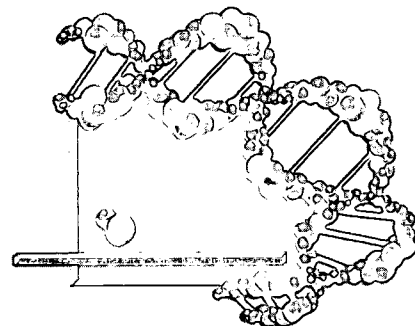

INFORMATION RESOURCES FOR ULTRAVIOLET LIGHT (SUN PROTECTION)

Stratospheric Ozone Hotline: 800-296-1996
 Ozone Depletion Resource Center
 Internet: <http://www.epa.gov/docs/ozone/resource/public.html>

Ultraviolet Light (Sun Protection) Publications and Sources	
Publication	Source
Sun Safety for Kids: The SunWise School Program (brochure, EPA 430-F-00-003)	Stratospheric Ozone Hotline http://www.epa.gov/sunwise
SunWise School Program Guide (booklet, EPA 430-K-99-036)	Stratospheric Ozone Hotline http://www.epa.gov/sunwise
The Sun, UV, and You: A Guide to SunWise Behavior (booklet, EPA 430-K-99-035)	Stratospheric Ozone Hotline http://www.epa.gov/sunwise
SunWise Monitor (newsletter, EPA 430-F-99-033 and EPA 430-F-00-008)	Stratospheric Ozone Hotline http://www.epa.gov/sunshine
Action Steps for Sun Protection (fact sheet, EPA 430-F-99-026)	Stratospheric Ozone Hotline http://www.epa.gov/sunwise
Health Effects of Overexposure to the Sun (fact sheet, EPA 430-F-99-025)	Stratospheric Ozone Hotline http://www.epa.gov/sunwise
Ozone Depletion (fact sheet, EPA 430-F-99-023)	Stratospheric Ozone Hotline http://www.epa.gov/sunwise
UV Radiation (fact sheet, EPA 430-F-99-024)	Stratospheric Ozone Hotline http://www.epa.gov/sunshine

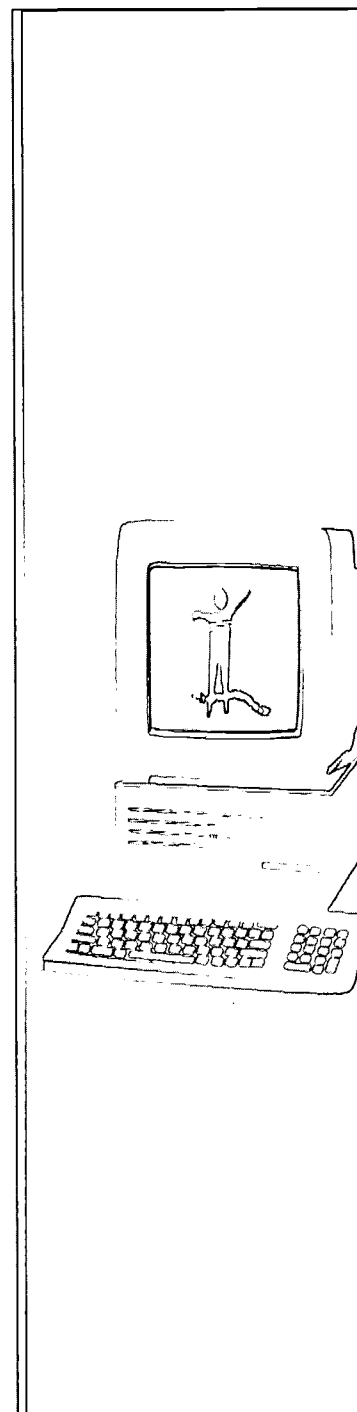

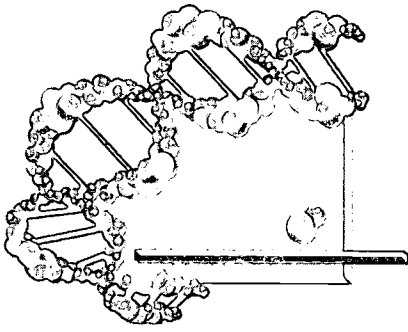

Ultraviolet Light (Sun Protection) Publications and Sources <i>(continued)</i>	
Publication	Source
What is the Ultraviolet (UV) Index (fact sheet, EPA 430-H-99-001)	Stratospheric Ozone Hotline http://www.epa.gov/sunwise
The Ultraviolet Index: What You Need to Know (pamphlet, EPA 430-F-94-016)	Stratospheric Ozone Hotline
Stratospheric Update (newsletter, EPA 430-F-99-009)	Stratospheric Ozone Hotline
Moving Out of CFCs, Benefits of the CFC Phaseout (fact sheet, EPA 430-F-96-020)	Stratospheric Ozone Hotline
SunWise School Program	Office of Air and Radiation Maura Cantor, 202-564-9096 http://www.epa.gov/sunwise
Ozone Depletion Art Project	Office of Air and Radiation Christine Dibble, 202-564-9147 http://www.epa.gov/ozone/art
Protecting the Ozone Layer: Safe Disposal of Home Appliances Containing Ozone Depleting Substances (EPA 430-K-93-001)	NSCEP
Protection of the Ozone Layer (EPA 230-N-95-002)	NSCEP
Ozone Layer Educator's Guide (guidance packet, EPA 430-E-95-003)	NSCEP

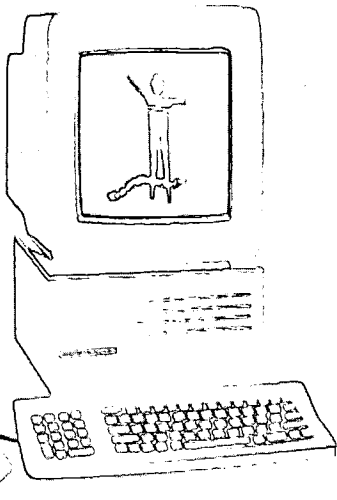

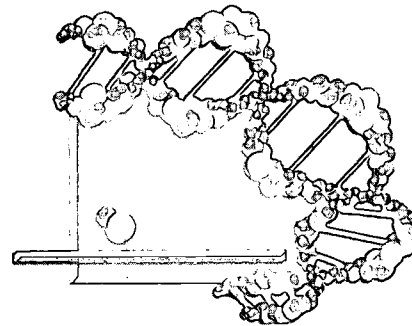

DEVELOPMENTAL AND NEUROLOGICAL TOXICITY

INFORMATION RESOURCES FOR LEAD

National Lead Information Center Hotline and Clearinghouse

Phone: 800-LEADFYI (hotline)

Phone: 800-424-LEAD (clearinghouse)

Fax: 202-659-1192

E-mail: ehc@cais.com

Internet: <http://www.epa.gov/lead/nlicdocs.htm>

The Hotline is available 24 hours a day, 7 days a week, in English and Spanish. The Hotline distributes a basic information packet on lead that includes the EPA brochure "Lead Poisoning and Your Children," three fact sheets, and a list of state and local contacts for additional information. Callers who have more specific questions are referred to the clearinghouse (800-424-LEAD) and can speak directly with an information specialist. Information specialists provide on-phone technical assistance.

Office of Prevention, Pesticides, and Toxic Substances

U.S. Environmental Protection Agency

Ariel Rios Building

1200 Pennsylvania Avenue, N.W.

Mail Code 7407

Washington, DC 20460-0001

Phone: 202-260-2902

Lead Programs home page: <http://www.epa.gov/lead>

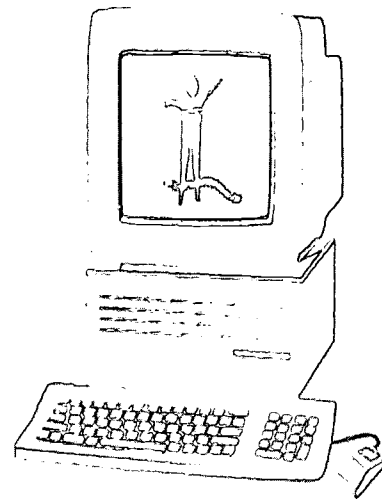

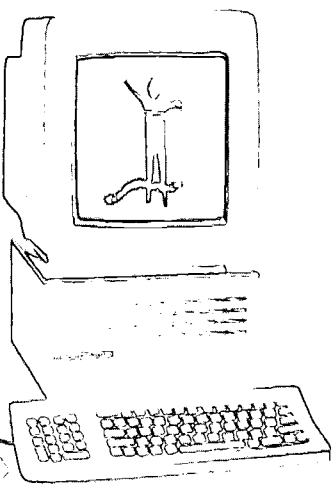
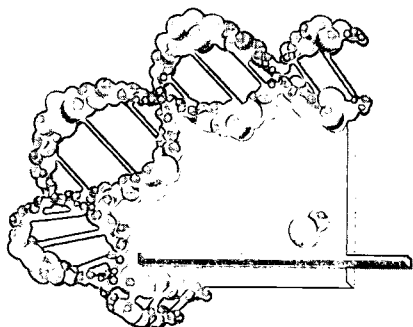

Lead Publications and Sources

Publication	Source
Be Safe With Lead-Man (poster)	Region 4, Lead Coordinator, Rose Anne Rudd, 404-562-8998
Children and Lead: What You Can Do? A Guide for Parents and Day Day Care Providers From Physicians for Social Responsibility	Region 3, 215-814-5000
Controlling Lead In Soils Packet (1995)	Region 1, Katie Mazer, 617-918-1523
Eliminating Childhood Lead Poisoning: A Federal Strategy Targeting Lead Paint Hazards	NSCEP http://www.epa.gov/children
EMPACT Lead Safe Yard Project	http://www.epa.gov/region01/leadsafe
Fact Sheet: Disclosure of Lead-Based Paint Hazards in Housing (EPA 747-F-96-002, March 1996)	National Lead Information Center http://www.epa.gov/opptintr/lead/leadbase.htm
Finding a Qualified Lead Professional for Your Home (EPA 747-F-96-006)	National Lead Information Center http://www.epa.gov/lead/nlicdocs.htm
First Steps: Childcare Provider/Parent Lead Awareness Manuals	Region 1, James M. Bryson, 617-918-1524; Houlton Band of Maliseet Indians, Phillip Quint, 800-545-8524 or 207-532-4273
Healthy Beginnings: Lead Safe Families, an English-as-a-Second-Language Curriculum on Lead Poisoning Prevention (EPA 208-B-93-001, 1996)	Region 1, Katie Mazer, 617-918-1523, http://www.epa.gov/region01/eco/lead/

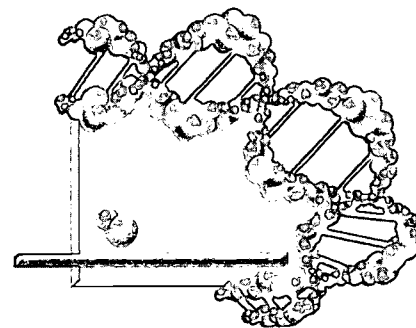

Lead Publications and Sources (continued)

Publication	Source
Home Repairs and Innovations: What You Should Know About Lead-Based Paints	Region 7, 800-223-0425
Identifying Lead Hazards in Your Home (fact sheet, EPA 747-F-96-007)	NSCEP
IMPACT Lead Safe Renovator Training Manual (also available on interactive CD-ROM)	Region 1, James M. Bryson, 617-918-1524
Lead in American Schools: What School Districts Should & Should Not Do	Region 3, 215-814-5000
Lead in Your Drinking Water (EPA 810-F-93-001)	NSCEP Water Resource Center
Lead in Your Home: A Parent's Reference Guide	National Lead Information Center, http://www.epa.gov/lead/nlicdocs.htm , Megan Carroll, 202-260-7269
Lead Prevention Videos: Lead Poisoning—A Parent's Guide to Prevention, Sesame Street Lead Away!, and Living With Lead	National Lead Information Center
Lead Poisoning and Your Children (pamphlet, EPA 800-B-92-002); El Envenenamiento por el Plomo y Sus Niños (EPA 747-K-95-001)	Region 4, Lead Coordinator, Rose Anne Rudd, 404-562-8998

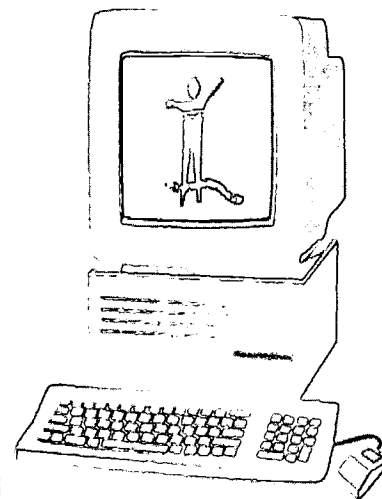

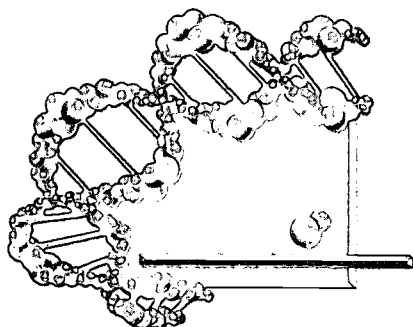

Lead Publications and Sources (continued)	
Publication	Source
Lead Poisoning Prevention Wheel	Region 7, 800-223-0425
Lead in Drinking Water Coolers (fact sheet EPA 810-F-90-021)	NSCEP, Water Resource Center
Lead-Free Kids, Lead-Free Homes (pamphlet)	Region 3, 215-814-5000
Lead—Is Your Child At Risk? (pamphlet)	Region 3, 215-814-5000
Let's Get the Lead Out 1997 Teaching Materials	Region 3, 215-814-5000
Making Your Kids & Your Home Safe from Lead Poisoning (pamphlet)	Region 5, 800-621-8431
Our Mid-Atlantic Environment—25 Years of Progress (EPA 903-R-017, December 1995)	Region 3, 215-814-5000
Protect Your Family from Lead in Your Home (pamphlet, EPA 747-DK-94-00, May 1 1995); Poteja a Su Familia del Plomo en Su Casa (EPA 747-K-94-001S)	Region 3, 215-814-5000

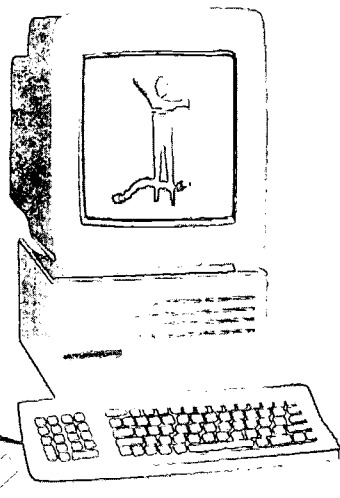

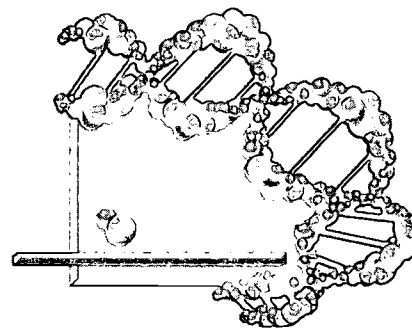

Lead Publications and Sources (continued)

Publication	Source
Protecting Your Family from Lead Poisoning: Como Proteger a Sus Hijos y Su Hogar contra el Envenenamiento por Plomo (pamphlet)	National Lead Information Center, http://www.epa.gov/lead/nlicdocs.htm
Questions & Answers on the EPA/HUD Disclosure Rule (EPA 747-F-96-001, March 1996)	Region 3, 215-814-5000
Questions Parents Ask About Lead Poisoning	National Lead Information Center, http://www.epa.gov/lead/nlicdocs.htm
Reducing Lead Hazards When Remodeling Your Home (EPA 747-R-94-002, April 1994); Como Reducir Los Peligros del Plomo al Remodelar Su Casa (EPA 747-R-94-002S)	Region 7, 800-223-0425
Testing Your Home for Lead	National Lead Information Center, http://www.epa.gov/lead/nlicdocs.htm
The Trouble with Lead (Video)	Region 7, 800-223-0425

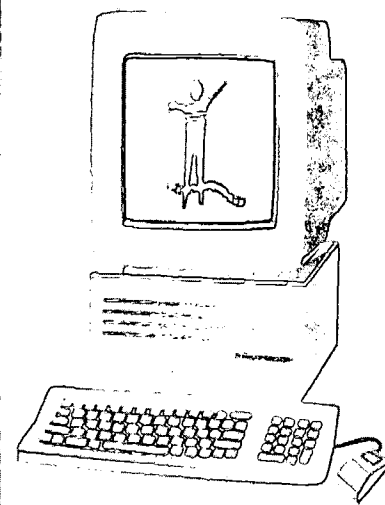

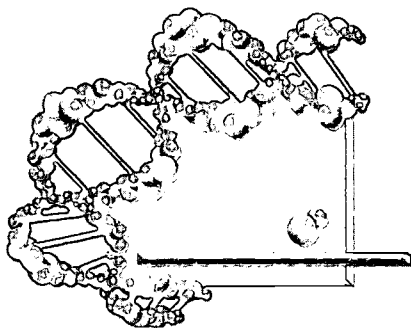

INFORMATION RESOURCES FOR ENDOCRINE DISRUPTORS AND OTHER NEUROTOXICS

Office of Research and Development
 National Health and Environmental Effects Research Laboratory, Mail Code MD-51
 Research Triangle Park, NC 27711
 Phone: 919-541-2281
 Fax: 919-541-4324
 Endocrine Disruptors Research Initiative home page: <http://www.epa.gov/endocrine>

Endocrine Disruptors and Other Neurotoxics Publications and Sources

Publication	Source
Endocrine Disruptor Research Initiative: Relevant Research Publications	http://www.epa.gov/endocrine/pubs.html
Public Health Implications of PCB Exposures (ATSDR/EPA Report, December 1996)	Region 5
Special Report on Environmental Endocrine Disruption: An Effects Assessment and Analysis (EPA 630-R-96-012)	http://www.epa.gov/endocrine/pubs.html
Workshop Report on Developmental Neurotoxic Effects Associated with Exposure to PCB's (EPA 630-R-92-004)	http://www.epa.gov/endocrine/pubs.html
Report to Congress on Mercury (Office of Air and Radiation, December 1997)	http://www.epa.gov/oar/mercury.html
Safe and Correct Handling of PCBs Is Your Responsibility (EPA 910-F-99-009)	Region 10

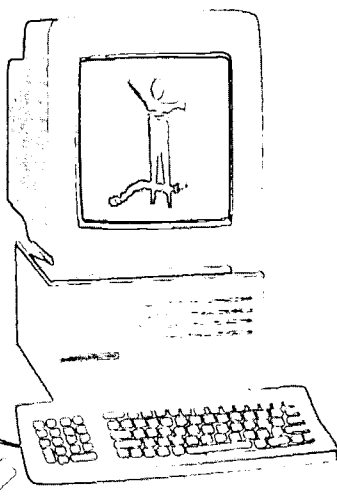

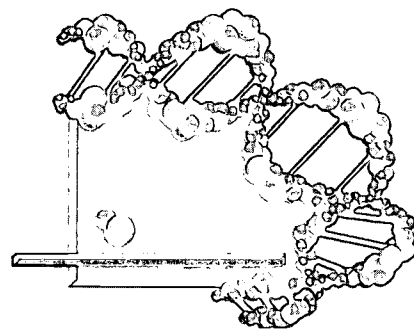

HEALTH EFFECTS OF PESTICIDES

INFORMATION RESOURCES FOR PESTICIDES

Office of Pesticide Programs (OPP)
Field and External Affairs Division
U.S. Environmental Protection Agency
Ariel Rios Building
1200 Pennsylvania Avenue, N.W.
Mail Code: 7506C
Washington, DC 20460-0001
Phone: 703-305-7012
Fax: 703-305-6244

National Pesticide Telecommunications Network (NPTN) Hotline
Toll Free Number: 800-858-7378
Internet: <http://ace.orst.edu/info/nptn/>
E-Mail: nptn@ace.orst.edu

A national toll-free telephone information service that provides callers (parents, consumers, medical community, and federal, state and local governments) with poisoning prevention and technical information on more than 600 pesticide active ingredients and approximately 25,000 product registrations in the United States.

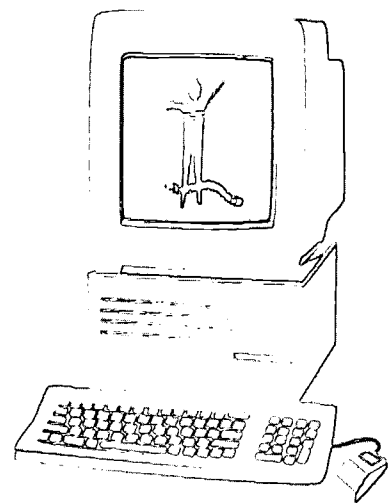

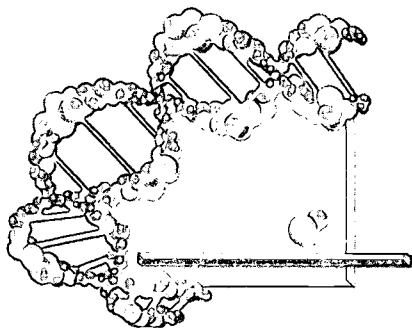

Pesticides Publications and Sources	
Publication	Source
Child-Resistant Packages for Pesticides	Region 4, 404-562-9900
Citizen's Guide to Pest Control and Pesticide Safety (EPA 730-K-95-001, September 1995)	NSCEP
Diagnostico y Tratamiento de Los Envenenamientos por Plaguicidas, Cuarta Edicion (Spanish, EPA 540-R-95-024)	NSCEP
Do You Really Need a Pesticide? (EPA 910-F-94-004)	Region 10, 800-424-4372
Emergency Action Guide for Pesticide Incidents (1992)	Region 5, Pesticides Program Section, 312-886-6003
For Your Information: Protecting the Public from Pesticide Residues in Food (fact sheet, EPA 735-F-96-001)	NSCEP
Growing Food Crops on City Lots (fact sheet, June 1994)	Region 5, Pesticides Program Section, 312-886-6003
Integrated Pest Management (poster, EPA 735-H-92-001)	NSCEP
Methyl Parathion in the Chicago Area (1997)	Region 5, Pesticides Program Section, 312-886-6003
Office of Pesticide Programs Annual Report for 1996 (EPA 735-R-96-001)	NSCEP

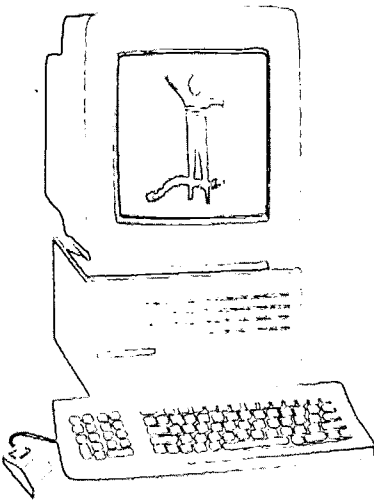

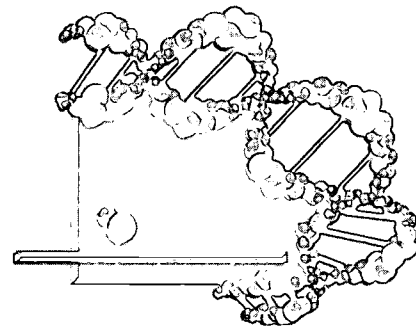

Pesticides Publications and Sources (continued)

Publication	Source
Pest Control in the School Environment: Adopting Integrated Pest Management (brochure, EPA 735-F-93-012)	NSCEP
Pesticide Poisoning Action Guide for Agricultural Pesticides in the Midwest: Resource Directory for Medical Personnel (EPA 905-B-94-001, May 1994)	Region 5, Pesticides Program Section, 312-886-6003
Pesticides and Child Safety (EPA 735-F-93-050R)	NSCEP
Protect Yourself from Pesticides: A Guide for Pesticide Handlers (EPA 735-B-93-003)	NSCEP
Protect Yourself from Pesticides: A Guide for Agricultural Workers/ Protejase de Los Pesticidas: Guia para Los Trabajadores Agricolas (EPA 735-B-93-002)	NSCEP
Protect Yourself from Pesticides (poster, EPA 735-H-93-001)	NSCEP
Protejase de Los Pesticidas: Guia Para Los Que Manejan Pesticidas (EPA 735-B-94-001)	NSCEP

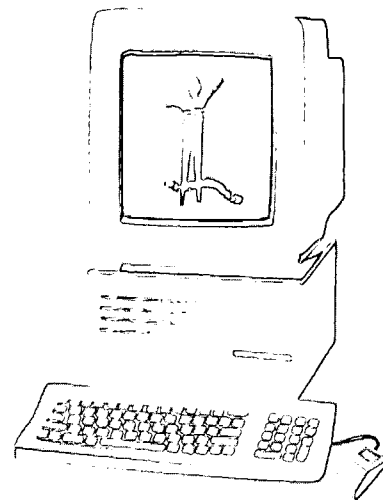

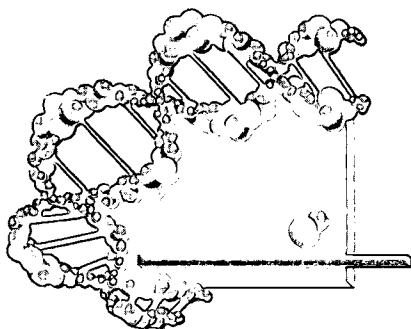

Pesticides Publications and Sources (continued)	
Publication	Source
Recognition and Management of Pesticide Poisonings (Fourth Edition, EPA 540-R-98-001, Fifth Edition, EPA 735-R-98-003. In Spanish, EPA 735-R-98-004)	NSCEP
Status of Pesticides in Re-Registration and Special Review (Rainbow Report, EPA 738-R-94-008)	NSCEP
Steps to Protect Yourself from Pesticides (English/Laotian: EPA 735-F-95-006) (English/Cambodian: EPA 735-F-95-005) (English/Vietnamese: EPA 735-F-95-004) (English/Haitian Creole: EPA 735-F-95-003) (English/Spanish: EPA 735-F-95-002)	NSCEP
10 Tips to Protect Children from Pesticide and Lead Poisonings around the Home (English/Spanish, EPA 735-F-97-001)	NSCEP
The Federal Insecticide, Fungicide, and Rodenticide Act (FIFRA) and Federal Food, Drug, and Cosmetic Act (FFDCA) as amended by the Food Quality Protection Act (FQPA) of August 3, 1996 (EPA 730-L-97-001)	NSCEP
To Spray or Not To Spray (pamphlet, EPA 905-F-95-003)	Region 5, Pesticides Program Section, 312-886-6003

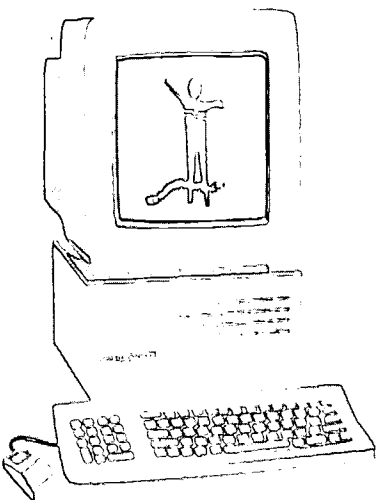

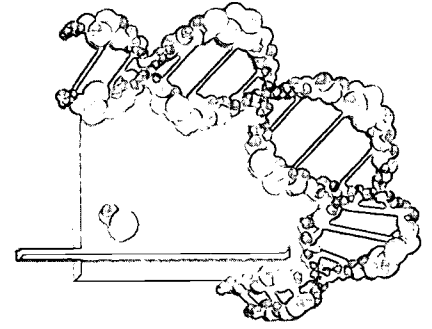

Pesticides Publications and Sources <i>(continued)</i>	
Publication	Source
What You Need to Know About Methyl Parathion and Your Health (fact sheet, 1997)	Region 5, Pesticides Program Section, 312-886-6003
Wood Preservatives for Applicators (booklet, 1987)	Region 5, Pesticides Program Section, 312-886-6003

POTENTIAL RISKS FROM CONTAMINATED WATER

INFORMATION RESOURCES FOR CONTAMINANTS IN DRINKING WATER, SURFACE WATER, AND FISH

Safe Drinking Water Hotline
 Phone: 800-426-4791
 E-Mail: hotline-sdwa@epa.gov

The Safe Drinking Water Hotline is available to help the public, drinking water stakeholders, and state and local officials understand the regulations and programs developed in response to the Safe Drinking Water Act (as amended in 1986 and 1996). This includes information about drinking water regulations and publications, source water protection programs, and public education materials. The Hotline can be reached Monday through Friday (except federal holidays) from 9 a.m. to 5:30 p.m. (Eastern Standard Time).

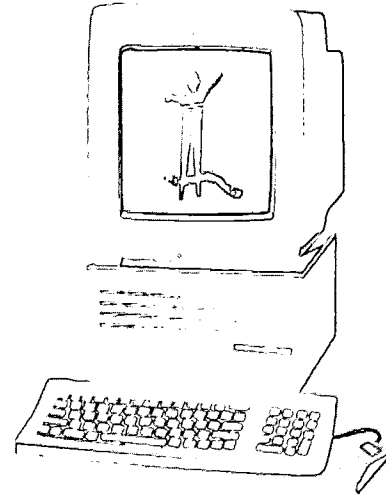

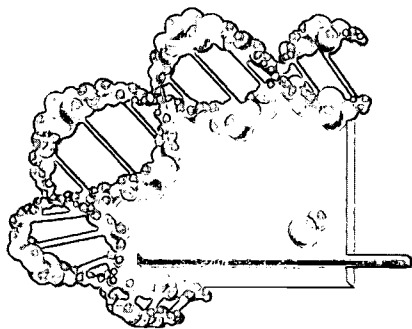

EPA's Office of Water Resource Center
 Water Resource Center (RC-4100)
 Ariel Rios Building
 1200 Pennsylvania Avenue, N.W.
 Washington, DC 20460-0001
 Phone: 202-260-7786
 Fax: 202-260-0386
 E-mail: center.water-resource@epa.gov
 Internet: <http://www.epa.gov/ogwdw/rescenter.html>

EPA's Office of Water Resource Center is a one-stop location for information and materials produced by the Office of Ground Water and Drinking Water, the Office of Science and Technology, and the Office of Wastewater Management, within EPA's Office of Water. Materials available include: fact sheets, guidance manuals, technical reports, models, educational kits, training materials, brochures, videotapes, and posters. The Office of Water Resource Center is open from 8:30 a.m. to 4:30 p.m. EST.

Office of Water Web Site
 Internet: <http://www.epa.gov/ow>

EPA's Office of Water Web site contains current information about a variety of responsibilities throughout the office. The Office of Ground Water and Drinking Water site contains information about the public water system program and standard setting for contaminants. The Office of Science and Technology site contains information about beaches and fish, as well as contaminant health advisories. The Office of Wetlands, Oceans and Watersheds site includes information about watershed protection. The Office of Wastewater Management site includes materials on control and prevention of water pollution from industrial discharge and sludge.

Drinking Water Information in Spanish
<http://www.epa.gov/safewater/agua.html>

This Web site provides basic information about drinking water and some key drinking water materials in Spanish.

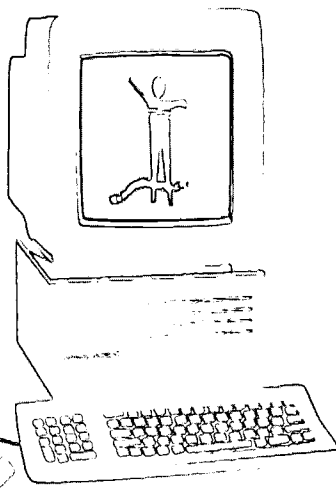

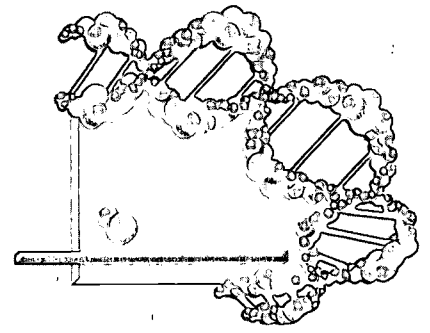

Local Drinking Water Information

<http://www.epa.gov/safewater/dwinfo.htm>

For information about drinking water in your state, click on a state within a U.S. map and you will go to a page which lists major links for that state, including local water systems and their water quality reports, data on whether local water systems have met national drinking water standards, watershed maps, state programs listing how the state intends to prioritize drinking water funding, state programs for drinking water source assessment and protection.

Great Lakes National Program Office
 U.S. Environmental Protection Agency
 Region 5
 77 West Jackson Boulevard
 Chicago, IL 60604-3507
 Phone: 312-886-4046
 Fax: 312-353-2018

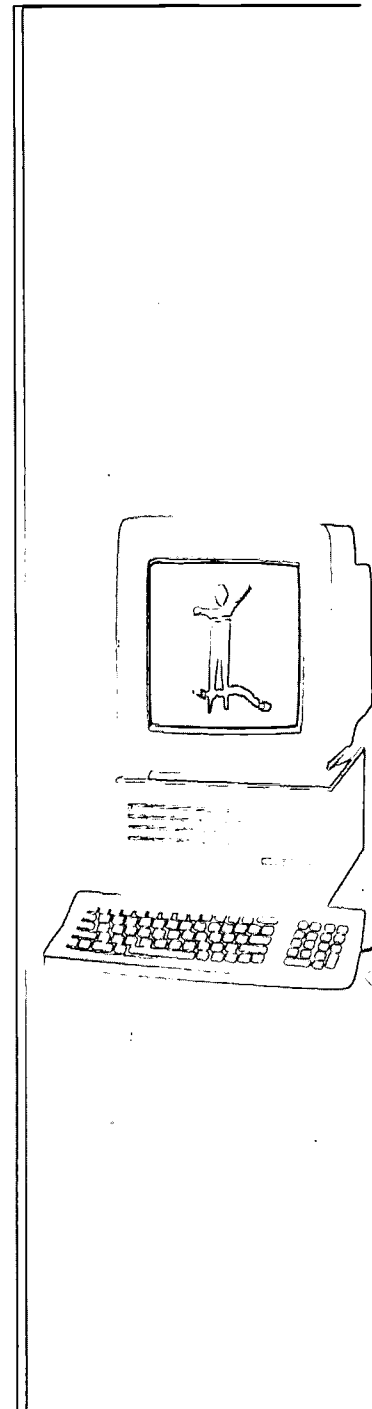

Contaminated Drinking Water, Surface Water, and Fish Publications and Sources

Publication	Source
Before You Go to the Beach (EPA 820-K-97-001, September 1997)	Water Resource Center
Children and Drinking Water Standards (EPA 815-K-99-001)	Safe Drinking Water Hotline or Water Resource Center www.epa.gov/safewater/dwhealth.html

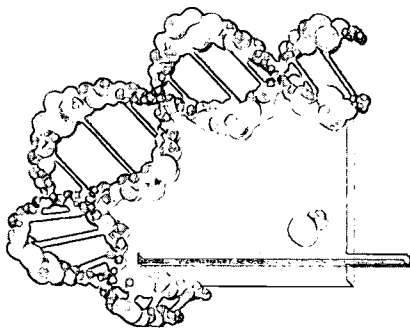

**Contaminated Drinking Water, Surface Water, and Fish
Publications and Sources (continued)**

Publication	Source
Drinking Water and Health (EPA 811-F-95-002-C, October 1995)	Water Resource Center
Drinking Water and Health: What You Need to Know (EPA 816-K-99-001)	Safe Drinking Water Hotline or Water Resource Center www.epa.gov/safewater/dwhealth.html
Drinking Water Counts on You: Blue Thumb Kit (EPA 810-B-97-001)	NSCEP
Drinking Water Health Fact Sheet on Atrazine	Water Resource Center
Drinking Water Health Advisories (fact sheet listing)	Water Resource Center
Drinking Water Public Service Announcements: "Now it Comes With a List of Ingredients"; Drinking Water: Pour Over the Facts" (Posters, line screens, and CDs for radio spots, all in English and Spanish)	Safe Water Hotline or Water Resource Center http://www.epa.gov/safewater/psa.html
Great Lakes Water Quality Initiative Case Studies Show Benefits Outweigh Costs (fact sheet, EPA 820-F-95-002)	Great Lakes National Program Office, Region 5, 312-886-4046
Great Lakes Water Quality Initiative: A Summary (fact sheet, EPA 820-S-95-001)	Great Lakes National Program Office, Region 5, 312-886-4046

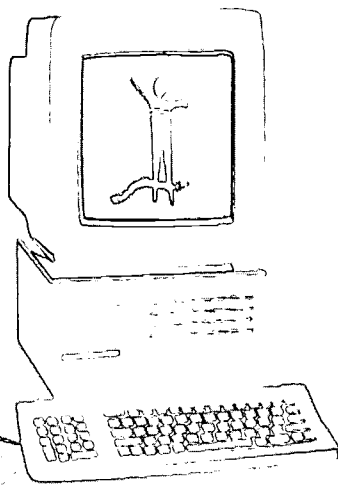

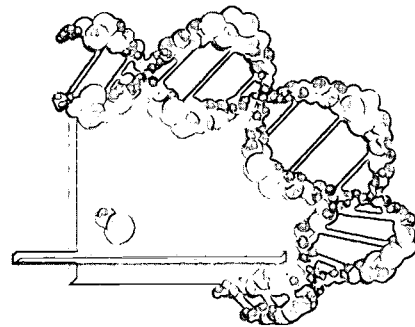

**Contaminated Drinking Water, Surface Water, and Fish
Publications and Sources (continued)**

Publication	Source
Indicator I: Population Served by Community Drinking Water Systems Violating Health-Based Requirements (Safe Drinking Water Information System)	Water Resource Center
Kids Can Help Save Our Streams! (EPA 840-F-96-900)	NSCEP
Lead in Drinking Water: An Annotated List of Publications (EPA 812-K-93-001, October 1993)	Water Resource Center
Lead in Your Drinking Water: Actions You Can Take to Reduce Lead in Your Drinking Water (EPA 810-F-93-001)	Safe Drinking Water Hotline or Water Resource Center www.epa.gov/OGWDW/pubs/lead1.html
National Listing of Fish Consumption Advisories (fact sheet, EPA 823-F-96-006)	Water Resource Center
National Listing of Fish Consumption Advisories Software (7 disk set, EPA 823-C-96-011)	NSCEP
National Study of Chemical Residues in Fish (fact sheet, EPA 823-F-92-001, 1992)	NSCEP

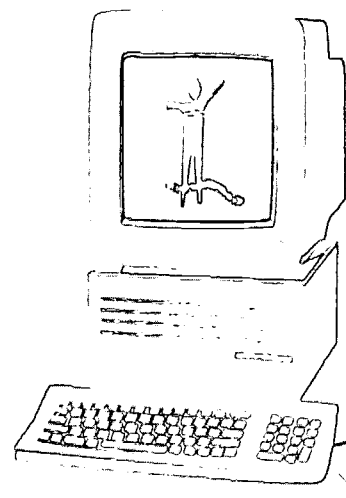

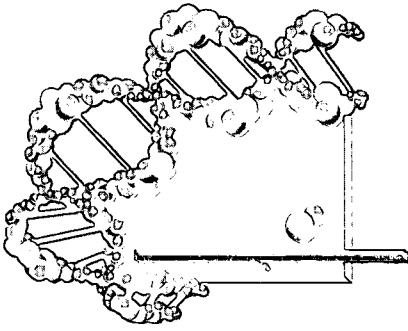

Contaminated Drinking Water, Surface Water, and Fish Publications and Sources (continued)	
Publication	Source
National Primary Drinking Water Standards (EPA 810-F-94-001A, February 1994)	NSCEP
National Listing of Fish Consumption Advisories, Update Fact Sheet (EPA 823-F-95-004)	NSCEP
Preamble to National Primary Drinking Water Regulations for Lead and Copper	<i>Federal Register</i> , Volume 56, Page 26460
Protecting the Great Lakes: The Cost and Benefits of Reducing Toxic Pollution in Three Communities Office (EPA 820-F-95-004)	Great Lakes National Program Office, Region 5, 312-886-4046
Public Drinking Water Information (brochure, EPA 816-F-99-010)	Safe Drinking Water Hotline or Water Resource Center
Public Water Systems Inventory and Compliance Statistics, FY 1991-1995 (EPA 816-R-97-006)	NSCEP
Safe Drinking Water Act Amendments of 1996: General Guide to Provisions (EPA 810-S-96-001)	NSCEP
Safe Drinking Water is in Our Hands (Poster, EPA 815-F-99-003; Booklet, EPA 815-F-99-004)	Safe Drinking Water Hotline or Water Resource Center

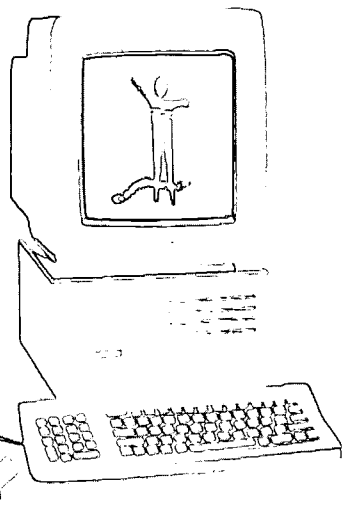

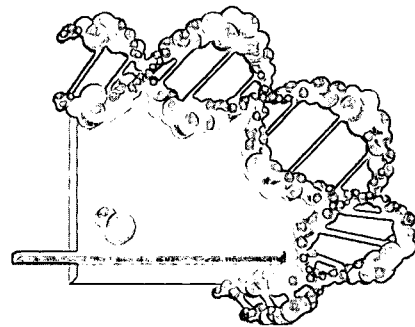

Contaminated Drinking Water, Surface Water, and Fish Publications and Sources (continued)	
Publication	Source
Should I Eat the Fish I Catch? (EPA 823-B-97-009, September 1997)	Water Resource Center
Student Activity Sheets For Drinking Water Projects (EPA 810-F-92-003)	Water Resource Center
Summary of U.S. Great Lakes Beach Closings, 1981-1994 (EPA 905-R-97-003)	NTIS
The Great Lakes: An Environmental Atlas and Resource Book (EPA 905-B-95-001)	Region 5, http://www.epa.gov/region5/fish
The Effects of Great Lakes Contaminants on Human Health: Report to Congress (EPA 905-R-95-017, September 1995)	Great Lakes National Program Office, Region 5, 312-886-4046
U.S. EPA 1997 Supplementary Fish Consumption Advisory for Michigan's Great Lakes Waters Fact Sheet	Region 5, http://www.epa.gov/region5/fish
Water on Tap: A Consumer's Guide to the Nation's Drinking Water (EPA 810-K-97-002, July 1997)	Water Resource Center
Watersheds: Where We Live (poster)	NSCEP
We All Live Downstream (booklet)	Region 3, 215-814-5000

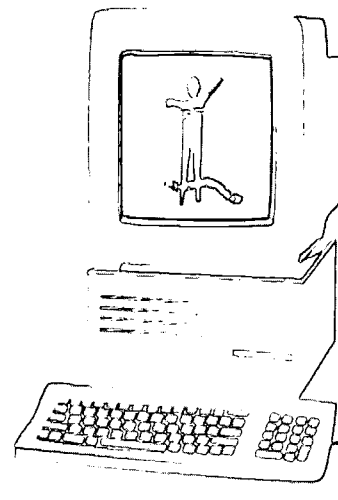

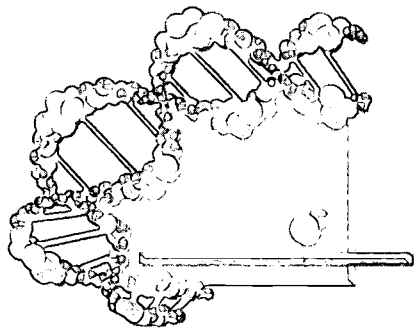

INTERNATIONAL ACTIVITIES

Reducing Health Risks Worldwide: EPA's International Lead Risk Reduction Program. EPA 160-K-98-001. Available from NSCEP.
<http://www.epa.gov/oia/itc/htm>

ENVIRONMENTAL EDUCATION

INFORMATION RESOURCES FOR ENVIRONMENTAL EDUCATION

Office of Environmental Education
U.S. Environmental Protection Agency
Ariel Rios Building, MC-1701
1200 Pennsylvania Avenue, N.W.
Washington, DC 20460-0001
Phone: 202-260-4865
Fax: 202-260-4095
Internet: <http://www.epa.gov/enviroed>

EPA's Office of Environmental Education mission is to advance and support national education efforts to develop an environmentally conscious and responsible public, and to inspire a sense of personal responsibility for the care of the environment in all individuals. For more information regarding Environmental Education Grants, please call 202-260-8619 or fax 202-260-4095.

National Education Association
Health Information Network (NEA, HIN)
1201 16th Street, N.W.
Washington, DC 20036-3290
Phone: 202-822-7570
Fax: 202-822-7775
Internet: <http://www.neahin.org/>
E-mail: neahin@aol.com

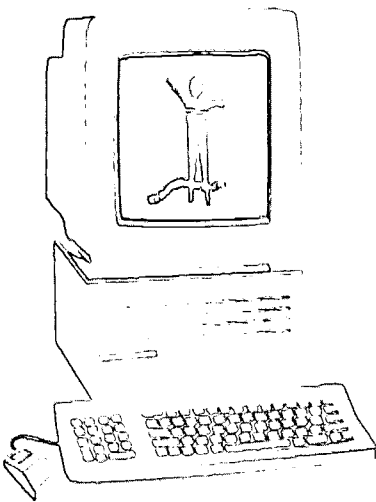

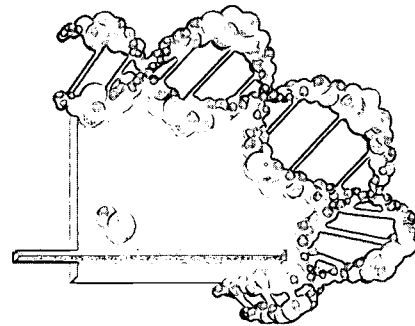

National Parent Teacher's Association
 National PTA Headquarters
 330 N. Wabash Avenue, Suite 2100
 Chicago, IL 60611-3673
 Phone: 800-307-4782
 Fax: 312-670-6783
 Internet: <http://www.pta.org/programs/envlibr.htm>
 E-mail: info@pta.org

Environmental Education Publications and Sources

Publication	Source
1997 PTA Green Almanac A Guide to Environmental Education Resources (January 1996)	OAR-Sponsored National PTA Resources Region 1, Kristen Conroy, 617-918-1069
The ABC's of Environmental Education (EPA 905-K-94-001)	NSCEP
Acid Rain: A Student's First Source Book (children's workbook, EPA 600-990-027A)	http://www.epa.gov/acidrain/student/student2.html , Acid Rain Hotline, 202-564-9620
Breakfast With UEI: Film Descriptions and Ordering Information (a list of educational videos)	Region 1, Kristy Rea, 617-918-1595
Children's Environmental Health Yearbook (EPA 100-R-98-100)	NSCEP OCHP, 202-260-7778

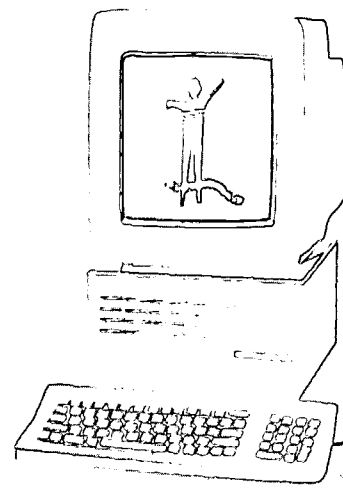

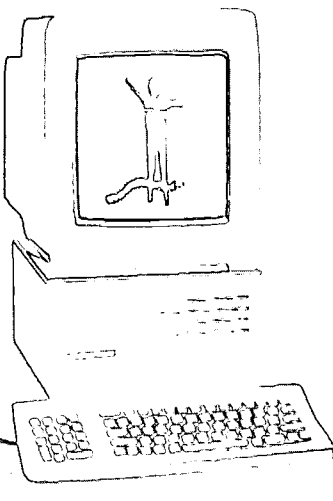
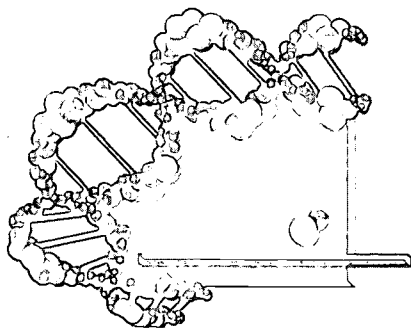

Environmental Education Publications and Sources (continued)

Publication	Source
Environmental Hazards in Your School: A Resource Handbook	Region 3, 215-814-5000
Children's Health Booklet and Video: "E-Hazards"—They're Out There . . .	Region 6, Paula Flores-Gregg, 214-665-8123, or Laura Talbot, 214-665-6678
Drinking Water Activities for Students, Teachers, and Parents (EPA 810-B-99-002)	Safe Drinking Water Hotline, 800-426-4791, or Water Resource Center, 202-260-7786
Environmental Justice Grants Bulletin	OAR-Sponsored NEA, Health Information Network Resources
Environmental Justice and the Indoor Environment (November 1997)	OAR-Sponsored NEA, Health Information Network Resources
Guidelines for Prevention, Recognition, and Resolution of Environmentally-Related Illness in Schools	Region 2, Environmental Education, 212-637-3674
HAZ-ED: Classroom Activities for Understanding Hazardous Waste (EPA 540-K-95-005, April 1996)	http://www.epa.gov/superfund/students/clas_act/haz-ed/hazindex.htm
The Importance of Parent Involvement in Addressing Children's Environmental Health Issues	OAR-Sponsored National PTA Resources

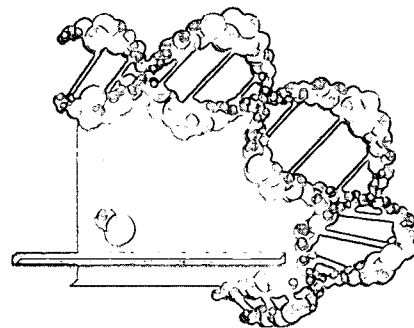

Environmental Education Publications and Sources <i>(continued)</i>	
Publication	Source
Internet Teacher's Lounge	http://www.epa.gov/region07/kids/teachres.htm
Kids Page	Region 7 http://www.epa.gov/region07/kids/welcome.htm
Leader's Guide to Environmental Issues, February 1997	OAR-Sponsored National PTA Resources
Meeting New York State's Crisis in School Facilities Today	Region 2, Environmental Education, 212-637-3674
NEA Health Information Network: IAQ in Schools	OAR-Sponsored NEA Health Information Network Resources
New England Area Environmental Education Grants Program, Federal Fiscal Year 1998	Region 1 http://www.epa.gov/region/ra/ed/grant98.html
Report to the New York State Board of Regents on the Environmental Quality of Schools	Region 2, Environmental Education, 212-637-3674
School Recycling Programs: A Handbook for Educators (booklet)	Region 3, 215-814-5000
Student Activity Sheet: Tracking Pollution, a Hazardous Whodunnit (EPA 810-F-93-003)	NSCEP

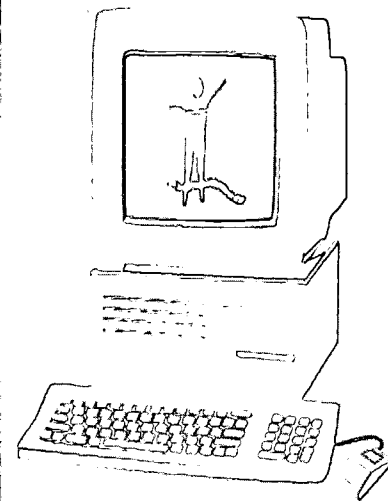

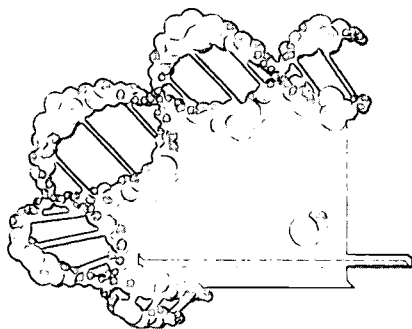

Environmental Education Publications and Sources (<i>continued</i>)	
Publication	Source
The Source: Indoor Air, Water and Your Schools (Volumes 1-4, June 1997)	OAR-Sponsored NEA Health Information Network Resources
Tips to Protect Children from Environmental Health Threats (EPA 100-F-00-008)	NSCEP OCHP, 202-260-7778
Tips to Protect Children from Environmental Threats-NSC Video "My Kids"	OCHP-sponsored NSC-EHC 202-293-2270
Workshop Presentation Kit (for use by PTA leaders to conduct environmental workshops at state PTA conventions)	OAR-Sponsored National PTA Resources

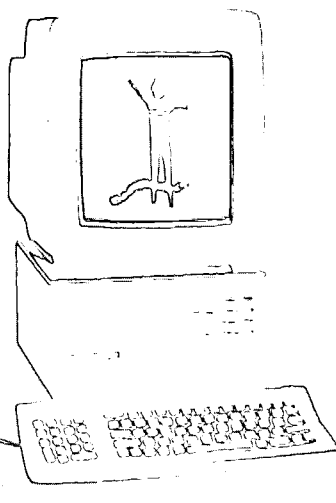

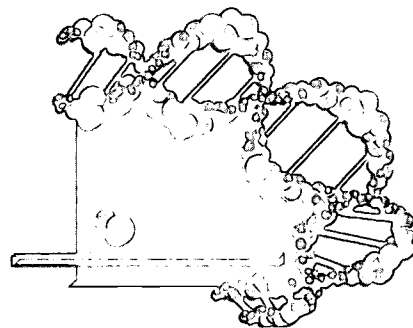

ENHANCED COMMUNITY RIGHT-TO-KNOW

INFORMATION RESOURCES FOR COMMUNITY RIGHT-TO-KNOW

Office of Prevention, Pesticides, and Toxic Substances

U.S. Environmental Protection Agency

Ariel Rios Building, MC-7404

1200 Pennsylvania Avenue, N.W.

Washington, DC 20460-0001

Phone: 202-260-1531

Toxic Release Inventory (TRI) home page: <http://www.epa.gov/opptintr/tri>

Defines TRI and provides information on accessing and using TRI data; program development; national and international programs; stakeholder dialogue; contacts; latest public data release report; training for newly added industries; guidance documents for newly added industries; and public meetings.

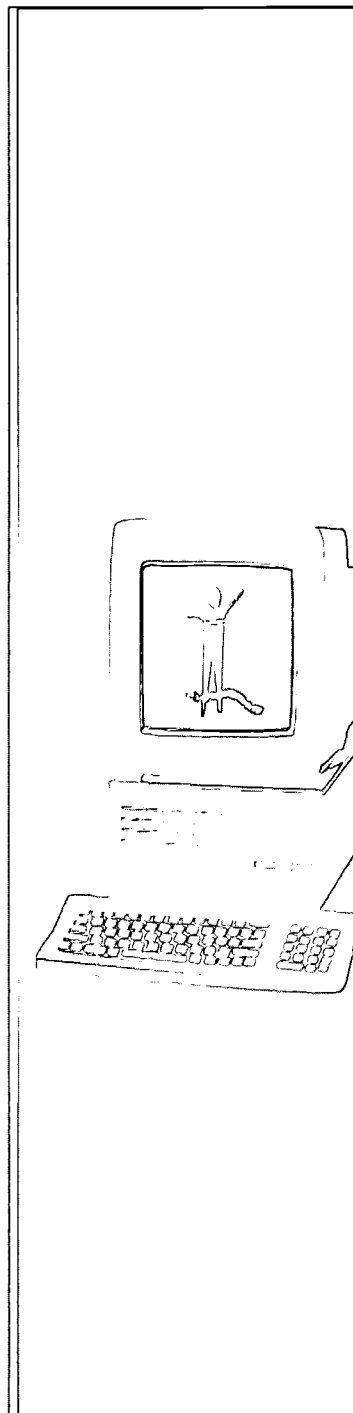

Community Right-to-Know Publications and Sources

Publication	Source
1997 Toxics Release Inventory Public Data Release, April, 1999	http://www.epa.gov/opptintr/tri
1997 Toxics Release Inventory State Fact Sheets (EPA 745-F-99-001, April 1999)	NSCEP
Chemicals in Our Community	http://www.epa.gov/opptintr

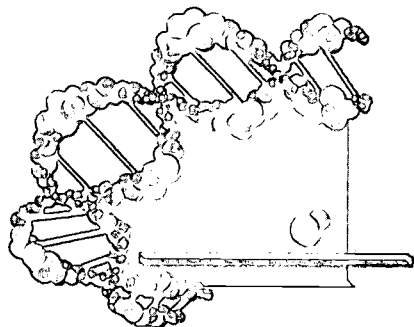

Community Right-to-Know Publications and Sources	
Publication	Source
Chemical Right to Know Fact Sheet Series (EPA 745-F-98-002)	NSCEP
Children's Health Testing Program	http://www.epa.gov/opptintr/chemrtk/childhlt.htm
Children's Healthline	http://www.epa.gov/reg03esd1/childhealth/index.htm
Consumer Labeling Initiative (CLI)	http://www.epa.gov/opptintr/labeling/index.html
EPA's Guide to Environmental Database Basics	OPPTS, Georgianne McDonald, 202-260-4182
Guidance for Chemical Indexing Abstract	http://www.epa.gov/reg3artd/tchem/chemind.htm (for a complete copy, contact Debra L. Forman at 215-566-2073)
The Right to Know Network	http://www.rtk.net
TRI Information Kit (EPA 749-K-98-001)	http://www.epa.gov/opptintr/tri/whatis.htm or NSCEP
The TRI Teachers Guide, Getting Started (CD-ROM)	OPPTS, Georgianne McDonald, 202-260-4182

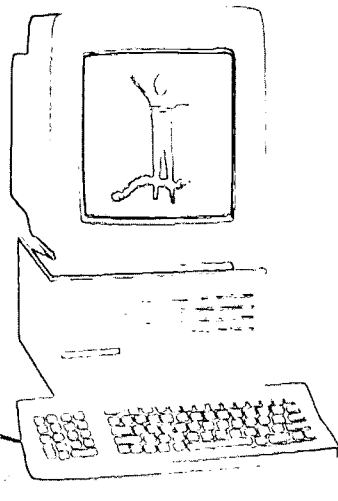

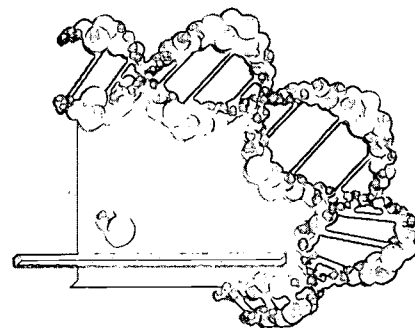

OTHER FEDERAL AGENCIES WITH PROGRAMS RELATED TO CHILDREN'S ENVIRONMENTAL HEALTH

Nearly all federal agencies are pursuing children's environmental health. The Task Force to Reduce Environmental Health Risks and Safety Risks to Children (established by President Clinton's Executive Order on Protection of Children from Environmental Health Risks and Safety Risks) involves EPA and the following:

- **Office of Science and Technology Policy, National Science and Technology Council (NSTC)** Old Executive Office Building, 17th Street and Pennsylvania Avenue, N.W., Washington, DC 20502, 202-456-7116. Internet: http://www.whitehouse.gov/WH/EOP/OSTP/NSTC/html/NSTC_Home.html
- **Council of Economic Advisers (CEA)** Old Executive Office Building, 17th Street and Pennsylvania Avenue, N.W., Washington, DC 20502, 202-395-5042. Internet: <http://www.whitehouse.gov/WH/EOP/CEA/html/>
- **Council on Environmental Quality (CEQ)** Old Executive Office Building, 17th Street and Pennsylvania Avenue, N.W., Washington, DC 20502, 202-465-6224. Internet: <http://www.whitehouse.gov/CEQ>
- **Office of Management and Budget (OMB)** Old Executive Office Building, 17th Street and Pennsylvania Avenue, N.W., Washington, DC 20502, 202-395-5042. Internet: <http://www.whitehouse.gov/OMB>
- **Department of Health and Human Services, National Institute of Environmental Health Sciences (NIEHS)** Building 101, Headquarters, P.O. Box 12233, Research Triangle Park, NC 27709, 919-541-3345. Internet: <http://www.niehs.nih.gov>
- **Department of Health and Human Services, Agency for Toxic Substances and Disease Registry (ATSDR)** Building 16, Centers for Disease Control and Prevention, 1600 Clifton Road, N.E., Atlanta, GA 30333, 888-42-ATSDR. Internet: <http://www.atsdr.cdc.gov/child>
- **Department of Health and Human Services, Centers for Disease Control and Prevention (CDC)** Building 16, Centers for Disease Control and Prevention, 1600 Clifton Road, N.E., Atlanta, GA 30333, 404-639-3534. Internet: <http://www.cdc.gov>; and Mail Stop F-29, 4770 Buford Highway, N.E., Atlanta, GA 30341-3724, 888-232-6789. Internet: <http://www.cdc.gov/nceh/info/programs.html>

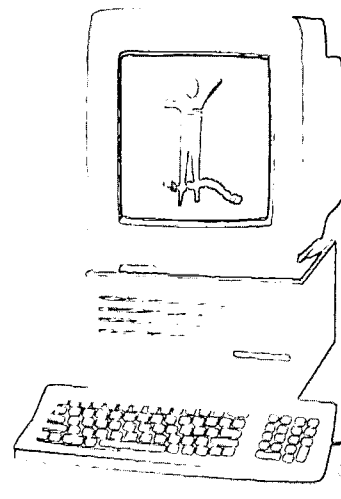

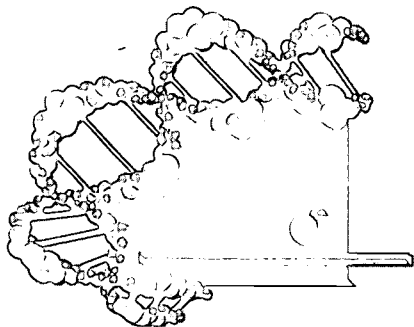

- **Department of Health and Human Services, Office of Disease Prevention and Health Promotion (ODPHP)** Hubert H. Humphrey Building, 200 Independence Avenue, S.W., Washington, DC 20202, 202-205-8611. Internet: <http://odphp.osophs.dhhs.gov>
- **Department of Education (DoED)** 400 Maryland Ave, S.W., Washington, DC 20202, 800-USA-LEARN. Internet: <http://www.ed.gov>
- **Department of Labor (DOL)** Francis Perkins Building, 200 Constitution Avenue, N.W., Washington, DC 20210, 202-693-4650. Internet: <http://www.dol.gov>
- **Department of Justice (DOJ)** Main Justice Building, 950 Pennsylvania Avenue, N.W., Washington, DC 20530-0001, 202-514-2001. Internet: <http://www.usdoj.gov>
- **Department of Energy (DOE)** Forrestal Building, 1000 Independence Avenue, S.W., Washington, DC 20585, 202-586-6210. Internet: <http://www.doe.gov>
- **Department of Housing and Urban Development (HUD)** HUD Building, 451 Seventh Street, S.W., Washington, DC 20410, 202-708-0417. Internet: <http://www.hud.gov>
- **Department of Transportation (DOT) National Highway Traffic Safety Administration** Nassif Building, 400 Seventh Street, S.W., Washington, DC 20590, 202-366-1111. Internet: <http://www.dot.gov>
- **Department of Agriculture (USDA)** Jamie L. Whitten Federal Building, 1400 Independence Avenue, S.W., Washington, DC 20250, 202-720-3631. Internet: <http://www.usda.gov>
- **Consumer Product Safety Commission (CPSC)** East West Towers, 4330 East West Highway, Bethesda, MD 20814, 301-504-0213. Internet: <http://www.cpsc.gov>

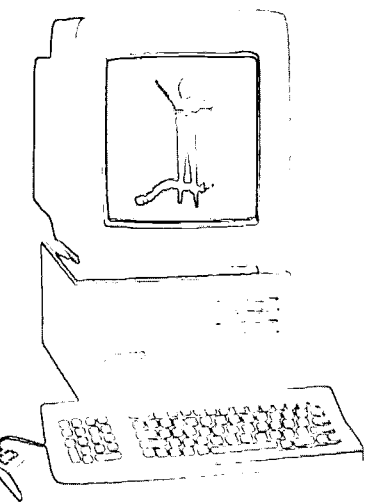

INDEX

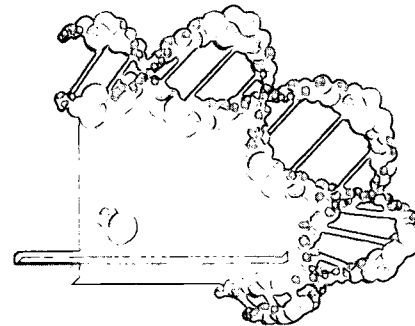

EPA Program Offices

Office of Air and Radiation

IAQ Tools for Schools	23
Working with Partners to Improve Indoor Air	
Quality in Schools	23
National Education Association	23
American Association of School Administrators	23
National Parent-Teacher Association	24
Urban Schools IAQ Project	24
Training School Nurses on <i>IAQ Tools for Schools</i> and Asthma	25
School Intervention Study	25
American Lung Association Open Airways	25
Environmental Tobacco Smoke Media Campaign	29
Reducing Exposure to ETS through Child Care Outreach	30
Community-Based Pediatrician Outreach	30
Hispanic Health Project	30
Asthma Media Campaign	33
Asthma Case Studies	33
Increasing Indoor Air Action in American Asian and Pacific Islander (AAPI) Communities ..	33
Asthma and Allergy Essentials for Childcare Providers	34
Asthma Collaborative Program	34
Early Intervention and Treatment of Asthma ..	35
Clearing The Air: Asthma and Indoor Air Exposures	45
Let Kids Lead	51
SunWise School Program	59
Ozone Depletion Art Project	60
U.S.-Canada Air Quality Agreement	138

Office of Children's Health Protection

Centers of Excellence in Children's Environmental Health Research	7
University of Southern California, Department of Preventive Medicine, Los Angeles, California	8
University of Iowa, College of Medicine, Iowa City, Iowa	8

University of Michigan, School of Public Health, Ann Arbor, Michigan	8
Johns Hopkins University, School of Medicine, Baltimore, Maryland	8
University of California at Berkeley, School of Public Health, Berkeley, California	9
University of Washington, Department of Environmental Health, Seattle, Washington	9
Mount Sinai School of Medicine, New York, New York	9
Columbia University, School of Public Health, New York, New York	9
Children's Environmental Health and Safety Inventory of Research	10
Institutionalizing Children's Health Protection in EPA's Rule Making	10
Federal Advisory Committee on Protection of Children's Environmental Health	10
Reviewing Existing Regulations and Standards	11
Workshop on Valuing Children's Health Effects	11
Child Health Champion Campaign	11
Incorporating Children's Environmental Health into Youth-Based Organizations	14
Targeting Criminal Violations that Threaten the Health and Safety of Children	15
State Profiles - Children's Environmental Health	15
Promoting Children's Environmental Health With Pediatric Chief Residents	15
Action to Eliminate Major Uses of the Pesticide Dursban to Protect Children and Public Health	15
Tips to Protect Children from Environmental Threats	16
Eliminating Childhood Lead Poisoning: A Federal Strategy Targeting Lead Paint Hazards	65

Office of International Activities

Children's Lung Function Study in China	138
Alaska Native Cord Blood Monitoring Program	139

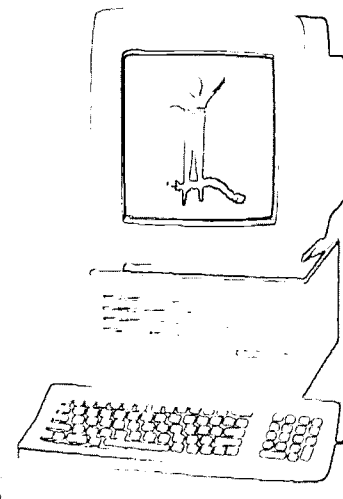

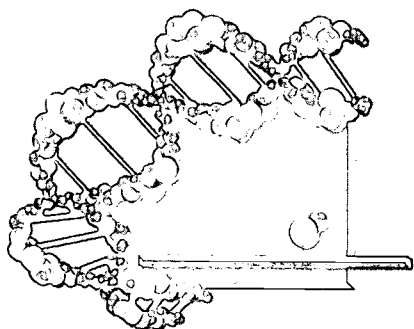

National Strategy for Lead Risk Reduction in Russia	139	Mechanisms of Age-Dependent Ozone-Induced Airway Dysfunction	53
Children's Blood Lead Level Screening in Russia	140	Deposition of Air Pollutants in the Developing Human Lung	54
Mobile Source Training/Lead Phase-Out Training	140	Assessment of Genetic Alterations in Newborns and Adults	61
Pesticides Management Project in Central America	141	Fetal Metabolism of Aflatoxin B1 and Susceptibility to Childhood Cancer	61
Microbiologically Safe Drinking Water Laboratory Capacity in Latin America	142	Identification of Lead Exposure and Risk Reduction	66
Municipal Water Management in Latin America	143	Environmental Lead Risks	66
The Central American Small Community Wastewater Treatment Project	143	Endocrine Disrupting Chemicals Theme	86
Office of Policy, Economics and Innovation		Receptor and Signal Transduction Pathways in Developmental Toxicity	86
Direct and Indirect Costs of Asthma and the Potential Benefit of Education and Intervention	45	Developmental and Reproductive Toxicology (DART) Database	88
Office of Prevention, Pesticides, and Toxic Substances		Heat Shock Model (Mechanisms) for Developmental Toxicity	88
Public Education and Outreach Grants	66	Biologically Based Dose-Response Modeling of Developmental Toxicity	89
The National Cinema Outreach Pilot Project	67	Texas Neural Tube Defect Project	89
Proposed Labeling Restriction for Insect Repellents used on Infants and Children	95	Cellular and Molecular Markers of Developmental Neurotoxicity	89
Cockroaches, Kids and Asthma Video	96	Environmental Exposures and Human Neurological Function	90
IPM in School Projects	98	Role of Apoptosis in Developmental Toxicity	90
IPM in Schools Training/Workshops	99	Improved Evaluation of Gamete Function	90
Children's Health Chemical Testing Program	159	Molecular Characterization of a Biological Threshold in Developmental Toxicity	91
Pre-Renovation Information Rule	159	Using Biomarkers of Exposure and Neurobehavioral Test Batteries to Assess Children's Neurological Vulnerability to Residential Exposure to Tetrachloroethene (Perc)	91
Lower Threshold for Lead TRI Reporting	160	Study of Exposure and Body Burden of Children of Different Ages to Pesticides in the Environment	102
TRI Education Product	160	Ingestion of Pesticides by Children in an Agricultural Community on the U.S.-Mexico Border	102
Office of Research and Development		Exposure of Children to Persistent Organic Pollutants and Pesticides	103
Increased Vulnerability of Neonates to Naphthalene and Its Derivatives	46	NAFTA Border Project: Pesticides and Kids	103
Childhood Susceptibility to Air Pollutants	52	Microenvironmental Methods for Residential Exposure to Pesticides	103
Oro-Nasal Ventilation Pattern in Children and Associated Fine Particulate Matter Deposition	52		
Exacerbation of Asthma among Inner City Children	52		
Acute Respiratory Health and Ambient Air Quality in the Paso del Norte Airshed	53		

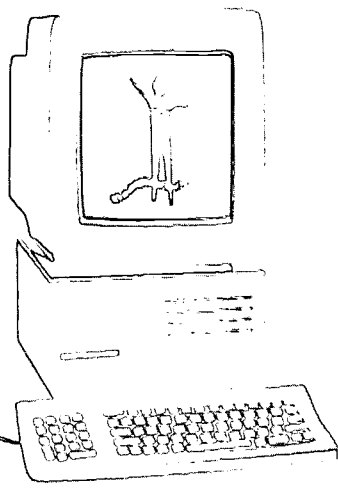

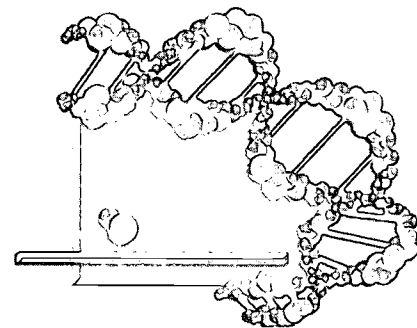

Exposure of Children to Pesticides and Toxics	104	Evaluation of Arsenic Metabolic Profiles in Adults and Children	114
Exposure of Children to Pesticides in Yuma County, Arizona	104	Disinfectant Byproducts and Birth Defects	114
Vulnerability of Young Children to Organophosphate Pesticides and Selected Metals Through Intermittent Exposures in Yuma County, Arizona	105	Community Intervention Studies for Drinking Water	114
Exposure of Children to Pesticide Residues	105	Exposure of Children and Susceptible Populations to Chemicals in Drinking Water	115
Interactions and Mechanisms of Pesticide Mixtures—Children's Risk	105	Genetic Damage Associated with DBPs	121
Pesticide Interactions Affecting Fate and Transport and Children's Risk	106	Rapid Scientific Methods for Measuring the Quality of Bathing Beach Waters	121
Long-Term Potentiation as a Model System for Cognitive Function	106	Bathing Beaches Monitoring Protocols and Communicating Swimming Activity Risk to the Public	122
Pilot Study of Symptomatic Young Children for Pesticide Exposure	106	Human Exposure-to-Dose Models: Models and Modeling Methods for Assessing Human Exposure and Dose to Toxic Chemicals and Pollutants	126
Pilot Study of Immunologic Effects of Pesticide Exposure in Infants	107	Dietary Exposure of Children	126
Biochemical Effects of Pesticides on the Central Nervous System	107	Developing Risk Assessment and Risk Management Models for Exposure of Children to Toxic Mold, Using <i>Stachybotrys chartarum</i> as the Model Mold	127
Cognitive Effects of Pesticide Exposure During Development	107	Multipathway Exposure Modeling of Children and Adults to Pesticides and Toxics	127
Identifying the Mode and Mechanism of Action of Atrazine on Endocrine Function in the Female Rat	108	Workshop to Identify Critical Windows of Exposure for Children's Health	128
The Effects of Pesticides on the Immune System and Allergic Response	108	Childhood Exposure Factors Handbook	128
Perinatal Exposure of Rats to Toxic Chemicals and Pesticides and the Effects on Immune Function Development	108	IEUBK Model Expansion	128
A Study of Childhood Pesticide Poisoning in the Lower Rio Grande Valley	109	EPA's Contribution to Children's Assessment in NHANES IV	129
Non-Occupational Pesticide Illness Surveillance	109	Children's Risk: Summary Statistics of Selected Data Elements of NHANES III	130
Pesticide Exposure and Health Effects in Young Children along the U.S.-Mexico Border	109	Evaluation of Methods to Scale Pharmacokinetic Parameters between Adults and Children	130
Neurobehavioral Characterization of Susceptible Populations and Pesticide Neurotoxicity	110	Ethnic and Minority Highly Exposed Children's Populations	130
Metabolic Basis for Age-Dependent Effects of Pesticides	110	Children's Environmental Health and Safety Inventory of Research	130
Chronic Arsenic Exposure and Reproductive Effects from Drinking Water	113	Protective Mechanisms Theme	131
		North Carolina Birth Cohort Study	131
		A Survey of Health and Environmental Conditions along the Texas-Mexico Border	132
		Assessment of Chemical Mixtures	134

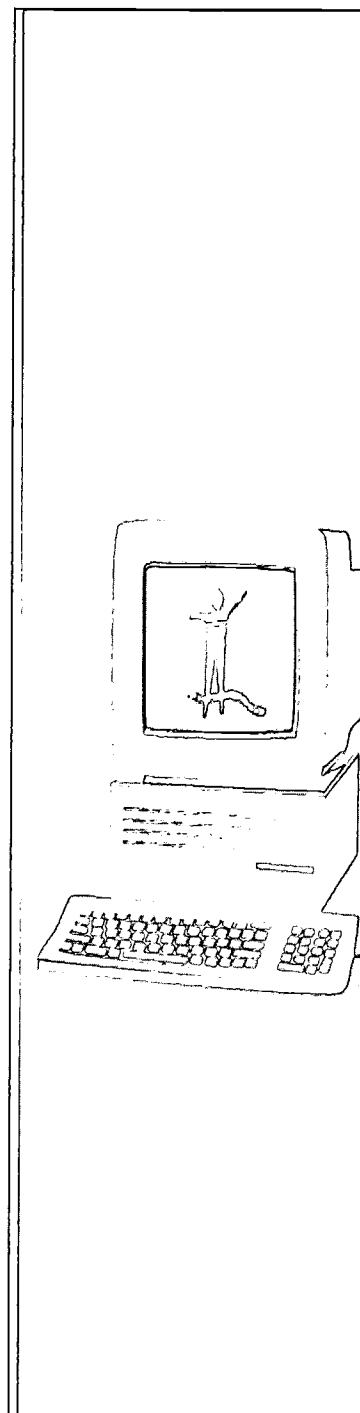

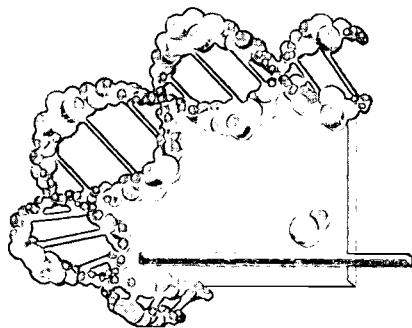

Particulate Matter Epidemiology in Children . . .	137	Environmental Monitoring for Public Access and Community Tracking (EMPACT) Lead Safe Yard Program	69
China Urban Respiratory Health Study	137	EPA National Lead Poisoning Prevention and Lead Hazard Awareness Public Education and Outreach Program: Crittenton Hastings House, Boston, Massachusetts	70
The Effects of Lead in Children and Adolescent Development	139	EPA Supplemental Environmental Projects (SEP), Providence, Rhode Island	70
Office of Solid Waste and Emergency Response		Keep It Clean Campaign, Video, Posters, Billboards	70
Development of Guidance on the Use of Probabilistic Analysis in Risk Assessment at Superfund Sites	122	Providence, Rhode Island, Mayor's Safe Housing Lead Task Force	71
Community Involvement in Superfund Risk Assessments	123	IMPACT CD-ROM Technology	71
Superfund Basic Research Program	123	Lead Safe Renovation Training - Interactive CD-ROM	71
Office of Solid Waste Risk Assessments	124	First Steps: Childcare Provider/Parent Lead Awareness Manuals, Video, and CD-ROM	72
Office of Water		Urban Environmental Initiative (UEI) Cooperative Agreement: Urban Revival, Inc., Prevent Lead Poisoning Project	72
Children and Drinking Water Standards Brochure	113	Time Related Environmental Numeric Health Data System (TRENHDS) CD-ROM	73
Microbial Disinfectants and Disinfection Byproducts	115	UEI Cooperative Agreement: Lead Poisoning Prevention Awareness Program for Childcare Providers	73
Non-Commercial Fish Consumption Kit for Health Care Providers	118	UEI Cooperative Agreement: Codman Square Lead Poisoning Prevention Initiative	73
Drinking Water Quality Reports	161	UEI Cooperative Agreement: ReVision House, Roxbury, Massachusetts	74
EPA Regions		Healthy Beginnings: Lead Safe Families	74
Region 1		Lead Suite CD-ROM	75
Child Health Champion Program, Manchester, New Hampshire	12	One Way to Increase the Commitment: Conference on the Food Quality Protection Act	96
EPA Regional School-Based Programs to Improve Indoor Air Quality	26	Environmental Justice in the "Hood" 1999	146
National Civil League Coalition Building Training	35	An Afternoon with UEI: Community Gardens/Urban Agriculture	147
ZAP Asthma Community Conference	36	Healthy Schools: Designing, Renovating, and Maintaining Our School Buildings	147
Urban Asthma Community Conference and Coalitions	36	Urban and Environmental Initiative	148
Asbestos-in-Schools Rule	59	Region 2	
Environmental Justice Grant: Lead Action Collaborative, Boston, Massachusetts	67	Child Health Champion Program, Ironbound Section, Newark, New Jersey	12
Consortium of North East States and Tribes (CONEST)	68		
New England Lead Coordinating Committee (NELCC)	68		
Tribal Based Environmental Protection (TBEP) Program	69		

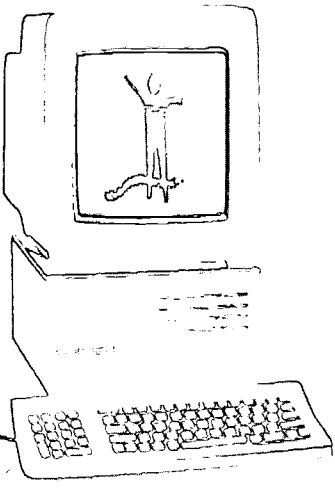

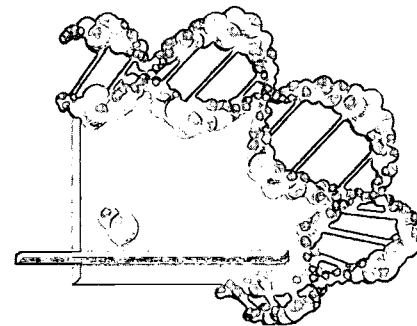

Puerto Rico Department of Health—Asthma Coordinator37

Integrated Pest Management in Urban Low-Income Housing Projects37

Educational Photoliterature as a Means to Reduce Cockroach and Rodent Infestations Without Pesticides in a Low-Income Setting37

Asthma Education in East Harlem38

Fighting Asthma in HUD Housing38

Clinical Directors Network Asthma Intervention Project39

Camden-Rutgers University Asthma Project39, 75

English/Spanish Video on Reducing Indoor Asthma Triggers in Inner City Dwellings ...40

Meeting of Hispanic Biomedical Association ...46

Asthma Intervention Study in Hunts Point ...47

Montefiore Medical Center Asthma Intervention Project47

Allergen Levels in Homes of Native Americans48

Indoor Allergens Study in Puerto Rico48

Educational Photoliterature on Pesticide Misuse99

Non-PRASA (Puerto Rico Aqueduct and Sewer Authority) Initiative116

Fish Advisories118

Determining Potential Exposure of Children near Superfund Sites124

Vega Baja Solid Waste Disposal125

Education about Asthma, Environmental Tobacco Smoke, and Lead148

Asthma and Lead Abatement Training and Education (ALATE), Camden, New Jersey, and Northern Philadelphia, Pennsylvania ...148

Environmental Education Grants149

Environmental Justice Grants149

Getting a Head Start on Environmental Education150

Newark Asthma and Lead Poisoning Education and Risk Reduction Project150

Region 3

Child Health Champion Program, Anacostia Section, Washington, DC12

SunWise60

Environmental Education Project75

Lead-Safe Babies Project76

Reducing Exposure to Lead in Drinking Water in Philadelphia's School District77

Childhood Risk Assessment at Superfund Sites91

The Children's Healthline161

Region 4

Child Health Champion Program, Prichard, Alabama12

EPA Regional School-Based Programs to Improve Indoor Air Quality27

Outreach Campaign on Secondhand Smoke and Children31

Indoor Asthma and Allergen Control40

Radon Mitigation for School Maintenance Personnel57

Lead Umbrella Workshop77

The National Urban and Residential Pesticide Control and Enforcement Program (Urban Initiative)100

Preparing Maps of Region 4 Depicting Environmental, Health, and Demographic Characteristics132

Pediatric Environmental Health Specialty Unit145

Children's Pesticides, Asbestos, and Lead (PAL) Initiative151

Region 5

Child Health Champion Program, Near South/North Side Sections, Milwaukee, Wisconsin13

EPA Regional School-Based Programs to Improve Indoor Air Quality27

Grant to Cuyahoga County Board of Health, Ohio31

Seminar Series on Asthma40

Community Partnership to Improve the Lives of Asthmatic Children in Chicago41

Managing Asthma in the Childcare Setting41

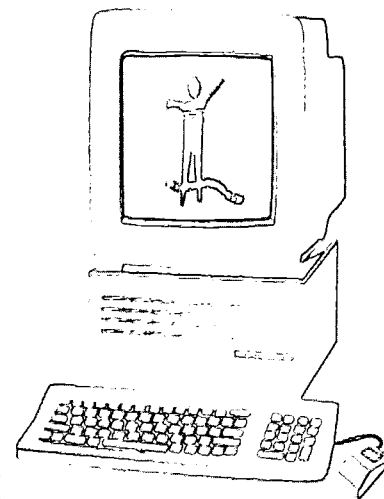

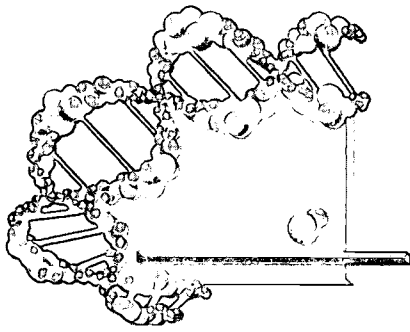

School Intervention Project—Headquarters/ Springfield School Indoor Air Risk Factors Study	49	Childhood Asthma and Allergies Conference	41, 154
Asthma Risk Factor Study of Chicago Public School, Before and After Implementation of an Integrated Pest Management Program . . .	49	Environmental House Calls	42
Elevated Blood Lead Levels - Regions 5 States	78	Indoor Biological Risk Factors for Asthma in School Age Children	49
Outreach to Migrant Farm Worker Health Promoters on Reducing Lead Exposure Risks to Children	78	Lead Poisoning Prevention and Control Training	79
Environmental WATCH Small Grants (Lead) . .	78	TSCA Section 406(b) Pre-Renovation Notification Rule	79
Environmental WATCH Small Grants (Mercury)	87	Bilingual (English/Spanish) Pesticide Safety Bingo Game	97
Elemental Mercury Exposures in Children: A Workshop to Examine the Scope of the Problem and Opportunities for Prevention . .	87	Water Awareness Program	117
Pesticide Regulatory Education Program	99	Environmental Health Workshops	144
Environmental WATCH Small Grants (Pesticides)	99	Community-Based Training for Lay Health Promoters (Promotores) and Primary Care Clinicians	145
Safe Drinking Water Branch Compliance Workshops	116	Children's Video: "E-Hazards"—They're Out There	153
Reduction/Elimination of Persistent Toxic Substance in Great Lakes	117	Children's Health Booklet: "E-Hazards"— They're Out There	153
Children's Exposure Priorities at/near Superfund Sites	125	Educating Parents about Environmental Dangers to Children	154
Environmental Pollutant Exposures in Children (EPEC) Project	133	Healthy Environments and Living Places (HELP) for Kids	154
Update on Chicago Cumulative Risk Initiative (CCRI) Project	135		
U.S.-Canada Great Lakes Water Quality Agreement (GLWQA)	142	Region 7	
Center for Children's Environmental Health at Cook County Hospital, Chicago, Illinois . .	146	Child Health Champion Program, New Madrid County, Missouri	13
Second Annual Region 5 Children's Environmental Health Conference	152	EPA Regional School-Based Programs to Improve Indoor Air Quality	28
Pollution Prevention Educational Demonstrations	152	Indoor Air Environment Program for Children	31
Environmental WATCH Small Grants: Operation Clean Sweep	153	Radon Outreach	57
		Asbestos Outreach and Technical Assistance . . .	59
Region 6		Region 7 Lead-Based Paint Activities	80
Child Health Champion Program, Cherokee Nation, Talequah, Oklahoma	13	Local Lead Awareness Campaign	81
		Environmental Education in the Paris School District	155
		Region 8	
		Child Health Champion Program, Chippewa Cree Tribe, Rocky Boy's Reservation, Montana	13
		EPA Regional School-Based Programs to Improve Indoor Air Quality	28

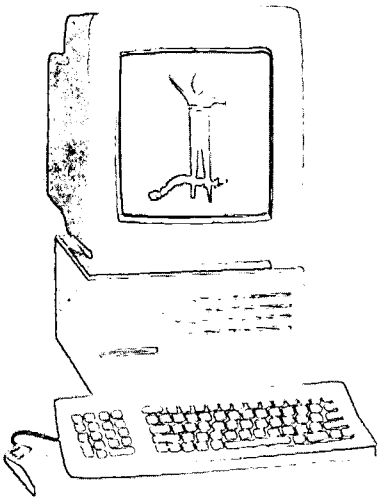

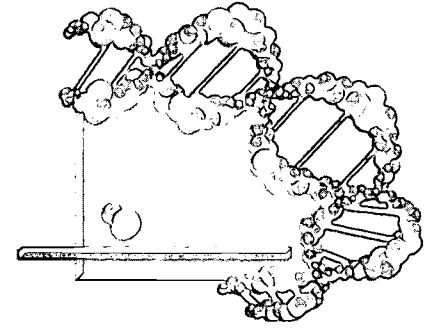

ETS Outreach Project32
 Colorado Asthma Summit 42
 Girl Scouts Asthma Awareness Badge 43
 Indoor Environmental Intervention Study in
 Grade Schools and Childcare Centers to Reduce
 Childhood Asthma Symptoms50
 Radon Outreach/Community Projects 58
 Environmental Justice and Children's Health
 Data: Investigating Potential Relationships
 with Spatial Data 62
 Determining the Effectiveness of a Pesticide Risk
 Reduction Program for Migrant Farm Workers
 in Colorado 97
 Assessment of Urban Residential Exposure
 to 2,4-D111
 Children's Health Forum156
 Children's Health Display156

Region 9

Child Health Champion Program, Nogales,
 Arizona13
 Child Health Champion Program, East Side/Pico
 Section, Los Angeles, California 14
 EPA Regional School-Based Programs to
 Improve Indoor Air Quality 28
 Asbestos-in-Schools Rule59
 Region 9 Lead Poisoning Prevention 81
 Farm Worker Safety in San Luis Obispo,
 California 98
 Reducing Use of Pesticides in Schools100
 Reducing Pesticide Misuse101
 Pesticides at the Border111
 Site Assessment in Response to Cancer in
 Children: McFarland, California133
 West Oakland Urban Pilot Project134
 Defensible Space Project134
 Epidemiologic Survey of Lead Exposure of
 Children in Tijuana, Mexico141

Hazardous Materials Awareness and
 Preparedness Training156

Region 10

Child Health Champion Program, Toppenish,
 Washington14
 EPA Regional School-Based Programs to
 Improve Indoor Air Quality29
 Environmental Tobacco Smoke Outreach32
 Neighbor to Neighbor Indoor Air Quality:
 Environmental Justice Education Program .. 43
 Master Home Environmentalist Program 43
 Community Outreach on Indoor Air and
 Asthma44
 Seattle Healthy Homes Project50
 Community-Based Environmental Monitoring
 with the Toppenish School District and the
 Yakama Nation51
 Community-Based Lead Projects in Oregon ... 82
 Urban League Lead Outreach Program 82
 Lead Hazard Reduction Act Compliance,
 Oregon 83
 "Runs Better Unleaded" Bus Campaign 83
 Tri-Regional Lead Conference 83
 Advance Notice of Funds Available for
 Lead Grant Program for Indian Tribes 84
 Focused Outreach to Realtors 84
 Preventing Lead Exposure in Northern Idaho ... 85
 Yakima County, Childhood Lead Poisoning
 Reduction Program 85
 PCBs in Schools86
 Shoalwater Bay Indian Tribe Reproductive
 Health 92
 IPM in Schools100
 Protecting Drinking Water Supplies117
 Environmental Health Resources for
 Schools157

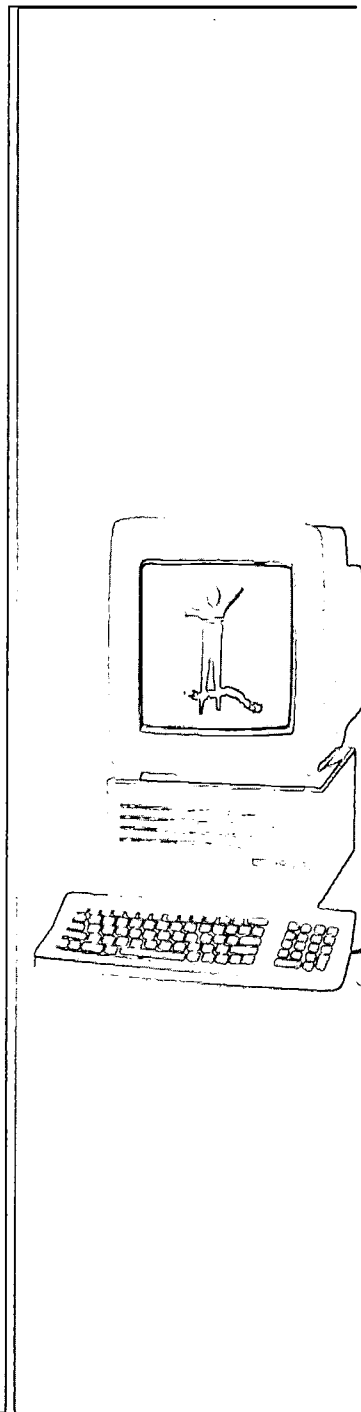

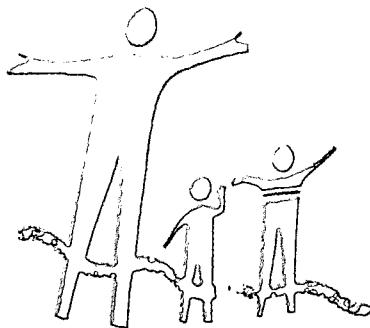

Office of Children's Health Protection

♻️ Printed on paper that contains at least 30 percent postconsumer recovered fiber.



*U.S. Department of Education
Office of Educational Research and Improvement (OERI)
National Library of Education (NLE)
Educational Resources Information Center (ERIC)*



NOTICE

Reproduction Basis



This document is covered by a signed "Reproduction Release (Blanket)" form (on file within the ERIC system), encompassing all or classes of documents from its source organization and, therefore, does not require a "Specific Document" Release form.



This document is Federally-funded, or carries its own permission to reproduce, or is otherwise in the public domain and, therefore, may be reproduced by ERIC without a signed Reproduction Release form (either "Specific Document" or "Blanket").

EFF-089 (3/2000)