

DOCUMENT RESUME

ED 446 551

HE 033 387

TITLE Statistical Abstract: Higher Education in Alabama, 1999-2000.

INSTITUTION Alabama State Commission on Higher Education, Montgomery.

PUB DATE 2000-06-00

NOTE 217p.; Published by the Alabama Commission on Higher Education, Office of Financial Affairs.

AVAILABLE FROM Alabama Commission on Higher Education, 100 North Union Street, P.O. Box 302000, Montgomery, AL 36130-2000. For full text: <http://www.ache.state.al.us/99Abstract/TOC.htm>.

PUB TYPE Numerical/Quantitative Data (110)

EDRS PRICE MF01/PC09 Plus Postage.

DESCRIPTORS College Faculty; College Libraries; College Students; Degrees (Academic); Educational Finance; Enrollment Trends; Facilities; *Higher Education; *Private Colleges; *Public Colleges; Tables (Data); Teacher Salaries; Tuition

IDENTIFIERS *Alabama

ABSTRACT

This report provides data and reference information on Alabama's public institutions of higher education and private universities and colleges. After an institutional data summary (public four-year institutions, public two-year institutions, and private institutions), the first section examines current enrollment data (e.g., general characteristics, all Alabama higher education institutions, all public higher education institutions, all private higher education institutions, and student origins). The second section presents data on finance (revenues and expenditures). The third section examines tuition and required fees (e.g., public four-year median undergraduate, public four-year median graduate, and public two-year institutions). The third section examines average faculty salaries (e.g., five-year summary, public four-year institutions, and public two-year institutions). The fourth section highlights degrees conferred (e.g., number of completions conferred by public and private institutions, completions conferred by level and gender, and percentage completions awarded to women by level). The fifth section discusses facilities (e.g., gross square footage by category, net assignable space by use, and Alabama public colleges and universities, land inventory). The sixth section examines the network of Alabama academic libraries (e.g., library expenditures, personnel information, and library income). (SM)

ED 446 551

STATISTICAL ABSTRACT: HIGHER EDUCATION IN ALABAMA 1999-2000



PERMISSION TO REPRODUCE AND
DISSEMINATE THIS MATERIAL HAS
BEEN GRANTED BY
H. J. Hector
TO THE EDUCATIONAL RESOURCES
INFORMATION CENTER (ERIC)
1



U.S. DEPARTMENT OF EDUCATION
Office of Educational Research and Improvement
EDUCATIONAL RESOURCES INFORMATION
CENTER (ERIC)
 This document has been reproduced as
received from the person or organization
originating it.
 Minor changes have been made to
improve reproduction quality.
• Points of view or opinions stated in this
document do not necessarily represent
official OERI position or policy.

Published by the
Alabama Commission on Higher Education
Office of Financial Affairs

June 2000



(Acrobat Reader Required)

BEST COPY AVAILABLE

Alabama Commission on Higher Education
Statistical Abstract: Higher Education in Alabama
1999-2000

Map of Alabama - Location of Institutions of Higher
Education

HF033387





Alabama Commission on Higher Education

Mailing Address: P.O. Box 302000 ' Montgomery, Alabama
36130-2000

Delivery Address: 100 North Union Street ' Montgomery,
Alabama 36104-3702

<http://www.ache.state.al.us>

Telephone: (334) 242-1998 ' ATNet: 220-1998 ' Fax (334)
242-0268

Don Siegelman
Governor

MEMORANDUM

TO: Recipients of the 1999-2000 Statistical Abstract
FROM: Henry J. Hector
DATE: July 2000

The "Statistical Abstract: Higher Education in Alabama 1999-2000 provides data and reference information on Alabama's public institutions of higher education as well as private universities and colleges.

The document is published every year by the Office of Financial Affairs as a service to those requiring such data and information. Further inquiries should be directed to either of the following staff members in that department:

- (1) Sandra Woodley, Director, 334-242-2104, swoodley@ache.state.al.us;
- (2) Susan Cagle, Asst. Director, 334-242-2105, scagle@ache.state.al.us;
- (3) Janis Lowther, Adm.Asst. (IPEDS), 334-242-2106, jlowther@ache.state.al.us.

We hope you will find this publication useful, but we gladly welcome suggestions you may have for the improvement of future editions.

' Fournier J. Gale, III, Chairman, ' Charles H. Morris, III, Vice Chairman
' Ben F. Beard ' Bettye Fine Collins, ' Gaynell K. Dixon, ' Joseph A. Lowman
' Johnnie J. McDougald ' Danny K. Patterson ' Trip Pittman ' Roland Pugh
' Cindy Baker Strickland ' Roberta O. Watts ' Henry J. Hector, Executive Director



*Back To ACHE
Home Page*

00 4

Letter From Dr. Henry J. Hector, Executive Director

Institutional Data Summary

Public Four-Year Institutions

Public Two-Year Institutions

Private Institutions

Contents

Current Enrollment

General Characteristics, Fall 1999

All Alabama Higher Education Institutions, Fall 1999 (Chart)

All Alabama Higher Education Institutions, Fall 1989 - 1999

All Public Higher Education Institutions, Fall 1989 - 1999 (Chart)

All Private Higher Education Institutions, Fall 1989 - 1999 (Chart)

Alabama Public and Private Institutions, Fall 1989 - 1999

First Professional Health Sciences, Fall 1989 - 1999 (Chart)

First Professional Health Sciences, Fall 1989 - 1999

School of Veterinary Medicine, Fall 1980 - 1999 (Chart)

School of Veterinary Medicine - Auburn University and Tuskegee University, Fall 1980 - 1999

Full-Time/Part-Time, Public and Private Institutions, Fall 1999

By Level and Gender, Public and Private Institutions, Fall 1999

By Gender, Race and Residence Status, Public and Private Institutions, Fall 1999

Students Origins, All Public Institutions, Fall 1999 (Chart)

Students Origins, All Public Institutions, Fall 1999

Enrollment by Age, Gender and Enrollment Status, Fall 1999

FTE Public Institutions, Fall 1989 - 1999

Finance - Revenues and Expenditures

Alabama Current Funds Revenues and Expenditures
Public Institutions, FY 1999

Tuition and Required Fees

Public Four-Year Median Undergraduate, In-State and
Out-Of-State, 1996-1997 - 1999-2000 (Chart)

Undergraduate In-State and Out-Of-State, Public Four-Year
Institutions, 1996-1997 - 1999-2000

Public Four-Year Median Graduate In-State and Out-Of-State,
1996-1997 - 1999-2000 (Chart)

Graduate In-State and Out-Of-State, Public Four-Year Institutions,
1996-1997 - 1999-2000

First Professional In-State and Out-Of-State, Public Four-Year

Institutions, 1996-1997 - 1999-2000Public Two-Year Institutions, In-State and Out-Of-State, 1999-2000**Average Faculty Salaries**Five-Year Summary, State Averages, Full-Time PublicFour-Year Institutions, 1995-1996 - 1999-2000Average Full-Time, Public Four-Year Institutions, 1995-1996 - 1999-2000 (Chart)Public Four-Year Institutions by Gender and Rank, 1999-2000Public Two-Year Institutions by Gender and Rank, 1999-2000**Completions - (Degrees Conferred)**Number of Completions Conferred by Public and Private Institutions, 1997-98 - 1998-99 (Chart)Number of Completions Conferred by Public Four-Year, 1995-96 - 1998-99Number of Completions Conferred by Private Four-Year Institutions, 1995-96 - 1998-99Completions Conferred by Level and Gender, Public Four-Year 1998-99 (Chart)Completions Conferred of Less Than Four Years by Level and Gender, Public and Private Institutions, 1998-99Completions Conferred Baccalaureate and Higher by Level and Gender, Public and Private Four-Year Institutions, 1998-99Number and Percent of Completions Conferred by Field of Study and Level,Public and Private Four-Year Institutions, 1998-99Number and Percent of Completions Conferred by Field of Study and Level,Public and Private Four-Year Institutions, 1998-99Number and Percent of Completions Conferred by Field of Study andLevel, Public and Private Two-Year Institutions, 1998-99Baccalaureate and Higher Completions By Gender, 1989 - 1999 (Chart)Baccalaureate and Higher Completions By Level and Gender, 1989 - 1999Baccalaureate and Higher Completions Conferred by Level and Control of Institution, Public and Private, 1989 - 1999Percentage Completions Awarded to Women by Level, Public and Private, 1989 - 1999**Facilities**Gross Square Footage by Category, Public Alabama Colleges and Universities, 1999

Net Assignable Space By Use, Public Alabama Colleges and Universities, 1999

Net Assignable Space By Use, Public Alabama Colleges and Universities, 1999 Chart

Alabama Public Colleges and Universities, Land Inventory, 1999

Physical Plant By Age, Alabama Public Colleges and Universities, 1820 - 1999

Proportion of Physical Plant Gross Square Footage By Age, Before 1960 - 1999

Network of Alabama Academic Libraries

Library Expenditures (Chart), 1998-99

Print Information Resources, 1998-99

Non-Print Information Resources, 1998-99

Personnel Information, 1998-99

Materials Expenditures, 1998-99

Other Operating Expenditures, 1998-99

Library Income, 1998-99

Circulation and Other Services, 1998-99

Notes



Back To ACHE Home Page

Public Four-Year Universities

1. Alabama A&M University
2. Alabama State University
3. Athens State University
4. Auburn University
5. Auburn University at Montgomery
6. Jacksonville State University
7. Troy State University
8. Troy State University Dothan
9. Troy State University Montgomery
10. The University of Alabama
11. Univ. of Alabama at Birmingham
12. Univ. of Alabama in Huntsville
13. University of Montevallo
14. University of North Alabama
15. University of South Alabama
16. University of West Alabama

Public Two-Year Institutions

17. Alabama Southern CC
18. Ayers State Technical College
19. Bessemer State Technical College
20. Beville State CC
21. Bishop State CC
22. Calhoun State CC
23. Central Alabama State CC
24. Chattahoochee Valley CC
25. Drake State Technical College
26. Enterprise State Junior College
27. Faulkner State CC
28. Gadsden St. CC
29. Ingram State Technical College
30. Jefferson Davis CC
31. Jefferson State CC
32. Lawson State CC
33. L. B. Wallace Junior College
34. MacArthur State Technical College
35. Northeast Alabama CC
36. Northwest-Shoals CC
37. Patterson State Technical College
38. Reid State Technical College
39. Shelton State CC
40. Snead State CC
41. Southern Union State CC
42. Trenholm State Technical College
43. G. C. Wallace St. CC Dothan
44. G. C. Wallace St. CC Hanceville
45. G. C. Wallace St. CC Selma

Private Four-Year Colleges

46. Birmingham Southern College
47. Concordia College
48. Faulkner University
49. Huntingdon College
50. Judson College
51. Miles College
52. Oakwood College
53. Samford University
54. Selma University
55. Southeastern Bible College
56. Spring Hill College

**ALABAMA HIGHER EDUCATION INSTITUTIONS
1999-2000**

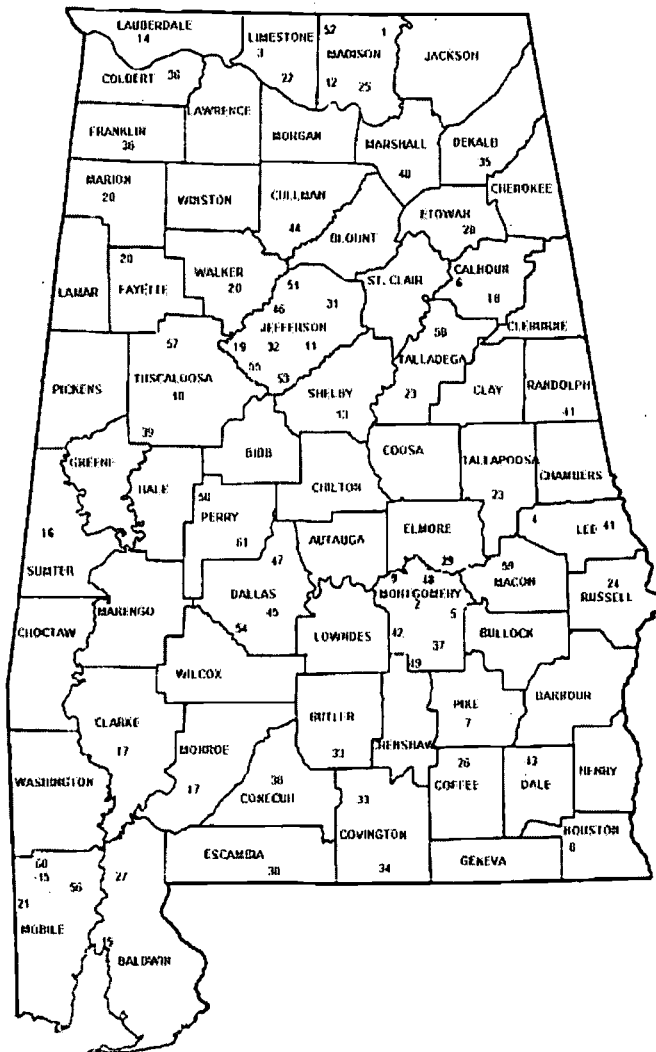

BEST COPY AVAILABLE

- 57. Stillman College
- 58. Talladega College
- 59. Tuskegee University
- 60. University of Mobile

Private Two-Year Colleges

- 61. Marion Military Institute



[Back To ACHE](#)
[Home Page](#)

Summary Public 4-Year Institutions

Alabama A&M University

1999 Fall Headcount Enrollment:

Total = 5,497
Undergraduate = 4,332
Graduate = 1,165

1999-2000 Tuition & Fees:

In-State U-G = \$2,332
Out-of-State = \$4,264
In-State Grad = \$2,332
Out-of-State = \$4,264

Completions Awarded 1998-99:

Baccalaureate = 504
Master's = 317
Doctoral = 7

Full-time instructional Faculty = 243

Alabama State University

1999 Fall Headcount Enrollment:

Total = 5,664
Undergraduate = 4,683
Graduate = 981

1999-2000 Tuition & Fees:

In-State U-G = \$2,520
Out-of-State = \$5,040
In-State Grad = \$2,880
Out-of-State = \$5,760

Completions Awarded 1998-99:

Baccalaureate = 474
Master's = 204

Full-time instructional Faculty = 213

Athens State University

1999 Fall Headcount Enrollment:

Total = 2,790
Undergraduate = 2,790

1999-2000 Tuition & Fees:

In-State U-G = \$2,250
Out-of-State = \$4,440

Completions Awarded 1998-99:

Baccalaureate = 854

Full-time instructional faculty = 82

Auburn University

1999 Fall Headcount Enrollment:

Total = 22,120
Undergraduate = 18,669
Graduate = 2,793
First Prof. = 658

1999-2000 Tuition & Fees:

In-State U-G = \$2,895
Out-of-State = \$8,685
In-State Grad = \$2,895
Out-of-State = \$8,685

Completions Awarded 1998-99:

Baccalaureate = 3,921
Master's = 703
Doctoral = 178
First Prof. = 119

Full-time Instructional Faculty = 1,146

Auburn University at Montgomery

1999 Fall Headcount Enrollment:

Total = 5,354
Undergraduate = 4,539
Graduate = 815

1999-2000 Tuition & Fees:

In-State U-G = \$2,577
Out-of-State = 7,731
In-State Grad = 2,514
Out-of-State = 7,542

Completions Awarded 1998-99:

Baccalaureate = 702
Master's = 353

Full-time instructional Faculty = 191

Jacksonville State University

1999 Fall Headcount Enrollment:

Total = 7,928
Undergraduate = 6,640
Graduate = 1,288

1999-2000 Tuition & Fees:

In-State U-G = \$2,440
Out-of-State = \$4,880
In-State Grad = \$2,440
Out-of-State = \$4,880

Completions Awarded 1998-99:

Baccalaureate = 1,047
Master's = 427

Full-time Instructional Faculty = 262

Troy State University

1999 Fall Headcount Enrollment:

Total = 6,266
Undergraduate = 4,695
Graduate = 1,571

1999-2000 Tuition & Fees:

In-State U-G = \$2,900
Out-Of-State = \$5,560
In-State Grad = \$3,120
Out-of-State = \$6,000

Completions Awarded 1998-99:

Associate = 112
Baccalaureate = 1,057
Master's = 714

Full-time Instructional faculty = 212

Troy State University Dothan

1999 Fall Headcount Enrollment:

Total = 1,998
Undergraduate = 1,553
Graduate = 445

1999-2000 Tuition & Fees:

In-State U-G = \$2,832
Out-of-State = 5,712
In-State Grad = 2,952
Out-of-State = 5,832

Completions Awarded 1998-99:

Associate = 25
Baccalaureate = 394
Master's = 192

Full-time Instructional faculty = 52

Troy State University Montgomery

1999 Fall Headcount Enrollment:

Total = 3,363
Undergraduate = 2,799
Graduate = 564

1999-2000 Tuition & Fees:

In-State U-G = \$2,430
Out-of-State = 4,830
In-State Grad = 2,262
Out-of-State = 4,494

Completions Awarded 1998-99:

Associate = 85
Baccalaureate = 242
Master's = 185

Full-time Instructional faculty = 40

University of Alabama

1999 Fall Headcount Enrollment:

Total = 18,744
Undergraduate = 14,645
Graduate = 3,473
First Prof = 626

1999-2000 Tuition & Fees:

In-State U-G = \$2,872
Out-of-State = 7,722
In-State Grad = 2,872
Out-of-State = 7,722

Completions Awarded 1998-99:

Baccalaureate = 2,743
Master's = 1,160
Doctoral = 135
First Prof = 183

Full-time Instructional faculty = 795

University of Alabama at Birmingham

1999 Fall Headcount Enrollment:

Total = 15,098
Undergraduate = 10,420
Graduate = 3,674
First Prof = 1,004

1999-2000 Tuition & Fees:

In-State U-G = \$3,240
Out-of-State = 5,970
In-State Grad = 2,928
Out-of-State = 5,424

Completions Awarded 1998-99:

Baccalaureate = 1,549
Master's = 1,089
Doctoral = 114
First Prof = 252

Full-time Instructional faculty = 474

University of Alabama in Huntsville

1999 Fall Headcount Enrollment:

Total = 6,874
Undergraduate = 5,513
Graduate = 1,361

1999-2000 Tuition & Fees:

In-State U-G = \$3,112
Out-of-State = \$6,516
In-State Grad = \$3,880
Out-of-State = \$7,956

Completions Awarded 1998-99:

Baccalaureate = 676
Master's = 302
Doctoral = 31

Full-time Instructional faculty = 277

University of Montevallo

1999 Fall Headcount Enrollment:

Total = 3,147
Undergraduate = 2,691
Graduate = 456

1999-2000 Tuition & Fees:

In-State U-G = \$3,290
Out-of-State = \$6,440
In-State Grad = \$2,852
Out-of-State = \$5,564

Completions Awarded 1998-99:

Baccalaureate = 484
Master's = 154

Full-time Instructional faculty = 133

University of North Alabama

1999 Fall Headcount Enrollment:

Total = 5,805
Undergraduate = 5,099
Graduate = 706

1999-2000 Tuition & Fees:

In-State U-G = \$2,392
Out-of-State = \$4,624
In-State Grad = \$2,728
Out-of-State = \$5,296

Completions Awarded 1998-99:

Baccalaureate = 819
Master's = 208

Full-time Instructional faculty = 203

University of South Alabama

1999 Fall Headcount Enrollment:

Total = 11,185
Undergraduate = 9,029
Graduate = 1,899
First Prof = 257

1999-2000 Tuition & Fees:

In-State U-G = \$2,911
Out-of-State = \$5,581
In-State Grad = \$3,001
Out-of-State = \$5,761

Completions Awarded 1998-99:

Certificates = 10
Less than 2 Yrs = 28
Less than 4 Yrs = 19
Baccalaureate = 1,472
Master's = 539
Doctoral = 19
First Prof = 59

Full-time Instructional faculty = 442

University of West Alabama

1999 Fall Headcount Enrollment:

Total = 1,980
Undergraduate = 1,681
Graduate = 299

1999-2000 Tuition & Fees:

In-State U-G = \$3,270
Out-of-State = \$6,150
In-State Grad = \$2,778
Out-of-State = \$5,466

Completions Awarded 1998-99:

Associate = 49
Baccalaureate = 271
Master's = 97

Full-time Instructional faculty = 85

SOURCE: Integrated Postsecondary Education Data Systems (IPEDS); and Alabama Commission on Higher Education.

TWO-YEAR INSTITUTIONS

Alabama Southern Community College

1999 Fall Headcount Enrollment:
Total = 1,240
1999-2000 Tuition & Fees:
In-State = \$1,680
Out-of-State = \$3,120
Completions Awarded 1998-99:
Certificates = 122
Associate = 156
Full-time Instructional faculty = 34

Ayers State Technical College

1999 Fall Headcount Enrollment:
Total = 966
1999-2000 Tuition & Fees:
In-State = \$1,500
Out-of-State = \$2,880
Completions Awarded 1998-99:
Certificates = 117
Associate = 64
Full-time Instructional faculty = 33

Bessemer State Technical College

1999 Fall Headcount Enrollment:
Total = 1,354
1999-2000 Tuition & Fees:
In-State = \$1,560
Out-of-State = \$3,000
Completions Awarded 1998-99:
Certificates = 265
Associate = 110
Full-time Instructional faculty = 40

Bevill State Community College

1999 Fall Headcount Enrollment:
Total = 3,554
1999-2000 Tuition & Fees:
In-State = \$1,590
Out-of-State = \$3,090
Completions Awarded 1998-99:
Certificates = 568
Associate = 420
Full-time Instructional faculty = 99

Bishop State Community College

1999 Fall Headcount Enrollment:
Total = 3,393
1999-2000 Tuition & Fees:
In-State = \$1,800
Out-of-State = \$3,360
Completions Awarded 1998-99:
Certificates = 427
Associate = 437
Full-time Instructional faculty = 114

Calhoun State Community College

1999 Fall Headcount Enrollment:
Total = 7,598
1999-2000 Tuition & Fees:
In-State = \$1,680
Out-of-State = \$3,240
Completions Awarded 1998-99:
Certificates = 250
Associate = 542
Full-time Instructional faculty = 120

Central Alabama Community College

1999 Fall Headcount Enrollment:
Total = 1,612
1999-2000 Tuition & Fees:
In-State = \$1,620
Out-of-State = \$3,120
Completions Awarded 1998-99:
Certificates = 98
Associate = 197
Full-time Instructional faculty = 47

Chattahoochee Valley Community College

1999 Fall Headcount Enrollment:
Total = 1,735
1999-2000 Tuition & Fees:
In-State = \$1,650
Out-of-State = \$3,210
Completions Awarded 1998-99:
Certificates = 28
Associates = 204
Full-time Instructional faculty = 30

Drake State Technical College

1999 Fall Headcount Enrollment:
Total = 611
1999-2000 Tuition & Fees:
In-State = \$1,560
Out-of-State = \$3,000
Completions Awarded 1998-99:
Certificates = 142
Associate = 51
Full-time Instructional faculty = 23

Enterprise State Junior College

1999 Fall Headcount Enrollment:
Total = 1,644
1999-2000 Tuition & Fees:
In-State = \$1,680
Out-of-State = \$3,240
Completions Awarded 1998-99:
Certificates = 76
Associate = 307
Full-time Instructional faculty = 36

Faulkner State Community College

1999 Fall Headcount Enrollment:
Total = 2,832
1999-2000 Tuition & Fees:
In-State = \$1,800
Out-of-State = \$3,360
Completions Awarded 1998-99:
Certificates = 22
Associate = 289
Full-time Instructional faculty = 52

Gadsden State Community College

1999 Fall Headcount Enrollment:
Total = 4,729
1999-2000 Tuition & Fees:
In-State = \$1,560
Out-of-State = \$3,000
Completions Awarded 1998-99:
Certificates = 194
Associate = 452
Full-time Instructional faculty = 120

Ingram State Technical College

1999 Fall Headcount Enrollment:
Total = 753
1999-2000 Tuition & Fees:
In-State = \$1,200
Completions Awarded 1998-99:
Certificates = 133
Associates = 12
Full-time Instructional faculty = 50

Jefferson Davis Community College

1999 Fall Headcount Enrollment:
Total = 1,159
1999-2000 Tuition & Fees:
In-State = \$1,800
Out-of-State = \$3,360
Completions Awarded 1998-99:
Certificates = 84
Associates = 133
Full-time Instructional faculty = 48

Jefferson State Community College

1999 Fall Headcount Enrollment:
Total = 5,408
1999-2000 Tuition & Fees:
In-State = \$1,650
Out-of-State = \$3,150
Completions Awarded 1998-99:
Certificates = 9
Associates = 306
Full-time Instructional faculty = 101

Lawson State Community College

1999 Fall Headcount Enrollment:
Total = 1,541
1999-2000 Tuition & Fees:
In-State = \$1,560
Out-of-State = \$3,000
Completions Awarded 1998-99:
Certificates = 49
Associates = 81
Full-time Instructional faculty = 59

L. B. Wallace Junior College

1999 Fall Headcount Enrollment:
Total = 834
1999-2000 Tuition & Fees:
In-State = \$1,680
Out-of-State = \$3,240
Completions Awarded 1998-99:
Certificates = 19
Associates = 111
Full-time Instructional faculty = 23

Douglas MacArthur State Technical College

1999 Fall Headcount Enrollment:
Total = 555
1999-2000 Tuition & Fees:
In-State = \$1,440
Out-of-State = \$2,760
Completions Awarded 1998-99:
Certificates = 151
Associates = 70
Full-time Instructional faculty = 27

Northeast Alabama State Community College

1999 Fall Headcount Enrollment:
Total = 1,576
1999-2000 Tuition & Fees:
In-State = \$1,380
Out-of-State = \$2,700
Completions Awarded 1998-99:
Certificates = 41
Associates = 203
Full-time Instructional faculty = 34

Northwest-Shoals Community College

1999 Fall Headcount Enrollment:
Total = 3,394
1999-2000 Tuition & Fees:
In-State = \$1,680
Out-of-State = \$3,120
Completions Awarded 1998-99:
Certificates = 173
Associates = 288
Full-time Instructional faculty = 75

John M. Patterson State Technical College

1999 Fall Headcount Enrollment:
Total = 955
1999-2000 Tuition & Fees:
In-State = \$1,620
Out-of-State = \$3,120
Completions Awarded 1998-99:
Certificates = 250
Associates = 128
Full-time Instructional faculty = 35

Reid State Technical College

1999 Fall Headcount Enrollment:
Total = 681
1999-2000 Tuition & Fees:
In-State = \$1,620
Out-of-State = \$3,120
Completions Awarded 1998-99:
Certificates = 186
Associates = 59
Full-time Instructional faculty = 23

Shelton State Community College

1999 Fall Headcount Enrollment:
Total = 4,385
1999-2000 Tuition & Fees:
In-State = \$1,560
Out-of-State = \$3,000
Completions Awarded 1998-99:
Certificates = 173
Associates = 215
Full-time Instructional faculty = 81

Snead State Community College

1999 Fall Headcount Enrollment:
Total = 1,676
1999-2000 Tuition & Fees:
In-State = \$1,470
Out-of-State = \$2,790
Completions Awarded 1998-99:
Certificates = 35
Associates = 201
Full-time Instructional faculty = 24

Southern Union St. Community College

1999 Fall Headcount Enrollment:
Total = 4,258
1999-2000 Tuition & Fees:
In-State = \$1,710
Out-of-State = \$3,240
Completions Awarded 1998-99:
Certificates = 288
Associates = 319
Full-time Instructional faculty = 76

Sparks State Technical College

1999 Fall Headcount Enrollment
Total = 549
1999-2000 Tuition & Fees:
In-State = \$1,620
Out-of-State = \$3,120
Completions Awarded 1998-99:
Certificates = 136
Associate = 77
Full-time Instructional faculty = reported with
Wallace Dothan

Trenholm State Technical College

1999 Fall Headcount Enrollment:
Total = 680
1999-2000 Tuition & Fees:
In-State = \$1,440
Out-of-State = \$2,700
Completions Awarded 1998-99:
Certificates = 182
Associates = 79
Full-time Instructional faculty = 35

G. C. Wallace St. Community College-Dothan

1999 Fall Headcount Enrollment:
Total = 2,984
1999-2000 Tuition & Fees:
In-State = \$1,620
Out-of-State = \$3,120
Completions Awarded 1998-99:
Certificates = 170
Associates = 345
Full-time Instructional faculty = 117

G. C. Wallace St. Community College-Hanceville

1999 Fall Headcount Enrollment:
Total = 4,747
1999-2000 Tuition & Fees:
In-State = \$1,260
Out-of-State = \$2,460
Completions Awarded 1998-99:
Certificates = 265
Associates = 721
Full-time Instructional faculty = 117

G. C. Wallace St. Community College-Selma

1999 Fall Headcount Enrollment:
Total = 1,461
1999-2000 Tuition & Fees:
In-State = \$1,620
Out-of-State = \$3,120
Completions Awarded 1998-99:
Certificates = 198
Associates = 185
Full-time Instructional faculty = 50

SOURCE: Integrated Postsecondary Education Data Systems (IPEDS); and Alabama Commission on Higher Education.

Private Four-Year Institutions**Birmingham-Southern College**

1999 Fall Headcount Enrollment:
Total = 1,528
Completions Awarded 1998-99:
Baccalaureate = 284
Master's = 24
Full-time Instructional faculty = 93

Concordia College

1999 Fall Headcount Enrollment:
Total = 525
Completions Awarded 1998-99:
Associate = 13
Baccalaureate = 38
Full-time Instructional faculty = 16

Faulkner University

1999 Fall Headcount Enrollment:
Total = 2,645
Completions Awarded 1998-99:
Associate = 96
Baccalaureate = 480
Master's = 59
First Prof = 105
Full-time Instructional faculty = 44

Huntingdon College

1999 Fall Headcount Enrollment:
Total = 705
Completions Awarded 1998-99:
Associate = 3
Baccalaureate = 122
Full-time Instructional faculty = 44

Judson College

1999 Fall Headcount Enrollment:
Total = 308
Completions Awarded 1998-99:
Baccalaureate = 57
Full-time Instructional faculty = 25

Miles College

1999 Fall Headcount Enrollment:
Total = 1,453
Completions Awarded 1998-99:
Baccalaureate = 153
Full-time Instructional faculty = 47

Oakwood College

1999 Fall Headcount Enrollment:
Total = 1,736
Completions Awarded 1998-99:
Associate = 32
Baccalaureate = 193
Full-time Instructional faculty = 91

Samford University

1999 Fall Headcount Enrollment:
Total = 4,494
Completions Awarded 1998-99:
Associate = 17
Baccalaureate = 626
Master's = 149
Doctoral = 16
First Prof = 329
Full-time Instructional faculty = 245

Southeastern Bible College

1999 Fall Headcount Enrollment:
Total = 181
Completions Awarded 1998-99:
Associate = 8
Baccalaureate = 27
Full-time Instructional faculty = 8

Spring Hill College

1999 Fall Headcount Enrollment:
Total = 1,484
Completions Awarded 1998-99:
Associates = 1
Baccalaureate = 213
Master's = 41
Full-time Instructional faculty = 64

Stillman College

1999 Fall Headcount Enrollment:
Total = 1,458
Completions Awarded 1998-99:
Baccalaureate = 165
Full-time Instructional faculty = 61

Talladega College

1999 Fall Headcount Enrollment:
Total = 455
Completions Awarded 1998-99:
Baccalaureate = 129
Full-time Instructional faculty = 39

Tuskegee University

1999 Fall Headcount Enrollment:
Total = 3,009
Completions Awarded 1998-99:
Baccalaureate = 436
Master's = 45
First Prof = 53
Full-time Instructional faculty = 231

University of Mobile

1999 Fall Headcount Enrollment:
Total = 1,978
Completions Awarded 1998-99:
Associate = 31
Baccalaureate = 286
Master's = 74
Full-time Instructional faculty = 92

Marion Military Institute

1999 Fall Headcount Enrollment:
Total = 143
Completions Awarded 1998-99:
Associate = 66
Full-time Instructional faculty = 22

SOURCE: Integrated Postsecondary Education Data Systems (IPEDS); and Alabama Commission on Higher Education.

GENERAL CHARACTERISTICS OF HEADCOUNT ENROLLMENT
Alabama Higher Education Colleges and Universities
Fall 1999

ENROLLMENT CHARACTERISTICS	PUBLIC INSTITUTIONS		PRIVATE INSTITUTIONS		ALL INSTITUTIONS	
	Number	Percent	Number	Percent	Number	Percent
<u>TOTAL ENROLLMENT</u>						
Four-Year Institutions	123,813	64.3	21,959	99.4	145,772	67.9
Two-Year Institutions	68,864	35.7	143	0.6	69,007	32.1
Total	192,677	100.0	22,102	100.0	214,779	100.0
<u>GENDER</u>						
Men	83,501	43.3	8,966	40.6	92,467	43.1
Women	109,176	56.7	13,136	59.4	122,312	56.9
Total	192,677	100.0	22,102	100.0	214,779	100.0
<u>RACIAL</u>						
Black	44,876	23.3	10,046	45.5	54,922	25.6
White	135,792	70.5	10,629	48.1	146,421	68.2
Other	12,009	6.2	1,427	6.5	13,436	6.3
Total	192,677	100.0	22,102	100.0	214,779	100.0
<u>ATTENDANCE STATUS</u>						
Full-Time	125,259	65.0	19,037	86.1	144,296	67.2
Part-Time	67,418	35.0	3,065	13.9	70,483	32.8
Total	192,677	100.0	22,102	100.0	214,779	100.0
<u>LEVEL OF INSTRUCTION</u>						
Undergraduate	168,642	87.5	19,104	86.4	187,746	87.4
Graduate	21,490	11.2	1,227	5.6	22,717	10.6
First Professional	2,545	1.3	1,771	8.0	4,316	2.0
Total	192,677	100.0	22,102	100.0	214,779	100.0

SOURCE: Integrated Postsecondary Education Data System, (IPEDS), Fall 1999.

FALL 1999 - HEADCOUNT ENROLLMENT

ALL ALABAMA HIGHER EDUCATION INSTITUTIONS

123,813 (57.6%) Public Senior

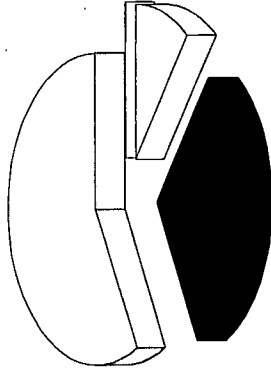

143 (0.1%) Private Junior

21,959 (10.2%) Private Senior

68,864 (32.1%) Public Two-Year

SOURCE: Integrated Postsecondary Education Data System (IPEDS), 1999 Fall Enrollment.

TOTAL HEADCOUNT ENROLLMENT 1
ALL ALABAMA HIGHER EDUCATION INSTITUTIONS
FALL 1989 - 1999

	1989	1990	1991	1992	1993	1994	1995	1996	1997	1998	1999
Public Four-Year Institution	120,822	123,848	127,849	127,527	128,205	126,079	126,508	122,798	122,105	123,542	123,813
% of Total	55.4	54.8	55.6	54.5	55.9	55.8	57.9	56.8	57.3	57.5	57.6
Public Two-Year Colleges	69,474	75,435	78,163	81,741	84,414	81,746	78,310	74,350	72,604	68,029	68,864
% of Total	31.8	33.4	34.0	34.9	36.8	36.1	35.8	34.4	34.1	31.7	32.1
Private Four-Year Colleges	16,566	18,753	19,958	20,786	21,262	21,491	21,100	21,337	21,445	21,464	21,959
% of Total	7.6	8.3	8.7	8.9	9.3	9.5	9.7	9.9	10.1	10.0	10.2
Private Two-Year Colleges	312	246	136	86	141	203	223	166	175	164	143
% of Total	0.1	0.1	0.1	0.0	0.1	0.1	0.1	0.1	0.1	0.1	0.1
TOTAL	207,174	218,282	226,106	230,140	234,022	229,519	226,141*	218,651	216,329	213,199	214,779
	100.0	100.0	100.0	100.0	100.0	100.0	100.0	100.0	100.0	100.0	100.0

SOURCE: Integrated Postsecondary Education Data System (IPEDS), Fall Enrollment 1989-1999.

NOTE: (1) Historical numbers are changed to reflect mergers. An explanation of the calculations are included on the Notes page in the back of this publication.

FALL 1989 - 1999 HEADCOUNT ENROLLMENT

All Alabama Public Higher Education Institutions

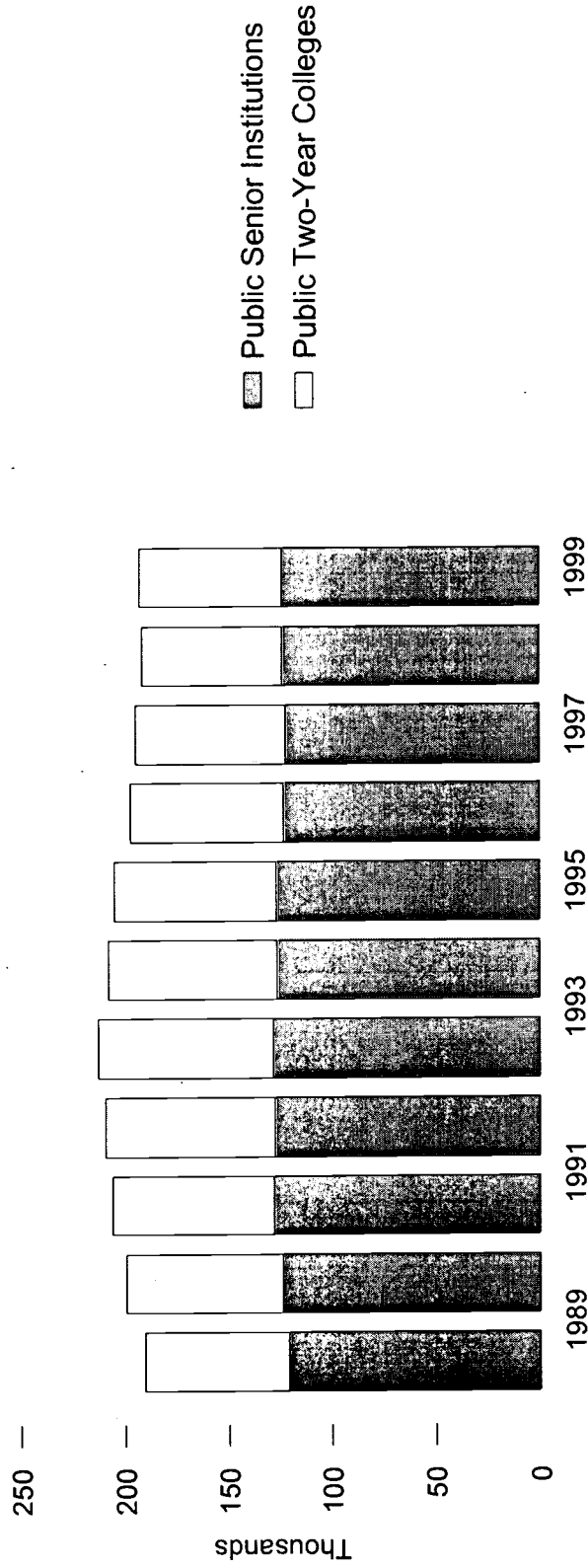

SOURCE: Integrated Postsecondary Education Data System (IPEDS), Fall Enrollment.

FALL 1989 - 1999 HEADCOUNT ENROLLMENT

ALL PRIVATE HIGHER EDUCATION INSTITUTIONS

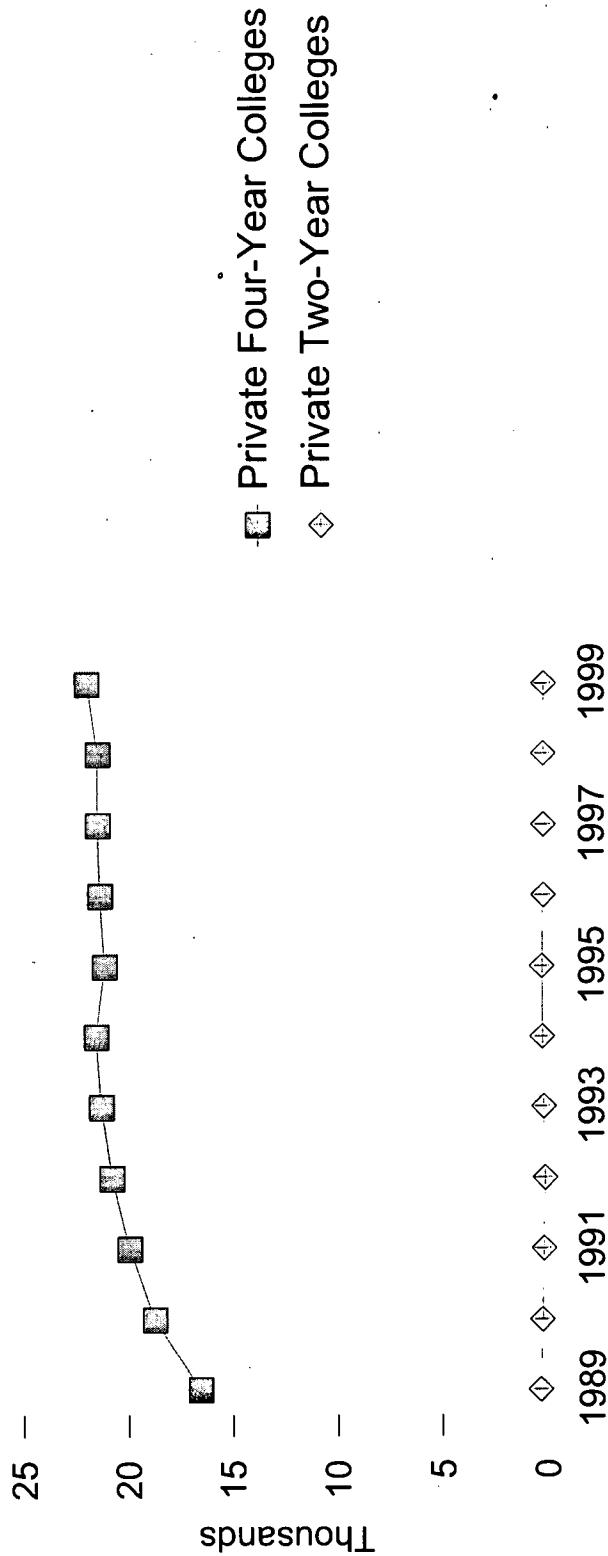

SOURCE: Integrated Postsecondary Education Data System (IPEDS), Fall Enrollment.

HEADCOUNT ENROLLMENT (1)
All Alabama Higher Education Institutions
Fall 1989 - 1999

	Fall 1989	Fall 1990	Fall 1991	Fall 1992	Fall 1993	Fall 1994	Fall 1995	Fall 1996	Fall 1997	Fall 1998	Fall 1999
Total All Public Colleges and Univ	190,296	199,283	206,012	209,268	212,619	207,825	204,818	197,148	194,709	191,571	192,677
Total All Public Four-Year Institutions	120,822	123,848	127,849	127,527	128,205	126,079	126,508	122,798	122,105	123,542	123,813
Total All Public Two Year Institutions	69,474	75,435	78,163	81,741	84,414	81,746	78,310	74,350	72,604	68,029	68,864
Total All Private Institutions	16,878	18,999	20,094	20,872	21,403	21,694	21,323	21,503	21,620	21,628	22,102
Public Four-Year Institutions (2)											
Alabama A&M University	4,501	4,886	5,215	5,069	5,593	5,543	5,400	5,263	5,094	5,128	5,497
Alabama State University	4,456	4,587	4,822	5,488	5,608	5,037	5,416	5,552	5,273	5,552	5,664
Athens State University	2,417	2,770	3,017	3,239	2,980	2,971	2,892	2,698	2,671	2,739	2,790
Auburn University	21,701	21,537	21,836	21,551	21,363	21,226	22,122	21,778	21,505	21,775	22,120
Auburn University at Montgomery	5,997	6,261	6,575	6,386	6,341	6,148	5,882	5,645	5,526	5,408	5,354
Jacksonville State University	8,260	8,448	8,240	8,022	7,506	7,553	7,697	7,688	7,619	7,618	7,928
Troy State University	4,772	5,024	5,482	6,063	6,396	6,458	6,496	6,211	6,468	6,630	6,266
Troy State University Dothan	1,833	1,933	2,039	2,319	2,355	2,366	2,303	2,167	2,112	2,215	1,998
Troy State University Montgomery	2,833	2,736	3,193	3,331	3,469	3,408	3,360	3,136	3,349	3,455	3,363
University of Alabama	19,432	19,794	19,797	19,234	19,480	19,306	18,985	17,953	18,324	18,426	18,744
University of AL at Birmingham	14,692	15,356	15,922	15,742	15,913	15,362	15,502	15,274	14,933	15,056	15,098
University of AL in Huntsville	8,082	8,139	8,624	8,026	8,232	7,492	7,218	6,713	6,464	6,998	6,874
University of Montevallo	3,175	3,250	3,256	3,246	3,315	3,282	3,236	3,206	3,125	3,177	3,147
University of North Alabama	5,581	5,622	5,755	5,523	5,409	5,221	5,437	5,529	5,575	5,773	5,805
University of South Alabama	11,329	11,584	11,990	12,311	12,260	12,386	12,254	11,832	11,999	11,445	11,185
University of West Alabama	1,761	1,921	2,086	1,977	1,985	2,320	2,308	2,153	2,068	2,147	1,980
Public Two-Year Institutions											
Alabama Southern Community College	1,381	1,753	1,853	1,678	1,866	1,545	1,721	1,653	1,417	1,208	1,240
Ayers State Technical College	504	529	565	606	591	606	579	662	822	769	966
Bessemer State Technical College	1,630	1,730	1,797	1,868	1,763	1,773	1,704	1,531	1,465	1,417	1,354
Bevill State Community College	1,760	2,083	2,084	2,966	3,758	3,998	3,890	3,625	3,678	3,616	3,554
Walker College	919	909	1,041	893	750	861	957	1,005	1,002	(3)	(3)
Bishop State Community College	3,306	3,618	3,734	4,194	4,650	4,511	4,127	3,661	3,733	3,660	3,393



HEADCOUNT ENROLLMENT (1)
All Alabama Higher Education Institutions
Fall 1989 - 1999

	Fall 1989	Fall 1990	Fall 1991	Fall 1992	Fall 1993	Fall 1994	Fall 1995	Fall 1996	Fall 1997	Fall 1998	Fall 1999
Public Two-Year Institutions											
Calhoun State Community College	7,544	7,833	7,840	8,070	7,899	7,249	7,231	6,936	7,249	7,313	7,598
Central Alabama State Community College	1,800	2,097	2,080	2,092	2,043	1,865	1,917	1,851	1,820	1,609	1,612
Chattahoochee Valley State CC	1,621	1,685	1,727	1,763	1,989	2,118	2,118	2,008	1,858	1,681	1,735
Drake State Technical College	677	852	805	870	825	768	683	678	657	663	611
Enterprise State Junior College	2,178	2,108	2,123	2,282	2,039	1,886	1,800	1,887	1,705	1,584	1,644
Faulkner Community College	2,922	3,109	3,448	3,504	3,458	3,320	3,043	3,023	2,922	2,777	2,832
Gadsden State Community College	4,912	5,478	5,837	5,975	6,145	5,871	5,719	5,170	4,961	4,651	4,729
Ingram State Technical College	1,093	1,144	961	1,251	1,032	1,279	946	849	735	661	753
Jefferson Davis Community College	1,715	1,659	1,721	1,837	1,866	1,744	1,575	1,522	1,501	1,160	1,159
Jefferson State Community College	6,578	6,639	6,731	6,656	6,608	5,647	5,548	5,104	5,235	5,137	5,408
Lawson State Community College	1,470	1,711	1,959	2,041	2,307	1,920	1,892	1,701	1,589	1,395	1,541
L. B. Wallace Junior College	1,162	1,256	1,102	1,263	1,191	1,096	1,092	943	906	824	834
MacArthur State Technical College	544	560	586	550	569	548	587	665	564	557	555
Northeast Alabama State Community Coll	1,360	1,546	1,667	1,788	1,847	1,603	1,587	1,797	1,682	1,577	1,576
Northwest-Shoals Community College	3,456	4,125	4,717	4,803	4,702	5,126	4,495	3,600	3,635	3,235	3,394
Patterson State Technical College	658	681	789	961	972	1,064	1,099	1,147	1,089	900	955
Reid State Technical College	408	364	468	667	831	856	740	860	685	519	681
Shelton State Community College	4,415	5,392	5,142	5,208	6,255	5,867	5,145	4,932	4,513	4,585	4,385
Snead State Community College	1,487	1,691	1,763	1,709	1,669	1,600	1,690	1,580	1,663	1,815	1,676
Southern Union State Community College	3,279	3,579	3,646	3,956	4,162	4,651	4,330	4,324	4,118	4,303	4,258
Sparks State Technical College	383	506	609	565	674	592	635	688	634	606	549
Trenholm State Technical College	716	783	746	962	945	785	707	695	694	593	680
G. C. Wallace Community Coll- Dothan	3,805	3,755	3,643	3,657	3,494	3,374	3,421	3,360	3,091	2,979	2,984
AL Aviation & Technical College	530	539	582	480	402	329	293	322	317	(4)	(4)
G. C. Wallace Community Coll - Hanceville	3,735	4,043	4,566	4,810	5,178	5,449	5,223	4,813	4,865	4,659	4,747
G. C. Wallace Community Coll- Selma	1,526	1,678	1,831	1,816	1,934	1,845	1,816	1,758	1,799	1,576	1,461

Continued

HEADCOUNT ENROLLMENT (1)
All Alabama Higher Education Institutions
Fall 1989 - 1999

	Fall 1989	Fall 1990	Fall 1991	Fall 1992	Fall 1993	Fall 1994	Fall 1995	Fall 1996	Fall 1997	Fall 1998	Fall 1999
Continued											
Private Four-Year Institutions											
Birmingham-Southern	1,937	1,902	1,825	1,763	1,673	1,583	1,562	1,489	1,531	1,540	1,528
Concordia College	378	380	383	356	387	435	472	473	525	564	525
Faulkner University	(5)	1,422	1,961	2,274	2,348	2,378	2,225	2,301	2,420	2,491	2,645
Huntingdon College	838	791	797	760	664	668	645	645	673	705	705
Judson College	391	312	354	327	320	315	300	326	305	322	308
Miles College	(5)	584	732	751	868	1,068	1,122	1,202	1,340	1,390	1,453
Oakwood College	1,224	1,266	1,244	1,334	1,451	1,534	1,626	1,666	1,756	1,805	1,736
Samford University	4,159	4,164	4,248	4,341	4,443	4,571	4,630	4,473	4,485	4,473	4,494
Selma University	242	204	219	285	360	206	(5)	66	(5)	(5)	(5)
Southeastern Bible College	157	152	158	155	178	166	199	187	160	170	181
Spring Hill College	1,174	1,305	1,295	1,333	1,349	1,362	1,414	1,446	1,425	1,373	1,484
Stillman College	774	770	821	888	953	913	842	1,014	1,035	1,017	1,458
Talladega College	615	666	753	918	1,027	976	786	633	650	616	455
Tuskegee University	3,487	3,510	3,749	3,598	3,371	3,322	3,100	3,175	3,023	3,080	3,009
University of Mobile	1,190	1,325	1,419	1,703	1,870	1,994	2,177	2,241	2,117	1,918	1,978
Private Two-Year Institutions	312	246	136	86	141	203	223	166	175	164	143
Marion Military Institute											

SOURCE: Integrated Postsecondary Education Data System (IPEDS), Fall Enrollment, 1989 - 1999.

Notes:

- (1) Historical numbers are changed to reflect mergers. An explanation of the calculations are included on the Notes page in the back of this presentation.
- (2) Includes all students enrolled on-campus and off-campus as well as in first professional degree programs in health science.
- (3) Included in Beville State Community College.
- (4) Included in Wallace State Community College-Dothan.
- (5) Not reported.



FIRST PROFESSIONAL HEALTH SCIENCE

Fall Enrollment - 1989 - 1999

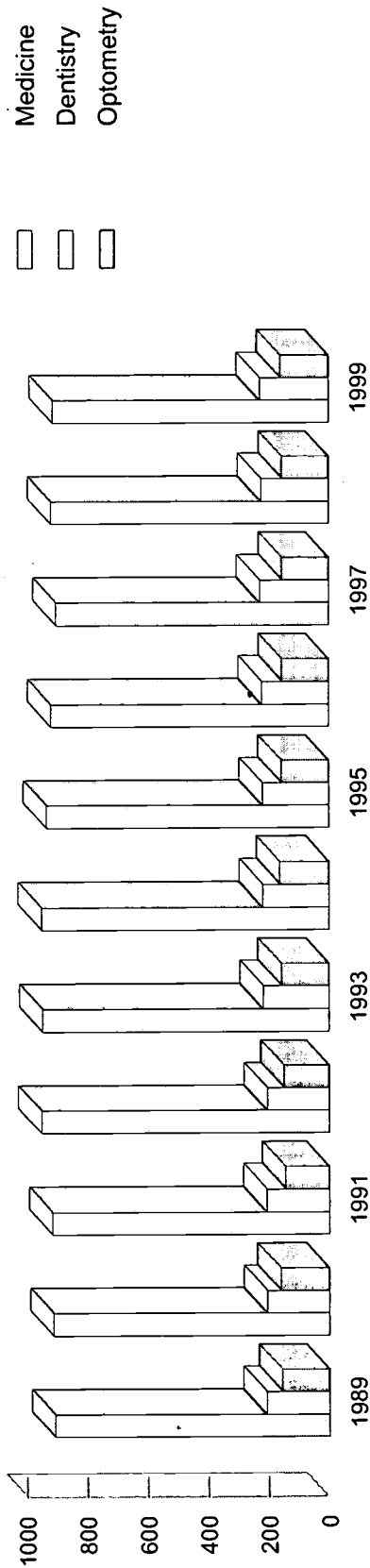

SOURCE: Integrated Postsecondary Education Data System (IPEDS), Fall Enrollment.

FIRST PROFESSIONAL ENROLLMENT

Health Sciences
Fall 1989 - 1999

Institution	1989	1990	1991	1992	1993	1994	1995	1996	1997	1998	1999
UA - Medicine	46	43	38	43	41	39	42	49	42	42	41
UAB - Medicine	560	571	574	585	589	603	632	609	605	622	615
- Dentistry	205	204	205	204	217	220	219	222	227	224	228
- Optometry	157	161	147	151	159	163	158	156	157	156	161
Subtotal: UAB	922	936	926	940	965	986	1,009	987	989	1,002	1,004
UAH - Medicine	44	46	47	53	53	51	*	*	*	*	*
USA - Medicine	257	250	255	271	264	259	260	261	254	255	257
Totals: Medicine	907	910	914	952	947	952	934	919	901	919	913
Dentistry	205	204	205	204	217	220	219	222	227	224	228
Optometry	157	161	147	151	159	163	158	156	157	156	161
GRAND TOTAL	1,269	1,275	1,266	1,307	1,323	1,335	1,311	1,297	1,285	1,299	1,302

SOURCE: Integrated Postsecondary Education Data System (IPEDS), Fall Enrollment 1989 - 1999.

* University of Alabama in Huntsville's First Professional Medicine Enrollment is included in University of Alabama at Birmingham.

SCHOOL OF VETERINARY MEDICINE HEADCOUNT

FALL 1980 - 1999

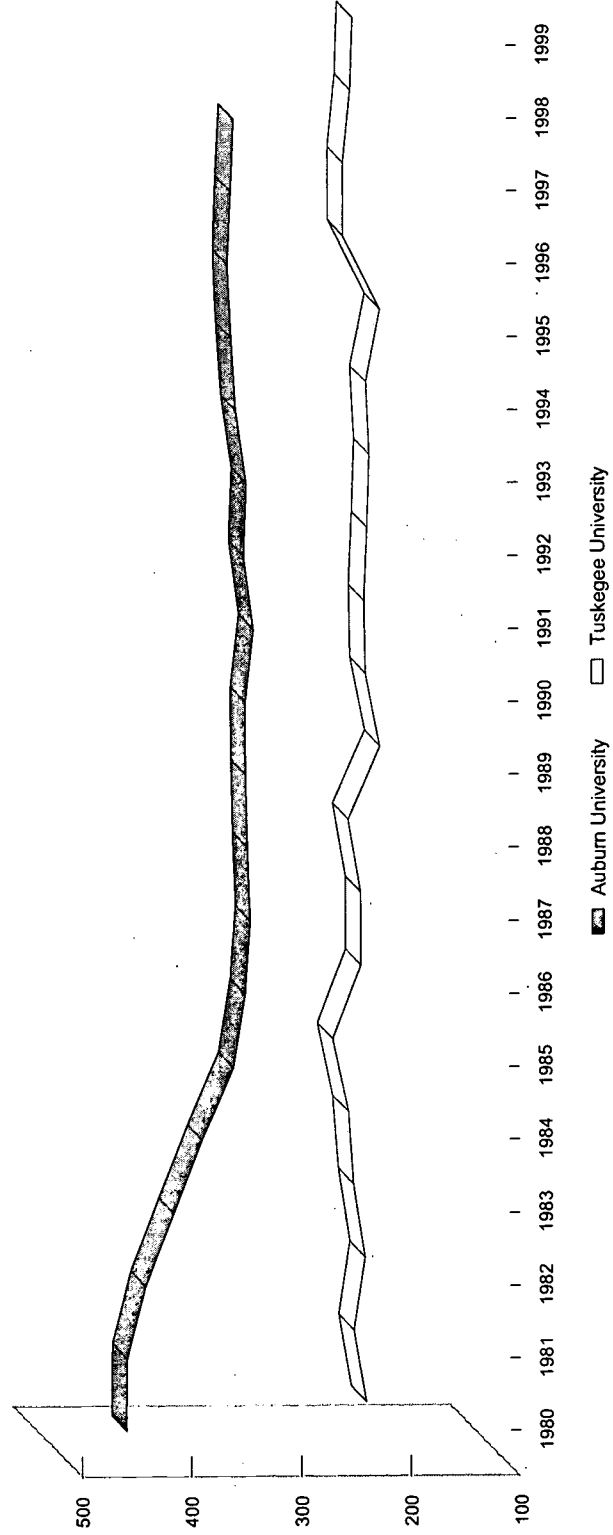

SOURCE: HEGIS Opening, Fall Enrollment Reports, Integrated Postsecondary Education Data System (IPEDS), Fall Enrollment.



SCHOOL OF VETERINARY MEDICINE HEADCOUNT
Auburn University and Tuskegee University
Fall 1980 - 1999

<u>Year</u>	<u>Auburn University Number of Students</u>	<u>Percent Change</u>	<u>Tuskegee University Number of Students</u>	<u>Percent Change</u>
1980	459	0.0	202	6.4
1981	459	-0.2	215	5.1
1982	458	-3.7	226	-4.4
1983	441	-5.9	216	4.6
1984	415	-6.3	226	2.2
1985	389	-7.5	231	6.1
1986	360	-3.1	245	-10.6
1987	349	-1.4	219	0.0
1988	344	0.6	219	5.0
1989	346	0.6	230	-12.6
1990	348	0.0	201	6.5
1991	348	-2.3	214	0.5
1992	340	2.6	215	-1.4
1993	349	-0.9	212	-0.9
1994	346	2.9	210	1.4
1995	356	1.1	213	-6.1
1996	360	0.8	200	16.5
1997	363	-0.8	233	0.0
1998	360	-0.8	233	-3.0
1999	357	0.8	226	-0.9
	360		224	

SOURCE: HEGIS Opening Fall Enrollment and Compliance Report, 1980-1985; Integrated Postsecondary Education Data System, (IPEDS), Fall Enrollment, 1986-1999.

TOTAL HEADCOUNT ENROLLMENT - FULL-TIME/PART-TIME

Fall 1999

	Undergraduate			Graduate			First Professional			Grand Total		
	Full-Time	Part-Time	Total	Full-Time	Part-Time	Total	Full-Time	Part-Time	Total	Full-Time	Part-Time	Total
Total All Public Colleges and Univ	112,706	55,936	168,642	10,045	11,445	21,490	2,508	37	2,545	125,259	67,418	192,677
Total All Public Four-Year Institutions	77,314	22,464	99,778	10,045	11,445	21,490	2,508	37	2,545	89,867	33,946	123,813
Total All Public Two-Year Institutions	35,392	33,472	68,864							35,392	33,472	68,864
Total All Private Institutions	16,901	2,203	19,104	469	758	1,227	1,667	104	1,771	19,037	3,065	22,102
Public Four-Year Institutions												
Alabama A&M University	3,976	356	4,332	452	713	1,165				4,428	1,069	5,497
Alabama State University	4,030	653	4,683	205	776	981				4,235	1,429	5,664
Athens State College	1,177	1,613	2,790				1,177	1,613	2,790			
Auburn University	17,177	1,492	18,669	1,397	1,396	2,793	655	3	658	19,229	2,891	22,120
Auburn University at Montgomery	3,003	1,536	4,539	429	386	815				3,432	1,922	5,354
Jacksonville State University	5,257	1,383	6,640	359	929	1,288				5,616	2,312	7,928
Troy State University	3,903	792	4,695	560	1,011	1,571				4,463	1,803	6,266
Troy State University Dothan	764	789	1,553	98	347	445				862	1,136	1,998
Troy State University Montgomery	892	1,907	2,799	280	284	564				1,172	2,191	3,363
University of Alabama	13,141	1,504	14,645	1,988	1,485	3,473	592	34	626	15,721	3,023	18,744
University of AL at Birmingham	6,919	3,501	10,420	2,274	1,400	3,674	1,004		1,004	10,197	4,901	15,098
University of AL in Huntsville	3,088	2,425	5,513	489	872	1,361				3,577	3,297	6,874
University of Montevallo	2,404	287	2,691	147	309	456				2,551	596	3,147
University of North Alabama	4,346	753	5,099	105	601	706				4,451	1,354	5,805
University of South Alabama	5,715	3,314	9,029	1,104	795	1,899	257		257	7,076	4,109	11,185
University of West Alabama	1,522	159	1,681	158	141	299				1,680	300	1,980
Public Two-Year Institutions												
Alabama Southern Comm. College	625	615	1,240							625	615	1,240
Ayers State Technical	532	434	966							532	434	966
Bessemer State Technical	556	798	1,354							556	798	1,354
Bevill State Community College a	2,185	1,369	3,554							2,185	1,369	3,554
Bishop State Community College	1,133	2,260	3,393							1,133	2,260	3,393
Calhoun St. Community College	2,464	5,134	7,598							2,464	5,134	7,598
Central AL St. Comm. College	952	660	1,612							952	660	1,612
Chattahoochee Valley CC	811	924	1,735							811	924	1,735
Drake State Technical	271	340	611							271	340	611
Enterprise State Junior	846	798	1,644							846	798	1,644
Faulkner St. Community College	1,725	1,107	2,832							1,725	1,107	2,832
Gadsden St. Community College	2,581	2,148	4,729							2,581	2,148	4,729
Ingram State Technical	564	189	753							564	189	753
Jeff Davis State CC	723	436	1,159							723	436	1,159
Jefferson St. Comm. College	1,988	3,420	5,408							1,988	3,420	5,408
Lawson State Community College	600	941	1,541							600	941	1,541



TOTAL HEADCOUNT ENROLLMENT - FULL-TIME/PART-TIME

Fall 1999

	Undergraduate			Graduate			First Professional			Grand Total		
	Full-Time	Part-Time	Total Headcount	Full-Time	Part-Time	Total Headcount	Full-Time	Part-Time	Total Headcount	Full-Time	Part-Time	Total Headcount
Continued -												
Public Two-Year Institutions												
L. B. Wallace Junior	613	221	834							613	221	834
MacArthur State Technical	489	66	555							489	66	555
Northeast Alabama St. CC	857	719	1,576							857	719	1,576
Northwest-Shoals Community Coll	2,041	1,353	3,394							2,041	1,353	3,394
Patterson State Technical	403	552	955							403	552	955
Reid State Technical	413	268	681							413	268	681
Shelton State Community College	2,600	1,785	4,385							2,600	1,785	4,385
Snead State CC	1,099	577	1,676							1,099	577	1,676
Southern Union State CC	2,668	1,590	4,258							2,668	1,590	4,258
Sparks State Technical	442	107	549							442	107	549
Trenholm State Technical	484	196	680							484	196	680
G. C. Wallace St. CC-Dothan b	1,409	1,575	2,984							1,409	1,575	2,984
G. C. Wallace St. CC-Hanceville	2,613	2,134	4,747							2,613	2,134	4,747
G.C.Wallace St. CC-Selma	705	756	1,461							705	756	1,461
Private Four-Year Institutions												
Birmingham-Southern	1,369	84	1,453	51	24	75				1,420	108	1,528
Concordia College	460	65	525							460	65	525
Faulkner University	1,588	644	2,232	50		50	282	81	363	1,920	725	2,645
Huntingdon College	621	84	705							621	84	705
Judson College	262	46	308							262	46	308
Miles College	1,323	130	1,453							1,323	130	1,453
Oakwood College	1,523	213	1,736							1,523	213	1,736
Samford University	2,650	205	2,855	176	279	455	1,161	23	1,184	3,987	507	4,494
Selma University c												
Southeastern Bible College	144	37	181							144	37	181
Spring Hill College	987	225	1,212	23	249	272				1,010	474	1,484
Stillman College	1,417	41	1,458							1,417	41	1,458
Talladega College	443	12	455							443	12	455
Tuskegee University	2,510	106	2,616	104	65	169	224		224	2,838	171	3,009
University of Mobile	1,463	309	1,772	65	141	206				1,528	450	1,978
Private Two-Year Institutions												
Marion Military Institute	141	2	143							141	2	143

SOURCE: Integrated Postsecondary Education Data System (IPEDS), Fall Enrollment 1999.

- a. Walker College is included with Beville State Community College.
- b. Alabama Aviation & Technical College included with Wallace CC - Dothan.
- c. Data not reported.

BEST COPY AVAILABLE



TOTAL HEADCOUNT ENROLLMENT BY LEVEL AND GENDER

Fall 1999

	Undergraduate		Graduate		First Professional		Total		Grand
	Men	Women	Men	Women	Men	Women	Men	Women	Total
Total All Public Colleges and Univ	73,691	94,950	8,404	13,087	1,406	1,139	83,501	109,176	192,677
Total All Public Four-Year Institutions	44,717	55,060	8,404	13,087	1,406	1,139	54,527	69,286	123,813
Total All Public Two-Year Institutions	28,974	39,890					28,974	39,890	68,864
Total All Private Institutions	7,558	11,546	505	722	903	868	8,966	13,136	22,102
<u>Public Four-Year Institutions</u>									
Alabama A&M University	2,117	2,215	368	797			2,485	3,012	5,497
Alabama State University	2,073	2,610	262	719			2,335	3,329	5,664
Athens State University	1,009	1,781					1,009	1,781	2,790
Auburn University	9,771	8,898	1,539	1,254	226	432	11,536	10,584	22,120
Auburn University at Montgomery	1,704	2,835	284	531			1,988	3,366	5,354
Jacksonville State University	2,854	3,786	454	834			3,308	4,620	7,928
Troy State University	1,875	2,820	428	1,143			2,303	3,963	6,266
Troy State University Dothan	570	982	145	301			715	1,283	1,998
Troy State University Montgomery	1,074	1,725	206	358			1,280	2,083	3,363
University of Alabama	7,071	7,574	1,507	1,966	396	230	8,974	9,770	18,744
University of AL at Birmingham	4,362	6,058	1,392	2,282	642	362	6,396	8,702	15,098
University of AL in Huntsville	2,732	2,781	792	569			3,524	3,350	6,874
University of Montevallo	888	1,803	102	354			990	2,157	3,147
University of North Alabama	2,072	3,027	242	464			2,314	3,491	5,805
University of South Alabama	3,824	5,205	612	1,287	142	115	4,578	6,607	11,185
University of West Alabama	721	960	71	228			792	1,188	1,980
<u>Public Two-Year Institutions</u>									
Alabama Southern Comm. College	409	831					409	831	1,240
Ayers State Technical	379	587					379	587	966
Bessemer State Technical	830	524					830	524	1,354
Bevill State Community College a	1,343	2,211					1,343	2,211	3,554
Bishop State Community College	1,221	2,172					1,221	2,172	3,393
Calhoun St. Community College	3,307	4,291					3,307	4,291	7,598
Central AL St. Comm. College	546	1,066					546	1,066	1,612
Chattahoochee Valley CC	610	1,125					610	1,125	1,735
Drake State Technical	359	252					359	252	611
Enterprise State Junior	586	1,058					586	1,058	1,644
Faulkner St. Community College	1,239	1,593					1,239	1,593	2,832
Gadsden St. Community College	2,077	2,652					2,077	2,652	4,729
Ingram State Technical	620	133					620	133	753
Jeff Davis State CC	582	577					582	577	1,159
Jefferson St. Comm. College	2,138	3,270					2,138	3,270	5,408

TOTAL HEADCOUNT ENROLLMENT BY LEVEL AND GENDER

Fall 1999

	Undergraduate		Graduate		First Professional		Total		Grand
	Men	Women	Men	Women	Men	Women	Men	Women	Total
Continued									
Lawson State Community College	517	1,024					517	1,024	1,541
L. B. Wallace Junior College	360	474					360	474	834
MacArthur State Technical	198	357					198	357	555
Northeast Alabama St. CC	602	974					602	974	1,576
Northwest-Shoals Community Coll	1,394	2,000					1,394	2,000	3,394
Patterson State Technical	572	383					572	383	955
Reid State Technical	262	419					262	419	681
Shelton State Community College	1,874	2,511					1,874	2,511	4,385
Snead State CC	656	1,020					656	1,020	1,676
Southern Union State CC	2,007	2,251					2,007	2,251	4,258
Sparks State Technical	324	225					324	225	549
Trenholm State Technical	153	527					153	527	680
G. C. Wallace St. CC-Dothan b	1,293	1,691					1,293	1,691	2,984
G. C. Wallace St. CC-Hanceville	1,980	2,767					1,980	2,767	4,747
G.C.Wallace St. CC-Seima	536	925					536	925	1,461
Private Four-Year Institutions									
Birmingham-Southern	583	870	43		32		626	902	1,528
Concordia College	180	345					180	345	525
Faulkner University	888	1,344	23		27	137	1,137	1,508	2,645
Huntingdon College	265	440					265	440	705
Judson College	7	301					7	301	308
Miles College	622	831					622	831	1,453
Oakwood College	761	975					761	975	1,736
Samford University	1,095	1,760	180		275	576	1,883	2,611	4,494
Southeastern Bible College	102	79					102	79	181
Spring Hill College	475	737	90		182		565	919	1,484
Stillman College	679	779					679	779	1,458
Talladega College	178	277					178	277	455
Tuskegee University	1,062	1,554	98		71	155	1,229	1,780	3,009
University of Mobile	537	1,235	71		135		608	1,370	1,978
Private Two-Year Institutions									
Marion Military Institute	124	19					124	19	143

SOURCE: Integrated Postsecondary Education Data System (IPEDS), Fall Enrollment, 1999.

- a. Walker College included with Bevill State Community College.
- b. Includes Alabama Aviation & State Technical College.

HEADCOUNT ENROLLMENT IN ALABAMA BY GENDER, RACE AND RESIDENCE STATUS

Fall 1999

	Non-Resident		Black		Indian or		Asian or		Hispanic		White		Race Unknown		Grand Total	
	Alien		Non-Hispanic		Alaskan/Native		Pacific Islander		Men		Women		Men		Women	
	Men	Women	Men	Women	Men	Women	Men	Women	Men	Women	Men	Women	Men	Women	Men	Women
Total All Public Colleges and Univ	2,953	1,557	16,116	28,760	633	859	1,116	1,220	784	858	60,989	74,803	910	1,119	83,501	109,176
Total All Public Four-Year Institutions	2,682	1,393	10,148	17,662	372	468	884	944	514	585	39,347	47,429	580	805	54,527	69,286
Total All Public Two-Year Institutions	271	164	5,968	11,098	261	391	232	276	270	273	21,642	27,374	330	314	28,974	39,890
Total All Private Institutions	306	253	3,867	6,179	32	46	71	87	71	71	4,466	6,163	153	337	8,966	13,136
Public Senior Institutions	195	110	2,048	2,429	4	10	12	9	10	6	213	443	3	5	2,485	3,012
Alabama A&M University	22	4	2,127	2,970	2	2	3	2	10	18	166	331	5	4	2,335	3,329
Alabama State University			107	201	18	40	6	12	4	8	862	1,501	12	19	1,009	1,781
Athens State University	396	216	677	820	65	55	132	131	96	89	10,135	9,242	35	31	11,536	10,584
Auburn University	16	15	444	1,219	4	15	43	48	20	36	1,447	2,011	14	22	1,988	3,366
Auburn Univ. at Montgomery	122	72	576	905	21	22	24	25	22	47	2,532	3,533	11	16	3,308	4,620
Jacksonville State University	75	68	463	1,174	10	22	21	20	26	28	1,556	2,304	152	347	2,303	3,963
Troy State University		2	88	197	5	15	16	11	14	23	584	1,018	8	17	715	1,283
Troy State Univ. Dothan			395	969	6	11	24	20	21	29	799	1,020	35	34	1,280	2,083
Troy State University Montgomery			891	1,518	57	50	91	89	81	69	7,258	7,777	153	167	8,974	9,770
University of Alabama	596	267	421	323	23	27	227	244	57	67	4,536	5,496	116	77	6,396	8,702
Univ. of Alabama at Birmingham	314	125	314	586	58	56	135	129	47	59	2,540	2,318	116	77	3,524	3,350
Univ. of Alabama in Huntsville	27	17	108	296	8	15	4	5	7	18	834	1,791	2	15	990	2,157
University of Montevallo	1		245	338	45	72	19	26	16	20	1,954	2,984	34	51	2,314	3,491
University of North Alabama	490	164	411	1,182	42	54	127	170	76	64	3,432	4,973			4,578	6,607
University of South Alabama	7	10	275	480	4	4		3	7	4	499	687			792	1,188
University of West Alabama																
Public Two-Year Colleges																
Alabama Southern CC			94	322	2	7		1	1	3	311	496	1	2	409	831
Ayers State Technical			78	210	1	3		3	5	9	292	356	1	6	379	587
Bessemer State Technical			272	261	2	2	2	2	4	4	539	246	11	15	830	524
Bevill State CC, a	1		100	283	3	3	3	4	5	6	1,221	1,899	13	16	1,343	2,211
Bishop State CC	4	2	583	1,430	5	12	20	9	6	5	540	682	63	32	1,221	2,172
Calhoun State CC	2	1	636	938	96	157	41	74	56	53	2,388	2,994	88	74	3,307	4,291
Central Alabama CC	4	6	55	292	5	4	2	3	6	7	480	754			546	1,066
Chattahoochee Valley CC			174	453	3	3	10	15	22	28	388	601	13	25	610	1,125
Drake State Technical	15	2	135	143	8	1	1	1	3	2	194	103	3	1	359	252
Enterprise State Junior	2		75	196	6	13	17	33	25	28	448	772	13	16	586	1,058
Faulkner State CC	6		112	220	12	19	9	5	9	6	1,088	1,335	3	8	1,239	1,593
Gadsden State CC	103	60	303	478	7	10	9	9	12	16	1,635	2,073	8	6	2,077	2,652
Ingram State Technical			434	67	9	2	2	2	9	4	162	66	4	2	620	133
Jefferson State CC			249	134	11	14	2	4	1	4	317	419	2	2	582	577
Jefferson Davis St. CC			249	695	10	11	15	34	19	24	1,740	2,414	10	17	2,138	3,270
Jefferson State CC	95	75	504	1,021			1	1	9	1	9	1	3	1	517	1,024
Lawson State CC			39	70	1	2		2	2		317	399	1	2	360	474
L.B. Wallace Junior College	1		34	65	1	2		1	1	1	163	288		2	198	357
MacArthur State Technical			5	10	46	55	6	7	4	5	541	896		1	602	974
Northeast State CC			133	267	14	35	3	2	13	11	1,209	1,670			1,394	2,000
Northwest-Shoals CC	22	15	221	235			4	3	3	3	331	135	13	6	572	383
Patterson State Technical			121	237	1	4	4	4	1	4	138	173	1	1	262	419
Reid State Technical			326	855	2	5	51	32	17	17	1,426	1,551	52	51	1,874	2,511
Shelton State CC																



HEADCOUNT ENROLLMENT IN ALABAMA BY GENDER, RACE AND RESIDENCE STATUS

Fall 1999

	Non-Resident		Black		Indian or		Asian or		Hispanic		White		Race Unknown		Grand Total		
	Alien		Non-Hispanic		Alaskan/Native		Pacific Islander		Men		Non-Hispanic		Men		All Students		
	Men	Women	Men	Women	Men	Women	Men	Women	Men	Women	Men	Women	Men	Women	Men	Women	Total
Continued																	
Snead State CC	3	2	27	14	3	11	2	2	11	17	624	990	3	3	656	1,020	1,676
Southern Union St. CC			269	628	4	7	11	10	4	4	1,697	1,574	12	13	2,007	2,251	4,258
Sparks State Technical	1		146	137			2	2	1	1	164	85	8	2	324	225	549
Trenholm State Technical	12		84	454	8	2	17	17	27	17	65	63	1	7	153	527	680
G.C. Wallace CC-Dothan b	1		215	419	4	9	4	2	9	4	1,014	1,230	6	6	1,293	1,691	2,984
G.C. Wallace CC-Hanceville			79	60	4	9	2	2	9	4	1,883	2,692			1,980	2,767	4,747
G.C. Wallace CC-Seima			216	504	1	1	2	2			318	417	1	1	536	925	1,461
Private Senior Institutions																	
Birmingham Southern University	7	3	35	157	6	6	30	26	3	1	544	709	1	1	626	902	1,528
Concordia College	25	10	131	313							24	22			180	345	525
Faulkner University	7	1	267	623	2	7	5	4	10	7	842	861	4	5	1,137	1,508	2,645
Huntingdon College	16	13	8	38	1	6	3	10	1	1	236	372			265	440	705
Judson College		5		41				2			7	253			7	301	308
Miles College			619	831							3	3			622	831	1,453
Oakwood College	92	125	608	781	1	2	1	3	6	11	15	7	38	46	761	975	1,736
Samford University	40	25	99	166	10	5	14	26	16	14	1,676	2,347	28	28	1,883	2,611	4,494
Southeastern Bible College	8	2	6	3			1				87	74			102	79	181
Spring Hill College	15	6	42	162	3	7	9	11	17	20	465	681	14	32	565	919	1,484
Stillman College	9	2	665	775				1			5	1			679	779	1,458
Talladega College		1	171	269							5	3			178	277	455
Tuskegee University	68	41	1,130	1,716			3	3	9	6	10	12	9	5	1,229	1,780	3,009
University of Mobile	19	19	75	300	9	13	2	3	6	8	438	809	59	218	608	1,370	1,978
Private Two-Year Colleges																	
Marion Military Institute			11	4			3	1	1	2	109	12			124	19	143

SOURCE: Integrated Postsecondary Education Data System (IPEDS), Fall Enrollment, 1999.

NOTE: a. Walker College included with Bevill State Community College.
 b. Alabama Aviation & Technical College included with Wallace State Community College-Dothan.

BEST COPY AVAILABLE

STUDENTS ORIGINS

All Students Public Institutions - Fall 1999

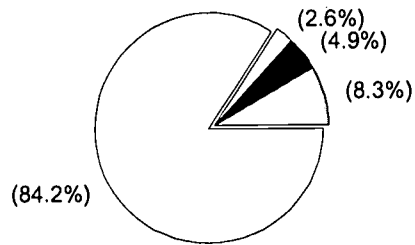

SOURCE: Alabama Commission on Higher Education, Student Source Survey, Fall 1999.

STUDENTS ORIGINS
TOTAL ALL STUDENTS
Alabama Public Institutions
Fall 1999

	FLORIDA	GEORGIA	MISSISSIPPI	TENNESSEE	ADJOINING STATES	OTHER STATES	FOREIGN COUNTRIES	TOTAL INMIGRANTS	FROM ALABAMA	TOTAL
Total All Public Colleges and Univ	3,660	7,082	2,355	2,705	15,802	9,350	4,917	30,069	160,194	190,263
Total All Public Four-Year Institutions	3,113	5,740	2,158	2,446	13,457	8,463	4,063	25,983	95,082	121,065
Total All Public Two-Year Institutions	547	1,342	197	259	2,345	887	854	4,086	65,112	69,198
Public Four-Year Institutions										
Alabama A&M University	64	184	44	133	425	980	305	1,710	3,787	5,497
Alabama State University	181	235	41	16	473	901	26	1,400	4,264	5,664
Athens State University		1	1	126	128	6		134	2,656	2,790
Auburn University	983	2,441	145	759	4,328	2,467	611	7,406	14,056	21,462
Auburn University at Montgomery	31	32	9	3	75	125	62	262	5,092	5,354
Jacksonville State University	25	719	14	24	782	120	194	1,096	6,821	7,917
Troy State University	259	134	12	15	420	367	143	930	4,100	5,030
Troy State University-Phenix City	1	827			828	7		835	401	1,236
Troy State University Dothan	176	91			267	1	2	270	1,728	1,998
Troy State University Montgomery	3	5			8	17	3	28	3,314	3,342
University of Alabama	498	798	406	420	2,122	1,986	858	4,966	13,152	18,118
University of AL at Birmingham	91	171	91	64	417	370	737	1,524	12,570	14,094
University of AL in Huntsville	45	58	22	319	444	715	439	1,598	5,276	6,874
University of Montevallo	20	14	7	4	45	37	44	126	3,021	3,147
University of North Alabama	30	14	279	551	874	84	141	1,099	4,706	5,805
University of South Alabama	651	13	842	10	1,516	228	485	2,229	8,530	10,759
University of West Alabama	55	3	245	2	305	52	13	370	1,608	1,978
Public Two-Year Institutions										
Alabama Southern Community College	24	6	12		42	2		44	1,200	1,244
Ayers State Technical College									945	945
Bessemer State Technical College									1,298	1,353
Bevill State Community College	13	5	40	2	60	38	53	55	1,298	1,353
Bishop State Community College	20	2	46	1	69	18	80	178	3,546	3,724
Calhoun State Community College		10		74	84	49	133	220	3,428	3,648
Central Alabama State Community College	2							133	7,074	7,207
Chattahoochee Valley State CC		655			655	3		670	1,549	1,566
Drake State Technical College	49	11		20	21	6	12	54	1,051	1,721
Enterprise State Junior College				7	67	34	27	102	1,514	1,616
Faulkner Community College						145	9	154	2,641	2,795
Gadsden State Community College	3	26		1	30	65	123	218	4,510	4,728
Ingram State Technical College			1		1	1		2	749	751
Jefferson Davis Community College	155	2	1	2	160	12	5	177	989	1,166

Continued

Jefferson State Community College	5	8	2	5	20	5	210	235	5,008	5,243
Lawson State Community College			1		1	19	6	26	1,527	1,553
L. B. Wallace Junior College	32	10		2	44	17	10	71	753	824
MacArthur State Technical College	33				33			33	522	555
Northeast Alabama State Community Coll		12		2	14		18	32	1,540	1,572
Northwest-Shoals Community College	4	4	22	98	128	10	13	151	3,710	3,861
Patterson State Technical College	1				1	4	1	6	951	957
Reid State Technical College	23			1	24		2	26	646	672
Shelton State Community College	21	24	55	13	113	231		344	4,493	4,837
Snead State Community College		24		3	27	5	51	83	1,627	1,710
Southern Union State Community College	41	427	13	13	494	107		601	3,609	4,210
Sparks State Technical College		35			35	18	11	64	488	552
Trenholm State Technical College						2		2	664	666
G. C. Wallace Community Coll- Dothan	113	65	3	2	183	39	43	265	2,737	3,002
G. C. Wallace Community Coll - Hanceville	5	11	1	13	30	37	44	111	4,306	4,417
G. C. Wallace Community Coll- Selma	3	2	2		5	5	2	12	1,482	1,494

SOURCE: Alabama Commission on Higher Education, Student Source Survey, Fall 1999.

STUDENTS ORIGINS
ALL UNDERGRADUATE STUDENTS
Alabama Public Institutions
Fall 1999

	FLORIDA	GEORGIA	MISSISSIPPI	TENNESSEE	ADJOINING STATES	OTHER STATES	FOREIGN COUNTRIES	TOTAL INMIGRANTS	FROM ALABAMA	TOTAL
Total All Public Colleges and Univ	3,155	5,473	1,970	2,338	12,936	7,567	3,196	23,699	145,249	168,948
Total All Public Four-Year Institutions	2,608	4,131	1,773	2,079	10,591	6,680	2,342	19,613	80,137	99,750
Total All Public Two-Year Institutions	547	1,342	197	259	2,345	887	854	4,086	65,112	69,198
Alabama A&M University	57	174	36	111	378	938	185	1,501	2,831	4,332
Alabama State University	179	233	38	15	465	883	25	1,373	3,310	4,683
Athens State University		1	1	126	128	6		134	2,656	2,790
Auburn University	852	2,175	114	669	3,810	1,827	144	5,781	12,888	18,669
Auburn University at Montgomery	26	27	8	3	64	99	44	207	4,332	4,539
Jacksonville State University	25	437	11	23	496	115	164	775	5,855	6,630
Troy State University	218	86	10	7	321	201	123	645	3,704	4,349
Troy State University-Phenix City		150			150	5		155	191	346
Troy State University Dothan	125	59			184		2	186	1,366	1,552
Troy State University Montgomery	3	4			7	15		22	2,754	2,776
University of Alabama	430	629	297	355	1,711	1,488	410	3,609	11,036	14,645
University of AL at Birmingham	55	78	45	21	199	151	334	684	9,736	10,420
University of AL in Huntsville	37	40	12	224	313	638	242	1,193	4,320	5,513
University of Montevallo	16	10	5	4	35	30	42	107	2,584	2,691
University of North Alabama	30	14	252	511	807	77	130	1,014	4,085	5,099
University of South Alabama	503	11	726	8	1,248	158	485	1,891	7,138	9,029
University of West Alabama	52	3	218	2	275	49	12	336	1,351	1,687
Public Two-Year Institutions										
Alabama Southern Community College	24	6	12		42	2		44	1,200	1,244
Ayers State Technical College									945	945
Bessemer State Technical College									1,298	1,353
Bevill State Community College	13	5	40	2	60	38	53	55	1,298	1,353
Bishop State Community College	20	2	46	1	69	18	133	220	3,428	3,648
Calhoun State Community College		10		74	84	49		133	7,074	7,207
Central Alabama State Community College	2	2			4	13		17	1,549	1,566
Chattahoochee Valley State CC		655			655	3	12	670	1,051	1,721
Drake State Technical College		1		20	21	6	27	54	555	609
Enterprise State Junior College	49	11		7	67	34	1	102	1,514	1,616
Faulkner Community College						145	9	154	2,641	2,795
Gadsden State Community College	3	26		1	30	65	123	218	4,510	4,728
Ingram State Technical College			1		1	1		2	749	751
Jefferson Davis Community College	155	2	1	2	160	12	5	177	989	1,166



Continued

Jefferson State Community College	5	8	2	5	20	5	210	235	5,008	5,243
Lawson State Community College		1			1	19	6	26	1,527	1,553
L. B. Wallace Junior College	32	10		2	44	17	10	71	753	824
MacArthur State Technical College	33				33			33	522	555
Northeast Alabama State Community Coll	4	12		2	14		18	32	1,540	1,572
Northwest-Shoals Community College	1	4	22	98	128	10	13	151	3,710	3,861
Patterson State Technical College					1	4	1	6	951	957
Reid State Technical College	23			1	24		2	26	646	672
Shelton State Community College	21	24	55	13	113	231		344	4,493	4,837
Snead State Community College		24		3	27	5	51	83	1,627	1,710
Southern Union State Community College	41	427	13	13	494	107		601	3,609	4,210
Sparks State Technical College		35			35	18	11	64	488	552
Trenholm State Technical College						2		2	664	666
G. C. Wallace Community Coll- Dothan	113	65	3	2	183	39	43	265	2,737	3,002
G. C. Wallace Community Coll - Hanceville	5	11	1	13	30	37	44	111	4,306	4,417
G. C. Wallace Community Coll- Selma	3	2			5	5	2	12	1,482	1,494

SOURCE: Alabama Commission on Higher Education, Student Source Survey, Fall 1999.

STUDENTS ORIGINS
ALL GRADUATE STUDENTS
Alabama Public Four-Year Institutions
Fall 1999

	FLORIDA	GEORGIA	MISSISSIPPI	TENNESSEE	ADJOINING STATES	OTHER STATES	FOREIGN COUNTRIES	TOTAL INMIGRANTS	FROM ALABAMA	TOTAL
Total All Public Colleges and Univ	505	1,609	385	367	2,866	1,783	1,721	6,370	14,935	21,315
Total All Public Four-Year Institutions	505	1,609	385	367	2,866	1,783	1,721	6,370	14,935	21,315
Alabama A&M University	7	10	8	22	47	42	120	209	956	1,165
Alabama State University	2	2	3	1	8	18	1	27	954	981
Athens State University										
Auburn University	131	266	31	90	518	640	467	1,625	1,168	2,793
Auburn University at Montgomery	5	5	1		11	26	18	55	760	815
Jacksonville State University		282	3	1	286	5	30	321	966	1,287
Troy State University	41	48	2	8	99	166	20	285	396	681
Troy State University-Phenix City	1	677			678	2		680	210	890
Troy State University Dothan	51	32			83	1		84	362	446
Troy State University Montgomery		1			1	2	3	6	560	566
University of Alabama	68	169	109	65	411	498	448	1,357	2,116	3,473
University of AL at Birmingham	36	93	46	43	218	219	403	840	2,834	3,674
University of AL in Huntsville	8	18	10	95	131	77	197	405	956	1,361
University of Montevallo	4	4	2		10	7	2	19	437	456
University of North Alabama			27	40	67	7	11	85	621	706
University of South Alabama	148	2	116	2	268	70		338	1,382	1,730
University of West Alabama	3		27		30	3	1	34	257	291

SOURCE: Alabama Commission on Higher Education, Student Source Survey, Fall 1999.

ENROLLMENT BY AGE, GENDER, AND ENROLLMENT STATUS
ALABAMA PUBLIC INSTITUTIONS
FALL 1999

TOTAL PUBLIC FOUR-YEAR INSTITUTIONS

Age	Full-Time			Part-Time			All Students		
	Men	Women	Total	Men	Women	Total	Men	Women	Total
Under 18	243	396	639	413	408	821	656	804	1,460
18 - 19	10,022	13,441	23,463	591	814	1,405	10,613	14,255	24,868
20 - 21	11,010	14,480	25,491	1,215	1,568	2,783	12,225	16,048	28,273
22 - 24	10,034	10,289	20,248	2,789	3,547	6,336	12,823	13,836	26,659
25 - 29	4,991	4,837	9,805	3,455	4,398	7,853	8,446	9,235	17,681
30 - 34	1,546	1,798	3,327	1,981	2,561	4,542	3,527	4,359	7,886
35 - 39	800	1,323	2,115	1,322	2,007	3,329	2,122	3,330	5,452
40 - 49	748	1,480	2,210	1,671	3,222	4,893	2,419	4,702	7,121
50 - 64	194	365	557	530	1,081	1,611	724	1,446	2,170
65 and Over	72	58	129	63	72	135	135	130	265
Age Unknown	762	978	1,740	75	163	238	837	1,141	1,978
TOTAL	40,422	49,445	89,724	14,105	19,841	33,946	54,527	69,286	123,813
Percent	32.6	39.9	72.5	11.4	16.0	27.4	44.0	56.0	100.0
Median Age *	21.7	21.4	21.6	27.9	29.0	28.5	22.8	22.6	22.7

TOTAL PUBLIC TWO-YEAR INSTITUTIONS

Age	Full-Time			Part-Time			All Students		
	Men	Women	Total	Men	Women	Total	Men	Women	Total
Under 18	379	476	855	484	675	1,159	863	1,151	2,014
18 - 19	6,611	8,098	14,709	2,195	2,838	5,033	8,806	10,936	19,742
20 - 21	3,605	3,656	7,261	2,419	3,064	5,483	6,024	6,720	12,744
22 - 24	1,552	1,969	3,521	2,121	2,736	4,857	3,673	4,705	8,378
25 - 29	1,200	2,005	3,205	1,957	3,042	4,999	3,157	5,047	8,204
30 - 34	657	1,312	1,969	1,261	2,133	3,394	1,918	3,445	5,363
35 - 39	474	954	1,428	1,030	1,827	2,857	1,504	2,781	4,285
40 - 49	680	1,070	1,750	1,269	2,323	3,592	1,949	3,393	5,342
50 - 64	236	381	617	552	984	1,536	788	1,365	2,153
65 and Over	23	44	67	249	295	544	272	339	611
Age Unknown	8	2	10	12	6	18	20	8	28
TOTAL	15,425	19,967	35,392	13,549	19,923	33,472	28,974	39,890	68,864
Percent	22.4	29.0	51.4	19.7	28.9	48.6	42.1	57.9	100.0
Median Age *	20.4	20.8	20.6	24.4	26.1	25.2	21.6	22.7	22.0

TOTAL PRIVATE FOUR-YEAR INSTITUTIONS

<u>Age</u>	<u>Full-Time</u>			<u>Part-Time</u>			<u>All Students</u>		
	<u>Men</u>	<u>Women</u>	<u>Total</u>	<u>Men</u>	<u>Women</u>	<u>Total</u>	<u>Men</u>	<u>Women</u>	<u>Total</u>
Under 18	287	445	728	18	48	66	301	493	794
18 - 19	2,258	3,602	5,831	58	92	150	2,316	3,694	6,010
20 - 21	2,049	3,214	5,263	90	153	243	2,139	3,367	5,506
22 - 24	1,252	1,544	2,796	157	247	404	1,409	1,791	3,200
25 - 29	841	877	1,718	195	384	579	1,036	1,261	2,297
30 - 34	341	391	732	149	240	389	490	631	1,121
35 - 39	215	302	517	133	254	387	348	556	904
40 - 49	240	348	588	142	340	482	382	688	1,070
50 - 64	38	65	103	70	130	200	108	195	303
65 and Over	136	64	200	20	20	40	156	84	240
Age Unknown	120	270	390	37	87	124	152	356	508
TOTAL	7,777	11,122	18,899	1,069	1,995	3,064	8,837	13,116	21,953
Percent	35.4	50.7	86.1	4.9	9.1	14.0	40.3	59.7	100.0
Median Age *	21.3	20.9	21.0	29.9	30.6	30.4	21.6	21.3	21.4

TOTAL PRIVATE TWO-YEAR INSTITUTIONS

<u>Age</u>	<u>Full-Time</u>			<u>Part-Time</u>			<u>All Students</u>		
	<u>Men</u>	<u>Women</u>	<u>Total</u>	<u>Men</u>	<u>Women</u>	<u>Total</u>	<u>Men</u>	<u>Women</u>	<u>Total</u>
Under 18	4	1	5				4	1	5
18 - 19	89	16	105				89	16	105
20 - 21	23	1	24		1	1	23	2	25
22 - 24	6		6				6		6
25 - 29									
30 - 34	1		1				1		1
35 - 39				1		1	1		1
40 - 49									
50 - 64									
65 and Over									
Age Unknown									
TOTAL	123	18	141	1	1	2	124	19	143
Percent	86.0	12.6	98.6	0.7	0.7	1.4	86.7	13.3	100.0
Median Age *	18.6	18.5	18.6	37.0	20.5	35.0	18.7	18.5	18.6

Alabama A&M University

Age	Full-Time			Part-Time			All Students		
	Men	Women	Total	Men	Women	Total	Men	Women	Total
Under 18	40	45	85	2	9	11	42	54	96
18 - 19	789	885	1,674	9	7	16	798	892	1,690
20 - 21	516	542	1,059	21	16	37	537	558	1,095
22 - 24	433	425	783	63	107	170	496	532	1,028
25 - 29	196	186	359	108	175	283	304	361	665
30 - 34	49	74	106	60	109	169	109	183	292
35 - 39	26	68	86	37	79	116	63	147	210
40 - 49	48	83	113	60	143	203	108	226	334
50 - 64	10	11	19	14	40	54	24	51	75
65 and Over	1	1	1	3	7	10	4	8	12
Age Unknown									
TOTAL	2,108	2,320	4,285	377	692	1,069	2,485	3,012	5,497
Percent	38.3	42.2	78.0	6.9	12.6	19.4	45.2	54.8	100.0
Median Age *	20.9	20.8	20.7	29.3	31.5	30.5	21.5	22.0	21.8

Alabama State University

Age	Full-Time			Part-Time			All Students		
	Men	Women	Total	Men	Women	Total	Men	Women	Total
Under 18									
18 - 19	36	32	68	1	1	2	37	33	70
20 - 21	535	656	1,191	22	33	55	557	689	1,246
22 - 24	394	478	872	89	124	213	483	602	1,085
25 - 29	150	142	292	135	272	407	285	414	699
30 - 34	22	60	82	70	137	207	92	197	289
35 - 39	11	31	42	43	114	157	54	145	199
40 - 49	23	42	65	55	205	260	78	247	325
50 - 64	3	12	15	13	72	85	16	84	100
65 and Over									
Age Unknown	711	897	1,608	22	21	43	733	918	1,651
TOTAL	1,885	2,350	4,235	450	979	1,429	2,335	3,329	5,664
Percent	33.3	41.5	74.8	7.9	17.3	25.2	41.2	58.8	100.0
Median Age *	22.1	22.2	22.2	28.8	31.8	30.4	23.3	24.4	23.9

Athens State University

Age	Full-Time			Part-Time			All Students		
	Men	Women	Total	Men	Women	Total	Men	Women	Total
Under 18									
18 - 19	1	1	2	1	2	3	2	3	5
20 - 21	70	225	295	26	68	94	96	293	389
22 - 24	136	223	359	117	200	317	253	423	676
25 - 29	84	108	192	130	210	340	214	318	532
30 - 34	42	78	120	103	150	253	145	228	373
35 - 39	25	64	89	95	113	208	120	177	297
40 - 49	34	64	98	108	205	313	142	269	411
50 - 64	10	9	19	21	57	78	31	66	97
65 and Over		1	1	2	2	4	2	3	5
Age Unknown	2		2	2	1	3	4	1	5
TOTAL	404	773	1,177	605	1,008	1,613	1,009	1,781	2,790
Percent	14.5	27.7	42.2	21.7	36.1	57.8	36.2	63.8	100.0
Median Age *	24.9	24.2	24.4	31.3	30.8	31.0	28.5	27.7	28.0

Auburn University

Age	Full-Time			Part-Time			All Students		
	Men	Women	Total	Men	Women	Total	Men	Women	Total
Under 18	40	62	102	2	1	3	42	63	105
18 - 19	3,035	3,538	6,573	81	74	155	3,116	3,612	6,728
20 - 21	3,166	3,414	6,580	244	161	405	3,410	3,575	6,985
22 - 24	2,432	1,734	4,166	456	291	747	2,888	2,025	4,913
25 - 29	742	413	1,155	425	233	658	1,167	646	1,813
30 - 34	206	97	303	221	128	349	427	225	652
35 - 39	96	72	168	125	78	203	221	150	371
40 - 49	88	65	153	129	140	269	217	205	422
50 - 64	16	12	28	30	66	96	46	78	124
65 and Over	1		1	1	2	3	2	2	4
Age Unknown					3	3		3	3
TOTAL	9,822	9,407	19,229	1,714	1,177	2,891	11,536	10,584	22,120
Percent	44.4	42.5	86.9	7.7	5.3	13.1	52.2	47.8	100.0
Median Age *	21.2	20.6	20.9	25.9	26.3	26.0	21.5	20.9	21.2

Auburn University at Montgomery

Age	Full-Time			Part-Time			All Students		
	Men	Women	Total	Men	Women	Total	Men	Women	Total
Under 18	3	8	11	3	10	13	6	18	24
18 - 19	318	510	828	85	130	215	403	640	1,043
20 - 21	256	515	771	127	165	292	383	680	1,063
22 - 24	298	476	774	156	259	415	454	735	1,189
25 - 29	187	320	507	180	259	439	367	579	946
30 - 34	67	111	178	76	120	196	143	231	374
35 - 39	56	101	157	49	78	127	105	179	284
40 - 49	42	127	169	51	118	169	93	245	338
50 - 64	7	28	35	23	27	50	30	55	85
65 and Over	1		1				1		1
Age Unknown	1		1	2	4	6	3	4	7
TOTAL	1,236	2,196	3,432	752	1,170	1,922	1,988	3,366	5,354
Percent	23.1	41.0	64.1	14.0	21.9	35.9	37.1	62.9	100.0
Median Age *	22.4	22.4	22.4	25.1	25.4	25.3	23.3	23.4	23.4

Jacksonville State University

Age	Full-Time			Part-Time			All Students		
	Men	Women	Total	Men	Women	Total	Men	Women	Total
Under 18	27	49	76	42	63	105	69	112	181
18 - 19	645	870	1,515	25	31	56	670	901	1,571
20 - 21	670	961	1,631	66	94	160	736	1,055	1,791
22 - 24	577	641	1,218	165	246	411	742	887	1,629
25 - 29	299	335	634	242	325	567	541	660	1,201
30 - 34	78	138	216	134	170	304	212	308	520
35 - 39	35	90	125	88	137	225	123	227	350
40 - 49	49	119	168	113	259	372	162	378	540
50 - 64	17	16	33	36	74	110	53	90	143
65 and Over					2	2		2	2
Age Unknown									
TOTAL	2,397	3,219	5,616	911	1,401	2,312	3,308	4,620	7,928
Percent	30.2	40.6	70.8	11.5	17.7	29.2	41.7	58.3	100.0
Median Age *	21.6	21.4	21.5	28.3	29.1	28.7	22.7	22.8	22.8

Troy State University

Age	Full-Time			Part-Time			All Students		
	Men	Women	Total	Men	Women	Total	Men	Women	Total
Under 18	1	3	4		1	1	1	4	5
18 - 19	424	649	1,073	7	13	20	431	662	1,093
20 - 21	518	864	1,382	25	48	73	543	912	1,455
22 - 24	473	459	932	97	155	252	570	614	1,184
25 - 29	149	252	401	102	263	365	251	515	766
30 - 34	47	105	152	62	183	245	109	288	397
35 - 39	37	86	123	52	157	209	89	243	332
40 - 49	40	107	147	59	244	303	99	351	450
50 - 64	21	40	61	50	108	158	71	148	219
65 and Over	66	53	119	40	33	73	106	86	192
Age Unknown	19	50	69	14	90	104	33	140	173
TOTAL	1,795	2,668	4,463	508	1,295	1,803	2,303	3,963	6,266
Percent	28.6	42.6	71.2	8.1	20.7	28.8	36.8	63.2	100.0
Median Age *	21.8	21.5	21.6	31.3	33.3	32.8	22.8	23.6	23.3

Troy State University Dothan

Age	Full-Time			Part-Time			All Students		
	Men	Women	Total	Men	Women	Total	Men	Women	Total
Under 18		1	1					1	1
18 - 19	14	41	55	7	6	13	21	47	68
20 - 21	40	127	167	21	31	52	61	158	219
22 - 24	59	127	186	69	114	183	128	241	369
25 - 29	58	116	174	98	153	251	156	269	425
30 - 34	47	63	110	71	138	209	118	201	319
35 - 39	23	50	73	57	91	148	80	141	221
40 - 49	32	46	78	79	128	207	111	174	285
50 - 64	7	8	15	24	37	61	31	45	76
65 and Over				2	2	4	2	2	4
Age Unknown		3	3	7	1	8	7	4	11
TOTAL	280	582	862	435	701	1,136	715	1,283	1,998
Percent	14.0	29.1	43.1	21.8	35.1	56.9	35.8	64.2	100.0
Median Age *	27.3	24.8	25.6	31.3	31.7	31.6	29.6	28.6	29.0

Troy State University Montgomery

Age	Full-Time			Part-Time			All Students		
	Men	Women	Total	Men	Women	Total	Men	Women	Total
Under 18	1	6	7	4	2	6	5	8	13
18 - 19	40	115	155	47	96	143	87	211	298
20 - 21	50	93	143	71	154	225	121	247	368
22 - 24	71	153	224	126	202	328	197	355	552
25 - 29	94	180	274	197	286	483	291	466	757
30 - 34	48	74	122	138	169	307	186	243	429
35 - 39	47	60	107	119	161	280	166	221	387
40 - 49	45	62	107	129	192	321	174	254	428
50 - 64	6	9	15	28	41	69	34	50	84
65 and Over		1	1					1	1
Age Unknown	7	10	17	12	17	29	19	27	46
TOTAL	409	763	1,172	871	1,320	2,191	1,280	2,083	3,363
Percent	12.2	22.7	34.8	25.9	39.3	65.2	38.1	61.9	100.0
Median Age *	27.1	25.3	25.9	29.6	28.5	28.9	28.8	27.2	27.8

The University of Alabama

Age	Full-Time			Part-Time			All Students		
	Men	Women	Total	Men	Women	Total	Men	Women	Total
Under 18	93	159	252	3	1	4	96	160	256
18 - 19	2,154	2,803	4,957	29	35	64	2,183	2,838	5,021
20 - 21	2,245	2,604	4,849	107	104	211	2,352	2,708	5,060
22 - 24	1,838	1,515	3,353	183	274	457	2,021	1,789	3,810
25 - 29	860	563	1,423	266	327	593	1,126	890	2,016
30 - 34	251	166	417	216	214	430	467	380	847
35 - 39	116	102	218	148	191	339	264	293	557
40 - 49	80	102	182	250	413	663	330	515	845
50 - 64	29	40	69	99	149	248	128	189	317
65 and Over	1		1	6	8	14	7	8	15
Age Unknown									
TOTAL	7,667	8,054	15,721	1,307	1,716	3,023	8,974	9,770	18,744
Percent	40.9	43.0	83.9	7.0	9.2	16.1	47.9	52.1	100.0
Median Age *	21.4	20.8	21.1	31.5	32.7	32.1	21.9	21.4	21.6

University of Alabama at Birmingham

Age	Full-Time			Part-Time			All Students		
	Men	Women	Total	Men	Women	Total	Men	Women	Total
Under 18	7	10	17	14	11	25	21	21	42
18 - 19	657	1,029	1,686	53	75	128	710	1,104	1,814
20 - 21	820	1,297	2,117	152	203	355	972	1,500	2,472
22 - 24	1,200	1,592	2,792	453	593	1,046	1,653	2,185	3,838
25 - 29	1,067	1,023	2,090	601	736	1,337	1,668	1,759	3,427
30 - 34	344	308	652	295	404	699	639	712	1,351
35 - 39	165	214	379	166	282	448	331	496	827
40 - 49	114	224	338	181	433	614	295	657	952
50 - 64	28	66	94	54	163	217	82	229	311
65 and Over					7	7		7	7
Age Unknown	17	15	32	8	17	25	25	32	57
TOTAL	4,419	5,778	10,197	1,977	2,924	4,901	6,396	8,702	15,098
Percent	29.3	38.3	67.5	13.1	19.4	32.5	42.4	57.6	100.0
Median Age *	23.8	23.0	23.4	27.6	28.9	28.3	24.7	24.3	24.5

University of Alabama in Huntsville

Age	Full-Time			Part-Time			All Students		
	Men	Women	Total	Men	Women	Total	Men	Women	Total
Under 18	6	9	15	315	243	558	321	252	573
18 - 19	433	476	909	81	64	145	514	540	1,054
20 - 21	421	415	836	94	107	201	515	522	1,037
22 - 24	420	395	815	239	226	465	659	621	1,280
25 - 29	249	237	486	342	281	623	591	518	1,109
30 - 34	100	113	213	223	172	395	323	285	608
35 - 39	56	93	149	177	160	337	233	253	486
40 - 49	36	92	128	237	185	422	273	277	550
50 - 64	13	12	25	69	67	136	82	79	161
65 and Over				4	2	6	4	2	6
Age Unknown	1		1	8	1	9	9	1	10
TOTAL	1,735	1,842	3,577	1,789	1,508	3,297	3,524	3,350	6,874
Percent	25.2	26.8	52.0	26.0	21.9	48.0	51.3	48.7	100.0
Median Age *	22.1	22.2	22.1	27.4	27.0	27.2	23.9	23.7	23.8

University of Montevallo

Age	Full-Time			Part-Time			All Students		
	Men	Women	Total	Men	Women	Total	Men	Women	Total
Under 18	9	27	36		6	6	9	33	42
18 - 19	271	604	875	9	14	23	280	618	898
20 - 21	268	579	847	15	28	43	283	607	890
22 - 24	185	338	523	41	102	143	226	440	666
25 - 29	62	84	146	49	103	152	111	187	298
30 - 34	9	40	49	26	49	75	35	89	124
35 - 39	4	23	27	14	35	49	18	58	76
40 - 49	7	34	41	17	59	76	24	93	117
50 - 64	1	6	7	3	21	24	4	27	31
65 and Over					1	1		1	1
Age Unknown					4	4		4	4
TOTAL	816	1,735	2,551	174	422	596	990	2,157	3,147
Percent	25.9	55.1	81.1	5.5	13.4	18.9	31.5	68.5	100.0
Median Age *	21.0	20.8	20.9	27.2	27.9	27.7	21.5	21.4	21.5

University of North Alabama

Age	Full-Time			Part-Time			All Students		
	Men	Women	Total	Men	Women	Total	Men	Women	Total
Under 18	3	3	6	17	40	57	20	43	63
18 - 19	456	738	1,194	22	28	50	478	766	1,244
20 - 21	558	876	1,434	28	44	72	586	920	1,506
22 - 24	519	572	1,091	89	133	222	608	705	1,313
25 - 29	168	181	349	140	207	347	308	388	696
30 - 34	46	99	145	77	121	198	123	220	343
35 - 39	25	72	97	39	91	130	64	163	227
40 - 49	29	77	106	59	137	196	88	214	302
50 - 64	7	19	26	25	49	74	32	68	100
65 and Over	2	1	3	5	3	8	7	4	11
Age Unknown									
TOTAL	1,813	2,638	4,451	501	853	1,354	2,314	3,491	5,805
Percent	31.2	45.4	76.7	8.6	14.7	23.3	39.9	60.1	100.0
Median Age *	21.6	21.3	21.4	28.4	29.4	29.0	22.4	22.1	22.2

University of South Alabama

Age	Full-Time			Part-Time			All Students		
	Men	Women	Total	Men	Women	Total	Men	Women	Total
Under 18	9	8	17	11	21	32	20	29	49
18 - 19	512	825	1,337	130	230	360	642	1,055	1,697
20 - 21	662	1,039	1,701	187	285	472	849	1,324	2,173
22 - 24	833	985	1,818	424	493	917	1,257	1,478	2,735
25 - 29	571	596	1,167	417	518	935	988	1,114	2,102
30 - 34	173	250	423	196	265	461	369	515	884
35 - 39	76	167	243	108	211	319	184	378	562
40 - 49	71	203	274	137	327	464	208	530	738
50 - 64	19	73	92	40	103	143	59	176	235
65 and Over		1	1		3	3		4	4
Age Unknown	2	1	3		3	3	2	4	6
TOTAL	2,928	4,148	7,076	1,650	2,459	4,109	4,578	6,607	11,185
Percent	26.2	37.1	63.3	14.8	22.0	36.7	40.9	59.1	100.0
Median Age *	23.0	22.6	22.8	25.9	26.9	26.5	23.9	23.8	23.8

University of West Alabama

<u>Age</u>	<u>Full-Time</u>			<u>Part-Time</u>			<u>All Students</u>		
	<u>Men</u>	<u>Women</u>	<u>Total</u>	<u>Men</u>	<u>Women</u>	<u>Total</u>	<u>Men</u>	<u>Women</u>	<u>Total</u>
Under 18	4	6	10				4	6	10
18 - 19	237	325	562	4	8	12	241	333	574
20 - 21	215	273	488	9	27	36	224	300	524
22 - 24	166	176	342	22	28	50	188	204	392
25 - 29	55	101	156	23	50	73	78	151	229
30 - 34	17	22	39	13	32	45	30	54	84
35 - 39	2	30	32	5	29	34	7	59	66
40 - 49	10	33	43	7	34	41	17	67	84
50 - 64		4	4	1	7	8	1	11	12
65 and Over									
Age Unknown	2	2	4		1	1	2	3	5
TOTAL	708	972	1,680	84	216	300	792	1,188	1,980
Percent	35.8	49.1	84.8	4.2	10.9	15.2	40.0	60.0	100.0
Median Age *	21.0	21.1	21.1	26.5	29.5	28.5	21.3	21.7	21.5

Alabama Southern Community College

Age	Full-Time			Part-Time			All Students		
	Men	Women	Total	Men	Women	Total	Men	Women	Total
Under 18		4	6	5	13	18	7	17	24
18 - 19	139	210	349	87	112	199	226	322	548
20 - 21	44	85	129	37	70	107	81	155	236
22 - 24	13	43	56	24	59	83	37	102	139
25 - 29	9	25	34	17	54	71	26	79	105
30 - 34	4	15	19	9	41	50	13	56	69
35 - 39	2	11	13	5	27	32	7	38	45
40 - 49	2	14	16	8	36	44	10	50	60
50 - 64	1	2	3	1	8	9	2	10	12
65 and Over					2	2		2	2
Age Unknown									
TOTAL	216	409	625	193	422	615	409	831	1,240
Percent	17.4	33.0	50.4	15.6	34.0	49.6	33.0	67.0	100.0
Median Age *	18.8	19.0	18.9	20.2	22.8	21.7	18.9	21.0	20.4

Avers State Technical College

Age	Full-Time			Part-Time			All Students		
	Men	Women	Total	Men	Women	Total	Men	Women	Total
Under 18	1	3	4	1	5	6	2	8	10
18 - 19	80	84	164	30	20	50	110	104	214
20 - 21	27	47	74	22	19	41	49	66	115
22 - 24	22	41	63	14	27	41	36	68	104
25 - 29	20	61	81	17	30	47	37	91	128
30 - 34	9	28	37	17	35	52	26	63	89
35 - 39	7	20	27	21	25	46	28	45	73
40 - 49	24	37	61	30	57	87	54	94	148
50 - 64	9	11	20	14	31	45	23	42	65
65 and Over	1		1	13	6	19	14	6	20
Age Unknown									
TOTAL	200	332	532	179	255	434	379	587	966
Percent	20.7	34.4	55.1	18.5	26.4	44.9	39.2	60.8	100.0
Median Age *	21.4	24.3	23.1	31.6	33.8	33.1	24.4	27.6	26.6

Bessemer State Technical

Age	Full-Time			Part-Time			All Students		
	Men	Women	Total	Men	Women	Total	Men	Women	Total
Under 18	2		2	3	1	4	2		2
18 - 19	101	65	166	65	24	89	104	66	170
20 - 21	57	59	116	84	28	112	122	83	205
22 - 24	18	40	58	85	31	116	102	68	170
25 - 29	22	58	80	75	38	113	107	89	196
30 - 34	20	24	44	76	23	99	95	62	157
35 - 39	10	18	28	64	34	98	86	41	127
40 - 49	22	20	42	78	30	108	86	54	140
50 - 64	11	6	17	27	17	44	89	36	125
65 and Over				4	4	8	27	17	44
Age Unknown	1	2	3	5	2	7	5	6	11
TOTAL	264	292	556	566	232	798	830	524	1,354
Percent	19.5	21.6	41.1	41.8	17.1	58.9	61.3	38.7	100.0
Median Age *	18.5	21.1	18.9	23.8	24.5	24.1	24.4	23.5	24.0

Bevill State Community College

Age	Full-Time			Part-Time			All Students		
	Men	Women	Total	Men	Women	Total	Men	Women	Total
Under 18	34	36	70	32	41	73	66	77	143
18 - 19	503	634	1,137	120	168	288	623	802	1,425
20 - 21	149	150	299	86	96	182	235	246	481
22 - 24	49	112	161	71	115	186	120	227	347
25 - 29	38	135	173	73	149	222	111	284	395
30 - 34	15	77	92	43	99	142	58	176	234
35 - 39	23	72	95	32	73	105	55	145	200
40 - 49	12	89	101	36	74	110	48	163	211
50 - 64	10	43	53	13	42	55	23	85	108
65 and Over	1	3	4	3	3	6	4	6	10
Age Unknown									
TOTAL	834	1,351	2,185	509	860	1,369	1,343	2,211	3,554
Percent	23.5	38.0	61.5	14.3	24.2	38.5	37.8	62.2	100.0
Median Age *	18.8	20.1	18.9	22.7	25.3	24.3	19.0	21.8	20.9

Bishop State Community College

Age	Full-Time			Part-Time			All Students		
	Men	Women	Total	Men	Women	Total	Men	Women	Total
Under 18	2		2	4	7	11	6	7	13
18 - 19	152	142	294	131	245	376	283	387	670
20 - 21	115	148	263	128	241	369	243	389	632
22 - 24	63	120	183	142	206	348	205	326	531
25 - 29	51	105	156	99	265	364	150	370	520
30 - 34	28	68	96	83	178	261	111	246	357
35 - 39	17	38	55	66	133	199	83	171	254
40 - 49	22	38	60	75	164	239	97	202	299
50 - 64	7	9	16	18	48	66	25	57	82
65 and Over	6	2	8	12	15	27	18	17	35
Age Unknown									
TOTAL	463	670	1,133	758	1,502	2,260	1,221	2,172	3,393
Percent	13.6	19.7	33.4	22.3	44.3	66.6	36.0	64.0	100.0
Median Age *	21.3	23.1	22.1	24.5	26.0	25.4	23.1	24.8	24.2

Calhoun State Community College

Age	Full-Time			Part-Time			All Students		
	Men	Women	Total	Men	Women	Total	Men	Women	Total
Under 18	19	13	32	37	76	113	56	89	145
18 - 19	386	592	978	364	410	774	750	1,002	1,752
20 - 21	205	272	477	395	463	858	600	735	1,335
22 - 24	103	129	232	333	413	746	436	542	978
25 - 29	106	131	237	354	447	801	460	578	1,038
30 - 34	96	92	188	256	342	598	352	434	786
35 - 39	61	69	130	195	322	517	256	391	647
40 - 49	83	70	153	228	320	548	311	390	701
50 - 64	21	15	36	51	109	160	72	124	196
65 and Over	1		1	13	6	19	14	6	20
Age Unknown									
TOTAL	1,081	1,383	2,464	2,226	2,908	5,134	3,307	4,291	7,598
Percent	14.2	18.2	32.4	29.3	38.3	67.6	43.5	56.5	100.0
Median Age *	21.3	20.6	20.9	24.9	26.0	25.5	23.7	23.8	23.7

Central Alabama Community College

Age	Full-Time			Part-Time			All Students		
	Men	Women	Total	Men	Women	Total	Men	Women	Total
Under 18	1	5	6	19	18	37	20	23	43
18 - 19	190	276	466	20	54	74	210	330	540
20 - 21	107	119	226	43	74	117	150	193	343
22 - 24	17	48	65	38	57	95	55	105	160
25 - 29	9	59	68	34	59	93	43	118	161
30 - 34	6	54	60	23	64	87	29	118	147
35 - 39	2	29	31	16	51	67	18	80	98
40 - 49		25	25	15	50	65	15	75	90
50 - 64		4	4	5	18	23	5	22	27
65 and Over	1		1		2	2	1	2	3
Age Unknown									
TOTAL	333	619	952	213	447	660	546	1,066	1,612
Percent	20.7	38.4	59.1	13.2	27.7	40.9	33.9	66.1	100.0
Median Age *	18.9	20.5	20.0	23.9	26.7	25.4	20.6	21.9	21.3

Chattahoochee Valley Community College

Age	Full-Time			Part-Time			All Students		
	Men	Women	Total	Men	Women	Total	Men	Women	Total
Under 18	6	4	10	54	73	127	60	77	137
18 - 19	120	210	330	41	49	90	161	259	420
20 - 21	58	93	151	48	68	116	106	161	267
22 - 24	33	48	81	54	91	145	87	139	226
25 - 29	20	79	99	55	104	159	75	183	258
30 - 34	13	42	55	41	70	111	54	112	166
35 - 39	10	31	41	24	58	82	34	89	123
40 - 49	9	27	36	20	47	67	29	74	103
50 - 64	1	6	7	2	20	22	3	26	29
65 and Over		1	1	1	4	5	1	5	6
Age Unknown									
TOTAL	270	541	811	340	584	924	610	1,125	1,735
Percent	15.6	31.2	46.7	19.6	33.7	53.3	35.2	64.8	100.0
Median Age *	20.3	21.2	20.9	23.5	25.5	24.7	21.6	23.4	22.6

Drake State Technical College

Age	Full-Time			Part-Time			All Students		
	Men	Women	Total	Men	Women	Total	Men	Women	Total
Under 18	1		1	5		5	6		6
18 - 19	31	19	50	47	8	55	78	27	105
20 - 21	23	21	44	38	13	51	61	34	95
22 - 24	12	25	37	18	14	32	30	39	69
25 - 29	11	25	36	36	15	51	47	40	87
30 - 34	3	19	22	17	24	41	20	43	63
35 - 39	9	15	24	23	13	36	32	28	60
40 - 49	27	13	40	33	13	46	60	26	86
50 - 64	9	7	16	12	7	19	21	14	35
65 and Over	1		1	3	1	4	4	1	5
Age Unknown									
TOTAL	127	144	271	232	108	340	359	252	611
Percent	20.8	23.6	44.4	38.0	17.7	55.6	58.8	41.2	100.0
Median Age *	24.1	26.4	25.5	26.1	30.8	27.6	25.5	28.3	26.8

Enterprise State Junior College

Age	Full-Time			Part-Time			All Students		
	Men	Women	Total	Men	Women	Total	Men	Women	Total
Under 18				2	10	12	2	10	12
18 - 19	1		1	46	42	88	47	42	89
20 - 21	194	230	424	44	60	104	238	290	528
22 - 24	70	73	143	34	57	91	104	130	234
25 - 29	20	35	55	38	72	110	58	107	165
30 - 34	16	68	84	20	46	66	36	114	150
35 - 39	9	35	44	21	52	73	30	87	117
40 - 49	6	22	28	32	78	110	38	100	138
50 - 64	7	43	50	8	50	58	15	93	108
65 and Over	1	16	17	17	69	86	18	85	103
Age Unknown									
TOTAL	324	522	846	262	536	798	586	1,058	1,644
Percent	19.7	31.8	51.5	15.9	32.6	48.5	35.6	64.4	100.0
Median Age *	21.7	23.3	22.0	25.7	32.9	29.7	22.2	27.7	24.5

Faulkner State Community College

Age	Full-Time			Part-Time			All Students		
	Men	Women	Total	Men	Women	Total	Men	Women	Total
Under 18	3	18	21	3	8	11	6	26	32
18 - 19	450	615	1,065	72	83	155	522	698	1,220
20 - 21	194	162	356	91	105	196	285	267	552
22 - 24	51	58	109	99	92	191	150	150	300
25 - 29	33	43	76	74	98	172	107	141	248
30 - 34	14	21	35	36	68	104	50	89	139
35 - 39	7	21	28	37	52	89	44	73	117
40 - 49	12	12	24	35	82	117	47	94	141
50 - 64	2	8	10	16	38	54	18	46	64
65 and Over		1	1	10	8	18	10	9	19
Age Unknown									
TOTAL	766	959	1,725	473	634	1,107	1,239	1,593	2,832
Percent	27.0	33.9	60.9	16.7	22.4	39.1	43.8	56.3	100.0
Median Age *	18.8	18.8	18.8	24.1	26.5	25.0	20.6	20.5	20.6

Gadsden State Community College

Age	Full-Time			Part-Time			All Students		
	Men	Women	Total	Men	Women	Total	Men	Women	Total
Under 18	34	55	89	58	64	122	92	119	211
18 - 19	531	627	1,158	113	165	278	644	792	1,436
20 - 21	195	201	396	151	193	344	346	394	740
22 - 24	106	124	230	135	167	302	241	291	532
25 - 29	95	116	211	118	195	313	213	311	524
30 - 34	57	80	137	86	137	223	143	217	360
35 - 39	43	62	105	63	101	164	106	163	269
40 - 49	100	89	189	90	162	252	190	251	441
50 - 64	38	26	64	47	78	125	85	104	189
65 and Over	1	1	2	16	9	25	17	10	27
Age Unknown									
TOTAL	1,200	1,381	2,581	877	1,271	2,148	2,077	2,652	4,729
Percent	25.4	29.2	54.6	18.5	26.9	45.4	43.9	56.1	100.0
Median Age *	20.4	20.1	20.2	24.6	26.2	25.4	21.7	22.2	21.9

Ingram State Technical College

Age	Full-Time			Part-Time			All Students		
	Men	Women	Total	Men	Women	Total	Men	Women	Total
Under 18	6		6	4		4	10		10
18 - 19	41	2	43	18		18	59	2	61
20 - 21	58	4	62	15	1	16	73	5	78
22 - 24	107	10	117	35	2	37	142	12	154
25 - 29	90	30	120	30	6	36	120	36	156
30 - 34	61	27	88	17	8	25	78	35	113
35 - 39	42	15	57	20	4	24	62	19	81
40 - 49	41	17	58	17	4	21	58	21	79
50 - 64	10	3	13	8		8	18	3	21
65 and Over									
Age Unknown									
TOTAL	456	108	564	164	25	189	620	133	753
Percent	60.6	14.3	74.9	21.8	3.3	25.1	82.3	17.7	100.0
Median Age *	25.9	31.5	27.3	26.7	32.2	27.7	26.1	31.6	27.4

Jefferson Davis Community College

Age	Full-Time			Part-Time			All Students		
	Men	Women	Total	Men	Women	Total	Men	Women	Total
Under 18	1		1	5	1	6	6	1	7
18 - 19	113	154	267	51	35	86	164	189	353
20 - 21	79	49	128	19	41	60	98	90	188
22 - 24	62	28	90	15	23	38	77	51	128
25 - 29	47	27	74	21	33	54	68	60	128
30 - 34	37	26	63	24	33	57	61	59	120
35 - 39	21	20	41	20	22	42	41	42	83
40 - 49	34	16	50	16	51	67	50	67	117
50 - 64	4	5	9	8	11	19	12	16	28
65 and Over				5	2	7	5	2	7
Age Unknown									
TOTAL	398	325	723	184	252	436	582	577	1,159
Percent	34.3	28.0	62.4	15.9	21.7	37.6	50.2	49.8	100.0
Median Age *	22.3	20.3	21.5	25.5	28.9	27.6	22.9	22.5	22.7

Jefferson State Community College

Age	Full-Time			Part-Time			All Students		
	Men	Women	Total	Men	Women	Total	Men	Women	Total
Under 18	12	11	23	52	78	130	64	89	153
18 - 19	469	564	1,033	224	326	550	693	890	1,583
20 - 21	217	221	438	258	339	597	475	560	1,035
22 - 24	66	99	165	216	311	527	282	410	692
25 - 29	52	82	134	213	357	570	265	439	704
30 - 34	18	49	67	107	220	327	125	269	394
35 - 39	19	37	56	75	200	275	94	237	331
40 - 49	16	37	53	74	236	310	90	273	363
50 - 64	9	10	19	33	88	121	42	98	140
65 and Over				8	5	13	8	5	13
Age Unknown									
TOTAL	878	1,110	1,988	1,260	2,160	3,420	2,138	3,270	5,408
Percent	16.2	20.5	36.8	23.3	39.9	63.2	39.5	60.5	100.0
Median Age *	18.9	19.0	18.9	23.3	25.4	24.5	21.3	22.7	21.9

L. B. Wallace Community College

Age	Full-Time			Part-Time			All Students		
	Men	Women	Total	Men	Women	Total	Men	Women	Total
Under 18	1	3	4	2	3	5	3	6	9
18 - 19	182	218	400	13	26	39	195	244	439
20 - 21	64	47	111	24	20	44	88	67	155
22 - 24	17	14	31	16	14	30	33	28	61
25 - 29	9	17	26	8	14	22	17	31	48
30 - 34	3	10	13	9	18	27	12	28	40
35 - 39	1	6	7	5	9	14	6	15	21
40 - 49	3	14	17		28	28	3	42	45
50 - 64		4	4	2	8	10	2	12	14
65 and Over				1	1	2	1	1	2
Age Unknown									
TOTAL	280	333	613	80	141	221	360	474	834
Percent	33.6	39.9	73.5	9.6	16.9	26.5	43.2	56.8	100.0
Median Age *	18.8	18.8	18.8	22.2	27.7	24.3	18.9	18.9	18.9

Lawson State Community College

Age	Full-Time			Part-Time			All Students		
	Men	Women	Total	Men	Women	Total	Men	Women	Total
Under 18	2	1	3	4	12	16	6	13	19
18 - 19	41	99	140	58	170	228	99	269	368
20 - 21	55	100	155	49	100	149	104	200	304
22 - 24	37	54	91	39	77	116	76	131	207
25 - 29	40	44	84	42	81	123	82	125	207
30 - 34	19	17	36	25	77	102	44	94	138
35 - 39	13	16	29	22	56	78	35	72	107
40 - 49	17	26	43	35	54	89	52	80	132
50 - 64	6	9	15	12	18	30	18	27	45
65 and Over		4	4	1	9	10	1	13	14
Age Unknown									
TOTAL	230	370	600	287	654	941	517	1,024	1,541
Percent	14.9	24.0	38.9	18.6	42.4	61.1	33.5	66.5	100.0
Median Age *	23.4	21.7	22.1	24.5	23.8	24.0	24.0	22.7	23.2

MacArthur State Technical College

Age	Full-Time			Part-Time			All Students		
	Men	Women	Total	Men	Women	Total	Men	Women	Total
Under 18	2	5	7				2	5	7
18 - 19	55	56	111	5	4	9	60	60	120
20 - 21	35	40	75	7	6	13	42	46	88
22 - 24	14	36	50	4	1	5	18	37	55
25 - 29	8	46	54	6	4	10	14	50	64
30 - 34	14	38	52	5	3	8	19	41	60
35 - 39	9	28	37	3	1	4	12	29	41
40 - 49	16	52	68	2	4	6	18	56	74
50 - 64	4	29	33	4	2	6	8	31	39
65 and Over		2	2	5		5	5	2	7
Age Unknown									
TOTAL	157	332	489	41	25	66	198	357	555
Percent	28.3	59.8	88.1	7.4	4.5	11.9	35.7	64.3	100.0
Median Age *	21.2	28.2	25.1	28.8	26.9	28.0	21.8	28.1	25.6

Northeast Alabama Community College

Age	Full-Time			Part-Time			All Students		
	Men	Women	Total	Men	Women	Total	Men	Women	Total
Under 18	4	3	7	13	18	31	17	21	38
18 - 19	226	312	538	39	63	102	265	375	640
20 - 21	64	58	122	46	69	115	110	127	237
22 - 24	16	36	52	34	63	97	50	99	149
25 - 29	25	34	59	30	80	110	55	114	169
30 - 34	3	28	31	20	36	56	23	64	87
35 - 39	6	17	23	27	54	81	33	71	104
40 - 49	1	15	16	33	63	96	34	78	112
50 - 64	2	7	9	12	18	30	14	25	39
65 and Over				1		1	1		1
Age Unknown									
TOTAL	347	510	857	255	464	719	602	974	1,576
Percent	22.0	32.4	54.4	16.2	29.4	45.6	38.2	61.8	100.0
Median Age *	18.8	18.8	18.8	24.6	26.2	25.7	20.3	21.4	20.9

Northwest Shoals Community College

Age	Full-Time			Part-Time			All Students		
	Men	Women	Total	Men	Women	Total	Men	Women	Total
Under 18	5	6	11	8	9	17	13	15	28
18 - 19	447	612	1,059	71	70	141	518	682	1,200
20 - 21	177	185	362	104	120	224	281	305	586
22 - 24	50	87	137	85	96	181	135	183	318
25 - 29	57	110	167	94	141	235	151	251	402
30 - 34	34	75	109	68	89	157	102	164	266
35 - 39	18	71	89	32	65	97	50	136	186
40 - 49	14	65	79	59	124	183	73	189	262
50 - 64	6	17	23	27	44	71	33	61	94
65 and Over				27	12	39	27	12	39
Age Unknown	5		5	6	2	8	11	2	13
TOTAL	813	1,228	2,041	581	772	1,353	1,394	2,000	3,394
Percent	24.0	36.2	60.1	17.1	22.7	39.9	41.1	58.9	100.0
Median Age *	18.9	19.0	19.0	26.0	28.2	27.3	21.1	22.0	21.6

Patterson State Technical College

Age	Full-Time			Part-Time			All Students		
	Men	Women	Total	Men	Women	Total	Men	Women	Total
Under 18	4		4	4		4	8		8
18 - 19	50	30	80	48	31	79	98	61	159
20 - 21	40	32	72	57	27	84	97	59	156
22 - 24	29	30	59	49	26	75	78	56	134
25 - 29	25	35	60	49	41	90	74	76	150
30 - 34	19	24	43	34	19	53	53	43	96
35 - 39	11	8	19	31	22	53	42	30	72
40 - 49	32	15	47	50	23	73	82	38	120
50 - 64	15	4	19	24	13	37	39	17	56
65 and Over				1	3	4	1	3	4
Age Unknown									
TOTAL	225	178	403	347	205	552	572	383	955
Percent	23.6	18.6	42.2	36.3	21.5	57.8	59.9	40.1	100.0
Median Age *	23.9	24.7	24.3	26.6	27.3	26.9	25.3	26.0	25.7

Reid State Technical College

Age	Full-Time			Part-Time			All Students		
	Men	Women	Total	Men	Women	Total	Men	Women	Total
Under 18	7	2	9	17	15	32	24	17	41
18 - 19	40	51	91	18	15	33	58	66	124
20 - 21	26	43	69	18	7	25	44	50	94
22 - 24	11	35	46	9	6	15	20	41	61
25 - 29	18	61	79	10	13	23	28	74	102
30 - 34	8	34	42	6	12	18	14	46	60
35 - 39	7	23	30	8	12	20	15	35	50
40 - 49	9	24	33	11	24	35	20	48	68
50 - 64	5	8	13	16	11	27	21	19	40
65 and Over	1		1	17	23	40	18	23	41
Age Unknown									
TOTAL	132	281	413	130	138	268	262	419	681
Percent	19.4	41.3	60.6	19.1	20.3	39.4	38.5	61.5	100.0
Median Age *	21.5	25.8	24.4	26.5	35.4	31.7	22.8	27.4	26.0

Shelton State Community College

Age	Full-Time			Part-Time			All Students		
	Men	Women	Total	Men	Women	Total	Men	Women	Total
Under 18	184	249	433	40	42	82	224	291	515
18 - 19	332	369	701	50	61	111	382	430	812
20 - 21	368	361	729	176	241	417	544	602	1,146
22 - 24	153	166	319	164	205	369	317	371	688
25 - 29	76	121	197	121	173	294	197	294	491
30 - 34	23	65	88	47	82	129	70	147	217
35 - 39	11	41	52	34	94	128	45	135	180
40 - 49	22	34	56	40	134	174	62	168	230
50 - 64	8	13	21	22	44	66	30	57	87
65 and Over	1	3	4	2	13	15	3	16	19
Age Unknown									
TOTAL	1,178	1,422	2,600	696	1,089	1,785	1,874	2,511	4,385
Percent	26.9	32.4	59.3	15.9	24.8	40.7	42.7	57.3	100.0
Median Age *	20.4	20.5	20.5	23.5	24.9	24.3	21.2	21.8	21.5

Snead State Junior College

Age	Full-Time			Part-Time			All Students		
	Men	Women	Total	Men	Women	Total	Men	Women	Total
Under 18	2	2	4	30	43	73	32	45	77
18 - 19	296	306	602	42	66	108	338	372	710
20 - 21	107	97	204	38	57	95	145	154	299
22 - 24	20	30	50	18	37	55	38	67	105
25 - 29	10	58	68	28	43	71	38	101	139
30 - 34	4	37	41	11	36	47	15	73	88
35 - 39	8	47	55	22	28	50	30	75	105
40 - 49	5	45	50	10	47	57	15	92	107
50 - 64	1	23	24	2	17	19	3	40	43
65 and Over		1	1	2		2	2	1	3
Age Unknown									
TOTAL	453	646	1,099	203	374	577	656	1,020	1,676
Percent	27.0	38.5	65.6	12.1	22.3	34.4	39.1	60.9	100.0
Median Age *	18.8	20.3	18.9	21.6	23.7	22.7	18.9	21.2	20.3

Southern Union State Community College

Age	Full-Time			Part-Time			All Students		
	Men	Women	Total	Men	Women	Total	Men	Women	Total
Under 18	3	14	17	9	18	27	12	32	44
18 - 19	624	656	1,280	99	103	202	723	759	1,482
20 - 21	433	275	708	144	177	321	577	452	1,029
22 - 24	172	111	283	151	171	322	323	282	605
25 - 29	82	88	170	80	154	234	162	242	404
30 - 34	25	64	89	51	103	154	76	167	243
35 - 39	14	27	41	29	76	105	43	103	146
40 - 49	20	40	60	34	98	132	54	138	192
50 - 64	4	12	16	21	50	71	25	62	87
65 and Over	2		2	7	12	19	9	12	21
Age Unknown	2		2	1	2	3	3	2	5
TOTAL	1,381	1,287	2,668	626	964	1,590	2,007	2,251	4,258
Percent	32.4	30.2	62.7	14.7	22.6	37.3	47.1	52.9	100.0
Median Age *	20.3	19.0	20.1	23.2	25.4	24.3	20.9	21.5	21.2

Sparks State Technical College

Age	Full-Time			Part-Time			All Students		
	Men	Women	Total	Men	Women	Total	Men	Women	Total
Under 18	2	1	3	1		1	3	1	4
18 - 19	67	46	113	1	10	11	68	56	124
20 - 21	38	26	64	7	6	13	45	32	77
22 - 24	48	24	72	3	17	20	51	41	92
25 - 29	44	26	70	4	10	14	48	36	84
30 - 34	25	7	32	1	11	12	26	18	44
35 - 39	32	7	39	2	9	11	34	16	50
40 - 49	29	8	37	4	10	14	33	18	51
50 - 64	10	1	11	5	6	11	15	7	22
65 and Over	1		1				1		1
Age Unknown									
TOTAL	296	146	442	28	79	107	324	225	549
Percent	53.9	26.6	80.5	5.1	14.4	19.5	59.0	41.0	100.0
Median Age *	24.6	22.0	23.7	27.5	28.3	28.0	24.7	23.7	24.3

Trenholm State Technical College

Age	Full-Time			Part-Time			All Students		
	Men	Women	Total	Men	Women	Total	Men	Women	Total
Under 18	1	2	3				1	2	3
18 - 19	18	79	97	5	5	10	23	84	107
20 - 21	12	75	87	8	6	14	20	81	101
22 - 24	12	72	84	7	14	21	19	86	105
25 - 29	18	65	83	8	26	34	26	91	117
30 - 34	10	38	48	3	22	25	13	60	73
35 - 39	4	20	24	5	23	28	9	43	52
40 - 49	16	24	40	11	31	42	27	55	82
50 - 64	11	5	16	3	18	21	14	23	37
65 and Over		2	2	1		1	1	2	3
Age Unknown									
TOTAL	102	382	484	51	145	196	153	527	680
Percent	15.0	56.2	71.2	7.5	21.3	28.8	22.5	77.5	100.0
Median Age *	27.2	23.5	24.0	28.4	34.9	33.8	27.6	25.6	26.0

BEST COPY AVAILABLE

Wallace State Community College-Dothan

Age	Full-Time			Part-Time			All Students		
	Men	Women	Total	Men	Women	Total	Men	Women	Total
Under 18	2	2	4	6	4	10	8	6	14
18 - 19	239	266	505	154	201	355	393	467	860
20 - 21	165	110	275	107	141	248	272	251	523
22 - 24	62	99	161	89	139	228	151	238	389
25 - 29	73	103	176	84	135	219	157	238	395
30 - 34	32	67	99	41	113	154	73	180	253
35 - 39	29	45	74	46	76	122	75	121	196
40 - 49	41	44	85	55	98	153	96	142	238
50 - 64	11	15	26	41	29	70	52	44	96
65 and Over	3	1	4	13	3	16	16	4	20
Age Unknown									
TOTAL	657	752	1,409	636	939	1,575	1,293	1,691	2,984
Percent	22.0	25.2	47.2	21.3	31.5	52.8	43.3	56.7	100.0
Median Age *	21.1	22.0	21.4	23.7	24.7	24.3	21.8	23.5	22.7

Wallace State Community College-Hanceville

Age	Full-Time			Part-Time			All Students		
	Men	Women	Total	Men	Women	Total	Men	Women	Total
Under 18	33	34	67	65	106	171	98	140	238
18 - 19	531	630	1,161	94	142	236	625	772	1,397
20 - 21	216	254	470	134	175	309	350	429	779
22 - 24	98	130	228	107	133	240	205	263	468
25 - 29	75	142	217	107	127	234	182	269	451
30 - 34	30	100	130	67	86	153	97	186	283
35 - 39	25	96	121	69	97	166	94	193	287
40 - 49	38	124	162	118	137	255	156	261	417
50 - 64	13	35	48	93	132	225	106	167	273
65 and Over	2	7	9	65	80	145	67	87	154
Age Unknown									
TOTAL	1,061	1,552	2,613	919	1,215	2,134	1,980	2,767	4,747
Percent	22.4	32.7	55.0	19.4	25.6	45.0	41.7	58.3	100.0
Median Age *	18.9	20.9	20.3	27.8	27.0	27.4	21.5	22.5	21.9

Wallace State Community College-Selma

Age	Full-Time			Part-Time			All Students		
	Men	Women	Total	Men	Women	Total	Men	Women	Total
Under 18	3	3	6	1	10	11	4	13	17
18 - 19	156	174	330	69	130	199	225	304	529
20 - 21	83	92	175	41	101	142	124	193	317
22 - 24	21	47	68	33	72	105	54	119	173
25 - 29	17	44	61	32	78	110	49	122	171
30 - 34	11	18	29	18	38	56	29	56	85
35 - 39	4	9	13	13	38	51	17	47	64
40 - 49	7	14	21	20	44	64	27	58	85
50 - 64	1	1	2	5	9	14	6	10	16
65 and Over				1	3	4	1	3	4
Age Unknown									
TOTAL	303	402	705	233	523	756	536	925	1,461
Percent	20.7	27.5	48.3	15.9	35.8	51.7	36.7	63.3	100.0
Median Age *	19.0	20.5	20.2	22.5	22.9	22.7	20.6	21.5	21.2

ENROLLMENT BY AGE, GENDER, AND ENROLLMENT STATUS
ALABAMA PRIVATE INSTITUTIONS
FALL 1999

Birmingham Southern College

Age	Full-Time			Part-Time			All Students		
	Men	Women	Total	Men	Women	Total	Men	Women	Total
Under 18	1	3	4	1		1	2	3	5
18 - 19	209	319	528	1	1	2	210	320	530
20 - 21	246	302	548	1	3	4	247	305	552
22 - 24	65	57	122	8	3	11	73	60	133
25 - 29	24	37	61	9	9	18	33	46	79
30 - 34	11	35	46	6	13	19	17	48	65
35 - 39	13	20	33	4	12	16	17	32	49
40 - 49	19	44	63	2	21	23	21	65	86
50 - 64	4	11	15	2	12	14	6	23	29
65 and Over									
Age Unknown									
TOTAL	592	828	1,420	34	74	108	626	902	1,528
Percent	38.7	54.2	92.9	2.2	4.8	7.1	41.0	59.0	100.0
Median Age *	20.7	20.6	20.6	28.3	38.3	34.7	20.8	20.8	20.8

Concordia College

Age	Full-Time			Part-Time			All Students		
	Men	Women	Total	Men	Women	Total	Men	Women	Total
Under 18	1	1	2	1	1	2	2	2	4
18 - 19	59	64	123		3	3	59	67	126
20 - 21	62	73	135	2	2	4	64	75	139
22 - 24	22	38	60		13	13	22	51	73
25 - 29	10	41	51		9	9	10	50	60
30 - 34	4	23	27	4	10	14	8	33	41
35 - 39	3	9	12		12	12	3	21	24
40 - 49	4	16	20		2	2	4	18	22
50 - 64	2	5	7		1	1	2	6	8
65 and Over				1	4	5	1	4	5
Age Unknown	5	18	23				5	18	23
TOTAL	172	288	460	8	57	65	180	345	525
Percent	32.8	54.9	87.6	1.5	10.9	12.4	34.3	65.7	100.0
Median Age *	20.8	21.9	21.4	31.3	30.3	30.5	20.8	23.1	21.7

Faulkner University

Age	Full-Time			Part-Time			All Students		
	Men	Women	Total	Men	Women	Total	Men	Women	Total
Under 18	4	5	9	1	4	5	5	9	14
18 - 19	110	171	281	13	15	28	123	186	309
20 - 21	95	112	207	10	41	51	105	153	258
22 - 24	117	146	263	33	69	102	150	215	365
25 - 29	195	203	398	50	86	136	245	289	534
30 - 34	121	125	246	38	71	109	159	196	355
35 - 39	97	110	207	48	72	120	145	182	327
40 - 49	118	142	260	52	89	141	170	231	401
50 - 64	17	26	43	14	17	31	31	43	74
65 and Over	2	2	4		1	1	2	3	5
Age Unknown	2		2		1	1	2	1	3
TOTAL	878	1,042	1,920	259	466	725	1,137	1,508	2,645
Percent	33.2	39.4	72.6	9.8	17.6	27.4	43.0	57.0	100.0
Median Age *	27.9	27.1	27.5	33.0	31.2	31.8	28.8	28.3	28.5

ENROLLMENT BY AGE, GENDER, AND ENROLLMENT STATUS
ALABAMA PRIVATE INSTITUTIONS
FALL 1999

Huntingdon College

Age	Full-Time			Part-Time			All Students		
	Men	Women	Total	Men	Women	Total	Men	Women	Total
Under 18	4	5	9		3	3	4	8	12
18 - 19	105	173	278		2	2	105	175	280
20 - 21	91	153	244	1	5	6	92	158	250
22 - 24	31	33	64	6	11	17	37	44	81
25 - 29	6	8	14	3	7	10	9	15	24
30 - 34	1	1	2	2	4	6	3	5	8
35 - 39	1	4	5	1	5	6	2	9	11
40 - 49		3	3	5	14	19	5	17	22
50 - 64	1		1	4	7	11	5	7	12
65 and Over		1	1	2		2	2	1	3
Age Unknown				1	1	2	1	1	2
TOTAL	240	381	621	25	59	84	265	440	705
Percent	34.0	54.0	88.1	3.5	8.4	11.9	37.6	62.4	100.0
Median Age *	20.2	20.2	20.2	35.0	31.3	32.5	20.5	20.5	20.5

Judson College

Age	Full-Time			Part-Time			All Students		
	Men	Women	Total	Men	Women	Total	Men	Women	Total
Under 18		3	3		2	2		5	5
18 - 19		129	129					129	129
20 - 21	1	90	91	2	1	3	3	91	94
22 - 24	1	18	19		4	4	1	22	23
25 - 29		9	9	1	8	9	1	17	18
30 - 34	1	6	7		4	4	1	10	11
35 - 39					9	9		9	9
40 - 49		3	3	1	10	11	1	13	14
50 - 64		1	1		3	3		4	4
65 and Over					1	1		1	1
Age Unknown									
TOTAL	3	259	262	4	42	46	7	301	308
Percent	1.0	84.1	85.1	1.3	13.6	14.9	2.3	97.7	100.0
Median Age *	23.5	19.0	19.0	25.0	36.1	35.6	23.5	20.4	20.4

Miles College

Age	Full-Time			Part-Time			All Students		
	Men	Women	Total	Men	Women	Total	Men	Women	Total
Under 18	200	250	450				200	250	450
18 - 19	90	150	240	20	35	55	110	185	295
20 - 21	40	115	155	15	20	35	55	135	190
22 - 24	30	35	65				30	35	65
25 - 29	25	20	45	10	25	35	35	45	80
30 - 34	20	25	45				20	25	45
35 - 39	20	55	75				20	55	75
40 - 49	20	35	55				20	35	55
50 - 64									
65 and Over	132	61	193				132	61	193
Age Unknown					5	5		5	5
TOTAL	577	746	1,323	45	85	130	622	831	1,453
Percent	39.7	51.3	91.1	3.1	5.8	8.9	42.8	57.2	100.0
Median Age *	19.0	18.8	18.9	20.3	20.5	20.4	20.0	18.9	18.9

ENROLLMENT BY AGE, GENDER, AND ENROLLMENT STATUS
ALABAMA PRIVATE INSTITUTIONS
FALL 1999

Oakwood College

Age	Full-Time			Part-Time			All Students		
	Men	Women	Total	Men	Women	Total	Men	Women	Total
Under 18	8	20	28	3	15	18	11	35	46
18 - 19	239	340	579	10	14	24	249	354	603
20 - 21	203	312	515	21	25	46	224	337	561
22 - 24	118	128	246	11	8	19	129	136	265
25 - 29	42	32	74	13	9	22	55	41	96
30 - 34	23	10	33	9	6	15	32	16	48
35 - 39	15	5	20	17	20	37	32	25	57
40 - 49	7	4	11	7	9	16	14	13	27
50 - 64		1	1	2	1	3	2	2	4
65 and Over	1		1	7	6	13	8	6	14
Age Unknown	5	10	15				5	10	15
TOTAL	661	862	1,523	100	113	213	761	975	1,736
Percent	38.1	49.7	87.7	5.8	6.5	12.3	43.8	56.2	100.0
Median Age *	20.8	20.4	20.6	26.9	22.9	24.9	21.1	20.6	20.8

Samford University

Age	Full-Time			Part-Time			All Students		
	Men	Women	Total	Men	Women	Total	Men	Women	Total
Under 18	6	13	19				6	13	19
18 - 19	402	743	1,145	1	2	3	403	745	1,148
20 - 21	478	746	1,224	4	10	14	482	756	1,238
22 - 24	367	422	789	28	38	66	395	460	855
25 - 29	293	189	482	33	74	107	326	263	589
30 - 34	67	67	134	38	44	82	105	111	216
35 - 39	39	33	72	25	44	69	64	77	141
40 - 49	39	55	94	32	82	114	71	137	208
50 - 64	12	13	25	15	33	48	27	46	73
65 and Over	1		1				1		1
Age Unknown	2		2	1	3	4	3	3	6
TOTAL	1,706	2,281	3,987	177	330	507	1,883	2,611	4,494
Percent	38.0	50.8	88.7	3.9	7.3	11.3	41.9	58.1	100.0
Median Age *	21.9	21.0	21.4	32.9	34.5	33.8	22.4	21.4	21.7

Southeastern Bible College

Age	Full-Time			Part-Time			All Students		
	Men	Women	Total	Men	Women	Total	Men	Women	Total
Under 18									
18 - 19	10	19			2	2	10	21	31
20 - 21	27	32	59	3	3	6	30	35	65
22 - 24	10	5	15	8	3	11	18	8	26
25 - 29	15		15	5	2	7	20	2	22
30 - 34	9	2	11	3	1	4	12	3	15
35 - 39	5	3	8	1		1	6	3	9
40 - 49	3	3	6	2	1	3	5	4	9
50 - 64		1	1	1	1	2	1	2	3
65 and Over					1	1		1	1
Age Unknown									
TOTAL	79	65	115	23	14	37	102	79	181
Percent	43.6	35.9	63.5	12.7	7.7	20.4	56.4	43.6	100.0
Median Age *	22.8	20.8	21.9	25.5	24.0	24.9	23.8	21.1	21.8

ENROLLMENT BY AGE, GENDER, AND ENROLLMENT STATUS
ALABAMA PRIVATE INSTITUTIONS
FALL 1999

Spring Hill College

Age	Full-Time			Part-Time			All Students		
	Men	Women	Total	Men	Women	Total	Men	Women	Total
Under 18	2	4	6	3	9	12	5	13	18
18 - 19	170	252	422	1	4	5	171	256	427
20 - 21	165	214	379	1	2	3	166	216	382
22 - 24	49	72	121	11	20	31	60	92	152
25 - 29	13	25	38	30	63	93	43	88	131
30 - 34	10	3	13	21	52	73	31	55	86
35 - 39	5	8	13	17	47	64	22	55	77
40 - 49	3	11	14	24	76	100	27	87	114
50 - 64	1	1	2	28	41	69	29	42	71
65 and Over				5	5	10	5	5	10
Age Unknown	1	1	2	5	9	14	6	10	16
TOTAL	419	591	1,010	146	328	474	565	919	1,484
Percent	28.2	39.8	68.1	9.8	22.1	31.9	38.1	61.9	100.0
Median Age *	20.4	20.4	20.4	36.0	36.0	36.0	21.2	21.7	21.5

Stillman College

Age	Full-Time			Part-Time			All Students		
	Men	Women	Total	Men	Women	Total	Men	Women	Total
Under 18	7	23	30		4	4	7	27	34
18 - 19	360	409	769	2	1	3	362	410	772
20 - 21	132	159	291	4	2	6	136	161	297
22 - 24	66	76	142	7	5	12	73	81	154
25 - 29	46	53	99	4	8	12	50	61	111
30 - 34	33	21	54	2	2	4	35	23	58
35 - 39	3	15	18				3	15	18
40 - 49	13	1	14				13	1	14
50 - 64									
65 and Over									
Age Unknown									
TOTAL	660	757	1,417	19	22	41	679	779	1,458
Percent	45.3	51.9	97.2	1.3	1.5	2.8	46.6	53.4	100.0
Median Age *	18.9	18.9	18.9	23.5	24.4	23.9	18.9	18.9	18.9

Talladega College

Age	Full-Time			Part-Time			All Students		
	Men	Women	Total	Men	Women	Total	Men	Women	Total
Under 18	1	3	4				1	3	4
18 - 19	35	94	129		2	2	35	96	131
20 - 21	70	107	177				70	107	177
22 - 24	45	34	79		1	1	45	35	80
25 - 29	12	13	25	1	1	2	13	14	27
30 - 34	4	8	12				4	8	12
35 - 39	2	5	7		4	4	2	9	11
40 - 49	3	1	4		3	3	3	4	7
50 - 64									
65 and Over									
Age Unknown	5	1	6						
TOTAL	177	266	443	1	11	12	173	276	449
Percent	39.4	59.2	98.7	0.2	2.4	2.7	38.5	61.5	100.0
Median Age *	21.4	20.7	21.0	27.0	36.9	36.3	21.4	20.7	21.0

ENROLLMENT BY AGE, GENDER, AND ENROLLMENT STATUS
ALABAMA PRIVATE INSTITUTIONS
FALL 1999

Tuskegee University

Age	Full-Time			Part-Time			All Students		
	Men	Women	Total	Men	Women	Total	Men	Women	Total
Under 18	6	3	9	9	8	17	15	11	26
18 - 19	398	632	1,030	10	10	20	408	642	1,050
20 - 21	306	579	885	23	30	53	329	609	938
22 - 24	244	271	515	20	22	42	264	293	557
25 - 29	129	136	265	8	7	15	137	143	280
30 - 34	26	24	50	6	6	12	32	30	62
35 - 39	6	5	11	4	1	5	10	6	16
40 - 49	2	3	5	1		1	3	3	6
50 - 64		1	1					1	1
65 and Over				5	2	7	5	2	7
Age Unknown	26	40	66				26	40	66
TOTAL	1,143	1,694	2,837	86	86	172	1,229	1,780	3,009
Percent	38.0	56.3	94.3	2.9	2.9	5.7	40.8	59.2	100.0
Median Age *	21.0	20.7	20.8	22.2	21.7	21.8	21.1	20.7	20.8

University of Mobile

Age	Full-Time			Part-Time			All Students		
	Men	Women	Total	Men	Women	Total	Men	Women	Total
Under 18	43	112	155		2	2	43	114	157
18 - 19	71	107	178		1	1	71	108	179
20 - 21	133	220	353	3	9	12	136	229	365
22 - 24	87	209	296	25	50	75	112	259	371
25 - 29	31	111	142	28	76	104	59	187	246
30 - 34	11	41	52	20	27	47	31	68	99
35 - 39	6	30	36	16	28	44	22	58	80
40 - 49	9	27	36	16	33	49	25	60	85
50 - 64	1	5	6	4	14	18	5	19	24
65 and Over									
Age Unknown	74	200	274	30	68	98	104	268	372
TOTAL	466	1,062	1,528	142	308	450	608	1,370	1,978
Percent	23.6	53.7	77.2	7.2	15.6	22.8	30.7	69.3	100.0
Median Age *	21.2	21.9	21.7	30.0	28.8	29.1	22.1	23.2	22.8

Marion Military Institute

Age	Full-Time			Part-Time			All Students		
	Men	Women	Total	Men	Women	Total	Men	Women	Total
Under 18	4	1	5				4	1	5
18 - 19	89	16	105				89	16	105
20 - 21	23	1	24		1	1	23	2	25
22 - 24	6		6				6		6
25 - 29									
30 - 34	1		1				1		1
35 - 39				1		1	1		1
40 - 49									
50 - 64									
65 and Over									
Age Unknown									
TOTAL	123	18	141	1	1	2	124	19	143
Percent	86.0	12.6	98.6	0.7	0.7	1.4	86.7	13.3	100.0
Median Age *	18.6	18.5	18.6	37.0	20.5	35.0	18.7	18.5	18.6

SOURCE: Integrated Postsecondary Education Data System (IPEDS), Fall Enrollment 1999.

* Median estimated excluding students of unknown age.

FALL FTE ENROLLMENT (1)(3)

1989 - 1999

	Fall 1989	Fall 1990	Fall 1991	Fall 1992	Fall 1993	Fall 1994	Fall 1995	Fall 1996	Fall 1997	Fall 1998	Fall 1999
Total All Public Colleges and Univ	156,659	163,954	167,534	170,441	174,689	171,840	169,133	164,914	163,559	151,640	151,749
Total All Public Four-Year Institutions	101,602	103,814	106,544	106,641	107,815	104,802	105,585	103,614	102,545	102,798	102,906
Total All Public Two-Year Institutions	55,057	60,140	60,990	63,800	66,874	67,038	63,548	61,300	61,014	48,842	48,843
Public Four-Year Institutions											
Alabama A&M University	3,901	4,144	4,317	4,083	4,881	4,711	4,011	4,444	4,327	4,488	4,826
Alabama State University	3,791	3,761	4,093	4,930	5,046	4,581	4,810	4,772	4,644	4,607	4,659
Athens State University	1,903	2,153	2,328	2,472	2,268	2,277	2,264	2,153	1,849	1,781	1,775
Auburn University	20,963	20,696	20,653	20,455	20,867	19,885	21,249	20,391	20,349	20,674	21,291
Auburn University at Montgomery	4,726	5,010	5,267	5,194	5,239	5,040	5,217	4,804	4,733	4,589	4,585
Jacksonville State University	7,118	7,165	7,230	6,905	6,456	6,561	6,543	6,359	6,260	6,247	6,423
Troy State University	4,448	4,683	4,975	5,463	5,651	5,690	5,535	5,517	5,663	5,821	4,725
Troy State University Dothan	1,214	1,316	1,465	1,674	1,854	1,623	1,637	1,515	1,551	1,705	1,266
Troy State University Montgomery	1,634	1,566	1,853	1,952	2,011	2,009	1,971	1,870	1,816	2,035	2,000
University of Alabama	17,025	17,391	17,367	16,767	16,882	16,603	16,436	15,641	15,735	15,750	16,697
University of Alabama at Birmingham	11,890	12,610	12,914	12,963	12,958	12,627	12,688	13,261	12,512	12,716	12,852
University of Alabama in Huntsville	5,038	5,033	5,012	4,883	5,079	4,451	4,217	4,080	4,127	4,262	4,304
University of Montevallo	2,659	2,787	2,834	2,715	2,731	2,713	2,716	2,673	2,633	2,647	2,622
University of North Alabama	4,567	4,533	4,657	4,430	4,228	4,094	4,356	4,532	4,568	4,725	4,733
University of South Alabama	9,046	9,219	9,648	9,922	9,884	9,968	9,948	9,747	9,998	8,884	8,608
University of West Alabama	1,679	1,747	1,931	1,833	1,780	1,969	1,987	1,855	1,780	1,867	1,540

Public Two-Year Institutions (2)

Alabama Southern CC	1,264	1,409	1,474	1,433	1,621	1,435	1,635	1,533	1,389	999	1,019
Ayers St. Technical	490	485	539	573	606	575	544	623	613	585	694
Bessemer St. Technical	980	1,248	1,189	1,291	1,220	1,202	1,173	955	972	855	797
Bevill St. CC	1,524	1,888	2,088	2,491	2,893	3,018	3,641	3,363	3,203	2,931	3,001
Walker College (4)						676	639	690	736		
Bishop St. CC	1,273	1,378	1,351	1,214	3,464	3,413	3,171	2,800	2,894	2,414	2,302
Calhoun St. CC	5,529	5,650	5,570	5,770	5,467	5,280	5,093	5,244	5,362	4,312	4,459
Central AlabamaCC	1,589	1,703	1,835	1,775	1,716	1,589	1,670	1,627	1,562	1,134	1,163



FALL FTE ENROLLMENT (1)(3)

1989 - 1999

	Fall 1989	Fall 1990	Fall 1991	Fall 1992	Fall 1993	Fall 1994	Fall 1995	Fall 1996	Fall 1997	Fall 1998	Fall 1999
Continued -											
Chattahoochee Valley CC	1,196	1,310	1,252	1,257	1,440	1,606	1,612	1,502	1,440	1,090	1,099
Drake St. Technical	486	585	594	631	617	532	514	516	543	468	417
Enterprise State Jr.	1,765	1,751	1,711	1,733	1,598	1,475	1,458	1,509	1,372	1,121	1,084
Faulkner St. CC	2,633	2,737	2,798	2,853	2,765	2,639	2,475	2,505	2,472	2,009	2,056
Gadsden St. CC	4,208	4,662	4,769	4,700	4,659	4,432	4,366	3,996	4,039	3,391	3,339
Ingram St. Technical	978	1,275	1,023	1,022	1,175	892	886	603	762	556	659
Jefferson Davis CC	1,526	1,572	1,627	1,601	1,589	1,503	1,244	1,272	1,244	971	961
Jefferson State CC	5,074	5,091	4,896	4,793	4,592	4,291	4,284	3,951	4,103	3,132	3,068
Lawson St. CC	1,340	1,685	1,673	1,869	1,986	1,581	1,641	1,389	1,312	1,058	1,121
L. B. Wallace Junior	962	1,096	983	1,076	1,013	978	938	861	844	679	674
MacArthur St. Technical	544	573	600	574	579	555	567	641	554	477	507
Northeast AL St. CC	1,224	1,358	1,366	1,464	1,499	1,360	1,343	1,514	1,442	1,117	1,112
Northwest-Shoals CC	2,956	3,473	3,776	3,901	3,790	5,266	2,844	2,964	3,048	2,405	2,512
Patterson St. Technical	562	578	687	806	774	793	831	863	857	605	627
Reid St. Technical	338	326	449	612	732	712	666	660	560	462	520
Shelton St. CC	3,410	3,976	4,202	5,372	5,697	5,755	5,376	4,972	5,056	3,470	3,348
Snead St. CC	1,342	1,495	1,553	1,508	1,478	1,405	1,557	1,456	1,518	1,378	1,276
Southern Union St. CC	2,891	3,037	2,956	3,335	3,422	3,949	3,543	3,545	3,429	3,589	3,567
Sparks St. Technical	315	432	589	557	628	594	583	600	602	506	455
Trenholm St. Technical	628	730	637	843	899	772	673	679	669	497	530
Wallace St.-Dothan CC (5)	2,886	3,085	2,919	2,896	2,800	2,644	2,583	2,658	2,504	2,197	2,207
AL Aviation & Tech. (5)	617	577	567	417	348	308	285	312	295		
Wallace St.-Hanceville CC	3,203	3,503	3,744	3,911	4,138	4,244	4,140	3,953	4,040	3,289	3,199
Wallace St.-Selma CC	1,324	1,472	1,573	1,522	1,669	1,564	1,573	1,544	1,578	1,145	1,070

SOURCE: Alabama Commission on Higher Education's Fall Credit Hour Production Reports; and The Alabama College System Enrollment Summary Fall 1999.

- NOTES: 1. FTE (full-time equivalent) = Fall Undergraduate hours divided by 15, graduate-1 (master's level) hours divided by 12, and graduate-2 (doctoral level) hours divided by 9. The divisors 15, 12 and 9 are considered the standard credit course load taken by a full-time student at the under-graduate, master's and doctoral level respectively. Each first professional student is counted as one FTE. Includes health sciences and first professional students. Includes all students enrolled on campus and off-campus.
- Two year institutions converted from quarter to semester system Fall 1998, except Southern Union CC which operates on a quarter system until Fall 2000.
 - Historical numbers are changed to reflect mergers. See explanation in Appendix i (1).
 - Walker College merged from a private institution with UAB in 1994-97; is included in Bevill State CC.
 - Alabama Aviation & Technical College merged with Wallace CC-Dothan in 1998.

1998-99 CURRENT FUNDS REVENUES AND EXPENDITURES

	Revenues			Expenditures		
	Unrestricted	Restricted		Unrestricted	Restricted	
TOTAL ALABAMA PUBLIC COLLEGES						
Tuition and Fees	505,256,348	408,755	505,665,103	707,127,801	55,515,382	762,643,183
Federal appropriations	47,665	16,840,144	16,887,809	61,839,332	256,014,128	317,853,460
State appropriations	946,448,566	2,395,158	948,847,724	130,254,426	80,980,541	211,234,967
Local appropriations	2,500,760	1,689,432	4,190,192	107,185,220	11,050,744	118,235,964
Federal grants & contracts	61,988,054	421,842,160	483,830,214	57,602,697		57,602,697
State grants & contracts	4,924,171	38,296,016	43,220,187	111,322,481	18,639,279	129,961,760
Local grants & contracts	565,381	6,501,043	7,066,424	212,030,630	8,981,622	221,012,252
Private gifts, grants, & contracts	30,691,708	84,162,176	114,853,884	159,085,551	2,161,594	161,247,145
Endowment income	7,870,334	19,022,260	26,892,594	67,915,790	155,236,755	223,152,545
Sales/services educational activities	75,136,671	539,819	75,676,490	48,252,048	132,018	48,384,066
Auxiliary enterprises	223,967,288	44,428	224,011,716	31,725,833	960,175	32,686,008
Hospitals	893,094,600	4,659	893,099,259	227,679,584	411,792	228,091,376
Other sources	102,117,894	3,601,388	105,719,282	873,844,801		873,844,801
Independent operations						
Total Current Funds Revenues	2,854,629,440	595,351,438	3,449,980,878	2,795,866,194	590,084,030	3,385,950,224

	Revenue Contribution Ratios			Expenditure Demand Ratios		
	Unrestricted	Restricted		Unrestricted	Restricted	
Tuition and Fees	14.6	0.0	14.7	20.9	1.6	22.5
Federal appropriations	0.0	0.5	0.5	1.8	7.6	9.4
State appropriations	27.4	0.1	27.5	3.8	2.4	6.2
Local appropriations	0.1	0.0	0.1	3.2	0.3	3.5
Federal grants & contracts	1.8	12.2	14.0	1.7		1.7
State grants & contracts	0.1	1.1	1.3	3.3	0.6	3.8
Local grants & contracts	0.0	0.2	0.2	6.3	0.3	6.5
Private gifts, grants, & contracts	0.9	2.4	3.3	4.7	0.1	4.8
Endowment income	0.2	0.6	0.8	2.0	4.6	6.6
Sales/services educational activities	2.2	0.0	2.2	1.4	0.0	1.4
Auxiliary enterprises	6.5	0.0	6.5	0.9	0.0	1.0
Hospitals	25.9	0.0	25.9	6.7	0.0	6.7
Other sources	3.0	0.1	3.1	25.8		25.8
Independent operations						
Total Current Funds Revenues	82.7	17.3	100.0	82.6	17.4	100.0

SOURCE: Integrated Postsecondary Education Data System (IPEDS), Finance FY 1999.
 NOTE: A diskette in Lotus format of all public and private colleges' revenues and expenditures will be made available upon request.



1998-99 CURRENT FUNDS REVENUES AND EXPENDITURES

	Revenues			Expenditures	
	Unrestricted	Restricted		Unrestricted	Restricted
TOTAL ALABAMA PUBLIC FOUR-YEAR					
Tuition and Fees	407,229,003	401,580	Instruction	552,193,482	33,820,459
Federal appropriations	47,865	16,840,144	Research	61,839,332	256,014,128
State appropriations	735,114,066	301,711	Public service	129,451,820	78,099,709
Local appropriations	665,323	1,545,007	Academic support	88,663,435	7,572,127
Federal grants & contracts	61,910,197	324,268,605	Library	49,924,156	49,924,156
State grants & contracts	3,464,604	31,898,130	Student services	84,442,943	3,716,988
Local grants & contracts	153,254	6,095,092	Institutional support	163,615,381	5,834,011
Private gifts, grants, & contracts	30,227,808	83,481,603	Operations/maintenance plant	125,240,229	1,209,802
Endowment income	7,813,463	18,912,216	Scholarships and fellowships	47,048,567	94,302,913
Sales/services educational activities	73,509,421	539,819	Mandatory transfers	34,678,410	115,999
Hospitals	198,772,794	44,428	Nonmandatory transfers	21,599,207	1,010,164
Other sources	892,982,124	3,573,992	Auxiliary enterprises	202,937,409	331,703
Independent operations	86,661,073		Hospitals	873,844,801	
Total Current Funds Revenues	2,500,550,795	487,902,327	Independent Operations		
			Total Expenditures and transfers	2,435,479,172	482,028,003
					2,917,507,175

	Revenue Contribution Ratios			Expenditure Demand Ratios	
	Unrestricted	Restricted		Unrestricted	Restricted
Tuition and Fees	13.63	0.01	Instruction	18.93	1.16
Federal appropriations	0.00	0.56	Research	2.12	6.78
State appropriations	24.60	0.01	Public service	4.44	2.68
Local appropriations	0.02	0.05	Academic support	3.04	0.26
Federal grants & contracts	2.07	10.85	Library	1.71	1.71
State grants & contracts	0.12	1.07	Student services	2.89	0.13
Local grants & contracts	0.01	0.20	Institutional support	5.61	0.20
Private gifts, grants, & contracts	1.01	2.79	Operations/maintenance plant	4.29	0.04
Endowment income	0.26	0.63	Scholarships and fellowships	1.61	3.23
Sales/services educational activities	2.46	0.02	Mandatory transfers	1.19	0.00
Auxiliary enterprises	6.65	0.00	Nonmandatory transfers	0.74	0.03
Hospitals	29.88		Auxiliary enterprises	6.96	0.01
Other sources	2.97	0.12	Hospitals	29.95	29.95
Independent operations			Independent Operations		
Total Current Funds Revenues	83.67	16.33	Total Expenditures and transfers	83.48	16.52
					100.00

SOURCE: Integrated Postsecondary Education Data System (IPEDS), Finance FY 1999.

NOTE: A diskette in Lotus format of all public and private colleges' revenues and expenditures will be made available upon request.

1998-99 CURRENT FUNDS REVENUES AND EXPENDITURES

	Revenues			Expenditures	
	Unrestricted	Restricted		Unrestricted	Restricted
Tuition and Fees	98,027,345	7,175	Instruction	154,934,319	21,694,923
Federal appropriations	211,334,500	2,097,447	Research	802,606	2,680,832
Local appropriations	1,835,437	144,425	Public service	18,521,785	3,478,617
Federal grants & contracts	77,857	97,573,555	Library	7,678,541	7,678,541
State grants & contracts	1,459,567	6,397,886	Student services	26,879,538	14,922,291
Local grants & contracts	432,127	405,951	Institutional support	48,415,249	3,147,611
Private gifts, grants, & contracts	463,900	680,573	Operations/maintenance plant	33,845,322	951,792
Endowment income	56,871	110,044	Scholarships and fellowships	20,867,223	60,933,842
Sales/services educational activities	1,627,250		Mandatory transfers	13,573,638	16,019
Auxiliary enterprises	25,194,494		Nonmandatory transfers	10,126,626	(49,989)
Hospitals	112,476	4,659	Auxiliary enterprises	24,742,175	80,089
Other sources	13,456,821	27,396	Hospitals		
Independent operations			Independent Operations		
Total Current Funds Revenues	354,078,645	107,449,111	Total Expenditures and transfers	360,387,022	108,056,027
			Total	468,443,049	

TOTAL ALABAMA PUBLIC TWO-YEAR

	Revenue Contribution Ratios			Expenditure Demand Ratios	
	Unrestricted	Restricted		Unrestricted	Restricted
Tuition and Fees	21.2	0.0	Instruction	33.1	4.6
Federal appropriations	45.8	0.5	Research	0.2	0.6
State appropriations	0.4	0.0	Public service	4.0	0.7
Local appropriations	0.0	21.1	Academic support	1.6	1.6
Federal grants & contracts	0.3	1.4	Library	5.7	3.2
State grants & contracts	0.1	0.1	Student services	10.3	0.7
Local grants & contracts	0.1	0.1	Institutional support	7.2	0.2
Private gifts, grants, & contracts	0.0	0.0	Operations/maintenance plant	4.5	13.0
Endowment income	0.4		Scholarships and fellowships	2.9	0.0
Sales/services educational activities	5.5		Mandatory transfers	2.2	0.0
Auxiliary enterprises	0.0	0.0	Nonmandatory transfers	5.3	0.0
Hospitals	2.9	0.0	Auxiliary enterprises		
Other sources			Hospitals		
Independent operations			Independent Operations		
Total Current Funds Revenues	76.7	23.3	Total Expenditures and transfers	76.9	23.1
			Total	100.0	100.0

SOURCE: Integrated Postsecondary Education Data System (IPEDS), Finance FY 1999.
 NOTE: A diskette in Lotus format of all public and private colleges' revenues and expenditures will be made available upon request.

MEDIAN UNDERGRADUATE TUITION AND REQUIRED FEES
Public Four-Year 1996-97 - 1999-2000

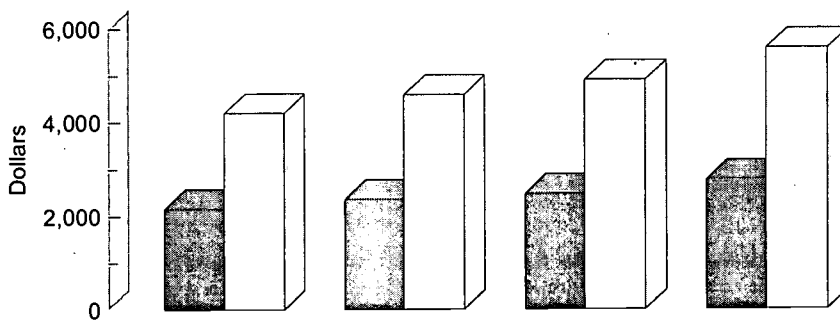

SOURCE: Alabama Commission on Higher Education Survey
Annual Tuition and Required Fees Combined.

ANNUAL UNDERGRADUATE TUITION AND REQUIRED FEES COMBINED (1)
1996-97 - 1999-2000

Institution	In-State			% Change over 1998-99	Out-Of-State			% Change over 1998-99		
	1996-97	1997-98	1998-99		1999-00	1998-99	1999-00		1998-99	
Alabama A&M University	\$2,076	\$2,420	\$2,332	\$2,332	0.0	\$3,916	\$4,352	\$4,264	\$4,264	0.0
Alabama State University	2,090	2,090	2,090	2,520	20.6	3,890	3,890	3,890	5,040	29.6
Athens State University (2)	1,620	1,800	2,130	2,250	5.6	3,195	3,555	4,200	4,440	5.7
Auburn University	2,355	2,565	2,760	2,895	4.9	7,065	7,695	8,280	8,685	4.9
Auburn University at Montgomery	2,130	2,289	2,442	2,577	5.5	6,390	6,867	7,326	7,731	5.5
Jacksonville State University	1,960	2,040	2,140	2,440	14.0	2,930	4,080	4,280	4,880	14.0
Troy State University	2,175	2,250	2,490	2,900	16.5	4,155	4,305	4,740	5,560	17.3
Troy State University Dothan	2,145	2,229	2,460	2,832	15.1	4,245	4,413	4,860	5,712	17.5
Troy St. University Montgomery	2,025	2,085	2,280	2,430	6.6	4,005	4,140	4,530	4,830	6.6
University of Alabama	2,470	2,594	2,684	2,872	7.0	6,268	6,808	7,216	7,722	7.0
Univ. of Alabama at Birmingham	2,700	2,970	3,060	3,240	5.9	5,100	5,490	5,670	5,970	5.3
Univ. of Alabama in Huntsville	2,699	2,832	2,942	3,112	5.8	5,656	5,938	6,166	6,516	5.7
University of Montevallo	2,780	2,930	3,110	3,290	5.8	5,420	5,720	6,080	6,440	5.9
University of North Alabama	2,016	2,184	2,256	2,392	6.0	3,918	4,248	4,392	4,624	5.3
University of South Alabama (2)	2,538	2,673	2,676	2,911	8.8	4,878	5,148	5,151	5,581	8.3
University of West Alabama	2,370	2,568	2,655	2,694	1.5	2,370	4,758	4,935	4,998	1.3
TOTAL UNDERGRADUATE MEDIAN	\$2,160	\$2,355	\$2,475	\$2,763	11.6	\$4,200	\$4,586	\$4,898	\$5,571	13.7

SOURCE: Alabama Commission on Higher Education Survey, Annual Tuition and Required Fees Combined, 1996-97 - 1999-2000.

NOTES: 1. Tuition amounts are based on undergraduate load of 30 and graduate load of 24, or per term data supplied by institution. Other specific surcharges and fees may be required for certain programs.

2. Converted from quarter to semester terms Fall 1998, Athens State University and University of South Alabama; Fall 1999, Troy State University, Troy State University Dothan, and University of West Alabama. In Fall 1998, all public two-year converted to semester except Southern Union CC. See notes at end of this publication.



MEDIAN GRADUATE TUITION AND REQUIRED FEES

Public Four-Year 1996-97 - 1999-2000

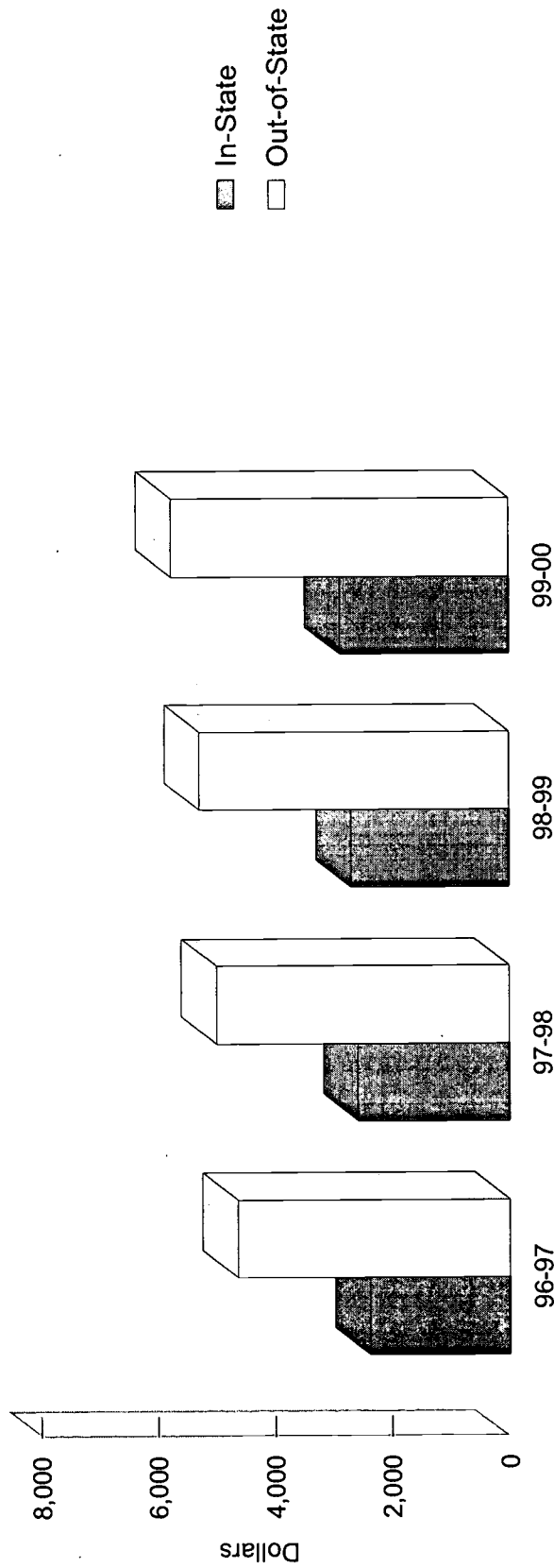

SOURCE: Alabama Commission on Higher Education
Annual Tuition and Required Fees Combined.

ANNUAL GRADUATE TUITION AND REQUIRED FEES COMBINED (1)
Public Four-Year Institutions
1996-97 - 1999-2000

Institution	In-State				Out-Of-State				% Change over 1998-99
	1996-97	1997-98	1998-99	1999-00	1996-97	1997-98	1998-99	1999-00	
Alabama A&M University	2,355	2,565	2,760	2,895	7,065	7,695	8,280	8,685	4.9
Alabama State University	2,130	2,286	2,400	2,514	6,390	6,858	7,200	7,542	4.8
Athens State University	2,010	2,040	2,140	2,440	3,006	4,080	4,280	4,880	14.0
Auburn University	2,247	2,310	2,688	3,120	4,299	4,434	5,280	6,000	13.6
Jacksonville State University	2,232	2,322	2,508	2,952	4,428	4,608	4,956	5,832	17.7
Troy State University	1,836	1,902	2,118	2,262	3,636	3,774	4,206	4,494	6.8
Troy State University Dothan	2,470	2,594	2,684	2,872	6,268	6,808	7,216	7,722	7.0
University of Alabama	2,448	2,688	2,760	2,928	4,632	4,992	5,136	5,424	5.6
Univ. of Alabama at Birmingham	3,386	3,550	3,684	3,880	6,918	7,260	7,542	7,956	5.5
Univ. of Alabama at Huntsville	2,420	2,564	2,708	2,852	4,700	4,988	5,276	5,564	5.5
University of Montevallo	2,256	2,472	2,568	2,728	4,416	4,824	5,016	5,296	5.6
University of North Alabama	2,646	2,754	2,757	3,001	5,094	5,310	5,313	5,761	8.4
University of South Alabama (2)	2,379	2,595	2,718	2,778	2,379	5,115	5,346	5,466	2.2
University of West Alabama									
TOTAL GRADUATE MEDIAN	\$2,376	\$2,564	\$2,684	\$2,872	\$4,632	\$4,992	\$5,276	\$5,760	9.2

SOURCE: Alabama Commission on Higher Education Survey, Annual Tuition and Required Fees Combined, 1996-97 - 1999-2000.

- NOTES: 1. Tuition amounts are based on undergraduate load of 30 and graduate load of 24. Other specific surcharges and fees may be required for certain programs.
2. Converted from quarter to semester terms Fall 1998, University of South Alabama; Fall 1999, Troy State University, Troy State University Dothan, and University of West Alabama. In Fall 1998, all public two-year converted to semester except Southern Union CC.
See notes at end of this publication.

ANNUAL FIRST PROFESSIONAL TUITION AND REQUIRED FEES
Public Four-Year Institutions
1996-97 - 1999-2000

	In-State				Out-Of-State			
	1996-97	1997-98	1998-99	1999-00	1996-97	1997-98	1998-99	1999-00
Dentistry: University of Alabama at Birmingham	\$6,335	\$6,668	\$7,133	\$7,538	\$16,661	\$17,510	\$18,515	\$19,490
				5.68				5.27
Law: University of Alabama	3,578	3,758	4,490	4,812	7,712	8,382	9,484	10,156
				7.17				7.09
Medicine: University of Alabama	6,736	7,196	7,505	7,827	18,952	20,268	21,099	21,965
University of Alabama at Birmingham	7,280	7,783	8,089	8,481	19,496	20,855	21,683	22,619
University of South Alabama	8,025	8,031	7,828	7,874	15,027	15,033	14,828	14,874
				0.59				0.31
Optometry: University of Alabama at Birmingham	5,024	5,636	6,068	6,704	12,728	14,108	15,392	16,958
				10.48				10.17
Pharmacy: Auburn University	3,375	4,905	5,280	5,535	10,095	14,715	15,840	16,605
				4.83				4.83
Veterinary Medicine: Auburn University	3,675	4,905	5,280	5,535	11,025	14,715	15,840	16,605
				4.83				4.83

SOURCE: Alabama Commission on Higher Education Survey, Annual Tuition and Required Fees Combined, 1996-97 - 1999-2000.

ANNUAL TUITION AND REQUIRED FEES 1
Alabama Public Two-Year Institutions
1999-2000

	<u>In-State</u>	<u>Out-of-State</u>
Alabama Southern Community College	\$1,680	\$3,120
Ayers State Technical College	1,500	2,880
Bessemer State Technical College	1,560	3,000
Bevill State Community College	1,590	3,090
Bishop State Community College	1,800	3,360
Calhoun State Community College	1,680	3,240
Central Alabama Community College	1,620	3,120
Chattahoochee Valley Community College	1,650	3,210
Drake State Technical College	1,560	3,000
Enterprise State Junior College	1,680	3,240
Faulkner State Community College	1,800	3,360
Gadsden State Community College	1,560	3,000
Ingram State Technical College	1,200	
Jefferson Davis Community College	1,800	3,360
Jefferson State Community College	1,650	3,150
Lawson State Community College	1,560	3,000
L. B. Wallace Junior College	1,680	3,240
MacArthur State Technical College	1,440	2,760
Northeast AL. St. Community College	1,380	2,700
Northwest -Shoals Community College	1,680	3,120
Patterson State Technical College	1,620	3,120
Reid State Technical College	1,620	3,120
Shelton State Community College	1,560	3,000
Snead State Community College	1,470	2,790
Southern Union State Community College 2	1,710	3,240
Sparks State Technical College	1,620	3,120
Trenholm State Technical College	1,440	2,700
G. C. Wallace - Dothan Comm College	1,620	3,120
G. C. Wallace - Hanceville Community College	1,260	2,460
G. C. Wallace - Selma Community College	1,620	3,120
Median	1,620	3,120

NOTES: 1. Tuition amounts are based on undergraduate load of 15 hours.
2. Southern Union Community College operates on a quarter system.

SOURCE: AL Comm. on Higher Education Annual Tuition & Fee Schedule 1999-2000.

AVERAGE FULL-TIME FACULTY SALARIES a
Public Four-Year Institutions
1995-96 through 1999-2000

Five Year Summary - State Averages

	<u>Professor</u>	<u>Associate Professor</u>	<u>Assistant Professor</u>	<u>Instructor</u>	<u>Undesignated Rank b</u>	<u>All Ranks</u>
<u>1995-96</u>						
Avg. Salary	\$57,751	\$44,320	\$37,273	\$28,472	\$30,228	\$44,550
# of Faculty	1,456	1,452	1,454	449	76	4,887
<u>1996-97</u>						
Avg. Salary	59,722	45,562	38,444	29,084	30,451	45,952
# of Faculty	1,458	1,482	1,363	497	57	4,857
<u>1997-98</u>						
Avg. Salary	60,572	45,229	38,108	29,609	29,967	46,657
# of Faculty	1,471	1,524	1,296	484	63	4,838
<u>1998-99</u>						
Avg. Salary	66,913	49,829	42,047	31,157	33,245	50,556
# of Faculty	1,423	1,440	1,299	519	64	4,745
<u>1999-2000</u>						
Avg. Salary	68,971	51,336	43,155	31,845	35,954	51,886
# of Faculty	1,447	1,443	1,332	558	70	4,850
<u>5 Year % Change</u>						
Salary	19.4	15.8	15.8	11.8	18.9	16.5
Number of Faculty	-0.6	-0.6	-8.4	24.3	-7.9	-0.8

SOURCE: Integrated Postsecondary Education Data System (IPEDS), Salaries, Tenure, and Fringe Benefits of Full-time Instructional Faculty, 1995-96 - 1999-2000.

- a. 11-12 month salaries converted to 9-10 month with conversion factor of 0.8182.
- b. Includes those listed in 'Lecturer' category.

AVERAGE FULL-TIME FACULTY SALARIES

Public Four-Year 1995-1996 - 1999-2000

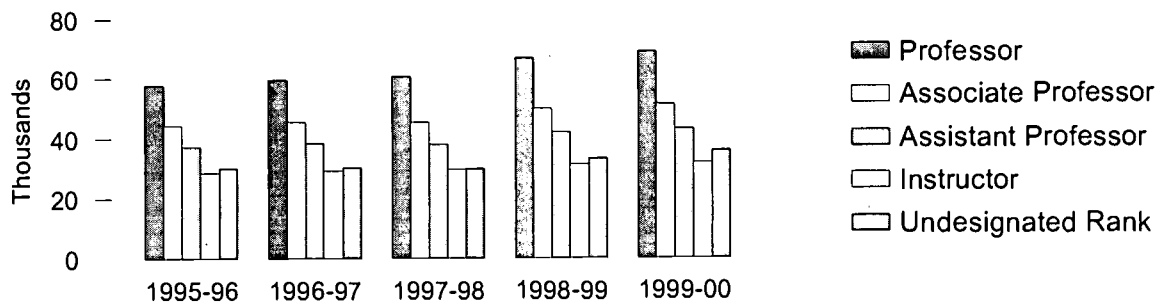

SOURCE: Integrated Postsecondary Education Data System (IPEDS),
Salaries, Tenure and Fringe Benefits of Full-time Instructional Faculty.

AVERAGE FACULTY SALARIES BY GENDER AND RANK a
Public Four-Year Institutions
1999-2000

	Professor		Associate Professor		Assistant Professor							
	Male	Female	Male	Female	Male	Female						
	Number	Avg. Salary	Number	Avg. Salary	Number	Avg. Salary						
Total All Public Four-Year Institutions	1,233	\$62,219	214	\$57,879	986	\$51,790	457	\$41,106	708	\$38,633	624	\$36,866
Public Four-Year Institutions												
Alabama A&M University	33	57,027	14	53,300	46	49,222	18	43,659	71	41,212	24	36,761
Alabama State Univ.	23	57,496	13	53,431	32	47,450	22	50,421	32	41,011	42	40,466
Athens State University	17	61,241	4	65,927	10	55,098	9	53,338	17	45,822	22	46,078
Auburn University	397	73,206	35	67,288	281	55,098	107	51,304	117	47,696	70	42,608
Auburn Univ. at Montgomery	40	63,450	14	62,606	40	49,108	20	44,233	19	48,187	33	40,913
Jacksonville State Univ.	73	57,377	14	53,876	29	46,113	20	44,762	31	41,259	32	38,752
Troy State University	14	56,759	6	56,348	40	45,528	27	42,528	42	36,953	56	21,099
Troy St. Univ. Dothan	9	55,962	5	48,153	7	46,876	6	42,667	15	38,619	5	41,092
Troy St. University Montgomery	4	65,921			9	46,565	5	38,330	12	42,306	6	44,178
University of Alabama	246	75,872	39	70,094	163	55,880	65	51,603	98	47,329	85	42,931
Univ. of AL-Birmingham c	114	76,612	27	71,365	119	53,859	58	49,904	57	46,083	62	44,777
Univ. of AL-Huntsville	76	74,979	4	73,151	60	53,307	28	46,707	38	50,661	38	42,594
University of Montevallo	30	56,339	7	51,889	21	49,284	16	41,555	21	36,541	21	34,940
University of North Alabama	47	56,723	13	55,590	33	49,605	15	49,730	38	43,864	37	42,591
University of South Alabama	94	69,188	14	64,348	82	51,845	28	50,651	83	46,403	80	44,341
University of West Alabama	16	50,122	5	47,355	14	40,092	13	43,566	17	36,087	11	32,776

SOURCE: Integrated Postsecondary Education Data System (IPEDS), Salaries, Tenure and Fringe Benefits of Full-Time Instructional Faculty, 1999-2000.
a. A factor of 0.8182 was used to convert 11/12 month contracts to their 9/10 month equivalents. Eminent Scholar not included in average salary.
b. Includes those listed in "Lecturer" category.
c. Includes University College and Nursing.

AVERAGE FACULTY SALARIES BY GENDER AND RANK a.
Public Four-Year Institutions
1999-2000

	Instructor		Undesignated Rank b		Total Faculty	Number Tenured				
	Male	Female	Male	Female						
	Number	Avg. Salary	Number	Avg. Salary	Number	Avg. Salary				
Total All Public Four-Year Institutions	212	\$31,387	346	\$31,018	37	\$36,818	33	\$30,638	4,850	2,955
Public Four-Year Institutions										
Alabama A&M University	14	32,950	23	30,586					243	93
Alabama State Univ.	21	34,933	28	34,594					213	93
Athens State University	1	42,038	2	40,510					82	69
Auburn University	48	28,383	63	28,109	18	36,921	10	39,142	1,146	832
Auburn Univ. at Montgomery	6	30,163	19	34,344					191	127
Jacksonville State Univ.	19	36,154	43	35,601	1	85,219			262	129
Troy State University	9	25,269	18	29,406					212	115
Troy St. Univ. Dothan	1	31,000	3	32,625	1	34,502			52	12
Troy St. University Montgomery	3	29,053	1	24,546					40	18
University of Alabama	40	28,883	52	30,071	4	46,499	3	38,205	795	507
Univ. of AL-Birmingham c	12	28,967	22	32,957	2	42,228	1	28,300	474	308
Univ. of AL-Huntsville	4	37,290	6	41,705	7	37,793	16	30,687	277	159
University of Montevallo	6	29,033	11	32,256					133	71
University of North Alabama	8	37,580	12	37,928					203	143
University of South Alabama	20	35,801	40	32,978	1	33,489			442	224
University of West Alabama			3	28,947	3	23,025	3	23,200	85	55

SOURCE: Integrated Postsecondary Education Data System (IPEDS), Salaries, Tenure and Fringe Benefits of Full-Time Instructional Faculty, 1999-2000.

a. A factor of 0.8182 was used to convert 11/12 month contracts to their 9/10 month equivalents. Eminent Scholar not included in average salary.

b. Includes those listed in "Lecturer" category.

c. Includes University College and Nursing.

AVERAGE FACULTY SALARIES BY GENDER AND RANK a
Public Two-Year Institutions
1999-2000

	Instructor		Undesignated Rank b		Total Faculty	Number Tenured
	Male	Female	Male	Female		
	Number	Avg. Salary	Number	Avg. Salary	Number	Avg. Salary
Total All Public Two-Year Institutions	834	\$45,828	889	\$41,480	1,723	1,474
Public Two-Year Institutions						
Alabama Southern CC	17	\$45,911	17	\$39,291	34	26
Ayers State Technical College	18	43,581	15	40,878	33	23
Bessemer State Technical College	20	47,736	20	43,503	40	34
Bevill State CC	58	42,758	41	43,249	99	78
Bishop State CC	48	42,797	66	39,515	114	101
Calhoun State CC	54	44,966	66	43,547	120	105
Central Alabama State CC	25	44,013	22	40,883	47	41
Chattahoochee Valley State CC	14	45,645	16	42,758	30	24
Drake State Technical College	12	47,350	11	50,069	23	21
Enterprise State Junior College	17	44,707	19	43,717	36	29
Faulkner CC	27	42,836	25	42,790	52	46
Gadsden St. CC	53	45,371	67	42,302	120	99
Ingram State Technical College	42	45,382	8	50,200	50	47
Jefferson Davis CC	29	44,052	19	39,667	48	41
Jefferson State CC	45	47,436	56	40,991	101	85
Lawson State CC	27	45,601	32	44,095	59	50
L. B. Wallace Junior College	12	43,082	11	40,742	23	18
MacArthur State Technical College	12	59,905	15	53,565	27	24
Northeast Alabama State CC	15	45,245	19	44,739	34	31
Northwest-Shoals CC	37	44,210	38	40,483	75	63
Patterson State Technical College	24	48,644	11	51,741	35	29
Reid State Technical College	9	41,378	14	46,368	23	22
Shelton State CC	32	44,668	49	44,189	81	75
Snead State CC	13	45,227	11	43,864	24	19
Southern Union State CC	27	42,978	49	40,053	76	64
Trenholm State Technical College	14	42,531	21	49,341	35	32
G. C. Wallace - Dothan c	61	45,630	56	42,297	117	106
G. C. Wallace - Hanceville	46	59,354	71	26,590	117	97
G. C. Wallace - Selma	26	45,515	24	40,725	50	44

SOURCE: Integrated Postsecondary Education Data System (IPEDS), Salaries, Tenure and Fringe Benefits of Full-Time Instructional Faculty, 1999-2000.

a. A factor of 0.8182 was used to convert 11/12 month contracts to their 9/10 month equivalents. Eminent Scholar not included in average salary.

b. Includes those listed in "Lecturer" category.

c. Includes Alabama Aviation & Technical College and Sparks State Technical College.

NUMBER OF COMPLETIONS

Public and Private Four-Year - 1997-98 - 1998-99

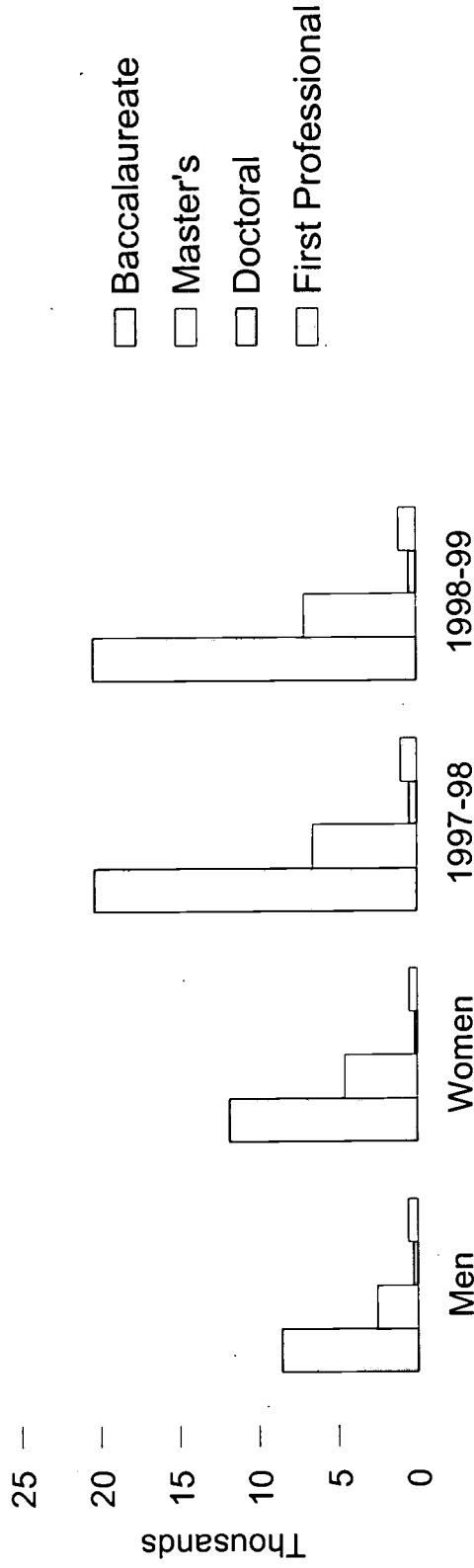

SOURCE: Integrated Postsecondary Education Data System (IPEDS), Completions.

**NUMBER OF COMPLETIONS
Public Four-Year Institutions
1995-96 - 1998-99**

Institutions	BACCALAUREATE				MASTERS			
	Number of Degrees 1995-96	Number of Degrees 1997-98	Number of Degrees 1998-99	% Change over 1997-98	Number of Degrees 1995-96	Number of Degrees 1997-98	Number of Degrees 1998-99	% Change over 1997-98
Alabama A&M University	589	600	544	-7.4	383	414	366	-13.4
Alabama State University	419	504	474	-12.1	128	203	198	3.0
Athens State University	1,000	956	1,053	8.54	N/A	N/A	N/A	N/A
Auburn University	3,586	3,672	3,735	3.921	721	758	703	-7.3
Auburn University at Montgomery	763	696	648	-8.3	383	378	353	-7.6
Jacksonville State University	1,041	1,056	1,053	-0.6	363	405	368	-16.0
Troy State University	1,021	968	993	1.057	209	177	171	-12.3
Troy State University Dothan	375	393	399	1.3	211	178	185	-1.6
Troy St. University Montgomery	231	209	219	242	178	188	185	-1.6
University of Alabama	2,684	2,683	2,713	1.1	1,218	1,146	1,160	12.6
Univ. of Alabama at Birmingham	1,577	1,740	1,601	-1,549	1,002	1,136	1,024	6.3
Univ. of Alabama in Huntsville	585	577	602	676	259	257	302	13.1
University of Montevallo	438	444	447	484	193	165	184	-16.3
University of North Alabama	764	800	804	819	155	160	191	8.9
University of South Alabama	1,496	1,421	1,590	1,472	542	524	480	-12.3
University of West Alabama	212	257	233	-271	100	156	96	97
TOTAL	16,781	16,976	17,173	17,209	6,421	6,547	6,194	7.3

SOURCE: Integrated Postsecondary Education Data System. (IPEDS), Completions, 1995-96 - 1998-99.

NOTE: Baccalaureate includes Post-Baccalaureate and Master's includes Post-Master's.

**NUMBER OF COMPLETIONS
Public Four-Year Institutions
1995-96 - 1998-99**

Institutions	DOCTORAL				FIRST PROFESSIONAL			
	Number of Degrees 1995-96	Number of Degrees 1997-98	Number of Degrees 1998-99	% Change over 1997-98	Number of Degrees 1995-96	Number of Degrees 1997-98	Number of Degrees 1998-99	% Change over 1997-98
Alabama A&M University	8	17	9	7	-22.2			
Alabama State University								
Athens State University	151	166	192	178	-7.3	99	96	102
Auburn University								
Auburn University at Montgomery								
Jacksonville State University								
Troy State University								
Troy State University Dothan								
Troy St. University Montgomery								
University of Alabama	197	186	150	135	-10.0	195	177	183
Univ. of Alabama at Birmingham	126	139	142	114	-19.7	256	241	252
Univ. of Alabama in Huntsville	41	32	41	31	-24.4			
University of Montevallo								
University of North Alabama	8	15	21	19	-9.5	63	65	59
University of South Alabama								
University of West Alabama	531	555	555	484	-12.8	612	583	613
TOTAL	531	555	555	484	-12.8	612	583	613

SOURCE: Integrated Postsecondary Education Data System (IPEDS), Completions, 1995-96 - 1998-99.

NUMBER OF COMPLETIONS
Private Four-Year Institutions
1995-96 - 1998-99

	BACCALAUREATE				MASTER'S					
	Number of Degrees 1995-96	Number of Degrees 1996-97	Number of Degrees 1997-98	Number of Degrees 1998-99	1998-99 % Change over 1997-99	Number of Degrees 1995-96	Number of Degrees 1996-97	Number of Degrees 1997-98	Number of Degrees 1998-99	1998-99 % Change over 1997-99
Institutions										
Birmingham-Southern	336	316	334	284	-15.0	24	36	27	24	-11.1
Concordia College	17	26	9	38	322.2					
Faulkner University	412	399	443	480	8.4				59	
Huntingdon College	111	97	93	122	31.2					
Judson College	42	49	39	57	46.2					
Miles College	140	143	176	153	-13.1					
Oakwood College	212	202	221	193	-12.7					
Samford University	698	742	608	626	3.0	144	148	167	149	-10.8
Seima University	31	Not Reported					Not Reported			
Southeastern Bible College	25	42	21	27	28.6	3	8			
Spring Hill College	219	211	218	213	-2.3	83	108	82	71	-13.4
Stillman College	138	143	187	165	-11.8					
Talladega College	131	125	134	129	-3.7					
Tuskegee University	526	439	416	436	4.8	49	44	45	45	0.0
University of Mobile	312	282	290	286	-1.4	57	68	60	74	23.3
TOTAL	3,350	3,216	3,189	3,209	0.6	360	412	381	422	10.8
GRAND TOTAL FOUR YEAR	20,131	20,192	20,362	20,418	0.3	6,781	6,959	6,575	7,066	7.5

SOURCE: Integrated Postsecondary Education Data System, (IPEDS), Completions, 1995-96 - 1998-99.

NOTE: Baccalaureate includes Post-Baccalaureate and Master's includes Post-Master's.

NUMBER OF COMPLETIONS
Private Four-Year Institutions
1995-96 - 1998-99

Continued -

	DOCTORAL				FIRST PROFESSIONAL					
	Number of Degrees 1995-96	Number of Degrees 1996-97	Number of Degrees 1997-98	Number of Degrees 1998-99	1998-99 % Change over 1997-98	Number of Degrees 1995-96	Number of Degrees 1996-97	Number of Degrees 1997-98	Number of Degrees 1998-99	1998-99 % Change over 1997-98
<u>Institutions</u>										
Birmingham-Southern						91	118	61	105	72.1
Concordia College										
Faulkner University										
Huntingdon College										
Judson College										
Miles College										
Oakwood College										
Samford University				16		292	333	340	327	-3.8
Southeastern Bible College										
Spring Hill College										
Stillman College										
Talladega College						44	57	56	53	-5.4
Tuskegee University						427	508	457	485	6.1
University of Mobile										
TOTAL	531	555	555	484	-12.8	1,027	1,120	1,040	1,098	5.6
GRAND TOTAL FOUR-YEAR										

SOURCE: Integrated Postsecondary Education Data System (IPEDS), Completions, 1995-96 - 1998-99.

**COMPLETIONS CONFERRED BY LEVEL AND GENDER
PUBLIC FOUR-YEAR - 1998-99**

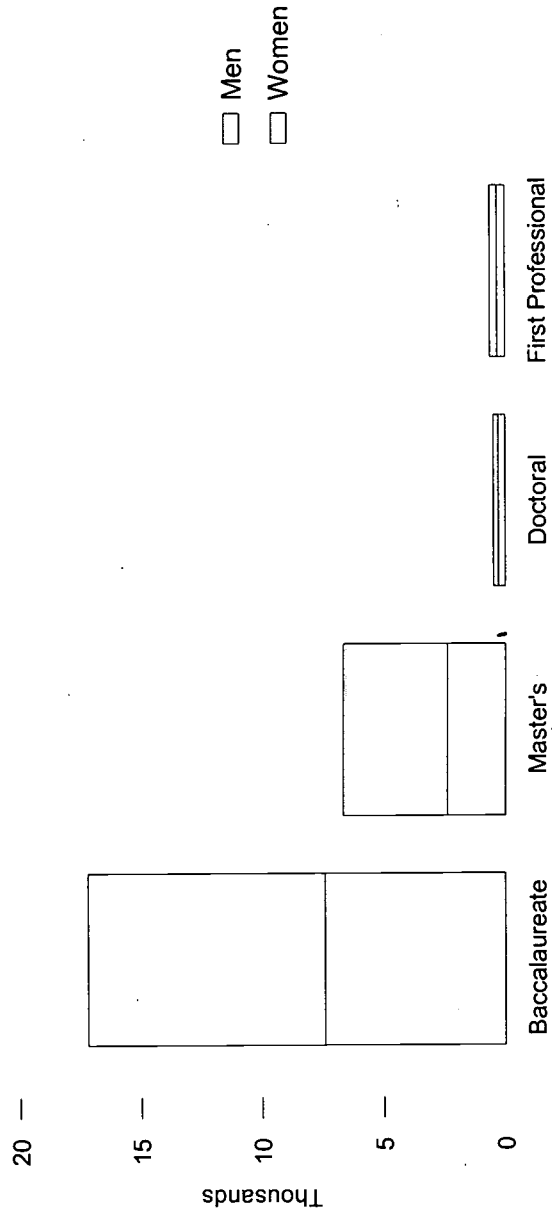

SOURCE: Integrated Postsecondary Education Data System, (IPEDS), Completions.

COMPLETIONS CONFERRED BY LEVEL AND GENDER

1998-99

	LESS THAN 1 YEAR		LESS THAN 2 YEARS		ASSOCIATE		LESS THAN 4 YEARS		TOTAL	
	Men	Women	Men	Women	Men	Women	Men	Women	Men	Women
Total All Public Colleges and Univ	1,127	709	1,229	1,824	2,386	4,647	5	14	4,747	7,194
Total All Public Four-Year Institutions	1	9	18	10	77	194	5	14	101	227
Total All Public Two Year Institutions	1,126	700	1,211	1,814	2,309	4,453			4,646	6,967
Total All Private Institutions					116	151			116	151
Troy State University					15	97			15	97
Troy State University Dothan					14	11			14	11
Troy State University Montgomery					32	53			32	53
University of South Alabama	1	9	18	10			5	14	24	33
University of West Alabama					16	33			16	33
Concordia College					2	11			2	11
Faulkner University					29	67			29	67
Huntingdon College						3				3
Oakwood College					9	23			9	23
Samford University					4	13			4	13
Southeastern Bible College					3	5			3	5
Spring Hill College					1				1	
University of Mobile					8	23			8	23
Al Southern Community College	24	29	3	66	56	100			83	195
Ayers State Technical College	6	29	28	54	36	28			70	111
Bessemer State Technical College	62	43	80	80	50	60			192	183
Bevill State Community College	283	114	40	131	142	278			465	523
Bishop State Community College	106	108	82	131	135	302			323	541
Calhoun Community College	104	6	38	102	224	318			366	426
Central Alabama Community College	10	7	19	62	58	139			87	208
Chattahoochee Valley C.C.	4	5	4	15	64	140			72	160
Drake State Technical College			63	79	27	24			90	103
Enterprise St. Junior College	31	18	6	21	109	198			146	237
Faulkner St. Community College	19	3	6	16	109	180			115	196
Gadsden State Community Coll	2		93	79	149	303			261	385
Ingram State Technical College	24	1	59	33	3	9			103	42
Jeff Davis St. Community College	1	2	3	3	38	95			121	96
Jefferson State Community College	1	1	3	3	116	190			120	195
Lawson St. Community College	4	1	28	16	23	58			55	75

COMPLETIONS CONFERRED BY LEVEL AND GENDER

1998-99

	LESS THAN 1 YEAR		LESS THAN 2 YEARS		ASSOCIATE		LESS THAN 4 YEARS		TOTAL	
	Men	Women	Men	Women	Men	Women	Men	Women	Men	Women
Continued -										
L. B. Wallace Junior College	6	13			41	70			47	83
MacArthur State Technical College		13	42	96	35	35			77	144
Northeast AL St. Jr. College	30	11			49	154			79	165
Northwest-Shoals C C	11	28	48	86	81	207			140	321
Patterson State Technical College	132	20	25	73	75	53			232	146
Reid State Technical College	30	65	37	54	15	44			82	163
Shelton St. Community College	15	11	55	92	78	137			148	240
Snead St. Community College	6	15	1	13	72	129			79	157
So. Union St. Community College	120	59	45	64	98	221			263	344
Sparks State Technical College	24	24	67	45	34	43			125	88
Trenholm State Technical College	20	60	22	80	12	67			54	207
Wallace St. CC/Dothan	7	2	48	113	109	236			164	351
Wallace St. CC/Hanceville	33	12	104	116	208	513			345	641
Wallace St. CC/Seima	12	25	67	94	63	122			142	241
Marion Military Institute					60	6			60	6

SOURCE: Integrated Postsecondary Education Data System (IPEDS), Completions, 1998-99.

NOTE: A breakdown of all merged institutions will be furnished upon request. See Notes page at the end of this publication.

COMPLETIONS CONFERRED BY LEVEL AND GENDER
ALABAMA FOUR-YEAR INSTITUTIONS
1998-99

	BACCALAUREATE ^a		MASTER'S ^a		DOCTORAL		FIRST PROFESSIONAL		TOTAL	
	Men	Women	Men	Women	Men	Women	Men	Women	Men	Women
Total All Public Four-Year Institutions	7,395	9,814	2,380	4,264	286	198	331	282	10,392	14,558
Total All Private Four-Year Institutions	1,180	2,029	154	268	16		276	209	1,626	2,506
Alabama A&M University	206	298	86	231	6	1			298	530
Alabama State University	182	292	59	145					241	437
Athens State University	313	541							313	541
Auburn University	1,989	1,932	328	375	117	61	41	78	2,475	2,446
Auburn University at Montgomery	230	472	147	206					377	678
Jacksonville State University	407	640	163	264					570	904
Troy State University	390	667	136	578					526	1,245
Troy State University Dothan	159	235	82	110					241	345
Troy St. University Montgomery	123	119	76	109					199	228
University of Alabama	1,269	1,474	465	695	71	64	106	77	1,911	2,310
Univ. of Alabama at Birmingham	677	872	408	681	55	59	148	104	1,288	1,716
Univ. of Alabama in Huntsville	298	378	128	174	25	6			451	558
University of Montevallo	136	348	39	115					175	463
University of North Alabama	306	513	83	125					389	638
University of South Alabama	584	888	158	381					790	1,299
University of West Alabama	126	145	22	75	12	7	36	23	148	220
Birmingham-Southern	118	166	7	17					125	183
Concordia College	6	32							6	32
Faulkner University	219	261	25	34			65	40	309	335
Huntingdon College	44	78							44	78
Judson College	1	56							1	56
Miles College	41	112							41	112
Oakwood College	74	119							74	119
Samford University	232	394	60	89	16		191	136	499	619
Selma University ^b	14	13							14	13
Southeastern Bible College	89	124	15	56					104	180
Spring Hill College	57	108							57	108
Stillman College	34	95							34	95
Talladega College	166	270	23	22			20	33	209	325
Tuskegee University	85	201	24	50					109	251

SOURCE: Integrated Postsecondary Education Data System, (IPEDS), Completions, 1998-99.

- a. Baccalaureate includes Post-Baccalaureate and Master's includes Post-Master's.
- b. Data not reported.

NUMBER AND PERCENT OF COMPLETIONS CONFERRED BY FIELD OF STUDY AND LEVEL OF DEGREE
Alabama Four Year Institutions
1998-99

FIELD OF STUDY AND TYPE OF INSTITUTION	LESS THAN 1 YEAR		LESS THAN 2 YEARS		ASSOCIATE		LESS THAN 4 YEARS	
	Number	Percent	Number	Percent	Number	Percent	Number	Percent
COMMUNICATIONS								
Public Senior Institutions	---	---	---	---	---	---	---	---
Private Senior Institutions	---	---	---	---	---	---	---	---
Total	---	---	---	---	---	---	---	---
COMPUTER & INFORMATION SCIENCES								
Public Senior Institutions	---	---	---	---	2	0.7	---	---
Private Senior Institutions	---	---	---	---	8	4.0	---	---
Total	---	---	---	---	10	2.1	---	---
EDUCATION								
Public Senior Institutions	---	---	---	---	---	---	---	---
Private Senior Institutions	---	---	---	---	---	---	---	---
Total	---	---	---	---	---	---	---	---
ENGINEERING								
Public Senior Institutions	---	---	---	---	---	---	---	---
Private Senior Institutions	---	---	---	---	---	---	---	---
Total	---	---	---	---	---	---	---	---
ENGR. & ENGR. RELATED TECH.								
Public Senior Institutions	---	---	---	---	---	---	---	---
Private Senior Institutions	---	---	---	---	---	---	---	---
Total	---	---	---	---	---	---	---	---
FOREIGN LANGUAGES AND LITERATURE								
Public Senior Institutions	---	---	---	---	---	---	---	---
Private Senior Institutions	---	---	---	---	---	---	---	---
Total	---	---	---	---	---	---	---	---
VOCATIONAL HOME ECONOMICS								
Public Senior Institutions	---	---	---	---	---	---	---	---
Private Senior Institutions	---	---	---	---	---	---	---	---
Total	---	---	---	---	---	---	---	---
TECH EDUCATIONAL/INDUSTRIAL ARTS								
Public Senior Institutions	---	---	---	---	---	---	---	---
Private Senior Institutions	---	---	---	---	---	---	---	---
Total	---	---	---	---	---	---	---	---
LAW								
Public Senior Institutions	---	---	---	---	---	---	---	---
Private Senior Institutions	---	---	---	---	6	3.0	---	---
Total	---	---	---	---	6	1.3	---	---
LIB ARTS & SCI, GEN STUD & HUMANITIES								
Public Senior Institutions	---	---	---	---	89	32.8	---	---
Private Senior Institutions	---	---	---	---	81	40.3	---	---
Total	---	---	---	---	170	36.0	---	---

NUMBER AND PERCENT OF COMPLETIONS CONFERRED BY FIELD OF STUDY AND LEVEL OF DEGREE
Alabama Four Year Institutions
1998-99

Continued -

FIELD OF STUDY AND TYPE OF INSTITUTION	LESS THAN 1 YEAR		LESS THAN 2 YEARS		ASSOCIATE		LESS THAN 4 YEARS	
	Number	Percent	Number	Percent	Number	Percent	Number	Percent
MULTI/INTERDISCIPLINARY STUDIES								
Public Senior Institutions	10	100.0						
Private Senior Institutions								
Total	10	100.0						
THEOLOGICAL, STU. & RELIGIOUS VOC								
Public Senior Institutions					11	5.5		
Private Senior Institutions					11	2.3		
Total								
PROTECTIVE SERVICES								
Public Senior Institutions					10	5.0		
Private Senior Institutions					10	2.1		
Total								
PUBLIC ADMINISTRATION AND SERVICES								
Public Senior Institutions								
Private Senior Institutions					6	3.0		
Total					6	1.3		
SOCIAL SCIENCES AND HISTORY								
Public Senior Institutions								
Private Senior Institutions								
Total								
MECHANICS AND REPAIRERS								
Public Senior Institutions					7	1.5		
Private Senior Institutions								
Total					7	1.5		
VISUAL AND PERFORMING ARTS								
Public Senior Institutions								
Private Senior Institutions					2	1.0		
Total					2	0.4		
HEALTH PROF. & RELATED SCIENCES								
Public Senior Institutions			28	100.0	154	56.8	19	100.0
Private Senior Institutions					64	31.8		
Total			28	100.0	218	46.2	19	100.0
BUSINESS & MGT. & ADMIN. SERV.								
Public Senior Institutions					19	7.0		
Private Senior Institutions					13	6.5		
Total					32	6.8		
GRAND TOTAL								
Public Senior Institutions	10	100.0	28	100.0	271	100.0	19	100.0
Private Senior Institutions					201	100.0		
Total	10	100.0	28	100.0	472	100.0	19	100.0

SOURCE: Integrated Postsecondary Education Data System (IPEDS), Completions, 1998-99.

NOTE: Selma University data not reported.

NUMBER AND PERCENT OF COMPLETIONS CONFERRED BY FIELD OF STUDY AND LEVEL OF DEGREE
Alabama Four-Year Institutions
1998-99

FIELD OF STUDY AND TYPE OF INSTITUTION	BACCALAUREATE		MASTER'S		DOCTORAL		FIRST PROFESSIONAL	
	Number	Percent	Number	Percent	Number	Percent	Number	Percent
AG. BUSINESS & PRODUCTION								
Public Senior	45	0.3	22	0.3	6	1.2	---	---
Private Senior	---	---	6	1.4	---	---	---	---
Total	45	0.2	28	0.4	6	1.2	---	---
AGRICULTURAL SCIENCES								
Public Senior	192	1.1	30	0.5	13	2.7	---	---
Private Senior	25	0.8	3	0.7	---	---	---	---
Total	217	1.1	33	0.5	13	2.6	---	---
CONSERV. & RENEWABLE NAT RESOURCES								
Public Senior	103	0.6	17	0.3	4	0.8	---	---
Private Senior	8	0.2	5	1.2	---	---	---	---
Total	103	0.5	17	0.2	4	0.8	---	---
ARCHITECTURE & RELATED PROGRAMS								
Public Senior	96	0.6	15	0.2	---	---	---	---
Private Senior	9	0.3	---	---	---	---	---	---
Total	105	0.5	15	0.2	---	---	---	---
AREA, ETHNIC & CULTURAL STUDIES								
Public Senior	8	0.0	14	0.2	---	---	---	---
Private Senior	1	0.0	---	---	---	---	---	---
Total	8	0.0	14	0.2	---	---	---	---
MARKETING & DISTRIBUTION								
Public Senior	---	---	---	---	---	---	---	---
Private Senior	1	0.0	---	---	---	---	---	---
Total	1	0.0	---	---	---	---	---	---
COMMUNICATIONS								
Public Senior	650	3.8	28	0.4	8	1.7	---	---
Private Senior	110	3.4	---	---	---	---	---	---
Total	760	3.7	28	0.4	8	1.6	---	---
COMMUNICATION TECHNOLOGIES								
Public Senior	17	0.1	---	---	---	---	---	---
Private Senior	---	---	---	---	---	---	---	---
Total	17	0.1	---	---	---	---	---	---

NUMBER AND PERCENT OF COMPLETIONS CONFERRED BY FIELD OF STUDY AND LEVEL OF DEGREE
Alabama Four-Year Institutions

1998-99

Continued-

FIELD OF STUDY AND TYPE OF INSTITUTION	BACCALAUREATE		MASTER'S		DOCTORAL		FIRST PROFESSIONAL	
	Number	Percent	Number	Percent	Number	Percent	Number	Percent
COMPUTER & INFORMATION SCI.								
Public Senior	402	2.3	131	2.0	7	1.4	---	---
Private Senior	53	1.7	---	---	---	---	---	---
Total	455	2.2	131	1.9	7	1.4	---	---
EDUCATION								
Public Senior	2,685	15.6	3,003	45.2	93	19.2	---	---
Private Senior	378	11.8	121	28.7	---	---	---	---
Total	3,063	15.0	3,124	44.2	93	18.6	---	---
ENGINEERING								
Public Senior	1,136	6.6	318	4.8	66	13.6	---	---
Private Senior	97	3.0	13	3.1	---	---	---	---
Total	1,233	6.0	331	4.7	66	13.2	---	---
ENGINEERING & ENGR-RELATED TECH.								
Public Senior	87	0.5	9	0.1	---	---	---	---
Private Senior	4	0.1	32	7.6	---	---	---	---
Total	91	0.4	41	0.6	---	---	---	---
FOREIGN LANGUAGES								
Public Senior	127	0.7	13	0.2	4	---	---	---
Private Senior	17	0.5	---	---	---	---	---	---
Total	144	0.7	13	0.2	4	---	---	---
HOME ECONOMICS								
Public Senior	512	3.0	26	0.4	---	---	---	---
Private Senior	54	1.7	6	1.4	---	---	---	---
Total	566	2.8	32	0.5	---	---	---	---
VOCATIONAL HOME ECONOMICS								
Public Senior	---	---	---	---	---	---	---	---
Private Senior	---	---	---	---	---	---	---	---
Total	---	---	---	---	---	---	---	---
LAW								
Public Senior	---	---	1	0.0	---	---	183	29.9
Private Senior	12	0.4	2	0.5	---	---	297	61.2
Total	12	0.1	3	0.0	---	---	480	43.7

NUMBER AND PERCENT OF COMPLETIONS CONFERRED BY FIELD OF STUDY AND LEVEL OF DEGREE
Alabama Four-Year Institutions

Continued - 1998-99

FIELD OF STUDY AND TYPE OF INSTITUTION	BACCALAUREATE		MASTER'S		DOCTORAL		FIRST PROFESSIONAL	
	Number	Percent	Number	Percent	Number	Percent	Number	Percent
ENGLISH LANG & LITERATURE/LETTERS								
Public Senior	486	2.8	96	1.4	11	2.3	---	---
Private Senior	149	4.6	1	0.2	---	---	---	---
Total	635	3.1	96	1.4	11	2.2	---	---
LIB ARTS & SOC. GEN STUDIES & HUMANITIES								
Public Senior	149	0.9	10	0.2	---	---	---	---
Private Senior	25	0.8	3	0.7	---	---	---	---
Total	174	0.9	13	0.2	---	---	---	---
LIBRARY SCIENCE								
Public Senior	---	---	69	1.0	---	---	---	---
Private Senior	---	---	---	---	---	---	---	---
Total	---	---	69	1.0	---	---	---	---
BIOLOGICAL SCI/LIFE SCIENCES								
Public Senior	783	4.5	87	1.3	62	12.8	---	---
Private Senior	213	6.6	2	0.5	---	---	---	---
Total	996	4.9	89	1.3	62	12.4	---	---
MATHEMATICS								
Public Senior	163	0.9	34	0.5	16	3.3	---	---
Private Senior	52	1.6	---	---	---	---	---	---
Total	215	1.1	34	0.5	16	3.2	---	---
MULTI-INTERDISCIPLINARY STUDIES								
Public Senior	169	1.0	6	0.1	7	1.4	---	---
Private Senior	34	1.1	---	---	---	---	---	---
Total	203	1.0	6	0.1	7	1.4	---	---
PARKS, RECR, LEISURE & FITNESS STUDIES								
Public Senior	86	0.5	3	0.0	8	1.7	---	---
Private Senior	72	2.2	---	---	---	---	---	---
Total	158	0.8	3	0.0	8	1.6	---	---
PHILOSOPHY & RELIGION								
Public Senior	43	0.2	---	---	---	---	---	---
Private Senior	31	1.0	1	0.2	---	---	---	---
Total	74	0.4	1	0.0	---	---	---	---

NUMBER AND PERCENT OF COMPLETIONS CONFERRED BY FIELD OF STUDY AND LEVEL OF DEGREE
Alabama Four-Year Institutions

1998-99

Continued -

FIELD OF STUDY AND TYPE OF INSTITUTION	BACCALAUREATE		MASTER'S		DOCTORAL		FIRST PROFESSIONAL	
	Number	Percent	Number	Percent	Number	Percent	Number	Percent
THEOLOGICAL STUDIES/RELIGIOUS VOC								
Public Senior	---	---	---	---	---	---	---	---
Private Senior	68	2.1	17	4.0	16	100.0	39	8.0
Total	68	0.3	17	0.2	16	3.2	39	3.6
PHYSICAL SCIENCE								
Public Senior	219	1.3	56	0.8	36	7.4	---	---
Private Senior	46	1.4	4	0.9	---	---	---	---
Total	265	1.3	60	0.8	36	7.2	---	---
SCIENCE TECHNOLOGIES								
Public Senior	1	0.0	---	---	---	---	---	---
Private Senior	---	---	---	---	---	---	---	---
Total	1	0.0	---	---	---	---	---	---
PSYCHOLOGY								
Public Senior	781	4.5	250	3.8	49	10.1	---	---
Private Senior	145	4.5	---	---	---	---	---	---
Total	926	4.5	250	3.5	49	9.8	---	---
PROTECTIVE SERVICES								
Public Senior	579	3.4	102	1.5	---	---	---	---
Private Senior	21	0.7	---	---	---	---	---	---
Total	600	2.9	102	1.4	---	---	---	---
PUBLIC ADMIN AND SERVICES								
Public Senior	353	2.1	307	4.6	12	2.5	---	---
Private Senior	87	2.7	---	---	---	---	---	---
Total	440	2.2	307	4.3	12	2.4	---	---
SOCIAL SCIENCES AND HISTORY								
Public Senior	1,052	6.1	117	1.8	17	3.5	---	---
Private Senior	219	6.8	---	---	---	---	---	---
Total	1,271	6.2	117	1.7	17	3.4	---	---
CONSTRUCTION TRADES								
Public Senior	---	---	---	---	---	---	---	---
Private Senior	6	0.2	---	---	---	---	---	---
Total	6	0.0	---	---	---	---	---	---

NUMBER AND PERCENT OF COMPLETIONS CONFERRED BY FIELD OF STUDY AND LEVEL OF DEGREE
Alabama Four-Year Institutions

Continued - 1998-99

FIELD OF STUDY AND TYPE OF INSTITUTION	BACCALAUREATE		MASTER'S		DOCTORAL		FIRST PROFESSIONAL	
	Number	Percent	Number	Percent	Number	Percent	Number	Percent
VISUAL & PERFORMING ARTS								
Public Senior	444	2.6	43	0.6	2	0.4	----	----
Private Senior	79	2.5	----	----	----	----	----	----
Total	523	2.6	43	0.6	2	0.4	----	----
HLTH PROF & RELATED SCIENCES								
Public Senior	1,715	10.0	826	12.4	38	7.9	430	70.1
Private Senior	178	5.5	62	14.7	----	----	149	30.7
Total	1,893	9.3	888	12.6	38	7.6	579	52.7
BUSINESS MGT. & ADMIN SERVICES								
Public Senior	4,126	24.0	1,011	15.2	25	5.2	----	----
Private Senior	1,015	31.6	144	34.1	----	----	----	----
Total	5,141	25.2	1,155	16.3	25	5.0	----	----
GRAND TOTAL								
Public Senior	17,209	100.0	6,644	100.0	484	100.0	613	100.0
Private Senior	3,209	100.0	422	100.0	16	100.0	485	100.0
Total	20,418	100.0	7,066	100.0	500	100.0	1,098	100.0

SOURCE: Integrated Postsecondary Education Data System, (IPEDS), Completions, 1998-99.

NUMBER AND PERCENT OF COMPLETIONS CONFERRED BY FIELD OF STUDY AND LEVEL OF DEGREE
Alabama Four-Year Institutions
1998-99

FIELD OF STUDY AND TYPE OF INSTITUTION	BACCALAUREATE		MASTER'S		DOCTORAL		FIRST PROFESSIONAL	
	Number	Percent	Number	Percent	Number	Percent	Number	Percent
AG. BUSINESS & PRODUCTION								
Public Senior	45	0.3	22	0.3	6	1.2	---	---
Private Senior	---	---	6	1.4	---	---	---	---
Total	45	0.2	28	0.4	6	1.2	---	---
AGRICULTURAL SCIENCES								
Public Senior	192	1.1	30	0.5	13	2.7	---	---
Private Senior	25	0.8	3	0.7	---	---	---	---
Total	217	1.1	33	0.5	13	2.6	---	---
CONSERV. & RENEWABLE NAT RESOURCES								
Public Senior	103	0.6	17	0.3	4	0.8	---	---
Private Senior	8	0.2	5	1.2	---	---	---	---
Total	103	0.5	17	0.2	4	0.8	---	---
ARCHITECTURE & RELATED PROGRAMS								
Public Senior	96	0.6	15	0.2	---	---	---	---
Private Senior	9	0.3	---	---	---	---	---	---
Total	105	0.5	15	0.2	---	---	---	---
AREA, ETHNIC & CULTURAL STUDIES								
Public Senior	8	0.0	14	0.2	---	---	---	---
Private Senior	1	0.0	---	---	---	---	---	---
Total	8	0.0	14	0.2	---	---	---	---
MARKETING & DISTRIBUTION								
Public Senior	---	---	---	---	---	---	---	---
Private Senior	1	0.0	---	---	---	---	---	---
Total	1	0.0	---	---	---	---	---	---
COMMUNICATIONS								
Public Senior	650	3.8	28	0.4	8	1.7	---	---
Private Senior	110	3.4	---	---	---	---	---	---
Total	760	3.7	28	0.4	8	1.6	---	---
COMMUNICATION TECHNOLOGIES								
Public Senior	17	0.1	---	---	---	---	---	---
Private Senior	---	---	---	---	---	---	---	---
Total	17	0.1	---	---	---	---	---	---

NUMBER AND PERCENT OF COMPLETIONS CONFERRED BY FIELD OF STUDY AND LEVEL OF DEGREE
Alabama Four-Year Institutions

1998-99

Continued-

FIELD OF STUDY AND TYPE OF INSTITUTION	BACCALAUREATE		MASTER'S		DOCTORAL		FIRST PROFESSIONAL	
	Number	Percent	Number	Percent	Number	Percent	Number	Percent
COMPUTER & INFORMATION SCI.								
Public Senior	402	2.3	131	2.0	7	1.4	---	---
Private Senior	53	1.7	---	---	---	---	---	---
Total	455	2.2	131	1.9	7	1.4	---	---
EDUCATION								
Public Senior	2,685	15.6	3,003	45.2	93	19.2	---	---
Private Senior	378	11.8	121	28.7	---	---	---	---
Total	3,063	15.0	3,124	44.2	93	18.6	---	---
ENGINEERING								
Public Senior	1,136	6.6	318	4.8	66	13.6	---	---
Private Senior	97	3.0	13	3.1	---	---	---	---
Total	1,233	6.0	331	4.7	66	13.2	---	---
ENGINEERING & ENGR-RELATED TECH.								
Public Senior	87	0.5	9	0.1	---	---	---	---
Private Senior	4	0.1	32	7.6	---	---	---	---
Total	91	0.4	41	0.6	---	---	---	---
FOREIGN LANGUAGES								
Public Senior	127	0.7	13	0.2	4	---	---	---
Private Senior	17	0.5	---	---	---	---	---	---
Total	144	0.7	13	0.2	4	---	---	---
HOME ECONOMICS								
Public Senior	512	3.0	26	0.4	---	---	---	---
Private Senior	54	1.7	6	1.4	---	---	---	---
Total	566	2.8	32	0.5	---	---	---	---
VOCATIONAL HOME ECONOMICS								
Public Senior	---	---	---	---	---	---	---	---
Private Senior	---	---	---	---	---	---	---	---
Total	---	---	---	---	---	---	---	---
LAW								
Public Senior	---	---	1	0.0	---	---	183	29.9
Private Senior	12	0.4	2	0.5	---	---	297	61.2
Total	12	0.1	3	0.0	---	---	480	43.7

NUMBER AND PERCENT OF COMPLETIONS CONFERRED BY FIELD OF STUDY AND LEVEL OF DEGREE
Alabama Four-Year Institutions

Continued - 1998-99

FIELD OF STUDY AND TYPE OF INSTITUTION	BACCALAUREATE		MASTER'S		DOCTORAL		FIRST PROFESSIONAL	
	Number	Percent	Number	Percent	Number	Percent	Number	Percent
ENGLISH LANG & LITERATURE/LETTERS								
Public Senior	486	2.8	96	1.4	11	2.3	---	---
Private Senior	149	4.6	1	0.2	---	---	---	---
Total	635	3.1	96	1.4	11	2.2	---	---
LIB ARTS & SOC. GEN STUDIES & HUMANITIES								
Public Senior	149	0.9	10	0.2	---	---	---	---
Private Senior	25	0.8	3	0.7	---	---	---	---
Total	174	0.9	13	0.2	---	---	---	---
LIBRARY SCIENCE								
Public Senior	---	---	69	1.0	---	---	---	---
Private Senior	---	---	---	---	---	---	---	---
Total	---	---	69	1.0	---	---	---	---
BIOLOGICAL SCI/LIFE SCIENCES								
Public Senior	783	4.5	87	1.3	62	12.8	---	---
Private Senior	213	6.6	2	0.5	---	---	---	---
Total	996	4.9	89	1.3	62	12.4	---	---
MATHEMATICS								
Public Senior	163	0.9	34	0.5	16	3.3	---	---
Private Senior	52	1.6	---	---	---	---	---	---
Total	215	1.1	34	0.5	16	3.2	---	---
MULTI-INTERDISCIPLINARY STUDIES								
Public Senior	169	1.0	6	0.1	7	1.4	---	---
Private Senior	34	1.1	---	---	---	---	---	---
Total	203	1.0	6	0.1	7	1.4	---	---
PARKS, RECR, LEISURE & FITNESS STUDIES								
Public Senior	86	0.5	3	0.0	8	1.7	---	---
Private Senior	72	2.2	---	---	---	---	---	---
Total	158	0.8	3	0.0	8	1.6	---	---
PHILOSOPHY & RELIGION								
Public Senior	43	0.2	---	---	---	---	---	---
Private Senior	31	1.0	1	0.2	---	---	---	---
Total	74	0.4	1	0.0	---	---	---	---

NUMBER AND PERCENT OF COMPLETIONS CONFERRED BY FIELD OF STUDY AND LEVEL OF DEGREE
Alabama Four-Year Institutions

1998-99

Continued -

FIELD OF STUDY AND TYPE OF INSTITUTION	BACCALAUREATE		MASTER'S		DOCTORAL		FIRST PROFESSIONAL	
	Number	Percent	Number	Percent	Number	Percent	Number	Percent
THEOLOGICAL STUDIES/RELIGIOUS VOC								
Public Senior	---	---	---	---	---	---	---	---
Private Senior	68	2.1	17	4.0	16	100.0	39	8.0
Total	68	0.3	17	0.2	16	3.2	39	3.6
PHYSICAL SCIENCE								
Public Senior	219	1.3	56	0.8	36	7.4	---	---
Private Senior	46	1.4	4	0.9	---	---	---	---
Total	265	1.3	60	0.8	36	7.2	---	---
SCIENCE TECHNOLOGIES								
Public Senior	1	0.0	---	---	---	---	---	---
Private Senior	---	---	---	---	---	---	---	---
Total	1	0.0	---	---	---	---	---	---
PSYCHOLOGY								
Public Senior	781	4.5	250	3.8	49	10.1	---	---
Private Senior	145	4.5	---	---	---	---	---	---
Total	926	4.5	250	3.5	49	9.8	---	---
PROTECTIVE SERVICES								
Public Senior	579	3.4	102	1.5	---	---	---	---
Private Senior	21	0.7	---	---	---	---	---	---
Total	600	2.9	102	1.4	---	---	---	---
PUBLIC ADMIN AND SERVICES								
Public Senior	353	2.1	307	4.6	12	2.5	---	---
Private Senior	87	2.7	---	---	---	---	---	---
Total	440	2.2	307	4.3	12	2.4	---	---
SOCIAL SCIENCES AND HISTORY								
Public Senior	1,052	6.1	117	1.8	17	3.5	---	---
Private Senior	219	6.8	---	---	---	---	---	---
Total	1,271	6.2	117	1.7	17	3.4	---	---
CONSTRUCTION TRADES								
Public Senior	---	---	---	---	---	---	---	---
Private Senior	6	0.2	---	---	---	---	---	---
Total	6	0.0	---	---	---	---	---	---

NUMBER AND PERCENT OF COMPLETIONS CONFERRED BY FIELD OF STUDY AND LEVEL OF DEGREE
Alabama Four-Year Institutions

Continued - 1998-99

FIELD OF STUDY AND TYPE OF INSTITUTION	BACCALAUREATE		MASTER'S		DOCTORAL		FIRST PROFESSIONAL	
	Number	Percent	Number	Percent	Number	Percent	Number	Percent
VISUAL & PERFORMING ARTS								
Public Senior	444	2.6	43	0.6	2	0.4	----	----
Private Senior	79	2.5	----	----	----	----	----	----
Total	523	2.6	43	0.6	2	0.4	----	----
HLTH PROF & RELATED SCIENCES								
Public Senior	1,715	10.0	826	12.4	38	7.9	430	70.1
Private Senior	178	5.5	62	14.7	----	----	149	30.7
Total	1,893	9.3	888	12.6	38	7.6	579	52.7
BUSINESS MGT. & ADMIN SERVICES								
Public Senior	4,126	24.0	1,011	15.2	25	5.2	----	----
Private Senior	1,015	31.6	144	34.1	----	----	----	----
Total	5,141	25.2	1,155	16.3	25	5.0	----	----
GRAND TOTAL								
Public Senior	17,209	100.0	6,644	100.0	484	100.0	613	100.0
Private Senior	3,209	100.0	422	100.0	16	100.0	485	100.0
Total	20,418	100.0	7,066	100.0	500	100.0	1,098	100.0

SOURCE: Integrated Postsecondary Education Data System, (IPEDS), Completions, 1998-99.

Baccalaureate And Higher Completions By Gender

Alabama Four-Year Institutions - 1988-89 - 1998-99

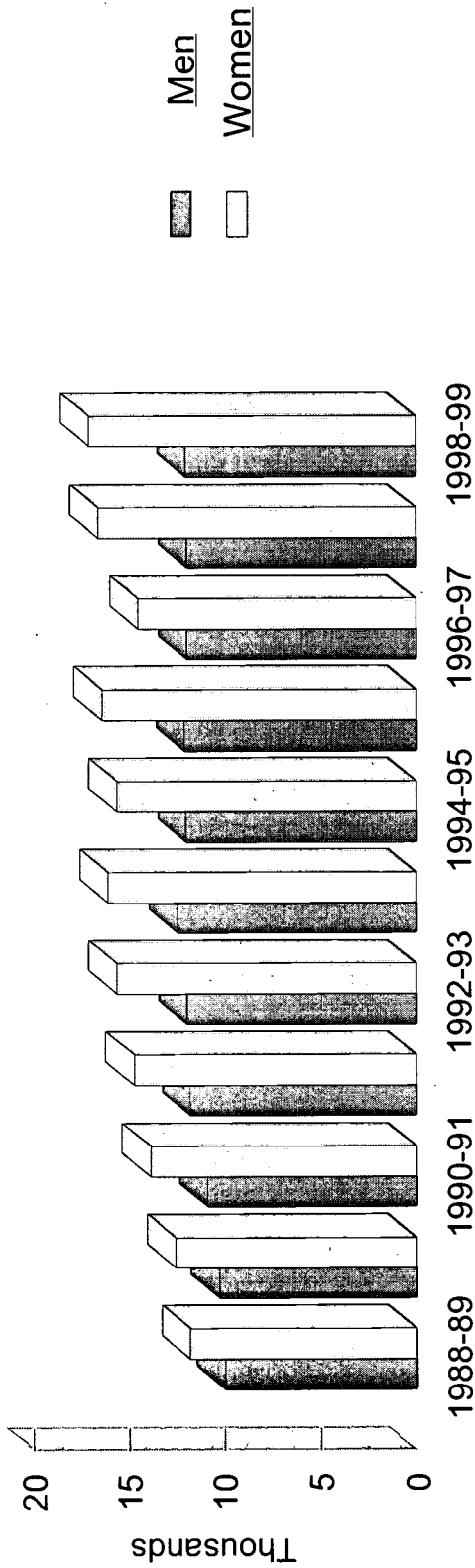

SOURCE: Integrated Postsecondary Education Data System (IPEDS), Completions.

BACCALAUREATE AND HIGHER COMPLETIONS CONFERRED BY LEVEL OF DEGREE AND GENDER
Alabama Four-Year Institutions
1989 - 1999

Year	All Levels		Baccalaureate		Master's		Doctoral		First Professional	
	Men	Women	Men	Women	Men	Women	Men	Women	Men	Women
Total 1989-99	127,294	167,133	93,406	120,853	24,706	40,191	2,858	2,054	6,324	4,035
1988-89	9,975	11,811	7,522	8,913	1,750	2,481	189	152	514	265
1989-90	10,276	12,572	7,718	9,405	1,809	2,733	208	146	541	288
1990-91	10,885	13,870	8,148	10,197	1,941	3,234	227	163	569	276
1991-92	11,765	14,722	8,746	10,878	2,237	3,407	238	135	544	302
1992-93	11,938	15,590	8,923	11,607	2,249	3,481	244	160	522	342
1993-94	12,444	16,069	9,271	11,887	2,352	3,579	257	217	564	387
1994-95	11,984	15,597	8,676	11,263	2,485	3,764	236	199	587	371
1995-96	12,084	16,386	8,768	11,363	2,403	4,378	320	211	593	434
1996-97	11,952	14,497	8,482	11,710	2,482	4,477	313	242	675	445
1997-98	11,973	16,577	8,577	11,787	2,466	4,125	324	231	606	434
1998-99	12,018	17,064	8,575	11,843	2,532	4,532	302	198	609	491
Peak Year	1994	1999	1994	1994	1999	1999	1998	1997	1997	1999
1999 as percent of peak year	96.6	100.0	92.5	99.6	100.0	100.0	93.2	81.8	90.2	100.0
Percent change 1989 - 1999	20.5	44.5	14.0	32.9	44.7	82.7	59.8	30.3	18.5	85.3

SOURCE: Integrated Postsecondary Education Data Systems (IPEDS), Completions, 1988-89 - 1998-99.

**BACCALAUREATE AND HIGHER COMPLETIONS CONFERRED
BY LEVEL OF DEGREE AND CONTROL OF INSTITUTION**
Alabama Four-Year Institutions
1989 - 1999

Year	All Levels		Baccalaureate		Master's		Doctoral		First Professional	
	Public	Private	Public	Private	Public	Private	Public	Private	Public	Private
Total 1989-1999	254,533	39,634	182,087	32,173	61,454	3,428	4,714	---	6,278	4,033
1989	19,137	2,649	14,268	2,167	4,021	210	341	---	507	272
1990	20,014	2,834	14,802	2,321	4,312	230	354	---	546	283
1991	21,501	3,254	15,623	2,722	4,936	239	390	---	552	293
1992	23,135	3,355	16,851	2,776	5,372	272	373	---	539	307
1993	23,966	3,562	17,569	2,961	5,424	306	404	---	569	295
1994	24,648	3,819	17,984	3,174	5,624	306	474	---	566	339
1995	23,836	3,745	16,851	3,088	5,959	290	435	---	591	367
1996	24,333	4,137	16,781	3,350	6,421	360	531	---	600	427
1997	24,690	4,136	16,976	3,216	6,547	412	555	---	612	508
1998	24,505	4,027	17,173	3,189	6,194	381	555	---	583	457
1999	24,768	4,116	17,209	3,209	6,644	422	302	16	613	485
Peak Year	1999	1996	1994	1996	1999	1999	1998	1999	1999	1997
1999 as percent of peak year	100.0	99.5	95.7	95.8	100.0	100.0	54.4	100.0	100.0	95.5
Percent change 1989 - 1999	29.4	55.4	20.6	48.1	65.2	101.0	-11.4	0.0	20.9	78.3

SOURCE: Integrated Postsecondary Education Data Systems (IPEDS), Completions, 1989-1999.

PERCENTAGE OF COMPLETIONS AWARDED TO WOMEN, BY LEVEL
Alabama Four-Year Institutions
1989 - 1999

<u>Year</u>	<u>All Levels</u>	<u>Baccalaureate</u>	<u>Master's</u>	<u>Doctoral</u>	<u>First Professional</u>
Total 1989-1999	56.7	56.3	61.7	41.8	38.6
1989	54.2	54.2	58.6	44.6	34.0
1990	55.0	55.0	60.2	41.2	34.7
1991	56.0	55.6	62.5	41.8	32.7
1992	55.6	55.4	60.4	36.2	35.7
1993	57.5	56.5	60.8	39.6	39.6
1994	56.4	56.2	60.4	45.8	40.7
1995	56.5	56.5	60.2	45.7	38.7
1996	57.5	56.4	64.6	39.7	42.3
1997	58.5	58.0	64.3	43.6	39.7
1998	58.1	57.9	62.6	41.6	41.7
1999	58.7	58.0	64.1	39.6	44.7

SOURCE: Integrated Postsecondary Education Data Systems (IPEDS), Completions, 1989 - 1999.

Gross Square Footage by Category
Alabama Public Institutions
1999

Institution	Gross Building Area			Percent of Total			Total	1988 Total GSF	Percent Change			
	E&G	Health	Hospital	AUX	Other	Total				E&G	Health	Hospital
Alabama A&M University	985,710	1,500		879,415	5,538	1,872,163	52.7	47.0	0.3	100.0	1,337,209	40.0
Alabama State University	885,195			600,724		1,485,919	59.6	40.4		100.0	1,034,815	43.6
Athens State University	243,233			27,500		286,511	84.9	9.6	5.5	100.0	200,332	43.0
Auburn University a											4,839,491	
AU-Vet Med a											255,042	
AU-AES/CES a												
Auburn University at Montgomery	608,040			181,970		790,010	77.0	23.0		100.0	642,352	23.0
Jacksonville State University	1,200,566			651,450		1,852,016	64.8	35.2		100.0	1,819,917	1.8
Troy State University	863,617			480,418	29,883	1,373,918	62.9	35.0	2.2	100.0	1,194,663	15.0
Troy State University Phenix City	44,858			1,520		46,378	96.7	3.3		100.0	9,200	404.1
Troy State University Dothan	69,712			2,737		72,449	96.2	3.8		100.0	74,627	(2.9)
Troy State University Montgomery	169,342			63,141	10,710	243,193	69.6	26.0	4.4	100.0	97,813	148.6
University of Alabama	4,758,085	100,030		3,003,609	88,192	7,949,916	59.9	37.8	1.1	100.0	5,961,719	33.3
University of Alabama at Birmingham	2,488,374	1,017,646		2,895,012	412,215	6,813,247	36.5	42.5	6.1	100.0	4,342,128	56.9
UAB-Health		2,222,611	1,964,207			4,186,818		46.9	53.1	100.0	3,629,094	15.4
University of Alabama in Huntsville	1,272,307			435,004	11,929	1,719,240	74.0	25.3	0.7	100.0	1,237,063	39.0
University of Montevallo	548,711			444,344	15,472	1,008,527	54.4	44.1	1.5	100.0	960,024	5.1
University of North Alabama	849,167	11,685		366,570	23,207	1,250,629	67.9	29.3	1.9	100.0	1,088,395	14.9
University of South Alabama	1,897,560			1,945,763	116,773	3,960,096	47.9	49.1	2.9	100.0	2,914,336	35.9
USA-Baldwin	19,194			958		20,152	95.2	4.8		100.0		
USA-Health		611,807	945,256	2,883	224,434	1,784,380		53.0	34.3	100.0	1,345,899	32.6
University of West Alabama	474,051			267,922		741,973	63.9	36.1		100.0	637,989	16.3
Total Senior Institutions	17,377,722	3,965,279	2,909,463	12,250,940	954,131	37,457,535	46.4	10.6	7.8	100.0	33,622,108	11.4
Alabama Southern Community College	175,820			3,332		179,152	98.1	1.9		100.0	169,781	5.5
Ayers State Technical College	133,344			6,557		139,901	95.3	4.7		100.0	105,002	33.2
Bessemer State Technical College	243,473			10,277	252	254,002	95.9	4.0	0.1	100.0	229,238	10.8
Bishop State Community College	544,111			147,309	30,454	721,874	75.4	20.4	4.2	100.0	408,720	76.6
Bishop State Community College	527,845			17,237		545,082	96.8	3.2		100.0	269,819	102.0
Calhoun State Community College	553,113			20,264	14,000	587,397	94.2	3.5	2.4	100.0	501,172	17.2
Central Alabama Community College	250,907			38,473	10,955	300,335	83.5	12.8	3.6	100.0	253,897	18.3
Chattahoochee Valley Community College	125,428			125,428		250,856	100.0			100.0	87,980	42.6
Drake State Technical College	104,225			4,888		109,113	95.5	4.5		100.0	105,501	3.4
Enterprise State Jr. College	167,752			7,059		174,811	96.0	4.0		100.0	130,632	33.8
Faulkner State Community College	225,136			65,231	7,200	297,567	75.7	21.9	2.4	100.0	233,451	27.5
Gadsden State Community College	650,829			63,576		714,405	91.1	8.9		100.0	628,171	13.7
Ingram State Technical College	138,886			30,329	16,141	185,156	100.0	10.7	5.7	100.0	185,062	52.8
Jeff Davis Community College	236,239			22,509		258,748	93.6	3.9		100.0	506,174	13.0
Jefferson State Community College	549,493			6,017		555,510	97.1	2.1		100.0	275,637	5.3
Lawson State Community College	284,297			290,314		574,611	96.9	3.1		100.0	107,925	10.3
L. B. Wallace Junior College	118,993			118,993		237,986	100.0			100.0	107,925	10.3
MacArthur State Technical College	104,765			5,883		110,648	94.7	5.3		100.0	97,276	13.7
Northeast Alabama Community College	239,600			5,909		245,509	97.6	2.4		100.0	193,878	26.6
Northwest-Shoals Community College	416,481			26,661		443,142	94.0	6.0		100.0	270,549	63.8
Patterson State Technical College	128,668			4,773	4,893	138,334	93.0	3.5	3.5	100.0	129,452	6.9
Reid State Technical College	66,976			2,330		69,306	96.6	3.4		100.0	69,306	
Shelton State Community College	878,732			29,564		908,296	96.7	3.3		100.0	283,724	220.1
Snead State Community College	271,777			26,356	9,673	307,806	88.3	8.6	3.1	100.0	227,940	35.0
Southern Union State Community College	461,982			60,071		522,053	88.5	11.5		100.0	84,069	521.0
Sparks State Technical College	79,169			4,900	7,947	84,069	94.2	5.8	6.5	100.0	332,966	(74.8)
Trenholm State Technical College	114,382			122,329		236,711	93.5	7.4		100.0	77,079	56.7
Wall State Community College Dothan	537,242			42,935		580,177	92.6	7.4		100.0	370,169	56.7
Wall State Community College Hanceville	706,055			97,539	2,835	806,429	87.6	12.1	0.4	100.0	428,212	88.3
Wall State Community College Selma	205,748			1,379	15,130	222,257	92.6	0.6	6.8	100.0	204,373	8.8
Total Two-Year institutions	9,241,468			751,378	119,480	10,112,326	91.4	7.4	1.2	100.0	7,068,857	43.1
Total All Public Institutions	26,619,190	3,965,279	2,909,463	13,002,318	1,073,611	47,569,861	56.0	27.3	2.3	100.0	40,690,965	16.9

Source: Alabama Commission on Higher Education's 1999 Facility Inventory Survey.
a. Data not available due to implementation of new space management system.

Net Assignable Space By Use
Alabama Public Institutions
1999

Institution	Fall 1999		Classroom & Service		Class Laboratory & Service		Open Laboratory & Service		Research Laboratory & Service		Special Use		NASF/ FTE	
	FTE	NASF/ FTE	NASF/ FTE	NASF/ FTE	NASF/ FTE	NASF/ FTE	NASF/ FTE	NASF/ FTE	NASF/ FTE	NASF/ FTE	NASF/ FTE	NASF/ FTE	NASF/ FTE	NASF/ FTE
Alabama A&M University	4,826	112,148	232	61,178	127	13,569	2.8	44,379	9.2	195,106	40.4	38,541	8.0	130,886
Alabama State University	4,659	70,992	152	60,582	13.0	15,684	3.4	2,843	0.6	135,282	29.0	67,706	14.5	137,937
Athens State University	1,775	30,788	17.3	13,741	7.7	1,953	1.1			32,849	18.5	15,982	9.0	28,278
Auburn University a														
AU-Vet Med a														
AU-AES/CES a														
Auburn University at Montgomery	4,585	52,521	11.5	36,452	8.0	14,021	2.2	3,313	0.5	187,634	29.2	17,595	10.9	55,286
Jacksonville State University	6,423	196,044	24.3	68,170	10.6	15,269	3.8	3,433	0.8	229,664	56.7	72,032	18.3	103,588
Troy State University	4,051	74,976	18.5	83,340	20.6	3,300	4.9*			11,065	16.4	1,385	2.1	51,769
Troy State University Phenix City	674	22,380	33.2	3,300	4.9*					12,901	10.2	9,908	7.8	619
Troy State University Dothan	1,266	16,547	13.1	3,121	2.5					46,925	23.5	6,352	3.2	6,347
Troy State University Montgomery	2,000	32,844	16.5	9,835	4.9	1,196	0.6			1,002,521	60.0	309,396	18.5	744,030
University of Alabama	16,697	224,842	13.5	141,090	8.5	108,377	6.5	262,565	15.7					
University of Alabama at Birmingham b														
UAB-Health b														
University of Alabama in Huntsville	4,304	90,430	21.0	84,821	19.7	37,972	8.8	172,371	40.0	287,734	66.9	49,756	11.6	47,453
University of Montevallo	2,622	45,062	17.2	28,978	11.1	30,823	11.7			80,604	30.7	47,543	18.1	57,218
University of North Alabama	4,733	117,750	24.9	44,299	9.4	14,819	3.1	621	0.1	132,769	28.1	57,238	12.1	80,686
University of South Alabama c	8,608	149,282	17.3	131,188	15.2	58,325	6.8	145,877	16.9	601,212	69.8	102,137	11.9	295,756
University of West Alabama	1,540	38,642	25.1	35,752	23.2	31,860	20.7	192	0.1	53,366	34.7	27,777	18.0	50,165
Total Senior Institutions	68,763	1,235,348	18.0	805,847	11.7	343,868	5.0	639,254	9.3	3,118,873	45.4	973,435	14.2	1,790,018
Alabama Southern Community College	1,019	23,458	23.0	38,630	37.9	4,400	4.3			14,537	14.3	10,277	10.1	12,351
Ayers State Technical College	694	18,021	26.0	47,715	68.8	5,000	7.2			12,297	17.7	10,240	14.8	1,020
Bessemer State Technical College	797	44,563	55.9	97,778	122.7					19,756	24.8	3,600	4.5	5,415
Bevill State Community College	3,001	108,564	36.2	131,651	43.9	5,946	2.0			49,577	16.5	27,026	9.0	120,575
Bishop State Community College	2,302	33,808	14.7	173,430	75.3					50,881	22.0	23,234	10.1	97,347
Calhoun State Community College	4,459	290,455	65.1	16,249	3.6					72,118	16.2	23,243	5.2	23,833
Central Alabama Community College	1,163	36,284	31.2	69,018	59.3	12,903	11.1			26,919	23.1	21,880	18.8	20.5
Chattahoochee Valley Community College	1,099	21,481	19.5	42,205	38.4					17,066	15.5	25,140	22.9	
Drake State Technical College	417	15,280	36.6	51,799	124.2					9,914	23.8	1,488	3.6	
Enterprise State Jr. College	1,084	37,335	34.4	8,278	7.6					16,694	15.4	14,449	13.3	23,735
Faulkner State Community College	2,056	38,167	18.6	53,547	26.0	2,943	1.4			20,393	9.9	6,849	3.3	19,669
Gadsden State Community College	3,339	113,526	34.0	145,830	43.7	20,234	6.1	163	0.0	76,703	23.0	31,116	9.3	37,031
Ingram State Technical College	659	20,840	31.6	78,341	118.9					10,908	16.6	1,973	3.0	475
Jeff Davis Community College	961	40,103	41.7	90,783	94.5					14,875	15.5	10,040	10.4	23,169
Jefferson State Community College	3,068	73,305	23.9	43,785	14.3	9,479	3.1			64,808	21.1	28,963	9.4	63,252
Lawson State Community College	1,121	32,524	29.0	69,016	61.6	2,678	2.4			29,503	26.3	6,777	6.0	47,548
L. B. Wallace Junior College	674	22,952	34.1	5,493	8.1	1,575	2.3			16,554	24.6	7,073	10.5	14,209
MacArthur State Technical College	507	13,299	26.2	61,604	121.5					6,603	13.0			
Northeast Alabama Community College	1,112	28,976	26.1	27,462	24.7	3,985	3.6			26,515	23.8	15,562	14.0	20,099
Northwest-Shoals Community College	2,512	51,310	20.4	93,761	37.3					33,685	13.4	12,115	4.8	72,342
Paterson State Technical College	627	13,636	21.7	61,203	97.6					12,469	19.9	357	0.6	
Reid State Technical College	520	7,433	14.3	25,616	49.3					7,178	13.8			6,152
Shelton State Community College b														
Snead State Community College	1,276	30,797	24.1	22,372	17.5	6,608	5.2			22,581	17.7	12,669	9.9	24,136
Southern Union State Community College	3,567	66,123	18.5	89,588	25.1	921	0.3			41,247	11.6	16,918	4.7	55,727
Sparks State Technical College	455	51,033	112.2							9,661	21.2			3,761
Trenholm State Technical College	530	18,750	35.4	48,810	92.1					18,253	34.4			
Wall State Community College Dothan	2,207	102,239	46.3	104,931	47.5	21,007	9.5			30,633	13.9	2,580	1.2	36,172
Wall State Community College Hanceville	3,199	92,391	28.9	127,062	39.7	12,788	4.0			67,687	21.2	24,384	7.6	81,266
Wall State Community College Selma	1,070	49,081	45.9			37,586	35.1			40,329	37.7			47,824
Total Two-Year Institutions	45,495	1,495,734	32.9	1,825,957	40.1	148,053	3.3	7,978	0.2	840,044	18.5	337,953	7.4	837,108
Total All Public Institutions	114,258	2,731,082	23.9	2,631,804	23.0	491,721	4.3	647,232	5.7	3,958,917	34.6	1,311,388	11.5	2,627,126

Source: Alabama Commission on Higher Education's 1999 Facility Inventory Survey.

a. Data not available due to implementation of new space management system.

b. Data not available.

c. Includes USA-Health and Baldwin Campus

Net Assignable Space By Use

Alabama Public Institutions - 1999

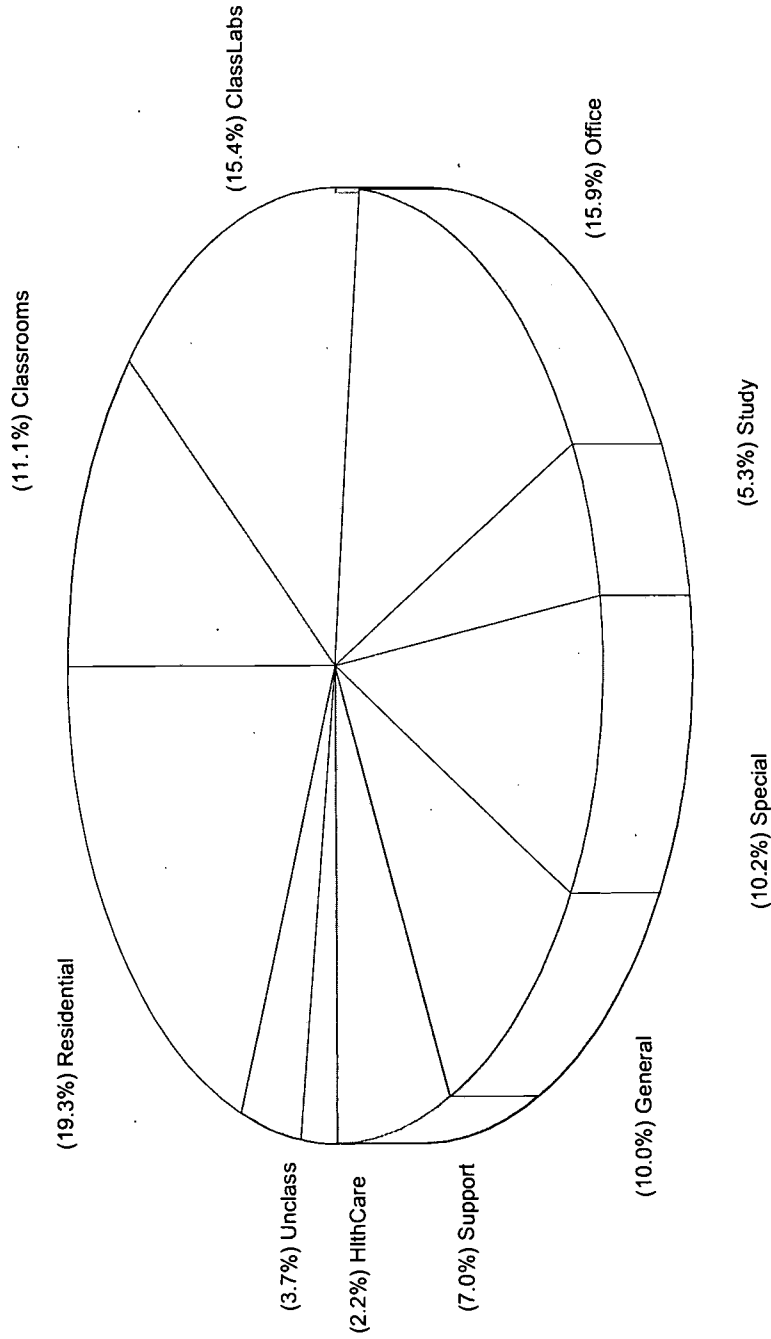

Source: Alabama Commission on Higher Education's 1999 Facilities Inventory Survey.

1999 Land Inventory
Land Area (Acres)
Alabama Public Colleges and Universities

Institution	Highly Groomed Landscaped Grounds	Semi-groomed & Ungroomed Unimproved/Park		Pavements		Agricultural Crops, Pasture, Timber	Outleased	Total
		Streets & Walks	Parking Lots	Streets & Walks	Parking Lots			
Alabama A&M University								
E&G	367.00	240.00		20.80	34.20	2,200.00		2,862.00
Auxiliary						10.00		10.00
Other								
Subtotal	367.00	240.00		20.80	34.20	2,210.00		2,872.00
Alabama State University								
E&G	74.00			25.00	16.00	15.00		130.00
Auxiliary								
Other								
Subtotal	74.00			25.00	16.00	15.00		130.00
Athens State University								
E&G	21.22	1.23		1.23	6.71			30.39
Auxiliary	5.39							5.39
Other								
Subtotal	26.61	1.23		1.23	6.71			35.78
Auburn University a								
E&G								
Auxiliary								
Other								
Subtotal								
Auburn University at Montgomery								
E&G	100.50	212.10		6.50	10.50		509.00	838.60
Auxiliary								
Other								
Subtotal	100.50	212.10		6.50	10.50		509.00	838.60
Jacksonville State University								
E&G	165.00	25.44		49.56	80.00	40.00		360.00
Auxiliary								
Other								
Subtotal	165.00	25.44		49.56	80.00	40.00		360.00

1999 Land Inventory
Land Area (Acres)
Alabama Public Colleges and Universities

Institution	Highly Groomed Landscaped Grounds	Semi-groomed & Ungroomed Unimproved/Park	Pavements		Agricultural Crops, Pasture, Timber	Outleased	Total
			Streets & Walks	Parking Lots			
Troy State University							
E&G	476.61	24.86	41.45	20.08			563.00
Auxiliary							
Other							
Subtotal	476.61	24.86	41.45	20.08			563.00
Troy State University Phenix City							
E&G	1.61	15.07	0.17	0.52			17.37
Auxiliary							
Other							
Subtotal	1.61	15.07	0.17	0.52			17.37
Troy State University Dothan							
E&G	12.30	178.00	2.70	7.00		50.00	250.00
Auxiliary							
Other							
Subtotal	12.30	178.00	2.70	7.00		50.00	250.00
Troy State University Montgomery							
E&G	2.30		1.70	2.00			6.00
Auxiliary							
Other							
Subtotal	2.30		1.70	2.00			6.00
University of Alabama							
E&G	194.04	300.64	57.75	51.22			603.65
Auxiliary	313.84		35.83	31.78			381.45
Other						30.80	30.80
Subtotal	507.88	300.64	93.58	83.00		30.80	1,015.90
Univ. of Alabama at Birmingham b							
E&G							
Auxiliary							
Other							
Subtotal							

1999 Land Inventory
Land Area (Acres)
Alabama Public Colleges and Universities

Institution	Highly Groomed Landscaped Grounds	Semi-groomed & Ungroomed Unimproved/Park	Pavements		Agricultural Crops, Pasture, Timber	Outleased	Total
			Streets & Walks	Parking Lots			
Univ. of Alabama in Huntsville							
E&G	255.70	31.00	81.80				368.50
Auxiliary	5.60		1.80				7.40
Other							
Subtotal	261.30	31.00	83.60				375.90
University of Montevallo							
E&G	94.20	25.73	13.70	11.20	178.00	84.00	406.83
Auxiliary	65.60	16.00	6.00	7.50	111.30	56.00	262.40
Other							
Subtotal	159.80	41.73	19.70	18.70	289.30	140.00	669.23
University of North Alabama							
E&G	58.50	25.00	13.00	30.00	27.00		153.50
Auxiliary	9.00		2.00	5.00			16.00
Other							
Subtotal	67.50	25.00	15.00	35.00	27.00		169.50
University of South Alabama							
E&G	486.00	273.00	68.00	115.00			942.00
Auxiliary	319.00	222.00	13.00	59.00			613.00
Other	69.00		19.00				88.00
Subtotal	874.00	495.00	100.00	174.00			1,643.00
University of West Alabama							
E&G	142.37	125.87	15.90	13.49	266.37	18.50	582.50
Auxiliary							
Other							
Subtotal	142.37	125.87	15.90	13.49	266.37	18.50	582.50
Senior Total							
E&G	2,451.35	1,477.94	399.26	397.92	2,726.37	661.50	8,114.34
Auxiliary	718.43	238.00	58.63	103.28	121.30	56.00	1,295.64
Other	69.00		19.00			30.80	118.80
Grand Total	3,238.78	1,715.94	476.89	501.20	2,847.67	748.30	9,528.78

1999 Land Inventory
Land Area (Acres)
Alabama Public Colleges and Universities

Institution	Highly Groomed Landscaped Grounds	Semi-groomed & Ungroomed Unimproved/Park	Streets & Walks	Pavements Parking Lots	Agricultural Crops, Pasture, Timber	Outleased	Total
Alabama Southern Comm College							
E&G	15.85	8.50	5.15	4.50	98.00		132.00
Auxiliary							
Other					2.00		2.00
Subtotal	15.85	8.50	5.15	4.50	100.00		134.00
Ayers State Tech College							
E&G	18.00	11.00	1.00	6.00			36.00
Auxiliary							
Other			1.00	6.00			36.00
Subtotal	18.00	11.00	1.00	6.00			36.00
Bessemer State Technical College							
E&G	30.00	17.30	2.00	6.00			55.30
Auxiliary							
Other			2.00	6.00			55.30
Subtotal	30.00	17.30	2.00	6.00			55.30
Bevill State Community College							
E&G	79.64	29.54	5.35	17.64	8.00		140.17
Auxiliary		3.50	1.00	0.50			5.00
Other							
Subtotal	79.64	33.04	6.35	18.14	8.00		145.17
Bishop State Comm College							
E&G	20.00	34.00	7.00	11.00			72.00
Auxiliary							
Other			7.00	11.00			72.00
Subtotal	20.00	34.00	7.00	11.00			72.00
Calhoun State Comm College							
E&G	77.00	30.00	10.00	20.00			137.00
Auxiliary							
Other			10.00	20.00			137.00
Subtotal	77.00	30.00	10.00	20.00			137.00



1999 Land Inventory
Land Area (Acres)
Alabama Public Colleges and Universities

Institution	Highly Groomed Landscaped Grounds	Semi-groomed & Ungroomed Unimproved/Park	Pavements		Agricultural Crops, Pasture, Timber	Outleased	Total
			Streets & Walks	Parking Lots			
Central Alabama Comm College							
E&G	57.50		7.75	13.50	40.50		119.25
Auxiliary	19.00	15.00	1.94	0.54	219.50		255.98
Other	6.50				2.25		8.75
Subtotal	83.00	15.00	9.69	14.04	262.25		383.98
Chatt Valley Comm College							
E&G	5.15	91.49	4.36	2.00			103.00
Auxiliary							
Other							
Subtotal	5.15	91.49	4.36	2.00			103.00
Drake State Technical College							
E&G	10.02	15.34	2.00	4.48			31.84
Auxiliary							
Other							
Subtotal	10.02	15.34	2.00	4.48			31.84
Enterprise State Junior College							
E&G	40.00	88.00	2.87	7.10			137.97
Auxiliary							
Other							
Subtotal	40.00	88.00	2.87	7.10			137.97
Faulkner State Comm College							
E&G	40.00	14.00	5.00	5.00	75.00		139.00
Auxiliary	1.00						1.00
Other		1.00					1.00
Subtotal	41.00	15.00	5.00	5.00	75.00		141.00
Gadsden State Comm College							
E&G	50.00	60.00	43.00	26.00	121.00	15.00	315.00
Auxiliary							
Other							
Subtotal	50.00	60.00	43.00	26.00	121.00	15.00	315.00

1999 Land Inventory
Land Area (Acres)
Alabama Public Colleges and Universities

Institution	Highly Groomed Landscaped Grounds	Semi-groomed & Ungroomed Unimproved/Park	Pavements		Agricultural Crops, Pasture, Timber	Outleased	Total
			Streets & Walks	Parking Lots			
Ingram State Technical College							
E&G	8.00			2.00		40.00	50.00
Auxiliary							
Other							
Subtotal	8.00			2.00		40.00	50.00
Jeff Davis Comm College							
E&G	45.06	10.30		4.00	11.00	133.10	203.46
Auxiliary	5.00	13.25					18.25
Other	56.90	5.00				1.19	63.09
Subtotal	106.96	28.55		4.00	11.00	133.10	284.80
Jefferson State Comm Coll							
E&G	85.31	141.36		6.55	26.20		259.42
Auxiliary							
Other							
Subtotal	85.31	141.36		6.55	26.20		259.42
Lawson State Comm College							
E&G	61.50	9.00		3.00	2.50		76.00
Auxiliary	0.50			0.50			1.00
Other							
Subtotal	62.00	9.00		3.50	2.50		77.00
L. B. Wallace State Jr College							
E&G	35.00	32.00		3.50	5.00		75.50
Auxiliary					0.50		0.50
Other	97.50						97.50
Subtotal	132.50	32.00		3.50	5.50		173.50
MacArthur State Technical College							
E&G	13.80	30.30		5.00	1.20	41.00	91.30
Auxiliary							
Other							
Subtotal	13.80	30.30		5.00	1.20	41.00	91.30

1999 Land Inventory
Land Area (Acres)
Alabama Public Colleges and Universities

Institution	Highly Groomed Landscaped Grounds	Semi-groomed & Ungroomed Unimproved/Park	Pavements		Agricultural Crops, Pasture, Timber	Outleased	Total
			Streets & Walks	Parking Lots			
Northeast AL Comm College							
E&G	20.00	89.00	1.00	3.00			113.00
Auxiliary							
Other							
Subtotal	20.00	89.00	1.00	3.00			113.00
Northwest-Shoals Comm College							
E&G	105.00		17.00	10.00	78.00		210.00
Auxiliary							
Other							
Subtotal	105.00		17.00	10.00	78.00		210.00
Patterson State Technical College							
E&G	12.50	19.25	5.00	5.00			41.75
Auxiliary							
Other	12.50	19.25	5.00	5.00			41.75
Reid State Technical College							
E&G	14.00	9.00	3.00	1.00			27.00
Auxiliary							
Other							
Subtotal	14.00	9.00	3.00	1.00			27.00
Shelton State Comm College							
E&G	65.00	120.00	3.00	6.00			194.00
Auxiliary							
Other							
Subtotal	65.00	120.00	3.00	6.00			194.00
Snead State Comm College							
E&G	29.44		2.18	10.75			42.37
Auxiliary							
Other							
Subtotal	29.44		2.18	10.75			42.37
Southern Union St Comm College							
E&G	84.44	73.01	2.00	16.32			175.77
Auxiliary	3.30						3.30
Other							
Subtotal	87.74	73.01	2.00	16.32			179.07

1999 Land Inventory
Land Area (Acres)
Alabama Public Colleges and Universities

Institution	Highly Groomed Landscaped Grounds	Semi-groomed & Ungroomed Unimproved/Park	Streets & Walks	Pavements Parking Lots	Agricultural Crops, Pasture, Timber	Outleased	Total
Sparks State Technical College							
E&G	11.50	6.00	3.50	6.00			27.00
Auxiliary							
Other							
Subtotal	11.50	6.00	3.50	6.00			27.00
Trenholm State Technical College							
E&G	8.50	29.00	1.50	2.00			41.00
Auxiliary							
Other							
Subtotal	8.50	29.00	1.50	2.00			41.00
Wall State Comm College Dothan							
E&G	49.00	15.50	5.00	19.00		4.00	92.50
Auxiliary	2.00		0.50	1.00	150.00		153.50
Other							
Subtotal	51.00	15.50	5.50	20.00	150.00	4.00	246.00
Wall St Comm College Hanceville							
E&G	1.00	110.50	25.00	50.00	25.00		211.50
Auxiliary		5.00					5.00
Other							
Subtotal	1.00	115.50	25.00	50.00	25.00		216.50
Wall State Comm College Selma							
E&G	10.00	8.00	6.00	8.00	20.00		52.00
Auxiliary	8.00						8.00
Other							
Subtotal	18.00	8.00	6.00	8.00	20.00		60.00
Two-Year Colleges Total							
E&G	1,102.21	1,101.39	193.71	306.19	639.60	59.00	3,402.10
Auxiliary	38.80	36.75	3.94	2.54	369.50		451.53
Other	160.90	6.00			4.25	1.19	172.34
Grand Total	1,301.91	1,144.14	197.65	308.73	1,013.35	60.19	4,025.97
Total All Public Institutions							
E&G	3,553.56	2,579.33	592.97	704.11	3,365.97	720.50	11,516.44
Auxiliary	757.23	274.75	62.57	105.82	490.80	56.00	1,747.17
Other	229.90	6.00	19.00		4.25	31.99	291.14
Grand Total	4,540.69	2,860.08	674.54	809.93	3,861.02	808.49	13,554.75

Source: Alabama Commission on Higher Education's 1999 Facility Inventory Survey.

a. Data not available due to implementation of new space management system.

b. Data not available.

Physical Plant By Age
Alabama Public Colleges and Universities
1820 - 1999

Decade	Total Senior			Total Two-Year			Total Dauphin Island Sealab / MESL			Total All		
	Total GSF	Percent of Total	Cumulative Percent	Total GSF	Percent of Total	Cumulative Percent	Total GSF	Percent of Total	Cumulative Percent	Total GSF	Percent of Total	Cumulative Percent
Unknown	33,736	0.08		1,587	0.02					35,323	0.06	
1820-1829	17,012	0.04	0.11							17,012	0.03	0.10
1830-1839	17,809	0.04	0.15							17,809	0.03	0.13
1840-1849	81,388	0.18	0.34							81,388	0.15	0.28
1850-1859	66,528	0.15	0.48							66,528	0.12	0.40
1860-1869	68,731	0.15	0.64							68,731	0.13	0.52
1870-1879	10,502	0.02	0.66							10,502	0.02	0.54
1880-1889	137,019	0.31	0.97							137,019	0.25	0.79
1890-1899	13,414	0.03	1.00							13,414	0.02	0.82
1900-1909	466,162	1.04	2.04				4,420	3.80		466,162	0.85	1.66
1910-1919	233,733	0.52	2.56							238,153	0.43	2.10
1920-1929	1,694,855	3.79	6.36	206,421	2.04	2.06				1,901,276	3.46	5.56
1930-1939	1,944,411	4.35	10.71	80,945	0.80	2.86				2,025,356	3.69	9.25
1940-1949	1,484,498	3.32	14.03	188,255	1.86	4.72	5,374	4.62	8.42	1,678,127	3.06	12.30
1950-1959	3,492,782	7.82	21.84	318,477	3.15	7.88	84,144	72.30	80.72	3,895,403	7.09	19.40
1960-1969	11,334,520	25.36	47.21	3,490,723	34.55	42.42				14,825,243	27.00	46.40
1970-1979	9,776,505	21.88	69.08	2,667,874	26.40	68.83				12,444,379	22.66	69.06
1980-1989	6,606,351	14.78	83.86	1,169,936	11.58	80.41	5,616	4.83	85.55	7,781,903	14.17	83.23
1990-1999	7,211,985	16.14	100.00	1,979,512	19.59	100.00	16822	14.45	100.00	9,208,319	16.77	100.00
Total	44,691,941	100.00		10,103,730	100.00		116,376	100.00		54,912,047	100.00	

Source: Alabama Commission on Higher Education's 1999 Facility Inventory Survey.

Proportion of Physical Plant Gross Square Footage By Age

Alabama Public Colleges

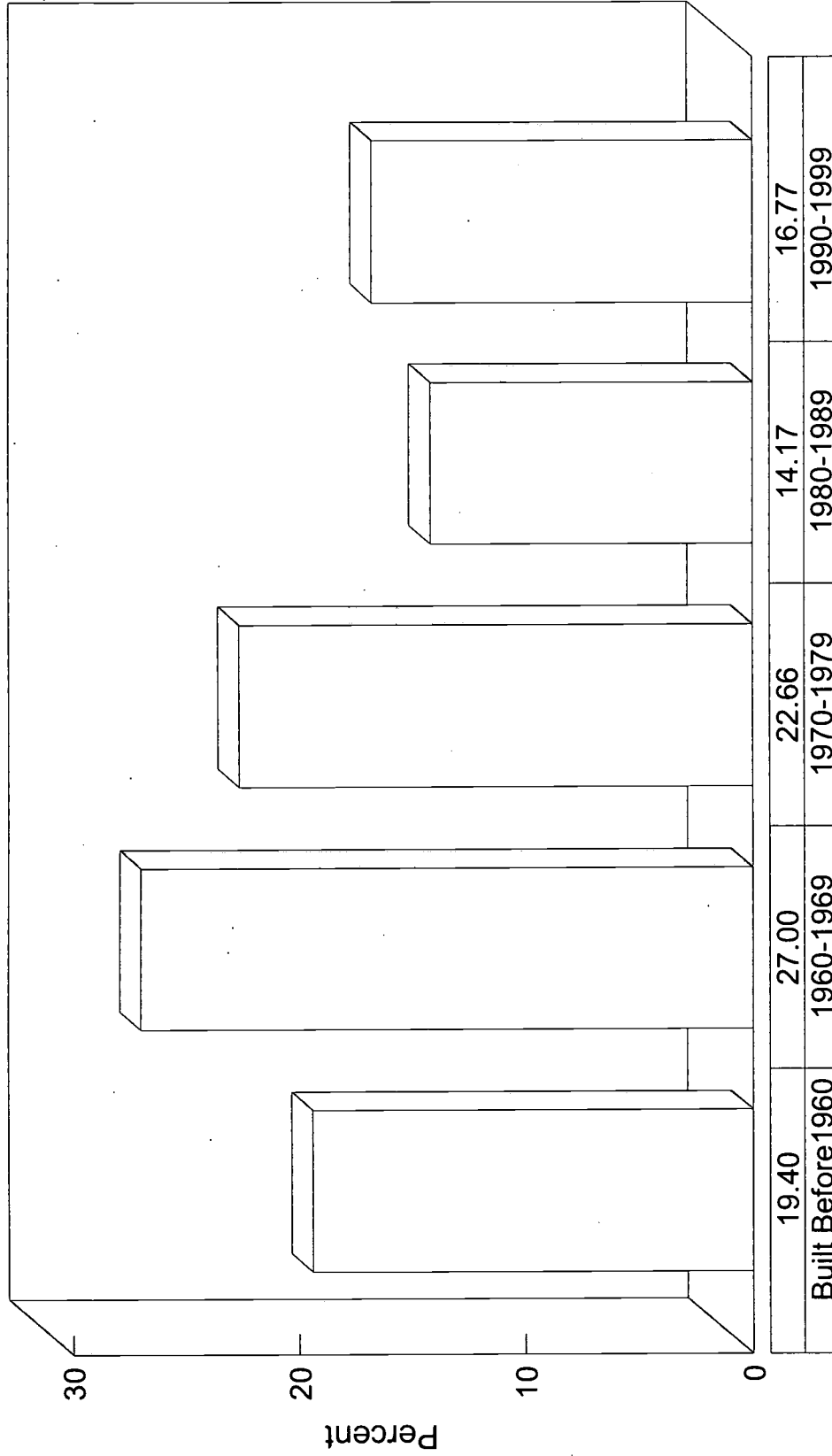

Source: Alabama Commission on Higher Education's 1999 Facility Inventory Survey.

Library Expenditures - 1998-1999

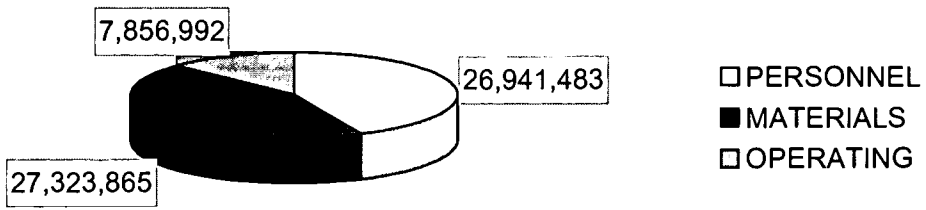

SOURCE: Annual Statistical Reports filed by the institutions with the Network of Alabama Libraries.

NETWORK OF ALABAMA ACADEMIC LIBRARIES

Annual Statistical Reports, 1998-1999

INSTITUTION	FALL 98 VOLUMES HELD		MONOGRAPH TITLES HELD		SERIALS CURRENT		MICROFORMS PHYSICAL UNITS		GOV. DOCS. NOT MANUSCRIPTS	
	VOLUMES HELD	TITLES HELD	VOLUMES PURCHASED	TITLES HELD	SERIALS CURRENT	VOLUMES	UNITS	COUNTED ELSEWHERE	(linear feet)	
ALABAMA A&M UNIVERSITY	4,488	240,233	203,183	2,093	45,450	644,658	17,642			
ALABAMA STATE UNIVERSITY	4,607	265,150	192,035	1,486	125,147	2,492,770		877		
ATHENS STATE UNIVERSITY	1,781	99,645	67,328	309	12,610	101		44		
AUBURN UNIVERSITY	20,674	2,545,463	1,719,907	46,184	23,121	2,462,002	394,405	8,800		
AUBURN UNIVERSITY AT MONTGOMERY	4,589	39,762	245,589	7,420	48,960	1,123,609	40,593	684		
FAULKNER UNIVERSITY	1,996	55,313	13,324	4,938	20,244	101,722				
JACKSONVILLE STATE UNIVERSITY	6,247	639,824	414,767	8,185	83,451	1,246,515		376		
SAMFORD UNIVERSITY	4,191	375,471	N/A	N/A	3,632	1,051,378	148,159	N/A		
SPRING HILL COLLEGE	1,132	160,922	89,876	1,719	24,559	273,449	18,360			
TROY STATE UNIVERSITY	5,821	306,177	247,711	4,900	56,081	1,296,239	160	389		
TROY STATE UNIVERSITY DOTHAN	1,705	97,679	66,865	1,404	599	269,307	200			
UNIVERSITY OF ALABAMA	15,750	2,172,175	1,391,956	19,706	17,505	3,542,386	1,168,876	26,569		
UNIVERSITY OF ALABAMA AT BIRMINGHAM	12,716	1,152,289	774,293	12,069	4,458	329,224	1,267,511	2,565		
UNIVERSITY OF ALABAMA IN HUNTSVILLE	4,262	331,448	276,710	3,538	1,668	572,812	173,179			
UNIVERSITY OF MOBILE	1,563	104,536	77,610	1,874	652	133,727				
UNIVERSITY OF MONTEVALLO	2,647	244,638	151,535	4,391	62,718	732,393		325		
UNIVERSITY OF NORTH ALABAMA	4,725	337,811	236,741	3,961	66,930	935,977	2,000	806		
UNIVERSITY OF SOUTH ALABAMA	8,884	337,331	259,006	709	3,826	67,803	512,873	3,332		
UNIVERSITY OF WEST ALABAMA	1,867	110,359	100,771	1,146	257	579,663		189		
UNITED STATES SPORTS ACADEMY	142									
FY99 TOTALS	109,787	9,616,226	6,529,207	130,295	45,424	1,181,053	20,146,270	2,476,447	44,956	

SOURCE: Annual Statistical Reports filed by the institutions with the Network of Alabama Academic Libraries for the year October 1, 1998 - September 30, 1999. Current serials subscriptions include print and microform. Data for Birmingham Southern College, Troy State University Montgomery, and Tuskegee University are not available.

NETWORK OF ALABAMA ACADEMIC LIBRARIES

Annual Statistical Reports, 1998-1999

INSTITUTION	AUDIOVISUAL MATERIALS										TOTAL AUDIO VISUAL	
	AUDIO FORMATS and SOUND RECORDINGS		FILM STRIPS		MIXED MEDIA KITS		FILM AND VIDEO MATERIALS		TRANS- ARENCIE: OTHER			
ALABAMA A&M UNIVERSITY								5,755				
ALABAMA STATE UNIVERSITY	6,350	3,440	35	2,572	26,644	10	42	39,093				
ATHENS STATE UNIVERSITY	799		3	429				1,231				
AUBURN UNIVERSITY	40,404			7,678	118,450	6	3,596	170,134				
AUBURN UNIVERSITY AT MONTGOM	4,361	1,402	103	1,841	15,136	1,441	305	24,589				
FAULKNER UNIVERSITY	189			21				210				
JACKSONVILLE STATE UNIVERSITY	14,091	1,560	727	2,988	10,858	1,036	698	31,958				
SAMFORD UNIVERSITY	4,533			3,534			5,097	N/A				
SPRING HILL COLLEGE												
TROY STATE UNIVERSITY	4,422	193	345	3,607	80	76		8,723				
TROY STATE UNIVERSITY DOTHAN	1,292	165	610	1,016	4,507	346		7,936				
UNIVERSITY OF ALABAMA	19,031	561	411	2,410	7,754	89	2,137	32,393				
UNIVERSITY OF ALABAMA AT BIRM	10,252	924	94	6,438	58,850	106	24	76,688				
UNIVERSITY OF ALABAMA IN HUNT:	1,144			7	1,526			2,677				
UNIVERSITY OF MOBILE	490		208	770				1,468				
UNIVERSITY OF MONTEVALLO	2,154			62				2,216				
UNIVERSITY OF NORTH ALABAMA	2,555	38	867	4,773	14	50		8,297				
UNIVERSITY OF SOUTH ALABAMA	6,353	1,304	70	8,674	41,963	130	62	58,556				
UNIVERSITY OF WEST ALABAMA	1,863							1,863				
UNITED STATES SPORTS ACADEMY												
FY99 TOTALS	120,283	9,587	3,473	52,575	285,782	3,290	11,961	468,032				

SOURCE: Annual Statistical Reports filed by the institutions with the Network of Alabama Academic Libraries for the year October

NETWORK OF ALABAMA ACADEMIC LIBRARIES

Annual Statistical Reports, 1998-1999

INSTITUTION	-----MACHINE READABLE MATERIALS-----			TOTAL MACHINE READABLE	MAPS	ALL OTHER MATERIALS
	COMPUTER DISKETTE	CD-ROM DATABASE	OTHER			
ALABAMA A&M UNIVERSITY		9	46	152		
ALABAMA STATE UNIVERSITY	163	88	51	302	5	3,135
ATHENS STATE UNIVERSITY		4		4	2	
AUBURN UNIVERSITY				1,143	139,834	318,742
AUBURN UNIVERSITY AT MONTGOMERY	17	809		826	1,584	22,952
FAULKNER UNIVERSITY	43	1	44	88		
JACKSONVILLE STATE UNIVERSITY	320	676		996	1,890	1,045
SAMFORD UNIVERSITY	445	709		1,154		8,647
SPRING HILL COLLEGE		233		233		
TROY STATE UNIVERSITY	53	6	18	77	89	159
TROY STATE UNIVERSITY DOTHAN	28	4		32		756
UNIVERSITY OF ALABAMA	39	306		3,012	275,471	168,316
UNIVERSITY OF ALABAMA AT BIRMINGHAM	59	148	921	1,138	5	23
UNIVERSITY OF ALABAMA IN HUNTSVILLE	87	5	109	201	962	
UNIVERSITY OF MOBILE	20	13		33	400	
UNIVERSITY OF MONTEVALLO	10	12		22	300	
UNIVERSITY OF NORTH ALABAMA	61	67	32	160	2,167	1,642
UNIVERSITY OF SOUTH ALABAMA	193	1,217		1,411	10,733	728,257
UNIVERSITY OF WEST ALABAMA	2,518	9	2,280	4,807		
UNITED STATES SPORTS ACADEMY						
FY99 TOTALS	4,056	4,316	3,501	15,791	433,442	1,253,674

SOURCE: Annual Statistical Reports filed by the institutions with the Network of Alabama Academic Libraries for the year Octo

All other materials includes charts, flat pictures, games, photographs (prints and negatives), study sets, etc.

NETWORK OF ALABAMA ACADEMIC LIBRARIES

Annual Statistical Reports, 1998-1999

INSTITUTION	LIBRARY PERSONNEL (FTE)						TOTAL LIBRARY PERSONNEL	STUDENTS "charged to library"	STUDENTS "charged to other budgets"
	LIBRARIAN	OTHER PROFESSIONAL	TECHNICAL CLERICAL	STUDENT FTE	STUDENT FTE	STUDENT FTE			
ALABAMA A&M UNIVERSITY	5	1	12	2	20	2	2		
ALABAMA STATE UNIVERSITY	15	10	8	141	174	141	141		
ATHENS STATE UNIVERSITY	5	1	5	2	13	2	2		
AUBURN UNIVERSITY	42	3	73	40	158	34	34	6	
AUBURN UNIVERSITY AT MONTGOMERY	10		16	14	40	12	12	2	
FAULKNER UNIVERSITY	4		4	2	10			2	
JACKSONVILLE STATE UNIVERSITY	18		19	15	52	15	15		
SAMFORD UNIVERSITY	17		26	7	50	6	6		
SPRING HILL COLLEGE	6	0	8	1	15			1	
TROY STATE UNIVERSITY	11	1	14	9	35	9	9	0	
TROY STATE UNIVERSITY DOTHAN	3	1	4	4	12	2	2	3	
UNIVERSITY OF ALABAMA	48	4	78	47	177	40	40	8	
UNIVERSITY OF ALABAMA AT BIRMINGHAM	29	21	69	26	145	26	26		
UNIVERSITY OF ALABAMA IN HUNTSVILLE	10	4	15	19	47	18	18	1	
UNIVERSITY OF MOBILE	4	1	5	2	12	2	2		
UNIVERSITY OF MONTEVALLO	7		5	5	17	4	4	2	
UNIVERSITY OF NORTH ALABAMA	11		15	17	42	16	16	1	
UNIVERSITY OF SOUTH ALABAMA	25	3	43	21	92	19	19	2	
UNIVERSITY OF WEST ALABAMA	4		3	2	9	2	2		
UNITED STATES SPORTS ACADEMY									
FY99 TOTALS	273	50	420	375	1,118	347	347	28	

SOURCE: Annual Statistical Reports filed by the institutions with the Network of Alabama Academic Libraries for the year October 1, 1999

NETWORK OF ALABAMA ACADEMIC LIBRARIES
Annual Statistical Reports, 1998-1999

PERSONNEL EXPENDITURES

INSTITUTION	SALARIES & WAGES	FRINGE BENEFITS	STUDENT WAGES
ALABAMA A&M UNIVERSITY	\$471,446	\$53,874	\$91,624
ALABAMA STATE UNIVERSITY	995,508		
ATHENS STATE UNIVERSITY	421,498	80,109	17,358
AUBURN UNIVERSITY	3,427,929	646,409	351,790
AUBURN UNIVERSITY AT MONTGOM	602,939	113,025	118,121
FAULKNER UNIVERSITY	145,851	36,463	4,320
JACKSONVILLE STATE UNIVERSITY	1,091,410	261,534	27,453
SAMFORD UNIVERSITY	1,069,664	332,050	62,197
SPRING HILL COLLEGE	285,295	61,880	
TROY STATE UNIVERSITY	585,760	115,086	60,222
TROY STATE UNIVERSITY DOTHAN	123,000	63,000	12,100
UNIVERSITY OF ALABAMA	3,523,984	787,579	411,212
UNIVERSITY OF ALABAMA AT BIRM	3,508,859	727,462	229,931
UNIVERSITY OF ALABAMA IN HUNT:	762,963	126,894	125,930
UNIVERSITY OF MOBILE	194,079	48,519	5,590
UNIVERSITY OF MONTEVALLO	344,562	60,994	38,000
UNIVERSITY OF NORTH ALABAMA	986,649	189,841	117,674
UNIVERSITY OF SOUTH ALABAMA	2,186,293	404,831	123,569
UNIVERSITY OF WEST ALABAMA	229,938	54,984	22,232
UNITED STATES SPORTS ACADEMY			
FY99 TOTALS	\$20,957,627	\$4,164,534	\$1,819,323

SOURCE: Annual Statistical Reports filed by the institutions with the Network of Alabama: for the year October 1, 1998 - September 30, 1999.

NETWORK OF ALABAMA ACADEMIC LIBRARIES

Annual Statistical Reports, 1998-1999

INSTITUTION	LIBRARY MATERIALS EXPENDITURES									
	MONOGRAPHS	CURRENT SERIALS	PAPER SERIALS	MICROFORM SERIALS	ELECTRONIC JOURNALS	MICROFORMS & PRESERVATION	BINDING	OTHER LIBRARY MATERIALS		
ALABAMA A&M UNIVERSITY		\$453,566		\$60,514		\$42,616		\$15,709		
ALABAMA STATE UNIVERSITY	\$423,888	287,291	\$251,033	36,258		15,342				
ATHENS STATE UNIVERSITY	88,324	38,064	38,064			5,609				
AUBURN UNIVERSITY	1,846,571	2,369,097			\$205,821	89,474		465		
AUBURN UNIVERSITY AT MONTGOMERY	361,230	251,488				7,755				
FAULKNER UNIVERSITY	184,871	42,916	4,755	5,992	32,169	9,000		8,278		
JACKSONVILLE STATE UNIVERSITY	268,868	368,142				12,974		8,867		
SAMFORD UNIVERSITY	176,309	771,991				27,788		20,486		
SPRING HILL COLLEGE	115,696	58,282				4,336				
TROY STATE UNIVERSITY	160,553	241,486	175,163	59,000		16,000		20,000		
TROY STATE UNIVERSITY DOTHAN	42,000	85,038	85,038			500		3,500		
UNIVERSITY OF ALABAMA	1,019,642	3,308,743	2,419,449		228,665	\$135,502		49,018		
UNIVERSITY OF ALABAMA AT BIRMINGHAM	757,271	1,187,951	2,221,414	14,625	134,880	16,014		289,449		
UNIVERSITY OF ALABAMA IN HUNTSVILLE	131,656	793,449	781,198	12,251		820				
UNIVERSITY OF MOBILE	73,652	58,591	32,003	8,389	13,416	4,783		1,500		
UNIVERSITY OF MONTEVALLO	122,803	74,132	55,372	18,750		5,753		657		
UNIVERSITY OF NORTH ALABAMA	122,329	215,342	170,354	43,888	1,100	7,314		161,534		
UNIVERSITY OF SOUTH ALABAMA	157,216	1,285,100	660,337	1,604	43,545	20,888		22,166		
UNIVERSITY OF WEST ALABAMA	15,000		35,939		64,424	2,600				
UNITED STATES SPORTS ACADEMY										
FY99 TOTALS	\$6,067,879	\$11,890,669	\$6,930,119	\$261,271	\$724,020	\$244,512	\$603,767	\$601,629		

SOURCE: Annual Statistical Reports filed by the institutions with the Network of Alabama Academic Libraries for the year October 1, 1998 - September 30, 1999.

NETWORK OF ALABAMA ACADEMIC LIBRARIES

Annual Statistical Reports, 1998-1999

INSTITUTION	OPERATING EXPENDITURES													
	TELECOMMUNICATIONS		CONTRACTS		ELECTRONIC		OTHER		STAFF		DOCUMENT		OTHER	
	OPERATING	EXPENDITURES	OPERATING	EXPENDITURES	OPERATING	EXPENDITURES	OPERATING	EXPENDITURES	OPERATING	EXPENDITURES	OPERATING	EXPENDITURES	OPERATING	EXPENDITURES
ALABAMA A&M UNIVERSITY	\$16,329	\$13,755	\$10,170	\$30,518	\$10,135	\$839	\$11,594	\$1,068	\$125,683					
ALABAMA STATE UNIVERSITY		62,103	144,094	12,924	45,225	27	10,071		19,597					
ATHENS STATE UNIVERSITY	1,500	23,911	25,515		6,705	795	2,532		7,837					
AUBURN UNIVERSITY	39,993	59,363	557,664	25,796	672,662	35,439	85,537	224,889	343,355					
AUBURN UNIVERSITY AT MONTGOMERY	5,166		70,106	43,341	15,575	5,613	8,853	1,155	64,531					
FAULKNER UNIVERSITY	2,890	19,000			14,699	996	5,000	60						
JACKSONVILLE STATE UNIVERSITY	5,030	57,921	N/A		33,082	6,047	7,036	429	59,577					
SAMFORD UNIVERSITY	18,311	31,996	114,403	4,239	28,507	7,304	11,383	350	25,184					
SPRING HILL COLLEGE	467	16,796	563	11,327	9,338	1,376	4,100	462	207,049					
TROY STATE UNIVERSITY	982	59,187	67,498	8,309	60,232	3,002	5,156							
TROY STATE UNIVERSITY DOTHAN	2,500	10,800	6,684		25,000	2,500	2,600							
UNIVERSITY OF ALABAMA	79,773	164,127	137	21,936	159,324	28,634	12,090	6,002	589,207					
UNIVERSITY OF ALABAMA AT BIRMINGHAM	99,445		777	124,166	251,374	26,954	100,195	23,703	752,846					
UNIVERSITY OF ALABAMA IN HUNTSVILLE	19,799		103,414		73,099	9,024	8,076	7,073	120,237					
UNIVERSITY OF MOBILE	2,189	15,701		6,326	21,446	1,644	1,126	1,750	11,368					
UNIVERSITY OF MONTEVALLO	1,660	7,755	33,080	33,189	149,966	1,729	7,637	368	49,249					
UNIVERSITY OF NORTH ALABAMA	4,692	33,950	450	42,894	86,797	3,012	12,556	1,124	61,259					
UNIVERSITY OF SOUTH ALABAMA	28,722	105,666	60,552	45,207	79,122	12,774	23,681	21,477	181,074					
UNIVERSITY OF WEST ALABAMA	667	17,394	940		9,365	1,050	2,914							
UNITED STATES SPORTS ACADEMY														
FY99 TOTALS	\$330,115	\$729,555	\$1,196,047	\$410,172	\$1,751,653	\$148,759	\$322,137	\$289,910	\$2,678,644					

SOURCE: Annual Statistical Reports filed by the institutions with the Network of Alabama Academic Libraries for the year October 1, 1998 - September 30.

NETWORK OF ALABAMA ACADEMIC LIBRARIES
Annual Statistical Reports, 1998-1999

INSTITUTION	TOTAL PERSONNEL EXPENDITURES	TOTAL LIBRARY MATERIALS	TOTAL OPERATING EXPEND.	TOTAL LIBRARY EXPENDITURES
ALABAMA A&M UNIVERSITY	\$616,944	\$572,405	\$220,091	\$1,409,440
ALABAMA STATE UNIVERSITY	995,508	1,013,812	294,041	2,303,361
ATHENS STATE UNIVERSITY	518,965	170,061	68,795	757,821
AUBURN UNIVERSITY	4,426,128	4,511,428	2,044,698	10,982,254
AUBURN UNIVERSITY AT MONTGOM	834,085	620,473	214,340	1,668,898
FAULKNER UNIVERSITY	186,634	287,980	42,645	517,259
JACKSONVILLE STATE UNIVERSITY	1,380,397	658,851	169,707	2,208,955
SAMFORD UNIVERSITY	1,463,911	1,132,076	276,149	2,872,136
SPRING HILL COLLEGE	347,175	194,328	69,501	611,004
TROY STATE UNIVERSITY	761,067	702,793	411,877	1,875,737
TROY STATE UNIVERSITY DOTHAN	198,100	242,076	50,084	490,260
UNIVERSITY OF ALABAMA	4,722,775	7,182,144	1,061,230	12,966,149
UNIVERSITY OF ALABAMA AT BIRM	4,466,252	4,736,067	1,379,460	10,581,779
UNIVERSITY OF ALABAMA IN HUNT:	1,015,787	1,739,440	370,852	3,126,079
UNIVERSITY OF MOBILE	248,188	198,087	61,550	507,825
UNIVERSITY OF MONTEVALLO	443,556	278,085	284,633	1,006,274
UNIVERSITY OF NORTH ALABAMA	1,294,164	731,410	246,734	2,272,308
UNIVERSITY OF SOUTH ALABAMA	2,714,693	2,234,386	558,275	5,507,354
UNIVERSITY OF WEST ALABAMA	307,154	117,963	32,330	457,447
UNITED STATES SPORTS ACADEM ¹				
FY99 TOTALS	\$26,941,483	\$27,323,865	\$7,856,992	\$62,122,340

SOURCE: Annual Statistical Reports filed by the institutions with the Network of Alabama Academic Libraries
 October 1, 1998 - September 30, 1999.

NETWORK OF ALABAMA ACADEMIC LIBRARIES
Annual Statistical Reports, 1998-1999

INSTITUTION	INSTITUTION BUDGETED	GIFTS & ENDOWMENT	SPECIAL PURPOSE	GRANTS & CONTRACTS	INCOME	
					TOTAL LIBRARY INCOME	TOTAL LIBRARY INCOME
ALABAMA A&M UNIVERSITY	\$1,420,491			\$101,141	\$1,420,491	
ALABAMA STATE UNIVERSITY	1,847,660				1,948,801	
ATHENS STATE UNIVERSITY	667,617				667,617	
AUBURN UNIVERSITY	9,905,403	\$316,486	\$80,887	42,026	10,344,802	
AUBURN UNIVERSITY AT MONTGOMERY	1,669,938	8,892	8,850	13,029	1,700,709	
FAULKNER UNIVERSITY	515,521	1,140			516,661	
JACKSONVILLE STATE UNIVERSITY	2,197,240			19,103	2,216,343	
SAMFORD UNIVERSITY	2,742,867	92,325	109,542		2,944,734	
SPRING HILL COLLEGE	611,004	25,817	5,958		642,779	
TROY STATE UNIVERSITY	1,911,479	125,000		10,927	2,047,406	
TROY STATE UNIVERSITY DOTHAN	453,870			2,500	456,370	
UNIVERSITY OF ALABAMA	9,111,119	492,628	352,664		9,956,411	
UNIVERSITY OF ALABAMA AT BIRMINGHAM	7,937,142	95,246	1,082,121	38,791	9,153,300	
UNIVERSITY OF ALABAMA IN HUNTSVILLE	1,988,373			50,000	2,038,373	
UNIVERSITY OF MOBILE	435,696				435,696	
UNIVERSITY OF MONTEVALLO	825,216	101,263	33,871		960,350	
UNIVERSITY OF NORTH ALABAMA	2,055,540			18,151	2,073,691	
UNIVERSITY OF SOUTH ALABAMA	4,473,660		118,266	3,000	4,594,926	
UNIVERSITY OF WEST ALABAMA	373,832	7,066	4,498	19,046	404,442	
UNITED STATES SPORTS ACADEMY						
FY99 TOTALS	\$51,143,668	\$1,265,863	\$1,796,657	\$317,714	\$54,523,902	

SOURCE: Annual Statistical Reports filed by the institutions with the Network of Alabama Academic Libraries for the year October 1, 1998 - September 30, 1999.

NETWORK OF ALABAMA ACADEMIC LIBRARIES

Annual Statistical Reports, 1998-1999

CIRCULATION AND REFERENCE SERVICES

INSTITUTION	REGULAR CIRCULATION	RESERVE ROOM CIRCULATION	RESERVE MATERIALS LENT	LIBRARY LOAN/DOCUMENT MATERIALS BORROWED	TOTAL ILL	PHOTO COPIES FOR USERS	MAIN LIBRARY	
							HOURS OPEN (wk)	DOOR COUNTS (yr)
ALABAMA A&M UNIVERSITY	31,250	2,331	858	448	1,306		87	83,430
ALABAMA STATE UNIVERSITY	11,841	837	646	334	980		82	
ATHENS STATE UNIVERSITY	23,039	461	385	325	710	157,899	80	131,275
AUBURN UNIVERSITY	232,599	10,824	17,952	9,497	27,449	1,385,129	95	471,726
AUBURN UNIVERSITY AT MONTGOM	35,584	7,547	1,494	482	1,976	440,561	85	225,694
FAULKNER UNIVERSITY	4,927	139	20	12	33		87	
JACKSONVILLE STATE UNIVERSITY	71,560	3,997	3,646	2,007	5,653	518,159	87	196,120
SAMFORD UNIVERSITY	N/A	N/A	5,533	4,364	9,897	N/A	92	N/A
SPRING HILL COLLEGE	5,922	1,543	777	656	1,433	37,275	84	29,929
TROY STATE UNIVERSITY	33,260	5,191	2,951	1,315	4,266	306,532	85	
TROY STATE UNIVERSITY DOTHAN	33,292	7,624	649	690	1,339	119,000	72	50,662
UNIVERSITY OF ALABAMA	266,741	8,003	9,732	10,203	19,935	3,007,952	99	789,199
UNIVERSITY OF ALABAMA AT BIRM	327,390	99,369	24,752	8,636	22,693	3,138,809	86	339,114
UNIVERSITY OF ALABAMA IN HUNT:	45,987	6,847	1,458	2,780	4,238	510,281	94	130,000
UNIVERSITY OF MOBILE	12,136		290	412	702	71,369	70	
UNIVERSITY OF MONTEVALLO	46,705	8,256	1,121	764	1,885	194,478	85	164,966
UNIVERSITY OF NORTH ALABAMA	48,466	11,002	2,052	899	2,951	541,301	96	328,435
UNIVERSITY OF SOUTH ALABAMA	111,977	6,860	4,635	5,353	9,988	648,454	97	279,904
UNIVERSITY OF WEST ALABAMA	22,005	2,000	473	1,189	1,664		72	
UNITED STATES SPORTS ACADEMY								
FY99 TOTALS	1,364,681	182,831	79,424	50,366	119,098	11,077,199	1,635	3,220,454

SOURCE: Annual Statistical Reports filed by the institutions with the Network of Alabama Academic Libraries for the year October 1, 1998 - September 30, 1999.

NETWORK OF ALABAMA ACADEMIC LIBRARIES

Annual Statistical Reports, 1998-1999

INSTITUTION	LIBRARY FACILITIES									
	MAIN LIBRARY SQ. FT.	STUDY SEATS	CONSULT SEATS	OTHER LIBRARIES SQ. FT.	STUDY SEATS	CONSULT SEATS	TOTAL SQUARE FEET	TOTAL STUDY SEATS		
ALABAMA A&M UNIVERSITY	60,000	1,000	147				60,000	1,000		
ALABAMA STATE UNIVERSITY	100,000	600	25				100,000	600		
ATHENS STATE UNIVERSITY	32,000	279					32,000	279		
AUBURN UNIVERSITY	294,000	2,500	100	10,700	240		304,700	2,740		
AUBURN UNIVERSITY AT MONTGOM	61,546	700					61,546	700		
FAULKNER UNIVERSITY	13,000	184	29	1,475	33	2	14,475	217		
JACKSONVILLE STATE UNIVERSITY	151,268	1,288	98				151,268	1,288		
SAMFORD UNIVERSITY	109,500	857	34	42,500	474			1,331		
SPRING HILL COLLEGE	18,308	150	10				18,308	150		
TROY STATE UNIVERSITY	50,068	687		26,000	160	16	76,068	847		
TROY STATE UNIVERSITY DOTHAN	11,400	118	5				11,400	118		
UNIVERSITY OF ALABAMA	143,019	805		182,902	1,995		325,921	2,800		
UNIVERSITY OF ALABAMA AT BIRM	154,000	1,000	100	89,980	776	141	243,980	1,776		
UNIVERSITY OF ALABAMA IN HUNT	78,000	355	27				78,000	355		
UNIVERSITY OF MOBILE	25,000	180	8				25,000	180		
UNIVERSITY OF MONTEVALLO	43,716	402	84				43,716	402		
UNIVERSITY OF NORTH ALABAMA	54,745	561	60	6,744	136	6	61,489	697		
UNIVERSITY OF SOUTH ALABAMA	54,408	384	15	40,856	236	31	95,264	620		
UNIVERSITY OF WEST ALABAMA	19,050	200	5				19,050	200		
UNITED STATES SPORTS ACADEMY										
FY99 TOTALS	1,473,028	12,250	747	401,157	4,050	196	1,722,185	16,300		

SOURCE: Annual Statistical Reports filed by the institutions with the Network of Alabama Academic Libraries for the year October 1, 1998 - September 30, 1999.

NOTES:

(1) Historical numbers have been adjusted to reflect mergers. For comparison purposes mergers are reflected back for the entire history even when they occurred later. For example: Alabama Aviation and Technical College merged with G. C. Wallace Dothan in 1997, but the merger is reflected in all historical numbers back to 1988. A breakout of historical numbers prior to mergers can be furnished upon request. This is the reason that historical numbers change from year to year in this publication. Following is the list of mergers and dates:

- Central AL CC Merged 1989 Northwest Alabama-Shoals CC Merged 1989
 Alexander City St. Jr. Northwest AL. St. Jr.
 Nunnelley St. Technical Northwest AL St. Technical-Hamilton
 Northwest AL St. Technical-Tuscumbia

- Alabama Southern CC Merged 1992 Bishop St. CC Merged 1992
 Patrick Henry St. Jr. Bishop St. Jr.
 Hobson St. Technical Southwest St. Technical
 Carver St. Technical

- Walker College - Private Two-Year Southern Union St. CC Merged 1994
 1994 merged with UAB Southern Union St. Jr.
 1998 public Two-Year Opelika St. Technical

- Concordia College Became Private Four-Year 1994 was Private Two-Year

- Jefferson Davis CC Merged 1995 Shelton St. CC Merged 1995
 Jeff Davis St. Jr. Shelton St. Jr.
 Atmore St. Technical Fredd St. Technical

- Bevill St. CC Merged 1995 G. C. Wallace-Dothan Merged 1997
 Brewer St. Jr. G. C. Wallace-Dothan
 Walker St. Technical AL Aviation St. Technical
 Northwest AL CC-Hamilton Campus Sparks State Technical College 1999
 Walker College 1999

- Troy State University, Troy State University Dothan and University of West Alabama converted from quarter to semester system in Fall 1999, and all Public Two-Year Institutions except Southern Union State Community College converted from quarter system to semester system Fall 1998. This should be taken into account when looking at Headcount, FTE and Tuition changes.



U.S. Department of Education
Office of Educational Research and Improvement (OERI)
National Library of Education (NLE)
Educational Resources Information Center (ERIC)



NOTICE

Reproduction Basis



This document is covered by a signed "Reproduction Release (Blanket)" form (on file within the ERIC system), encompassing all or classes of documents from its source organization and, therefore, does not require a "Specific Document" Release form.



This document is Federally-funded, or carries its own permission to reproduce, or is otherwise in the public domain and, therefore, may be reproduced by ERIC without a signed Reproduction Release form (either "Specific Document" or "Blanket").

EFF-089 (3/2000)