

DOCUMENT RESUME

ED 440 594

HE 032 811

AUTHOR Shapiro, Yvonne, Comp.; Jacobs, Johan, Comp.
TITLE South African Graduate Statistics, 1999: Profiles and Recent Trends. Labour Market Analysis.
INSTITUTION Human Sciences Research Council, Pretoria (South Africa).
ISBN ISBN-0-7969-1923-2
PUB DATE 1999-00-00
NOTE 110p.
AVAILABLE FROM Human Sciences Research Council Bookshop, P.O. Box 5556, Pretoria, 0001, South Africa. Tel: 012-302-2004/2103; Fax: 012-302-2002/2440/2933; e-mail: jels@beauty.hsrc.ac.za; Web site: <http://www.hsrc.ac.za>.
PUB TYPE Numerical/Quantitative Data (110) -- Reports - Research (143)
EDRS PRICE MF01/PC05 Plus Postage.
DESCRIPTORS Affirmative Action; Blacks; *College Graduates; Degrees (Academic); Education Work Relationship; *Employment Opportunities; Employment Potential; *Employment Qualifications; Equal Opportunities (Jobs); Foreign Countries; Higher Education; Labor Market; *Occupational Surveys; *Occupations; Tables (Data)
IDENTIFIERS *South Africa

ABSTRACT

This Register of Graduates was compiled by the Human Science Research Council (Pretoria, South Africa) and offers statistical data on college graduates in South Africa for 1999. This information on graduate availability is used by employers to prepare and implement employment equity plans, as required by the Employment Equity Act, No. 55 of 1998. The base information on the graduates was obtained electronically from each South African university. A questionnaire was then sent to each graduate requesting further information on occupation, address, and other issues. Graduate qualifications were sorted into 48 categories (e.g., fields of study). Each degree and postgraduate diploma, as well as each major field of study (980 total) was allocated to a category. Each graduate is shown in all the categories in which he or she has qualifications. A double page of data for each category lists qualification trends by level, qualification trends by population group and gender, qualification trends by current province of residence, and total availability information, by region, and by race and gender. (SM)

ED 440 594

South African Graduate Statistics 1999

Profiles and Recent Trends

PERMISSION TO REPRODUCE AND DISSEMINATE THIS MATERIAL HAS BEEN GRANTED BY

R. H. Stumpf

TO THE EDUCATIONAL RESOURCES INFORMATION CENTER (ERIC)

Compiled by

Yvonne Shapiro and Johan Jacobs

Labour Market Analysis

U.S. DEPARTMENT OF EDUCATION
Office of Educational Research and Improvement
EDUCATIONAL RESOURCES INFORMATION CENTER (ERIC)

- This document has been reproduced as received from the person or organization originating it.
- Minor changes have been made to improve reproduction quality.

ERIC
Views of view or opinions stated in this document do not necessarily represent official OERI position or policy.



Human Sciences
Research Council

**SOUTH AFRICAN
GRADUATE STATISTICS
1999**

Profiles and Recent Trends

Compiled by Yvonne Shapiro and Johan Jacobs

Group for Economic and Social Analysis

Unit: Labour Market Analysis

incorporating the Register of Graduates

**HSRC
134 Pretorius Street
Pretoria
0002
SOUTH AFRICA**

All rights reserved. No part of this publication may be reproduced or transmitted in any form or by any means, electronic or mechanical, including photocopying, recording or any information storage and retrieval system, without **permission in writing from the Unit for Labour Market Analysis of the HSRC.**

Although all the information in this book has been compiled with great care, the HSRC does not accept responsibility for any loss or damage that may arise from the reliance of any person upon information this book contains.

Distributed by:

HSRC Bookshop

PO Box 5556

Pretoria

0001

Tel : (012) 302 2004 / 302 2103

Fax: (012) 302 2002 / 302 2440 / 302 2933

E-mail : jels@beauty.hsrc.ac.za

Web-site : <http://www.hsrc.ac.za>

Design of cover and contents: Marten le Roux, Design & Proof Prepress

Film and print co-ordination: Jet Set Photosetting

Film reproduction: Future Graphics

Printing: LAW Printing and Promotions

First edition, 1999.

ISBN 0-7969-1923-2

CONTENTS

| | Page |
|--|------|
| Introduction | 3 |
| Profiles and Trends | 7 |
| Natural Sciences – All | 8 |
| Computer Science / Information Technology | 10 |
| Geological Sciences | 12 |
| Mathematical and Statistical Sciences | 14 |
| Biological Sciences | 16 |
| Physical and Chemical Sciences | 18 |
| Engineering – All | 20 |
| Engineering – Mechanical | 22 |
| Engineering – Civil | 24 |
| Engineering – Industrial | 26 |
| Engineering – Chemical | 28 |
| Engineering – Electrical and Electronic | 30 |
| Engineering – Mining | 32 |
| Engineering – Metallurgical | 34 |
| Quantity Surveying | 36 |
| Architecture | 38 |
| Building Science / Construction Management | 40 |
| Town and Regional Planning | 42 |
| Land Surveying | 44 |
| Agriculture | 46 |
| Food Science and Home Economics | 48 |
| Veterinary Science | 50 |
| Medicine and Surgery | 52 |
| Dentistry | 54 |
| Nursing | 56 |
| Physiotherapy | 58 |
| Pharmacy | 60 |
| General Health | 62 |
| Humanities and Arts – General | 64 |
| Publishing, Journalism, Advertising, Marketing | 66 |
| Literature and Languages | 68 |
| Politics | 70 |
| Psychology | 72 |
| Social Science | 74 |
| The Arts | 76 |
| Education | 78 |
| Library and Information Science | 80 |
| Social Work | 82 |
| Legal | 84 |
| Law | 86 |
| Theology | 88 |
| Commerce | 90 |
| Marketing (Commercial) | 92 |
| Administration and Public Administration | 94 |
| Economics | 96 |
| Business Management and Administration | 98 |
| Accountancy (CA) | 100 |
| Human Resources Management | 102 |
| Overall | 104 |
| Alphabetical Index | 106 |



ACKNOWLEDGEMENTS

The Human Sciences Research Council wishes to thank the following:

- All the graduates of South Africa, especially the 300 000 who maintain contact with the HSRC, informing us of changes to their addresses and occupations, plus their additional qualifications.
- All clients who regularly commission assignments and data analysis based on the Register of Graduates, and whose many requests have prompted the production of this book.
- The many professional councils and institutes that provide their registration totals from time to time, so that they can be compared with those on the Register of Graduates.

The authors wish to thank the following:

- The Register Team, currently Annatjie Greyvenstein, Maritha Coertze, Carol Bennett, Annetjie Verster and Cathrine Mashile (and until recently also Babsie Scholtz, Elaine Eksteen and Silas Mabena), for 34 years of patient checking and input of the Register data, and the numerous other tasks occasioned by the maintenance and development of such a database.
- Joan Roodt, for her patient checking of the figures.
- Elize van Zyl, for her leadership and advice.
- The HSRC Computer Centre, especially Tredoux Badenhorst and Marie-Louise van Wyk, for their technical support.
- Everyone in the Unit for Labour Market Analysis, for all the support and encouragement received during the conceptualisation and preparation of this book.

INTRODUCTION

The Employment Equity Act, No. 55 of 1998, requires that every employer with 50 or more employees should prepare and implement an employment equity plan. This should include realistic goals for changing the representation of all 'population groups' within the organisation concerned. The challenge to employers, then, is to investigate the availability of potential employees, together with the necessary demographic information.

The Register of Graduates, housed at the Human Sciences Research Council (HSRC), is the primary source of information concerning graduate availability within South Africa. During the last few months, the HSRC has received numerous requests from employers for these graduate statistics, and has thus decided to publish them comprehensively, in book form.

Background to the Register of Graduates

The Register of Graduates was established by the national Department of Education in 1965, and handed over to the HSRC in 1968. At the time, it was literally a register, whereas now it is a large relational database, providing information on approximately 530 000 South African graduates, such as their qualifications and demographics. In addition to providing information from the database, surveys are undertaken regularly, on topics such as the average remuneration of graduates in various occupations and their first-time employment experiences.¹ The Register of Graduates is now part of the Division for Labour Market Analysis at the HSRC. The Register provides information on labour market supply, while other project teams analyse and do projections concerning labour market demand.²

The information for the Register of Graduates is obtained electronically from each university in South Africa. A questionnaire is then sent to each graduate, requesting information concerning occupation, best address, etc, and the responses are added to the database. Those who respond to the questionnaire are flagged as *respondents*. Those who do not respond are retained on the database, but are not sent further questionnaires or literature unless they make contact with the HSRC.

An annual publication, *The Graduate*, is sent to all 300 000 respondents. It analyses, in summary form, Register information that is of interest to graduates, such as comparative incomes and trends in graduate numbers and demographics. It is sent together with a personalised, prepaid postcard, which the respondents are requested to send in if they change occupation, name or address, or obtain further qualifications.

The Register is currently making the transition from listing university graduates only, and will shortly incorporate all technikon qualifiers (at the level of Matric + 3 upwards). Thus, while this publication deals only with university graduates, any subsequent ones will include technikon qualifiers.

¹ The reports on the *Remuneration of Graduates* and *First Employment Experiences of Graduates* surveys are available from the HSRC Publishers.

² Two labour market reports are available from the HSRC Publishers. The first is the full technical report of the recent analysis, *The SA Labour Market: Market Trends and future workforce needs 1998 – 2003*, and the second is the popular report, *Skills Needs of the SA Labour Market: 1998 – 2003*.

Methodology

This report consists of database statistics rather than survey statistics. In other words, the entire database has been analysed, rather than conducting a survey of a sample of graduates, in order to arrive at current South African graduate profiles and trends.

The figures cited are **conservative**: until 1985, it was not possible to load the information received from the universities directly onto the database. Thus, only respondents' information was entered into the system, manually, when they returned their questionnaires. However, all information received since 1986, for respondents and non-respondents alike, has been electronically loaded. Some universities are slow to transmit their information, which has led to some gaps in latter years. However, it is possible to estimate the numbers and demographic profiles of these graduates, based on existing information, and this has been done.

Another reason why the figures are conservative is that only a small proportion of South African people who obtained qualifications at foreign universities while in exile, and foreigners living and working in South Africa, have made contact with the HSRC, despite several advertisements requesting this. To a certain extent, however, this is balanced by the number of graduates who have emigrated without notifying the Register of Graduates.

The qualifications have been sorted into 48 categories, based on the obvious categorisation of degrees, as well as the requests most regularly received from employers. Each degree and postgraduate diploma, as well as each major field of study (980 in all), has been allocated to a category. Each graduate is shown in all the categories in which she or he has a qualification. Thus, for example, an individual with a B Sc in Mathematics, followed by a postgraduate teaching diploma, will be shown in *Natural Sciences – All*, as well as *Mathematical and Statistical Sciences* and *Education*. Thus, the numbers should not be summated across categories. The overall total should be obtained from the *Overall* category at the end of the book, which counts each graduate only once.

For each category, a double-page spread has been produced:

The right-hand page gives **Total Availability** information. This is the number of people currently living in South Africa who have qualifications in that specific field (whether or not they are practising in the field), and are aged 65 years or younger. The graphs and tables show the percentage of graduates in each 'population group,' the number of graduates according to the level of their highest qualification in that field, and the number of graduates by current province of residence, 'population group' and gender. Estimates of the current location of the non-respondents have been made, based on the location of the respondents.

If the figures are compared with those for people up to 65 years old registered with the relevant professional councils, slight variations become apparent. There are several reasons for this, notably:

- For some of the councils, registration is not compulsory. Notable examples are the Engineering Council of South Africa, the South African Institute of Building and the General Bar Council of South Africa (although most advocates do register). In these cases, the HSRC's figures are higher than the council's figures.
- Many graduates are employed in managerial positions, or in various capacities throughout the private and public sectors. Thus, they are not specifically working in the professions indicated by their qualifications, and do not maintain their registrations. In these cases, the HSRC's figures are also higher than the council's figures. Two examples are Engineering and Law.

- In all categories where it is (or has been) possible to qualify at technikons as well as universities, the HSRC's figures are lower than those of the professional councils. Examples are Quantity Surveying, Land Surveying, Pharmacy and Optometry (the latter is included in the *General Health* category).
- In some professions, for example Medicine and Surgery, many practitioners qualified before 1986, and have not obtained subsequent qualifications. This causes the HSRC's figures to be lower than those of the relevant council.

The left-hand page gives **Qualification Trends, 1991 to 1998**. These are shown in three tables: level; 'population group' and gender; and current province of residence. The figures refer to the number of qualifications awarded by the universities, rather than to the number of people. Thus, the qualifications of an individual who obtained a Bachelors degree in 1991, a postgraduate diploma in 1992, an Honours degree in 1993 and a Masters degree in 1998 will be shown in all four of those years. In some categories, this has such a marked effect that the number of qualifications from 1991 to 1998 exceeds the total number of available graduates. In addition, the qualifications of people over 65 years old, or now resident outside South Africa, have not been excluded, as they form part of the overall picture of qualifications awarded.

The term 'black' is used inclusively, to denote the total of graduates in the African, Asian and coloured 'population groups.' In addition, Asian is used rather than Indian, as this was the initial classification used on the Register, and it is thus still a broader rather than narrower 'population group.'

The level shown as 'Bachelors (4 years)' can, in some cases, refer to a specialised degree or a Bachelors degree of greater than four years (such as Architecture).

The order in which the categories appear is the same as the order in which they appear on the Register of Graduates.

The situation is not rosy for employers hoping to find graduates in the 'designated groups' who will fill the positions that they offer. The figures shown in this book prove that there is a daunting task ahead of them, as black people make up only 32% of the graduate population of South Africa, and women 45%. The qualification trends since 1991 show that black people are now claiming 45% of the total qualifications awarded, and women 50%. However, closer examination shows that they are obtaining the qualifications at lower levels than their white or male counterparts, and the categories within which they fall are mostly those where there is an oversupply of qualified people, such as Education.

Certain areas still attract especially few black candidates. Based on this, it is going to be particularly difficult to change employee profiles, unless more black people are encouraged to study within these fields. The most prominent are Natural Sciences, Engineering, Built Environment qualifications (Architecture, etc), Health qualifications except Nursing, Law, and all Economic and Management Sciences qualifications except Administration.

This, then is the challenge to South Africa over the next few years: to produce top-class black graduates in the fields where, today, they are simply not available.

**PROFILES
AND
TRENDS**

NATURAL SCIENCES - ALL

All graduates with any Natural Sciences qualifications, such as B Sc or M Sc, are shown in this category. Those with qualifications in any of the fields of Computer Science / IT, Geological Sciences, Mathematical / Statistical Sciences, Biological Sciences and Physical / Chemical Sciences, are repeated in those categories.

QUALIFICATION TRENDS BY LEVEL

| | 1991 | 1992 | 1993 | 1994 | 1995 | 1996 | 1997 | 1998 | TOTAL |
|-----------------|------|------|------|------|------|------|------|------|-------|
| Bachelors (3yr) | 3704 | 3655 | 3637 | 3636 | 3806 | 3995 | 3986 | 4063 | 30687 |
| Bachelors (4yr) | 12 | 35 | 71 | 122 | 51 | 114 | 144 | 217 | 766 |
| PG Diploma | 1 | 6 | 8 | 8 | 6 | 22 | 24 | 22 | 97 |
| Honours | 1057 | 1111 | 1014 | 1137 | 1115 | 1117 | 1213 | 1293 | 9057 |
| Masters | 381 | 442 | 431 | 422 | 624 | 523 | 524 | 560 | 3907 |
| Doctorate | 170 | 156 | 154 | 152 | 184 | 128 | 145 | 151 | 1240 |
| TOTAL | 5325 | 5405 | 5315 | 5677 | 5786 | 5899 | 6036 | 6311 | 45754 |

QUALIFICATION TRENDS BY POPULATION GROUP AND GENDER

| | | 1991 | 1992 | 1993 | 1994 | 1995 | 1996 | 1997 | 1998 | TOTAL |
|----------|---|------|------|------|------|------|------|------|------|-------|
| Asian | F | 135 | 195 | 205 | 240 | 251 | 282 | 296 | 310 | 1914 |
| | M | 234 | 320 | 238 | 313 | 281 | 321 | 338 | 354 | 2399 |
| African | F | 151 | 202 | 201 | 367 | 400 | 489 | 526 | 584 | 2920 |
| | M | 373 | 433 | 508 | 678 | 731 | 856 | 838 | 945 | 5362 |
| Coloured | F | 114 | 111 | 94 | 167 | 160 | 146 | 177 | 181 | 1150 |
| | M | 200 | 239 | 154 | 249 | 198 | 179 | 202 | 212 | 1633 |
| White | F | 1835 | 1761 | 1755 | 1664 | 1657 | 1696 | 1681 | 1719 | 13768 |
| | M | 2283 | 2144 | 2160 | 1999 | 2108 | 1930 | 1978 | 2006 | 16608 |
| OVERALL | F | 2235 | 2269 | 2255 | 2438 | 2468 | 2613 | 2680 | 2794 | 19752 |
| | M | 3090 | 3136 | 3060 | 3239 | 3318 | 3286 | 3356 | 3517 | 26002 |
| TOTAL | | 5325 | 5405 | 5315 | 5677 | 5786 | 5899 | 6036 | 6311 | 45754 |

QUALIFICATION TRENDS BY CURRENT PROVINCE OF RESIDENCE

| | 1991 | 1992 | 1993 | 1994 | 1995 | 1996 | 1997 | 1998 | TOTAL |
|---------------|------|------|------|------|------|------|------|------|-------|
| Western Cape | 950 | 989 | 948 | 1022 | 1191 | 901 | 950 | 921 | 7872 |
| Northern Cape | 79 | 106 | 79 | 65 | 83 | 56 | 75 | 75 | 618 |
| Free State | 325 | 355 | 349 | 366 | 390 | 380 | 417 | 401 | 2983 |
| Eastern Cape | 431 | 430 | 415 | 546 | 570 | 540 | 533 | 544 | 4009 |
| KwaZulu-Natal | 645 | 740 | 868 | 859 | 727 | 806 | 815 | 847 | 6307 |
| Mpumalanga | 115 | 116 | 152 | 107 | 134 | 146 | 135 | 123 | 1028 |
| Northern Prov | 138 | 146 | 127 | 213 | 140 | 188 | 200 | 225 | 1377 |
| Gauteng | 2285 | 2115 | 1914 | 2001 | 2037 | 2439 | 2426 | 2674 | 17891 |
| North West | 174 | 265 | 253 | 302 | 332 | 286 | 335 | 351 | 2298 |
| Outside SA | 183 | 143 | 210 | 196 | 182 | 157 | 150 | 150 | 1371 |
| TOTAL | 5325 | 5405 | 5315 | 5677 | 5786 | 5899 | 6036 | 6311 | 45754 |

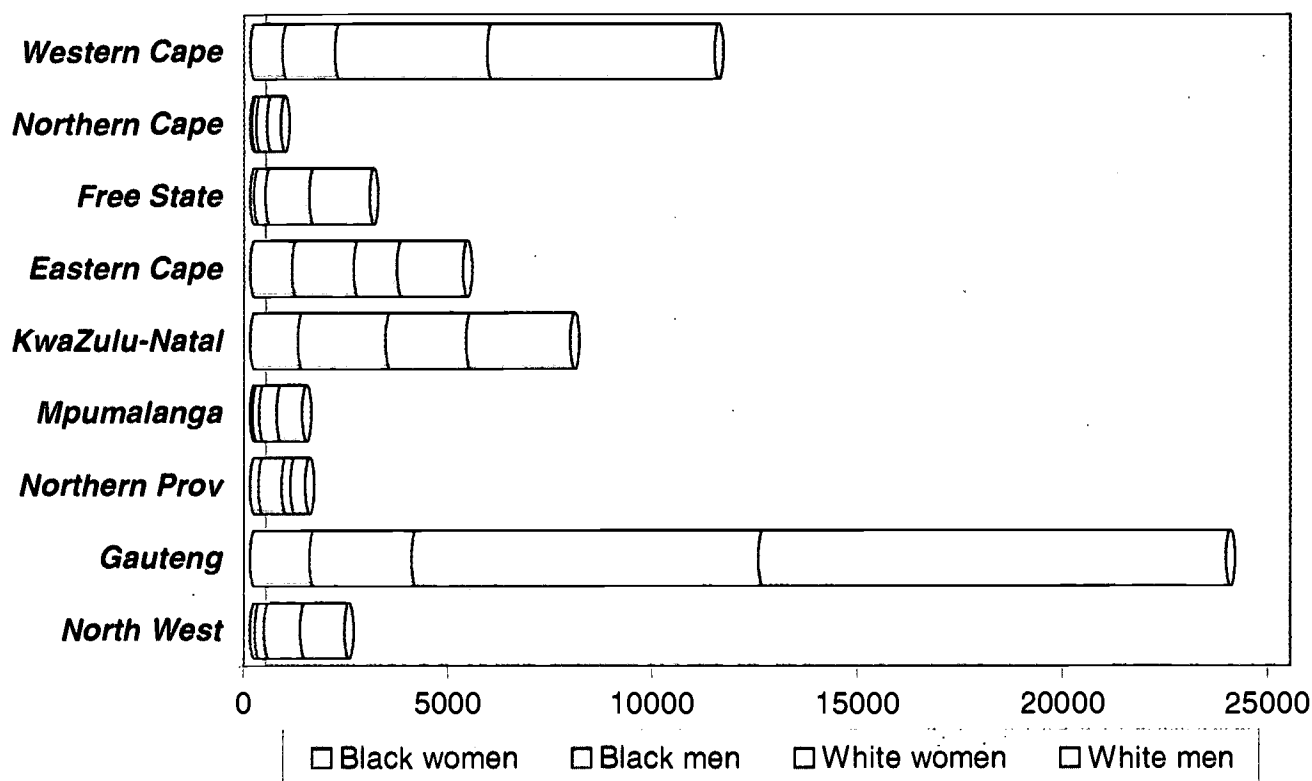
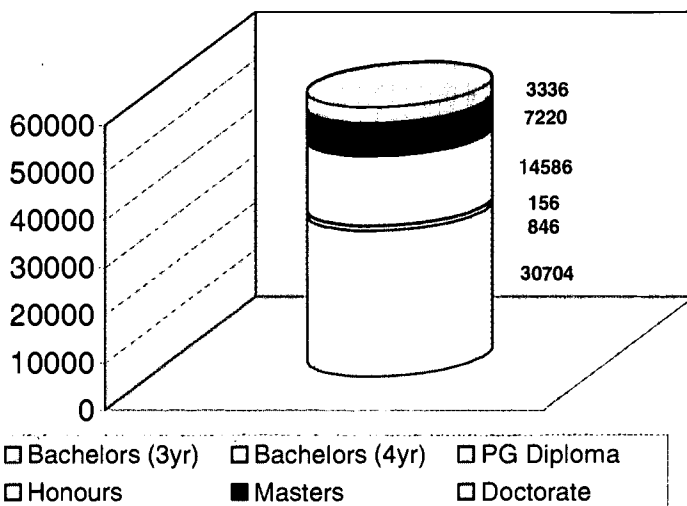
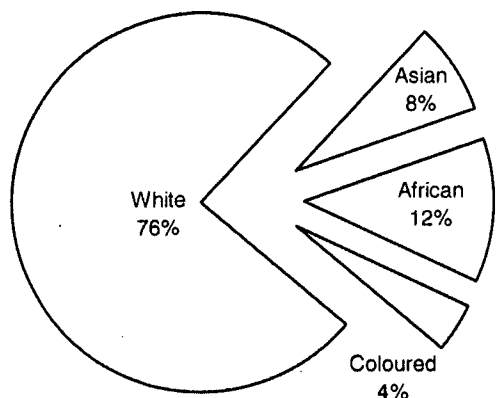

| | Asian | | African | | Coloured | | White | | OVERALL | | TOTAL |
|---------------|-------------|-------------|-------------|-------------|-------------|-------------|--------------|--------------|--------------|--------------|--------------|
| | Women | Men | Women | Men | Women | Men | Women | Men | Women | Men | |
| Western Cape | 125 | 163 | 88 | 92 | 579 | 1030 | 3728 | 5553 | 4520 | 6838 | 11358 |
| Northern Cape | 6 | 10 | 8 | 32 | 23 | 66 | 265 | 341 | 302 | 449 | 751 |
| Free State | 4 | 12 | 88 | 246 | 4 | 21 | 1073 | 1472 | 1169 | 1751 | 2920 |
| Eastern Cape | 51 | 156 | 884 | 1173 | 84 | 185 | 1067 | 1610 | 2086 | 3124 | 5210 |
| KwaZulu-Natal | 869 | 1647 | 247 | 429 | 51 | 75 | 1965 | 2547 | 3132 | 4698 | 7830 |
| Mpumalanga | 18 | 35 | 38 | 127 | | 2 | 428 | 634 | 484 | 798 | 1282 |
| Northern Prov | 18 | 18 | 180 | 541 | 10 | | 226 | 361 | 434 | 920 | 1354 |
| Gauteng | 466 | 713 | 859 | 1640 | 123 | 150 | 8476 | 11403 | 9924 | 13906 | 23830 |
| North West | 21 | 29 | 88 | 197 | 4 | 7 | 892 | 1078 | 1005 | 1311 | 2316 |
| TOTAL | 1578 | 2783 | 2480 | 4477 | 878 | 1536 | 18120 | 24999 | 23056 | 33795 | 56851 |
| | 4361 | | 6957 | | 2414 | | 43119 | | | | |

COMPUTER SCIENCE/ INFORMATION TECHNOLOGY

The majority of these graduates obtained their qualifications as part of a Natural Sciences degree (such as a B Sc), or Economic and Management Sciences degree (such as a B Com).

QUALIFICATION TRENDS BY LEVEL

| | 1991 | 1992 | 1993 | 1994 | 1995 | 1996 | 1997 | 1998 | TOTAL |
|-----------------|------------|-------------|------------|-------------|-------------|------------|------------|-------------|-------------|
| Bachelors (3yr) | 744 | 804 | 753 | 849 | 782 | 695 | 735 | 760 | 6127 |
| Bachelors (4yr) | 4 | 1 | 3 | 2 | 1 | 5 | 2 | 2 | 20 |
| PG Diploma | | | 1 | 8 | 6 | 23 | 24 | 22 | 84 |
| Honours | 163 | 184 | 140 | 138 | 184 | 181 | 175 | 227 | 1392 |
| Masters | 26 | 28 | 36 | 25 | 52 | 33 | 30 | 34 | 264 |
| Doctorate | 3 | | 6 | 5 | 4 | 3 | 3 | 4 | 28 |
| TOTAL | 940 | 1017 | 944 | 1027 | 1029 | 940 | 969 | 1049 | 7915 |

QUALIFICATION TRENDS BY POPULATION GROUP AND GENDER

| | | 1991 | 1992 | 1993 | 1994 | 1995 | 1996 | 1997 | 1998 | TOTAL |
|--------------|---|------------|-------------|------------|-------------|-------------|------------|------------|-------------|-------------|
| Asian | F | 16 | 15 | 30 | 29 | 35 | 42 | 44 | 44 | 255 |
| | M | 42 | 63 | 25 | 59 | 55 | 65 | 66 | 72 | 447 |
| African | F | 9 | 6 | 5 | 17 | 20 | 30 | 41 | 55 | 183 |
| | M | 21 | 15 | 25 | 37 | 42 | 66 | 72 | 80 | 358 |
| Coloured | F | 7 | 6 | 2 | 8 | 7 | 8 | 2 | 6 | 46 |
| | M | 23 | 24 | 16 | 33 | 21 | 19 | 24 | 25 | 185 |
| White | F | 277 | 300 | 257 | 245 | 248 | 204 | 218 | 232 | 1981 |
| | M | 545 | 588 | 584 | 599 | 601 | 506 | 502 | 535 | 4460 |
| OVERALL | F | 309 | 327 | 294 | 299 | 310 | 284 | 305 | 337 | 2465 |
| | M | 631 | 690 | 650 | 728 | 719 | 656 | 664 | 712 | 5450 |
| TOTAL | | 940 | 1017 | 944 | 1027 | 1029 | 940 | 969 | 1049 | 7915 |

QUALIFICATION TRENDS BY CURRENT PROVINCE OF RESIDENCE

| | 1991 | 1992 | 1993 | 1994 | 1995 | 1996 | 1997 | 1998 | TOTAL |
|---------------|------------|-------------|------------|-------------|-------------|------------|------------|-------------|-------------|
| Western Cape | 160 | 243 | 196 | 196 | 197 | 145 | 123 | 130 | 1390 |
| Northern Cape | 14 | 15 | 18 | 4 | 5 | 3 | | | 59 |
| Free State | 81 | 90 | 111 | 77 | 66 | 36 | 57 | 73 | 591 |
| Eastern Cape | 71 | 64 | 43 | 97 | 107 | 58 | 57 | 70 | 567 |
| KwaZulu-Natal | 69 | 85 | 103 | 119 | 80 | 89 | 103 | 97 | 745 |
| Mpumalanga | 21 | 20 | 15 | 23 | 20 | 25 | 24 | 24 | 172 |
| Northern Prov | 11 | 13 | 7 | 14 | | 8 | 6 | 12 | 71 |
| Gauteng | 452 | 416 | 378 | 406 | 452 | 498 | 512 | 555 | 3669 |
| North West | 24 | 41 | 46 | 41 | 74 | 36 | 33 | 33 | 328 |
| Outside SA | 37 | 30 | 27 | 50 | 28 | 42 | 54 | 55 | 323 |
| TOTAL | 940 | 1017 | 944 | 1027 | 1029 | 940 | 969 | 1049 | 7915 |

TOTAL AVAILABILITY

COMPUTER SCIENCE/ INFORMATION TECHNOLOGY

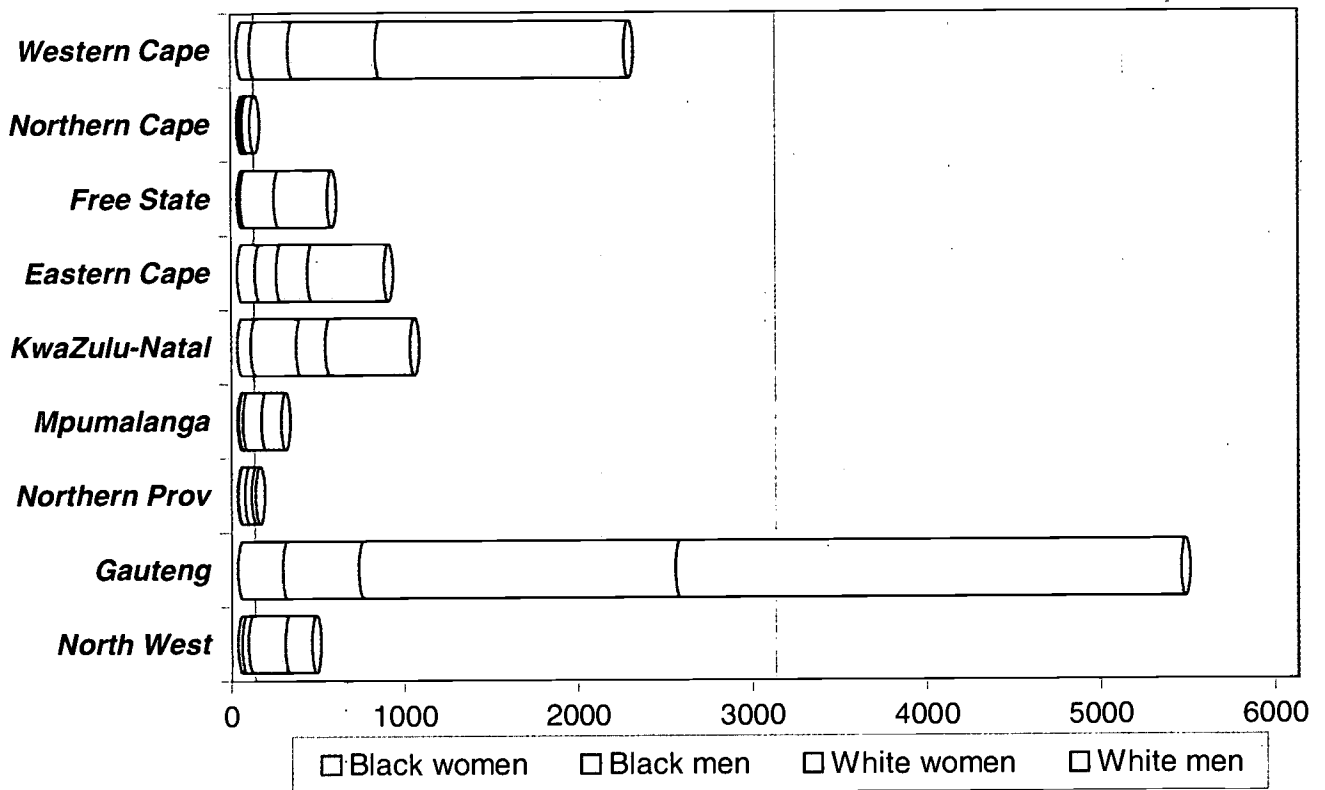
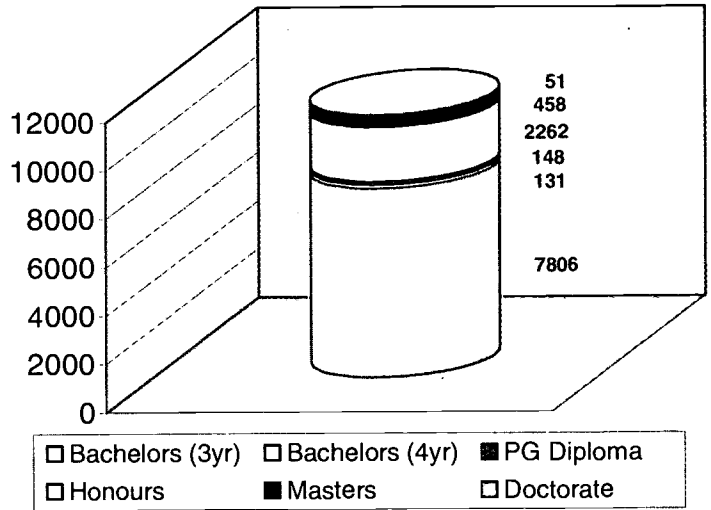
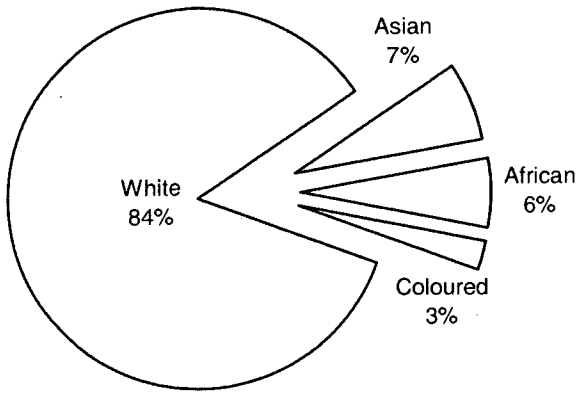

| | Asian | | African | | Coloured | | White | | OVERALL | | TOTAL |
|---------------|------------|------------|------------|------------|------------|------------|-------------|-------------|-------------|-------------|--------------|
| | Women | Men | Women | Men | Women | Men | Women | Men | Women | Men | |
| Western Cape | 39 | 46 | 3 | 5 | 31 | 169 | 502 | 1433 | 575 | 1653 | 2228 |
| Northern Cape | | | | 7 | | 5 | 16 | 46 | 16 | 58 | 74 |
| Free State | | | 3 | 14 | | | 192 | 310 | 195 | 324 | 519 |
| Eastern Cape | 12 | 22 | 78 | 78 | 11 | 20 | 182 | 441 | 283 | 561 | 844 |
| KwaZulu-Natal | 66 | 232 | 10 | 18 | | 11 | 169 | 489 | 245 | 750 | 995 |
| Mpumalanga | 2 | 2 | 5 | 20 | | | 105 | 116 | 112 | 138 | 250 |
| Northern Prov | | 2 | 3 | 36 | | | 40 | 20 | 43 | 58 | 101 |
| Gauteng | 129 | 206 | 115 | 200 | 13 | 33 | 1820 | 2905 | 2077 | 3344 | 5421 |
| North West | 2 | 7 | 20 | 31 | | | 211 | 155 | 233 | 193 | 426 |
| TOTAL | 250 | 517 | 237 | 409 | 55 | 238 | 3237 | 5915 | 3779 | 7079 | 10858 |
| | 767 | | 646 | | 293 | | 9152 | | | | |

This category consists of all aspects of Geology, Hydrology, Geophysics, Geochemistry and Oceanography.

QUALIFICATION TRENDS BY LEVEL

| | 1991 | 1992 | 1993 | 1994 | 1995 | 1996 | 1997 | 1998 | TOTAL |
|-----------------|------------|------------|------------|------------|------------|------------|------------|------------|-------------|
| Bachelors (3yr) | 202 | 182 | 176 | 144 | 126 | 124 | 126 | 125 | 1205 |
| Bachelors (4yr) | | | | | | | | | 0 |
| PG Diploma | | | | | | | | | 0 |
| Honours | 110 | 117 | 108 | 104 | 73 | 76 | 78 | 86 | 752 |
| Masters | 39 | 26 | 30 | 27 | 37 | 25 | 22 | 26 | 232 |
| Doctorate | 13 | 16 | 9 | 12 | 8 | 1 | 3 | 5 | 67 |
| TOTAL | 364 | 341 | 323 | 287 | 244 | 226 | 229 | 242 | 2256 |

QUALIFICATION TRENDS BY POPULATION GROUP AND GENDER

| | | 1991 | 1992 | 1993 | 1994 | 1995 | 1996 | 1997 | 1998 | TOTAL |
|--------------|---|------------|------------|------------|------------|------------|------------|------------|------------|-------------|
| Asian | F | 4 | 20 | 10 | 6 | 7 | 7 | 5 | 8 | 67 |
| | M | 7 | 16 | 16 | 15 | 9 | 14 | 12 | 13 | 102 |
| African | F | 1 | | 1 | 3 | 2 | 6 | 4 | 3 | 20 |
| | M | 13 | 9 | 7 | 17 | 15 | 33 | 29 | 36 | 159 |
| Coloured | F | 1 | | 1 | 4 | 7 | 5 | 6 | 7 | 31 |
| | M | 8 | 6 | 6 | 9 | 12 | 10 | 14 | 15 | 80 |
| White | F | 81 | 73 | 79 | 59 | 58 | 43 | 53 | 54 | 500 |
| | M | 249 | 217 | 203 | 174 | 134 | 108 | 106 | 106 | 1297 |
| OVERALL | F | 87 | 93 | 91 | 72 | 74 | 61 | 68 | 72 | 618 |
| | M | 277 | 248 | 232 | 215 | 170 | 165 | 161 | 170 | 1638 |
| TOTAL | | 364 | 341 | 323 | 287 | 244 | 226 | 229 | 242 | 2256 |

QUALIFICATION TRENDS BY CURRENT PROVINCE OF RESIDENCE

| | 1991 | 1992 | 1993 | 1994 | 1995 | 1996 | 1997 | 1998 | TOTAL |
|---------------|------------|------------|------------|------------|------------|------------|------------|------------|-------------|
| Western Cape | 41 | 58 | 44 | 54 | 53 | 38 | 53 | 49 | 390 |
| Northern Cape | 14 | 22 | 8 | 9 | 9 | 4 | 2 | | 68 |
| Free State | 35 | 24 | 21 | 11 | 13 | 19 | 13 | 18 | 154 |
| Eastern Cape | 29 | 14 | 19 | 19 | 15 | 13 | 20 | 18 | 147 |
| KwaZulu-Natal | 52 | 73 | 65 | 46 | 28 | 28 | 34 | 32 | 358 |
| Mpumalanga | 6 | 2 | 15 | 7 | 8 | 6 | 9 | 7 | 60 |
| Northern Prov | 13 | 6 | 5 | 15 | 6 | 2 | 2 | 2 | 51 |
| Gauteng | 157 | 122 | 120 | 110 | 95 | 96 | 76 | 89 | 865 |
| North West | 3 | 14 | 8 | 9 | 6 | 11 | 13 | 18 | 82 |
| Outside SA | 14 | 6 | 18 | 7 | 11 | 9 | 7 | 9 | 81 |
| TOTAL | 364 | 341 | 323 | 287 | 244 | 226 | 229 | 242 | 2256 |

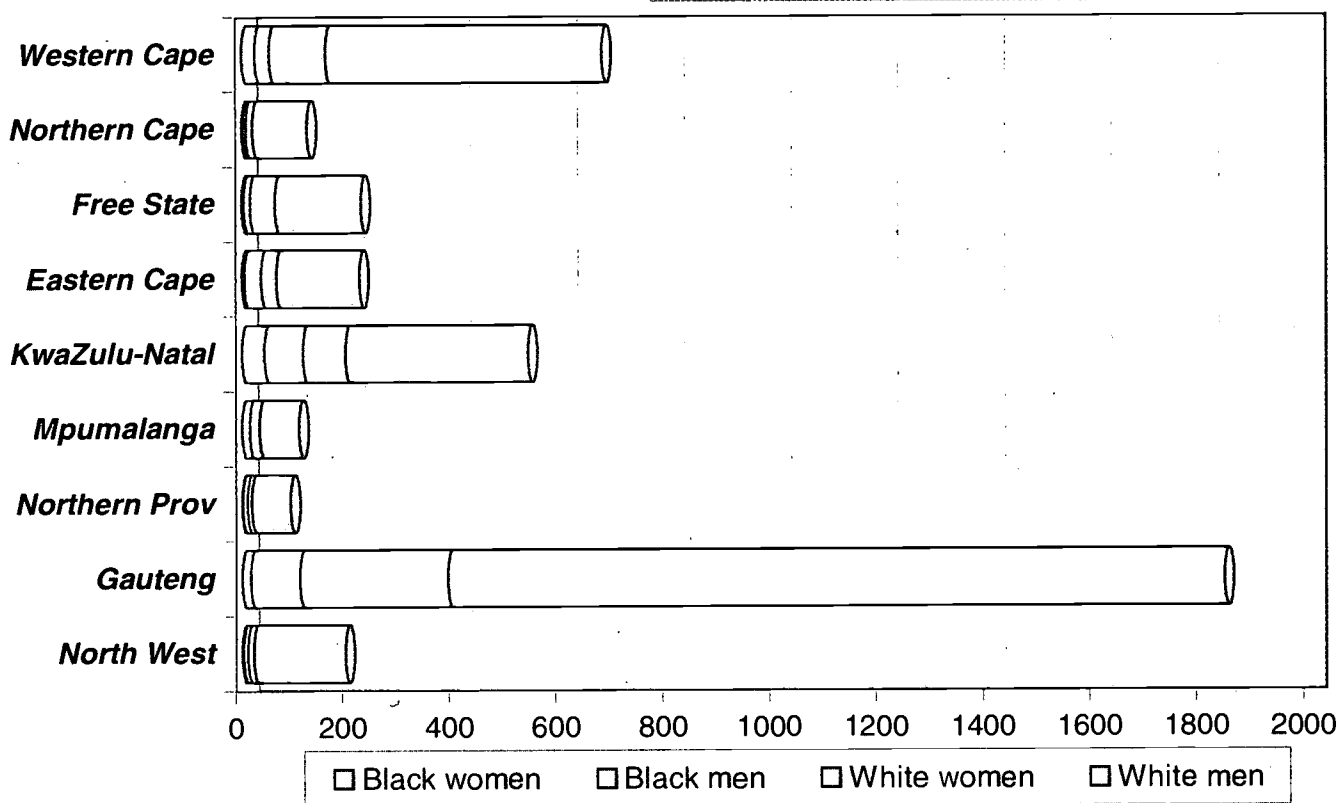
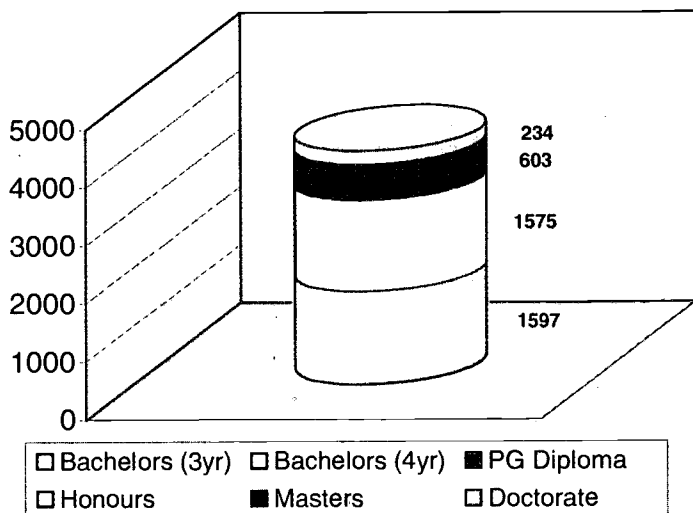
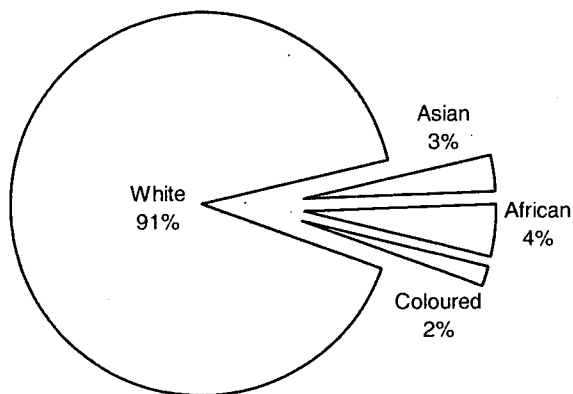

| | Asian | | African | | Coloured | | White | | OVERALL | | TOTAL |
|---------------|------------|-----------|------------|------------|-----------|-----------|-------------|-------------|------------|-------------|-------------|
| | Women | Men | Women | Men | Women | Men | Women | Men | Women | Men | |
| Western Cape | | | 5 | 9 | 20 | 18 | 105 | 519 | 130 | 546 | 676 |
| Northern Cape | 2 | | | | | 5 | 13 | 102 | 15 | 107 | 122 |
| Free State | 2 | 4 | 1 | 3 | | 5 | 47 | 162 | 50 | 174 | 224 |
| Eastern Cape | | 2 | 4 | 23 | | 7 | 28 | 157 | 32 | 189 | 221 |
| KwaZulu-Natal | 35 | 43 | 7 | 25 | | 3 | 81 | 343 | 123 | 414 | 537 |
| Mpumalanga | | 2 | | 12 | | | 19 | 73 | 19 | 87 | 106 |
| Northern Prov | | | 1 | 9 | | | 8 | 72 | 9 | 81 | 90 |
| Gauteng | 7 | 21 | 7 | 59 | 2 | 11 | 279 | 1454 | 295 | 1545 | 1840 |
| North West | 2 | 2 | | 6 | | | 11 | 172 | 13 | 180 | 193 |
| TOTAL | 48 | 74 | 25 | 146 | 22 | 49 | 591 | 3054 | 686 | 3323 | 4009 |
| | 122 | | 171 | | 71 | | 3645 | | | | |



MATHEMATICAL AND STATISTICAL SCIENCES

These graduates obtained their qualifications as part of a Natural Sciences degree or, in some cases, an Arts degree, and not as part of an Economic and Management Sciences degree (such as a B Com). The latter are shown under those categories only, without highlighting their mathematical fields of study.

QUALIFICATION TRENDS BY LEVEL

| | 1991 | 1992 | 1993 | 1994 | 1995 | 1996 | 1997 | 1998 | TOTAL |
|-----------------|------------|------------|------------|------------|------------|------------|------------|------------|-------------|
| Bachelors (3yr) | 690 | 671 | 647 | 668 | 616 | 675 | 661 | 674 | 5302 |
| Bachelors (4yr) | | | | | | | | | 0 |
| PG Diploma | | | | | | | | | 0 |
| Honours | 107 | 92 | 87 | 97 | 93 | 100 | 104 | 114 | 794 |
| Masters | 39 | 36 | 33 | 36 | 34 | 29 | 25 | 34 | 266 |
| Doctorate | 20 | 6 | 10 | 10 | 17 | 7 | 8 | 9 | 87 |
| TOTAL | 856 | 805 | 777 | 811 | 760 | 811 | 798 | 831 | 6449 |

QUALIFICATION TRENDS BY POPULATION GROUP AND GENDER

| | | 1991 | 1992 | 1993 | 1994 | 1995 | 1996 | 1997 | 1998 | TOTAL |
|--------------|---|------------|------------|------------|------------|------------|------------|------------|------------|-------------|
| Asian | F | 18 | 15 | 27 | 47 | 27 | 28 | 30 | 28 | 220 |
| | M | 59 | 67 | 58 | 82 | 64 | 70 | 74 | 80 | 554 |
| African | F | 20 | 28 | 21 | 44 | 43 | 62 | 53 | 72 | 343 |
| | M | 74 | 95 | 109 | 130 | 164 | 182 | 191 | 192 | 1137 |
| Coloured | F | 8 | 10 | 7 | 12 | 6 | 6 | 4 | 7 | 60 |
| | M | 38 | 44 | 24 | 40 | 18 | 25 | 18 | 21 | 228 |
| White | F | 248 | 240 | 204 | 189 | 173 | 171 | 169 | 171 | 1565 |
| | M | 391 | 306 | 327 | 267 | 265 | 267 | 259 | 260 | 2342 |
| OVERALL | F | 294 | 293 | 259 | 292 | 249 | 267 | 256 | 278 | 2188 |
| | M | 562 | 512 | 518 | 519 | 511 | 544 | 542 | 553 | 4261 |
| TOTAL | | 856 | 805 | 777 | 811 | 760 | 811 | 798 | 831 | 6449 |

QUALIFICATION TRENDS BY CURRENT PROVINCE OF RESIDENCE

| | 1991 | 1992 | 1993 | 1994 | 1995 | 1996 | 1997 | 1998 | TOTAL |
|---------------|------------|------------|------------|------------|------------|------------|------------|------------|-------------|
| Western Cape | 153 | 138 | 106 | 116 | 136 | 104 | 98 | 109 | 960 |
| Northern Cape | 7 | 9 | 5 | 5 | 4 | 5 | 4 | 7 | 46 |
| Free State | 49 | 53 | 46 | 53 | 46 | 63 | 58 | 60 | 428 |
| Eastern Cape | 62 | 53 | 56 | 59 | 77 | 50 | 67 | 37 | 461 |
| KwaZulu-Natal | 71 | 80 | 106 | 127 | 67 | 72 | 75 | 84 | 682 |
| Mpumalanga | 10 | 17 | 24 | 12 | 25 | 23 | 20 | 19 | 150 |
| Northern Prov | 24 | 32 | 11 | 41 | 33 | 48 | 49 | 46 | 284 |
| Gauteng | 421 | 377 | 329 | 304 | 305 | 394 | 383 | 416 | 2929 |
| North West | 36 | 29 | 46 | 41 | 40 | 27 | 24 | 37 | 280 |
| Outside SA | 23 | 17 | 48 | 53 | 27 | 25 | 20 | 16 | 229 |
| TOTAL | 856 | 805 | 777 | 811 | 760 | 811 | 798 | 831 | 6449 |

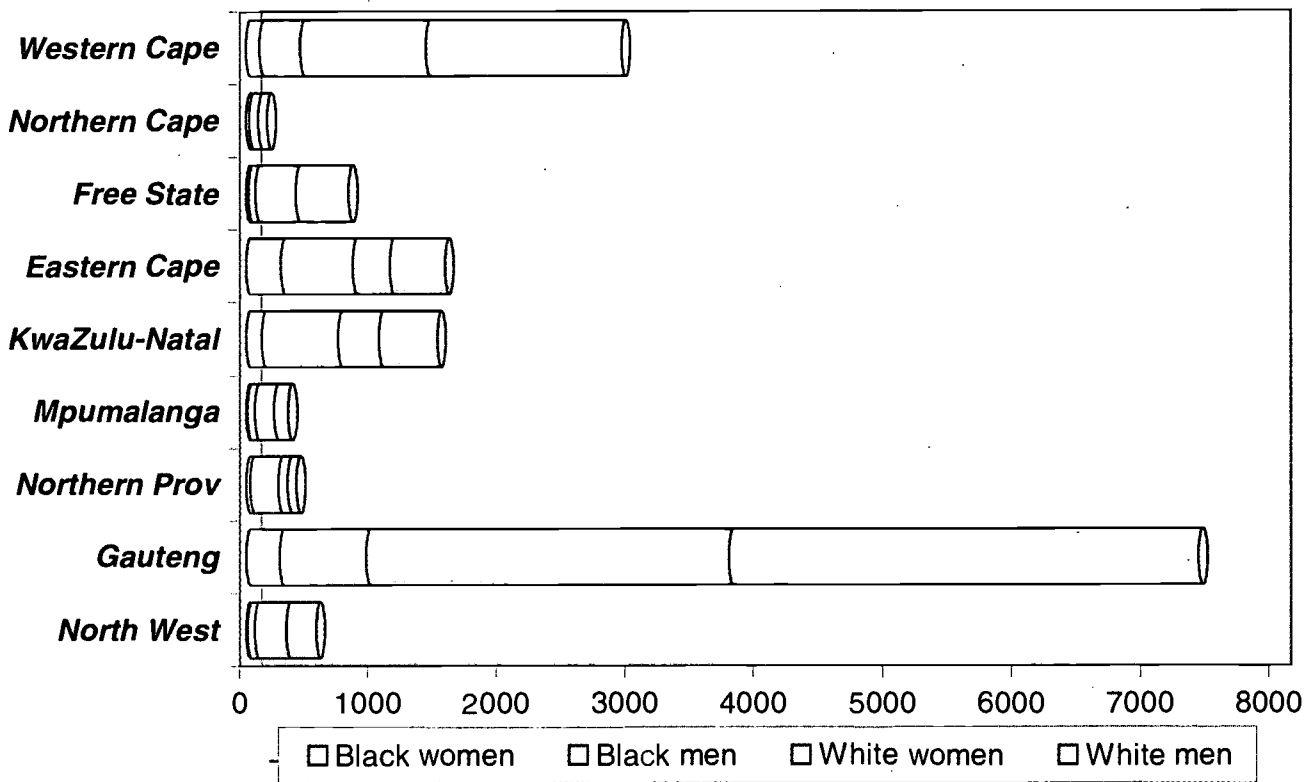
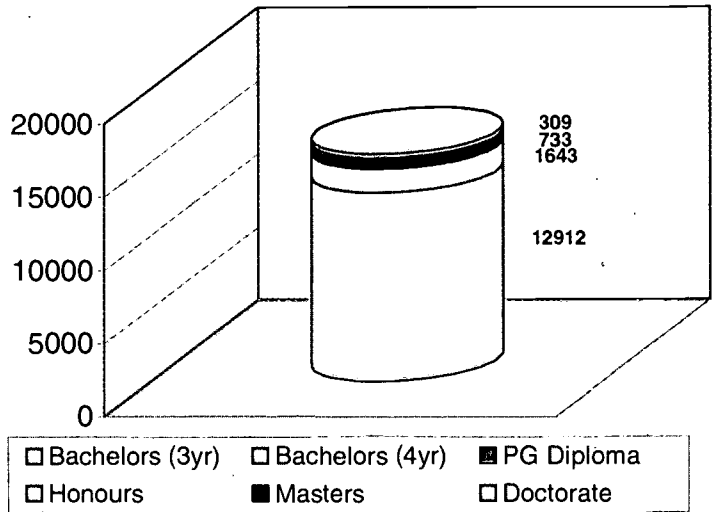
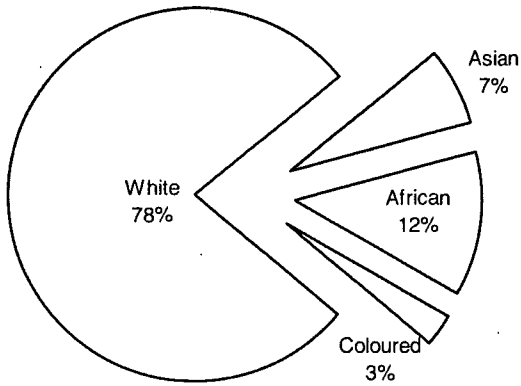

| | Asian | | African | | Coloured | | White | | OVERALL | | |
|---------------|-------------|------------|-------------|-------------|------------|------------|--------------|-------------|-------------|-------------|--------------|
| | Women | Men | Women | Men | Women | Men | Women | Men | Women | Men | TOTAL |
| Western Cape | 44 | 29 | 17 | 33 | 47 | 254 | 977 | 1521 | 1085 | 1837 | 2922 |
| Northern Cape | 2 | 3 | | 5 | 1 | 16 | 70 | 71 | 73 | 95 | 168 |
| Free State | 2 | | 17 | 45 | | 10 | 316 | 412 | 335 | 467 | 802 |
| Eastern Cape | 17 | 78 | 242 | 439 | 13 | 45 | 287 | 430 | 559 | 992 | 1551 |
| KwaZulu-Natal | 100 | 430 | 23 | 145 | 1 | 19 | 319 | 452 | 443 | 1046 | 1489 |
| Mpumalanga | 4 | 7 | 6 | 53 | | | 150 | 108 | 160 | 168 | 328 |
| Northern Prov | 6 | 2 | 26 | 216 | | | 74 | 67 | 106 | 285 | 391 |
| Gauteng | 107 | 174 | 142 | 475 | 13 | 27 | 2816 | 3649 | 3078 | 4325 | 7403 |
| North West | 4 | 14 | 6 | 45 | | | 244 | 231 | 254 | 290 | 544 |
| TOTAL | 286 | 737 | 479 | 1456 | 75 | 371 | 5253 | 6941 | 6093 | 9505 | 15598 |
| | 1023 | | 1935 | | 446 | | 12194 | | | | |

BIOLOGICAL SCIENCES

This category includes Botany, Zoology, Biophysics, Environmental Science and Biochemistry, as well as non-agricultural Soil Science and non-medical Anatomy, Physiology and Pathology.

QUALIFICATION TRENDS BY LEVEL

| | 1991 | 1992 | 1993 | 1994 | 1995 | 1996 | 1997 | 1998 | TOTAL |
|-----------------|------|------|------|------|------|------|------|------|-------|
| Bachelors (3yr) | 1345 | 1339 | 1354 | 1477 | 1578 | 1620 | 1494 | 1537 | 11742 |
| Bachelors (4yr) | 1 | 1 | 11 | 6 | 3 | 13 | 11 | 10 | 56 |
| PG Diploma | | | | | | | | | 0 |
| Honours | 378 | 433 | 373 | 410 | 429 | 427 | 454 | 527 | 3431 |
| Masters | 146 | 227 | 168 | 153 | 195 | 206 | 187 | 200 | 1482 |
| Doctorate | 71 | 70 | 52 | 65 | 53 | 46 | 46 | 47 | 450 |
| TOTAL | 1941 | 2070 | 1958 | 2111 | 2256 | 2312 | 2192 | 2321 | 17161 |

QUALIFICATION TRENDS BY POPULATION GROUP AND GENDER

| | | 1991 | 1992 | 1993 | 1994 | 1995 | 1996 | 1997 | 1998 | TOTAL |
|----------|---|------|------|------|------|------|------|------|------|-------|
| Asian | F | 41 | 89 | 57 | 87 | 106 | 125 | 128 | 131 | 764 |
| | M | 44 | 93 | 59 | 71 | 70 | 97 | 87 | 100 | 621 |
| African | F | 59 | 95 | 99 | 164 | 203 | 222 | 243 | 259 | 1344 |
| | M | 108 | 161 | 154 | 215 | 238 | 244 | 225 | 263 | 1608 |
| Coloured | F | 56 | 67 | 60 | 98 | 93 | 56 | 74 | 78 | 582 |
| | M | 67 | 92 | 50 | 75 | 77 | 42 | 46 | 49 | 498 |
| White | F | 870 | 784 | 804 | 798 | 835 | 858 | 799 | 838 | 6586 |
| | M | 696 | 689 | 675 | 603 | 634 | 668 | 590 | 603 | 5158 |
| OVERALL | F | 1026 | 1035 | 1020 | 1147 | 1237 | 1261 | 1244 | 1306 | 9276 |
| | M | 915 | 1035 | 938 | 964 | 1019 | 1051 | 948 | 1015 | 7885 |
| TOTAL | | 1941 | 2070 | 1958 | 2111 | 2256 | 2312 | 2192 | 2321 | 17161 |

QUALIFICATION TRENDS BY CURRENT PROVINCE OF RESIDENCE

| | 1991 | 1992 | 1993 | 1994 | 1995 | 1996 | 1997 | 1998 | TOTAL |
|---------------|------|------|------|------|------|------|------|------|-------|
| Western Cape | 431 | 417 | 416 | 435 | 514 | 381 | 355 | 351 | 3300 |
| Northern Cape | 29 | 41 | 35 | 31 | 31 | 29 | 29 | 29 | 254 |
| Free State | 125 | 133 | 137 | 143 | 148 | 145 | 150 | 130 | 1111 |
| Eastern Cape | 154 | 182 | 174 | 217 | 181 | 218 | 177 | 223 | 1526 |
| KwaZulu-Natal | 252 | 310 | 302 | 320 | 342 | 375 | 343 | 378 | 2622 |
| Mpumalanga | 59 | 64 | 68 | 38 | 38 | 49 | 37 | 37 | 390 |
| Northern Prov | 52 | 56 | 60 | 73 | 53 | 57 | 66 | 70 | 487 |
| Gauteng | 700 | 680 | 589 | 685 | 737 | 864 | 844 | 905 | 6004 |
| North West | 67 | 109 | 108 | 119 | 139 | 143 | 156 | 161 | 1002 |
| Outside SA | 72 | 78 | 69 | 50 | 73 | 51 | 35 | 37 | 465 |
| TOTAL | 1941 | 2070 | 1958 | 2111 | 2256 | 2312 | 2192 | 2321 | 17161 |

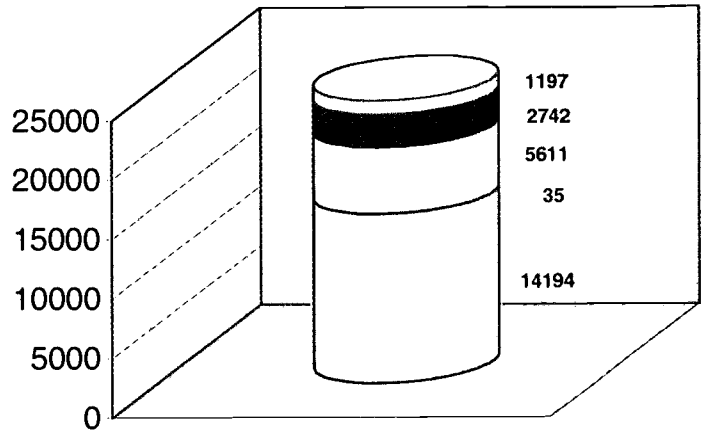
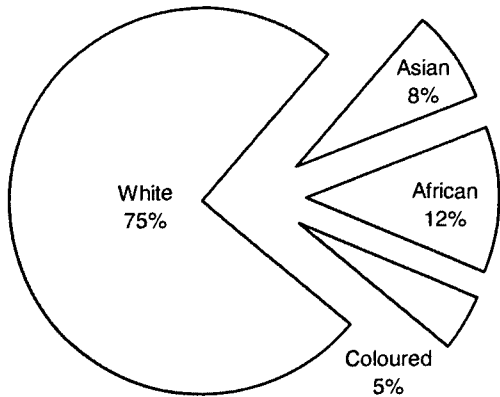

Bachelors (3yr)
 Bachelors (4yr)
 PG Diploma
 Honours
 Masters
 Doctorate

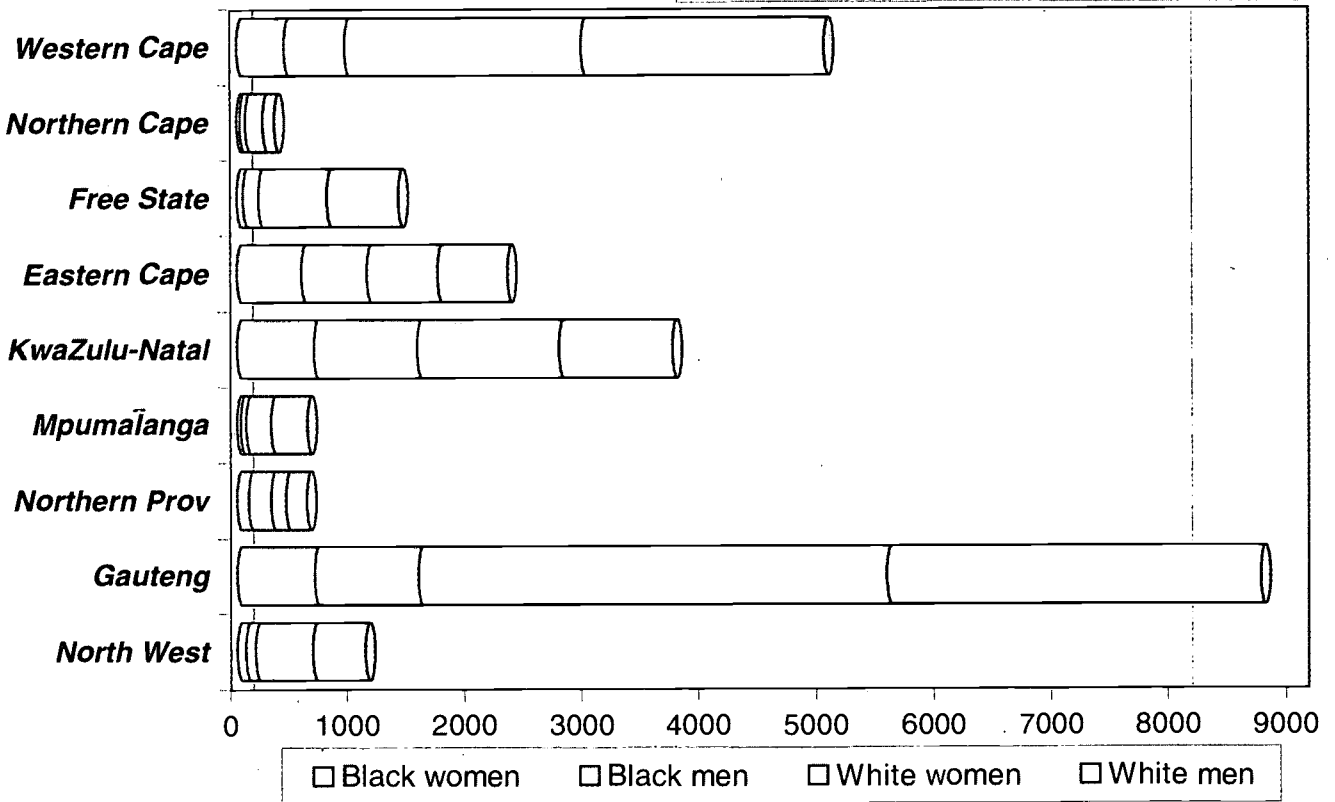

| | Asian | | African | | Coloured | | White | | OVERALL | | TOTAL |
|---------------|-------------|-------------|-------------|-------------|-------------|------------|--------------|-------------|--------------|--------------|--------------|
| | Women | Men | Women | Men | Women | Men | Women | Men | Women | Men | |
| Western Cape | 46 | 62 | 43 | 25 | 317 | 433 | 2017 | 2071 | 2423 | 2591 | 5014 |
| Northern Cape | 2 | 6 | 7 | 12 | 15 | 30 | 152 | 99 | 176 | 147 | 323 |
| Free State | | 7 | 49 | 118 | 3 | 8 | 589 | 608 | 641 | 741 | 1382 |
| Eastern Cape | 16 | 50 | 489 | 430 | 44 | 81 | 610 | 594 | 1159 | 1155 | 2314 |
| KwaZulu-Natal | 487 | 665 | 141 | 198 | 29 | 22 | 1208 | 971 | 1865 | 1856 | 3721 |
| Mpumalanga | 7 | 21 | 23 | 27 | | 1 | 211 | 313 | 241 | 362 | 603 |
| Northern Prov | 8 | 11 | 84 | 182 | 4 | | 130 | 180 | 226 | 373 | 599 |
| Gauteng | 199 | 292 | 404 | 543 | 59 | 53 | 3992 | 3189 | 4654 | 4077 | 8731 |
| North West | 8 | 7 | 62 | 71 | 3 | 6 | 493 | 445 | 566 | 529 | 1095 |
| TOTAL | 773 | 1121 | 1302 | 1606 | 474 | 634 | 9402 | 8470 | 11951 | 11831 | 23782 |
| | 1894 | | 2908 | | 1108 | | 17872 | | | | |

PHYSICAL AND CHEMICAL SCIENCES

This category also includes Metallurgy.

QUALIFICATION TRENDS BY LEVEL

| | 1991 | 1992 | 1993 | 1994 | 1995 | 1996 | 1997 | 1998 | TOTAL |
|-----------------|------------|------------|------------|------------|------------|------------|------------|------------|-------------|
| Bachelors (3yr) | 467 | 458 | 494 | 494 | 465 | 473 | 443 | 459 | 3753 |
| Bachelors (4yr) | 1 | 1 | 1 | 1 | 3 | | | | 7 |
| PG Diploma | | | | 5 | 8 | 4 | 2 | 2 | 21 |
| Honours | 177 | 196 | 143 | 149 | 172 | 190 | 169 | 207 | 1403 |
| Masters | 84 | 81 | 88 | 76 | 87 | 60 | 61 | 73 | 610 |
| Doctorate | 55 | 49 | 49 | 31 | 44 | 25 | 27 | 29 | 309 |
| TOTAL | 784 | 785 | 775 | 756 | 779 | 752 | 702 | 770 | 6103 |

QUALIFICATION TRENDS BY POPULATION GROUP AND GENDER

| | | 1991 | 1992 | 1993 | 1994 | 1995 | 1996 | 1997 | 1998 | TOTAL |
|--------------|---|------------|------------|------------|------------|------------|------------|------------|------------|-------------|
| Asian | F | 27 | 27 | 30 | 35 | 39 | 43 | 46 | 49 | 296 |
| | M | 38 | 44 | 51 | 51 | 57 | 48 | 56 | 56 | 401 |
| African | F | 21 | 23 | 16 | 55 | 58 | 67 | 64 | 73 | 377 |
| | M | 69 | 76 | 102 | 132 | 127 | 173 | 157 | 179 | 1015 |
| Coloured | F | 3 | 7 | 9 | 8 | 9 | 5 | 6 | 7 | 54 |
| | M | 21 | 27 | 23 | 30 | 23 | 23 | 18 | 21 | 186 |
| White | F | 243 | 247 | 235 | 191 | 181 | 186 | 154 | 165 | 1602 |
| | M | 362 | 334 | 309 | 254 | 285 | 207 | 201 | 220 | 2172 |
| OVERALL | F | 294 | 304 | 290 | 289 | 287 | 301 | 270 | 294 | 2329 |
| | M | 490 | 481 | 485 | 467 | 492 | 451 | 432 | 476 | 3774 |
| TOTAL | | 784 | 785 | 775 | 756 | 779 | 752 | 702 | 770 | 6103 |

QUALIFICATION TRENDS BY CURRENT PROVINCE OF RESIDENCE

| | 1991 | 1992 | 1993 | 1994 | 1995 | 1996 | 1997 | 1998 | TOTAL |
|---------------|------------|------------|------------|------------|------------|------------|------------|------------|-------------|
| Western Cape | 133 | 113 | 92 | 79 | 114 | 95 | 84 | 84 | 794 |
| Northern Cape | 12 | 18 | 10 | 5 | 12 | 6 | 15 | 14 | 92 |
| Free State | 38 | 60 | 61 | 68 | 72 | 57 | 67 | 67 | 490 |
| Eastern Cape | 82 | 94 | 86 | 120 | 97 | 95 | 75 | 84 | 733 |
| KwaZulu-Natal | 110 | 97 | 163 | 116 | 108 | 112 | 105 | 116 | 927 |
| Mpumalanga | 10 | 13 | 10 | 7 | 19 | 11 | 19 | 14 | 103 |
| Northern Prov | 26 | 25 | 24 | 35 | 28 | 46 | 32 | 47 | 263 |
| Gauteng | 332 | 315 | 280 | 260 | 264 | 271 | 265 | 297 | 2284 |
| North West | 26 | 37 | 25 | 46 | 47 | 44 | 34 | 41 | 300 |
| Outside SA | 15 | 13 | 24 | 20 | 18 | 15 | 6 | 6 | 117 |
| TOTAL | 784 | 785 | 775 | 756 | 779 | 752 | 702 | 770 | 6103 |

TOTAL AVAILABILITY

PHYSICAL AND CHEMICAL SCIENCES

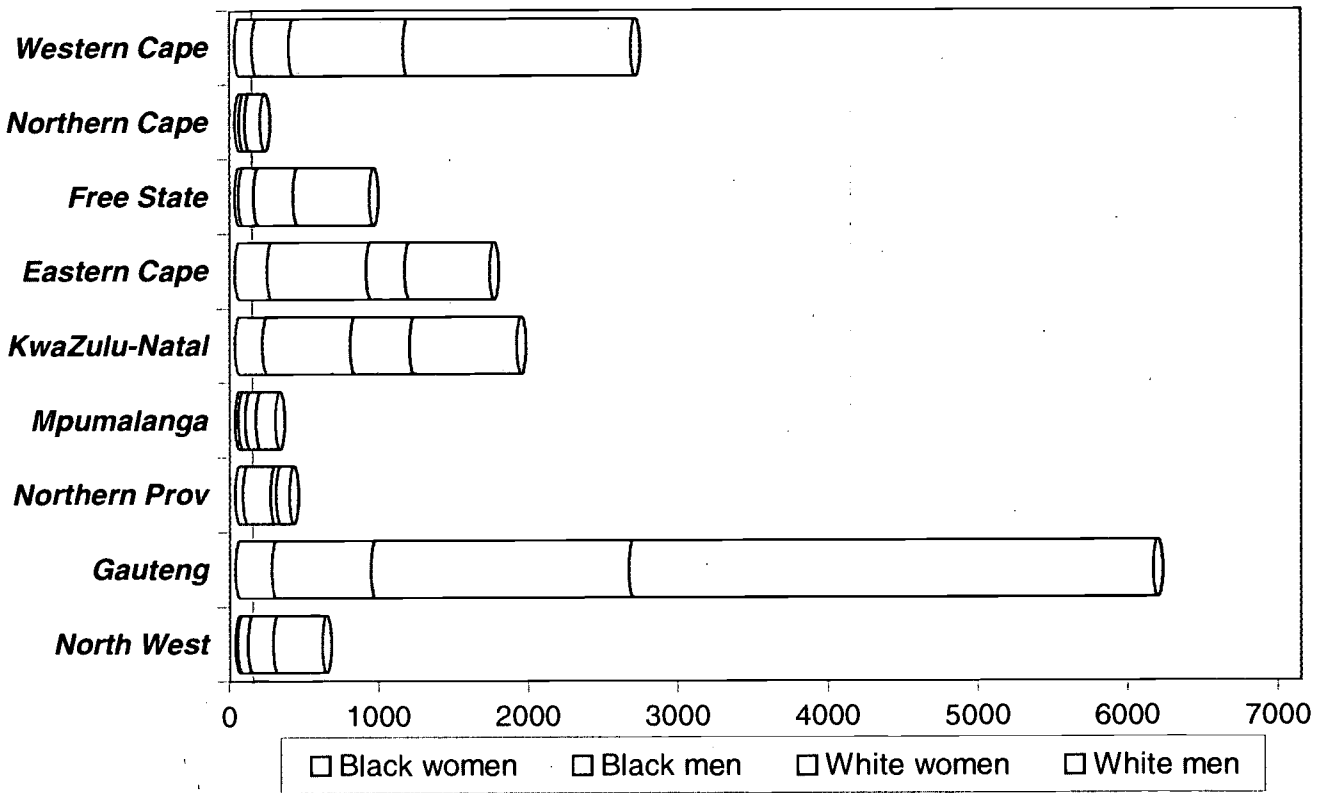
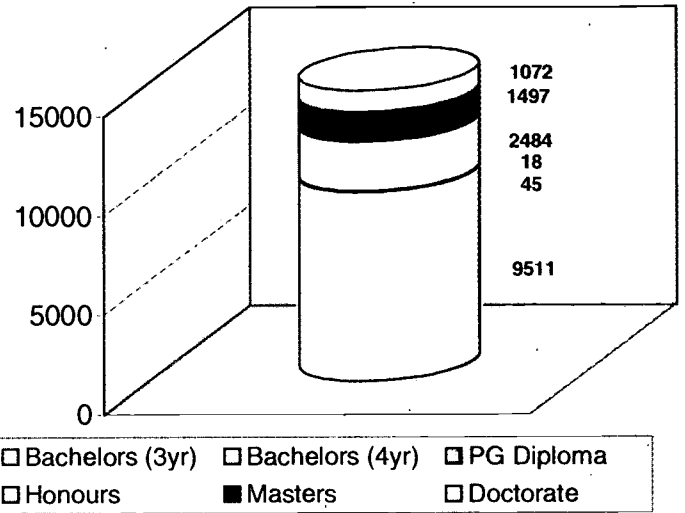
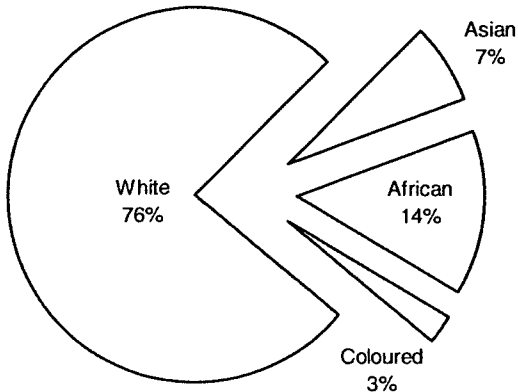

| | Asian | | African | | Coloured | | White | | OVERALL | | TOTAL |
|---------------|------------|------------|-------------|-------------|------------|------------|--------------|-------------|-------------|--------------|--------------|
| | Women | Men | Women | Men | Women | Men | Women | Men | Women | Men | |
| Western Cape | 34 | 36 | 24 | 33 | 57 | 175 | 765 | 1520 | 880 | 1764 | 2644 |
| Northern Cape | | 3 | | 13 | 2 | 10 | 37 | 104 | 39 | 130 | 169 |
| Free State | | 1 | 23 | 93 | | 6 | 264 | 510 | 287 | 610 | 897 |
| Eastern Cape | 14 | 41 | 181 | 581 | 15 | 43 | 260 | 566 | 470 | 1231 | 1701 |
| KwaZulu-Natal | 150 | 443 | 25 | 127 | 5 | 17 | 399 | 716 | 579 | 1303 | 1882 |
| Mpumalanga | 7 | 7 | 14 | 39 | | | 69 | 130 | 90 | 176 | 266 |
| Northern Prov | 7 | 4 | 44 | 176 | | | 38 | 92 | 89 | 272 | 361 |
| Gauteng | 77 | 144 | 157 | 485 | 7 | 36 | 1718 | 3501 | 1959 | 4166 | 6125 |
| North West | 7 | 11 | 6 | 57 | | | 169 | 330 | 182 | 398 | 580 |
| TOTAL | 296 | 690 | 474 | 1604 | 86 | 287 | 3719 | 7469 | 4575 | 10050 | 14625 |
| | 986 | | 2078 | | 373 | | 11188 | | | | |

All graduates with any Engineering qualifications are shown in this category. Those with known Engineering specialisations are repeated in the specialised categories.

QUALIFICATION TRENDS BY LEVEL

| | 1991 | 1992 | 1993 | 1994 | 1995 | 1996 | 1997 | 1998 | TOTAL |
|-----------------|-------------|-------------|-------------|-------------|-------------|-------------|-------------|-------------|--------------|
| Bachelors (3yr) | 10 | 8 | 5 | 79 | 226 | 279 | 61 | 88 | 746 |
| Bachelors (4yr) | 1156 | 1379 | 1397 | 1463 | 1519 | 1225 | 1399 | 1428 | 10966 |
| PG Diploma | 83 | 108 | 72 | 84 | 112 | 111 | 108 | 112 | 790 |
| Honours | 94 | 97 | 119 | 138 | 128 | 111 | 126 | 123 | 936 |
| Masters | 274 | 240 | 243 | 248 | 379 | 313 | 310 | 342 | 2349 |
| Doctorate | 53 | 40 | 39 | 55 | 76 | 44 | 45 | 54 | 406 |
| TOTAL | 1670 | 1867 | 1875 | 2067 | 2440 | 2083 | 2049 | 2142 | 16193 |

QUALIFICATION TRENDS BY POPULATION GROUP AND GENDER

| | | 1991 | 1992 | 1993 | 1994 | 1995 | 1996 | 1997 | 1998 | TOTAL |
|--------------|---|-------------|-------------|-------------|-------------|-------------|-------------|-------------|-------------|--------------|
| Asian | F | 5 | 10 | 11 | 13 | 30 | 36 | 38 | 41 | 184 |
| | M | 62 | 99 | 100 | 151 | 191 | 191 | 186 | 200 | 1180 |
| African | F | 4 | 5 | 1 | 2 | 5 | 10 | 13 | 18 | 58 |
| | M | 36 | 60 | 62 | 90 | 130 | 151 | 155 | 181 | 865 |
| Coloured | F | 3 | 2 | 2 | 1 | 3 | 10 | 8 | 11 | 40 |
| | M | 11 | 34 | 37 | 45 | 42 | 52 | 43 | 39 | 303 |
| White | F | 74 | 120 | 129 | 141 | 176 | 147 | 127 | 141 | 1055 |
| | M | 1475 | 1537 | 1533 | 1624 | 1863 | 1486 | 1479 | 1511 | 12508 |
| OVERALL | F | 86 | 137 | 143 | 157 | 214 | 203 | 186 | 211 | 1337 |
| | M | 1584 | 1730 | 1732 | 1910 | 2226 | 1880 | 1863 | 1931 | 14856 |
| TOTAL | | 1670 | 1867 | 1875 | 2067 | 2440 | 2083 | 2049 | 2142 | 16193 |

QUALIFICATION TRENDS BY CURRENT PROVINCE OF RESIDENCE

| | 1991 | 1992 | 1993 | 1994 | 1995 | 1996 | 1997 | 1998 | TOTAL |
|---------------|-------------|-------------|-------------|-------------|-------------|-------------|-------------|-------------|--------------|
| Western Cape | 248 | 278 | 277 | 347 | 524 | 341 | 320 | 338 | 2673 |
| Northern Cape | 9 | 18 | 21 | 15 | 21 | 12 | 29 | 27 | 152 |
| Free State | 68 | 81 | 81 | 117 | 104 | 82 | 70 | 75 | 678 |
| Eastern Cape | 44 | 44 | 56 | 64 | 45 | 49 | 41 | 42 | 385 |
| KwaZulu-Natal | 124 | 163 | 170 | 203 | 215 | 244 | 196 | 190 | 1505 |
| Mpumalanga | 80 | 95 | 91 | 117 | 133 | 100 | 122 | 120 | 858 |
| Northern Prov | 8 | 26 | 27 | 26 | 27 | 36 | 15 | 21 | 186 |
| Gauteng | 1012 | 1037 | 1044 | 1087 | 1248 | 1113 | 1157 | 1224 | 8922 |
| North West | 30 | 65 | 58 | 40 | 56 | 70 | 70 | 72 | 461 |
| Outside SA | 47 | 60 | 50 | 51 | 67 | 36 | 29 | 33 | 373 |
| TOTAL | 1670 | 1867 | 1875 | 2067 | 2440 | 2083 | 2049 | 2142 | 16193 |

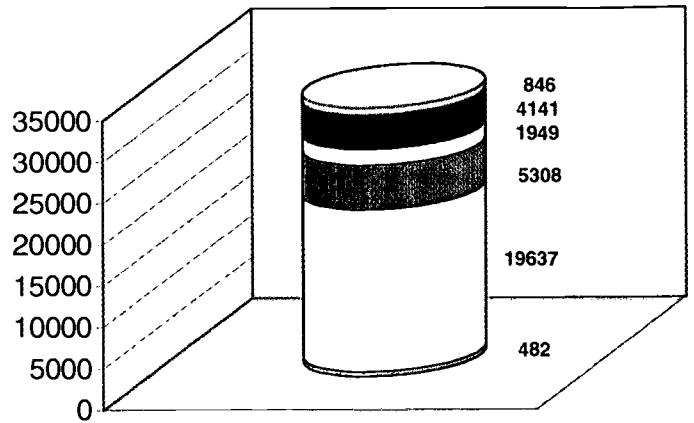
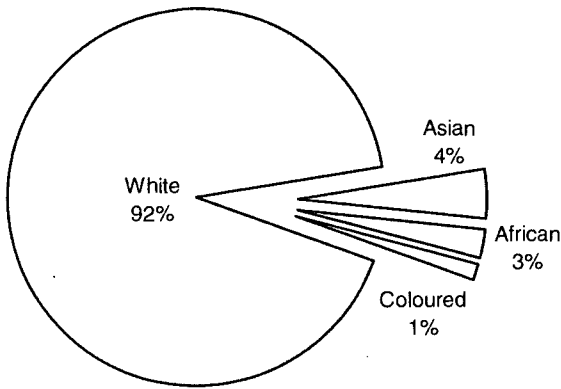

Bachelors (3yr) Bachelors (4yr) PG Diploma
 Honours Masters Doctorate

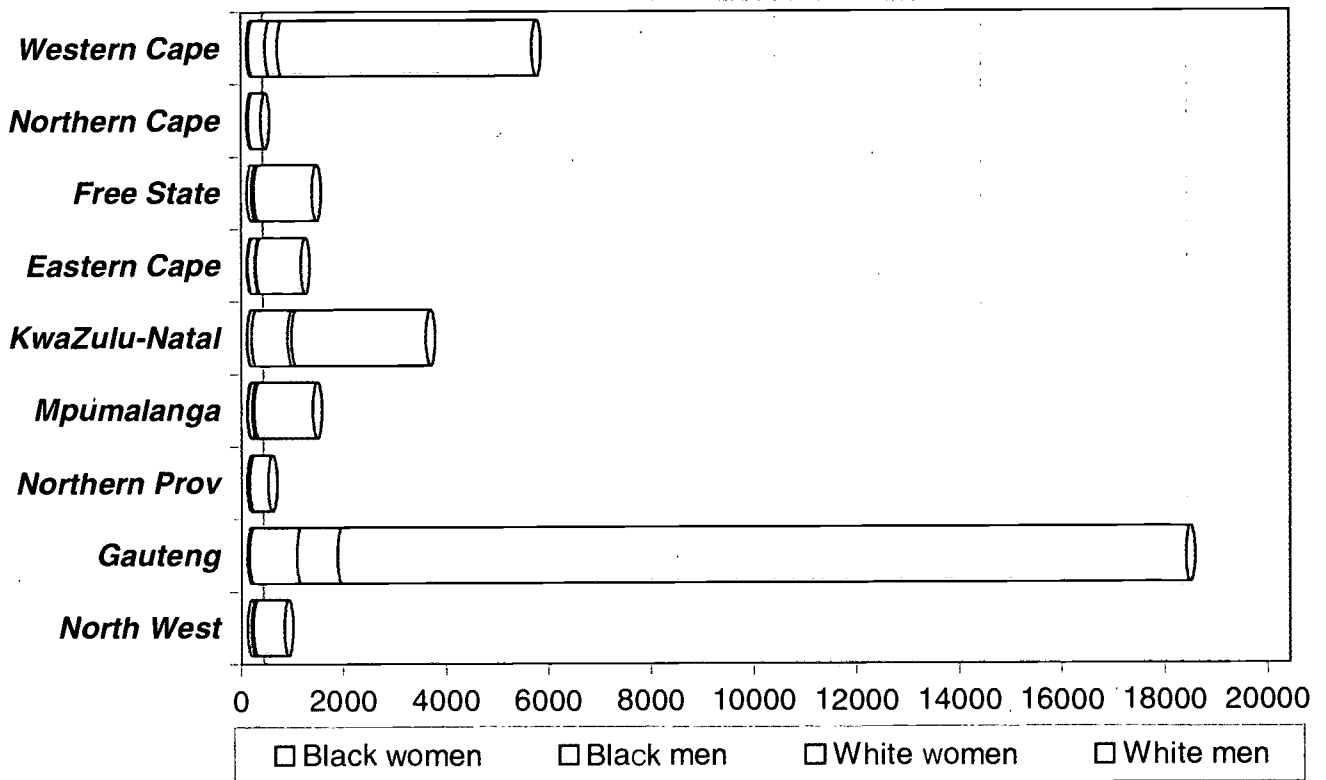

| | Asian | | African | | Coloured | | White | | OVERALL | | TOTAL |
|---------------|-------------|-------------|------------|------------|------------|------------|--------------|--------------|-------------|--------------|--------------|
| | Women | Men | Women | Men | Women | Men | Women | Men | Women | Men | |
| Western Cape | 13 | 66 | 3 | 44 | 17 | 222 | 236 | 4971 | 269 | 5303 | 5572 |
| Northern Cape | | 2 | | 5 | | 8 | 8 | 250 | 8 | 265 | 273 |
| Free State | | 44 | | 39 | | | 57 | 1138 | 57 | 1221 | 1278 |
| Eastern Cape | 13 | 18 | 6 | 93 | | 25 | 19 | 877 | 38 | 1013 | 1051 |
| KwaZulu-Natal | 89 | 577 | | 91 | 2 | 31 | 72 | 2636 | 163 | 3335 | 3498 |
| Mpumalanga | 6 | 32 | 6 | 49 | | 8 | 40 | 1150 | 52 | 1239 | 1291 |
| Northern Prov | | | | 41 | | 2 | 8 | 356 | 10 | 397 | 407 |
| Gauteng | 16 | 457 | 21 | 368 | 5 | 100 | 789 | 16527 | 831 | 17452 | 18283 |
| North West | | 28 | 3 | 41 | | 6 | 36 | 597 | 39 | 672 | 711 |
| TOTAL | 137 | 1224 | 39 | 771 | 26 | 400 | 1265 | 28502 | 1467 | 30897 | 32364 |
| | 1361 | | 810 | | 426 | | 29767 | | | | |

QUALIFICATION TRENDS BY LEVEL

| | 1991 | 1992 | 1993 | 1994 | 1995 | 1996 | 1997 | 1998 | TOTAL |
|-----------------|------------|------------|------------|------------|------------|------------|------------|------------|-------------|
| Bachelors (3yr) | 2 | | 1 | 6 | | | | | 9 |
| Bachelors (4yr) | 278 | 382 | 360 | 346 | 384 | 283 | 288 | 326 | 2647 |
| PG Diploma | | | | | | | | | 0 |
| Honours | 9 | 10 | 18 | 4 | 12 | 14 | 13 | 13 | 93 |
| Masters | 45 | 46 | 34 | 55 | 70 | 53 | 54 | 60 | 417 |
| Doctorate | 5 | 4 | 8 | 8 | 7 | 4 | 8 | 8 | 52 |
| TOTAL | 339 | 442 | 421 | 419 | 473 | 354 | 363 | 407 | 3218 |

QUALIFICATION TRENDS BY POPULATION GROUP AND GENDER

| | | 1991 | 1992 | 1993 | 1994 | 1995 | 1996 | 1997 | 1998 | TOTAL |
|--------------|---|------------|------------|------------|------------|------------|------------|------------|------------|-------------|
| Asian | F | | | 1 | | 4 | 4 | 2 | 4 | 15 |
| | M | 12 | 16 | 19 | 15 | 24 | 23 | 25 | 23 | 157 |
| African | F | | 1 | | | 1 | | | 2 | 4 |
| | M | 6 | 11 | 14 | 13 | 19 | 12 | 11 | 28 | 114 |
| Coloured | F | | | | | | | | 1 | 1 |
| | M | | 4 | 6 | 5 | 3 | 3 | 3 | 8 | 32 |
| White | F | 7 | 9 | 7 | 9 | 12 | 11 | 6 | 6 | 67 |
| | M | 314 | 401 | 374 | 377 | 410 | 301 | 316 | 335 | 2828 |
| OVERALL | F | 7 | 10 | 8 | 9 | 17 | 15 | 8 | 13 | 87 |
| | M | 332 | 432 | 413 | 410 | 456 | 339 | 355 | 394 | 3131 |
| TOTAL | | 339 | 442 | 421 | 419 | 473 | 354 | 363 | 407 | 3218 |

QUALIFICATION TRENDS BY CURRENT PROVINCE OF RESIDENCE

| | 1991 | 1992 | 1993 | 1994 | 1995 | 1996 | 1997 | 1998 | TOTAL |
|---------------|------------|------------|------------|------------|------------|------------|------------|------------|-------------|
| Western Cape | 53 | 69 | 74 | 71 | 71 | 52 | 50 | 51 | 491 |
| Northern Cape | 3 | 3 | 6 | 8 | 3 | | | | 23 |
| Free State | 12 | 14 | 15 | 26 | 24 | 14 | 11 | 12 | 128 |
| Eastern Cape | 9 | 17 | 8 | 16 | 16 | 7 | 6 | 6 | 85 |
| KwaZulu-Natal | 31 | 35 | 28 | 30 | 44 | 35 | 28 | 31 | 262 |
| Mpumalanga | 28 | 33 | 34 | 26 | 45 | 21 | 44 | 45 | 276 |
| Northern Prov | | 9 | 8 | 6 | 5 | 14 | 3 | 6 | 51 |
| Gauteng | 181 | 229 | 216 | 212 | 231 | 187 | 180 | 208 | 1644 |
| North West | 12 | 17 | 17 | 12 | 16 | 7 | 22 | 27 | 130 |
| Outside SA | 10 | 16 | 15 | 12 | 18 | 17 | 19 | 21 | 128 |
| TOTAL | 339 | 442 | 421 | 419 | 473 | 354 | 363 | 407 | 3218 |

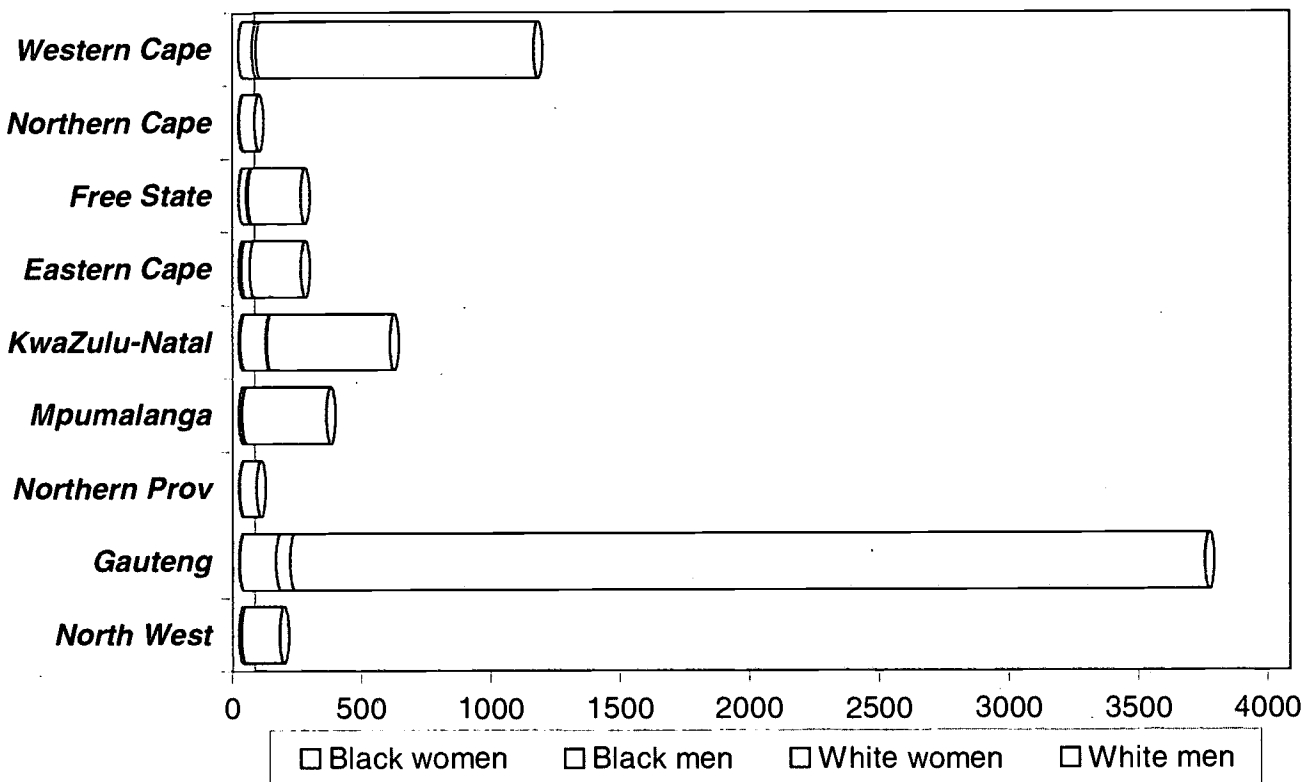
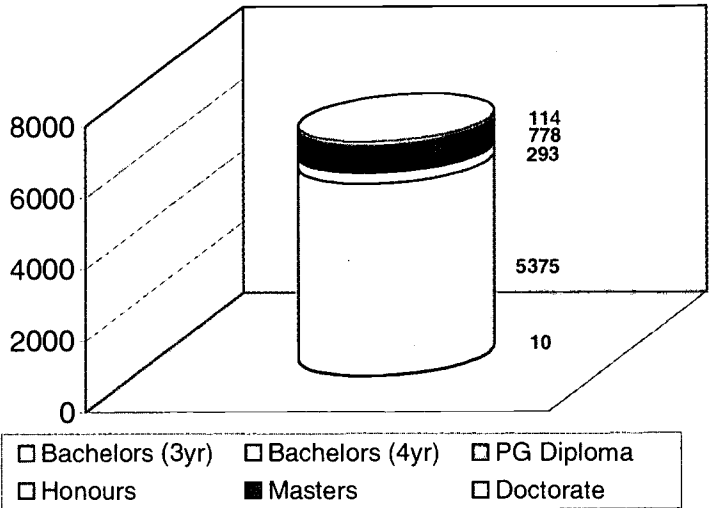
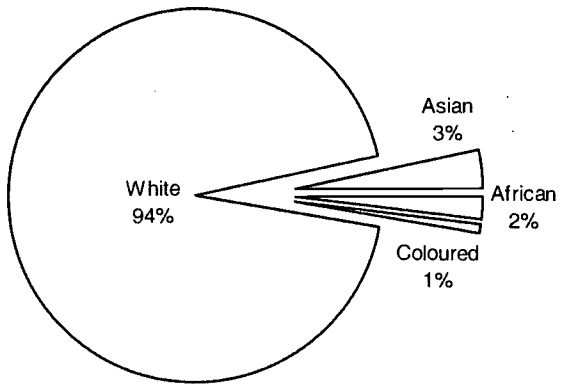

| | Asian | | African | | Coloured | | White | | OVERALL | | TOTAL | | |
|---------------|------------|------------|------------|------------|-----------|-----------|-------------|-------------|------------|-------------|-------------|-------------|------|
| | Women | Men | Women | Men | Women | Men | Women | Men | Women | Men | | | |
| Western Cape | | 12 | | 10 | | 31 | | 14 | 1076 | 14 | 1129 | 1143 | |
| Northern Cape | | 2 | | | | 2 | | | 59 | 0 | 63 | 63 | |
| Free State | | 18 | | 12 | | | | 5 | 205 | 5 | 235 | 240 | |
| Eastern Cape | 10 | 8 | | 15 | | 10 | | | 198 | 10 | 231 | 241 | |
| KwaZulu-Natal | 6 | 80 | | 12 | | 6 | | 5 | 474 | 11 | 572 | 583 | |
| Mpumalanga | | 2 | | 7 | | 2 | | 2 | 327 | 2 | 338 | 340 | |
| Northern Prov | | | | 2 | | | | 2 | 66 | 2 | 68 | 70 | |
| Gauteng | | 84 | | 3 | | 46 | | 12 | 54 | 3533 | 57 | 3675 | 3732 |
| North West | | 2 | | 5 | | | | 2 | 149 | 2 | 156 | 158 | |
| TOTAL | 16 | 208 | 3 | 109 | 0 | 63 | 84 | 6087 | 103 | 6467 | 6570 | | |
| | 224 | | 112 | | 63 | | 6171 | | | | | 6570 | |

This category also includes Structural and Transport Engineering.

QUALIFICATION TRENDS BY LEVEL

| | 1991 | 1992 | 1993 | 1994 | 1995 | 1996 | 1997 | 1998 | TOTAL |
|-----------------|------------|------------|------------|------------|------------|------------|------------|------------|-------------|
| Bachelors (3yr) | 2 | | | 4 | | 1 | | | 7 |
| Bachelors (4yr) | 144 | 182 | 197 | 185 | 201 | 155 | 171 | 205 | 1440 |
| PG Diploma | | | | | | | | | 0 |
| Honours | 21 | 27 | 29 | 10 | 19 | 15 | 20 | 19 | 160 |
| Masters | 38 | 55 | 47 | 41 | 38 | 25 | 31 | 32 | 307 |
| Doctorate | 11 | 9 | 4 | 6 | 8 | 8 | 5 | 6 | 57 |
| TOTAL | 216 | 273 | 277 | 246 | 266 | 204 | 227 | 262 | 1971 |

QUALIFICATION TRENDS BY POPULATION GROUP AND GENDER

| | | 1991 | 1992 | 1993 | 1994 | 1995 | 1996 | 1997 | 1998 | TOTAL |
|--------------|---|------------|------------|------------|------------|------------|------------|------------|------------|-------------|
| Asian | F | | 1 | 4 | 1 | | | 1 | | 7 |
| | M | 3 | 4 | 19 | 7 | 16 | 9 | 10 | 12 | 80 |
| African | F | | 2 | | | | 1 | 1 | 3 | 7 |
| | M | 5 | 6 | 9 | 11 | 10 | 10 | 11 | 15 | 77 |
| Coloured | F | | | 1 | | | | | 1 | 2 |
| | M | 1 | 2 | 10 | 6 | | 3 | 2 | 6 | 30 |
| White | F | 9 | 23 | 16 | 18 | 24 | 17 | 22 | 25 | 154 |
| | M | 198 | 235 | 218 | 203 | 216 | 164 | 180 | 200 | 1614 |
| OVERALL | F | 9 | 26 | 21 | 19 | 24 | 18 | 24 | 29 | 170 |
| | M | 207 | 247 | 256 | 227 | 242 | 186 | 203 | 233 | 1801 |
| TOTAL | | 216 | 273 | 277 | 246 | 266 | 204 | 227 | 262 | 1971 |

QUALIFICATION TRENDS BY CURRENT PROVINCE OF RESIDENCE

| | 1991 | 1992 | 1993 | 1994 | 1995 | 1996 | 1997 | 1998 | TOTAL |
|---------------|------------|------------|------------|------------|------------|------------|------------|------------|-------------|
| Western Cape | 39 | 41 | 43 | 35 | 69 | 24 | 35 | 44 | 330 |
| Northern Cape | 3 | 2 | 2 | | | | | | 7 |
| Free State | 9 | 5 | 26 | 19 | 7 | 9 | 9 | 10 | 94 |
| Eastern Cape | 14 | 11 | 21 | 11 | 5 | 6 | 3 | 3 | 74 |
| KwaZulu-Natal | 15 | 29 | 40 | 28 | 29 | 27 | 35 | 40 | 243 |
| Mpumalanga | 2 | | 9 | 5 | 7 | | 9 | 10 | 42 |
| Northern Prov | 2 | 9 | 4 | 5 | 2 | 9 | 6 | 7 | 44 |
| Gauteng | 119 | 149 | 122 | 130 | 133 | 126 | 124 | 141 | 1044 |
| North West | 2 | 5 | 4 | 2 | 2 | | | | 15 |
| Outside SA | 11 | 22 | 6 | 11 | 12 | 3 | 6 | 7 | 78 |
| TOTAL | 216 | 273 | 277 | 246 | 266 | 204 | 227 | 262 | 1971 |

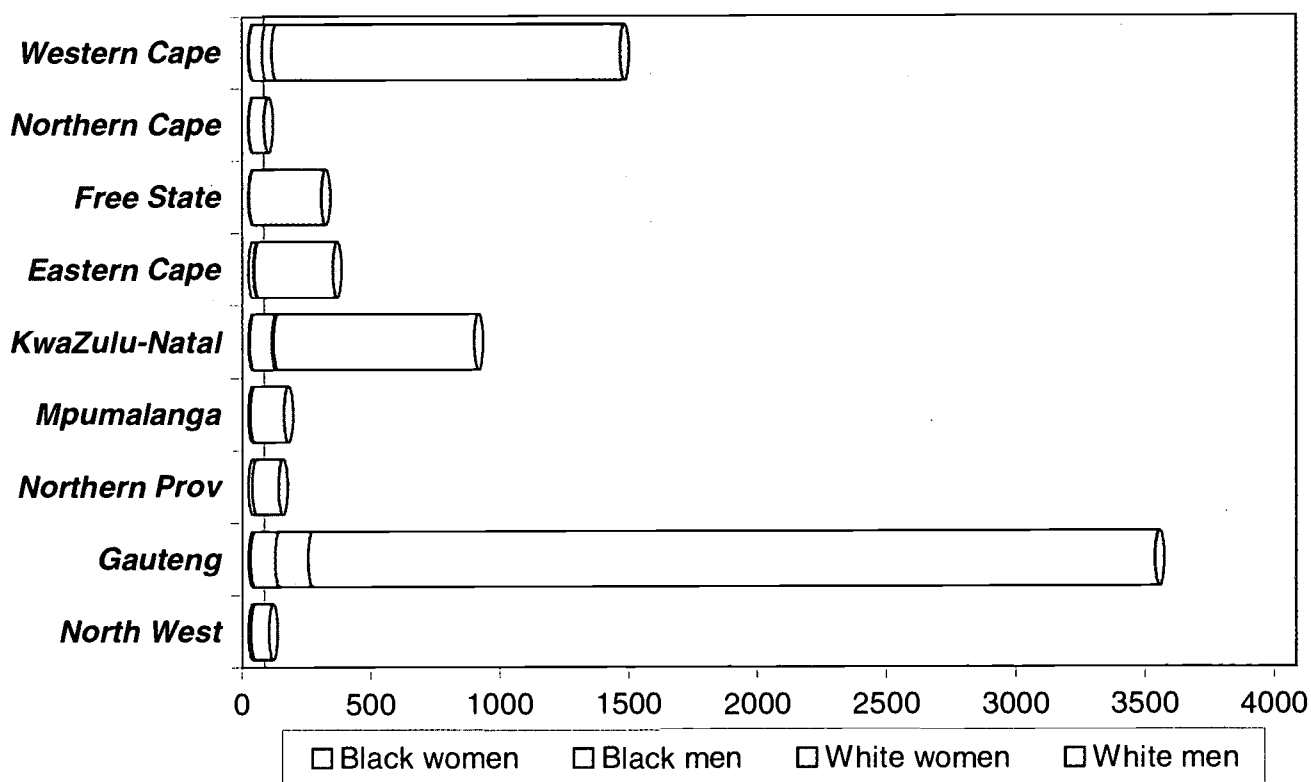
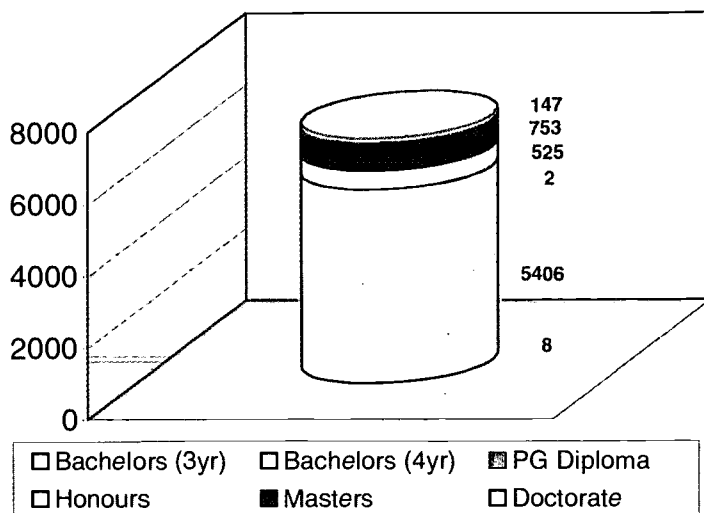
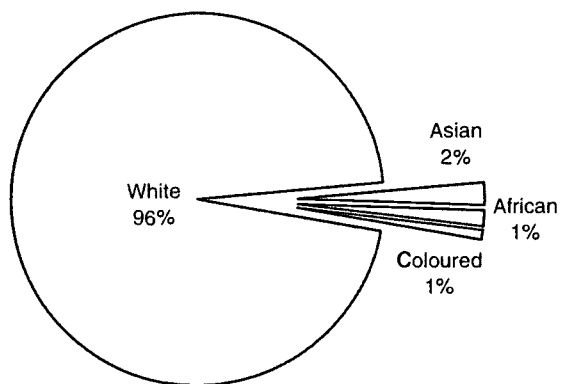

| | Asian | | African | | Coloured | | White | | OVERALL | | TOTAL |
|---------------|------------|------------|-----------|-----------|-----------|-----------|-------------|-------------|------------|-------------|-------------|
| | Women | Men | Women | Men | Women | Men | Women | Men | Women | Men | |
| Western Cape | | 8 | | 7 | 3 | 36 | 39 | 1350 | 42 | 1401 | 1443 |
| Northern Cape | | | | | | | 2 | 60 | 2 | 60 | 62 |
| Free State | | | | 3 | | | | 280 | 0 | 283 | 283 |
| Eastern Cape | | | | 17 | | 2 | 4 | 304 | 4 | 323 | 327 |
| KwaZulu-Natal | 4 | 78 | | 5 | | 4 | 8 | 777 | 12 | 864 | 876 |
| Mpumalanga | | 2 | | 3 | | | 2 | 132 | 2 | 137 | 139 |
| Northern Prov | | | | 13 | | | 2 | 103 | 2 | 116 | 118 |
| Gauteng | 4 | 48 | 4 | 34 | | 13 | 127 | 3282 | 135 | 3377 | 3512 |
| North West | | 2 | | 3 | | | 4 | 70 | 4 | 75 | 79 |
| TOTAL | 8 | 138 | 4 | 85 | 3 | 55 | 188 | 6358 | 203 | 6636 | 6839 |
| | 146 | | 89 | | 58 | | 6546 | | | | |



This category also includes Production Engineering.

QUALIFICATION TRENDS BY LEVEL

| | 1991 | 1992 | 1993 | 1994 | 1995 | 1996 | 1997 | 1998 | TOTAL |
|-----------------|-----------|-----------|------------|------------|------------|------------|------------|------------|------------|
| Bachelors (3yr) | 1 | | | | | 1 | 1 | 1 | 4 |
| Bachelors (4yr) | 53 | 65 | 91 | 95 | 118 | 91 | 85 | 87 | 685 |
| PG Diploma | | | | | | | | | 2 |
| Honours | 17 | 14 | 17 | 24 | 21 | 13 | 21 | 21 | 148 |
| Masters | 17 | 11 | 12 | 10 | 22 | 14 | 19 | 20 | 125 |
| Doctorate | 2 | 2 | | 3 | 2 | 1 | | | 10 |
| TOTAL | 90 | 92 | 121 | 133 | 163 | 120 | 126 | 129 | 974 |

QUALIFICATION TRENDS BY POPULATION GROUP AND GENDER

| | | 1991 | 1992 | 1993 | 1994 | 1995 | 1996 | 1997 | 1998 | TOTAL |
|--------------|---|-----------|-----------|------------|------------|------------|------------|------------|------------|------------|
| Asian | F | | | | | 1 | 1 | 1 | 2 | 5 |
| | M | | 3 | 1 | 7 | 1 | 3 | 3 | 3 | 21 |
| African | F | | | | | | | | | 0 |
| | M | 1 | | 1 | | 1 | 2 | 2 | 2 | 9 |
| Coloured | F | | | | | | | | | 0 |
| | M | 2 | 1 | 1 | | | | | | 4 |
| White | F | 9 | 13 | 13 | 19 | 29 | 22 | 23 | 25 | 153 |
| | M | 78 | 75 | 105 | 107 | 131 | 92 | 97 | 97 | 782 |
| OVERALL | F | 9 | 13 | 13 | 19 | 30 | 23 | 24 | 27 | 158 |
| | M | 81 | 79 | 108 | 114 | 133 | 97 | 102 | 102 | 816 |
| TOTAL | | 90 | 92 | 121 | 133 | 163 | 120 | 126 | 129 | 974 |

QUALIFICATION TRENDS BY CURRENT PROVINCE OF RESIDENCE

| | 1991 | 1992 | 1993 | 1994 | 1995 | 1996 | 1997 | 1998 | TOTAL |
|---------------|-----------|-----------|------------|------------|------------|------------|------------|------------|------------|
| Western Cape | 13 | 15 | 11 | 23 | 41 | 21 | 27 | 26 | 177 |
| Northern Cape | | 3 | | | | | 2 | 2 | 7 |
| Free State | 5 | 3 | 5 | 4 | 5 | | 2 | 2 | 26 |
| Eastern Cape | | 2 | | 8 | 5 | 7 | 7 | 7 | 36 |
| KwaZulu-Natal | 2 | 2 | 10 | 2 | 6 | 3 | 4 | 5 | 34 |
| Mpumalanga | 10 | 5 | 5 | 12 | 18 | 14 | 20 | 20 | 104 |
| Northern Prov | 3 | 2 | 2 | 2 | 2 | | 2 | 2 | 15 |
| Gauteng | 50 | 57 | 84 | 82 | 84 | 72 | 60 | 63 | 552 |
| North West | 2 | 3 | 2 | | 2 | 3 | 2 | 2 | 16 |
| Outside SA | 5 | | 2 | | | | | | 7 |
| TOTAL | 90 | 92 | 121 | 133 | 163 | 120 | 126 | 129 | 974 |

QUALIFICATION TRENDS BY LEVEL

| | 1991 | 1992 | 1993 | 1994 | 1995 | 1996 | 1997 | 1998 | TOTAL |
|-----------------|------------|------------|------------|------------|------------|------------|------------|------------|-------------|
| Bachelors (3yr) | 3 | 2 | 2 | 15 | 2 | 2 | 2 | 2 | 30 |
| Bachelors (4yr) | 133 | 188 | 172 | 159 | 211 | 177 | 167 | 230 | 1437 |
| PG Diploma | | | | | | | | | 0 |
| Honours | 2 | 1 | 3 | 3 | 2 | 2 | 2 | 1 | 16 |
| Masters | 16 | 8 | 10 | 10 | 20 | 15 | 13 | 18 | 110 |
| Doctorate | 5 | 3 | 2 | 7 | 5 | 6 | 2 | 5 | 35 |
| TOTAL | 159 | 202 | 189 | 194 | 240 | 202 | 186 | 256 | 1628 |

QUALIFICATION TRENDS BY POPULATION GROUP AND GENDER

| | | 1991 | 1992 | 1993 | 1994 | 1995 | 1996 | 1997 | 1998 | TOTAL |
|--------------|---|------------|------------|------------|------------|------------|------------|------------|------------|-------------|
| Asian | F | 2 | 6 | 1 | 7 | 13 | 13 | 12 | 17 | 71 |
| | M | 17 | 21 | 16 | 19 | 38 | 42 | 41 | 41 | 235 |
| African | F | | | | | | 2 | 1 | 4 | 7 |
| | M | 7 | 11 | 7 | 5 | 10 | 9 | 10 | 27 | 86 |
| Coloured | F | 1 | 1 | 1 | | | 3 | 2 | 5 | 13 |
| | M | | 8 | 3 | 3 | 2 | 4 | 1 | 6 | 27 |
| White | F | 17 | 32 | 36 | 36 | 36 | 35 | 28 | 38 | 258 |
| | M | 115 | 123 | 125 | 124 | 141 | 94 | 91 | 118 | 931 |
| OVERALL | F | 20 | 39 | 38 | 43 | 49 | 53 | 43 | 64 | 349 |
| | M | 139 | 163 | 151 | 151 | 191 | 149 | 143 | 192 | 1279 |
| TOTAL | | 159 | 202 | 189 | 194 | 240 | 202 | 186 | 256 | 1628 |

QUALIFICATION TRENDS BY CURRENT PROVINCE OF RESIDENCE

| | 1991 | 1992 | 1993 | 1994 | 1995 | 1996 | 1997 | 1998 | TOTAL |
|---------------|------------|------------|------------|------------|------------|------------|------------|------------|-------------|
| Western Cape | 26 | 28 | 28 | 32 | 26 | 29 | 28 | 47 | 244 |
| Northern Cape | | 2 | 4 | 2 | 6 | 3 | 3 | 4 | 24 |
| Free State | 14 | 26 | 11 | 15 | 20 | 18 | 25 | 30 | 159 |
| Eastern Cape | 3 | 2 | 4 | 4 | | 3 | | | 16 |
| KwaZulu-Natal | 20 | 29 | 20 | 41 | 31 | 23 | 18 | 22 | 204 |
| Mpumalanga | 10 | 15 | 8 | 13 | 11 | 23 | 16 | 21 | 117 |
| Northern Prov | 2 | 2 | 2 | 4 | 6 | 3 | 3 | 4 | 26 |
| Gauteng | 72 | 90 | 100 | 79 | 126 | 85 | 87 | 115 | 754 |
| North West | 3 | 6 | 4 | | 11 | 12 | 3 | 9 | 48 |
| Outside SA | 9 | 2 | 8 | 4 | 3 | 3 | 3 | 4 | 36 |
| TOTAL | 159 | 202 | 189 | 194 | 240 | 202 | 186 | 256 | 1628 |

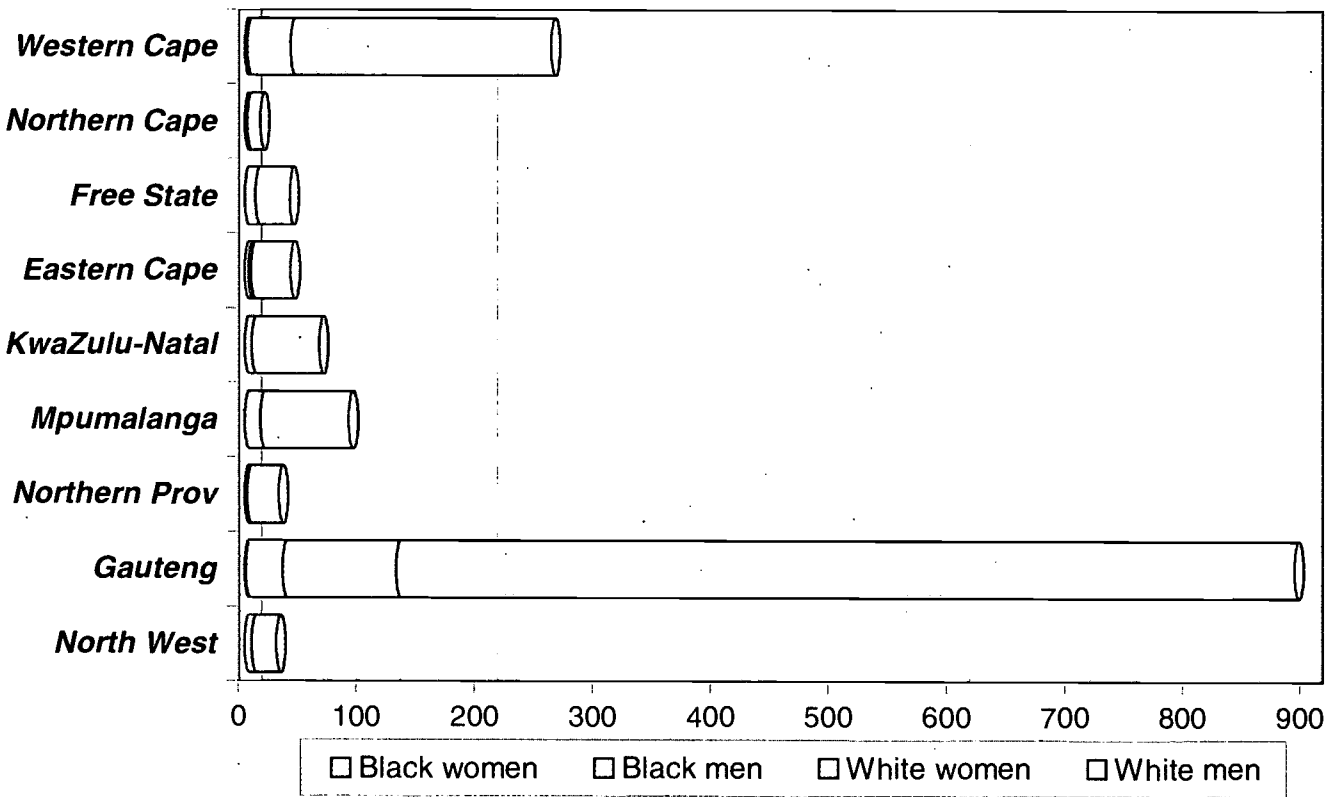
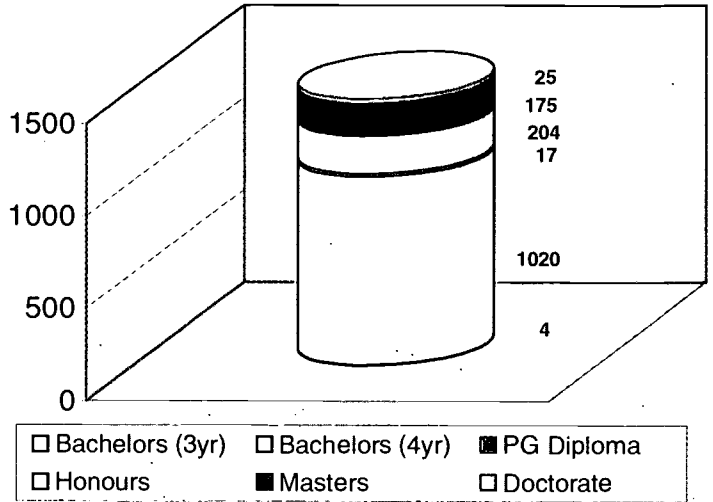
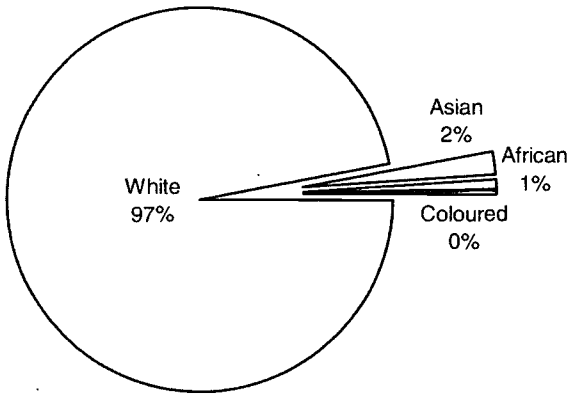

| | Asian | | African | | Coloured | | White | | OVERALL | | TOTAL |
|---------------|-----------|-----------|-----------|-----------|----------|----------|-------------|-------------|------------|-------------|-------------|
| | Women | Men | Women | Men | Women | Men | Women | Men | Women | Men | |
| Western Cape | | 2 | | | | | 37 | 220 | 37 | 222 | 259 |
| Northern Cape | | | | | | | 2 | 11 | 2 | 11 | 13 |
| Free State | | | | | | | 9 | 29 | 9 | 29 | 38 |
| Eastern Cape | 3 | | | | | | 2 | 34 | 5 | 34 | 39 |
| KwaZulu-Natal | | | | | | | 6 | 57 | 6 | 57 | 63 |
| Mpumalanga | | | | | | | 13 | 75 | 13 | 75 | 88 |
| Northern Prov | | | | | | | 2 | 27 | 2 | 27 | 29 |
| Gauteng | 1 | 16 | | 10 | | 5 | 96 | 762 | 97 | 793 | 890 |
| North West | | 6 | | | | | | 21 | 0 | 27 | 27 |
| TOTAL | 4 | 24 | 0 | 10 | 0 | 5 | 167 | 1236 | 171 | 1275 | 1446 |
| | 28 | | 10 | | 5 | | 1403 | | | | |

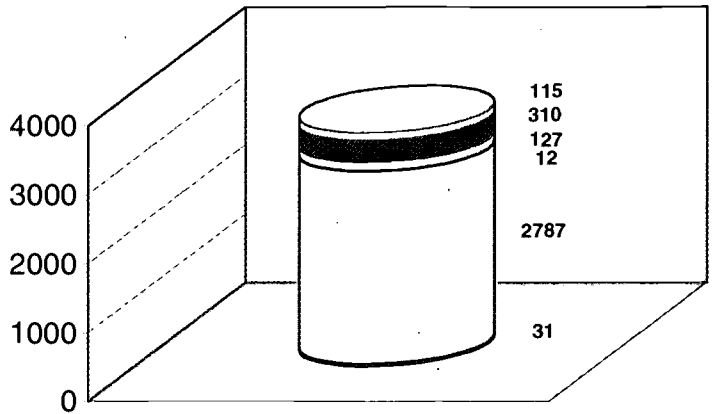
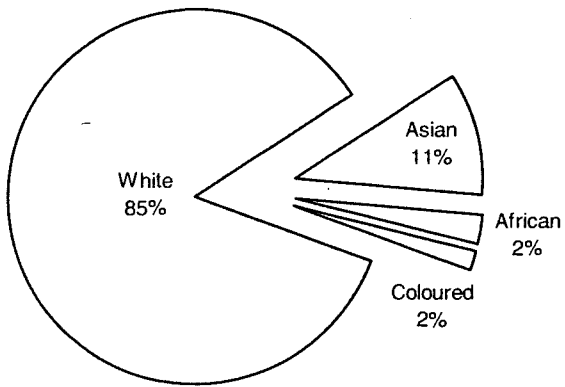

Bachelors (3yr) Bachelors (4yr) PG Diploma
 Honours Masters Doctorate

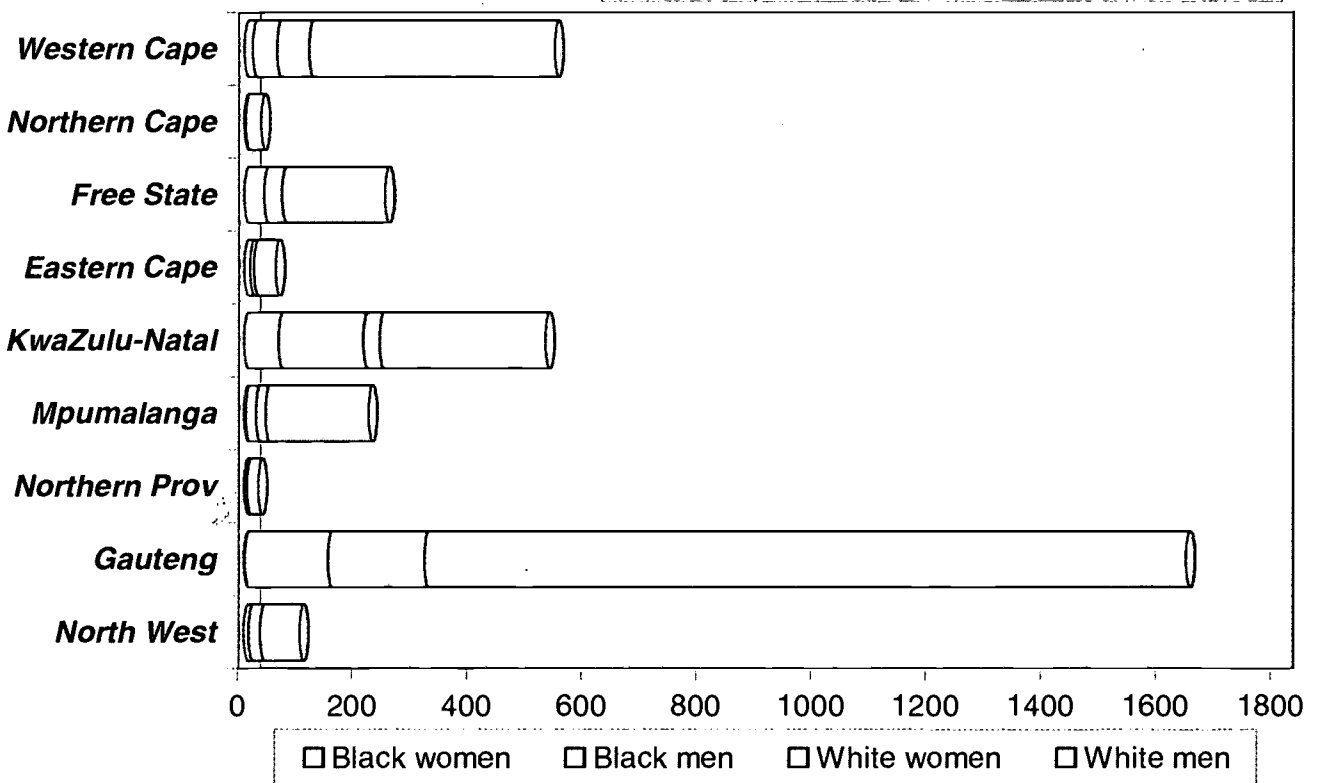

| | Asian | | African | | Coloured | | White | | OVERALL | | |
|---------------|------------|------------|-----------|-----------|-----------|-----------|-------------|-------------|------------|-------------|-------------|
| | Women | Men | Women | Men | Women | Men | Women | Men | Women | Men | TOTAL |
| Western Cape | 9 | 16 | 4 | | 2 | 27 | 55 | 429 | 70 | 472 | 542 |
| Northern Cape | | | | | | 2 | | 28 | 0 | 30 | 30 |
| Free State | | 30 | | 5 | | | 32 | 180 | 32 | 215 | 247 |
| Eastern Cape | | 3 | | 8 | | | 6 | 39 | 6 | 50 | 56 |
| KwaZulu-Natal | 61 | 130 | | 13 | | 5 | 28 | 289 | 89 | 437 | 526 |
| Mpumalanga | 3 | 16 | | | | 2 | 17 | 180 | 20 | 198 | 218 |
| Northern Prov | | | | 3 | 2 | | | 20 | 2 | 23 | 25 |
| Gauteng | | 87 | | 45 | 2 | 12 | 169 | 1327 | 171 | 1471 | 1642 |
| North West | | 3 | | 3 | | 2 | 21 | 68 | 21 | 76 | 97 |
| TOTAL | 73 | 285 | 4 | 77 | 6 | 50 | 328 | 2560 | 411 | 2972 | 3383 |
| | 358 | | 81 | | 56 | | 2888 | | | | |

ENGINEERING – ELECTRICAL AND ELECTRONIC

QUALIFICATION TRENDS BY LEVEL

| | 1991 | 1992 | 1993 | 1994 | 1995 | 1996 | 1997 | 1998 | TOTAL |
|-----------------|------------|------------|------------|------------|------------|------------|------------|------------|-------------|
| Bachelors (3yr) | 1 | | 1 | 8 | 8 | 8 | 2 | 23 | 41 |
| Bachelors (4yr) | 423 | 410 | 417 | 391 | 447 | 394 | 383 | 483 | 3348 |
| PG Diploma | | | | | | | | | 0 |
| Honours | 34 | 28 | 27 | 22 | 29 | 24 | 24 | 23 | 211 |
| Masters | 93 | 57 | 62 | 50 | 83 | 67 | 75 | 89 | 576 |
| Doctorate | 18 | 9 | 15 | 20 | 20 | 8 | 5 | 5 | 100 |
| TOTAL | 569 | 504 | 522 | 491 | 582 | 496 | 489 | 623 | 4276 |

QUALIFICATION TRENDS BY POPULATION GROUP AND GENDER

| | | 1991 | 1992 | 1993 | 1994 | 1995 | 1996 | 1997 | 1998 | TOTAL |
|--------------|---|------------|------------|------------|------------|------------|------------|------------|------------|-------------|
| Asian | F | 1 | 3 | 3 | 4 | 3 | 2 | 3 | 7 | 26 |
| | M | 21 | 39 | 36 | 36 | 45 | 41 | 43 | 60 | 321 |
| African | F | 2 | 2 | | | 1 | 2 | 1 | 4 | 12 |
| | M | 4 | 13 | 13 | 13 | 22 | 23 | 15 | 50 | 153 |
| Coloured | F | | | | | | 2 | | 1 | 3 |
| | M | 6 | 11 | 18 | 12 | 7 | 8 | 2 | 12 | 76 |
| White | F | 20 | 26 | 27 | 28 | 32 | 25 | 13 | 20 | 191 |
| | M | 515 | 410 | 425 | 398 | 472 | 393 | 412 | 469 | 3494 |
| OVERALL | F | 23 | 31 | 30 | 32 | 36 | 31 | 17 | 32 | 232 |
| | M | 546 | 473 | 492 | 459 | 546 | 465 | 472 | 591 | 4044 |
| TOTAL | | 569 | 504 | 522 | 491 | 582 | 496 | 489 | 623 | 4276 |

QUALIFICATION TRENDS BY CURRENT PROVINCE OF RESIDENCE

| | 1991 | 1992 | 1993 | 1994 | 1995 | 1996 | 1997 | 1998 | TOTAL |
|---------------|------------|------------|------------|------------|------------|------------|------------|------------|-------------|
| Western Cape | 90 | 98 | 76 | 100 | 159 | 121 | 110 | 136 | 890 |
| Northern Cape | | 4 | 5 | | 10 | | 8 | 6 | 33 |
| Free State | 14 | 25 | 18 | 27 | 22 | 18 | 10 | 13 | 147 |
| Eastern Cape | 14 | 7 | 14 | 15 | 5 | 8 | 5 | 10 | 78 |
| KwaZulu-Natal | 41 | 37 | 46 | 41 | 49 | 50 | 44 | 63 | 371 |
| Mpumalanga | 19 | 23 | 21 | 15 | 19 | 15 | 18 | 23 | 153 |
| Northern Prov | | 2 | 2 | 6 | | | | 3 | 13 |
| Gauteng | 383 | 288 | 310 | 260 | 292 | 253 | 275 | 347 | 2408 |
| North West | 5 | 11 | 14 | 17 | 7 | 23 | 16 | 19 | 112 |
| Outside SA | 3 | 9 | 16 | 10 | 19 | 8 | 3 | 3 | 71 |
| TOTAL | 569 | 504 | 522 | 491 | 582 | 496 | 489 | 623 | 4276 |

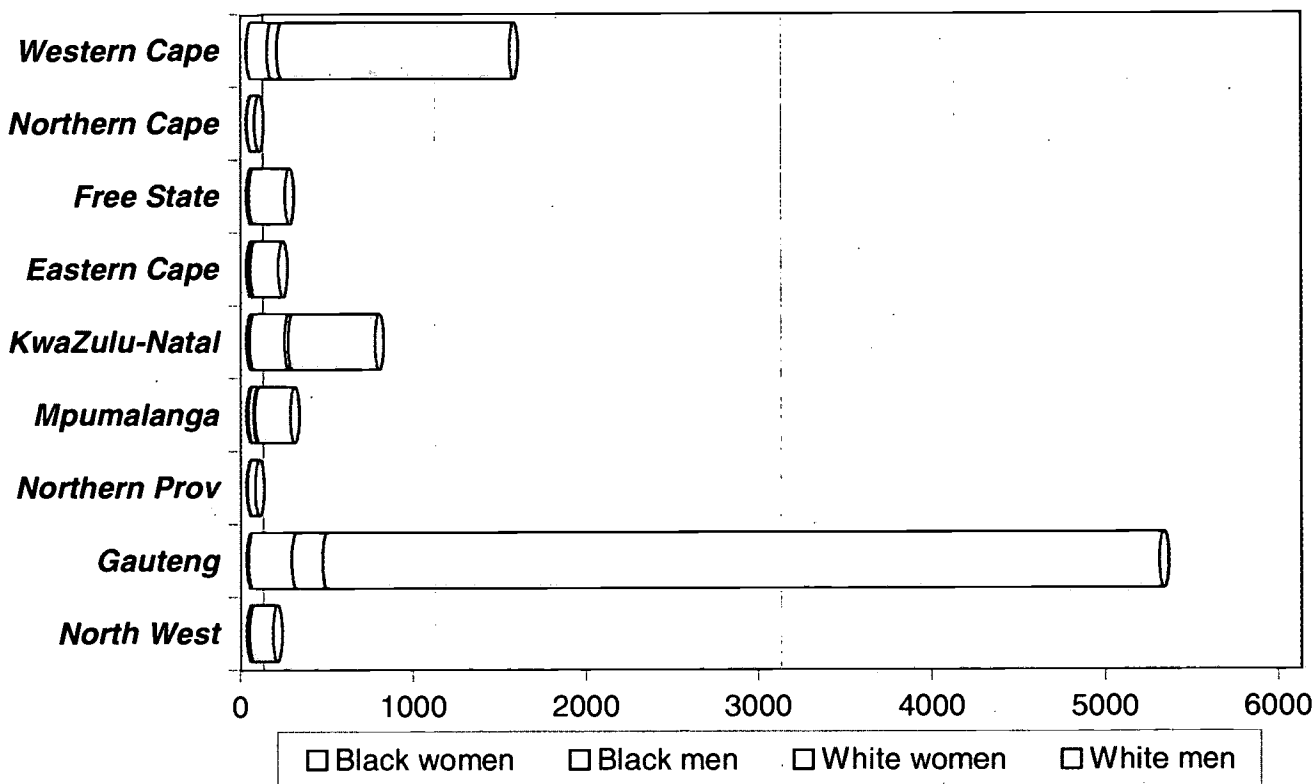
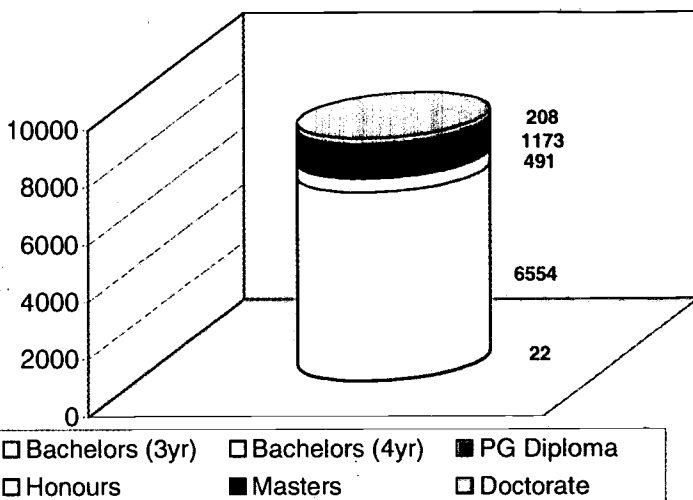
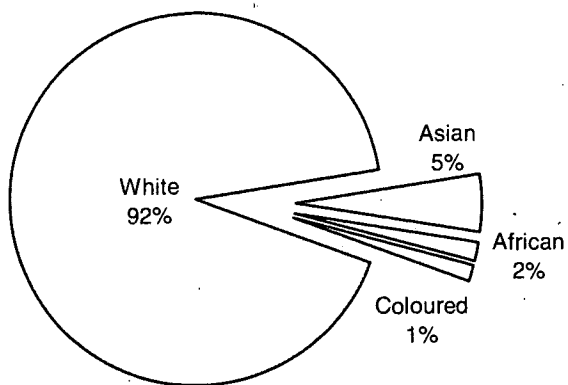

| | Asian | | African | | Coloured | | White | | OVERALL | | TOTAL |
|---------------|------------|------------|------------|------------|------------|------------|-------------|-------------|------------|-------------|-------------|
| | Women | Men | Women | Men | Women | Men | Women | Men | Women | Men | |
| Western Cape | | 34 | | 11 | 3 | 70 | 59 | 1345 | 62 | 1460 | 1522 |
| Northern Cape | | | | | | 2 | 2 | 43 | 2 | 45 | 47 |
| Free State | | 2 | | 9 | | | 2 | 210 | 2 | 221 | 223 |
| Eastern Cape | | 2 | 3 | 9 | | 5 | 2 | 163 | 5 | 179 | 184 |
| KwaZulu-Natal | 15 | 189 | | 9 | 1 | 5 | 20 | 502 | 36 | 705 | 741 |
| Mpumalanga | 5 | 17 | 5 | 13 | | | 7 | 206 | 17 | 236 | 253 |
| Northern Prov | | | | 4 | | | | 45 | 0 | 49 | 49 |
| Gauteng | 5 | 138 | 5 | 87 | | 26 | 177 | 4842 | 187 | 5093 | 5280 |
| North West | | 13 | | | | | 2 | 135 | 2 | 148 | 150 |
| TOTAL | 25 | 395 | 13 | 142 | 4 | 108 | 271 | 7491 | 313 | 8136 | 8449 |
| | 420 | | 155 | | 112 | | 7762 | | | | |



QUALIFICATION TRENDS BY LEVEL

| | 1991 | 1992 | 1993 | 1994 | 1995 | 1996 | 1997 | 1998 | TOTAL |
|-----------------|-----------|-----------|-----------|-----------|-----------|-----------|-----------|-----------|------------|
| Bachelors (3yr) | | | | | | | | | 0 |
| Bachelors (4yr) | 45 | 42 | 42 | 70 | 54 | 38 | 38 | 41 | 370 |
| PG Diploma | | | 1 | | | | | | 1 |
| Honours | 1 | 2 | 1 | | | 1 | | | 5 |
| Masters | 16 | 11 | 9 | 13 | 20 | 12 | 12 | 13 | 106 |
| Doctorate | 4 | 4 | 2 | | 4 | 3 | 2 | 2 | 21 |
| TOTAL | 66 | 59 | 55 | 83 | 78 | 54 | 52 | 56 | 503 |

QUALIFICATION TRENDS BY POPULATION GROUP AND GENDER

| | | 1991 | 1992 | 1993 | 1994 | 1995 | 1996 | 1997 | 1998 | TOTAL |
|--------------|---|-----------|-----------|-----------|-----------|-----------|-----------|-----------|-----------|------------|
| Asian | F | | | | | | | | | 0 |
| | M | 1 | | | 1 | 1 | 1 | 1 | 1 | 6 |
| African | F | | | | | | 1 | 1 | 1 | 3 |
| | M | 5 | 5 | 5 | 13 | 21 | 17 | 19 | 23 | 108 |
| Coloured | F | | | | | | | | | 0 |
| | M | | 1 | | 1 | | | | | 2 |
| White | F | | | | 2 | 3 | | | | 5 |
| | M | 60 | 53 | 50 | 66 | 53 | 35 | 31 | 31 | 379 |
| OVERALL | F | 0 | 0 | 0 | 2 | 3 | 1 | 1 | 1 | 8 |
| | M | 66 | 59 | 55 | 81 | 75 | 53 | 51 | 55 | 495 |
| TOTAL | | 66 | 59 | 55 | 83 | 78 | 54 | 52 | 56 | 503 |

QUALIFICATION TRENDS BY CURRENT PROVINCE OF RESIDENCE

| | 1991 | 1992 | 1993 | 1994 | 1995 | 1996 | 1997 | 1998 | TOTAL |
|---------------|-----------|-----------|-----------|-----------|-----------|-----------|-----------|-----------|------------|
| Western Cape | | | | | | | | | 0 |
| Northern Cape | 2 | | 2 | 3 | | | | | 7 |
| Free State | 5 | 2 | 4 | 18 | 8 | 7 | 4 | 5 | 53 |
| Eastern Cape | | | | | | | | | 0 |
| KwaZulu-Natal | | | | 3 | | | | | 3 |
| Mpumalanga | 5 | 5 | 11 | 3 | 12 | 7 | 4 | | 47 |
| Northern Prov | | | 2 | | 7 | | 4 | 4 | 17 |
| Gauteng | 41 | 36 | 29 | 47 | 43 | 36 | 36 | 42 | 310 |
| North West | 2 | 16 | 7 | 3 | 8 | 4 | 4 | 5 | 49 |
| Outside SA | 11 | | | 6 | | | | | 17 |
| TOTAL | 66 | 59 | 55 | 83 | 78 | 54 | 52 | 56 | 503 |

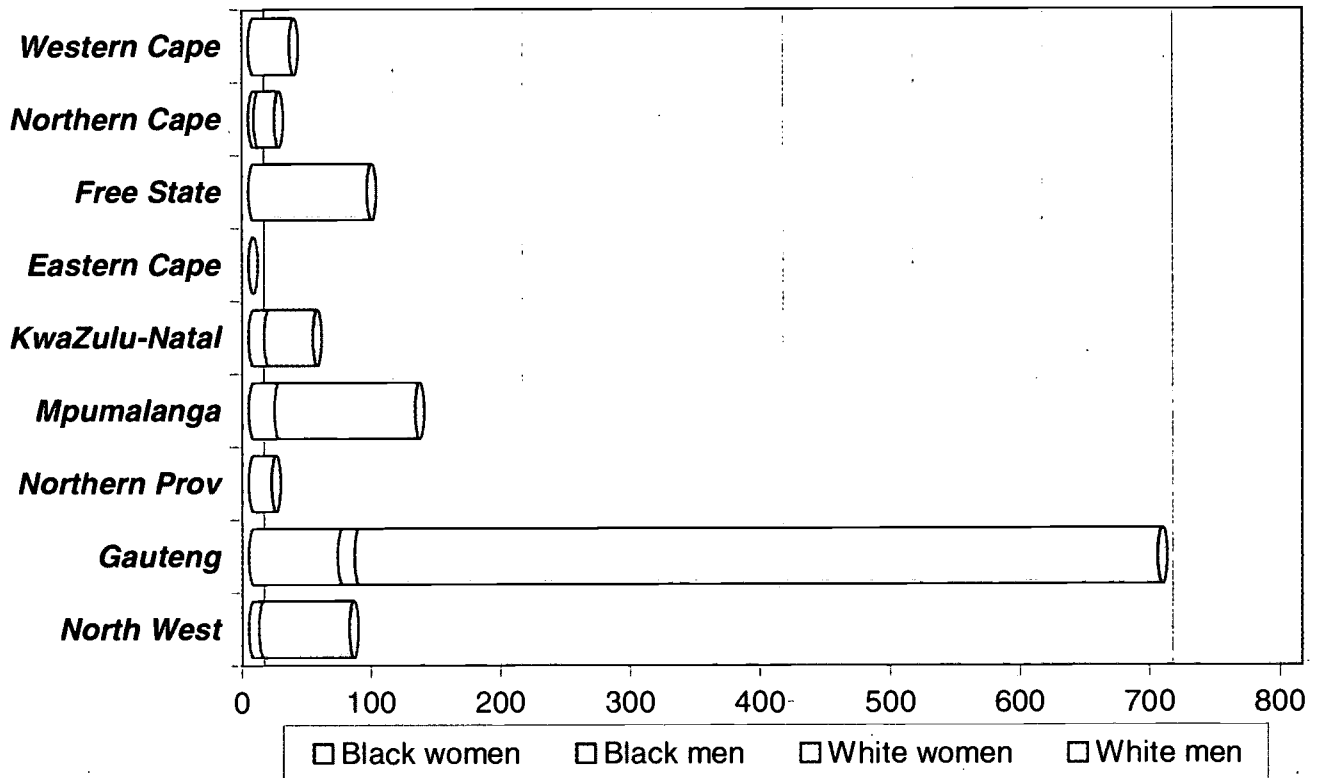
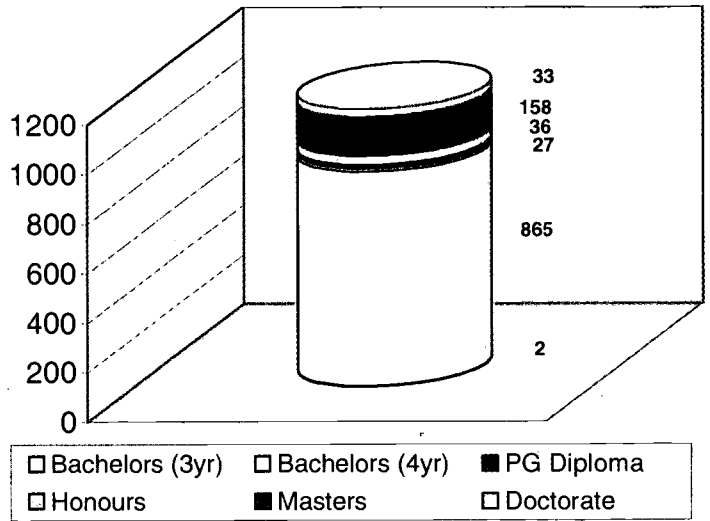
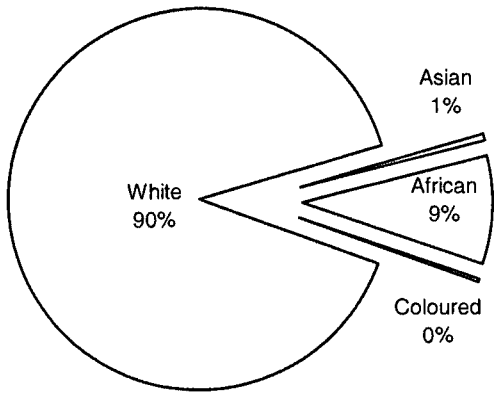

| | Asian | | African | | Coloured | | White | | OVERALL | | |
|---------------|----------|----------|------------|------------|----------|----------|-------------|------------|-----------|-------------|-------------|
| | Women | Men | Women | Men | Women | Men | Women | Men | Women | Men | TOTAL |
| Western Cape | | | | | | | 32 | | 0 | 32 | 32 |
| Northern Cape | | | | 4 | | | 16 | | 0 | 20 | 20 |
| Free State | | | | | | | 92 | | 0 | 92 | 92 |
| Eastern Cape | | | | | | | | | 0 | 0 | 0 |
| KwaZulu-Natal | | 8 | | 4 | | | 38 | | 0 | 50 | 50 |
| Mpumalanga | | | | 20 | | | 109 | | 0 | 129 | 129 |
| Northern Prov | | | | | | | 18 | | 0 | 18 | 18 |
| Gauteng | | | | 67 | | 2 | 13 | 619 | 13 | 688 | 701 |
| North West | | | | 8 | | | 70 | | 0 | 78 | 78 |
| TOTAL | 0 | 8 | 0 | 103 | 0 | 2 | 13 | 994 | 13 | 1107 | 1120 |
| | 8 | | 103 | | 2 | | 1007 | | | | |

ENGINEERING – METALLURGICAL

QUALIFICATION TRENDS BY LEVEL

| | 1991 | 1992 | 1993 | 1994 | 1995 | 1996 | 1997 | 1998 | TOTAL |
|-----------------|------|------|------|------|------|------|------|------|-------|
| Bachelors (3yr) | | | | | | | | | 0 |
| Bachelors (4yr) | 57 | 77 | 85 | 66 | 45 | 39 | 29 | 29 | 427 |
| PG Diploma | | | | | | | | | 0 |
| Honours | 2 | 2 | 2 | | 4 | 6 | 6 | 6 | 28 |
| Masters | 15 | 15 | 8 | 8 | 21 | 14 | 17 | 17 | 115 |
| Doctorate | 5 | 6 | 2 | 5 | 10 | 6 | 8 | 8 | 50 |
| TOTAL | 79 | 100 | 97 | 79 | 80 | 65 | 60 | 60 | 620 |

QUALIFICATION TRENDS BY POPULATION GROUP AND GENDER

| | | 1991 | 1992 | 1993 | 1994 | 1995 | 1996 | 1997 | 1998 | TOTAL |
|----------|---|------|------|------|------|------|------|------|------|-------|
| Asian | F | 1 | | 1 | | | | | | 2 |
| | M | 2 | 1 | 5 | 2 | 1 | 1 | 1 | 1 | 14 |
| African | F | 1 | | | | | | | | 1 |
| | M | 3 | 5 | 3 | 1 | 2 | 2 | 2 | 2 | 20 |
| Coloured | F | 2 | | | | 1 | 1 | 1 | 1 | 6 |
| | M | 1 | | | | 1 | | | | 2 |
| White | F | 8 | 11 | 16 | 11 | 12 | 5 | 5 | 5 | 73 |
| | M | 61 | 83 | 72 | 65 | 63 | 56 | 51 | 51 | 502 |
| OVERALL | F | 12 | 11 | 17 | 11 | 13 | 6 | 6 | 6 | 82 |
| | M | 67 | 89 | 80 | 68 | 67 | 59 | 54 | 54 | 538 |
| TOTAL | | 79 | 100 | 97 | 79 | 80 | 65 | 60 | 60 | 620 |

QUALIFICATION TRENDS BY CURRENT PROVINCE OF RESIDENCE

| | 1991 | 1992 | 1993 | 1994 | 1995 | 1996 | 1997 | 1998 | TOTAL |
|---------------|------|------|------|------|------|------|------|------|-------|
| Western Cape | 5 | 10 | 7 | 2 | 8 | 3 | 5 | 5 | 45 |
| Northern Cape | 2 | 2 | | 2 | 2 | 6 | 2 | 2 | 18 |
| Free State | 5 | 2 | 5 | 4 | 4 | | 2 | 2 | 24 |
| Eastern Cape | | | 2 | | 2 | | 2 | 2 | 8 |
| KwaZulu-Natal | 2 | 3 | 6 | 7 | 8 | 13 | 3 | 3 | 45 |
| Mpumalanga | 5 | 8 | | 4 | 2 | 3 | 2 | 2 | 26 |
| Northern Prov | | 2 | 2 | | | | | | 4 |
| Gauteng | 55 | 69 | 70 | 58 | 46 | 40 | 44 | 44 | 426 |
| North West | 3 | 2 | 5 | 2 | 6 | | | | 18 |
| Outside SA | 2 | 2 | | | 2 | | | | 6 |
| TOTAL | 79 | 100 | 97 | 79 | 80 | 65 | 60 | 60 | 620 |

TOTAL AVAILABILITY ENGINEERING - METALLURGICAL

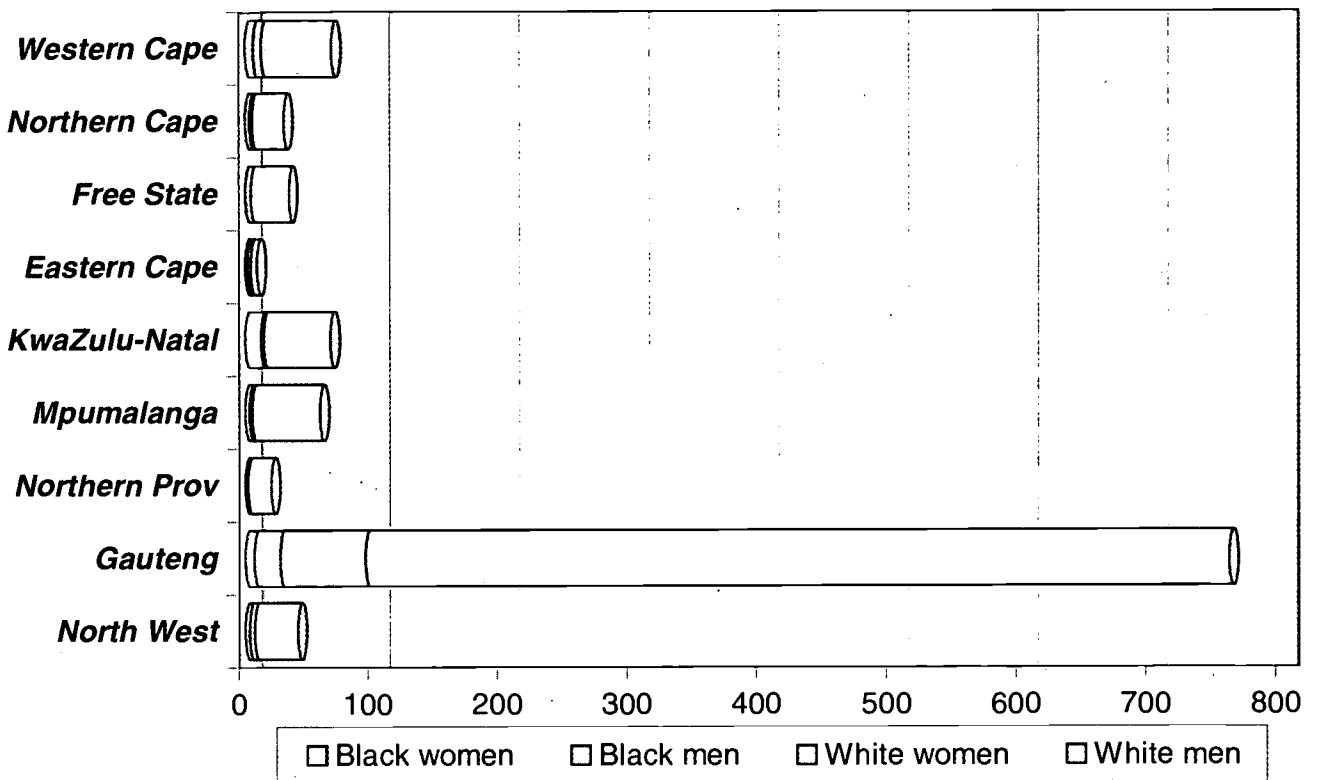
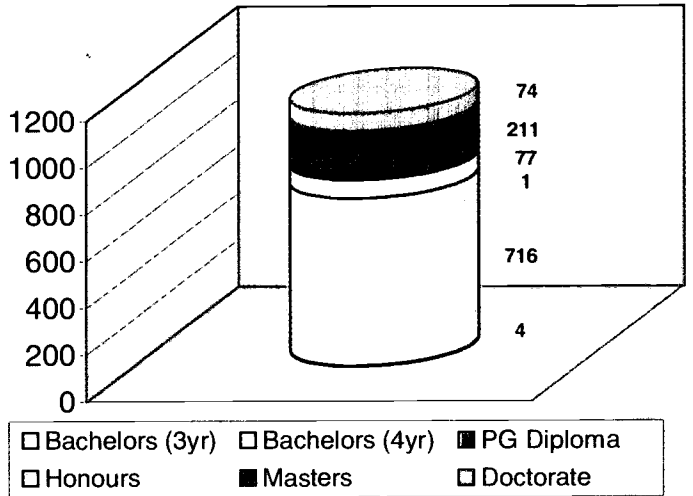
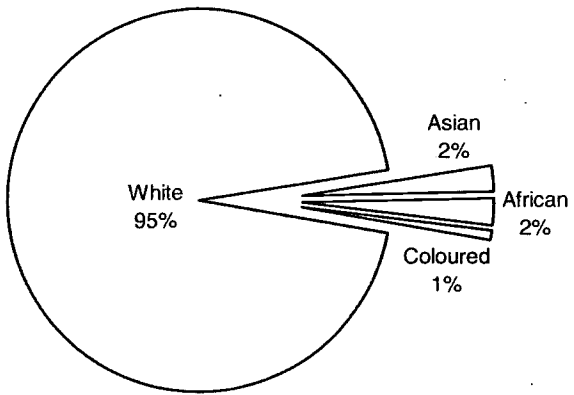

| | Asian | | African | | Coloured | | White | | OVERALL | | TOTAL |
|---------------|-----------|-----------|-----------|-----------|-----------|----------|-------------|------------|------------|------------|-------------|
| | Women | Men | Women | Men | Women | Men | Women | Men | Women | Men | |
| Western Cape | | | | | 6 | | 6 | 55 | 12 | 55 | 67 |
| Northern Cape | | | | 3 | | | 2 | 25 | 2 | 28 | 30 |
| Free State | | | | | | | 4 | 30 | 4 | 30 | 34 |
| Eastern Cape | | | | 2 | | | 2 | 5 | 2 | 7 | 9 |
| KwaZulu-Natal | | | | | | 3 | 2 | 52 | 2 | 64 | 66 |
| Mpumalanga | | | | | | 3 | 2 | 53 | 2 | 56 | 58 |
| Northern Prov | | | | | | | 2 | 18 | 2 | 18 | 20 |
| Gauteng | 3 | 9 | 2 | 9 | 2 | 2 | 66 | 666 | 73 | 686 | 759 |
| North West | | | | | | 3 | 4 | 34 | 4 | 37 | 41 |
| TOTAL | 3 | 20 | 2 | 21 | 8 | 2 | 90 | 938 | 103 | 981 | 1084 |
| | 23 | | 23 | | 10 | | 1028 | | | | |

QUANTITY SURVEYING

QUALIFICATION TRENDS BY LEVEL

| | 1991 | 1992 | 1993 | 1994 | 1995 | 1996 | 1997 | 1998 | TOTAL |
|-----------------|------------|-----------|-----------|------------|-----------|-----------|-----------|-----------|------------|
| Bachelors (3yr) | | | | | | | | | 0 |
| Bachelors (4yr) | 105 | 93 | 84 | 137 | 86 | 99 | 90 | 96 | 790 |
| PG Diploma | | | | | | | | | 0 |
| Honours | 2 | | 1 | | | | | | 3 |
| Masters | 3 | 2 | 4 | 1 | 2 | | 1 | 1 | 14 |
| Doctorate | 1 | 2 | 2 | | | | | | 5 |
| TOTAL | 111 | 97 | 91 | 138 | 88 | 99 | 91 | 97 | 812 |

QUALIFICATION TRENDS BY POPULATION GROUP AND GENDER

| | | 1991 | 1992 | 1993 | 1994 | 1995 | 1996 | 1997 | 1998 | TOTAL |
|--------------|---|------------|-----------|-----------|------------|-----------|-----------|-----------|-----------|------------|
| Asian | F | 1 | | 2 | 4 | 1 | 1 | 2 | | 11 |
| | M | 6 | 5 | 12 | 11 | 6 | 8 | 8 | 7 | 63 |
| African | F | 1 | 2 | 2 | 3 | 4 | 9 | 8 | 10 | 39 |
| | M | | 3 | 5 | 6 | 6 | 7 | 7 | 16 | 50 |
| Coloured | F | 3 | | | | | 3 | | | 6 |
| | M | 1 | 1 | 1 | 1 | 2 | 7 | 4 | 3 | 20 |
| White | F | 16 | 13 | 9 | 24 | 19 | 17 | 14 | 13 | 125 |
| | M | 83 | 73 | 60 | 89 | 50 | 47 | 48 | 48 | 498 |
| OVERALL | F | 21 | 15 | 13 | 31 | 24 | 30 | 24 | 23 | 181 |
| | M | 90 | 82 | 78 | 107 | 64 | 69 | 67 | 74 | 631 |
| TOTAL | | 111 | 97 | 91 | 138 | 88 | 99 | 91 | 97 | 812 |

QUALIFICATION TRENDS BY CURRENT PROVINCE OF RESIDENCE

| | 1991 | 1992 | 1993 | 1994 | 1995 | 1996 | 1997 | 1998 | TOTAL |
|---------------|------------|-----------|-----------|------------|-----------|-----------|-----------|-----------|------------|
| Western Cape | 20 | 14 | 13 | 19 | 9 | 13 | | | 88 |
| Northern Cape | | | 2 | 3 | | 4 | | | 9 |
| Free State | 17 | 7 | 7 | 16 | 4 | 4 | 5 | 5 | 65 |
| Eastern Cape | 19 | 12 | 4 | 19 | 9 | 13 | 18 | 20 | 114 |
| KwaZulu-Natal | 5 | 6 | 15 | 10 | 5 | 9 | 8 | 6 | 64 |
| Mpumalanga | 2 | 2 | | 5 | | | | | 9 |
| Northern Prov | | 7 | 4 | 8 | 4 | | | | 23 |
| Gauteng | 44 | 42 | 40 | 50 | 53 | 43 | 46 | 51 | 369 |
| North West | | | 2 | | | 4 | 5 | 5 | 16 |
| Outside SA | 4 | 7 | 4 | 8 | 4 | 9 | 9 | 10 | 55 |
| TOTAL | 111 | 97 | 91 | 138 | 88 | 99 | 91 | 97 | 812 |

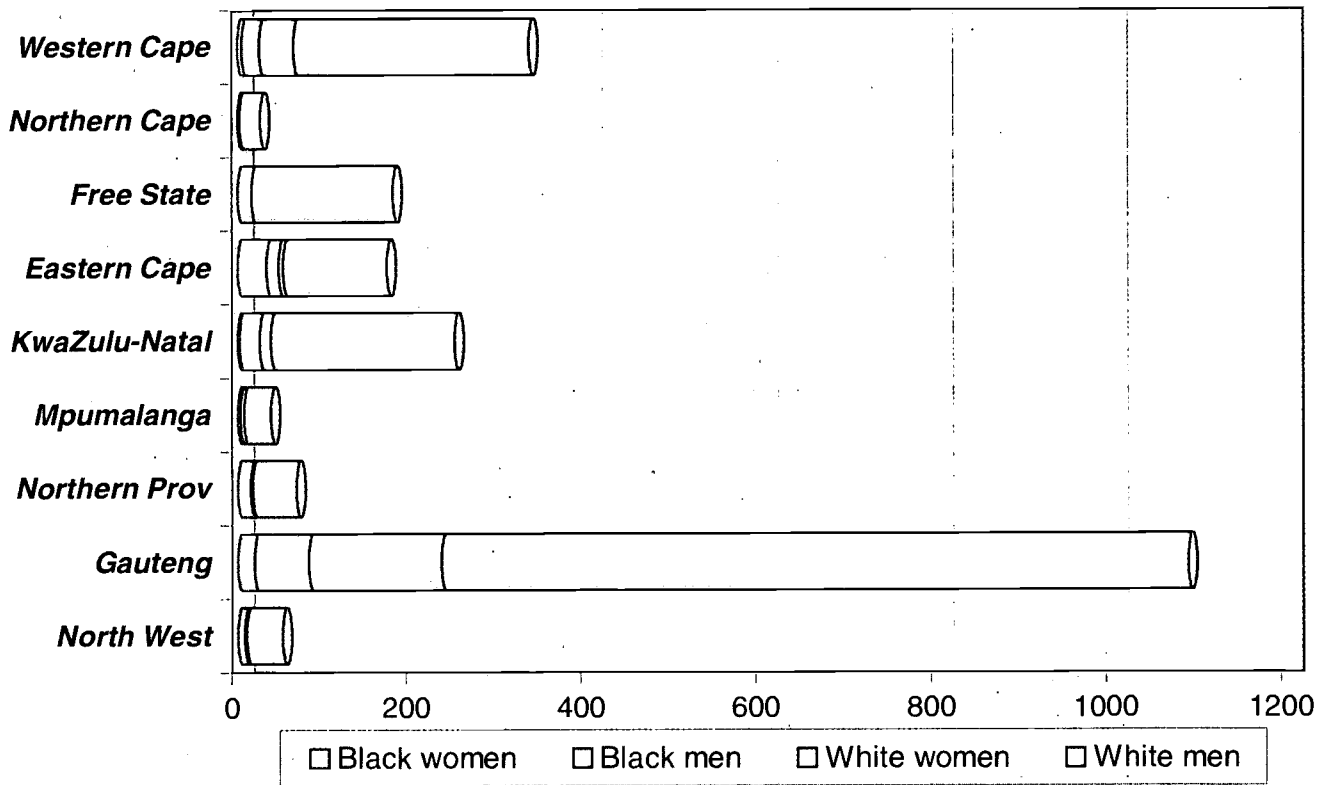
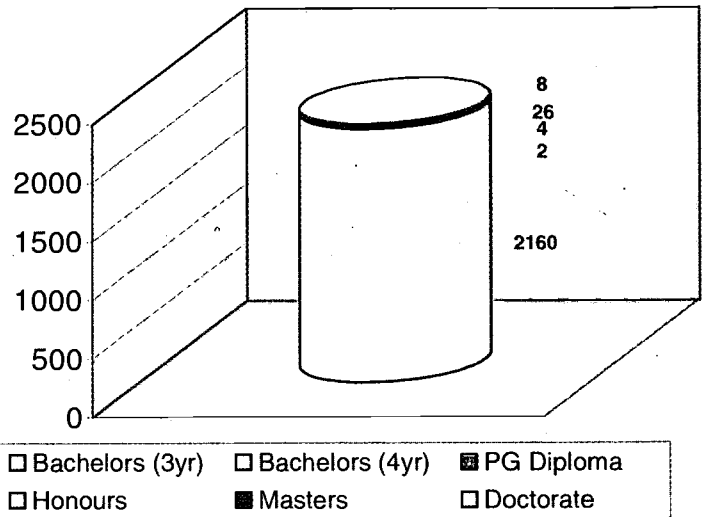
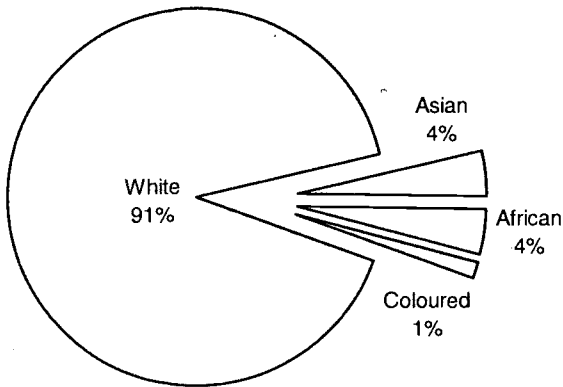

| | Asian | | African | | Coloured | | White | | OVERALL | | TOTAL |
|---------------|-----------|-----------|-----------|-----------|-----------|-----------|-------------|-------------|------------|-------------|-------------|
| | Women | Men | Women | Men | Women | Men | Women | Men | Women | Men | |
| Western Cape | | 4 | | 3 | 5 | 13 | 39 | 270 | 44 | 290 | 334 |
| Northern Cape | | | | | | | 2 | 24 | 2 | 24 | 26 |
| Free State | | | | | | | 16 | 162 | 16 | 162 | 178 |
| Eastern Cape | 6 | 2 | 27 | 6 | | 6 | 5 | 119 | 38 | 133 | 171 |
| KwaZulu-Natal | 2 | 23 | | | | | 13 | 210 | 15 | 233 | 248 |
| Mpumalanga | | | | 3 | | | 4 | 31 | 4 | 34 | 38 |
| Northern Prov | | 4 | | 11 | | | 2 | 50 | 2 | 65 | 67 |
| Gauteng | 6 | 42 | 11 | 14 | 2 | 6 | 152 | 854 | 171 | 916 | 1087 |
| North West | | | | 8 | | | 2 | 41 | 2 | 49 | 51 |
| TOTAL | 14 | 75 | 38 | 45 | 7 | 25 | 235 | 1761 | 294 | 1906 | 2200 |
| | 89 | | 83 | | 32 | | 1996 | | | | |

ARCHITECTURE

This category includes Landscape Architecture.

QUALIFICATION TRENDS BY LEVEL

| | 1991 | 1992 | 1993 | 1994 | 1995 | 1996 | 1997 | 1998 | TOTAL |
|-----------------|------------|------------|------------|------------|------------|------------|------------|------------|-------------|
| Bachelors (3yr) | | | | | | | | | 0 |
| Bachelors (4yr) | 251 | 173 | 278 | 311 | 300 | 258 | 262 | 277 | 2110 |
| PG Diploma | | 2 | 2 | 2 | 2 | 2 | 2 | 2 | 14 |
| Honours | 2 | 1 | 7 | 3 | 6 | 5 | 8 | 9 | 41 |
| Masters | 8 | 8 | 4 | 1 | 3 | 6 | 5 | 5 | 40 |
| Doctorate | 2 | 3 | | 4 | 3 | 5 | 6 | 6 | 29 |
| TOTAL | 263 | 187 | 291 | 321 | 314 | 276 | 283 | 299 | 2234 |

QUALIFICATION TRENDS BY POPULATION GROUP AND GENDER

| | | 1991 | 1992 | 1993 | 1994 | 1995 | 1996 | 1997 | 1998 | TOTAL |
|--------------|---|------------|------------|------------|------------|------------|------------|------------|------------|-------------|
| Asian | F | | | | | 2 | 3 | 4 | 3 | 12 |
| | M | 1 | 3 | 4 | 11 | 5 | 11 | 9 | 9 | 53 |
| African | F | | | 1 | | 3 | 1 | 6 | 2 | 13 |
| | M | 2 | 5 | 4 | 14 | 9 | 16 | 25 | 19 | 94 |
| Coloured | F | 2 | 2 | 2 | 1 | 1 | 2 | 4 | | 14 |
| | M | 1 | 1 | 1 | 2 | 13 | 6 | 9 | 8 | 41 |
| White | F | 84 | 59 | 92 | 108 | 94 | 89 | 75 | 93 | 694 |
| | M | 173 | 117 | 187 | 185 | 187 | 148 | 151 | 165 | 1313 |
| OVERALL | F | 86 | 61 | 95 | 109 | 100 | 95 | 89 | 98 | 733 |
| | M | 177 | 126 | 196 | 212 | 214 | 181 | 194 | 201 | 1501 |
| TOTAL | | 263 | 187 | 291 | 321 | 314 | 276 | 283 | 299 | 2234 |

QUALIFICATION TRENDS BY CURRENT PROVINCE OF RESIDENCE

| | 1991 | 1992 | 1993 | 1994 | 1995 | 1996 | 1997 | 1998 | TOTAL |
|---------------|------------|------------|------------|------------|------------|------------|------------|------------|-------------|
| Western Cape | 59 | 44 | 63 | 80 | 68 | 55 | 53 | 31 | 453 |
| Northern Cape | | 2 | 9 | 5 | 3 | | 3 | 3 | 25 |
| Free State | 6 | 8 | 32 | 36 | 33 | 14 | 20 | 27 | 176 |
| Eastern Cape | 6 | 10 | 24 | 10 | 30 | 28 | 23 | 31 | 162 |
| KwaZulu-Natal | 56 | 32 | 52 | 57 | 58 | 58 | 57 | 66 | 436 |
| Mpumalanga | 6 | | 6 | 5 | | | | | 17 |
| Northern Prov | | | | | 12 | | 7 | 7 | 26 |
| Gauteng | 112 | 75 | 99 | 110 | 86 | 104 | 117 | 124 | 827 |
| North West | | 6 | 2 | 10 | 6 | | | | 24 |
| Outside SA | 18 | 10 | 4 | 8 | 18 | 17 | 3 | 10 | 88 |
| TOTAL | 263 | 187 | 291 | 321 | 314 | 276 | 283 | 299 | 2234 |

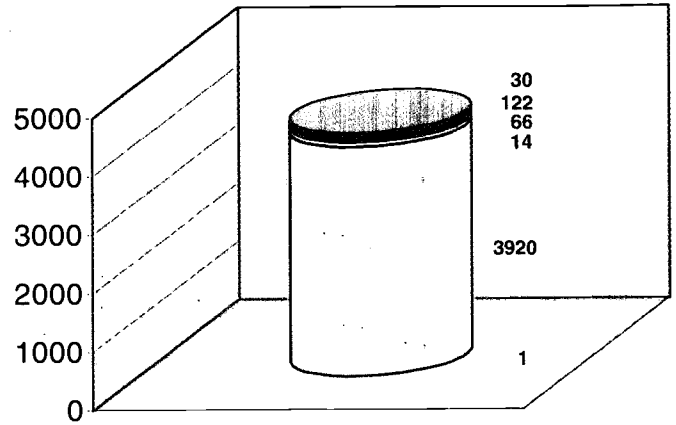
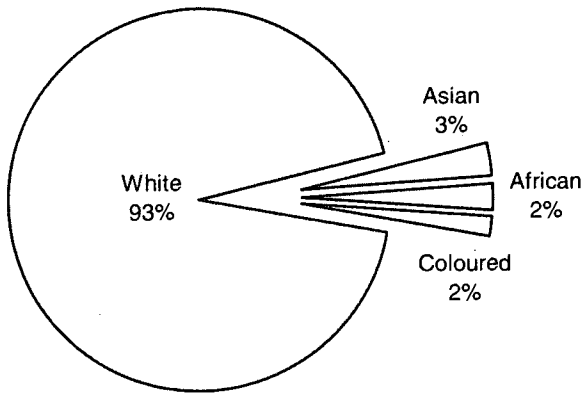

Bachelors (3yr) Bachelors (4yr) PG Diploma
 Honours Masters Doctorate

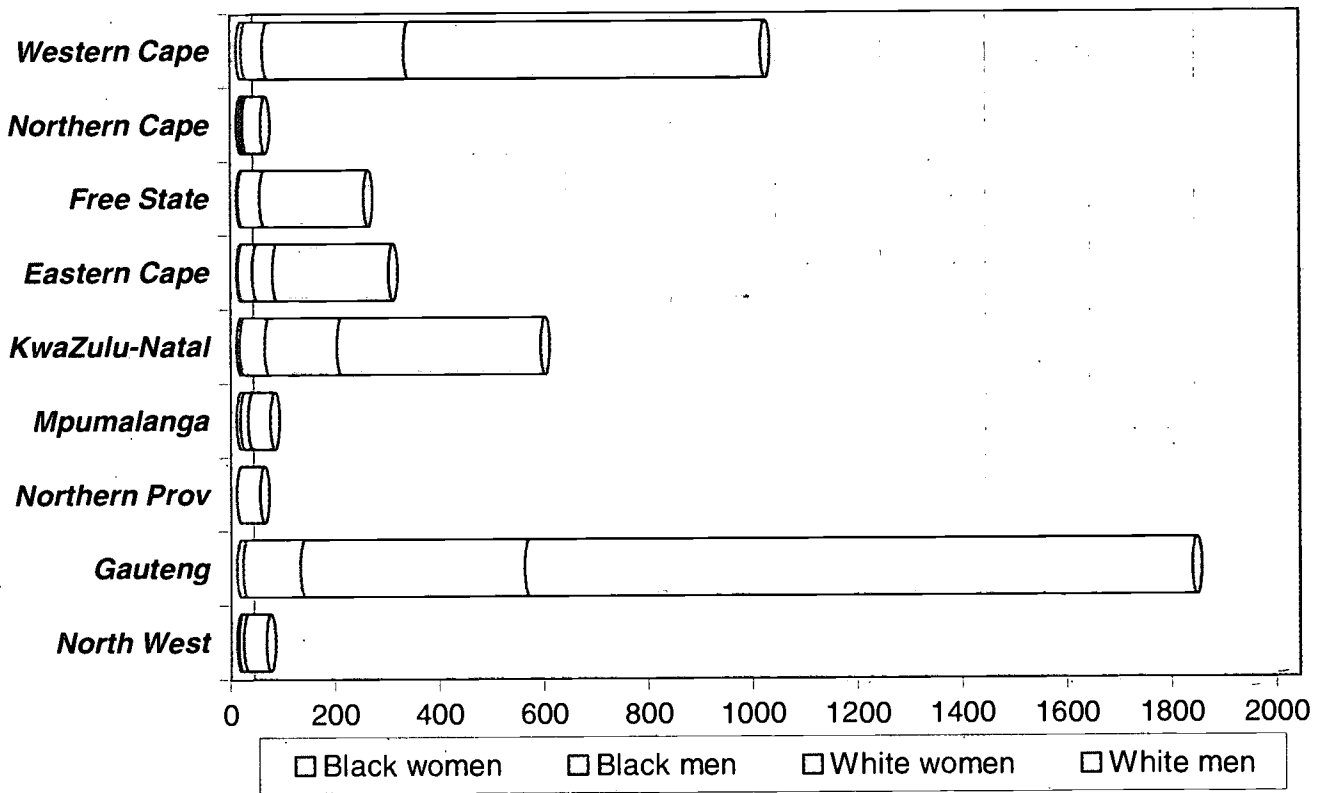

| | Asian | | African | | Coloured | | White | | OVERALL | | TOTAL |
|---------------|------------|-----------|-----------|-----------|-----------|-----------|-------------|-------------|------------|-------------|-------------|
| | Women | Men | Women | Men | Women | Men | Women | Men | Women | Men | |
| Western Cape | 2 | 8 | 9 | | 7 | 24 | 270 | 683 | 279 | 724 | 1003 |
| Northern Cape | 2 | 5 | | | | | 4 | 35 | 6 | 40 | 46 |
| Free State | | | 2 | | | | 42 | 199 | 42 | 201 | 243 |
| Eastern Cape | 2 | 8 | 2 | | | 18 | 38 | 222 | 40 | 250 | 290 |
| KwaZulu-Natal | 5 | 23 | 25 | | | | 138 | 390 | 143 | 438 | 581 |
| Mpumalanga | | | 5 | | 2 | | 15 | 42 | 22 | 42 | 64 |
| Northern Prov | | | | | | | | 44 | 0 | 44 | 44 |
| Gauteng | 2 | 51 | 5 | 47 | 4 | 12 | 429 | 1276 | 440 | 1386 | 1826 |
| North West | | 3 | | | | | 10 | 42 | 10 | 45 | 55 |
| TOTAL | 13 | 98 | 10 | 85 | 13 | 54 | 946 | 2933 | 982 | 3170 | 4152 |
| | 111 | | 95 | | 67 | | 3879 | | | | |

BUILDING SCIENCE/ CONSTRUCTION MANAGEMENT

QUALIFICATION TRENDS BY LEVEL

| | 1991 | 1992 | 1993 | 1994 | 1995 | 1996 | 1997 | 1998 | TOTAL |
|-----------------|------------|------------|------------|------------|------------|------------|------------|------------|-------------|
| Bachelors (3yr) | | | | | 5 | 5 | 5 | 5 | 20 |
| Bachelors (4yr) | 152 | 107 | 150 | 150 | 130 | 109 | 124 | 126 | 1048 |
| PG Diploma | | | | | | | | | 0 |
| Honours | 3 | 4 | 3 | 1 | | | | | 11 |
| Masters | 14 | 6 | 6 | 13 | 9 | 11 | 12 | 11 | 82 |
| Doctorate | | | | | | | | | 0 |
| TOTAL | 169 | 117 | 159 | 164 | 144 | 125 | 141 | 142 | 1161 |

QUALIFICATION TRENDS BY POPULATION GROUP AND GENDER

| | | 1991 | 1992 | 1993 | 1994 | 1995 | 1996 | 1997 | 1998 | TOTAL |
|--------------|---|------------|------------|------------|------------|------------|------------|------------|------------|-------------|
| Asian | F | 1 | | 2 | | | | 3 | 4 | 10 |
| | M | 1 | 2 | 2 | 7 | 8 | 10 | 13 | 12 | 55 |
| African | F | | | 1 | | 4 | 1 | 1 | 1 | 8 |
| | M | 2 | | 5 | 8 | 5 | 7 | 8 | 6 | 41 |
| Coloured | F | 1 | | 2 | | 1 | 1 | 2 | 2 | 9 |
| | M | 2 | 1 | 12 | 4 | 8 | 7 | 3 | 5 | 42 |
| White | F | 12 | 17 | 15 | 12 | 14 | 9 | 8 | 9 | 96 |
| | M | 150 | 97 | 120 | 133 | 104 | 90 | 103 | 103 | 900 |
| OVERALL | F | 14 | 17 | 20 | 12 | 19 | 11 | 14 | 16 | 123 |
| | M | 155 | 100 | 139 | 152 | 125 | 114 | 127 | 126 | 1038 |
| TOTAL | | 169 | 117 | 159 | 164 | 144 | 125 | 141 | 142 | 1161 |

QUALIFICATION TRENDS BY CURRENT PROVINCE OF RESIDENCE

| | 1991 | 1992 | 1993 | 1994 | 1995 | 1996 | 1997 | 1998 | TOTAL |
|---------------|------------|------------|------------|------------|------------|------------|------------|------------|-------------|
| Western Cape | 27 | 21 | 28 | 27 | 44 | 5 | 7 | | 159 |
| Northern Cape | 2 | | | | | | | | 2 |
| Free State | | 2 | | 3 | | | | | 5 |
| Eastern Cape | 40 | 28 | 36 | 49 | 25 | 27 | 35 | 39 | 279 |
| KwaZulu-Natal | 27 | 4 | 20 | 9 | 6 | 12 | 7 | 8 | 93 |
| Mpumalanga | 4 | 2 | 3 | | | 5 | 7 | 8 | 29 |
| Northern Prov | 2 | 2 | | 3 | | | | | 7 |
| Gauteng | 63 | 53 | 62 | 70 | 63 | 76 | 85 | 87 | 559 |
| North West | 2 | | 5 | | | | | | 7 |
| Outside SA | 2 | 5 | 5 | 3 | 6 | | | | 21 |
| TOTAL | 169 | 117 | 159 | 164 | 144 | 125 | 141 | 142 | 1161 |

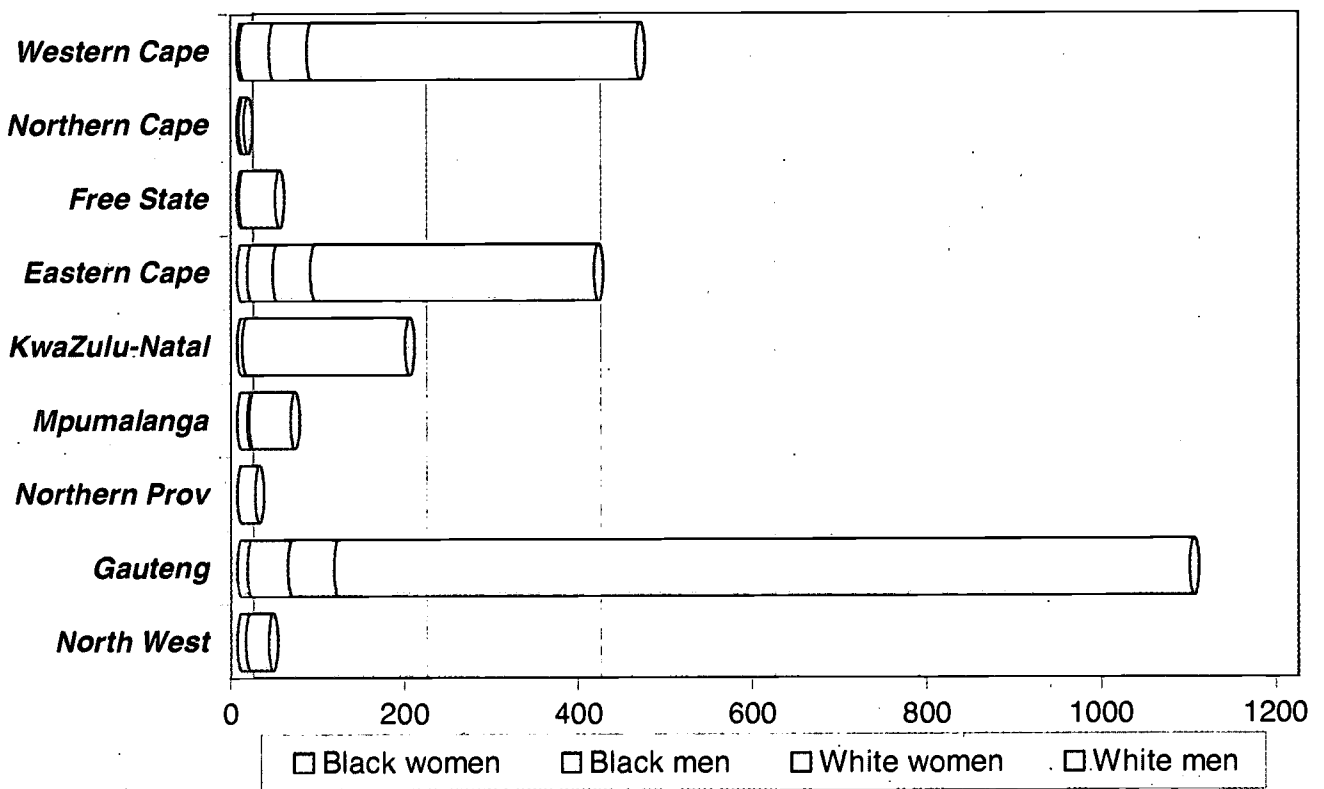
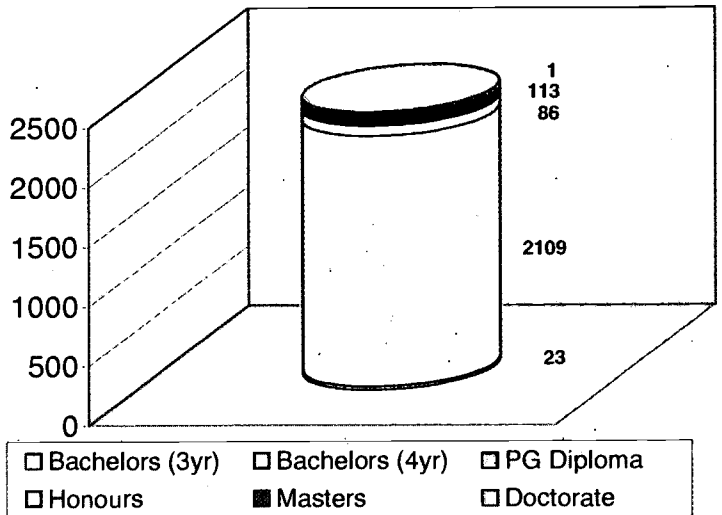
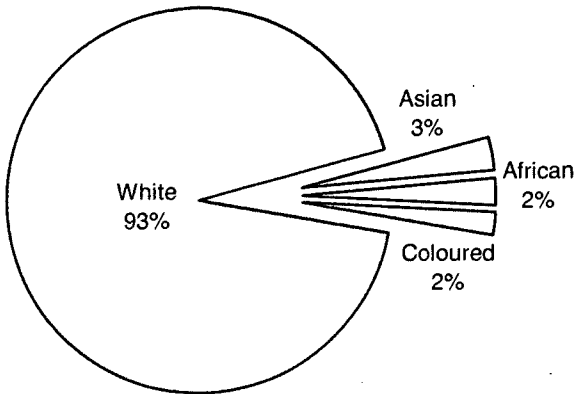

| | Asian | | African | | Coloured | | White | | OVERALL | | TOTAL |
|---------------|-----------|-----------|-----------|-----------|-----------|-----------|-------------|-------------|------------|-------------|-------------|
| | Women | Men | Women | Men | Women | Men | Women | Men | Women | Men | |
| Western Cape | 3 | 12 | | 12 | | 11 | 43 | 378 | 46 | 413 | 459 |
| Northern Cape | | | | | | | 2 | 6 | 2 | 6 | 8 |
| Free State | | | | | | | 2 | 43 | 2 | 43 | 45 |
| Eastern Cape | 7 | | 5 | 4 | | 26 | 43 | 326 | 55 | 356 | 411 |
| KwaZulu-Natal | | | | | | | 6 | 188 | 6 | 188 | 194 |
| Mpumalanga | | | | 12 | | | 2 | 48 | 2 | 60 | 62 |
| Northern Prov | | | | | | | | 21 | 0 | 21 | 21 |
| Gauteng | | 35 | 5 | 12 | 7 | | 52 | 983 | 64 | 1030 | 1094 |
| North West | | 6 | | 4 | | | | 27 | 0 | 37 | 37 |
| TOTAL | 10 | 53 | 10 | 44 | 7 | 37 | 150 | 2020 | 177 | 2154 | 2331 |
| | 63 | | 54 | | 44 | | 2170 | | | | |

TOWN AND REGIONAL PLANNING

QUALIFICATION TRENDS BY LEVEL

| | 1991 | 1992 | 1993 | 1994 | 1995 | 1996 | 1997 | 1998 | TOTAL |
|-----------------|------|------|------|------|------|------|------|------|-------|
| Bachelors (3yr) | | | | | | | | | 0 |
| Bachelors (4yr) | 75 | 75 | 59 | 71 | 60 | 58 | 59 | 57 | 514 |
| PG Diploma | 15 | 21 | 4 | 13 | 23 | 35 | 38 | 39 | 188 |
| Honours | | | | | | | | | 0 |
| Masters | 57 | 74 | 48 | 66 | 78 | 58 | 60 | 69 | 510 |
| Doctorate | 1 | | 2 | | | 1 | | | 4 |
| TOTAL | 148 | 170 | 113 | 150 | 161 | 152 | 157 | 165 | 1216 |

QUALIFICATION TRENDS BY POPULATION GROUP AND GENDER

| | | 1991 | 1992 | 1993 | 1994 | 1995 | 1996 | 1997 | 1998 | TOTAL |
|----------|---|------|------|------|------|------|------|------|------|-------|
| Asian | F | 1 | 2 | | 2 | 5 | 4 | 6 | 3 | 23 |
| | M | 1 | 2 | 2 | 4 | 3 | 4 | 4 | 5 | 25 |
| African | F | 1 | 9 | 2 | 8 | 9 | 20 | 17 | 17 | 83 |
| | M | 5 | 6 | 7 | 8 | 25 | 21 | 22 | 24 | 118 |
| Coloured | F | 2 | | 1 | | 3 | 1 | 2 | 3 | 12 |
| | M | 2 | | 1 | 1 | | 3 | 3 | 2 | 12 |
| White | F | 51 | 61 | 40 | 50 | 58 | 40 | 44 | 50 | 394 |
| | M | 85 | 90 | 60 | 77 | 58 | 59 | 59 | 61 | 549 |
| OVERALL | F | 55 | 72 | 43 | 60 | 75 | 65 | 69 | 73 | 512 |
| | M | 93 | 98 | 70 | 90 | 86 | 87 | 88 | 92 | 704 |
| TOTAL | | 148 | 170 | 113 | 150 | 161 | 152 | 157 | 165 | 1216 |

QUALIFICATION TRENDS BY CURRENT PROVINCE OF RESIDENCE

| | 1991 | 1992 | 1993 | 1994 | 1995 | 1996 | 1997 | 1998 | TOTAL |
|---------------|------|------|------|------|------|------|------|------|-------|
| Western Cape | 29 | 21 | 28 | 9 | 47 | 19 | 29 | 27 | 209 |
| Northern Cape | | 7 | | | 5 | | 2 | 3 | 17 |
| Free State | 12 | 14 | 9 | 19 | 15 | 11 | 17 | 19 | 116 |
| Eastern Cape | | 5 | 3 | 4 | 5 | 8 | 2 | 5 | 32 |
| KwaZulu-Natal | 9 | 20 | 19 | 19 | 14 | 15 | 22 | 16 | 134 |
| Mpumalanga | | 2 | | | 5 | 5 | 7 | 5 | 24 |
| Northern Prov | 3 | 2 | 5 | 7 | 2 | 8 | 5 | 5 | 37 |
| Gauteng | 84 | 86 | 44 | 83 | 54 | 76 | 66 | 77 | 570 |
| North West | 8 | 11 | 5 | 9 | 12 | 5 | 2 | 3 | 55 |
| Outside SA | 3 | 2 | | | 2 | 5 | 5 | 5 | 22 |
| TOTAL | 148 | 170 | 113 | 150 | 161 | 152 | 157 | 165 | 1216 |

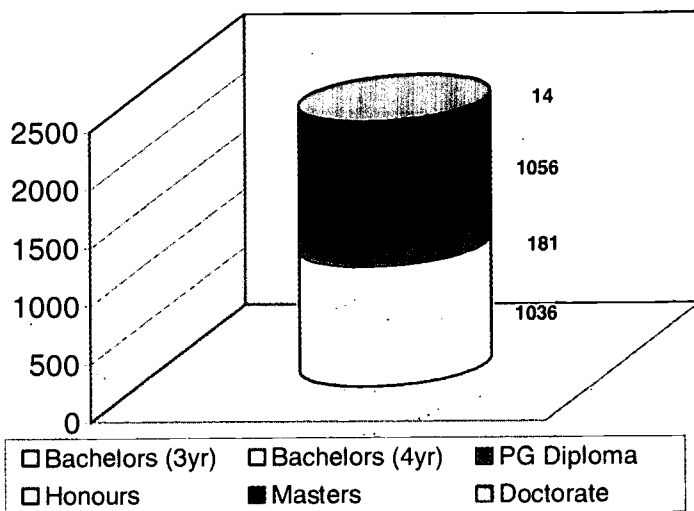
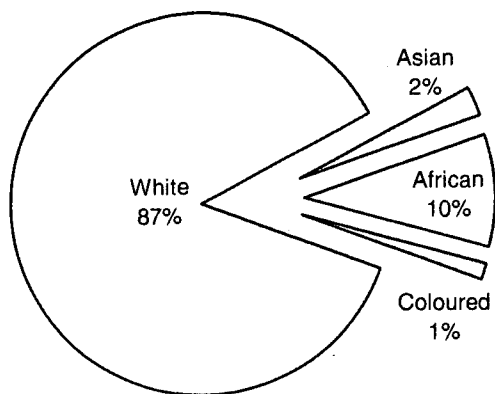

Bachelors (3yr) Bachelors (4yr) PG Diploma
 Honours Masters Doctorate

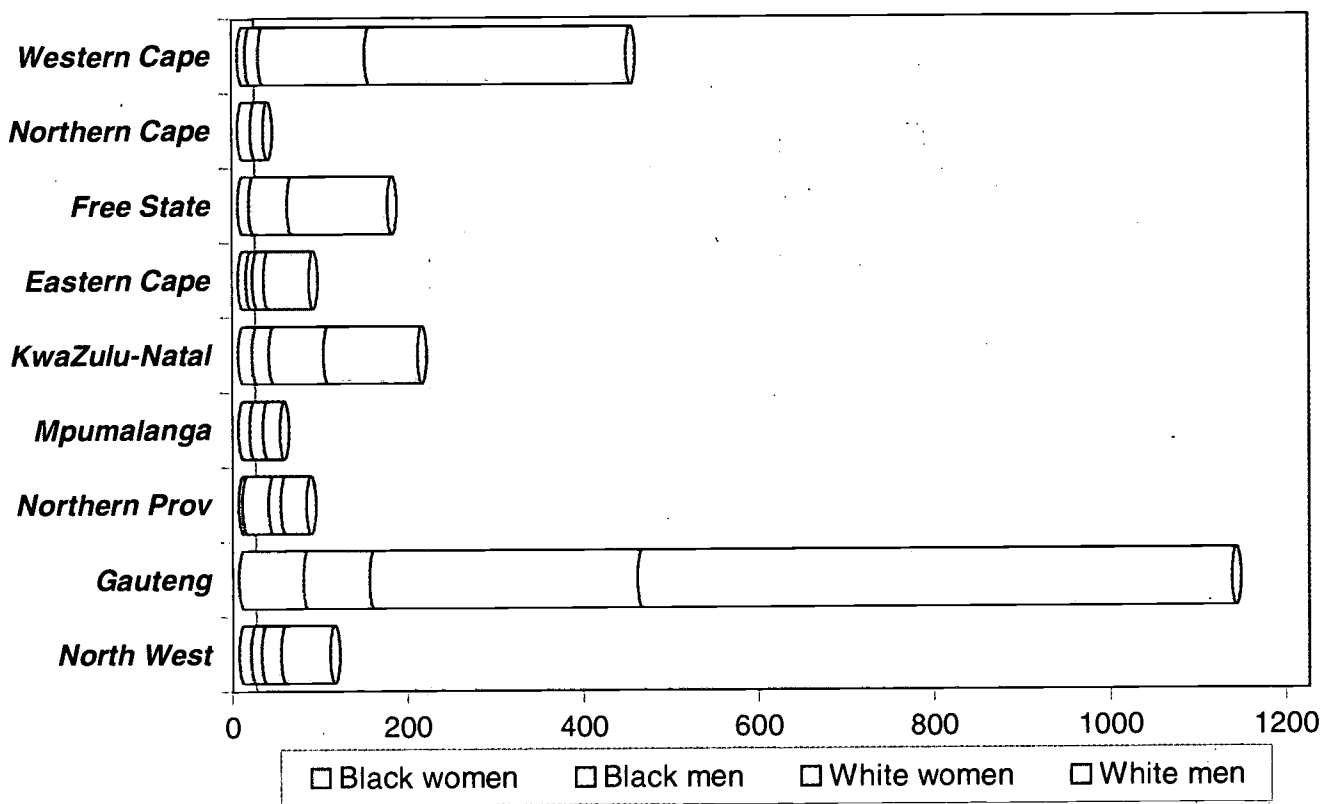

| | Asian | | African | | Coloured | | White | | OVERALL | | TOTAL |
|---------------|-----------|-----------|------------|------------|-----------|-----------|-------------|-------------|------------|-------------|-------------|
| | Women | Men | Women | Men | Women | Men | Women | Men | Women | Men | |
| Western Cape | 1 | | 4 | 5 | 4 | 9 | 122 | 298 | 131 | 312 | 443 |
| Northern Cape | | | | | | | 14 | 14 | 14 | 14 | 28 |
| Free State | | 5 | | 7 | | | 43 | 115 | 43 | 127 | 170 |
| Eastern Cape | | | 9 | 7 | | | 12 | 52 | 21 | 59 | 80 |
| KwaZulu-Natal | 15 | 7 | | 12 | | | 63 | 107 | 78 | 126 | 204 |
| Mpumalanga | | | | 12 | | | 15 | 19 | 15 | 31 | 46 |
| Northern Prov | | | 4 | 29 | | | 14 | 30 | 18 | 59 | 77 |
| Gauteng | 8 | 21 | 57 | 46 | 8 | 8 | 306 | 677 | 379 | 752 | 1131 |
| North West | | | 13 | 12 | | | 22 | 57 | 35 | 69 | 104 |
| TOTAL | 24 | 33 | 87 | 130 | 12 | 17 | 611 | 1369 | 734 | 1549 | 2283 |
| | 57 | | 217 | | 29 | | 1980 | | | | |



QUALIFICATION TRENDS BY LEVEL

| | 1991 | 1992 | 1993 | 1994 | 1995 | 1996 | 1997 | 1998 | TOTAL |
|-----------------|-----------|-----------|-----------|-----------|-----------|-----------|-----------|-----------|------------|
| Bachelors (3yr) | | | | | | | | | 0 |
| Bachelors (4yr) | 15 | 18 | 23 | 26 | 26 | 25 | 18 | 25 | 176 |
| PG Diploma | | | | | | | | | 0 |
| Honours | | | | | | | | | 0 |
| Masters | 4 | | | | | | | | 4 |
| Doctorate | | | | | | | | | 0 |
| TOTAL | 19 | 18 | 23 | 26 | 26 | 25 | 18 | 25 | 180 |

QUALIFICATION TRENDS BY POPULATION GROUP AND GENDER

| | | 1991 | 1992 | 1993 | 1994 | 1995 | 1996 | 1997 | 1998 | TOTAL |
|--------------|---|-----------|-----------|-----------|-----------|-----------|-----------|-----------|-----------|------------|
| Asian | F | | | | | | | | | 0 |
| | M | 2 | | 1 | | 1 | | | | 4 |
| African | F | | 1 | 1 | 3 | 2 | 2 | 2 | 2 | 13 |
| | M | 2 | 1 | 1 | 1 | 3 | 4 | 2 | 3 | 17 |
| Coloured | F | | | | | | | | | 0 |
| | M | 1 | 1 | 2 | 2 | 1 | 2 | 1 | 2 | 12 |
| White | F | 1 | 2 | 1 | 1 | 1 | | 1 | | 7 |
| | M | 13 | 13 | 17 | 19 | 18 | 17 | 12 | 18 | 127 |
| OVERALL | F | 1 | 3 | 2 | 4 | 3 | 2 | 3 | 2 | 20 |
| | M | 18 | 15 | 21 | 22 | 23 | 23 | 15 | 23 | 160 |
| TOTAL | | 19 | 18 | 23 | 26 | 26 | 25 | 18 | 25 | 180 |

QUALIFICATION TRENDS BY CURRENT PROVINCE OF RESIDENCE

| | 1991 | 1992 | 1993 | 1994 | 1995 | 1996 | 1997 | 1998 | TOTAL |
|---------------|-----------|-----------|-----------|-----------|-----------|-----------|-----------|-----------|------------|
| Western Cape | 6 | 3 | 9 | 10 | 7 | | 4 | 5 | 44 |
| Northern Cape | | | | | | | | | 0 |
| Free State | 1 | | | 3 | | | | | 4 |
| Eastern Cape | | 5 | | 3 | 2 | 8 | 4 | 5 | 27 |
| KwaZulu-Natal | 3 | 5 | 8 | 4 | 6 | 9 | 6 | 10 | 51 |
| Mpumalanga | | | | | | | | | 0 |
| Northern Prov | 4 | | 3 | | | 4 | | | 11 |
| Gauteng | 4 | 5 | 3 | 3 | | 4 | | | 19 |
| North West | | | | 3 | 4 | | | | 7 |
| Outside SA | 1 | | | | 7 | | 4 | 5 | 17 |
| TOTAL | 19 | 18 | 23 | 26 | 26 | 25 | 18 | 25 | 180 |

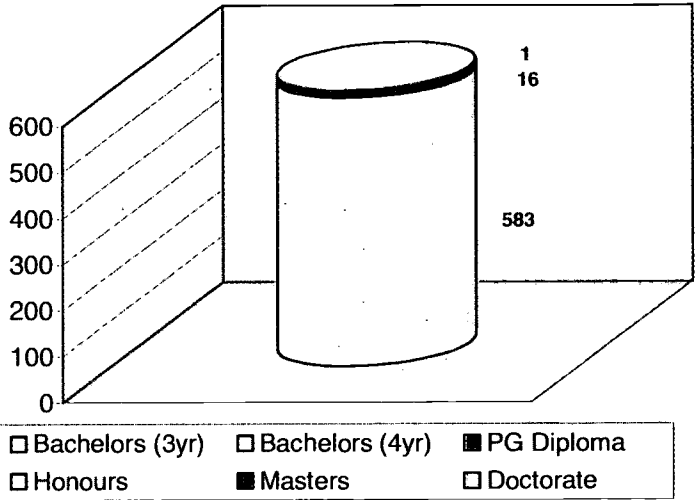
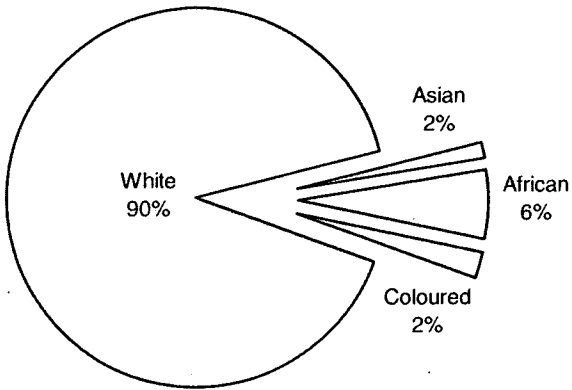

Bachelors (3yr) Bachelors (4yr) PG Diploma
 Honours Masters Doctorate

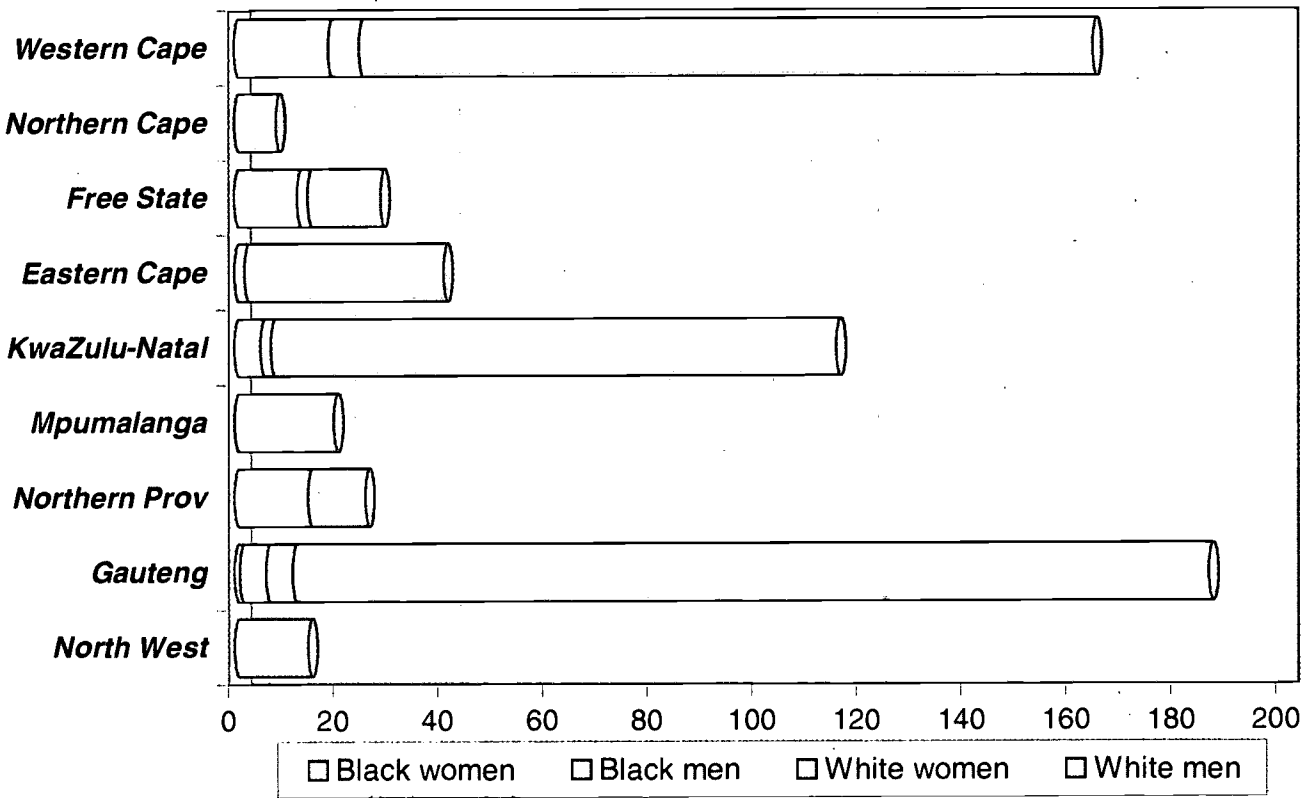

| | Asian | | African | | Coloured | | White | | OVERALL | | TOTAL |
|---------------|----------|----------|-----------|-----------|-----------|-----------|------------|------------|-----------|------------|------------|
| | Women | Men | Women | Men | Women | Men | Women | Men | Women | Men | |
| Western Cape | | 5 | | | | 13 | 6 | 140 | 6 | 158 | 164 |
| Northern Cape | | | | | | | | 8 | 0 | 8 | 8 |
| Free State | | | 12 | 2 | | | | 14 | 12 | 16 | 28 |
| Eastern Cape | | | | | | | 2 | 38 | 2 | 38 | 40 |
| KwaZulu-Natal | | 3 | | 2 | | | 2 | 108 | 2 | 113 | 115 |
| Mpumalanga | | | | | | | | 19 | 0 | 19 | 19 |
| Northern Prov | | | | 14 | | | | 11 | 0 | 25 | 25 |
| Gauteng | 1 | | | 5 | | | 5 | 175 | 6 | 180 | 186 |
| North West | | | | | | | | 14 | 0 | 14 | 14 |
| TOTAL | 1 | 8 | 12 | 23 | 0 | 13 | 15 | 527 | 28 | 571 | 599 |
| | 9 | | 35 | | 13 | | 542 | | | | |



AGRICULTURE

This category also includes Agricultural Administration and Management, Nature Conservation, Forestry and Soil Conservation.

QUALIFICATION TRENDS BY LEVEL

| | 1991 | 1992 | 1993 | 1994 | 1995 | 1996 | 1997 | 1998 | TOTAL |
|-----------------|------|------|------|------|------|------|------|------|-------|
| Bachelors (3yr) | 60 | 117 | 112 | 97 | 153 | 121 | 111 | 120 | 891 |
| Bachelors (4yr) | 512 | 481 | 415 | 431 | 539 | 412 | 420 | 437 | 3647 |
| PG Diploma | | | | 4 | 1 | 2 | 7 | 7 | 21 |
| Honours | 180 | 178 | 205 | 186 | 166 | 235 | 257 | 272 | 1679 |
| Masters | 82 | 83 | 65 | 81 | 110 | 75 | 92 | 89 | 677 |
| Doctorate | 23 | 23 | 18 | 22 | 21 | 13 | 17 | 18 | 160 |
| TOTAL | 857 | 887 | 815 | 821 | 990 | 858 | 904 | 943 | 7075 |

QUALIFICATION TRENDS BY POPULATION GROUP AND GENDER

| | | 1991 | 1992 | 1993 | 1994 | 1995 | 1996 | 1997 | 1998 | TOTAL |
|----------|---|------|------|------|------|------|------|------|------|-------|
| Asian | F | 2 | 2 | 2 | 2 | 3 | 1 | 2 | 1 | 15 |
| | M | 1 | 1 | 4 | 1 | 3 | 3 | 4 | 4 | 21 |
| African | F | 6 | 20 | 23 | 21 | 37 | 51 | 57 | 58 | 273 |
| | M | 74 | 111 | 114 | 126 | 131 | 166 | 183 | 198 | 1103 |
| Coloured | F | | | | 2 | 1 | 2 | 3 | 3 | 11 |
| | M | | | | 1 | 3 | 1 | 1 | 1 | 7 |
| White | F | 177 | 171 | 168 | 156 | 196 | 176 | 183 | 186 | 1413 |
| | M | 597 | 582 | 504 | 512 | 616 | 458 | 471 | 492 | 4232 |
| OVERALL | F | 185 | 193 | 193 | 181 | 237 | 230 | 245 | 248 | 1712 |
| | M | 672 | 694 | 622 | 640 | 753 | 628 | 659 | 695 | 5363 |
| TOTAL | | 857 | 887 | 815 | 821 | 990 | 858 | 904 | 943 | 7075 |

QUALIFICATION TRENDS BY CURRENT PROVINCE OF RESIDENCE

| | 1991 | 1992 | 1993 | 1994 | 1995 | 1996 | 1997 | 1998 | TOTAL |
|---------------|------|------|------|------|------|------|------|------|-------|
| Western Cape | 178 | 188 | 160 | 144 | 237 | 130 | 162 | 182 | 1381 |
| Northern Cape | 40 | 23 | 38 | 31 | 31 | 3 | 11 | 12 | 189 |
| Free State | 133 | 179 | 89 | 106 | 74 | 101 | 95 | 88 | 865 |
| Eastern Cape | 83 | 87 | 74 | 99 | 97 | 104 | 103 | 111 | 758 |
| KwaZulu-Natal | 79 | 59 | 83 | 72 | 90 | 83 | 73 | 81 | 620 |
| Mpumalanga | 53 | 60 | 58 | 42 | 83 | 57 | 59 | 47 | 459 |
| Northern Prov | 37 | 37 | 53 | 68 | 72 | 70 | 73 | 82 | 492 |
| Gauteng | 178 | 166 | 175 | 170 | 186 | 174 | 195 | 190 | 1434 |
| North West | 58 | 58 | 53 | 54 | 77 | 104 | 86 | 103 | 593 |
| Outside SA | 18 | 30 | 32 | 35 | 43 | 32 | 47 | 47 | 284 |
| TOTAL | 857 | 887 | 815 | 821 | 990 | 858 | 904 | 943 | 7075 |

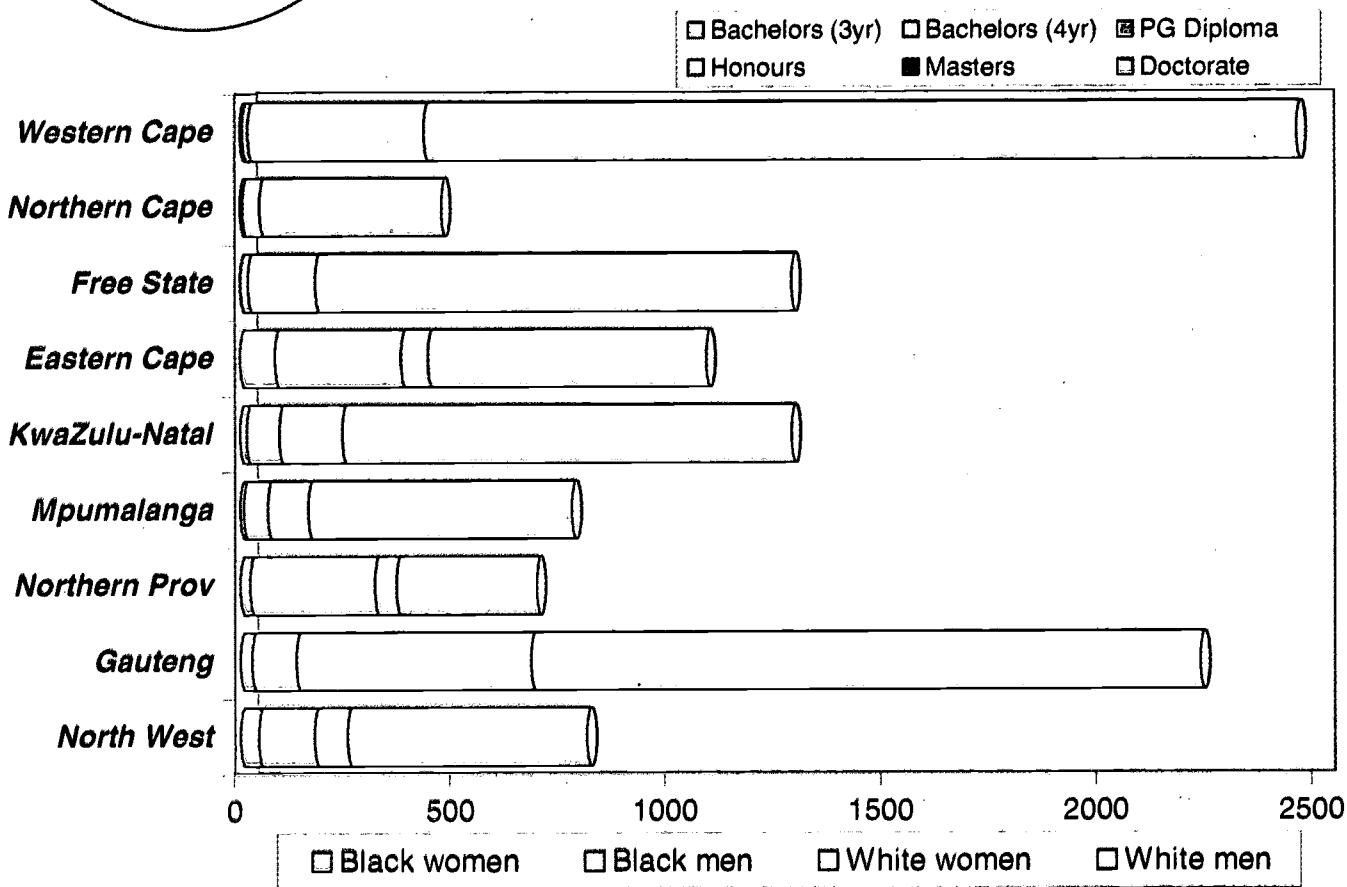
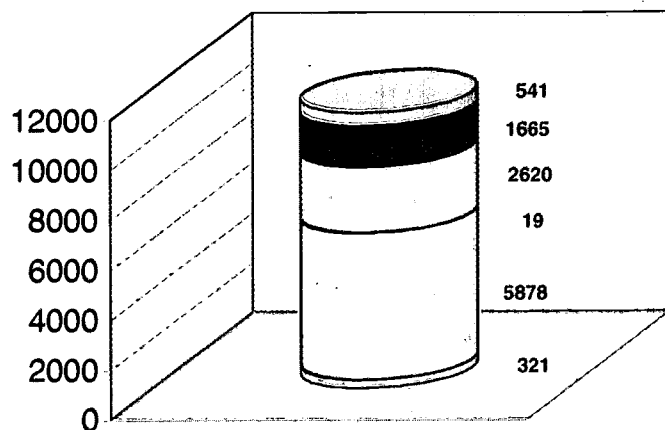
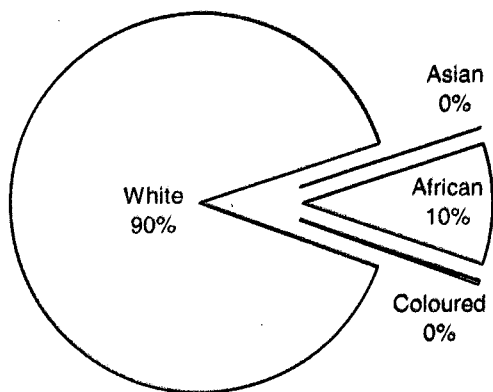

| | Asian | | African | | Coloured | | White | | OVERALL | | |
|---------------|-----------|-----------|-------------|------------|-----------|-----------|-------------|-------------|-------------|-------------|--------------|
| | Women | Men | Women | Men | Women | Men | Women | Men | Women | Men | TOTAL |
| Western Cape | | | 2 | 7 | 4 | 6 | 408 | 2024 | 414 | 2037 | 2451 |
| Northern Cape | | | | 4 | | 1 | 40 | 422 | 40 | 427 | 467 |
| Free State | | | 2 | 17 | | | 155 | 1105 | 157 | 1122 | 1279 |
| Eastern Cape | | 3 | 81 | 288 | | 1 | 62 | 646 | 143 | 938 | 1081 |
| KwaZulu-Natal | | 3 | 15 | 72 | | | 147 | 1042 | 162 | 1117 | 1279 |
| Mpumalanga | | 3 | 8 | 52 | | | 94 | 613 | 102 | 668 | 770 |
| Northern Prov | | | 23 | 288 | | 1 | 49 | 326 | 72 | 615 | 687 |
| Gauteng | 6 | 3 | 17 | 94 | 4 | 5 | 545 | 1553 | 572 | 1655 | 2227 |
| North West | | 6 | 36 | 129 | | | 78 | 555 | 120 | 684 | 804 |
| TOTAL | 12 | 12 | 184 | 951 | 8 | 14 | 1578 | 8286 | 1782 | 9263 | 11045 |
| | 24 | | 1135 | | 22 | | 9864 | | | | |

FOOD SCIENCE AND HOME ECONOMICS

This category also includes Food Technology (human and animal foods), and non-medical Nutrition.

QUALIFICATION TRENDS BY LEVEL

| | 1991 | 1992 | 1993 | 1994 | 1995 | 1996 | 1997 | 1998 | TOTAL |
|-----------------|------------|------------|------------|------------|------------|------------|------------|------------|-------------|
| Bachelors (3yr) | 1 | 8 | 7 | 9 | 32 | 12 | 12 | 11 | 92 |
| Bachelors (4yr) | 107 | 87 | 93 | 112 | 87 | 87 | 97 | 114 | 784 |
| PG Diploma | | | | | | | | | 0 |
| Honours | 18 | 15 | 16 | 9 | 20 | 16 | 16 | 18 | 128 |
| Masters | 4 | 4 | 7 | 3 | 6 | 6 | 12 | 15 | 57 |
| Doctorate | 2 | 1 | 1 | 2 | 1 | 2 | 3 | 5 | 17 |
| TOTAL | 132 | 115 | 124 | 135 | 146 | 123 | 140 | 163 | 1078 |

QUALIFICATION TRENDS BY POPULATION GROUP AND GENDER

| | | 1991 | 1992 | 1993 | 1994 | 1995 | 1996 | 1997 | 1998 | TOTAL |
|--------------|---|------------|------------|------------|------------|------------|------------|------------|------------|-------------|
| Asian | F | | | | | | | | | 0 |
| | M | | | | | | | | | 0 |
| African | F | 15 | 7 | 7 | 9 | 20 | 11 | 21 | 35 | 125 |
| | M | | 3 | 3 | 3 | 3 | 4 | 5 | 3 | 24 |
| Coloured | F | | 1 | 1 | | 3 | 1 | 2 | 2 | 10 |
| | M | | | | | | 1 | 1 | 2 | 4 |
| White | F | 115 | 103 | 111 | 119 | 116 | 99 | 102 | 110 | 875 |
| | M | 2 | 1 | 2 | 4 | 4 | 7 | 9 | 11 | 40 |
| OVERALL | F | 130 | 111 | 119 | 128 | 139 | 111 | 125 | 147 | 1010 |
| | M | 2 | 4 | 5 | 7 | 7 | 12 | 15 | 16 | 68 |
| TOTAL | | 132 | 115 | 124 | 135 | 146 | 123 | 140 | 163 | 1078 |

QUALIFICATION TRENDS BY CURRENT PROVINCE OF RESIDENCE

| | 1991 | 1992 | 1993 | 1994 | 1995 | 1996 | 1997 | 1998 | TOTAL |
|---------------|------------|------------|------------|------------|------------|------------|------------|------------|-------------|
| Western Cape | 32 | 32 | 41 | 45 | 47 | 29 | 51 | 51 | 328 |
| Northern Cape | 4 | | | 2 | | 9 | | | 15 |
| Free State | 5 | 6 | 3 | 7 | 11 | 6 | 7 | 9 | 54 |
| Eastern Cape | 7 | | 7 | 2 | 4 | 3 | 7 | 7 | 37 |
| KwaZulu-Natal | 10 | 9 | 5 | 10 | 14 | 5 | 10 | 19 | 82 |
| Mpumalanga | 11 | 8 | 5 | 13 | 4 | 3 | 5 | 5 | 54 |
| Northern Prov | 4 | | 5 | 2 | 2 | 6 | 7 | 9 | 35 |
| Gauteng | 50 | 53 | 41 | 43 | 49 | 56 | 46 | 54 | 392 |
| North West | 7 | 5 | 15 | 7 | 11 | 3 | 5 | 7 | 60 |
| Outside SA | 2 | 2 | 2 | 4 | 4 | 3 | 2 | 2 | 21 |
| TOTAL | 132 | 115 | 124 | 135 | 146 | 123 | 140 | 163 | 1078 |

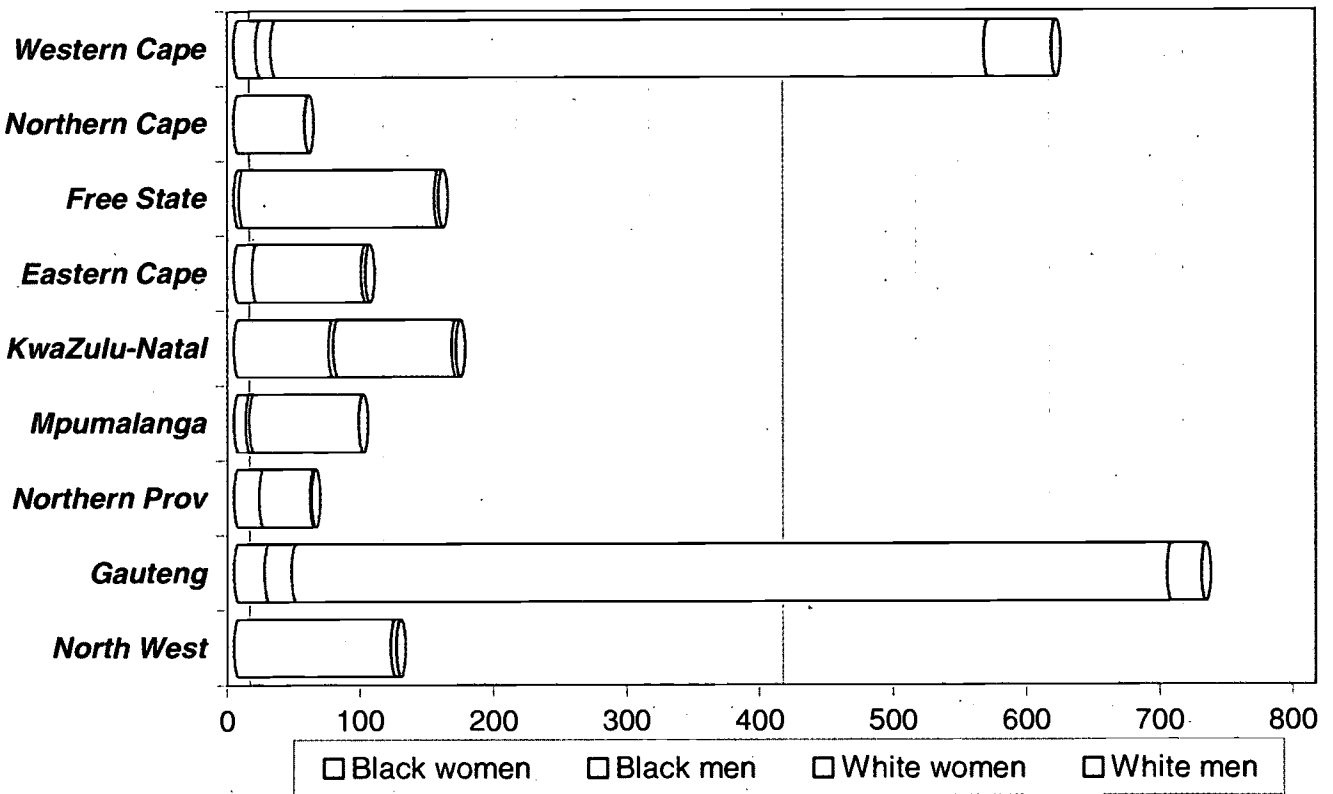
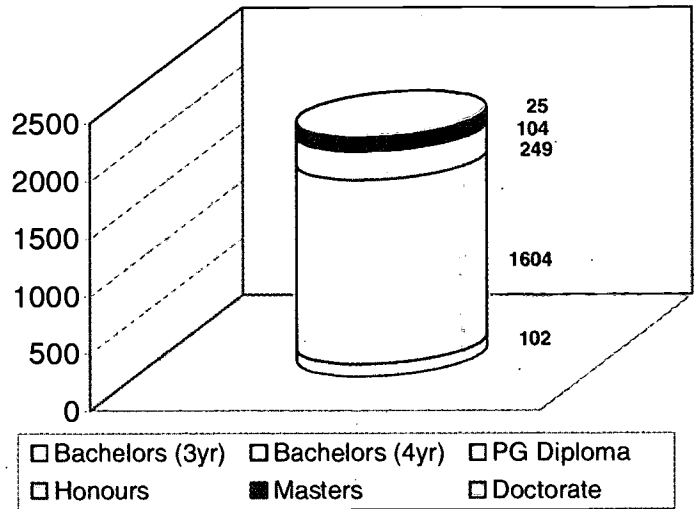
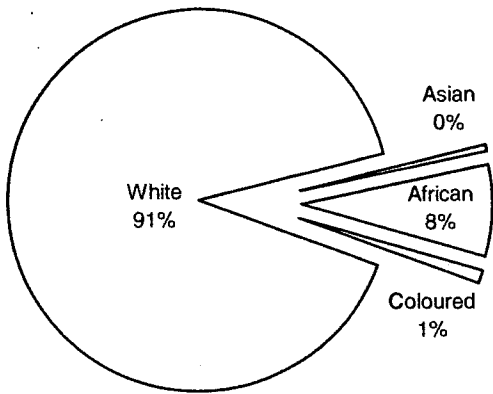

| | Asian | | African | | Coloured | | White | | OVERALL | | TOTAL |
|---------------|----------|----------|------------|-----------|-----------|-----------|-------------|-----------|-------------|------------|-------------|
| | Women | Men | Women | Men | Women | Men | Women | Men | Women | Men | |
| Western Cape | | | 6 | 1 | 11 | 10 | 535 | 51 | 552 | 62 | 614 |
| Northern Cape | | | | | | | 53 | | 53 | 0 | 53 |
| Free State | | | 4 | | | | 147 | 3 | 151 | 3 | 154 |
| Eastern Cape | | | 13 | | 1 | | 82 | 3 | 96 | 3 | 99 |
| KwaZulu-Natal | 6 | | 65 | 4 | | | 89 | 3 | 160 | 7 | 167 |
| Mpumalanga | | | 9 | 3 | | | 82 | | 91 | 3 | 94 |
| Northern Prov | | | 19 | | | | 38 | 1 | 57 | 1 | 58 |
| Gauteng | 3 | | 17 | 20 | 3 | | 657 | 26 | 680 | 46 | 726 |
| North West | | | | | | | 118 | 4 | 118 | 4 | 122 |
| TOTAL | 9 | 0 | 133 | 28 | 15 | 10 | 1801 | 91 | 1958 | 129 | 2087 |
| | 9 | | 161 | | 25 | | 1892 | | | | |

QUALIFICATION TRENDS BY LEVEL

| | 1991 | 1992 | 1993 | 1994 | 1995 | 1996 | 1997 | 1998 | TOTAL |
|-----------------|------------|------------|------------|------------|------------|------------|------------|------------|------------|
| Bachelors (3yr) | | | | | | | | | 0 |
| Bachelors (4yr) | 83 | 102 | 92 | 94 | 95 | 100 | 105 | 90 | 761 |
| PG Diploma | | | | | | | | | 0 |
| Honours | 13 | 5 | 19 | 10 | 14 | 10 | 10 | 10 | 91 |
| Masters | 7 | 8 | 7 | 7 | 11 | 8 | 12 | 12 | 72 |
| Doctorate | 1 | 5 | 2 | 4 | 2 | 4 | 3 | 3 | 24 |
| TOTAL | 104 | 120 | 120 | 115 | 122 | 122 | 130 | 115 | 948 |

QUALIFICATION TRENDS BY POPULATION GROUP AND GENDER

| | | 1991 | 1992 | 1993 | 1994 | 1995 | 1996 | 1997 | 1998 | TOTAL |
|--------------|---|------------|------------|------------|------------|------------|------------|------------|------------|------------|
| Asian | F | 1 | | | 1 | 1 | 1 | 1 | 1 | 6 |
| | M | | 2 | 1 | 1 | 1 | 1 | 1 | 1 | 8 |
| African | F | 1 | | 2 | 1 | 4 | 1 | 7 | | 16 |
| | M | 5 | 2 | 9 | 3 | 11 | 8 | 14 | 5 | 57 |
| Coloured | F | | | | | 1 | | 1 | | 2 |
| | M | | 2 | 1 | | | 1 | 1 | 1 | 6 |
| White | F | 26 | 30 | 54 | 41 | 38 | 47 | 41 | 43 | 320 |
| | M | 71 | 84 | 53 | 68 | 66 | 63 | 64 | 64 | 533 |
| OVERALL | F | 28 | 30 | 56 | 43 | 44 | 49 | 50 | 44 | 344 |
| | M | 76 | 90 | 64 | 72 | 78 | 73 | 80 | 71 | 604 |
| TOTAL | | 104 | 120 | 120 | 115 | 122 | 122 | 130 | 115 | 948 |

QUALIFICATION TRENDS BY CURRENT PROVINCE OF RESIDENCE

| | 1991 | 1992 | 1993 | 1994 | 1995 | 1996 | 1997 | 1998 | TOTAL |
|---------------|------------|------------|------------|------------|------------|------------|------------|------------|------------|
| Western Cape | 12 | 12 | 10 | 13 | 11 | 11 | 18 | 17 | 104 |
| Northern Cape | 2 | | | | 2 | | 3 | 3 | 10 |
| Free State | 5 | 6 | 2 | 2 | | | | | 15 |
| Eastern Cape | 7 | 4 | 4 | 9 | 11 | | 3 | 3 | 41 |
| KwaZulu-Natal | 8 | 14 | 12 | 5 | 17 | 12 | 12 | 7 | 87 |
| Mpumalanga | 5 | 4 | 4 | 4 | 2 | 4 | 3 | 6 | 32 |
| Northern Prov | 3 | 4 | | 2 | 2 | 4 | 3 | 3 | 21 |
| Gauteng | 56 | 62 | 66 | 65 | 63 | 80 | 70 | 62 | 524 |
| North West | 3 | 2 | 10 | 2 | 7 | 11 | 12 | 8 | 55 |
| Outside SA | 3 | 12 | 12 | 13 | 7 | | 6 | 6 | 59 |
| TOTAL | 104 | 120 | 120 | 115 | 122 | 122 | 130 | 115 | 948 |

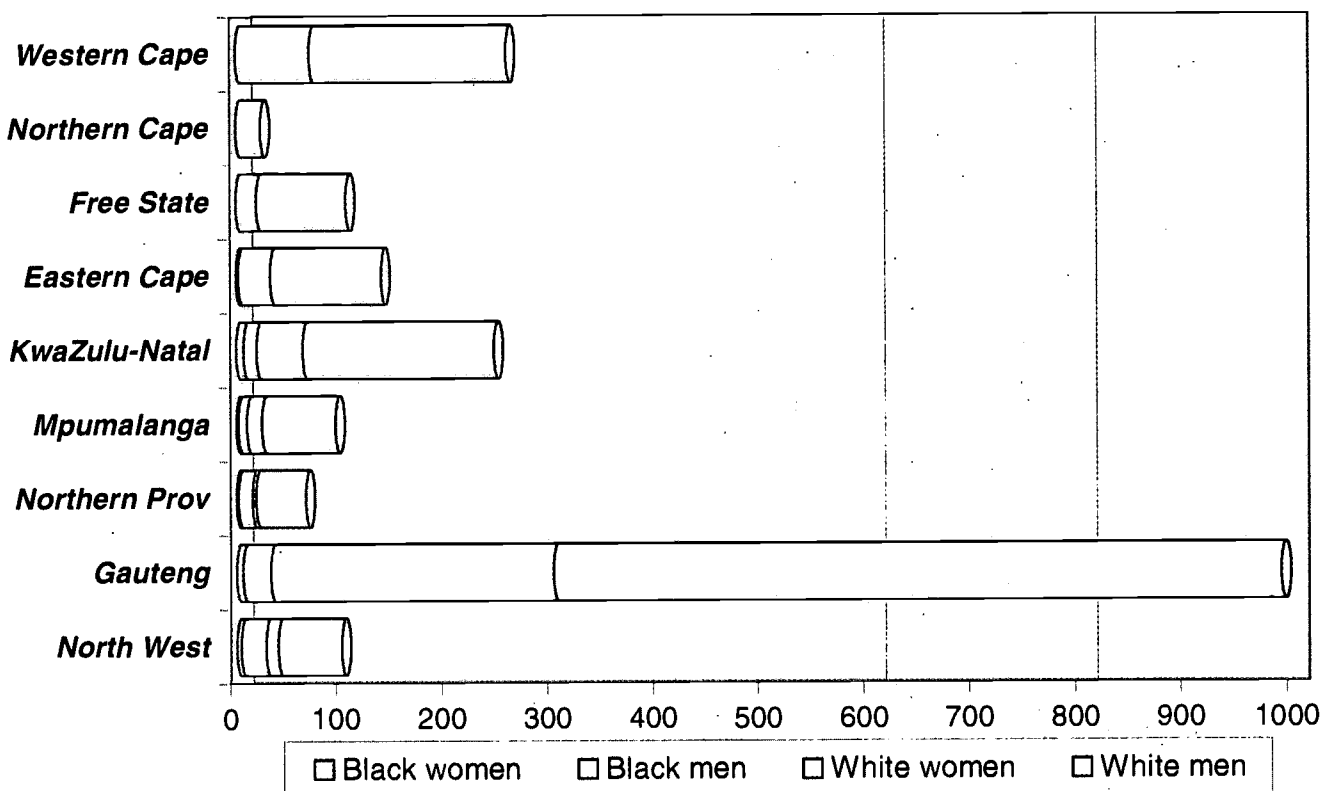
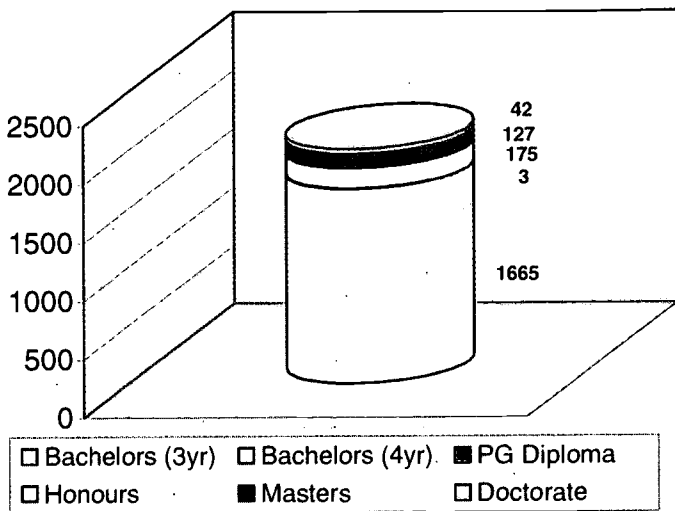
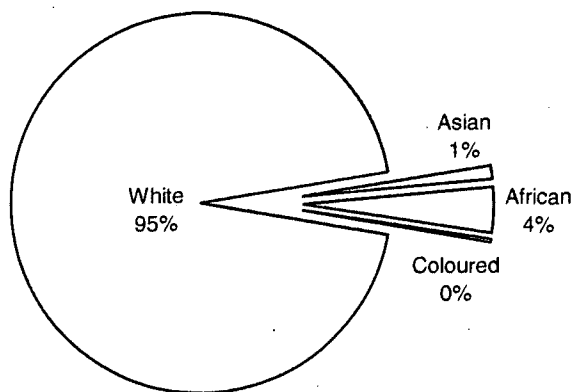

| | Asian | | African | | Coloured | | White | | OVERALL | | |
|---------------|-----------|-----------|-----------|-----------|----------|----------|-------------|-------------|------------|-------------|-------------|
| | Women | Men | Women | Men | Women | Men | Women | Men | Women | Men | TOTAL |
| Western Cape | | | | | | | 70 | 186 | 70 | 186 | 256 |
| Northern Cape | | | | | | | | 23 | 0 | 23 | 23 |
| Free State | | | | | | | 19 | 85 | 19 | 85 | 104 |
| Eastern Cape | | | | 2 | | | 30 | 105 | 30 | 107 | 137 |
| KwaZulu-Natal | 7 | 7 | | 4 | | 1 | 44 | 181 | 51 | 193 | 244 |
| Mpumalanga | | | 2 | 8 | | | 14 | 70 | 16 | 78 | 94 |
| Northern Prov | | | 2 | 13 | | | 3 | 48 | 5 | 61 | 66 |
| Gauteng | | 4 | 4 | 21 | 2 | 1 | 268 | 689 | 274 | 715 | 989 |
| North West | | 2 | 4 | 21 | | | 12 | 60 | 16 | 83 | 99 |
| TOTAL | 7 | 13 | 12 | 69 | 2 | 2 | 460 | 1447 | 481 | 1531 | |
| | 20 | | 81 | | 4 | | 1907 | | | | 2012 |



This category comprises all General Practitioner and Specialist qualifications.

QUALIFICATION TRENDS BY LEVEL

| | 1991 | 1992 | 1993 | 1994 | 1995 | 1996 | 1997 | 1998 | TOTAL |
|-----------------|-------------|-------------|-------------|-------------|-------------|-------------|-------------|-------------|--------------|
| Bachelors (3yr) | 1 | | | 11 | 10 | 11 | 12 | 13 | 58 |
| Bachelors (4yr) | 882 | 917 | 948 | 974 | 1023 | 1262 | 1269 | 1274 | 8549 |
| PG Diploma | 14 | 12 | 15 | 16 | 33 | 29 | 28 | 26 | 173 |
| Honours | | | 1 | 2 | 1 | 3 | 2 | 4 | 13 |
| Masters | 267 | 252 | 240 | 306 | 333 | 345 | 359 | 369 | 2471 |
| Doctorate | 23 | 26 | 21 | 36 | 46 | 23 | 25 | 26 | 229 |
| TOTAL | 1190 | 1207 | 1225 | 1345 | 1446 | 1673 | 1695 | 1712 | 11493 |

QUALIFICATION TRENDS BY POPULATION GROUP AND GENDER

| | | 1991 | 1992 | 1993 | 1994 | 1995 | 1996 | 1997 | 1998 | TOTAL |
|--------------|---|-------------|-------------|-------------|-------------|-------------|-------------|-------------|-------------|--------------|
| Asian | F | 31 | 39 | 42 | 53 | 64 | 89 | 102 | 99 | 519 |
| | M | 50 | 79 | 81 | 90 | 117 | 110 | 120 | 132 | 779 |
| African | F | 50 | 42 | 48 | 64 | 82 | 84 | 105 | 107 | 582 |
| | M | 84 | 90 | 129 | 121 | 153 | 141 | 171 | 153 | 1042 |
| Coloured | F | 10 | 13 | 17 | 25 | 30 | 31 | 27 | 36 | 189 |
| | M | 22 | 14 | 29 | 33 | 37 | 31 | 35 | 39 | 240 |
| White | F | 300 | 289 | 302 | 319 | 377 | 521 | 471 | 502 | 3081 |
| | M | 643 | 641 | 577 | 640 | 586 | 666 | 664 | 644 | 5061 |
| OVERALL | F | 391 | 383 | 409 | 461 | 553 | 725 | 705 | 744 | 4371 |
| | M | 799 | 824 | 816 | 884 | 893 | 948 | 990 | 968 | 7122 |
| TOTAL | | 1190 | 1207 | 1225 | 1345 | 1446 | 1673 | 1695 | 1712 | 11493 |

QUALIFICATION TRENDS BY CURRENT PROVINCE OF RESIDENCE

| | 1991 | 1992 | 1993 | 1994 | 1995 | 1996 | 1997 | 1998 | TOTAL |
|---------------|-------------|-------------|-------------|-------------|-------------|-------------|-------------|-------------|--------------|
| Western Cape | 302 | 233 | 310 | 333 | 397 | 300 | 293 | 300 | 2468 |
| Northern Cape | 21 | 6 | 12 | 30 | 20 | 17 | 23 | 23 | 152 |
| Free State | 93 | 150 | 121 | 159 | 173 | 324 | 293 | 354 | 1667 |
| Eastern Cape | 61 | 44 | 61 | 48 | 70 | 67 | 59 | 50 | 460 |
| KwaZulu-Natal | 112 | 106 | 143 | 142 | 170 | 186 | 208 | 185 | 1252 |
| Mpumalanga | 32 | 36 | 22 | 25 | 14 | 27 | 23 | 23 | 202 |
| Northern Prov | 19 | 38 | 32 | 25 | 70 | 34 | 98 | 40 | 356 |
| Gauteng | 484 | 548 | 467 | 520 | 473 | 627 | 600 | 667 | 4386 |
| North West | 32 | 21 | 27 | 40 | 17 | 71 | 49 | 40 | 297 |
| Outside SA | 34 | 25 | 30 | 23 | 42 | 20 | 49 | 30 | 253 |
| TOTAL | 1190 | 1207 | 1225 | 1345 | 1446 | 1673 | 1695 | 1712 | 11493 |

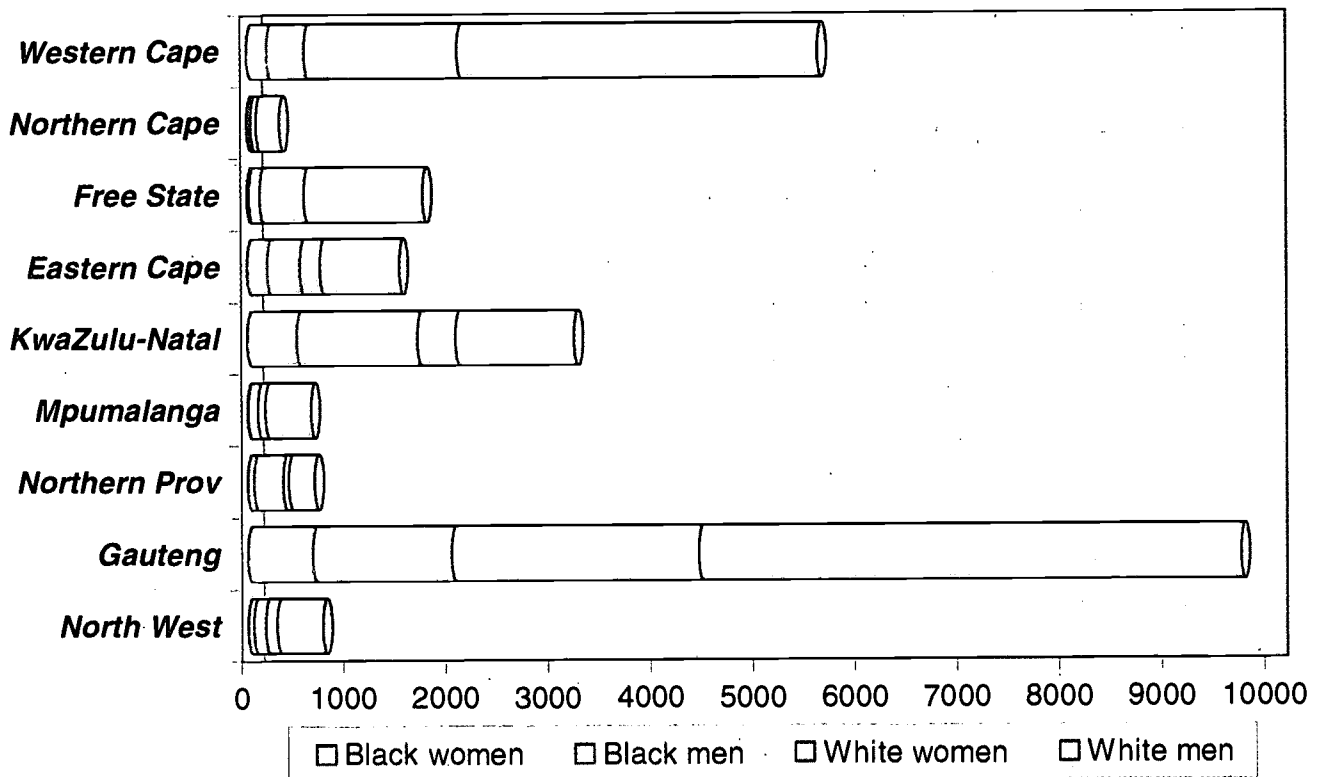
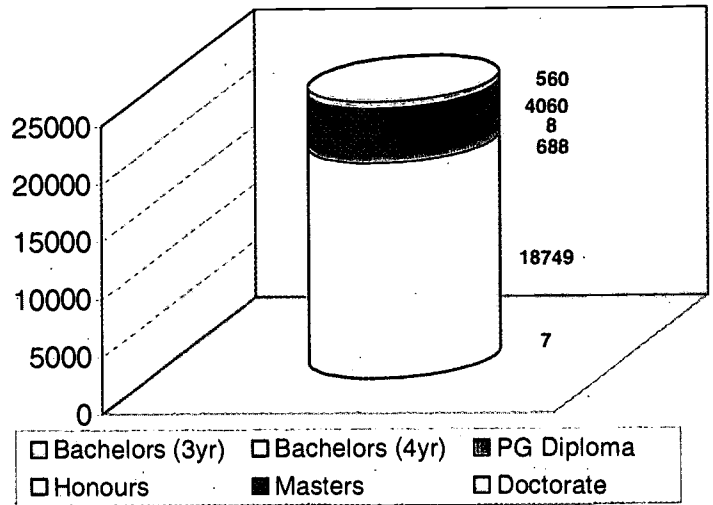
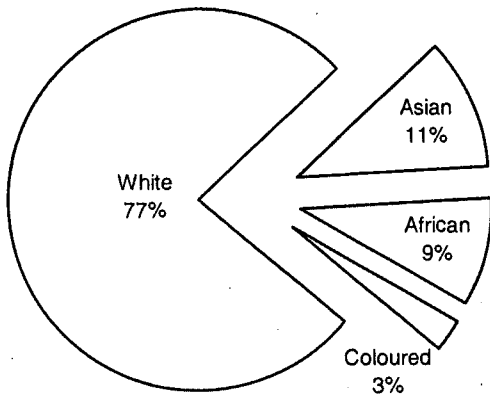

| | Asian | | African | | Coloured | | White | | OVERALL | | |
|---------------|-------------|-------------|-------------|-------------|------------|------------|--------------|--------------|-------------|--------------|--------------|
| | Women | Men | Women | Men | Women | Men | Women | Men | Women | Men | TOTAL |
| Western Cape | 38 | 110 | 15 | 22 | 142 | 244 | 1490 | 3524 | 1685 | 3900 | 5585 |
| Northern Cape | 2 | 8 | 4 | 5 | 3 | 13 | 54 | 234 | 63 | 260 | 323 |
| Free State | | 5 | 19 | 87 | | 13 | 441 | 1158 | 460 | 1263 | 1723 |
| Eastern Cape | 16 | 76 | 141 | 170 | 39 | 79 | 199 | 776 | 395 | 1101 | 1496 |
| KwaZulu-Natal | 391 | 1034 | 96 | 90 | 3 | 57 | 365 | 1165 | 855 | 2346 | 3201 |
| Mpumalanga | 7 | 41 | | 49 | | 2 | 75 | 455 | 82 | 547 | 629 |
| Northern Prov | | 30 | 61 | 260 | | | 56 | 255 | 117 | 545 | 662 |
| Gauteng | 266 | 596 | 318 | 719 | 56 | 37 | 2422 | 5296 | 3062 | 6648 | 9710 |
| North West | 9 | 44 | 46 | 71 | | | 118 | 450 | 173 | 565 | 738 |
| TOTAL | 729 | 1944 | 700 | 1473 | 243 | 445 | 5220 | 13313 | 6892 | 17175 | 24067 |
| | 2673 | | 2173 | | 688 | | 18533 | | | | |

DENTISTRY

This category excludes Oral Health and Dental Therapy qualifications, which are placed under *General Health*.

QUALIFICATION TRENDS BY LEVEL

| | 1991 | 1992 | 1993 | 1994 | 1995 | 1996 | 1997 | 1998 | TOTAL |
|-----------------|------------|------------|------------|------------|------------|------------|------------|------------|-------------|
| Bachelors (3yr) | | | | | | | | | 0 |
| Bachelors (4yr) | 132 | 132 | 100 | 136 | 100 | 217 | 166 | 217 | 1200 |
| PG Diploma | 13 | 3 | 7 | 7 | 22 | 33 | 31 | 32 | 148 |
| Honours | 1 | | | | 2 | 2 | 2 | 2 | 9 |
| Masters | 29 | 36 | 18 | 27 | 40 | 21 | 24 | 30 | 225 |
| Doctorate | 5 | 1 | 2 | 2 | 4 | 3 | 2 | 2 | 21 |
| TOTAL | 180 | 172 | 127 | 172 | 168 | 276 | 225 | 283 | 1603 |

QUALIFICATION TRENDS BY POPULATION GROUP AND GENDER

| | | 1991 | 1992 | 1993 | 1994 | 1995 | 1996 | 1997 | 1998 | TOTAL |
|--------------|---|------------|------------|------------|------------|------------|------------|------------|------------|-------------|
| Asian | F | 3 | 7 | 5 | 7 | 15 | 21 | 21 | 28 | 107 |
| | M | 9 | 12 | 10 | 15 | 13 | 41 | 37 | 45 | 182 |
| African | F | 6 | 3 | 10 | 20 | 3 | 25 | 9 | 31 | 107 |
| | M | 8 | 10 | 10 | 23 | 10 | 25 | 11 | 28 | 125 |
| Coloured | F | 7 | 8 | 2 | 4 | 1 | 12 | 12 | 12 | 58 |
| | M | 13 | 13 | 7 | 4 | 5 | 10 | 11 | 11 | 74 |
| White | F | 25 | 21 | 24 | 23 | 30 | 42 | 40 | 41 | 246 |
| | M | 109 | 98 | 59 | 76 | 91 | 100 | 84 | 87 | 704 |
| OVERALL | F | 41 | 39 | 41 | 54 | 49 | 100 | 82 | 112 | 518 |
| | M | 139 | 133 | 86 | 118 | 119 | 176 | 143 | 171 | 1085 |
| TOTAL | | 180 | 172 | 127 | 172 | 168 | 276 | 225 | 283 | 1603 |

QUALIFICATION TRENDS BY CURRENT PROVINCE OF RESIDENCE

| | 1991 | 1992 | 1993 | 1994 | 1995 | 1996 | 1997 | 1998 | TOTAL |
|---------------|------------|------------|------------|------------|------------|------------|------------|------------|-------------|
| Western Cape | 48 | 51 | 20 | 24 | 50 | 76 | 68 | 65 | 402 |
| Northern Cape | | | 2 | | | | | | 2 |
| Free State | 2 | 2 | 5 | 7 | 2 | 11 | 5 | 7 | 41 |
| Eastern Cape | 4 | 2 | 2 | 4 | 5 | 11 | 10 | 10 | 48 |
| KwaZulu-Natal | 6 | 17 | 14 | 23 | 6 | 27 | 19 | 30 | 142 |
| Mpumalanga | 6 | | 5 | 7 | 5 | 8 | 8 | 12 | 51 |
| Northern Prov | 2 | 2 | 5 | 2 | 2 | 5 | 5 | 10 | 33 |
| Gauteng | 103 | 84 | 70 | 94 | 94 | 119 | 97 | 132 | 793 |
| North West | | 5 | 2 | 2 | 2 | 8 | 5 | 5 | 29 |
| Outside SA | 9 | 9 | 2 | 9 | 2 | 11 | 8 | 12 | 62 |
| TOTAL | 180 | 172 | 127 | 172 | 168 | 276 | 225 | 283 | 1603 |

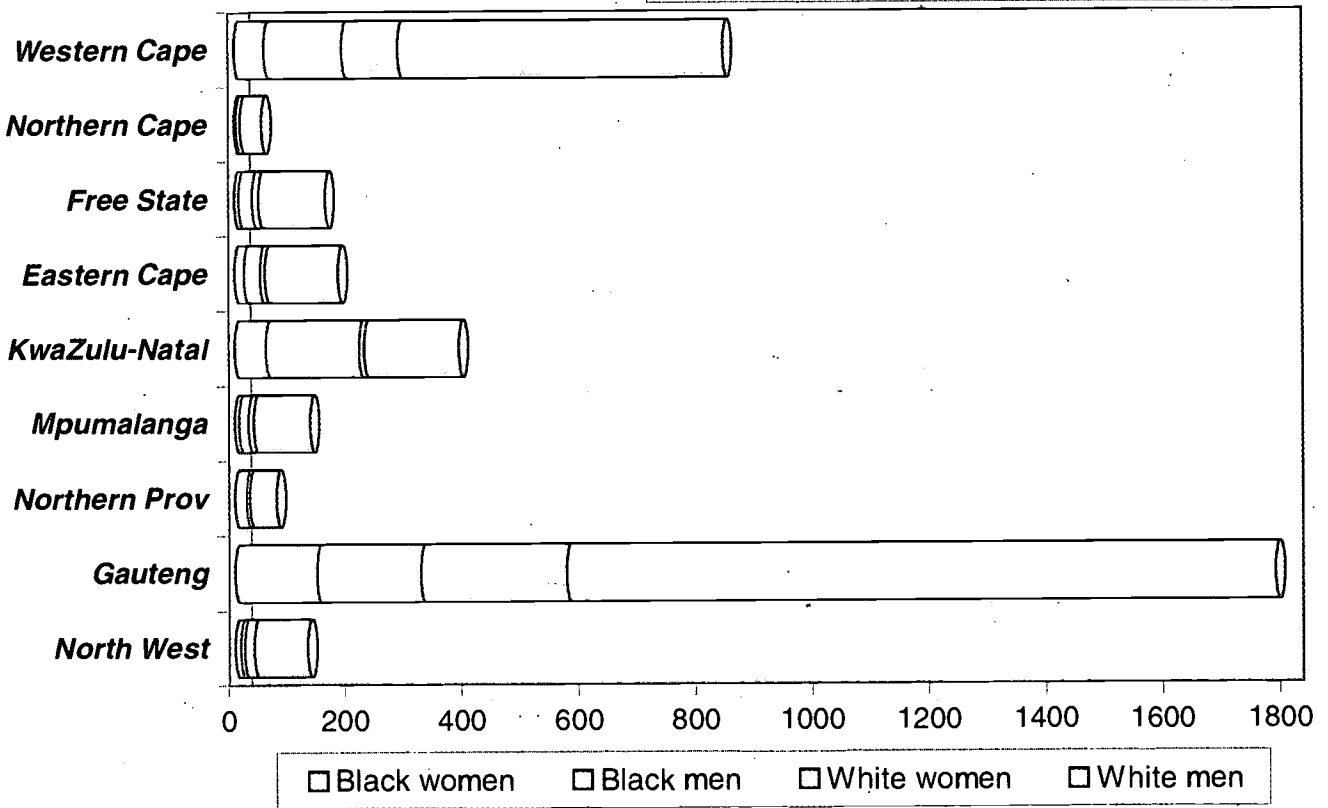
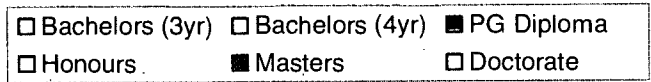
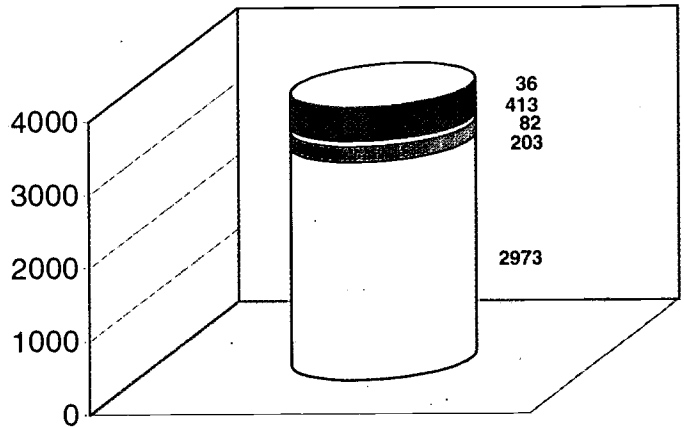
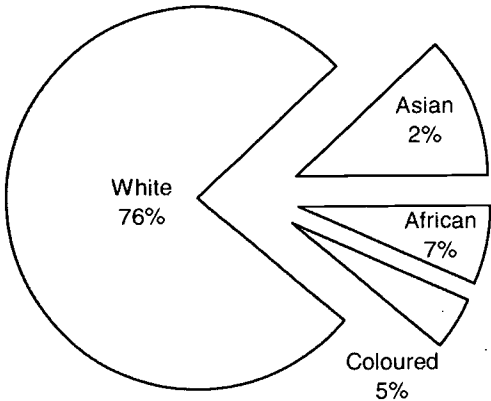

| | Asian | | African | | Coloured | | White | | OVERALL | | TOTAL |
|---------------|------------|------------|------------|------------|------------|------------|-------------|-------------|------------|-------------|-------------|
| | Women | Men | Women | Men | Women | Men | Women | Men | Women | Men | |
| Western Cape | 11 | 36 | | 5 | 41 | 92 | 96 | 556 | 148 | 689 | 837 |
| Northern Cape | | 3 | | | | | 7 | 38 | 7 | 41 | 48 |
| Free State | | 2 | 7 | 22 | | | 11 | 114 | 18 | 138 | 156 |
| Eastern Cape | 9 | 18 | 7 | 7 | | 3 | 9 | 125 | 25 | 153 | 178 |
| KwaZulu-Natal | 54 | 138 | | 17 | | 5 | 9 | 162 | 63 | 322 | 385 |
| Mpumalanga | | 5 | 7 | 7 | | 5 | 9 | 96 | 16 | 113 | 129 |
| Northern Prov | | 8 | | 12 | | | 6 | 45 | 6 | 65 | 71 |
| Gauteng | 45 | 113 | 81 | 58 | 14 | 7 | 250 | 1213 | 390 | 1391 | 1781 |
| North West | | | 9 | 7 | | | 17 | 91 | 26 | 98 | 124 |
| TOTAL | 119 | 323 | 111 | 135 | 55 | 112 | 414 | 2440 | 699 | 3010 | 3709 |
| | 442 | | 246 | | 167 | | 2854 | | | | |

It should be noted that the majority of nurses in South Africa are not graduates. This category refers only to those nurses who do have degrees.

Most institutions offer a four-year Bachelors degree. The three-year Bachelors degree is offered only by the University of South Africa (UNISA). It includes Health Services Management and Community Nursing. Individuals are only admitted to this degree if they are already registered nurses.

QUALIFICATION TRENDS BY LEVEL

| | 1991 | 1992 | 1993 | 1994 | 1995 | 1996 | 1997 | 1998 | TOTAL |
|-----------------|-------------|-------------|-------------|-------------|-------------|-------------|-------------|-------------|--------------|
| Bachelors (3yr) | 1409 | 1523 | 1324 | 1525 | 1405 | 1219 | 1393 | 1436 | 11244 |
| Bachelors (4yr) | 241 | 210 | 165 | 274 | 391 | 369 | 452 | 523 | 2625 |
| PG Diploma | 19 | 8 | 11 | 15 | 33 | 24 | 21 | 23 | 154 |
| Honours | 77 | 86 | 153 | 99 | 206 | 168 | 225 | 221 | 1235 |
| Masters | 34 | 44 | 35 | 29 | 37 | 38 | 48 | 50 | 315 |
| Doctorate | 6 | 7 | 8 | 8 | 6 | 8 | 4 | 8 | 40 |
| TOTAL | 1786 | 1883 | 1696 | 1945 | 2078 | 1821 | 2148 | 2256 | 15613 |

QUALIFICATION TRENDS BY POPULATION GROUP AND GENDER

| | | 1991 | 1992 | 1993 | 1994 | 1995 | 1996 | 1997 | 1998 | TOTAL |
|--------------|---|-------------|-------------|-------------|-------------|-------------|-------------|-------------|-------------|--------------|
| Asian | F | 48 | 67 | 52 | 66 | 61 | 58 | 73 | 73 | 498 |
| | M | 2 | 2 | 1 | 4 | 4 | 4 | 4 | 3 | 24 |
| African | F | 894 | 1033 | 957 | 1154 | 1237 | 1274 | 1436 | 1524 | 9509 |
| | M | 39 | 46 | 31 | 57 | 67 | 61 | 69 | 78 | 448 |
| Coloured | F | 93 | 70 | 63 | 82 | 83 | 81 | 94 | 97 | 663 |
| | M | 2 | 4 | 2 | 5 | 4 | | 4 | 3 | 24 |
| White | F | 692 | 641 | 582 | 571 | 613 | 341 | 465 | 475 | 4380 |
| | M | 16 | 20 | 8 | 6 | 9 | 2 | 3 | 3 | 67 |
| OVERALL | F | 1727 | 1811 | 1654 | 1873 | 1994 | 1754 | 2068 | 2169 | 15050 |
| | M | 59 | 72 | 42 | 72 | 84 | 67 | 80 | 87 | 563 |
| TOTAL | | 1786 | 1883 | 1696 | 1945 | 2078 | 1821 | 2148 | 2256 | 15613 |

QUALIFICATION TRENDS BY CURRENT PROVINCE OF RESIDENCE

| | 1991 | 1992 | 1993 | 1994 | 1995 | 1996 | 1997 | 1998 | TOTAL |
|---------------|-------------|-------------|-------------|-------------|-------------|-------------|-------------|-------------|--------------|
| Western Cape | 177 | 142 | 182 | 181 | 225 | 131 | 180 | 176 | 1394 |
| Northern Cape | 40 | 21 | 26 | 22 | 32 | 29 | 35 | 36 | 241 |
| Free State | 188 | 209 | 226 | 157 | 189 | 117 | 149 | 152 | 1387 |
| Eastern Cape | 222 | 217 | 184 | 231 | 229 | 271 | 243 | 224 | 1821 |
| KwaZulu-Natal | 260 | 315 | 253 | 295 | 288 | 280 | 320 | 354 | 2365 |
| Mpumalanga | 60 | 63 | 44 | 92 | 68 | 114 | 102 | 116 | 659 |
| Northern Prov | 141 | 194 | 202 | 291 | 305 | 281 | 352 | 353 | 2119 |
| Gauteng | 544 | 611 | 472 | 539 | 626 | 483 | 626 | 677 | 4578 |
| North West | 94 | 94 | 63 | 92 | 100 | 95 | 125 | 136 | 799 |
| Outside SA | 60 | 17 | 44 | 45 | 16 | 20 | 16 | 32 | 250 |
| TOTAL | 1786 | 1883 | 1696 | 1945 | 2078 | 1821 | 2148 | 2256 | 15613 |

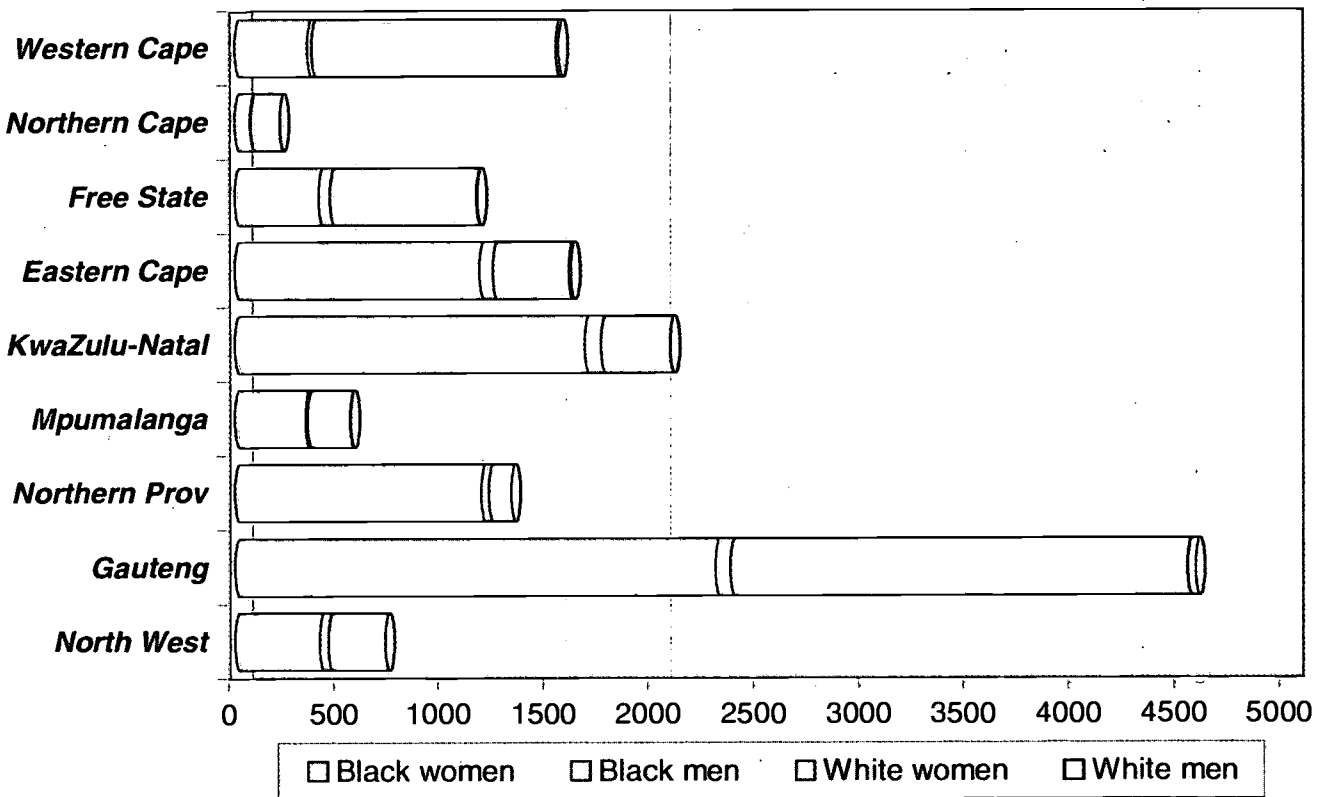
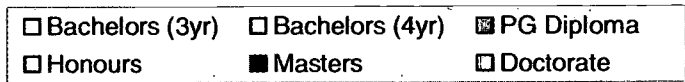
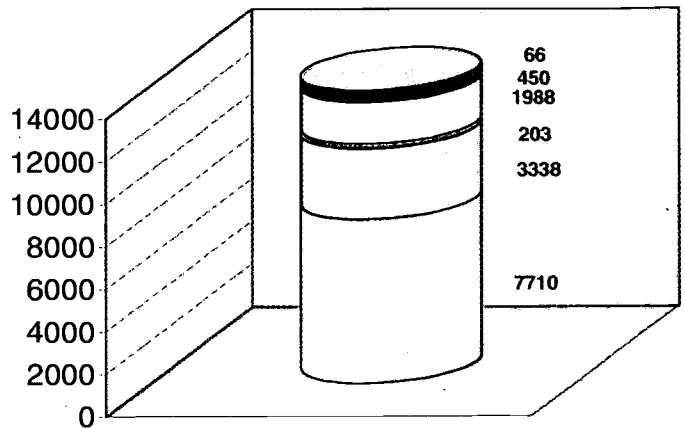
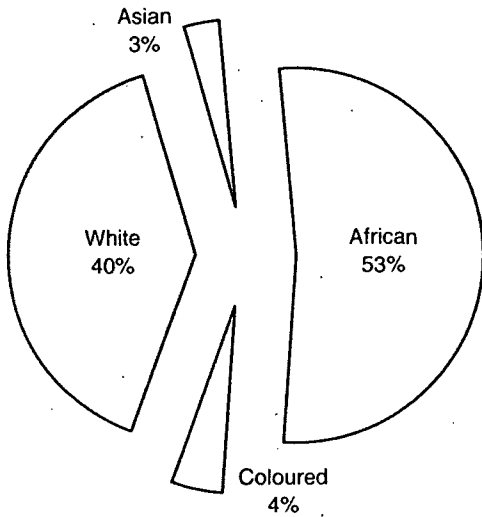

| | Asian | | African | | Coloured | | White | | OVERALL | | TOTAL |
|---------------|------------|-----------|-------------|------------|------------|-----------|-------------|-----------|--------------|------------|--------------|
| | Women | Men | Women | Men | Women | Men | Women | Men | Women | Men | |
| Western Cape | 18 | | 53 | 11 | 276 | 9 | 1163 | 14 | 1510 | 34 | 1544 |
| Northern Cape | | | 42 | 2 | 30 | | 139 | 2 | 211 | 4 | 215 |
| Free State | | | 397 | 52 | 4 | 2 | 697 | 5 | 1098 | 59 | 1157 |
| Eastern Cape | 16 | | 1083 | 60 | 68 | 4 | 360 | 12 | 1527 | 76 | 1603 |
| KwaZulu-Natal | 279 | 16 | 1282 | 62 | 107 | | 326 | 3 | 1994 | 81 | 2075 |
| Mpumalanga | | | 335 | 11 | 2 | | 201 | 3 | 538 | 14 | 552 |
| Northern Prov | 12 | | 1162 | 36 | | | 107 | | 1281 | 36 | 1317 |
| Gauteng | 62 | | 2138 | 69 | 90 | 2 | 2171 | 40 | 4461 | 111 | 4572 |
| North West | | | 400 | 41 | 4 | | 271 | 2 | 675 | 43 | 718 |
| TOTAL | 387 | 16 | 6892 | 344 | 581 | 17 | 5435 | 81 | 13295 | 458 | 13753 |
| | 403 | | 7236 | | 598 | | 5516 | | | | |



PHYSIOTHERAPY

QUALIFICATION TRENDS BY LEVEL

| | 1991 | 1992 | 1993 | 1994 | 1995 | 1996 | 1997 | 1998 | TOTAL |
|-----------------|------------|------------|------------|------------|------------|------------|------------|------------|-------------|
| Bachelors (3yr) | | | | | | | | | 0 |
| Bachelors (4yr) | 173 | 205 | 173 | 206 | 218 | 277 | 256 | 265 | 1773 |
| PG Diploma | 8 | 3 | 8 | 5 | 12 | 4 | 5 | 7 | 52 |
| Honours | | 9 | 3 | 1 | | 5 | 3 | 6 | 27 |
| Masters | 6 | 1 | 6 | 7 | 5 | 6 | 9 | 9 | 49 |
| Doctorate | | | | | | | | | 0 |
| TOTAL | 187 | 218 | 190 | 219 | 235 | 292 | 273 | 287 | 1901 |

QUALIFICATION TRENDS BY POPULATION GROUP AND GENDER

| | | 1991 | 1992 | 1993 | 1994 | 1995 | 1996 | 1997 | 1998 | TOTAL |
|--------------|---|------------|------------|------------|------------|------------|------------|------------|------------|-------------|
| Asian | F | 11 | 16 | 16 | 18 | 12 | 16 | 15 | 18 | 122 |
| | M | 1 | 2 | 3 | | 1 | 1 | 2 | | 10 |
| African | F | 13 | 10 | 7 | 16 | 21 | 20 | 29 | 27 | 143 |
| | M | 3 | 9 | 11 | 10 | 14 | 11 | 14 | 11 | 83 |
| Coloured | F | 8 | 12 | 8 | 4 | 15 | 22 | 18 | 23 | 110 |
| | M | 5 | 3 | 1 | 1 | 1 | 6 | 6 | 8 | 31 |
| White | F | 125 | 150 | 124 | 151 | 150 | 180 | 158 | 171 | 1209 |
| | M | 21 | 16 | 20 | 19 | 21 | 36 | 31 | 29 | 193 |
| OVERALL | F | 157 | 188 | 155 | 189 | 198 | 238 | 220 | 239 | 1584 |
| | M | 30 | 30 | 35 | 30 | 37 | 54 | 53 | 48 | 317 |
| TOTAL | | 187 | 218 | 190 | 219 | 235 | 292 | 273 | 287 | 1901 |

QUALIFICATION TRENDS BY CURRENT PROVINCE OF RESIDENCE

| | 1991 | 1992 | 1993 | 1994 | 1995 | 1996 | 1997 | 1998 | TOTAL |
|---------------|------------|------------|------------|------------|------------|------------|------------|------------|-------------|
| Western Cape | 47 | 60 | 41 | 49 | 98 | 83 | 74 | 81 | 533 |
| Northern Cape | | | 2 | 2 | | 7 | 11 | 9 | 31 |
| Free State | 9 | 8 | 24 | 9 | 3 | 42 | 26 | 17 | 138 |
| Eastern Cape | 11 | 13 | 7 | 13 | 8 | 17 | 11 | 13 | 93 |
| KwaZulu-Natal | 13 | 37 | 28 | 46 | 21 | 19 | 23 | 26 | 213 |
| Mpumalanga | 2 | 8 | 2 | 2 | 5 | 3 | 7 | 4 | 33 |
| Northern Prov | 2 | 6 | | 2 | 5 | 7 | 11 | 13 | 46 |
| Gauteng | 87 | 71 | 77 | 85 | 74 | 76 | 81 | 94 | 645 |
| North West | 8 | 9 | 2 | 4 | 8 | 24 | 18 | 13 | 86 |
| Outside SA | 8 | 6 | 7 | 7 | 13 | 14 | 11 | 17 | 83 |
| TOTAL | 187 | 218 | 190 | 219 | 235 | 292 | 273 | 287 | 1901 |

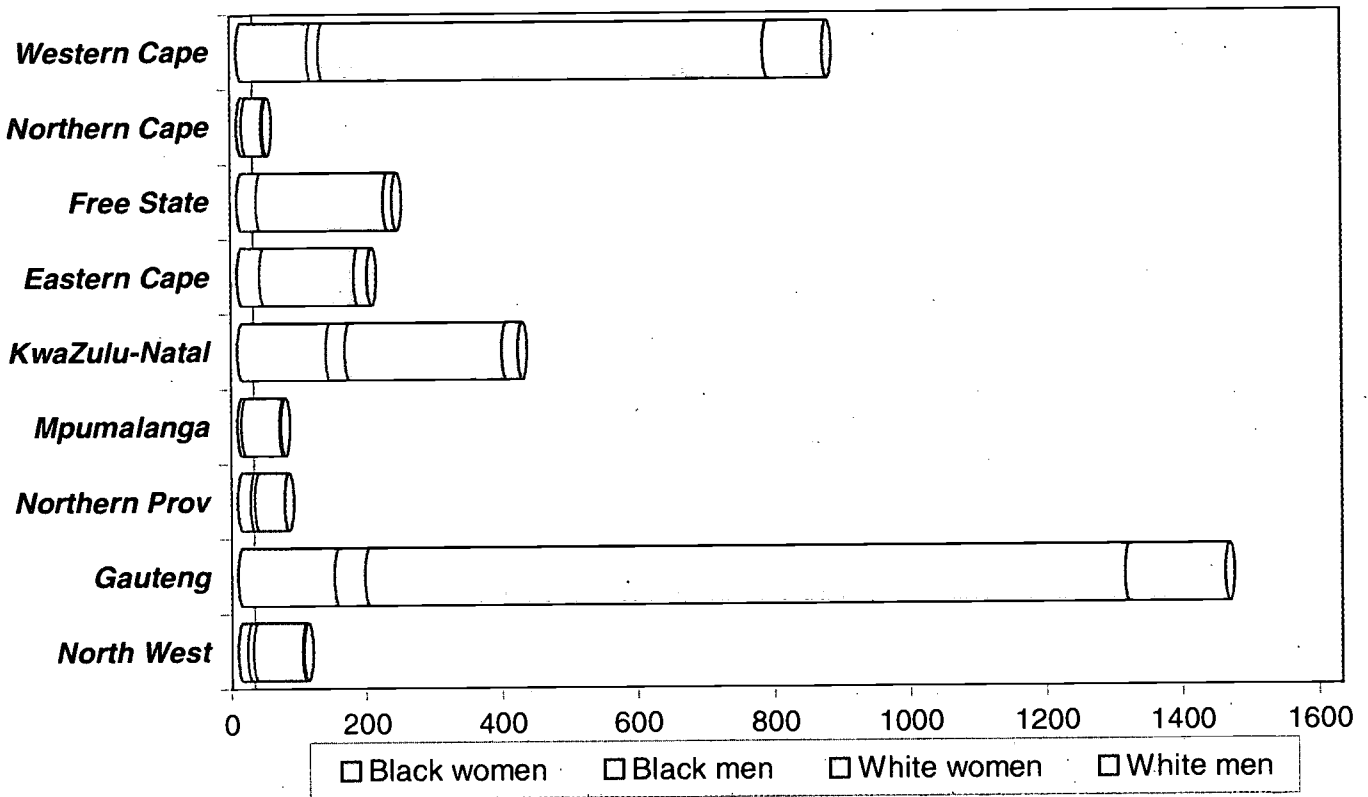
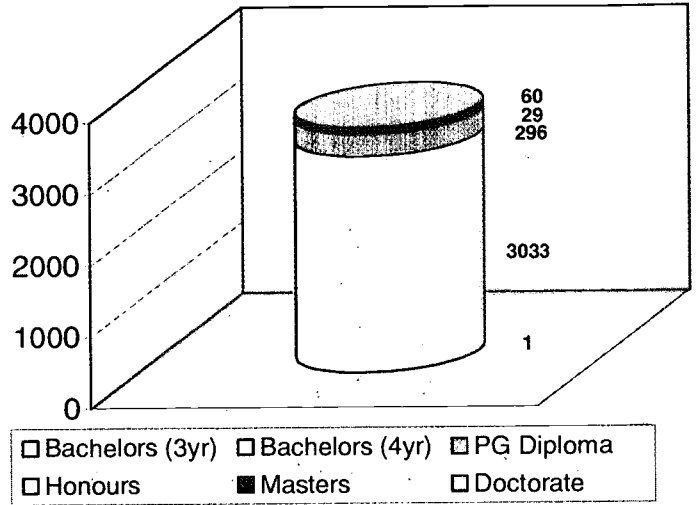
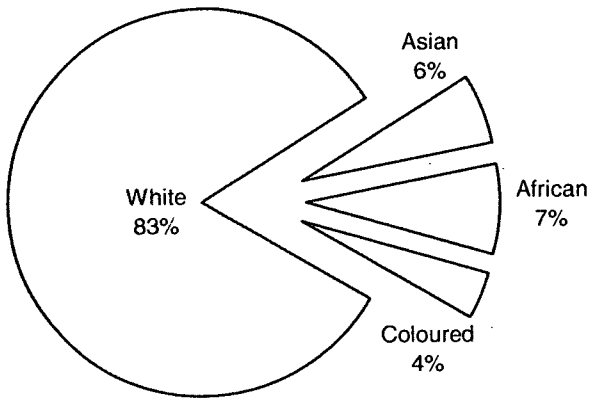

| | Asian | | African | | Coloured | | White | | OVERALL | | TOTAL |
|---------------|------------|-----------|------------|-----------|------------|-----------|-------------|------------|-------------|------------|-------------|
| | Women | Men | Women | Men | Women | Men | Women | Men | Women | Men | |
| Western Cape | 10 | | 10 | | 84 | 17 | 654 | 88 | 758 | 105 | 863 |
| Northern Cape | | | | | | 7 | 29 | 2 | 29 | 9 | 38 |
| Free State | | | | 28 | | | 188 | 13 | 188 | 41 | 229 |
| Eastern Cape | 8 | | 23 | | 2 | | 139 | 20 | 172 | 20 | 192 |
| KwaZulu-Natal | 105 | 21 | 18 | 7 | 7 | | 232 | 24 | 362 | 52 | 414 |
| Mpumalanga | | | | 5 | | | 57 | 2 | 57 | 7 | 64 |
| Northern Prov | | | 18 | 7 | | | 44 | | 62 | 7 | 69 |
| Gauteng | 42 | 4 | 88 | 42 | 12 | | 1117 | 147 | 1259 | 193 | 1452 |
| North West | 10 | | 3 | 7 | | 2 | 73 | 2 | 86 | 11 | 97 |
| TOTAL | 175 | 25 | 160 | 96 | 105 | 26 | 2533 | 298 | 2973 | 445 | 3418 |
| | 200 | | 256 | | 131 | | 2831 | | | | |

QUALIFICATION TRENDS BY LEVEL

| | 1991 | 1992 | 1993 | 1994 | 1995 | 1996 | 1997 | 1998 | TOTAL |
|-----------------|------------|------------|------------|------------|------------|------------|------------|------------|-------------|
| Bachelors (3yr) | | | | | | | | | 0 |
| Bachelors (4yr) | 237 | 336 | 245 | 332 | 416 | 420 | 475 | 502 | 2963 |
| PG Diploma | | | | | | | | | 0 |
| Honours | 1 | 18 | 15 | 1 | 22 | 18 | 17 | 20 | 112 |
| Masters | 23 | 17 | 30 | 14 | 30 | 32 | 26 | 33 | 205 |
| Doctorate | 4 | 2 | 6 | 2 | 2 | 3 | 6 | 7 | 32 |
| TOTAL | 265 | 373 | 296 | 349 | 470 | 473 | 524 | 562 | 3312 |

QUALIFICATION TRENDS BY POPULATION GROUP AND GENDER

| | | 1991 | 1992 | 1993 | 1994 | 1995 | 1996 | 1997 | 1998 | TOTAL |
|--------------|---|------------|------------|------------|------------|------------|------------|------------|------------|-------------|
| Asian | F | 30 | 45 | 46 | 58 | 105 | 101 | 106 | 121 | 612 |
| | M | 27 | 30 | 26 | 41 | 53 | 44 | 49 | 51 | 321 |
| African | F | 16 | 11 | 20 | 24 | 27 | 28 | 34 | 37 | 197 |
| | M | 10 | 11 | 14 | 17 | 21 | 22 | 21 | 21 | 137 |
| Coloured | F | 10 | 9 | 10 | 16 | 14 | 15 | 23 | 26 | 123 |
| | M | 18 | 9 | 11 | 12 | 7 | 11 | 7 | 7 | 82 |
| White | F | 95 | 172 | 115 | 133 | 174 | 179 | 190 | 199 | 1257 |
| | M | 59 | 86 | 54 | 48 | 69 | 73 | 94 | 100 | 583 |
| OVERALL | F | 151 | 237 | 191 | 231 | 320 | 323 | 353 | 383 | 2189 |
| | M | 114 | 136 | 105 | 118 | 150 | 150 | 171 | 179 | 1123 |
| TOTAL | | 265 | 373 | 296 | 349 | 470 | 473 | 524 | 562 | 3312 |

QUALIFICATION TRENDS BY CURRENT PROVINCE OF RESIDENCE

| | 1991 | 1992 | 1993 | 1994 | 1995 | 1996 | 1997 | 1998 | TOTAL |
|---------------|------------|------------|------------|------------|------------|------------|------------|------------|-------------|
| Western Cape | 26 | 72 | 16 | 44 | 36 | 36 | 51 | 56 | 337 |
| Northern Cape | 2 | 4 | | 4 | 6 | | 4 | 4 | 24 |
| Free State | 14 | 22 | 16 | 7 | 18 | 28 | 25 | 26 | 156 |
| Eastern Cape | 31 | 36 | 23 | 40 | 24 | 46 | 47 | 49 | 296 |
| KwaZulu-Natal | 36 | 39 | 53 | 67 | 59 | 89 | 93 | 78 | 514 |
| Mpumalanga | 7 | 8 | 9 | 4 | 30 | 14 | 25 | 30 | 127 |
| Northern Prov | 5 | 8 | 9 | 9 | 9 | 7 | 11 | 11 | 69 |
| Gauteng | 118 | 150 | 121 | 130 | 210 | 171 | 188 | 214 | 1302 |
| North West | 17 | 32 | 47 | 29 | 63 | 78 | 69 | 79 | 414 |
| Outside SA | 9 | 2 | 2 | 15 | 15 | 4 | 11 | 15 | 73 |
| TOTAL | 265 | 373 | 296 | 349 | 470 | 473 | 524 | 562 | 3312 |

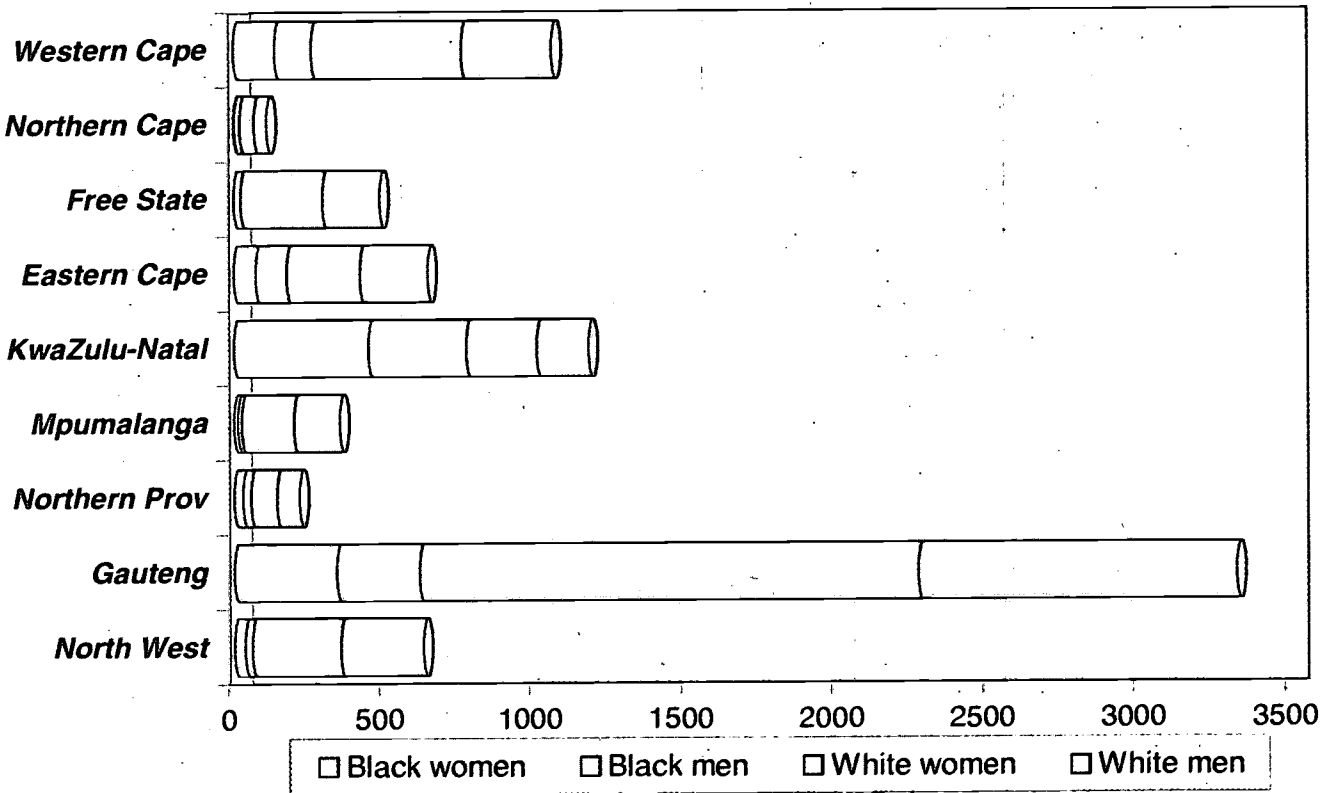
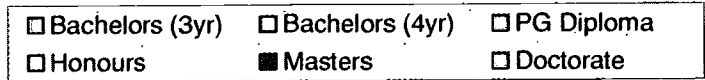
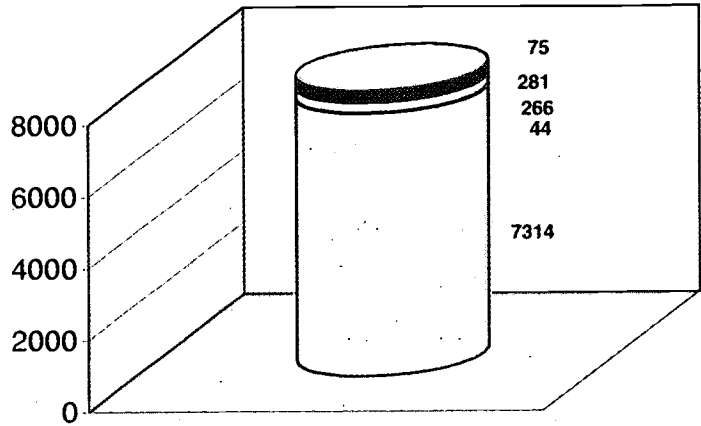
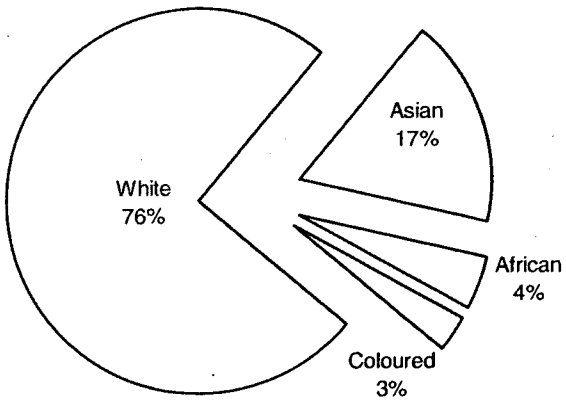

| | Asian | | African | | Coloured | | White | | OVERALL | | TOTAL |
|---------------|-------------|------------|------------|------------|------------|------------|-------------|-------------|-------------|-------------|-------------|
| | Women | Men | Women | Men | Women | Men | Women | Men | Women | Men | |
| Western Cape | 56 | 44 | 16 | 6 | 65 | 72 | 498 | 300 | 635 | 422 | 1057 |
| Northern Cape | 3 | 5 | | 2 | | 10 | 47 | 43 | 50 | 60 | 110 |
| Free State | | | | 22 | | | 272 | 190 | 272 | 212 | 484 |
| Eastern Cape | 19 | 60 | 38 | 20 | 15 | 23 | 244 | 224 | 316 | 327 | 643 |
| KwaZulu-Natal | 422 | 302 | 16 | 16 | 9 | 6 | 235 | 169 | 682 | 493 | 1175 |
| Mpumalanga | 13 | 7 | | 4 | | | 173 | 154 | 186 | 165 | 351 |
| Northern Prov | 13 | 4 | 16 | 22 | | | 86 | 75 | 115 | 101 | 216 |
| Gauteng | 224 | 183 | 82 | 78 | 35 | 12 | 1653 | 1054 | 1994 | 1327 | 3321 |
| North West | 24 | 11 | 8 | 12 | 3 | | 294 | 275 | 329 | 298 | 627 |
| TOTAL | 774 | 616 | 176 | 182 | 127 | 123 | 3502 | 2484 | 4579 | 3405 | 7984 |
| | 1390 | | 358 | | 250 | | 5986 | | | | |



GENERAL HEALTH

This category consists of General Medicine, Laboratory Medicine, Occupational Therapy, Optometry, Radiography, Dietetics, Hygiene, Speech Therapy, Dental Therapy and Oral Health. Medical practitioners and specialists who also have qualifications in general health are not repeated here.

QUALIFICATION TRENDS BY LEVEL

| | 1991 | 1992 | 1993 | 1994 | 1995 | 1996 | 1997 | 1998 | TOTAL |
|-----------------|------------|------------|------------|------------|------------|-------------|-------------|-------------|-------------|
| Bachelors (3yr) | 57 | 64 | 43 | 49 | 37 | 51 | 46 | 49 | 396 |
| Bachelors (4yr) | 351 | 508 | 537 | 559 | 648 | 730 | 733 | 736 | 4802 |
| PG Diploma | 116 | 79 | 127 | 60 | 115 | 112 | 137 | 142 | 888 |
| Honours | 114 | 81 | 81 | 87 | 84 | 92 | 88 | 84 | 711 |
| Masters | 49 | 47 | 60 | 55 | 69 | 82 | 68 | 73 | 503 |
| Doctorate | 13 | 11 | 15 | 11 | 7 | 13 | 14 | 12 | 96 |
| TOTAL | 700 | 790 | 863 | 821 | 960 | 1080 | 1086 | 1096 | 7396 |

QUALIFICATION TRENDS BY POPULATION GROUP AND GENDER

| | | 1991 | 1992 | 1993 | 1994 | 1995 | 1996 | 1997 | 1998 | TOTAL |
|--------------|---|------------|------------|------------|------------|------------|-------------|-------------|-------------|-------------|
| Asian | F | 49 | 61 | 61 | 83 | 93 | 101 | 109 | 100 | 657 |
| | M | 24 | 25 | 34 | 27 | 58 | 58 | 58 | 66 | 350 |
| African | F | 27 | 48 | 58 | 53 | 77 | 75 | 99 | 95 | 532 |
| | M | 33 | 51 | 61 | 75 | 80 | 86 | 76 | 94 | 556 |
| Coloured | F | 13 | 31 | 26 | 15 | 45 | 43 | 45 | 40 | 258 |
| | M | 4 | 8 | 10 | 3 | 10 | 16 | 11 | 12 | 74 |
| White | F | 405 | 461 | 488 | 454 | 484 | 572 | 570 | 567 | 4001 |
| | M | 145 | 105 | 125 | 111 | 113 | 129 | 118 | 122 | 968 |
| OVERALL | F | 494 | 601 | 633 | 605 | 699 | 791 | 823 | 802 | 5448 |
| | M | 206 | 189 | 230 | 216 | 261 | 289 | 263 | 294 | 1948 |
| TOTAL | | 700 | 790 | 863 | 821 | 960 | 1080 | 1086 | 1096 | 7396 |

QUALIFICATION TRENDS BY CURRENT PROVINCE OF RESIDENCE

| | 1991 | 1992 | 1993 | 1994 | 1995 | 1996 | 1997 | 1998 | TOTAL |
|---------------|------------|------------|------------|------------|------------|-------------|-------------|-------------|-------------|
| Western Cape | 167 | 162 | 208 | 147 | 281 | 243 | 206 | 194 | 1608 |
| Northern Cape | 10 | 7 | 14 | 14 | 10 | 19 | 16 | 8 | 98 |
| Free State | 49 | 72 | 71 | 66 | 36 | 78 | 99 | 72 | 543 |
| Eastern Cape | 32 | 30 | 22 | 23 | 31 | 35 | 40 | 31 | 244 |
| KwaZulu-Natal | 66 | 112 | 128 | 165 | 143 | 189 | 186 | 172 | 1161 |
| Mpumalanga | 10 | 18 | 30 | 29 | 44 | 19 | 46 | 39 | 235 |
| Northern Prov | 24 | 23 | 16 | 29 | 36 | 32 | 43 | 50 | 253 |
| Gauteng | 299 | 312 | 340 | 299 | 325 | 408 | 394 | 472 | 2849 |
| North West | 19 | 33 | 18 | 29 | 36 | 35 | 43 | 39 | 252 |
| Outside SA | 24 | 21 | 16 | 20 | 18 | 22 | 13 | 19 | 153 |
| TOTAL | 700 | 790 | 863 | 821 | 960 | 1080 | 1086 | 1096 | 7396 |

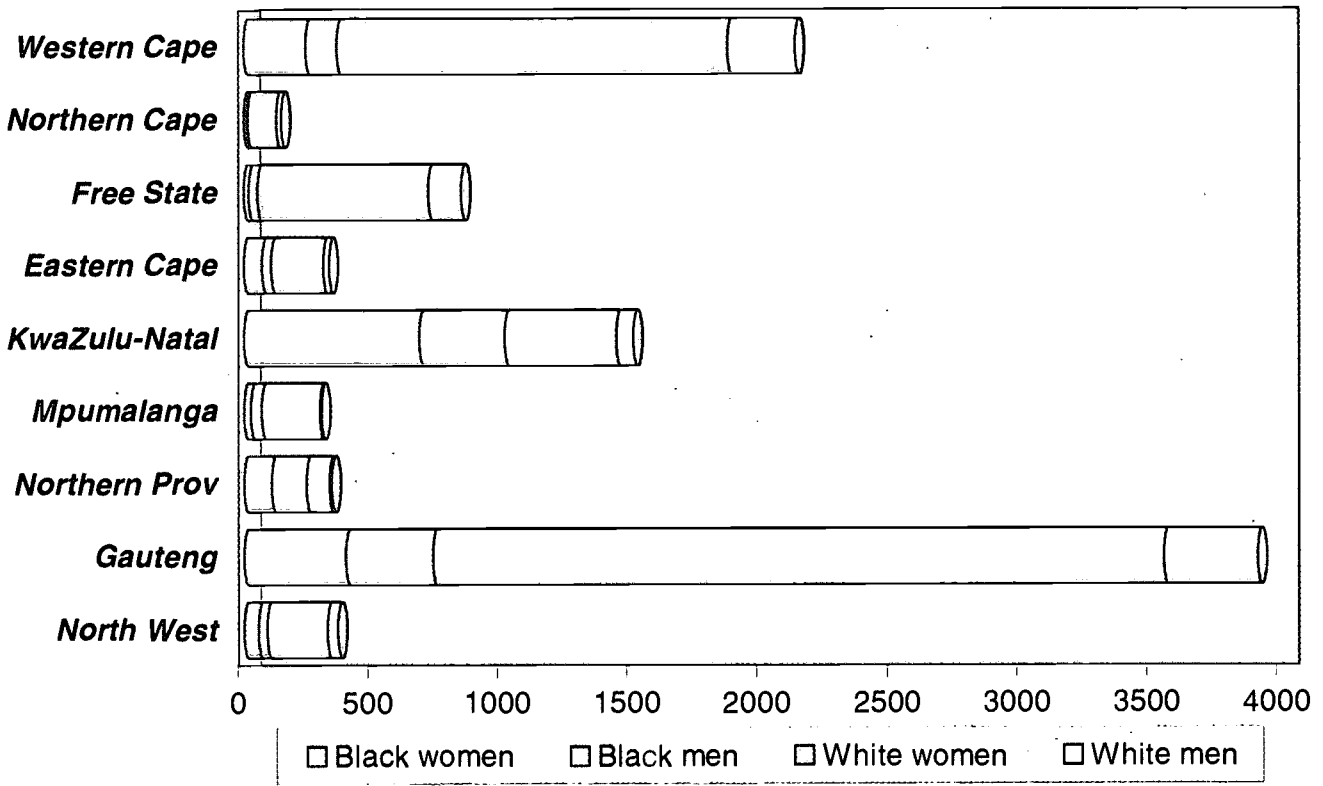
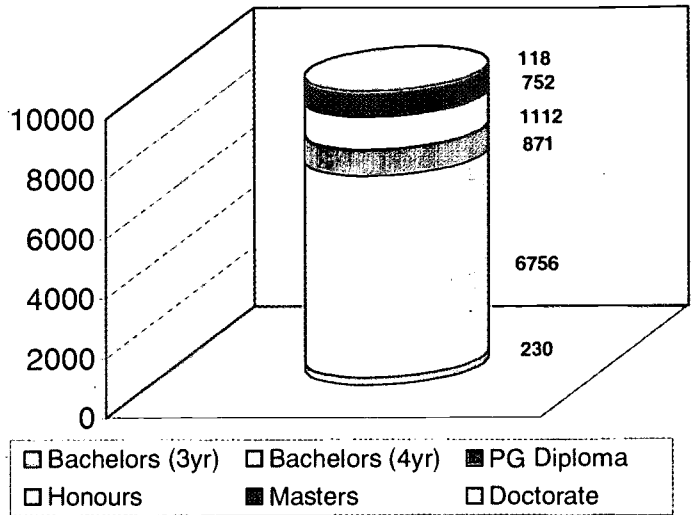
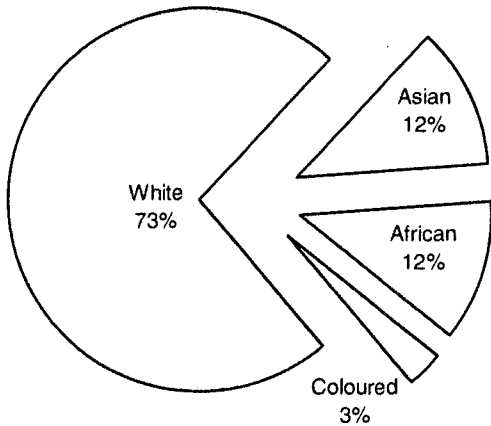

| | Asian | | African | | Coloured | | White | | OVERALL | | |
|---------------|-------------|------------|-------------|------------|------------|-----------|-------------|------------|-------------|-------------|-------------|
| | Women | Men | Women | Men | Women | Men | Women | Men | Women | Men | TOTAL |
| Western Cape | 49 | 57 | 28 | 15 | 161 | 50 | 1504 | 260 | 1742 | 382 | 2124 |
| Northern Cape | | 2 | | 7 | 6 | | 110 | 19 | 116 | 28 | 144 |
| Free State | | 2 | 19 | 25 | | 6 | 660 | 127 | 679 | 160 | 839 |
| Eastern Cape | 9 | 7 | 43 | 20 | 18 | 8 | 200 | 24 | 270 | 59 | 329 |
| KwaZulu-Natal | 566 | 264 | 89 | 64 | 22 | | 431 | 66 | 1108 | 394 | 1502 |
| Mpumalanga | 11 | 9 | 15 | 32 | | | 224 | 7 | 250 | 48 | 298 |
| Northern Prov | 4 | | 102 | 134 | | | 90 | 9 | 196 | 143 | 339 |
| Gauteng | 105 | 70 | 266 | 260 | 22 | 6 | 2812 | 361 | 3205 | 697 | 3902 |
| North West | 15 | 7 | 39 | 27 | | | 233 | 42 | 287 | 76 | 363 |
| TOTAL | 759 | 418 | 601 | 584 | 229 | 70 | 6264 | 915 | 7853 | 1987 | 9840 |
| | 1177 | | 1185 | | 299 | | 7179 | | | | |

This category includes History, Geography, Anthropology, Archaeology, Museum Science, Philosophy, Economics (as an Arts major), Religious Studies (other than Theology), Physical Education, Military Science and Police Science.

QUALIFICATION TRENDS BY LEVEL

| | 1991 | 1992 | 1993 | 1994 | 1995 | 1996 | 1997 | 1998 | TOTAL |
|-----------------|-------------|-------------|-------------|-------------|-------------|-------------|-------------|-------------|--------------|
| Bachelors (3yr) | 4721 | 5037 | 5141 | 5335 | 5356 | 5534 | 5806 | 5310 | 42890 |
| Bachelors (4yr) | 118 | 170 | 170 | 252 | 172 | 161 | 230 | 306 | 1579 |
| PG Diploma | 50 | 53 | 53 | 41 | 57 | 37 | 62 | 57 | 410 |
| Honours | 746 | 765 | 836 | 672 | 838 | 812 | 958 | 937 | 6564 |
| Masters | 132 | 110 | 169 | 158 | 299 | 284 | 312 | 317 | 1781 |
| Doctorate | 31 | 42 | 45 | 47 | 96 | 70 | 62 | 70 | 463 |
| TOTAL | 5798 | 6227 | 6414 | 6555 | 6818 | 6948 | 7430 | 7497 | 53687 |

QUALIFICATION TRENDS BY POPULATION GROUP AND GENDER

| | | 1991 | 1992 | 1993 | 1994 | 1995 | 1996 | 1997 | 1998 | TOTAL |
|--------------|---|-------------|-------------|-------------|-------------|-------------|-------------|-------------|-------------|--------------|
| Asian | F | 214 | 205 | 215 | 188 | 194 | 195 | 239 | 245 | 1695 |
| | M | 154 | 146 | 111 | 134 | 135 | 137 | 171 | 188 | 1176 |
| African | F | 774 | 935 | 1131 | 1332 | 1639 | 1840 | 1991 | 2025 | 11667 |
| | M | 1047 | 1306 | 1321 | 1711 | 1817 | 1913 | 2141 | 2142 | 13398 |
| Coloured | F | 368 | 405 | 341 | 329 | 277 | 250 | 296 | 308 | 2574 |
| | M | 409 | 448 | 337 | 308 | 244 | 256 | 256 | 268 | 2526 |
| White | F | 1436 | 1475 | 1586 | 1338 | 1354 | 1278 | 1297 | 1296 | 11060 |
| | M | 1396 | 1307 | 1372 | 1215 | 1158 | 1079 | 1039 | 1025 | 9591 |
| OVERALL | F | 2792 | 3020 | 3273 | 3187 | 3464 | 3563 | 3823 | 3874 | 26996 |
| | M | 3006 | 3207 | 3141 | 3368 | 3354 | 3385 | 3607 | 3623 | 26691 |
| TOTAL | | 5798 | 6227 | 6414 | 6555 | 6818 | 6948 | 7430 | 7497 | 53687 |

QUALIFICATION TRENDS BY CURRENT PROVINCE OF RESIDENCE

| | 1991 | 1992 | 1993 | 1994 | 1995 | 1996 | 1997 | 1998 | TOTAL |
|---------------|-------------|-------------|-------------|-------------|-------------|-------------|-------------|-------------|--------------|
| Western Cape | 1149 | 1291 | 1084 | 1113 | 1431 | 1033 | 1188 | 1205 | 9494 |
| Northern Cape | 105 | 137 | 122 | 110 | 98 | 120 | 132 | 115 | 939 |
| Free State | 317 | 295 | 310 | 391 | 364 | 460 | 408 | 520 | 3065 |
| Eastern Cape | 663 | 581 | 591 | 832 | 848 | 890 | 918 | 914 | 6237 |
| KwaZulu-Natal | 678 | 794 | 948 | 796 | 874 | 1071 | 1114 | 1075 | 7350 |
| Mpumalanga | 175 | 186 | 206 | 246 | 222 | 301 | 263 | 287 | 1886 |
| Northern Prov | 451 | 780 | 589 | 643 | 775 | 855 | 846 | 864 | 5803 |
| Gauteng | 1889 | 1776 | 2094 | 2046 | 1912 | 1852 | 2209 | 2163 | 15941 |
| North West | 225 | 252 | 300 | 191 | 180 | 240 | 253 | 260 | 1901 |
| Outside SA | 146 | 135 | 170 | 187 | 114 | 126 | 99 | 94 | 1071 |
| TOTAL | 5798 | 6227 | 6414 | 6555 | 6818 | 6948 | 7430 | 7497 | 53687 |

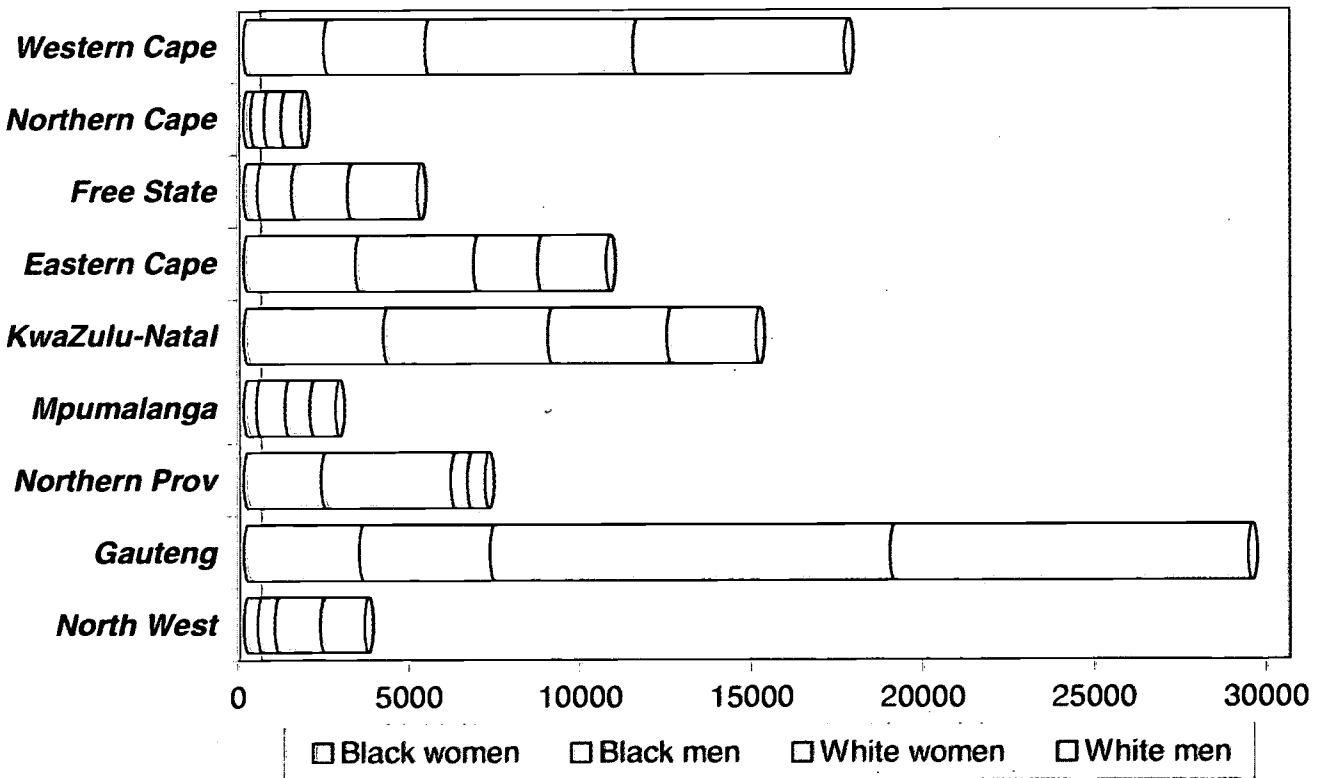
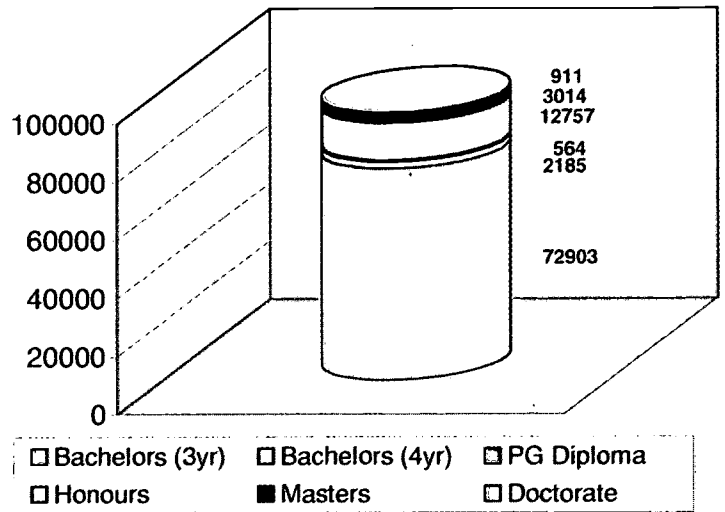
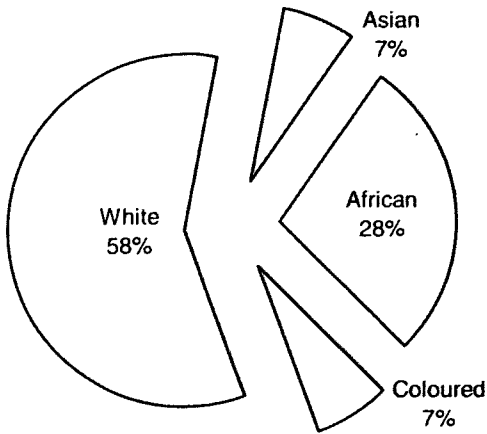

| | Asian | | African | | Coloured | | White | | OVERALL | | |
|---------------|-------------|-------------|--------------|--------------|-------------|-------------|--------------|--------------|--------------|--------------|--------------|
| | Women | Men | Women | Men | Women | Men | Women | Men | Women | Men | TOTAL |
| Western Cape | 124 | 72 | 551 | 442 | 1673 | 2438 | 6064 | 6166 | 8412 | 9118 | 17530 |
| Northern Cape | 2 | 8 | 59 | 86 | 152 | 290 | 502 | 561 | 715 | 945 | 1660 |
| Free State | 2 | 6 | 376 | 960 | 25 | 38 | 1625 | 2035 | 2028 | 3039 | 5067 |
| Eastern Cape | 41 | 53 | 2965 | 2967 | 259 | 429 | 1863 | 2020 | 5128 | 5469 | 10597 |
| KwaZulu-Natal | 2521 | 2741 | 1391 | 1904 | 171 | 150 | 3476 | 2592 | 7559 | 7387 | 14946 |
| Mpumalanga | 12 | 20 | 349 | 809 | 4 | 6 | 724 | 757 | 1089 | 1592 | 2681 |
| Northern Prov | 10 | 7 | 2247 | 3779 | 2 | 11 | 478 | 505 | 2737 | 4302 | 7039 |
| Gauteng | 289 | 282 | 2837 | 3177 | 247 | 358 | 11654 | 10443 | 15027 | 14260 | 29287 |
| North West | 12 | 24 | 371 | 416 | 27 | 47 | 1323 | 1306 | 1733 | 1793 | 3526 |
| TOTAL | 3013 | 3213 | 11146 | 14540 | 2560 | 3767 | 27709 | 26385 | 44428 | 47905 | 92333 |
| | 6226 | | 25686 | | 6327 | | 54094 | | | | |



PUBLISHING, JOURNALISM, ADVERTISING, MARKETING

This category also includes Media Science and Communication. It covers all of these qualifications awarded as part of any Humanities or Arts degree.

QUALIFICATION TRENDS BY LEVEL

| | 1991 | 1992 | 1993 | 1994 | 1995 | 1996 | 1997 | 1998 | TOTAL |
|-----------------|------------|------------|------------|------------|------------|------------|------------|------------|-------------|
| Bachelors (3yr) | 651 | 630 | 660 | 725 | 624 | 653 | 592 | 659 | 5249 |
| Bachelors (4yr) | 25 | 22 | 23 | 63 | 72 | 68 | 34 | 35 | 342 |
| PG Diploma | 18 | 17 | 37 | 9 | 23 | 15 | 12 | 12 | 143 |
| Honours | 77 | 91 | 93 | 67 | 105 | 78 | 102 | 114 | 727 |
| Masters | 9 | 9 | 15 | 8 | 27 | 11 | 14 | 15 | 108 |
| Doctorate | 4 | 9 | 11 | 13 | 7 | 8 | 8 | 11 | 71 |
| TOTAL | 784 | 828 | 839 | 885 | 858 | 838 | 762 | 846 | 6640 |

QUALIFICATION TRENDS BY POPULATION GROUP AND GENDER

| | | 1991 | 1992 | 1993 | 1994 | 1995 | 1996 | 1997 | 1998 | TOTAL |
|--------------|---|------------|------------|------------|------------|------------|------------|------------|------------|-------------|
| Asian | F | 9 | 4 | 8 | 9 | 13 | 17 | 12 | 13 | 85 |
| | M | 2 | 4 | 1 | 10 | 5 | 11 | 7 | 7 | 47 |
| African | F | 65 | 76 | 67 | 102 | 124 | 165 | 158 | 211 | 968 |
| | M | 65 | 66 | 83 | 89 | 91 | 115 | 103 | 120 | 732 |
| Coloured | F | 7 | 7 | 13 | 8 | 1 | 7 | 11 | 15 | 69 |
| | M | 1 | 2 | 3 | 1 | 4 | 1 | 7 | 9 | 28 |
| White | F | 526 | 576 | 555 | 550 | 473 | 405 | 377 | 378 | 3840 |
| | M | 109 | 93 | 109 | 116 | 147 | 117 | 87 | 93 | 871 |
| OVERALL | F | 607 | 663 | 643 | 669 | 611 | 594 | 558 | 617 | 4962 |
| | M | 177 | 165 | 196 | 216 | 247 | 244 | 204 | 229 | 1678 |
| TOTAL | | 784 | 828 | 839 | 885 | 858 | 838 | 762 | 846 | 6640 |

QUALIFICATION TRENDS BY CURRENT PROVINCE OF RESIDENCE

| | 1991 | 1992 | 1993 | 1994 | 1995 | 1996 | 1997 | 1998 | TOTAL |
|---------------|------------|------------|------------|------------|------------|------------|------------|------------|-------------|
| Western Cape | 80 | 89 | 95 | 72 | 93 | 55 | 59 | 66 | 609 |
| Northern Cape | 12 | 11 | 28 | 26 | 10 | 23 | 34 | 33 | 177 |
| Free State | 92 | 92 | 130 | 132 | 85 | 75 | 64 | 82 | 752 |
| Eastern Cape | 95 | 100 | 75 | 127 | 137 | 151 | 115 | 173 | 973 |
| KwaZulu-Natal | 55 | 64 | 46 | 60 | 57 | 65 | 36 | 50 | 433 |
| Mpumalanga | 14 | 24 | 10 | 26 | 41 | 23 | 25 | 28 | 191 |
| Northern Prov | 14 | 11 | 18 | 21 | 16 | 17 | 15 | 21 | 133 |
| Gauteng | 354 | 346 | 340 | 347 | 344 | 303 | 292 | 262 | 2588 |
| North West | 41 | 78 | 59 | 49 | 54 | 98 | 100 | 105 | 584 |
| Outside SA | 27 | 13 | 38 | 25 | 21 | 28 | 22 | 26 | 200 |
| TOTAL | 784 | 828 | 839 | 885 | 858 | 838 | 762 | 846 | 6640 |

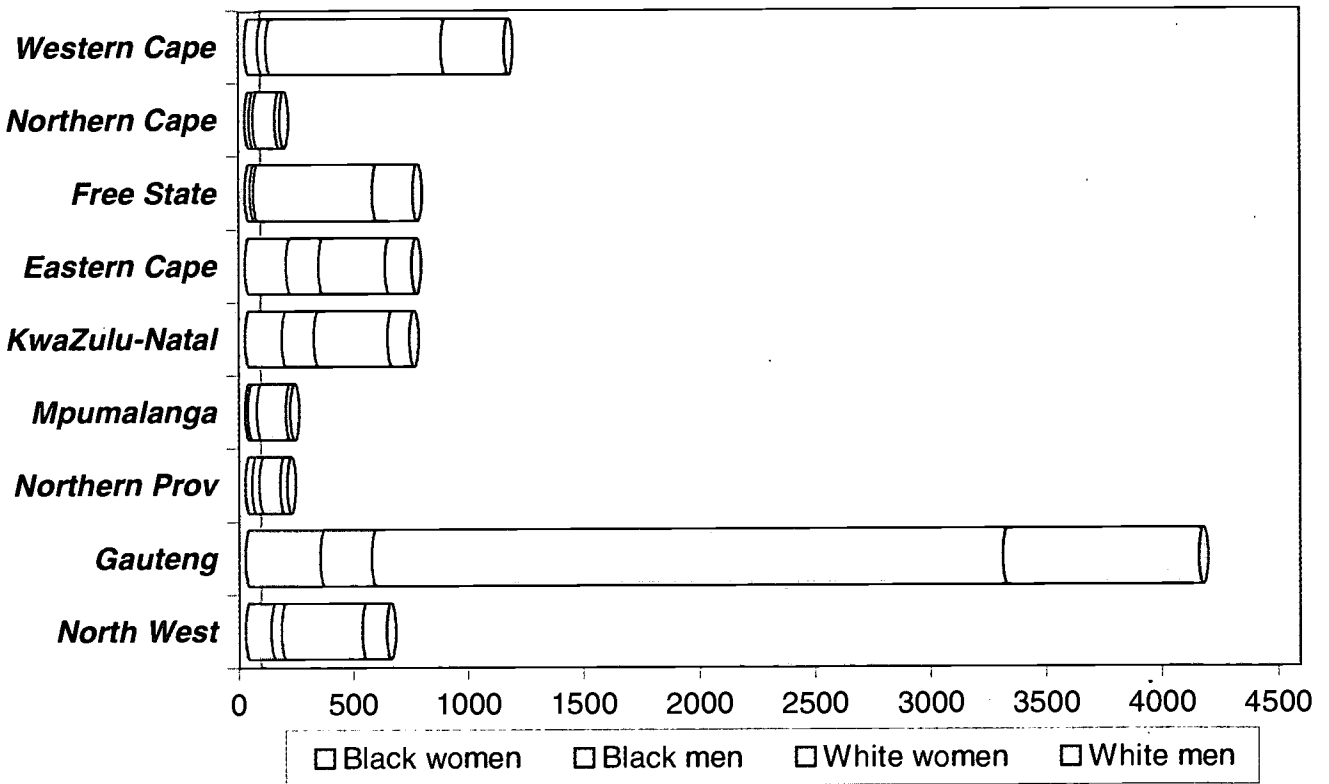
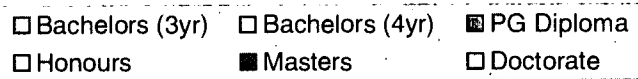
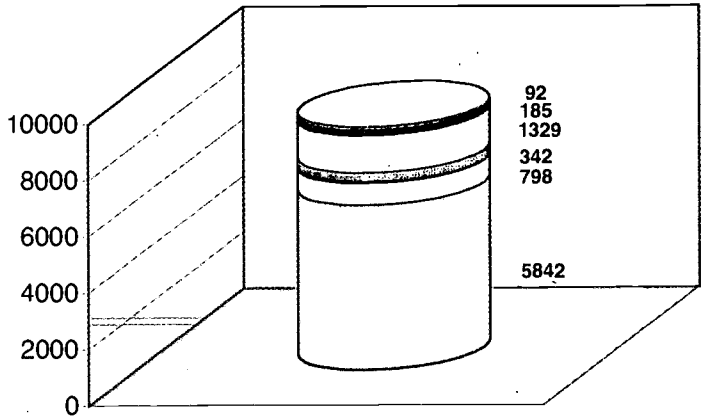
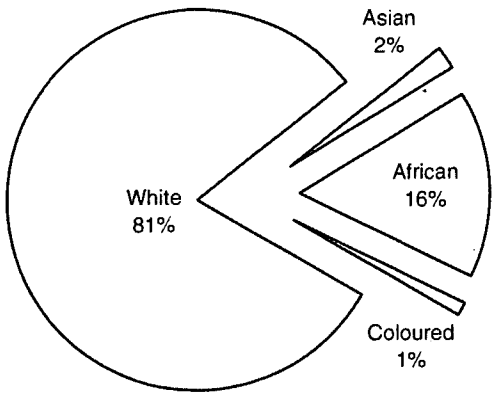

| | Asian | | African | | Coloured | | White | | OVERALL | | |
|---------------|------------|-----------|-------------|------------|------------|-----------|-------------|-------------|-------------|-------------|-------------|
| | Women | Men | Women | Men | Women | Men | Women | Men | Women | Men | TOTAL |
| Western Cape | 10 | 3 | 16 | 9 | 31 | 25 | 759 | 276 | 816 | 313 | 1129 |
| Northern Cape | | 2 | 12 | 15 | 7 | | 96 | 21 | 115 | 38 | 153 |
| Free State | | | 16 | 14 | 7 | | 518 | 177 | 541 | 191 | 732 |
| Eastern Cape | 5 | | 167 | 141 | 9 | | 289 | 117 | 470 | 258 | 728 |
| KwaZulu-Natal | 77 | 40 | 84 | 96 | | 5 | 321 | 95 | 482 | 236 | 718 |
| Mpumalanga | | 2 | 12 | 38 | | | 128 | 19 | 140 | 59 | 199 |
| Northern Prov | | 2 | 30 | 30 | | | 91 | 31 | 121 | 63 | 184 |
| Gauteng | 15 | 2 | 300 | 213 | 12 | 9 | 2730 | 846 | 3057 | 1070 | 4127 |
| North West | | | 112 | 46 | | | 351 | 107 | 463 | 153 | 616 |
| TOTAL | 107 | 51 | 749 | 602 | 66 | 39 | 5283 | 1689 | 6205 | 2381 | 8586 |
| | 158 | | 1351 | | 105 | | 6972 | | | | |



QUALIFICATION TRENDS BY LEVEL

| | 1991 | 1992 | 1993 | 1994 | 1995 | 1996 | 1997 | 1998 | TOTAL |
|-----------------|-------------|-------------|-------------|-------------|-------------|-------------|-------------|-------------|--------------|
| Bachelors (3yr) | 3184 | 3724 | 3965 | 4311 | 5141 | 5253 | 5540 | 5627 | 37248 |
| Bachelors (4yr) | 2 | | 1 | | | | | | 3 |
| PG Diploma | 21 | 30 | 23 | 20 | 24 | 37 | 34 | 35 | 224 |
| Honours | 591 | 673 | 718 | 618 | 712 | 649 | 673 | 736 | 5370 |
| Masters | 160 | 158 | 165 | 156 | 196 | 208 | 216 | 225 | 1484 |
| Doctorate | 23 | 33 | 30 | 20 | 43 | 37 | 42 | 44 | 282 |
| TOTAL | 3986 | 4618 | 4902 | 5625 | 6121 | 6187 | 6505 | 6667 | 44611 |

QUALIFICATION TRENDS BY POPULATION GROUP AND GENDER

| | | 1991 | 1992 | 1993 | 1994 | 1995 | 1996 | 1997 | 1998 | TOTAL |
|--------------|---|-------------|-------------|-------------|-------------|-------------|-------------|-------------|-------------|--------------|
| Asian | F | 75 | 107 | 139 | 182 | 186 | 200 | 215 | 224 | 1328 |
| | M | 29 | 25 | 33 | 44 | 36 | 56 | 53 | 56 | 332 |
| African | F | 868 | 1368 | 1619 | 2150 | 2849 | 2902 | 3145 | 3251 | 18152 |
| | M | 791 | 1020 | 1139 | 1407 | 1414 | 1513 | 1636 | 1639 | 10559 |
| Coloured | F | 156 | 172 | 106 | 165 | 133 | 100 | 119 | 127 | 1078 |
| | M | 119 | 135 | 48 | 90 | 70 | 50 | 40 | 51 | 603 |
| White | F | 1487 | 1359 | 1384 | 1220 | 1052 | 1037 | 969 | 994 | 9502 |
| | M | 461 | 432 | 434 | 367 | 381 | 329 | 328 | 325 | 3057 |
| OVERALL | F | 2586 | 3006 | 3248 | 3717 | 4220 | 4239 | 4448 | 4596 | 30060 |
| | M | 1400 | 1612 | 1654 | 1908 | 1901 | 1948 | 2057 | 2071 | 14551 |
| TOTAL | | 3986 | 4618 | 4902 | 5625 | 6121 | 6187 | 6505 | 6667 | 44611 |

QUALIFICATION TRENDS BY CURRENT PROVINCE OF RESIDENCE

| | 1991 | 1992 | 1993 | 1994 | 1995 | 1996 | 1997 | 1998 | TOTAL |
|---------------|-------------|-------------|-------------|-------------|-------------|-------------|-------------|-------------|--------------|
| Western Cape | 631 | 762 | 581 | 751 | 950 | 761 | 762 | 801 | 5999 |
| Northern Cape | 46 | 75 | 38 | 52 | 64 | 43 | 51 | 51 | 420 |
| Free State | 149 | 204 | 202 | 335 | 381 | 386 | 450 | 452 | 2559 |
| Eastern Cape | 490 | 490 | 547 | 757 | 816 | 793 | 753 | 853 | 5499 |
| KwaZulu-Natal | 527 | 495 | 762 | 714 | 828 | 1051 | 1016 | 971 | 6364 |
| Mpumalanga | 129 | 150 | 166 | 222 | 261 | 283 | 303 | 305 | 1819 |
| Northern Prov | 440 | 680 | 680 | 833 | 813 | 1013 | 939 | 1035 | 6433 |
| Gauteng | 1333 | 1481 | 1568 | 1658 | 1726 | 1568 | 1946 | 1885 | 13165 |
| North West | 150 | 178 | 196 | 192 | 209 | 212 | 222 | 250 | 1609 |
| Outside SA | 91 | 103 | 162 | 111 | 73 | 77 | 63 | 64 | 744 |
| TOTAL | 3986 | 4618 | 4902 | 5625 | 6121 | 6187 | 6505 | 6667 | 44611 |

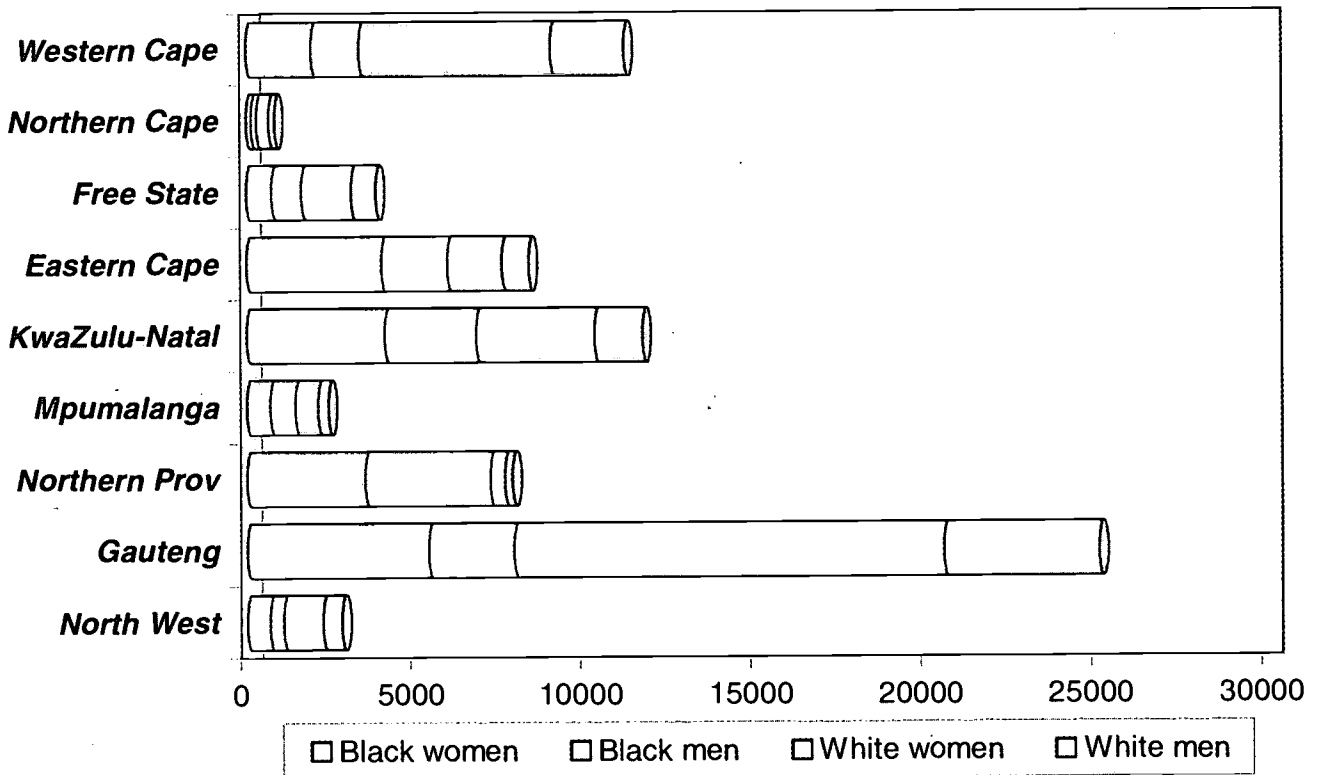
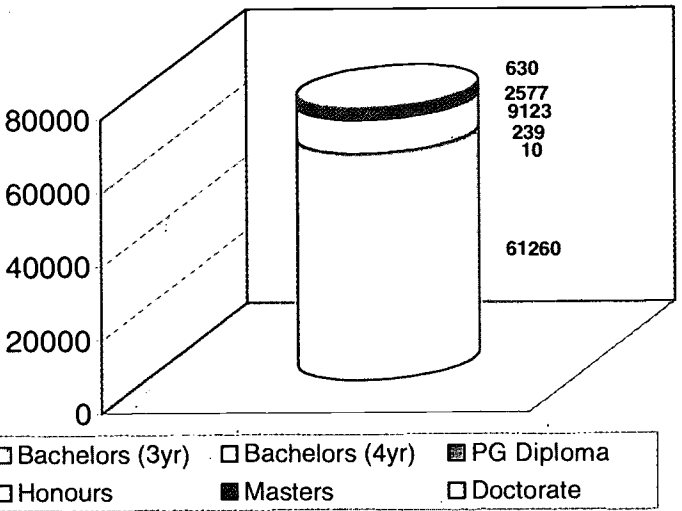
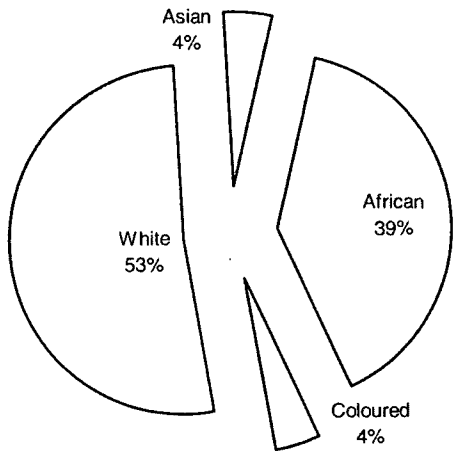

| | Asian | | African | | Coloured | | White | | OVERALL | | TOTAL |
|---------------|-------------|-------------|--------------|--------------|-------------|-------------|--------------|--------------|--------------|--------------|--------------|
| | Women | Men | Women | Men | Women | Men | Women | Men | Women | Men | |
| Western Cape | 95 | 56 | 746 | 306 | 1095 | 1030 | 5648 | 2154 | 7584 | 3546 | 11130 |
| Northern Cape | 4 | | 58 | 50 | 80 | 111 | 364 | 173 | 506 | 334 | 840 |
| Free State | 4 | 3 | 711 | 880 | 24 | 14 | 1463 | 720 | 2202 | 1617 | 3819 |
| Eastern Cape | 40 | 17 | 3762 | 1727 | 169 | 204 | 1620 | 770 | 5591 | 2718 | 8309 |
| KwaZulu-Natal | 1624 | 933 | 2338 | 1704 | 104 | 60 | 3482 | 1414 | 7548 | 4111 | 11659 |
| Mpumalanga | 2 | 9 | 676 | 743 | 7 | | 674 | 298 | 1359 | 1050 | 2409 |
| Northern Prov | 5 | 5 | 3462 | 3694 | 3 | | 435 | 221 | 3905 | 3920 | 7825 |
| Gauteng | 269 | 88 | 4955 | 2303 | 116 | 129 | 12635 | 4560 | 17975 | 7080 | 25055 |
| North West | 11 | 14 | 630 | 380 | 14 | 18 | 1171 | 555 | 1826 | 967 | 2793 |
| TOTAL | 2054 | 1125 | 17338 | 11787 | 1612 | 1566 | 27492 | 10865 | 48496 | 25343 | 73839 |

This also includes International Relations.

QUALIFICATION TRENDS BY LEVEL

| | 1991 | 1992 | 1993 | 1994 | 1995 | 1996 | 1997 | 1998 | TOTAL |
|-----------------|------------|------------|------------|------------|------------|------------|------------|------------|-------------|
| Bachelors (3yr) | 633 | 793 | 717 | 719 | 606 | 607 | 623 | 639 | 5387 |
| Bachelors (4yr) | | | | | | | | | 0 |
| PG Diploma | 6 | 4 | 9 | 5 | 5 | 11 | 9 | 10 | 59 |
| Honours | 141 | 136 | 120 | 123 | 127 | 133 | 139 | 145 | 1064 |
| Masters | 20 | 20 | 21 | 20 | 28 | 19 | 20 | 21 | 169 |
| Doctorate | 7 | 7 | 2 | 2 | 4 | 4 | 6 | 6 | 38 |
| TOTAL | 857 | 960 | 869 | 869 | 770 | 774 | 797 | 821 | 6717 |

QUALIFICATION TRENDS BY POPULATION GROUP AND GENDER

| | | 1991 | 1992 | 1993 | 1994 | 1995 | 1996 | 1997 | 1998 | TOTAL |
|--------------|---|------------|------------|------------|------------|------------|------------|------------|------------|-------------|
| Asian | F | 22 | 22 | 30 | 40 | 45 | 54 | 50 | 57 | 320 |
| | M | 14 | 21 | 22 | 21 | 22 | 32 | 29 | 35 | 196 |
| African | F | 32 | 43 | 21 | 43 | 58 | 72 | 76 | 85 | 430 |
| | M | 100 | 169 | 148 | 182 | 188 | 237 | 254 | 254 | 1532 |
| Coloured | F | 6 | 12 | 12 | 24 | 15 | 13 | 18 | 16 | 116 |
| | M | 10 | 17 | 13 | 13 | 14 | 13 | 12 | 13 | 105 |
| White | F | 319 | 348 | 323 | 286 | 244 | 204 | 220 | 224 | 2168 |
| | M | 354 | 328 | 300 | 260 | 184 | 149 | 138 | 137 | 1850 |
| OVERALL | F | 379 | 425 | 386 | 393 | 362 | 343 | 364 | 382 | 3034 |
| | M | 478 | 535 | 483 | 476 | 408 | 431 | 433 | 439 | 3683 |
| TOTAL | | 857 | 960 | 869 | 869 | 770 | 774 | 797 | 821 | 6717 |

QUALIFICATION TRENDS BY CURRENT PROVINCE OF RESIDENCE

| | 1991 | 1992 | 1993 | 1994 | 1995 | 1996 | 1997 | 1998 | TOTAL |
|---------------|------------|------------|------------|------------|------------|------------|------------|------------|-------------|
| Western Cape | 110 | 121 | 114 | 146 | 128 | 108 | 120 | 130 | 977 |
| Northern Cape | 9 | 3 | 9 | 4 | 5 | 10 | 10 | 12 | 62 |
| Free State | 48 | 20 | 35 | 24 | 25 | 12 | 17 | 20 | 201 |
| Eastern Cape | 72 | 81 | 61 | 86 | 88 | 91 | 79 | 76 | 634 |
| KwaZulu-Natal | 83 | 79 | 112 | 107 | 99 | 107 | 104 | 106 | 797 |
| Mpumalanga | 12 | 22 | 15 | 24 | 8 | 24 | 22 | 22 | 149 |
| Northern Prov | 33 | 121 | 48 | 66 | 88 | 96 | 104 | 100 | 656 |
| Gauteng | 427 | 446 | 414 | 356 | 288 | 296 | 308 | 321 | 2856 |
| North West | 36 | 35 | 33 | 32 | 13 | 10 | 19 | 17 | 195 |
| Outside SA | 27 | 32 | 28 | 24 | 28 | 20 | 14 | 17 | 190 |
| TOTAL | 857 | 960 | 869 | 869 | 770 | 774 | 797 | 821 | 6717 |

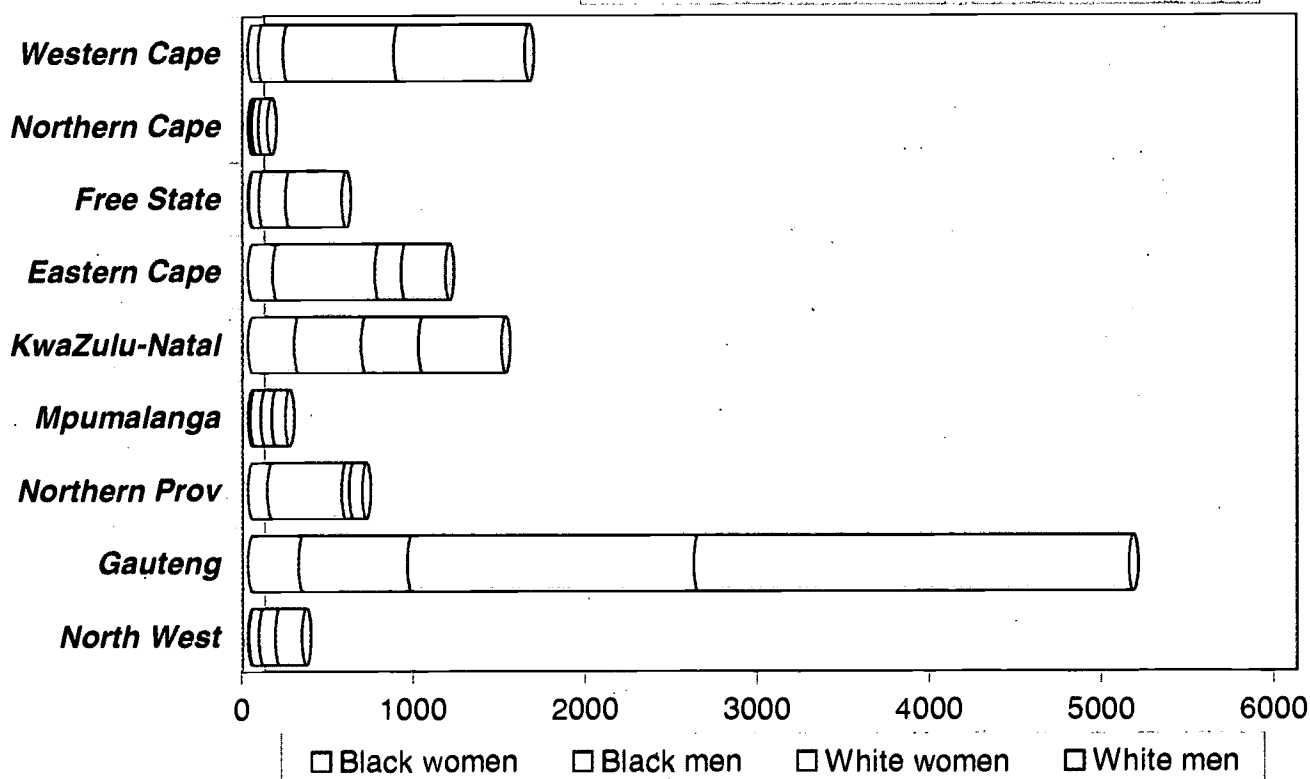
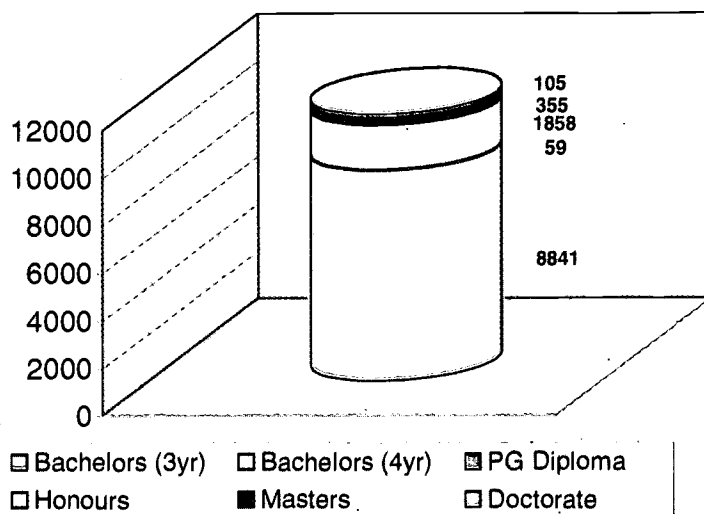
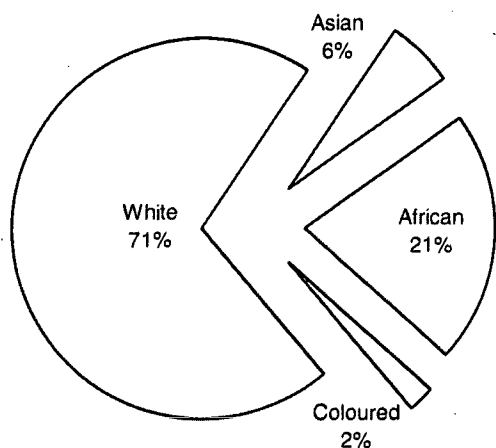

| | Asian | | African | | Coloured | | White | | OVERALL | | |
|---------------|------------|------------|-------------|-------------|------------|------------|-------------|-------------|-------------|-------------|--------------|
| | Women | Men | Women | Men | Women | Men | Women | Men | Women | Men | TOTAL |
| Western Cape | 12 | 18 | 3 | 55 | 43 | 75 | 644 | 763 | 702 | 911 | 1613 |
| Northern Cape | 6 | | | 9 | 1 | 6 | 36 | 55 | 43 | 70 | 113 |
| Free State | | 5 | 5 | 53 | | | 156 | 326 | 161 | 384 | 545 |
| Eastern Cape | 4 | 13 | 123 | 563 | 16 | 18 | 156 | 254 | 299 | 848 | 1147 |
| KwaZulu-Natal | 220 | 169 | 49 | 208 | 3 | 9 | 335 | 483 | 607 | 869 | 1476 |
| Mpumalanga | 2 | | 7 | 63 | 3 | | 62 | 81 | 74 | 144 | 218 |
| Northern Prov | 2 | | 111 | 430 | | | 45 | 75 | 158 | 505 | 663 |
| Gauteng | 102 | 99 | 163 | 496 | 31 | 38 | 1665 | 2529 | 1961 | 3162 | 5123 |
| North West | | 4 | 7 | 53 | | | 93 | 159 | 100 | 216 | 316 |
| TOTAL | 348 | 308 | 468 | 1930 | 97 | 146 | 3192 | 4725 | 4105 | 7109 | 11214 |
| | 656 | | 2398 | | 243 | | 7917 | | | | |



Graduates in this category have at least a Masters degree in Clinical, Counselling, Educational or Industrial Psychology. They are not repeated in the Social Science category.

QUALIFICATION TRENDS BY LEVEL

| | 1991 | 1992 | 1993 | 1994 | 1995 | 1996 | 1997 | 1998 | TOTAL |
|-----------------|------------|------------|------------|------------|------------|------------|------------|------------|-------------|
| Bachelors (3yr) | | | | | | | | | 0 |
| Bachelors (4yr) | | | | | | | | | 0 |
| PG Diploma | | | | | | | | | 0 |
| Honours | | | | | | | | | 0 |
| Masters | 182 | 193 | 129 | 144 | 195 | 181 | 152 | 173 | 1349 |
| Doctorate | 18 | 30 | 21 | 21 | 18 | 23 | 22 | 21 | 174 |
| TOTAL | 200 | 223 | 150 | 165 | 213 | 204 | 174 | 194 | 1523 |

QUALIFICATION TRENDS BY POPULATION GROUP AND GENDER

| | | 1991 | 1992 | 1993 | 1994 | 1995 | 1996 | 1997 | 1998 | TOTAL |
|--------------|---|------------|------------|------------|------------|------------|------------|------------|------------|-------------|
| Asian | F | 3 | 3 | 4 | 6 | 6 | 8 | 8 | 8 | 46 |
| | M | | 2 | 1 | 3 | 1 | 3 | 2 | 4 | 16 |
| African | F | 3 | 5 | 8 | 11 | 14 | 19 | 11 | 23 | 94 |
| | M | 6 | 5 | 4 | 7 | 2 | 4 | 3 | 5 | 36 |
| Coloured | F | 4 | 5 | 4 | | 6 | 6 | 5 | 7 | 37 |
| | M | 2 | 2 | 3 | 1 | 6 | 1 | 2 | 2 | 19 |
| White | F | 108 | 127 | 76 | 92 | 127 | 132 | 103 | 105 | 870 |
| | M | 74 | 74 | 50 | 45 | 51 | 31 | 40 | 40 | 405 |
| OVERALL | F | 118 | 140 | 92 | 109 | 153 | 165 | 127 | 143 | 1047 |
| | M | 82 | 83 | 58 | 56 | 60 | 39 | 47 | 51 | 476 |
| TOTAL | | 200 | 223 | 150 | 165 | 213 | 204 | 174 | 194 | 1523 |

QUALIFICATION TRENDS BY CURRENT PROVINCE OF RESIDENCE

| | 1991 | 1992 | 1993 | 1994 | 1995 | 1996 | 1997 | 1998 | TOTAL |
|---------------|------------|------------|------------|------------|------------|------------|------------|------------|-------------|
| Western Cape | 35 | 32 | 30 | 19 | 32 | 35 | 25 | 28 | 236 |
| Northern Cape | 3 | 3 | | 3 | 1 | | | | 10 |
| Free State | 10 | 27 | 6 | 13 | 19 | 11 | 16 | 15 | 117 |
| Eastern Cape | 13 | 17 | 11 | 12 | 21 | 11 | 10 | 9 | 104 |
| KwaZulu-Natal | 23 | 14 | 27 | 27 | 22 | 17 | 12 | 13 | 155 |
| Mpumalanga | 4 | 10 | | 1 | 4 | 6 | 10 | 10 | 45 |
| Northern Prov | 6 | 1 | 3 | 1 | | | | | 11 |
| Gauteng | 96 | 106 | 61 | 79 | 107 | 110 | 94 | 110 | 763 |
| North West | | 7 | 6 | 4 | 1 | 12 | 4 | 6 | 40 |
| Outside SA | 10 | 6 | 6 | 6 | 6 | 2 | 3 | 3 | 42 |
| TOTAL | 200 | 223 | 150 | 165 | 213 | 204 | 174 | 194 | 1523 |

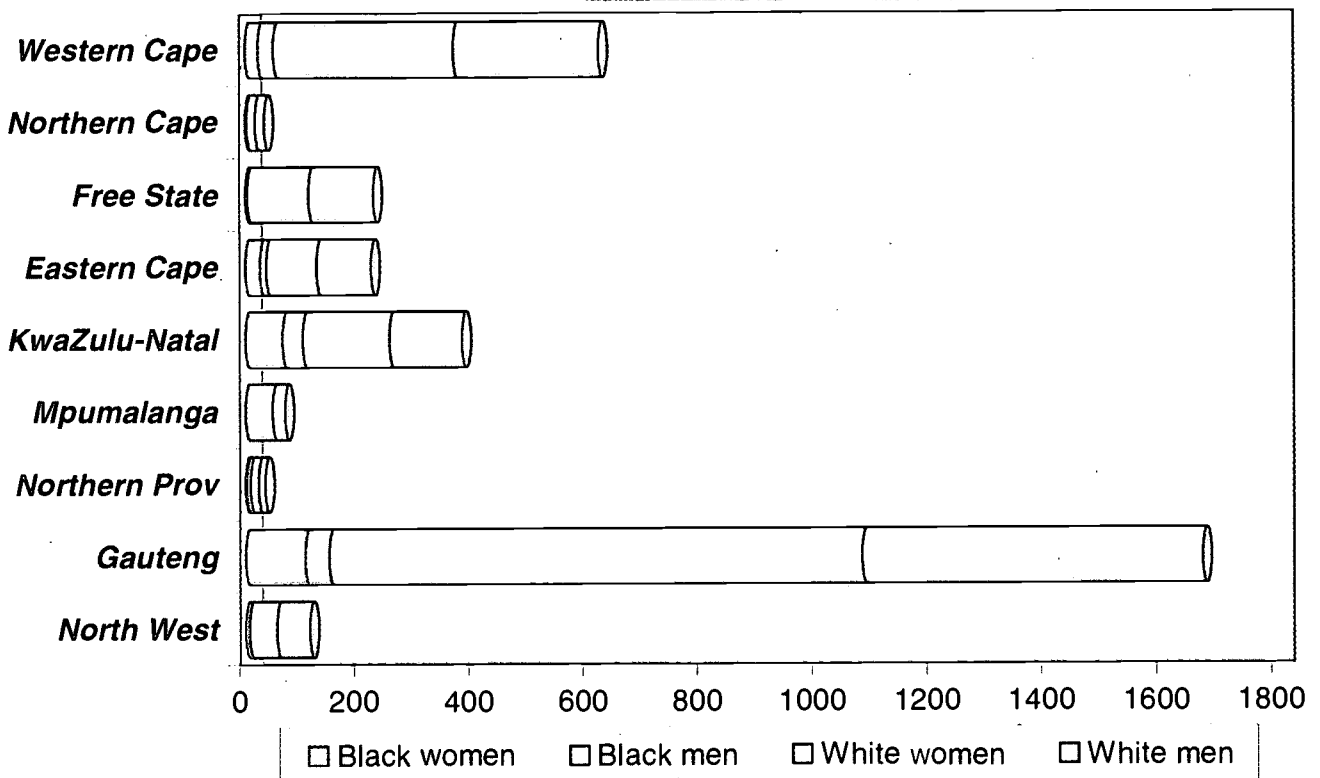
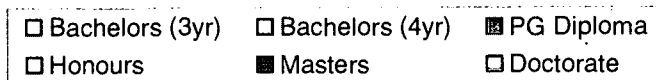
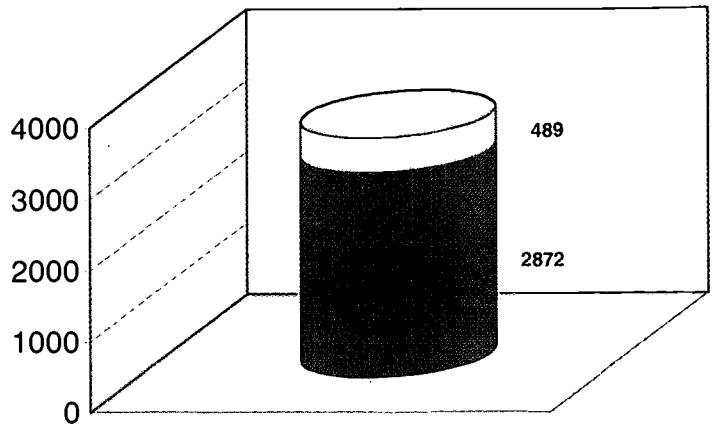
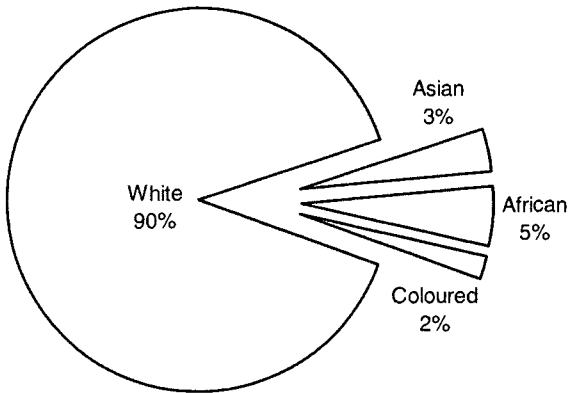

| | Asian | | African | | Coloured | | White | | OVERALL | | TOTAL |
|---------------|------------|-----------|------------|-----------|-----------|-----------|-------------|-------------|-------------|-------------|-------------|
| | Women | Men | Women | Men | Women | Men | Women | Men | Women | Men | |
| Western Cape | 5 | 6 | 2 | | 15 | 21 | 314 | 255 | 336 | 282 | 618 |
| Northern Cape | | | | | | 2 | 15 | 16 | 15 | 18 | 33 |
| Free State | | | | 3 | | | 108 | 112 | 108 | 115 | 223 |
| Eastern Cape | 4 | 1 | 16 | 10 | 5 | | 89 | 94 | 114 | 105 | 219 |
| KwaZulu-Natal | 47 | 24 | 12 | 12 | 6 | | 151 | 126 | 216 | 162 | 378 |
| Mpumalanga | | | | | | | 47 | 22 | 47 | 22 | 69 |
| Northern Prov | | | 2 | 6 | | | 14 | 12 | 16 | 18 | 34 |
| Gauteng | 20 | 8 | 74 | 27 | 11 | 6 | 930 | 594 | 1035 | 635 | 1670 |
| North West | | | 5 | 1 | | | 48 | 59 | 53 | 60 | 113 |
| TOTAL | 76 | 39 | 111 | 59 | 37 | 29 | 1716 | 1290 | 1940 | 1417 | 3357 |
| | 115 | | 170 | | 66 | | 3006 | | | | |

This category includes Criminology and Industrial Psychology / Sociology as Arts majors, as well as Sociology. Graduates with Psychology up to Honours level are also included here, while those with Psychology at Masters and Doctorate level are shown in the *Psychology* category only.

QUALIFICATION TRENDS BY LEVEL

| | 1991 | 1992 | 1993 | 1994 | 1995 | 1996 | 1997 | 1998 | TOTAL |
|-----------------|-------------|-------------|-------------|-------------|-------------|-------------|-------------|-------------|--------------|
| Bachelors (3yr) | 4380 | 4574 | 4426 | 5244 | 4874 | 4824 | 5019 | 5110 | 38451 |
| Bachelors (4yr) | 5 | | | 160 | 4 | 139 | 229 | 217 | 754 |
| PG Diploma | | | | | | 2 | 1 | | 4 |
| Honours | 864 | 974 | 1087 | 1020 | 1012 | 1027 | 1157 | 1263 | 8404 |
| Masters | 97 | 105 | 94 | 115 | 166 | 140 | 150 | 164 | 1031 |
| Doctorate | 9 | 10 | 9 | 6 | 12 | 5 | 8 | 8 | 67 |
| TOTAL | 5355 | 5663 | 5616 | 6545 | 6068 | 6137 | 6564 | 6763 | 48711 |

QUALIFICATION TRENDS BY POPULATION GROUP AND GENDER

| | | 1991 | 1992 | 1993 | 1994 | 1995 | 1996 | 1997 | 1998 | TOTAL |
|--------------|---|-------------|-------------|-------------|-------------|-------------|-------------|-------------|-------------|--------------|
| Asian | F | 243 | 247 | 324 | 474 | 396 | 441 | 443 | 464 | 3032 |
| | M | 60 | 70 | 92 | 94 | 83 | 96 | 92 | 111 | 698 |
| African | F | 475 | 643 | 739 | 974 | 1096 | 1319 | 1478 | 1597 | 8321 |
| | M | 430 | 529 | 560 | 837 | 693 | 833 | 957 | 947 | 5786 |
| Coloured | F | 195 | 247 | 207 | 239 | 260 | 248 | 299 | 339 | 2034 |
| | M | 129 | 143 | 103 | 160 | 151 | 98 | 114 | 106 | 1004 |
| White | F | 2629 | 2594 | 2529 | 2618 | 2423 | 2241 | 2271 | 2308 | 19613 |
| | M | 1194 | 1190 | 1062 | 1149 | 966 | 861 | 910 | 891 | 8223 |
| OVERALL | F | 3542 | 3731 | 3799 | 4305 | 4175 | 4249 | 4491 | 4708 | 33000 |
| | M | 1813 | 1932 | 1817 | 2240 | 1893 | 1888 | 2073 | 2055 | 15711 |
| TOTAL | | 5355 | 5663 | 5616 | 6545 | 6068 | 6137 | 6564 | 6763 | 48711 |

QUALIFICATION TRENDS BY CURRENT PROVINCE OF RESIDENCE

| | 1991 | 1992 | 1993 | 1994 | 1995 | 1996 | 1997 | 1998 | TOTAL |
|---------------|-------------|-------------|-------------|-------------|-------------|-------------|-------------|-------------|--------------|
| Western Cape | 1061 | 1141 | 978 | 1064 | 1213 | 993 | 931 | 909 | 8290 |
| Northern Cape | 78 | 74 | 74 | 82 | 75 | 71 | 91 | 83 | 628 |
| Free State | 243 | 356 | 321 | 516 | 420 | 347 | 496 | 457 | 3156 |
| Eastern Cape | 469 | 555 | 499 | 777 | 618 | 616 | 623 | 764 | 4921 |
| KwaZulu-Natal | 779 | 692 | 1029 | 953 | 899 | 1056 | 1048 | 1027 | 7483 |
| Mpumalanga | 126 | 176 | 147 | 201 | 179 | 205 | 201 | 230 | 1465 |
| Northern Prov | 142 | 181 | 165 | 227 | 224 | 309 | 284 | 298 | 1830 |
| Gauteng | 2073 | 2124 | 2069 | 2352 | 2135 | 2257 | 2544 | 2643 | 18197 |
| North West | 266 | 255 | 200 | 240 | 196 | 184 | 279 | 291 | 1911 |
| Outside SA | 118 | 109 | 134 | 133 | 109 | 99 | 67 | 61 | 830 |
| TOTAL | 5355 | 5663 | 5616 | 6545 | 6068 | 6137 | 6564 | 6763 | 48711 |

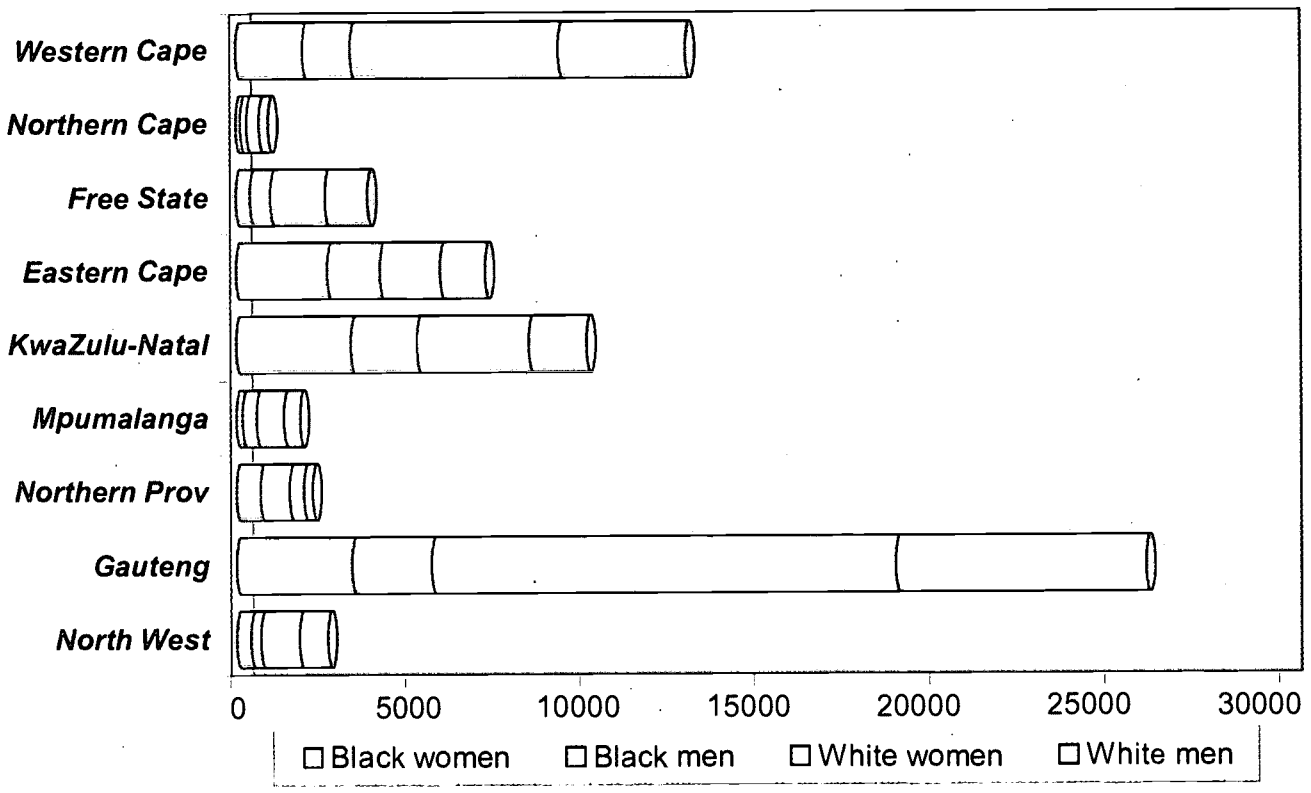
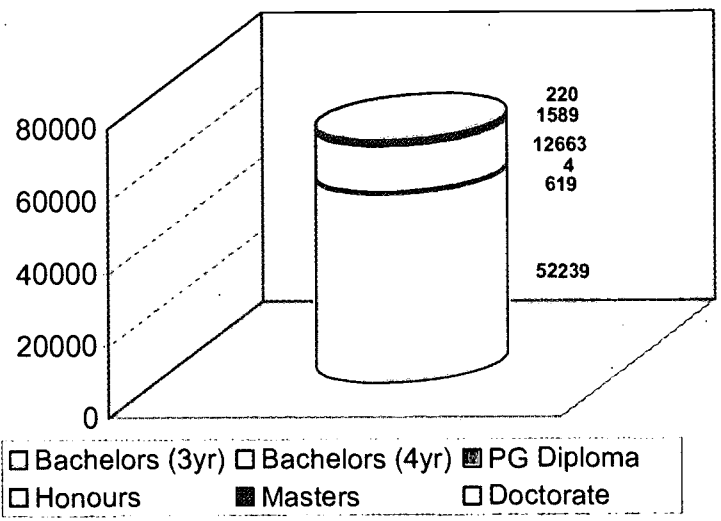
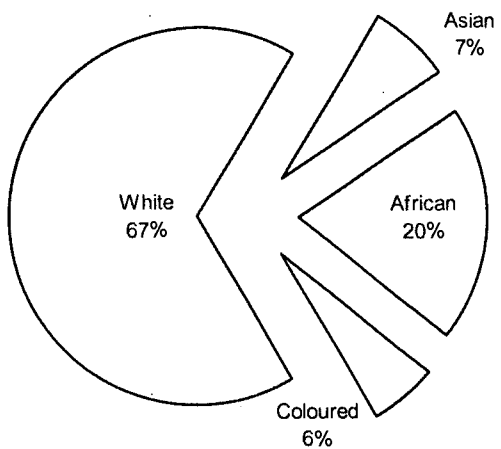

| | Asian | | African | | Coloured | | White | | OVERALL | | TOTAL |
|---------------|-------------|-------------|--------------|-------------|-------------|-------------|--------------|--------------|--------------|--------------|--------------|
| | Women | Men | Women | Men | Women | Men | Women | Men | Women | Men | |
| Western Cape | 162 | 69 | 416 | 223 | 1317 | 1114 | 5947 | 3637 | 7842 | 5043 | 12885 |
| Northern Cape | 8 | 6 | 52 | 60 | 74 | 116 | 354 | 250 | 488 | 432 | 920 |
| Free State | 2 | 1 | 368 | 552 | 40 | 20 | 1579 | 1205 | 1989 | 1778 | 3767 |
| Eastern Cape | 70 | 31 | 2313 | 1192 | 238 | 268 | 1742 | 1263 | 4363 | 2754 | 7117 |
| KwaZulu-Natal | 2304 | 1130 | 820 | 681 | 171 | 77 | 3211 | 1634 | 6506 | 3522 | 10028 |
| Mpumalanga | 14 | 4 | 160 | 384 | 8 | 3 | 774 | 460 | 956 | 851 | 1807 |
| Northern Prov | 8 | 4 | 666 | 829 | 2 | 1 | 418 | 257 | 1094 | 1091 | 2185 |
| Gauteng | 592 | 197 | 2498 | 1878 | 225 | 203 | 13255 | 7158 | 16570 | 9436 | 26006 |
| North West | 10 | 10 | 368 | 238 | 29 | 37 | 1092 | 834 | 1499 | 1119 | 2618 |
| TOTAL | 3170 | 1452 | 7661 | 6037 | 2104 | 1839 | 28372 | 16698 | 41307 | 26026 | 67333 |
| | 4622 | | 13698 | | 3943 | | 45070 | | | | |

This consists of the Visual Arts, Music and Drama.

QUALIFICATION TRENDS BY LEVEL

| | 1991 | 1992 | 1993 | 1994 | 1995 | 1996 | 1997 | 1998 | TOTAL |
|-----------------|------------|------------|------------|------------|------------|------------|------------|------------|-------------|
| Bachelors (3yr) | 131 | 132 | 114 | 135 | 146 | 151 | 130 | 134 | 1073 |
| Bachelors (4yr) | 253 | 335 | 306 | 322 | 311 | 297 | 349 | 347 | 2520 |
| PG Diploma | 2 | 1 | 1 | 1 | 2 | 1 | 1 | 1 | 10 |
| Honours | 125 | 114 | 108 | 73 | 128 | 111 | 132 | 138 | 929 |
| Masters | 44 | 44 | 40 | 43 | 62 | 56 | 62 | 72 | 423 |
| Doctorate | 8 | 5 | 11 | 8 | 5 | 6 | 8 | 7 | 58 |
| TOTAL | 563 | 631 | 580 | 582 | 654 | 622 | 682 | 699 | 5013 |

QUALIFICATION TRENDS BY POPULATION GROUP AND GENDER

| | | 1991 | 1992 | 1993 | 1994 | 1995 | 1996 | 1997 | 1998 | TOTAL |
|--------------|---|------------|------------|------------|------------|------------|------------|------------|------------|-------------|
| Asian | F | 14 | 23 | 20 | 25 | 28 | 28 | 32 | 35 | 205 |
| | M | 1 | 11 | 6 | 5 | 13 | 12 | 12 | 13 | 73 |
| African | F | 11 | 21 | 9 | 24 | 24 | 38 | 38 | 33 | 198 |
| | M | 17 | 28 | 18 | 18 | 38 | 36 | 54 | 44 | 253 |
| Coloured | F | 10 | 15 | 9 | 11 | 10 | 9 | 13 | 15 | 92 |
| | M | 5 | 6 | 4 | 7 | 6 | 5 | 9 | 7 | 49 |
| White | F | 375 | 395 | 390 | 372 | 393 | 378 | 398 | 422 | 3123 |
| | M | 130 | 132 | 124 | 120 | 142 | 116 | 126 | 130 | 1020 |
| OVERALL | F | 410 | 454 | 428 | 432 | 455 | 453 | 481 | 505 | 3618 |
| | M | 153 | 177 | 152 | 150 | 199 | 169 | 201 | 194 | 1395 |
| TOTAL | | 563 | 631 | 580 | 582 | 654 | 622 | 682 | 699 | 5013 |

QUALIFICATION TRENDS BY CURRENT PROVINCE OF RESIDENCE

| | 1991 | 1992 | 1993 | 1994 | 1995 | 1996 | 1997 | 1998 | TOTAL |
|---------------|------------|------------|------------|------------|------------|------------|------------|------------|-------------|
| Western Cape | 153 | 153 | 142 | 134 | 211 | 98 | 116 | 136 | 1143 |
| Northern Cape | 5 | 4 | 8 | 7 | 9 | 4 | 3 | 4 | 44 |
| Free State | 33 | 27 | 26 | 26 | 21 | 44 | 53 | 47 | 277 |
| Eastern Cape | 35 | 34 | 46 | 33 | 49 | 29 | 40 | 39 | 305 |
| KwaZulu-Natal | 56 | 101 | 83 | 100 | 108 | 141 | 143 | 140 | 872 |
| Mpumalanga | 7 | 11 | 16 | 7 | 12 | 22 | 20 | 14 | 109 |
| Northern Prov | 7 | 36 | 18 | 21 | 12 | 15 | 17 | 14 | 140 |
| Gauteng | 235 | 229 | 203 | 214 | 199 | 247 | 250 | 265 | 1842 |
| North West | 14 | 23 | 16 | 16 | 15 | 18 | 33 | 36 | 171 |
| Outside SA | 18 | 13 | 22 | 24 | 18 | 4 | 7 | 4 | 110 |
| TOTAL | 563 | 631 | 580 | 582 | 654 | 622 | 682 | 699 | 5013 |

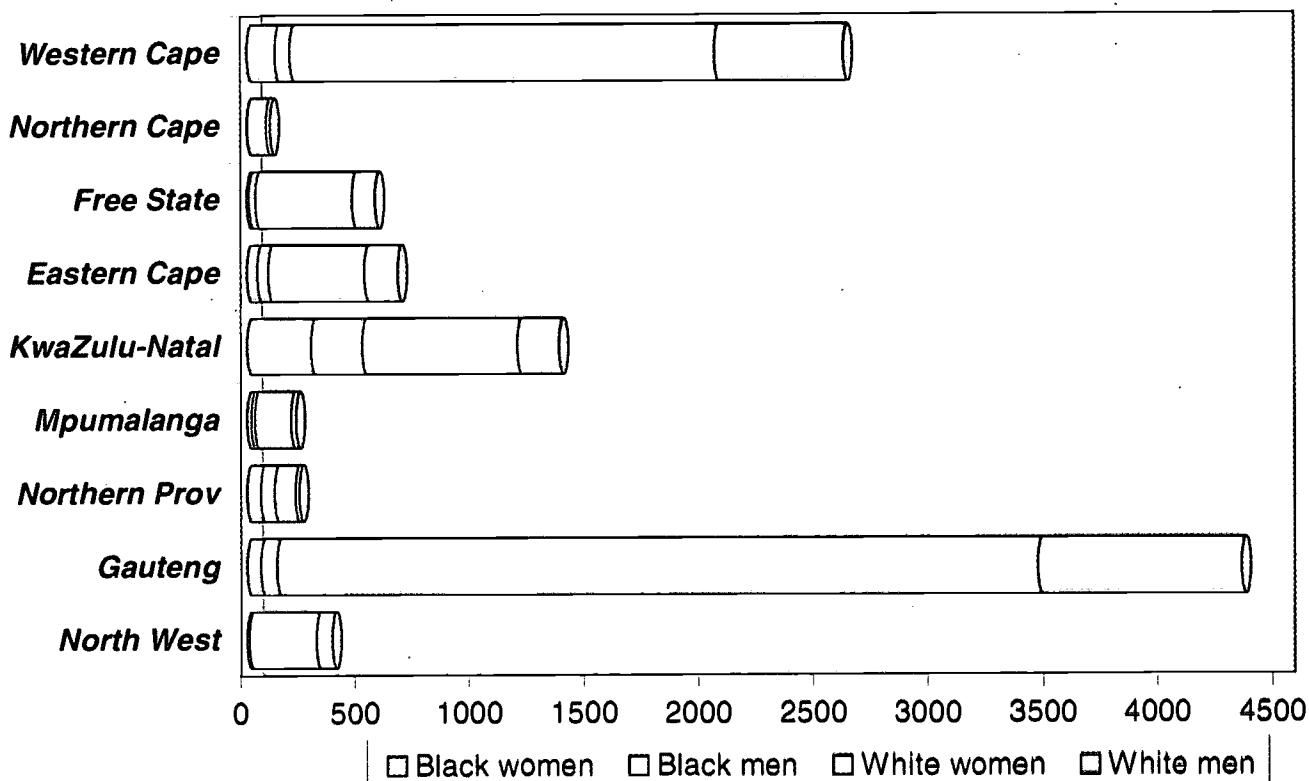
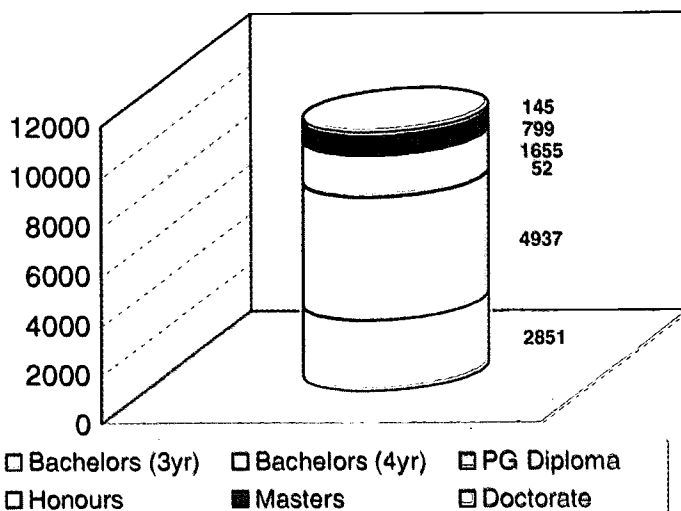
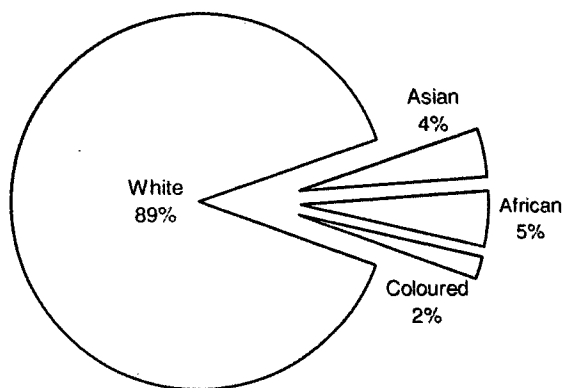

| | Asian | | African | | Coloured | | White | | OVERALL | | TOTAL |
|---------------|------------|------------|------------|------------|------------|-----------|-------------|-------------|-------------|-------------|--------------|
| | Women | Men | Women | Men | Women | Men | Women | Men | Women | Men | |
| Western Cape | 11 | 2 | 20 | 4 | 93 | 58 | 1853 | 561 | 1977 | 625 | 2602 |
| Northern Cape | | | | | | 2 | 85 | 16 | 85 | 18 | 103 |
| Free State | 2 | | 4 | 30 | 2 | | 423 | 101 | 431 | 131 | 562 |
| Eastern Cape | 2 | 2 | 27 | 41 | 16 | 7 | 420 | 145 | 465 | 195 | 660 |
| KwaZulu-Natal | 238 | 142 | 38 | 71 | 2 | 13 | 677 | 183 | 955 | 409 | 1364 |
| Mpumalanga | | | 16 | 15 | 2 | | 160 | 20 | 178 | 35 | 213 |
| Northern Prov | | | 60 | 62 | | | 89 | 16 | 149 | 78 | 227 |
| Gauteng | 18 | 9 | 33 | 58 | 10 | 4 | 3316 | 888 | 3377 | 959 | 4336 |
| North West | | | 2 | 6 | | | 293 | 71 | 295 | 77 | 372 |
| TOTAL | 271 | 155 | 200 | 287 | 125 | 84 | 7316 | 2001 | 7912 | 2527 | 10439 |
| | 426 | | 487 | | 209 | | 9317 | | | | |

It should be noted that the majority of teachers in South Africa are not graduates. This category refers only to people with educational degrees or postgraduate diplomas.

QUALIFICATION TRENDS BY LEVEL

| | 1991 | 1992 | 1993 | 1994 | 1995 | 1996 | 1997 | 1998 | TOTAL |
|-----------------|-------------|-------------|-------------|-------------|-------------|-------------|-------------|-------------|--------------|
| Bachelors (3yr) | 325 | 285 | 202 | 297 | 294 | 309 | 317 | 293 | 2322 |
| Bachelors (4yr) | 1465 | 1156 | 902 | 1286 | 1654 | 1780 | 1810 | 1971 | 12024 |
| PG Diploma | 2313 | 2509 | 3163 | 2747 | 3064 | 2789 | 3069 | 2921 | 22575 |
| Honours | 1593 | 1363 | 2055 | 1637 | 2441 | 2290 | 2409 | 2524 | 16312 |
| Masters | 348 | 303 | 365 | 347 | 463 | 466 | 518 | 575 | 3385 |
| Doctorate | 66 | 91 | 86 | 90 | 105 | 95 | 85 | 95 | 713 |
| TOTAL | 6110 | 5707 | 6773 | 6404 | 8021 | 7729 | 8208 | 8379 | 57331 |

QUALIFICATION TRENDS BY POPULATION GROUP AND GENDER

| | | 1991 | 1992 | 1993 | 1994 | 1995 | 1996 | 1997 | 1998 | TOTAL |
|--------------|---|-------------|-------------|-------------|-------------|-------------|-------------|-------------|-------------|--------------|
| Asian | F | 272 | 228 | 350 | 305 | 409 | 411 | 458 | 450 | 2883 |
| | M | 147 | 134 | 189 | 161 | 162 | 175 | 186 | 187 | 1341 |
| African | F | 1186 | 1250 | 1564 | 1692 | 2634 | 2742 | 2975 | 3041 | 17084 |
| | M | 1249 | 1256 | 1559 | 1688 | 2205 | 2202 | 2420 | 2488 | 15067 |
| Coloured | F | 383 | 347 | 388 | 294 | 314 | 245 | 279 | 284 | 2534 |
| | M | 478 | 385 | 431 | 270 | 300 | 231 | 259 | 267 | 2621 |
| White | F | 1721 | 1468 | 1636 | 1419 | 1459 | 1292 | 1258 | 1277 | 11530 |
| | M | 674 | 639 | 656 | 575 | 538 | 431 | 373 | 385 | 4271 |
| OVERALL | F | 3562 | 3293 | 3938 | 3710 | 4816 | 4690 | 4970 | 5052 | 34031 |
| | M | 2548 | 2414 | 2835 | 2694 | 3205 | 3039 | 3238 | 3327 | 23300 |
| TOTAL | | 6110 | 5707 | 6773 | 6404 | 8021 | 7729 | 8208 | 8379 | 57331 |

QUALIFICATION TRENDS BY CURRENT PROVINCE OF RESIDENCE

| | 1991 | 1992 | 1993 | 1994 | 1995 | 1996 | 1997 | 1998 | TOTAL |
|---------------|-------------|-------------|-------------|-------------|-------------|-------------|-------------|-------------|--------------|
| Western Cape | 1058 | 923 | 922 | 785 | 1146 | 718 | 879 | 859 | 7290 |
| Northern Cape | 113 | 124 | 142 | 113 | 147 | 151 | 149 | 154 | 1093 |
| Free State | 301 | 328 | 367 | 457 | 502 | 522 | 556 | 597 | 3630 |
| Eastern Cape | 571 | 624 | 757 | 684 | 978 | 857 | 966 | 911 | 6348 |
| KwaZulu-Natal | 885 | 742 | 1008 | 973 | 1088 | 1228 | 1328 | 1302 | 8554 |
| Mpumalanga | 289 | 225 | 263 | 262 | 368 | 390 | 439 | 433 | 2669 |
| Northern Prov | 691 | 748 | 903 | 928 | 1263 | 1376 | 1433 | 1499 | 8841 |
| Gauteng | 1809 | 1624 | 1996 | 1803 | 1898 | 1837 | 1861 | 1929 | 14757 |
| North West | 313 | 290 | 335 | 308 | 550 | 593 | 526 | 629 | 3544 |
| Outside SA | 80 | 79 | 80 | 91 | 81 | 57 | 71 | 66 | 605 |
| TOTAL | 6110 | 5707 | 6773 | 6404 | 8021 | 7729 | 8208 | 8379 | 57331 |

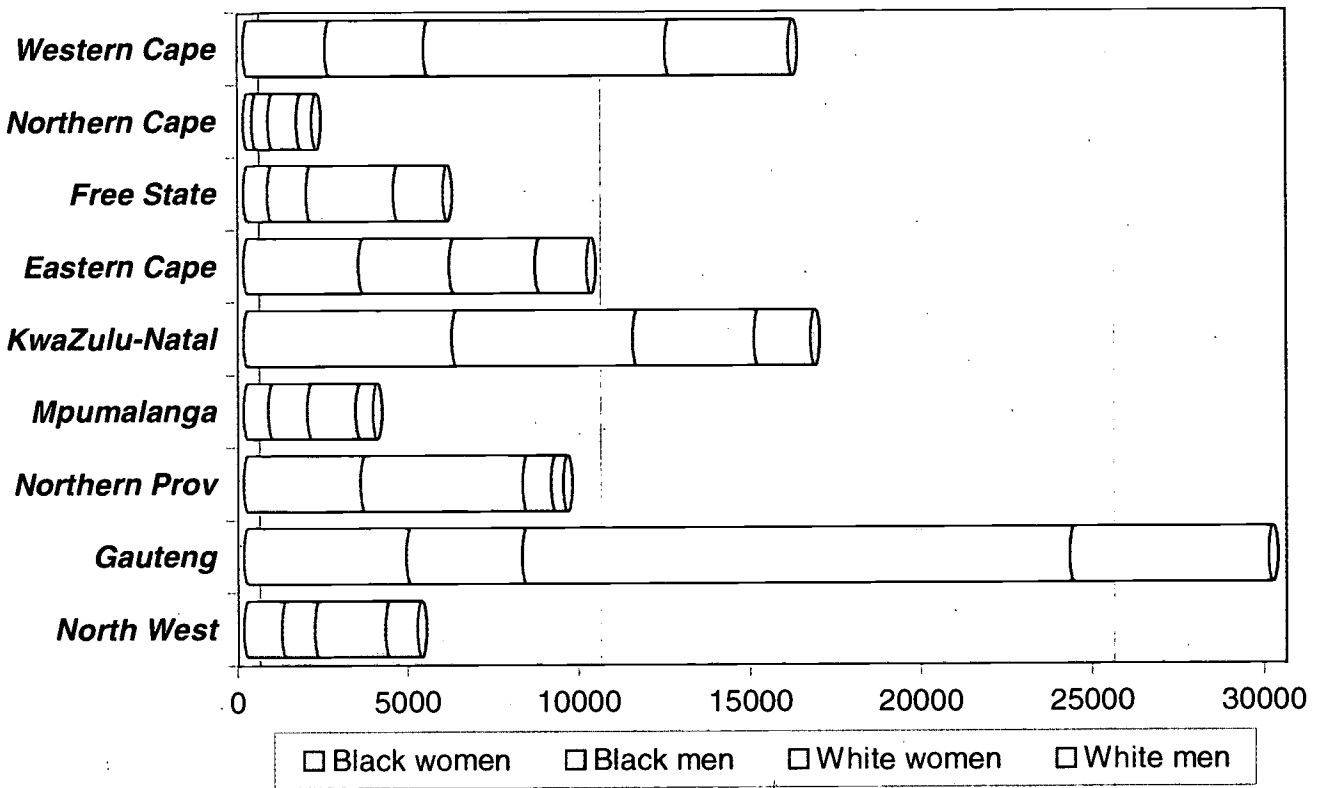
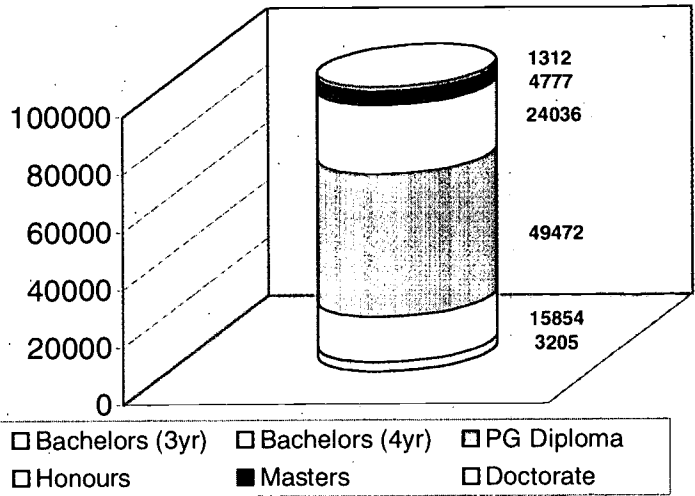
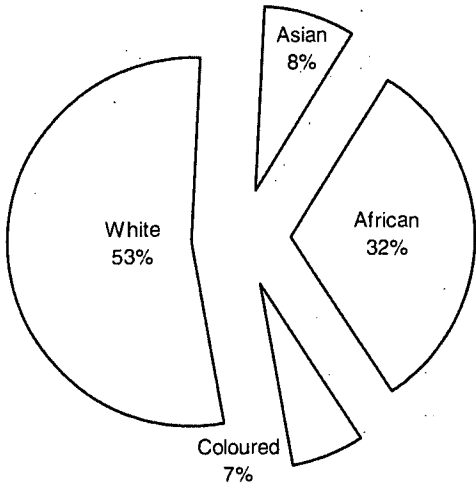

| | Asian | | African | | Coloured | | White | | OVERALL | | |
|---------------|-------------|-------------|--------------|--------------|-------------|-------------|--------------|--------------|--------------|--------------|--------------|
| | Women | Men | Women | Men | Women | Men | Women | Men | Women | Men | TOTAL |
| Western Cape | 128 | 71 | 490 | 326 | 1790 | 2498 | 7030 | 3616 | 9438 | 6511 | 15949 |
| Northern Cape | 6 | 19 | 86 | 186 | 159 | 283 | 835 | 448 | 1086 | 936 | 2022 |
| Free State | 8 | 7 | 658 | 1089 | 50 | 46 | 2548 | 1445 | 3264 | 2587 | 5851 |
| Eastern Cape | 66 | 80 | 3031 | 2106 | 276 | 478 | 2507 | 1503 | 5880 | 4167 | 10047 |
| KwaZulu-Natal | 3691 | 2912 | 2233 | 2252 | 183 | 124 | 3543 | 1656 | 9650 | 6944 | 16594 |
| Mpumalanga | 16 | 20 | 709 | 1109 | 14 | 13 | 1404 | 509 | 2143 | 1651 | 3794 |
| Northern Prov | 20 | 16 | 3401 | 4729 | 5 | 3 | 829 | 352 | 4255 | 5100 | 9355 |
| Gauteng | 441 | 224 | 4135 | 2929 | 202 | 235 | 15972 | 5815 | 20750 | 9203 | 29953 |
| North West | 30 | 37 | 1063 | 885 | 30 | 43 | 2060 | 945 | 3183 | 1910 | 5093 |
| TOTAL | 4406 | 3386 | 15806 | 15611 | 2709 | 3723 | 36728 | 16289 | 59649 | 39009 | 98658 |
| | 7792 | | 31417 | | 6432 | | 53017 | | | | |



QUALIFICATION TRENDS BY LEVEL

| | 1991 | 1992 | 1993 | 1994 | 1995 | 1996 | 1997 | 1998 | TOTAL |
|-----------------|------------|------------|------------|------------|------------|------------|------------|------------|-------------|
| Bachelors (3yr) | 495 | 496 | 310 | 423 | 343 | 340 | 353 | 371 | 3086 |
| Bachelors (4yr) | 2 | | 1 | | 5 | | 1 | 5 | 14 |
| PG Diploma | 116 | 47 | 64 | 73 | 55 | 55 | 80 | 65 | 557 |
| Honours | 66 | 81 | 65 | 76 | 66 | 72 | 94 | 86 | 606 |
| Masters | 14 | 10 | 23 | 9 | 16 | 18 | 14 | 13 | 117 |
| Doctorate | 6 | 3 | 4 | 1 | 4 | 1 | 3 | 2 | 24 |
| TOTAL | 636 | 637 | 467 | 592 | 494 | 486 | 550 | 542 | 4404 |

QUALIFICATION TRENDS BY POPULATION GROUP AND GENDER

| | | 1991 | 1992 | 1993 | 1994 | 1995 | 1996 | 1997 | 1998 | TOTAL |
|--------------|---|------------|------------|------------|------------|------------|------------|------------|------------|-------------|
| Asian | F | 2 | 5 | 12 | 19 | 21 | 20 | 21 | 26 | 126 |
| | M | 13 | 8 | 9 | 2 | 8 | 10 | 14 | 15 | 79 |
| African | F | 87 | 81 | 72 | 125 | 147 | 149 | 169 | 162 | 992 |
| | M | 26 | 35 | 32 | 36 | 33 | 58 | 81 | 84 | 385 |
| Coloured | F | 17 | 21 | 12 | 30 | 22 | 19 | 20 | 21 | 162 |
| | M | 3 | 16 | 4 | 12 | 6 | 9 | 8 | 8 | 66 |
| White | F | 453 | 428 | 312 | 346 | 222 | 205 | 213 | 203 | 2382 |
| | M | 35 | 43 | 14 | 22 | 35 | 16 | 24 | 23 | 212 |
| OVERALL | F | 559 | 535 | 408 | 520 | 412 | 393 | 423 | 412 | 3662 |
| | M | 77 | 102 | 59 | 72 | 82 | 93 | 127 | 130 | 742 |
| TOTAL | | 636 | 637 | 467 | 592 | 494 | 486 | 550 | 542 | 4404 |

QUALIFICATION TRENDS BY CURRENT PROVINCE OF RESIDENCE

| | 1991 | 1992 | 1993 | 1994 | 1995 | 1996 | 1997 | 1998 | TOTAL |
|---------------|------------|------------|------------|------------|------------|------------|------------|------------|-------------|
| Western Cape | 93 | 94 | 54 | 139 | 104 | 110 | 121 | 110 | 825 |
| Northern Cape | 7 | 12 | 9 | 3 | 4 | 4 | 12 | 12 | 63 |
| Free State | 57 | 49 | 35 | 51 | 12 | 20 | 16 | 12 | 252 |
| Eastern Cape | 34 | 34 | 31 | 36 | 64 | 63 | 62 | 67 | 391 |
| KwaZulu-Natal | 64 | 70 | 78 | 72 | 41 | 52 | 61 | 46 | 484 |
| Mpumalanga | 30 | 7 | 9 | 19 | 2 | 12 | 8 | 2 | 89 |
| Northern Prov | 26 | 40 | 5 | 11 | 12 | 26 | 43 | 47 | 210 |
| Gauteng | 267 | 291 | 222 | 223 | 231 | 173 | 209 | 232 | 1848 |
| North West | 32 | 30 | 14 | 23 | 16 | 24 | 18 | 14 | 171 |
| Outside SA | 26 | 10 | 10 | 15 | 8 | 2 | | | 71 |
| TOTAL | 636 | 637 | 467 | 592 | 494 | 486 | 550 | 542 | 4404 |

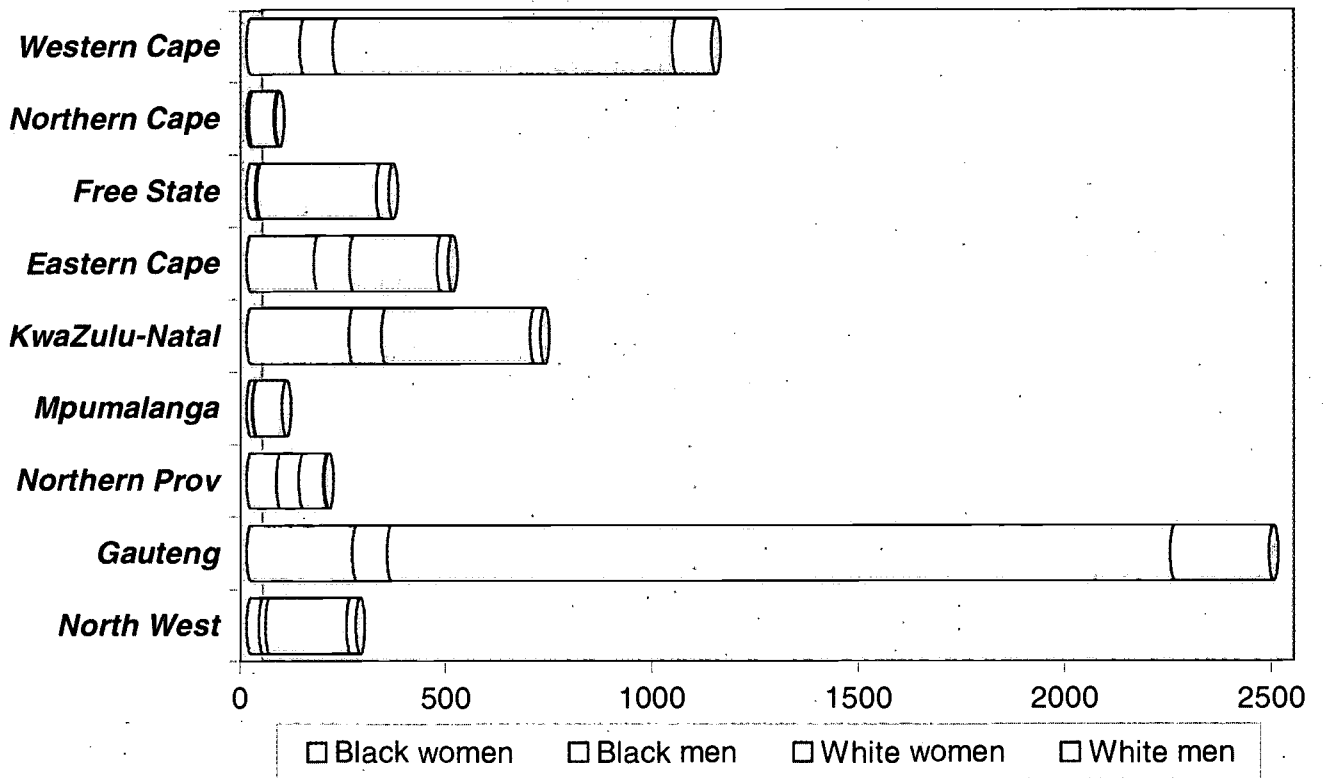
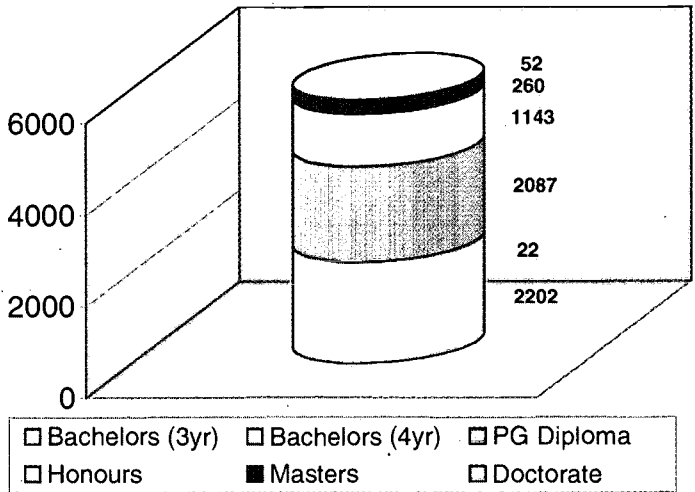
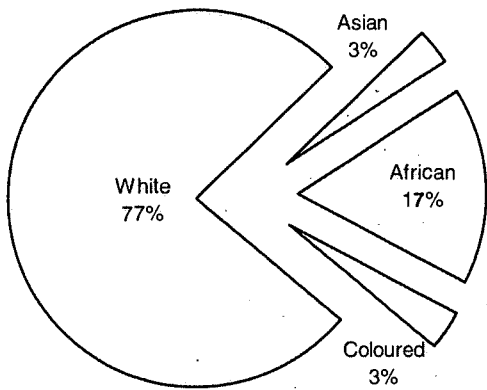

| | Asian | | African | | Coloured | | White | | OVERALL | | TOTAL |
|---------------|------------|-----------|------------|------------|------------|-----------|-------------|------------|-------------|------------|-------------|
| | Women | Men | Women | Men | Women | Men | Women | Men | Women | Men | |
| Western Cape | 4 | | 23 | 28 | 101 | 54 | 823 | 95 | 951 | 177 | 1128 |
| Northern Cape | | | | 6 | | | 61 | 3 | 61 | 9 | 70 |
| Free State | | | 20 | 4 | | 1 | 290 | 30 | 310 | 35 | 345 |
| Eastern Cape | | | 159 | 85 | 3 | 3 | 213 | 28 | 375 | 116 | 491 |
| KwaZulu-Natal | 97 | 61 | 149 | 17 | 3 | | 362 | 25 | 611 | 103 | 714 |
| Mpumalanga | | | 11 | 2 | 2 | | 71 | | 84 | 2 | 86 |
| Northern Prov | | | 72 | 54 | | | 60 | 3 | 132 | 57 | 189 |
| Gauteng | 10 | 7 | 235 | 63 | 12 | 13 | 1899 | 239 | 2156 | 322 | 2478 |
| North West | | | 29 | 15 | | | 198 | 23 | 227 | 39 | 266 |
| TOTAL | 111 | 69 | 698 | 274 | 121 | 71 | 3977 | 446 | 4907 | 860 | 5767 |

QUALIFICATION TRENDS BY LEVEL

| | 1991 | 1992 | 1993 | 1994 | 1995 | 1996 | 1997 | 1998 | TOTAL |
|-----------------|-------------|------------|------------|-------------|-------------|-------------|-------------|-------------|-------------|
| Bachelors (3yr) | 965 | 895 | 849 | 939 | 1032 | 979 | 978 | 1009 | 7646 |
| Bachelors (4yr) | 3 | 6 | 4 | 11 | 25 | 3 | 1 | 25 | 78 |
| PG Diploma | | 2 | 1 | 1 | 1 | 1 | 2 | 3 | 11 |
| Honours | 71 | 36 | 48 | 23 | 19 | 16 | 16 | 18 | 247 |
| Masters | 37 | 30 | 38 | 43 | 62 | 44 | 75 | 85 | 414 |
| Doctorate | 11 | 15 | 5 | 15 | 6 | 14 | 14 | 13 | 93 |
| TOTAL | 1087 | 984 | 945 | 1032 | 1145 | 1057 | 1086 | 1153 | 8489 |

QUALIFICATION TRENDS BY POPULATION GROUP AND GENDER

| | | 1991 | 1992 | 1993 | 1994 | 1995 | 1996 | 1997 | 1998 | TOTAL |
|--------------|---|-------------|------------|------------|-------------|-------------|-------------|-------------|-------------|-------------|
| Asian | F | 65 | 54 | 65 | 65 | 84 | 88 | 102 | 103 | 626 |
| | M | 4 | 1 | | 1 | 9 | 9 | 8 | 9 | 41 |
| African | F | 268 | 272 | 260 | 353 | 404 | 475 | 443 | 510 | 2985 |
| | M | 42 | 50 | 41 | 68 | 73 | 68 | 75 | 69 | 486 |
| Coloured | F | 74 | 57 | 54 | 50 | 72 | 62 | 63 | 63 | 495 |
| | M | 28 | 17 | 12 | 11 | 9 | 8 | 7 | 7 | 99 |
| White | F | 544 | 501 | 482 | 461 | 464 | 329 | 369 | 369 | 3519 |
| | M | 62 | 32 | 31 | 23 | 30 | 18 | 19 | 23 | 238 |
| OVERALL | F | 951 | 884 | 861 | 929 | 1024 | 954 | 977 | 1045 | 7625 |
| | M | 136 | 100 | 84 | 103 | 121 | 103 | 109 | 108 | 864 |
| TOTAL | | 1087 | 984 | 945 | 1032 | 1145 | 1057 | 1086 | 1153 | 8489 |

QUALIFICATION TRENDS BY CURRENT PROVINCE OF RESIDENCE

| | 1991 | 1992 | 1993 | 1994 | 1995 | 1996 | 1997 | 1998 | TOTAL |
|---------------|-------------|------------|------------|-------------|-------------|-------------|-------------|-------------|-------------|
| Western Cape | 185 | 176 | 158 | 155 | 257 | 79 | 117 | 123 | 1250 |
| Northern Cape | 34 | 36 | 27 | 26 | 29 | 16 | 29 | 14 | 211 |
| Free State | 78 | 92 | 100 | 87 | 75 | 39 | 53 | 57 | 581 |
| Eastern Cape | 142 | 97 | 95 | 146 | 162 | 167 | 191 | 208 | 1208 |
| KwaZulu-Natal | 159 | 102 | 122 | 150 | 119 | 193 | 199 | 157 | 1201 |
| Mpumalanga | 27 | 40 | 34 | 67 | 31 | 35 | 38 | 59 | 331 |
| Northern Prov | 56 | 46 | 51 | 48 | 48 | 63 | 53 | 64 | 429 |
| Gauteng | 324 | 296 | 285 | 283 | 344 | 373 | 344 | 400 | 2649 |
| North West | 72 | 78 | 66 | 61 | 65 | 90 | 60 | 69 | 561 |
| Outside SA | 10 | 21 | 7 | 9 | 15 | 2 | 2 | 2 | 68 |
| TOTAL | 1087 | 984 | 945 | 1032 | 1145 | 1057 | 1086 | 1153 | 8489 |

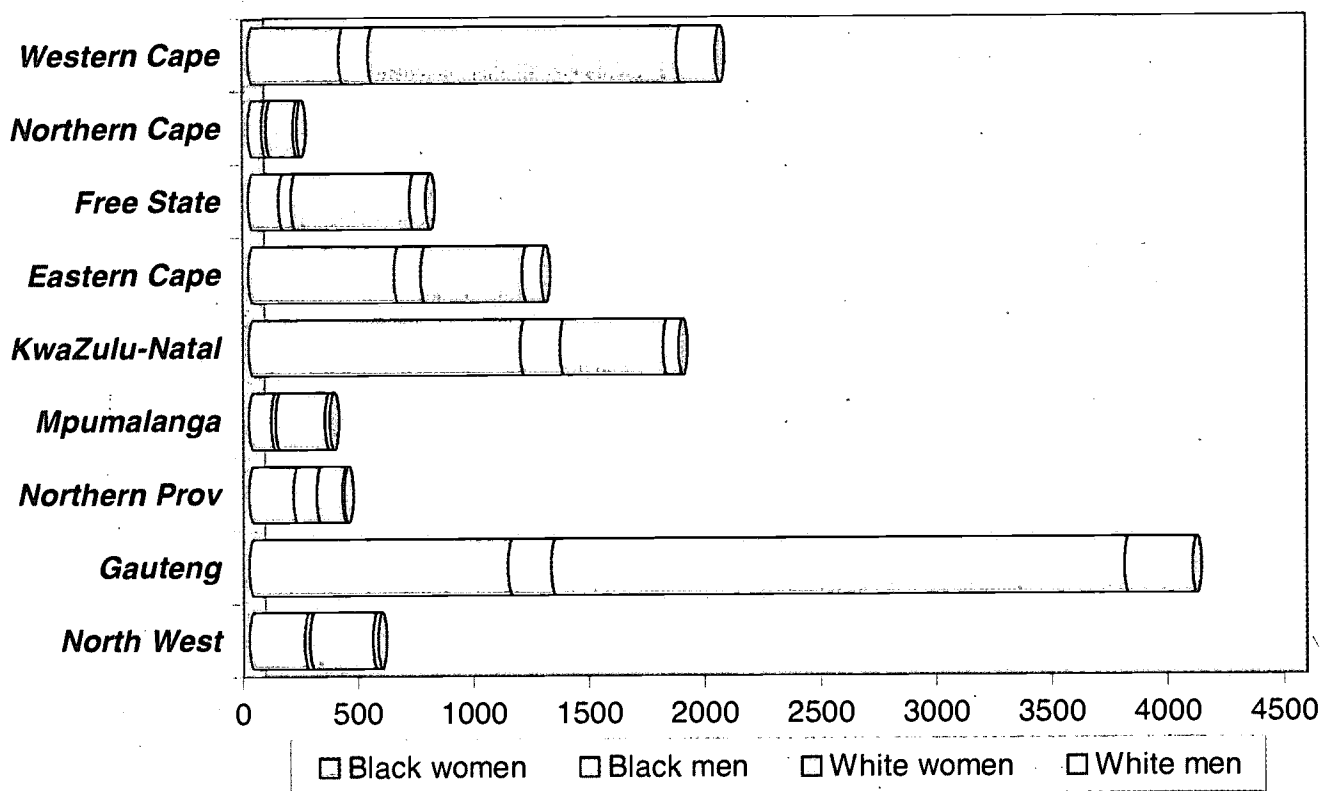
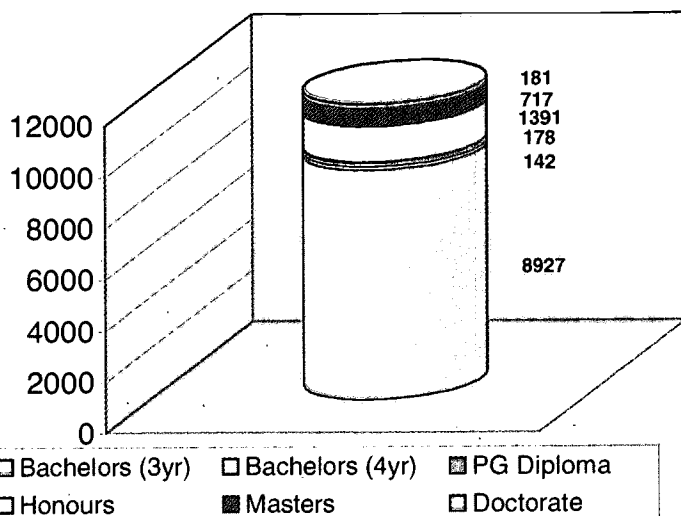
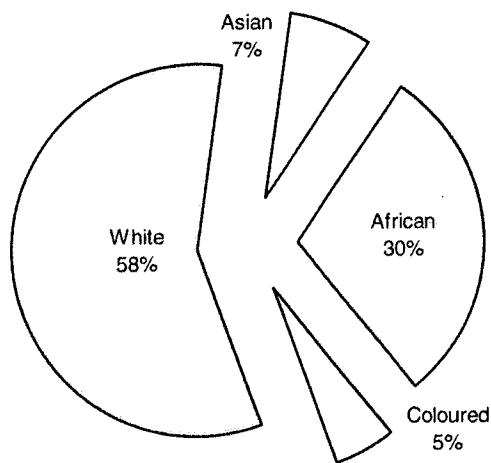

| | Asian | | African | | Coloured | | White | | OVERALL | | TOTAL |
|---------------|------------|-----------|-------------|------------|------------|------------|-------------|------------|-------------|-------------|--------------|
| | Women | Men | Women | Men | Women | Men | Women | Men | Women | Men | |
| Western Cape | 18 | | 88 | 33 | 290 | 94 | 1333 | 167 | 1729 | 294 | 2023 |
| Northern Cape | 4 | | 43 | 17 | 12 | 3 | 120 | 15 | 179 | 35 | 214 |
| Free State | 4 | | 116 | 54 | 14 | 1 | 511 | 70 | 645 | 125 | 770 |
| Eastern Cape | 15 | 4 | 552 | 94 | 68 | 15 | 437 | 82 | 1072 | 195 | 1267 |
| KwaZulu-Natal | 630 | 51 | 490 | 119 | 56 | 1 | 446 | 68 | 1622 | 239 | 1861 |
| Mpumalanga | 4 | | 95 | 17 | | 1 | 214 | 22 | 313 | 40 | 353 |
| Northern Prov | | | 194 | 100 | 2 | | 109 | 7 | 305 | 107 | 412 |
| Gauteng | 102 | 8 | 967 | 168 | 53 | 8 | 2477 | 293 | 3599 | 477 | 4076 |
| North West | 4 | | 233 | 23 | 6 | | 270 | 22 | 513 | 45 | 558 |
| TOTAL | 781 | 63 | 2778 | 625 | 501 | 123 | 5917 | 746 | 9977 | 1557 | 11534 |



This category consists of legal qualifications that do not entitle one to practise as an advocate or attorney. Advocates and attorneys who also have other legal qualifications are not repeated here under Total Availability, but their legal qualifications are shown under qualification trends.

QUALIFICATION TRENDS BY LEVEL

| | 1991 | 1992 | 1993 | 1994 | 1995 | 1996 | 1997 | 1998 | TOTAL |
|-----------------|-------------|-------------|-------------|-------------|-------------|-------------|-------------|-------------|--------------|
| Bachelors (3yr) | 2425 | 2493 | 2513 | 3052 | 2743 | 2670 | 2310 | 2374 | 21595 |
| Bachelors (4yr) | 18 | 19 | 18 | 57 | 33 | 37 | 54 | 56 | 292 |
| PG Diploma | 55 | 143 | 48 | 100 | 63 | 126 | 114 | 126 | 775 |
| Honours | 1 | 29 | 8 | 8 | 10 | 25 | 14 | 14 | 109 |
| Masters | 1 | | 1 | 28 | 1 | 3 | 3 | 3 | 40 |
| Doctorate | 2 | 1 | | 2 | 1 | 2 | 3 | 5 | 16 |
| TOTAL | 2502 | 2690 | 2593 | 3247 | 2856 | 2863 | 2998 | 3078 | 22827 |

QUALIFICATION TRENDS BY POPULATION GROUP AND GENDER

| | | 1991 | 1992 | 1993 | 1994 | 1995 | 1996 | 1997 | 1998 | TOTAL |
|--------------|---|-------------|-------------|-------------|-------------|-------------|-------------|-------------|-------------|--------------|
| Asian | F | 70 | 108 | 100 | 134 | 90 | 103 | 110 | 111 | 826 |
| | M | 47 | 44 | 46 | 58 | 54 | 67 | 63 | 65 | 444 |
| African | F | 84 | 120 | 168 | 170 | 213 | 275 | 277 | 312 | 1619 |
| | M | 303 | 506 | 628 | 707 | 847 | 871 | 945 | 954 | 5761 |
| Coloured | F | 57 | 52 | 58 | 92 | 60 | 74 | 91 | 85 | 569 |
| | M | 55 | 132 | 76 | 71 | 73 | 64 | 73 | 69 | 613 |
| White | F | 952 | 797 | 806 | 1043 | 767 | 705 | 727 | 749 | 6546 |
| | M | 934 | 931 | 711 | 972 | 752 | 704 | 712 | 733 | 6449 |
| OVERALL | F | 1163 | 1077 | 1132 | 1439 | 1130 | 1157 | 1205 | 1257 | 9560 |
| | M | 1339 | 1613 | 1461 | 1808 | 1726 | 1706 | 1793 | 1821 | 13267 |
| TOTAL | | 2502 | 2690 | 2593 | 3247 | 2856 | 2863 | 2998 | 3078 | 22827 |

QUALIFICATION TRENDS BY CURRENT PROVINCE OF RESIDENCE

| | 1991 | 1992 | 1993 | 1994 | 1995 | 1996 | 1997 | 1998 | TOTAL |
|---------------|-------------|-------------|-------------|-------------|-------------|-------------|-------------|-------------|--------------|
| Western Cape | 418 | 489 | 438 | 561 | 384 | 323 | 282 | 295 | 3190 |
| Northern Cape | 21 | 39 | 20 | 49 | 35 | 18 | 26 | 28 | 236 |
| Free State | 81 | 87 | 76 | 190 | 90 | 162 | 91 | 139 | 916 |
| Eastern Cape | 241 | 270 | 277 | 418 | 410 | 287 | 493 | 295 | 2691 |
| KwaZulu-Natal | 240 | 223 | 274 | 278 | 293 | 311 | 283 | 356 | 2258 |
| Mpumalanga | 84 | 91 | 65 | 101 | 96 | 137 | 104 | 149 | 827 |
| Northern Prov | 83 | 176 | 156 | 171 | 215 | 277 | 211 | 278 | 1567 |
| Gauteng | 1119 | 1116 | 1070 | 1230 | 1121 | 1096 | 1184 | 1139 | 9075 |
| North West | 192 | 143 | 179 | 207 | 195 | 223 | 308 | 381 | 1828 |
| Outside SA | 23 | 56 | 38 | 42 | 17 | 29 | 16 | 18 | 239 |
| TOTAL | 2502 | 2690 | 2593 | 3247 | 2856 | 2863 | 2998 | 3078 | 22827 |

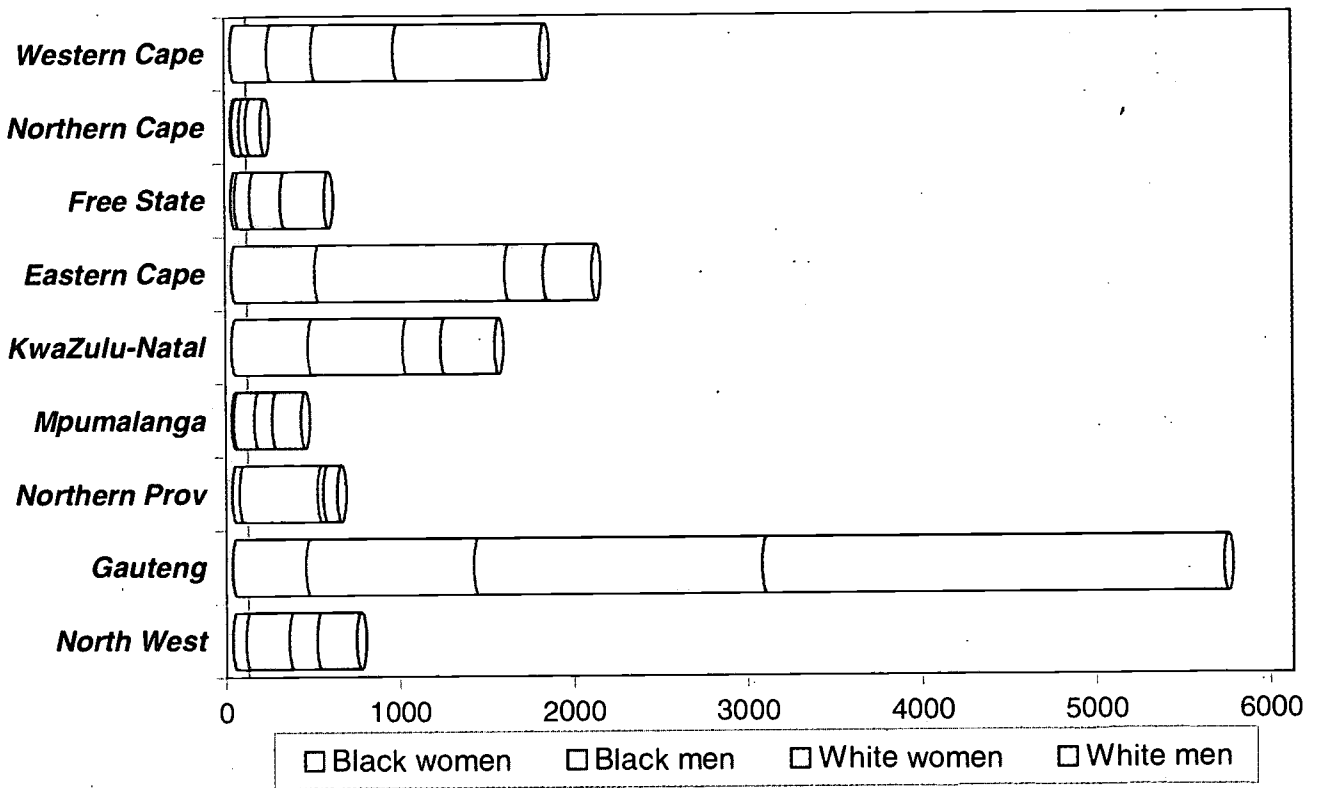
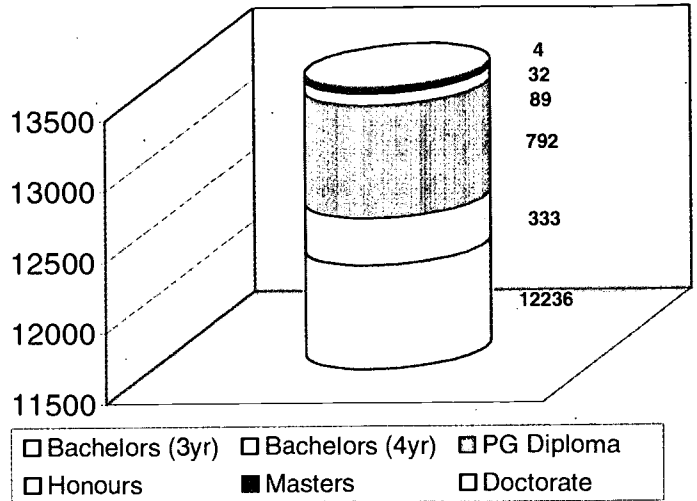
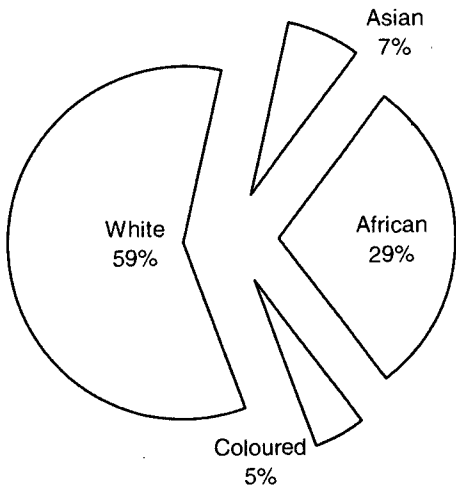

| | Asian | | African | | Coloured | | White | | OVERALL | | |
|---------------|------------|------------|-------------|-------------|------------|------------|-------------|-------------|-------------|-------------|--------------|
| | Women | Men | Women | Men | Women | Men | Women | Men | Women | Men | TOTAL |
| Western Cape | 24 | 7 | 47 | 55 | 138 | 193 | 470 | 849 | 679 | 1104 | 1783 |
| Northern Cape | | | 2 | 24 | 7 | 16 | 40 | 84 | 49 | 124 | 173 |
| Free State | | 5 | 18 | 83 | 3 | | 175 | 255 | 196 | 343 | 539 |
| Eastern Cape | 12 | 7 | 394 | 1001 | 72 | 85 | 223 | 276 | 701 | 1369 | 2070 |
| KwaZulu-Natal | 344 | 252 | 80 | 268 | 13 | 24 | 220 | 308 | 657 | 852 | 1509 |
| Mpumalanga | | 5 | 10 | 114 | | | 101 | 166 | 111 | 285 | 396 |
| Northern Prov | | 9 | 43 | 439 | | | 35 | 78 | 78 | 526 | 604 |
| Gauteng | 125 | 94 | 251 | 842 | 46 | 28 | 1655 | 2651 | 2077 | 3615 | 5692 |
| North West | | 16 | 78 | 221 | | 6 | 165 | 228 | 243 | 471 | 714 |
| TOTAL | 505 | 395 | 923 | 3047 | 279 | 352 | 3084 | 4895 | 4791 | 8689 | 13480 |
| | 900 | | 3970 | | 631 | | 7979 | | | | |



This category consists of legal qualifications that entitle one to practise as an advocate or attorney. The Honours level includes LLB.

QUALIFICATION TRENDS BY LEVEL

| | 1991 | 1992 | 1993 | 1994 | 1995 | 1996 | 1997 | 1998 | TOTAL |
|-----------------|-------------|-------------|-------------|-------------|-------------|-------------|-------------|-------------|--------------|
| Bachelors (3yr) | 2 | 3 | | 1 | 1 | 1 | 1 | 1 | 10 |
| Bachelors (4yr) | 501 | 649 | 786 | 932 | 1095 | 1142 | 1130 | 1144 | 7379 |
| PG Diploma | | | | | | | | | 0 |
| Honours | 1135 | 1203 | 1485 | 1213 | 1608 | 1647 | 1781 | 1798 | 11870 |
| Masters | 58 | 91 | 122 | 113 | 203 | 224 | 251 | 274 | 1336 |
| Doctorate | 14 | 7 | 12 | 18 | 16 | 20 | 15 | 15 | 117 |
| TOTAL | 1710 | 1953 | 2405 | 2277 | 2923 | 3034 | 3178 | 3232 | 20712 |

QUALIFICATION TRENDS BY POPULATION GROUP AND GENDER

| | | 1991 | 1992 | 1993 | 1994 | 1995 | 1996 | 1997 | 1998 | TOTAL |
|--------------|---|-------------|-------------|-------------|-------------|-------------|-------------|-------------|-------------|--------------|
| Asian | F | 74 | 101 | 129 | 148 | 202 | 217 | 244 | 250 | 1365 |
| | M | 52 | 72 | 116 | 88 | 111 | 130 | 127 | 131 | 827 |
| African | F | 57 | 89 | 132 | 161 | 218 | 217 | 264 | 265 | 1403 |
| | M | 169 | 234 | 283 | 356 | 457 | 525 | 553 | 596 | 3173 |
| Coloured | F | 20 | 29 | 38 | 30 | 50 | 93 | 89 | 96 | 445 |
| | M | 48 | 76 | 56 | 67 | 75 | 110 | 129 | 143 | 704 |
| White | F | 517 | 565 | 708 | 565 | 764 | 766 | 817 | 808 | 5510 |
| | M | 773 | 787 | 943 | 862 | 1046 | 976 | 955 | 943 | 7285 |
| OVERALL | F | 668 | 784 | 1007 | 904 | 1234 | 1293 | 1414 | 1419 | 8723 |
| | M | 1042 | 1169 | 1398 | 1373 | 1689 | 1741 | 1764 | 1813 | 11989 |
| TOTAL | | 1710 | 1953 | 2405 | 2277 | 2923 | 3034 | 3178 | 3232 | 20712 |

QUALIFICATION TRENDS BY CURRENT PROVINCE OF RESIDENCE

| | 1991 | 1992 | 1993 | 1994 | 1995 | 1996 | 1997 | 1998 | TOTAL |
|---------------|-------------|-------------|-------------|-------------|-------------|-------------|-------------|-------------|--------------|
| Western Cape | 249 | 382 | 472 | 221 | 491 | 511 | 504 | 487 | 3317 |
| Northern Cape | 24 | 30 | 22 | 27 | 25 | 29 | 32 | 29 | 218 |
| Free State | 90 | 130 | 125 | 147 | 101 | 170 | 133 | 125 | 1021 |
| Eastern Cape | 124 | 111 | 160 | 169 | 218 | 279 | 223 | 274 | 1558 |
| KwaZulu-Natal | 220 | 250 | 434 | 375 | 378 | 449 | 461 | 440 | 3007 |
| Mpumalanga | 47 | 50 | 67 | 77 | 98 | 94 | 107 | 108 | 648 |
| Northern Prov | 55 | 46 | 78 | 92 | 84 | 91 | 96 | 99 | 641 |
| Gauteng | 805 | 839 | 914 | 1047 | 1321 | 1247 | 1425 | 1475 | 9073 |
| North West | 69 | 74 | 89 | 80 | 176 | 117 | 162 | 160 | 927 |
| Outside SA | 27 | 41 | 44 | 42 | 31 | 47 | 35 | 35 | 302 |
| TOTAL | 1710 | 1953 | 2405 | 2277 | 2923 | 3034 | 3178 | 3232 | 20712 |

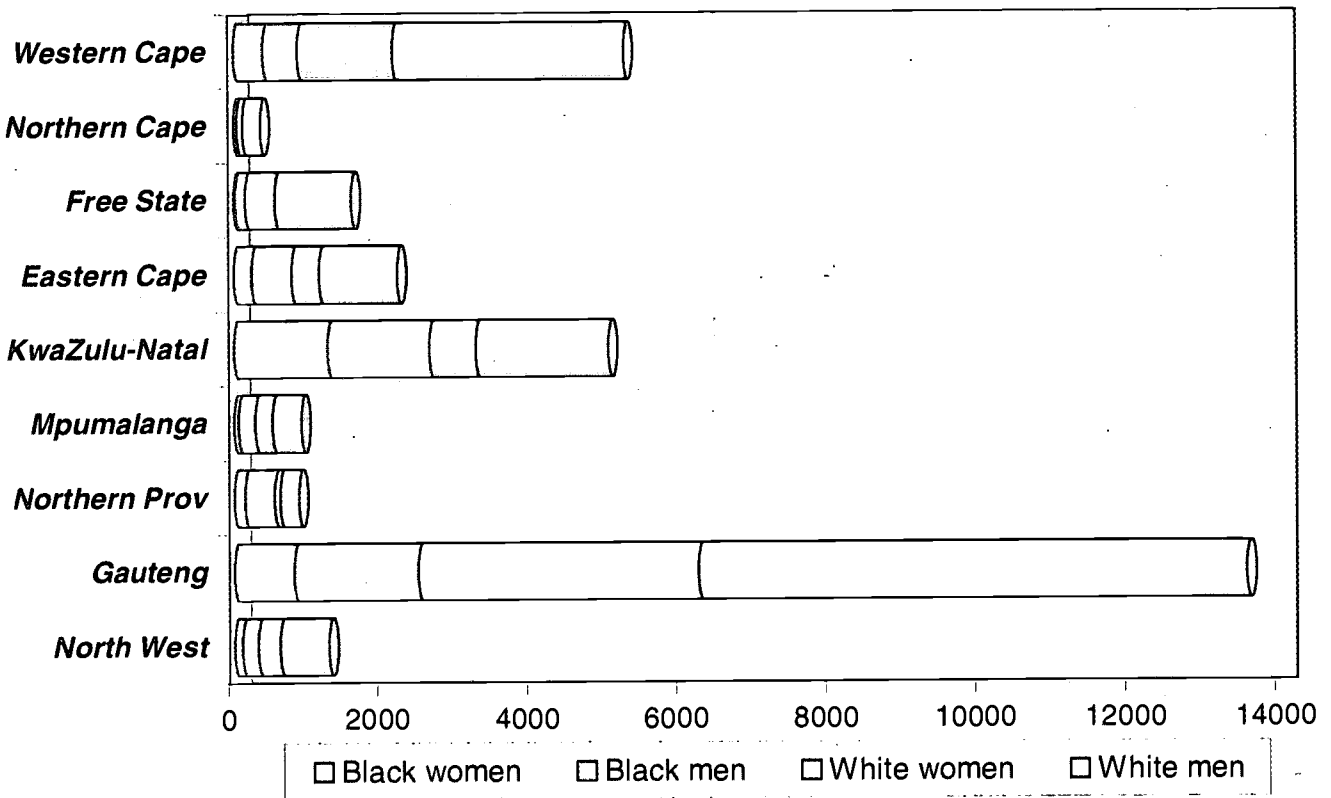
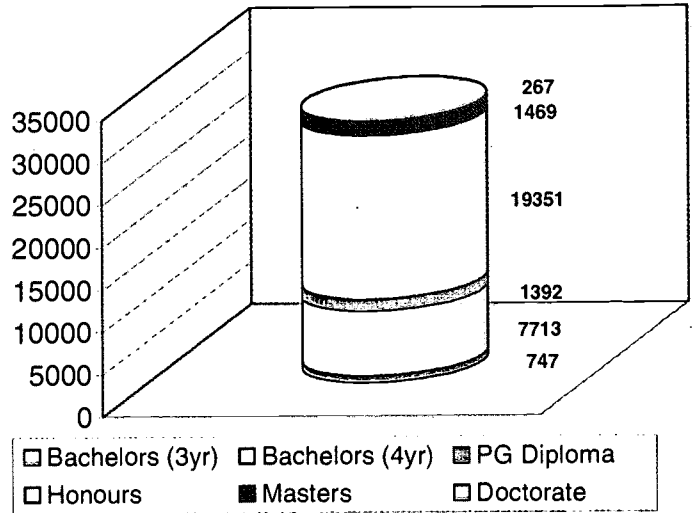
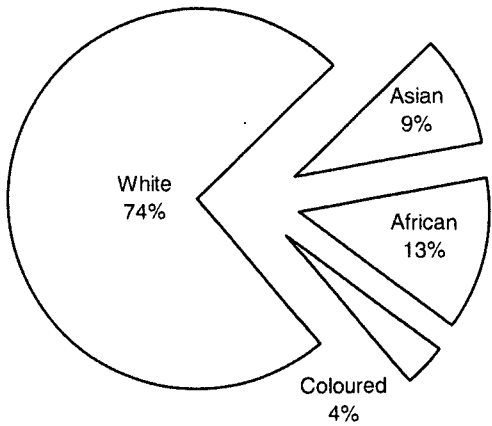

| | Asian | | African | | Coloured | | White | | OVERALL | | TOTAL |
|---------------|-------------|-------------|-------------|-------------|-------------|------------|--------------|--------------|--------------|--------------|--------------|
| | Women | Men | Women | Men | Women | Men | Women | Men | Women | Men | |
| Western Cape | 88 | 53 | 50 | 74 | 264 | 329 | 1276 | 3092 | 1678 | 3548 | 5226 |
| Northern Cape | | | 9 | 5 | 13 | 17 | 78 | 242 | 100 | 264 | 364 |
| Free State | | 2 | 19 | 130 | | 6 | 395 | 1030 | 414 | 1168 | 1582 |
| Eastern Cape | 25 | 40 | 165 | 361 | 53 | 128 | 371 | 1047 | 614 | 1576 | 2190 |
| KwaZulu-Natal | 1126 | 895 | 96 | 372 | 34 | 92 | 625 | 1770 | 1881 | 3129 | 5010 |
| Mpumalanga | | 4 | 59 | 224 | | 2 | 228 | 382 | 287 | 612 | 899 |
| Northern Prov | 5 | 8 | 137 | 386 | 3 | | 72 | 250 | 217 | 644 | 861 |
| Gauteng | 311 | 292 | 435 | 1281 | 50 | 94 | 3743 | 7333 | 4539 | 9000 | 13539 |
| North West | 5 | 15 | 99 | 201 | 3 | | 282 | 662 | 389 | 878 | 1267 |
| TOTAL | 1560 | 1309 | 1069 | 3034 | 420 | 668 | 7070 | 15808 | 10119 | 20819 | 30938 |
| | 2869 | | 4103 | | 1088 | | 22878 | | | | |

.....
 This category excludes qualifications in Religious Studies.

QUALIFICATION TRENDS BY LEVEL

| | 1991 | 1992 | 1993 | 1994 | 1995 | 1996 | 1997 | 1998 | TOTAL |
|-----------------|------------|------------|------------|------------|-------------|-------------|-------------|-------------|-------------|
| Bachelors (3yr) | 245 | 244 | 233 | 324 | 762 | 678 | 675 | 706 | 3867 |
| Bachelors (4yr) | | 1 | 1 | | 2 | | | 1 | 5 |
| PG Diploma | | | 1 | | | 1 | 2 | 2 | 6 |
| Honours | 181 | 152 | 196 | 102 | 96 | 122 | 138 | 128 | 1115 |
| Masters | 66 | 61 | 85 | 93 | 107 | 154 | 147 | 154 | 867 |
| Doctorate | 33 | 32 | 47 | 34 | 54 | 87 | 82 | 77 | 446 |
| TOTAL | 525 | 490 | 563 | 553 | 1021 | 1042 | 1044 | 1068 | 6306 |

QUALIFICATION TRENDS BY POPULATION GROUP AND GENDER

| | | 1991 | 1992 | 1993 | 1994 | 1995 | 1996 | 1997 | 1998 | TOTAL |
|--------------|---|------------|------------|------------|------------|-------------|-------------|-------------|-------------|-------------|
| Asian | F | 6 | | | 3 | 1 | 1 | 2 | 2 | 15 |
| | M | 10 | 10 | 11 | 10 | 23 | 17 | 23 | 27 | 131 |
| African | F | | 2 | 3 | 9 | 17 | 19 | 14 | 18 | 82 |
| | M | 69 | 60 | 71 | 63 | 122 | 120 | 150 | 167 | 822 |
| Coloured | F | 4 | 4 | 4 | 5 | 13 | 13 | 16 | 15 | 74 |
| | M | 22 | 37 | 25 | 37 | 42 | 42 | 46 | 47 | 298 |
| White | F | 82 | 83 | 75 | 93 | 182 | 122 | 166 | 161 | 964 |
| | M | 332 | 294 | 374 | 333 | 621 | 708 | 627 | 631 | 3920 |
| OVERALL | F | 92 | 89 | 82 | 110 | 213 | 155 | 198 | 196 | 1135 |
| | M | 433 | 401 | 481 | 443 | 808 | 887 | 846 | 872 | 5171 |
| TOTAL | | 525 | 490 | 563 | 553 | 1021 | 1042 | 1044 | 1068 | 6306 |

QUALIFICATION TRENDS BY CURRENT PROVINCE OF RESIDENCE

| | 1991 | 1992 | 1993 | 1994 | 1995 | 1996 | 1997 | 1998 | TOTAL |
|---------------|------------|------------|------------|------------|-------------|-------------|-------------|-------------|-------------|
| Western Cape | 121 | 88 | 135 | 132 | 144 | 148 | 162 | 165 | 1095 |
| Northern Cape | 7 | 20 | 12 | 28 | 21 | 16 | 22 | 18 | 144 |
| Free State | 43 | 31 | 37 | 36 | 25 | 83 | 56 | 39 | 350 |
| Eastern Cape | 53 | 38 | 45 | 34 | 52 | 78 | 73 | 78 | 451 |
| KwaZulu-Natal | 63 | 65 | 61 | 36 | 68 | 85 | 69 | 77 | 524 |
| Mpumalanga | 16 | 23 | 17 | 36 | 52 | 72 | 53 | 57 | 326 |
| Northern Prov | 26 | 20 | 20 | 12 | 19 | 9 | 16 | 14 | 136 |
| Gauteng | 143 | 163 | 189 | 199 | 485 | 448 | 462 | 487 | 2576 |
| North West | 29 | 22 | 27 | 22 | 113 | 54 | 82 | 87 | 436 |
| Outside SA | 24 | 20 | 20 | 18 | 42 | 49 | 49 | 46 | 268 |
| TOTAL | 525 | 490 | 563 | 553 | 1021 | 1042 | 1044 | 1068 | 6306 |

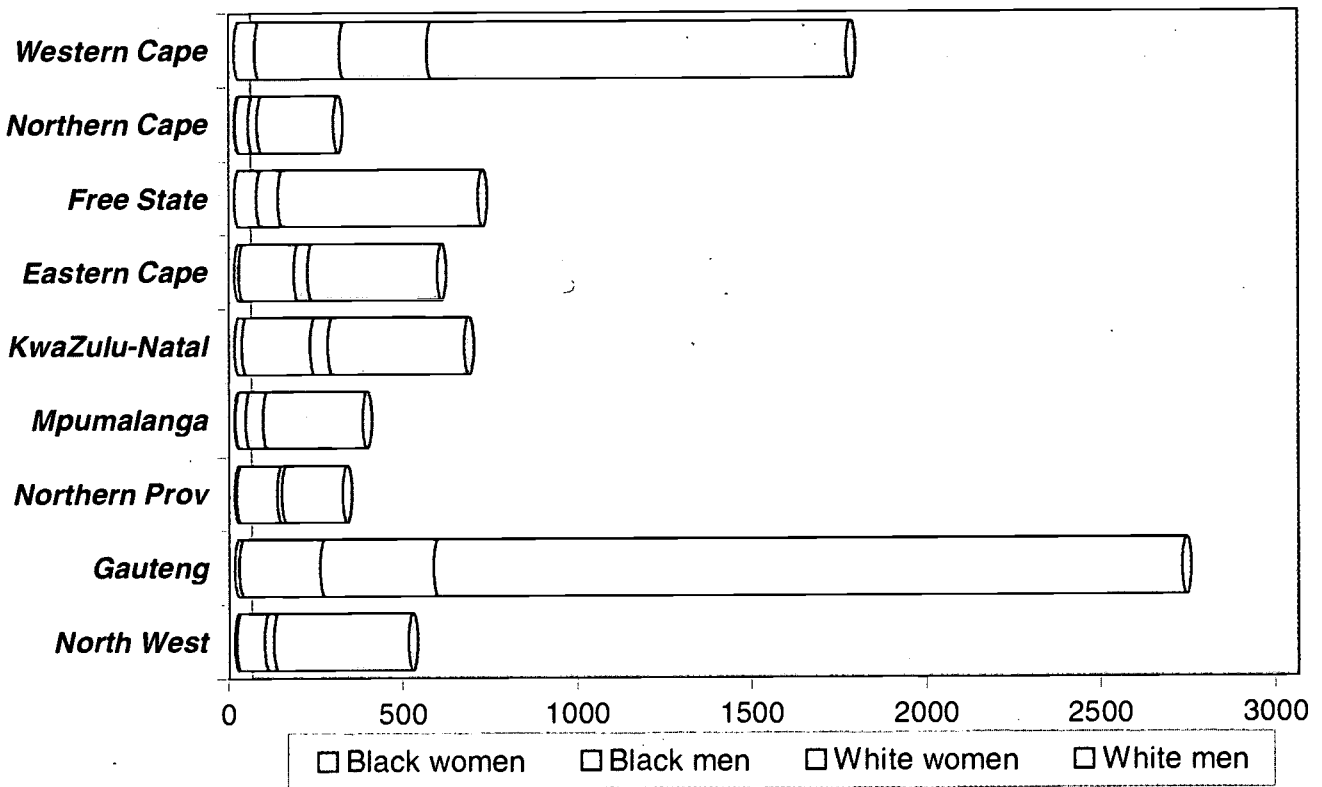
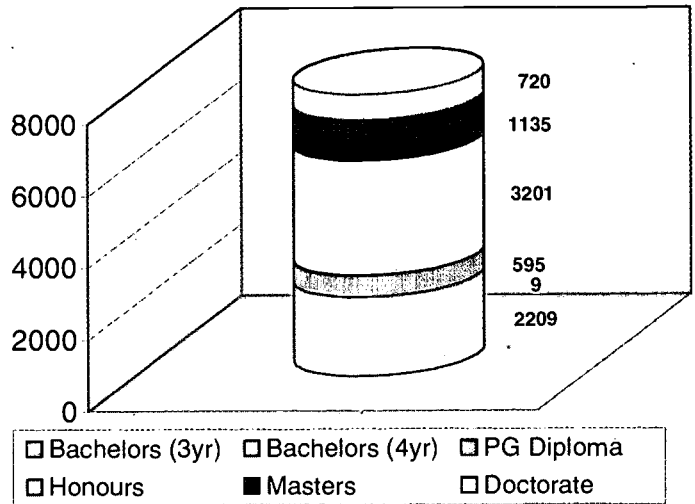
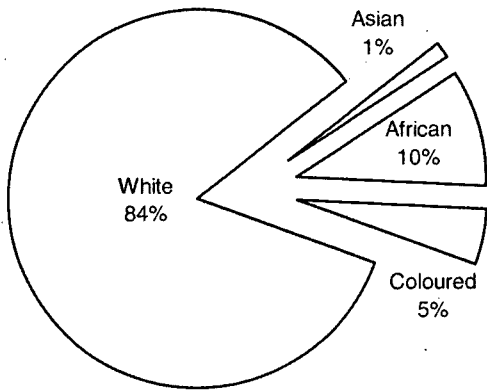

| | Asian | | African | | Coloured | | White | | OVERALL | | |
|---------------|------------|-----------|------------|------------|------------|------------|-------------|-------------|------------|-------------|-------------|
| | Women | Men | Women | Men | Women | Men | Women | Men | Women | Men | TOTAL |
| Western Cape | 2 | 18 | 5 | 30 | 52 | 195 | 251 | 1201 | 310 | 1444 | 1754 |
| Northern Cape | | | 3 | 2 | | 35 | 25 | 220 | 28 | 257 | 285 |
| Free State | | | | 58 | | 5 | 61 | 575 | 61 | 638 | 699 |
| Eastern Cape | | 8 | 5 | 119 | 7 | 30 | 40 | 372 | 52 | 529 | 581 |
| KwaZulu-Natal | 10 | 65 | 11 | 124 | | 7 | 51 | 391 | 72 | 587 | 659 |
| Mpumalanga | | | 3 | 26 | | 2 | 49 | 286 | 52 | 314 | 366 |
| Northern Prov | | | 5 | 115 | | | 13 | 177 | 18 | 292 | 310 |
| Gauteng | | 8 | 13 | 191 | | 33 | 325 | 2144 | 338 | 2376 | 2714 |
| North West | 2 | | 3 | 75 | | 5 | 25 | 388 | 30 | 468 | 498 |
| TOTAL | 14 | 99 | 48 | 740 | 59 | 312 | 840 | 5754 | 961 | 6905 | 7866 |
| | 113 | | 788 | | 371 | | 6594 | | | | |

This category consists of Commerce and Accountancy qualifications that do not entitle one to practise as a chartered accountant.

QUALIFICATION TRENDS BY LEVEL

| | 1991 | 1992 | 1993 | 1994 | 1995 | 1996 | 1997 | 1998 | TOTAL |
|-----------------|--------------|--------------|--------------|--------------|--------------|--------------|--------------|--------------|--------------|
| Bachelors (3yr) | 9551 | 10463 | 10804 | 9422 | 9176 | 8955 | 9262 | 9520 | 76653 |
| Bachelors (4yr) | 35 | 83 | 85 | 315 | 48 | 49 | 55 | 61 | 731 |
| PG Diploma | 281 | 310 | 344 | 324 | 290 | 272 | 259 | 235 | 2315 |
| Honours | 781 | 937 | 1046 | 991 | 1032 | 899 | 1079 | 1122 | 7887 |
| Masters | 132 | 142 | 184 | 167 | 209 | 156 | 168 | 179 | 1337 |
| Doctorate | 30 | 32 | 23 | 22 | 32 | 25 | 27 | 29 | 220 |
| TOTAL | 10810 | 11967 | 11986 | 11241 | 10787 | 10356 | 10850 | 11146 | 89143 |

QUALIFICATION TRENDS BY POPULATION GROUP AND GENDER

| | | 1991 | 1992 | 1993 | 1994 | 1995 | 1996 | 1997 | 1998 | TOTAL |
|--------------|---|--------------|--------------|--------------|--------------|--------------|--------------|--------------|--------------|--------------|
| Asian | F | 152 | 157 | 280 | 338 | 315 | 356 | 381 | 392 | 2371 |
| | M | 286 | 397 | 426 | 467 | 436 | 444 | 475 | 519 | 3450 |
| African | F | 261 | 291 | 411 | 502 | 676 | 860 | 896 | 1006 | 4903 |
| | M | 416 | 620 | 663 | 851 | 1009 | 1123 | 1258 | 1317 | 7257 |
| Coloured | F | 123 | 161 | 142 | 240 | 162 | 211 | 239 | 255 | 1533 |
| | M | 199 | 268 | 220 | 260 | 263 | 254 | 273 | 293 | 2030 |
| White | F | 3371 | 3966 | 3890 | 3317 | 3189 | 2898 | 2967 | 2981 | 26579 |
| | M | 6002 | 6107 | 5954 | 5266 | 4737 | 4210 | 4361 | 4383 | 41020 |
| OVERALL | F | 3907 | 4575 | 4723 | 4397 | 4342 | 4325 | 4483 | 4634 | 35386 |
| | M | 6903 | 7392 | 7263 | 6844 | 6445 | 6031 | 6367 | 6512 | 53757 |
| TOTAL | | 10810 | 11967 | 11986 | 11241 | 10787 | 10356 | 10850 | 11146 | 89143 |

QUALIFICATION TRENDS BY CURRENT PROVINCE OF RESIDENCE

| | 1991 | 1992 | 1993 | 1994 | 1995 | 1996 | 1997 | 1998 | TOTAL |
|---------------|--------------|--------------|--------------|--------------|--------------|--------------|--------------|--------------|--------------|
| Western Cape | 1468 | 1590 | 1434 | 1717 | 1734 | 1384 | 1433 | 1480 | 12240 |
| Northern Cape | 91 | 128 | 81 | 106 | 117 | 73 | 84 | 97 | 777 |
| Free State | 392 | 376 | 455 | 614 | 377 | 310 | 382 | 348 | 3254 |
| Eastern Cape | 843 | 752 | 749 | 1001 | 827 | 900 | 917 | 808 | 6797 |
| KwaZulu-Natal | 1026 | 1213 | 1621 | 1422 | 1355 | 1738 | 1621 | 1751 | 11747 |
| Mpumalanga | 368 | 376 | 437 | 414 | 384 | 250 | 266 | 275 | 2770 |
| Northern Prov | 207 | 331 | 276 | 232 | 211 | 177 | 236 | 246 | 1916 |
| Gauteng | 5657 | 6279 | 6067 | 4871 | 4694 | 4630 | 5000 | 5050 | 42248 |
| North West | 475 | 632 | 618 | 643 | 783 | 654 | 658 | 810 | 5273 |
| Outside SA | 283 | 290 | 248 | 221 | 305 | 240 | 253 | 281 | 2121 |
| TOTAL | 10810 | 11967 | 11986 | 11241 | 10787 | 10356 | 10850 | 11146 | 89143 |

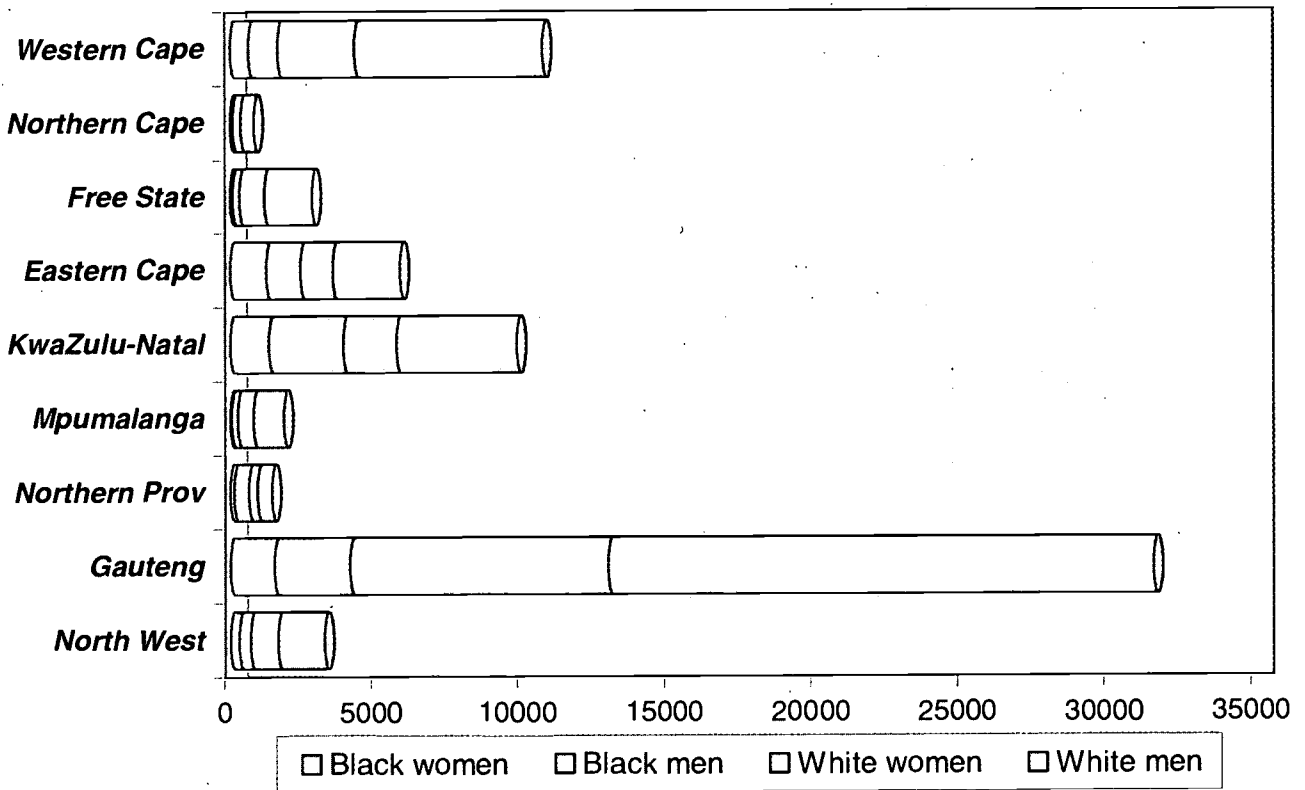
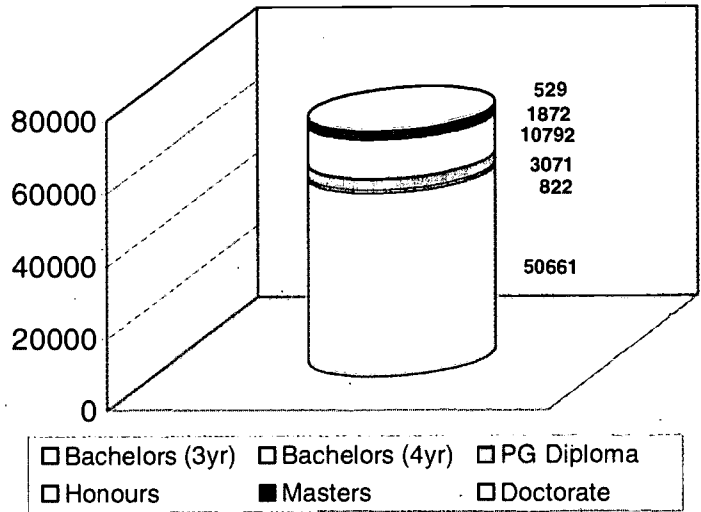
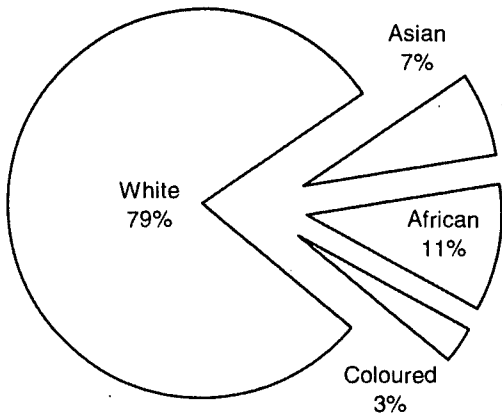

| | Asian | | African | | Coloured | | White | | OVERALL | | |
|---------------|-------------|-------------|-------------|-------------|-------------|-------------|--------------|--------------|--------------|--------------|--------------|
| | Women | Men | Women | Men | Women | Men | Women | Men | Women | Men | TOTAL |
| Western Cape | 73 | 143 | 65 | 70 | 485 | 785 | 2623 | 6410 | 3246 | 7408 | 10654 |
| Northern Cape | 2 | 4 | 11 | 16 | 8 | 42 | 269 | 452 | 290 | 514 | 804 |
| Free State | | 4 | 78 | 196 | 8 | 23 | 852 | 1638 | 938 | 1861 | 2799 |
| Eastern Cape | 89 | 113 | 1004 | 888 | 130 | 168 | 1115 | 2294 | 2338 | 3463 | 5801 |
| KwaZulu-Natal | 1098 | 2117 | 172 | 356 | 51 | 61 | 1814 | 4114 | 3135 | 6648 | 9783 |
| Mpumalanga | 9 | 28 | 39 | 157 | | 11 | 545 | 1032 | 593 | 1228 | 1821 |
| Northern Prov | 9 | 24 | 112 | 489 | | | 289 | 486 | 410 | 999 | 1409 |
| Gauteng | 370 | 539 | 1006 | 1860 | 125 | 170 | 8819 | 18573 | 10320 | 21142 | 31462 |
| North West | 5 | 54 | 276 | 332 | 10 | 8 | 933 | 1598 | 1224 | 1992 | 3216 |
| TOTAL | 1655 | 3026 | 2763 | 4364 | 817 | 1268 | 17259 | 36597 | 22494 | 45255 | 67749 |
| | 4681 | | 7127 | | 2085 | | 53856 | | | | |



MARKETING (COMMERCIAL)

This category consists of Marketing qualifications awarded as part of any Economic and Management Sciences degree.

QUALIFICATION TRENDS BY LEVEL

| | 1991 | 1992 | 1993 | 1994 | 1995 | 1996 | 1997 | 1998 | TOTAL |
|-----------------|------------|------------|------------|------------|------------|------------|------------|------------|-------------|
| Bachelors (3yr) | 308 | 278 | 317 | 358 | 251 | 223 | 248 | 254 | 2237 |
| Bachelors (4yr) | | 1 | | | | | | | 1 |
| PG Diploma | | | | | | | | | 0 |
| Honours | 62 | 54 | 67 | 62 | 49 | 46 | 46 | 50 | 436 |
| Masters | 5 | 1 | 5 | 3 | 1 | 10 | 12 | 13 | 50 |
| Doctorate | 1 | 1 | | | 1 | 1 | 1 | 1 | 6 |
| TOTAL | 371 | 335 | 389 | 423 | 302 | 285 | 307 | 318 | 2730 |

QUALIFICATION TRENDS BY POPULATION GROUP AND GENDER

| | | 1991 | 1992 | 1993 | 1994 | 1995 | 1996 | 1997 | 1998 | TOTAL |
|--------------|---|------------|------------|------------|------------|------------|------------|------------|------------|-------------|
| Asian | F | 4 | 9 | 14 | 14 | 12 | 14 | 13 | 13 | 93 |
| | M | 10 | 8 | 14 | 10 | 9 | 10 | 9 | 11 | 81 |
| African | F | 1 | 2 | 2 | 2 | 2 | 3 | 2 | 3 | 17 |
| | M | 2 | 3 | 2 | 7 | 7 | 4 | 7 | 7 | 39 |
| Coloured | F | | | 4 | 1 | | | 1 | 1 | 7 |
| | M | | 1 | 2 | 3 | 1 | 1 | 2 | 2 | 12 |
| White | F | 201 | 161 | 172 | 193 | 147 | 138 | 143 | 149 | 1304 |
| | M | 153 | 151 | 179 | 193 | 124 | 115 | 130 | 132 | 1177 |
| OVERALL | F | 206 | 172 | 192 | 210 | 161 | 155 | 159 | 166 | 1421 |
| | M | 165 | 163 | 197 | 213 | 141 | 130 | 148 | 152 | 1309 |
| TOTAL | | 371 | 335 | 389 | 423 | 302 | 285 | 307 | 318 | 2730 |

QUALIFICATION TRENDS BY CURRENT PROVINCE OF RESIDENCE

| | 1991 | 1992 | 1993 | 1994 | 1995 | 1996 | 1997 | 1998 | TOTAL |
|---------------|------------|------------|------------|------------|------------|------------|------------|------------|-------------|
| Western Cape | 12 | 6 | 4 | 17 | 11 | 4 | 8 | 8 | 70 |
| Northern Cape | 2 | | | 2 | 2 | | | | 6 |
| Free State | 4 | 4 | 2 | 10 | 9 | 2 | 4 | 2 | 37 |
| Eastern Cape | | 2 | | 4 | 4 | 2 | | 2 | 14 |
| KwaZulu-Natal | 112 | 65 | 129 | 68 | 64 | 87 | 76 | 81 | 682 |
| Mpumalanga | 12 | 4 | 9 | 13 | 9 | 11 | 8 | 8 | 74 |
| Northern Prov | 4 | 17 | 15 | 10 | 6 | 8 | 10 | 8 | 78 |
| Gauteng | 215 | 221 | 206 | 279 | 182 | 152 | 185 | 193 | 1633 |
| North West | 6 | 10 | 13 | 10 | 6 | 11 | 6 | 6 | 68 |
| Outside SA | 4 | 6 | 11 | 10 | 9 | 8 | 10 | 10 | 68 |
| TOTAL | 371 | 335 | 389 | 423 | 302 | 285 | 307 | 318 | 2730 |

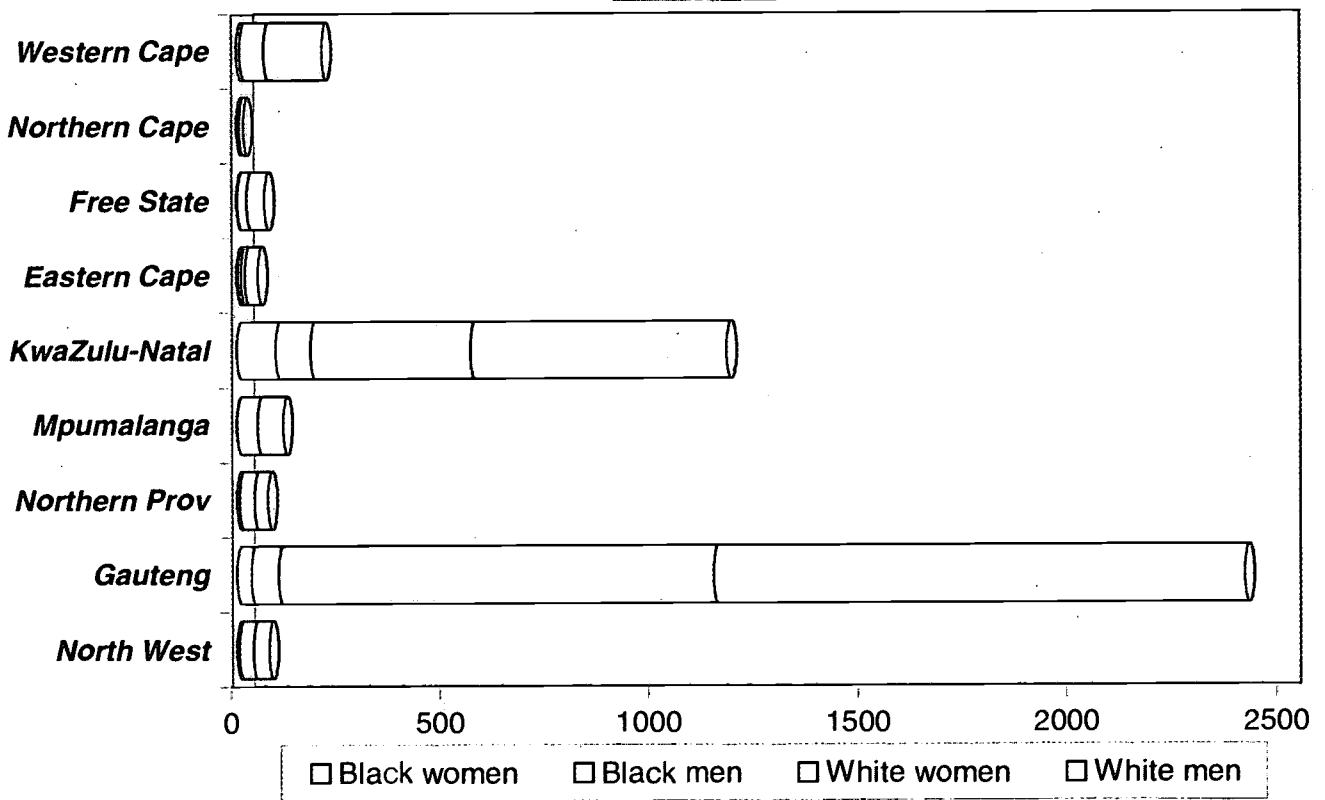
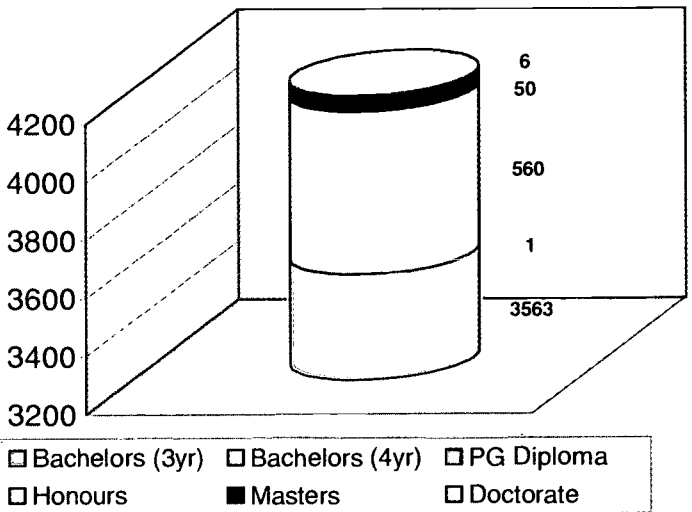
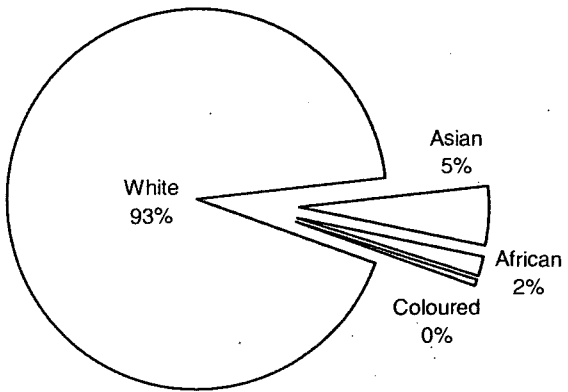

| | Asian | | African | | Coloured | | White | | OVERALL | | TOTAL |
|---------------|------------|------------|-----------|-----------|-----------|-----------|-------------|-------------|-------------|-------------|-------------|
| | Women | Men | Women | Men | Women | Men | Women | Men | Women | Men | |
| Western Cape | | 5 | | | | 2 | 58 | 139 | 58 | 146 | 204 |
| Northern Cape | | | | | | | 5 | 10 | 5 | 10 | 15 |
| Free State | | | 1 | | | | 22 | 44 | 23 | 44 | 67 |
| Eastern Cape | | | 3 | 2 | | 4 | 9 | 33 | 12 | 39 | 51 |
| KwaZulu-Natal | 90 | 76 | | 5 | 3 | 2 | 382 | 615 | 475 | 698 | 1173 |
| Mpumalanga | | | | | | | 49 | 61 | 49 | 61 | 110 |
| Northern Prov | | | | 5 | | | 36 | 33 | 36 | 38 | 74 |
| Gauteng | 13 | 24 | 18 | 37 | 3 | 4 | 1041 | 1270 | 1075 | 1335 | 2410 |
| North West | 2 | | 1 | 1 | | | 34 | 38 | 37 | 39 | 76 |
| TOTAL | 105 | 105 | 23 | 50 | 6 | 12 | 1636 | 2243 | 1770 | 2410 | 4180 |
| | 210 | | 73 | | 18 | | 3879 | | | | |

ADMINISTRATION AND PUBLIC ADMINISTRATION

QUALIFICATION TRENDS BY LEVEL

| | 1991 | 1992 | 1993 | 1994 | 1995 | 1996 | 1997 | 1998 | TOTAL |
|-----------------|------------|-------------|-------------|-------------|-------------|-------------|-------------|-------------|-------------|
| Bachelors (3yr) | 568 | 951 | 876 | 979 | 1030 | 1114 | 1173 | 1252 | 7988 |
| Bachelors (4yr) | 4 | | | 4 | 10 | 1 | 2 | 11 | 32 |
| PG Diploma | 1 | 1 | | | 18 | 18 | 22 | 18 | 78 |
| Honours | 103 | 139 | 178 | 147 | 192 | 209 | 244 | 241 | 1453 |
| Masters | 22 | 21 | 35 | 19 | 54 | 55 | 69 | 68 | 343 |
| Doctorate | 1 | 5 | 5 | 2 | 2 | 2 | 3 | 3 | 23 |
| TOTAL | 694 | 1117 | 1094 | 1151 | 1356 | 1399 | 1513 | 1593 | 9917 |

QUALIFICATION TRENDS BY POPULATION GROUP AND GENDER

| | | 1991 | 1992 | 1993 | 1994 | 1995 | 1996 | 1997 | 1998 | TOTAL |
|--------------|---|------------|-------------|-------------|-------------|-------------|-------------|-------------|-------------|-------------|
| Asian | F | 41 | 37 | 26 | 44 | 50 | 51 | 63 | 55 | 367 |
| | M | 31 | 27 | 42 | 27 | 33 | 30 | 35 | 33 | 258 |
| African | F | 88 | 255 | 284 | 358 | 416 | 458 | 500 | 533 | 2892 |
| | M | 208 | 396 | 410 | 456 | 597 | 606 | 659 | 710 | 4042 |
| Coloured | F | 23 | 44 | 27 | 33 | 21 | 29 | 27 | 32 | 236 |
| | M | 22 | 38 | 37 | 39 | 47 | 41 | 49 | 52 | 325 |
| White | F | 103 | 135 | 94 | 73 | 68 | 81 | 73 | 72 | 699 |
| | M | 178 | 185 | 174 | 121 | 124 | 103 | 107 | 106 | 1098 |
| OVERALL | F | 255 | 471 | 431 | 508 | 555 | 619 | 663 | 692 | 4194 |
| | M | 439 | 646 | 663 | 643 | 801 | 780 | 850 | 901 | 5723 |
| TOTAL | | 694 | 1117 | 1094 | 1151 | 1356 | 1399 | 1513 | 1593 | 9917 |

QUALIFICATION TRENDS BY CURRENT PROVINCE OF RESIDENCE

| | 1991 | 1992 | 1993 | 1994 | 1995 | 1996 | 1997 | 1998 | TOTAL |
|---------------|------------|-------------|-------------|-------------|-------------|-------------|-------------|-------------|-------------|
| Western Cape | 70 | 139 | 125 | 186 | 211 | 150 | 184 | 191 | 1256 |
| Northern Cape | | 10 | 22 | 27 | 7 | 11 | 9 | 12 | 98 |
| Free State | 51 | 66 | 46 | 44 | 30 | 9 | 37 | 19 | 302 |
| Eastern Cape | 46 | 94 | 88 | 126 | 131 | 163 | 147 | 177 | 972 |
| KwaZulu-Natal | 96 | 211 | 204 | 208 | 248 | 244 | 295 | 290 | 1796 |
| Mpumalanga | 24 | 43 | 79 | 73 | 73 | 89 | 104 | 104 | 589 |
| Northern Prov | 71 | 166 | 96 | 75 | 122 | 147 | 159 | 132 | 968 |
| Gauteng | 248 | 317 | 355 | 350 | 351 | 410 | 373 | 413 | 2817 |
| North West | 60 | 53 | 64 | 44 | 157 | 150 | 177 | 215 | 920 |
| Outside SA | 28 | 18 | 15 | 18 | 26 | 26 | 28 | 40 | 199 |
| TOTAL | 694 | 1117 | 1094 | 1151 | 1356 | 1399 | 1513 | 1593 | 9917 |

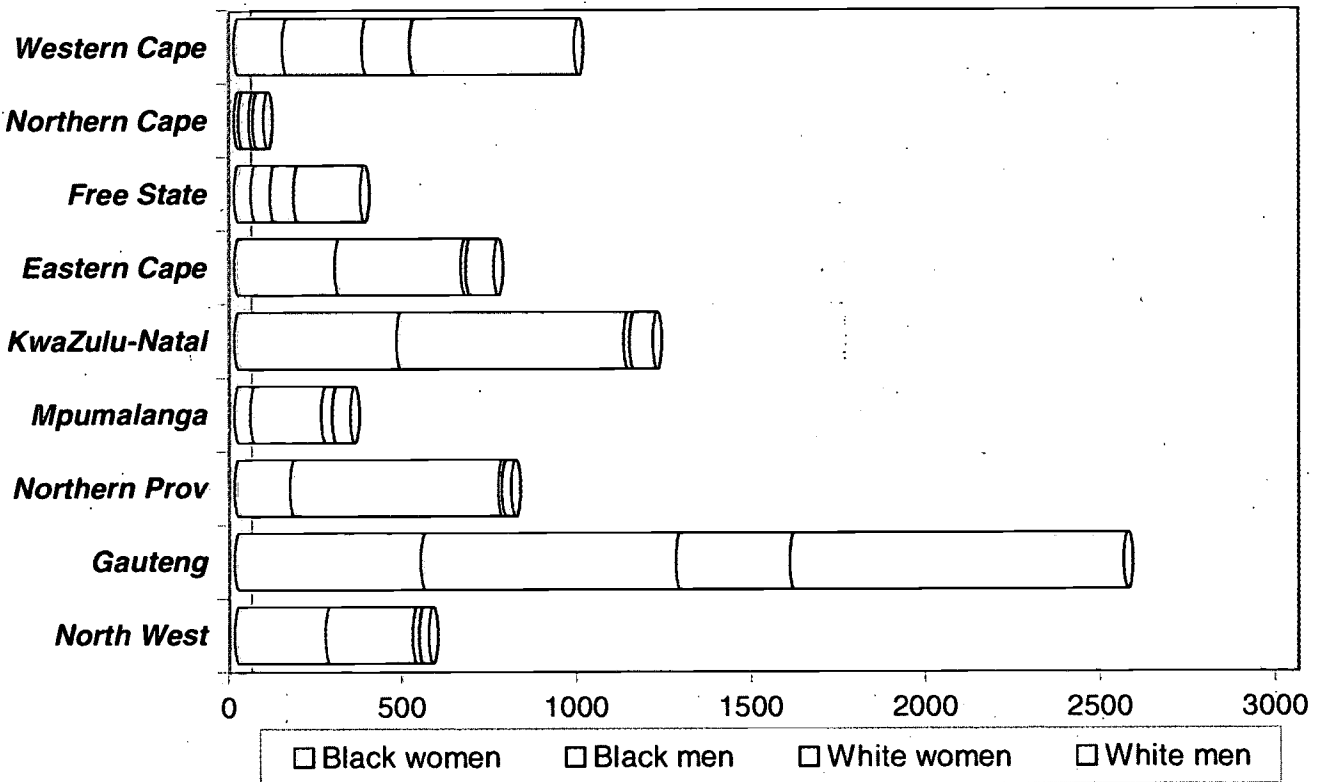
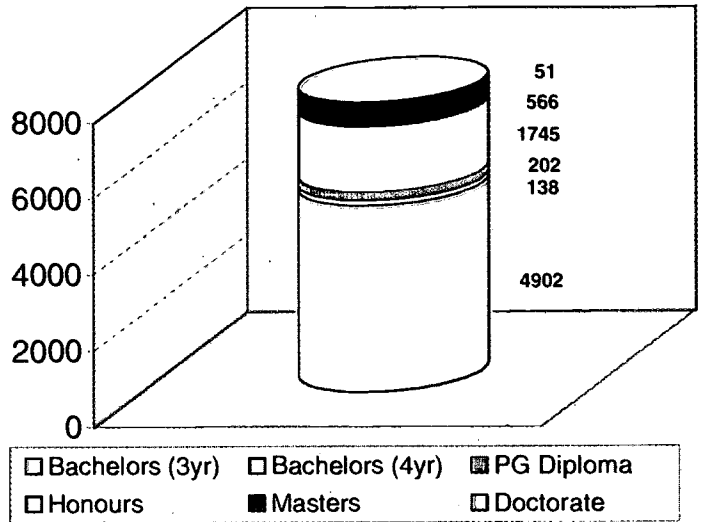
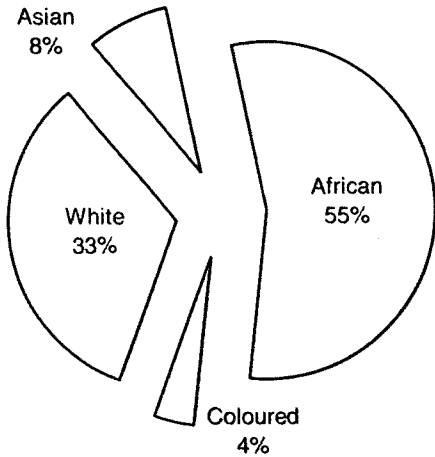

| | Asian | | African | | Coloured | | White | | OVERALL | | TOTAL |
|---------------|------------|------------|-------------|-------------|------------|------------|-------------|-------------|-------------|-------------|-------------|
| | Women | Men | Women | Men | Women | Men | Women | Men | Women | Men | |
| Western Cape | 2 | 10 | 54 | 69 | 84 | 150 | 137 | 471 | 277 | 700 | 977 |
| Northern Cape | | | 10 | 24 | 2 | 6 | 10 | 33 | 22 | 63 | 85 |
| Free State | 4 | 2 | 44 | 52 | | 1 | 68 | 192 | 116 | 247 | 363 |
| Eastern Cape | 2 | 5 | 285 | 354 | 2 | 3 | 13 | 82 | 302 | 444 | 746 |
| KwaZulu-Natal | 236 | 261 | 221 | 378 | 10 | 11 | 16 | 67 | 483 | 717 | 1200 |
| Mpumalanga | 12 | 2 | 33 | 203 | | | 31 | 52 | 76 | 257 | 333 |
| Northern Prov | 8 | | 152 | 598 | | | 10 | 28 | 170 | 626 | 796 |
| Gauteng | 16 | 25 | 508 | 686 | 12 | 18 | 328 | 956 | 864 | 1685 | 2549 |
| North West | | 2 | 262 | 248 | | | 18 | 28 | 280 | 278 | 558 |
| TOTAL | 280 | 307 | 1569 | 2612 | 110 | 189 | 631 | 1909 | 2590 | 5017 | 7607 |
| | 587 | | 4181 | | 299 | | 2540 | | | | 7607 |

QUALIFICATION TRENDS BY LEVEL

| | 1991 | 1992 | 1993 | 1994 | 1995 | 1996 | 1997 | 1998 | TOTAL |
|-----------------|------------|------------|------------|------------|------------|------------|------------|------------|-------------|
| Bachelors (3yr) | 306 | 294 | 308 | 408 | 373 | 206 | 279 | 269 | 2438 |
| Bachelors (4yr) | 3 | 2 | | 1 | 2 | | | | 8 |
| PG Diploma | 30 | 44 | 57 | 63 | 113 | 107 | 125 | 110 | 649 |
| Honours | 46 | 32 | 42 | 29 | 58 | 32 | 41 | 44 | 324 |
| Masters | 7 | 9 | 7 | 9 | 18 | 2 | 9 | 8 | 69 |
| Doctorate | | | 1 | | | | | | 1 |
| TOTAL | 392 | 381 | 410 | 505 | 569 | 347 | 454 | 431 | 3489 |

QUALIFICATION TRENDS BY POPULATION GROUP AND GENDER

| | | 1991 | 1992 | 1993 | 1994 | 1995 | 1996 | 1997 | 1998 | TOTAL |
|--------------|---|------------|------------|------------|------------|------------|------------|------------|------------|-------------|
| Asian | F | 1 | | 1 | 2 | 3 | 4 | 6 | 7 | 24 |
| | M | 2 | | 3 | 5 | 8 | 6 | 6 | 7 | 37 |
| African | F | 3 | 3 | 8 | 7 | 22 | 15 | 21 | 18 | 97 |
| | M | 10 | 19 | 14 | 14 | 29 | 22 | 35 | 26 | 169 |
| Coloured | F | 22 | 16 | 7 | 5 | 10 | 8 | 9 | 9 | 86 |
| | M | 27 | 29 | 13 | 14 | 23 | 11 | 18 | 17 | 152 |
| White | F | 122 | 135 | 144 | 168 | 171 | 115 | 135 | 124 | 1114 |
| | M | 205 | 179 | 220 | 290 | 303 | 166 | 224 | 223 | 1810 |
| OVERALL | F | 148 | 154 | 160 | 182 | 206 | 142 | 171 | 158 | 1321 |
| | M | 244 | 227 | 250 | 323 | 363 | 205 | 283 | 273 | 2168 |
| TOTAL | | 392 | 381 | 410 | 505 | 569 | 347 | 454 | 431 | 3489 |

QUALIFICATION TRENDS BY CURRENT PROVINCE OF RESIDENCE

| | 1991 | 1992 | 1993 | 1994 | 1995 | 1996 | 1997 | 1998 | TOTAL |
|---------------|------------|------------|------------|------------|------------|------------|------------|------------|-------------|
| Western Cape | 192 | 179 | 210 | 234 | 294 | 147 | 210 | 216 | 1682 |
| Northern Cape | 16 | 11 | 15 | 38 | 30 | 8 | 16 | 20 | 154 |
| Free State | 38 | 31 | 29 | 33 | 21 | 38 | 51 | 30 | 271 |
| Eastern Cape | 2 | 23 | 19 | 16 | 19 | 13 | 21 | 15 | 128 |
| KwaZulu-Natal | | 21 | 23 | 8 | 24 | 18 | 16 | 16 | 126 |
| Mpumalanga | 8 | 9 | 6 | | 9 | 3 | 9 | 5 | 49 |
| Northern Prov | | | 3 | 5 | 16 | 8 | 19 | 13 | 64 |
| Gauteng | 104 | 95 | 84 | 153 | 110 | 96 | 93 | 98 | 833 |
| North West | 13 | | 6 | 2 | 16 | 8 | 5 | 3 | 53 |
| Outside SA | 19 | 12 | 15 | 16 | 30 | 8 | 14 | 15 | 129 |
| TOTAL | 392 | 381 | 410 | 505 | 569 | 347 | 454 | 431 | 3489 |

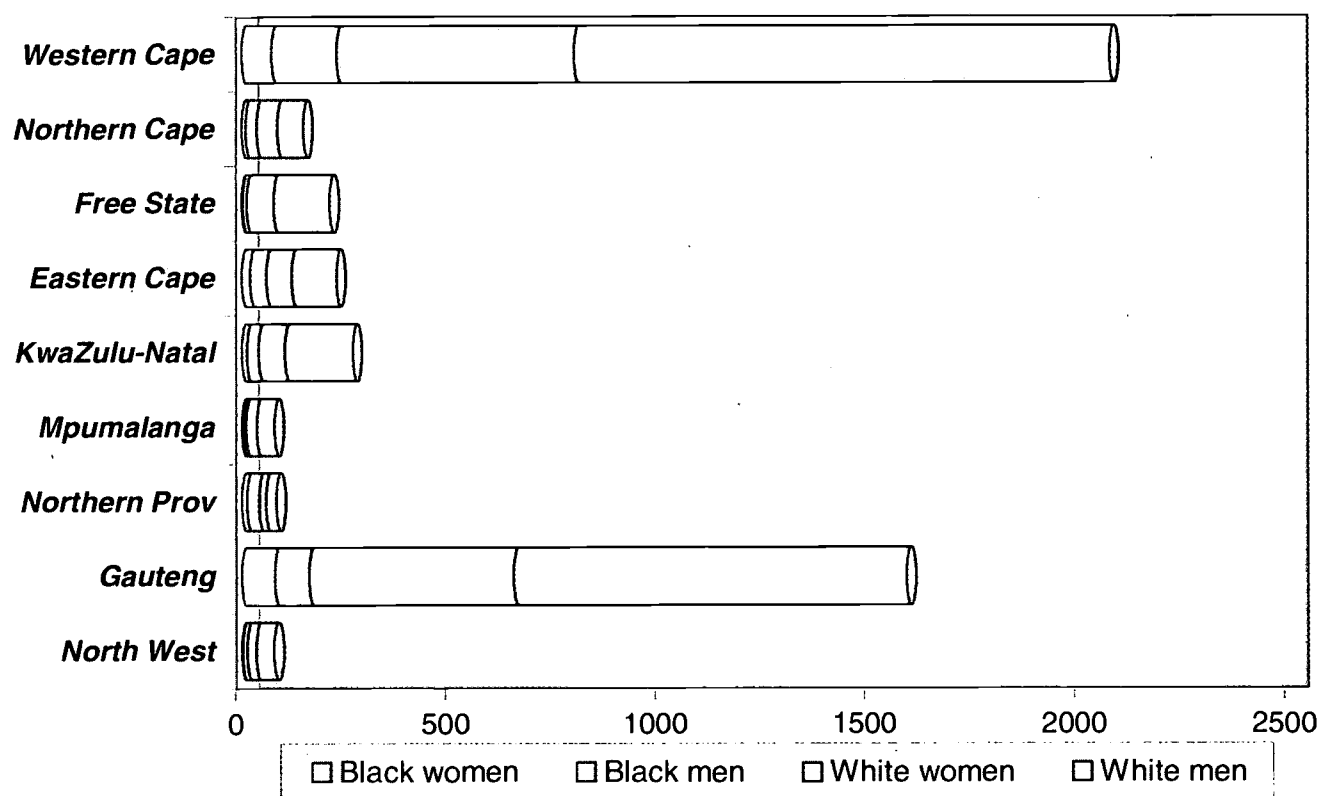
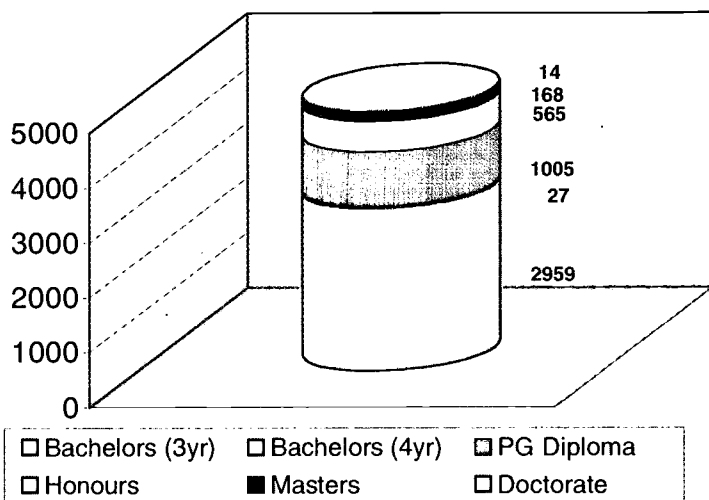
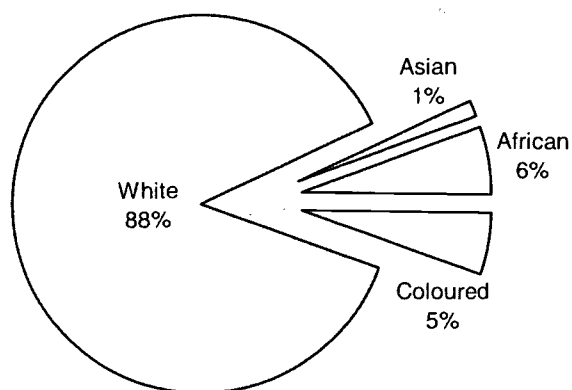

| | Asian | | African | | Coloured | | White | | OVERALL | | TOTAL |
|---------------|-----------|-----------|------------|------------|------------|------------|-------------|-------------|-------------|-------------|-------------|
| | Women | Men | Women | Men | Women | Men | Women | Men | Women | Men | |
| Western Cape | | | 4 | 41 | 68 | 113 | 567 | 1276 | 639 | 1430 | 2069 |
| Northern Cape | | | | 10 | 9 | 17 | 49 | 61 | 58 | 88 | 146 |
| Free State | | | 2 | 3 | | 6 | 65 | 133 | 67 | 142 | 209 |
| Eastern Cape | 2 | 3 | 16 | 22 | 2 | 14 | 60 | 106 | 80 | 145 | 225 |
| KwaZulu-Natal | 5 | 11 | 7 | 17 | | | 63 | 162 | 75 | 190 | 265 |
| Mpumalanga | | | 2 | 3 | 2 | 3 | 25 | 43 | 29 | 49 | 78 |
| Northern Prov | | | 13 | 28 | | | 16 | 25 | 29 | 53 | 82 |
| Gauteng | 22 | 23 | 49 | 50 | 8 | 7 | 489 | 937 | 568 | 1017 | 1585 |
| North West | | 3 | 2 | 7 | | 1 | 21 | 43 | 23 | 54 | 77 |
| TOTAL | 29 | 40 | 95 | 181 | 89 | 161 | 1355 | 2786 | 1568 | 3168 | 4736 |
| | 69 | | 276 | | 250 | | 4141 | | | | |

BUSINESS MANAGEMENT AND ADMINISTRATION

QUALIFICATION TRENDS BY LEVEL

| | 1991 | 1992 | 1993 | 1994 | 1995 | 1996 | 1997 | 1998 | TOTAL |
|-----------------|-------------|-------------|-------------|-------------|-------------|-------------|-------------|-------------|--------------|
| Bachelors (3yr) | 1594 | 1479 | 1941 | 2108 | 1778 | 1513 | 1587 | 1587 | 13582 |
| Bachelors (4yr) | 157 | 204 | 205 | 638 | 234 | 203 | 220 | 267 | 2128 |
| PG Diploma | 134 | 173 | 128 | 264 | 305 | 369 | 457 | 441 | 2271 |
| Honours | 144 | 123 | 105 | 82 | 162 | 125 | 140 | 145 | 1026 |
| Masters | 578 | 564 | 512 | 549 | 789 | 705 | 661 | 751 | 5109 |
| Doctorate | 7 | 6 | 7 | 6 | 1 | 4 | 7 | 5 | 43 |
| TOTAL | 2614 | 2549 | 2898 | 3647 | 3264 | 2919 | 3072 | 3196 | 24159 |

QUALIFICATION TRENDS BY POPULATION GROUP AND GENDER

| | | 1991 | 1992 | 1993 | 1994 | 1995 | 1996 | 1997 | 1998 | TOTAL |
|--------------|---|-------------|-------------|-------------|-------------|-------------|-------------|-------------|-------------|--------------|
| Asian | F | 50 | 67 | 63 | 117 | 84 | 102 | 103 | 114 | 700 |
| | M | 149 | 150 | 219 | 223 | 168 | 170 | 184 | 194 | 1457 |
| African | F | 25 | 45 | 28 | 78 | 114 | 120 | 168 | 158 | 736 |
| | M | 82 | 103 | 142 | 166 | 192 | 240 | 269 | 289 | 1483 |
| Coloured | F | 22 | 20 | 16 | 37 | 30 | 44 | 48 | 54 | 271 |
| | M | 31 | 38 | 45 | 81 | 41 | 49 | 53 | 55 | 393 |
| White | F | 580 | 635 | 670 | 990 | 866 | 697 | 732 | 769 | 5939 |
| | M | 1675 | 1491 | 1715 | 1955 | 1769 | 1497 | 1515 | 1563 | 13180 |
| OVERALL | F | 677 | 767 | 777 | 1222 | 1094 | 963 | 1051 | 1095 | 7646 |
| | M | 1937 | 1782 | 2121 | 2425 | 2170 | 1956 | 2021 | 2101 | 16513 |
| TOTAL | | 2614 | 2549 | 2898 | 3647 | 3264 | 2919 | 3072 | 3196 | 24159 |

QUALIFICATION TRENDS BY CURRENT PROVINCE OF RESIDENCE

| | 1991 | 1992 | 1993 | 1994 | 1995 | 1996 | 1997 | 1998 | TOTAL |
|---------------|-------------|-------------|-------------|-------------|-------------|-------------|-------------|-------------|--------------|
| Western Cape | 709 | 716 | 880 | 949 | 1229 | 713 | 882 | 924 | 7002 |
| Northern Cape | 35 | 42 | 52 | 25 | 43 | 15 | 32 | 36 | 280 |
| Free State | 119 | 136 | 178 | 172 | 184 | 120 | 134 | 140 | 1183 |
| Eastern Cape | 107 | 47 | 80 | 108 | 91 | 140 | 111 | 126 | 810 |
| KwaZulu-Natal | 313 | 354 | 343 | 523 | 310 | 431 | 377 | 367 | 3018 |
| Mpumalanga | 56 | 57 | 67 | 107 | 86 | 97 | 103 | 109 | 682 |
| Northern Prov | 30 | 44 | 47 | 63 | 62 | 59 | 82 | 81 | 468 |
| Gauteng | 1034 | 976 | 1001 | 1526 | 1040 | 1143 | 1119 | 1173 | 9012 |
| North West | 71 | 39 | 48 | 42 | 76 | 71 | 95 | 92 | 534 |
| Outside SA | 140 | 138 | 202 | 132 | 143 | 130 | 137 | 148 | 1170 |
| TOTAL | 2614 | 2549 | 2898 | 3647 | 3264 | 2919 | 3072 | 3196 | 24159 |

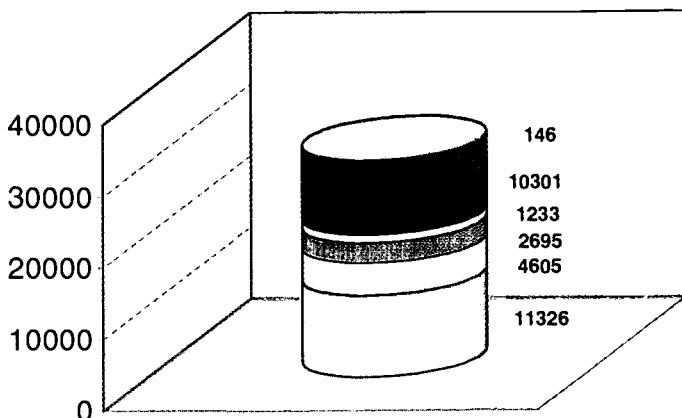
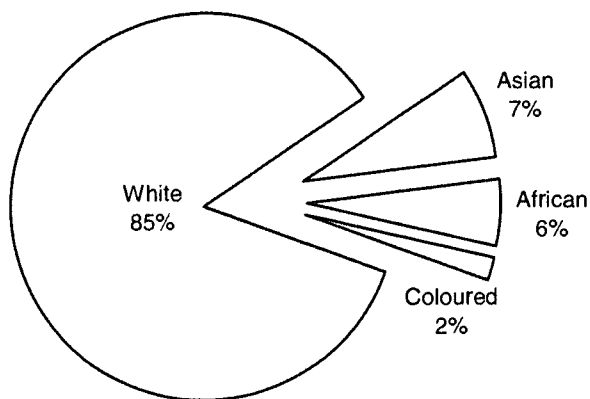

Bachelors (3yr) Bachelors (4yr) PG Diploma
 Honours Masters Doctorate

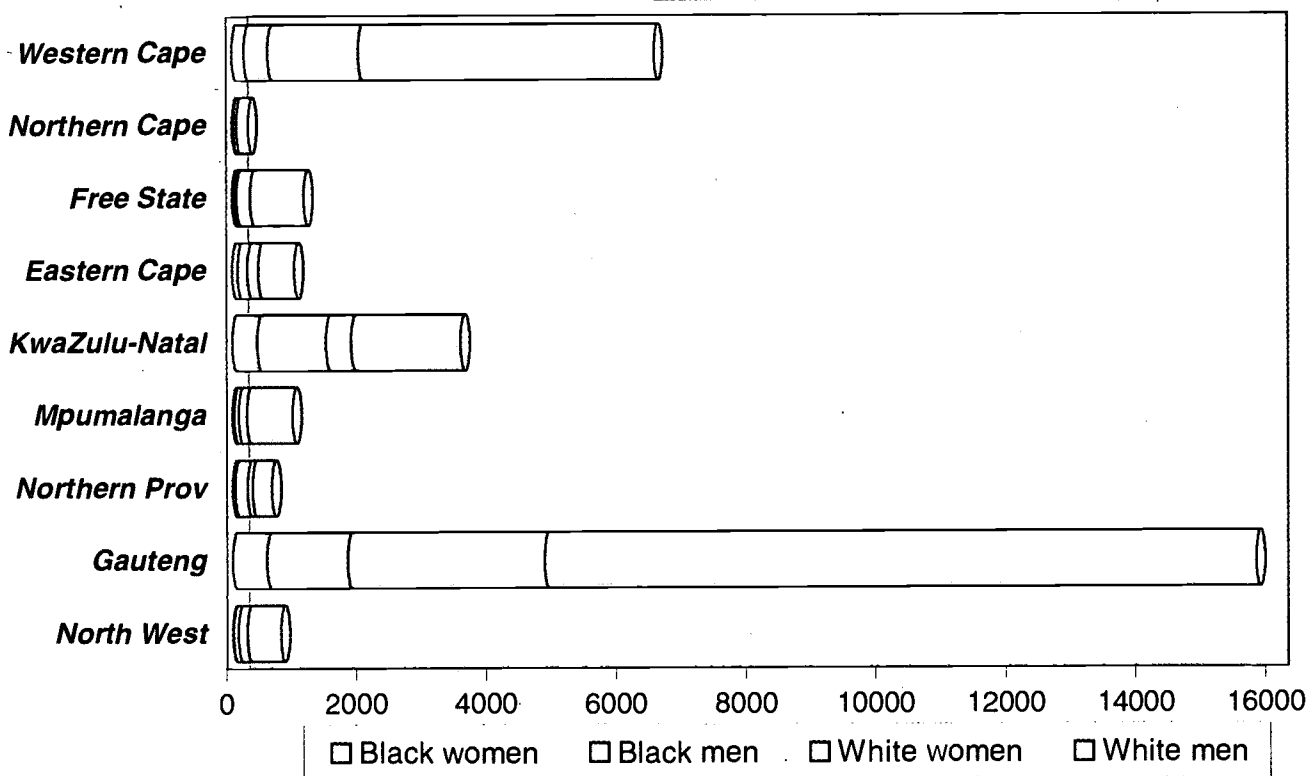

| | Asian | | African | | Coloured | | White | | OVERALL | | |
|---------------|-------------|-------------|-------------|-------------|------------|------------|--------------|--------------|-------------|--------------|--------------|
| | Women | Men | Women | Men | Women | Men | Women | Men | Women | Men | TOTAL |
| Western Cape | 23 | 66 | 34 | 38 | 131 | 264 | 1400 | 4547 | 1588 | 4915 | 6503 |
| Northern Cape | | 2 | 5 | 6 | | 5 | 46 | 185 | 51 | 198 | 249 |
| Free State | | 3 | 26 | 38 | | | 212 | 820 | 238 | 861 | 1099 |
| Eastern Cape | 2 | 24 | 72 | 102 | 8 | 28 | 163 | 549 | 245 | 703 | 948 |
| KwaZulu-Natal | 350 | 932 | 28 | 94 | 8 | 33 | 393 | 1675 | 779 | 2734 | 3513 |
| Mpumalanga | 9 | 24 | 18 | 44 | | | 129 | 694 | 156 | 762 | 918 |
| Northern Prov | | 7 | 39 | 185 | | | 74 | 291 | 113 | 483 | 596 |
| Gauteng | 157 | 573 | 322 | 608 | 49 | 67 | 3023 | 10954 | 3551 | 12202 | 15753 |
| North West | 2 | 22 | 8 | 52 | | 2 | 136 | 506 | 146 | 582 | 728 |
| TOTAL | 543 | 1653 | 552 | 1167 | 196 | 399 | 5576 | 20221 | 6867 | 23440 | 30307 |
| | 2196 | | 1719 | | 595 | | 25797 | | | | |

.....
 : Graduates in this category are qualified to practise as Chartered Accountants. :

QUALIFICATION TRENDS BY LEVEL

| | 1991 | 1992 | 1993 | 1994 | 1995 | 1996 | 1997 | 1998 | TOTAL |
|-----------------|-------------|-------------|-------------|-------------|-------------|-------------|-------------|-------------|--------------|
| Bachelors (3yr) | 177 | 188 | 22 | 33 | 42 | 21 | 20 | 30 | 478 |
| Bachelors (4yr) | 24 | 8 | 5 | 5 | | 2 | | 2 | 46 |
| PG Diploma | 115 | 81 | 69 | 52 | 70 | 106 | 121 | 120 | 734 |
| Honours | 825 | 893 | 1128 | 1324 | 1392 | 1221 | 1310 | 1293 | 9386 |
| Masters | 10 | 52 | 18 | 21 | 19 | 10 | 12 | 13 | 155 |
| Doctorate | 6 | 3 | 3 | 1 | | 2 | 2 | 2 | 19 |
| TOTAL | 1157 | 1170 | 1245 | 1436 | 1523 | 1362 | 1465 | 1460 | 10818 |

QUALIFICATION TRENDS BY POPULATION GROUP AND GENDER

| | | 1991 | 1992 | 1993 | 1994 | 1995 | 1996 | 1997 | 1998 | TOTAL |
|--------------|---|-------------|-------------|-------------|-------------|-------------|-------------|-------------|-------------|--------------|
| Asian | F | 11 | 8 | 19 | 12 | 40 | 46 | 47 | 49 | 232 |
| | M | 38 | 44 | 53 | 38 | 61 | 50 | 60 | 65 | 409 |
| African | F | 6 | 7 | 9 | 6 | 16 | 15 | 26 | 18 | 103 |
| | M | 27 | 17 | 36 | 20 | 23 | 29 | 34 | 29 | 215 |
| Coloured | F | 6 | 7 | 8 | 2 | 11 | 11 | 16 | 12 | 73 |
| | M | 18 | 11 | 27 | 13 | 14 | 13 | 10 | 11 | 117 |
| White | F | 262 | 273 | 346 | 418 | 432 | 387 | 417 | 420 | 2955 |
| | M | 789 | 803 | 747 | 927 | 926 | 811 | 855 | 856 | 6714 |
| OVERALL | F | 285 | 295 | 382 | 438 | 499 | 459 | 506 | 499 | 3363 |
| | M | 872 | 875 | 863 | 998 | 1024 | 903 | 959 | 961 | 7455 |
| TOTAL | | 1157 | 1170 | 1245 | 1436 | 1523 | 1362 | 1465 | 1460 | 10818 |

QUALIFICATION TRENDS BY CURRENT PROVINCE OF RESIDENCE

| | 1991 | 1992 | 1993 | 1994 | 1995 | 1996 | 1997 | 1998 | TOTAL |
|---------------|-------------|-------------|-------------|-------------|-------------|-------------|-------------|-------------|--------------|
| Western Cape | 154 | 188 | 266 | 129 | 224 | 214 | 243 | 210 | 1628 |
| Northern Cape | 6 | 11 | 11 | 15 | | 7 | 4 | | 54 |
| Free State | 32 | 41 | 62 | 48 | 59 | 54 | 50 | 53 | 399 |
| Eastern Cape | 58 | 54 | 51 | 28 | 92 | 74 | 82 | 97 | 536 |
| KwaZulu-Natal | 77 | 76 | 103 | 88 | 93 | 94 | 105 | 88 | 724 |
| Mpumalanga | 19 | 21 | 23 | 35 | 28 | 25 | 25 | 21 | 197 |
| Northern Prov | 13 | 11 | 13 | 24 | 35 | 23 | 27 | 29 | 175 |
| Gauteng | 756 | 716 | 654 | 1002 | 935 | 803 | 862 | 899 | 6627 |
| North West | 13 | 28 | 39 | 37 | 31 | 32 | 38 | 36 | 254 |
| Outside SA | 29 | 24 | 23 | 30 | 26 | 36 | 29 | 27 | 224 |
| TOTAL | 1157 | 1170 | 1245 | 1436 | 1523 | 1362 | 1465 | 1460 | 10818 |

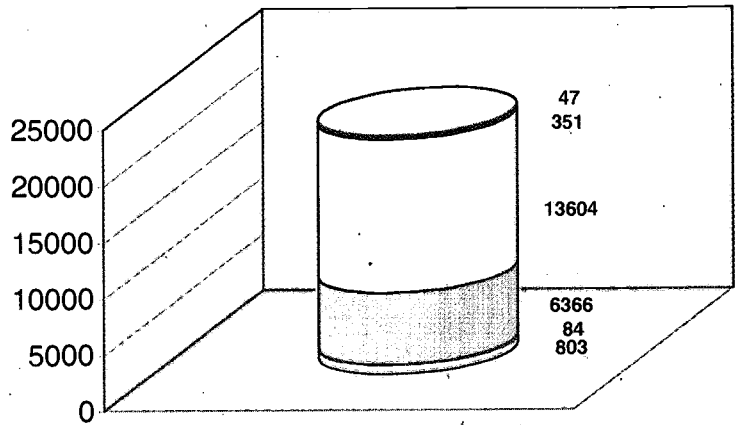
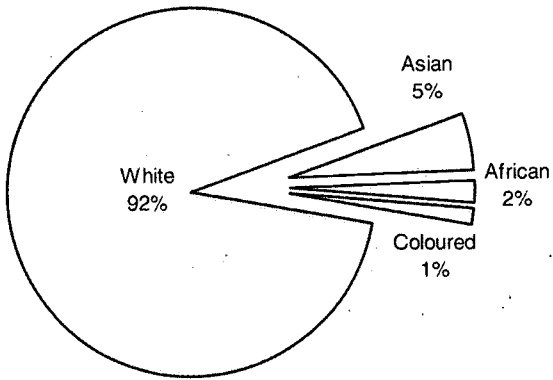

Bachelors (3yr) Bachelors (4yr) PG Diploma
 Honours Masters Doctorate

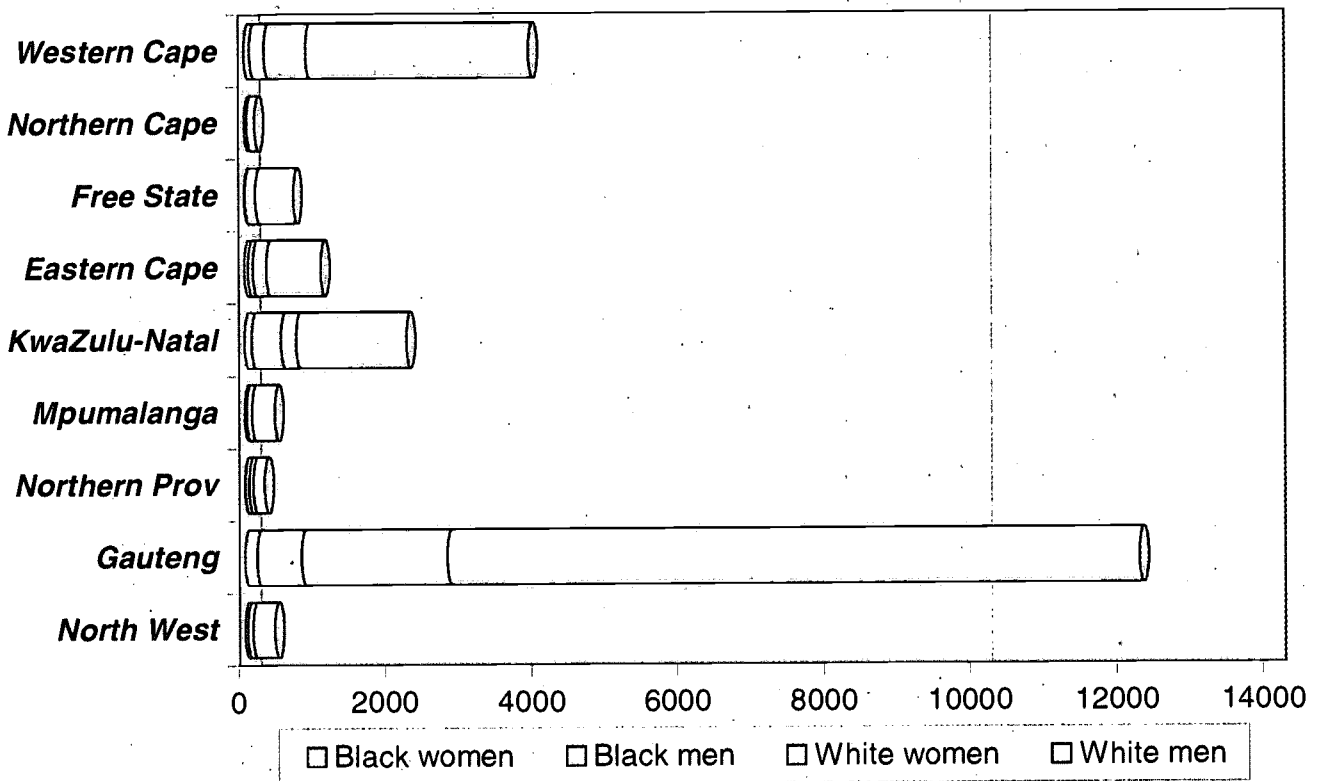

| | Asian | | African | | Coloured | | White | | OVERALL | | |
|---------------|-------------|------------|------------|------------|------------|------------|--------------|--------------|-------------|--------------|--------------|
| | Women | Men | Women | Men | Women | Men | Women | Men | Women | Men | TOTAL |
| Western Cape | 6 | 50 | 14 | 15 | 57 | 128 | 571 | 3049 | 648 | 3242 | 3890 |
| Northern Cape | | 1 | | | 2 | 5 | 23 | 112 | 25 | 118 | 143 |
| Free State | | 1 | | 8 | | | 143 | 510 | 143 | 519 | 662 |
| Eastern Cape | 23 | 22 | 17 | 38 | 7 | 9 | 183 | 749 | 230 | 818 | 1048 |
| KwaZulu-Natal | 85 | 358 | 6 | 35 | 5 | 4 | 202 | 1518 | 298 | 1915 | 2213 |
| Mpumalanga | 4 | 19 | | 2 | | | 75 | 303 | 79 | 324 | 403 |
| Northern Prov | | 12 | 9 | 37 | | | 56 | 155 | 65 | 204 | 269 |
| Gauteng | 93 | 394 | 66 | 162 | 5 | 48 | 1997 | 9462 | 2161 | 10066 | 12227 |
| North West | 8 | 13 | | 12 | | | 71 | 297 | 79 | 322 | 401 |
| TOTAL | 219 | 870 | 112 | 309 | 76 | 194 | 3321 | 16155 | 3728 | 17528 | 21256 |
| | 1089 | | 421 | | 270 | | 19476 | | | | |



QUALIFICATION TRENDS BY LEVEL

| | 1991 | 1992 | 1993 | 1994 | 1995 | 1996 | 1997 | 1998 | TOTAL |
|-----------------|------------|------------|------------|------------|------------|-----------|------------|------------|-------------|
| Bachelors (3yr) | 231 | 230 | 260 | 300 | 144 | 70 | 94 | 107 | 1436 |
| Bachelors (4yr) | | 5 | 7 | | 2 | | | | 14 |
| PG Diploma | | | | 1 | | | 5 | | 6 |
| Honours | 26 | 12 | 31 | 14 | 20 | 3 | 11 | 9 | 126 |
| Masters | 3 | 5 | | 2 | | 2 | 3 | 2 | 17 |
| Doctorate | | | | | | | | | 0 |
| TOTAL | 260 | 252 | 298 | 317 | 166 | 75 | 113 | 118 | 1599 |

QUALIFICATION TRENDS BY POPULATION GROUP AND GENDER

| | | 1991 | 1992 | 1993 | 1994 | 1995 | 1996 | 1997 | 1998 | TOTAL |
|--------------|---|------------|------------|------------|------------|------------|-----------|------------|------------|-------------|
| Asian | F | | | | | | | | | 0 |
| | M | | | | | | | | | 0 |
| African | F | | 9 | 5 | 13 | 11 | 13 | 14 | 16 | 81 |
| | M | 11 | 7 | 9 | 21 | 15 | 21 | 24 | 29 | 137 |
| Coloured | F | | | | | 3 | 1 | 2 | 2 | 8 |
| | M | | | 2 | | 2 | | | | 4 |
| White | F | 124 | 172 | 157 | 156 | 83 | 23 | 46 | 44 | 805 |
| | M | 125 | 64 | 125 | 127 | 52 | 17 | 27 | 27 | 564 |
| OVERALL | F | 124 | 181 | 162 | 169 | 97 | 37 | 62 | 62 | 894 |
| | M | 136 | 71 | 136 | 148 | 69 | 38 | 51 | 56 | 705 |
| TOTAL | | 260 | 252 | 298 | 317 | 166 | 75 | 113 | 118 | 1599 |

QUALIFICATION TRENDS BY CURRENT PROVINCE OF RESIDENCE

| | 1991 | 1992 | 1993 | 1994 | 1995 | 1996 | 1997 | 1998 | TOTAL |
|---------------|------------|------------|------------|------------|------------|-----------|------------|------------|-------------|
| Western Cape | 14 | 14 | 4 | 11 | 19 | | 13 | 4 | 79 |
| Northern Cape | | 14 | 14 | 17 | | | | | 45 |
| Free State | 151 | 99 | 158 | 73 | 22 | 2 | 13 | 11 | 529 |
| Eastern Cape | 22 | 13 | 10 | 51 | 33 | 43 | 26 | 59 | 257 |
| KwaZulu-Natal | 7 | 16 | 8 | 3 | | | 12 | | 46 |
| Mpumalanga | 14 | | | 6 | | | | | 20 |
| Northern Prov | | | 2 | | | 2 | 3 | 2 | 9 |
| Gauteng | 32 | 66 | 94 | 154 | 89 | 28 | 46 | 42 | 551 |
| North West | 20 | 22 | 8 | 2 | 3 | | | | 55 |
| Outside SA | | 8 | | | | | | | 8 |
| TOTAL | 260 | 252 | 298 | 317 | 166 | 75 | 113 | 118 | 1599 |

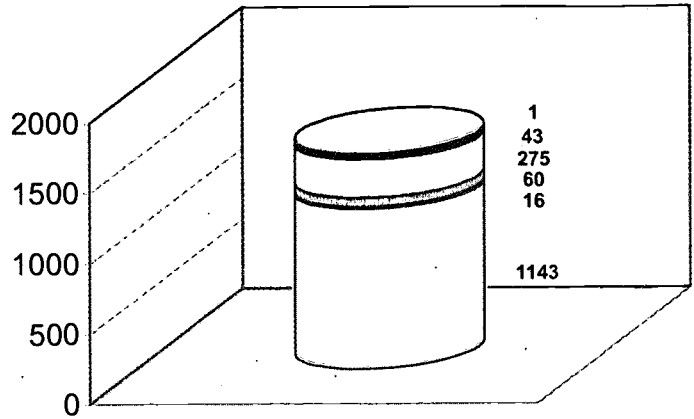
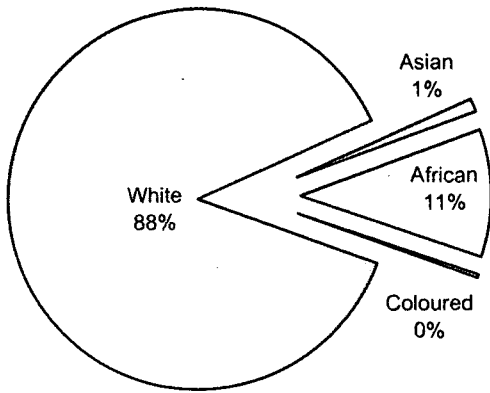

Bachelors (3yr) Bachelors (4yr) PG Diploma
 Honours Masters Doctorate

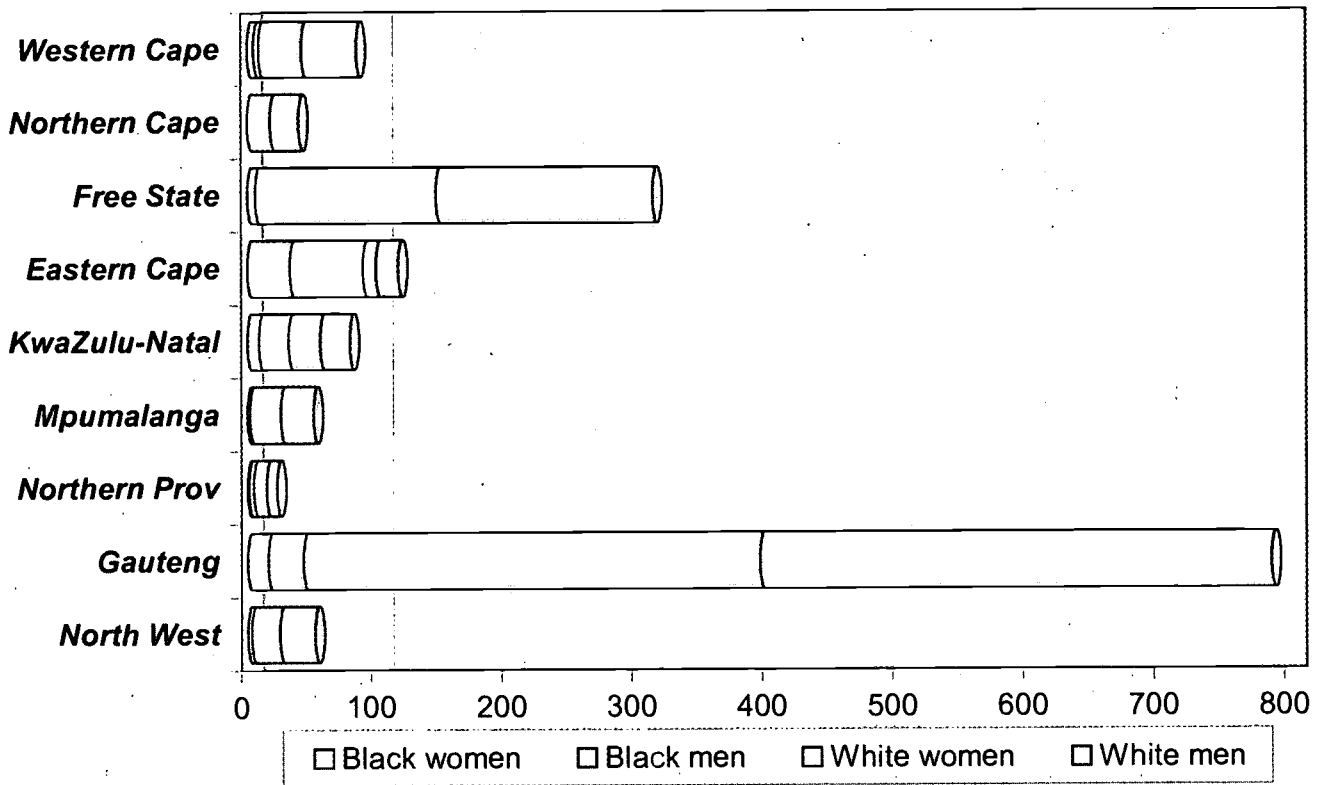

| | Asian | | African | | Coloured | | White | | OVERALL | | TOTAL |
|---------------|-----------|-----------|------------|------------|----------|----------|-------------|------------|------------|------------|-------------|
| | Women | Men | Women | Men | Women | Men | Women | Men | Women | Men | |
| Western Cape | | | 1 | 4 | 4 | | 33 | 42 | 38 | 46 | 84 |
| Northern Cape | | | | | | | 18 | 22 | 18 | 22 | 40 |
| Free State | | 1 | | 5 | | | 139 | 166 | 139 | 172 | 311 |
| Eastern Cape | | | 33 | 56 | | | 10 | 17 | 43 | 73 | 116 |
| KwaZulu-Natal | 6 | 7 | 3 | 16 | | | 24 | 23 | 33 | 46 | 79 |
| Mpumalanga | | | | 2 | | | 24 | 25 | 24 | 27 | 51 |
| Northern Prov | | | 1 | 4 | | | 10 | 8 | 11 | 12 | 23 |
| Gauteng | 1 | 3 | 15 | 22 | | 2 | 350 | 392 | 366 | 419 | 785 |
| North West | | | 3 | 4 | | | 22 | 27 | 25 | 27 | 52 |
| TOTAL | 7 | 11 | 56 | 109 | 4 | 2 | 630 | 722 | 697 | 844 | 1541 |
| | 18 | | 165 | | 6 | | 1352 | | | | |



QUALIFICATION TRENDS BY LEVEL

| | 1991 | 1992 | 1993 | 1994 | 1995 | 1996 | 1997 | 1998 | TOTAL |
|-----------------|--------------|--------------|--------------|--------------|--------------|--------------|--------------|--------------|---------------|
| Bachelors (3yr) | 19250 | 20794 | 21031 | 22460 | 23272 | 24029 | 24726 | 25143 | 180705 |
| Bachelors (4yr) | 7018 | 7413 | 7324 | 9375 | 9110 | 9495 | 10050 | 10755 | 70540 |
| PG Diploma | 3393 | 3651 | 4255 | 3915 | 4469 | 4314 | 4719 | 4537 | 33258 |
| Honours | 9074 | 9375 | 10982 | 9378 | 11208 | 10816 | 11996 | 12350 | 85179 |
| Masters | 3115 | 3145 | 3199 | 3138 | 4361 | 4040 | 4237 | 4567 | 29802 |
| Doctorate | 587 | 612 | 592 | 603 | 756 | 636 | 646 | 701 | 5133 |
| TOTAL | 42442 | 44990 | 47383 | 48869 | 53176 | 53330 | 56374 | 58053 | 404617 |

QUALIFICATION TRENDS BY POPULATION GROUP AND GENDER

| | | 1991 | 1992 | 1993 | 1994 | 1995 | 1996 | 1997 | 1998 | TOTAL |
|--------------|---|--------------|--------------|--------------|--------------|--------------|--------------|--------------|--------------|---------------|
| Asian | F | 1259 | 1376 | 1693 | 1846 | 2145 | 2323 | 2563 | 2647 | 15852 |
| | M | 1097 | 1331 | 1470 | 1495 | 1635 | 1759 | 1878 | 1988 | 12653 |
| African | F | 4213 | 5201 | 6175 | 7499 | 10090 | 10833 | 11994 | 12518 | 68523 |
| | M | 4508 | 5359 | 6262 | 7526 | 8613 | 9291 | 10326 | 10708 | 62593 |
| Coloured | F | 1420 | 1435 | 1415 | 1396 | 1425 | 1494 | 1675 | 1792 | 12052 |
| | M | 1525 | 1646 | 1511 | 1323 | 1350 | 1321 | 1432 | 1502 | 11610 |
| White | F | 13271 | 13628 | 13909 | 13313 | 13468 | 13069 | 13251 | 13504 | 107413 |
| | M | 15149 | 15014 | 14948 | 14471 | 14450 | 13240 | 13255 | 13394 | 113921 |
| OVERALL | F | 20163 | 21640 | 23192 | 24054 | 27128 | 27719 | 29483 | 30461 | 203840 |
| | M | 22279 | 23350 | 24191 | 24815 | 26048 | 25611 | 26891 | 27592 | 200777 |
| TOTAL | | 42442 | 44990 | 47383 | 48869 | 53176 | 53330 | 56374 | 58053 | 404617 |

QUALIFICATION TRENDS BY CURRENT PROVINCE OF RESIDENCE

| | 1991 | 1992 | 1993 | 1994 | 1995 | 1996 | 1997 | 1998 | TOTAL |
|---------------|--------------|--------------|--------------|--------------|--------------|--------------|--------------|--------------|---------------|
| Western Cape | 7681 | 8105 | 7992 | 7854 | 10439 | 7928 | 8467 | 8473 | 66939 |
| Northern Cape | 575 | 655 | 672 | 636 | 667 | 624 | 728 | 677 | 5234 |
| Free State | 2183 | 2489 | 2612 | 3087 | 2782 | 3086 | 3373 | 3326 | 22938 |
| Eastern Cape | 3524 | 3504 | 3760 | 4540 | 4956 | 5069 | 5207 | 5447 | 36007 |
| KwaZulu-Natal | 4985 | 5200 | 6772 | 6455 | 6573 | 7802 | 7855 | 7770 | 53412 |
| Mpumalanga | 1298 | 1451 | 1495 | 1728 | 1874 | 1913 | 2137 | 2185 | 14081 |
| Northern Prov | 2112 | 2756 | 2816 | 3265 | 3510 | 4101 | 4300 | 4447 | 27307 |
| Gauteng | 17354 | 17784 | 18018 | 18250 | 18613 | 19101 | 20374 | 21445 | 150939 |
| North West | 1596 | 1936 | 2001 | 1886 | 2578 | 2727 | 2968 | 3260 | 18952 |
| Outside SA | 1134 | 1110 | 1245 | 1168 | 1184 | 979 | 965 | 1023 | 8808 |
| TOTAL | 42442 | 44990 | 47383 | 48869 | 53176 | 53330 | 56374 | 58053 | 404617 |

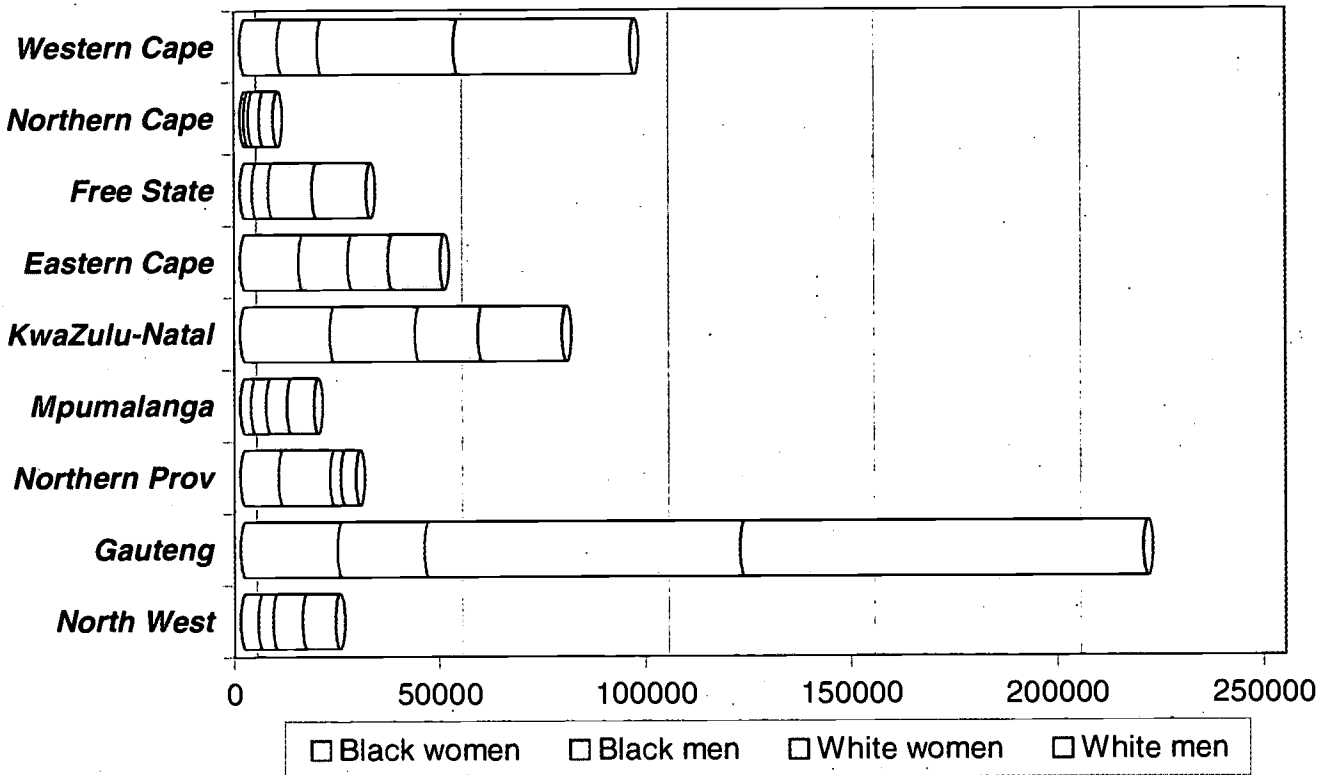
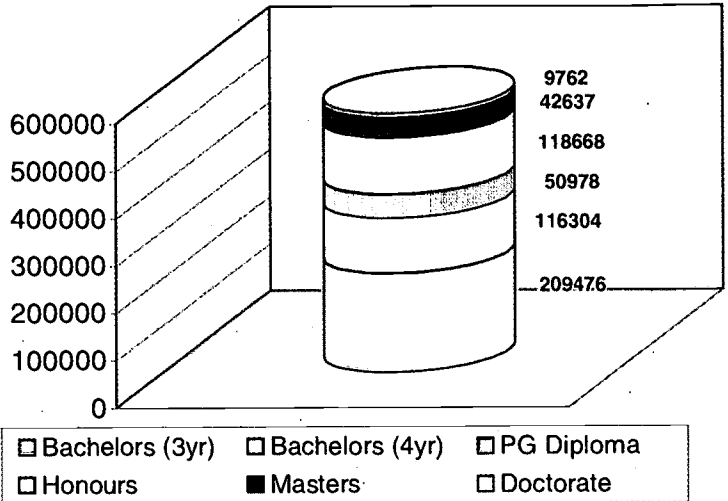
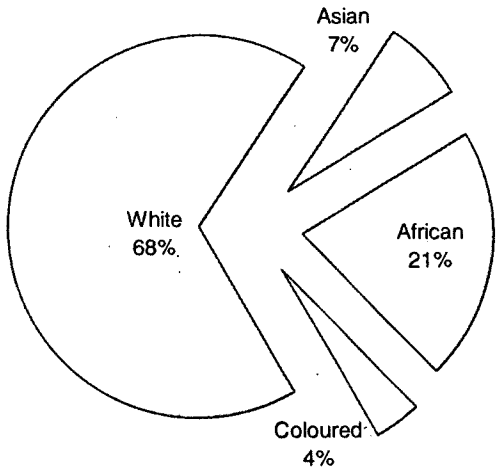

| | Asian | | African | | Coloured | | White | | OVERALL | | TOTAL |
|---------------|--------------|--------------|--------------|--------------|-------------|--------------|---------------|---------------|---------------|---------------|---------------|
| | Women | Men | Women | Men | Women | Men | Women | Men | Women | Men | |
| Western Cape | 849 | 891 | 1852 | 1413 | 6278 | 7427 | 33173 | 42844 | 42152 | 52575 | 94727 |
| Northern Cape | 33 | 60 | 349 | 417 | 389 | 683 | 2638 | 3353 | 3409 | 4513 | 7922 |
| Free State | 24 | 79 | 2612 | 3688 | 144 | 136 | 10775 | 13058 | 13555 | 16961 | 30516 |
| Eastern Cape | 455 | 618 | 12450 | 9993 | 1092 | 1475 | 9716 | 12753 | 23713 | 24839 | 48552 |
| KwaZulu-Natal | 12920 | 12609 | 8061 | 7420 | 717 | 591 | 15261 | 20504 | 36959 | 41124 | 78083 |
| Mpumalanga | 130 | 213 | 2285 | 3444 | 28 | 40 | 5036 | 6638 | 7479 | 10335 | 17814 |
| Northern Prov | 87 | 136 | 8979 | 12484 | 17 | 15 | 2732 | 3521 | 11815 | 16156 | 27971 |
| Gauteng | 3389 | 4094 | 18893 | 15743 | 1205 | 1250 | 76712 | 97843 | 100199 | 118930 | 219129 |
| North West | 141 | 268 | 3865 | 3183 | 88 | 118 | 7264 | 8184 | 11358 | 11753 | 23111 |
| TOTAL | 18028 | 18968 | 59346 | 57785 | 9958 | 11735 | 163307 | 208698 | 250639 | 297186 | 547825 |

ALPHABETICAL INDEX

| | Page |
|--|------|
| Accountancy (CA) | 100 |
| Administration and Public Administration | 94 |
| Agriculture | 46 |
| Architecture | 38 |
| The Arts | 76 |
| Biological Sciences | 16 |
| Building Science / Construction Management | 40 |
| Business Management and Administration | 98 |
| Commerce | 90 |
| Computer Science / Information Technology | 10 |
| Dentistry | 54 |
| Economics | 96 |
| Education | 78 |
| Engineering – All | 20 |
| Engineering – Chemical | 28 |
| Engineering – Civil | 24 |
| Engineering – Electrical and Electronic | 30 |
| Engineering – Industrial | 26 |
| Engineering – Mechanical | 22 |
| Engineering – Metallurgical | 34 |
| Engineering – Mining | 32 |
| Food Science and Home Economics | 48 |
| Geological Sciences | 12 |
| Health – General | 62 |
| Humanities and Arts – General | 64 |
| Human Resources Management | 102 |
| Land Surveying | 44 |
| Law | 86 |
| Legal | 84 |
| Library and Information Science | 80 |
| Literature and Languages | 68 |
| Marketing (Commercial) | 92 |
| Mathematical and Statistical Sciences | 14 |
| Medicine and Surgery | 52 |
| Natural Sciences – All | 8 |
| Nursing | 56 |
| Overall | 104 |
| Pharmacy | 60 |
| Physical and Chemical Sciences | 18 |
| Physiotherapy | 58 |
| Politics | 70 |
| Psychology | 72 |
| Publishing, Journalism, Advertising, Marketing | 66 |
| Quantity Surveying | 36 |
| Social Science | 74 |
| Social Work | 82 |
| Theology | 88 |
| Town and Regional Planning | 42 |
| Veterinary Science | 50 |

ISBN: 0-7969-1923-2

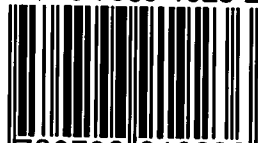

9 780796 919236



U.S. Department of Education
Office of Educational Research and Improvement (OERI)
National Library of Education (NLE)
Educational Resources Information Center (ERIC)



NOTICE

REPRODUCTION BASIS



This document is covered by a signed "Reproduction Release (Blanket) form (on file within the ERIC system), encompassing all or classes of documents from its source organization and, therefore, does not require a "Specific Document" Release form.



This document is Federally-funded, or carries its own permission to reproduce, or is otherwise in the public domain and, therefore, may be reproduced by ERIC without a signed Reproduction Release form (either "Specific Document" or "Blanket").