

DOCUMENT RESUME

ED 432 906

EF 005 594

TITLE Fire and the Design of Educational Buildings. Building Bulletin 7. Sixth Edition.

INSTITUTION Department of Education and Science, London (England).

ISBN ISBN-0-11-270585-5

PUB DATE 1997-00-00

NOTE 47p.

AVAILABLE FROM Publications Centre, P.O. Box 276, London SW8 5DT, England, United Kingdom; Tel: 0870-600-5522 Fax: 0870-600-5533 (14.95 British pounds).

PUB TYPE Guides - Non-Classroom (055)

EDRS PRICE MF01/PC02 Plus Postage.

DESCRIPTORS Alarm Systems; Construction Materials; *Educational Facilities Design; Elementary Secondary Education; *Fire Protection; Foreign Countries; Guidelines; Public Schools; *School Construction; *School Safety; Standards

IDENTIFIERS *Emergency Evacuations; England

ABSTRACT

This bulletin offers guidance on English school premises regulations applying to safety protection against fires in the following general areas: means of escape in case of fire; precautionary measures to prevent fire; fire warning systems and fire fighting; fire spreading speed; structures and materials resistant to fires; and damage control. It includes major revisions in the requirements for means of escape and the requirements aimed specifically at the designers of new construction. It also provides recommendations on planning and construction of escape routes dealing primarily with the number, width, location and construction of these routes. The use of fire resistant construction in its ability to restrict the spread of smoke and flame are explored as are suggestions on installing wiring equipment; everyday precautions occupants should observe if other precautions are not to be nullified; the ways fires can be prevented through careful design, management, and maintenance practice; and ideas for limiting fire damage. (GR)

* Reproductions supplied by EDRS are the best that can be made *
* from the original document. *

Department of Education and Science

live!
EF 005 594

FIRE and the design of educational buildings

U.S. DEPARTMENT OF EDUCATION
Office of Educational Research and Improvement
EDUCATIONAL RESOURCES INFORMATION
CENTER (ERIC)

This document has been reproduced as received from the person or organization originating it.

Minor changes have been made to improve reproduction quality.

• Points of view or opinions stated in this document do not necessarily represent official OERI position or policy.

PERMISSION TO REPRODUCE AND DISSEMINATE THIS MATERIAL HAS BEEN GRANTED BY

J. Birch

TO THE EDUCATIONAL RESOURCES INFORMATION CENTER (ERIC)

1

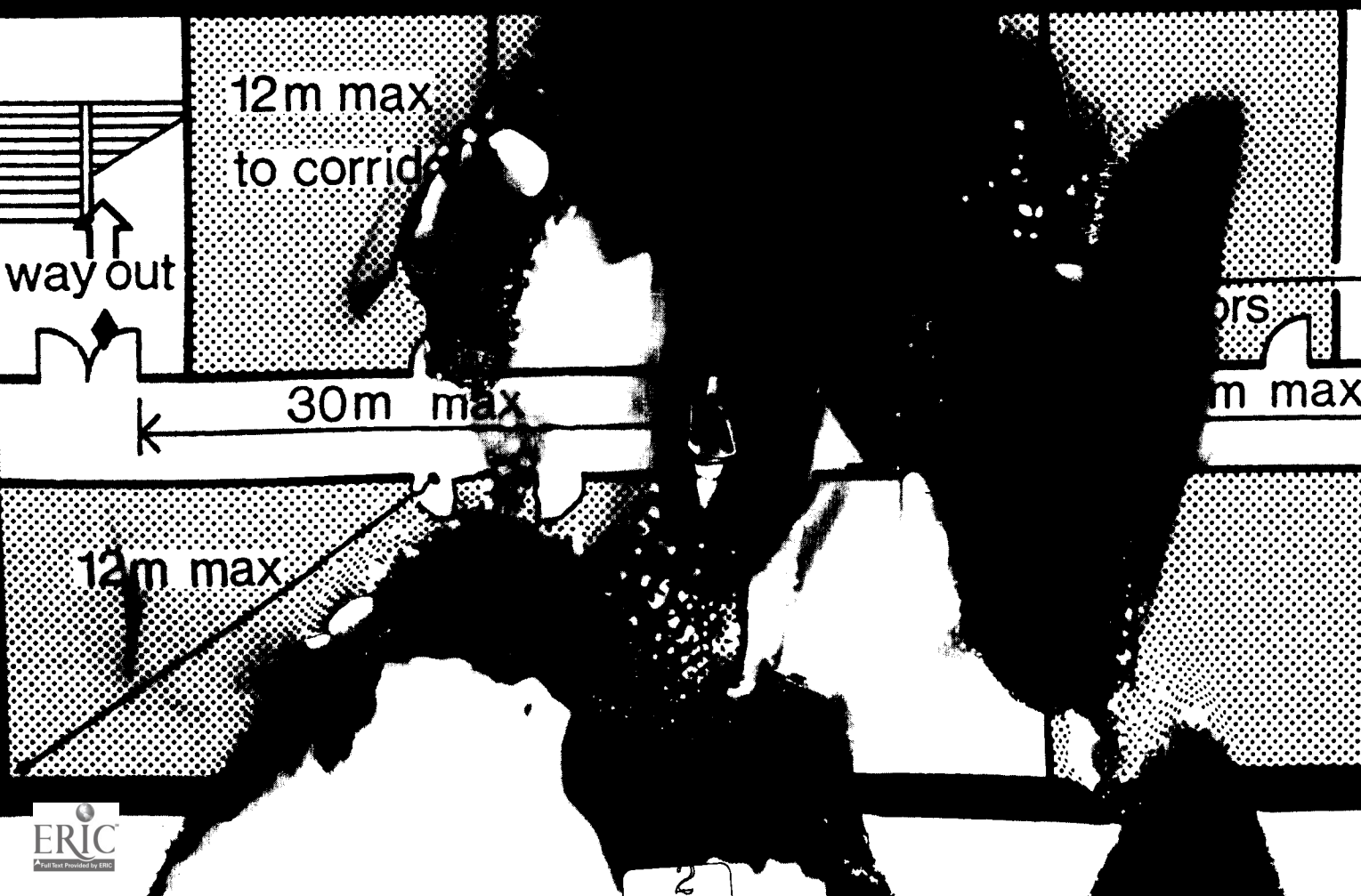

Fire and the design of educational buildings

Department of Education and Science

Building Bulletin 7

Sixth edition

London: The Stationery Office

First published 1952
Sixth edition
Third impression 1994
Fourth impression 1997
ISBN 0 11 270585 5

Acknowledgements

The preparation of the original Bulletin and this revision would not have been possible without the active cooperation of persons outside the Department of Education and Science. The Secretary of State wishes to acknowledge all the assistance given.

Thanks are also due to those, particularly in local education and fire authorities, who at various times have helped to improve this Bulletin during the 35 years since it was first published.

© Crown copyright 1997. Published with the permission of the DfEE on behalf of the Controller of Her Majesty's Stationery Office. Applications for reproduction should be made in writing to The Copyright Unit, Her Majesty's Stationery Office, St Clements House, 2-16 Colegate, Norwich NR3 1BQ

Contents

	Page
Introduction	1
Terminology	3
1 Means of escape: general principles	
the approach to the problem	6
first principle: alternative means of escape	6
escape criteria	6
the first phase: the early stages of fire	6
small rooms	6
large rooms	7
corridors	7
dual-purpose areas and open planning	7
stairways	8
the second phase: horizontal spread of fire	8
dead-end corridors	8
interconnected and open-plan areas	8
the third phase: vertical spread of fire	9
stairway arrangement above ground floor level	9
faulty planning	10
open-plan on two floor levels	11
arrangement of ground floor exits from stairway enclosures	11
two-storey buildings	12
2 Precautions against fire	
planning means of escape	13
room exits	13
horizontal circulation areas	15
stairways	21
doors	24
3 Structural fire precautions	
general requirements	26
the use of fire resisting construction	26
restricting the spread of flame and smoke: cavity barriers	26
ventilation and heating ducts	28
limiting the spread of fire from building to building	28
4 Fire warning systems and fire fighting	
general requirements for fire warning systems	29
installation of fire warning systems	29
type of system	29
call-points	30

fire fighting by the fire brigade	30
fire fighting by the occupants	30
types of equipment	30
installation of equipment	31
5 Precautions by the occupants	
action in the event of fire	33
everyday precautions	33
stairways and doors	33
interconnected and open-plan areas	33
rubbish and the storage of combustible material including polyurethane	34
electrical supply and fittings	34
laboratories	34
housecraft rooms	34
furnishings and equipment—including play equipment and sports equipment	34
temporary displays and decorations	35
vandalism and security	35
community and dual use	35
periodic action	36
fire inspections	36
fire drills	36
fire warning systems	36
fire extinguishers	36
6 Fire prevention and damage limitation	
design factors	37
fire prevention by management	37
fire prevention by maintenance	37
damage limitation	38
Short index	39
List of tables	
1 Exit widths of standard single and double internal doors, based on an evacuation rate of 40 persons per minute for 2.5 minutes	14
2 Minimum clear width of stairways where there are two stairways	22
3 Additional width for external doors serving ground and upper floors	24
4 Standards of fire resistance of elements of structure to apply in lieu of Table 5.1 in the Approved Document B 2/3/4 of the Building Regulations 1985	27
5 Installation of fire extinguishers in areas of high fire risk	31

Introduction

1. This Bulletin is issued in support of the Department's Constructional Standards.¹ These relate to building work at educational establishments which is exempt from the Building Regulations by virtue of its approval by the Secretary of State for Education and Science. The legislative provisions were consolidated as follows in the Building Act 1984:

"4.-1. Nothing in this Part of this Act with respect to building regulations, and nothing in any building regulations, applies in relation to:—

- a. a building required for the purposes of a school or other educational establishment erected or to be erected according to plans that have been approved by the Secretary of State for Education and Science or the Secretary of State for Wales, or according to particulars submitted to and approved by the Secretary of State under Section 14 of the Education Act 1980 or under regulations made under Section 27(4) of that Act."

(The relevant regulations referred to above are the Education (Schools and Further Education) Regulations 1981, as amended—see Regulation 7.)

In the case of schools the Education (School Premises) Regulations 1981 also apply and this Bulletin offers guidance in relation to Regulation 24 which deals as follows with fire precautions:

"Safety protection

24.—(1) Every part of a school building shall be of such design and construction, in particular, as respects the matters mentioned in paragraph (2), that—

- (a) the safe escape of occupants in case of fire, and
 - (b) their health and safety in other respects,
- are reasonably assured.

1. See Administrative Memorandum 2/85, *Constructional standards for maintained educational buildings in England*.

(2) The matters referred to in paragraph (1) are—

- (a) the likely rate at which flames would spread across exposed surfaces;
- (b) resistance to fire of the structures and of the materials used therein and their other properties, and
- (c) the means of escape in case of fire."

2. The recommendations of this Bulletin apply to new construction. They may also be appropriate in the context of adaptation or remodelling work to existing buildings.

However, there are specific recommendations that apply only to the design of new construction (see paragraphs 49, 53, 61, 69, 82). The recommendations do not apply to residential accommodation which will need to be considered with regard both to the standards of the Building Regulations and the requirements of the local fire authority. For buildings which are specifically intended for pupils or students with severe disabilities, the requirements of this Bulletin will generally apply but may need to be considered on an individual basis and should be discussed with the DES and the local fire authority. However, in all educational premises where the number of disabled occupants is likely to be small, the recommendations should be read in conjunction with those of the current edition of Design Note 18, *Access for disabled people to educational buildings*.

3. It should be noted that some parts of educational buildings which are used as offices or shops may also be subject as regards means of escape to the Fire Precautions Act 1971. In these cases the local fire authority should be consulted.

4. The main emphasis of the Bulletin is on precautions to ensure the safe escape of the occupants of the building in the event of fire, rather than on those necessary to preserve its structure or fabric. However, the Bulletin does include within Chapters 3 and 6 recommendations aimed at limiting damage to the structure.

5. The formulation of systematic principles to serve as a guide in individual cases presents special difficulties. Such principles, to be of general use, must hold good for a wide range of designs, materials and methods of construction. In particular they must remain valid not only for traditional building methods and design, but also for new systems of construction and for designs which aim to break down rigid divisions between one space and another and provide for dual and multiple use of spaces. The recommendations as a whole attempt to embrace these varying conditions, and to permit the maximum freedom in planning and construction, compatible with ensuring personal safety and restricting structural damage.

6. This sixth edition of the Bulletin is of a wider scope than the previous editions so as to be applicable to the whole range of educational buildings. It has also been revised in the light of experience gained and evidence obtained from published information on fires in educational buildings. To avoid unnecessary complexity, as in earlier editions of the Bulletin, recommendations are aligned, wherever possible, with the relevant Building Regulations and British Standards.

7. The Bulletin deals with various types of fire precautions that should be designed into an educational building but its main emphasis is on proper design and construction to ensure the safe escape of the occupants in the event of fire. Other requirements that are covered include the construction of the building as a whole and its resistance to the rapid spread of fire, and the provision of fire warning systems and fire fighting equipment. As all these requirements interact with each other it may be thought that one kind of provision can be balanced within narrow limits against another; however the characteristics of fire make it necessary to adopt a minimum standard for each.

8. These various requirements are covered as follows:

Chapter 1 serves as a general introduction to the subject of means of escape from a building. It describes the behaviour of fire in so far as it may affect those parts of the building which

people must necessarily use to reach safety.

Chapter 2 makes detailed recommendations about the planning and construction of these escape routes and is based largely on the considerations discussed in Chapter 1. These recommendations deal chiefly with the number, width, location and construction of escape routes.

Chapter 3 deals with structural fire precautions; with limiting the use of combustible materials; with the use of fire resisting construction and with restricting the spread of smoke and flames.

Chapter 4 describes various types of fire warning systems and fire fighting equipment and suggests the scale on which they might be installed.

Chapter 5 calls attention to some everyday precautions by the occupants which it is important to observe if other precautions are not to be nullified.

Chapter 6 considers how fires can often be prevented by careful design, management and maintenance, and how the damage caused by fires may be limited.

Terminology

Escape route

9. The term 'escape route' means a route from any point in a building to a final exit. Escape routes must not terminate in enclosed courtyards from which it would be necessary to reenter the building.
10. Escape routes may comprise one or more of the following constituent parts:
- The route from any point in a room to the room exit door
 - Horizontal circulation areas (defined below) and the exits from them
 - Protected stairways and the final exits from them (defined below).

Direct distance

11. The term direct distance in relation to escape routes is the shortest distance from any point in a room to that room exit regardless of furniture layout.

Travel distance

12. The term travel distance in relation to escape routes is the distance within a room taking account of fixed furniture.

Final exit

13. "The termination of an escape route from a building giving direct access to a street, passageway, walkway or open space, and sited to ensure the rapid dispersal of persons from the vicinity of a building so that they are no longer in danger from fire and/or smoke" (BS 5588 Part 2).

Dual-purpose area

14. The term 'dual-purpose area' means any area which may serve at least two different purposes, one of which is that of an escape route. Dual-purpose areas frequently feature in buildings with large interconnected areas.

Horizontal circulation area

15. The term 'horizontal circulation area' means both corridors and dual-purpose areas (defined above).

Area of high fire risk

16. The term 'area of high fire risk' means any room or space in which, on account of its function, use or contents, an outbreak of fire is more likely than in a non-specialist teaching room. Boiler rooms, kitchens, laboratories, workshops, store-rooms and any space with a fixed or portable heating (or heat producing) appliance should be considered as being among such areas. Partitions and doors between areas of high fire risk and horizontal circulation areas should have a fire resistance of not less than 30 minutes and a Class 0 surface spread of flame to walls and ceiling surfaces (see Table 4, note 3 for boiler rooms).

Unprotected corridor

17. A corridor which may form part of an escape route having a Class 0 surface spread of flame to wall and ceiling surfaces except that 20% of the total wall and ceiling surfaces may be Class 1, provided that all rooms opening onto it have alternative means of escape (paragraph 63).

Protected stairway

18. A stairway whose enclosing structure, including fire doors (paragraphs 27–33), has a fire resistance equal to that required for elements of structure (Table 4) and a Class 0 surface spread of flame (paragraphs 77–84). Non load-bearing external walls to protected stairways normally require no fire resistance, except where they are required to comply with the provisions of paragraph B4(i) of the Building Regulations 1985 (paragraph 104). A protected stairway leads directly, or via a protected route of the same fire resistance and of at least equal width, to a final exit.

Protected corridor

19. A corridor which can be treated as a sub-compartment for a short period (5 minutes) which has a fire resistance to its enclosing structure of 30 minutes including fire doors, and a Class 0 surface spread of flame to walls and ceiling surfaces. External walls to protected corridors require no protection, except where this is required to comply with the provisions of paragraph B4(i) of the Building Regulations 1985 (paragraph 62). A protected corridor should contain no pin-board where that corridor serves a dead-end (paragraph 61).

Protected lobby

20. A lobby adjoining a protected stairway, which is not a dual-purpose area, having a fire resistance to its enclosing structure of 30 minutes including fire doors, and a Class 0 surface spread of flame to walls and ceiling surfaces.

Compartmentation

21. A compartment is defined in BS 4422 Part 2 as "the division of a building into fire-tight compartments by fire resisting elements of building construction in order to contain a fire within the compartment of origin". Table 4 contains recommended minimum levels for the fire resistance of the structures of buildings, relevant to compartment size, volume or to type of design or use of accommodation.

Compartment walls and compartment floors

22. The terms 'compartment wall' and 'compartment floor' mean respectively a wall and a floor forming the vertical and horizontal limits to a compartment. These elements should comply with the current, and generally accepted, technical definitions of such elements in the Approved Document B 2/3/4 issued in support of the Building Regulations 1985.

Combustibility and fire resistance

23. The terms 'combustibility' and 'fire

resistance' and their derivatives are used as defined in BS 476, which indicates that 'non-combustibility' applies to materials only, and that 'fire resistance' applies to elements of structure only.^{1,2,3}

Lining material

24. The term 'lining material' means a material incorporated in a building structure to form the exposed surface of a wall or ceiling. The surfaces of exposed lining materials are classified by a surface spread of flame test specified in BS 476, Part 7. Lining material may also be required to be non-combustible (BS 476, Part 4) or Class 0 as defined in Appendix A5 of the Approved Document B 2/3/4 issued in support of the Building Regulations 1985.

1. BS 476, *Fire tests on building materials and structures*. Parts 3–8, 10, 11, 20, 21, 22, 24 and 31. Part 3: external fire exposure roof test. Part 4: non-combustibility test for materials. Part 5: Method of test for ignitability. Part 6: Method of test for fire propagation for products. Part 7: surface spread of flame tests for materials. Part 8: Test methods and criteria for the fire resistance of elements of building construction. Part 10: guide to the principles and application of fire testing. Part 11: method for assessing the heat emission from building materials. Part 20: method for the determination of the fire resistance of elements of construction (general principles). Part 21: method for determination of the fire resistance of load-bearing elements of construction. Part 22: method for determination of the fire resistance of non load-bearing elements of construction. Part 24: determination of fire resistance of elements of construction penetrated by building services—ventilation ducts and dampers. Part 31: methods for measuring smoke penetration through doorsets and shutter assemblies. Other parts of this Standard, which are relevant to fire protection in educational establishments, are likely to be published in the near future. (British Standards Institution, London N1 9ND.) Standards for fire testing of building materials and components are constantly being reviewed and developed. It is therefore necessary, in terms of safety and availability of components of tested performance, to refer to the latest Standards.
2. BS 6336, *Guide to development and presentations of fire tests and their use in hazard assessment*, defines a more complex range of properties or functions in terms of fire hazards. They include ignitability, flammability, surface spread of flame, heat release, smoke (or gas) release, fire resistance, flame penetration, smoke (or gas) penetrations. Standards testing these features and recommendations of performance levels are being developed.
3. In cases where this Bulletin may be used for assessment of safety in existing buildings, the level of reasonable protection against fire should be judged in the light of local circumstances and existing provisions.

Roof covering

25. The term 'roof covering' means either the roof covering by itself or in combination with other materials (or other parts of the roof structure) necessary to improve the properties of the covering itself in retarding penetration of fire from outside.

26. Roof coverings are designated in accordance with standard tests specified in BS 476 Part 3 'external fire exposure roof tests', and are referred to in Appendix A3 of the Approved Document B 2/3/4 issued in support of the Building Regulations 1985.

Fire doors

27. Fire resisting and 'smoke control' doors are referred to in this Bulletin under the general title of 'fire doors' and are one of the most important elements of fire safety precautions.

28. For the purpose of this Bulletin, the fire doors recommended are referred to as FD or FDS doors and are described in BS 5588: Parts 2 and 3 and BS PD 6512 Part 1 'Guide to fire doors'. In all cases test standards referred to are those in BS 476 Part 22¹ for testing fire doorsets. There is no current Standard for smoke control doors, although a standard test has been laid down in BS 476 Section 31.1. In the absence of this Standard BS PD 6512 Part 1 recommends that "flexible edge seals should be provided for the early control of smoke movement".

29. Fire doors are for use in compartments or protected structures requiring a fire resistance for the doorset, including ironmongery, of at least 30 minutes. They should also control the passage of smoke. The doors are classified by the time in minutes required for resistance (eg FD 30S, FD 60S). The suffix S denotes smoke control. The doorset should have a performance for integrity not less than that required for the structure, except that a

doorset for a boiler room must have not less than 60 minutes fire resistance.

30. Smoke control doors are primarily to retard the passage of smoke and dangerous gases spreading along an escape route. They must however have a fire-resistance of at least 20 minutes (eg FD 20S). The effectiveness of fire and smoke control doors depends on a close fit to the frame and tolerances should be 2 mm to 3 mm maximum. Flexible edge seals are recommended in all cases to the top and vertical door edges.

31. Fire doors and smoke control doors must be self-closing with an automatic device other than a rising butt, and kept closed whenever possible. They should be clearly marked with a warning notice such as 'Fire door: keep shut'. Smoke control doors across escape routes may, however, be held open by electro-mechanical or electro-magnetic devices which allow the door to close if activated by the following, either singly or in combination.

- a. Automatic smoke detection
- b. Manual operation of switch
- c. Failure of electricity supply
- d. When the fire alarm is set off.

Where these devices are used, doors should be closed when the building is not occupied.

32. The failure of doors under fire usually occurs at the point between the door and the frame or at the points where items of ironmongery (particularly hinges and locks) are fixed. Concealed door closures can also reduce the fire resistance of a normal door. Any ironmongery on which the door depends for its stability (such as hinges, locks and latches) should not be of a material which is combustible, melts or is otherwise likely to fail at a temperature below 800°C (eg plastic or aluminium).

33. Glazing in fire and smoke control doors may be incorporated providing the doorset has the required performance for integrity.

¹ References to BS 476 Part 22 should also be taken to include BS 476 Part 20. It is accepted that whilst BS 476 Part 8 is now superseded it is still referred to in Building Regulations and other legislative documents, and therefore the implementation of the revised Standards may not be immediate.

1 Means of escape: general principles

The approach to the problem

34. The design of means of escape from a building must be based on an appreciation of the probable behaviour of fire, which may break out in any part of the building and then spread to other parts. Although recommendations based on such considerations can be devised, they can be used intelligently only if the nature of the risks which they are intended to meet is continually borne in mind. The design of a building should therefore be analysed, part by part, in order to determine the danger which might arise from a fire, either in the part where the fire may originate or in any other part to which it may spread. The value of analysing a plan with these facts in mind cannot be over-stressed. To illustrate this approach to the problem, the following paragraphs contain a study of the behaviour of fire in the course of which the fundamental precautions which form the basis of the recommendations in this Bulletin are deduced. Cross-references are given to the later parts of the Bulletin where these general principles are expressed as specific recommendations.

35. A fire will normally start at a particular point; and it is usually assumed that not more than one fire will start at the same time. Thus, at the moment of initiation, a fire will not involve any large area and will at first create a hazard only in the part in which it starts. Subsequently it may spread to other parts, through doorways, corridors, stairways and any openings in the building's structure. Only spread along the communication routes will be considered here as this is the primary consideration as far as means of escape are concerned. (Measures to prevent spread through the structure are considered in Chapter 3.) Fire spreading along the communication route will affect, first, other parts of the same floor and then, by way of stairways or other vertical shafts, the upper floors. The risk which may be caused by a fire in each of these three phases will be examined separately.

36. The primary danger associated with fire in its early stages is not flame or heat

but smoke and toxic gases produced by the fire. These may make an escape route impassible long before a temperature which is dangerous to life is reached. Many plastics in common use such as polyurethane or polypropelene are highly toxic when burning. It is against smoke and toxic fumes therefore that precautions must be mainly directed.

First principle: alternative means of escape

37. The first and fundamental principle is the provision of alternative means of escape. The principle is widely accepted but its implications are perhaps not so fully appreciated. The general consideration of the problem which follows will therefore largely revolve around the one principle of alternative means of escape.

Escape criteria

38. The speed of travel of persons escaping from a fire to a place of safety is assumed as 12 metres per minute¹. This speed is considerably slower than a normal walking pace, but takes account of the loss of mobility that can occur in the vicinity of fire and smoke. Escape from a room is based on a flow rate of 40 persons per minute² per unit width of the exit of 0.530 metres. Travel distances are based on an evacuation time of 2.5 minutes to a place of safety. A place of safety can be a final exit, a separate compartment with alternative exits, a protected stairway, a protected lobby adjoining a stairway or, for a limited period of up to 5 minutes, a protected corridor.

The first phase: the early stages of fire

Small rooms

39. If a fire starts in a small room the number of occupants will be so small and the distance to the doorway so short that there is little risk that the occupants will not be able to escape through a single

^{1,2} Both figures are conservative and therefore should not be related to each other.

doorway. In this case, a second way out is not usually necessary.

Large rooms

40. In a large room there is always a risk of confusion should a fire break out because of the greater number of persons who may be involved. There is also a greater risk that a fire breaking out within the room may trap some of the occupants unless there is an alternative exit. For this reason large rooms designed to accommodate over 60 persons should have more than one exit. (Table 1 and paragraphs 54–56.) The size and number of exits should be adequate for the discharge of occupants in a very short time (Table 1 and paragraph 56).

KEY

escape route to final exit	
escape route blocked by smoke	
fire (point of origin)	
smoke	
high fire risk area	
dual-purpose area	
protected structure	
fire doors types FD 30S, FD 60S, FD 90S, FD 120S, (see Table 4, para. 29), and smoke-control doors type FD 20S. (para. 30)	
vision panels	
dimensions, in metres (maxima unless otherwise indicated)	
dimension greater than indicated	
angle greater than 45°	
clear width of stairway	

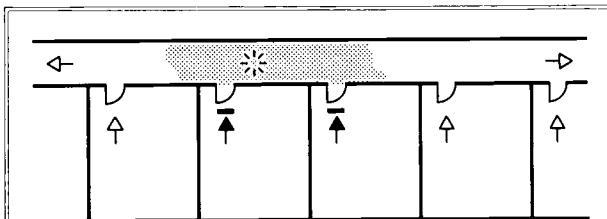

Diagram 1

Rooms with a single exit to a corridor: (paragraph 41)

1. Maximum direct distance to exit door from any point in the room is 12 m.
2. Class 0 surface spread of flame to corridor walls and ceiling.
3. Number of occupants to a room may not exceed 60 without a second exit.

Corridors

41. A serious situation may arise should a fire start in a corridor (Diagram 1), since it may not be detected before smoke cuts off the escape route from nearby rooms. For this reason corridors which serve any room with only one exit should have wall and ceiling lining materials of Class 0 type (paragraphs 17 and 19).

Dual-purpose areas and open-planning

42. As with a corridor, a dual-purpose area which serves any room with only one exit should have wall and ceiling linings of Class 0 type for surface spread of flame. If a dual-purpose area, which serves any room with only one exit, has only one exit itself, the requirements are the same as those for a dead-end corridor (paragraph 45). In the situation illustrated in Diagrams 2, 18, 19, 23, 24 and 25 vision panels suitably placed in the inner rooms are necessary to give the occupants early warning of any fire in the

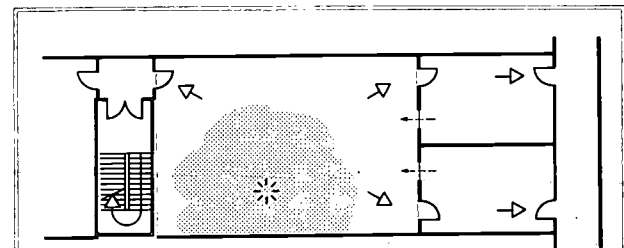

Diagram 2

Rooms opening onto dual purpose areas. (paragraph 42)

1. If rooms opening onto dual-purpose area have only one escape route the dual-purpose area to be Class '0' surface spread of flame.
2. If rooms have an alternative escape route, the dual-purpose area to be Class '0' surface spread of flame except 20% of wall and ceiling surfaces may be Class 1.
3. Vision panels between inner rooms and dual-purpose area required.
4. Diagram 19 applies where the area is a dead-end.
5. If room opens onto an area of high fire risk, it must have an alternative escape route (paragraph 54).

dual-purpose area. Where the area contains furniture or display which can be considered a high fire risk, then all rooms opening into it should have a second way out.

Stairways

43. Where a fire starts in a stairway it will quickly make the stairway unusable by the occupants of all the floors above the point of origin of the fire. They may find it possible to escape by some other route, but smoke and fire rise rapidly through any openings in the floors and may quickly spread to the upper floors. All stairways, therefore, should be constructed in such a way that an outbreak of fire is virtually impossible and combustible material within protected stairways should be minimised.

The second phase: horizontal spread of fire

44. Consider first a fire starting in a small room and spreading from that room to a main corridor (Diagram 3). The occupants of the room in which the fire originates should find no difficulty in escaping. However, there is a risk that smoke may

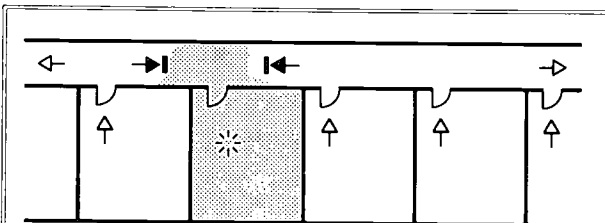

Diagram 3

Rooms with alternative directions of escape (paragraph 41, 44, 63)

1. Maximum distance between smoke control/fire doors across escape route is 30 m.
2. Maximum direct distance from any point to the nearest protected stairway, protected lobby, separate compartment or final exit is 30 m.
3. One door from any room should be within 18 m of the nearest protected stairway, protected lobby, separate compartment or final exit.
4. Diagram 1 conditions also apply.

enter the corridor through the open door in such quantities as to cut off the escape of occupants of the other rooms. As a fire may break out in any one of the rooms it is desirable that escape should be possible along the corridor in either direction. As a general rule, therefore, on all floors above the ground floor, corridors should lead to at least two stairways placed well apart. If the storey is divided into separate fire compartments, escape can be via a separate fire compartment with alternative exits. If there is no other compartment to the storey, escape can be via a protected stairway, protected lobby leading to a stairway or, on the ground floor, a final exit. Additional smoke control doors will be required if the length of corridor exceeds 30 metres between separate fire compartments, protected stairways or lobbies. Ground floor rooms may additionally have separate exits to the open air as means of escape in which case the limiting distances for means of escape in corridors need not apply to those rooms.

Dead-end corridors

45. If the principle that escape along corridors should be possible in either direction were to be rigidly applied, it would be necessary for stairways to be placed at the extremities of corridors. The condition known as a 'dead-end' corridor would not then be possible (Diagram 4). Dead-end conditions should be avoided in the design of new construction, but may be unavoidable in the context of the adaptation or remodelling of existing buildings (see paragraph 61 for specific recommendations).

Interconnected and open-plan areas

46. The risk of smoke spreading horizontally is greatly increased with open-plans, where areas are not separated by floor-to-ceiling walls. With open-plans it may, of course, be possible to raise the alarm quickly and to escape in several directions away from the source of the outbreak. However it will be important to check on the length of the escape routes across the open area and to ensure that, in the case of large spaces, alternative routes are available. In this connection, the furnishing of open-plan areas poses special

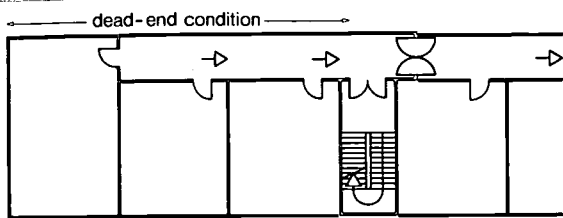

Diagram 4 (existing buildings only)

Rooms with a single direction of escape: 'dead-end' condition. (paragraph 45, 61)

1. Maximum direct distance from any part of a dead-end to an alternative escape route or final exit is 24 m.
2. Maximum direct distance to a room exit from any point in a room is 12 m.
3. Maximum number of persons in dead-end is 120.
4. Minimum clear width of corridor to be 1.6 m (except where diagram 19 conditions apply).
5. Dead-end must be protected as described in paragraph 19 (unless paragraph 61(b) and (h) conditions apply).
6. No room or area of high fire risk may be situated in a dead-end.
7. No room should contain an inner room.

problems as does the positioning of movable partitioning. Special attention must be paid to any small enclosed rooms which open only onto a large open-plan area (Diagrams 2, 18, 19, 23 and 24). Vision panels should be provided to ensure the occupants of any room off a dual-purpose area have a clear view.

The third phase: vertical spread of fire

47. The principles and procedures outlined in paragraphs 44-46 enable horizontal escape routes to be so designed and constructed as to ensure that nobody will be trapped on a floor by a fire spreading horizontally. It now remains to consider what is needed to ensure that the occupants of all the floors above the ground will be able to reach the final exit in safety. This entails studying the risk of a fire on any lower floor spreading to a stairway and cutting off that escape route from the upper floors. The two conditions (stairway arrangement on ground and upper floors) will be considered separately.

Stairway arrangement above ground floor level

48. In the plan shown in Diagram 5 a fire starting in one room has spread along the corridor and entered both stairways. Although the occupants of the rooms on this floor should have been able to escape before the fire reached these dimensions (the plan conforms with the principles deduced when studying the first and second phases of fire), it cannot be assumed that the occupants of the floor or floors above will have escaped in the same time. Should their movements be delayed it is clear that both their escape routes to the ground will be cut off by smoke and subsequently fire spreading up stairways and other vertical shafts. In order to reduce this risk to a minimum it is essential that stairways be protected as described in paragraph 18. (See also Diagram 6.) A fire within or affecting a

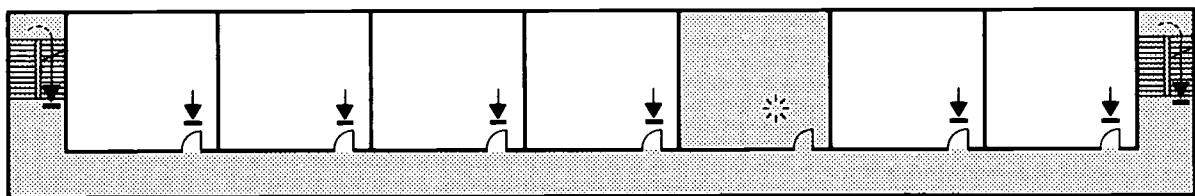

Diagram 5 (bad)

Rooms served by accommodation stairways (paragraph 48)

1. Accommodation stairways are discounted for means of escape purposes.
2. In an existing building, the stairways would require protection to be used for means of escape (paragraph 18).

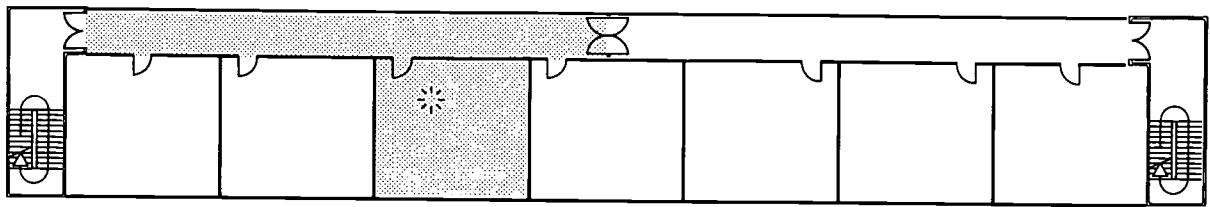

Diagram 6 (good)

Alternative directions of escape leading to protected stairways (paragraph 48)

1. Travel distances as paragraph 63.
2. Number of room occupants as Table 1 (paragraphs 54, 66, 70).
3. If rooms have a single exit, corridor must be Class '0' (paragraph 41).

stairway will render it unusable for means of escape. For this reason one stairway is discounted for calculating numbers of stairways and stairway widths for means of escape in Table 2.

Faulty planning

49. Diagram 7 shows how fire passing up the stairway next to the dead-end corridor may trap the occupants of the rooms in the dead-end. As a general principle, the

stairway enclosure on upper floors should be arranged so that any part of a horizontal escape route which forms the sole means of escape from any portion of a building does not pass through the enclosure. The remedies for the faults illustrated in Diagram 7 are shown in Diagram 8. **It is in any event good practice to ensure that horizontal circulation routes allow protected stairways to be by-passed; this is essential in the design of new construction.**

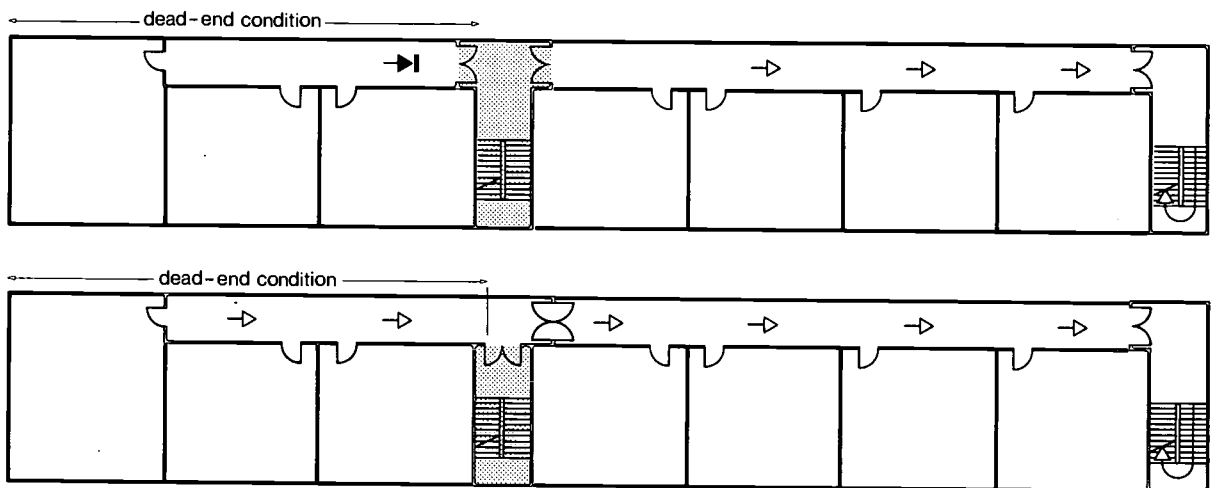

Diagrams 7 and 8 (existing buildings only)

Escape routes from dead-ends to protected stairways (paragraph 49)

Escape routes must not pass through any protected stairway on any floor where a dead-end condition occurs (and it is good practice to bypass protected stairways in all situations).

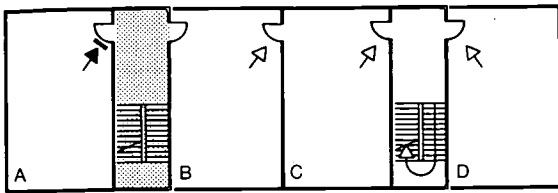

Diagrams 9 and 10

Alternative escape routes (paragraph 50)

A second exit through another room may provide an alternative escape route.

50. Another instance of faulty planning is illustrated in Diagram 9. Fire passing up the stairway may make escape by that route impossible and any room opening into the stairway enclosure should, if used for teaching purposes, have a second way out leading by a separate escape route to the final exit. Room A which has only one way out, is unsafe, but room B, which has a second way out through room C to another stairway, is safe. (The need to provide a second way out of a room which opens into a stairway enclosure does not apply to lavatories and washrooms.) One remedy for the fault shown in Diagram 9 is shown in Diagram 10.

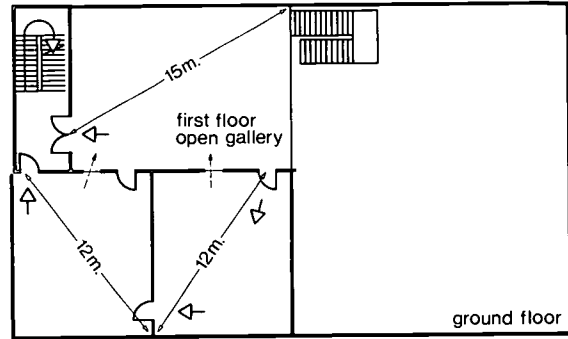
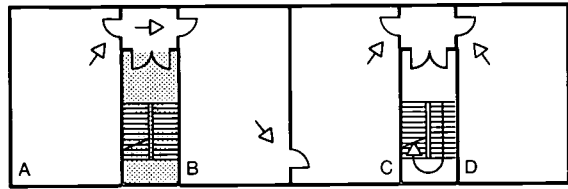

Diagram 11

First floor plan: open gallery condition (paragraph 51)

Open-plan on two floor levels

51. Rooms at an upper level reached by an accommodation staircase may open directly into an open gallery providing they have a second means of escape. Diagram 11 illustrates one example. No rooms opening into a protected stairway may be areas of high fire risk. Maximum travel distance across the gallery to the protected stairway is limited to 15 metres, and rooms should contain vision panels onto the gallery. The structure separating the gallery from any room must have a fire resistance of 30 minutes, and all doors to the gallery must be FD 30S. Any area of high fire risk below the gallery (eg kitchen) must contain smoke detectors as close to the gallery as possible.

1. Gallery served by an accommodation stairway must have an alternative means of escape.
2. Maximum distance to a protected stairway from any point in the open gallery is 15 m.
3. Rooms onto the gallery must have an alternative means of escape which may be via other rooms. In this case the direct distance from any part of the upper storey may not be more than 24 m from the protected stairway.
4. Rooms opening onto the gallery must contain vision panels and must not be areas of high fire risk.
5. Half-hour fire resistance is required between the gallery and any rooms opening onto it; the supporting structure to the gallery must also have half-hour fire resistance.
6. Class 0 surface spread of flame is required to all walls and ceilings to the gallery.

Arrangement of ground floor exits from stairway enclosures

52. A critical point in any escape route from buildings of more than one storey will be the way from the bottom of a stairway

to the open air. All persons descending from upper floors, and often those leaving the ground floor, converge upon and pass through this area. A fire spreading to it will make a whole escape route from every floor

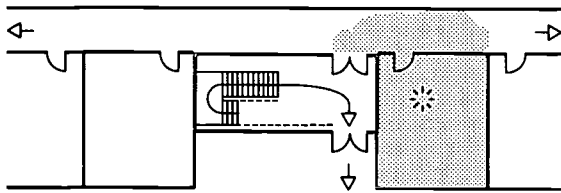

Diagram 12

Ground floor exit from a protected stairway (paragraph 52)

Preferred arrangement for final exit at ground floor level from a protected stairway.

useless. The simplest and safest precaution against such a risk is to provide a protected stairway enclosure which, on the ground floor, has a doorway leading directly to the open air and which, except for the minimum number of doors opening from the horizontal circulation area, is otherwise completely shut off. Such an arrangement is shown in Diagram 12, where the enclosure is connected to the rest of the ground floor by only one doorway into a corridor.

Two-storey buildings

53. Although the principles discussed earlier apply to all multi-storey buildings, the chance of persons escaping from the upper floor of a two-storey building is greater than it is in higher buildings because the vertical distance to the ground is shorter. The detailed recommendations that follow in paragraph 61 and 69 include several that apply specifically to situations in existing two-storey buildings; these situations should be avoided in the design of new construction (eg dead-ends, single stairways).

2 Precautions against fire

Planning means of escape

Room exits

54. More than one room exit must be provided from any room as follows:

- a. where the room is an assembly room, dining room or room likely to have more than 60 persons, in which case Table 1 will apply;

or

- b. if the dimensions of a room are such that any part of the room exceeds 12 metres direct distance from the room exit (Diagrams 22 and 23);

or

- c. if the room opens into a room or an area (including any area which can be associated with the horizontal circulation area by the use of movable partitions) which is a high fire risk; in this case the second exit must lead by a separate route to a final exit (Diagram 2 and 24);

or

- d. in a laboratory or other high fire risk room, if a single exit door would be in a hazardous position;

or

- e. in lecture theatres seating more than 60 on fixed seats. Lecture theatres which may be used by external users should be clearly labelled with large fire exit signs (see also paragraph 56).

55. Alternative room exits should be as far apart as possible, but in no case less than 45° taken from any point in the room (Diagram 22).

Exits from assembly halls¹ and other large spaces

56. Room exits direct to the open air (but not to an enclosed courtyard) are generally preferable. Where a room exit does not

discharge either direct to the open air or into a stairway enclosure, the distance to an external doorway or a stairway should be short and the route direct. At its narrowest point the route should not be less than the minimum clear width of doorway given in Table 1 below, relative to the number of occupants concerned. If more than one exit uses part or the whole of the same escape route, the width of the route should be increased accordingly. In the case of halls and large spaces without natural lighting, or likely to be used during the hours of darkness, emergency lighting should be considered. (This is covered in BS 5266: Part 1.)

57. Doors from rooms that may have more than 60 occupants should open in the direction of escape, or swing both ways. The locking of these doors, and all doors other than from dual-purpose areas, should be as in paragraph 90 (see paragraph 64 for dual-purpose areas).

58. In assembly halls deigned to seat more than 200 occupants, seats should be fixed together in groups of at least four if the hall is likely to be used frequently by a seated audience. In large assembly halls, consideration may need to be given to the desirability of fixing some or all of the seats to the floors, and to their arrangement, if fixed.

59. If the stage of an assembly hall is likely to be used for any purpose requiring scenery or costumes, or if a projection room is provided, adequate means of escape from these areas (and also the arrangement and construction of the projection and ancillary rooms) is especially important. Additionally, the projection room may also need to comply with the current cinematograph legislation. Advice should be sought from the local fire prevention officer.

¹ Paragraphs 56 to 59 apply to assembly halls when they are used solely for school or college activities. If they are licensed for public assembly, it will usually be necessary to obtain the approval of the local licensing authority whose requirements may not be satisfied by these recommendations.

Table 1 Exit widths of standard single and double internal doors, based on an evacuation rate of 40 persons per minute for 2.5 minutes

No of occupants* to room or hall	Minimum no of exits	Minimum clear width of each doorway opening
up to 60	1	0.726 m/0.826 m/0.926 m (0.800 m-1.000 m nominal)
100	2	0.726 m/0.826 m/0.926 m (0.800 m-1.000 m nominal)
200	3	0.726 m/0.826 m/0.926 m (0.800 m-1.000 m nominal)
300	4	0.726 m/0.826 m/0.926 m (0.800 m-1.000 m nominal)
213	2	1.124 m (1.200 m nominal)
273	2	1.424 m (1.500 m nominal)
327	2	1.724 m (1.800 m nominal)
387	2	2.024 m (2.100 m nominal)
426	3	1.124 m
546	3	1.424 m
639	4	1.124 m
654	3	1.724 m
774	3	2.024 m
819	4	1.424 m
852	5	1.124 m
981	4	1.724 m
1065	6	1.124 m
1092	5	1.424 m
1161	4	2.024 m
1308	5	1.724 m
1548	5	2.024 m

*With fixed seating, the same as the number of seats; otherwise, on the basis of 0.45 m² of floor area per occupant in assembly halls and 0.90 m² of floor area per occupant in dining spaces and gymnasias.

With two or three exits, each exit should lead by a separate route to a final exit. With four or five exits, one exit may use part or whole of the escape route from one of the other exits. All figures above one exit are based on the assumption of one exit being blocked.

The table is based on a unit of exit width=0.530 m per person. Above two units of exit width (1.060 m) each 0.075 m allows a further 15 persons in 2.5 minutes.

Boiler rooms

60. a. Exits from boiler rooms housing boilers over 45 kw capacity output should be to the open air only, and not less than 3 m from any other external doors.
- b. There should be an alternative means of escape (which may be raking steps with a balustrade) where any point in the boiler room is more than 6 m from the exit.
- c. Where an internal approach is proposed for boiler rooms of less than 45 kw capacity output, it must be through two separate self-closing fire doors, type FD 60S, with a space between them forming a ventilated lobby.
- d. Any boiler room should be separated from all other parts of the building by compartment walls and floors having a fire resistance of at least 2 hours as shown in note 3 of Table 4. The separation should comply with the current technical definitions and standards for such elements set out in the Approved Documents issued in support of the Building Regulations 1985.

Horizontal circulation areas

'Dead-end' situations

61. In the design of new construction horizontal circulation areas forming part of an escape route should have at least two ways out leading by separate routes to final exits. Where means of escape is possible in one direction only the accommodation up to the point where there are alternative escape routes or a final exit (or, for single stairway condition (paragraph 69), a protected stairway) is a 'dead-end'. In the context of the remodelling or adaptation of an existing building a 'dead-end' condition may be unavoidable; this is acceptable on any floor where the dead-end leads to alternative escape routes, otherwise on the ground or first floors only subject to the following:

- a. Dead-end horizontal circulation areas must be separated from alternative escape routes by fire doors.

- b. Dead-end horizontal circulation areas must be protected (paragraph 19) except where the direct distance to the furthest part of a dead-end does not exceed 12 metres when no protection is required (Diagrams 20 and 21). Any door separating the dead-end from an alternative escape route, protected stairway or protected lobby must be not less than FD 30S.
- c. No accommodation of high fire risk may be situated in a dead-end. No pin-board may be fixed in a dead-end corridor, nor any loose or combustible items such as furniture, clothes, etc stored there.
- d. The maximum direct distance from any point in the dead-end to an alternative escape route, protected stairway or protected lobby must not exceed 24 metres, of which 12 metres may be the direct distance in any room to the room exit. (Diagrams, 16, 17, 18 and 19.)
- e. The maximum travel distance from any point in the dead-end to the alternative escape route must not exceed 30 metres of which 18 metres is the maximum travel distance within any room.
- f. No inner room should be situated within any room in a dead-end.
- g. Exit doors from rooms should be staggered to help the free flow of persons escaping.
- h. Maximum number of persons in a dead-end situation or combination of dead-ends must not exceed 120 (Diagrams 16–19) or, if the escape route is unprotected, 60 (Diagrams 20 and 21).
- j. Minimum clear width of corridor to be 1.60 m unless only a single room of less than 60 persons is served by a corridor not exceeding 4.5 metres length when the minimum width may be 1.0 metres (Diagram 20). Dual-purpose areas may form part of the escape route in a dead-end but the conditions relating to dual-purpose areas are the same as those for corridors: they must be considered as part of the protected route (Diagrams 18 and 19).

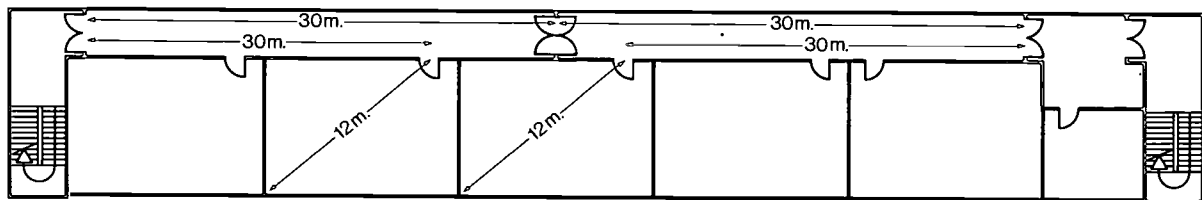

Diagram 13 (existing buildings only)

Protected corridor: alternative escape routes (paragraph 62)

1. Maximum distance from any point in a storey to a protected stairway, protected lobby, fire compartment with alternative exits or final exit, is 42 m.
2. Maximum direct distance from any room exit door to a protected stairway, protected lobby, separate compartment with alternative exits or final exit is 30 m.
3. Protected corridor to comply with paragraph 19.
4. Smoke control doors across escape route at approximately 30 m intervals.
5. Protected corridors may be used in existing buildings where the limitations on direct distances for unprotected corridors cannot be met; however in the design of new construction it is recommended that the travel distances which are given for unprotected corridors should apply in all cases.

62. If the horizontal circulation area between any protected stairways and compartment doors consists wholly of a protected route then at least one door from each room opening into the route should be within 30 metres of the nearest protected stairway, protected lobby or separate compartment door; however, no corridor should exceed 30 metres between either smoke control doors or fire doors (Diagrams 13 and 15).

63. If the horizontal circulation area has no protection, at least one door from each room opening into the corridor or dual-purpose area should be within 18 metres of the nearest protected stairway, protected lobby, separate compartment or final exit and the maximum direct distance from any point on a floor to the nearest protected stairway, protected lobby or separate compartment or final exit should not exceed 30 metres (Diagrams 14, 15, 22, 23, 24 and 25).

64. If dual-purpose or open-planned areas are part of an escape route, the precautions relating to door locks as recommended in paragraph 90 should be taken into account. The recommendation in the Department of Education and Science's booklet *Safety in science laboratories*, DES Safety Series No 2,¹ relating to the security of

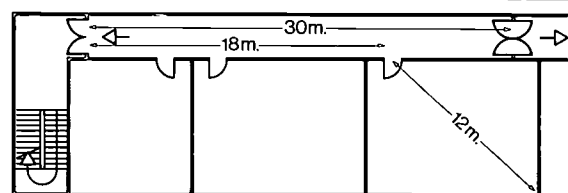

Diagram 14

Unprotected corridor: alternative escape routes (paragraph 63)

1. Maximum distance between smoke control doors FD 20S across escape route to be about 30 m.
2. Maximum direct distance from *any point on a storey* to a protected lobby, protected stairway, separate fire compartment with alternative exits or final exit is 30 m.
3. Maximum direct distance from room exit door to protected stairway (etc) is 18 m.
4. Doors into separate fire compartments must be of the same fire resistance as the compartment and should normally be in a closed position.
5. Compartments to comply with Table 4.

laboratories should also be considered in this connection. If laboratories or any other rooms are to be locked for security reasons when the premises may be occupied, this would preclude their use as dual-purpose areas forming part of any escape routes.

¹ *Safety in science laboratories*, HMSO (1978)

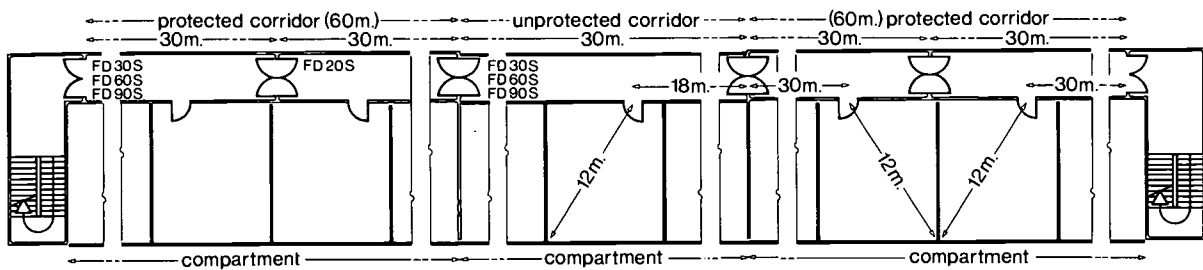

Diagram 15 (existing buildings only)

Protected and unprotected corridor: alternative escape routes (paragraphs 62 and 63)

1. Protected corridor to comply with Diagram 13 conditions.
2. Unprotected corridor to comply with Diagram 14 conditions.
3. Protected corridors may be used in existing buildings where the limitations on direct distances for unprotected corridors cannot be met; however in new buildings it is recommended that the travel distances which are given for unprotected corridors should apply in all cases.

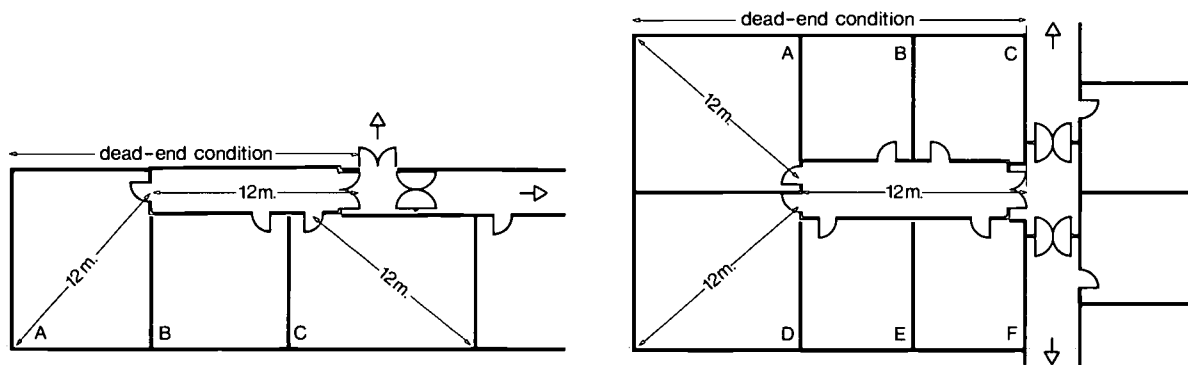

Diagram 16 and 17 (existing buildings only)

Dead-ends leading to alternative escape routes: any floor (paragraph 61)

1. Maximum number of persons to rooms A—C (Diagram 16) and A—F (Diagram 17) is 120.
2. Maximum distance from any point in a dead-end to an alternative escape route or final exit is 24 m.
3. Maximum direct distance to a room exit from any point in a room is 12 m.
4. Dead-end corridor to be protected as paragraph 19.
5. Minimum clear width of corridor is 1.6 m (except where paragraph 61(j) applies).
6. No area of high fire risk to be in a dead-end.
7. No room should contain an inner room.

65. In single-storey buildings or parts of buildings and on the ground floors of educational establishments of greater height, the limitations of paragraphs 61, 63 and 64 will apply if escape is possible only through the normal circulation area. If, however,

every room opening into a horizontal circulation area has a second way out direct to an unenclosed external space, then no planning limitations on the horizontal circulation area are necessary.

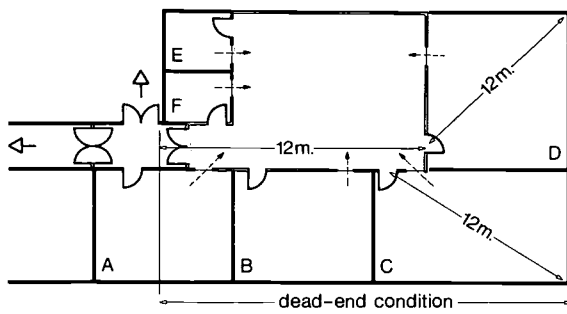

Diagram 18 (existing buildings only)

Dead-end including dual-purpose area leading to alternative escape routes: any floor (paragraph 61)

1. Maximum number of persons to rooms B-F and the dual-purpose area is 120.
2. Distances as Diagrams 16 and 17.
3. Vision panels from rooms B-F required.
4. Dual-purpose area to be protected and have a Class 0 surface spread of flame to walls and ceiling.
5. No area of high fire risk in a dead-end.
6. No room should contain an inner room.

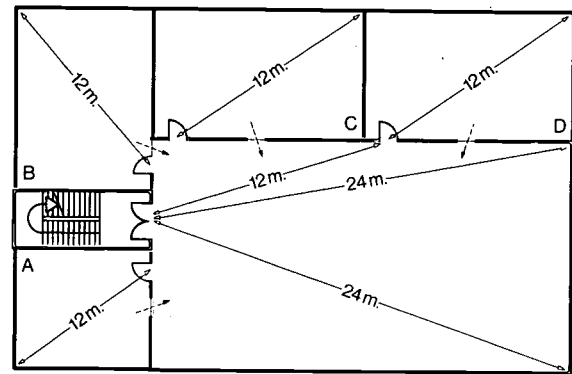
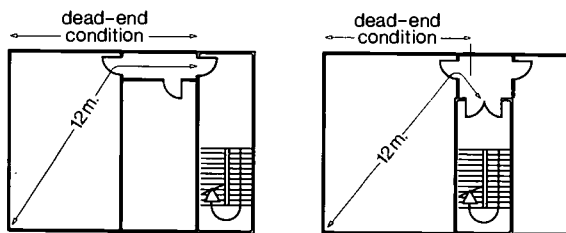

Diagram 19 (existing buildings only)

Dead end including dual purpose area leading to a single escape route: first floor only (paragraph 61)

1. Diagram 18 conditions apply for distances and protection.
2. Maximum number of persons is 120.
3. Vision panels between rooms A, B, C, D and dual-purpose area required.
4. No area of high fire risk in a dead-end.
5. No room should contain an inner room.
6. On the ground floor a protected lobby would be required between the stairway and the dual-purpose area (paragraph 69(c)).



Diagrams 20 and 21 (existing buildings only)

Dead-end leading to single escape route, ground and first floor only: unprotected route (paragraph 61)

1. Where the maximum direct distance from the furthest part of a dead-end does not exceed 12 m to a protected stairway, alternative means of escape or final exit, no protection is required. (paragraph 61(b)).
2. Maximum number of persons is 60 (paragraph 61(h)).
3. Class 0 surface spread of flame to corridor walls and ceiling.

Other recommendations

66. The width of corridors forming part of an escape route should be adequate for the numbers likely to use them. For example, a corridor of 1.6 m width will be adequate for 300 persons where one unit of exit width = 0.530 metres, the flow rate is 40 persons/minute and the escape time to the next compartment is 2.5 minutes (see paragraph 38).

$$(3 \times 40 \times 2.5 = 300)$$

Over 2 units of exit width, each additional 0.075 m allows a further 15 persons in 2.5 minutes. Short corridors serving small numbers can be less, based on this formula, but in no case should be less than 1.0 m wide. Where separate escape routes converge, the combined route should be adequate for the total numbers of the separate routes. The junction should be designed to ensure that there is no impediment to the free flow of persons

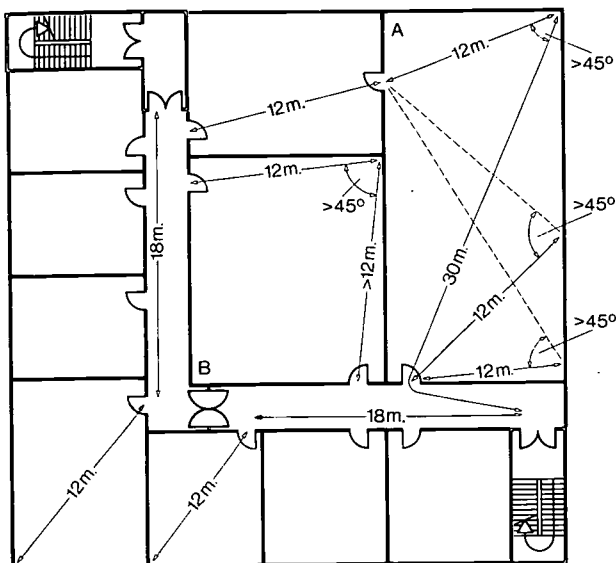

Diagram 22

Room exits, alternative escape routes: any floor (paragraphs 54, 55, 57, 63)

1. Rooms containing over 60 persons, or where the distance within the room to the room exit exceeds 12 m, should be provided with a second way out (Table 1). No part of a room should be further than 12 m from an exit from that room.
2. Exits from a room should be more than 45° apart from any point in that room.
3. Diagram 14 conditions apply.

escaping. Doors opening into corridors should, where possible, be staggered to assist the quick exit from any room. All corridors should be well lit and ventilated, where possible, at high level. Consideration should be given to the provision of

emergency lighting to escape routes when the buildings may be used during the hours of darkness (see also paragraph 56).

67. If steps are required for small changes of level in horizontal circulation areas, there

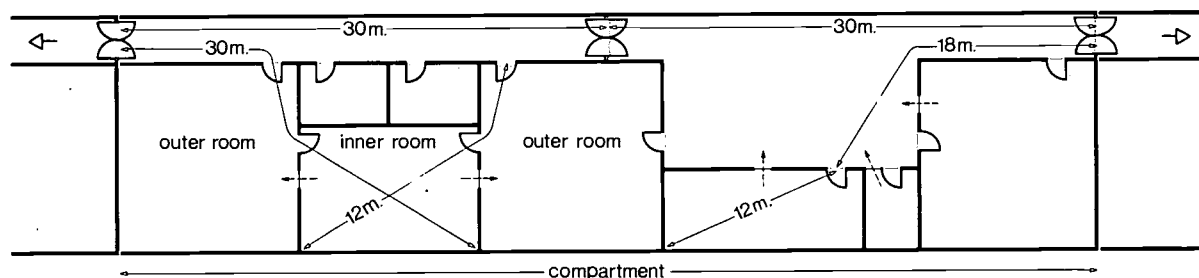
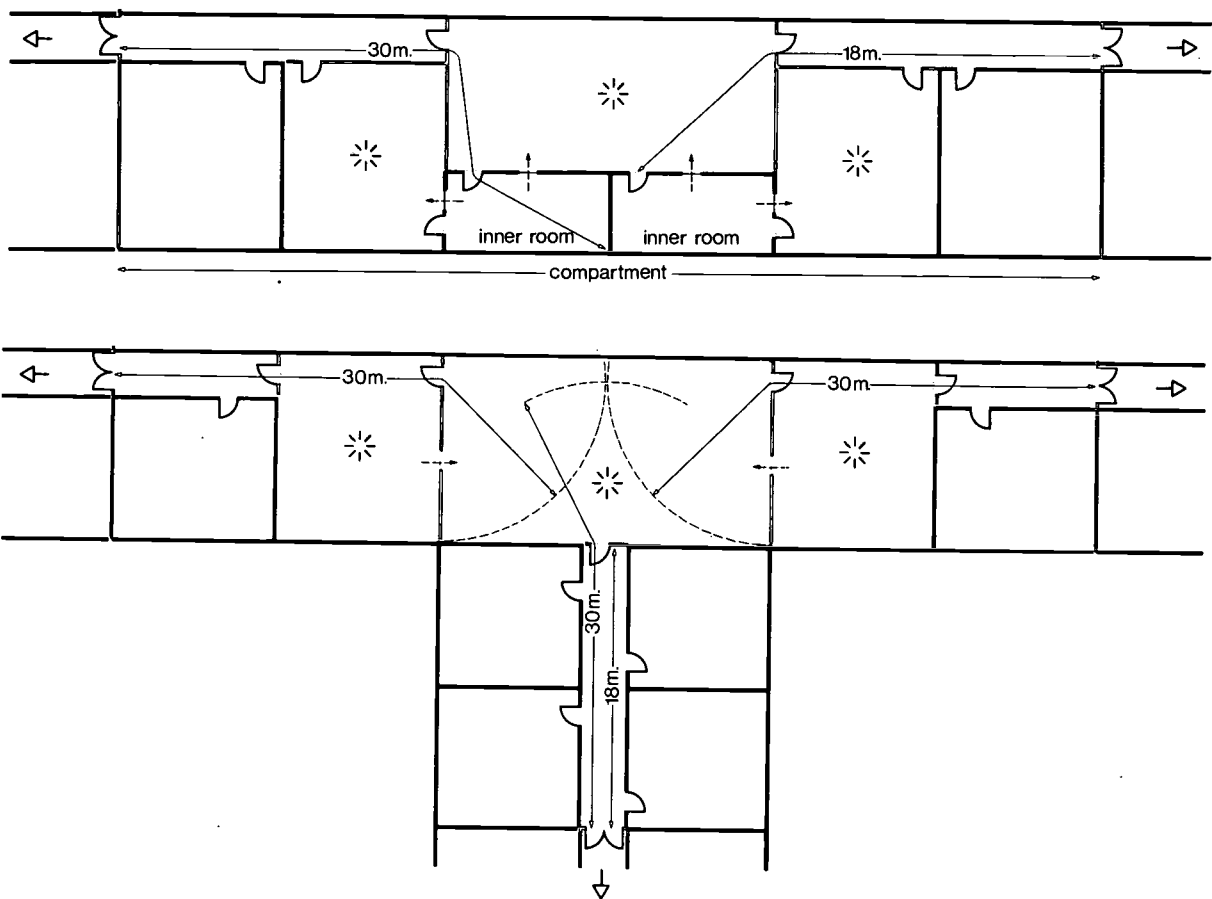

Diagram 23

Inner rooms, alternative escape routes: any floor (paragraphs 42, 46, 54, 55, 63)

1. Distance from any point in an inner room to an exit from the outer room should not exceed 12 m. If this distance is exceeded, a second way out of the inner room must be provided leading to an alternative exit.
2. Maximum distance from any point in a storey to a separate compartment with alternative exits, protected stairway, protected lobby or final exit is 30 m.
3. Maximum distance from any outer room exit to a protected stairway, protected lobby, separate compartment with alternative exits or final exit is 18 m.
4. Inner rooms should contain vision panels onto the outer room or dual-purpose areas.
5. Inner rooms opening into rooms or dual-purpose areas of high fire risk must have a second way out leading to an alternative exit.



Diagrams 24 and 25

Dual-purpose areas with fixed partitions, alternative exits leading to separate escape routes: any floor (paragraphs 40,42, 54, 64, 68, 95)

1. Maximum distance from any point in a storey to a protected stairway, protected lobby, separate compartment with alternative exits or final exit is 30 m.
2. Dual-purpose areas with fixed partitions which may be areas of high fire risk must have alternative exits leading to separate escape routes.
3. Inner rooms opening onto dual-purpose areas should contain vision panels onto the dual-purpose area; if opening onto an area of high fire risk, they must have an alternative escape route.
4. Door type FD20S to be provided at approximately 30 m intervals across escape routes or FD30S if dual purpose area high fire risk.

should be at least three risers together. If such steps are associated with a door then a landing of at least 900 mm should be provided in front of the door. For such steps each riser should not be more than about 150 mm and the tread not less than 300 mm.

68. All glazing in partitions between any room of high fire risk and any horizontal circulation area should:

- a. be fixed with no openable sections

- b. provide an equivalent level of fire resistance (if tested in accordance with BS 476 Part 22) as the structure into which it is installed (but not less than 30 minutes). The requirement for insulation need not be met, provided that no glazing extends below 1100 mm above floor level.

Additional information on fire performance of glazing is published in BSI PD 6512 Part 3 'Guide to fire performance of glass'.

The number of stairways¹

69. In the design of new construction single stairway conditions should be avoided. In the case of existing buildings a two-storey building or two-storey part of a building may have only one stairway, which must be a protected stairway, provided that:

- a. there are not more than 120 occupants on the upper floor; and
- b. the distance between the stairway and the door of the furthest room is not more than 12 m where the horizontal circulation area leading to the stairway is a protected corridor having fixed partitions, or is a protected dual-purpose area (Diagram 19); and
- c. the stairway is protected as described in paragraph 18 and the only internal doors opening into the stairway enclosure on the ground floor are from lavatories or horizontal circulation areas which are not dual-purpose areas; at first floor level if an opening into the stairway enclosure is from a dual-purpose area, this must not be an area of high fire risk; and
- d. the staircase is of limited combustibility as described in Table A7 of Approved Document B 2/3/4 issued in support of the Building Regulations 1985.

Otherwise all parts of a building above the ground floor should have at least two protected stairways.

70. More than two protected stairways may be required:

- a. to conform with the recommendations in paragraphs 62 and 63 about the maximum distance to the nearest protected stairways in horizontal circulation areas; or
- b. to satisfy the recommendations in Table 2 about the width of stairways in relation to the number of occupants who will be using them; or
- c. to conform with the recommendations in Table 1 about exits from assembly halls when they are on a floor above the ground floor.

71. No stairway should be of less than 1050 mm clear width² between handrails. No stairway should become narrower in the direction of escape.

72. In buildings or parts of buildings with two, three or more stairways interconnected at every floor level by horizontal circulation areas, the minimum width of the stairways (except as mentioned in paragraph 75) should be as in Table 2 according to the height of building and the total number of occupants accommodated on all floors above ground floor.

73. A stairway that serves part of an assembly hall, but does not also serve any other part of the building, should be at least the width of the assembly hall exit leading to it. If a stairway also serves other parts of the building, its width generally should be determined from Table 2 but, from the level of that part of the assembly hall which the stairway serves to ground level, the width of the stairway should in no case be less than the width of the assembly hall exit doors leading to it.

74. Stairways should be clear of all obstructions. Any stairway (but not steps of the kind referred to in paragraph 67) that is more than 1800 mm wide should be divided with one or more handrails, and no part of

1 In the past, some buildings have been provided with external 'fire-escape' stairways. Experience has shown that these are often vulnerable to attack by fire from adjoining doors and windows, that proper maintenance is frequently neglected, that under some weather conditions they may be unsafe in use and that the occupants are often unfamiliar with them. For these reasons, external fire-escape stairways should not be used in new buildings more than two storeys high. If the use of an external fire-escape staircase is unavoidable it should not pass near to windows, but any window within the following distances of an escape staircase should be fixed shut (with fire-resisting glazing (see paragraph 68(b)) to give at least half hour fire resistance: horizontally 1.8 m, vertically downwards 9 m, vertically upwards 1.8 m. The distances should be measured from the nearest tread or landing of the staircase. All doors giving access to the stairs below top level should be half hour fire doors. Spiral staircases are not recommended for means of escape.

2 The widths recommended in Table 2 will allow a building to be evacuated quickly in an emergency. Designers may consider that these widths would not be enough in all cases for normal day-to-day use (when traffic will often be in both directions at the same time). It is emphasised that the widths recommended have only been considered for emergency use. Furthermore, it has been assumed that approximately the same number of occupants will be using each stairway.

Table 2 Minimum clear width of stairways where there are TWO stairways

Height of building in storeys (from final exit doors)	Maximum number of occupants on all upper floors*				
	1050 mm	1200 mm	1350 mm	1500 mm	1650 mm
2	260	290	330	360	390
3	300	340	380	430	480
4	340	390	440	500	560
5	390	450	510	580	650
6	430	500	570	650	730
7	470	550	630	720	810
8	510	600	690	790	890
9	550	650	750	860	970
10	600	710	820	940	1060

In buildings with three stairways the values in this table should be multiplied by 1.8. Where there are more than three stairways the maximum number of occupants on all upper floors will be obtained by multiplying the values:

1. above the dotted line by 0.625 × number of stairways
2. below the dotted line by 0.670 × number of stairways

* For the purpose of calculating the widths of stairways and the numbers and widths of exits generally, the number of occupants in any part of an educational establishment should be calculated on the following basis:

Dining rooms (or areas used for dining) and gymnasia	0.90 m ² of floor area per occupant
Teaching rooms and non-teaching accommodation	The maximum number of occupants for which the room is designed
Assembly halls	0.45 m ² of floor area per occupant

a stairway so divided should be less than 1050 mm wide. There should be a continuous handrail on each side.

Stairway flights

75. Every stairway should be designed to ensure ease and safety according to the use for which it is designed. Risers should not be more than 163 mm. Goings should preferably be 280 mm and must never be less than 250 mm. No flight of stairs should have more than 16 or less than 3 risers. (See paragraph 67.)

76. There should not be more than two successive flights without a change of direction. The length of landing between

flights, whether there is a change of direction or not, should not be less than the width of the stairway; where doors open onto landings (except at the top of steps or a stairway; see paragraph 89) the doors should not reduce the effective passageway round the landing to less than the width of the stairway (Diagram 26).

Stairway enclosures

77. Throughout its entire height, every stairway used for means of escape should be individually protected (other than any part which is an external wall of a building) from the ceiling of its top floor to its final exit doors.

78. The protecting walls of every stairway enclosure including any glazing (but see also paragraph 79) should have the period of fire resistance required for elements of structure recommended in Table 4 (other than any part which is an external wall of a building).

79. Any glazing to protected stairways other than in external walls (but see note to paragraph 69) should satisfy the criteria for integrity to BS 476 Part 22 and PD 6512 Part 3. The criteria for insulation can only be achieved by the use of special glazing. If this requirement is to be avoided, the glazing should be restricted to areas 1.1 m above the floor level. However, where a protected lobby adjoins a protected stairway there is no requirement for insulation to glazing between the two. Where the protected stairway forms the single means of escape, or the stairway is in part of a building requiring a fire resistance to the stairway of one hour or more, then no glazing should be incorporated into the protecting structure.

80. No part of a stairway enclosure shall

open directly to an area of high fire risk. No part of a stairway enclosure should impede persons attempting to escape from the building.

81. The lining materials to walls and ceilings in protected stairways should be non-combustible or possess a Class 0 surface (see paragraph 18) but doors and door frames, frames in which glazing is fitted and architraves, skirting and similar narrow members are exempt from this requirement providing they are not made of plastic.

Openings into stairway enclosures

82. In the design of new construction only lavatory accommodation, a horizontal circulation area or a protected lobby should open directly into a stairway enclosure. In the case of existing buildings the door from any room (except a boiler room, a store, a cleaners' cupboard, or any area of high fire risk) may open directly into a stairway enclosure, although this should be avoided if at all possible (for openings into single stairways see paragraph 69(c)).

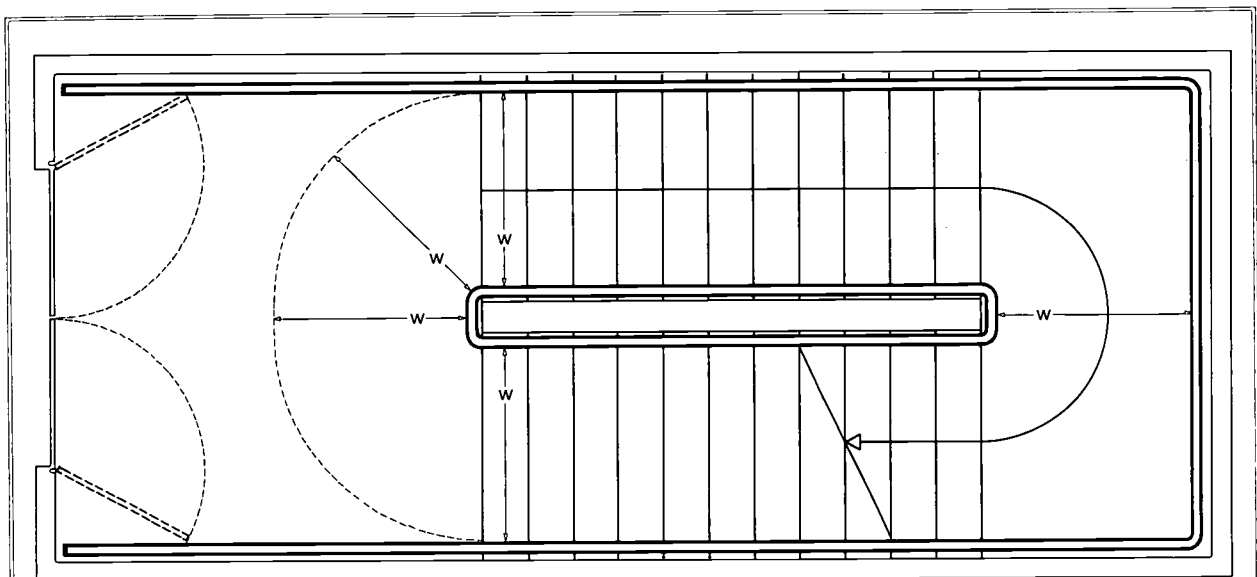

Diagram 26

Doors opening into protected stairways (paragraph 76)

1. Doors opening into stairways must not obstruct flow of persons descending.
2. The minimum clear width of the stairway must be maintained throughout its height.
3. The minimum landing at the head of any protected stairway can be 0.9 m between the doors opening into the stairway and the edge of the top stair.

83. Every opening into a protected stairway should be provided with a fire door having a rating equal to that of the protecting structure (see paragraph 79).

Smoke removal from protected stairways

84. Protected stairways should include effective means of smoke removal. This should include ventilation at the head of the stairway which can be by natural means or by mechanical extractors.

Final exits from stairway enclosures

85. Every stairway enclosure should have direct access through its own external doors to the open air clear of the building and not open into an enclosed courtyard. These external doors should be clearly visible and so placed as to make clear the direction of escape to the open air.¹ There should be no doors across the escape route between the bottom of the stairway and the external doors, other than the internal doors of an external lobby, if provided.

86. External exit doors from every stairway enclosure should, when open, be at least the full width of the stairway and, where they may be used by occupants leaving both the ground and upper floors, should be wider than the stairway by at least the amount shown in Table 3.

¹ This recommendation is made because, if there is a basement, there is a danger that people may descend below ground floor level; escape to the open air should be clearly defined at ground floor level.

Doors

General recommendations

87. Specific recommendations have already been made about:

- a. the number of room exit doors (paragraph 54),
- b. the distance of room exit doors from stairways or external doors (paragraphs 61, 63 and 69(b)),
- c. doors across horizontal circulation areas (paragraphs 61, 62 and 63),
- d. doors into stairway enclosures (paragraphs 28, 29, 79, 82 and 83), and
- e. ground-floor exit doors from stairways (paragraphs 85 and 86).

Recommendations of a more general nature are contained in the following paragraphs.

88. All doors across escape routes (except from rooms or spaces having less than 60 occupants, calculated according to the notes to Table 1) should open in the direction of escape or swing both ways. Every door opening outwards into a corridor should be arranged so that when open it does not obstruct the corridor. Revolving or sliding doors should not be provided across any escape route.

89. Every door opening onto steps (including any door at the head of a stairway) should have a landing at least 900 mm long between the door in its closed position and the edge of the top step. Where there are landings between flights, paragraph 76 will apply.

Table 3 Additional width for external doors serving ground and upper floors

Number of occupants from ground floor using doorway*	Minimum addition to stairway width required for external doorway width
up to 50	300 mm
51-100	550 mm
101-150	800 mm
151-200	1050 mm

* See notes at foot of Table 1.

90. Doors across escape routes should always be capable of being easily opened from the side from which escape is required.¹ A lock, if provided, should not require a key to open the door in any direction likely to be used for escape.²

91. To be effective, fire doors into protected stairways, compartments or protected lobbies should be kept closed at all times. Smoke control doors across corridors may, however, be held open with electro-magnetic or electro-mechanical devices operating as described in paragraph 31. No fire door should ever be held open on a wedge. A warning note such as 'Fire door: keep shut' should be fitted in a prominent position on both sides of all fire doors; and all fire and smoke control doors should be closed when the building is unoccupied.

1 It should be noted that doors across horizontal circulation areas may need to be used for escape in either direction.

2 This recommendation will be satisfied in respect of external doors, where locks will generally be needed, if the doors can at all times be opened from the inside either by pressure (as when panic bolts are fitted) or by turning a single action (espagnolette bolts are one way of securing a pair of doors so that both doors are released by a single action).

3 Structural fire precautions

General requirements

92. Safety in any building is closely connected with the structural fire precautions. These include:

- a. limiting the use of combustible materials
- b. the use of fire resisting construction
- c. restricting the spread of smoke and flames both on and within the construction
- d. precautions limiting the spread of fire from building to building.

The use of fire resisting construction

93. Table 4 shall apply.

94. The following hypothetical examples illustrate the use of Table 4:

- a. A single-storey building of floor area 790 m². Since the floor area does not exceed the limits shown on the first line of the table there are no requirements for the fire resistance of the elements of structure.
- b. A single-storey building of floor area 1000 m². Since the floor area exceeds 800 m² the designer has the choice of providing elements of structure of half-an-hour minimum fire resistance, or of dividing the area into 2 parts neither of which exceeds 800 m² in area by a compartment wall having half-an-hour minimum fire resistance.
- c. A large single storey sports hall complex where the compartmentation size of 800 m² is too onerous is limited to a volume of 8,500 m³ and requires a fire resistance to elements of structure of half-an-hour.

95. In order to restrict the spread of flame over surfaces (see paragraph 24):

'PROTECTED STAIRWAYS, PROTECTED CORRIDORS AND PROTECTED LOBBIES' (paragraphs 18, 19 and 20) shall have

Class 0 wall and ceiling surfaces (paragraph 81).

'HORIZONTAL CIRCULATION AREAS' (paragraph 15) shall have Class 0 wall and ceiling surfaces except that 20% of the total wall and ceiling surfaces may be Class 1 where rooms opening onto it have alternative means of escape (paragraphs 41 and 42). The area of Class 1 materials can exclude doors but must include all sliding and folding partitions, display boards and applied trim exceeding 300 mm in exposed girth.

'SMALL ROOMS' which shall mean spaces not exceeding 30 m² in area. All wall and ceiling surfaces in these rooms shall be at least Class 3.

'ROOMS OTHER THAN SMALL ROOMS' (exceeding 30 m²) shall have wall and ceiling surfaces of at least Class 1 except that 20% of the total wall and ceiling surfaces may be Class 3. The area of Class 3 materials can exclude doors but must include all sliding and folding partitions, display boards and applied trim exceeding 300 mm in exposed girth.

'AREAS OF HIGH FIRE RISK' (paragraph 16) shall have wall and ceiling surfaces of Class 0.

96. Guidance about the use of plastic materials is provided in Appendix B of Approved Document B 2/3/4 issued in support of the Building Regulations 1985.

Restricting the spread of flame and smoke: cavity barriers

97. Experience has shown that fires can spread very rapidly in cavities in walls, floors and roofs thus causing extensive damage by smoke and flames. To restrict such damage cavity barriers are required as follows:

- a. At any junction of cavities in compartment walls, external or stairway walls, floors or roofs and at junctions of cavities between these and other similar walls, floors or roofs. Where walls break the continuity of fire-

resisting ceilings, cavity barriers should be provided unless such walls are made of non-combustible materials (see paragraph 23).

- b. At intervals no greater than 20 m in any direction in a cavity where all surfaces within that cavity have Class 0 surface spread of flame.

- c. At intervals no greater than 8 m in any direction and with junctions at ceilings in a cavity where any surfaces within that cavity have Class 2 or Class 3 surfaces.

98. Surfaces of Class 4 should not normally be exposed within cavities. Where this is unavoidable, the continuous volume of that

Table 4 Standards of fire resistance of elements of structure to apply in lieu of Table 5.1 in the Approved Document B 2/3/4 of the Building Regulations 1985

Number of storeys (notes 1 and 6)	Maximum height of building structure (m)	Maximum floor area of a storey or compartment (m ²)	Maximum cubic capacity of building or compartment (m ³)	Minimum fire resistance in ground floor or upper storeys of structure and compartment walls (notes 2, 3, 5 and 6) (hours)	Minimum fire resistance in basement storey of elements of structure and compartment walls (note 3) (hours)
1	No limit	800	No limit	Nil (note 4)	1 (note 5)
1	No limit	No limit	8500	0.5	1
2-4	No limit	800	No limit	0.5	1
5-7	No limit	800	No limit	1	1.5
over 7	No limit	800	No limit	1.5	2

Note 1: Regardless of the number of storeys 'fire rated' stores may have to be provided to meet particular needs within buildings, eg storage of chemicals in bulk for use in laboratories or for the storage of PE equipment containing cellular foam; storage areas should be enclosed in one hour rated construction and be provided with one hour self-closing fire doors.

Note 2: A roof beam in a structural frame is regarded as an element of structure if, in the case of fire, the early collapse of the beam would deform the remaining structure.

Note 3: Except Boiler Rooms, which in every case should be separated from all other parts of the building by construction having a fire resistance of at least 2 hours. Additionally where a boiler room is adjacent to a building more than 4 storeys high, the whole of its roof structure should have a fire resistance of at least 2 hours and be non-combustible.

Note 4: Except the following which should have a minimum fire resistance of half-an-hour:

- i compartment walls and supports to a gallery
- ii external walls (and their supports) requiring fire resistance because of their proximity to a boundary or a building (see Approved Document B4 Purpose Group Assembly)
- iii protected corridors.

Note 5: Any internal oil storage must be in a completely separate one hour compartment with a catch pit which is imperforate.

Note 6: Where a building comprises different storey heights, the different levels may be separated by compartmentation with each level assessed on its own storey height. Where this is not possible, the higher level of resistance shall apply to the whole building.

cavity should be restricted to 4 m in any direction between cavity barriers. An alternative way of dealing with this problem is to provide cavity barriers at 8 m intervals and separate the cavity from adjoining accommodation by a jointless¹ ceiling or a partition of half-hour fire resistance.

99. Cavity barriers are likely to be more effective if their location coincides with some permanent divisions within buildings. Where any services pass through a cavity barrier, the effectiveness of the cavity barriers must be maintained. At least one intermediate cavity barrier should be formed between every two adjacent stairway enclosures. Cavity barriers should comply with Paragraph G8 of Appendix G of Approved Document B 2/3/4 to the Building Regulations 1985.

100. In the case of pitched roofs it is thought likely that the behaviour of fire may be different from that in a flat roof cavity. On the other hand it has to be recognised that the installation of cavity barriers in pitched roofs is more costly and probably less effective when compared with flat ones. Pitched roofs are often associated with jointless ceilings, with occasional access openings for maintenance work, which can provide half-hour fire resistance; in general they offer better long-term protection to the cavity above than would a demountable ceiling. In these circumstances cavity barriers should be at 20 m intervals in any direction.

101. In order to prevent condensation some cavities, especially in roof zones, have to be ventilated and it has to be recognised that there is a conflict between this need and the need to provide cavity barriers. In most instances cavity barriers may be located in such a way that cross ventilation through openings in the eaves will be possible. In other cases ridge or other forms of roof ventilator should be provided.

102. For a fuller discussion of provision of cavity barriers see Appendices G and H of Approved Document B 2/3/4, issued in support of the Building Regulations 1985.

Ventilation and heating ducts

103. Particular care is necessary to ensure that any ducts passing through compartment walls and floors are fire stopped externally and fully protected by internal fire dampers with the appropriate fire resistance. Should ducts pass through cavity barriers in ceiling voids, care must be taken to ensure that the resistance of the cavity barrier to the passage of flame and smoke is not reduced. Where ducting or the ceiling void is used to carry air into more than one space, it is essential that the plant is shut down by the action of *smoke detectors* as soon as any combustion gas enters the system, or by the operation of the fire alarm. Particular care should be taken to ensure that smoke laden air is not drawn across or through escape routes.

Limiting the spread of fire from building to building

104. Buildings should also comply with the requirements from Part B4 of Schedule 1 (external fire spread) to the Building Regulations 1985 and the relevant parts of B 2/3/4, Approved Document purpose group assembly, with the exception of Table 5.1 (for which Table 4 in this Bulletin should be substituted), paragraph 5.11, and Diagram 5.1.

¹ The term 'jointless' is used to describe a type of construction of a ceiling which provides a certain level of security in its fire performance when a building is in every day use, including maintenance of services which are commonly run in ceiling cavities. Other types of ceilings with the required level of fire resistance would be acceptable, provided they include technical means of achieving a satisfactory security in use for such a performance.

4 Fire warning systems and fire fighting

General requirements for fire warning systems

105. An audible fire warning system should be provided in every educational establishment as the first link in the chain of precautions. The occupants must be warned quickly of any outbreak so that they can leave the building without delay. Fire alarms are covered in BS 5839 *Fire detection and alarm systems in buildings*, Part 1 'Code of Practice for installing and servicing'.

106. There are three main types of warning system:

- a. Electric bells activated manually from one or more call-points. Provision should be made so that the warning, once activated, continues to sound automatically. Modern systems of this kind overcome the disadvantage described in c. below, but are more expensive to install and maintain.
- b. Electric bells activated by some kind of automatic detector. These may also be incorporated in the system described in a. above. Automatically activated systems are usually installed in buildings where a fire might burn undiscovered for some time. The installation of such systems will have to be considered in each case on a risk assessment basis.
- c. Hand-operated fire-bells or sounders mounted at suitable points in the building. These should only be used in certain small buildings (see paragraph 111). They need little maintenance but have disadvantages—a warning, once given, should continue until everyone is out of the building, and with hand-operated bells this may not be possible. Any one sounder should be audible throughout the building.

107. The same type of system and alarm should be used throughout all parts of an establishment and each category of equipment should be standard throughout

the establishment, and, if possible, throughout a local authority's area.

108. In establishments which consist of several separate buildings, the same system should be installed in all parts, but the system in each separate building may be self-contained, so that an alarm may be sounded in one part without automatically operating throughout the rest of the establishment.

109. Whatever type of system is installed, the alarm note, whether intermittent or continuous sound, should differ from any other signal. When sounded, it should be capable of being heard above any other expected noise. If a class change bell is used as a fire alarm it is recommended that a continuous tone be the warning for fire and an intermittent tone for class changes (but see also paragraph 111).

Installation of fire warning systems

110. Precise recommendations cannot be made in this Bulletin about the type of fire-warning system to be installed in a particular establishment or about the method of installing it, since a satisfactory solution in any one case will depend largely upon the design and use of the building and the nature of the escape routes from it.

Type of system

111. In buildings of one storey, with less than 160 pupils or students, a system of hand-operated fire-bells or sounders may be sufficient, provided that any one sounder is audible throughout the premises. In establishments of which any part is more than one storey high, an electric warning system, manually operated from call-points of the kind described in paragraph 115, will normally be required.

112. Power for electrical systems for fire alarms must be reliable and independent of

the public electricity supply system.
Detailed guidance is given in BS 5309.

Call-points

113. Call-points should be in prominent positions preferably on escape routes and should be placed so that the walking distance to the nearest call-point is nowhere more than 30 m.

114. There should be at least one call-point on every floor. A call-point should be provided in or close to every kitchen, laboratory, workshop, housecraft and craft room, and assembly hall.

115. Call-points for electric systems should preferably be of the 'break-glass release' type to BS 5839 Part 2 with the facility to operate the alarm for test or practice purposes without breaking the glass.

116. Indicator boards, which show the call-points from which the warning has been given, are necessary in larger establishments. BS 3116 Part 4 'Control and indicating equipment' is the relevant Standard.

Fire fighting by the fire brigade

117. Earlier parts of this Bulletin have been concerned with measures of passive defence against fire. It is also necessary to consider what active measures are required to assist the fire brigade and the establishment's occupants to combat the spread of fire.

118. The Chief Fire Officer should always be consulted early in the planning stage about facilities for fire fighting by the fire brigade. Local conditions may differ from area to area, but the following basic facilities will normally be needed:

- a. Means of access to the building. When the building is some way back from the public highway, road access for fire appliances will be necessary. Any entrance through which appliances may need to pass should be a clear 3 m in width with 3.7 m headroom and there must also be adequate space to enable appliances to turn. Any

roadway should be at least 3.7 m wide to allow for the operating widths of fire appliances.

- b. Water supply. Even where there are sufficient hydrants available on public mains, it may still be necessary to install one or more hydrants on the site if the building is set far back from the road. The fire brigade should not normally have to lay more than 70 m of hose to the building entrance, and the distance of the building from the nearest hydrant must allow for this.¹ The adequacy of water supply should be checked periodically.
- c. Internal equipment. Internal hydrants or dry risers will not normally be required unless the building is more than four storeys in height or there are special circumstances.

Fire fighting by the occupants

Types of equipment

119. Fire fighting equipment is needed in all educational establishments, but it should be strictly limited to what is necessary and to what can be used effectively with little training after the safety of the occupants has been ensured (see paragraph 127). The Chief Fire Officer should be consulted about the nature and installation of fire fighting equipment in particular cases, especially in high buildings, and the necessary periodic testing of equipment. The usual types of equipment are:

- a. Hosereels, which may be considered by the chief fire officer to be preferable, especially in larger buildings or where there are special risks, as an alternative to portable water extinguishers.
- b. Portable fire extinguishers, which may prove to be the most satisfactory means of dealing with the types of fires generally met in smaller establishments. Such fires fall into

¹ If the public water supply is limited, it may be necessary to make special arrangements. With little expense natural sources can often be utilised if preparations are made beforehand.

two categories: those involving ordinary combustible materials such as wood, paper and textiles, and those involving flammable liquids such as oils, solvents used in chemistry, and cooking fat. For dealing with the first of these, water extinguishers are suitable. For fires involving flammable liquids where the use of water would be hazardous, either foam, dry powder, BCF or carbon dioxide extinguishers may be used. Carbon dioxide and BCF extinguishers should only be used in unconfined well ventilated areas due to the slight toxic risk associated with their use.

- c. Buckets of sand when provided in conjunction with an appropriate portable fire extinguisher,¹ are useful in a laboratory particularly for the containment of spillages of flammable or other heavy liquids. Nearly every kind of outbreak likely to occur in a

laboratory can be dealt with by one or the other.

- d. Fire blankets are invaluable in dealing with people whose clothes are alight; they should be wrapped and rolled in a blanket. Fire blankets stored in containers can also be used to smother small fires involving cooking fat and other flammable liquids. The relevant standard is BS 6575.

120. Each type of fire fighting equipment should be standardised throughout an establishment and should be in accordance with the appropriate British Standard. Any equipment involving the use of water, whether hose reel or extinguisher, must not be used in fire fighting if live electrical services are known or thought to be present. For fires in electrical apparatus non-conducting fire extinguishing agents such as BCF, carbon dioxide or dry powder should be used.

¹ In some laboratories where very volatile liquids are used or fragile equipment is installed, dry powder or carbon dioxide extinguishers may be preferable to foam.

Installation of equipment

121. At least one portable fire extinguisher should be provided in each position as

Table 5 Installation of fire extinguishers in areas of high fire risk

Location	Type of extinguisher
Every craft room Every workshop Stage of every assembly hall	Water
Every laboratory* Every housecraft room#	Foam or dry powder or BCF
Every boiler room where oil fuel is used	Foam
Every kitchen	Foam or dry powder

* See paragraph 121

Where there is no fixed frying equipment, dry powder extinguishers may be preferable to foam. These last two types of extinguishers also have the characteristics of being non-conductors of electricity, which may sometimes be advantageous.

specified in Table 5. Water and foam extinguishers should be of about 9 litres capacity (13A)* and dry powder types should contain about 1.5 kg powder (13B)*. Carbon dioxide extinguishers should contain not less than 2.5 kg (13B)* carbon dioxide, BCF 1.5 kg (13B)* when used in laboratories or housecraft rooms. Extinguishers marked with an asterisk should conform to BS 5423, type A for wooden crib fires, type B for flammable liquid fires.

122. In addition to the extinguishers provided in accordance with Table 5, water extinguishers should be provided throughout the building so that the walking distance to the nearest of these extinguishers does not exceed 30 m from any point. Extinguishers should be placed on escape routes; if in a room, the extinguisher should be near the door. There should be an extinguisher adjacent to every fire warning call-point. A shelf or bracket should be provided for every extinguisher so that the handle or carrying device of the extinguisher is about 1.1 m above the floor level. (The recommendations about the placing of extinguishers also apply in general to the extinguishers mentioned in Table 5.)

123. Two buckets of sand should be provided in every laboratory.

124. A fire blanket in a suitable container fixed to the wall should be provided, adjacent to the fire extinguisher, in every kitchen, laboratory, housecraft room, pottery craft room and metal workshop, and every assembly hall.

5 Precautions by the occupants

125. The earlier chapters of this Bulletin have been written primarily for those designing educational establishments but architects alone cannot secure the safety of a building's occupants; any building can quickly become dangerous unless there is foresight and care in its day to day use. No alterations, however minor, should be made to the structure particularly to doors, walls and ceilings, or windows which may provide fire protection or an escape, without seeking professional advice and approval. Only the occupants and those responsible for them can ensure that the premises continue to be safe, and that everyone who uses the building knows what to do if there is a fire.

126. The proper training of teachers and other staff must be given for the correct procedures in the event of a fire. Fire evacuation drills must be practised on a regular basis, at least once a term, and in particular with new pupils at the beginning of the school year. Evacuation should be carried out according to the procedures agreed in consultation with the local chief fire officer, who may wish to be represented at selected drills. Ideally each fire drill should be recorded, and any problems or defects relating to the building or alarm system reported as a matter of urgency.

Action in the event of fire

127. The Fire Brigade should be called immediately to any fire, however small. In the event of a fire, staff must supervise the evacuation from the building as quickly and safely as possible. No attempt should be made to fight the fire until evacuation is complete. Where possible, staff should contain the spread of smoke and fire by closing doors, but only where there is no risk to their own safety.

Everyday precautions

Stairways and doors

128. Stairways and final exit doors must never be obstructed, and all exit doors must be capable of being opened easily and immediately from the inside while there is anyone in the building. Stairways and exit doors should be kept in good repair. No combustible material should be stored or allowed to accumulate in the stairway enclosures. Ideally, doors across escape routes should not be fitted with locks. If however, they are lockable, those doors which provide essential escape routes from occupied parts of the premises,¹ must (during the period of such occupation) be kept unlocked with the key removed (see also paragraph 90).

129. The purpose of fire doors into stairway enclosures and across escape routes is to prevent smoke and dangerous gases blocking any escape route. This should be explained to all the occupants of a building, together with the importance of ensuring that such doors, which should have notices as in paragraph 91, are closed if there is a fire in any part of the building. All fire doors should be closed at night and during weekends and holidays so that, if there is an outbreak of fire, its spread will be reduced and the damage by smoke contained.

Interconnected and open-plan areas

130. In large open-plan rooms fixed furniture and equipment such as that used for cooking and science teaching should be positioned where there is no risk of its forming a hazard on escape routes. In such open-plan areas, materials or loose furniture should not be allowed to accumulate and impede the movement of the occupants. It

¹ Where parts of an establishment are used whilst the rest is close (eg schools used for adult education evening classes), it is important that alternative escape routes are maintained from the accommodation in use.

is essential that all occupants should have an unobstructed passage to the exits in such areas.

Rubbish and the storage of combustible material including polyurethane

131. Rubbish and combustible waste including paper, cardboard, plastics and chemicals should not be allowed to accumulate in any area, particularly high risk areas (laboratories, workshops, craft rooms, boiler rooms etc). Rubbish and combustible waste must never be put in any escape route, including corridors, dual-purpose areas, protected lobbies and stairways, and entrance/exit areas. All such material should be put in a metal or other non-combustible closed container and removed from the building to a safe place as soon as possible, but at least daily. Particular care should be taken with the storage of any material of this type in caretaker's rooms, stage storage areas and PE equipment stores. If any items of polyurethane or similar materials are to be used and stored (eg gymnasium mats) advice on storage and special fire precautions must be sought at the earliest opportunity from the local fire prevention officer. *This advice will contain the current Home Office guidance on polyurethane storage and detailed fire precautions.*

132. Home Office statistics (1984) for school fires indicate that the most likely source of a school fire is the burning of paper and cardboard followed by other combustible material such as clothes, upholstery and furniture, and the most likely place for a fire to occur is in a classroom or store.

133. Every open fire (gas, electric or solid fuel) must be provided with a fire guard complying with the appropriate British Standard Specification. Other heating appliances, such as convectors and storage heaters, may require protection to ensure that they are not misused, eg by blocking air grilles. Regular maintenance is strongly recommended.

Electrical supply and fittings

134. Fuses that have blown must only be replaced after establishing the cause for

blowing, with fuses of the correct rating. A fuse should never be replaced with one of a higher rating or, as sometimes happens, with thick copper wire. Flexible cable to fittings should be as short as possible and should be inspected regularly and replaced immediately if worn. Additions or alterations to wiring should be undertaken only by a qualified electrician. Special care should be taken over improvising stage lighting and when fairy lights or other types of lighting are used for decorative purposes.

Laboratories

135. The precautions against fire that should be taken in laboratories are dealt with in *Safety in science laboratories* (DES Safety Series No 2).

136. Hazardous experiments and demonstrations should not be carried out near the door of a laboratory or workshop.

137. Unless a separate store, detached from the main building, is provided, the amount of petrol and other flammable liquids stored on the premises should be severely limited. With petrol, there is a statutory requirement¹ that, unless its storage has been licensed by the local authority (who may attach to the licence such conditions as they consider appropriate) not more than 14 litres in the aggregate may be stored, in separate containers each containing not more than 0.5 litres.

Housecraft rooms

138. General guidance on fire precautions in housecraft and art rooms is provided in the booklet *Safety in practical studies* (DES Safety Series No 3).

Furnishings and equipment—including play equipment and sports equipment

139. Great care should be taken that educational and display materials, which may be added to the building by the

¹ By virtue of the Petroleum (Consolidation) Act, 1928 (18 & 19 Geo 5 ch 32) HMSO. Attention is also drawn to the Petroleum (Consolidation) Act—Model Code of Principles of Construction and Licensing Conditions, Part 1 HMSO 1968.

occupants, do not constitute a particular fire hazard. For example, collecting a large quantity of plastic waste material for a teaching project will introduce a new risk unless properly controlled.

140. It is essential when furnishing any educational establishment to give careful attention to the fire properties of furnishing materials and items of furniture. The most important considerations apply to soft furnishing such as curtains and upholstered furniture. In the case of upholstered furniture a minimum level of requirement, when tested according to BS 5852 Part 1 is ignition source 0 (smouldering cigarette), with ignition source 1 being preferable. However, in many areas a higher level of ignition resistance—say to ignition source 5 or 7 of BS 5852, Part 2—may be more appropriate. Dual-purpose areas, staff rooms, reception areas, administration rooms, student common areas, domestic science areas etc, where soft upholstery is used, are examples of such areas. Consideration should also be given to existing furniture which may require to be uprated in high risk areas. The level should be set after an appraisal of the fire hazard taking account not only of the likelihood of a fire source being present, but also the consequential hazard to the occupants should a fire occur. In the case of curtains, they should be capable of being classified as fabric type B when tested to BS 5867 Part 2. Mattresses should be specified in accordance with the tests in BS 6807; here ignition source 5 resistance is appropriate. Advice may also be sought from specialist organisations¹ as to the suitability for use of various materials, based on their proposed purpose and association with other materials (eg certain types of PE mattresses, upholstery for informal seating areas) and safety rules should be strictly observed. With the greater use of mobile and loose furniture, it can be difficult to maintain clear unobstructed escape routes. These escape routes are, however, essential and the educational management must ensure that they are not obstructed in any way by furniture or display equipment.

Temporary displays and decorations

141. Great care must be taken when using paper or flimsy materials either for decorations or for costumes, especially

where heating is by any kind of open fire. Such decorations, and also natural or artificial foliage, should not be suspended from light fittings or anywhere near a heat source; fire occurring in suspended and highly flammable materials spreads rapidly, and blazing pieces may drop over a wide area before everyone in the room has a chance to escape. Cotton wool and most plastic materials, particularly foamed plastics, should not be used for these purposes.²

142. Fancy dresses and costumes are often by their nature highly flammable and the greatest care should be exercised when plays or parties are being held. At such times open or portable fires are undesirable but if used must be adequately protected with fire guards. In order to minimise the risk of dresses and costumes catching fire, mirrors should never be placed above fires in 'dressing rooms'.

Vandalism and security

143. There is concern about the increased incidence of fires cause by vandalism at night or during holidays, often resulting in extensive material damage and disruption of pupils' education.^{3,4} The opportunity for such acts of vandalism may be reduced by ensuring that windows and external and internal doors are properly secured when buildings are unoccupied and that flammable material is not left needlessly accessible to intruders (see also Chapter 6).

Community and dual use

144. Where premises are used by members of the public, especially outside normal

1 Eg Furniture Industry Research Association; Rubber and Plastics Research Association; International Wool Secretariat; Fire Research Station; Fire Protection Association.

2 N.B. The standards relating to foam-filled furnishings are due to change early in 1989.

3 See A & B Broadsheet No 12 *Vandalism in schools and colleges: some ways of reducing damage*, available free from DES.

4 See Building Bulletin No 67 *Crime prevention in schools—practical guidance*, available from HMSO.

opening hours, additional safety considerations may arise particularly where disabled people are involved. Escape routes and exits should be clearly marked for the benefit of those who may not be familiar with the layout of the building (see also footnote to paragraph 128) Those responsible for such out of hours activities should be carefully briefed about the position of telephones, escape routes, fire alarms, fire fighting equipment, etc.

145. Substantial ashtrays should be provided in rooms where smoking is allowed, although smoking should be prohibited in areas of high fire risk and discouraged elsewhere. Thorough checks of all parts of the premises should be made at the end of an evening or session by the person or persons responsible to ensure that no smouldering fires or cigarettes are left burning and that doors and windows are properly secured etc.¹

Periodic action

Fire inspections

146. The chief fire officer should be consulted about periodic inspection of premises by fire brigade officers or other responsible persons to ensure that escape routes are properly available and no fire hazards have been introduced. It may be appropriate to designate one or more persons to take a special interest in safety, particularly in relation to possible fire hazards and the necessary fire precautions.

Fire drills

147. It is important to ensure that periodic fire drills (by which is meant practice evacuations of the building, not fire fighting practice) are carried out in every educational establishment. Again, the advice of the chief fire officer should be sought on details. Clearly one such drill must take place soon after new occupants arrive at the beginning of every academic year. Additional fire drills on a termly basis are desirable (paragraph 126).

Fire warning systems

148. Independent electric fire warning systems should be tested once a week and any fault rectified immediately. Faulty items relating to the building fabric should be notified and rectified quickly. Tests, results and action taken should always be recorded and kept in a place of safety, both in the school and duplicated elsewhere.

Fire extinguishers

149. Fire extinguishers should be maintained and recharged according to the manufacturer's instructions. When in position they should be well away from any fire, radiator or heat-producing appliance and should not stand in direct sunlight. Spare extinguishers and refills should be stored in a cool, dry place and never in store-rooms attached to teaching spaces.²

150. All the above recommendations should be read in conjunction with the others contained in the Department of Education and Science Safety Series publications.

1 See free advice leaflet, *Fire safety check list for youth clubs*, and other material issued by the Fire Protection Association.

2 BSCP 5306: Part 3: 1985 'Code of practice for selection, installation and maintenance of portable fire extinguishers'.

6 Fire prevention and damage limitation

151. Fires fall into two categories, accidental and deliberate. The number of accidental fires in educational buildings has remained fairly constant from year to year, but the number of deliberate fires has increased to around 60% of all fires in educational establishments. Accidental fires can be caused in many ways and can often be prevented by careful management. Deliberate fires can be caused by opportunists, or as a cover to theft. Many of these fires are caused by young people, mostly when the building is unoccupied, and the damage caused by arson can be extensive.

152. Fire prevention can be assisted by careful design, management and maintenance—of these management is the most crucial factor. Damage limitation can be assisted by structural fire precautions, compartmentation, security and fire alarm systems.

Design factors

153. It is important to assess any proposed or existing educational building in the light of the known or assessed risk of the location. This may require advice from the police and fire authorities on proposals at an early stage. A check list of factors to be considered includes the following:

- a. Boundary security to suit location and level of risk;
- b. Controlled site access preferably with natural surveillance (eg by neighbours, passers-by and the schoolkeeper/caretaker);
- c. Reduction of concealed entrances or areas which offer cover to intruders;
- d. Limited entrances to site and buildings;
- e. External lighting, particularly to hidden or vulnerable areas;
- f. Combustible materials or rubbish in secure locked stores away from buildings or boundaries;

- g. Fire and security alarms;
- h. Security locks and robust door and window ironmongery;
- i. Provision of secure zones, rooms, stores, cabinets or safes;
- j. Landscaping to enhance the building without providing cover to intruders;
- k. Prevention of access to roofs (eg from surrounding buildings or walls, or from within the site).

Fire prevention by management

154. It is important that any educational building should be considered in the context of its likely total use. This can include evening and weekend use, and sometimes use outside the normal academic year. Vulnerable times for arson are often at changeover periods at the beginning and end of school terms, and early evening. Key factors in effective management to prevent vandalism and arson include the following:

- a. A responsible person with a positive approach to be in charge of repairs to the building and contents;
- b. A schoolkeeper/caretaker who is encouraged to have a good working relationship with other staff, pupils, maintenance staff, neighbours and police;
- c. A clear philosophy fostering respect for school property;
- d. A tangible ethos communicated to school users and neighbours preferably encouraging community links.

Fire prevention by maintenance

155. Priority should be given to maintaining security, with repairs to broken windows, ironmongery including door and window locks, faulty fire doors, alarm systems and electrical faults. Maintenance

repairs should be checked to ensure that the building is safe and secure whilst the work is in progress, and that the occupants are not exposed to any unnecessary risks. Fire fighting equipment should be checked periodically (see paragraphs 148 and 149).

Damage limitation

156. Buildings that are safe will have been designed to restrict the easy spread of fire. The structural fire precautions as described in Chapter 3 will both assist escape from buildings and restrict and contain the spread of fire—the latter, however, depends also on a quick response by the fire authority to a fire alarm call. In rural areas, where response could be delayed by remoteness of location or extremes of weather, a higher level of fire resistance or compartmentation may be appropriate.

157. Fire and security alarms may be considered on the known level of risk, or a risk assessment made with input from the fire authority and police. Alarm systems should be cost effective, reliable, straightforward to repair and preferably standardised within an authority.

Short index

This index is not intended to be exhaustive. The contents page at the front of this Bulletin refers the reader to the main subjects covered. Several points, however, are either not covered by separate entries in the contents page or are covered more than once in different connections. This short index draws these points together. The references are to paragraph numbers unless otherwise stated.

Access:

for motor appliances, 118(a)

Assembly halls:

exits from, 56–59 and Table 1
stairways serving, 73
fire warning call-points near stage of, 114
fire extinguishers on stage of, 121 and Table 5
fire blankets on stage of, 124

Basements:

access to, 85 and note
fire resistance of elements of structure, Table 4 and notes

Beams:

see columns and beams

Blankets:

types of, 119(d)
provision of, 124

Boiler rooms:

see high fire risk areas
exits from, 60
fire resistance of construction, of Table 4 and notes

Buckets:

sand, 119(c) and 123

Cavity barriers:

provision of, 97–102

Ceilings:

lining materials to, 81 and 95

Columns and beams:

recommended standards of fire resistance of, Table 4 and 94

Combustible materials:

see non-combustible and combustible materials

Corridors:

exits from, 61–63
lining materials in, 95
length of, 62
doors across, 62, 91 and 129
in single storey or ground floor, 65
width of, 66

Craft rooms:

see high fire risk areas
fire warning call-points near, 114
fire extinguishers in, 121 and Table 5
fire blankets in, 124

Dead-ends:

lining materials in, 95
length of, 61(b) and (d)–(e)
in single storey or ground floor, 65

Dining space:

exits from, 54(a), 55 and Table 1

Disabled occupants:

provision for, 2

Doors:

generally, 87–91
fire doors, Terminology, 44, 60(c), 61(a)–(b), 62, 83, 91 and 129

Dual-purpose areas:

definition, Terminology
generally, 42
in single storey or ground floor, 65

Emergency lighting:

provision of, 56, 66, 153

Exits:

from rooms generally, 54–60 and Table 1
from horizontal circulation areas, 61(a)–(j) and 62–65
from stairway enclosures, 85, 86 and Table 3
from dual-purpose areas, 61(j), 63–64 and 69

Fire-escape stairways:

unsuitability, see note to paragraph 69

Fire extinguishers:

types of, 119(b)
provision of, 122, 123, 149 and Table 5

Fire resistance:

definition, Terminology
recommended standards of, Table 4 and 94

Floors:

compartment, Terminology
recommended standards of fire resistance
of, Table 4 and 94

Heating system:

ducted warm air, 103

High fire risk areas:

definition, Terminology
exits from, 54(c)-(d)
glazing in partitions to, 68
excluded from stairway enclosures, 80
lining materials in, 95

Horizontal circulation areas:

definition, Terminology
generally, 61-68
see separately under corridors, dead-ends
and dual-purpose areas

Hose reels:

provision of, 119(a)

Housecraft rooms:

see craft rooms and 138

Interconnected and open-plan areas:

see open-plan areas

Kitchens:

see high fire risk areas
fire warning call-points near, 114
fire extinguishers in, 121 and Table 5
fire blankets in, 124

Laboratories:

see high fire risk areas
locking of doors in, 64
fire warning call-points near, 114
fire extinguishers in, 121 and Table 5
buckets of sand in, 123
fire blankets in, 124

Lining materials:

definition, Terminology
in stairway enclosures, 81
in all other areas, 95 and 96

Non-combustible and combustible materials:

definition, Terminology
in elements of structure, Table 4
in fire stopping, 97-102
in lining materials, 81 and 95
combustible waste, 131

Oil:

fuel storage, Table 4 and note

Open-plan areas:

generally, 42, 46, 64 and 130
on two floor levels, 51

Partitions:

movable, 46, 54(c) and 68
fixed, 68
combustible and non-combustible
materials in, Table 4 and 95
lining materials to, 95

Roofs:

fire stopping in cavities in, 97-102
roof covering, Terminology
recommended standards of fire resistance
of, Table 4 and 94

Stairways:

stairway enclosures, definition,
Terminology
generally, 69-86

Steelwork:

recommended standards of fire resistance
of columns and beams, Table 4 and 94

Stores:

exits from, 82
lining materials in, 95

Surfaces:

spread of flame, 95

Walls:

lining materials to, 81 and 95
recommended standards of fire resistance
of, Table 4 and 94
distance from site boundary, 104
fire stopping in cavities in, 97-102

Water supply:

provision of, 118(b)

Workshops:

see craft rooms

7			(K2)
---	--	--	------

Building Bulletin 7 has been regularly revised since the first edition was published in 1952. This sixth edition has been extended to cover all educational buildings. It includes major revisions in the requirements for means of escape and, for the first time, requirements aimed specifically at the designers of new construction. The Bulletin continues to give advice on the management and use of buildings in relation to fire safety.

The Stationery
Office

Published by The Stationery Office and available from:

The Publications Centre

(mail, telephone and fax orders only)
PO Box 276, London SW8 5DT
General enquiries 0171 873 0011
Telephone orders 0171 873 9090
Fax orders 0171 873 8200

The Stationery Office Bookshops

49 High Holborn, London WC1V 6HB
(counter service and fax orders only)
Fax 0171 831 1326
68-69 Bull Street, Birmingham B4 6AD
0121 236 9696 Fax 0121 236 9699
33 Wine Street, Bristol BS1 2BQ
0117 9264306 Fax 0117 9294515
9-21 Princess Street, Manchester M60 8AS
0161 834 7201 Fax 0161 833 0634
16 Arthur Street, Belfast BT1 4GD
01232 238451 Fax 01232 235401
The Stationery Office Oriel Bookshop
The Friary, Cardiff CF1 4AA
01222 395548 Fax 01222 384347
71 Lothian Road, Edinburgh EH3 9AZ
(counter service only)

Customers in Scotland may
mail, telephone or fax their orders to:
Scottish Publications Sales
South Gyle Crescent, Edinburgh EH12 9EB
0131 479 3141 Fax 0131 479 3142

The Stationery Office's Accredited Agents
(see Yellow Pages)

and through good booksellers

BEST COPY AVAILABLE

ISBN 0-11-270585-5



9 780112 705857



U.S. Department of Education
Office of Educational Research and Improvement (OERI)
National Library of Education (NLE)
Educational Resources Information Center (ERIC)



NOTICE

REPRODUCTION BASIS



This document is covered by a signed “Reproduction Release (Blanket) form (on file within the ERIC system), encompassing all or classes of documents from its source organization and, therefore, does not require a “Specific Document” Release form.



This document is Federally-funded, or carries its own permission to reproduce, or is otherwise in the public domain and, therefore, may be reproduced by ERIC without a signed Reproduction Release form (either “Specific Document” or “Blanket”).