

DOCUMENT RESUME

ED 431 301

EF 005 395

TITLE A Guide to Energy Efficient Refurbishment. Maintenance and  
Renewal in Educational Buildings. Building Bulletin 73.  
INSTITUTION Department for Education and Employment, London (England).  
Architects and Building Branch.  
ISBN ISBN-0-11-270772-6  
PUB DATE 1991-00-00  
NOTE 44p.; Funding assistance provided by the Department of  
Energy's Energy Efficiency Office.  
AVAILABLE FROM HMSO Publications Centre, P.O. Box 276, London, SW8 5DT  
England; Tel: 0171-873-9090; Fax: 0171-873-8200 (8.50  
British pounds).  
PUB TYPE Guides - Non-Classroom (055)  
EDRS PRICE MF01/PC02 Plus Postage.  
DESCRIPTORS \*Building Operation; Educational Facilities Design;  
\*Educational Facilities Improvement; Elementary Secondary  
Education; \*Energy Management; Foreign Countries;  
Guidelines; \*School Maintenance  
IDENTIFIERS \*Cost Containment; England

ABSTRACT

With little or relatively modest investment, schools being refurbished or undergoing maintenance can make disproportionately large gains in energy efficiency that can also result in large financial savings. This document offers guidance on the selection of appropriate measures that can improve a facility's energy efficiency, depending on the type of building, method of construction, and physical condition of the facility. It provides technical descriptions of the most commonly used measures, followed by examples of a combination of measures as applied to older, heavily constructed buildings and more recently built schools. It describes proven energy efficiency measures undertaken during school refurbishment along with case studies that illustrate the effectiveness of these measures. The case studies include details on economic performance together with descriptions of other benefits not readily expressed in monetary terms, such as improved comfort. Appendices present a description of the measures of economic performance and definition of financial terms, and discuss the creation of "user manuals" by the design team that can guide users in the physical operations of the building and its maintenance. A glossary is provided. (Contains 58 references.) (GR)

\*\*\*\*\*  
\* Reproductions supplied by EDRS are the best that can be made \*  
\* from the original document. \*  
\*\*\*\*\*

A GUIDE TO

# ENERGY EFFICIENT REFURBISHMENT

Maintenance and Renewal in Educational Buildings

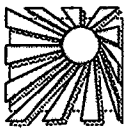
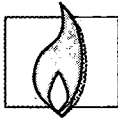

**EF 005 395**

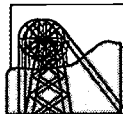

PERMISSION TO REPRODUCE AND  
DISSEMINATE THIS MATERIAL HAS  
BEEN GRANTED BY

John Birch

TO THE EDUCATIONAL RESOURCES  
INFORMATION CENTER (ERIC)

U.S. DEPARTMENT OF EDUCATION  
Office of Educational Research and Improvement  
EDUCATIONAL RESOURCES INFORMATION  
CENTER (ERIC)

- This document has been reproduced as received from the person or organization originating it.
- Minor changes have been made to improve reproduction quality.
- Points of view or opinions stated in this document do not necessarily represent official OERI position or policy.

*Building Bulletin 73  
Architects and Buildings Branch*

**DES**

THE DEPARTMENT OF  
EDUCATION & SCIENCE

# A GUIDE TO ENERGY EFFICIENT REFURBISHMENT

Maintenance and Renewal in Educational Buildings

BEST COPY AVAILABLE



LONDON: HMSO

## ACKNOWLEDGEMENTS

The Department of Education and Science would like to thank the Department of Energy's Energy Efficiency Office for help in funding the preparation of this Bulletin and for other assistance. Thanks are also due to Building Research Energy Conservation Support Unit (BRECSU) at the Building Research Establishment, who helped in managing the project and to Databuild Ltd. who carried out the drafting. The work was supervised by a small steering group which included:

D Hampton — Building Research Energy Conversation Support Unit

J Howrie — Databuild Ltd.

Dr R Hobday — Databuild Ltd.

R Bowen — Society of Chief Electrical and Mechanical Engineers

F Trout — Society of Chief Architects in Local Authorities

D Curtis — Essex County Council

Professor D Poole — University of Wales, College of Cardiff

The DES would also like to thank Local Education Authorities who provided information on various case studies.

DES Project Team:

Head of Division — B Whitehouse

Principal Engineer — M Patel

Senior Engineer — R Daniels

© Crown copyright 1991

First published 1991

ISBN 011 270772 6

Designed by PJ Denly

Edited by DES Information Branch



***Energy Efficiency Office***  
**DEPARTMENT OF ENERGY**

## FOREWORD

---

It is important that schools save energy because it not only saves them money but also conserves fossil fuels and limits environmental damage. Maintenance and refurbishment of schools often also provides ideal opportunities to improve the energy efficiency of schools. This bulletin offers advice on various measures that can be undertaken and describes a number of successful case studies. This bulletin is one of the initiatives that I am taking to encourage energy efficiency in schools, following the publication of the white paper on the Environment, *This Common Inheritance*.



Robert Atkins MP  
Parliamentary Under-Secretary of State

**SUMMARY****CHAPTER 1****INTRODUCTION**

1.1	Background	1
1.2	Reasons for differences in energy performance of schools	1
1.3	Rationalisation and upgrading the stock of school buildings	1
1.4	Local management of schools	1
1.5	Indirect benefits	2
1.6	Financial and technical constraints	2
1.7	How to use this guide	2
1.8	Cost and benefit analyses	2
1.9	Combining energy saving measures	2

**CHAPTER 2****OPPORTUNITIES FOR ENERGY EFFICIENCY DURING MAINTENANCE**

(Technical descriptions and case studies)

2.1	Insulation materials	5
2.2	Re-roofing and roof insulation	5
2.3	Recladding	9
2.4	Cavity insulation	11
2.5	Window and door maintenance	11
2.6	Lighting improvements and rewiring	12
2.7	Boiler replacement	15
2.8	Boiler controls	16
2.9	Heating controls	16
2.10	Heat emitters	21
2.11	Domestic hot water	21

**CHAPTER 3****INTEGRATING ENERGY EFFICIENCY INTO REFURBISHMENT SCHEMES**

3.1	Victorian schools	23
3.2	Lightweight schools	24
3.3	Temporary buildings	29
3.4	Indoor swimming pools	30

**APPENDICES**

1	Measures of economic performance	32
2	User manuals, commissioning and handover	32

**GLOSSARY**

33

**REFERENCES**

34



This guide is intended to assist architects, engineers, surveyors and others such as head teachers and governors who are responsible for the refurbishment of educational buildings.

Maintenance and renewal of these buildings presents an excellent opportunity for the introduction of measures which improve energy efficiency. Rather than replace like with like when repair and maintenance work has to be carried out, a relatively modest or no increase in investment can often produce disproportionately large energy savings and, thus, financial and environmental gains. The measures introduced will vary from building to building, depending on the method of construction, the physical condition of the structure and services, and the available finance; this document gives guidance as to the selection of appropriate measures. Although the advice relates mostly to schools the measures are also relevant to other educational buildings.

Two broad classifications of school building are considered:

**Heavyweight** Victorian/Edwardian schools, schools of the inter-war period and 1970s schools.

**Lightweight** Lightweight system-built schools of the 1950s to 70s and temporary buildings.

A range of measures appropriate to each of these buildings is described although many are common to both, and issues which relate to their implementation are outlined.

The financial and technical constraints which form the background of refurbishment projects can vary considerably. However, whilst refurbishment is in progress the marginal cost of including energy efficiency measures can be repaid in a very short time from the energy savings that result; good practice in energy efficient refurbishment can therefore represent a very attractive financial investment. In addition, the conservation of energy plays a key role in protecting the environment.

## 1.1 BACKGROUND

1. Energy conservation and energy conscious design are once again subjects of growing concern nationally and internationally. This concern is clearly emphasised in the Government white paper on the environment, 'This Common Inheritance'. For most local education authorities energy represents a significant proportion of building related expenditure. Total energy consumption for all local authority maintained schools and colleges in England is in the region of 19,000 million kWh per year which makes the national energy bill for schools and colleges in the order of £315 million per annum (1988/89 figures). Some 5 million tonnes of carbon dioxide are produced each year as a consequence of this energy use.

2. Actions which bring about improvements in the energy efficiency of school buildings will reduce the amount of carbon dioxide and other greenhouse gases released into the atmosphere, and the rate at which fuel resources are depleted. Local authorities can help to save money and protect the environment, by reducing energy consumption in their schools.

## 1.2 REASONS FOR THE DIFFERENCES IN ENERGY PERFORMANCE OF SCHOOLS

3. Apart from differences in building fabric and the condition of the plant, the energy consumptions in comparable schools may differ considerably, due, in large part, to the manner in which space and equipment is used. For example, a motivated, well trained caretaker can make a great difference to the amount of energy used in a school. The attitudes of staff, pupils and out-of-hours users to energy efficiency will also have a major bearing on the amount of energy consumed.

4. Timetabling, for example, can influence energy use; pottery kilns, instructional cookery, woodworking and metalworking machinery can consume significant amounts of electricity and may cause increased costs if the timetable

allows them to be used at the same time, particularly in winter months.

Similarly, energy savings can be made in schools by rescheduling timetables and holiday periods, or making use of teaching space for other purposes associated with education or community use. A great deal depends on the motivation of the occupants to save energy, the amount of information and training they receive, and the design of equipment, particularly controls.

## 1.3 RATIONALISATION AND UPGRADING THE STOCK OF SCHOOL BUILDINGS

5. Since 1979, pupil numbers have declined and will still be below 1988 levels in the year 2000. This phenomenon is not found evenly throughout the country but affects some areas more than others. With a decline in the school population there is a need to rationalise the educational accommodation provided. A reduction in the total area of schools will produce a reduction in energy consumption.

6. A large proportion of the educational building stock, much of which was designed and constructed in a period when energy was relatively cheap is now in need of rationalisation, upgrading or refurbishment. Energy efficiency often coincides with these needs. Authorities are closing schools which are under utilised, or in a poor state of repair, in order that funds can be concentrated on sound buildings which can be used effectively. By making the best use of the building stock there will be considerable scope for reducing energy consumption. This will result in greater financial savings than could be obtained simply by the introduction of energy saving features to all existing schools.

7. Many authorities review occupation levels in their schools as part of wider assessment programmes which include maintenance requirements, energy use and the need for refurbishment. Regular appraisals of patterns of use should be undertaken in schools to ensure that energy is being used to maximum effect. The remodelling of existing schools, brought about by the need to use

resources more efficiently, should be undertaken with energy efficiency as a priority. In choosing which buildings to retain, energy consumption is an important factor.

8. Significant reductions in energy consumption can be obtained from existing equipment before any energy saving techniques and materials are introduced. This can be achieved by 'good housekeeping' and simple energy management practices - providing that the users of existing equipment are sufficiently motivated and informed.

## 1.4 LOCAL MANAGEMENT OF SCHOOLS

9. The Education Reform Act introduced local financial management under LMS (local management of schools) thereby enabling schools to manage their own budgets. LMS emphasises the importance of both good housekeeping and physical energy saving measures and the occupants of school buildings will have a strong financial incentive to decrease fuel costs, which, though only a small part of the total budget for a school (typically 3-5% of the total) represent one of the most controllable items.

Any school which demonstrates its commitment to energy efficiency does so to a wide audience of teachers, governors, parents, and pupils concerned for the future of their environment.

**Energy issues are now often part of the curriculum in a number of subjects. Where better to demonstrate good practice in energy conservation than in the buildings in which these studies are undertaken?**

10. The role of local authorities has changed with the introduction of the Education Reform Act of 1988; while they will still be responsible for capital work and 'structural' maintenance (which includes most major work to the fabric and to services in schools, see DES circular No7/88 Education Reform Act: Local Management of Schools), the running costs of schools will be delegated to the schools themselves. It is important to identify the respective areas of responsibility for energy saving so that the efforts of the schools and the LEA complement each other.



## 1.5 INDIRECT BENEFITS

11. The conservation measures described in this document, particularly insulation retrofits, are frequently introduced in schools to improve the comfort of staff and pupils as well as to save energy.

Furthermore, the useful life of a building may be extended by improving the fabric at the same time as improving the thermal efficiency. Also maintenance and repairs can be reduced by appropriate refurbishment of plant and fabric.

## 1.6 FINANCIAL AND TECHNICAL CONSTRAINTS

12. The manner in which local authorities organise finance for energy saving measures — their maintenance, energy conservation and fuel budgets — varies from one authority to the next. This will have a major influence on the resources that are available for reducing energy consumption in schools and, in turn, the strategy adopted. It will also establish the financial criteria by which the success or failure of a particular energy saving scheme is judged.

13. In addition, the reasons for installing a particular energy saving measure may differ from one local authority to another on technical grounds; not all authorities agree on the type of work that should be carried out. Each authority will have its own view as to the success or failure of a particular measure. Those described here represent a catalogue of current good practice drawn from a wide range of authorities. It is hoped that this information will help to broaden the understanding and application of solutions that are currently in use.

14. The measures must be appropriate to the building in question, and their affects on the building as a whole must be considered. For example, it is important to ensure that draught stripping and improved levels of insulation do not produce increased levels of condensation. The impact of the measures on the appearance of the building must also be considered, particularly where buildings of architectural merit or local significance are concerned. Appendix 1 describes measures of economic performance which can be used in the financial assessment of energy saving options.

## 1.7 HOW TO USE THIS GUIDE

15. School buildings may be classified broadly according to their thermal response:

- Thermally heavyweight schools are typically of solid or cavity-walled brick/block construction, built during the Victorian or Edwardian era, between the wars, or since the 1970s.
- The thermally lightweight system built schools of the 1960s and early 1970s are characterised by flat roofs, large areas of glazing and are generally single storey primary schools or larger multi-storey secondary schools.

At the end of this introductory chapter there is a pictorial diagram of the two types of school under consideration, showing which energy efficient measures are covered in each section.

Technical descriptions of the most commonly used measures are then given in the second chapter of the document.

In the third chapter, examples of a combination of measures — applied to the two school types — are presented.

16. This guide describes proven measures which have been undertaken during school refurbishment. Case studies are presented in order to illustrate the effectiveness of these measures and to promote a number of methods of saving energy which have yet to be adopted by every LEA.

## 1.8 COST AND BENEFIT ANALYSES

17. Cyclical maintenance and renewal of components can provide an opportunity to include at low (or even no) overall cost an energy saving measure that can produce large energy savings, e.g., by including additional insulation during re-roofing.

The case studies include details on economic performance together with descriptions of other benefits not readily expressed in monetary terms such as improved comfort. See Appendix 1 for description of the measures of economic performance and definition of financial terms.

18. The decisions on priorities for spending on energy saving measures is rarely straightforward and may require professional advice and discounted cash

flow analysis. It should also be remembered that the opportunity to include energy efficiency measures together with refurbishment or rationalisation work will probably not recur.

## 1.9 COMBINING ENERGY EFFICIENT MEASURES

19. It must be appreciated that energy use is the result of a complex interaction between the building, its occupants and the environment. The building must be considered as a system and the system must be understood fully. Any measure to improve energy efficiency must not be considered in isolation; if the building envelope is insulated, the existing heating plant must be able to accommodate efficiently any reduction in demand for energy. Similarly, improved insulation of an overglazed facade may involve reducing the window area which could, in turn, result in increased demand for electricity for artificial lighting.

20. Every building is different. Techniques introduced during a refurbishment or remodelling exercise must take into account a number of factors including the type of building, its appearance, its construction, its physical condition and any changes in occupancy which may be planned. Moreover, the effects of energy saving measures are interrelated which must be taken into account if the full potential for savings is to be realised.

# FABRIC

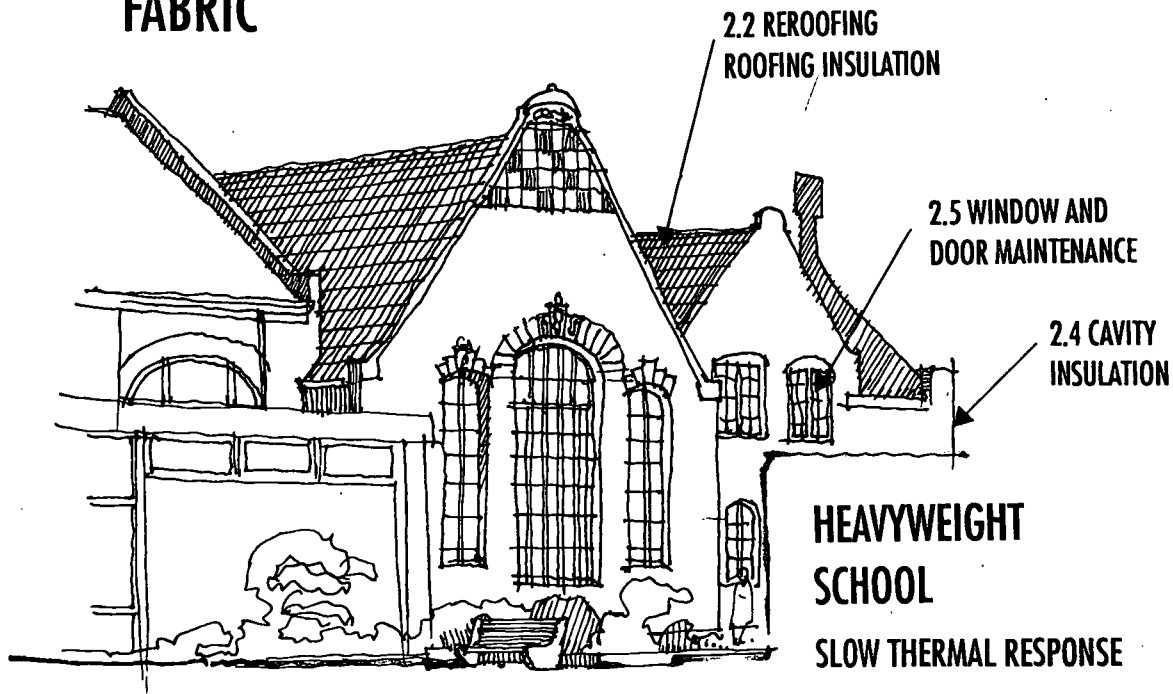

# SERVICES

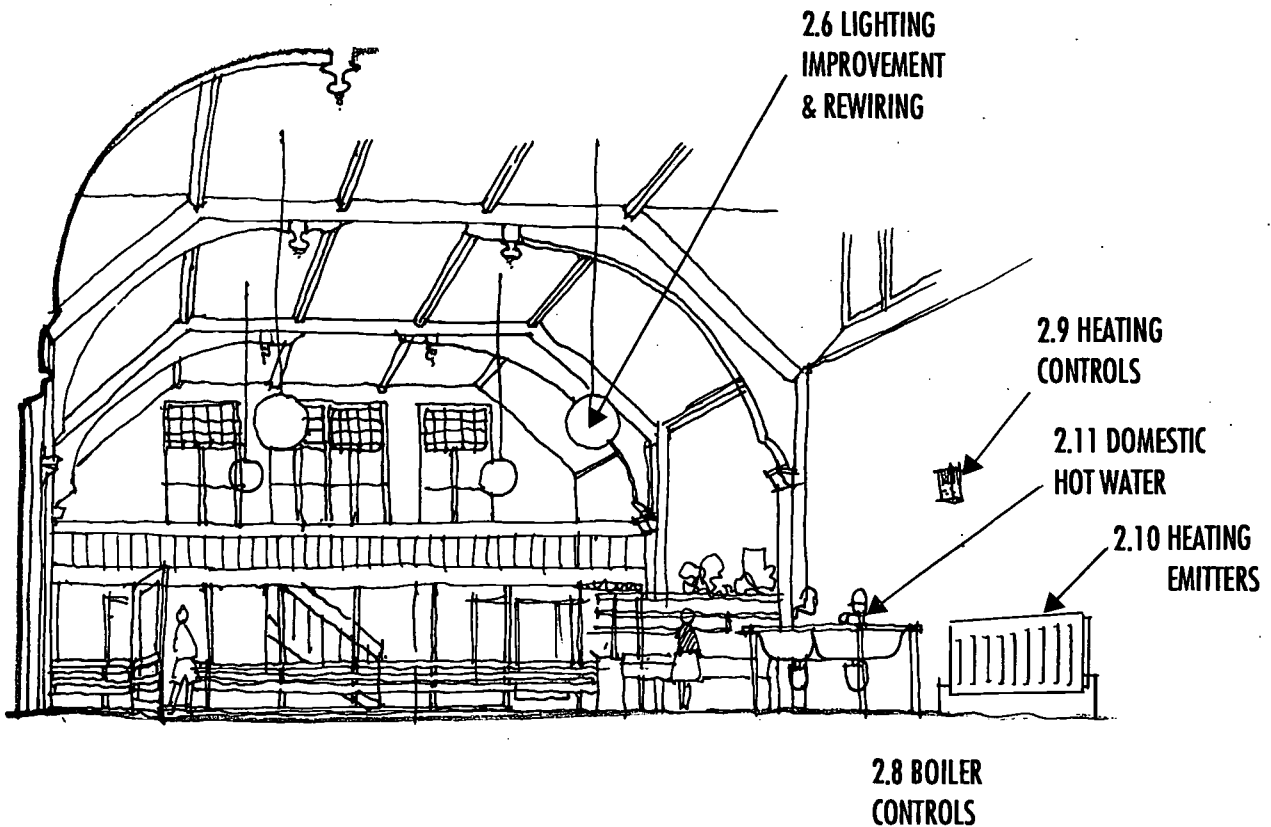

# FABRIC

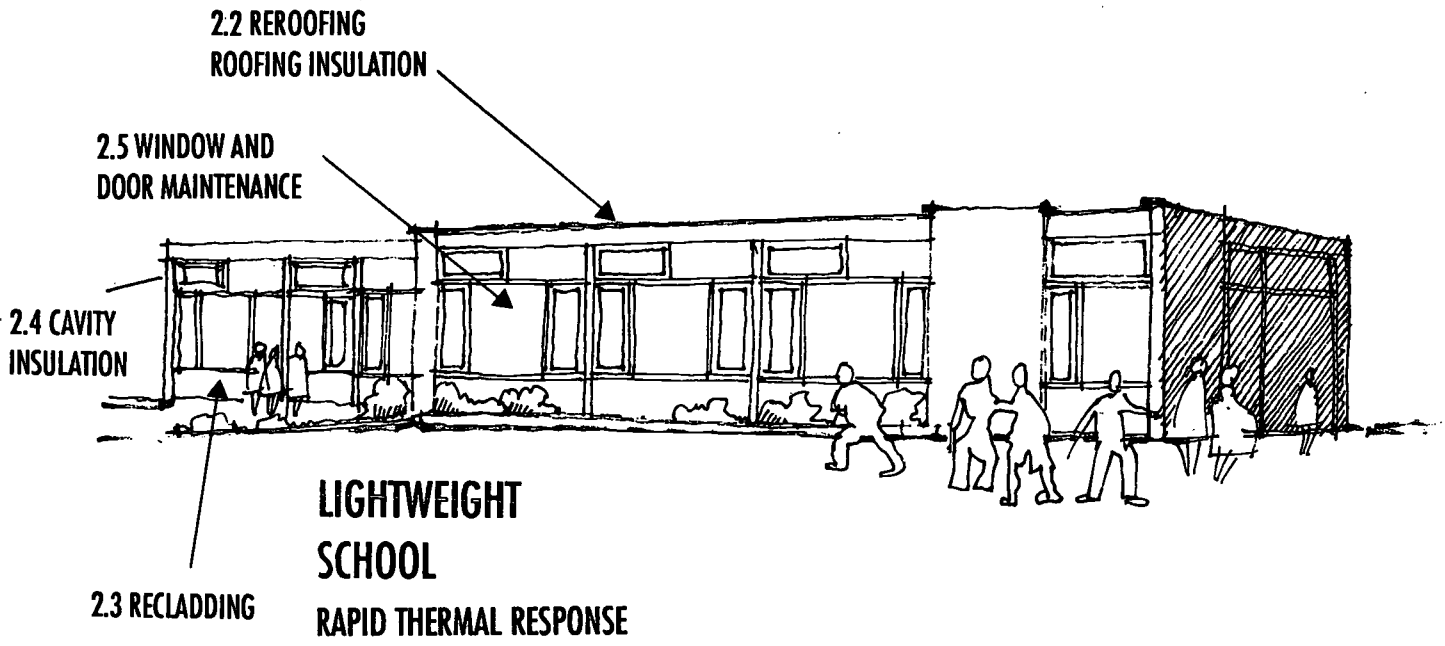

# SERVICES

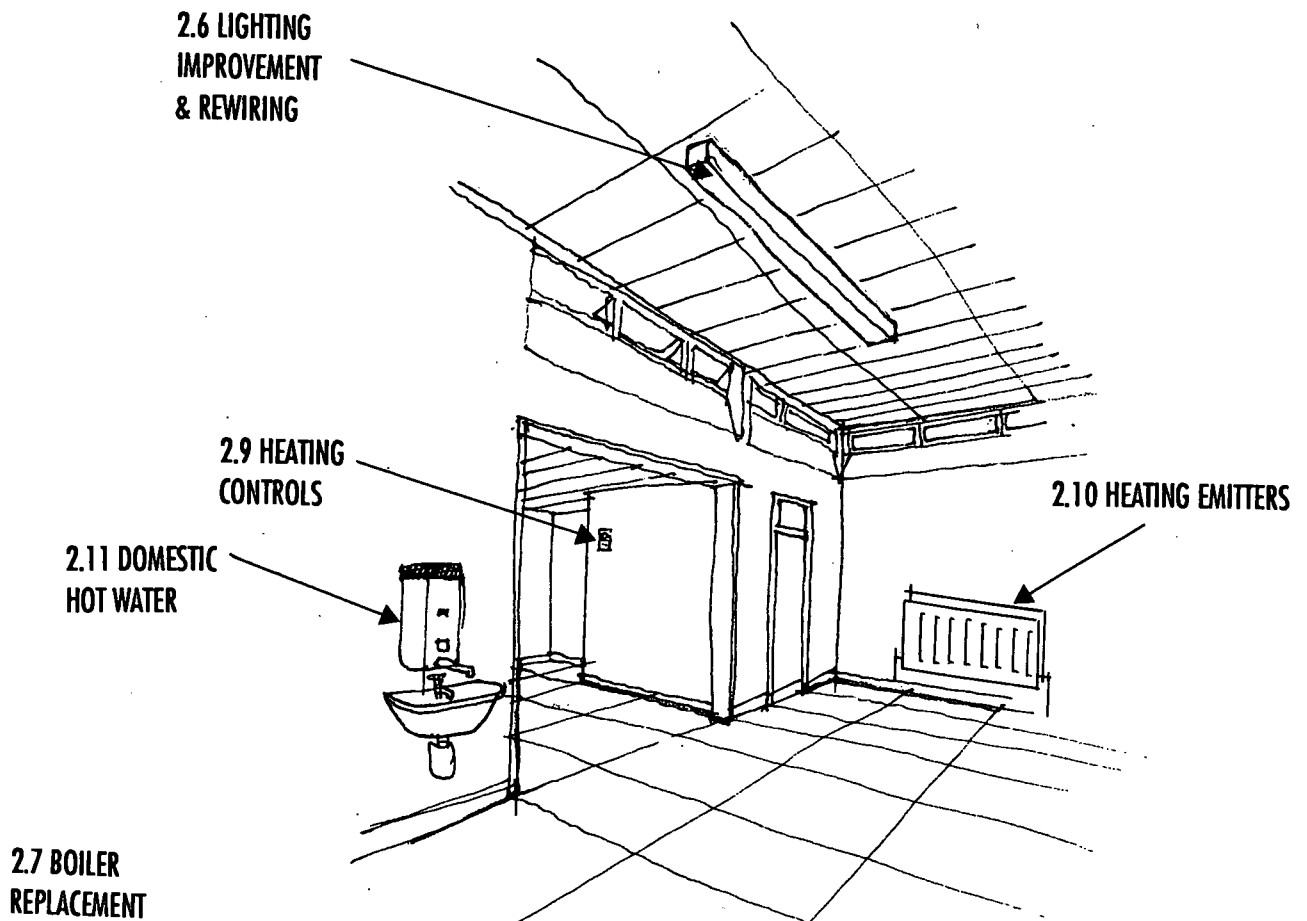

21. This chapter deals with the more common energy saving measures that can be introduced during maintenance work. The technical background to each of the areas of interest is described and, where appropriate, one or more case study is outlined. These same measures can form part of refurbishment programmes of the type described in Chapter 3 of this guide.

22. Before adopting these measures it is important to ensure that the maximum performance is obtained from existing equip-

ment and that the cheapest tariffs are used for electrical appliances. These are still the most effective methods of reducing energy costs. Good practice in the maintenance and operation of equipment is the surest way to reduce energy bills. Energy saving technologies are an addition to, and not a substitute for, the correct use and maintenance of existing equipment.

The measures described in the following pages have been successful where sufficient care and attention have been paid to their implementation, from the design stage to handover.

## 2.1 INSULATION MATERIALS

23. A range of materials is available for insulating walls and roofs. Some are inorganic in nature such as glass fibre, foamed glass and mineral wool (eg rock-wool) while others are organic polymers such as phenolic resins, polystyrene, polyurethane, urea-formaldehyde (UF) and polyisocyanurate. Most are available either in block form or laminated with timber or masonry materials. In addition, polyurethane and polyisocyanurate foams can be applied in situ to wall panels and roof surfaces. UF foam is used to insulate existing cavity walls.

24. Some insulation materials contain chlorofluorocarbons (CFCs) and hydrochlorofluorocarbons (HCFCs) or use them as blowing agents during manufacture. These gases contribute to the depletion of the ozone layer and to the greenhouse warming of the earth. Many alternative CFC free insulants are available now which can be used.

25. Some organic polymers increase fire risks, due both to combustibility and the production of toxic fumes on combustion. This must be considered during design and appropriate precautions taken, e.g., fire stops and smoke alarms.

## 2.2 RE-ROOFING AND ROOF INSULATION

### Flat roofs

26. A large amount of the maintenance funds allocated for use on educational buildings is spent on the repair and renewal of flat roofs. In practice, most authorities only improve the level of insulation of flat roofs when replacement

of the weather-proof finish is necessary; insulating flat roofs is cost effective only where major roof maintenance work has to be undertaken, or where the U value

of the roof is exceptionally poor by present day standards.

The most common methods of insulation for flat roofs are:

- the 'warm roof' where insulation is placed above the deck and then covered with a weather-proof skin. The 'sandwich' warm roof has a vapour barrier between the insulation and the roof deck to prevent condensation in the insulation (See case study).

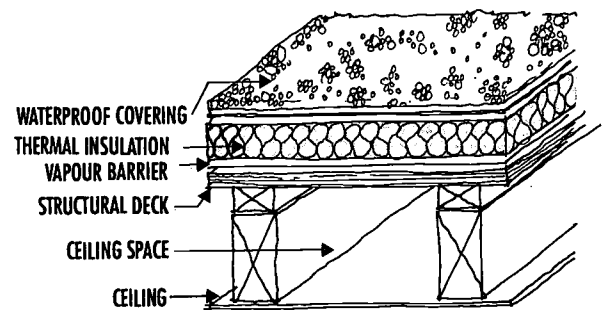

WARM ROOF

- the 'inverted roof' where insulation is applied on top of the weatherproof covering so that the entire roof, including the weatherproofing, is protected from temperature extremes.

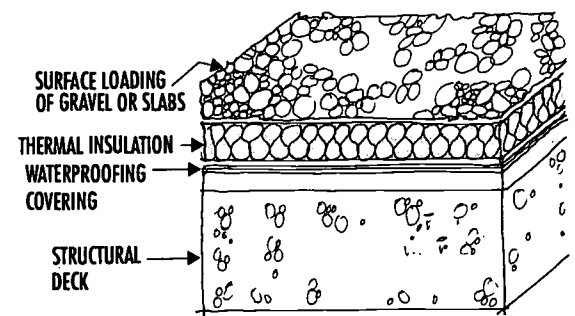

INVERTED ROOF

- the 'cold roof' where the insulation is placed above the ceiling and a ventilated cavity between the insulation and the roof deck prevents condensation.

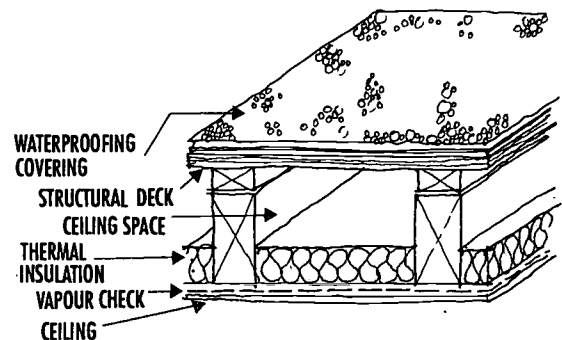

COLD ROOF

27. It is essential to ensure that the roof structure is capable of accepting the increased load caused by additional insulation, especially in the case of the inverted roof.

28. Nearly every authority has undertaken reroofing work at some stage, but not necessarily for reasons of energy efficiency; insulation levels are also increased, to prevent ponding by correcting falls thus allowing better drainage, to improve comfort levels in summer and winter, to remove the risk of condensation within the voids of 'cold' roofs and, in the case of overlay techniques, to extend the life of the waterproofing membrane by protecting it from environmental degradation. However, in all cases where insulation is introduced, or increased, the likelihood of creating conditions where condensation can occur must be carefully assessed.<sup>(1)</sup>

29. The following materials have been used to upgrade existing roofs:

- Insulation slabs: lightweight and usually bonded to the deck with bitumen. Bonding avoids the need for

heavy ballast. Top surfaces are a separate, weatherproof material.

- Tapering cork insulation slabs with a top surface of a separate weatherproof material.
- Roll-on insulation in the form of segmented sheets bonded to rolls of roofing felt.
- Spray-on rigid polyurethane foam internally applied or externally applied with either an elastomeric polyurethane coating or an asphalt and chippings finish.
- Foil-faced polyurethane insulation of fire-resisting quality.

30. Many roofs are in excess of 20 years old, built with only fibre board or a lightweight screed insulation. In such circumstances the choice to upgrade both the thermal insulation and the drainage falls will be dictated by a number of factors including the design, dimensions, and condition of the roof and the finance available. Again, the environmental impact of any insulating material

chosen should be considered, in particular, CFCs and HCFCs used during the manufacturing process.

31. Most flat roofs over a decade old are of the 'cold deck' type of construction where insulation, if present at all, is placed under the roof deck. This means that the decking is subjected to high thermal stress unless movement is accommodated adequately. In upgrading the thermal performance of a flat roof it is therefore sensible to minimise this thermal movement and/or thermal stress in the decking by placing the insulation above it. This is also generally easier than placing insulation under the deck where access may be difficult.

32. For further information on the refurbishment of flat roofs see DES Design Note 46 'Maintenance and Renewal in Educational Buildings - Flat Roofs - Criteria and Methods of Assessment, Repair and Replacement'<sup>(2)</sup>, Thermal Insulation; Avoiding risks<sup>(1)</sup>, Building Research Establishment Digests 312<sup>(3)</sup> and 324<sup>(4)</sup> and 'Overroofing: especially for large panel system dwellings'<sup>(5)</sup>

## CASE STUDY

### Recladding and reroofing

33. The London Borough of Wandsworth have reclad and reroofed two of their 'Hills' system buildings. These are both primary schools. The first refurbishment at Southmead Junior School was completed under the ILEA. The second at Granard Junior school in Putney was recently completed. Prior to reroofing the concrete panel cladding was replaced. At the same time three light wells which had repeatedly flooded due to blocked drains were glazed over (see photograph below), forming spaces which can be used for growing plants. The total roof area is 1500m<sup>2</sup> divided into 5 areas.

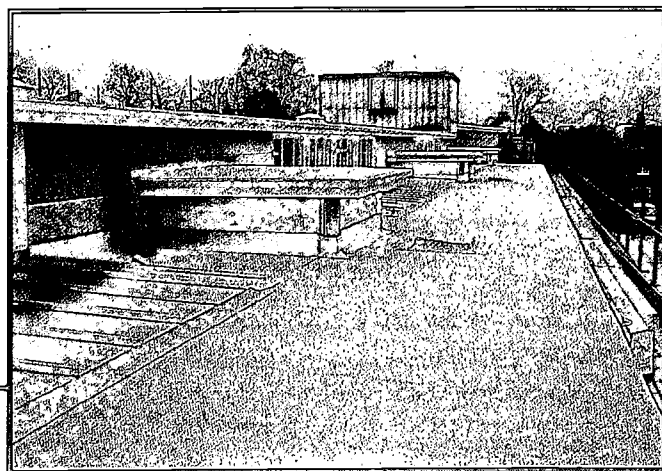
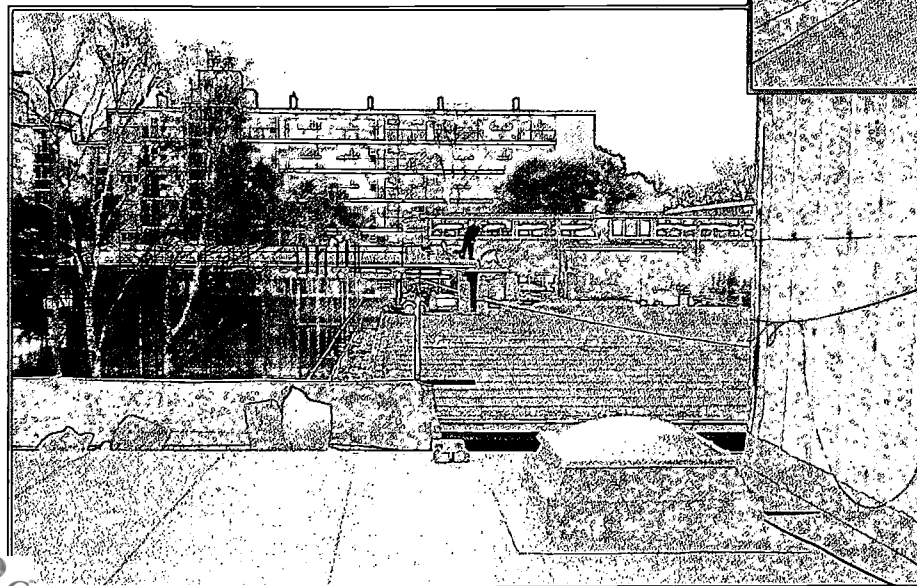

The 500m<sup>2</sup> infants school roof on the same site is in need of repair and will be recovered as soon as funds are available.

Both schools show similar energy savings.

The polystyrene insulation board replacing the existing roofing has bituminous roofing felt factory bonded to its upper surface and is provided cut to falls of 1 in 60. It is CFC free. The work was carried out without disruption of the use of the building.

The insulation was specified for its

high insulation properties coupled with its ability to be easily sculpted around the built-in roof lights.

The existing asphalt weatherproofing was removed and a high performance vapour check was placed under the insulation. The new weatherproofing membrane on top of the insulation consists of a high performance elastomeric underlay and a white mineral elastomeric capping sheet. A 12mm 'Overlay' fibre insulating board is placed between the

weatherproof layer and the polystyrene insulation to absorb some of the heat from the top layer in hot weather.

The insulating boards, provide the required upgrading of the original roof and effective drainage to prevent future ponding. The use of high duty grade boards and covering allows light maintenance pedestrian traffic.

The U-value of the roof was improved from 1.8W/m<sup>2</sup>°C to 0.5W/m<sup>2</sup>°C.

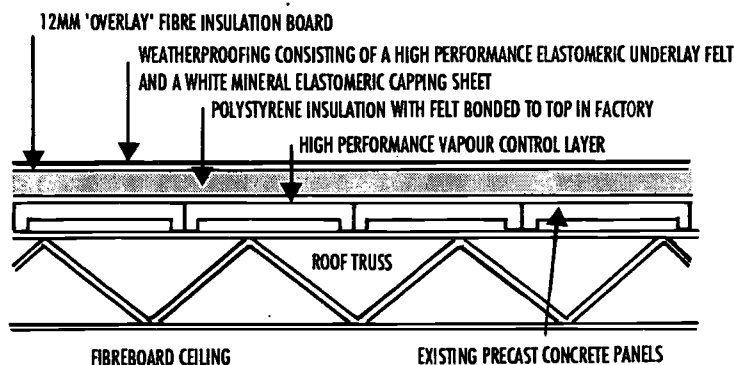

## COSTS AND BENEFITS (3rd quarter 1990)

### Reclad and reroofed school:

Granard Junior School, London Borough of Wandsworth  
Pupil Places 400-450 Gross area 4,400m<sup>2</sup>  
Roof area 1500m<sup>2</sup> (Junior)  
Cost of reroofing £212,000 (unit cost £140/m<sup>2</sup>)  
Cost of roof insulation (materials only)  
£16,500 (unit cost £11/m<sup>2</sup>)  
Completed March 1991

Energy savings of approximately 18.5% are evident for 89/90 and 90/91 compared with 1980 to 1985

### Gas consumption:

Average annual savings of 7,900 Therms (231,470 kWh)  
Value of savings £2,600  
NPV = £19,289  
IRR = 15.6%  
30 years remaining life of the building used in calculations  
Simple payback period on insulation only of 6.4 years

### Other benefits

Improved comfort conditions in winter.  
Better surface drainage eliminating ponding.

## Pitched roofs

34. Roofs with large accessible voids, such as pitched roofs, are the easiest and cheapest to insulate. This can be undertaken independently of any maintenance or refurbishment work, but is often included in refurbishment programmes because it is straightforward and cost effective.

35. Many of the pitched roofs of older schools are constructed of tiles and felt on battens and rafters. The ceilings are often lined with mineral boards, but have little or no insulation. The insulation of pitched roofs has been the most widely adopted measure for reduction of energy loss from the fabric of school buildings to date.

The U value of this type of roof can be reduced from 1.5 W/m<sup>2</sup>°C to 0.5 W/m<sup>2</sup>°C by the addition of 75mm of glass wool or mineral fibre. Further improvements can be achieved using 150mm of insulation, which will reduce the U value to 0.26 W/m<sup>2</sup>°C and is cost effective under normal circumstances.

36. Insulation may be placed at ceiling level, rafter level, or a combination of the two. In doing so the following points should be considered:

where condensation may be a problem. Proprietary devices are available which prevent this occurring.

- Gaps in roof insulation may create cold bridges where condensation may occur. A high level of quality control must be maintained during installation. Most cold bridge problems occur at the roof/wall junction.
- Placing insulation over electric cables should be avoided. Where impracticable, the size of the cable must be appropriately increased (see IEE Regulations 522-6(6))

When PVC cables are in contact with some types of thermoplastic materials the plasticiser migrates from the PVC leaving the cable brittle and causing softening of the thermoplastic.

This occurs with Polystyrene and probably polycarbonate but does not occur with formaldehyde foam as used in cavity insulation(7). This condition should be avoided.

- Specify pipe insulation for all pipes including overflows in unheated roof spaces. Water tanks must also be protected from frost.

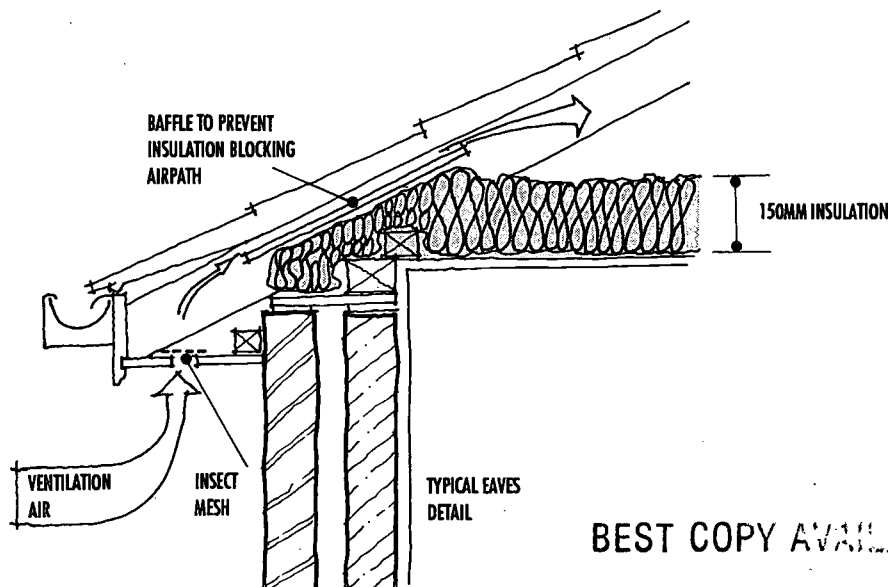

BEST COPY AVAILABLE

## Suspended ceilings

37. Another method of reducing the energy loss and maintenance requirement in pitched roofs is to install suspended ceilings. Opinions differ as to their effectiveness. The benefits of introducing suspended ceilings include reducing the volume of teaching spaces thereby cutting down the volume of air which has to be heated, lower air infiltration rates and reduction in temperature gradients from floor to ceiling. However, deterioration of plasterwork above suspended

ceilings has been a problem in some schools. It is important to ensure that there is an effective vapour barrier above suspended ceilings if this problem is to be avoided. Chicken wire, or some other form of wire mesh, should be installed to prevent plaster, which may become dislodged, falling onto the ceiling below. Safety film should be applied to the glazing above a suspended ceiling to prevent any broken glass falling onto the insulation.

Provided that air quality can be

maintained without the need to open windows in winter, and too much window area is not sacrificed in favour of artificial lighting, the concerns over the appropriateness of suspended ceilings focus on the appearance of the space and the psychological and spatial implications for the user.

38. The following case study is a successful suspended ceiling retrofit where both daylight and artificial lighting were considered.

## CASE STUDY

### Insulated suspended ceiling<sup>(8)</sup>

39. The high ceilings of Lady Bay Infants School, West Bridgford, Nottinghamshire were difficult to maintain and were poorly insulated. Energy consumption and environmental conditions were monitored before and after the installation of the suspended ceilings.

Interior of classroom after installation

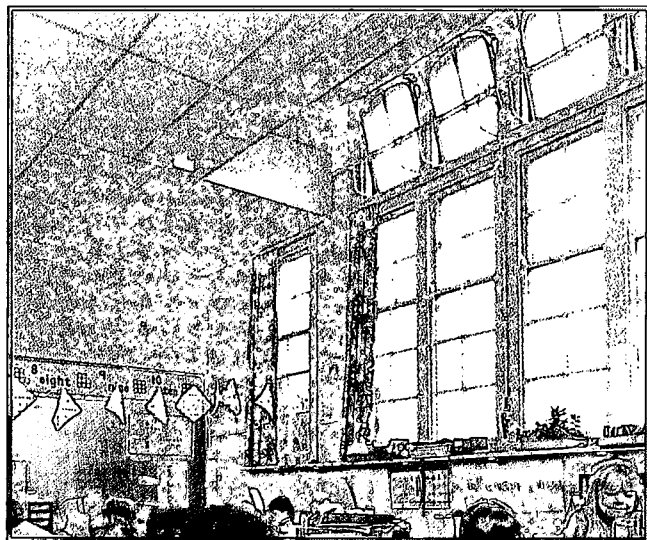

Interior of hall after installation

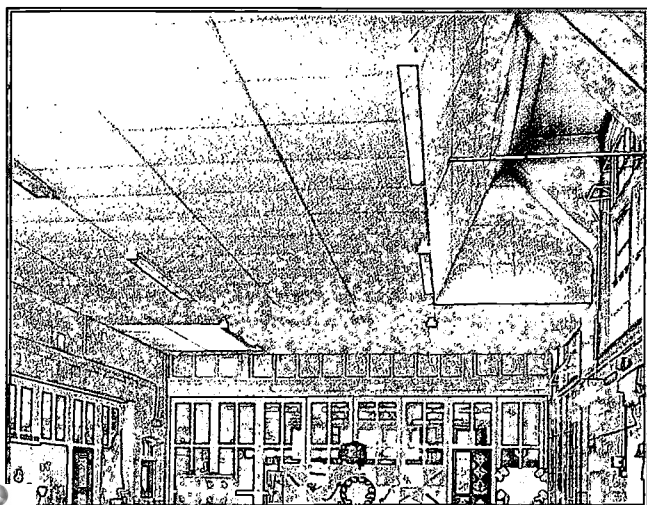

The suspended ceiling line was chosen to match the existing window and partition details, helping to make it unobtrusive from outside the building. The height varies between 3.1m and 3.5m which is in keeping with the scale of the rooms. To have adopted the minimum allowable height of 2.4m would have hindered daylighting of the school. In order to further improve the daylighting and ventilation, the ceiling is flared up in places at 45° to meet the window heads. This feature increased the cost but allowed for the provision of natural ventilation from the existing windows without the security risk from use of the lower sash windows.

40. The new ceilings consist of acoustic tiles with 100mm mineral fibre insulation, giving an overall U value of 0.31W/m<sup>2</sup>°C. On sloping areas the insulation roll was pinned at the upper edge and allowed to drape against the tiles. Ventilation to outside is provided above the new ceiling to prevent condensation. The opportunity was taken to replace the original lighting system with fluorescent fittings.

41. This scheme provided a reduction of energy use of

15–20%, a reduction in wall area requiring decoration, and better environmental conditions including improved lighting and acoustics.

42. After the ceiling was installed room temperatures were measured and found to be 3–4°C above the desired level. It was calculated that the elimination of this excess temperature by the addition of a heating system controller would produce a further energy saving of 20%, giving a typical combined energy saving from ceiling installation and temperature regulation of 35–40%.

### COSTS AND BENEFITS (1985 prices)

#### Insulated suspended ceiling and heating system optimiser control

Lady Bay Infants School, Nottingham

Cost of measures	
Suspended ceiling and insulation	£5156
Cost of optimiser installation	£1350
Total cost	£6506

#### Energy consumptions:

Pre-refurbishment	coal	233,100 kWh
Post-refurbishment		144,900 kWh
Cost savings		
@ £70/tonne	£774/annum	
	or	£1.45/m <sup>2</sup> /annum

Treasury test discount rate = 6%

Redecoration costs (included in NPV and IRR calculation) of £5.6/m<sup>2</sup> (every 10 years) = 5.6 x £534 = £2990

NPV = £2,336

IRR = 8.78%

60 years remaining life of the building used in calculations

Simple payback period of 11 years

#### Other Benefits

Reduction in wall area requiring redecoration, more comfortable temperatures, improved lighting and acoustics.

## 2.3 RECLADDING

43. Large numbers of schools built in the 1950s and 60s were constructed using system methods; structural steel frames support the internal fabric and the external curtain walls of these buildings. Highly glazed facades were adopted in order to satisfy the 2% minimum daylight requirement. Unfortunately many of these buildings are thermally inefficient, lightweight structures; they have neither the thermal mass nor the levels of insulation needed to avoid temperature extremes. In many instances, the benefits of high levels of natural illumination are outweighed by uncontrolled solar gains in the summer and high heat losses in the winter.

Middlesborough City Technology College

Before Refurbishment

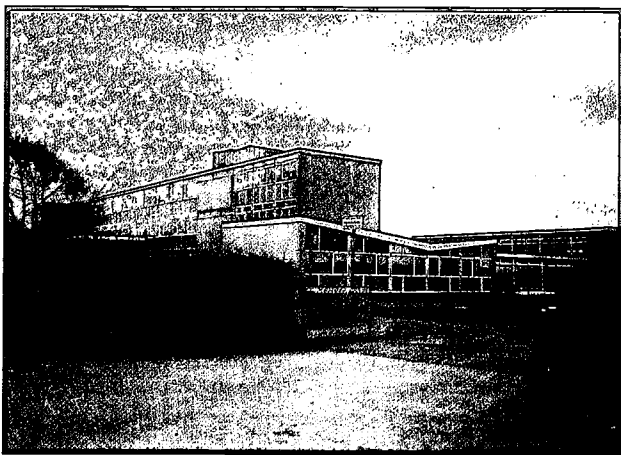

After Refurbishment

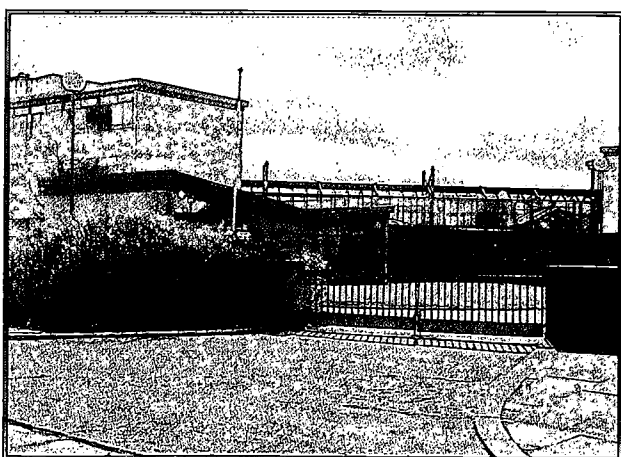

44. The design life of these buildings was 60 years. Due to the nature of the construction, major refurbishment is expected after 25 to 30 years. The curtain walling used in these system built

schools is at the top of many Local Authority lists for refurbishment. However, partial measures may have to be used for refurbishment of many of these schools where the work is not of sufficient priority for there to be replacement of the entire cladding.

45. The deterioration of timber framed and steel framed curtain walling can be addressed in a number of ways:

1) Replacement of timber components using hardwood frames, using a like for like approach. Alternatively softwood frames can be used together with modern protective finishes and better weather excluding construction details.

2) Replacement with plastics-covered or metal framed windows and plastics faced insulation panels.

3) Replacement with window-wall subsystems developed by consortia to upgrade earlier systems, or other standard replacements developed with manufacturers.

4) Purpose built components used by individual authorities.

5) The use of brick spandrels which are either storey height frames with a brick skin from floor to sill level, or of cavity construction to sill level with window height framing above.

6) Return to the traditional 'hole in the wall' windows with walls rebuilt using cavity brickwork.

46. The resources available and the extent of the deterioration of the building fabric will dictate which of the above will be adopted. However, for the purposes of reducing energy loss from the building fabric, and summer time overheating, improved levels of insulation and reduced fenestration should be priorities.

47. In order to improve the U value of a walling element in a lightweight school, the area of glazing can be reduced from

the 80% of wall area — common in many schools of this type — to between 40 and 70%. Fitting insulating panels outside existing glazing reduces heat losses and also overcomes the problem of unwanted solar gains in south facing rooms. However, this reduces external views and natural daylighting which may increase the use of electricity for artificial lighting. DES Design Note 17<sup>(11)</sup> 'Guidelines for Environmental Design and Fuel Conservation in Educational Buildings' sets out the various parameters within which window walls should be designed with regard to energy saving and internal lighting. The CIBSE Application Manual AM2 'Window Design'<sup>(9)</sup> contains a methodology for estimating the size and position of windows.

48. Fabric modification involving a reduction in the glazed area together with the addition of rooflights and shading has been demonstrated recently by Hampshire County Council and has shown significant benefits — see chapter 3, Crookham School case study

49. An alternative approach to refurbishment of curtain walling is to insulate existing infill panels, retain the same area of fenestration and, as an optional extra, replace the existing glazing by double glazed units. Whether the economics favour this approach or that of reducing glazed areas, rebuilding the entire facade or modifying it (e.g., by over-cladding or enveloping) will depend on a number of factors, not least the condition of the original wall panels. It is important to strike the right balance between savings from solar heating and daylighting, and the benefits obtained from improved insulation levels and reduced summer-time overheating. It would be unfortunate to produce a building which is well insulated, but which consumes significantly more electricity for lighting purposes.

50. In cases where window walls are upgraded with highly insulated solid panels and double glazing — thermal breaks should be included so that metal frames do not become cold bridges attracting local condensation.

51. Heating equipment must be able to accommodate any alteration in the thermal response of the building. Controls must be provided which take into account the fact that the building will heat up more quickly in the morning and can be turned off earlier in the evening. This also applies to buildings where cavity or ceiling insulation has been installed.



## CASE STUDY

### Curtain wall refurbishment

Harlow Burnt Mill School, Essex

52. Essex County Council have developed a method of forming insulating panels over the external surfaces of the glazing of curtain wall system built schools. The glazing insulation system consists of rigid polystyrene insulation which is cut to existing window size and bonded to the glass. The external facing is 2-3mm of GRP self finish with powder coated aluminium trim and is strong, durable and maintenance free. The panels can be installed from the outside of the building with minimum distur-

bance to the occupants. Internally pinboard is bonded to the glass. The resulting U-value is 0.46W/M<sup>2</sup>C with pinboard and 0.51W/M<sup>2</sup>C with the glazing painted internally. This method of improving wall insulation has shown favourable pay-back periods.

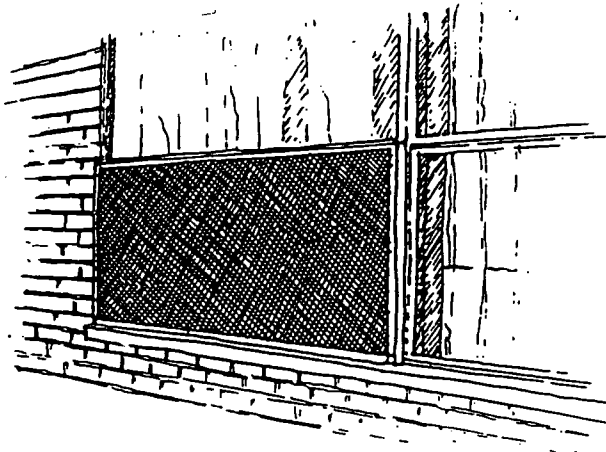

## COSTS AND BENEFITS (1st quarter 1988 prices)

### Curtain wall refurbishment

Harlow Burnt Mill Primary School

Approximately 25% of buildings on the site fitted with 846m<sup>2</sup> of panels @ £84/m<sup>2</sup> (including installation excluding scaffolding).

U-value of glazed panels:

before refurbishment 5.6 W/m<sup>2</sup>C  
after refurbishment 0.46-0.51 W/m<sup>2</sup>C

Total cost of installation £71,000

70% contribution from maintenance budget £50,000

30% contribution from energy conservation budget £21,000

### Energy savings:

Thermal energy consumption has slightly increased, probably due to increased temperatures.

### Other benefits

Comfort conditions improved from previous under-heating in winter and overheating in summer due to solar gain. More efficient use of radiators, improved radiant temperatures and resistance to impact damage and vandalism.

## CASE STUDY

### Curtain wall recladding<sup>(10)</sup>

53. Litcham County Primary School, Norfolk, is a single storey building that was designed to more than satisfy the 2% daylight factor required during the early 1960s. The timber framed curtain walling used in the construction of the school featured large areas of glazing, with plywood infill panels below sill level. The glazing, the low level of insulation and the poor condition of the window frames caused the occupants discomfort during the summer and winter months. Refurbishment was carried out in response to their complaints.

54. During the summer of 1982 new external walls were installed. These ensure a good standard of thermal insulation and a smaller window area. The overall U value for the new wall is 3.9 W/m<sup>2</sup>C compared with 5.9 W/m<sup>2</sup>C for the original walling. A draught lobby was introduced on the northern access door. The north-west elevation of the building is of brick construction with small windows to the kitchen, stores, etc., and was left unchanged.

55. The refurbishment has had effect of improving the standard

of environmental comfort, prolonging the life of the building and reducing energy consumption by 25%.

56. There has been no discernible increase in the use of lights in spite of the reduction in window area which resulted from the refurbishment.

57. The cost of the installation was divided equally between the maintenance

Before Refurbishment

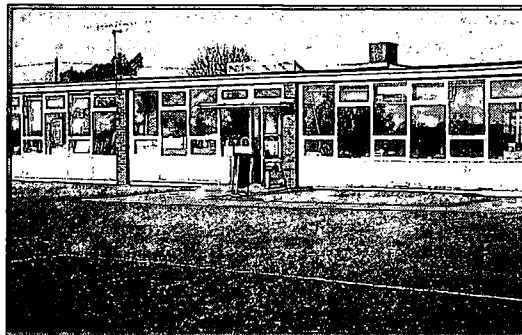

After Refurbishment



and the energy conservation budgets. The programme described has been repeated successfully on a number of buildings in Norfolk.

58. This is not presented as the definitive solution; the ratio of panel to glazing in this instance may not be appropriate for other school buildings.

## COSTS AND BENEFITS (1986 prices)

### Curtain wall recladding

Litcham County Primary

Energy consumptions:-

	kWh	kWh	£
	Electricity	Oil	Cost
Pre-refurbishment	21,400	175,000	4,000
Post-refurbishment	21,400	132,000	3,200
Savings		44,000	800

Total cost of installation £14,000

50% contribution from maintenance budget £7,000

50% contribution from energy conservation budget £7,000

For the energy efficiency related costs:

NPV = £4,012

IRR = 11%

30 years remaining life of the building used in calculations

Simple payback period of 9 years

### Other benefits

Comfort conditions improved from previous underheating in winter and overheating in summer due to solar gain. Reduced maintenance.

## Double glazing

59. Double glazing cannot be considered to be cost effective unless windows are having to be replaced anyway for other reasons in which case the payback can be shorter than five years. This is due to the fact that tender prices for double glazing are comparable to those for single glazing. Double glazed sealed units are available with a heat retaining coating applied to the inner surface of the outer pane and with internal panes of low emissivity glass. This further decreases the heat loss and is an effective means of reducing solar gains.

60. Secondary glazing can be cost effective where laylights are treated to prevent cold downdraughts and excessive heat loss. Twin-walled polycarbonate can be used, although fire regulations may require the specification of toughened glass. Where plastics double glazing is fitted, double-sided tape can be used to prevent noise generated by movement of the secondary glazing due to changes in air pressure, whilst allowing removal of the glazing for cleaning purposes.

## 2.4 CAVITY INSULATION

61. This is the cheapest form of wall insulation but has caused some problems in the past mostly due to rain penetration of the cavity in the case of urea-formaldehyde foam. Few of the cavity fill insulants use CFCs.

62. As with double glazing and roof insulation, cavity wall insulation is not undertaken during normal maintenance work but is an energy saving measure which often forms part of refurbishment programmes. It is important to ensure that heating systems in buildings where insulation is applied are capable of accommodating any reduction in energy consumption. Cavity insulation, in itself, will not necessarily produce financial savings unless heating controls are in place which respond to the prolonged heat retention and bring about a later start up and an earlier shut down of the heating system.

63. The different forms of cavity wall insulation include urea-formaldehyde foam, mineral fibre, polyurethane granules, polyurethane foam and polystyrene granules.

64. Urea-formaldehyde (UF) foam has been the most commonly used form of cavity insulation. It is injected into the cavity wall between the internal and external leaves where it subsequently

hardens and dries. When the foam is injected, and for some time after, it will give off formaldehyde gas. These fumes will rarely enter a building where a normal cavity wall of two leaves of masonry, plastered on the inner leaf, has been used. There is a greater risk where the inner skin is of permeable material such as plasterboard, particularly if the outer skin is impermeable. The problem is also more likely to occur where cavities are wider than 100mm or in older buildings where there has been some cracking of the wall. Care and attention are required to ensure that this measure does not result in problems such as dampness reaching the inner leaf of the cavity wall via shrinkage cracks in the foam which act as paths for the water. Two British Standards have been published which deal specifically with urea-formaldehyde foam cavity fill: BS5617<sup>(55)</sup> and BS5618<sup>(56)</sup>.

65. The second most widely used cavity fill in the U.K. is mineral fibre. These are fibres, coated with a water repellent, which are blown as tufts into the cavity where they form a water repellent mat. The raw material costs are higher than urea-formaldehyde.

66. Two of the more recent materials introduced for cavity filling are glass-fibre, and polyurethane foamed in-situ. The latter adheres strongly to masonry and, unlike urea-formaldehyde foam, does not shrink, however it is only usually used for tying together walls where the ties have rusted away. Polyurethane granules and expanded polystyrene beads are also used for cavity insulation. Polystyrene beads can run out of cavities when holes are drilled for services.

67. Cavity insulation reduces heat loss whilst maintaining the inner face of the inner leaf of the cavity at a higher temperature than if no insulant was present. This improves comfort levels and reduces the risk of condensation.

## 2.5 WINDOW AND DOOR MAINTENANCE

68. The rate at which heat is lost from a building can be reduced significantly by reducing the infiltration and ventilation rates. However, minimum rates are required to prevent condensation and the build up of fumes and odours as outlined in DES Design Note 17<sup>(11)</sup>.

69. Ventilation is air movement caused by mechanical ventilation or by natural ventilation through windows or vents.

70. Infiltration is air movement through the building fabric which is independent of the behaviour of the occupants and the ventilation system. It is important to reduce infiltration through joints between components in the external envelope. Damage to catches and door closers should also be rectified.

71. In a naturally ventilated building the rates of air change that occur will vary widely according to wind direction and speed. On the most exposed sites it may be worth considering dense tree planting or even screen walls to reduce the exposure of the building to the wind. In any case it is worth bearing in mind that measures such as draught stripping and thermal insulation will be of greatest value in the parts of the building most exposed to the prevailing wind.

72. In winter, in buildings where thermostatic control of heating appliances is inadequate, classroom windows are sometimes opened to reduce internal temperatures. This can be prevented by improved controls or simply by regular shutting of windows.

73. In the summer, when natural ventilation is most needed, it is pleasant to be able to open windows wide to increase air movement. In many old schools opening lights become painted up and the opening mechanisms difficult to use. Comfort in summer will be increased if these opening portions are freed, especially top lights.

74. During cold weather, less natural ventilation is required. Infiltration rates during the heating season, particularly when a building is not occupied, can often be reduced significantly. Draught stripping windows and external doors is commonly used to achieve this. Whilst such measures may not be cost effective on their own, it is often desirable to include draught stripping in a refurbishment package so that the full savings potential of a number of energy saving measures can be realised.

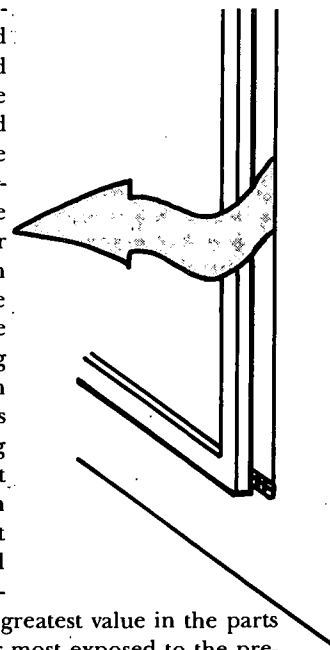

### ***Draught stripping***

75. Draught stripping can be undertaken independently of maintenance and refurbishment; indeed many authorities employ teams to install draught stripping materials. However, it is important to ensure that work of this kind is not carried out prior to redecoration of the exterior of the building in question; care should be taken in the specification and supervision of subsequent redecoration to ensure that the seals are not rendered less effective by over-painting.

76. In many older schools slight movement of the structure and repeated painting of the windows has resulted in gaps between opening light and frame which may allow more air infiltration than is required. The amount of reduction of uncontrolled ventilation and heat loss, and thus the cost effectiveness of this, will depend upon the width of the gap being sealed. It may be worthwhile to have external doors refitted and to replace opening lights.

77. Periodic inspection and, in due course, replacement of draught proofing material is necessary because of its relatively short life.

78. Stick-on foam rubber strip can be used where windows and doors fit properly. It is important to ensure that surfaces are cleaned and prepared before the adhesive strip is applied. Silicone sealant is an effective material for the draught stripping of casement windows and metal framed doors. Nylon brush strip is commonly used for wooden sash windows and doors and this should incorporate a fin to ensure a good seal.

79. Some of the earlier types of metal louvre windows have high infiltration rates at the jambs. This cannot easily be remedied and replacement may be the only option. They are often replaced with fixed lights for reasons of cost. However, sufficient openable area should be left to allow adequate natural ventilation.

### ***Draught lobbies***

80. External doors, particularly those that are frequently used, are a major source of heat loss in winter. Door closers, fitted and maintained in good working order, are very effective in reducing such losses, helping to prevent doors from being left open. Care must be taken to ensure that doors are not so heavily sprung that children have difficulty in opening them. On the main circulation routes in the school, where space is available, it is worth considering whether

a second set of doors can be constructed to form a draught lobby. The patterns of movement of occupants within a building should be established before draught lobbies are introduced and, once installed, the doors which form draught lobbies must be used correctly. To retain heat, both sets of doors should be kept closed whenever possible.

81. In older schools it may be possible to glaze covered walkways and verandas in order to create unheated draught lobbies or enclosed corridors. Adjoining teaching spaces will retain their heat for longer periods and solar gains, if suitably controlled, may be a bonus. Care should be taken to ensure that, sufficient ventilation is provided to prevent condensation in these areas, solar gains are not excessive in summer months; sufficient access is provided for handicapped pupils and that the purpose of the draught lobbies is explained to the users. It is important to ensure that patterns of use do not change adversely; it is not uncommon for such spaces to become uninsulated resource areas. Heating may then be introduced by teaching staff and energy use will increase accordingly, negating any potential energy savings.

## **2.6 LIGHTING IMPROVEMENTS AND REWIRING**

82. Electricity generation produces carbon dioxide (CO<sub>2</sub>), a greenhouse gas, and gases such as nitrous oxides and sulphur dioxide which are responsible for acid rain. To produce one kWh of electrical energy requires approximately four kWh of thermal energy. If this energy is produced from burning fossil fuels the production of electricity results in around three times as much gas emissions as if the thermal energy is used directly, e.g., for space heating using a coal or gas fired domestic boiler.

Electricity for lighting forms a large proportion of the energy used in schools. The following measures should be considered in order to reduce unnecessary use of lighting and in doing so save money and protect the environment:

- Ensure good use is made of daylight.
- Provide adequate local switch control of lighting.
- Replace energy inefficient lamps.
- Adopt automatic lighting control.

### ***Daylight***

83. In general, maximum energy con-

servation will result from a carefully considered approach to lighting with the fullest use of daylight. Electric lighting should be designed to supplement daylight when and where necessary, with local lighting available for the most demanding visual tasks.

84. DES is currently preparing a publication on Lighting in Educational Buildings<sup>(13)</sup> which will give design guidance on the integrated design of daylighting and artificial lighting.

85. The impact of refurbishment measures on internal daylight availability should be borne in mind when considering refurbishment of lighting and controls; improved insulation levels, such as the recladding of a curtain wall facade, may reduce daylighting and increase demand for artificial lighting.

86. Care should be taken to ensure that colours used for interior decoration reflect sufficient light; the perceived need to use artificial lighting is controlled by both the quantity and by the quality of available daylight. Quality in lighting requires consideration of a number of effects during design<sup>(13)</sup>. The quantity is controlled by the extent and positioning of windows and rooflights, and by the reflection of light from internal surfaces. For example, the areas of floors close to windows should be specified such that there is a balance between adequate reflectance and resistance to scuff marks. Walls will benefit from light colours, and teachers may accept advice not to obscure windows with display materials if sufficient display boards are provided.

### ***Switch control***

87. Over-use of lighting not only arises when appliances are left on after occupants have finished using an area, but also where the whole lighting system has to be turned on to illuminate one area of a room.

Economic use of electric lighting is encouraged if luminaire control is related to the distribution of daylight in the building, i.e., if the lights furthest from the windows can be switched on independently of those closer to the windows. If the installation does not permit this, it may be possible at little cost to reorganise the switching when refurbishing.

Whenever rewiring takes place the switching arrangements should be reviewed. Switches should permit individual rows (parallel to the window) of luminaires to be controlled separately, and should be positioned as near as possible to the luminaires they control.

88. Consideration should also be given to activities such as cleaning of school buildings which only requires local lights to be switched on. The remainder can be switched off by a time clock.

### Lighting replacement

89. The replacement of tungsten lighting with other, more efficient, forms of lighting has been common practice for many years. For example fluorescent lamps are about four times more energy efficient than tungsten filament lamps, and have many times the life.

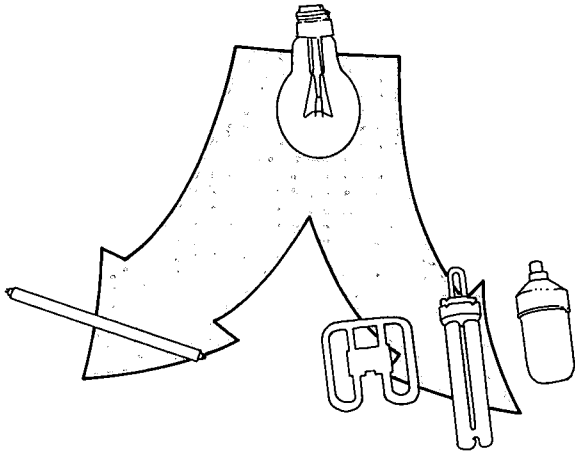

90. Fluorescent lamps and luminaires are now available which operate at 'high frequency' and give energy cost savings of about 30% over conventional fluorescent lighting and eliminate flicker.

91. When reviewing the relamping of schools some of the points to be considered are:

- Higher initial cost of energy efficient lamping.

- Reduced maintenance cost due to longer life of units.
- Reduced energy consumption for a given light output
- Reduced heat gain to the building.

92. One of the problems associated with replacing tungsten filament General Light Service (GLS) lamps with higher value components, such as compact fluorescent tubes, is that the costs associated with pilfering or vandalism are much more significant. High efficiency compact tubes which are separate from their control gear reduce the incentive for theft. Expensive lighting equipment should only be installed where security is at an adequate level.

93. Compact fluorescent lamps can be used to replace filament bulbs directly, but fittings and wiring must be able to accommodate the additional weight of these units.

94. Some of the more straightforward replacements are listed as follows:-

- The replacement of ordinary tungsten filament GLS light fittings with standard or compact fluorescent fittings can achieve energy savings of 50 to 70 per cent.
- Fluorescent luminaires (with switch-start control gear) which have argon filled 38mm diameter fluorescent tubes can be replaced by krypton

filled 26mm diameter fluorescent tubes which use approximately 8 per cent less energy.

- Reflectors may also be installed in fluorescent fittings which improve the light output from these units. Some of the fluorescent lamps may then be removed while existing lighting levels are maintained.

- Outdoor light fittings with tungsten filament lamps can be replaced with compact fluorescent units. Discharge lighting, e.g., high pressure (SON) or low pressure (SOX) sodium lamps may also be used out of doors or in sports halls and swimming pools where colour rendering is not critical - high pressure sodium lamps have proved more popular for such applications. Fluorescent lights may be required to provide back-up lighting while discharge lamps are warming up.

- Where existing or replacement lamps/luminaires provide for higher than required levels of illumination, the opportunity should be taken to reduce their number.

95. Normally it is when installations are rewired that tungsten fittings are replaced with fluorescent luminaires. This is an excellent opportunity to change the layout, introduce lighting controls and to consider the repositioning of switches.

However in many instances fluorescent luminaires have been installed and connected to existing, electrically sound, wiring. This is even more cost effective (in terms of installation costs), and is described in the following case study.

## CASE STUDY

### Replacement of lamps

96. The original lighting installation at Manor College, Cambridge comprised tungsten multi-lamp pendant fittings with glass shades. In order to provide a higher level of illumination and conserve energy, existing tungsten fittings were replaced with fluorescent luminaires connected to existing wiring. As fewer luminaires were needed the surplus wiring points were blanked off.

97. Planned maintenance comprises the cleaning of lamps, diffusers and reflectors annually, with those in the workshops being cleaned more frequent-

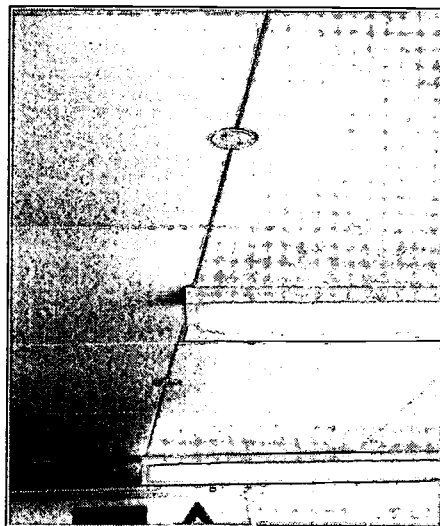

## COSTS AND BENEFITS (January 1986 prices)

### Replacement of lamps

Manor College, Cambridge

Floor area 8320m<sup>2</sup>

Cost of measure £13,000

Electricity consumption:-

before 278,000 kWh

after 213,000 kWh

Average annual saving 65,000 kWh

Value of saving £2,400

NPV = £20,036

IRR = 18.3%

30 years remaining life of the building used in calculations

Simple payback period of 5.7 years

### Other benefits

Improved lighting levels,

Reduction in lighting maintenance costs.

### **Automatic lighting controls**

98. In addition to manual controls, time switches and energy management systems can be used to make sure that lighting is only switched on during pre-set periods. Many timers now have provision for an adjustable light sensor which will switch lighting off when daylight levels are adequate.

99. Automatic lighting controls can be very effective but, for small areas, lighting loads are usually too low to make energy savings worthwhile. The more advanced lighting controls are not cost effective if wiring has to be undertaken specifically for such controls. However, they can be installed cost effectively when a building is being rewired. The introduction of mains borne signalling technology may make the retrofit of lighting controls a more attractive option in schools where rewiring is not planned.

100. In all cases where the introduction of lighting controls is being considered, a quick calculation can show the expected level of savings from reduced hours of use. This will indicate the maximum cost of lighting control equipment and installation which will achieve the reduction in lighting energy consumption economically. Building Research Establishment Digest 272<sup>(14)</sup> provides guidance.

101. The main forms of lighting controls are:

#### **Manual control**

Effective manual control should be encouraged by proper labelling and layout of switches.

#### **Time controls**

These can be used to turn bulk lighting on and off to match the working day. A manual reset may be provided to cater for out of hours use, e.g., lunchtimes and during cleaning. Time switching may be used to switch off lighting at regular intervals, forcing occupants to reassess their need for lighting and to turn on lights only if required.

#### **Photoelectric controls**

Occupants rarely switch lighting off when a classroom is receiving adequate illumination from daylight. Photoelectric controls can ensure that the lighting cannot be turned on, or remain on, when daylight provides the required illuminance by itself. Automatic dimming of lighting, a further option, is less likely to be cost effective than time switching because of the higher initial costs incurred. A time lag should be incorpo-

rated in photo-electric systems to avoid 'hunting' during periods of continually varying daylight, which is annoying to those using the building.

### **Occupancy sensors**

Acoustic, ultrasonic or infra-red sensors may be used to trigger the control system to turn the lights off when a period of occupancy has finished. It is important to ensure that the system does not respond too rapidly to the occupants leaving the area being illuminated. There should be a delay of 10 minutes, or more, between occupancy ending and lights switching off.

102. Lighting controls should not be allowed to create conditions of total darkness during occupancy periods - manual controls should be retained on 20% of classroom lights. Wherever safety issues need additional consideration, such as, in laboratories, workshops, sports halls or escape routes then automatic controls should only be used where there will always be adequate background lighting.

103. Lighting controls can prove to be very unpopular if occupants find that lighting is being switched at times that are inconvenient. Frequent turning off of lights during hours of occupancy can serve to antagonise the users and reduce the life of equipment.

104. An example of a lighting control which has been developed by a local authority is the 'Bedfordshire' switch. A conventional rocker switch is used to enable minimum lighting - usually one row - to be switched on by anyone entering a classroom. If more lighting is then required a key must be used by a member of staff to switch on the remainder of the lighting, typically a further three rows. These lights stay on for a preset period, after which illumination reverts to the minimum condition. All of the lighting can be extinguished by the use of the rocker switch which also zeros the timer sequence. This form of lighting control has been used in a number of schools, including Hither Green, see section 3.1. Similar controls are now available from other manufacturers.

## **CASE STUDY**

### **Automatic lighting control**

105. During a major rewire of Beacon Heath First School, Devon, existing tungsten lighting was replaced by fluorescent luminaires. Programmable switching was introduced into classrooms, controlled by a central programmer. The programmer switches off all classroom lighting at pre-determined times during the day, and also switches off the row of lights adjacent to the windows at any time that daylight levels are adequate.

106. Lighting is turned on by a push button in the normal classroom switch location. This will either turn on all of the classroom lighting or, if daylight is above a preset level, only bring on the

inner rows of lights which are not daylight level controlled. Lighting may be turned off manually by a separate push button, as well as automatically under time control.

The photo-electric control will allow lights adjacent to the windows to be turned on when daylight is below the pre-set level and will also turn these lights off automatically when daylight has risen above the pre-set level for a pre-determined period.

A 10 or 20 minute delay in the lights going off is incorporated so that the system does not react to fleeting changes in daylight levels.

107. Instructions in the operation of these controls were given to staff at a group meeting and, after an initial period of adjustment, they have found that the degree of control which they can exercise over the lighting is acceptable.

108. This control system employs dedicated low-voltage cabling between the central programmer and individual classroom control panels. The cost of this cabling precludes the system's introduction except where general rewiring of a school is undertaken.

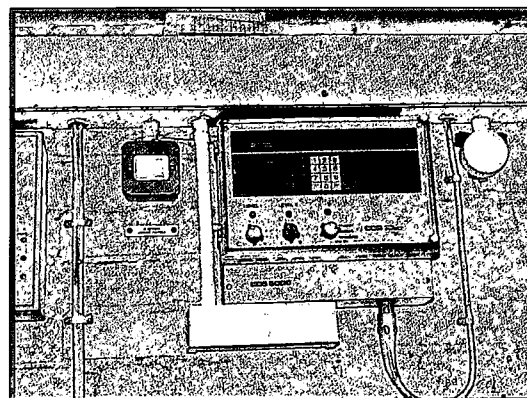

## COSTS AND BENEFITS (January 1986 prices)

### Central time switch/ local photo-electric control

Beacon Heath First school, Devon

Floor area 1700m<sup>2</sup>

Cost of measure £1,300

Average annual saving 2,900 kWh

Value of saving £160

NPV = £1,286

IRR = 12.3%

60 years remaining life of the building used in calculations

Simple payback period of 8 years

(The additional cost of wiring the system was minimal in this instance)

### Other benefits

Better and more even lighting

## 2.7 BOILER REPLACEMENT

109. Boilers consume most of the energy in educational buildings and are the most obvious target for upgrading or replacement by authorities. The decision to replace boiler plant will be governed by a number of factors, for example:

- The efficiency of the existing boiler, both part-load and full-load.
- The current maintenance requirements, and reliability.
- The availability of parts.
- Changes in the heating load of the school.

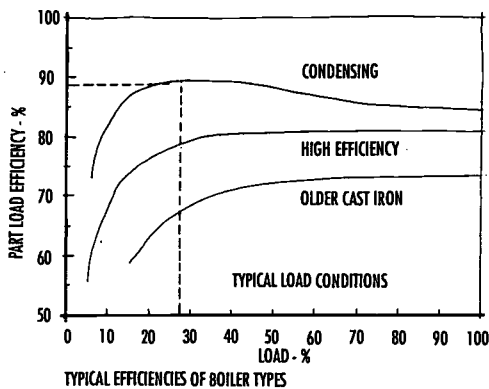

However, it is important to establish that the maximum performance is being obtained from existing boiler plant before new equipment is considered. It is also important to establish the amount of heat that is being used.

### Heating load

110. In many instances the heating loads of schools have not been measured for several years; some form of monitoring should be undertaken to establish the

amount of heating used before new equipment is introduced. When this information has been acquired, it will then be possible to determine whether refurbishment or replacement of boiler plant is appropriate.

This monitoring exercise should also include an inspection of pipework. This can be used to determine whether transmission losses can be reduced by eliminating unnecessarily long pipe runs, installing point-of-use heating, or simply improving levels of insulation. The extent to which transmission losses constitute the base load of heating plant should be determined.

111. This initial inspection is also an opportune time to establish whether the existing system is balanced and whether controls, such as time clocks and thermostats, are operating correctly.<sup>(58)</sup>

### Boiler size

112. Where a building is being refurbished and energy efficiency measures introduced, there may be a significant reduction in space heating demand. Many boiler replacement schemes are carried out as part of a wider package of measures to refurbish a school. Such a package may include: the introduction of a building energy management system, zone controls, decentralised hot water systems and improvements to the building fabric. All of these may change the load pattern considerably and influence boiler sizing. Any planned changes in occupancy patterns should be taken into account when calculating the anticipated heating load.

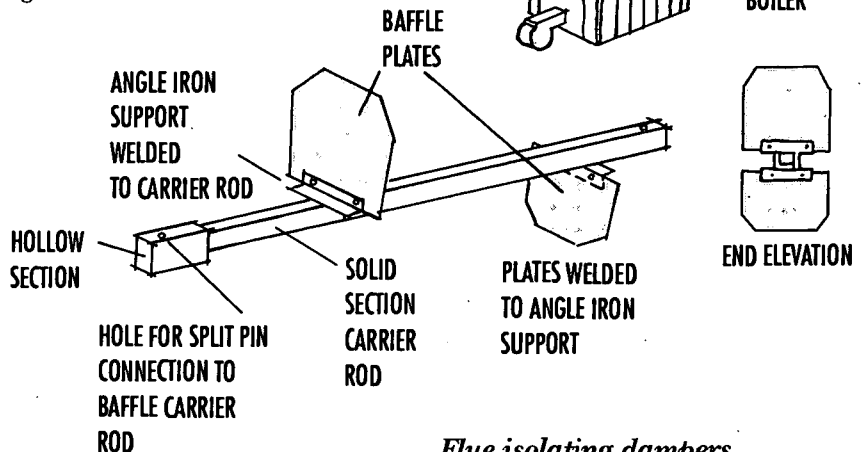

### Condensing boilers<sup>(43)</sup>

113. These boilers outperform high-efficiency conventionally flued boilers under all conditions. Part-load efficiency is very good due to very low standing losses.

If existing boilers are due to be replaced, and gas is the primary fuel, it will normally be appropriate to install a condensing boiler at least as the lead boiler. A reduced heat requirement, as

often occurs when a building has been insulated will mean that existing radiators can provide sufficient output at lower mean temperatures so allowing the boiler to operate in the more efficient condensing mode in which it recovers the maximum heat from the flue gases.

Three condensing boilers have been installed to serve an underfloor heating system at a new extension at Charlbury School, Oxfordshire. A pay-back period of four years has been achieved on the additional cost of these boilers compared with conventional boilers<sup>(45)</sup>.

### Maintenance

114. Boiler plant will only perform efficiently if it is properly maintained. Service schemes should be considered in detail at the time of boiler replacement. The training of the operators of the new equipment is important; for example, poor de-ashing of coal-fired boilers can result in low efficiencies and this can often be attributed to inadequate training of staff.

### Flue baffles

115. Flue baffles can be designed to fit most of the pressure-jet oil, and gas-fired, older pattern cast iron sectional boilers used in schools. This inexpensive retrofit measure has resulted in improvements in boiler efficiency of approximately 5% and payback periods of under one year.<sup>(16)</sup>

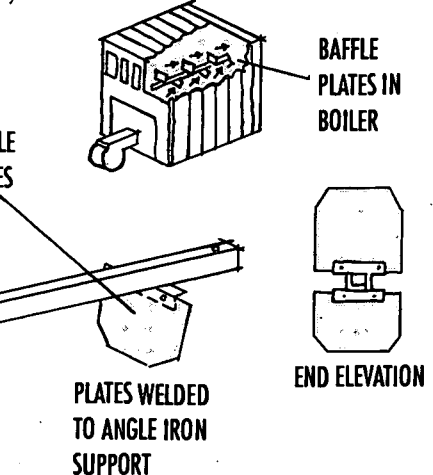

### Flue isolating dampers

116. Where sequenced boilers operate with one or more boilers on standby the flue losses from the standby boiler can be eliminated by the fitting of flue isolating dampers which close when the boiler is on standby and prevent most of the heat loss from the water circulating through the boiler. Both flue baffles and flue isolating dampers must be properly engineered and their operation should be failsafe.

### Solid fuel stokers

117. Considerable economy can be achieved, on solid fuel installations, by installing modulating stokers rather than fixed-time stokers. It is important to specify stokers with good continuous firing turndown ratios. Modulating stokers used on larger boilers can be responsible for 'cycling' during heating and it is important to ensure that this is reduced to a minimum. Burners should be capable of meeting the highest load required but should not exceed this requirement. The maximum output of such stokers may be altered by limiting the range over which they modulate.

### Ancillary equipment

118. In addition to the boiler there is the sizing of the combustor, fan and pumps to be considered as well as selection of appropriate controls and instrumentation. It is important to ensure that the equipment selected matches the boiler.

119. The replacement of boiler plant presents an opportunity to examine and, possibly, upgrade other associated equipment including, perhaps, the boiler house itself. Pipework, chimneys and flues and fuel storage and handling plant may merit attention. There will be changes or additions to pipework when a replacement boiler is installed and this may be a good opportunity to rationalise what already exists perhaps by adding controls or increasing the number of zones in the heating system. The insulation of pipework is particularly important. Hot water mains should be insulated as should heated oil storage tanks.

## 2.8 BOILER CONTROLS

120. Controls can be introduced which reduce boiler cycling (on-off operation) to a minimum. The boiler should be allowed to stand idle, without cycling, until there is a genuine demand for heating. The success of this strategy depends on the amount of insulation on the external surfaces of the boiler and the amount of air leakage through the boiler.

121. Boiler controls on hot water boilers may be altered so that the boiler cannot operate if the output circulating pump is stopped. Proprietary control units are available to minimise cycling and match the boiler output to the load. These can be beneficial on large boilers; if a boiler operates at full load when only a small proportion of its output is required, cycling will normally occur.

122. It is important to ensure condensation on the fireside of boilers which have been switched off, so as to minimise the risk of corrosion. Flue gases should only condense in purpose designed gas boilers of the condensing type.

123. It is also important to ensure that fuel/air ratios and boiler efficiency are optimised for the full turn-down range of the plant. This can be achieved by controlling air-flow according to information gained from periodic checks using oxygen or carbon dioxide sensors in the boiler flue.

### Sequencing of boilers

124. Once the anticipated load has been estimated it may be worthwhile investigating the replacement of one large boiler with two or more smaller units. The majority of boilers are most efficient when operating at full output, but there will be only a few days in the year when full output will be required for extended periods. Significantly less heating will be required during the remainder of the year. Consequently, the boiler and burner are over-sized for the bulk of the heating season. It may be more economical to satisfy large variations in demand by installing a multiple boiler system. Then, in milder weather, one or more boilers can be isolated, allowing the remaining boilers to operate at peak load and high efficiency. Boiler sequencing of this type is carried out using automatic controls.

125. The financial benefits of sequential firing of boilers must be weighed against capital costs and maintenance costs. There is evidence to suggest that the feeling of security produced by duplicating boilers may encourage laxity in maintenance and an increased risk of breakdown. A single boiler with a planned maintenance policy and on-call emergency provision may be a more practical arrangement giving lower running

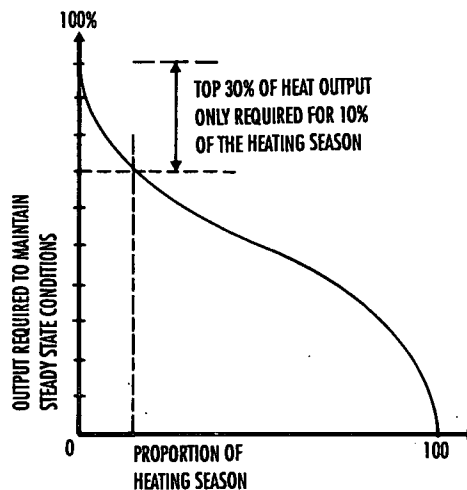

costs and preventing loss of boiler condition due to under-use. Moreover, sequencing is often specified for multiple boiler systems without close examination of the implications, e.g. maintenance of a more sophisticated control system.

126. For energy efficient use:

- The controller must only enable sufficient boiler capacity to produce an acceptable pre-heat, and ensure after-heat is minimised.
- Circulation through non-enabled boilers should be inhibited to stop heat loss, or alternatively flue isolating dampers should be fitted.
- Boiler duty cycles should be examined to determine the minimum number of boilers required to operate simultaneously.
- The boiler sequencing panel should provide sufficient information for the operator to restore normal operation without the need to refer to a manual or other documentation. A test procedure to validate the system should also be available. These can be provided as wall charts.
- Hot water load should not be regulated by weather related control.

127. It may be worth considering a condensing boiler for the 'lead' role in a sequenced gas-fired multiple boiler system.<sup>(45)</sup>

## 2.9 HEATING CONTROLS

128. Each school will require controls appropriate to its heating plant, occupancy patterns, form and thermal mass. The characteristics of the building and its heating system must always be considered along with the type of control that is proposed. It is important to match the control system to the needs of the user and to make calculations of likely savings before adopting a particular technology.

129. The introduction of LMS may increase the demand for heating controls which can be understood and operated by school staff. In these circumstances the technical optimum may not be the best solution; a control system which can be readily understood will be preferred.

130. The heating control system should ensure that :

- The building is brought to temperature as late as possible before the beginning of the school day.
- Comfort conditions are maintained only in those parts of the school which are occupied.
- Incidental heat gains from occupants and equipment, and any solar gains, can be accommodated.
- Frost and condensation protection is ensured.
- Provision is made for weekend and evening use of all or part of the building.
- Standing losses are minimised during milder weather.

131. Some authorities have a distinctly centralised policy and make use of computerised control systems, whilst others maintain a more traditional approach with local control. In larger buildings there is a strong case for the installation of heating plant controls which can be linked to a building energy management system (BEMS), particularly if those responsible for the operation of the equipment have some experience of microprocessor based systems. However, before embarking on a major investment of this kind, it is important to consider the simpler options available. A considerable number of school buildings were constructed during the period when fuel was relatively cheap, and still have simple heating systems with few controls. There are opportunities to improve energy use and comfort conditions in such buildings with much less complex and costly equipment.

132. Significant energy savings can be made simply by ensuring that the duration and temperature of heating is at the minimum acceptable level. Savings can also be made if controls are simple to operate and easy to maintain. The regular maintenance and checking of controls is a very cost effective way of saving energy.

133. In practice, many schools are heated to the required temperatures several hours before the building is occupied, and probably after it is empty again, because:

- Heating plant is operated by an automatic time control which is faulty or is not set correctly.

Heating plant is controlled by a sys-

tem which is not monitoring internal or external temperatures correctly.

- Heating is needed for the cleaning staff.
- Insufficient zoning exists to allow selective heating of one zone only eg. for out of hours use.

134. Thus it is important that the elements of a control system are operating correctly and are appropriate for the building in question. In practice, it is temperature, time and area which have to be regulated.

### Temperature control

135. Temperature sensors are used to control the output from central plant and heat emitters alike. Accuracy and reliability in the measurement of representative temperatures are vital if a heating system is not to waste energy. A 1°C rise in a room thermostat setting can increase energy consumption by as much as 10%.

136. Sensors should be positioned so that they detect the required temperatures as accurately as possible, and the effects of disturbing influences are minimised. Indoor thermostats must be in representative positions for the zones they serve and, ideally, each zone should have separate thermostatic control.

137. Indoor and outdoor air temperature sensors are often installed in locations where they are exposed to direct sunshine, or reflected heat from surfaces warmed by the sun, giving a false impression of the temperature. This will, in turn, give rise to incorrect heating patterns and complaints from occupants. Outdoor air temperature sensors should not be installed facing south and indoor sensors should never be exposed to direct sunlight.

138. It is particularly important to zone any part of a building which is subject to direct heating from the sun separately, so that gains in spring and autumn can be accommodated. Separate thermostatic controls allow different zones to be heated to different temperatures.

### Compensators

139. Weather compensated controls are used to regulate the temperature of the hot water flowing through radiator systems so that the output of the radiators is reduced or increased in line with changes in external temperature. Sensors are used to measure the outside air temperature and water temperature which is regulated accordingly. It is

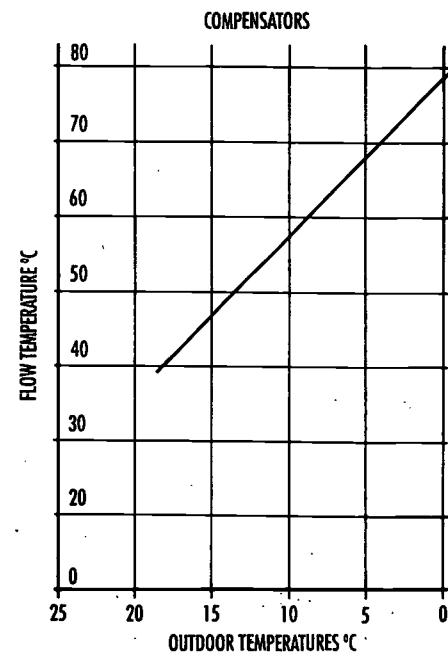

Typical compensated control of a radiator system.

important to ensure that sensors are sited in representative positions and are fully operational.

### Thermostatic radiator valves

140. These valves have sensors which detect temperature variations from sources such as solar gains and occupants. The output of the radiators is modulated accordingly, and stable room temperatures are maintained.

They can be a very effective means of making hot water systems more responsive to changes in space heating requirements. Whilst thermostatic radiator valves (TRVs) have been adopted by many authorities, others do not specify them because of problems of vandalism, durability and calibration.

TRVs and heating control temperature sensors should not be installed in the same room as the two forms of control may work against each other. On variable temperature networks designed to operate at a constant flow rate, the viability of TRVs can be improved if they are not installed on every radiator. This also helps to reduce pump volume and head changes.

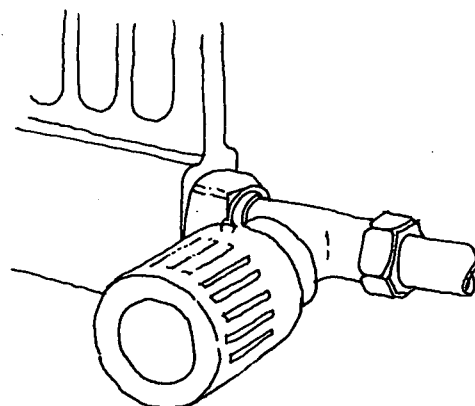



### Frost protection

141. This is required to ensure that the heating system will not be damaged in cold weather by freezing or, in heavy-weight buildings to prevent the formation of condensation.

142. Frost protection systems have two stages; initially an external frost thermostat brings on the pumps to circulate water through the heating system and then, if the building temperature drops to below a pre-set level, an internal frost thermostat activates the heating system. A considerable amount of energy is wasted in educational buildings in the winter because frost protection thermostats operate at too high a temperature. Accurate calibration and sensible operation of frost protection equipment is important if the amount of heating required to protect the building's heating system is to be minimised. All external pipework should be insulated to prevent frost damage.

### Time control

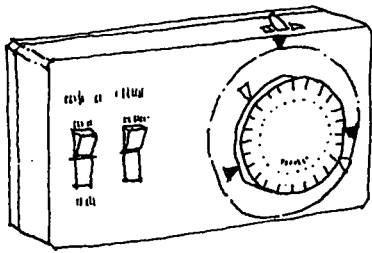

### Time clocks

143. Simple time clocks allow heating requirements to be programmed for a 24-hour period and can be a very cost effective method of matching heating to occupancy patterns. They often incorporate a 7-day function so that heating can be prevented from coming on at weekends and should have a resolution no greater than 15 minutes. The more modern electronic controllers can be pre-programmed to deal with heating requirements for days or weeks in advance, but they demand a greater degree of skill to commission and operate. Time clocks are often found to be set incorrectly, damaged, or entirely disconnected from the heating systems of schools. Consequently, a great deal of energy is wasted.

### Optimisers

144. Many schools now have optimum start control systems which regulate the start-up of the heating plant according to the prevailing weather conditions – using outside air temperature, inside air tem-

perature or a combination of the two – so that the building reaches operating temperature just prior to occupancy. Some of the more advanced optimisers incorporate a self-learning process, adjusting the pre-heat time to suit the thermal response of the building. Optimum stop controllers are also available for heavy-weight buildings where energy can be saved by switching off heating prior to the end of occupancy.

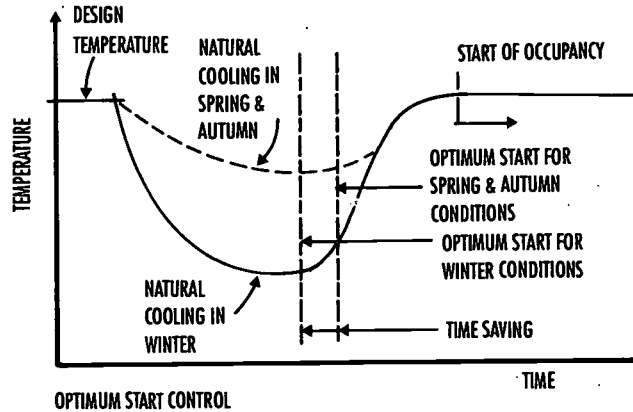

145. It is important to ensure that these relatively complex systems are installed and commissioned correctly, and that they are not tampered with.

146. A time control with fixed preheat period is most suitable for buildings with boilers rated up to about 100kW. Above this an optimiser should be considered.

147. A rule of thumb calculation of the viability of such optimum-start controllers can be based on potential savings of 8% of fuel costs annually. Additional benefits of the order of 10% may be available from inhibiting heating during periods of high internal or external temperatures.

148. In some respects stand-alone optimisers have been superseded by the development of energy management technology which offers a number of advantages over conventional control systems.

149. A number of authorities have developed their own control equipment in conjunction with manufacturers. For example, Hertfordshire County Council has developed a vandal and tamper-proof room thermostat which has a switching differential of 1°C or less, compared with the 3°–5°C common to conventional bimetallic strip thermostats. These have been shown to produce pay back periods of less than six months and are being

incorporated in frost and boiler control thermostats. Low cost optimum start controllers have been developed by Cambridgeshire County Council.

### Out of hours use

150. Any extension in the use of a school beyond normal school hours must be catered for by the heating system. This is becoming more important as patterns of use in schools change, with greater emphasis on the community. Control equipment such as optimum start and optimum stop must be able to accommodate extended use without wasting energy.

151. The definition of the start time and length of any extension period must also be accurate and easily programmed. Furthermore, programming the extension period should not be carried out in an area

of the heating controls where data entry may corrupt the main programme. Some schools have a simple switch which gives a pre-set extension when operated by the caretaker.

152. The amount of hot water required during extended use must be considered; often existing stored hot water is sufficient and no further heating is required.

### Area control

153. In large colleges and schools significant energy savings can be made by matching heating periods more closely to occupancy patterns. Zoned heating controls avoid the unnecessary wastage of energy brought about by all the blocks of a multi-block site being switched on when only one block is in use. Evening and weekend use of the buildings will be more energy efficient if the heating is adequately zoned.

154. Zone valves can be added to the pipework feeding each block and these can be programmed by a multi-channel timer to switch off the heating to unwanted zones as required. However, it must be emphasised that zoning is only cost effective where suitable pipework is in place; many schools have different circuits with common returns, and even single pipe circuits which preclude sophisticated control or zoning. In these cases, it may be worth investigating optimising patterns of use to suit the existing heating system.

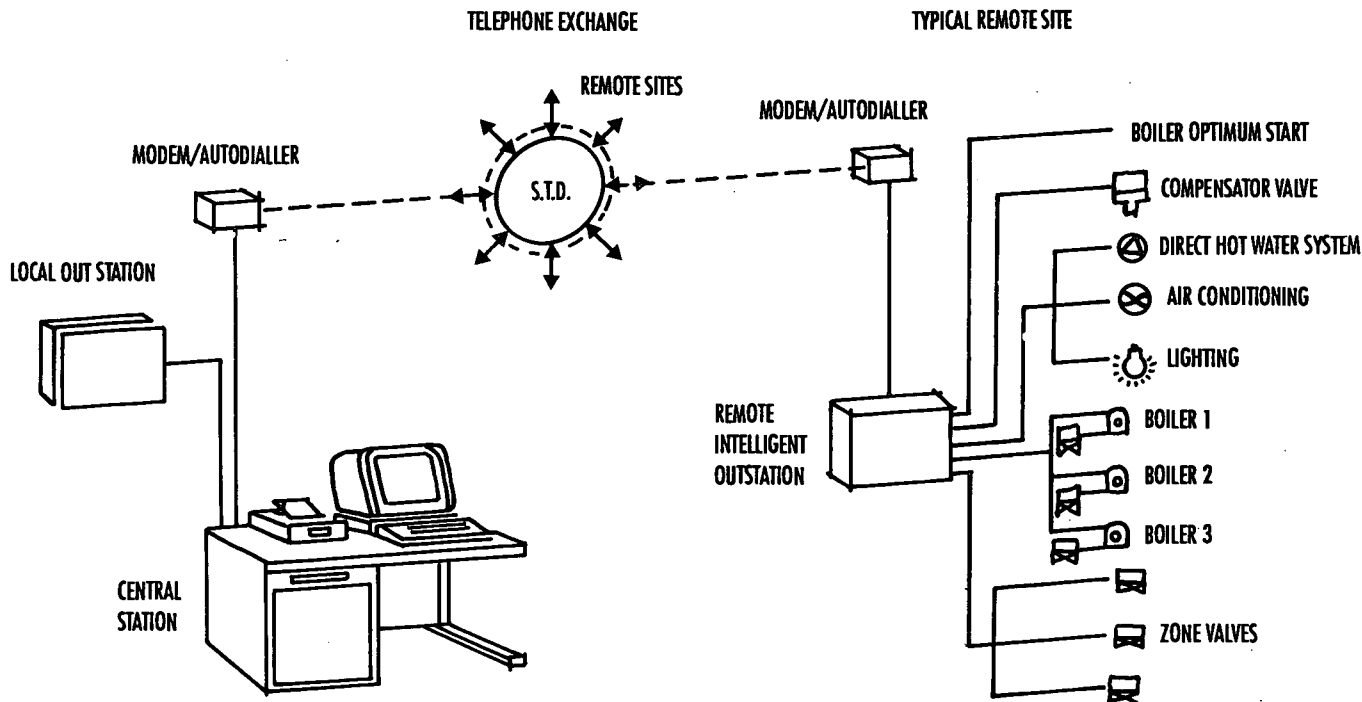

155. The users of zoned heating should be provided with a plan of the system so that it can be operated efficiently — see Appendix 2. The development of mains-borne signalling means that, in some instances, zoning will be more cost effective as hard wiring for the controls will not be required.

**Building energy management systems**

156. Building energy management systems (BEMS) are used to monitor and control a range of building energy services often located on a number of sites. In doing so they minimise energy use and maximise the efficiency of the plant. The remote monitoring and control of these services should enable a higher standard of operation and maintenance to be maintained whilst providing information on energy flows, consumption, performance of equipment, maintenance requirements and trends.

157. The following are just a few of the functions in schools which are controlled by energy management systems:

- Time and type of day control.
- Self adjusting optimum start/stop.
- Weather compensation.
- Boiler sequencing.
- Frost protection.

- Programmed override for out of hours use.
- Central recording of data.

158. Advances in microelectronic technology have now made it feasible to consider the cost effective application of this technology for the refurbishment of even moderately sized schools.

159. Given the prevailing shortage of skilled staff, the quality and quantity of the manpower required to install and support any control system must be considered. One of the problems with a centralised, computerised control strategy is a reliance on key personnel; their expertise is often very costly to replace. The cost of the central computer and software should be considered when assessing the cost effectiveness of BEMS technology as should the lengthy learning process usually associated with its introduction. The maintenance requirement for computer equipment is a further consideration. The costs of operating and maintaining a BEMS should be weighed carefully against any potential gains. With large recurrent maintenance costs likely a discounted cash flow analysis will be needed in most cases to determine the cost effectiveness of installing a BEMS (see Appendix 1)

160. Many of the energy savings which result from a BEMS installation may not be directly attributable to the technology. The site investigation and system design

phases of installation involve detailed and expert examination of the overall control requirements. A BEMS will be effective in maintaining the levels of efficiency established as the result of such an exercise. However, such an expert survey, followed by corrective action and the installation of conventional controls, may lead to comparable savings.

161. With the introduction of LMS there may be an increasing demand for energy management systems from schools wishing to control their own heating systems. Much will depend on the availability of a suitably trained member of staff.

However, it may no longer be possible to group schools together in a centrally controlled BEMS. This will mean that the costs of installing and operating the equipment cannot be spread over a number of sites. It may also prove to be difficult to continue a policy of recording performance figures in a central database. This may make the negotiation of contracts for fuel, maintenance, etc., more difficult.

162. A considerable amount of expertise in saving energy with energy management systems has been gained by authorities; many are willing to discuss their experiences of BEMS with prospective users. Indeed, several authorities have, as with other controls, developed their own BEMS technology in collaboration with commercial manufacturers and achieved substantial energy savings.

## CASE STUDY

### Boiler replacement and controls

163. Space heating at Queen Edith's Junior and Infant's School, Cambridge, was originally provided by three oil-fired boilers. These served underfloor panels in the classrooms and main hall, with radiators in the corridors. The plant also

provided the domestic hot water and heat for a small outdoor swimming pool. In the summer of 1982, the maintenance department refurbished the boiler house, rewired the school and replaced the underfloor heating system with 25 fan convectors in the classrooms and halls. The opportunity was taken to install four 144kW boilers and to divide the school into a number of heating circuits. These zones included the fan convector circuits in the junior and infants in addition to

the existing radiator, domestic hot water and swimming pool circuits. Heating system controls included optimum stop/start, a compensator control for each of the three heating zones and boiler sequencing controls. In March 1984 the internal thermostats in the fan convectors were replaced by room thermostats. These measures, plus the replacement of tungsten bulbs with fluorescent tubes reduced energy consumption by nearly 43%.

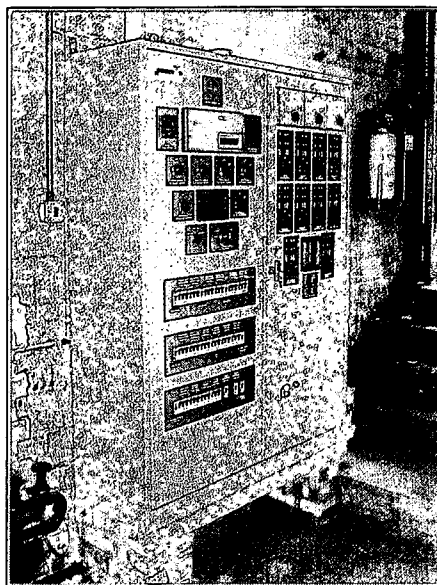
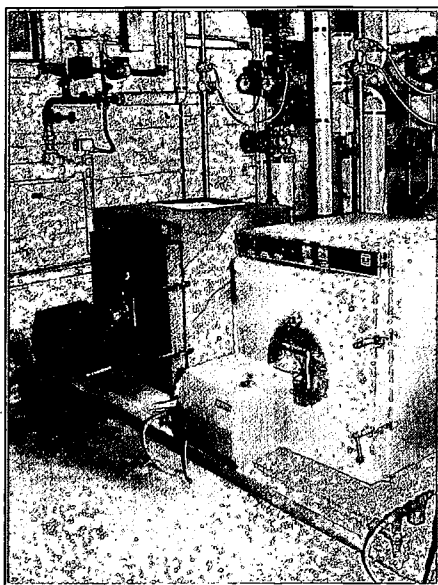

### COSTS AND BENEFITS (January 1986 prices)

#### Boiler replacement and controls; replacement of tungsten bulbs by fluorescent tubes

Queen Edith's Junior and Infants School, Cambridge

Floor area 2900m<sup>2</sup>

Cost of measure £7,600

Average annual saving

Oil 380,000 kWh

Electricity 20,600 kWh

Value of saving £6,900

NPV = £103,900

IRR = 91%

60 years remaining life of the building used in calculations

Simple payback period of just over 1 year

#### Other Benefits

Versatile heating controls, improved lighting levels and improved comfort conditions.

## CASE STUDY

### Boiler replacement and BEMS installation

164. The original boilers of Hereford Technical College were coming to the end of their useful life and the existing controls were inadequate. The boilers were replaced and Energy Management Controls were installed to link into an existing central control station at the headquarters of Hereford and Worcester County Council.

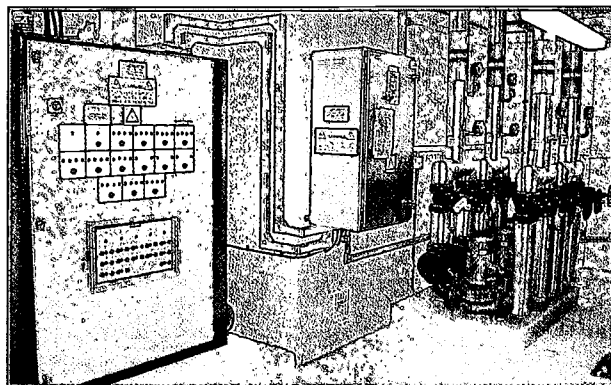

Main control panel with EMS control centre

The refurbishment of the space heating and hot water plant included the installation of three gas-fired 1.3MW boilers in the main plant room, control panels in the main boiler and subsidiary plant rooms, removal of existing calorifiers and associated pumps, pipes, immersion heaters, and replacement by direct gas-fired water heaters, insulation of appropriate pipework and the refurbish-

ment of fan convectors where required.

Staff of the property department are now able to monitor and reschedule the operation of the plant at the Technical College much more readily, and respond to maintenance problems with a clearer idea of the nature of any faults. System temperatures and plant status are monitored at each plant room and internal temperatures in each building. A plant status and fault-indicator panel was also installed in the permanently manned senior caretaker's office.

### COSTS AND BENEFITS (January 1986 prices)

#### Boiler replacement and BEMS installation

Hereford Technical College

Floor area 20,700m<sup>2</sup>

Cost of measure £54,000

(35.5% of total refurbishment cost borne by energy conservation fund)

Average annual saving 1,000,000 kWh

Value of saving £39,000

NPV = £576,000

IRR = 72%

60 years remaining life of the building used in calculations

Simple payback period of 18 months

#### Other benefits

Quicker monitoring and fault diagnosis from County Council offices and caretaker's office, easier rescheduling of plant operation, electric heating replaced by gas giving significant cost saving. Reduced complaints about under/over heating.

165. Electricity consumption in the complex was reduced by 23% due to the removal of the original hot water immersion heaters and auxiliary electrical space heating. Overall energy consumption was reduced by 15% and further significant reductions in energy consumption are anticipated by virtue of the BEMS. A simple payback period of 18 months was achieved.

**Boiler and hot water controls**

166. Space heating at Upcroft Junior School, Berkshire, was provided by four 56kW gas-fired hot water boilers, which were controlled by a simple time clock system. A fifth gas-fired boiler, housed separately, supplied heating for the school's outdoor swimming pool which is used by the pupils for approximately 12 weeks a year.

167. One of the measures adopted was to provide indirect heating to the kitchen hot water storage vessel from one of the existing boiler modules, and disconnect the existing immersion heater with significant cost advantage. The boiler was also derated to 42kW which was deemed adequate for the provision of hot water.

168. The second measure was that of boiler control. A BEMS outstation was installed which included features such as optimisation, frost control and zoned temperatures. A facility for central control of the heating system is available but was not adopted immediately after the installation.

A manual override switch for out of hours use is the only control that the caretaker can utilize. This provides for extra two hour periods as required. An energy saving of 31% was achieved.

New boiler control with caretaker override switch

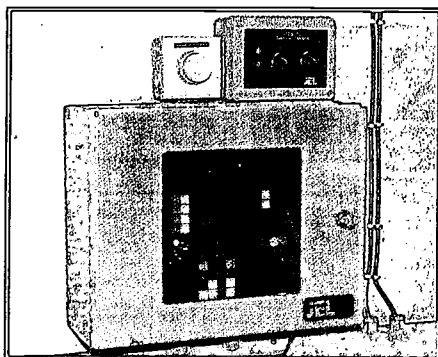

**COSTS AND BENEFITS  
(January 1986 prices)**

Boiler and hot water controls	
Upcroft Junior School, Berkshire	
Floor area	970m <sup>2</sup>
Cost of measure	£2,300
Average annual saving	125,000 kWh
Value of saving	£2,100
NPV =	£27,000
IRR =	91%
30 years remaining life of the building used in calculations	
Simple payback period of 1.1 years.	

**2.10 HEAT EMITTERS**

169. Basic maintenance of heat emitters, such as the cleaning of air filters in fan convectors, is essential if energy is to be used efficiently. The performance of heaters can also be improved by the introduction of accurate, tamperproof and robust thermostats.

170. Radiators are often installed beneath single glazed windows so that the warm air they emit mixes with the cold draught generated at the window surface. This prevents the cold air from falling, passing over the floor and causing discomfort to the occupants and eliminates the 'cold radiator' effect of the glass. However, a suitably designed shelf positioned about 75mm above a radiator will help to counteract cold draughts in a more energy efficient manner; the mixing of warm and cold air streams takes place away from the window surface and thus heat losses from the building are reduced.

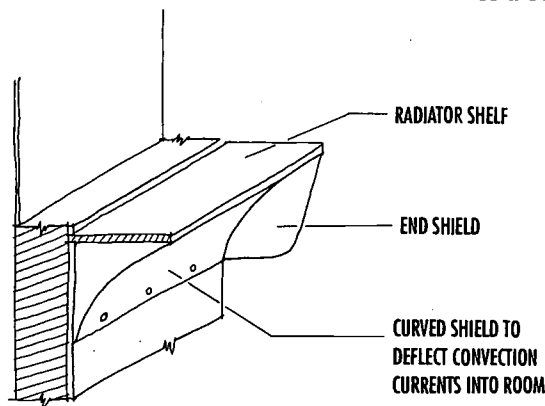

171. In many lightweight schools the section of wall immediately behind radiators mounted on external walls provides low levels of insulation. Consequently much of the heat from the rear surface of the radiator is lost to the exterior. This can be reduced by the retrofit installation of metallic foil, insulating board or a combination of the two.

172. In poorly insulated buildings which are occupied only for short periods it may be advantageous to consider some form of radiant heating. This allows the teaching space to be used at short notice with no costly pre-heat period.

**2.11 DOMESTIC HOT WATER**

173. The replacement of space heating and hot water boiler plant presents an

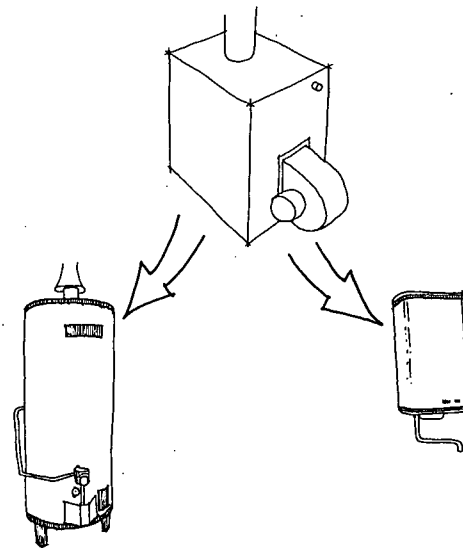

opportunity to improve the efficiency with which hot water is provided in school buildings. Hot water services may be decentralised by introducing point of use hot water appliances. Alternatively, hot water services can be decoupled from space heating plant by the introduction of a separate DHW boiler and distribution system. The approach adopted will depend on the existing heating and hot water plant, the length and condition of pipe runs and the cost of installing gas or electricity supplies for retrofit water heaters.

174. Electric hot water calorifiers which do not operate on an economy 7 tariff should be fitted with time clocks and thermostats, so that water is not kept warm out of

school hours and is at the minimum temperature required when in use.

Many schools of the 50s and 60s had two, or more, large hot water cylinders which were usually oversized by today's standards. It is often worth reducing this overcapacity by completely isolating one of the cylinders or replacing it with a smaller unit.

175. As a precaution against Legionnaires Disease it is essential that dead-legs are minimised and that hot water is stored at not less than 55°C. This is too hot for handwashing, bathing and showers. The supply temperature to showers and baths in all premises and wash basins in infants schools only, should not exceed 43.5°C (17). This requires the use of automatic thermostatic mixing valves to bring the temperature down to an acceptable level.

The Chartered Institute of Building Services Engineers have recommended design procedures which reduce

the risk of domestic hot water systems harbouring legionella bacteria (see CIBSE TM13)<sup>(18)</sup>.

176. The requirements for hot water in any school should be checked; resource areas may require only cold taps as it is sometimes the case that considerable amounts of hot water are wasted in cleaning utensils which are just as easily cleaned with cold water. It is also important to ensure that the amount of hot water used by outside contractors, such as cleaners and caterers, is minimised. This may require the installation of sub-meters.

177. Centralised hot water systems which distribute DHW to one or more buildings by primary feeds, with secondary return pipes and a return pump, should incorporate a time-clock. This will help to reduce heat losses and electricity which would otherwise be wasted in circulating the water when the school is unoccupied.

178. Seasonal efficiency varies widely in systems with heating and hot water derived from common boilers. In the summer, DHW operation has to support the non-useful heated water in the distribution pipework plus the standing losses in the boilerhouse, whereas the losses are shared with the larger heating load during combined operation. Thus, in summer, efficiency will be significantly less than in winter.

179. Ways to save on DHW requirements include:

- Reduce standing losses by adopting time switch operation of secondary pumps within periods of occupation.
- Domestic hot water load should not be regulated by weather related control.
- Minimise the number of days during vacations when hot water is required for cleaning.

- Provide local hot water heaters where they can be shown to be cost effective.
- Use low temperature cleaning chemicals where possible.
- Adopt flow restrictors on taps to reduce demand for hot water.

180. Water charges will form an increasingly significant part of school running costs and efforts should be made to ensure that showers, taps, WCs and urinals deliver no more water than is absolutely necessary. In addition to flow restrictors on taps, urinals can be fitted with occupancy sensors. Dual flush toilets, economic spray shower heads and cisterns fitted with dams to reduce the quantity of water used are available. Water leaks should be traced and eliminated, and consumption levels monitored closely to discover leaks early before large expensive losses have time to occur.

## CASE STUDY

### Decentralised hot water

181. The water heating system at Lode Heath School, Solihull had very long pipe runs and a boiler working inefficiently on low load. This arrangement lead to high summer DHW heating costs.

It was decided to shut down the oil burners during the summer and install an electric flow boiler at each of the hot water cylinders. The heaters are designed to provide as much hot water as possible on the low night rate tariff, with

daytime boost facilities if needed. The hot water facilities were fully insulated.

182. Two 12 kW heaters were installed in the 280 gallon cylinders in the sports hall for the showers. These have operated entirely on night rate. Two further 12 kW heaters in domestic science and a 6 kW heater in the 80 gallon cylinder in the science labs have been operated with a 7 hour night charging period and a 2 hour day time boost.

183. The electric hot water system is now providing a full summer hot water

service at a considerably reduced cost. It is simple to use, requires very little maintenance and can act as a reserve system in winter.

Solihull Council is continuing to install similar systems in a number of schools and is now using a Mark II improved design.

### COSTS AND BENEFITS (1985 prices)

#### Decentralised hot water electric flow heaters

Lode Heath School, Solihull

Cost of measure £5400 (£900 per heater including plumbing)

Energy consumption (in 16 week summer period)

Before: 169,600 kWh (16,000 litres of oil)

After: Electricity consumption:

Day rate 9,600 kWh (6p/kWh)

Night rate 35,616 kWh (2p/kWh)

Approximate annual energy saving 124,000 kWh

Value of saving £2000 per annum

NPV = £24,714

IRR = 37%

60 years remaining life of the building used in calculations

Simple payback period Approximately 2.5 years

#### Other benefits

Little or no maintenance, ease of use and a reserve system which can be used in winter in case of breakdown of main boiler plant.

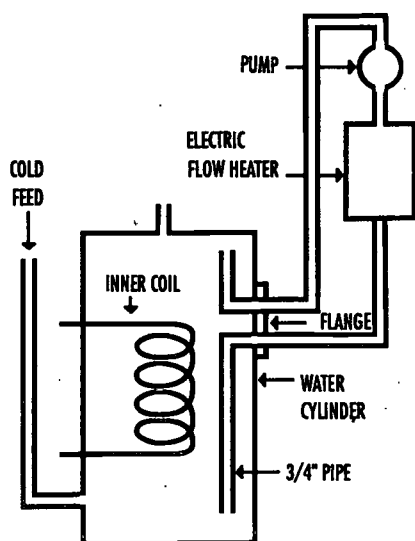

MARK I

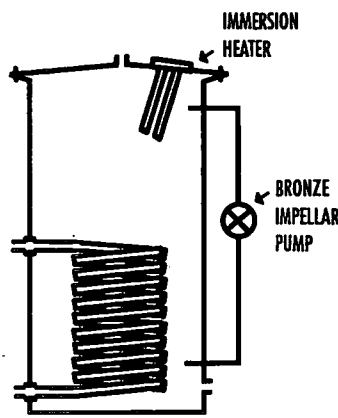

MARK II

*Point-of-use decentralised hot water*

184. At Vandyke Upper School, Bedfordshire it was decided that it was uneconomic to provide point-of-use water heating throughout the year, but that worthwhile savings could be obtained during vacations. The cost to modify a typical school installation, so that total demand could be satisfied by point-of-use appliances, was shown to be prohibitive. However, during summer months demand is considerably lower and hot water mainly required for cleaning activities.

185. Five 3 kW electric water heaters, incorporating 15 litres of storage capacity, were installed above the existing sinks in cleaning cupboards. The caretaker regulates the use of these appliances with the aid of a key operated switch, labelled to indicate when the heating may be used.

186. Cleaning staff welcomed the change in supply as hot water was always immediately available, in contrast to the previous arrangement. During the six weeks of the first summer holiday when this point-of-use heating was available, a reduction of 11,771 kWh (1,187 litres of

oil) was achieved and a simple payback period of just over 4 summer holidays estimated. This does not take into account savings in power from main boiler house pumps and oil burners not being in use.

Where this system has been installed in other Bedfordshire schools, paybacks of between 1.5 to 4 summer periods have been achieved.

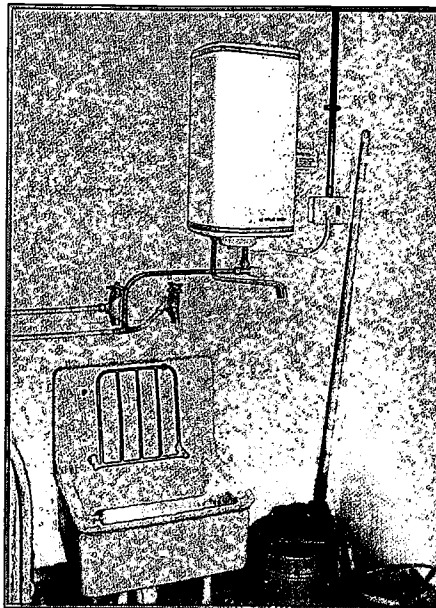

**COSTS AND BENEFITS  
(January 1986 prices)**

<b>Point of use hot water heaters</b>	
Vandyke Upper School, Bedfordshire	
Cost of measure	£750
Approximate saving for six week holiday period	11,800 kWh
Value of saving	£180
NPV =	£1,852
IRR =	24%
60 years remaining life of the building used in calculations	
Simple payback period approximately 4 summer holiday periods	

3

**Integrating energy efficiency into refurbishment schemes**

This chapter describes the refurbishment of typical school buildings and shows how the measures described previously can be applied to:

- 3.1 Victorian schools
- 3.2 Lightweight system built schools
- 3.3 Temporary buildings
- 3.4 Swimming pools

When a number of energy saving measures are introduced during maintenance or refurbishment work it is important to ensure that an integrated approach is adopted: the benefits gained from one component in the programme may be cancelled out by

another measure if the overall strategy is not considered carefully. For example, a reduction in window area may result in reduced heat losses from the building fabric, but may produce dark interiors which have to be lit by expensive electric lighting. It may then be necessary to introduce lighting controls to try to reduce electricity consumption. Alternatively, if it is found that energy consumption has been reduced in a school by, say, 50%, a BEMS may no longer be a cost effective method of control.

Careful management of maintenance work involving correct project planning should avoid this type of phasing error, e.g., rationalisation of the use of space within a building should be addressed before the heating load is calculated and decisions on appropriate controls are made; similarly decoration should follow on from electrical rewiring rather than precede it. This type of integrated approach involves liaison between the various interested parties and mechanisms for consultation.

**3.1 VICTORIAN SCHOOLS<sup>(20)</sup>**

187. The school that has been chosen to represent Victorian heavyweight construction, is a typical three storey building originally constructed in 1885 and enlarged in 1914. It is located at Hither , in South East London, and is typi-

cal of about 1000 schools of this type within the Inner and Outer Boroughs. The fabric was generally in a reasonable state of repair, but apart from the conversion of the boilers from oil to gas very little had been done to improve energy efficiency.

188. A typical example of Victorian building, its walls are of 9 inch solid

brickwork and the pitched roof is covered with slates.

The original timber sash windows were still in use and the wet heating system was served by two cast iron boilers rated at 202kW each. Apart from the replacement of tungsten lamps by strip fluorescent lighting during rewiring in 1978/79 and the switch from oil to gas in 1981/82, no energy related work had

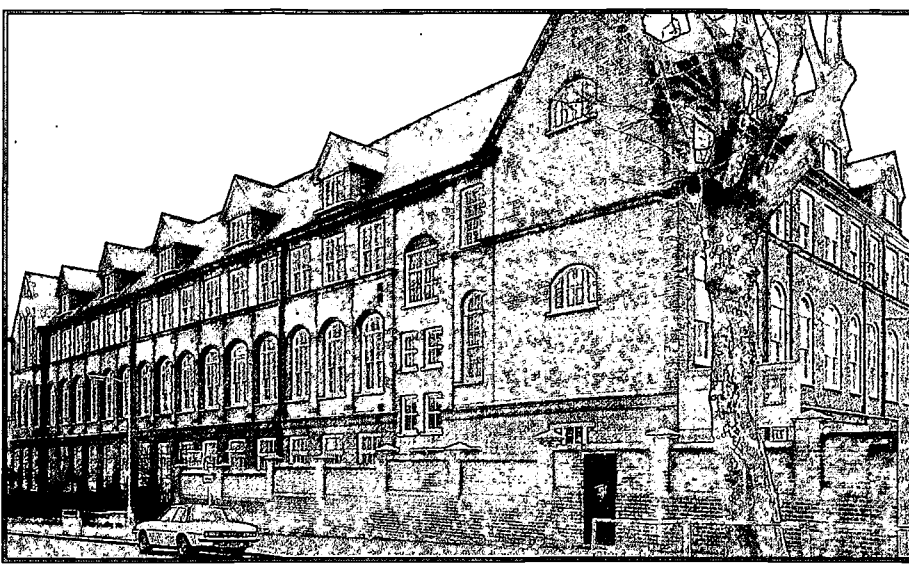

Hither Green School, front view

been carried out on the school prior to its recent refurbishment.

189. Detailed measurements of temperature and air change rates showed a large temperature difference between the three floors of the school; on average 4.2°C between top and bottom floors, large air change rates for the school as a whole and great variability between classrooms.

190. These results were due to:

- Heat escaping through the uninsulated roof and dormer windows.
- Heat leaking into the ground floor from uninsulated underfloor pipes carrying water for central heating.
- Poorly fitting external doors with worn thresholds, and sash windows which, although in good condition were excessively leaky.
- In addition, boiler efficiency was found from spot tests to be at 68% — instead of an anticipated 75% — due to the poor condition of the casing insulation.

191. Finally, measurements of electrical consumption and a study of lighting patterns in classrooms suggested that reduced consumption could be effected by the use of lighting controls. The twin aims of the refurbishment were to reduce energy consumption and cost, and to improve comfort conditions for pupils and staff. In order to achieve these aims, four tasks were identified:

- To reduce the heat demand of the building fabric.

- To improve the efficiency of the heat supply.

- To reduce temperature variations throughout the building.
- To reduce electrical (mainly lighting) consumption.

192. A package of measures was installed to address these problems:

- The roof was insulated to reduce heat losses from the top floor.
- Underfloor pipework on the ground floor was insulated to reduce heat losses from circulating water and reduce unwanted heat gains into the ground floor.
- The boilers, associated pipework and flanges were insulated and a sequencing control was fitted to improve the efficiency of the heating system.
- Windows were draught-stripped; external doors were fitted with closers, efficient locks and draught stripping and also screeds and thresholds were built up. These measures were designed to reduce heat losses through excessive air infiltration.
- Time switches ('Bedfordshire' switches) were fitted to classrooms to reduce electrical lighting load whilst still maintaining adequate levels of lighting.

193. Energy consumption at Hither Green School has been monitored over

three successive heating seasons. The energy conservation measures reduced the energy consumption by approximately 46% although the payback period of some of the measures was higher than expected. The specific fuel consumption of the school as a whole fell to 139 kWh/m<sup>2</sup> from the previous value of 258 kWh/m<sup>2</sup>.

194. Simple paybacks for the insulation of boilers, pipework and roofing were 1.3, 4.4 and 9.6 years respectively. The lighting controls were estimated to achieve a payback period of 9.7 years. Some of the paybacks are rather long but are appropriate for a long lived public building. Difficulties were encountered in applying several of the measures, in particular, the roof insulation. State of the art technology would render some of the measures introduced more attractive.

195. Subsequent monitoring has shown:

- Gas consumption reduced by 40-50%.
- Electricity consumption reduced by about 20%.
- Temperature differences between floors reduced (to 0.8°C difference in average temperature between top and bottom floors in winter compared with the previous 4.2°C).
- Heating system efficiency improved.
- Air change rates reduced overall and more consistent throughout the building.

196. Portions of the roof had conventional loft space above and it was therefore relatively simple to lay a 150mm mineral fibre insulation. In some other areas the rooms on the top floor had sloping ceilings following the profile of the external roof line. It was intended that the building should be lined with plastics foam insulated plasterboard. However, at the time of installation, this material was not available at the appropriate thickness and did not comply fully with the GLC fire regulations. A more expensive approach therefore had to be adopted comprising softwood battens and rock-wool cavity batts to a thickness of 150mm held in position by 12.5mm plasterboard. A number of dormer windows were omitted by running the insulation straight across the dormer recess. The overall character of the space was not dramatically altered.

197. The technique used to reduce energy consumption in the corridor areas of the school, was to install insulated suspended ceilings containing laylights below existing rooflights to retain daylighting.

The boiler insulation consisted of 63mm of rockwool insulation introduced between the boiler and its casing. Efficiency tests carried out under a number of different part-load conditions indicated that the predicted saving of 3% had been achieved. Whilst this measure only produces a small improvement it has a very small capital cost, long life expectancy, and a very low risk factor. If existing boilers have little insulation, that has in all probability disintegrated over the years, then this measure can confidently be recommended.

198. Energy is being saved in the school, comfort conditions have been improved and the useful life of the building has probably been extended. However, there are a number of other measures which were not appropriate for Hither Green which could be included in the refurbishment of other heavyweight schools as follows:

- Zone controls.
- High efficiency lighting.
- Tamperproof thermostatic radiator valves.

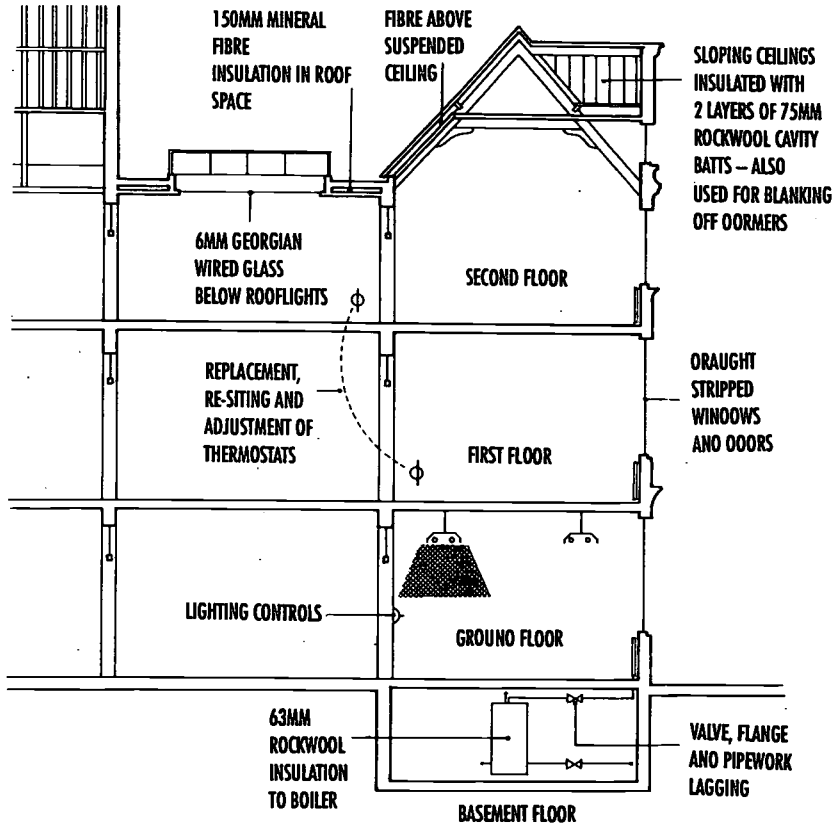

A typical section through the school showing energy saving measures.

### COSTS AND BENEFITS (1984 prices)

#### Package of energy conservation measures

Heavyweight Victorian School

Hither Green

Floor area 3217m<sup>2</sup>

Cost of measures £39,000

Annual Energy Consumptions (kWh)  
(related to a standard heating season)

	Gas	Electricity	Total
Before	774,400	54,800	829,200
After	404,600	40-45,000	444,600-449,600
Gas saved	369,800	9,800-14,800	379,600-384,600

Value of actual savings

£4693 (1984 fuel prices)

NPV = £32,363

IRR = 11.7%

60 years remaining life of the building used in calculations

Simple payback period of 8.6 years

#### Other benefits

Building more comfortable; stratification between top and ground floor reduced from 4.2°C to 0.8°C.

Electricity consumption reduced more than the amount saved by the lighting controls probably due to less use of electric heaters in winter.

Measure	Annual energy saving kWh	Annual cost saving £	Subcontractor costs £	Simple payback period years	Life expectancy years	IRR %	NPV £
Stage 1 (1984 prices: 1.2p/kWh for gas, 5p/kWh for electricity)							
Boiler insulation	31632	380	480	1.3	10	77	4916
Roof insulation	228648	2744	28268*	10.4	50	9.6	14986
Pipework insulation	29458	353	1541	4.4	50	23	4023
Total for Stage 1	289738	3477	30928	8.8	50	11	24000
Stage 2 (second quarter 1985 prices)							
Thermostat adjustment	32918	395					
Draught stripping	47147	566	6703		10		-5797
Lighting control	4800 to 5400	240 to 270	2482		10		-1431
Total for Stage 2	84865 to 85465	1201 to 1231	9185	21.8	50	4.6	-100
Total for Stages 1 & 2 (1984 prices)	374603 to 375203	4678 to 4708	39000	8.6	50	12	31000

### 3.2 LIGHTWEIGHT SCHOOLS

199. Three approaches to the refurbishment of lightweight system built schools are illustrated in this section. The first, at Ryelands School in Hertfordshire, where a package of conventional energy saving measures have been introduced. The second, at Crookham School in Hampshire, where a more radical approach was taken in order to reduce energy loss from the building fabric. The third, at Thorpe Bay High School in Essex, where glazed link corridors and improved heating system controls were added.

#### Ryelands Junior Mixed Infants School.

200. Ryelands Junior Mixed Infants School in Hertfordshire is an early 1970s lightweight single storey school with a

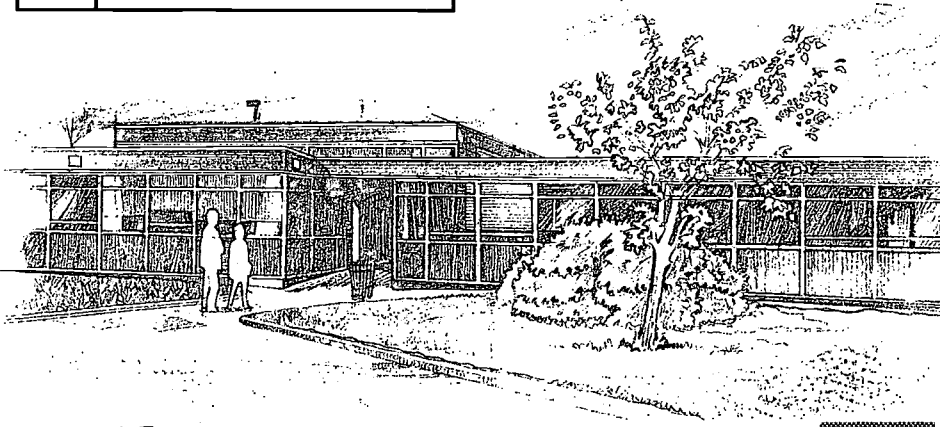



floor area of 1200m<sup>2</sup>. The following measures were introduced:

- An optimum start control was fitted to the heating system.
- A day extension timer was added to regulate heating times outside normal school hours.
- Zone controls were introduced to reduce heating demand during these periods.
- Replacement of bi-metallic thermostats (3–5°C switching differential) in fan convectors with electronic room thermostats (1°C switching differential).
- Draught stripping of all doors and windows.
- Automatic closers fitted to doors.

- Insulation panels fitted to the inside of all low level glazing.

201. The school has a gas fired boiler for heating and hot water services which also serves an outdoor swimming pool during the summer. Fan convectors, fed from the low pressure hot water system, are used to heat the classrooms. Prior to the refurbishment these were fitted with bi-metallic thermostats which were not sensitive enough to achieve satisfactory control of room temperatures. A higher temperature setting was being used than would have been necessary with more accurate controls. Electronic thermostats, developed by Hertfordshire County Council in collaboration with a commercial manufacturer, were fitted in each classroom.

A substantial reduction of energy use in this school of some 34% was monitored.

## COSTS AND BENEFITS (1986 prices)

**Replacement of bi-metallic thermostats by electronic thermostats, new zone controls and insulation panels fitted by the caretaker**

Lightweight school

Ryelands junior mixed infants school

Floor area 1200m<sup>2</sup>

Annual energy use:

Pre-refurbishment NPI = 366 kWh/m<sup>2</sup> Gas 12,000 therms

Post-refurbishment NPI = 241 kWh/m<sup>2</sup> Gas 7,490 therms

Cost of 21 electronic thermostats £700

Cost of new controls £500

Cost of insulation materials £500

Total capital cost £1700

Savings on Gas 4,500 therms = 131,900 kWh

Value of savings on Gas £1900

NPV = £18,600

IRR = 88%

30 years remaining life of the building used in calculations

Simple payback period of 14 months

### Other benefits

Zoned heating of school for evening classes. Improved comfort.

### Crookham Junior School.<sup>(21)</sup>

202. Crookham Junior School, at Fleet in Hampshire, is one of the Mark 1 Second Consortium of Local Authorities (SCOLA) schools left from the 1960s. As with many of these early system buildings, it was in need of repair. The objectives of the refurbishment exercise were to improve the building fabric and the teaching environment, and to develop general principles for dealing with other SCOLA buildings in the county.

203. Very high fuel consumption was occurring in this building due to:

- Negligible insulation and poor detailing.
- High infiltration losses due to poorly

fitting windows and doors, sections of louvred windows and lack of draught lobbies.

204. The following measures were proposed:-

- A reduction in glazed areas with improved daylight distribution.
- Provision of rooflights with insulating shutters.
- Provision of casement hung shutters.
- Replacement of windows.
- Provision of insulated shutters to windows.

- Draught stripping.

- Addition of weathershields.

205. The re-structuring of the glazing was carried out as part of an overall fabric refurbishment plan; most of the fabric was re-clad, replaced and insulated. The glazing levels were reduced considerably with up to 75% of clerestory area and 30% of remaining windows replaced with opaque insulating panels.

206. Large south facing rooflights with adjustable insulated shutters were

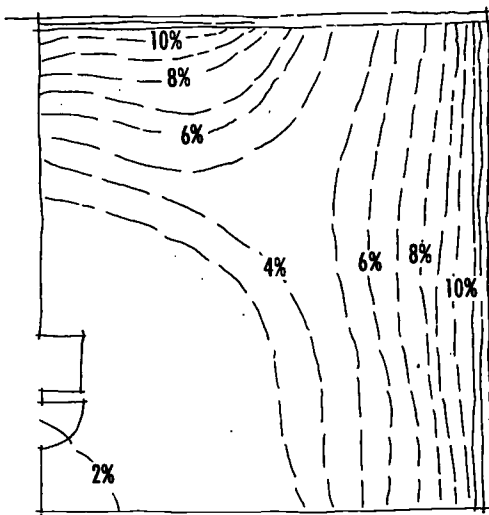

HT DISTRIBUTION IN ORIGINAL CLASSROOM

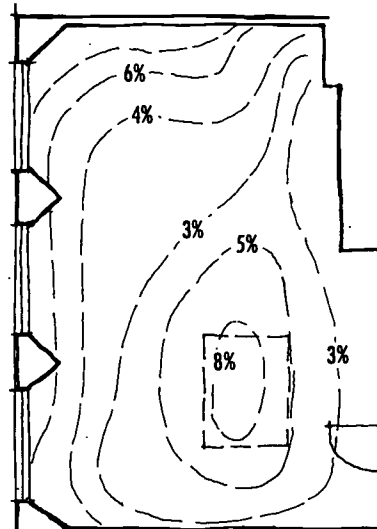

NORTH FACING CLASSROOM WITH ROOFLIGHT AND PERIMETER SHADING

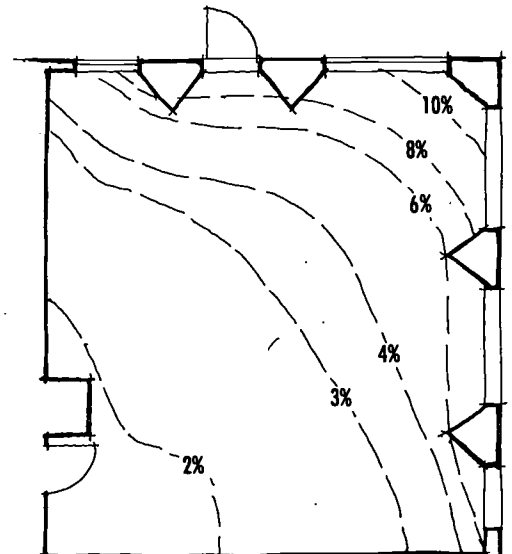

GROUND FLOOR CLASSROOM WITH PERIMETER SHADING

Daylight distribution Crookham School

UNINSULATED  
PLYWOOD  
FASCIA  
3.3W/M<sup>2</sup>C

SINGLE GLAZING  
IN ALUMINIUM  
FRAMES WITH NO  
THERMAL BREAK  
OR DRAUGHT STRIP  
5.6W/M<sup>2</sup>C

PLYWOOD WITH  
25MM INSULATION  
EDGES UNSEALED  
COMPOSITE  
PANEL  
1.53W/M<sup>2</sup>C  
SOLID  
PANEL  
0.9W/M<sup>2</sup>C

BEFORE



REFURBISHMENT

AFTER

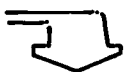

AREA REDUCED  
BY ONE THIRD  
NEW TIMBER  
FRAMED  
WINDOWS  
5.0W/M<sup>2</sup>C

U VALUE OF  
GLAZING AND  
SHUTTERS  
0.35W/M<sup>2</sup>C

NETLON SUN  
AND  
WINDBREAK  
MESH

INSULATION  
BEHIND NEW  
SPANDRELS AND  
FASCIAS

WALLS  
NEW SPANDRELS  
AND FASCIAS  
0.29W/M<sup>2</sup>C

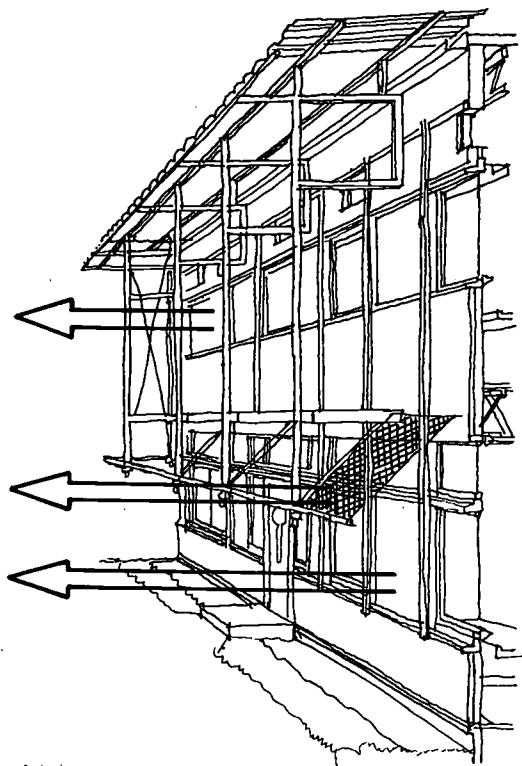
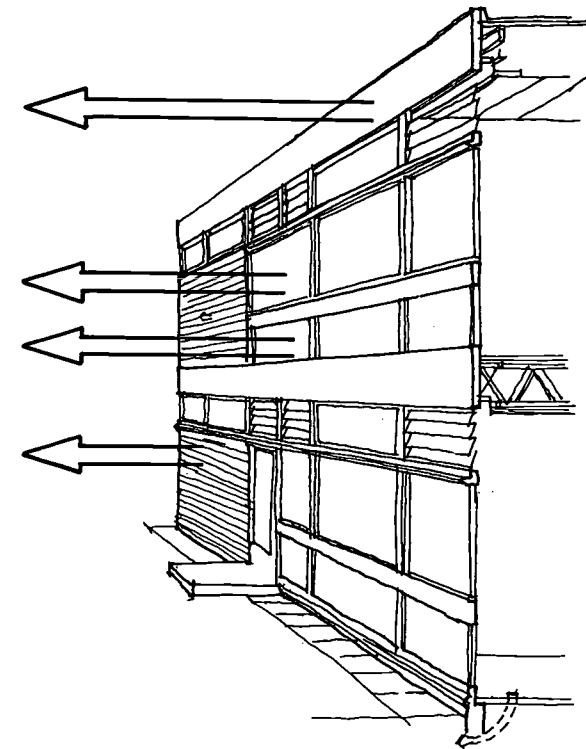

Facade of Crookham School before and after refurbishment

installed to boost the daylight and provide sunlight for north facing classrooms in winter months.

207. All windows were fitted with insulated shutters that form cupboard doors during daytime, doubling as display areas for pupils' work when closed at night. The contrast grading effect of the sloping reveals to the windows, produced by the open shutters, enhances the quality of the daylighting.

208. Fixed sunshades were introduced to exclude summer sun. These have the effect of lowering the daylight level at the perimeter, but do not affect daylight levels at the back of the room. Thus the uniformity of the daylighting is improved. In addition, the shades act as a weather-screen to the elevations, reducing maintenance liabilities. For this reason they have been introduced on all elevations of the building.

209. Since the refurbishment, the school is warmer and more comfortable and the indications are that energy expenditure may have been reduced by as much as 50% using this combination of fabric re-design and heating controls. However, the building has yet to be fully monitored.

210. The project demonstrates that with proper design considerations, the window area of a lightweight system built school can be reduced considerably without impairing daylight quality.

211. Because of the comprehensive nature of the refurbishment it is not possible to identify and provide a full economic evaluation of the energy efficiency related measures.

### Thorpe Bay High School

212. This school, formerly known as the Dowsett High School for Girls, is an example of a building which has been remodelled by Essex County Council in response to changing pupil numbers and a rationalisation of the school use. It has changed from a 600 pupil girls' school to a 900 pupil mixed school. The measures adopted during this exercise have produced a 34% reduction in heat energy cost per pupil, in spite of an increase in out of hours use. Primary floor area has been increased by over 1300m<sup>2</sup> during the remodelling exercise, but perimeter wall area has been reduced by 580m<sup>2</sup> and additional boiler power has not been required.

213. Prior to this exercise the original school provided 5140m<sup>2</sup> of teaching accommodation for 600 pupils, with a heat load of 715kW. The school was built in the 1960s and was of the lightweight system built pavilion style. In terms of energy efficiency, the adverse features of the original Dowsett School building were:

- Pavilion planning with unprotected internal courtyards.
- High external wall to floor ratio.
- Excessive glazed areas.
- Unprotected external circulation areas.
- Under-utilised open plan communal spaces.
- Absence of zone control.
- Lack of draught lobbies.



214. One solution to the problem of providing more teaching space during the expansion of the school would have been to provide yet a further pavilion. However, this would not have improved the shortcomings of the existing building which resulted from design faults. These were revealed during site inspection to be as follows:

- Major external circulation routes restricted timetabling if adverse weather conditions were to be avoided by pupils and staff.
- High infiltration levels at each lesson change.
- Excessive internal temperature swings during summer and winter.
- Poor environmental space/time control.
- Poor heat distribution.
- Above average running costs and maintenance difficulties.

### Fabric modifications

215. In order to overcome some of these problems within the available budget, accommodation was increased. New teaching space was built in the centre of the campus and linked to the rest of the complex with patent glazing to create glazed circulation areas. These are unheated but provide protection to both the new and the existing buildings. They also allow daylight to reach the surround-

ing areas and, together with the use of clerestory windows in the new spaces, provide good daylighting throughout.

216. Additional improvements were made to the existing fabric by eliminating or double glazing the numerous rooflights, draught stripping windows and doors, and insulating areas of glazing below sill level. It was not economic to improve the standard of insulation of the roof, this work having been carried out to a minimum standard some years previously as part of a maintenance programme. However, the overhaul and replacement of existing light fittings was undertaken using higher efficiency fluorescent lamps where appropriate.

217. The provision of glazed circulation areas and the enclosure of courtyards effectively reduced overall perimeter wall area and heat losses; infiltration rates were reduced and the performance of the building fabric improved.

### Services modifications

218. Two oil fired boilers provided the low pressure hot water (LPHW) heating for the school and neither these, nor the gas fired boilers which deal with DHW and kitchen demands, were due for replacement. However, the heating controls were upgraded as follows:

- Installation of an optimum start controller.

- Appropriate pipework revision with control valves and actuators.
- Replacement of temperature sensors.
- Heating was zoned.
- Thermostatic radiator valves fitted.

219. The original main LPHW heating distribution comprised a single pumped circuit serving the whole of the school with the flow temperature adjusted by the caretaker. This was zoned during the upgrading to provide two compensated circuits and six individually time controlled areas. The majority of the fan convector heaters used throughout the school were at the end of their useful lives and so were replaced by radiators fitted with TRVs.

220. Originally it was thought that additional boiler plant would be required to serve a new sports hall which was built alongside the existing gymnasium during the programme. However, the energy conscious approach adopted to the remodelling exercise has resulted in sufficient spare capacity being available from the boilers to satisfy this demand.

221. The measures described have resulted in a building with fuel consumption levels which do not exceed those of the former Dowsett School, but which accommodates a further 300 pupils in greater comfort and in a more appropriate teaching environment.

Axonometric view Thorpe Bay High School by permission of Essex County Council

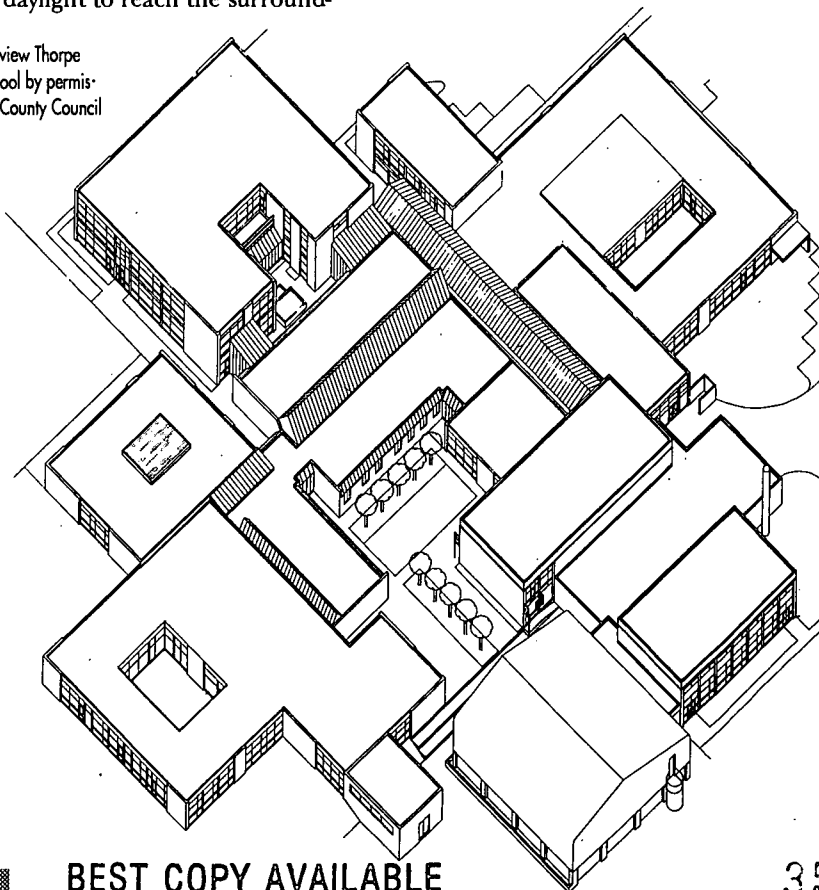

### COSTS AND BENEFITS

Remodelled school; zone controls, boiler controls and thermostatic radiator valves.

Thorpe Bay High School, Essex

Cost of remodelling and extension

£760,000 (1984 prices)

	Pupil Places	Teaching area	Gross area
Before	600	5140m <sup>2</sup>	6044m <sup>2</sup>
After	900*	5548m <sup>2</sup>	7452m <sup>2</sup>

\* (729 on role)

Unheated areas excluded:

326m<sup>2</sup> of glazed circulation and  
64m<sup>2</sup> of glazed atria

Extension areas: Gross area 1408m<sup>2</sup>;  
teaching area 1054m<sup>2</sup>;

Unheated extension areas:  
Glazed circulation 326m<sup>2</sup>;  
glazed courtyard 64m<sup>2</sup>.

Average annual saving; No change in annual energy use but pupil capacity increased.

Completed 1982/83

#### Other benefits

Gained space in atria areas.

Boiler capacity released to serve new sports hall.

Glazed circulation areas provide protection from weather.

### 3.3 TEMPORARY BUILDINGS

222. Part of the accommodation in many schools is in temporary buildings of various types and ages. Some were built before 1939 and these are often in relatively sub-standard timber construction. However, the majority presently in use are post-1945. These range from HORSAs with concrete portal frames, brick or block walls, and asbestos cement roofs, to sectional timber huts including the more recent 'mobiles'.

223. The performance of these huts in terms of energy consumption per unit area varies widely, but in most cases is worse than that of post-1945 permanent buildings, in some cases far worse. This poor performance is due to three main factors: the form of the huts (large surface area to volume), their low thermal insulation and the method of heating employed, often on-peak day rate electricity.

224. The high running costs of huted accommodation should lead authorities to replace temporary buildings with permanent ones as soon as possible or to

remove them when the need for them is over. Where temporary buildings have to be retained for a number of years, it will be worth considering what improvements, such as added thermal insulation, thermostats, draught stripping, door closers, improved controls, etc., would be cost effective. For example, in response to complaints of cold, Solihull Metropolitan Borough Council has experimented with installing a mineral wool bonded to plasterboard dry lining system and skirts to prevent wind blowing beneath the suspended floor. This has resulted in substantial energy savings and a payback period of about 6 years.

### CASE STUDY

#### *Control of electrical heating in mobile classrooms<sup>(10)</sup>*

225. The Property Department of Leicestershire County Council has to maintain about 700 mobile classrooms at its schools and colleges. The majority of these thermally inefficient, lightweight buildings are heated by on-peak convector heaters which provide a rapid warm-up but can consume excessive amounts of energy due to the limitations of existing controls. Each mobile classroom contains up to four heaters, with an internally mounted thermostat and a manual on-off switch for each heater.

226. If energy is not to be wasted in buildings with heating controls of this type, the occupants must be sufficiently motivated to turn off each appliance when heating is no longer required. Unfortunately the heaters in the mobile classrooms in Leicestershire were not being used efficiently; they were often left heating empty classrooms both during the day and outside school hours. In addition, rather than turn off the heaters to reduce internal temperatures, it was common practice for the occupants to open classroom windows.

227. In order to overcome these problems Leicestershire County Council have developed a control system which regulates the output of the four convector heaters in each mobile classroom. The system consists of a room temperature sensor, a control switch linked to a time clock and, in more recent versions, an acoustic occupancy sensor.

228. The room temperature sensor is installed to replace the internally mounted thermostat in each convector.

Similarly, instead of four on-off switches — one for each heater — there is now one manual switch for the entire heating system located above the main entrance of the mobile unit.

229. A time-clock, with a 7 day programme, limits the availability of the heating to two periods (typically 04.00 to 16.00hrs. for daytime use and 16.30 to 20.00hrs for extended evening use).

The caretaker must use the manual enabling push button to activate the heating system; this action is only effective during the periods governed by the time-clock. The output of the heaters is then regulated to give a room temperature of 19°C by the room temperature sensor via a thyristor controlled relay.

230. Energy savings are achieved because the heating operates only during predetermined periods, and there is no longer a requirement for the occupants or staff to turn the heating off. Furthermore, internal temperatures are now controlled very accurately.

231. An occupancy sensor is included in the current version of the control system so that, if the classroom is not in use when the heating is on, the temperature is allowed to fall to a set-back temperature of 16°C. A frost thermostat may be added to the system if required.

232. Simple payback periods of between 1.5 to 2 years have been achieved with successive versions of this control system. In addition to the energy savings achieved, comfort levels have been improved and pupils inflict less damage on the tamper-proof controls than was the case with the original equipment. Another important benefit of this

method of refurbishment is that it has been possible to adapt the existing heating system rather than undertake a much more costly heater replacement programme.

233. Leicestershire County Council is installing these controls in all of its mobile classrooms on a rolling programme and similar systems have been developed by other authorities. Many thousands of mobile classrooms throughout the country could be controlled with this type of equipment to achieve substantial savings.

#### **COSTS AND BENEFITS (January 1986 prices)**

##### **Control of electric heating in mobile classrooms**

Burleigh College, Leicester County Council Property Department

Cost of measure £800 for a single mobile  
(58m<sup>2</sup> floor area)

£1000 for a double classroom mobile

Average annual saving

10,700 kWh for a single mobile

Value of saving

£480 for a single £960 for a double

NPV = £4,706 for a single £10,011 for a double

IRR = 60% for a single 96% for a double

20 years remaining life of the building used in calculations

Simple payback period 2 heating seasons for a single and 1 heating season for a double mobile

##### **Other benefits**

Reduced occupant interference with heating controls.

More comfortable temperatures

234. It is not uncommon for off-peak and balanced flue gas heaters to be installed in these buildings. In view of the low levels of insulation in older temporary accommodation, off-peak is not the best form of heating because of losses at night. However, it is often advantageous as capital costs are lower than a wet heating system. Balanced flue gas heaters also have low capital cost if an adequate gas supply is available. Alternatives to on-peak heating can be reasonably energy efficient provided that adequate controls are installed.

### 3.4 INDOOR SWIMMING POOLS

235. There is considerable scope for reducing energy consumption in indoor swimming pools<sup>(22)</sup>. A detailed energy survey should always be undertaken, and usage patterns established, in order to identify the most appropriate energy saving programme. A high priority should be given to 'good housekeeping' and the low cost measures described in this document; these should give an excellent return on investment given the amounts of energy consumed in swimming pools.

236. There are four main areas which account for the energy consumption in swimming pools:

- The heating system.
- The evaporation and cooling of pool water.
- Energy for heating ventilation air.
- Energy for pool hall dehumidification.

237. The replacement or upgrading of heating equipment and related controls should be investigated and, in addition to more efficient conventional equipment, it may be appropriate to introduce more advanced technologies such as Combined Heat and Power systems and Heat Pumps<sup>(21)</sup>.

238. Pool covers are the most cost effective energy saving equipment for swimming pools. They can almost completely eliminate evaporation and reduce the heat loss when the pool is not in use. Therefore they reduce the need for overnight heating to protect the fabric from condensation. Covers also reduce the requirement for night time ventilation, which can produce significant savings if a pool has a variable ventilation system.

239. Variable ventilation allows the ventilation level to be matched to the pool hall requirements. Most pool ventilation systems operate at a constant rate and are designed to reduce humidity to an acceptable level for the worst conditions that could occur. This results in energy being used to heat incoming air, and run ventilation fans, at a higher level than necessary for the greater part of the year. Once equipment has been installed to overcome this problem, and that of unnecessary evaporation, it may be worth considering some form of heat recovery system. Some of the available heat discharged by the ventilation system may then be transferred to the cooler, incoming make-up air, using a direct heat exchanger or a heat pump.

240. A direct air to air heat recovery system can cut the energy consumption for pool hall heating by 30% and, in conjunction with pool covers and variable ventilation, produce savings in the total fuel bill for a pool of the order of 40%.

241. High efficiency lighting, in particular sodium lamps, can be installed in swimming pools as colour rendering is not usually a priority. Any equipment in a swimming pool hall must be able to operate satisfactorily in conditions where high levels of moisture are common and consequently corrosion can be severe.

## CASE STUDY

### Swimming pool refurbishment

242. The pool hall at Carnforth County High School was built in 1978 as an addition and is constructed of rendered breeze block cavity walls with a pitched roof. All of the windows are double glazed. The pool serves the school and the local community and is in use from early in the morning till late in the evening.

243. Space heating and pool and domestic hot water heating is provided by three 94kW gas fired hot water boilers. Prior to the refurbishment the pool hall was mechanically ventilated with 100% fresh air, supplied continuously and heated by a heater battery from the main boilers. The fresh air is supplied through high level wall mounted grilles, and extracted by fans mounted on the opposite wall. The ventilation and extract fans ran at full speed continuously. Swimming pool ventilation was a major source of energy loss and improved controls were a high priority. There was no pool cover.

### Refurbishment

244. Accordingly, during 1985, Carnforth High School's Swimming Pool was refurbished, and a package of measures introduced, in order to reduce energy consumption.

246. Mineral wool cavity-fill insulation was injected into the 5 exterior walls of the pool hall. Ventilation rate controls were installed; pool hall humidity and temperature sensors now operate so that if the humidity is lower than 72.5% RH and the temperature is greater than 15°C,

the ventilation rate is reduced as the risk of condensation is less. A manual override is available in the plant room to provide full ventilation rates in high temperature/low humidity situations as required by spectator events such as galas. The supply and extract fans were balanced to achieve equal flow rates.

246. During the course of the refurbishment the original 80W fluorescent tubes were replaced by half the number of 150W sodium lamps. This was carried out not to save energy but to reduce the maintenance requirements as the atmosphere in the pool hall was reducing the life of the fluorescent tubes.

## COSTS AND BENEFITS (January 1986 prices)

### Swimming pool refurbishment

Carnforth County High School  
Cost of measure £8,919

Annual energy consumption before and after refurbishment.

	Electricity			Gas	Total
	Day	Night	Total	kWh	kWh
	kWh	kWh	kWh	kWh	kWh
Before	78,912	29,645	108,557	828,838	937,395
After	82,650	28,060	110,710	594,761	705,471

Average annual saving 231,924 kWh

Value of saving £2,800

NPV = £26,000

IRR = 31%

30 years remaining life of the building used in calculations

Simple payback period 3.2 years

### Other benefits

Improved comfort conditions  
Reduced lighting maintenance

### *Energy appraisal*

247. The artificial lighting refurbishment reduced ongoing maintenance work but has not reduced the lighting load. The main use of daytime electricity is for the fans and the lighting circuits.

The overall reduction in fan speeds has resulted in lower electrical consumption, but this has been offset by the increased use of electricity for lighting.

After ironing out initial control problems there have been no complaints

from staff regarding conditions in the hall.

Pool covers have not been introduced as it was felt that they would be difficult to use in this particular pool. Further savings would have been made if covers had been introduced.

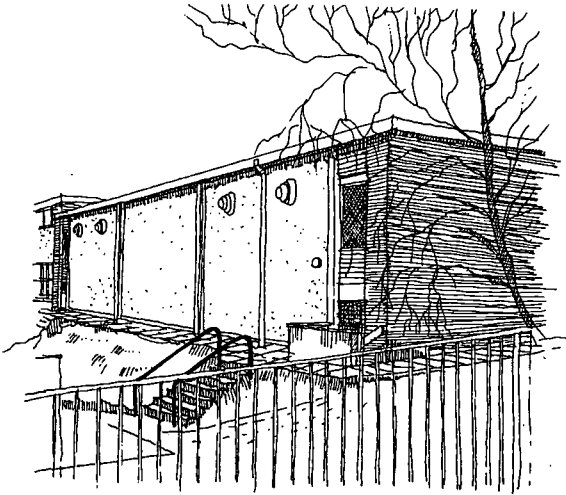
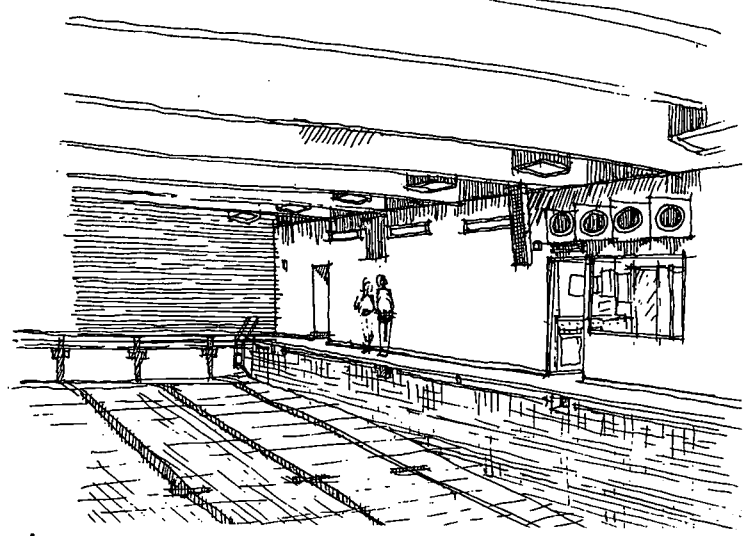

### *Replication*

248. The measures undertaken during the refurbishment of Carnforth High School's swimming pool have resulted in a significant reduction in energy consumption and could be applied to many other swimming pools. The

project illustrates the importance of coordinating energy management and maintenance activities so that a complementary package of measures is implemented. The installation of a more efficient lighting system, in conjunction with the improved ventilation controls, would have resulted in an even greater energy saving. It is important to ensure that controls of the type used in this project are commissioned effectively.

## Appendix 1

Measures of economic performance

### Net present value (NPV)

1. The sum of the present value of all benefits minus the sum of the present value of all costs. When employed in the appraisal of simple long life measures, eg roof insulation or draught stripping which are maintenance free once fixed, it can be calculated simply by discounting the expected future value of annual energy savings at the test discount rate (currently 6%) over a period that normally relates to the remaining life of the building and then deducting the initial capital cost.
2. In the case of measures with a life expectancy less than that of the building itself or requiring periodic maintenance, eg boiler controls, it will also be necessary to apply the discounting procedure to the expected future costs of component renewal and maintenance that will occur within the appraisal period.
3. When appraising different energy saving measures the one with the highest NPV that is affordable within the overall expenditure ceiling will normally provide

the greatest benefit. A device that may be used in selecting options when there is an expenditure constraint is to rank them in order of their net present value to expenditure (the benefit/cost ratio) within the expenditure ceiling.

4. In practice the decision to proceed with a particular option may only be partly based on economic performance; other factors which cannot be directly valued in monetary terms, such as comfort conditions, will also need to be taken into account.

5. For further information see 'Investment Appraisal in the Public Sector: A Technical Guide for Government Departments' - HM Treasury 1984.

6. Public sector expenditure should normally be appraised in terms of NPV with all costs and benefits discounted at the test discount rate (TDR). Two other widely used forms of appraisal are the internal rate of return and the payback period.

### Internal rate of return

7. The discount rate at which the NPV of a project is zero; that is when discounted benefits equal discounted costs.

Any project with a positive NPV will have an IRR above the TDR. A disadvantage with this method is that in unusual cases with large costs in the distant

future will quite different IRRs can be obtained for the same project.

8. IRR is not generally recommended for use in the public sector where there is a well defined discount rate. It may however, if used with care, be of use as a supporting indicator to compare different cases and has therefore been included in this study.

### Payback period

9. The initial capital cost divided by the annual savings brought about by the investment. The main drawback of this method is that it takes no account of net benefits occurring after the payback date. However it is simple to use and is generally suitable for appraising small investments over short periods. For longer periods and where large expenditures are involved the NPV should be used.

### Appraising projects containing multiple energy saving measures

10. When appraising proposals containing more than one energy saving measure it is important to appraise each measure separately; an apparently good proposal may include measures which give very good value along with others which give poor value. The poor value elements should be rejected.

## Appendix 2

The manual, commissioning and handover

### User Manuals

Consideration should always be given to the preparation by the design team of a comprehensive 'User Manual' for issue to the client at the handover or commissioning stages of a refurbishment project. This should cover the physical operation of the building; instructions for operating plant, maintenance of the materials used and services and equipment installed. It should also give an outline of the approach to energy saving adopted by the design team.

A User Manual of this type should help to ensure that the facilities provided are used as intended, and should assist the client and user to operate and maintain the building with full regard to the consumption and cost of energy. Such a document should be written with the target

audience in mind; it must be easy to understand and use.

Occupants must be familiarised with the energy saving features of their schools, particularly those members of staff responsible for the successful operation of equipment, as there is now a greater need for staff to take an active part in energy saving. It must be appreciated that there is often a very rapid turnover of personnel at some schools; staff who were instructed in the use of special equipment, for example a lighting control system, may be replaced by staff who are not made aware of its correct operation. In addition to a User Manual, it may be advantageous to have on display in each school an outline of energy use in that school, and an explanation of the technology used to reduce energy consumption and a sample guide to its use. Energy targets could form part of this display so that staff and pupils are made aware of any savings which have been achieved. Such an approach would ensure that staff are fully informed of their role in the energy saving strategy used in their school.

### Commissioning

The success of many of the energy saving measures outlined in this guide will depend on proper commissioning of equipment prior to handover; a great deal of energy is wasted in schools because insufficient attention has been given to the commissioning of plant and equipment. If proper commissioning is not carried out, then lighting and heating will not operate efficiently, probably for the rest of its working life.

The manufacturers of boilers, energy management systems, etc., should be able to demonstrate that they have a thorough, fully documented commissioning procedure. This should include the following:

- o System control and setting up.
- o Performance checks.
- o Electrical and mechanical safety checks.
- o Compliance with statutory requirements.

The commissioning procedure should ideally be verified or repeated after an initial settling down period. Certificates should be obtained from the commissioning engineer, setting out the actual control settings and the performance achieved.

Part of the commissioning procedure should include instruction in the correct operation and any routine maintenance requirements that the user is expected to carry out.

Successful refurbishment and commissioning often depends on co-operation between maintenance departments and

energy efficiency officers. In some LEAs the activities of these two sections are kept separate with budgets and personnel independent of each other. This may result in a lack of communication, which hampers the introduction of energy saving measures during refurbishment and may prevent effective commissioning.

### **Handover**

A heating or control system should not be accepted as 'handed over' until the user or his professional representative is completely satisfied that all contractual terms have been met. It is of particular importance that safety equipment is shown to operate effectively. For exam-

ple, there should be a clear demonstration that the boiler plant shuts down under fault conditions.

Several authorities are trying to persuade schools to nominate an Energy Manager to monitor the use of energy, and to publicise the need to save energy. The person responsible for these activities should be; appointed prior to the handover of any major equipment; made familiar with User Manuals and other technical information and supplied with reference energy consumption figures to enable them to characterise the performance of their building.

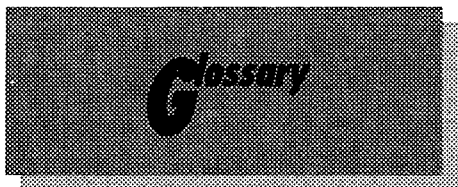

### **Actuator**

A device which responds to the commands of a controller. It enables power to be converted into a limited output motion, for example, for control valves.

### **Boiler sequencing control**

Boilers can be switched on and off as required to match the heating load. The lead boiler may be changed periodically.

### **Building energy management system**

Consists of a computerised controller and suitable outstations to connect to the boiler, valves, temperature sensors etc. Can add considerable sophistication to control methods and eliminate time-clocks and sequencers.

### **Cavity batts**

Blocks of insulation which are fixed to the internal skin of a cavity wall as it is being built.

### **Clerestory windows**

High level windows used to provide daylighting deep into a space where a view out is not required.

### **Condensing boiler**

A boiler with a high fuel efficiency resulting from reclaiming the heat from the flue gases by condensing the water vapour out of the flue gas and thus regaining the latent heat of evaporation.

### **DHWS**

Domestic hot water system.

### **Emissivity**

A measure of the ability of a surface to absorb and emit radiation including both heat radiation and light.

### **Frost protection**

Protects fabric and services during cold weather; two stage protection can be operated firstly by switching on circulating pumps and, secondly, by enabling the heating plant to function once internal temperatures fall below a pre-set level.

### **Heat pump**

Uses a refrigeration cycle to extract heat from a source at low temperature and upgrades it to a higher, more useful, temperature.

### **IRR**

Internal Rate of Return (see Appendix 1)

### **Lead boiler**

The boiler which fires first in a multi-boiler installation.

### **Load factor**

Load that a boiler is under compared with its maximum output.

### **Local extension override**

Allows a programmed extension of the heating period

### **Mains borne signalling**

Method of sending control signals via existing main cables.

### **NPI**

Normalised Performance Indicator is an energy consumption yardstick taking into account floor area, local weather information, exposure and hours of use. (See 'How to bring down energy costs in schools' Energy Efficiency Office 1990)<sup>(24)</sup>

### **NPV**

Net present value (see Appendix 1).

### **Optimum start/stop control**

Inside and outside temperatures determine the optimum time to switch the heating plant on or off.

### **Patent glazing**

Proprietary glazing systems including mullions, transoms and glazing ie a complete system.

### **Thermostatic radiator valve**

Adjusts radiator output to accommodate changes in temperature within the heated space.

### **Turndown Ratio**

Ratio of maximum to minimum output of a boiler or burner.

### **U value**

Rate of heat transmission through a unit area of building fabric for each degree of temperature difference between the interior and exterior.

### **Weather Compensator**

Means of regulating the heat emission from radiators etc., according to changes in the weather, generally by reducing the system flow/return temperatures. Provides constant volume flow in the heating unit but not generally to the boiler plant.



## References

(1) Thermal insulation: Avoiding risks - Good practice construction related to guidance in Approved Document L of the Building Regulations, Building Research Establishment Report No. BRE 143, 1989.

(2) Maintenance and renewal in educational buildings - Flat Roofs - Criteria and methods of assessment, repair and replacement - Design Note 46, Architects and Building Branch, DES, 1985.

(3) Flat Roof Design: The Technical Options, Building Research Establishment Digest 312, August 1986.

(4) Flat Roof Design: Thermal Insulation, Building Research Establishment Digest 324, December 1987.

(5) Overroofing: especially for large panel system dwellings, BR185, 1991.

(6) IEE Wiring Regulations, 16th Edition, Institution of Electrical Engineers, 1991.

(7) Mechanical and Electrical Engineering Guide, Volume 3, Electrical, Section 23.3.1 Cables and Wiring, PVC Cables, Migration of Plasticisers, Property Services Agency, Department of the Environment, August 1989.

(8) Maintenance and renewal in educational buildings - Energy conservation and maintenance through retrofit measures - Three case studies in Nottinghamshire, Architects and Building Branch, DES, Research Report No.1 1988.

(9) Window Design, CIBSE Application Manual AM2, The Chartered Institution of Building Services Engineers, London 1987.

(10) Saving energy in schools - Three case studies in Nottinghamshire, Broadsheet 24, Architects and Building Branch, DES, November 1987.

(11) Guidelines for Environmental Design and Fuel Conservation in Educational Buildings, Design Note 17, Architects and Building Branch, DES, 1979.

(12) Maintenance and renewal in educational buildings, Maintenance of Mechanical Services - Building Bulletin 70, Architects and Building Branch, DES, 1990

(13) Building Bulletin on Lighting in Educational Buildings to be published by Architects and Building Branch, Department of Education and Science.

(14) Lighting Controls and Daylight Use, Building Research Establishment Digest 272, April 1983.

(15) Condensing boilers serving a school underfloor heating system, Energy Management, Journal of the Department of Energy, Issue 25, July/August 1990, p.28.

(16) Energy Savings From Using Flue Baffles in Boilers, Energy Efficiency Demonstration Scheme Expanded Project Profile 5, Energy Efficiency Office July 1985.

(17) School Premises Regulations, SI 1981, No.909.

(18) Minimising the Risk of Legionnaires' Disease, CIBSE Technical Memorandum TM 13, The Chartered Institution of Building Services Engineers, 1987.

(19) Legionnaires' Disease, Health & Safety Executive Guidance Note EH 48, Health & Safety Executive, 1987.

(20) Energy efficient refurbishment of a Victorian primary school, Building Research Establishment Final Report ED/254/119, 1990.

(21) School Refurbishment, Crookham, Hampshire, Architects Journal, 9th March 1988, p37-57.

(22) Energy efficiency technologies for swimming pools, Energy Technology Series 3, ETSU, Energy Efficiency Office, 1985.

(23) Guidance Notes for the Implementation of Small Scale Packaged Combined Heat and Power. Good Practice Guide, Energy Efficiency Office, 1989

(24) How to bring down energy costs in schools, Energy Efficiency Office, Energy Efficiency in Buildings, 1990.

## Further reading

(25) The refurbishment potential in school buildings, Energy Technology Support Unit market study No.4, Energy Efficiency Office, 1985.

(26) Energy efficient school refurbishment - Three case studies, Broadsheet No.27, Architects and Building Branch, DES, 1991.

(27) Cavity insulation, Building Research Establishment Digest 236, 1980.

(28) The weather stripping of windows and doors, Building Research Establishment Information Paper IP 16/81, 1981.

(29) Lighting controls: an essential element of energy efficient lighting, Building Research Establishment Information Paper IP5/87, 1987.

(30) Gas fired non-domestic condensing boilers, BRECSU information leaflet 18, BRE, February 1990.

(31) Energy Management Systems, ETSU, April 1987.

(32) Energy Conservation in Educational Buildings, Building Bulletin 55, Architects and Building Branch, DES, 1981.

(33) Building on Success. S.A.B.Heppell, SCALA (Society of Chief Architects of Local Authorities), Energy Management Group, Energy Efficiency Office, 1989.

(34) Saving Energy in Local Government Buildings. Audit Commission for Local Authorities, November 1985.

(35) Saving Energy in Schools, BRECSU, Energy efficiency in buildings Information, Leaflet 23, 1990

(36) Greenhouse-gas Emissions and Buildings in the United Kingdom, Building Research Establishment Information Paper IP 2/90, Henderson G. and Shorrock L.D. 1990.

(37) BREEAM - Building Research Establishment Environmental Assessment Method, Building Research Establishment Report, Version 1/90, 1990.

(38) The Weather Stripping of Windows and Doors, Building Research Establishment Information Paper, IP 16/81 October 1981.

BEST COPY AVAILABLE

(39) Principles of Natural Ventilation, Building Research Establishment, Digest 210 February 1978.

(40) CIBSE Code for Interior Lighting, The Chartered Institution of Building Services Engineers London 1984.

(41) Average Daylight Factor: A simple Basis for Daylight Design, Building Research Establishment Information Paper IP 15/88, November 1988.

(42) Automatic Controls and their Implication for System Design, CIBSE Application Manual AM1 The Chartered Institution of Building Services Engineers, London 1985.

(43) Condensing Boilers, CIBSE Application Manual AM3 The Chartered Institution of Building Services Engineers, 1989.

(44) Energy Efficiency Refurbishment in Schools, Final Report, P.J. Hobson and J.L. Wilson, Building Services Research and Information Association, July 1987.

(45) The Energy Managers' Handbook, Second Edition, Gordon A Payne, Westbury House, 1980.

(46) Energy Use and Energy Efficiency in UK Commercial and Public Buildings up to Year 2000. Energy Efficiency Office, Chief Scientists Group, Energy Technology Support Unit, Harwell, 1988.

(47) Surplus Capacity in Secondary Schools: A Progress Report, Audit Commission for Local Authorities in England and Wales Occasional Paper Number 6, HMSO August 1988.

(48) Cutting Energy Consumption in Local Government, Audit Commission for Local Authorities in England and Wales Occasional Paper Number 11, HMSO May 1990.

(49) BS6220:1982  
Code of practice for flat roofs with continuously supported coverings.

(50) BS5422:1977  
Specification for the use of thermal insulating materials.

(51) BS8208  
Guide to assessment of suitability of external cavity walls for filling with thermal insulants —  
Part 1:1985, Existing traditional cavity construction.

(52) BS5720:1979  
Code of practice for mechanical ventilation and air conditioning in buildings.

(53) BS5925:1980  
Code of practice for design of buildings: ventilation principles and designing for natural ventilation.

(54) BS5250:1975  
Code of basic data for the design of buildings: the control of condensation in dwellings. AMD 3025, June 1979 AMD 4210, March 1983.

(55) BS5617:1985  
Specification for urea-formaldehyde (UF) foam systems suitable for thermal insulation of cavity walls with masonry or concrete inner and outer leaves.

(56) BS5618:1985  
Code of Practice for thermal insulation of cavity walls (with masonry or concrete inner and outer leaves) by filling with urea-formaldehyde (UF) foam systems.

(57) This Common Inheritance Britain's Environmental Strategy. HMSO, London 1991. ISBN 0 10 112002 8. Cm 1200.

(58) CIBSE Applications Manual AM5: Energy Audits and Surveys Guide, The Chartered Institution of Building Services Engineers, London, 1991.

Printed in the UK for HMSO  
Dd.0295054 9/90 C15 488/2 12521

**Repair and maintenance work often provides opportunities to introduce energy efficiency measures at little or no extra cost, thus producing energy savings and, financial and environmental gains.**

**This Bulletin describes some measures which can be taken. These are illustrated with case studies. Cost information including savings achieved is also provided.**

**The guide will be of interest to architects, engineers, surveyors and others responsible for the refurbishment of educational buildings. It would also be helpful to head teachers and governors who are responsible for energy efficiency in schools.**



HMSO publications are available from:

**HMSO Publications Centre**

(Mail and telephone orders only)  
PO Box 276, London, SW8 5DT.  
Telephone orders 071-873 9090  
General enquiries 071-873 0011  
(queuing system in operation for both numbers)

**HMSO Bookshops**

49 High Holborn, London, WC1V 6HB 071-873 0011  
(counter service only)  
258 Broad Street, Birmingham, B1 2HE 021-643 3740  
Southey House, 33 Wine Street, Bristol, BSI 2BQ  
(0272) 264306  
9-21 Princess Street, Manchester, M60 8AS 061-834  
7201  
80 Chichester Street, Belfast, BT1 4JY (0232) 238451  
71 Lothian Road, Edinburgh, EH3 9AZ 031-228 4181

**HMSO's Accredited Agents**

(see Yellow Pages)

*AND THROUGH GOOD BOOKSELLERS*

BEST COPY AVAILABLE

ISBN 0-11-270772-6



9 780112 707721

**£8.50 net**



**U.S. Department of Education**  
Office of Educational Research and Improvement (OERI)  
National Library of Education (NLE)  
Educational Resources Information Center (ERIC)



## **NOTICE**

### **REPRODUCTION BASIS**



This document is covered by a signed "Reproduction Release (Blanket) form (on file within the ERIC system), encompassing all or classes of documents from its source organization and, therefore, does not require a "Specific Document" Release form.



This document is Federally-funded, or carries its own permission to reproduce, or is otherwise in the public domain and, therefore, may be reproduced by ERIC without a signed Reproduction Release form (either "Specific Document" or "Blanket").