

## DOCUMENT RESUME

ED 422 484

CE 077 007

TITLE Automated Equipment Repair Series. Educational Resources for the Machine Tool Industry. Course Syllabi, Instructor's Handbook, [and] Student Laboratory Manual.

INSTITUTION Texas State Technical Coll. System, Waco.

SPONS AGENCY Office of Vocational and Adult Education (ED), Washington, DC.; National Science Foundation, Arlington, VA. Div. of Undergraduate Education.

PUB DATE 1998-00-00

NOTE 1281p.; For related documents, see ED 401 431-445 and CE 077 005-017. Product of the MASTER (Machine Tool Advanced Skills Technology Educational Resources) Consortium.

CONTRACT DUE-9553716

AVAILABLE FROM Online at <http://machinetool.tstc.edu>

PUB TYPE Guides - Classroom - Learner (051) -- Guides - Classroom - Teacher (052)

EDRS PRICE MF10/PC52 Plus Postage.

DESCRIPTORS Behavioral Objectives; Competence; \*Competency Based Education; \*Computer Assisted Manufacturing; Computer Science; Consortia; Curriculum Design; Curriculum Guides; Employment Qualifications; Engineering Drawing; Entry Workers; Equipment Maintenance; Equipment Utilization; Job Skills; Learning Activities; Learning Modules; \*Machine Repairers; Machine Tool Operators; \*Machine Tools; Manufacturing Industry; Numerical Control; Postsecondary Education; Problem Solving; \*Production Technicians; Robotics; \*Technical Education; Troubleshooting; Vocational Education

IDENTIFIERS DACUM Process

## ABSTRACT

This package consists of course syllabi, an instructor's handbook, and a student laboratory manual for a 1-year vocational training program to prepare students for entry-level employment as automated equipment repair technicians. The program was developed through a modification of the DACUM (Developing a Curriculum) technique. The course syllabi volume begins with the MASTER (Machine Tool Advanced Skills Technology Educational Resources) Program Consortium competency profile with 10 duties (and supporting technical workplace competencies): apply science to solve industrial problems; use drawings to analyze and repair systems; use calibrated measuring instruments to test/calibrate components; resolve system failures with critical thinking, troubleshooting theory, and metrology; use techniques to isolate malfunctions of electrical/electronic systems; measure/isolate malfunctions of mechanical/fluid power systems; apply computer science to computer controlled industrial equipment; correct malfunctions in PLC [programmable logic controllers] controlled industrial equipment; resolve malfunctions in computer systems controlling manufacturing processes; and assemble/disassemble mechanical, electrical, electronic, and computer systems. The first volume contains the justification, documentation, and syllabi for the courses. Each syllabus contains the following: course description; prerequisites; course objectives; required course materials; methods of instruction; lecture outline; lab outline; Secretary's Commission on Achieving Necessary Skills competencies taught; and appropriate reference

+++++ ED422484 Has Multi-page SFR---Level=1 +++++

materials. The instructor's handbook consists of technical training modules that include some or all of the following: time required; duty; task; objective(s); instructional materials list; references; student preparation; introduction; presentation outline; practical application; evaluation; summary; and attachments, including handouts, laboratory worksheets, and self-assessment with answer key. The handbook is arranged by duty grouping, with technical modules developed for each task box on the competency profile. The student laboratory manual contains a DACUM chart and learning modules. Each module includes some or all of the following: objectives, outline, laboratory exercises, laboratory aids, and handouts. (MN)

\*\*\*\*\*  
\* Reproductions supplied by EDRS are the best that can be made \*  
\* from the original document. \*  
\*\*\*\*\*

ED 422 484

Automated Equipment Repair Series  
Educational Resources for the Machine Tool Industry  
Course Syllabi  
Instructor's Handbook  
Student Laboratory Manual

U.S. DEPARTMENT OF EDUCATION  
Office of Educational Research and Improvement  
EDUCATIONAL RESOURCES INFORMATION  
CENTER (ERIC)

This document has been reproduced as  
received from the person or organization  
originating it.

Minor changes have been made to  
improve reproduction quality.

- 
- Points of view or opinions stated in this  
document do not necessarily represent  
official OERI position or policy.

BEST COPY AVAILABLE

CE077007

MASTER

*a consortium of educators and industry*

EDUCATIONAL RESOURCES  
FOR THE  
MACHINE TOOL INDUSTRY

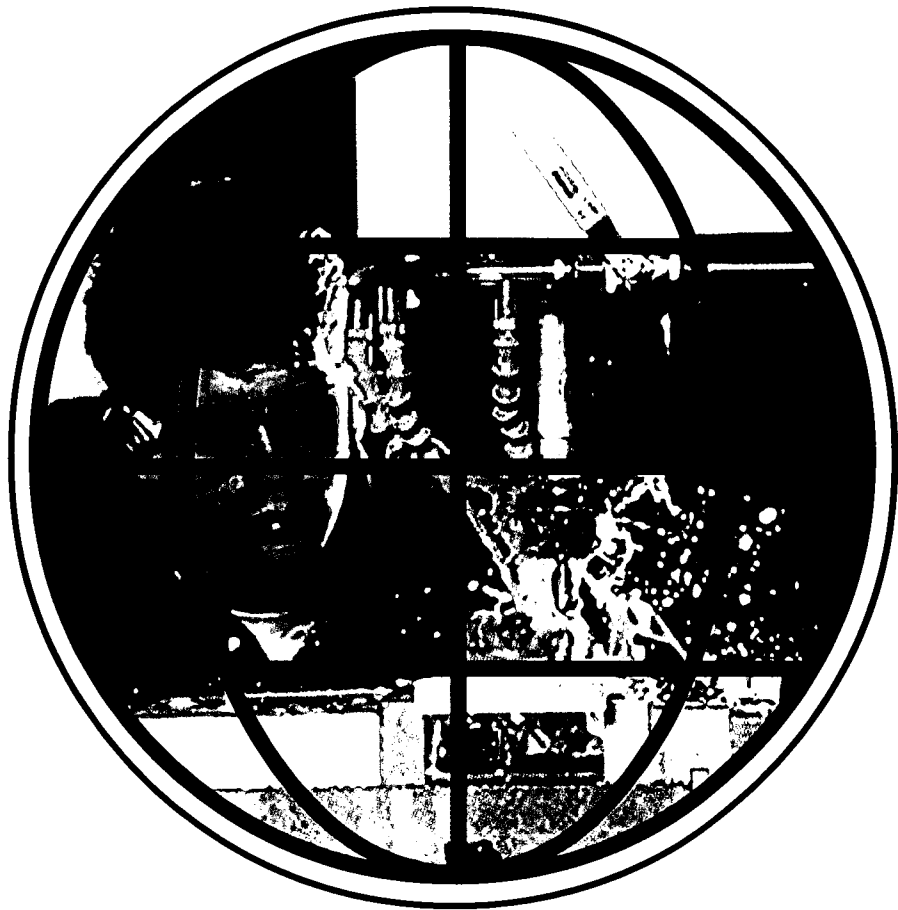

*Automated Equipment Repair Series*  
COURSE SYLLABI





*a consortium of educators and industry*

EDUCATIONAL RESOURCES  
FOR THE  
MACHINE TOOL INDUSTRY



*Automated Equipment Repair Series*  
COURSE SYLLABI

MASTER

*Supported by the National Science Foundation's Advanced Technological Education Program*



This material is based upon work supported by the  
National Science Foundation under Grant No. DUE-9553716

**National Science Foundation  
Advanced Technological  
Education Program**

"Any opinions, findings, and conclusions or recommendations  
expressed in this material are those of the author(s) and do  
not necessarily reflect the views of the Foundation."

# ACKNOWLEDGEMENTS

This project was made possible by the cooperation and direct support of the following organizations:

National Science Foundation - Division of Undergraduate Education  
MASTER Consortia of Employers and Educators

*MASTER has built upon the foundation which was laid by the Machine Tool Advanced Skills Technology (MAST) Program. The MAST Program was supported by the U.S. Department of Education - Office of Vocational and Adult Education. Without this prior support MASTER could not have reached the level of quality and quantity that is contained in these project deliverables.*

## MASTER DEVELOPMENT CENTERS

Augusta Technical Institute - Central Florida Community College - Itawamba Community College - Moraine Valley Community College - San Diego City College (CACT) - Springfield Technical Community College - Texas State Technical College

## INDUSTRIES

AB Lasers - AIRCAP/MTD - ALCOA - American Saw - AMOCO Performance Products - Automatic Switch Company - Bell Helicopter - Bowen Tool - Brunner - Chrysler Corp. - Chrysler Technologies - Conveyor Plus - Darr Caterpillar - Davis Technologies - Delta International - Devon - D. J. Plastics - Eaton Leonard - EBTEC - Electro-Motive - Emergency One - Eureka - Foster Mold - GeoDiamond/Smith International - Greenfield Industries - Hunter Douglas - Industrial Laser - ITT Engineered Valve - Kaiser Aluminum - Krueger International. - Laser Fare - Laser Services - Lockheed Martin - McDonnell Douglas - Mercury Tool - NASSCO - NutraSweet - Rapistan DEMAG - Reed Tool - ROHR, International - Searle - Solar Turbine - Southwest Fabricators - Smith & Wesson - Standard Refrigeration - Super Sagless - Taylor Guitars - Tecumseh - Teledyne Ryan - Thermal Ceramics - Thomas Lighting - FMC, United Defense - United Technologies Hamilton Standard

## COLLEGE AFFILIATES

Aiken Technical College - Bevil Center for Advanced Manufacturing Technology - Chicago Manufacturing Technology Extension Center - Great Lakes Manufacturing Technology Center - Indiana Vocational Technical College - Milwaukee Area Technical College - Okaloosa-Walton Community College - Piedmont Technical College - Pueblo Community College - Salt Lake Community College - Spokane Community College - Texas State Technical Colleges at Harlington, Marshall, Sweetwater

## FEDERAL LABS

Jet Propulsion Lab - Lawrence Livermore National Laboratory - L.B.J. Space Center (NASA) - Los Alamos Laboratory - Oak Ridge National Laboratory - Sandia National Laboratory - Several National Institute of Standards and Technology Centers (NIST) - Tank Automotive Research and Development Center (TARDEC) - Wright Laboratories

## SECONDARY SCHOOLS

Aiken Career Center - Chicopee Comprehensive High School - Community High School (Moraine, IL) - Connally ISD - Consolidated High School - Evans High - Greenwood Vocational School - Hoover Sr. High - Killeen ISD - LaVega ISD - Lincoln Sr. High - Marlin ISD - Midway ISD - Moraine Area Career Center - Morse Sr. High - Point Lamar Sr. High -

Pontotoc Ridge Area Vocational Center - Putnam Vocational High School - San Diego Sr. High - Tupelo-Lee Vocational Center - Waco ISD - Westfield Vocational High School

### **ASSOCIATIONS**

American Vocational Association (AVA) - Center for Occupational Research and Development (CORD) - CIM in Higher Education (CIMHE) - Heart of Texas Tech-Prep - Midwest (Michigan) Manufacturing Technology Center (MMTC) - National Coalition For Advanced Manufacturing (NACFAM) - National Coalition of Advanced Technology Centers (NCATC) - National Skills Standards Pilot Programs - National Tooling and Machining Association (NTMA) - New York Manufacturing Extension Partnership (NYMEP) - Precision Metalforming Association (PMA) - Society of Manufacturing Engineers (SME) - Southeast Manufacturing Technology Center (SMTC)

### **MASTER PROJECT EVALUATORS**

Dr. James Hales, East Tennessee State University and William Ruxton, formerly with the National Tooling and Machine Association (NTMA)

### **NATIONAL ADVISORY COUNCIL MEMBERS**

The National Advisory Council has provided input and guidance into the project since the beginning. Without their contributions, MASTER could not have been nearly as successful as it has been. Much appreciation and thanks go to each of the members of this committee from the project team.

Dr. Hugh Rogers-Dean of Technology-Central Florida Community College

Dr. Don Clark-Professor Emeritus-Texas A&M University

Dr. Don Edwards-Department of Management-Baylor University

Dr. Jon Botsford-Vice President for Technology-Pueblo Community College

Mr. Robert Swanson-Administrator of Human Resources-Bell Helicopter, TEXTRON

Mr. Jack Peck-Vice President of Manufacturing-Mercury Tool & Die

Mr. Don Hancock-Superintendent-Connally ISD

### **SPECIAL RECOGNITION**

Dr. Hugh Rogers recognized the need for this project, developed the baseline concepts and methodology, and pulled together industrial and academic partners from across the nation into a solid consortium. Special thanks and singular congratulations go to Dr. Rogers for his extraordinary efforts in this endeavor.

Dr. Don Pierson served as the Principal Investigator for the first two years of MASTER. His input and guidance of the project during the formative years was of tremendous value to the project team. Special thanks and best wishes go to Dr. Pierson during his retirement and all his worldly travels.

---

***All findings and deliverables resulting from MASTER are primarily based upon information provided by the above companies, schools and labs. We sincerely thank key personnel within these organizations for their commitment and dedication to this project. Including the national survey, more than 2,800 other companies and organizations participated in this project. We commend their efforts in our combined attempt to reach some common ground in precision manufacturing skills standards and curriculum development.***

---

**MASTER DEVELOPMENT CENTER, SAN DIEGO, CA**  
**Center for Applied Competitive Technologies**  
**San Diego City College**

Augustine P. Gallego, Chancellor  
San Diego Community College District  
Jerome Hunter, President  
San Diego City College  
Joan A. Stepsis, Dean/Director  
Center for Applied Competitive Technologies

1313 Twelfth Avenue  
San Diego, CA 92101-4787  
College phone: 619/230-2453, fax: 619/230-2063  
e-mail: jhunter@sdccd.cc.ca.us  
Center phone: 619/230-2080, fax: 619/230-2162  
e-mail: jstepsis@sdccd.cc.ca.us

---

### **Manufacturing in the San Diego Region**

Manufacturing represents a major sector of the San Diego economy, accounting for almost one out of every four dollars (24%) of San Diego's gross regional product. The county is currently home to approximately 3,500 manufacturers employing roughly 110,000 San Diegans. During the first half of the 1990s, manufacturing in San Diego was hard hit by the downturn in military and defense spending which accompanied the end of the cold war. Many of the region's largest aerospace contractors rapidly downsized or moved their plants out of state, leaving a large supplier base that needed to modernize its manufacturing processes and convert to commercial markets. Rapid recovery of manufacturing in the region has been driven by San Diego's high tech research and development sectors in electronics, telecommunications, software, advanced materials, biotechnology, and medical instrumentation.

### **San Diego City College and its Center for Applied Competitive Technologies (CACT)**

San Diego City College is an urban, minority institution, serving a large population of students from immigrant, disadvantaged, and low income households. In 1990, the College saw an opportunity to modernize its technical programs and improve the employment outlook for many of its students by agreeing to host one of the State of California's eight new regional manufacturing extension centers, the Centers for Applied Competitive Technologies (CACTs). The advanced technology centers were designed to assist local companies to modernize their manufacturing processes and convert from defense to newly emerging, technology-based commercial markets. This strategic partnership between the College and its resident CACT has proven to be highly successful. In developing the programs and lab facilities to serve the needs of regional manufacturing companies, the San Diego CACT and City College have simultaneously modernized the manufacturing and machine technology credit offerings of the College, thereby providing a well-trained, technically competent workforce for industry and enhancing career opportunities for students.

### **Development Team**

- **Project Director:** Joan A. Stepsis, Ph.D., Dean/Director of the CACT-SD, served as programmatic manager and academic coordinator for the MASTER project.
- **Subject Matter Expert:** John C. Bollinger, Assoc. Prof. of Machine Technology, had programmatic responsibility for developing skill standards and course/program materials for the Advanced CNC and CAM component of the MASTER project. Professor Bollinger also served as the lead instructor for the MASTER instructional pilot for his specialty area.
- **Subject Matter Expert:** Douglas R. Welch, Assoc. Prof. of Manufacturing, had programmatic responsibility for developing skill standards and course/program materials for the Automated Equipment Technology (AET) and Machine Tool Integration (CIM) component of the MASTER project. Professor Welch also served as lead instructor for the MASTER instructional pilot for his specialty area.

# Introduction

**MASTER** research indicates that individuals working as Automated Equipment Repair Technicians will preferably have received at least one year of structured training and education in technical courses in the areas of automated equipment repair. This training may have been conducted in a vocational institution or college.

In this one year program, the students progress through a series of courses designed to both educate and train students with knowledge and skills in areas such as systems troubleshooting with a balanced knowledge of computers, electronics, electrical, control systems, manufacturing processes and techniques, and the problem-solving skills needed to isolate malfunctions in an industrial process. Students receive a wide range of training which enables them to seek jobs in many different manufacturing areas. The Automated Equipment Repair Program at San Diego City College, Center for Applied Competitive Technologies, has been training Automated Equipment Repair Technicians for many years and works closely with advisory committee members to make sure that the skills being taught are the skills needed in industry. Students who complete this course of study receive certificates from San Diego City College, Center for Applied Competitive Technologies. The Automated Equipment Repair Department worked closely with the **MASTER** staff, made every effort to assist the **MASTER** staff with research, and currently seeks adoption of the recommended **MASTER** materials for their Automated Equipment Repair Department students. The Automated Equipment Repair Department at San Diego City College, Center for Applied Competitive Technologies, is recognized throughout California by large and small manufacturing companies as a premier source for entry-level Automated Equipment Repair Technicians. Upon completion, students are able to interpret complex drawings, select the correct materials, operate and program computers, maintain and repair automated machine tools and automated manufacturing processes. The curriculum has been designed to prepare students to enter the workforce as entry-level Automated Equipment Repair Technicians. Laboratory work is emphasized with actual industrial equipment in order to prepare students for interesting, rewarding work in a wide variety of industries. The Automated Equipment Repair Department has a unique blend of theoretical knowledge and practical application which directly corresponds to modern uses in manufacturing.

After many interviews with practitioners from industry and discussions with educators, managers, supervisors, and others involved with machine-related occupations (specifically automated equipment repair technology), the **MASTER** Consortium Partners have agreed to present our definition of an Automated Equipment Repair Technician as follows:

***AUTOMATED EQUIPMENT REPAIR TECHNICIAN - operates, programs, maintains, and repairs automated machine tools and automated manufacturing processes.***

This volume contains the justification, documentation, and course syllabi for the courses which we recommend as minimum training for individuals desiring to become Automated Equipment Repair Technicians.

The first and most important task of the MASTER program was the development of a foundation upon which all other works could be built. The MASTER Competency Profile is this foundation.



## **The MASTER Competency Profile**

Development of Competency Profiles at each of the MASTER sites began with visits to representative companies for the purpose of surveying expert workers within the industry and occupational areas under investigation. Each site began the survey process by asking a subject matter expert in the targeted technical area, generally a member of its faculty, to employ a modified version of the generally accepted DACUM (Developing A Curriculum) method to categorize the major skills needed to work in the selected occupation. As source materials, the college instructors drew on their professional knowledge and experience of current industry requirements and trends. The initial skill standards developed by the subject matter experts underwent numerous internal reviews and revisions within each site, assuming final form as a series of structured survey and interview questions designed to elicit a simple yes or no response.

To determine an appropriate survey sample, each site compiled a database of its region's small and medium-sized manufacturers and searched for companies likely to employ workers in the targeted occupational area. The resulting cross-industry samples were sorted further to achieve a balance of technological capability and workforce size; the sample companies within each region were then asked to participate in the project. Willing respondents were scheduled for interviews.

During the company interviews, the MASTER staff asked expert workers to identify the primary duties and tasks performed by a typical worker and to consider the special skills and knowledge, traits and attitudes, and industry trends that would have an impact on worker training, employability, and performance both now and in the future. The interview results were analyzed to create individual profiles identifying the most common duties and skills required of workers at each company. These individual company Competency Profiles served two purposes. First, they showed, in a format that could be easily understood by both industries and educators, a picture of the occupational specialty at a given company at that particular time. Second, these individual company Competency Profiles furnished the company with a document over which they could claim ownership. This, in effect, made them real partners in the work of MASTER.

Data for all companies were then aggregated to develop a composite Competency Profile of industry skill standards within the selected occupational specialty area of Automated Equipment Repair Technician, as shown on the following page.

These same duties and tasks were then included in both the Texas and National Surveys for further validation. As a result of the surveys, additional refinements were made in the Competency Profiles. These changes were incorporated into the individual course syllabi which were used for the pilot program.

The MASTER Competency Profile for Automated Equipment Repair Technician has been included on the following page.



# Automated Equipment Repair Competency Profile



Job Analysis conducted and prepared by

***MASTER***  
***Machine Tool Advanced Skills***  
***Technology Educational***  
***Resources Program***  
**Consortium**

# Automated Equipment Repair Technician

## Technical Workplace Competencies

### Duties

### Tasks

<b>A</b> <b>Apply Science to Solve Industrial Problems</b>	A-1 Apply scientific notation and engineering notation to solve technical problems	A-2 Apply algebraic formulas to solve technical problems	A-3 Use variables in algebraic formulas to predict behavior of industrial systems	A-4 Manipulate variables in algebraic formulas to analyze industrial systems
	A-5 Measure, calculate, and convert quantities in English and metric (SI, mks) systems of measurement	A-6 Use physics, algebra, and trigonometry to analyze simple vectored forces	A-7 Use mechanical physics to analyze mechanical industrial systems	A-8 Use math and mechanical physics to analyze problems found in hydraulic and pneumatic systems
	A-9 Use math and thermodynamics to analyze problems found in industrial heat treating systems	A-10 Use math, the physics of electromagnetism and optics to analyze industrial systems	A-11 Use chemical principles and formulas to predict and analyze reactions in chemical industrial processes	A-12 Apply the knowledge of electrochemical effects to analyze chemical industrial processes
	A-13 Apply properties of water to analyze industrial water treatment processes			
<b>B</b> <b>Use Drawings to Analyze and Repair Systems</b>	B-1 Use symbols, organization, and engineering values on mechanical drawings	B-2 Use symbols, organization, and engineering values on electrical drawings	B-3 Use symbols, organization, and engineering values on electronic drawings	B-4 Use symbols, organization, and engineering values on fluid power drawings
	B-5 Use symbols, organization, and engineering values on digital drawings			
<b>C</b> <b>Use Calibrated Measuring Instruments to Test/Calibrate Components</b>	C-1 Apply machine tool metrology and measurement instruments to align machine tools	C-2 Apply electrical measurement knowledge and instruments to test/calibrate electrical circuits	C-3 Apply electronic measurement knowledge and instruments to test/calibrate electronic circuits	C-4 Apply fluid power measurement and instruments to test/calibrate hydraulic and pneumatic systems
	C-5 Apply digital electronic measurement knowledge and instruments to test/calibrate digital electronic circuits			
<b>D</b> <b>Resolve System Failures With Critical Thinking, Troubleshooting, Theory, and Metrology</b>	D-1 Apply the troubleshooting process to the resolution of malfunctions found in industrial machine tools and automated equipment			

# Automated Equipment Repair Technician

## Technical Workplace Competencies

Duties		Tasks			
<b>E</b>	<b>Use Techniques to Isolate Malfunctions of Electrical/Electronic Systems</b>	E-1 Calculate, predict, and measure the response of quantities in DC circuits	E-2 Calculate, predict, and measure the response of quantities in AC circuits	E-3 Calculate, predict, and measure impedance and phase angle in AC circuits	E-4 Calculate, predict, and measure quantities in poly-phase AC circuits
		E-5 Properly set up, calibrate, and use meters and oscilloscopes	E-6 Use components such as resistors, inductors, and capacitors; construct circuits and test components	E-7 Use meters/oscilloscopes to measure phase shift or angle in series resistive-capacitive/resistive-inductive AC circuits	E-8 Apply electromagnetism theory to determine operational characteristics of relays, solenoids, transformers, and electrical motors for DC and AC circuits
		E-9 Apply principles of operation of electrical motors to identify various types of motors	E-10 Apply semiconductor theory and measurement techniques to determine operational characteristics of diodes, transistors, and power control semiconductors	E-11 Apply semiconductor theory and measurement techniques to determine operational characteristics of rectifiers/filtering circuits for single and three phase DC power supplies	E-12 Apply semiconductor theory and measurement techniques to determine operational characteristics of amplifiers and sensors
		E-13 Use schematic diagrams, meters, and oscilloscopes to identify, troubleshoot and repair or replace various types of electronic motor control circuits			
<b>F</b>	<b>Measure/Isolate Malfunctions of Mechanical/Fluid Power Systems</b>	F-1 Identify and explain the theory and use of major systems that comprise a hydraulic or pneumatic system	F-2 Apply purpose and use of valves in a hydraulic or pneumatic system to troubleshoot components or systems	F-3 Identify, assemble, measure, and apply knowledge of operating characteristics of hydraulic and pneumatic actuators	F-4 Apply hydraulic, pneumatic, and high vacuum systems knowledge to test, troubleshoot, and repair special components/devices
		F-5 Identify, assemble, measure, and apply knowledge of operating characteristics of selected, specialized fluid power circuits	F-6 Identify, assemble, measure, and apply knowledge of operating characteristics of electrically operated, specialized fluid power circuits	F-7 Use laws of simple machines and physics to identify and troubleshoot complex machines	F-8 Apply hydraulic, pneumatic, and high vacuum systems knowledge to test, troubleshoot, and repair high purity, high vacuum systems
		G-1 Perform digital operations in digital numbering systems	G-2 Perform Boolean operations in digital equipment	G-3 Solve digital logic circuits and ladder diagrams in electrical and programmable logic control circuits; express a complex logic problem in Boolean and convert it into ladder logic	G-4 Program computers and computer controlled industrial equipment
<b>H</b>	<b>Correct Malfunctions in PLC Controlled Industrial Equipment</b>	H-1 Perform operations on PLC (programmable logic controller) or PIC (programmable interface controller) systems			
<b>I</b>	<b>Resolve Malfunctions Found in Computer Systems Controlling Manufacturing Processes</b>	I-1 Use equipment manuals, manufacturer's specifications, and data entry/monitoring devices to configure, test and troubleshoot set up of a computer system and solve control problems			

# Automated Equipment Repair Technician

## Technical Workplace Competencies

### Duties

J	<b>Assemble/Disassemble Mechanical Electrical, Electronic, and Computer Systems</b>
---	---

### Tasks

<b>J-1</b> Safely assemble, disassemble, and adjust mechanical systems such as gearing systems, shafts, couplings, pulleys, belts	<b>J-2</b> Safely assemble, disassemble, and adjust subsystems or components of fluid power systems	<b>J-3</b> Safely assemble, disassemble or adjust electrical systems or components	<b>J-4</b> Safely assemble, disassemble or adjust electronic systems or components
<b>J-5</b> Safely assemble or disassemble digital systems or components such as PLCs, CNCs, or computers			

# **Automated Equipment Repair Technician**

## **Skills, Traits and Trends**

### **Skills and Knowledge**

Communication Skills  
Use Measurement Tools  
Use Inspection Devices  
Mathematical Skills  
Reading/Writing Skills  
Knowledge of Safety Regulations  
Practice Safety in the Workplace  
Organizational Skills  
Knowledge of Company Policies/  
Procedures  
Mechanical Aptitude  
Ability to Comprehend Written/  
Verbal Instructions  
Basic Knowledge of Fasteners  
Ability to Work as Part of a Team  
Converse in the Technical Language  
of the Trade  
Knowledge of Occupational  
Opportunities  
Knowledge of Employee/Employer  
Responsibilities  
Knowledge of Company Quality  
Assurance Activities  
Practice Quality-Consciousness in  
Performance of the Job  
Knowledge of Computers  
Electrical/Electronic Skills and  
Knowledge  
Knowledge of Computer  
Hardware/Software  
Programming Skills: PLC Ladder,  
Visual C, Visual Basic  
Manual Machining Experience

### **Traits and Attitudes**

Strong Work Ethic  
Motivation  
Interpersonal Skills  
Responsible  
Punctuality  
Physical Ability  
Dependability  
Professional  
Honesty  
Trustworthy  
Neatness  
Customer Relations  
Safety Conscientious  
Personal Ethics  
Eager to Learn

### **Current Trends**

Statistical Process Control  
Laser Machining  
Environmental concerns  
Automated Material Handling Equipment  
Computer Integrated Manufacturing  
Advanced Computer Applications  
Composites  
Robotics  
Fiber Optic Controls

## **TOOL/EQUIPMENT PROFICIENCY**

### **Hand Tools**

Hand tools appropriate to the construction, repair, and maintenance of electrical equipment such as electrical control systems and electrical motors

Hand tools appropriate to the construction, repair, and maintenance of electronic equipment such as computer controlled automated machinery

Hand tools appropriate to the construction, repair, and maintenance of hydraulic or pneumatic systems and components

### **Equipment**

Power supplies

Electronics test units

Electrical test units

Hydraulic test units

Pneumatic test units

Electrical components

Wire and cable, connectors

Computers 386, 486

Digital electronic components

Robot Programming software

PLC Programming software

Robots, SCARA and Articulated Pneumatic manipulators

Pneumatic fittings/components

Programmable Logic Controllers

Alignment/Calibration tools

Tool storage equipment

Vises

Coordinate Measurement Machine

Motion control servo systems test units

Wire termination devices, terminal lugs, etc.

Measuring instruments for mechanical parts - accuracy to .0001 inch

Hand held PLC programming terminals

Temperature, pressure, force, rotational velocity, and chemical measuring instruments

Robotic Welding equipment (SMAW, GMAW, FCAW)

Electrical motors

Stepper motors

Electronic motor controls

Electronic components

Electronic enclosures

Electrical enclosures

Analog multimeters

Digital multimeters

Oscilloscopes

FMS Programming software

CNC machines

Robot, pneumatic (bang-bang)

Hydraulic/pneumatic components

Hydraulic fittings/components

Heat treatment equipment

Personal safety equipment

Workbenches

Weld test equipment

## **The MASTER Pilot Program Curriculum and Course Descriptions**

After completing the Competency Profile for each occupational specialty area, each MASTER partner reviewed its existing curriculum against the industry-verified skill standards in order to identify a suitable foundation for new pilot training programs. Because each college had to comply with the requirements of its respective college system and appropriate state agency, the resulting pilot curricula for occupational specialty areas tended to vary in format and academic requirements (e.g., some programs were based on the semester system, others on the quarter system). Despite differences in the curricula developed at the partner colleges, each of the pilot programs was designed to achieve the following two goals mandated in the MASTER grant proposal:

*Pilot Program:* “Conduct a one year pilot program with 25 or more selected applicants at each college or advanced technology center to evaluate laboratory content and effectiveness, as measured by demonstrated competencies and indicators of each program area.”

*Student Assessment:* “Identify global skills competencies of program applicants both at point of entrance and point of exit for entry-level and already-employed technicians.”

(*Note:* Not all occupational specialty areas were pilot-tested at all Development Centers; however, all partner colleges conducted one or more pilot programs.)

Included on the following page is the curriculum listing for the pilot program which was used to validate course syllabi for this occupational specialty area. The curriculum also shows the number of hours assigned to each of the courses (lecture, laboratory and credit hours). Also included is a description of each of the courses.

**MASTER Curriculum**  
**Automated Equipment Repair Technology**  
 (Certificate Program)

		LEC	LAB	CR
AET 100	Manufacturing Metrics and Calculations	2	3	3
AET 101	Teamwork Skills	0	3	1
AET 102	Print Reading and Symbology	3	0	3
AET 106	Manufacturing Processes	3	3	4
AET 111	Industrial Programming Theory	2	3	3
AET 200	Industrial Electronics/Electricity	2	6	4
AET 205	Motion Control/Servo Systems	2	6	4
AET 210	Fluid Power Technology	2	3	3
AET 215	Programmable Logic Controllers	2	3	3
AET 220	Industrial Machine Technology	2	3	3
AET 225	Flexible Manufacturing Systems/Robotics	<u>2</u>	<u>6</u>	<u>4</u>
	Program Totals	22	39	35



## MASTER Course Descriptions

### Automated Equipment Repair Technology

**AET 100 Manufacturing Metrics and Calculations (2-3-3)** Basic application of mathematical concepts required for effective performance as an automation technician or machine technologist in the machine tool industry. Problem examples will be taken from machines and equipment typically found in the modern industrial manufacturing facility. Associate Degree credit. Prerequisites are eligibility for Math 54, Elementary Algebra, and English 56, College Reading Study Skills.

**AET 101 Teamwork Skills (0-3-1)** Basic application of team problem-solving concepts and techniques required for effective performance as a team member in the business environment. Prerequisite is eligibility for English 56, College Reading Study Skills.

**AET 102 Print Reading and Symbology (3-0-3)** Study of the types of symbols and engineering notations used for mechanical, electrical, hydraulic, and pneumatic drawings. Representative drawings will be used to demonstrate concepts and practice in interpreting the symbols and notations. Students will view and handle typical parts represented by the symbols. Associate Degree credit. Prerequisite is satisfactory completion of AET 100, Manufacturing Metrics and Calculations, concurrent enrollment, or equivalent.

**AET 106 Manufacturing Processes (3-3-4)** A survey of physical and chemical processes used to manufacture products. Designed for students who will pursue a career in automated manufacturing, the course will require students to test automated manufacturing processes. The course will also encourage students to pursue further training in physics and chemistry by exploring the principles underlying technologies used to manufacture products found in industry; these technologies will include machine technology, vacuum technology, heat treatment, hydraulic and pneumatic technology, and electro-chemical manufacturing processes. Students will use formulas and New Metric (S.I.) (mks) system of measurement to solve problems of industrial processes. Associate Degree credit. Prerequisite is satisfactory completion of AET 100, Manufacturing Metrics and Calculations, or concurrent enrollment, or equivalent.

**AET 111 Industrial Programming Theory (2-3-3)** Basic digital mathematical concepts required for effective performance as an automation technician or machine technologist in the computerized machine tool industry. Example will include computers or microprocessors found in the typical modern industrial manufacturing facility, including industrial computers, programmable logic controllers, and microprocessor-based control systems. Associate Degree Credit. Prerequisite is

satisfactory completion of AET 100, Manufacturing Metrics and Calculations, concurrent enrollment, or equivalent.

**AET 200 Industrial Electronics/Electricity (2-6-4)** Introduces the principles of operation of common electronics/electrical components through the use of hands-on experiments and classroom lectures. Also include theory of operation of different components such as switches, relays, transformers, motors, sensors, and diodes. Associate Degree credit. Prerequisites are satisfactory completion of, or concurrent enrollment in AET 100, Manufacturing Metrics and Calculations, AET 102, Print Reading and Symbology, or equivalent.

**AET 205 Motion Control/Servo Systems (2-6-4)** Study of the types of control circuits used to control industrial equipment, including motor, process, and hydraulic controls, as well as feedback systems used in control systems and their theory of operation. Emphasis of closed-loop servo systems and their theory of operation. Students will gain hands-on experience with control systems through lab exercises. Associate Degree credit. Prerequisite is satisfactory completion of AET 200, Industrial Electronics/Electricity, or equivalent.

**AET 210 Fluid Power Technology (2-3-3)** Basic principles of hydraulics and pneumatics through hands-on experiments and lecture. Explores various hydraulic and pneumatic systems, circuits, components, and applications. Associate Degree credit. Prerequisites are satisfactory completion of AET 102, Print Reading and Symbology, and AET 106, Manufacturing Processes, or equivalent.

**AET 215 Programmable Logic Controllers (2-3-3)** Study of concepts associated with the operation, construction, configuring, and programming of programmable logic controllers (PLC). Students will experiment with digital circuits to understand digital logic concepts, and hands-on lab exercises in constructing, operating, configuring, and programming PLCs. Associate Degree credit. Prerequisites are satisfactory completion of AET 109, Industrial Programming Theory, and AET 200, Industrial Electronics/Electricity, or equivalent.

**AET 220 Industrial Machine Technology (2-3-3)** A survey course designed to provide students with an overview of typical machine shop operations and an introduction to welding technology. Associate Degree credit. Prerequisites are satisfactory completion of AET 100, Manufacturing Metrics and Calculations, and AET 102, Print Reading and Symbology, or equivalent.

**AET 225 Flexible Manufacturing Systems/Robotics (2-6-4)** Design, installation, operation, and maintenance of a Flexible Manufacturing System (FMS). Includes the role, theory, and programming of robots and work centers in FMS. Lab exercises will cover the assembly, configuring, troubleshooting, and repair of various automated equipment and robots during construction of a flexible

manufacturing cell. Associate Degree credit. Prerequisites are satisfactory completion of AET 205, Motion Control/Servo Systems, AET 210, Fluid Power Technology, AET 215, Programmable Logic Controllers, or equivalent.

## The MASTER Technical Workplace Competencies and Course Crosswalk

After development of appropriate curricula for the pilot programs, each MASTER college began to develop individual course outlines for its assigned specialty area. The skill standards identified in the Competency Profile were cross walked against the technical competencies of the courses in the pilot curriculum. The resulting matrix provided a valuable tool for assessing whether current course content was sufficient or needed to be modified to ensure mastery of entry-level technical competencies. Exit proficiency levels for each of the technical competencies were further validated through industry wide surveys both in Texas and across the nation.

The Technical Workplace Competencies and Course Crosswalk on the following pages presents the match between industry—identified duties and tasks and the pilot curriculum for Automated Equipment Repair. Course titles are shown in columns; duties and tasks, in rows. The Exit Proficiency Level Scale (see Figure 1), an ascending scale with 5 as the highest level of proficiency, includes marked boxes indicating whether the task is covered by the instructor during the course; the numbers 1–5 indicate the degree of attention given to the task and the corresponding proficiency expected on the part of the student upon completion of the course of studies. The crosswalk is intended to serve as an aide to other instructional designers and faculty in community college programs across the nation.

EXIT PROFICIENCY LEVEL SCALE					
Technical Workplace Competency	1	2	3	4	5
	Rarely	Routinely with Supervision	Routinely with Limited Supervision	Routinely Without Supervision	Initiates/ Improves/ Modifies and Supervises Others

**Figure 1**

Included on the following pages is the Technical Workplace Competencies and Course Crosswalk for the pilot program curriculum. This crosswalk validates the fact that the duties and tasks which were identified by industry as being necessary for entry-level employees have been incorporated into the development of the course syllabi.

## The MASTER Technical Workplace Competencies and Course Crosswalk

After development of appropriate curricula for the pilot programs, each MASTER college began to develop individual course outlines for its assigned specialty area. The skill standards identified in the Competency Profile were cross walked against the technical competencies of the courses in the pilot curriculum. The resulting matrix provided a valuable tool for assessing whether current course content was sufficient or needed to be modified to ensure mastery of entry-level technical competencies. Exit proficiency levels for each of the technical competencies were further validated through industry wide surveys both in Texas and across the nation.

The Technical Workplace Competencies and Course Crosswalk on the following pages presents the match between industry—identified duties and tasks and the pilot curriculum for Automated Equipment Repair. Course titles are shown in columns; duties and tasks, in rows. The Exit Proficiency Level Scale (see Figure 1), an ascending scale with 5 as the highest level of proficiency, includes marked boxes indicating whether the task is covered by the instructor during the course; the numbers 1–5 indicate the degree of attention given to the task and the corresponding proficiency expected on the part of the student upon completion of the course of studies. The crosswalk is intended to serve as an aide to other instructional designers and faculty in community college programs across the nation.

EXIT PROFICIENCY LEVEL SCALE					
Technical Workplace Competency	1	2	3	4	5
	Rarely	Routinely with Supervision	Routinely with Limited Supervision	Routinely Without Supervision	Initiates/ Improves/ Modifies and Supervises Others

**Figure 1**

Included on the following pages is the Technical Workplace Competencies and Course Crosswalk for the pilot program curriculum. This crosswalk validates the fact that the duties and tasks which were identified by industry as being necessary for entry-level employees have been incorporated into the development of the course syllabi.

# AUTOMATED EQUIPMENT REPAIR TECHNICIAN

## Technical Workplace Competencies and Course Crosswalk

	Teamwork Skills	Mfg. -Metrics/Calculations	Print Reading & Symbolology	Manufacturing Processes	Industrial Programming	Indus. Electronics/Electricity	Motion Control/Servo Systems	Fluid Power Technology	Programmable Logic Controllers	Indus. Machine Technology	Flexible Mfg. Systems/Robotics									EXIT PROFICIENCY LEVEL
<b>A. APPLY SCIENCE TO SOLVE INDUSTRIAL PROBLEMS</b>																				
A-1 Apply scientific notation and engineering notation to solve technical problems	I	R	R	R	R	M	M	R	R	R										4
A-2 Apply algebraic formulas to solve technical problems	I	R	R	R	R	M	M	R	R	R										5
A-3 Use Variables in Algebraic formulas to predict behavior of industrial systems	I		R	R	R	M	M	R	R	R										4
A-4 Manipulate variables in algebraic formulas to analyze industrial systems	I		I	R	R	R	R		R	R										4
A-5 Measure, calculate, and convert quantities in English and Metric (SI, mks) systems of measurement	R		I	R	R	R	R	R		R										5
A-6 Use physics, algebra, and trigonometry to analyze simple vectored forces	R		I			R	R		R	R										4
A-7 Use mechanical physics to analyze mechanical industrial systems	R		I		R	R	R			R										4
A-8 Use math and mechanical physics to analyze problems found in hydraulic and pneumatic systems	R		I				R			R										5
A-9 Use math and thermodynamics to analyze problems found in industrial heat treating systems	R		I				R			R										5
A-10 Use math, the physics of electromagnetism and optics to analyze industrial systems	R		I							R										3
A-11 Use chemical principles and formulas to predict and analyze reactions in chemical industrial processes	R		I							R										2
A-12 Apply the knowledge of electrochemical effects to analyze chemical industrial processes			I		R															4
A-13 Apply properties of water to analyze industrial water treatment processes			I		R	R	R													4
<b>B. USE DRAWINGS TO ANALYZE AND REPAIR SYSTEMS</b>																				
B-1 Use symbols, organization, and engineering values on mechanical drawings	R	I		R	R	R	R	R		M										4
B-2 Use symbols, organization, and engineering values on electrical drawings	R	I		R	R	R	R	R		M										5
B-3 Use symbols, organization, and engineering values on electronic drawings	R	I		R	R	R	R	R		M										5
B-4 Use symbols, organization, and engineering values on fluid power drawings	R	I					R	R		M										5
B-5 Use symbols, organization, and engineering values on digital drawings	R	I		R		R		R		M										5
<b>C. USE CALIBRATED MEASURING INSTRUMENTS TO TEST/ CALIBRATE COMPONENTS</b>																				
C-1 Apply machine tool metrology and measurement instruments to align machine tools	R	R				R	R		I	I										3
C-2 Apply electrical measurement knowledge and instruments to test/calibrate electrical circuits	R	R		I	R	R	R		R											4
C-3 Apply electronic measurement knowledge and instruments to test/calibrate electronic circuits	R	R		R	I	R	R		R											4
C-4 Apply fluid power measurement and instruments to test/calibrate hydraulic and pneumatic systems	R	R		R	R	I	R		R											4
C-5 Apply digital electronic measurement knowledge and instruments to test/ calibrate digital electronic circuits	R	R		R	R	I	R		R											4



# AUTOMATED EQUIPMENT REPAIR TECHNICIAN

## Technical Workplace Competencies and Course Crosswalk

	Teamwork Skills	Mfg. Metrics/Calculations	Print Reading & Symbolology	Manufacturing Processes	Industrial Programming	Indus. Electronics/Electricity	Motion Control/Servo Systems	Fluid Power Technology	Programmable Logic Controllers	Indus. Machine Technology	Flexible Mfg. Systems/Robotics							EXIT PROFICIENCY LEVEL
<b>D. RESOLVE SYSTEM FAILURES WITH CRITICAL THINKING, TROUBLESHOOTING, THEORY, AND METROLOGY</b>																		
D-1 Apply the troubleshooting process to the resolution of malfunctions found in industrial machine tools and automated equipment	I	R	R	I	I	I	I	I	R	I								4
<b>E. USE TECHNIQUES TO ISOLATE MALFUNCTIONS OF ELECTRICAL/ELECTRONIC SYSTEMS</b>																		
E-1 Calculate, predict, and measure the response of quantities in DC circuits		R	R			I	R				R							4
E-2 Calculate, predict, and measure the response of quantities in AC circuits		R	R			I	R				R							4
E-3 Calculate, predict, and measure impedance and phase angle in AC circuits		R	R			I	R				R							4
E-4 Calculate, predict, and measure quantities in poly-phase AC circuits		R	R			I	R				R							4
E-5 Properly set up, calibrate, and use meters and oscilloscopes		R	R			I	R				R							5
E-6 Use components such as resistors, inductors, and capacitors; construct circuits and test components		R	R			I	R				R							3
E-7 Use meters/oscilloscopes to measure phase shift or angle in series resistive-capacitive/resistive-inductive AC circuits		R	R			I	R				R							4
E-8 Apply electromagnetism theory to determine operational characteristics of relays, solenoids, transformers, and electrical motors for DC and AC circuits		R	R			I	R				R							4
E-9 Apply principles of operation of electrical motors to identify various types of motors		R	R			I	R				R							4
E-10 Apply semiconductor theory and measurement techniques to determine operational characteristics of diodes, transistors, and power control semiconductors		R	R			R	I				R							3
E-11 Apply semiconductor theory and measurement techniques to determine operational characteristics of rectifiers/filtering circuits for single and three phase DC power supplies		R	R			R	I				R							4
E-12 Apply semiconductor theory and measurement techniques to determine operational characteristics of amplifiers and sensors		R	R			R	I				R							4
E-13 Use schematic diagrams, meters, and oscilloscopes to identify, troubleshoot and repair or replace various types of electronic motor control circuits		R	R			R	I				R							3
<b>F. MEASURE/ISOLATE MALFUNCTIONS OF MECHANICAL/FLUID POWER SYSTEMS</b>																		
F-1 Identify and explain the theory and use of major systems that comprise a hydraulic or pneumatic system		R	R	R				I			R							4
F-2 Apply purpose and use of valves in a hydraulic or pneumatic system to troubleshoot components or systems			R	R				I			R							4
F-3 Identify, assemble, measure, and apply knowledge of operating characteristics of hydraulic and pneumatic actuators		R	R	R				I			R							4
F-4 Apply hydraulic, pneumatic, and high vacuum systems knowledge to test, troubleshoot, and repair special components/devices		R	R	R				I			R							3
F-5 Identify, assemble, measure, and apply knowledge of operating characteristics of selected specialized fluid power circuits		R	R	R		R	R	I			R							3
F-6 Identify, assemble, measure, and apply knowledge of operating characteristics of electrically operated, specialized fluid power circuits		R	R	R		R	R	I			R							3
F-7 Use laws of simple machines and physics to identify and troubleshoot complex machines		R	R	I							R							3
F-8 Apply hydraulic, pneumatic, and high vacuum systems knowledge to test, troubleshoot, and repair high purity, high vacuum systems		R	R	R		R	R	I			R							3
<b>G. APPLY COMPUTER SCIENCE TO COMPUTER CONTROLLED INDUSTRIAL EQUIPMENT</b>																		
G-1 Perform digital operations in digital numbering systems		R				I			R	R								4

# AUTOMATED EQUIPMENT REPAIR TECHNICIAN

## Technical Workplace Competencies and Course Crosswalk

	<i>Teamwork Skills</i>	<i>Mfg.-Metrics/Calculations</i>	<i>Print Reading &amp; Symbology</i>	<i>Manufacturing Processes</i>	<i>Industrial Programming</i>	<i>Indus. Electronics/Electricity</i>	<i>Motion Control/Servo Systems</i>	<i>Fluid Power Technology</i>	<i>Programmable Logic Controllers</i>	<i>Indus. Machine Technology</i>	<i>Flexible Mfg. Systems/Robotics</i>						<b>EXIT PROFICIENCY LEVEL</b>
--	------------------------	----------------------------------	--------------------------------------	--------------------------------	-------------------------------	---------------------------------------	-------------------------------------	-------------------------------	---------------------------------------	----------------------------------	---------------------------------------	--	--	--	--	--	-------------------------------

G-2 Perform Boolean operations in digital equipment	R		R		R				I		R						3
G-3 Solve digital logic circuits and ladder diagrams in electrical and programmable logic control circuits; express a complex logic problem in Boolean and convert it into ladder logic	R		R		R				I		R						3
G-4 Program computers and computer controlled industrial equipment	R				I				I		R						3
<b>H. CORRECT MALFUNCTIONS IN PLC CONTROLLED INDUSTRIAL EQUIPMENT</b>																	
H-1 Perform operations on PLC (programmable logic controller) or PIC (programmable interface controller) systems	R	R	R		I	R	R	R	I	R	R						3
<b>I. RESOLVE MALFUNCTIONS FOUND IN COMPUTER SYSTEMS CONTROLLING MANUFACTURING PROCESSES</b>																	
I-1 Use equipment manuals, manufacturer's specifications, and data entry/monitoring devices to configure, test and troubleshoot set up of a computer system and solve control problems					I					R		R					3
<b>J. ASSEMBLE/DISASSEMBLE MECHANICAL ELECTRICAL, ELECTRONIC, AND COMPUTER SYSTEMS</b>																	
J-1 Safely assemble, disassemble, and adjust mechanical systems such as gearing systems, shafts, couplings, pulleys, belts	R		R									I					3
J-2 Safely assemble, disassemble, and adjust subsystems or components of fluid power systems	R	R	R	R				I				I					4
J-3 Safely assemble, disassemble or adjust electrical systems or components			R			R	I					I					4
J-4 Safely assemble, disassemble or adjust electronic systems or components	R	R	R			R	I	R				I					3
J-5 Safely assemble or disassemble digital systems or components such as PLCs, CNCs, or computers	R	R	R			R	R	R		I		R					3



## SCANS

The Secretary's Commission on Achieving Necessary Skills (SCANS), U. S. Department of Labor, has identified in its "AMERICA 2000 REPORT" the following five competencies and a three-part foundation of skills and personal qualities that are needed for solid job performance:

### COMPETENCIES:

<i>Resources:</i>	<i>Identifies, organizes, plans, and allocates resources</i>
<i>Interpersonal:</i>	<i>Works with others</i>
<i>Information:</i>	<i>Acquires and uses information</i>
<i>Systems:</i>	<i>Understands complex inter-relationships</i>
<i>Technology:</i>	<i>Works with a variety of technologies</i>

### FOUNDATION SKILLS:

<i>Basic Skills:</i>	<i>Reads, writes, performs arithmetic and mathematical operations, listens, and speaks well</i>
<i>Thinking Skills:</i>	<i>Thinks creatively, makes decisions, solves problems, visualizes, knows how to learn, and reasons</i>
<i>Personal Qualities:</i>	<i>Displays responsibility, self-esteem, sociability, self-management, integrity, and honesty</i>

Recognizing the value of SCANS proficiencies to job performance as well as the growing mandate in many states to include SCANS activities in course curricula, **MASTER** asked survey respondents to review the SCANS skill sets in the context of the draft skill standards for each occupational specialty area. **MASTER** also incorporated an evaluation of SCANS competencies and foundation skills into its assessment of the pilot training curricula. The results were summarized in a crosswalk that allowed the **MASTER** staff to modify course contents where needed to strengthen the achievement of SCANS competencies.

As soft skills, the SCANS competencies are inherently difficult to quantify. **MASTER** realizes that some faculty will emphasize the SCANS more or less than others. In time, faculty will learn to make these types of SCANS activities an integral and important part of the teaching process.

**MASTER Curriculum**  
**Automated Equipment Repair Technology**  
 (Certificate Program)

		LEC	LAB	CR
AET 100	Manufacturing Metrics and Calculations	2	3	3
AET 101	Teamwork Skills	0	3	1
AET 102	Print Reading and Symbology	3	0	3
AET 106	Manufacturing Processes	3	3	4
AET 111	Industrial Programming Theory	2	3	3
AET 200	Industrial Electronics/Electricity	2	6	4
AET 205	Motion Control/Servo Systems	2	6	4
AET 210	Fluid Power Technology	2	3	3
AET 215	Programmable Logic Controllers	2	3	3
AET 220	Industrial Machine Technology	2	3	3
AET 225	Flexible Manufacturing Systems/Robotics	<u>2</u>	<u>6</u>	<u>4</u>
	Program Totals	22	39	35

# **MASTER PROGRAM**

## **Manufacturing Metrics And Calculations**

### **COURSE SYLLABUS**

---

**Total lecture hours: 32**

**Total lab hours: 48**

**Credit hours: 3**

#### **COURSE DESCRIPTION:**

Covers basic applications of mathematical concepts that are required for effective performance as an automation technician or machine technologist. Problem examples will be taken from machines and equipment that are typically found in the modern manufacturing facility.

#### **PREREQUISITES:**

**Eligibility for Elementary Algebra and College Reading Study Skills**

#### **COURSE OBJECTIVES:**

After successful completion of this course, the student will be able to:

1. Use scientific notation and engineering notation to express mathematical values that are given or obtained by measurement, and apply these mathematical values to the solution of technical problems;
2. Use algebraic formulas such as those used in machining technology, electronics, electricity, fluid power, and technical physics, and apply scientific notation or engineering notation values to the solution of these equations to aid in solving technical problems;
3. Apply algebraic formulas such as those found in machining technology, electronics, electricity, fluid power, and technical physics, to identify the effects on a system of a change in a variable of the equation;
4. Transpose variables from one side of a formula to the other side of the formula to produce new relationships in the equation, and identify the relationship between the variables of the formula and the real world value that the variable represents;
5. Use the Cartesian (rectangular) coordinate system to identify quadrants and points in the system, and plot coordinates on the grid for lines and curves;
6. Use the rules of geometry to solve problems involving surface area and perimeters of geometric shapes, such as rectangles, squares, triangles, trapezoids, parallelograms, and circles;
7. Use the rules of solid geometry to solve problems involving the volume and surface area of geometric shapes such as cubes, right angle solids, cylinders, prisms, cones, and spheres; and,

8. Use the rules of trigonometry to solve simple vectors, find the angle formed by two measured line segments, calculate a dimension given an angle and other dimension, and plot the sine and cosine functions through 360 degrees on a Cartesian coordinate grid.

**REQUIRED COURSE MATERIALS:**

- Textbook:** *Elementary Technical Mathematics* by Ewen/Nelson, Latest Edition  
**Lab Manual:** Instructor handouts  
**Materials:** None

**METHODS OF INSTRUCTION:**

---

- Lecture:** Presentations will include lecture, demonstration, and group problem solving.  
**Laboratory:** Laboratory will be hands-on mathematical problem solving.

**Method of Evaluation:** A student's grade will be based on multiple measures of performance. The assessment will measure development of independent critical thinking skills and will include evaluation of the student's ability to:

1. Perform on written or oral examinations;
2. Perform on outside assignments;
3. Contribute to group problem solving;
4. Apply theory to problem solving; and,
5. Maintain attendance as per current policy.

**LECTURE OUTLINE:**

---

Lecture Topics	Contact Hrs.
<b>Geometry and the History of Mathematics</b>	
A. The role of problem solving and the building of cities and monuments by our ancestors in the creation of mathematics and geometry	
B. The creation of rules and formulas	
C. Using letters to represent mathematical concepts	
D. Plane geometry	
E. Applications of plane geometry to the solution of technical problems	
F. Solid geometry	
G. Applications of solid geometry to the solution of technical problems	

H. The rectangular (Cartesian) coordinate system

### **Trigonometry**

A. The history of the usage of trigonometry

B. The right triangle

C. Trigonometric functions of the right triangle  
(sine, cosine, tangent)

D. Using trigonometric functions to solve technical  
problems

E. Graphical representations of trigonometric  
functions

### **The Decimal Numbering System**

A. Negative and positive numbers

B. The ten base numbering system

### **The Fifteen Rules of Math**

A. Definitions

B. The rules of addition, subtraction, multiplication,  
and division of positive and negative numbers

C. The addition, subtraction, multiplication, and  
division axioms

D. The order of operations

E. The associative rule

F. The distributive rule

G. The identity rule

H. A number multiplied by its reciprocal

I. A number multiplied or divided by zero

J. Coefficients and coefficients of one

K. A number raised to the zero power or first power

L. Operations with exponentiated numbers

### **Scientific and Engineering Notation**

A. Scientific notation

B. Engineering notation

### **Algebra**

A. Algebraic expressions

B. Algebraic operations: addition, subtraction,  
multiplication, and division

C. Algebraic operations: factoring

D. Algebraic fractions

E. Equations

1) Transposing algebraic equations

2) Solving algebraic equations

3) Solving two linear equations in two  
unknowns

F. Graphing algebraic equations

1) Graphing linear equations

2) Graphing equations in two unknowns

## Formulas

- A. Using formulas to express physical concepts
- B. Deriving new concepts by transposing formulas
- C. Solving problems with the use of formulas  
(word problems)

## Estimating Problems

Total Lecture Hours     32

## LAB OUTLINE:

Lab Topics	Contact Hrs.
Geometry	
Trigonometry	
The Decimal Numbering System	
The Fifteen Rules of Math	
Scientific and Engineering Notation	
Algebra	
Formulas	
Estimating Problems	
Total Lab Hours	<u>48</u>

## COURSE OBJECTIVES: SCANS COMPETENCIES

*The Secretary's Commission on Achieving Necessary Skills (SCANS), U.S. Department of Labor, has identified in its "AMERICA 2000 REPORT" that all students should develop a new set of competencies and foundation skills if they are to enjoy a productive, full and satisfying life. These are in addition to the Technical Workplace Competencies required by industry. SCANS is made up of five competencies and a three-part foundation of skills and personal qualities that are needed for solid job performance. All italicized headings in this section are direct quotations from "What Work Requires of Schools: A SCANS Report for America 2000."*

The following activities will be performed by each student for successful completion of this course:

### I. COMPETENCIES

- A. *Resources: Identifies, organizes, plans, and allocates resources*
  - 1. Allocates time to complete assigned tasks on schedule
  - 2. Determines and allocates required materials and resources for meeting objectives
  - 3. Evaluates skills, performance, and quality of work and provides feedback

- B. *Interpersonal: Works with others***
  - 1. Participates as a member of the team, contributing to group effort
  - 2. Provides individual assistance/direction to peers as requested
  - 3. Determines and meets expectations
  - 4. Exercises leadership qualities to effectively communicate ideas and make decisions.
  - 5. Negotiates resources in order to accomplish objectives
  - 6. Works well with all members of the class
- C. *Information: Acquires and uses information***
  - 1. Acquires and evaluates information
  - 2. Organizes and maintains information
  - 3. Interprets and communicates information
- D. *Systems: Understands complex inter-relationships***
  - 1. Understands and works well with social, organizational, and technological systems
  - 2. Monitors and corrects performance of system during operation
  - 3. Recommends modifications to system to improve performance
- E. *Technology: Works with a variety of technologies***
  - 1. Chooses relevant procedures, tools, and equipment
  - 2. Applies appropriate procedures and techniques to accomplish tasks
  - 3. Identifies or solves problems to maintain equipment

## II. FOUNDATION SKILLS

- A. *Basic Skills: Reads, writes, performs arithmetic and mathematical operations, listens and speaks***
  - 1. *Reading: Locates, understands, and interprets written information in prose and in documents such as manuals, graphs, and schedules***
    - a. Demonstrates basic reading skills including abilities to perceive main ideas, draw appropriate conclusions, detect a sequence, locate answers, find facts, and infer from written texts
    - b. Demonstrates course specific reading skills including abilities to read, interpret, and comprehend information from text and supplemental materials on a level to facilitate productive independent and group study
    - c. Demonstrates ability to read, interpret, and utilize information from course specific instruments (i.e., charts, diagrams, graphs, schematics, blueprints, flow charts, etc.)

- d. Demonstrates ability to read, interpret, and follow schedules and procedural instructions in a timely and appropriate manner
  - e. Demonstrates ability to choose and use most appropriate reading method (skim, scan, or read for comprehension) for materials
2. ***Writing: Communicates thoughts, ideas, information, and messages in writing; and creates documents such as letters, directions, manuals, reports, graphs, and flow charts***
- a. Demonstrates basic writing skills including abilities to produce written documents which conform with accepted grammatical and communication standards required for effective daily functioning
  - b. Demonstrates effective written study skills including note taking, maintaining course specific journals, workbooks, manuals, etc.
  - c. Demonstrates technical writing skills in preparing outlines, summaries, time lines, flow charts, diagrams, etc. appropriate to materials covered
  - d. Demonstrates ability to complete all required writings in a timely, complete, and professional manner
  - e. Demonstrates competence in subject matter through the organization and presentation of answers to required written assessments
3. ***Arithmetic/Mathematics: Perform basic computations and approaches practical problems by choosing appropriately from a variety of mathematical techniques***
- a. Demonstrates proficiency in basic arithmetic functions including ability to add, subtract, multiply, and divide whole numbers, fractions, decimals, and percentages
  - b. Demonstrates ability to read, comprehend, and select appropriate math procedures to work basic math problems
  - c. Demonstrates ability to understand and perform multi-step computations
  - d. Demonstrates ability to read, interpret, and use standard measuring devices
  - e. Demonstrates ability to comprehend, retain, and utilize course specific measuring devices effectively
  - f. Demonstrates ability to understand, retain, and utilize higher mathematical formulas and functions required for course specific math performance



- g. Demonstrates ability to appropriately transfer mathematical calculations and information from paper to machines
  - 4. *Listening: Receives, attends to, interprets, and responds to verbal messages and other cues*
    - a. Functions at minimal or above required hearing levels to receive, attend, interpret, and respond to verbal messages and instructions and to safely operate machinery
    - b. Demonstrates ability to hear, comprehend, and appropriately follow directions
    - c. Demonstrates auditory ability to hear, comprehend, and utilize verbal classroom as well as other auditory instruction
    - d. Demonstrates ability to discriminate between essential and non-essential verbal information and react appropriately
    - e. Demonstrates ability to focus and fine-tune listening skills to receive, interpret, and respond to various sounds
    - f. Demonstrates ability and maturity to seek and receive additional individualized instruction as needed
  - 5. *Speaking: Organizes ideas and communicates orally*
    - a. Demonstrates appropriate listening and speaking skills in personal conversations
    - b. Demonstrates ability to choose and organize appropriate words to effectively communicate
    - c. Demonstrates ability to speak clearly and distinctly with appropriate volume, tone, and body language for situation
    - d. Demonstrates ability to spontaneously organize and present appropriate answers and/or short presentations for classroom and /or assessment purposes
    - e. Demonstrates ability to formulate, organize, and deliver major presentations to peers or groups
    - f. Demonstrates ability to speak effectively in one-on-one, small group, or large group presentations
    - g. Demonstrates ability to take responsibility for presentations
- B. Thinking Skills: Thinks creatively, makes decisions, solves problems, visualizes, knows how to learn and reasons**
- 1. *Decision Making: Specifies goals and constraints, generates alternatives, considers risks, and evaluates and chooses best alternative*
    - a. Demonstrates ability to objectively assess personal strengths and weaknesses

- b. Demonstrates ability to set realistic short-term and long-term goals
  - c. Demonstrates ability to recognize and distinguish between positive and negative alternatives
  - d. Demonstrates ability to identify potential pitfalls and take evasive actions
  - e. Demonstrates ability to objectively and responsibly evaluate alternatives by testing hypotheses and selecting most appropriate response
  - f. Demonstrates ability to profit from negative evaluations or mistakes by reformulating, redirecting, reconstructing, or retesting alternatives
  - g. Demonstrates maturity in taking responsibility for decisions
2. *Problem Solving: Recognizes problems and devises and implements plan of action*
- a. Demonstrates ability to detect problem through observation, inquiry, or directive
  - b. Demonstrates ability to grasp appropriate overview and degree of seriousness of problem and to behave responsibly in situation
  - c. Demonstrates ability to generate alternatives or options for problem solution
  - d. Demonstrates ability to research options, assess and evaluate options, and determine appropriate and best solution
  - e. Demonstrates ability to initiate and effect solution
  - f. Demonstrates ability to take responsibility for outcomes
  - g. Demonstrates ability to effectively problem solve in individual, team, or group situations
3. *Seeing Things In the Mind's Eye: Organizes, and processes symbols, pictures, graphs, objects, and other information*
- a. Functions at minimum or above required visual levels in order to see, interpret, attend and respond to visual imagery and meet safety requirements for necessary machinery
  - b. Demonstrates ability to read, interpret, and act upon signs, symbols, and other visual cues
  - c. Demonstrates ability to visually discriminate in gross and fine imagery
  - d. Demonstrates ability to visualize abstractly
  - e. Demonstrates ability to apply visual imagery to applied tasks

4. ***Knowing How to Learn:*** *Use efficient learning techniques to acquire and apply new knowledge and skills*
    - a. Demonstrates mastery of basic reading, math, and language skills through application
    - b. Demonstrates ability to translate abstract theory into practical application
    - c. Demonstrates ability to incorporate and generalize new learning into a sequential learning process
    - d. Demonstrates knowledge of good study skills and learning habits
  5. ***Reasoning:*** *Discovers a rule or principle underlying the relationship between two or more objects and applies it when solving a problem*
    - a. Demonstrates use of simple logic
    - b. Demonstrates ability to distinguish relationships
    - c. Demonstrates ability to determine and isolate factors in relationships
    - d. Demonstrates and applies knowledge through practice
    - e. Recognizes that attitudes, skills, and practice are essential to productivity
    - f. Demonstrates ability to discriminate between positive and negative, and act accordingly
- C. **Personal Qualities:** Displays responsibility, self-esteem, sociability, self-management, and integrity and honesty
1. ***Responsibility:*** *Exerts a high level of effort and perseveres towards goal attainment*
    - a. Demonstrates ability to formulate realistic and useful short and long term goals and complete steps necessary to timely achieve goals
    - b. Demonstrates ability to make adjustments, revisions, and changes to achieve goals in a cooperative and polite manner
    - c. Demonstrates ability to focus on task at hand and work to completion
    - d. Demonstrates good work ethics through regular attendance, adequate classroom preparations, and appropriate use of classroom time
    - e. Demonstrates maturity to take responsibility for actions
    - f. Demonstrates ability to cooperatively work in individual, team, and group situations in timely and effective manner
  2. ***Self-Esteem:*** *Believes in own self-worth and maintains a positive view of self*
    - a. Presents a positive attitude toward tasks

- b. Demonstrates ability to separate work and personal behaviors
  - c. Actively participates in learning opportunities by sharing knowledge and skills with peers and instructors
  - d. Demonstrates ability to accept personal strengths and weaknesses and builds on positive behaviors
  - e. Demonstrates ability to accept and use constructive criticism
  - f. Accepts positive reinforcement in an appropriate manner
3. ***Sociability: Demonstrates understanding, friendliness, adaptability, empathy, and politeness in group settings***
- a. Demonstrates appropriate and acceptable social behaviors in interactions
  - b. Demonstrates ability to work cooperatively in individual, team, or group situations
  - c. Demonstrates active interest in peers by offering assistance, sharing resources, and sharing knowledge in a professional and acceptable manner
  - d. Demonstrates professional work ethic by separating work and personal social behaviors and acting accordingly
4. ***Self-Management: Assesses self accurately, sets personal goals, monitors progress, and exhibits self-control***
- a. Accepts personal strengths and weaknesses and uses the same for positive advancement
  - b. Demonstrates ability to continuously set, assess, choose, and modify objectives as the situation demands in an appropriate manner
  - c. Demonstrates ability to formulate and follow personal schedules
  - d. Demonstrates ability to wisely use classroom time
  - e. Demonstrates use of good study habits and skills
  - f. Demonstrates maturity to take responsibility for own actions
5. ***Integrity/Honesty: Chooses ethical courses of action***
- a. Knows and demonstrates ability to distinguish between positive and negative behaviors
  - b. Demonstrates honesty and integrity in working with peers and supervisors
  - c. Takes full responsibility for personal actions
  - d. Demonstrates understanding of consequences for negative ethical behaviors and accepts responsibility for same when applicable
  - e. Demonstrates positive work and social ethics in undertakings

## **Appropriate Reference Materials:**

---

1. MASTER Technical Modules:
  - AET-A1 through AET-A11;
  - AET-B1 through AET-B5;
  - AET-C1 through AET-C5;
  - AET-D1;
  - AET-E1 through AET-E13;
  - AET-F1;
  - AET-F3 through AET-F8;
  - AET-G1;
  - AET-H1;
  - AET-J2; and,
  - AETJ4 through AET-J5.
2. *Technical Mathematics with Calculus* by Peterson, Latest Edition

AET 100  
05/052698

# MASTER PROGRAM

## Teamwork Skills

### COURSE SYLLABUS

---

Total lecture hours: 0

Total lab hours: 3

Credit hours: 1

#### COURSE DESCRIPTION:

Covers the basic application of team problem solving concepts and the techniques required for effective performance as a member of a team in the business environment.

**PREREQUISITES:** Eligibility for College Reading Study Skills

#### COURSE OBJECTIVES:

After successful completion of this course, the student will be able to:

1. Recall the *six steps* of the problem-solving process, including:
  - a. Identifying the problem;
  - b. Analyzing the cause of the problem;
  - c. Creating options for solutions;
  - d. Selecting the best solution;
  - e. Implementing the solution;
  - f. Evaluating the success of the solution;
2. *Select* and *use* effective techniques to define, analyze and solve problems, including:
  - a. Brainstorming;
  - b. Clarifying;
  - c. Combining;
  - d. Consensus;
  - e. Force field analysis;
  - f. NGT;
  - g. Criteria rating;
  - h. Defining the problem;
  - i. Circle and define;
  - j. Cause and effect;
  - k. plan analysis;
  - l. Data gathering;
  - m. Flow charting;
  - n. Plan of work;
  - o. Evaluation procedure;
  - p. Process monitoring;

3. **Demonstrate** facilitation skills in team problem-solving situations, including:
  - a. Encouraging participation;
  - b. Modeling attentive listening;
  - c. Refocusing;
  - d. Paraphrasing;
  - e. Summarizing; and,
  - f. Charting during a meeting.

**REQUIRED COURSE MATERIALS:**

**Textbook:** *Team Handbook* by Ken Scholtes, Latest Edition  
**Lab Manual:** Teamwork Skills participant handout

**Materials:**

- One easel pad and stand for each 4–6 students
- One to two easel pad markers per group of 4–6 students.
- A designated issue for problem solving in class exercises

**METHODS OF INSTRUCTION:**

---

**Lecture:** Presentations will include lecture and demonstration.

**Laboratory:** Group problem solving practice and application on an issue designated by the class.

**Method of Evaluation:** A student's grade will be based on multiple measures of performance. The assessment will measure development of independent critical thinking skills and will include evaluation of the student's ability to:

1. Contribute to group problem solving;
2. Apply tools and techniques to problem solving;
3. Naintain integrity to the problem solving process; and
4. Keep all team members participating and focused when leading/facilitating the team.

**LAB OUTLINE:**

<b>Lab Topics</b>	<b>Contact Hrs.</b>
Group problem solving practice and application on an issue designated by the class	—
<b>Total Lab Hours</b>	<b>48</b>

## **COURSE OBJECTIVES: SCANS COMPETENCIES**

---

*The Secretary's Commission on Achieving Necessary Skills (SCANS), U.S. Department of Labor, has identified in its "AMERICA 2000 REPORT" that all students should develop a new set of competencies and foundation skills if they are to enjoy a productive, full and satisfying life. These are in addition to the Technical Workplace Competencies required by industry. SCANS is made up of five competencies and a three-part foundation of skills and personal qualities that are needed for solid job performance. All italicized headings in this section are direct quotations from "What Work Requires of Schools: A SCANS Report for America 2000."*

---

The following activities will be performed by each student for successful completion of this course:

### **I. COMPETENCIES**

- A. *Resources: Identifies, organizes, plans, and allocates resources***
  - 1. Allocates time to complete assigned tasks on schedule
  - 2. Determines and allocates required materials and resources for meeting objectives
  - 3. Evaluates skills, performance, and quality of work and provides feedback
- B. *Interpersonal: Works with others***
  - 1. Participates as a member of the team, contributing to group effort
  - 2. Provides individual assistance/direction to peers as requested
  - 3. Determines and meets expectations
  - 4. Exercises leadership qualities to effectively communicate ideas and make decisions.
  - 5. Negotiates resources in order to accomplish objectives
  - 6. Works well with all members of the class
- C. *Information: Acquires and uses information***
  - 1. Acquires and evaluates information
  - 2. Organizes and maintains information
  - 3. Interprets and communicates information
- D. *Systems: Understands complex inter-relationships***
  - 1. Understands and works well with social, organizational, and technological systems
  - 2. Monitors and corrects performance of system during operation
  - 3. Recommends modifications to system to improve performance
- E. *Technology: Works with a variety of technologies***
  - 1. Chooses relevant procedures, tools, and equipment
  - 2. Applies appropriate procedures and techniques to accomplish tasks



3. Identifies or solves problems to maintain equipment

## II. FOUNDATION SKILLS

- A. **Basic Skills:** Reads, writes, performs arithmetic and mathematical operations, listens and speaks
  1. *Reading: Locates, understands, and interprets written information in prose and in documents such as manuals, graphs, and schedules*
    - a. Demonstrates basic reading skills including abilities to perceive main ideas, draw appropriate conclusions, detect a sequence, locate answers, find facts, and infer from written texts
    - b. Demonstrates course specific reading skills including abilities to read, interpret, and comprehend information from text and supplemental materials on a level to facilitate productive independent and group study
    - c. Demonstrates ability to read, interpret, and utilize information from course specific instruments (i.e., charts, diagrams, graphs, schematics, blueprints, flow charts, etc.)
    - d. Demonstrates ability to read, interpret, and follow schedules and procedural instructions in a timely and appropriate manner
    - e. Demonstrates ability to choose and use most appropriate reading method (skim, scan, or read for comprehension) for materials
  2. *Writing: Communicates thoughts, ideas, information, and messages in writing; and creates documents such as letters, directions, manuals, reports, graphs, and flow charts*
    - a. Demonstrates basic writing skills including abilities to produce written documents which conform with accepted grammatical and communication standards required for effective daily functioning
    - b. Demonstrates effective written study skills including note taking, maintaining course specific journals, workbooks, manuals, etc.
    - c. Demonstrates technical writing skills in preparing outlines, summaries, time lines, flow charts, diagrams, etc. appropriate to materials covered
    - d. Demonstrates ability to complete all required writings in a timely, complete, and professional manner
    - e. Demonstrates competence in subject matter through the organization and presentation of answers to required written assessments

3. ***Arithmetic/Mathematics: Perform basic computations and approaches practical problems by choosing appropriately from a variety of mathematical techniques***
  - a. Demonstrates proficiency in basic arithmetic functions including ability to add, subtract, multiply, and divide whole numbers, fractions, decimals, and percentages
  - b. Demonstrates ability to read, comprehend, and select appropriate math procedures to work basic math problems
  - c. Demonstrates ability to understand and perform multi-step computations
  - d. Demonstrates ability to read, interpret, and use standard measuring devices
  - e. Demonstrates ability to comprehend, retain, and utilize course specific measuring devices effectively
  - f. Demonstrates ability to understand, retain, and utilize higher mathematical formulas and functions required for course specific math performance
  - g. Demonstrates ability to appropriately transfer mathematical calculations and information from paper to machines
4. ***Listening: Receives, attends to, interprets, and responds to verbal messages and other cues***
  - a. Functions at minimal or above required hearing levels to receive, attend, interpret, and respond to verbal messages and instructions and to safely operate machinery
  - b. Demonstrates ability to hear, comprehend, and appropriately follow directions
  - c. Demonstrates auditory ability to hear, comprehend, and utilize verbal classroom as well as other auditory instruction
  - d. Demonstrates ability to discriminate between essential and non-essential verbal information and react appropriately
  - e. Demonstrates ability to focus and fine-tune listening skills to receive, interpret, and respond to various sounds
  - f. Demonstrates ability and maturity to seek and receive additional individualized instruction as needed
5. ***Speaking: Organizes ideas and communicates orally***
  - a. Demonstrates appropriate listening and speaking skills in personal conversations
  - b. Demonstrates ability to choose and organize appropriate words to effectively communicate

- c. Demonstrates ability to speak clearly and distinctly with appropriate volume, tone, and body language for situation
  - d. Demonstrates ability to spontaneously organize and present appropriate answers and/or short presentations for classroom and /or assessment purposes
  - e. Demonstrates ability to formulate, organize, and deliver major presentations to peers or groups
  - f. Demonstrates ability to speak effectively in one-on-one, small group, or large group presentations
  - g. Demonstrates ability to take responsibility for presentations
- B. Thinking Skills:** Thinks creatively, makes decisions, solves problems, visualizes, knows how to learn and reasons
1. *Decision Making: Specifies goals and constraints, generates alternatives, considers risks, and evaluates and chooses best alternative*
    - a. Demonstrates ability to objectively assess personal strengths and weaknesses
    - b. Demonstrates ability to set realistic short-term and long-term goals
    - c. Demonstrates ability to recognize and distinguish between positive and negative alternatives
    - d. Demonstrates ability to identify potential pitfalls and take evasive actions
    - e. Demonstrates ability to objectively and responsibly evaluate alternatives by testing hypotheses and selecting most appropriate response
    - f. Demonstrates ability to profit from negative evaluations or mistakes by reformulating, redirecting, reconstructing, or retesting alternatives
    - g. Demonstrates maturity in taking responsibility for decisions
  2. *Problem Solving: Recognizes problems and devises and implements plan of action*
    - a. Demonstrates ability to detect problem through observation, inquiry, or directive
    - b. Demonstrates ability to grasp appropriate overview and degree of seriousness of problem and to behave responsibly in situation
    - c. Demonstrates ability to generate alternatives or options for problem solution
    - d. Demonstrates ability to research options, assess and evaluate options, and determine appropriate and best solution

- e. Demonstrates ability to initiate and effect solution
  - f. Demonstrates ability to take responsibility for outcomes
  - g. Demonstrates ability to effectively problem solve in individual, team, or group situations
3. *Seeing Things In the Mind's Eye: Organizes, and processes symbols, pictures, graphs, objects, and other information*
- a. Functions at minimum or above required visual levels in order to see, interpret, attend and respond to visual imagery and meet safety requirements for necessary machinery
  - b. Demonstrates ability to read, interpret, and act upon signs, symbols, and other visual cues
  - c. Demonstrates ability to visually discriminate in gross and fine imagery
  - d. Demonstrates ability to visualize abstractly
  - e. Demonstrates ability to apply visual imagery to applied tasks
4. *Knowing How to Learn: Use efficient learning techniques to acquire and apply new knowledge and skills*
- a. Demonstrates mastery of basic reading, math, and language skills through application
  - b. Demonstrates ability to translate abstract theory into practical application
  - c. Demonstrates ability to incorporate and generalize new learning into a sequential learning process
  - d. Demonstrates knowledge of good study skills and learning habits
5. *Reasoning: Discovers a rule or principle underlying the relationship between two or more objects and applies it when solving a problem*
- a. Demonstrates use of simple logic
  - b. Demonstrates ability to distinguish relationships
  - c. Demonstrates ability to determine and isolate factors in relationships
  - d. Demonstrates and applies knowledge through practice
  - e. Recognizes that attitudes, skills, and practice are essential to productivity
  - f. Demonstrates ability to discriminate between positive and negative, and act accordingly
- C. **Personal Qualities:** Displays responsibility, self-esteem, sociability, self-management, and integrity and honesty
1. *Responsibility: Exerts a high level of effort and perseveres towards goal attainment*

- a. Demonstrates ability to formulate realistic and useful short and long term goals and complete steps necessary to timely achieve goals
  - b. Demonstrates ability to make adjustments, revisions, and changes to achieve goals in a cooperative and polite manner
  - c. Demonstrates ability to focus on task at hand and work to completion
  - d. Demonstrates good work ethics through regular attendance, adequate classroom preparations, and appropriate use of classroom time
  - e. Demonstrates maturity to take responsibility for actions
  - f. Demonstrates ability to cooperatively work in individual, team, and group situations in timely and effective manner
2. *Self-Esteem: Believes in own self-worth and maintains a positive view of self*
- a. Presents a positive attitude toward tasks
  - b. Demonstrates ability to separate work and personal behaviors
  - c. Actively participates in learning opportunities by sharing knowledge and skills with peers and instructors
  - d. Demonstrates ability to accept personal strengths and weaknesses and builds on positive behaviors
  - e. Demonstrates ability to accept and use constructive criticism
  - f. Accepts positive reinforcement in an appropriate manner
3. *Sociability: Demonstrates understanding, friendliness, adaptability, empathy, and politeness in group settings*
- a. Demonstrates appropriate and acceptable social behaviors in interactions
  - b. Demonstrates ability to work cooperatively in individual, team, or group situations
  - c. Demonstrates active interest in peers by offering assistance, sharing resources, and sharing knowledge in a professional and acceptable manner
  - d. Demonstrates professional work ethic by separating work and personal social behaviors and acting accordingly
4. *Self-Management: Assesses self accurately, sets personal goals, monitors progress, and exhibits self-control*
- a. Accepts personal strengths and weaknesses and uses the same for positive advancement

- b. Demonstrates ability to continuously set, assess, choose, and modify objectives as the situation demands in an appropriate manner
  - c. Demonstrates ability to formulate and follow personal schedules
  - d. Demonstrates ability to wisely use classroom time
  - e. Demonstrates use of good study habits and skills
  - f. Demonstrates maturity to take responsibility for own actions
5. ***Integrity/Honesty: Chooses ethical courses of action***
- a. Knows and demonstrates ability to distinguish between positive and negative behaviors
  - b. Demonstrates honesty and integrity in working with peers and supervisors
  - c. Takes full responsibility for personal actions
  - d. Demonstrates understanding of consequences for negative ethical behaviors and accepts responsibility for same when applicable
  - e. Demonstrates positive work and social ethics in undertakings

**Appropriate Reference Materials:**

---

1. MASTER Technical Modules:  
AET-D1;  
AET-G2 through AET-G4;  
AET-H1;  
AET-J1 through AET-J2; and,  
AET-J4 through AET-J5.
2. *The Rational Manager* by Charles Kepner and Benjamin Tregoe, Latest Edition
3. *The Team Handbook* by Ken Scholtes, Latest Edition
4. *Proactive Manager*, Latest Edition

AET 101  
05/052698

# MASTER PROGRAM

## Print Reading And Symbology

### COURSE SYLLABUS

---

**Total lecture hours: 48**

**Total lab hours: 0**

**Credit hours: 3**

#### **COURSE DESCRIPTION:**

Introduces the symbols and engineering notations used for mechanical, electrical, electronic, hydraulic, and pneumatic drawings. Representative drawings are used to demonstrate concepts and to practice interpreting the symbols and notations. Students view and handle typical parts represented by the symbols.

**PREREQUISITES:**                      **Concurrent enrollment in Manufacturing Metrics and Calculations, or equivalent**

#### **COURSE OBJECTIVES:**

After successful completion of this course the student will:

1. Use the symbols and organization associated with mechanical drawings to identify features of the part from the drawing, the part's dimensions, and the tolerance of the part's features, on both standard and Geometric Dimensioning drawings;
2. Use the symbols and organization associated with electrical ladder diagrams, or electronic schematic diagrams and electrical/electronic layout diagrams to identify components by their symbol, determine the location of the components, and apply engineering values obtained from the drawing to the solution of technical problems; and,
3. Use the symbols and organization associated with fluid power schematic diagrams, and fluid power layout diagrams, to identify components by their symbol, determine the location of the components, and apply engineering values obtained from the drawing to the solution of technical problems.

#### **REQUIRED COURSE MATERIALS:**

**Textbook:**                      An example of an appropriate text would be a text based upon the most current American National Standards Institute (ANSI) and/or International Standards Organization (ISO) specifications for drawing symbols and engineering notation.

**Lab Manual:**                      None



## METHODS OF INSTRUCTION:

**Lecture:** Presentations will include lecture, demonstration, and group problem solving.

**Method of Evaluation:** A student's grade will be based on multiple measures of performance. The assessment will measure development of independent critical thinking skills and will include evaluation of the student's ability to:

1. Perform on written or oral examinations;
2. Perform on outside assignments;
3. Contribute to group problem solving;
4. Apply theory to problem solving; and,
5. Maintain attendance per current policy.

## LECTURE OUTLINE:

<u>Lecture Topics</u>	<u>Contact Hrs.</u>
<b>Mechanical Drawing Symbols</b>	
A. Mechanical drawing symbols	
B. Engineering notation used in mechanical drawings	
C. Examples of mechanical parts that relate to the symbols used	
D. Tolerancing	
E. Geometric Dimensioning and Tolerancing	
F. Application of engineering values	
<b>Electrical Drawings</b>	
A. Electrical drawing symbols	
B. Engineering notation used in electrical drawings	
C. Examples of electrical parts that relate to the symbols used	
D. Ladder diagram organization	
E. Application of engineering values	
<b>Electronic Drawing</b>	
A. Electronic drawing symbols	
B. Engineering notation used in electronic drawings	
C. Examples of electronic parts that relate to the symbols used	
D. Organization of electronic schematics and specifications	
E. Application of engineering values	
<b>Hydraulic and Pneumatic Drawings</b>	
A. Hydraulic and pneumatic drawing symbols	
B. Engineering notation used in hydraulic and pneumatic drawings	



- C. Examples of hydraulic and pneumatic parts that relate to the symbols used
  - D. Organization of hydraulic and pneumatic drawings and specifications
  - E. Application of engineering values
- National and International Standards Organizations**      —  
**Total Lecture Hours**      48

**COURSE OBJECTIVES: SCANS COMPETENCIES**

*The Secretary’s Commission on Achieving Necessary Skills (SCANS), U.S. Department of Labor, has identified in its “AMERICA 2000 REPORT” that all students should develop a new set of competencies and foundation skills if they are to enjoy a productive, full and satisfying life. These are in addition to the Technical Workplace Competencies required by industry. SCANS is made up of five competencies and a three-part foundation of skills and personal qualities that are needed for solid job performance. All italicized headings in this section are direct quotations from “What Work Requires of Schools: A SCANS Report for America 2000.”*

The following activities will be performed by each student for successful completion of this course:

**I. COMPETENCIES**

- A. *Resources: Identifies, organizes, plans, and allocates resources***
  - 1. Allocates time to complete assigned tasks on schedule
  - 2. Determines and allocates required materials and resources for meeting objectives
  - 3. Evaluates skills, performance, and quality of work and provides feedback
- B. *Interpersonal: Works with others***
  - 1. Participates as a member of the team, contributing to group effort
  - 2. Provides individual assistance/direction to peers as requested
  - 3. Determines and meets expectations
  - 4. Exercises leadership qualities to effectively communicate ideas and make decisions.
  - 5. Negotiates resources in order to accomplish objectives
  - 6. Works well with all members of the class
- C. *Information: Acquires and uses information***
  - 1. Acquires and evaluates information
  - 2. Organizes and maintains information
  - 3. Interprets and communicates information
- D. *Systems: Understands complex inter-relationships***

1. Understands and works well with social, organizational, and technological systems
  2. Monitors and corrects performance of system during operation
  3. Recommends modifications to system to improve performance
- E. *Technology: Works with a variety of technologies***
1. Chooses relevant procedures, tools, and equipment
  2. Applies appropriate procedures and techniques to accomplish tasks
  3. Identifies or solves problems to maintain equipment

## II. FOUNDATION SKILLS

- A. Basic Skills: Reads, writes, performs arithmetic and mathematical operations, listens and speaks**
1. ***Reading: Locates, understands, and interprets written information in prose and in documents such as manuals, graphs, and schedules***
    - a. Demonstrates basic reading skills including abilities to perceive main ideas, draw appropriate conclusions, detect a sequence, locate answers, find facts, and infer from written texts
    - b. Demonstrates course specific reading skills including abilities to read, interpret, and comprehend information from text and supplemental materials on a level to facilitate productive independent and group study
    - c. Demonstrates ability to read, interpret, and utilize information from course specific instruments (i.e., charts, diagrams, graphs, schematics, blueprints, flow charts, etc.)
    - d. Demonstrates ability to read, interpret, and follow schedules and procedural instructions in a timely and appropriate manner
    - e. Demonstrates ability to choose and use most appropriate reading method (skim, scan, or read for comprehension) for materials
  2. ***Writing: Communicates thoughts, ideas, information, and messages in writing; and creates documents such as letters, directions, manuals, reports, graphs, and flow charts***
    - a. Demonstrates basic writing skills including abilities to produce written documents which conform with accepted grammatical and communication standards required for effective daily functioning
    - b. Demonstrates effective written study skills including note taking, maintaining course specific journals, workbooks, manuals, etc.

- c. Demonstrates technical writing skills in preparing outlines, summaries, time lines, flow charts, diagrams, etc. appropriate to materials covered
  - d. Demonstrates ability to complete all required writings in a timely, complete, and professional manner
  - e. Demonstrates competence in subject matter through the organization and presentation of answers to required written assessments
3. ***Arithmetic/Mathematics: Perform basic computations and approaches practical problems by choosing appropriately from a variety of mathematical techniques***
- a. Demonstrates proficiency in basic arithmetic functions including ability to add, subtract, multiply, and divide whole numbers, fractions, decimals, and percentages
  - b. Demonstrates ability to read, comprehend, and select appropriate math procedures to work basic math problems
  - c. Demonstrates ability to understand and perform multi-step computations
  - d. Demonstrates ability to read, interpret, and use standard measuring devices
  - e. Demonstrates ability to comprehend, retain, and utilize course specific measuring devices effectively
  - f. Demonstrates ability to understand, retain, and utilize higher mathematical formulas and functions required for course specific math performance
  - g. Demonstrates ability to appropriately transfer mathematical calculations and information from paper to machines
4. ***Listening: Receives, attends to, interprets, and responds to verbal messages and other cues***
- a. Functions at minimal or above required hearing levels to receive, attend, interpret, and respond to verbal messages and instructions and to safely operate machinery
  - b. Demonstrates ability to hear, comprehend, and appropriately follow directions
  - c. Demonstrates auditory ability to hear, comprehend, and utilize verbal classroom as well as other auditory instruction
  - d. Demonstrates ability to discriminate between essential and non-essential verbal information and react appropriately
  - e. Demonstrates ability to focus and fine-tune listening skills to receive, interpret, and respond to various sounds

- f. Demonstrates ability and maturity to seek and receive additional individualized instruction as needed
5. **Speaking: Organizes ideas and communicates orally**
- a. Demonstrates appropriate listening and speaking skills in personal conversations
  - b. Demonstrates ability to choose and organize appropriate words to effectively communicate
  - c. Demonstrates ability to speak clearly and distinctly with appropriate volume, tone, and body language for situation
  - d. Demonstrates ability to spontaneously organize and present appropriate answers and/or short presentations for classroom and /or assessment purposes
  - e. Demonstrates ability to formulate, organize, and deliver major presentations to peers or groups
  - f. Demonstrates ability to speak effectively in one-on-one, small group, or large group presentations
  - g. Demonstrates ability to take responsibility for presentations
- B. **Thinking Skills: Thinks creatively, makes decisions, solves problems, visualizes, knows how to learn and reasons**
1. **Decision Making: Specifies goals and constraints, generates alternatives, considers risks, and evaluates and chooses best alternative**
- a. Demonstrates ability to objectively assess personal strengths and weaknesses
  - b. Demonstrates ability to set realistic short-term and long-term goals
  - c. Demonstrates ability to recognize and distinguish between positive and negative alternatives
  - d. Demonstrates ability to identify potential pitfalls and take evasive actions
  - e. Demonstrates ability to objectively and responsibly evaluate alternatives by testing hypotheses and selecting most appropriate response
  - f. Demonstrates ability to profit from negative evaluations or mistakes by reformulating, redirecting, reconstructing, or retesting alternatives
  - g. Demonstrates maturity in taking responsibility for decisions
2. **Problem Solving: Recognizes problems and devises and implements plan of action**
- a. Demonstrates ability to detect problem through observation, inquiry, or directive

- b. Demonstrates ability to grasp appropriate overview and degree of seriousness of problem and to behave responsibly in situation
  - c. Demonstrates ability to generate alternatives or options for problem solution
  - d. Demonstrates ability to research options, assess and evaluate options, and determine appropriate and best solution
  - e. Demonstrates ability to initiate and effect solution
  - f. Demonstrates ability to take responsibility for outcomes
  - g. Demonstrates ability to effectively problem solve in individual, team, or group situations
3. ***Seeing Things In the Mind's Eye: Organizes, and processes symbols, pictures, graphs, objects, and other information***
- a. Functions at minimum or above required visual levels in order to see, interpret, attend and respond to visual imagery and meet safety requirements for necessary machinery
  - b. Demonstrates ability to read, interpret, and act upon signs, symbols, and other visual cues
  - c. Demonstrates ability to visually discriminate in gross and fine imagery
  - d. Demonstrates ability to visualize abstractly
  - e. Demonstrates ability to apply visual imagery to applied tasks
4. ***Knowing How to Learn: Use efficient learning techniques to acquire and apply new knowledge and skills***
- a. Demonstrates mastery of basic reading, math, and language skills through application
  - b. Demonstrates ability to translate abstract theory into practical application
  - c. Demonstrates ability to incorporate and generalize new learning into a sequential learning process
  - d. Demonstrates knowledge of good study skills and learning habits
5. ***Reasoning: Discovers a rule or principle underlying the relationship between two or more objects and applies it when solving a problem***
- a. Demonstrates use of simple logic
  - b. Demonstrates ability to distinguish relationships
  - c. Demonstrates ability to determine and isolate factors in relationships
  - d. Demonstrates and applies knowledge through practice

- e. Recognizes that attitudes, skills, and practice are essential to productivity
  - f. Demonstrates ability to discriminate between positive and negative, and act accordingly
- C. **Personal Qualities:** Displays responsibility, self-esteem, sociability, self-management, and integrity and honesty
1. **Responsibility:** *Exerts a high level of effort and perseveres towards goal attainment*
    - a. Demonstrates ability to formulate realistic and useful short and long term goals and complete steps necessary to timely achieve goals
    - b. Demonstrates ability to make adjustments, revisions, and changes to achieve goals in a cooperative and polite manner
    - c. Demonstrates ability to focus on task at hand and work to completion
    - d. Demonstrates good work ethics through regular attendance, adequate classroom preparations, and appropriate use of classroom time
    - e. Demonstrates maturity to take responsibility for actions
    - f. Demonstrates ability to cooperatively work in individual, team, and group situations in timely and effective manner
  2. **Self-Esteem:** *Believes in own self-worth and maintains a positive view of self*
    - a. Presents a positive attitude toward tasks
    - b. Demonstrates ability to separate work and personal behaviors
    - c. Actively participates in learning opportunities by sharing knowledge and skills with peers and instructors
    - d. Demonstrates ability to accept personal strengths and weaknesses and builds on positive behaviors
    - e. Demonstrates ability to accept and use constructive criticism
    - f. Accepts positive reinforcement in an appropriate manner
  3. **Sociability:** *Demonstrates understanding, friendliness, adaptability, empathy, and politeness in group settings*
    - a. Demonstrates appropriate and acceptable social behaviors in interactions
    - b. Demonstrates ability to work cooperatively in individual, team, or group situations
    - c. Demonstrates active interest in peers by offering assistance, sharing resources, and sharing knowledge in a professional and acceptable manner

- d. Demonstrates professional work ethic by separating work and personal social behaviors and acting accordingly
- 4. ***Self-Management: Assesses self accurately, sets personal goals, monitors progress, and exhibits self-control***
  - a. Accepts personal strengths and weaknesses and uses the same for positive advancement
  - b. Demonstrates ability to continuously set, assess, choose, and modify objectives as the situation demands in an appropriate manner
  - c. Demonstrates ability to formulate and follow personal schedules
  - d. Demonstrates ability to wisely use classroom time
  - e. Demonstrates use of good study habits and skills
  - f. Demonstrates maturity to take responsibility for own actions
- 5. ***Integrity/Honesty: Chooses ethical courses of action***
  - a. Knows and demonstrates ability to distinguish between positive and negative behaviors
  - b. Demonstrates honesty and integrity in working with peers and supervisors
  - c. Takes full responsibility for personal actions
  - d. Demonstrates understanding of consequences for negative ethical behaviors and accepts responsibility for same when applicable
  - e. Demonstrates positive work and social ethics in undertakings

### **Appropriate Reference Materials:**

---

- 1. MASTER Technical Modules:  
AET-A1 through AET-A2;  
AET-B1 through AET-B5;  
AET-C1 through AET-C5;  
AET-D1;  
AET-E1 through AET-E-13;  
AET-F1 through AET-F8;  
AET-G2 through AET-G3;  
AET-H1; and,  
AET-J1 through AET-J5.
- 2. *Print Reading for Industry* by Brown, Latest Edition

AET 102  
05/052698



# MASTER PROGRAM

## Manufacturing Processes COURSE SYLLABUS

---

Total lecture hours: 48

Total lab hours: 48

Credits: 4

### COURSE DESCRIPTION:

Surveys physical and chemical processes used to manufacture products. This course is designed to provide students who plan to pursue a career in automated manufacturing with the skills that will enable the student to test automated manufacturing processes and to encourage the further pursuit of training in physics and chemistry. The course explores the principles of physics and chemistry that underlie technologies used in industry such as machine technology, vacuum technology, heat treating technology, hydraulic and pneumatic technology, and electro-chemical manufacturing processes. The student will employ formulas and the New Metric (S.I.) (mks) system of measurement to solve problems relating to industrial processes.

### PREREQUISITES:

**Manufacturing Metrics and Calculations,  
concurrent enrollment or equivalent.**

### COURSE OBJECTIVES:

After successful completion of this course, the student will:

1. Use the rules of mathematics, algebra and trigonometry, and the theories and formulas found in the study of mechanical physics to calculate simple vectored forces;
2. Apply the rules of measuring systems in both the English and SI systems of measurement to calculate and convert quantities in both systems;
3. Use the rules of mathematics and the theories and formulas found in the study of mechanical physics to understand and calculate the effects on industrial machinery of the following: inertia, force, velocity, momentum, friction, and impulse momentum;
4. Use the rules of mathematics and the theories and formulas found in the study of gases and fluids to understand and calculate the effects on industrial machinery of the following properties of matter: Pascal's Law, Charles' and Bolve's Law (Ideal Gas Law), Bernoulli's Principle, pressure, flow, density, specific gravity, evaporation, sublimation, condensation, humidity, and relative humidity;

5. Use the rules of mathematics and the theories and formulas found in the study of high pressure and high vacuum systems, to calculate and convert pressures in various pressure systems, including psi (vacuum), psig, psia, inches of water, inches of mercury, bar (absolute), bar (atmospheric), SI system (Pascal's and kilopascals), and the torr system;
6. Use the rules of mathematics and the theories and formulas found in the study of thermodynamics to understand, calculate, and convert quantities found in industrial heat treating equipment such as temperature, scales, kilocalories, British Thermal Units, specific heat, thermal conductivity, expansion and contraction of solids, simple engines, and entropy;
7. Use the rules of mathematics and the theories and formulas found in the study of chemistry to calculate the proportions of chemicals used to produce various mixtures;
8. Use the rules and procedures found in the concepts of valence, ionization, the periodic table, chemical reaction formulas, and catalysts, to determine the types of elements that are used to obtain a given compound, whether the reaction is a producer of energy or needs energy to occur, and whether or not the reaction needs catalyst to occur;
9. Demonstrate the properties of pure water, deionized water, and water with various compounds in solution;
10. Perform physical and chemical experiments or tests on actual industrial systems;
11. Demonstrate the electro-chemical effect and its usage in batteries, industrial plating, chemical milling, and semi-conductor fabrication;
12. Demonstrate the procedures used to deionize water and produce chemically pure water; and,
13. Demonstrate the procedures used in the manufacture of industrial chemicals.

#### REQUIRED COURSE MATERIALS:

**Textbook:**            *Physics for Career Education*, by Ewen/Nelson/Schurter,  
 Latest Edition; and,  
*Chemistry Principles and Reactions*, by Masterton/Hurley,  
 Latest Edition

**Lab Manual:**        None

#### Materials:

Paper  
 Notebooks  
 Compass  
 Protractor  
 Ruler  
 Protective laboratory apron  
 Safety glasses

Scientific calculator  
Scantron examination sheets

### METHODS OF INSTRUCTION:

---

**Lecture:** Presentations will include lecture, video, and group problem solving.

**Laboratory:** Laboratory will be hands-on measurements of physical and chemical manufacturing processes.

**Method of Evaluation:** A student's grade will be based on multiple measures of performance. The assessment will measure development of independent critical thinking skills and will include evaluation of the student's ability to:

1. Perform on written or oral examinations;
2. Perform on outside assignments;
3. Contribute to group problem solving;
4. Apply theory to problem solving; and,
5. Maintain attendance per current policy.

### LECTURE OUTLINE:

---

#### Lecture Topics

#### Contact Hrs.

---

#### **Machine Technology**

- A. Rules of mechanics
- B. Work power and energy
- C. Simple machines
- D. Complex machines
- E. Rotational forces

#### **Thermal Technology**

- A. Materials
- B. Heat energy
- C. Heat transfer
- D. Thermodynamics

#### **Hydraulic and Pneumatic Technology**

- A. Force, pressure and flow
- B. Measuring scales
- C. Venturi
- D. Laws of fluid dynamics

#### **Atomic Structure**

- A. Valance
- B. Elements
- C. The periodic table

- D. Mixtures
- E. Compounds
- F. Mixing formulas

**Chemical Formulas**

- A. Endothermic and exothermic reactions
- B. Catalysts
- C. Electrochemistry
- D. Water, the universal solvent
- E. Material safety data sheets (OSHA)

**Vacuum Technology**

- A. Behavior of gasses
- B. Nature of vacuum
- C. Vacuum pumping system
- D. Vacuum instrumentation

Total Lecture Hours     48

**LAB OUTLINE:**

Lab Topic	Contact Hrs.
<b>Construct and Measure Simple Machines</b>	
A. Levers	
B. Gears	
C. Ramps	
D. Pulleys	
E. Rotational Machines (Bicycle)	
<b>Analyze and Measure a Complex Machine Such as a Mill or Lathe Axis</b>	
A. Identify Simple Machines	
B. Create a Theoretical Model of Complex Machine	
C. Measure Machine	
D. Analyze Results	
<b>Heat Treating</b>	
A. Test and Measure Thermocouples	
B. Test and Measure Resistance Temperature Devices (RTD)	
C. Create Theoretical Model of Heat Treating Oven	
D. Solve Mathematical Problems in Model	
<b>Hydraulic and Pneumatic Technology</b>	
A. Construct and Measure Hydraulic Circuits	
B. Construct and Measure Pneumatic Circuits	
C. Construct and Measure Venturi	
<b>Vacuum Technology</b>	
A. Construct Vacuum Circuits and Measure Properties	
B. Practice Safe Procedures for High Vacuum Equipment	

C. Use High Vacuum Measurement Equipment

**Chemical Technology**

- A. Measure Electrical Properties of Distilled Water
- B. Measure Electrical Properties of Tap Water
- C. Apply Mixing Formulas to Create Solutions and Mixtures
- D. Measure Electrical Properties of Distilled Water With Measured Amounts of Acids and Bases
- E. Create Chemical Reactions and Measure Results

—  
**Total Lab Hours**      **48**

---

**COURSE OBJECTIVES: SCANS COMPETENCIES**

---

*The Secretary's Commission on Achieving Necessary Skills (SCANS), U.S. Department of Labor, has identified in its "AMERICA 2000 REPORT" that all students should develop a new set of competencies and foundation skills if they are to enjoy a productive, full and satisfying life. These are in addition to the Technical Workplace Competencies required by industry. SCANS is made up of five competencies and a three-part foundation of skills and personal qualities that are needed for solid job performance. All italicized headings in this section are direct quotations from "What Work Requires of Schools: A SCANS Report for America 2000."*

---

The following activities will be performed by each student for successful completion of this course:

**I. COMPETENCIES**

- A. *Resources: Identifies, organizes, plans, and allocates resources*
  - 1. Allocates time to complete assigned tasks on schedule
  - 2. Determines and allocates required materials and resources for meeting objectives
  - 3. Evaluates skills, performance, and quality of work and provides feedback
- B. *Interpersonal: Works with others*
  - 1. Participates as a member of the team, contributing to group effort
  - 2. Provides individual assistance/direction to peers as requested
  - 3. Determines and meets expectations
  - 4. Exercises leadership qualities to effectively communicate ideas and make decisions.
  - 5. Negotiates resources in order to accomplish objectives
  - 6. Works well with all members of the class
- C. *Information: Acquires and uses information*

1. Acquires and evaluates information
  2. Organizes and maintains information
  3. Interprets and communicates information
- D. *Systems: Understands complex inter-relationships***
1. Understands and works well with social, organizational, and technological systems
  2. Monitors and corrects performance of system during operation
  3. Recommends modifications to system to improve performance
- E. *Technology: Works with a variety of technologies***
1. Chooses relevant procedures, tools, and equipment
  2. Applies appropriate procedures and techniques to accomplish tasks
  3. Identifies or solves problems to maintain equipment

## II. FOUNDATION SKILLS

- A. *Basic Skills: Reads, writes, performs arithmetic and mathematical operations, listens and speaks***
1. ***Reading: Locates, understands, and interprets written information in prose and in documents such as manuals, graphs, and schedules***
    - a. Demonstrates basic reading skills including abilities to perceive main ideas, draw appropriate conclusions, detect a sequence, locate answers, find facts, and infer from written texts
    - b. Demonstrates course specific reading skills including abilities to read, interpret, and comprehend information from text and supplemental materials on a level to facilitate productive independent and group study
    - c. Demonstrates ability to read, interpret, and utilize information from course specific instruments (i.e., charts, diagrams, graphs, schematics, blueprints, flow charts, etc.)
    - d. Demonstrates ability to read, interpret, and follow schedules and procedural instructions in a timely and appropriate manner
    - e. Demonstrates ability to choose and use most appropriate reading method (skim, scan, or read for comprehension) for materials
  2. ***Writing: Communicates thoughts, ideas, information, and messages in writing; and creates documents such as letters, directions, manuals, reports, graphs, and flow charts***
    - a. Demonstrates basic writing skills including abilities to produce written documents which conform with accepted

- grammatical and communication standards required for effective daily functioning
- b. Demonstrates effective written study skills including note taking, maintaining course specific journals, workbooks, manuals, etc.
  - c. Demonstrates technical writing skills in preparing outlines, summaries, time lines, flow charts, diagrams, etc. appropriate to materials covered
  - d. Demonstrates ability to complete all required writings in a timely, complete, and professional manner
  - e. Demonstrates competence in subject matter through the organization and presentation of answers to required written assessments
3. *Arithmetic/Mathematics: Perform basic computations and approaches practical problems by choosing appropriately from a variety of mathematical techniques*
- a. Demonstrates proficiency in basic arithmetic functions including ability to add, subtract, multiply, and divide whole numbers, fractions, decimals, and percentages
  - b. Demonstrates ability to read, comprehend, and select appropriate math procedures to work basic math problems
  - c. Demonstrates ability to understand and perform multi-step computations
  - d. Demonstrates ability to read, interpret, and use standard measuring devices
  - e. Demonstrates ability to comprehend, retain, and utilize course specific measuring devices effectively
  - f. Demonstrates ability to understand, retain, and utilize higher mathematical formulas and functions required for course specific math performance
  - g. Demonstrates ability to appropriately transfer mathematical calculations and information from paper to machines
4. *Listening: Receives, attends to, interprets, and responds to verbal messages and other cues*
- a. Functions at minimal or above required hearing levels to receive, attend, interpret, and respond to verbal messages and instructions and to safely operate machinery
  - b. Demonstrates ability to hear, comprehend, and appropriately follow directions
  - c. Demonstrates auditory ability to hear, comprehend, and utilize verbal classroom as well as other auditory instruction



- d. Demonstrates ability to discriminate between essential and non-essential verbal information and react appropriately
  - e. Demonstrates ability to focus and fine-tune listening skills to receive, interpret, and respond to various sounds
  - f. Demonstrates ability and maturity to seek and receive additional individualized instruction as needed
5. **Speaking:** *Organizes ideas and communicates orally*
- a. Demonstrates appropriate listening and speaking skills in personal conversations
  - b. Demonstrates ability to choose and organize appropriate words to effectively communicate
  - c. Demonstrates ability to speak clearly and distinctly with appropriate volume, tone, and body language for situation
  - d. Demonstrates ability to spontaneously organize and present appropriate answers and/or short presentations for classroom and /or assessment purposes
  - e. Demonstrates ability to formulate, organize, and deliver major presentations to peers or groups
  - f. Demonstrates ability to speak effectively in one-on-one, small group, or large group presentations
  - g. Demonstrates ability to take responsibility for presentations
- B. Thinking Skills:** Thinks creatively, makes decisions, solves problems, visualizes, knows how to learn and reasons
1. **Decision Making:** *Specifies goals and constraints, generates alternatives, considers risks, and evaluates and chooses best alternative*
- a. Demonstrates ability to objectively assess personal strengths and weaknesses
  - b. Demonstrates ability to set realistic short-term and long-term goals
  - c. Demonstrates ability to recognize and distinguish between positive and negative alternatives
  - d. Demonstrates ability to identify potential pitfalls and take evasive actions
  - e. Demonstrates ability to objectively and responsibly evaluate alternatives by testing hypotheses and selecting most appropriate response
  - f. Demonstrates ability to profit from negative evaluations or mistakes by reformulating, redirecting, reconstructing, or retesting alternatives
  - g. Demonstrates maturity in taking responsibility for decisions

2. ***Problem Solving: Recognizes problems and devises and implements plan of action***
  - a. Demonstrates ability to detect problem through observation, inquiry, or directive
  - b. Demonstrates ability to grasp appropriate overview and degree of seriousness of problem and to behave responsibly in situation
  - c. Demonstrates ability to generate alternatives or options for problem solution
  - d. Demonstrates ability to research options, assess and evaluate options, and determine appropriate and best solution
  - e. Demonstrates ability to initiate and effect solution
  - f. Demonstrates ability to take responsibility for outcomes
  - g. Demonstrates ability to effectively problem solve in individual, team, or group situations
3. ***Seeing Things In the Mind's Eye: Organizes, and processes symbols, pictures, graphs, objects, and other information***
  - a. Functions at minimum or above required visual levels in order to see, interpret, attend and respond to visual imagery and meet safety requirements for necessary machinery
  - b. Demonstrates ability to read, interpret, and act upon signs, symbols, and other visual cues
  - c. Demonstrates ability to visually discriminate in gross and fine imagery
  - d. Demonstrates ability to visualize abstractly
  - e. Demonstrates ability to apply visual imagery to applied tasks
4. ***Knowing How to Learn: Use efficient learning techniques to acquire and apply new knowledge and skills***
  - a. Demonstrates mastery of basic reading, math, and language skills through application
  - b. Demonstrates ability to translate abstract theory into practical application
  - c. Demonstrates ability to incorporate and generalize new learning into a sequential learning process
  - d. Demonstrates knowledge of good study skills and learning habits
5. ***Reasoning: Discovers a rule or principle underlying the relationship between two or more objects and applies it when solving a problem***
  - a. Demonstrates use of simple logic
  - b. Demonstrates ability to distinguish relationships

- c. Demonstrates ability to determine and isolate factors in relationships
  - d. Demonstrates and applies knowledge through practice
  - e. Recognizes that attitudes, skills, and practice are essential to productivity
  - f. Demonstrates ability to discriminate between positive and negative, and act accordingly
- C. **Personal Qualities:** Displays responsibility, self-esteem, sociability, self-management, and integrity and honesty
1. **Responsibility:** *Exerts a high level of effort and perseveres towards goal attainment*
    - a. Demonstrates ability to formulate realistic and useful short and long term goals and complete steps necessary to timely achieve goals
    - b. Demonstrates ability to make adjustments, revisions, and changes to achieve goals in a cooperative and polite manner
    - c. Demonstrates ability to focus on task at hand and work to completion
    - d. Demonstrates good work ethics through regular attendance, adequate classroom preparations, and appropriate use of classroom time
    - e. Demonstrates maturity to take responsibility for actions
    - f. Demonstrates ability to cooperatively work in individual, team, and group situations in timely and effective manner
  2. **Self-Esteem:** *Believes in own self-worth and maintains a positive view of self*
    - a. Presents a positive attitude toward tasks
    - b. Demonstrates ability to separate work and personal behaviors
    - c. Actively participates in learning opportunities by sharing knowledge and skills with peers and instructors
    - d. Demonstrates ability to accept personal strengths and weaknesses and builds on positive behaviors
    - e. Demonstrates ability to accept and use constructive criticism
    - f. Accepts positive reinforcement in an appropriate manner
  3. **Sociability:** *Demonstrates understanding, friendliness, adaptability, empathy, and politeness in group settings*
    - a. Demonstrates appropriate and acceptable social behaviors in interactions
    - b. Demonstrates ability to work cooperatively in individual, team, or group situations

- c. Demonstrates active interest in peers by offering assistance, sharing resources, and sharing knowledge in a professional and acceptable manner
- d. Demonstrates professional work ethic by separating work and personal social behaviors and acting accordingly
- 4. ***Self-Management: Assesses self accurately, sets personal goals, monitors progress, and exhibits self-control***
  - a. Accepts personal strengths and weaknesses and uses the same for positive advancement
  - b. Demonstrates ability to continuously set, assess, choose, and modify objectives as the situation demands in an appropriate manner
  - c. Demonstrates ability to formulate and follow personal schedules
  - d. Demonstrates ability to wisely use classroom time
  - e. Demonstrates use of good study habits and skills
  - f. Demonstrates maturity to take responsibility for own actions
- 5. ***Integrity/Honesty: Chooses ethical courses of action***
  - a. Knows and demonstrates ability to distinguish between positive and negative behaviors
  - b. Demonstrates honesty and integrity in working with peers and supervisors
  - c. Takes full responsibility for personal actions
  - d. Demonstrates understanding of consequences for negative ethical behaviors and accepts responsibility for same when applicable
  - e. Demonstrates positive work and social ethics in undertakings

### **Appropriate Reference Materials:**

---

1. MASTER Technical Modules:  
AET-A1 through AET-A13;  
AET-D1;  
AET-F1 through AET-F8; and,  
AET-J2.
2. *Technical Physics* by Erwin/Selleck, Latest Edition
3. *The Sciences, An Integrated Approach* by Trefil/Hazen, Latest Edition

AET 106  
05/052698

# **MASTER PROGRAM**

## **Industrial Programming Theory**

### **COURSE SYLLABUS**

---

**Total lecture hours: 32**

**Total lab hours: 48**

**Credit hours: 3**

#### **COURSE DESCRIPTION:**

Covers the basic digital mathematical concepts required for effective performance as an automation technician or machine technologist in the computerized machine tool industry. This course will include examples taken from computers or microprocessor systems that are typically found in the modern manufacturing facility, such as industrial computers, programmable logic controllers, and control systems.

#### **PREREQUISITES:**

**Manufacturing Metrics and Calculations, or  
Concurrent enrollment or equivalent.**

#### **COURSE OBJECTIVES:**

After successful completion of this course, the student will be able to:

1. Use the mathematics of numbering systems to create new numbering systems and convert mathematical quantities in numbering systems such as decimal, binary, octal, and hexadecimal from one numbering system to another;
2. Use quantities from the binary numbering system to perform mathematical operations on these quantities, such as addition, subtraction, multiplication, and division;
3. Use Boolean algebra to express a complex logic problem in Boolean expressions and apply this knowledge to the solution of programming problems;
4. Identify the major software components of a computer microprocessor control system, such as the Disk Operating System (DOS), Graphic User Interface (GUI), or Basic Input-Output System (BIOS), and explain the function of each system;
5. Use a personal computer to accomplish tasks such as formatting a disk, creating and using files, copying disks and files, configuring a serial or parallel computer interface, and configuring add-on modules;
6. Use a personal computer to connect communications cables to the computers communications ports such as RS-232, RS-485, and Local Area Network (LAN) cables; and,
7. Use a programming language such as BASIC or statement list programming to program a control task.

## REQUIRED COURSE MATERIALS:

**Textbook:** *Introducing Computers-Concepts, Systems, and Applications* by Blissmer, Latest Edition  
**Lab Manual:** None

### Materials:

Paper  
Notebooks  
Writing instruments  
Safety glasses  
Scientific calculator  
Scantron examination sheets

## METHODS OF INSTRUCTION:

---

**Lecture:** Presentations will include lecture, demonstration, and group problem solving.

**Laboratory:** Group projects will be assigned during the laboratory periods. Each set of projects will provide practice in one or more concepts. The students will work on problems that are derived from manufacturing or industrial situations.

**Method of Evaluation:** A student's grade will be based on multiple measures of performance. The assessment will measure development of independent critical thinking skills and will include evaluation of the student's ability to:

1. Perform on written or oral examinations;
2. Perform on outside assignments;
3. Contribute to group problem solving;
4. Apply theory to problem solving; and,
5. Maintain attendance per current policy.

## LECTURE OUTLINE:

---

### Lecture Topics

### Contact Hrs.

---

#### Numbering Systems

- A. Theory of numbering systems
- B. Practice in creating numbering systems
- C. The Binary numbering system
- D. The octal numbering system
- E. The hexadecimal numbering system
- F. Numbering system conversions
- G. Mathematical operations in the binary numbering system (addition, subtraction, multiplication and

division)

### Boolean Algebra

- A. Boolean operators (and, or, inclusive or, exclusive or, negation)
- B. Truth tables
- C. Complex logic expressions (combinational logic)
- D. Boolean theorems and operations (Demorgan's Theory, etc.)
- E. Symbolic logic (gate symbols, etc.)
- F. Conversions from Boolean expressions to symbolic logic
- G. Conversions from Boolean expressions to ladder logic

### Elements of a Computer System

- A. Hardware
- B. Software
- C. Operating system

### Programming

- A. Programming concepts
- B. Structured programming

Total Lecture Hours     32

### LAB OUTLINE:

Lab Topics	Contact Hrs.
Numbering Systems	
Boolean Algebra	
Elements of a Computer System	
Programming	
Total Lab Hours	<u>48</u>

### COURSE OBJECTIVES: SCANS COMPETENCIES

*The Secretary's Commission on Achieving Necessary Skills (SCANS), U.S. Department of Labor, has identified in its "AMERICA 2000 REPORT" that all students should develop a new set of competencies and foundation skills if they are to enjoy a productive, full and satisfying life. These are in addition to the Technical Workplace Competencies required by industry. SCANS is made up of five competencies and a three-part foundation of skills and personal qualities that are needed for solid job performance. All italicized headings in this section are direct quotations from "What Work Requires of Schools: A SCANS Report for America 2000."*

The following activities will be performed by each student for successful completion of this course:



## I. COMPETENCIES

- A. **Resources:** *Identifies, organizes, plans, and allocates resources*
  - 1. Allocates time to complete assigned tasks on schedule
  - 2. Determines and allocates required materials and resources for meeting objectives
  - 3. Evaluates skills, performance, and quality of work and provides feedback
- B. **Interpersonal:** *Works with others*
  - 1. Participates as a member of the team, contributing to group effort
  - 2. Provides individual assistance/direction to peers as requested
  - 3. Determines and meets expectations
  - 4. Exercises leadership qualities to effectively communicate ideas and make decisions.
  - 5. Negotiates resources in order to accomplish objectives
  - 6. Works well with all members of the class
- C. **Information:** *Acquires and uses information*
  - 1. Acquires and evaluates information
  - 2. Organizes and maintains information
  - 3. Interprets and communicates information
- D. **Systems:** *Understands complex inter-relationships*
  - 1. Understands and works well with social, organizational, and technological systems
  - 2. Monitors and corrects performance of system during operation
  - 3. Recommends modifications to system to improve performance
- E. **Technology:** *Works with a variety of technologies*
  - 1. Chooses relevant procedures, tools, and equipment
  - 2. Applies appropriate procedures and techniques to accomplish tasks
  - 3. Identifies or solves problems to maintain equipment

## II. FOUNDATION SKILLS

- A. **Basic Skills:** Reads, writes, performs arithmetic and mathematical operations, listens and speaks
  - 1. **Reading:** *Locates, understands, and interprets written information in prose and in documents such as manuals, graphs, and schedules*
    - a. Demonstrates basic reading skills including abilities to perceive main ideas, draw appropriate conclusions, detect a sequence, locate answers, find facts, and infer from written texts
    - b. Demonstrates course specific reading skills including abilities to read, interpret, and comprehend information

- from text and supplemental materials on a level to facilitate productive independent and group study
- c. Demonstrates ability to read, interpret, and utilize information from course specific instruments (i.e., charts, diagrams, graphs, schematics, blueprints, flow charts, etc.)
  - d. Demonstrates ability to read, interpret, and follow schedules and procedural instructions in a timely and appropriate manner
  - e. Demonstrates ability to choose and use most appropriate reading method (skim, scan, or read for comprehension) for materials
2. **Writing:** *Communicates thoughts, ideas, information, and messages in writing; and creates documents such as letters, directions, manuals, reports, graphs, and flow charts*
- a. Demonstrates basic writing skills including abilities to produce written documents which conform with accepted grammatical and communication standards required for effective daily functioning
  - b. Demonstrates effective written study skills including note taking, maintaining course specific journals, workbooks, manuals, etc.
  - c. Demonstrates technical writing skills in preparing outlines, summaries, time lines, flow charts, diagrams, etc. appropriate to materials covered
  - d. Demonstrates ability to complete all required writings in a timely, complete, and professional manner
  - e. Demonstrates competence in subject matter through the organization and presentation of answers to required written assessments
3. **Arithmetic/Mathematics:** *Perform basic computations and approaches practical problems by choosing appropriately from a variety of mathematical techniques*
- a. Demonstrates proficiency in basic arithmetic functions including ability to add, subtract, multiply, and divide whole numbers, fractions, decimals, and percentages
  - b. Demonstrates ability to read, comprehend, and select appropriate math procedures to work basic math problems
  - c. Demonstrates ability to understand and perform multi-step computations
  - d. Demonstrates ability to read, interpret, and use standard measuring devices

- e. Demonstrates ability to comprehend, retain, and utilize course specific measuring devices effectively
  - f. Demonstrates ability to understand, retain, and utilize higher mathematical formulas and functions required for course specific math performance
  - g. Demonstrates ability to appropriately transfer mathematical calculations and information from paper to machines
4. *Listening: Receives, attends to, interprets, and responds to verbal messages and other cues*
- a. Functions at minimal or above required hearing levels to receive, attend, interpret, and respond to verbal messages and instructions and to safely operate machinery
  - b. Demonstrates ability to hear, comprehend, and appropriately follow directions
  - c. Demonstrates auditory ability to hear, comprehend, and utilize verbal classroom as well as other auditory instruction
  - d. Demonstrates ability to discriminate between essential and non-essential verbal information and react appropriately
  - e. Demonstrates ability to focus and fine-tune listening skills to receive, interpret, and respond to various sounds
  - f. Demonstrates ability and maturity to seek and receive additional individualized instruction as needed
5. *Speaking: Organizes ideas and communicates orally*
- a. Demonstrates appropriate listening and speaking skills in personal conversations
  - b. Demonstrates ability to choose and organize appropriate words to effectively communicate
  - c. Demonstrates ability to speak clearly and distinctly with appropriate volume, tone, and body language for situation
  - d. Demonstrates ability to spontaneously organize and present appropriate answers and/or short presentations for classroom and /or assessment purposes
  - e. Demonstrates ability to formulate, organize, and deliver major presentations to peers or groups
  - f. Demonstrates ability to speak effectively in one-on-one, small group, or large group presentations
  - g. Demonstrates ability to take responsibility for presentations
- B. **Thinking Skills:** Thinks creatively, makes decisions, solves problems, visualizes, knows how to learn and reasons

1. ***Decision Making: Specifies goals and constraints, generates alternatives, considers risks, and evaluates and chooses best alternative***
  - a. Demonstrates ability to objectively assess personal strengths and weaknesses
  - b. Demonstrates ability to set realistic short-term and long-term goals
  - c. Demonstrates ability to recognize and distinguish between positive and negative alternatives
  - d. Demonstrates ability to identify potential pitfalls and take evasive actions
  - e. Demonstrates ability to objectively and responsibly evaluate alternatives by testing hypotheses and selecting most appropriate response
  - f. Demonstrates ability to profit from negative evaluations or mistakes by reformulating, redirecting, reconstructing, or retesting alternatives
  - g. Demonstrates maturity in taking responsibility for decisions
2. ***Problem Solving: Recognizes problems and devises and implements plan of action***
  - a. Demonstrates ability to detect problem through observation, inquiry, or directive
  - b. Demonstrates ability to grasp appropriate overview and degree of seriousness of problem and to behave responsibly in situation
  - c. Demonstrates ability to generate alternatives or options for problem solution
  - d. Demonstrates ability to research options, assess and evaluate options, and determine appropriate and best solution
  - e. Demonstrates ability to initiate and effect solution
  - f. Demonstrates ability to take responsibility for outcomes
  - g. Demonstrates ability to effectively problem solve in individual, team, or group situations
3. ***Seeing Things In the Mind's Eye: Organizes, and processes symbols, pictures, graphs, objects, and other information***
  - a. Functions at minimum or above required visual levels in order to see, interpret, attend and respond to visual imagery and meet safety requirements for necessary machinery
  - b. Demonstrates ability to read, interpret, and act upon signs, symbols, and other visual cues

- c. Demonstrates ability to visually discriminate in gross and fine imagery
  - d. Demonstrates ability to visualize abstractly
  - e. Demonstrates ability to apply visual imagery to applied tasks
4. ***Knowing How to Learn: Use efficient learning techniques to acquire and apply new knowledge and skills***
- a. Demonstrates mastery of basic reading, math, and language skills through application
  - b. Demonstrates ability to translate abstract theory into practical application
  - c. Demonstrates ability to incorporate and generalize new learning into a sequential learning process
  - d. Demonstrates knowledge of good study skills and learning habits
5. ***Reasoning: Discovers a rule or principle underlying the relationship between two or more objects and applies it when solving a problem***
- a. Demonstrates use of simple logic
  - b. Demonstrates ability to distinguish relationships
  - c. Demonstrates ability to determine and isolate factors in relationships
  - d. Demonstrates and applies knowledge through practice
  - e. Recognizes that attitudes, skills, and practice are essential to productivity
  - f. Demonstrates ability to discriminate between positive and negative, and act accordingly
- C. **Personal Qualities: Displays responsibility, self-esteem, sociability, self-management, and integrity and honesty**
1. ***Responsibility: Exerts a high level of effort and perseveres towards goal attainment***
- a. Demonstrates ability to formulate realistic and useful short and long term goals and complete steps necessary to timely achieve goals
  - b. Demonstrates ability to make adjustments, revisions, and changes to achieve goals in a cooperative and polite manner
  - c. Demonstrates ability to focus on task at hand and work to completion
  - d. Demonstrates good work ethics through regular attendance, adequate classroom preparations, and appropriate use of classroom time
  - e. Demonstrates maturity to take responsibility for actions

- f. Demonstrates ability to cooperatively work in individual, team, and group situations in timely and effective manner
2. *Self-Esteem: Believes in own self-worth and maintains a positive view of self*
- a. Presents a positive attitude toward tasks
  - b. Demonstrates ability to separate work and personal behaviors
  - c. Actively participates in learning opportunities by sharing knowledge and skills with peers and instructors
  - d. Demonstrates ability to accept personal strengths and weaknesses and builds on positive behaviors
  - e. Demonstrates ability to accept and use constructive criticism
  - f. Accepts positive reinforcement in an appropriate manner
3. *Sociability: Demonstrates understanding, friendliness, adaptability, empathy, and politeness in group settings*
- a. Demonstrates appropriate and acceptable social behaviors in interactions
  - b. Demonstrates ability to work cooperatively in individual, team, or group situations
  - c. Demonstrates active interest in peers by offering assistance, sharing resources, and sharing knowledge in a professional and acceptable manner
  - d. Demonstrates professional work ethic by separating work and personal social behaviors and acting accordingly
4. *Self-Management: Assesses self accurately, sets personal goals, monitors progress, and exhibits self-control*
- a. Accepts personal strengths and weaknesses and uses the same for positive advancement
  - b. Demonstrates ability to continuously set, assess, choose, and modify objectives as the situation demands in an appropriate manner
  - c. Demonstrates ability to formulate and follow personal schedules
  - d. Demonstrates ability to wisely use classroom time
  - e. Demonstrates use of good study habits and skills
  - f. Demonstrates maturity to take responsibility for own actions
5. *Integrity/Honesty: Chooses ethical courses of action*
- a. Knows and demonstrates ability to distinguish between positive and negative behaviors
  - b. Demonstrates honesty and integrity in working with peers and supervisors

- c. Takes full responsibility for personal actions
- d. Demonstrates understanding of consequences for negative ethical behaviors and accepts responsibility for same when applicable
- e. Demonstrates positive work and social ethics in undertakings

**Appropriate Reference Materials:**

---

1. MASTER Technical Modules:  
AET-A1 through AET-A5;  
AET-B1 through AET-B3;  
AET-B5;  
AET-D1;  
AET-G1 through AET-G4;  
AET-H1;  
AET-I1; and,  
AET-J5.
2. *Industrial Computing*, Pub. of Instrument Society of America (ISA), Latest Edition

AET 111  
05/052698



# MASTER PROGRAM

## Industrial Electronics/Electricity

### COURSE SYLLABUS

---

**Total lecture hours: 32**

**Total lab hours: 96**

**Credit hours: 4**

#### **COURSE DESCRIPTION:**

Introduces the principles of operation of common electronics/electrical components through the use of hands-on experimentation and classroom lectures. This course includes Ohm's Law, component testing, and the use of test equipment. It also includes the theory of operation of various components such as switches, relays, transformers, motors, sensors, and diodes.

#### **PREREQUISITES:**

**Manufacturing Metrics and Calculations, Print Reading and Symbology, concurrent enrollment or equivalent**

#### **COURSE OBJECTIVES:**

After successful completion of this course, the student will:

1. Apply mathematical formulas and the rules of mathematics to calculate and predict the behavior of the following quantities in DC electronics/electricity, resistance, voltage, current, power, and capacitor-resistor time constants;
2. Apply mathematical formulas and the rules of mathematics to calculate and predict the behavior of the following quantities in AC electronics/electricity, resistance, voltage, current, power, inductive reactance, capacitive reactance, peak AC voltage and current, peak-to-peak AC voltage and current, RMS, and average AC voltage and current;
3. Use mathematical formulas and the rules of mathematics from the study of algebra, basic vector mathematics, and trigonometry to calculate and predict the behavior of the following quantities in AC electronics/electricity, impedance of series resistive-capacitive circuits, impedance of series inductive-resistive circuits, and phase angle in the above circuits;
4. Apply the rules of AC electronics/electricity to predict and measure the voltage, current and phase angle in three phase AC circuits;
5. Properly set up, calibrate, and use meters, function generators, and oscilloscopes to accurately test resistance, voltage, current, frequency, and time in both DC and AC circuits;

6. Use components such as resistors, inductors, and capacitors to construct circuits and test the components in both DC and AC circuits to determine if the components are operating properly;
7. Use oscilloscopes, meters and the metrology of electrical measurement to measure phase shift and phase angle in series resistive-capacitive and series resistive-inductive AC circuits;
8. Apply the theory of electro-magnetism to explain the operation of magnetically coupled devices such as relays, solenoids, transformers, and electrical motors;
9. Use meters function generators and oscilloscopes to test magnetically coupled devices such as relays, solenoids, transformers, and electrical motors to determine if they are operating properly;
10. Identify DC motors such as permanent magnetic DC motors, series field DC motors, shunt field DC motors, combination DC motors, and universal motors;
11. Identify AC motors such as split phase capacitive start motors, split phase capacitive start-capacitive run motors, inductive start-inductive run motors, three phase squirrel cage motors, and universal motors; and,
12. Use the rules of semiconductor diodes such as barrier potential, PIV, forward bias, and reverse bias to test front-to-back ratios and measure forward and reverse voltage drop.

#### **REQUIRED COURSE MATERIALS:**

**Textbook:**            *Electricity/Electronics Fundamentals* by Zbar/Sloop, Latest Edition  
                               *Introductory DC/AC Electronics* by Nigel P. Cook, Latest Edition (with interactive software)

**Lab Manual:**        None

#### **Materials:**

Paper  
 Notebooks  
 Writing instruments  
 Safety glasses  
 Scientific calculator  
 Scantron examination sheets

#### **METHODS OF INSTRUCTION:**

---

**Lecture:**            Presentations will include lecture, demonstration, group problem solving.

**Laboratory:**        Laboratory will be hands-on Electrical/Electronic assignments.

**Method of Evaluation:** A student's grade will be based on multiple measures of performance. The assessment will measure development of independent critical thinking skills and will include evaluation of the student's ability to:

1. Perform on written or oral examinations;
2. Perform on outside assignments;
3. Contribute to group problem solving;
4. Apply theory to problem solving; and,
5. Maintain attendance per current policy.

**LECTURE OUTLINE:**

<b>Lecture Topics</b>	<b>Contact Hrs.</b>
<b>Basic Electronics</b>	
A. DC theory	
1) Ohm's Law	
2) Resistors/potentiometer	
3) Series/parallel circuits/voltage dividers	
4) Calculating voltage, current, and resistance	
5) Resistive bridge circuits	
6) Conductors/insulators	
7) Switches	
8) Power	
B. Sources of electrical energy	
C. Electrical safety	
D. Component symbols	
E. Test meters	
F. Capacitance	
G. Inductance	
H. Capacitive/inductive test equipment	
I. Magnetism	
J. Electro-magnetism	
K. DC relays/solenoids	
L. DC motors/generators	
<b>AC Theory</b>	
A. Analysis of a sine wave	
1) Single phase AC	
2) Two phase AC	
3) Three phase AC	
B. Use of the oscilloscope	
C. Phase relationships	
D. R-C, L-R, and L-C circuits	
E. Relays/solenoids	
F. Transformer theory	
G. AC motors/generators	

**Electronic Theory**

- A. Semiconductors
- B. Diodes
- C. Sensors
  - 1) Thermocouple/RTDs
  - 2) Force sensors
  - 3) Accelerometers
  - 4) Photosensors

Total Lecture Hours     32

**LAB OUTLINE:**

Lab Topics	Contact Hrs.
Basic Electronics	
AC Theory	
Electronic Theory	
Total Lecture Hours <u>96</u>	

**COURSE OBJECTIVES: SCANS COMPETENCIES**

*The Secretary's Commission on Achieving Necessary Skills (SCANS), U.S. Department of Labor, has identified in its "AMERICA 2000 REPORT" that all students should develop a new set of competencies and foundation skills if they are to enjoy a productive, full and satisfying life. These are in addition to the Technical Workplace Competencies required by industry. SCANS is made up of five competencies and a three-part foundation of skills and personal qualities that are needed for solid job performance. All italicized headings in this section are direct quotations from "What Work Requires of Schools: A SCANS Report for America 2000."*

The following activities will be performed by each student for successful completion of this course:

**I. COMPETENCIES**

- A. *Resources: Identifies, organizes, plans, and allocates resources*
  - 1. Allocates time to complete assigned tasks on schedule
  - 2. Determines and allocates required materials and resources for meeting objectives
  - 3. Evaluates skills, performance, and quality of work and provides feedback
- B. *Interpersonal: Works with others*
  - 1. Participates as a member of the team, contributing to group effort

2. Provides individual assistance/direction to peers as requested
  3. Determines and meets expectations
  4. Exercises leadership qualities to effectively communicate ideas and make decisions.
  5. Negotiates resources in order to accomplish objectives
  6. Works well with all members of the class
- C. Information: Acquires and uses information**
1. Acquires and evaluates information
  2. Organizes and maintains information
  3. Interprets and communicates information
- D. Systems: Understands complex inter-relationships**
1. Understands and works well with social, organizational, and technological systems
  2. Monitors and corrects performance of system during operation
  3. Recommends modifications to system to improve performance
- E. Technology: Works with a variety of technologies**
1. Chooses relevant procedures, tools, and equipment
  2. Applies appropriate procedures and techniques to accomplish tasks
  3. Identifies or solves problems to maintain equipment

## II. FOUNDATION SKILLS

- A. Basic Skills: Reads, writes, performs arithmetic and mathematical operations, listens and speaks**
1. **Reading: Locates, understands, and interprets written information in prose and in documents such as manuals, graphs, and schedules**
    - a. Demonstrates basic reading skills including abilities to perceive main ideas, draw appropriate conclusions, detect a sequence, locate answers, find facts, and infer from written texts
    - b. Demonstrates course specific reading skills including abilities to read, interpret, and comprehend information from text and supplemental materials on a level to facilitate productive independent and group study
    - c. Demonstrates ability to read, interpret, and utilize information from course specific instruments (i.e., charts, diagrams, graphs, schematics, blueprints, flow charts, etc.)
    - d. Demonstrates ability to read, interpret, and follow schedules and procedural instructions in a timely and appropriate manner

- e. Demonstrates ability to choose and use most appropriate reading method (skim, scan, or read for comprehension) for materials
2. **Writing:** *Communicates thoughts, ideas, information, and messages in writing; and creates documents such as letters, directions, manuals, reports, graphs, and flow charts*
- a. Demonstrates basic writing skills including abilities to produce written documents which conform with accepted grammatical and communication standards required for effective daily functioning
  - b. Demonstrates effective written study skills including note taking, maintaining course specific journals, workbooks, manuals, etc.
  - c. Demonstrates technical writing skills in preparing outlines, summaries, time lines, flow charts, diagrams, etc. appropriate to materials covered
  - d. Demonstrates ability to complete all required writings in a timely, complete, and professional manner
  - e. Demonstrates competence in subject matter through the organization and presentation of answers to required written assessments
3. **Arithmetic/Mathematics:** *Perform basic computations and approaches practical problems by choosing appropriately from a variety of mathematical techniques*
- a. Demonstrates proficiency in basic arithmetic functions including ability to add, subtract, multiply, and divide whole numbers, fractions, decimals, and percentages
  - b. Demonstrates ability to read, comprehend, and select appropriate math procedures to work basic math problems
  - c. Demonstrates ability to understand and perform multi-step computations
  - d. Demonstrates ability to read, interpret, and use standard measuring devices
  - e. Demonstrates ability to comprehend, retain, and utilize course specific measuring devices effectively
  - f. Demonstrates ability to understand, retain, and utilize higher mathematical formulas and functions required for course specific math performance
  - g. Demonstrates ability to appropriately transfer mathematical calculations and information from paper to machines
4. **Listening:** *Receives, attends to, interprets, and responds to verbal messages and other cues*

- a. Functions at minimal or above required hearing levels to receive, attend, interpret, and respond to verbal messages and instructions and to safely operate machinery
  - b. Demonstrates ability to hear, comprehend, and appropriately follow directions
  - c. Demonstrates auditory ability to hear, comprehend, and utilize verbal classroom as well as other auditory instruction
  - d. Demonstrates ability to discriminate between essential and non-essential verbal information and react appropriately
  - e. Demonstrates ability to focus and fine-tune listening skills to receive, interpret, and respond to various sounds
  - f. Demonstrates ability and maturity to seek and receive additional individualized instruction as needed
5. ***Speaking: Organizes ideas and communicates orally***
- a. Demonstrates appropriate listening and speaking skills in personal conversations
  - b. Demonstrates ability to choose and organize appropriate words to effectively communicate
  - c. Demonstrates ability to speak clearly and distinctly with appropriate volume, tone, and body language for situation
  - d. Demonstrates ability to spontaneously organize and present appropriate answers and/or short presentations for classroom and /or assessment purposes
  - e. Demonstrates ability to formulate, organize, and deliver major presentations to peers or groups
  - f. Demonstrates ability to speak effectively in one-on-one, small group, or large group presentations
  - g. Demonstrates ability to take responsibility for presentations

**B. Thinking Skills: Thinks creatively, makes decisions, solves problems, visualizes, knows how to learn and reasons**

1. ***Decision Making: Specifies goals and constraints, generates alternatives, considers risks, and evaluates and chooses best alternative***
- a. Demonstrates ability to objectively assess personal strengths and weaknesses
  - b. Demonstrates ability to set realistic short-term and long-term goals
  - c. Demonstrates ability to recognize and distinguish between positive and negative alternatives
  - d. Demonstrates ability to identify potential pitfalls and take evasive actions



- e. Demonstrates ability to objectively and responsibly evaluate alternatives by testing hypotheses and selecting most appropriate response
  - f. Demonstrates ability to profit from negative evaluations or mistakes by reformulating, redirecting, reconstructing, or retesting alternatives
  - g. Demonstrates maturity in taking responsibility for decisions
2. ***Problem Solving: Recognizes problems and devises and implements plan of action***
- a. Demonstrates ability to detect problem through observation, inquiry, or directive
  - b. Demonstrates ability to grasp appropriate overview and degree of seriousness of problem and to behave responsibly in situation
  - c. Demonstrates ability to generate alternatives or options for problem solution
  - d. Demonstrates ability to research options, assess and evaluate options, and determine appropriate and best solution
  - e. Demonstrates ability to initiate and effect solution
  - f. Demonstrates ability to take responsibility for outcomes
  - g. Demonstrates ability to effectively problem solve in individual, team, or group situations
3. ***Seeing Things In the Mind's Eye: Organizes, and processes symbols, pictures, graphs, objects, and other information***
- a. Functions at minimum or above required visual levels in order to see, interpret, attend and respond to visual imagery and meet safety requirements for necessary machinery
  - b. Demonstrates ability to read, interpret, and act upon signs, symbols, and other visual cues
  - c. Demonstrates ability to visually discriminate in gross and fine imagery
  - d. Demonstrates ability to visualize abstractly
  - e. Demonstrates ability to apply visual imagery to applied tasks
4. ***Knowing How to Learn: Use efficient learning techniques to acquire and apply new knowledge and skills***
- a. Demonstrates mastery of basic reading, math, and language skills through application
  - b. Demonstrates ability to translate abstract theory into practical application

- c. Demonstrates ability to incorporate and generalize new learning into a sequential learning process
  - d. Demonstrates knowledge of good study skills and learning habits
5. **Reasoning:** *Discovers a rule or principle underlying the relationship between two or more objects and applies it when solving a problem*
- a. Demonstrates use of simple logic
  - b. Demonstrates ability to distinguish relationships
  - c. Demonstrates ability to determine and isolate factors in relationships
  - d. Demonstrates and applies knowledge through practice
  - e. Recognizes that attitudes, skills, and practice are essential to productivity
  - f. Demonstrates ability to discriminate between positive and negative, and act accordingly
- C. **Personal Qualities:** *Displays responsibility, self-esteem, sociability, self-management, and integrity and honesty*
1. **Responsibility:** *Exerts a high level of effort and perseveres towards goal attainment*
- a. Demonstrates ability to formulate realistic and useful short and long term goals and complete steps necessary to timely achieve goals
  - b. Demonstrates ability to make adjustments, revisions, and changes to achieve goals in a cooperative and polite manner
  - c. Demonstrates ability to focus on task at hand and work to completion
  - d. Demonstrates good work ethics through regular attendance, adequate classroom preparations, and appropriate use of classroom time
  - e. Demonstrates maturity to take responsibility for actions
  - f. Demonstrates ability to cooperatively work in individual, team, and group situations in timely and effective manner
2. **Self-Esteem:** *Believes in own self-worth and maintains a positive view of self*
- a. Presents a positive attitude toward tasks
  - b. Demonstrates ability to separate work and personal behaviors
  - c. Actively participates in learning opportunities by sharing knowledge and skills with peers and instructors
  - d. Demonstrates ability to accept personal strengths and weaknesses and builds on positive behaviors

- e. Demonstrates ability to accept and use constructive criticism
- f. Accepts positive reinforcement in an appropriate manner
- 3. ***Sociability: Demonstrates understanding, friendliness, adaptability, empathy, and politeness in group settings***
  - a. Demonstrates appropriate and acceptable social behaviors in interactions
  - b. Demonstrates ability to work cooperatively in individual, team, or group situations
  - c. Demonstrates active interest in peers by offering assistance, sharing resources, and sharing knowledge in a professional and acceptable manner
  - d. Demonstrates professional work ethic by separating work and personal social behaviors and acting accordingly
- 4. ***Self-Management: Assesses self accurately, sets personal goals, monitors progress, and exhibits self-control***
  - a. Accepts personal strengths and weaknesses and uses the same for positive advancement
  - b. Demonstrates ability to continuously set, assess, choose, and modify objectives as the situation demands in an appropriate manner
  - c. Demonstrates ability to formulate and follow personal schedules
  - d. Demonstrates ability to wisely use classroom time
  - e. Demonstrates use of good study habits and skills
  - f. Demonstrates maturity to take responsibility for own actions
- 5. ***Integrity/Honesty: Chooses ethical courses of action***
  - a. Knows and demonstrates ability to distinguish between positive and negative behaviors
  - b. Demonstrates honesty and integrity in working with peers and supervisors
  - c. Takes full responsibility for personal actions
  - d. Demonstrates understanding of consequences for negative ethical behaviors and accepts responsibility for same when applicable
  - e. Demonstrates positive work and social ethics in undertakings

### Appropriate Reference Materials:

---

1. MASTER Technical Modules:  
AET-A1 through AET-A5;  
AET-A7;

AET-A12 through AET-A13;  
AET-B1 through AET-B3;  
AET-C2 through AET-C5;  
AET-D1;  
AET-E1 through AET-E13;  
AET-F5 through AET-F6;  
AET-F8;  
AET-H1; and,  
AET-J3 through AET-J5.

2. *Maintaining and Troubleshooting Electrical Equipment* by Parks/Wireman,  
Latest Edition

AET 200  
05/052698

# MASTER PROGRAM

## Motion Control/Servo Systems

### COURSE SYLLABUS

---

**Total lecture hours: 32**

**Total lab hours: 96**

**Credit hours: 4**

#### **COURSE DESCRIPTION:**

Studies the types of control circuits used to control industrial equipment, including motor, process, and hydraulic controls. In addition, this course includes the types of feedback systems employed in control systems and their theory of operation. An emphasis is placed upon closed loop servo systems and their operation. The students will experience hands-on interaction with these control systems through laboratory experiments.

**PREREQUISITES:**                      **Industrial Electronics/Electricity**

#### **COURSE OBJECTIVES:**

After successful completion of this course, the student will:

1. Use test equipment such as a meter or oscilloscope to test diodes, bipolar transistors, and power MOSFETs, both in and out of the circuit;
2. Use test equipment such as a meter or oscilloscope to test SCRs (Thyristors), triacs, and their associated triggering devices such as UJTs, PUTs, diacs, and SBSs, both in and out of circuit;
3. Use test equipment such as a meter or oscilloscope to test DC power supplies, including rectifiers, filtering capacitors, filtering inductors, and semiconductor devices found in power supply regulators, such as bi-polar transistors and power MOSFETs;
4. Use a schematic diagram and test equipment such as a meter or oscilloscope to test, troubleshoot, and repair series, shunt, and switching regulators in DC power supplies;
5. Identify, test, troubleshoot, and repair various types of motor control circuits such as DC motor controls, permanent magnet motor controls, DC shunt field motor controls, and universal motor controls;
6. Identify, test, troubleshoot, and repair motor control circuits such as SCR motor controls, pulse-width modulated motor controls, and three-phase inverter type motor controls;
7. Test electrical devices such as relays, contacts, solenoids, and switches, both in and out of circuit;

8. Test sensors such as pressure transducers, photoelectric sensors, and proximity sensors;
9. Identify and test various types of servo control systems such as bang-bang servos, type 0 servo systems, type 1 servo systems, type 2 servo systems and the types of feedback employed in these systems; and,
10. Apply the formulas and concepts of the study of servo systems, such as following error (steady state error), gain, integral and derivative to the solution of problems in point-to-point servo systems, contouring servo systems, and proportional-band-integral-derivative (PID) servo systems.

### REQUIRED COURSE MATERIALS:

**Textbook:** *Modern Industrial Electronics*, Revised and Expanded Edition by Schuler/MacNamee, Latest Edition (formerly, *Industrial Electronics and Robotics* by Schuler/McNamee)

**Lab Manual:** None

#### Materials:

- Paper
- Notebooks
- Writing instruments
- Safety glasses
- Scientific calculator
- Scantron examination sheets

### METHODS OF INSTRUCTION:

---

**Lecture:** Presentations will include lecture, demonstration, and group problem solving.

**Laboratory:** Laboratory will be hands-on exploration and problem solving.

**Method of Evaluation:** A student's grade will be based on multiple measures of performance. The assessment will measure development of independent critical thinking skills and will include evaluation of the student's ability to:

1. Perform on written or oral examinations;
2. Perform on outside assignments;
3. Contribute to group problem solving;
4. Apply theory to problem solving; and,
5. Maintain attendance per current policy.

### LECTURE OUTLINE:

Lecture Topic	Contact Hrs.
Solid State Components	

- A. Diodes
- B. Bi-polar transistors
- C. Field effect transistors, JFETs, MOSFETs
- D. SCRs, TRIACs, DIACs
- E. Integrated circuits

**Amplifiers**

- A. Transistor amplifiers
- B. Operational amplifiers

**Power Control Circuits**

- A. Power supplies
- B. SCR power control circuits
- C. Transistor power control circuits
- D. Three phase motor inverter control circuits
- E. Types of motors

**Hydraulic and Pneumatic Controls**

- A. Switches, relays
- B. Solenoids
- C. Amplifier circuits for hydraulic and pneumatic systems

**Closed Loop Controls**

- A. Motor controls
- B. Process controls
- C. Hydraulic/pneumatic controls

**Feedback Devices**

- A. Transducers
- B. Digital feedback devices
- C. Analog feedback devices
- D. Phase analog feedback devices

**Closed Loop Servo Systems**

- A. Bang-bank servos
- B. Proportional-band-integral-derivative (PID) servos
- C. Gain block algebra for servo systems

Total Lecture Hours    32

**LAB OUTLINE:**

Lab Topic	Contact Hrs.
<b>Solid State Components</b>	
<b>Amplifiers</b>	
<b>Power Control Circuits</b>	
<b>Hydraulic and Pneumatic Controls</b>	
<b>Closed Loop Controls</b>	
<b>Feedback Devices</b>	
<b>Closed Loop Servo Systems</b>	



**COURSE OBJECTIVES: SCANS COMPETENCIES**

---

*The Secretary's Commission on Achieving Necessary Skills (SCANS), U.S. Department of Labor, has identified in its "AMERICA 2000 REPORT" that all students should develop a new set of competencies and foundation skills if they are to enjoy a productive, full and satisfying life. These are in addition to the Technical Workplace Competencies required by industry. SCANS is made up of five competencies and a three-part foundation of skills and personal qualities that are needed for solid job performance. All italicized headings in this section are direct quotations from "What Work Requires of Schools: A SCANS Report for America 2000."*

---

The following activities will be performed by each student for successful completion of this course:

**I. COMPETENCIES**

- A. *Resources: Identifies, organizes, plans, and allocates resources***
  - 1. Allocates time to complete assigned tasks on schedule
  - 2. Determines and allocates required materials and resources for meeting objectives
  - 3. Evaluates skills, performance, and quality of work and provides feedback
- B. *Interpersonal: Works with others***
  - 1. Participates as a member of the team, contributing to group effort
  - 2. Provides individual assistance/direction to peers as requested
  - 3. Determines and meets expectations
  - 4. Exercises leadership qualities to effectively communicate ideas and make decisions.
  - 5. Negotiates resources in order to accomplish objectives
  - 6. Works well with all members of the class
- C. *Information: Acquires and uses information***
  - 1. Acquires and evaluates information
  - 2. Organizes and maintains information
  - 3. Interprets and communicates information
- D. *Systems: Understands complex inter-relationships***
  - 1. Understands and works well with social, organizational, and technological systems
  - 2. Monitors and corrects performance of system during operation
  - 3. Recommends modifications to system to improve performance
- E. *Technology: Works with a variety of technologies***
  - 1. Chooses relevant procedures, tools, and equipment

2. Applies appropriate procedures and techniques to accomplish tasks
3. Identifies or solves problems to maintain equipment

## II. FOUNDATION SKILLS

### A. **Basic Skills:** Reads, writes, performs arithmetic and mathematical operations, listens and speaks

1. **Reading:** *Locates, understands, and interprets written information in prose and in documents such as manuals, graphs, and schedules*
  - a. Demonstrates basic reading skills including abilities to perceive main ideas, draw appropriate conclusions, detect a sequence, locate answers, find facts, and infer from written texts
  - b. Demonstrates course specific reading skills including abilities to read, interpret, and comprehend information from text and supplemental materials on a level to facilitate productive independent and group study
  - c. Demonstrates ability to read, interpret, and utilize information from course specific instruments (i.e., charts, diagrams, graphs, schematics, blueprints, flow charts, etc.)
  - d. Demonstrates ability to read, interpret, and follow schedules and procedural instructions in a timely and appropriate manner
  - e. Demonstrates ability to choose and use most appropriate reading method (skim, scan, or read for comprehension) for materials
2. **Writing:** *Communicates thoughts, ideas, information, and messages in writing; and creates documents such as letters, directions, manuals, reports, graphs, and flow charts*
  - a. Demonstrates basic writing skills including abilities to produce written documents which conform with accepted grammatical and communication standards required for effective daily functioning
  - b. Demonstrates effective written study skills including note taking, maintaining course specific journals, workbooks, manuals, etc.
  - c. Demonstrates technical writing skills in preparing outlines, summaries, time lines, flow charts, diagrams, etc. appropriate to materials covered
  - d. Demonstrates ability to complete all required writings in a timely, complete, and professional manner

- e. Demonstrates competence in subject matter through the organization and presentation of answers to required written assessments
3. ***Arithmetic/Mathematics: Perform basic computations and approaches practical problems by choosing appropriately from a variety of mathematical techniques***
- a. Demonstrates proficiency in basic arithmetic functions including ability to add, subtract, multiply, and divide whole numbers, fractions, decimals, and percentages
  - b. Demonstrates ability to read, comprehend, and select appropriate math procedures to work basic math problems
  - c. Demonstrates ability to understand and perform multi-step computations
  - d. Demonstrates ability to read, interpret, and use standard measuring devices
  - e. Demonstrates ability to comprehend, retain, and utilize course specific measuring devices effectively
  - f. Demonstrates ability to understand, retain, and utilize higher mathematical formulas and functions required for course specific math performance
  - g. Demonstrates ability to appropriately transfer mathematical calculations and information from paper to machines
4. ***Listening: Receives, attends to, interprets, and responds to verbal messages and other cues***
- a. Functions at minimal or above required hearing levels to receive, attend, interpret, and respond to verbal messages and instructions and to safely operate machinery
  - b. Demonstrates ability to hear, comprehend, and appropriately follow directions
  - c. Demonstrates auditory ability to hear, comprehend, and utilize verbal classroom as well as other auditory instruction
  - d. Demonstrates ability to discriminate between essential and non-essential verbal information and react appropriately
  - e. Demonstrates ability to focus and fine-tune listening skills to receive, interpret, and respond to various sounds
  - f. Demonstrates ability and maturity to seek and receive additional individualized instruction as needed
5. ***Speaking: Organizes ideas and communicates orally***
- a. Demonstrates appropriate listening and speaking skills in personal conversations

- b. Demonstrates ability to choose and organize appropriate words to effectively communicate
- c. Demonstrates ability to speak clearly and distinctly with appropriate volume, tone, and body language for situation
- d. Demonstrates ability to spontaneously organize and present appropriate answers and/or short presentations for classroom and /or assessment purposes
- e. Demonstrates ability to formulate, organize, and deliver major presentations to peers or groups
- f. Demonstrates ability to speak effectively in one-on-one, small group, or large group presentations
- g. Demonstrates ability to take responsibility for presentations

**B. Thinking Skills:** Thinks creatively, makes decisions, solves problems, visualizes, knows how to learn and reasons

**1. *Decision Making:*** *Specifies goals and constraints, generates alternatives, considers risks, and evaluates and chooses best alternative*

- a. Demonstrates ability to objectively assess personal strengths and weaknesses
- b. Demonstrates ability to set realistic short-term and long-term goals
- c. Demonstrates ability to recognize and distinguish between positive and negative alternatives
- d. Demonstrates ability to identify potential pitfalls and take evasive actions
- e. Demonstrates ability to objectively and responsibly evaluate alternatives by testing hypotheses and selecting most appropriate response
- f. Demonstrates ability to profit from negative evaluations or mistakes by reformulating, redirecting, reconstructing, or retesting alternatives
- g. Demonstrates maturity in taking responsibility for decisions

**2. *Problem Solving:*** *Recognizes problems and devises and implements plan of action*

- a. Demonstrates ability to detect problem through observation, inquiry, or directive
- b. Demonstrates ability to grasp appropriate overview and degree of seriousness of problem and to behave responsibly in situation
- c. Demonstrates ability to generate alternatives or options for problem solution

- d. Demonstrates ability to research options, assess and evaluate options, and determine appropriate and best solution
  - e. Demonstrates ability to initiate and effect solution
  - f. Demonstrates ability to take responsibility for outcomes
  - g. Demonstrates ability to effectively problem solve in individual, team, or group situations
3. ***Seeing Things In the Mind's Eye: Organizes, and processes symbols, pictures, graphs, objects, and other information***
- a. Functions at minimum or above required visual levels in order to see, interpret, attend and respond to visual imagery and meet safety requirements for necessary machinery
  - b. Demonstrates ability to read, interpret, and act upon signs, symbols, and other visual cues
  - c. Demonstrates ability to visually discriminate in gross and fine imagery
  - d. Demonstrates ability to visualize abstractly
  - e. Demonstrates ability to apply visual imagery to applied tasks
4. ***Knowing How to Learn: Use efficient learning techniques to acquire and apply new knowledge and skills***
- a. Demonstrates mastery of basic reading, math, and language skills through application
  - b. Demonstrates ability to translate abstract theory into practical application
  - c. Demonstrates ability to incorporate and generalize new learning into a sequential learning process
  - d. Demonstrates knowledge of good study skills and learning habits
5. ***Reasoning: Discovers a rule or principle underlying the relationship between two or more objects and applies it when solving a problem***
- a. Demonstrates use of simple logic
  - b. Demonstrates ability to distinguish relationships
  - c. Demonstrates ability to determine and isolate factors in relationships
  - d. Demonstrates and applies knowledge through practice
  - e. Recognizes that attitudes, skills, and practice are essential to productivity
  - f. Demonstrates ability to discriminate between positive and negative, and act accordingly
- C. **Personal Qualities:** Displays responsibility, self-esteem, sociability, self-management, and integrity and honesty

1. **Responsibility:** *Exerts a high level of effort and perseveres towards goal attainment*
  - a. Demonstrates ability to formulate realistic and useful short and long term goals and complete steps necessary to timely achieve goals
  - b. Demonstrates ability to make adjustments, revisions, and changes to achieve goals in a cooperative and polite manner
  - c. Demonstrates ability to focus on task at hand and work to completion
  - d. Demonstrates good work ethics through regular attendance, adequate classroom preparations, and appropriate use of classroom time
  - e. Demonstrates maturity to take responsibility for actions
  - f. Demonstrates ability to cooperatively work in individual, team, and group situations in timely and effective manner
2. **Self-Esteem:** *Believes in own self-worth and maintains a positive view of self*
  - a. Presents a positive attitude toward tasks
  - b. Demonstrates ability to separate work and personal behaviors
  - c. Actively participates in learning opportunities by sharing knowledge and skills with peers and instructors
  - d. Demonstrates ability to accept personal strengths and weaknesses and builds on positive behaviors
  - e. Demonstrates ability to accept and use constructive criticism
  - f. Accepts positive reinforcement in an appropriate manner
3. **Sociability:** *Demonstrates understanding, friendliness, adaptability, empathy, and politeness in group settings*
  - a. Demonstrates appropriate and acceptable social behaviors in interactions
  - b. Demonstrates ability to work cooperatively in individual, team, or group situations
  - c. Demonstrates active interest in peers by offering assistance, sharing resources, and sharing knowledge in a professional and acceptable manner
  - d. Demonstrates professional work ethic by separating work and personal social behaviors and acting accordingly
4. **Self-Management:** *Assesses self accurately, sets personal goals, monitors progress, and exhibits self-control*
  - a. Accepts personal strengths and weaknesses and uses the same for positive advancement

- b. Demonstrates ability to continuously set, assess, choose, and modify objectives as the situation demands in an appropriate manner
  - c. Demonstrates ability to formulate and follow personal schedules
  - d. Demonstrates ability to wisely use classroom time
  - e. Demonstrates use of good study habits and skills
  - f. Demonstrates maturity to take responsibility for own actions
5. *Integrity/Honesty: Chooses ethical courses of action*
- a. Knows and demonstrates ability to distinguish between positive and negative behaviors
  - b. Demonstrates honesty and integrity in working with peers and supervisors
  - c. Takes full responsibility for personal actions
  - d. Demonstrates understanding of consequences for negative ethical behaviors and accepts responsibility for same when applicable
  - e. Demonstrates positive work and social ethics in undertakings

### Appropriate Reference Materials:

---

1. MASTER Technical Modules:  
AET-A1 through AETA7;  
AET-A13;  
AET-B1 through AET-B3;  
AET-B5;  
AET-C1 through AET-C5;  
AET-D1;  
AET-E1 through AET-E13;  
AET-F5 through AET-F6;  
AET-H1; and  
AET-J3 through AET-J5.
2. *Motion Control*, Pub of Instrument Society of America (ISA), Latest Edition
3. *Industrial Computing*, Pub of Instrument Society of America (ISA), Latest Edition
4. *SME Journal*, Pub of Society of Manufacturing Engineers (SME), Latest Edition
5. *Manufacturing Engineering*, Pub of Society of Manufacturing Engineers (SME), Latest Edition



# MASTER PROGRAM

## Fluid Power Technology

### COURSE SYLLABUS

---

**Total lecture hours: 32**

**Total lab hours: 48**

**Credit hours: 3**

#### **COURSE DESCRIPTION:**

Investigates the basic principles of hydraulics and pneumatics through the use of hands-on experiments and classroom lectures. In addition, this course explores various hydraulic and pneumatic systems, circuits, components, and applications.

#### **PREREQUISITES:**

**Print Reading and Symbology;  
Manufacturing Processes**

#### **COURSE OBJECTIVES:**

After successful completion of this course, the student will be able to:

1. Use the text and classroom lectures to demonstrate the use of major systems that comprise a hydraulic or pneumatic system such as pumps, tanks, plumbing, fluid, rotary actuators, linear actuators, flow control valves, pressure control valves, directional control valves, pilot-operated hydraulic and pneumatic components, and solenoid operated hydraulic and pneumatic components;
2. Apply formulas and mathematics to calculate force, pressure, volume, horsepower, rod speed for linear actuators, rotational speed for rotary actuators, pumping rates for pumps, and pressures in various scales for both hydraulic and pneumatic systems;
3. Using pneumatic and hydraulic system, the learner will demonstrate the effects of pressure upon the volume of fluid or air in the system;
4. Using a pneumatic and a hydraulic system, the learner will demonstrate the effects of system pressure upon actuator speed;
5. Using a pneumatic and hydraulic system, the learner will demonstrate the effects of system flow upon actuator speed;
6. Using a pneumatic system, a hydraulic system, and directional control valves, the learner will measure pressure drops as a function of flow, the method of diverting flow, and the leakage rate of the valves;
7. Using a pneumatic and hydraulic system, the learner will measure the cracking pressure and operating characteristics of pressure control valves;
8. Using a hydraulic system, the learner will demonstrate the function and operating characteristics of hydraulic accumulators;

9. Using a pneumatic and hydraulic system, the learner will connect, measure, and demonstrate the operating characteristics of a regenerative circuit, an intensifier circuit, a counter balance circuit, a sequencing circuit, an unloading accumulator circuit, an accumulator emergency power circuit, a venturi circuit, and electrical control of hydraulic and pneumatic circuits; and,
10. Using a pneumatic and hydraulic system, the learner will demonstrate the proper instruments and troubleshooting methods used for fluid power circuits.

### REQUIRED COURSE MATERIALS:

**Textbook:** *Industrial Hydraulic Technology* by Parker Hannifin Inc.,  
Latest Edition

**Lab Manual:** None

### Materials:

- Paper
- Notebooks
- Writing instruments
- Protective laboratory apron
- Safety glasses
- Scientific calculator
- Scantron examination sheets

### METHODS OF INSTRUCTION:

**Lecture:** Presentations will include lecture, demonstration, and group problem solving.

**Laboratory:** Laboratory will be hands-on mathematical problem solving.

**Method of Evaluation:** A student's grade will be based on multiple measures of performance. The assessment will measure development of independent critical thinking skills and will include evaluation of the student's ability to:

1. Perform on written or oral examinations;
2. Perform on outside assignments;
3. Contribute to group problem solving;
4. Apply theory to problem solving; and,
5. Maintain attendance as per current policy;

### LECTURE OUTLINE:

Lecture Topics	Contact Hrs.
Hydraulic and Pneumatic Safety	
Basic Physical Laws for Fluid Power	
A. Pressure, force	

- B. Flow rate, velocity
- C. Work, power and horsepower
- D. Hydrostatic systems
- E. Hydrodynamic systems

**Hydraulics**

- A. Fluid power symbols
- B. Fluid properties
- C. Fluid storage, conditioning
- D. Fluid transmission
- E. Hydraulic pumps
- F. Control valves:
  - 1) Pressure
  - 2) Directional
  - 3) Flow
- G. Actuators:
  - 1) Linear
  - 2) Rotary
- H. Hydraulic circuits
- I. Troubleshooting

**Pneumatics**

- A. Pneumatic symbols
- B. Gas properties
- C. Transmission of gas for pneumatics
- D. Compressors
- E. Control valves:
  - 1) Pressure
  - 2) Directional
  - 3) Flow
- F. Actuators:
  - 1) Linear
  - 2) Rotary
- G. Venturies
- H. Pneumatic circuits
- I. Troubleshooting

Total Lecture Hours     32

**LAB OUTLINE:**

Lab Topics	Contact Hrs.
Hydraulic and Pneumatic Safety	
Basic Physical Laws for Fluid Power	
Hydraulics	
Pneumatics	
<b>Total Lab Hours</b>	<u>48</u>

## COURSE OBJECTIVES: SCANS COMPETENCIES

---

*The Secretary's Commission on Achieving Necessary Skills (SCANS), U.S. Department of Labor, has identified in its "AMERICA 2000 REPORT" that all students should develop a new set of competencies and foundation skills if they are to enjoy a productive, full and satisfying life. These are in addition to the Technical Workplace Competencies required by industry. SCANS is made up of five competencies and a three-part foundation of skills and personal qualities that are needed for solid job performance. All italicized headings in this section are direct quotations from "What Work Requires of Schools: A SCANS Report for America 2000."*

---

The following activities will be performed by each student for successful completion of this course:

### **I. COMPETENCIES**

- A. *Resources: Identifies, organizes, plans, and allocates resources***
  - 1. Allocates time to complete assigned tasks on schedule
  - 2. Determines and allocates required materials and resources for meeting objectives
  - 3. Evaluates skills, performance, and quality of work and provides feedback
- B. *Interpersonal: Works with others***
  - 1. Participates as a member of the team, contributing to group effort
  - 2. Provides individual assistance/direction to peers as requested
  - 3. Determines and meets expectations
  - 4. Exercises leadership qualities to effectively communicate ideas and make decisions.
  - 5. Negotiates resources in order to accomplish objectives
  - 6. Works well with all members of the class
- C. *Information: Acquires and uses information***
  - 1. Acquires and evaluates information
  - 2. Organizes and maintains information
  - 3. Interprets and communicates information
- D. *Systems: Understands complex inter-relationships***
  - 1. Understands and works well with social, organizational, and technological systems
  - 2. Monitors and corrects performance of system during operation
  - 3. Recommends modifications to system to improve performance
- E. *Technology: Works with a variety of technologies***
  - 1. Chooses relevant procedures, tools, and equipment
  - 2. Applies appropriate procedures and techniques to accomplish tasks

3. Identifies or solves problems to maintain equipment

## II. FOUNDATION SKILLS

- A. **Basic Skills:** Reads, writes, performs arithmetic and mathematical operations, listens and speaks
  1. *Reading: Locates, understands, and interprets written information in prose and in documents such as manuals, graphs, and schedules*
    - a. Demonstrates basic reading skills including abilities to perceive main ideas, draw appropriate conclusions, detect a sequence, locate answers, find facts, and infer from written texts
    - b. Demonstrates course specific reading skills including abilities to read, interpret, and comprehend information from text and supplemental materials on a level to facilitate productive independent and group study
    - c. Demonstrates ability to read, interpret, and utilize information from course specific instruments (i.e., charts, diagrams, graphs, schematics, blueprints, flow charts, etc.)
    - d. Demonstrates ability to read, interpret, and follow schedules and procedural instructions in a timely and appropriate manner
    - e. Demonstrates ability to choose and use most appropriate reading method (skim, scan, or read for comprehension) for materials
  2. *Writing: Communicates thoughts, ideas, information, and messages in writing; and creates documents such as letters, directions, manuals, reports, graphs, and flow charts*
    - a. Demonstrates basic writing skills including abilities to produce written documents which conform with accepted grammatical and communication standards required for effective daily functioning
    - b. Demonstrates effective written study skills including note taking, maintaining course specific journals, workbooks, manuals, etc.
    - c. Demonstrates technical writing skills in preparing outlines, summaries, time lines, flow charts, diagrams, etc. appropriate to materials covered
    - d. Demonstrates ability to complete all required writings in a timely, complete, and professional manner
    - e. Demonstrates competence in subject matter through the organization and presentation of answers to required written assessments

3. ***Arithmetic/Mathematics: Perform basic computations and approaches practical problems by choosing appropriately from a variety of mathematical techniques***
  - a. Demonstrates proficiency in basic arithmetic functions including ability to add, subtract, multiply, and divide whole numbers, fractions, decimals, and percentages
  - b. Demonstrates ability to read, comprehend, and select appropriate math procedures to work basic math problems
  - c. Demonstrates ability to understand and perform multi-step computations
  - d. Demonstrates ability to read, interpret, and use standard measuring devices
  - e. Demonstrates ability to comprehend, retain, and utilize course specific measuring devices effectively
  - f. Demonstrates ability to understand, retain, and utilize higher mathematical formulas and functions required for course specific math performance
  - g. Demonstrates ability to appropriately transfer mathematical calculations and information from paper to machines
4. ***Listening: Receives, attends to, interprets, and responds to verbal messages and other cues***
  - a. Functions at minimal or above required hearing levels to receive, attend, interpret, and respond to verbal messages and instructions and to safely operate machinery
  - b. Demonstrates ability to hear, comprehend, and appropriately follow directions
  - c. Demonstrates auditory ability to hear, comprehend, and utilize verbal classroom as well as other auditory instruction
  - d. Demonstrates ability to discriminate between essential and non-essential verbal information and react appropriately
  - e. Demonstrates ability to focus and fine-tune listening skills to receive, interpret, and respond to various sounds
  - f. Demonstrates ability and maturity to seek and receive additional individualized instruction as needed
5. ***Speaking: Organizes ideas and communicates orally***
  - a. Demonstrates appropriate listening and speaking skills in personal conversations
  - b. Demonstrates ability to choose and organize appropriate words to effectively communicate

- c. Demonstrates ability to speak clearly and distinctly with appropriate volume, tone, and body language for situation
- d. Demonstrates ability to spontaneously organize and present appropriate answers and/or short presentations for classroom and /or assessment purposes
- e. Demonstrates ability to formulate, organize, and deliver major presentations to peers or groups
- f. Demonstrates ability to speak effectively in one-on-one, small group, or large group presentations
- g. Demonstrates ability to take responsibility for presentations

**B. Thinking Skills:** Thinks creatively, makes decisions, solves problems, visualizes, knows how to learn and reasons

**1. Decision Making:** *Specifies goals and constraints, generates alternatives, considers risks, and evaluates and chooses best alternative*

- a. Demonstrates ability to objectively assess personal strengths and weaknesses
- b. Demonstrates ability to set realistic short-term and long-term goals
- c. Demonstrates ability to recognize and distinguish between positive and negative alternatives
- d. Demonstrates ability to identify potential pitfalls and take evasive actions
- e. Demonstrates ability to objectively and responsibly evaluate alternatives by testing hypotheses and selecting most appropriate response
- f. Demonstrates ability to profit from negative evaluations or mistakes by reformulating, redirecting, reconstructing, or retesting alternatives
- g. Demonstrates maturity in taking responsibility for decisions

**2. Problem Solving:** *Recognizes problems and devises and implements plan of action*

- a. Demonstrates ability to detect problem through observation, inquiry, or directive
- b. Demonstrates ability to grasp appropriate overview and degree of seriousness of problem and to behave responsibly in situation
- c. Demonstrates ability to generate alternatives or options for problem solution
- d. Demonstrates ability to research options, assess and evaluate options, and determine appropriate and best solution



- e. Demonstrates ability to initiate and effect solution
  - f. Demonstrates ability to take responsibility for outcomes
  - g. Demonstrates ability to effectively problem solve in individual, team, or group situations
3. *Seeing Things In the Mind's Eye: Organizes, and processes symbols, pictures, graphs, objects, and other information*
- a. Functions at minimum or above required visual levels in order to see, interpret, attend and respond to visual imagery and meet safety requirements for necessary machinery
  - b. Demonstrates ability to read, interpret, and act upon signs, symbols, and other visual cues
  - c. Demonstrates ability to visually discriminate in gross and fine imagery
  - d. Demonstrates ability to visualize abstractly
  - e. Demonstrates ability to apply visual imagery to applied tasks
4. *Knowing How to Learn: Use efficient learning techniques to acquire and apply new knowledge and skills*
- a. Demonstrates mastery of basic reading, math, and language skills through application
  - b. Demonstrates ability to translate abstract theory into practical application
  - c. Demonstrates ability to incorporate and generalize new learning into a sequential learning process
  - d. Demonstrates knowledge of good study skills and learning habits
5. *Reasoning: Discovers a rule or principle underlying the relationship between two or more objects and applies it when solving a problem*
- a. Demonstrates use of simple logic
  - b. Demonstrates ability to distinguish relationships
  - c. Demonstrates ability to determine and isolate factors in relationships
  - d. Demonstrates and applies knowledge through practice
  - e. Recognizes that attitudes, skills, and practice are essential to productivity
  - f. Demonstrates ability to discriminate between positive and negative, and act accordingly
- C. **Personal Qualities:** Displays responsibility, self-esteem, sociability, self-management, and integrity and honesty
1. *Responsibility: Exerts a high level of effort and perseveres towards goal attainment*

- a. Demonstrates ability to formulate realistic and useful short and long term goals and complete steps necessary to timely achieve goals
  - b. Demonstrates ability to make adjustments, revisions, and changes to achieve goals in a cooperative and polite manner
  - c. Demonstrates ability to focus on task at hand and work to completion
  - d. Demonstrates good work ethics through regular attendance, adequate classroom preparations, and appropriate use of classroom time
  - e. Demonstrates maturity to take responsibility for actions
  - f. Demonstrates ability to cooperatively work in individual, team, and group situations in timely and effective manner
2. ***Self-Esteem: Believes in own self-worth and maintains a positive view of self***
- a. Presents a positive attitude toward tasks
  - b. Demonstrates ability to separate work and personal behaviors
  - c. Actively participates in learning opportunities by sharing knowledge and skills with peers and instructors
  - d. Demonstrates ability to accept personal strengths and weaknesses and builds on positive behaviors
  - e. Demonstrates ability to accept and use constructive criticism
  - f. Accepts positive reinforcement in an appropriate manner
3. ***Sociability: Demonstrates understanding, friendliness, adaptability, empathy, and politeness in group settings***
- a. Demonstrates appropriate and acceptable social behaviors in interactions
  - b. Demonstrates ability to work cooperatively in individual, team, or group situations
  - c. Demonstrates active interest in peers by offering assistance, sharing resources, and sharing knowledge in a professional and acceptable manner
  - d. Demonstrates professional work ethic by separating work and personal social behaviors and acting accordingly
4. ***Self-Management: Assesses self accurately, sets personal goals, monitors progress, and exhibits self-control***
- a. Accepts personal strengths and weaknesses and uses the same for positive advancement

- b. Demonstrates ability to continuously set, assess, choose, and modify objectives as the situation demands in an appropriate manner
  - c. Demonstrates ability to formulate and follow personal schedules
  - d. Demonstrates ability to wisely use classroom time
  - e. Demonstrates use of good study habits and skills
  - f. Demonstrates maturity to take responsibility for own actions
5. ***Integrity/Honesty: Chooses ethical courses of action***
- a. Knows and demonstrates ability to distinguish between positive and negative behaviors
  - b. Demonstrates honesty and integrity in working with peers and supervisors
  - c. Takes full responsibility for personal actions
  - d. Demonstrates understanding of consequences for negative ethical behaviors and accepts responsibility for same when applicable
  - e. Demonstrates positive work and social ethics in undertakings

**Appropriate Reference Materials:**

---

1. MASTER Technical Modules:  
AET-A1 through AET-A9;  
AET-A13;  
AET-B1 through AET-B4;  
AET-C1 through AET-C5;  
AET-D1;  
AET-F1 through AET-F6;  
AET-F8;  
AET-H1;  
AET-J2; and,  
AET-J4.
2. *Fluid Power* by Vickers Inc., Latest Edition

AET 210  
05/052698

# MASTER PROGRAM

## Programmable Logic Controllers

### COURSE SYLLABUS

---

Total lecture hours: 32

Total lab hours: 48

Credit hours: 3

#### COURSE DESCRIPTION:

Studies the concepts associated with the operation, construction, interfacing, and programming of programmable logic controllers. The student will explore the relationship between symbolic reasoning using Boolean concepts and the solution of control problems in modern industrial equipment. In addition, the student will conduct experiments with digital circuits to understand digital logic concepts. This course includes hands-on laboratory experiences in constructing, operating, configuring, and programming programmable logic controllers.

**PREREQUISITES:**                      **Industrial Programming Theory;**  
**Industrial Electronics/Electricity**

#### COURSE OBJECTIVES:

After successful completion of this course, the student will:

1. Define the symbology and proper operation of the following: and, or, nand, nor, digital inversion, exclusive or, exclusive nor, flip/flops, counters, registers, memories;
2. Correctly solve basic logic problems using Boolean algebra, De Morgan's Theorems;
3. Use a multimeter or oscilloscope to test and troubleshoot digital circuits;
4. Develop a Boolean solution to a basic logic problem, express the solution to the problem in digital logic, and convert the digital logic solution to a ladder diagram;
5. Properly connect a computer to the communications port of the programmable logic controller and configure and program the controller;
6. Use ladder programming, Boolean programming, statement list programming, or other types of programming languages suitable for use with a programmable logic controller, and a hand-held programming unit, or a computer, and program the controller with a control solution; and,
7. Properly interface a programmable logic controller's control modules to digital and analog devices and control those devices.

## REQUIRED COURSE MATERIALS:

**Textbook:** *Programmable Controllers—Theory and Implementation* by Bryan, Latest Edition

**Lab Manual:** None

### Materials:

Paper

Notebooks

Writing instruments

Safety glasses

Scientific calculator

Scantron examination sheets

## METHODS OF INSTRUCTION:

---

**Lecture:** Presentations will include lecture, demonstration, and group problem solving.

**Laboratory:** Laboratory will be hands-on exploration and problem solving.

**Method of Evaluation:** A student's grade will be based on multiple measures of performance. The assessment will measure development of independent critical thinking skills and will include evaluation of the student's ability to:

1. Perform on written or oral examinations;
2. Perform on outside assignments;
3. Contribute to group problem solving;
4. Apply theory to problem solving; and,
5. Maintain attendance per current policy.

## LECTURE OUTLINE:

---

### Lecture Topics

### Contact Hrs.

---

#### Logic Symbology and Devices

A. Integrated circuits

B. Logic families

C. Waveform measurement

D. Gates

E. Combinational logic

F. Latches, flip/flops

G. Counters

H. Registers

I. Memories

#### Microprocessor Controller

#### Troubleshooting

- A. Elements of a microprocessor
  - B. Testing a microprocessor controlled system
- Introduction to Programmable Logic Controllers**

- A. Basic components of a PLC system
- B. Inputs, outputs, processing

**PLC Programming Languages**

- A. Boolean programming
- B. Ladder programming
- C. Statement list programming
- D. Flow chart programming

**PLC Digital I/O**

- A. Digital I/O
- B. Analog I/O
- C. Motion control
- D. Miscellaneous I/O

Total Lecture Hours     32

**LAB OUTLINE:**

Lab Topics	Contact Hrs.
Logic Symboly and Devices	
Microprocessor Controller	
Troubleshooting	
Introduction to Programmable Logic Controllers	
PLC Programming Languages	
PLC Digital I/O	
<b>Total Lab Hours</b>	<u>48</u>

**COURSE OBJECTIVES: SCANS COMPETENCIES**

*The Secretary's Commission on Achieving Necessary Skills (SCANS), U.S. Department of Labor, has identified in its "AMERICA 2000 REPORT" that all students should develop a new set of competencies and foundation skills if they are to enjoy a productive, full and satisfying life. These are in addition to the Technical Workplace Competencies required by industry. SCANS is made up of five competencies and a three-part foundation of skills and personal qualities that are needed for solid job performance. All italicized headings in this section are direct quotations from "What Work Requires of Schools: A SCANS Report for America 2000."*

The following activities will be performed by each student for successful completion of this course:

**I. COMPETENCIES**

- A. *Resources: Identifies, organizes, plans, and allocates resources*

1. Allocates time to complete assigned tasks on schedule
  2. Determines and allocates required materials and resources for meeting objectives
  3. Evaluates skills, performance, and quality of work and provides feedback
- B. *Interpersonal: Works with others***
1. Participates as a member of the team, contributing to group effort
  2. Provides individual assistance/direction to peers as requested
  3. Determines and meets expectations
  4. Exercises leadership qualities to effectively communicate ideas and make decisions.
  5. Negotiates resources in order to accomplish objectives
  6. Works well with all members of the class
- C. *Information: Acquires and uses information***
1. Acquires and evaluates information
  2. Organizes and maintains information
  3. Interprets and communicates information
- D. *Systems: Understands complex inter-relationships***
1. Understands and works well with social, organizational, and technological systems
  2. Monitors and corrects performance of system during operation
  3. Recommends modifications to system to improve performance
- E. *Technology: Works with a variety of technologies***
1. Chooses relevant procedures, tools, and equipment
  2. Applies appropriate procedures and techniques to accomplish tasks
  3. Identifies or solves problems to maintain equipment

## II. FOUNDATION SKILLS

- A. Basic Skills: Reads, writes, performs arithmetic and mathematical operations, listens and speaks**
1. ***Reading: Locates, understands, and interprets written information in prose and in documents such as manuals, graphs, and schedules***
    - a. Demonstrates basic reading skills including abilities to perceive main ideas, draw appropriate conclusions, detect a sequence, locate answers, find facts, and infer from written texts
    - b. Demonstrates course specific reading skills including abilities to read, interpret, and comprehend information from text and supplemental materials on a level to facilitate productive independent and group study



- c. Demonstrates ability to read, interpret, and utilize information from course specific instruments (i.e., charts, diagrams, graphs, schematics, blueprints, flow charts, etc.)
  - d. Demonstrates ability to read, interpret, and follow schedules and procedural instructions in a timely and appropriate manner
  - e. Demonstrates ability to choose and use most appropriate reading method (skim, scan, or read for comprehension) for materials
2. *Writing: Communicates thoughts, ideas, information, and messages in writing; and creates documents such as letters, directions, manuals, reports, graphs, and flow charts*
- a. Demonstrates basic writing skills including abilities to produce written documents which conform with accepted grammatical and communication standards required for effective daily functioning
  - b. Demonstrates effective written study skills including note taking, maintaining course specific journals, workbooks, manuals, etc.
  - c. Demonstrates technical writing skills in preparing outlines, summaries, time lines, flow charts, diagrams, etc. appropriate to materials covered
  - d. Demonstrates ability to complete all required writings in a timely, complete, and professional manner
  - e. Demonstrates competence in subject matter through the organization and presentation of answers to required written assessments
3. *Arithmetic/Mathematics: Perform basic computations and approaches practical problems by choosing appropriately from a variety of mathematical techniques*
- a. Demonstrates proficiency in basic arithmetic functions including ability to add, subtract, multiply, and divide whole numbers, fractions, decimals, and percentages
  - b. Demonstrates ability to read, comprehend, and select appropriate math procedures to work basic math problems
  - c. Demonstrates ability to understand and perform multi-step computations
  - d. Demonstrates ability to read, interpret, and use standard measuring devices
  - e. Demonstrates ability to comprehend, retain, and utilize course specific measuring devices effectively

- f. Demonstrates ability to understand, retain, and utilize higher mathematical formulas and functions required for course specific math performance
- g. Demonstrates ability to appropriately transfer mathematical calculations and information from paper to machines

4. ***Listening: Receives, attends to, interprets, and responds to verbal messages and other cues***

- a. Functions at minimal or above required hearing levels to receive, attend, interpret, and respond to verbal messages and instructions and to safely operate machinery
- b. Demonstrates ability to hear, comprehend, and appropriately follow directions
- c. Demonstrates auditory ability to hear, comprehend, and utilize verbal classroom as well as other auditory instruction
- d. Demonstrates ability to discriminate between essential and non-essential verbal information and react appropriately
- e. Demonstrates ability to focus and fine-tune listening skills to receive, interpret, and respond to various sounds
- f. Demonstrates ability and maturity to seek and receive additional individualized instruction as needed

5. ***Speaking: Organizes ideas and communicates orally***

- a. Demonstrates appropriate listening and speaking skills in personal conversations
- b. Demonstrates ability to choose and organize appropriate words to effectively communicate
- c. Demonstrates ability to speak clearly and distinctly with appropriate volume, tone, and body language for situation
- d. Demonstrates ability to spontaneously organize and present appropriate answers and/or short presentations for classroom and /or assessment purposes
- e. Demonstrates ability to formulate, organize, and deliver major presentations to peers or groups
- f. Demonstrates ability to speak effectively in one-on-one, small group, or large group presentations
- g. Demonstrates ability to take responsibility for presentations

B. **Thinking Skills: Thinks creatively, makes decisions, solves problems, visualizes, knows how to learn and reasons**

- 1. ***Decision Making: Specifies goals and constraints, generates alternatives, considers risks, and evaluates and chooses best alternative***

- a. Demonstrates ability to objectively assess personal strengths and weaknesses
  - b. Demonstrates ability to set realistic short-term and long-term goals
  - c. Demonstrates ability to recognize and distinguish between positive and negative alternatives
  - d. Demonstrates ability to identify potential pitfalls and take evasive actions
  - e. Demonstrates ability to objectively and responsibly evaluate alternatives by testing hypotheses and selecting most appropriate response
  - f. Demonstrates ability to profit from negative evaluations or mistakes by reformulating, redirecting, reconstructing, or retesting alternatives
  - g. Demonstrates maturity in taking responsibility for decisions
2. *Problem Solving: Recognizes problems and devises and implements plan of action*
- a. Demonstrates ability to detect problem through observation, inquiry, or directive
  - b. Demonstrates ability to grasp appropriate overview and degree of seriousness of problem and to behave responsibly in situation
  - c. Demonstrates ability to generate alternatives or options for problem solution
  - d. Demonstrates ability to research options, assess and evaluate options, and determine appropriate and best solution
  - e. Demonstrates ability to initiate and effect solution
  - f. Demonstrates ability to take responsibility for outcomes
  - g. Demonstrates ability to effectively problem solve in individual, team, or group situations
3. *Seeing Things In the Mind's Eye: Organizes, and processes symbols, pictures, graphs, objects, and other information*
- a. Functions at minimum or above required visual levels in order to see, interpret, attend and respond to visual imagery and meet safety requirements for necessary machinery
  - b. Demonstrates ability to read, interpret, and act upon signs, symbols, and other visual cues
  - c. Demonstrates ability to visually discriminate in gross and fine imagery
  - d. Demonstrates ability to visualize abstractly

- e. Demonstrates ability to apply visual imagery to applied tasks
- 4. ***Knowing How to Learn: Use efficient learning techniques to acquire and apply new knowledge and skills***
  - a. Demonstrates mastery of basic reading, math, and language skills through application
  - b. Demonstrates ability to translate abstract theory into practical application
  - c. Demonstrates ability to incorporate and generalize new learning into a sequential learning process
  - d. Demonstrates knowledge of good study skills and learning habits
- 5. ***Reasoning: Discovers a rule or principle underlying the relationship between two or more objects and applies it when solving a problem***
  - a. Demonstrates use of simple logic
  - b. Demonstrates ability to distinguish relationships
  - c. Demonstrates ability to determine and isolate factors in relationships
  - d. Demonstrates and applies knowledge through practice
  - e. Recognizes that attitudes, skills, and practice are essential to productivity
  - f. Demonstrates ability to discriminate between positive and negative, and act accordingly
- C. **Personal Qualities: Displays responsibility, self-esteem, sociability, self-management, and integrity and honesty**
  - 1. ***Responsibility: Exerts a high level of effort and perseveres towards goal attainment***
    - a. Demonstrates ability to formulate realistic and useful short and long term goals and complete steps necessary to timely achieve goals
    - b. Demonstrates ability to make adjustments, revisions, and changes to achieve goals in a cooperative and polite manner
    - c. Demonstrates ability to focus on task at hand and work to completion
    - d. Demonstrates good work ethics through regular attendance, adequate classroom preparations, and appropriate use of classroom time
    - e. Demonstrates maturity to take responsibility for actions
    - f. Demonstrates ability to cooperatively work in individual, team, and group situations in timely and effective manner

2. ***Self-Esteem: Believes in own self-worth and maintains a positive view of self***
  - a. Presents a positive attitude toward tasks
  - b. Demonstrates ability to separate work and personal behaviors
  - c. Actively participates in learning opportunities by sharing knowledge and skills with peers and instructors
  - d. Demonstrates ability to accept personal strengths and weaknesses and builds on positive behaviors
  - e. Demonstrates ability to accept and use constructive criticism
  - f. Accepts positive reinforcement in an appropriate manner
3. ***Sociability: Demonstrates understanding, friendliness, adaptability, empathy, and politeness in group settings***
  - a. Demonstrates appropriate and acceptable social behaviors in interactions
  - b. Demonstrates ability to work cooperatively in individual, team, or group situations
  - c. Demonstrates active interest in peers by offering assistance, sharing resources, and sharing knowledge in a professional and acceptable manner
  - d. Demonstrates professional work ethic by separating work and personal social behaviors and acting accordingly
4. ***Self-Management: Assesses self accurately, sets personal goals, monitors progress, and exhibits self-control***
  - a. Accepts personal strengths and weaknesses and uses the same for positive advancement
  - b. Demonstrates ability to continuously set, assess, choose, and modify objectives as the situation demands in an appropriate manner
  - c. Demonstrates ability to formulate and follow personal schedules
  - d. Demonstrates ability to wisely use classroom time
  - e. Demonstrates use of good study habits and skills
  - f. Demonstrates maturity to take responsibility for own actions
5. ***Integrity/Honesty: Chooses ethical courses of action***
  - a. Knows and demonstrates ability to distinguish between positive and negative behaviors
  - b. Demonstrates honesty and integrity in working with peers and supervisors
  - c. Takes full responsibility for personal actions

- d. Demonstrates understanding of consequences for negative ethical behaviors and accepts responsibility for same when applicable
- e. Demonstrates positive work and social ethics in undertakings

### **Appropriate Reference Materials:**

---

1. MASTER Technical Modules:  
AET-A1 through AET-A3;  
AET-A5;  
AET-B1 through AET-B5;  
AET-C2 through AET-C5;  
AET-D1;  
AET-G1 through AET-G4  
AET-H1;  
AET-I1; and,  
AET-J5.
2. *Industrial Computing/Programmable Logic Controllers*, Instrument Society of America (ISA) publication, Latest Edition
3. *Modern Industrial Electronics*, Revised and Expanded Edition, (formerly *Industrial Electronics and Robotics*), by Schuler/MacNamee, Latest Edition

AET 215  
05/052698

# MASTER PROGRAM

## Industrial Machine Technology

### COURSE SYLLABUS

---

**Total lecture hours: 32**

**Total lab hours: 48**

**Credit hours: 3**

#### **COURSE DESCRIPTION:**

Provides the student with an overview of typical machine shop operations and an introduction to welding technology.

**PREREQUISITES:**                      **Manufacturing Metrics and Calculations;  
Print Reading and Symbology**

#### **COURSE OBJECTIVES:**

After successful completion of this course, the student will:

1. Use measuring instruments such as micrometers, vernier calipers, depth gages, JO blocks, sine bars, and dial indicators, to set up machines, and machine parts to drawing specifications;
2. Apply formulas found in the study of machining technology to calculate the spindle speeds and feed rates to be employed in cutting parts on lathes and mills;
3. Use mills and lathes to machine a usable part to drawing specifications;
4. Apply safety training to perform to standards on a written safety examination; and,
5. Perform satisfactorily on a written examination that contains questions pertaining to robotics applications of welding technology such as TIG, MIG, and resistance welding.

#### **REQUIRED COURSE MATERIALS:**

**Textbook:**                      *Technology of Machine Tools*, by Krar/Oswald, Latest Edition

**Lab Manual:**                      None

#### **Materials:**

Paper  
Notebooks  
Writing instruments  
Protective lab apron  
Safety glasses



Scientific calculator  
Scantron examination sheets  
Cutting tool steel, raw stock

## METHODS OF INSTRUCTION:

---

**Lecture:** Presentations will include lecture, demonstration, and group problem solving.

**Laboratory:** Laboratory will be hands-on fabrication of part.

**Method of Evaluation:** A student's grade will be based on multiple measures of performance. The assessment will measure development of independent critical thinking skills and will include evaluation of the student's ability to:

1. Perform on written or oral examinations;
2. Perform on outside assignments;
3. Contribute to group problem solving;
4. Apply theory to problem solving; and,
5. Maintain attendance per current policy.

## LECTURE OUTLINE:

---

<u>Lecture Topics</u>	<u>Contact Hrs.</u>
<b>Machine Shop Safety</b>	
<b>Measuring Instruments</b>	
A. 0-1" O.D. micrometer	
B. 6" machinist scale	
C. 6" dial calipers	
D. Vernier calipers	
E. 0-1" dial indicator	
F. Depth micrometer	
<b>Lathe Practice</b>	
A. Indicate 3 and 4 jaw chucks	
B. Grinding cutting tool	
C. Turning operation, outside diameter	
D. Drilling operation	
E. Reaming operation	
F. Polishing operation	
<b>Milling Machine</b>	
A. Squaring work piece to machine	
B. Slot milling operation	
C. Drill and tap operations	
D. Deburring operations	
<b>Welding Technology</b>	
A. Arc welding	

- B. Heliarc welding
  - 1) MIG welding
  - 2) TIG welding
- C. Resistance welding
- D. Induction welding

Total Lecture Hours     32

**LAB OUTLINE:**

Lab Topics	Contact Hrs.
Machine Shop Safety	
Measuring Instruments	
Lathe Practice	
Milling Machine	
Welding Technology	
<b>Total Lab Hours</b>	<u><b>32</b></u>

**COURSE OBJECTIVES: SCANS COMPETENCIES**

*The Secretary's Commission on Achieving Necessary Skills (SCANS), U.S. Department of Labor, has identified in its "AMERICA 2000 REPORT" that all students should develop a new set of competencies and foundation skills if they are to enjoy a productive, full and satisfying life. These are in addition to the Technical Workplace Competencies required by industry. SCANS is made up of five competencies and a three-part foundation of skills and personal qualities that are needed for solid job performance. All italicized headings in this section are direct quotations from "What Work Requires of Schools: A SCANS Report for America 2000."*

The following activities will be performed by each student for successful completion of this course:

**I. COMPETENCIES**

- A. *Resources: Identifies, organizes, plans, and allocates resources*
  - 1. Allocates time to complete assigned tasks on schedule
  - 2. Determines and allocates required materials and resources for meeting objectives
  - 3. Evaluates skills, performance, and quality of work and provides feedback
- B. *Interpersonal: Works with others*
  - 1. Participates as a member of the team, contributing to group effort
  - 2. Provides individual assistance/direction to peers as requested
  - 3. Determines and meets expectations

4. Exercises leadership qualities to effectively communicate ideas and make decisions.
  5. Negotiates resources in order to accomplish objectives
  6. Works well with all members of the class
- C. *Information: Acquires and uses information***
1. Acquires and evaluates information
  2. Organizes and maintains information
  3. Interprets and communicates information
- D. *Systems: Understands complex inter-relationships***
1. Understands and works well with social, organizational, and technological systems
  2. Monitors and corrects performance of system during operation
  3. Recommends modifications to system to improve performance
- E. *Technology: Works with a variety of technologies***
1. Chooses relevant procedures, tools, and equipment
  2. Applies appropriate procedures and techniques to accomplish tasks
  3. Identifies or solves problems to maintain equipment

## II. FOUNDATION SKILLS

- A. *Basic Skills: Reads, writes, performs arithmetic and mathematical operations, listens and speaks***
1. ***Reading: Locates, understands, and interprets written information in prose and in documents such as manuals, graphs, and schedules***
    - a. Demonstrates basic reading skills including abilities to perceive main ideas, draw appropriate conclusions, detect a sequence, locate answers, find facts, and infer from written texts
    - b. Demonstrates course specific reading skills including abilities to read, interpret, and comprehend information from text and supplemental materials on a level to facilitate productive independent and group study
    - c. Demonstrates ability to read, interpret, and utilize information from course specific instruments (i.e., charts, diagrams, graphs, schematics, blueprints, flow charts, etc.)
    - d. Demonstrates ability to read, interpret, and follow schedules and procedural instructions in a timely and appropriate manner
    - e. Demonstrates ability to choose and use most appropriate reading method (skim, scan, or read for comprehension) for materials

2. **Writing:** *Communicates thoughts, ideas, information, and messages in writing; and creates documents such as letters, directions, manuals, reports, graphs, and flow charts*
  - a. Demonstrates basic writing skills including abilities to produce written documents which conform with accepted grammatical and communication standards required for effective daily functioning
  - b. Demonstrates effective written study skills including note taking, maintaining course specific journals, workbooks, manuals, etc.
  - c. Demonstrates technical writing skills in preparing outlines, summaries, time lines, flow charts, diagrams, etc. appropriate to materials covered
  - d. Demonstrates ability to complete all required writings in a timely, complete, and professional manner
  - e. Demonstrates competence in subject matter through the organization and presentation of answers to required written assessments
3. **Arithmetic/Mathematics:** *Perform basic computations and approaches practical problems by choosing appropriately from a variety of mathematical techniques*
  - a. Demonstrates proficiency in basic arithmetic functions including ability to add, subtract, multiply, and divide whole numbers, fractions, decimals, and percentages
  - b. Demonstrates ability to read, comprehend, and select appropriate math procedures to work basic math problems
  - c. Demonstrates ability to understand and perform multi-step computations
  - d. Demonstrates ability to read, interpret, and use standard measuring devices
  - e. Demonstrates ability to comprehend, retain, and utilize course specific measuring devices effectively
  - f. Demonstrates ability to understand, retain, and utilize higher mathematical formulas and functions required for course specific math performance
  - g. Demonstrates ability to appropriately transfer mathematical calculations and information from paper to machines
4. **Listening:** *Receives, attends to, interprets, and responds to verbal messages and other cues*
  - a. Functions at minimal or above required hearing levels to receive, attend, interpret, and respond to verbal messages and instructions and to safely operate machinery

- b. Demonstrates ability to hear, comprehend, and appropriately follow directions
  - c. Demonstrates auditory ability to hear, comprehend, and utilize verbal classroom as well as other auditory instruction
  - d. Demonstrates ability to discriminate between essential and non-essential verbal information and react appropriately
  - e. Demonstrates ability to focus and fine-tune listening skills to receive, interpret, and respond to various sounds
  - f. Demonstrates ability and maturity to seek and receive additional individualized instruction as needed
5. ***Speaking: Organizes ideas and communicates orally***
- a. Demonstrates appropriate listening and speaking skills in personal conversations
  - b. Demonstrates ability to choose and organize appropriate words to effectively communicate
  - c. Demonstrates ability to speak clearly and distinctly with appropriate volume, tone, and body language for situation
  - d. Demonstrates ability to spontaneously organize and present appropriate answers and/or short presentations for classroom and /or assessment purposes
  - e. Demonstrates ability to formulate, organize, and deliver major presentations to peers or groups
  - f. Demonstrates ability to speak effectively in one-on-one, small group, or large group presentations
  - g. Demonstrates ability to take responsibility for presentations
- B. **Thinking Skills:** Thinks creatively, makes decisions, solves problems, visualizes, knows how to learn and reasons
1. ***Decision Making: Specifies goals and constraints, generates alternatives, considers risks, and evaluates and chooses best alternative***
- a. Demonstrates ability to objectively assess personal strengths and weaknesses
  - b. Demonstrates ability to set realistic short-term and long-term goals
  - c. Demonstrates ability to recognize and distinguish between positive and negative alternatives
  - d. Demonstrates ability to identify potential pitfalls and take evasive actions
  - e. Demonstrates ability to objectively and responsibly evaluate alternatives by testing hypotheses and selecting most appropriate response

- f. Demonstrates ability to profit from negative evaluations or mistakes by reformulating, redirecting, reconstructing, or retesting alternatives
  - g. Demonstrates maturity in taking responsibility for decisions
2. *Problem Solving: Recognizes problems and devises and implements plan of action*
- a. Demonstrates ability to detect problem through observation, inquiry, or directive
  - b. Demonstrates ability to grasp appropriate overview and degree of seriousness of problem and to behave responsibly in situation
  - c. Demonstrates ability to generate alternatives or options for problem solution
  - d. Demonstrates ability to research options, assess and evaluate options, and determine appropriate and best solution
  - e. Demonstrates ability to initiate and effect solution
  - f. Demonstrates ability to take responsibility for outcomes
  - g. Demonstrates ability to effectively problem solve in individual, team, or group situations
3. *Seeing Things In the Mind's Eye: Organizes, and processes symbols, pictures, graphs, objects, and other information*
- a. Functions at minimum or above required visual levels in order to see, interpret, attend and respond to visual imagery and meet safety requirements for necessary machinery
  - b. Demonstrates ability to read, interpret, and act upon signs, symbols, and other visual cues
  - c. Demonstrates ability to visually discriminate in gross and fine imagery
  - d. Demonstrates ability to visualize abstractly
  - e. Demonstrates ability to apply visual imagery to applied tasks
4. *Knowing How to Learn: Use efficient learning techniques to acquire and apply new knowledge and skills*
- a. Demonstrates mastery of basic reading, math, and language skills through application
  - b. Demonstrates ability to translate abstract theory into practical application
  - c. Demonstrates ability to incorporate and generalize new learning into a sequential learning process
  - d. Demonstrates knowledge of good study skills and learning habits

5. **Reasoning:** *Discovers a rule or principle underlying the relationship between two or more objects and applies it when solving a problem*
    - a. Demonstrates use of simple logic
    - b. Demonstrates ability to distinguish relationships
    - c. Demonstrates ability to determine and isolate factors in relationships
    - d. Demonstrates and applies knowledge through practice
    - e. Recognizes that attitudes, skills, and practice are essential to productivity
    - f. Demonstrates ability to discriminate between positive and negative, and act accordingly
- C. **Personal Qualities:** Displays responsibility, self-esteem, sociability, self-management, and integrity and honesty
1. **Responsibility:** *Exerts a high level of effort and perseveres towards goal attainment*
    - a. Demonstrates ability to formulate realistic and useful short and long term goals and complete steps necessary to timely achieve goals
    - b. Demonstrates ability to make adjustments, revisions, and changes to achieve goals in a cooperative and polite manner
    - c. Demonstrates ability to focus on task at hand and work to completion
    - d. Demonstrates good work ethics through regular attendance, adequate classroom preparations, and appropriate use of classroom time
    - e. Demonstrates maturity to take responsibility for actions
    - f. Demonstrates ability to cooperatively work in individual, team, and group situations in timely and effective manner
  2. **Self-Esteem:** *Believes in own self-worth and maintains a positive view of self*
    - a. Presents a positive attitude toward tasks
    - b. Demonstrates ability to separate work and personal behaviors
    - c. Actively participates in learning opportunities by sharing knowledge and skills with peers and instructors
    - d. Demonstrates ability to accept personal strengths and weaknesses and builds on positive behaviors
    - e. Demonstrates ability to accept and use constructive criticism
    - f. Accepts positive reinforcement in an appropriate manner



3. ***Sociability: Demonstrates understanding, friendliness, adaptability, empathy, and politeness in group settings***
  - a. Demonstrates appropriate and acceptable social behaviors in interactions
  - b. Demonstrates ability to work cooperatively in individual, team, or group situations
  - c. Demonstrates active interest in peers by offering assistance, sharing resources, and sharing knowledge in a professional and acceptable manner
  - d. Demonstrates professional work ethic by separating work and personal social behaviors and acting accordingly
4. ***Self-Management: Assesses self accurately, sets personal goals, monitors progress, and exhibits self-control***
  - a. Accepts personal strengths and weaknesses and uses the same for positive advancement
  - b. Demonstrates ability to continuously set, assess, choose, and modify objectives as the situation demands in an appropriate manner
  - c. Demonstrates ability to formulate and follow personal schedules
  - d. Demonstrates ability to wisely use classroom time
  - e. Demonstrates use of good study habits and skills
  - f. Demonstrates maturity to take responsibility for own actions
5. ***Integrity/Honesty: Chooses ethical courses of action***
  - a. Knows and demonstrates ability to distinguish between positive and negative behaviors
  - b. Demonstrates honesty and integrity in working with peers and supervisors
  - c. Takes full responsibility for personal actions
  - d. Demonstrates understanding of consequences for negative ethical behaviors and accepts responsibility for same when applicable
  - e. Demonstrates positive work and social ethics in undertakings

### **Appropriate Reference Materials:**

---

1. MASTER Technical Modules:  
AET-A1 through AET-A4;  
AET-A6;  
AET C1;  
AET-D1; and,  
AET-H1.

2. *Machine Tools—Processes and Applications* by Genevro/Stephen, Latest Edition

AET 220  
05/052698

# MASTER PROGRAM

## Flexible Manufacturing Systems/Robotics

### COURSE SYLLABUS

---

Total lecture hours: 32

Total lab hours: 96

Credit hours: 4

#### COURSE DESCRIPTION:

Covers the design, installation, operation, and maintenance of a flexible manufacturing system. In addition, the role of robots and work centers in flexible manufacturing along with the theory and programming of these robots and work centers is included. Laboratory practice includes the assembly, interfacing, troubleshooting, and repair of various automated equipment and robots during the construction of a flexible manufacturing cell.

#### PREREQUISITES:

**Motion Control/Servo Systems;  
Fluid Power Technology;  
Programmable Logic Controllers**

#### COURSE OBJECTIVES:

After successful completion of this course, the student will:

1. Use an IBM compatible computer and an industrial robot to connect a RS-232-C communications interface to provide communications between the robot and a computer;
2. Use a teach pendant, tooling and an industrial robot to teach the robot to perform a complex function;
3. Use an IBM compatible computer and an industrial robot to create, load, and run a pelletizing program in the robot;
4. Interface a programmable logic controller and an industrial robot to provide on/off and serial digital communication between the two systems;
5. Calibrate an industrial robot, using tools and measuring instruments by adjusting the home position of the robot;
6. Use measuring instruments such as oscilloscopes, and tools to adjust the servo response of a CNC machine and an industrial robot;
7. Adjust the speed and slow down cushions of a bang-bang pick and place pneumatic robot;
8. Operate the types of automated equipment associated with flexible manufacturing systems; and,
9. Assemble, interface, troubleshoot, maintain, and repair a flexible manufacturing system.

## REQUIRED COURSE MATERIALS:

**Textbook:** *Modern Industrial Electronics*, Revised and Expanded Edition, by Schuler/MacNamee, (formerly, *Industrial Electronics and Robotics* by Schuler/MacNamee), Latest Edition

**Lab Manual:** None

### Materials:

Paper  
Notebooks  
Writing instruments  
Safety glasses  
Scientific calculator  
Scantron examination sheets

## METHODS OF INSTRUCTION:

---

**Lecture:** Presentations will include lecture, video, and group problem solving.

**Laboratory:** Laboratory will be hands-on construction and problem solving.

**Method of Evaluation:** A student's grade will be based on multiple measures of performance. The assessment will measure development of independent critical thinking skills and will include evaluation of the student's ability to:

1. Perform on written or oral examinations;
2. Perform on outside assignments;
3. Contribute to group problem solving;
4. Apply theory to problem solving; and,
5. Maintain attendance per current policy.

## LECTURE OUTLINE:

---

### Lecture Topics

### Contact Hrs.

---

#### Introduction

- A. Definition of Flexible Manufacturing Systems
- B. History of Flexible Manufacturing Systems
- C. Economics of Flexible Manufacturing
- D. Future Applications of Flexible Manufacturing
- E. Terminology

#### Components of a Flexible Manufacturing Cell

- A. Work stations
- B. Robots
- C. Materials handling system
- D. Automated storage/retrieval system

E. Supervisory computer system

**Types of Data Communication**

A. Digital Input/Outputs

B. Dedicated Data Lines

C. Local Area Networks

**Programmable Logic Controllers**

A. PLC functions

B. Programming

C. Interfacing

D. Purpose of a PLC for a FMS cell

**Supervisor Computers**

A. Purpose of supervisory computers in FMS

B. Types of computers used in FMS

C. Examples of cell control software

**Robot Functions in a FMS Cell**

A. Robot terminology

B. Robot operation

C. Robot programming

D. Robot troubleshooting and adjustments

**Flexible Manufacturing as a Part of**

**Computer Integrated Manufacturing**

**Total Lecture Hours**      32

**LAB OUTLINE:**

---

**Lab Topics**

**Contact Hrs.**

---

**Components of a Flexible Manufacturing Cell**

**Types of Data Communication**

**Programmable Logic Controllers**

**Supervisor Computers**

**Robot Functions in a FMS Cell**

**Total Lab Hours**      96

---

**COURSE OBJECTIVES: SCANS COMPETENCIES**

*The Secretary's Commission on Achieving Necessary Skills (SCANS), U.S. Department of Labor, has identified in its "AMERICA 2000 REPORT" that all students should develop a new set of competencies and foundation skills if they are to enjoy a productive, full and satisfying life. These are in addition to the Technical Workplace Competencies required by industry. SCANS is made up of five competencies and a three-part foundation of skills and personal qualities that are needed for solid job performance. All italicized headings in this section are direct quotations from "What Work Requires of Schools: A SCANS Report for America 2000."*

---

The following activities will be performed by each student for successful completion of this course:

## I. COMPETENCIES

- A. **Resources:** *Identifies, organizes, plans, and allocates resources*
  - 1. Allocates time to complete assigned tasks on schedule
  - 2. Determines and allocates required materials and resources for meeting objectives
  - 3. Evaluates skills, performance, and quality of work and provides feedback
- B. **Interpersonal:** *Works with others*
  - 1. Participates as a member of the team, contributing to group effort
  - 2. Provides individual assistance/direction to peers as requested
  - 3. Determines and meets expectations
  - 4. Exercises leadership qualities to effectively communicate ideas and make decisions.
  - 5. Negotiates resources in order to accomplish objectives
  - 6. Works well with all members of the class
- C. **Information:** *Acquires and uses information*
  - 1. Acquires and evaluates information
  - 2. Organizes and maintains information
  - 3. Interprets and communicates information
- D. **Systems:** *Understands complex inter-relationships*
  - 1. Understands and works well with social, organizational, and technological systems
  - 2. Monitors and corrects performance of system during operation
  - 3. Recommends modifications to system to improve performance
- E. **Technology:** *Works with a variety of technologies*
  - 1. Chooses relevant procedures, tools, and equipment
  - 2. Applies appropriate procedures and techniques to accomplish tasks
  - 3. Identifies or solves problems to maintain equipment

## II. FOUNDATION SKILLS

- A. **Basic Skills:** Reads, writes, performs arithmetic and mathematical operations, listens and speaks
  - 1. **Reading:** *Locates, understands, and interprets written information in prose and in documents such as manuals, graphs, and schedules*
    - a. Demonstrates basic reading skills including abilities to perceive main ideas, draw appropriate conclusions, detect a sequence, locate answers, find facts, and infer from written texts

- b. Demonstrates course specific reading skills including abilities to read, interpret, and comprehend information from text and supplemental materials on a level to facilitate productive independent and group study
  - c. Demonstrates ability to read, interpret, and utilize information from course specific instruments (i.e., charts, diagrams, graphs, schematics, blueprints, flow charts, etc.)
  - d. Demonstrates ability to read, interpret, and follow schedules and procedural instructions in a timely and appropriate manner
  - e. Demonstrates ability to choose and use most appropriate reading method (skim, scan, or read for comprehension) for materials
2. **Writing:** *Communicates thoughts, ideas, information, and messages in writing; and creates documents such as letters, directions, manuals, reports, graphs, and flow charts*
- a. Demonstrates basic writing skills including abilities to produce written documents which conform with accepted grammatical and communication standards required for effective daily functioning
  - b. Demonstrates effective written study skills including note taking, maintaining course specific journals, workbooks, manuals, etc.
  - c. Demonstrates technical writing skills in preparing outlines, summaries, time lines, flow charts, diagrams, etc. appropriate to materials covered
  - d. Demonstrates ability to complete all required writings in a timely, complete, and professional manner
  - e. Demonstrates competence in subject matter through the organization and presentation of answers to required written assessments
3. **Arithmetic/Mathematics:** *Perform basic computations and approaches practical problems by choosing appropriately from a variety of mathematical techniques*
- a. Demonstrates proficiency in basic arithmetic functions including ability to add, subtract, multiply, and divide whole numbers, fractions, decimals, and percentages
  - b. Demonstrates ability to read, comprehend, and select appropriate math procedures to work basic math problems
  - c. Demonstrates ability to understand and perform multi-step computations



- d. Demonstrates ability to read, interpret, and use standard measuring devices
  - e. Demonstrates ability to comprehend, retain, and utilize course specific measuring devices effectively
  - f. Demonstrates ability to understand, retain, and utilize higher mathematical formulas and functions required for course specific math performance
  - g. Demonstrates ability to appropriately transfer mathematical calculations and information from paper to machines
4. *Listening: Receives, attends to, interprets, and responds to verbal messages and other cues*
- a. Functions at minimal or above required hearing levels to receive, attend, interpret, and respond to verbal messages and instructions and to safely operate machinery
  - b. Demonstrates ability to hear, comprehend, and appropriately follow directions
  - c. Demonstrates auditory ability to hear, comprehend, and utilize verbal classroom as well as other auditory instruction
  - d. Demonstrates ability to discriminate between essential and non-essential verbal information and react appropriately
  - e. Demonstrates ability to focus and fine-tune listening skills to receive, interpret, and respond to various sounds
  - f. Demonstrates ability and maturity to seek and receive additional individualized instruction as needed
5. *Speaking: Organizes ideas and communicates orally*
- a. Demonstrates appropriate listening and speaking skills in personal conversations
  - b. Demonstrates ability to choose and organize appropriate words to effectively communicate
  - c. Demonstrates ability to speak clearly and distinctly with appropriate volume, tone, and body language for situation
  - d. Demonstrates ability to spontaneously organize and present appropriate answers and/or short presentations for classroom and /or assessment purposes
  - e. Demonstrates ability to formulate, organize, and deliver major presentations to peers or groups
  - f. Demonstrates ability to speak effectively in one-on-one, small group, or large group presentations
  - g. Demonstrates ability to take responsibility for presentations

- B. Thinking Skills:** Thinks creatively, makes decisions, solves problems, visualizes, knows how to learn and reasons
1. ***Decision Making:*** *Specifies goals and constraints, generates alternatives, considers risks, and evaluates and chooses best alternative*
    - a. Demonstrates ability to objectively assess personal strengths and weaknesses
    - b. Demonstrates ability to set realistic short-term and long-term goals
    - c. Demonstrates ability to recognize and distinguish between positive and negative alternatives
    - d. Demonstrates ability to identify potential pitfalls and take evasive actions
    - e. Demonstrates ability to objectively and responsibly evaluate alternatives by testing hypotheses and selecting most appropriate response
    - f. Demonstrates ability to profit from negative evaluations or mistakes by reformulating, redirecting, reconstructing, or retesting alternatives
    - g. Demonstrates maturity in taking responsibility for decisions
  2. ***Problem Solving:*** *Recognizes problems and devises and implements plan of action*
    - a. Demonstrates ability to detect problem through observation, inquiry, or directive
    - b. Demonstrates ability to grasp appropriate overview and degree of seriousness of problem and to behave responsibly in situation
    - c. Demonstrates ability to generate alternatives or options for problem solution
    - d. Demonstrates ability to research options, assess and evaluate options, and determine appropriate and best solution
    - e. Demonstrates ability to initiate and effect solution
    - f. Demonstrates ability to take responsibility for outcomes
    - g. Demonstrates ability to effectively problem solve in individual, team, or group situations
  3. ***Seeing Things In the Mind's Eye:*** *Organizes, and processes symbols, pictures, graphs, objects, and other information*
    - a. Functions at minimum or above required visual levels in order to see, interpret, attend and respond to visual imagery and meet safety requirements for necessary machinery

- b. Demonstrates ability to read, interpret, and act upon signs, symbols, and other visual cues
  - c. Demonstrates ability to visually discriminate in gross and fine imagery
  - d. Demonstrates ability to visualize abstractly
  - e. Demonstrates ability to apply visual imagery to applied tasks
4. ***Knowing How to Learn: Use efficient learning techniques to acquire and apply new knowledge and skills***
- a. Demonstrates mastery of basic reading, math, and language skills through application
  - b. Demonstrates ability to translate abstract theory into practical application
  - c. Demonstrates ability to incorporate and generalize new learning into a sequential learning process
  - d. Demonstrates knowledge of good study skills and learning habits
5. ***Reasoning: Discovers a rule or principle underlying the relationship between two or more objects and applies it when solving a problem***
- a. Demonstrates use of simple logic
  - b. Demonstrates ability to distinguish relationships
  - c. Demonstrates ability to determine and isolate factors in relationships
  - d. Demonstrates and applies knowledge through practice
  - e. Recognizes that attitudes, skills, and practice are essential to productivity
  - f. Demonstrates ability to discriminate between positive and negative, and act accordingly
- C. **Personal Qualities: Displays responsibility, self-esteem, sociability, self-management, and integrity and honesty**
1. ***Responsibility: Exerts a high level of effort and perseveres towards goal attainment***
- a. Demonstrates ability to formulate realistic and useful short and long term goals and complete steps necessary to timely achieve goals
  - b. Demonstrates ability to make adjustments, revisions, and changes to achieve goals in a cooperative and polite manner
  - c. Demonstrates ability to focus on task at hand and work to completion
  - d. Demonstrates good work ethics through regular attendance, adequate classroom preparations, and appropriate use of classroom time

- e. Demonstrates maturity to take responsibility for actions
  - f. Demonstrates ability to cooperatively work in individual, team, and group situations in timely and effective manner
2. ***Self-Esteem: Believes in own self-worth and maintains a positive view of self***
- a. Presents a positive attitude toward tasks
  - b. Demonstrates ability to separate work and personal behaviors
  - c. Actively participates in learning opportunities by sharing knowledge and skills with peers and instructors
  - d. Demonstrates ability to accept personal strengths and weaknesses and builds on positive behaviors
  - e. Demonstrates ability to accept and use constructive criticism
  - f. Accepts positive reinforcement in an appropriate manner
3. ***Sociability: Demonstrates understanding, friendliness, adaptability, empathy, and politeness in group settings***
- a. Demonstrates appropriate and acceptable social behaviors in interactions
  - b. Demonstrates ability to work cooperatively in individual, team, or group situations
  - c. Demonstrates active interest in peers by offering assistance, sharing resources, and sharing knowledge in a professional and acceptable manner
  - d. Demonstrates professional work ethic by separating work and personal social behaviors and acting accordingly
4. ***Self-Management: Assesses self accurately, sets personal goals, monitors progress, and exhibits self-control***
- a. Accepts personal strengths and weaknesses and uses the same for positive advancement
  - b. Demonstrates ability to continuously set, assess, choose, and modify objectives as the situation demands in an appropriate manner
  - c. Demonstrates ability to formulate and follow personal schedules
  - d. Demonstrates ability to wisely use classroom time
  - e. Demonstrates use of good study habits and skills
  - f. Demonstrates maturity to take responsibility for own actions
5. ***Integrity/Honesty: Chooses ethical courses of action***
- a. Knows and demonstrates ability to distinguish between positive and negative behaviors

- b. Demonstrates honesty and integrity in working with peers and supervisors
- c. Takes full responsibility for personal actions
- d. Demonstrates understanding of consequences for negative ethical behaviors and accepts responsibility for same when applicable
- e. Demonstrates positive work and social ethics in undertakings

**Appropriate Reference Materials:**

---

1. MASTER Technical Modules:  
AET-A1 through AET-A11;  
AET-B1 through AET-B5;  
AET-C1 through AET-C5;  
AET-D1;  
AET-E1 through AET-E13;  
AET-F1 through AET-F8;  
AET-G1 through AET-G4;  
AET-H1;  
AET-I1; and,  
AET-J1 through AET-J5.
2. *Industrial Computing*, Pub. of Instrument Society of America (ISA), Latest Edition
3. *Motion Control*, Pub. of Instrument Society of America (ISA), Latest Edition
4. *SME Journal*, Pub. of Society of Manufacturing Engineers (SME), Latest Edition
5. *Manufacturing Engineering*, Pub. of Society of Manufacturing Engineers (SME), Latest Edition

AET 225  
05/052898

MASTER

*a consortium of educators and industry*

EDUCATIONAL RESOURCES  
FOR THE  
MACHINE TOOL INDUSTRY

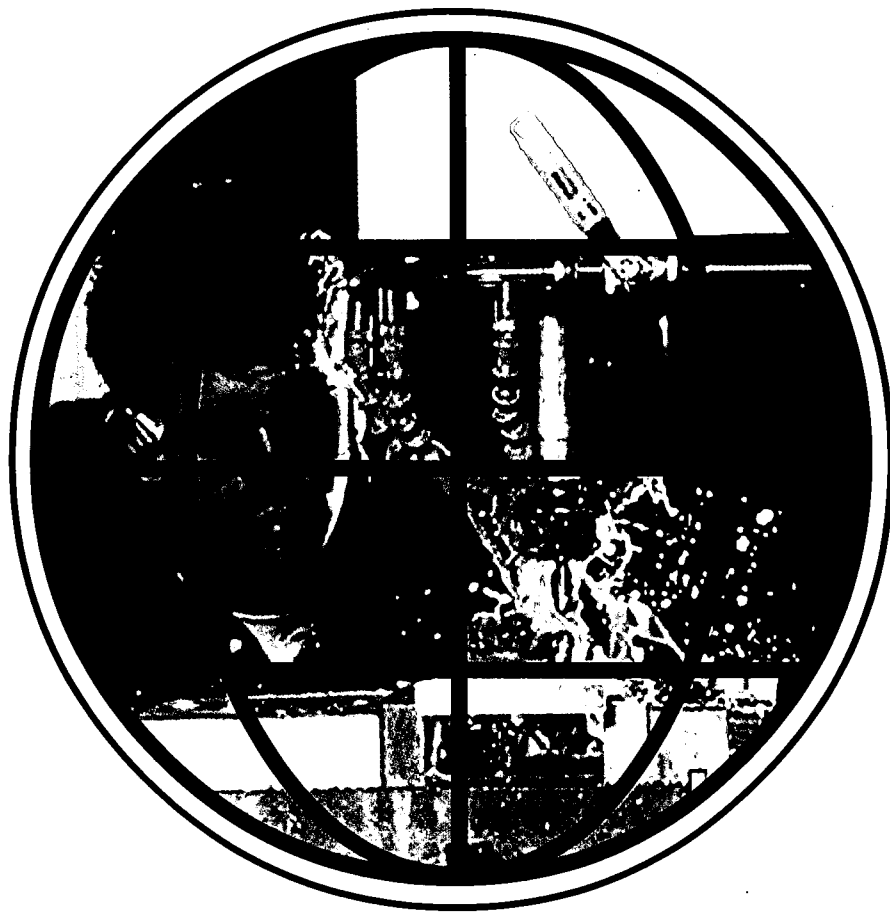

*Automated Equipment Repair Series*  
INSTRUCTOR'S HANDBOOK

141

Supported by the National Science Foundation's Advanced Technological Education Program

*a consortium of educators and industry*

EDUCATIONAL RESOURCES  
FOR THE  
MACHINE TOOL INDUSTRY



*Automated Equipment Repair Series*  
INSTRUCTOR'S HANDBOOK

142

BEST COPY AVAILABLE

*Supported by the National Science Foundation's Advanced Technological Education Program*





This material is based upon work supported by the  
National Science Foundation under Grant No. DUE-9553716

**National Science Foundation  
Advanced Technological  
Education Program**

"Any opinions, findings, and conclusions or recommendations  
expressed in this material are those of the author(s) and do  
not necessarily reflect the views of the Foundation."

**NOTE:**

Any references to **Handouts, Laboratory Exercises, Laboratory Aids, or Quizzes**, or any other materials that are not included in this book, may be obtained by contacting:

**Professor Douglas Welch**

***dwelch@cact-sd.org***  
(work web address)

**1-619-230-2080**  
(work phone number)

# ACKNOWLEDGEMENTS

This project was made possible by the cooperation and direct support of the following organizations:

National Science Foundation - Division of Undergraduate Education  
MASTER Consortia of Employers and Educators

*MASTER has built upon the foundation which was laid by the Machine Tool Advanced Skills Technology (MAST) Program. The MAST Program was supported by the U.S. Department of Education - Office of Vocational and Adult Education. Without this prior support MASTER could not have reached the level of quality and quantity that is contained in these project deliverables.*

## MASTER DEVELOPMENT CENTERS

Augusta Technical Institute - Central Florida Community College - Itawamba Community College - Moraine Valley Community College - San Diego City College (CACT) - Springfield Technical Community College - Texas State Technical College

## INDUSTRIES

AB Lasers - AIRCAP/MTD - ALCOA - American Saw - AMOCO Performance Products - Automatic Switch Company - Bell Helicopter - Bowen Tool - Brunner - Chrysler Corp. - Chrysler Technologies - Conveyor Plus - Darr Caterpillar - Davis Technologies - Delta International - Devon - D. J. Plastics - Eaton Leonard - EBTEC - Electro-Motive - Emergency One - Eureka - Foster Mold - GeoDiamond/Smith International - Greenfield Industries - Hunter Douglas - Industrial Laser - ITT Engineered Valve - Kaiser Aluminum - Krueger International - Laser Fare - Laser Services - Lockheed Martin - McDonnell Douglas - Mercury Tool - NASSCO - NutraSweet - Rapistan DEMAG - Reed Tool - ROHR, International - Searle - Solar Turbine - Southwest Fabricators - Smith & Wesson - Standard Refrigeration - Super Sagless - Taylor Guitars - Tecumseh - Teledyne Ryan - Thermal Ceramics - Thomas Lighting - FMC, United Defense - United Technologies Hamilton Standard

## COLLEGE AFFILIATES

Aiken Technical College - Bevil Center for Advanced Manufacturing Technology - Chicago Manufacturing Technology Extension Center - Great Lakes Manufacturing Technology Center - Indiana Vocational Technical College - Milwaukee Area Technical College - Okaloosa-Walton Community College - Piedmont Technical College - Pueblo Community College - Salt Lake Community College - Spokane Community College - Texas State Technical Colleges at Harlington, Marshall, Sweetwater

## FEDERAL LABS

Jet Propulsion Lab - Lawrence Livermore National Laboratory - L.B.J. Space Center (NASA) - Los Alamos Laboratory - Oak Ridge National Laboratory - Sandia National Laboratory - Several National Institute of Standards and Technology Centers (NIST) - Tank Automotive Research and Development Center (TARDEC) - Wright Laboratories

## SECONDARY SCHOOLS

Aiken Career Center - Chicopee Comprehensive High School - Community High School (Moraine, IL) - Connally ISD - Consolidated High School - Evans High - Greenwood Vocational School - Hoover Sr. High - Killeen ISD - LaVega ISD - Lincoln Sr. High - Marlin D - Midway ISD - Moraine Area Career Center - Morse Sr. High - Point Lamar Sr. High -

Pontotoc Ridge Area Vocational Center - Putnam Vocational High School - San Diego Sr. High - Tupelo-Lee Vocational Center - Waco ISD - Westfield Vocational High School

### **ASSOCIATIONS**

American Vocational Association (AVA) - Center for Occupational Research and Development (CORD) - CIM in Higher Education (CIMHE) - Heart of Texas Tech-Prep - Midwest (Michigan) Manufacturing Technology Center (MMTC) - National Coalition For Advanced Manufacturing (NACFAM) - National Coalition of Advanced Technology Centers (NCATC) - National Skills Standards Pilot Programs - National Tooling and Machining Association (NTMA) - New York Manufacturing Extension Partnership (NYMEP) - Precision Metalforming Association (PMA) - Society of Manufacturing Engineers (SME) - Southeast Manufacturing Technology Center (SMTC)

### **MASTER PROJECT EVALUATORS**

Dr. James Hales, East Tennessee State University and William Ruxton, formerly with the National Tooling and Machine Association (NTMA)

### **NATIONAL ADVISORY COUNCIL MEMBERS**

The National Advisory Council has provided input and guidance into the project since the beginning. Without their contributions, MASTER could not have been nearly as successful as it has been. Much appreciation and thanks go to each of the members of this committee from the project team.

Dr. Hugh Rogers-Dean of Technology-Central Florida Community College

Dr. Don Clark-Professor Emeritus-Texas A&M University

Dr. Don Edwards-Department of Management-Baylor University

Dr. Jon Botsford-Vice President for Technology-Pueblo Community College

Mr. Robert Swanson-Administrator of Human Resources-Bell Helicopter, TEXTRON

Mr. Jack Peck-Vice President of Manufacturing-Mercury Tool & Die

Mr. Don Hancock-Superintendent-Connally ISD

### **SPECIAL RECOGNITION**

Dr. Hugh Rogers recognized the need for this project, developed the baseline concepts and methodology, and pulled together industrial and academic partners from across the nation into a solid consortium. Special thanks and singular congratulations go to Dr. Rogers for his extraordinary efforts in this endeavor.

Dr. Don Pierson served as the Principal Investigator for the first two years of MASTER. His input and guidance of the project during the formative years was of tremendous value to the project team. Special thanks and best wishes go to Dr. Pierson during his retirement and all his worldly travels.

---

***All findings and deliverables resulting from MASTER are primarily based upon information provided by the above companies, schools and labs. We sincerely thank key personnel within these organizations for their commitment and dedication to this project. Including the national survey, more than 2,800 other companies and organizations participated in this project. We commend their efforts in our combined attempt to reach some common ground in precision manufacturing skills standards and curriculum development.***

---

**MASTER DEVELOPMENT CENTER, SAN DIEGO, CA**  
**Center for Applied Competitive Technologies**  
**San Diego City College**

Augustine P. Gallego, Chancellor  
**San Diego Community College District**  
Jerome Hunter, President  
**San Diego City College**  
Joan A. Stepsis, Dean/Director  
**Center for Applied Competitive Technologies**

1313 Twelfth Avenue  
San Diego, CA 92101-4787  
College phone: 619/230-2453, fax: 619/230-2063  
e-mail: jhunter@sdccd.cc.ca.us  
Center phone: 619/230-2080, fax: 619/230-2162  
e-mail: jstopsis@sdccd.cc.ca.us

---

### **Manufacturing in the San Diego Region**

Manufacturing represents a major sector of the San Diego economy, accounting for almost one out of every four dollars (24%) of San Diego's gross regional product. The county is currently home to approximately 3,500 manufacturers employing roughly 110,000 San Diegans. During the first half of the 1990s, manufacturing in San Diego was hard hit by the downturn in military and defense spending which accompanied the end of the cold war. Many of the region's largest aerospace contractors rapidly downsized or moved their plants out of state, leaving a large supplier base that needed to modernize its manufacturing processes and convert to commercial markets. Rapid recovery of manufacturing in the region has been driven by San Diego's high tech research and development sectors in electronics, telecommunications, software, advanced materials, biotechnology, and medical instrumentation.

### **San Diego City College and its Center for Applied Competitive Technologies (CACT)**

San Diego City College is an urban, minority institution, serving a large population of students from immigrant, disadvantaged, and low income households. In 1990, the College saw an opportunity to modernize its technical programs and improve the employment outlook for many of its students by agreeing to host one of the State of California's eight new regional manufacturing extension centers, the Centers for Applied Competitive Technologies (CACTs). The advanced technology centers were designed to assist local companies to modernize their manufacturing processes and convert from defense to newly emerging, technology-based commercial markets. This strategic partnership between the College and its resident CACT has proven to be highly successful. In developing the programs and lab facilities to serve the needs of regional manufacturing companies, the San Diego CACT and City College have simultaneously modernized the manufacturing and machine technology credit offerings of the College, thereby providing a well-trained, technically competent workforce for industry and enhancing career opportunities for students.

### **Development Team**

- **Project Director:** Joan A. Stepsis, Ph.D., Dean/Director of the CACT-SD, served as programmatic manager and academic coordinator for the MASTER project.
- **Subject Matter Expert:** John C. Bollinger, Assoc. Prof. of Machine Technology, had programmatic responsibility for developing skill standards and course/program materials for the Advanced CNC and CAM component of the MASTER project. Professor Bollinger also served as the lead instructor for the MASTER instructional pilot for his specialty area.
- **Subject Matter Expert:** Douglas R. Welch, Assoc. Prof. of Manufacturing, had programmatic responsibility for developing skill standards and course/program materials for the Automated Equipment Technology (AET) and Machine Tool Integration (CIM) component of the MASTER project. Professor Welch also served as lead instructor for the MASTER instructional pilot for his specialty area.

# **Introduction:**

## **INSTRUCTOR'S HANDBOOK**

Prior to the development of this Instructor's Handbook, MASTER project staff visited over 150 companies, conducted interviews with over 500 expert workers, and analyzed data from a national survey involving over 2800 participating companies. These investigations led to the development of a series of Instructor Handbooks, with each being fully industry-driven and specific to one of the technologies shown below.

Advanced CNC and CAM  
Automated Equipment Repair  
Computer Aided Design & Drafting  
Conventional Machining  
Industrial Maintenance  
Instrumentation  
LASER Machining  
Manufacturing Technology  
Mold Making  
Tool And Die  
Welding

Each Instructor's Handbook contains a collection of Technical Training Modules which are built around a Competency Profile for the specific occupation. **The Competency Profile which is the basis for this Instructor's Handbook, may be found on the following page (and on each of the tab pages of this book).**

Each Technical Training Module has been designed to be:

- \* Based on skill standards specified by industry. There must be a direct correlation between what industry needs and what is taught in the classroom and in the laboratory. For many years this type of training has been known as "competency-based training".
- \* Generic in nature. The training materials may then be customized by the trainer, for any given training situation based on the training need.
- \* Modular in design, to allow trainers to select lessons which are applicable to their training needs.
- \* Comprehensive, include training for advanced and emerging, highly-specialized manufacturing technologies.

- \* Self-contained, including all the components which might be needed by an experienced trainer. These components might include any or all of the following:
  - a standardized lesson plan,
  - an assessment instrument,
  - a listing of commercially available resources (e.g. recommended textbooks, instructor guides, student manuals, and videos),
  - new training materials, when suitable existing materials are not available (e.g., classroom handouts, transparency masters, and laboratory exercises).

This Instructor's Handbook is arranged by Duty groupings (Duty A, Duty B, etc.) with technical modules developed for each Task Box on the Competency Profile. Trainers are free to choose modules for a specific training need and combine modules to build individualized training programs.

This Instructor's Handbook is being offered with an accompanying Student Laboratory Manual for use by the students enrolled in the training program.



**AUTOMATED EQUIPMENT REPAIR TECHNICIAN ... operates, programs, maintains, and repairs automated machine tools and automated manufacturing processes.**

**Duties**

**Tasks**

Duties	A-1 Apply scientific notation and engineering notation to solve technical problems	A-2 Apply algebraic formulas to solve technical problems	A-3 Use variables in algebraic formulas to predict behavior of industrial systems	A-4 Manipulate algebraic formulas to analyze industrial systems	A-5 Measure, calculate, and convert quantities in English and metric (SI) measurement	A-6 Use mechanical physics to analyze mechanical industrial systems	A-7 Use mechanical physics to analyze mechanical industrial systems	A-8 Use mathematical physics to analyze problems found in pneumatic systems	A-9 Use mathematical dynamics to analyze problems found in industrial heat treating systems	A-10 Use mathematical and optics to analyze industrial systems	A-11 Use chemical formulas to predict and analyze reactions in chemical industrial processes	A-12 Apply the scientific method to analyze effects to analyze chemical industrial processes	A-13 Apply principles of water to analyze chemical industrial water treatment processes
<b>A</b> Apply Science to Industrial Problems													
<b>B</b> Use Drawings and Repair Systems	B-1 Use symbols, organization, and engineering drawings to identify mechanical systems	B-2 Use symbols, organization, and engineering drawings to identify electrical systems	B-3 Use symbols, organization, and engineering drawings to identify pneumatic systems	B-4 Use symbols, organization, and engineering drawings to identify hydraulic systems	B-5 Use symbols, organization, and engineering drawings to identify digital systems	B-6 Use symbols, organization, and engineering drawings to identify industrial systems	B-7 Use symbols, organization, and engineering drawings to identify mechanical systems	B-8 Use symbols, organization, and engineering drawings to identify pneumatic systems	B-9 Use symbols, organization, and engineering drawings to identify industrial heat treating systems	B-10 Use symbols, organization, and engineering drawings to identify industrial systems	B-11 Use symbols, organization, and engineering drawings to identify chemical industrial processes	B-12 Use symbols, organization, and engineering drawings to identify effects to analyze chemical industrial processes	B-13 Use symbols, organization, and engineering drawings to identify principles of water to analyze chemical industrial water treatment processes
<b>C</b> Use Calibrated Measuring Units to Troubleshoot Components	C-1 Apply machine tool metrology and measurement methods to align machine tools	C-2 Apply electrical measurement knowledge to troubleshoot electrical circuits	C-3 Apply electronic measurement knowledge to troubleshoot electronic circuits	C-4 Apply fluid power measurement knowledge to troubleshoot hydraulic systems	C-5 Apply digital electronic measurement knowledge to troubleshoot digital electronic circuits	C-6 Apply fluid power measurement knowledge to troubleshoot hydraulic systems	C-7 Use meters/oscilloscope to measure phase relationships in AC circuits	C-8 Apply electronic magnetics theory to determine operation of solenoids, transformers, and electrical motors for DC and AC circuits	C-9 Apply principles of operation of electrical motors to identify types of motors	C-10 Apply semiconductor theory and measurement techniques to troubleshoot characteristics of diodes, transistors, and power control semiconductor devices	C-11 Apply semiconductor theory and measurement techniques to troubleshoot characteristics of diodes, transistors, and power control semiconductor devices	C-12 Apply semiconductor theory and measurement techniques to troubleshoot characteristics of diodes, transistors, and power control semiconductor devices	C-13 Use electronic charts, meters, and oscilloscopes to troubleshoot and replace various types of electronic motor control circuits
<b>D</b> Resolve System Failures with Critical Thinking, Troubleshooting, Theory, and Metrology	D-1 Apply the troubleshooting process to the resolution of malfunctions found in machine tools and automated equipment	D-2 Calculate, predict, and measure quantities in DC circuits	D-3 Calculate, predict, and measure impedance quantities in AC circuits	D-4 Calculate, predict, and measure quantities in polyphase AC circuits	D-5 Properly set up, calibrate, and use meters and oscilloscopes	D-6 Use components such as resistors, inductors, capacitors, and test components	D-7 Use meters/oscilloscope to measure phase relationships in AC circuits	D-8 Apply electronic magnetics theory to determine operation of solenoids, transformers, and electrical motors for DC and AC circuits	D-9 Apply principles of operation of electrical motors to identify types of motors	D-10 Apply semiconductor theory and measurement techniques to troubleshoot characteristics of diodes, transistors, and power control semiconductor devices	D-11 Apply semiconductor theory and measurement techniques to troubleshoot characteristics of diodes, transistors, and power control semiconductor devices	D-12 Apply semiconductor theory and measurement techniques to troubleshoot characteristics of diodes, transistors, and power control semiconductor devices	D-13 Use electronic charts, meters, and oscilloscopes to troubleshoot and replace various types of electronic motor control circuits
<b>E</b> Use Techniques to Isolate Malfunctions of Electrical/Electronic Systems	E-1 Identify and explain the theory and use of major systems that comprise a pneumatic system	E-2 Apply pneumatic valves in a hydraulic or pneumatic system to troubleshoot components or systems	E-3 Identify, assemble, and apply knowledge of operating characteristics of pneumatic actuators	E-4 Apply hydraulic knowledge to test, troubleshoot, and compare special components/devices	E-5 Identify, assemble, and apply knowledge of operating characteristics of electrical systems	E-6 Use components such as resistors, inductors, capacitors, and test components	E-7 Use meters/oscilloscope to measure phase relationships in AC circuits	E-8 Apply electronic magnetics theory to determine operation of solenoids, transformers, and electrical motors for DC and AC circuits	E-9 Apply principles of operation of electrical motors to identify types of motors	E-10 Apply semiconductor theory and measurement techniques to troubleshoot characteristics of diodes, transistors, and power control semiconductor devices	E-11 Apply semiconductor theory and measurement techniques to troubleshoot characteristics of diodes, transistors, and power control semiconductor devices	E-12 Apply semiconductor theory and measurement techniques to troubleshoot characteristics of diodes, transistors, and power control semiconductor devices	E-13 Use electronic charts, meters, and oscilloscopes to troubleshoot and replace various types of electronic motor control circuits
<b>F</b> Measure/Isolate Malfunctions of Mechanical/Fluid Power Systems	F-1 Identify and explain the theory and use of major systems that comprise a pneumatic system	F-2 Apply pneumatic valves in a hydraulic or pneumatic system to troubleshoot components or systems	F-3 Identify, assemble, and apply knowledge of operating characteristics of pneumatic actuators	F-4 Apply hydraulic knowledge to test, troubleshoot, and compare special components/devices	F-5 Identify, assemble, and apply knowledge of operating characteristics of electrical systems	F-6 Use components such as resistors, inductors, capacitors, and test components	F-7 Use meters/oscilloscope to measure phase relationships in AC circuits	F-8 Apply electronic magnetics theory to determine operation of solenoids, transformers, and electrical motors for DC and AC circuits	F-9 Apply principles of operation of electrical motors to identify types of motors	F-10 Apply semiconductor theory and measurement techniques to troubleshoot characteristics of diodes, transistors, and power control semiconductor devices	F-11 Apply semiconductor theory and measurement techniques to troubleshoot characteristics of diodes, transistors, and power control semiconductor devices	F-12 Apply semiconductor theory and measurement techniques to troubleshoot characteristics of diodes, transistors, and power control semiconductor devices	F-13 Use electronic charts, meters, and oscilloscopes to troubleshoot and replace various types of electronic motor control circuits
<b>G</b> Apply Computer Science to Computer Controlled Industrial Equipment	G-1 Perform digital operations on PLC equipment	G-2 Perform Boolean operations on PLC equipment	G-3 Solve digital logic circuits and programs in electrical and programmable logic control circuits	G-4 Program computers and controlled industrial equipment	G-5 Identify, assemble, and apply knowledge of operating characteristics of electrical systems	G-6 Use components such as resistors, inductors, capacitors, and test components	G-7 Use meters/oscilloscope to measure phase relationships in AC circuits	G-8 Apply electronic magnetics theory to determine operation of solenoids, transformers, and electrical motors for DC and AC circuits	G-9 Apply principles of operation of electrical motors to identify types of motors	G-10 Apply semiconductor theory and measurement techniques to troubleshoot characteristics of diodes, transistors, and power control semiconductor devices	G-11 Apply semiconductor theory and measurement techniques to troubleshoot characteristics of diodes, transistors, and power control semiconductor devices	G-12 Apply semiconductor theory and measurement techniques to troubleshoot characteristics of diodes, transistors, and power control semiconductor devices	G-13 Use electronic charts, meters, and oscilloscopes to troubleshoot and replace various types of electronic motor control circuits
<b>H</b> Correct Malfunctions in PLC Controlled Industrial Equipment	H-1 Perform operations on PLC (programmable logic controller) equipment	H-2 Apply Boolean operations on PLC equipment	H-3 Identify, assemble, and apply knowledge of operating characteristics of pneumatic actuators	H-4 Apply hydraulic knowledge to test, troubleshoot, and compare special components/devices	H-5 Identify, assemble, and apply knowledge of operating characteristics of electrical systems	H-6 Use components such as resistors, inductors, capacitors, and test components	H-7 Use meters/oscilloscope to measure phase relationships in AC circuits	H-8 Apply electronic magnetics theory to determine operation of solenoids, transformers, and electrical motors for DC and AC circuits	H-9 Apply principles of operation of electrical motors to identify types of motors	H-10 Apply semiconductor theory and measurement techniques to troubleshoot characteristics of diodes, transistors, and power control semiconductor devices	H-11 Apply semiconductor theory and measurement techniques to troubleshoot characteristics of diodes, transistors, and power control semiconductor devices	H-12 Apply semiconductor theory and measurement techniques to troubleshoot characteristics of diodes, transistors, and power control semiconductor devices	H-13 Use electronic charts, meters, and oscilloscopes to troubleshoot and replace various types of electronic motor control circuits
<b>I</b> Resolve Malfunctions Found in Computer Systems Controlling Manufacturing Processes	I-1 Use equipment specifications to troubleshoot set up of a computer system and save programs	I-2 Safely assemble, disassemble, and adjust mechanical systems, shafts, couplings, pulleys, belts	I-3 Safely assemble, disassemble, and adjust electrical systems or components	I-4 Safely assemble, disassemble, or adjust electronic systems or components	I-5 Safely assemble, disassemble, or adjust digital systems or components	I-6 Use symbols, organization, and engineering drawings to identify industrial systems	I-7 Use symbols, organization, and engineering drawings to identify mechanical systems	I-8 Use symbols, organization, and engineering drawings to identify pneumatic systems	I-9 Use symbols, organization, and engineering drawings to identify industrial heat treating systems	I-10 Use symbols, organization, and engineering drawings to identify industrial systems	I-11 Use symbols, organization, and engineering drawings to identify chemical industrial processes	I-12 Use symbols, organization, and engineering drawings to identify effects to analyze chemical industrial processes	I-13 Use symbols, organization, and engineering drawings to identify principles of water to analyze chemical industrial water treatment processes
<b>J</b> Assemble/Disassemble Mechanical/Electrical/Electronic Computer Systems	J-1 Use equipment specifications to troubleshoot set up of a computer system and save programs	J-2 Safely assemble, disassemble, and adjust mechanical systems, shafts, couplings, pulleys, belts	J-3 Safely assemble, disassemble, and adjust electrical systems or components	J-4 Safely assemble, disassemble, or adjust electronic systems or components	J-5 Safely assemble, disassemble, or adjust digital systems or components	J-6 Use symbols, organization, and engineering drawings to identify industrial systems	J-7 Use symbols, organization, and engineering drawings to identify mechanical systems	J-8 Use symbols, organization, and engineering drawings to identify pneumatic systems	J-9 Use symbols, organization, and engineering drawings to identify industrial heat treating systems	J-10 Use symbols, organization, and engineering drawings to identify industrial systems	J-11 Use symbols, organization, and engineering drawings to identify chemical industrial processes	J-12 Use symbols, organization, and engineering drawings to identify effects to analyze chemical industrial processes	J-13 Use symbols, organization, and engineering drawings to identify principles of water to analyze chemical industrial water treatment processes

**AUTOMATED EQUIPMENT REPAIR TECHNICIAN ... operates, programs, maintains, and repairs automated machine tools and automated manufacturing processes.**

**Duties**

**Tasks**

Duties	A1 Apply scientific condition and solution to solve technical problems	A2 Apply algebraic formulas to solve technical problems	A3 Use variables in algebraic equations to predict behavior of industrial systems	A4 Manipulate variables in formulas to analyze industrial systems	A5 Measure, calculate, and use metric (SI, mks) systems	A6 Use mechanical physics to analyze industrial systems	A7 Use mechanical physics to analyze industrial systems	A8 Use math and thermodynamics to analyze industrial systems	A9 Use math and thermodynamics to analyze industrial systems	A10 Use math, physics, and thermodynamics to analyze industrial systems	A11 Use chemical principles and reactions in chemical processes	A12 Apply the knowledge of chemical processes to analyze industrial systems	A13 Apply principles of water to analyze industrial processes
<b>A</b> Apply Science to Solve Industrial Problems	B-1 Use symbols, organization, and engineering values on technical drawings	B-2 Use symbols, organization, and engineering values on technical drawings	B-3 Use symbols, organization, and engineering values on technical drawings	B-4 Use symbols, organization, and engineering values on fluid power drawings	B-5 Use symbols, organization, and engineering values on digital systems	B-6 Use symbols, organization, and engineering values on digital systems	B-7 Use symbols, organization, and engineering values on digital systems	B-8 Use symbols, organization, and engineering values on digital systems	B-9 Use symbols, organization, and engineering values on digital systems	B-10 Use symbols, organization, and engineering values on digital systems	B-11 Use symbols, organization, and engineering values on digital systems	B-12 Use symbols, organization, and engineering values on digital systems	B-13 Use symbols, organization, and engineering values on digital systems
<b>B</b> Use Drawings to Analyze and Repair Systems	C-1 Apply mechanical measurement instruments to machine tools	C-2 Apply electrical measurement instruments to electrical circuits	C-3 Apply electronic measurement instruments to electronic circuits	C-4 Apply pneumatic measurement instruments to pneumatic systems	C-5 Apply digital measurement instruments to digital electronic circuits	C-6 Apply hydraulic measurement instruments to hydraulic systems	C-7 Apply pneumatic measurement instruments to pneumatic systems	C-8 Apply electrical measurement instruments to electrical circuits	C-9 Apply electronic measurement instruments to electronic circuits	C-10 Apply digital measurement instruments to digital electronic circuits	C-11 Apply pneumatic measurement instruments to pneumatic systems	C-12 Apply hydraulic measurement instruments to hydraulic systems	C-13 Apply electrical measurement instruments to electrical circuits
<b>C</b> Use Calibrated Measuring Instruments to Test/Calibrate Components	D-1 Apply troubleshooting resolution of malfunctions found in industrial machinery and automated equipment	D-2 Calculate, predict, and measure the quantities in DC circuits	D-3 Calculate, predict, and measure the quantities in AC circuits	D-4 Calculate, predict, and measure the quantities in polyphase AC circuits	D-5 Properly set up, calibrate, and use meters and oscilloscopes	D-6 Use components such as resistors, inductors, and capacitors in circuits and test components	D-7 Use meters/oscilloscopes to measure phase shift or amplitude in capacitive/inductive AC circuits	D-8 Apply electromagnetism theory to determine operational characteristics of solenoids, transformers, and electrical motors for AC circuits	D-9 Apply electromagnetism theory to determine operational characteristics of solenoids, transformers, and electrical motors for AC circuits	D-10 Apply electromagnetism theory to determine operational characteristics of solenoids, transformers, and electrical motors for AC circuits	D-11 Apply semiconductor theory and measurement techniques to determine operational characteristics of rectifiers, amplifiers, and sensors	D-12 Apply semiconductor theory and measurement techniques to determine operational characteristics of rectifiers, amplifiers, and sensors	D-13 Use schematic diagrams, meters, and oscilloscopes to troubleshoot and repair or replace various types of electronic motor control circuits
<b>D</b> Resolve System Critical Thinking, Troubleshooting, Theory, and Metrology	E-1 Identify and explain the use of major systems that comprise hydraulic or pneumatic systems	E-2 Apply pneumatic and hydraulic systems	E-3 Identify, assemble, measure, and test hydraulic and pneumatic actuators	E-4 Apply hydraulic, pneumatic, and electrical terms knowledge to test, trouble shoot, and repair pneumatic components	E-5 Identify, assemble, measure, and test electrical circuits	E-6 Identify, assemble, measure, and test electrical circuits	E-7 Use laws of simple machines to identify and test complex machines	E-8 Apply hydraulic, pneumatic, and electrical terms knowledge to test, trouble shoot, and repair pneumatic components	E-9 Apply hydraulic, pneumatic, and electrical terms knowledge to test, trouble shoot, and repair pneumatic components	E-10 Apply hydraulic, pneumatic, and electrical terms knowledge to test, trouble shoot, and repair pneumatic components	E-11 Apply hydraulic, pneumatic, and electrical terms knowledge to test, trouble shoot, and repair pneumatic components	E-12 Apply hydraulic, pneumatic, and electrical terms knowledge to test, trouble shoot, and repair pneumatic components	E-13 Use laws of simple machines to identify and test complex machines
<b>E</b> Use Techniques to Isolate Malfunctions of Electronic Systems	F-1 Perform digital operations using binary systems	F-2 Perform Boolean operations in digital equipment	F-3 Solve digital logic circuits and ladder diagrams	F-4 Program computers and control equipment	F-5 Safely assemble, disassemble, or adjust electronic systems or components	F-6 Safely assemble, disassemble, or adjust electronic systems or components	F-7 Use laws of simple machines to identify and test complex machines	F-8 Apply hydraulic, pneumatic, and electrical terms knowledge to test, trouble shoot, and repair pneumatic components	F-9 Apply hydraulic, pneumatic, and electrical terms knowledge to test, trouble shoot, and repair pneumatic components	F-10 Apply hydraulic, pneumatic, and electrical terms knowledge to test, trouble shoot, and repair pneumatic components	F-11 Apply hydraulic, pneumatic, and electrical terms knowledge to test, trouble shoot, and repair pneumatic components	F-12 Apply hydraulic, pneumatic, and electrical terms knowledge to test, trouble shoot, and repair pneumatic components	F-13 Use laws of simple machines to identify and test complex machines
<b>F</b> Measure/Isolate Malfunctions of Fluid Power Systems	G-1 Perform digital operations using binary systems	G-2 Perform Boolean operations in digital equipment	G-3 Solve digital logic circuits and ladder diagrams	G-4 Program computers and control equipment	G-5 Safely assemble, disassemble, or adjust electronic systems or components	G-6 Safely assemble, disassemble, or adjust electronic systems or components	G-7 Use laws of simple machines to identify and test complex machines	G-8 Apply hydraulic, pneumatic, and electrical terms knowledge to test, trouble shoot, and repair pneumatic components	G-9 Apply hydraulic, pneumatic, and electrical terms knowledge to test, trouble shoot, and repair pneumatic components	G-10 Apply hydraulic, pneumatic, and electrical terms knowledge to test, trouble shoot, and repair pneumatic components	G-11 Apply hydraulic, pneumatic, and electrical terms knowledge to test, trouble shoot, and repair pneumatic components	G-12 Apply hydraulic, pneumatic, and electrical terms knowledge to test, trouble shoot, and repair pneumatic components	G-13 Use laws of simple machines to identify and test complex machines
<b>G</b> Apply Computer Science to Control Industrial Equipment	H-1 Perform operations on PLC (programmable logic controller) or PLC (programmable logic controller) systems	H-2 Safely assemble, disassemble, or adjust just subsystems or components of power systems	H-3 Safely assemble, disassemble, or adjust just subsystems or components of power systems	H-4 Safely assemble, disassemble, or adjust just subsystems or components of power systems	H-5 Safely assemble, disassemble, or adjust just subsystems or components of power systems	H-6 Safely assemble, disassemble, or adjust just subsystems or components of power systems	H-7 Use laws of simple machines to identify and test complex machines	H-8 Apply hydraulic, pneumatic, and electrical terms knowledge to test, trouble shoot, and repair pneumatic components	H-9 Apply hydraulic, pneumatic, and electrical terms knowledge to test, trouble shoot, and repair pneumatic components	H-10 Apply hydraulic, pneumatic, and electrical terms knowledge to test, trouble shoot, and repair pneumatic components	H-11 Apply hydraulic, pneumatic, and electrical terms knowledge to test, trouble shoot, and repair pneumatic components	H-12 Apply hydraulic, pneumatic, and electrical terms knowledge to test, trouble shoot, and repair pneumatic components	H-13 Use laws of simple machines to identify and test complex machines
<b>H</b> Correct Malfunctions in PLC Controlled Industrial Equipment	I-1 Use equipment manuals, specifications, and data entry/monitoring devices to troubleshoot set up of a computer system and solve problems	I-2 Safely assemble, disassemble, and adjust mechanical systems, shafts, couplings, pulleys, belts	I-3 Safely assemble, disassemble, or adjust just subsystems or components of power systems	I-4 Safely assemble, disassemble, or adjust just subsystems or components of power systems	I-5 Safely assemble, disassemble, or adjust just subsystems or components of power systems	I-6 Safely assemble, disassemble, or adjust just subsystems or components of power systems	I-7 Use laws of simple machines to identify and test complex machines	I-8 Apply hydraulic, pneumatic, and electrical terms knowledge to test, trouble shoot, and repair pneumatic components	I-9 Apply hydraulic, pneumatic, and electrical terms knowledge to test, trouble shoot, and repair pneumatic components	I-10 Apply hydraulic, pneumatic, and electrical terms knowledge to test, trouble shoot, and repair pneumatic components	I-11 Apply hydraulic, pneumatic, and electrical terms knowledge to test, trouble shoot, and repair pneumatic components	I-12 Apply hydraulic, pneumatic, and electrical terms knowledge to test, trouble shoot, and repair pneumatic components	I-13 Use laws of simple machines to identify and test complex machines
<b>I</b> Resolve Malfunctions Found in Computer Systems Controlling Processes	J-1 Safely assemble, disassemble, and adjust mechanical systems, shafts, couplings, pulleys, belts	J-2 Safely assemble, disassemble, or adjust just subsystems or components of power systems	J-3 Safely assemble, disassemble, or adjust just subsystems or components of power systems	J-4 Safely assemble, disassemble, or adjust just subsystems or components of power systems	J-5 Safely assemble, disassemble, or adjust just subsystems or components of power systems	J-6 Safely assemble, disassemble, or adjust just subsystems or components of power systems	J-7 Use laws of simple machines to identify and test complex machines	J-8 Apply hydraulic, pneumatic, and electrical terms knowledge to test, trouble shoot, and repair pneumatic components	J-9 Apply hydraulic, pneumatic, and electrical terms knowledge to test, trouble shoot, and repair pneumatic components	J-10 Apply hydraulic, pneumatic, and electrical terms knowledge to test, trouble shoot, and repair pneumatic components	J-11 Apply hydraulic, pneumatic, and electrical terms knowledge to test, trouble shoot, and repair pneumatic components	J-12 Apply hydraulic, pneumatic, and electrical terms knowledge to test, trouble shoot, and repair pneumatic components	J-13 Use laws of simple machines to identify and test complex machines
<b>J</b> Assemble/Disassemble Mechanical Electrical Electronic Systems													

# **AUTOMATED EQUIPMENT REPAIR SERIES**

## **MASTER Technical Module No. AET-A1**

---

**Subject:** Automated Equipment Repair **Time:** 6 Hrs.

**Duty:** Apply Science to Solve Industrial Problems

**Task:** Apply Scientific Notation and Engineering Notation to Solve Technical Problems

---

### **Objective(s):**

Upon completion of this unit the student will be able to use scientific notation and engineering notation to express mathematical values that are given or obtained by measurement, and apply these mathematical values to the solution of technical problems.

---

### **Instructional Materials:**

Machinists steel rule

Multimeter

Resistor color code chart and selected resistors

Inexpensive scientific/engineering calculator

MASTER Handout (AET-A1-HO-1)

MASTER Handout (AET-A1-HO-2) (The Fifteen Rules of Math Necessary to Solve Any Algebra Problem or Equation)

MASTER Handout (AET-A1-HO-3) (Math Quick Reference Sheet)

MASTER Laboratory Exercise (AET-A1-LE)

MASTER Quiz AET-A1-QU-1: Quiz on scientific notation

MASTER Quiz AET-A1-QU-2: Quiz on engineering notation

---

### **References:**

*Elementary Technical Mathematics*, Ewen/Nelson, Latest Edition

*Technical Mathematics with Calculus*, Peterson, Latest Edition

---

### **Student Preparation:**

This is the first Automated Equipment Repair module.

---

---

### **Introduction:**

The ability to use engineering notation in the repair of automated equipment is essential. A technician who does not know how to interpret information that is

presented in engineering notation is not adequately prepared to work in this field. The study of engineering notation cannot be accomplished without the knowledge of scientific notation. Automated equipment technicians must be prepared to recognize and use scientific notation as well as engineering notation. Engineering notation is designed to provide clarity to drawings, while scientific notation is used in applications such as research and development.

---

---

### **Presentation Outline:**

- I. **Apply Scientific Notation**
  - A. **Discuss the organization and rationale for the decimal system**
    - 1. **History, ten fingers, ten toes, other numbering systems**
    - 2. **Divide a multi-column decimal number into its component parts**
    - 3. **Show how each column is a power of ten with a multiplier**
  - B. **Discuss the organization of a decimal number in scientific notation**
    - 1. **Define the multiplier**
    - 2. **Define the powers of ten**
  - C. **Demonstrate the creation of a number in scientific notation**
    - 1. **Take examples from the audience**
    - 2. **Measure dimensions of mechanical parts and electronic measurements**
    - 3. **Use measurements taken from atoms and celestial objects**
    - 4. **Create numbers in scientific notation from examples**
  - D. **Demonstrate procedures for using a scientific calculator to calculate problems in scientific notation**
- II. **Apply Engineering Notation**
  - A. **Discuss the organization and rationale for the engineering notation system**
    - 1. **Used for clarity on engineering drawings and specifications**
    - 2. **Discuss alphabetical symbols associated with engineering notation**
    - 3. **Show how each symbol is a power of ten**
    - 4. **Discuss the numeric value of the multiplier**
  - B. **Discuss the organization of a decimal number in engineering notation**
    - 1. **Define the multiplier**
    - 2. **Define the alphabetic symbol for powers of ten**
  - C. **Demonstrate the creation of a number in engineering notation**
    - 1. **Take examples from the audience and examples from scientific notation**
    - 2. **Explain the resistor color codes**
    - 3. **Use measurements taken from mechanisms, hydraulics, and electronics**
    - 4. **Create numbers in engineering notation from examples**

5. Demonstrate the results on the engineering notation symbols when engineering notation numbers are multiplied and divided
- D. Demonstrate procedures for using a scientific calculator to calculate problems in engineering notation

---

---

**Practical Application:**

1. Using a machinist's rule, measure mechanical parts, and express the results in scientific notation;
2. Calculate selected problems in scientific notation using a scientific calculator;
3. Using the resistor color codes, read resistors, and express the results in engineering notation; and,
4. Calculate selected problems in engineering notation using a scientific calculator.

---

---

**Evaluation and/or Verification:**

Successful completion of this technical module will be based on the student's successful completion of the following components:

1. Ten question quiz on conversion of decimal numbers into scientific notation;
2. Ten question quiz on calculations using scientific notation;
3. Successful demonstration of the ability to use a scientific calculator to perform calculations in scientific notation;
4. Ten question quiz on conversion of decimal numbers and scientific notation numbers into engineering notation;
5. Ten question quiz on calculations using engineering notation; and,
6. Successful demonstration of the ability to use a scientific calculator to perform calculations in engineering notation.

---

---

**Summary:**

Review the main lesson points using the suggested texts listed in the reference section of this module. Hold class discussion and answer student questions.

---

---

**Next Lesson Assignment:**

**MASTER Technical Module (AET-A2)** dealing with using algebraic formulas to solve technical problems.

**AET-A1-HO-1**  
**Apply Scientific Notation and Engineering Notation**  
**to Solve Technical Problems**  
Attachment 1: MASTER Handout No. 1

---

**Objective(s):**

Upon completion of this unit the student will be able to use scientific notation and engineering notation to express mathematical values that are given or obtained by measurement, and apply these mathematical values to the solution of technical problems.

---

**Module Outline:**

- I. Apply Scientific Notation
  - A. Discuss the organization and rationale for the decimal system
    - 1. History, ten fingers, ten toes, other numbering systems
    - 2. Divide a multi-column decimal number into its component parts
    - 3. Show how each column is a power of ten with a multiplier
  - B. Discuss the organization of a decimal number in scientific notation
    - 1. Define the multiplier
    - 2. Define the powers of ten
  - C. Demonstrate the creation of a number in scientific notation
    - 1. Take examples from the audience
    - 2. Measure dimensions of mechanical parts and electronic measurements
    - 3. Use measurements taken from atoms and celestial objects
    - 4. Create numbers in scientific notation from examples
  - D. Demonstrate procedures for using a scientific calculator to calculate problems in scientific notation
- II. Apply Engineering Notation
  - A. Discuss the organization and rationale for the engineering notation system
    - 1. Used for clarity on engineering drawings and specifications
    - 2. Discuss alphabetical symbols associated with engineering notation
    - 3. Show how each symbol is a power of ten
    - 4. Discuss the numeric value of the multiplier
  - B. Discuss the organization of a decimal number in engineering notation
    - 1. Define the multiplier
    - 2. Define the alphabetic symbol for powers of ten
  - C. Demonstrate the creation of a number in engineering notation
    - 1. Take examples from the audience and examples from scientific notation

2. Explain the resistor color codes
  3. Use measurements taken from mechanisms, hydraulics, and electronics
  4. Create numbers in engineering notation from examples
  5. Demonstrate the results on the engineering notation symbols when engineering notation numbers are multiplied and divided
- D. Demonstrate procedures for using a scientific calculator to calculate problems in engineering notation



**AET-A1-HO-2**  
**Apply Scientific Notation and Engineering Notation**  
**to Solve Technical Problems**  
**Attachment 2: MASTER Handout No. 2**

---

**The Fifteen Rules of Math**  
**Necessary to Solve Any Technical Algebra Problem or Equation**  
**Definitions**

<b>Variable</b>	A general symbolic letter term used to define a mathematical relationship. Also a letter that represents an unknown number. A variable may be multiplied, divided, added, subtracted, etc., like any other real number.
<b>Coefficient</b>	A real number that indicates the quantity of variables in question. For example, $3x$ means that I have 3 of the $x$ variables. The number 3 is the coefficient of $x$ . A variable by itself has an implied coefficient of 1.
<b>Constant</b>	A real number whose value is known and can never change.
<b>Polynomial</b>	An algebraic expression containing two or more terms that are associated by addition or subtraction.
<b>Equation</b>	A monomial or polynomial that is set equal to another value (constant, monomial, or polynomial).
<b>Exponent</b>	A number that indicates how many times I need to multiply a number by itself. For example, $x^3$ means that I need to multiply $x$ by $x$ three times. The number 3 is the exponent.
<b>Reciprocal</b>	A number that is divided into 1.
<b>Base</b>	The number that will be raised to a power by an exponent.
<b>Negative number</b>	The mirror image of a positive number. For every positive real number, a negative counterpart exists. Negative numbers are used extensively in math, but have no

realistic counterparts in the real world. However, most important discoveries have been made using the negative number concept.

1. ***The rules of addition, subtraction, multiplication, and division of positive and negative numbers:***
  - A. When adding number that have like signs, add the numbers and give the result the same sign. When adding numbers of unlike signs, subtract the smaller number from the larger number and give the result the sign of the larger number.
  - B. When subtracting any combination of signed numbers, alike or unlike, change the sign of the number or expression that is being subtracted from another number to the opposite sign, and proceed as in addition. Use the following rules:
    - (1) If the sign of the number or expression is negative, change it to positive.
    - (2) If the sign is positive, change it to negative.
  - C. When multiplying signed numbers, if the signs are the same (both positive or negative) the result is positive. If the signs are unlike, the result is negative.
  - D. When dividing signed numbers, if the signs are the same (both positive or negative) the result is positive. If the signs are unlike, the result is negative.
2. ***The addition, subtraction, multiplication, and division axioms:***
  - A. If equals are added to equals, then the results will be equal.
  - B. If equals are subtracted from equals, then the results will be equal.
  - C. If equals are multiplied by equals, then the results will be equal.
  - D. If equals are divided by equals, then the results will be equal.
3. ***The order of operations - Please Excuse My Dear Aunt Sally***  
Parentheses, Exponents, Multiplication, Division, Addition, Subtraction.  
(Also perform operations from left to right).
4. ***The associative rule - The order of grouping is not important to the outcome for addition and multiplication.***  
Examples:  
$$a + b + c = (a + b) + c = a + (b + c)$$
$$a * b * c = (a * b) * c = a * (b * c)$$
5. ***The distributive rule - When a polynomial is multiplied by a variable, constant, or other polynomial, the variable, constant, or polynomial is multiplied by each term in the polynomial.***

Examples:

$$a(b + c + d) = ab + ac + ad$$

$$2x(a + b - c) = 2xa + 2xb - 2xc$$

$$5y(2y + 3x) = 10y^2 + 15xy$$

**6. *The identity rule - Equals are Equal to Equals.***

Examples:

$$a = a \quad x = x$$

If  $X = B$  and  $Y$  equals  $B$  then  $X = Y$

$$\text{If } X = 2a + 3c \text{ and } X = 4y + 5b \text{ then } 2a + 3c = 4y + 5b$$

**7. *If a number is multiplied by its reciprocal, the result is one.***

$$a * 1/a = 1$$

(also applies to dividing a number by itself)

**8. *If any number is multiplied by zero the result is zero.***

$$a * 0 = 0$$

**9. *All constants or variables have an implied coefficient of one.***

$$a = 1*a$$

$$14 = 1*(14)$$

(also applies to multiplying a number by one)

**10. *Division of a variable by zero is undefined and a illegal operation.***

$$x/0 = ?$$

**11. *Any number raised to the zero (0) power is one (1). Any number raised to the first (1) power is the number itself.***

Examples:

$$a^0 = 1$$

$$1,234,567,123,456,123,345,567,999^0 = 1$$

$$a^1 = a$$

$$10,234^1 = 10,234$$

**12. *When two equal number bases, raised to a power, are multiplied times each other, the exponents are added.***

Examples:

$$a^2 * a^4 = a^6$$

$$X^a * X^b = X^{(a+b)}$$

(the numbers *must* be the same base)

**13. *When two equal number bases, raised to a power, are divided, the exponents are subtracted.***

Examples:

$$a^2 / a^4 = a^{-2}$$

$$X^a / X^b = X^{(a-b)}$$

(the numbers *must* be the same base)

14. *When a number, raised to a power, is again raised to a power, the exponents are multiplied times each other.*

Examples:

$$(a^2)^3 = a^6$$

$$(x^3)^4 = x^{12}$$

15. *A number raised to a negative power is the reciprocal of the number multiplied by itself that number of times.*

Examples:

$$X^{-3} = 1/X * 1/X * 1/X = 1/X^3$$

$$10^{-4} = 1/10 * 1/10 * 1/10 * 1/10 = 1/10^4$$

**AET-A1-HO-3**  
**Apply Scientific Notation and Engineering Notation**  
**to Solve Technical Problems**  
**Attachment 3: MASTER Handout No. 3**

---

**Math Quick Reference**

1. **Goal: To understand the convention for stating math formulas for mathematical rules (not applied math).**  
x, y, z,... represents a variable in a math formula  
a, b, c,... represents a number in a math formula
  
2. **Goal: To understand the rules for adding, subtracting, multiplying, and dividing signed numbers.**

**Addition: For a = 15 and b = 6**

When a is plus and b is plus:  $(+a)+(+b) = +(a+b)$

Example  $(+15)+(+6) = +(15+6) = +21$

When a is minus and b is minus:  $(-a)+(-b) = -(a+b)$

Example  $(-15)+(-6) = -(15+6) = -21$

When a or b is minus, and the remaining quantity is plus  $(-a)+(+b) =$   
or  $(+a)+(-b) = ?$  **Take the smaller number from the larger number**  
**and give the result the sign of the larger number.**

Example:  $(-15) + (+6) = -(15-6) = -9$  (the larger number is -15)

or

Example:  $(+15) + (-6) = +(15-6) = +9$  (the larger number is +15)

**Subtraction:**

When the subtrahend is "b"  $(a)-(b) = ?$

**To avoid confusion, always change the sign (plus or minus) of "b" and proceed as in addition.**

**To change the sign of b, use the following rules:**

If b is positive  $-(+b)$  then change to -b

If b is negative  $-(-b)$  then change to +b

Example: For a = +19 and b = +7

$(+19)-(+7) = (+19) + (-7) = +(19-7) = +12$

Example: For a = -19 and b = +7

$(-19)-(+7) = (-19) + (-7) = -(19+7) = -26$

### Multiplication:

If both a and b are positive  $(+a)*(+b) = +(ab)$

If both a and b are negative  $(-a)*(-b) = +(ab)$

If either a or b are negative:

$$(-a)*(+b) = -(ab)$$

or

$$(+a)*(-b) = -(ab)$$

Example: For a = 12 and b = 3

$$(+12)*(+3) = +(12*3) = +36$$

Example: For a = -12 and b = -3

$$(-12)*(-3) = +(12*3) = +36$$

Example: For a = -12 and b = +3

$$(-12)*(+3) = -(12*3) = -36$$

### Division:

If both a and b are positive  $(+a)/(+b) = +(a/b)$

If both a and b are negative  $(-a)/(-b) = +(a/b)$

If either a or b are negative:

$$(+a)/(-b) = -(a/b)$$

or

$$(-a)/(+b) = -(a/b)$$

Example: For a = 12 and b = 3

$$(+12)/(+3) = +(12/3) = +4$$

Example: For a = -12 and b = -3

$$(-12)/(-3) = +(12/3) = +4$$

Example: For a = -12 and b = +3

$$(-12)/(+3) = -(12/3) = -4$$

Example: For a = +12 and b = -3

$$(+12)/(-3) = -(12/3) = -4$$

### 3. Goal: To understand the rules for exponents

For  $a^N$ : "a" is called the *base*. " $N$ " is called the *exponent*.

If a is multiplied by itself " $N$ " number of times:  $a*a*a*a...a^N = a^N$

Example: For a = 4

$$4*4*4 = 4^3$$

$$a*a*a*a*a = a^5$$

$$(1/a)*(1/a)*(1/a)...*(1/a^N) = a^{-N}$$

Example: For  $a = 10$   
 $(1/10) * (1/10) * (1/10) = 10^{-3}$

Special cases of exponents:

$$a^0 = 1$$
$$a^1 = a$$

**Note: Bases must be the same!**

Multiplication of Exponents

$$a^b * a^c = a^{(b+c)}$$

Division of Exponents:

$$a^b / a^c = a^{(b-c)}$$

4. **Goal: To understand the reason for using scientific notation, and the rules for scientific notation.**

Scientific notation is primarily used to multiply and divide very large and very small numbers.

A number expressed in scientific notation consists of a *multiplier* equal to or greater than 1 and less than 10, and a *base* of 10 raised to a power.

Example: 12,560,000 and .000748

Multiplier	Times	Base 10
1.256	*	$10^7$
7.48	*	$10^{-4}$

To combine the bases, use the rules for exponents and signed numbers.

*A number expressed in scientific notation cannot be added or subtracted unless the bases and exponents of both numbers are equal.*

5. **Goal: To understand the reason for using engineering notation and the rules of engineering notation.**

Engineering notation is used to prevent confusion on blueprints.

Engineering notation is like scientific notation with the following exceptions:

- The multiplier can be any number greater than 0 and less than 1000.
- The base is expressed as a *letter* which represents a power of 10.

$$G \text{ (Giga)} = 10^9$$



$$M \text{ (Mega)} = 10^6$$

$$k \text{ (kilo)} = 10^3$$

$$\text{units} = 10^0$$

$$m \text{ (milli)} = 10^{-3}$$

$$u \text{ (micro)} = 10^{-6}$$

$$n \text{ (nano)} = 10^{-9}$$

$$p \text{ (pico)} = 10^{-12}$$

Examples:

$$(a \text{ k}) * (b \text{ k}) = (a * b) \text{ M}$$

$$(a \text{ k}) * (b \text{ M}) = (a * b) \text{ G}$$

$$a / b \text{ k} = (a / b) \text{ m}$$

$$a / b \text{ M} = (a / b) \text{ u}$$

$$a \text{ M} / b \text{ k} = (a / b) \text{ k}$$

**AET-A1-LE**  
**Apply Scientific Notation and Engineering Notation**  
**to Solve Technical Problems**

---

The student shall:

1. Use a machinist's rule, measure mechanical parts, and express the results in scientific notation;
2. Calculate selected problems in scientific notation using a scientific calculator;
3. Use the resistor color codes, read resistors, and express the results in engineering notation; and,
4. Calculate selected problems in engineering notation using a scientific calculator.

Name: \_\_\_\_\_

Date: \_\_\_\_\_

**AET-A1-QU-1**  
**Apply Scientific Notation and Engineering Notation**  
**to Solve Technical Problems**  
**Quiz No. 1 (Scientific Notation)**

1. Express .00146 as a number in scientific notation.

\_\_\_\_\_

2. Express 122,880 as a number in scientific notation.

\_\_\_\_\_

3. Express .00001 as a number in scientific notation.

\_\_\_\_\_

4. Express .0047 as a number in scientific notation.

\_\_\_\_\_

5. Express 33,000 as a number in scientific notation.

\_\_\_\_\_

6. Express 1,200,000 as a number in scientific notation.

Perform the following calculations using scientific notation. Express the answers in scientific notation.

7.  $470 \times .000001$

\_\_\_\_\_

8.  $10 / .000025$

\_\_\_\_\_

9. Divide  $1.2 \times 10^6$  by  $2.2 \times 10^3$

\_\_\_\_\_

10. Solve:

$$3.142 \times 10^0 \times 1.2 \times 10^5$$

\_\_\_\_\_

$$4.7 \times 10^3 \times 1.0 \times 10^4$$

\_\_\_\_\_

Name: \_\_\_\_\_

Date: \_\_\_\_\_

**AET-A1-QU-2**  
**Apply Scientific Notation and Engineering Notation**  
**to Solve Technical Problems**  
**Quiz No. 2 (Engineering Notation)**

1. Express the following number in engineering notation:  
0.0000047  
\_\_\_\_\_
2. Express the following number in engineering notation:  
15,000,000  
\_\_\_\_\_
3. Express the following number in engineering notation:  
0.00022  
\_\_\_\_\_
4. Express the following number in engineering notation:  
68,000  
\_\_\_\_\_
5. Perform the following operation using engineering notation. Express the answer in engineering notation.  
 $2 \text{ M} / 22 \text{ k}$   
\_\_\_\_\_
6. Perform the following operation using engineering notation. Express the answer in engineering notation.  
 $33 \text{ u} / 3.3 \text{ m}$   
\_\_\_\_\_
7. Perform the following operation using engineering notation. Express the answer in engineering notation.  
 $560 \text{ k} / 5.6 \text{ k}$   
\_\_\_\_\_
8. Perform the following operation using engineering notation. Express the answer in engineering notation.  
 $670 \text{ k} \times 2.2 \text{ u}$   
\_\_\_\_\_

9. Divide 24 by 1.2 M

---

10. Multiply .47 u by 120 k

---

# **AUTOMATED EQUIPMENT REPAIR SERIES**

## **MASTER Technical Module No. AET-A2**

---

**Subject:** Automated Equipment Repair **Time:** 12 Hrs.

**Duty:** Apply Science to Solve Industrial Problems

**Task:** Apply Algebraic Formulas to Solve Technical Problems

---

### **Objective(s):**

Upon completion of this unit the student will be able to use algebraic formulas such as those used in machining technology, electronics, electricity, fluid power, and technical physics, and apply scientific notation or engineering notation values to the solution of these equations to aid in solving technical problems.

---

### **Instructional Materials:**

Mechanical, electronic or hydraulic set up to obtain measurements  
Multimeter, pressure gauges, flow meters, or machinists instruments to obtain measurements  
MASTER Handout (AET-A2-HO-1)  
MASTER Handout (AET-A2-HO-2) (The Fifteen Rules of Math Necessary to Solve Any Algebra Problem or Equation)  
MASTER Handout (AET-A2-HO-3) (Math Quick Reference Sheet)  
MASTER Laboratory Exercise (AET-A2-LE)  
MASTER Quiz AET-A2-QU-1: Quiz on using formulas

---

### **References:**

*Elementary Technical Mathematics*, Ewen/Nelson, Latest Edition  
*Technical Mathematics with Calculus*, Peterson, Latest Edition

---

### **Student Preparation:**

Students should have previously completed the following Technical Modules:

**AET-A1** "Apply Scientific Notation and Engineering Notation to Solve Technical Problems"

---

### **Introduction:**

The ability to use formulas to solve technical problems is an essential skill in any technical occupation. Technicians must learn to recognize the symbol in the formula

that represents a real world quantity, substitute engineering values for the symbol, and solve the formula for the desired result.

---

---

**Presentation Outline:**

- I. Discuss the organization and rationale for mathematics and formulas
  - A. History of formulas
  - B. Organization of formulas
  - C. What the alphabetic symbols represent in formulas
- II. Discuss the methods by which formulas are manipulated
  - A. The fifteen rules of math (MASTER Handout, AET-A2-HO-2 - The Fifteen Rules of Math Necessary to Solve Any Algebra Problem or Equation)
  - B. Demonstrate the applications of the rules
- III. Demonstrate the solution of formulas
  - A. Take examples from measurements on demonstration equipment
  - B. Demonstrate the organization of a solution
  - C. Using formulas, calculate expected results of measurements
- IV. Demonstrate procedures for using a scientific calculator to calculate results of measurements

---

---

**Practical Application:**

1. Using measurement instruments, measure a system and apply the measurements to the proper parts of a formula; and,
2. Calculate selected problems using a scientific calculator.

---

---

**Evaluation and/or Verification:**

Successful completion of this technical module will be based on the student's successful completion of the following components:

1. Ten question quiz on calculation of formulas; and
2. Successful demonstration of the ability to apply formulas to the solution of technical problems.

---

---

**Summary:**

Review the main lesson points using the suggested texts listed in the reference section of this module. Hold class discussion and answer student questions.



---

---

**Next Lesson Assignment:**

**MASTER Technical Module (AET-A3)** dealing with using variables in algebraic formulas to predict behavior of industrial systems.

**AET-A2-HO-1**  
**Apply Algebraic Formulas to Solve Technical Problems**  
**Attachment 1: MASTER Handout No. 1**

---

**Objective(s):**

Upon completion of this unit the student will be able to use algebraic formulas such as those used in machining technology, electronics, electricity, fluid power, and technical physics, and apply scientific notation or engineering notation values to the solution of these equations to aid in solving technical problems.

---

**Module Outline:**

- I. Discuss the organization and rationale for mathematics and formulas
  - A. History of formulas
  - B. Organization of formulas
  - C. What the alphabetic symbols represent in formulas
- II. Discuss the methods by which formulas are manipulated
  - A. The fifteen rules of math (MASTER Handout, AET-A2-HO-2 - The Fifteen Rules of Math Necessary to Solve Any Algebra Problem or Equation)
  - B. Demonstrate the applications of the rules
- III. Demonstrate the solution of formulas
  - A. Take examples from measurements on demonstration equipment
  - B. Demonstrate the organization of a solution
  - C. Using formulas, calculate expected results of measurements
- IV. Demonstrate procedures for using a scientific calculator to calculate results of measurements

**AET-A2-HO-2**  
**Apply Algebraic Formulas to Solve Technical Problems**  
**Attachment 2: MASTER Handout No. 2**

---

**The Fifteen Rules of Math**  
**Necessary to Solve Any Technical Algebra Problem or Equation**  
**Definitions**

<b>Variable</b>	A general symbolic letter term used to define a mathematical relationship. Also a letter that represents an unknown number. A variable may be multiplied, divided, added, subtracted, etc., like any other real number.
<b>Coefficient</b>	A real number that indicates the quantity of variables in question. For example, $3x$ means that I have 3 of the $x$ variables. The number 3 is the coefficient of $x$ . A variable by itself has an implied coefficient of 1.
<b>Constant</b>	A real number whose value is known and can never change.
<b>Polynomial</b>	An algebraic expression containing two or more terms that are associated by addition or subtraction.
<b>Equation</b>	A monomial or polynomial that is set equal to another value (constant, monomial, or polynomial).
<b>Exponent</b>	A number that indicates how many times I need to multiply a number by itself. For example, $x^3$ means that I need to multiply $x$ by $x$ three times. The number 3 is the exponent.
<b>Reciprocal</b>	A number that is divided into 1.
<b>Base</b>	The number that will be raised to a power by an exponent.
<b>Negative number</b>	The mirror image of a positive number. For every positive real number, a negative counterpart exists. Negative numbers are used extensively in math, but have no realistic counterparts in the real world. However, most

important discoveries have been made using the negative number concept.

1. ***The rules of addition, subtraction, multiplication, and division of positive and negative numbers:***
  - A. When adding number that have like signs, add the numbers and give the result the same sign. When adding numbers of unlike signs, subtract the smaller number from the larger number and give the result the sign of the larger number.
  - B. When subtracting any combination of signed numbers, alike or unlike, change the sign of the number or expression that is being subtracted from another number to the opposite sign, and proceed as in addition. Use the following rules:
    - (1) If the sign of the number or expression is negative, change it to positive.
    - (2) If the sign is positive, change it to negative.
  - C. When multiplying signed numbers, if the signs are the same (both positive or negative) the result is positive. If the signs are unlike, the result is negative.
  - D. When dividing signed numbers, if the signs are the same (both positive or negative) the result is positive. If the signs are unlike, the result is negative.
  
2. ***The addition, subtraction, multiplication, and division axioms:***
  - A. If equals are added to equals, then the results will be equal.
  - B. If equals are subtracted from equals, then the results will be equal.
  - C. If equals are multiplied by equals, then the results will be equal.
  - D. If equals are divided by equals, then the results will be equal.
  
3. ***The order of operations - Please Excuse My Dear Aunt Sally***  
Parentheses, Exponents, Multiplication, Division, Addition, Subtraction.  
(Also perform operations from left to right).
  
4. ***The associative rule - The order of grouping is not important to the outcome for addition and multiplication.***

Examples:

$$a + b + c = (a + b) + c = a + (b + c)$$
$$a * b * c = (a * b) * c = a * (b * c)$$
  
5. ***The distributive rule - When a polynomial is multiplied by a variable, constant, or other polynomial, the variable, constant, or polynomial is multiplied by each term in the polynomial.***

Examples:

$$a(b + c + d) = ab + ac + ad$$

$$2x(a + b - c) = 2xa + 2xb - 2xc$$

$$5y(2y + 3x) = 10y^2 + 15xy$$

6. ***The identity rule - Equals are Equal to Equals.***

Examples:

$$a = a \quad x = x$$

If  $X = B$  and  $Y$  equals  $B$  then  $X = Y$

If  $X = 2a + 3c$  and  $X = 4y + 5b$  then  $2a + 3c = 4y + 5b$

7. ***If a number is multiplied by its reciprocal, the result is one.***

$$a * 1/a = 1$$

(also applies to dividing a number by itself)

8. ***If any number is multiplied by zero the result is zero.***

$$a * 0 = 0$$

9. ***All constants or variables have an implied coefficient of one.***

$$a = 1*a$$

$$14 = 1*(14)$$

(also applies to multiplying a number by one)

10. ***Division of a variable by zero is undefined and a illegal operation.***

$$x/0 = ?$$

11. ***Any number raised to the zero (0) power is one (1). Any number raised to the first (1) power is the number itself.***

Examples:

$$a^0 = 1$$

$$1,234,567,123,456,123,345,567,999^0 = 1$$

$$a^1 = a$$

$$10,234^1 = 10,234$$

12. ***When two equal number bases, raised to a power, are multiplied times each other, the exponents are added.***

Examples:

$$a^2 * a^4 = a^6$$

$$X^a * X^b = X^{(a+b)}$$

(the numbers *must* be the same base)

13. ***When two equal number bases, raised to a power, are divided, the exponents are subtracted.***

Examples:

$$a^2 / a^4 = a^{-2}$$

$$X^a / X^b = X^{(a-b)}$$

(the numbers *must* be the same base)

14. *When a number, raised to a power, is again raised to a power, the exponents are multiplied times each other.*

Examples:

$$(a^2)^3 = a^6$$

$$(x^3)^4 = x^{12}$$

15. *A number raised to a negative power is the reciprocal of the number multiplied by itself that number of times.*

Examples:

$$X^{-3} = 1/X * 1/X * 1/X = 1/X^3$$

$$10^{-4} = 1/10 * 1/10 * 1/10 * 1/10 = 1/10^4$$

**AET-A2-HO-3**  
**Apply Algebraic Formulas to Solve Technical Problems**  
**Attachment 3: MASTER Handout No. 3**

---

**Math Quick Reference**

1. **Goal: To understand the convention for stating math formulas for mathematical rules (not applied math).**  
x, y, z,... represents a variable in a math formula  
a, b, c,... represents a number in a math formula
2. **Goal: To understand the rules for adding, subtracting, multiplying, and dividing signed numbers.**

**Addition: For a = 15 and b = 6**

When a is plus and b is plus:  $(+a)+(+b) = +(a+b)$

Example  $(+15)+(+6) = +(15+6) = +21$

When a is minus and b is minus:  $(-a)+(-b) = -(a+b)$

Example  $(-15)+(-6) = -(15+6) = -21$

When a or b is minus, and the remaining quantity is plus  $(-a)+(+b) =$   
or  $(+a)+(-b) = ?$  **Take the smaller number from the larger number  
and give the result the sign of the larger number.**

Example:  $(-15) + (+6) = -(15-6) = -9$  (the larger number is -15)

or

Example:  $(+15) + (-6) = +(15-6) = +9$  (the larger number is +15)

**Subtraction:**

When the subtrahend is "b"  $(a)-(b) = ?$

**To avoid confusion, always change the sign (plus or minus) of  
"b" and proceed as in addition.**

**To change the sign of b, use the following rules:**

If b is positive  $-(+b)$  then change to -b

If b is negative  $-(-b)$  then change to +b

Example: For a = +19 and b = +7

$(+19)-(+7) = (+19) + (-7) = +(19-7) = +12$

Example: For  $a = -19$  and  $b = +7$   
 $(-19) - (+7) = (-19) + (-7) = -(19+7) = -26$

### Multiplication:

If both  $a$  and  $b$  are positive  $(+a) * (+b) = +(ab)$

If both  $a$  and  $b$  are negative  $(-a) * (-b) = +(ab)$

If either  $a$  or  $b$  are negative:

$$(-a) * (+b) = -(ab)$$

or

$$(+a) * (-b) = -(ab)$$

Example: For  $a = 12$  and  $b = 3$   
 $(+12) * (+3) = +(12 * 3) = +36$

Example: For  $a = -12$  and  $b = -3$   
 $(-12) * (-3) = +(12 * 3) = +36$

Example: For  $a = -12$  and  $b = +3$   
 $(-12) * (+3) = -(12 * 3) = -36$

### Division:

If both  $a$  and  $b$  are positive  $(+a) / (+b) = +(a/b)$

If both  $a$  and  $b$  are negative  $(-a) / (-b) = +(a/b)$

If either  $a$  or  $b$  are negative:

$$(+a) / (-b) = -(a/b)$$

or

$$(-a) / (+b) = -(a/b)$$

Example: For  $a = 12$  and  $b = 3$   
 $(+12) / (+3) = +(12/3) = +4$

Example: For  $a = -12$  and  $b = -3$   
 $(-12) / (-3) = +(12/3) = +4$

Example: For  $a = -12$  and  $b = +3$   
 $(-12) / (+3) = -(12/3) = -4$

Example: For  $a = +12$  and  $b = -3$   
 $(+12) / (-3) = -(12/3) = -4$

### 3. Goal: To understand the rules for exponents

For  $a^N$ : " $a$ " is called the *base*. " $N$ " is called the *exponent*.

If  $a$  is multiplied by itself " $N$ " number of times:  $a * a * a * \dots * a^N = a^N$

Example: For  $a = 4$   
 $4 * 4 * 4 = 4^3$



$$a*a*a*a*a = a^5$$

$$(1/a)*(1/a)*(1/a)...*(1/a^N) = a^{-N}$$

Example: For  $a = 10$   
 $(1/10)*(1/10)*(1/10) = 10^{-3}$

Special cases of exponents:

$$a^0 = 1$$

$$a^1 = a$$

**Note: Bases must be the same!**

Multiplication of Exponents

$$a^b * a^c = a^{(b+c)}$$

Division of Exponents:

$$a^b / a^c = a^{(b-c)}$$

4. **Goal: To understand the reason for using scientific notation, and the rules for scientific notation.**

Scientific notation is primarily used to multiply and divide very large and very small numbers.

A number expressed in scientific notation consists of a *multiplier* equal to or greater than 1 and less than 10, and a *base* of 10 raised to a power.

Example: 12,560,000 and .000748

Multiplier	Times	Base 10
1.256	*	$10^7$
7.48	*	$10^{-4}$

To combine the bases, use the rules for exponents and signed numbers.

*A number expressed in scientific notation cannot be added or subtracted unless the bases and exponents of both numbers are equal.*

5. **Goal: To understand the reason for using engineering notation and the rules of engineering notation.**

Engineering notation is used to prevent confusion on blueprints.

Engineering notation is like scientific notation with the following exceptions:

- a. The multiplier can be any number greater than 0 and less than 1000.
- b. The base is expressed as a *letter* which represents a power of 10.

$$G \text{ (Giga)} = 10^9$$

$$M \text{ (Mega)} = 10^6$$

$$k \text{ (kilo)} = 10^3$$

$$\text{units} = 10^0$$

$$m \text{ (milli)} = 10^{-3}$$

$$u \text{ (micro)} = 10^{-6}$$

$$n \text{ (nano)} = 10^{-9}$$

$$p \text{ (pico)} = 10^{-12}$$

Examples:

$$(a \text{ k}) * (b \text{ k}) = (a * b) \text{ M}$$

$$(a \text{ k}) * (b \text{ M}) = (a * b) \text{ G}$$

$$a/b \text{ k} = (a/b) \text{ m}$$

$$a/b \text{ M} = (a/b) \text{ u}$$

$$a \text{ M}/b \text{ k} = (a/b) \text{ k}$$

**AET-A2-LE**  
**Apply Algebraic Formulas to Solve Technical Problems**  
**Attachment 4: MASTER Laboratory Exercise**

---

The student shall:

1. Use measurement instruments, measure a system, and apply the measurements to the proper parts of a formula; and,
2. Calculate selected problems using a scientific calculator.

Name: \_\_\_\_\_

Date: \_\_\_\_\_

**AET-A2-QU-1**  
**Apply Algebraic Formulas to Solve Technical Problems**  
**Quiz on Using Formulas**

1. In the formula  $F = P * A$ , A varies \_\_\_\_\_ with F
  - a. directly
  - b. inversely
  
2. In the formula  $I = V / R$ , I varies \_\_\_\_\_ with R
  - a. directly
  - b. inversely
  
3. In the formula  $X_c = 1/2\pi fC$ ,  $X_c$  varies \_\_\_\_\_ with f
  - a. directly
  - b. inversely
  
4. In the formula  $X_c = 1/2\pi fC$ ,  $\pi$  is a \_\_\_\_\_.
  
5. Using the formula for inductive reactance,  $X_L = 2\pi fL$ , find the value of L if  $X_L = 1000$  ohms, and  $f = 10$  k Hz.  
\_\_\_\_\_  
\_\_\_\_\_  
\_\_\_\_\_
  
6. Using the formula for capacitive reactance,  $X_c = 1/2\pi fC$ , find the value of C if  $X_c = 10$  ohms, and  $f = 1$  k Hz.  
\_\_\_\_\_  
\_\_\_\_\_  
\_\_\_\_\_
  
7. Using the formula for Impulse Momentum,  $Ft = mV$  (Force\*time = mass\*Velocity), find the value of V (V = meters/sec) if  $F = 980$  Newtons,  $m = 100$  Kg, and  $t = .1$  sec, for a mass brought to a complete stop. ( $F = \text{kg} * \text{m}/\text{sec}^2$ )  
\_\_\_\_\_  
\_\_\_\_\_  
\_\_\_\_\_

Solve the following equations for the given variable.

8.  $A = P + Prt$  (solve for  $r$ )

---

---

---

9.  $P = 2(e + w)$  (solve for  $e$ )

---

---

---

10.  $RT = \frac{R_1 * R_2}{R_1 + R_2}$  (solve for  $R_1$ )

---

---

---

# **AUTOMATED EQUIPMENT REPAIR SERIES**

## **MASTER Technical Module No. AET-A3**

---

**Subject:** Automated Equipment Repair

**Time:** 6 Hrs.

**Duty:** Apply Science to Solve Industrial Problems

**Task:** Use Variables in Algebraic Formulas to Predict Behavior of Industrial Systems

---

**Objective(s):**

Upon completion of this unit the student will be able to apply algebraic formulas such as those found in machining technology, electronics, electricity, fluid power, and technical physics, to identify the effects on a system of a change in a variable of the equation.

---

**Instructional Materials:**

Mechanical, electronic or hydraulic set up to obtain measurements  
Multimeter, pressure gauges, flow meters, or machinists instruments to obtain measurements

MASTER Handout (AET-A3-HO-1)

MASTER Handout (AET-A3-HO-2) (The Fifteen Rules of Math Necessary To Solve Any Algebra Problem or Equation)

MASTER Handout (AET-A3-HO-3) (Math Quick Reference Sheet)

MASTER Laboratory Exercise (AET-A3-LE)

MASTER Quiz AET-A3-QU-1: Quiz on formulas

---

**References:**

*Elementary Technical Mathematics*, Ewen/Nelson, Latest Edition

*Technical Mathematics with Calculus*, Peterson, Latest Edition

---

**Student Preparation:**

Students should have previously completed the following Technical Modules:

AET-A2 "Apply Algebraic Formulas to Solve Technical Problems"

---

**Introduction:**

The ability to manipulate formulas and to interpret the information that results from the new formula is an essential skill for the automation technician. Although mathematics is used extensively by colleges and universities to communicate

engineering concepts, no effort is made to explain why math is essential to understanding scientific principles. The automated equipment technician need to be taught that some physical concepts can *only be understood by an analysis of the underlying mathematical principles.*

---

---

**Presentation Outline:**

- I. Discuss the Organization and Rational for Expressing the Real World in Mathematical Formulas
  - A. History of expressing the real world in mathematics
  - B. How variables in an equation predict the outcome of events.
  - C. Discuss inverse and direct variation
- II. Using Formulas Such as "Two Resistors in Parallel" or "Thermal Transfer of Heat Energy Through an Insulation," Demonstrate How the Change of Variables in the Equation Effects the Outcome of the Result

---

---

**Practical Application:**

1. Using measurement instruments, measure a system, and apply the measurements to the proper parts of a formula;
2. Calculate expected results; and,
3. Measure the quantities that result from the calculations and compare to the formulas.

---

---

**Evaluation and/or Verification:**

Successful completion of this technical module will be based on the student's successful completion of the following components:

1. Ten question quiz on predicting expected results from calculations; and,
2. Successful demonstration of the ability to predict a result from the calculation of a formula.

---

---

**Summary:**

Review the main lesson points using the suggested texts listed in the reference section of this module. Hold class discussion and answer student questions.

---

---

**Next Lesson Assignment:**

**MASTER Technical Module (AET-A4)** dealing with manipulating variables in algebraic formulas to analyze industrial systems.

## AET-A3-HO-1

# Use Variables in Algebraic Formulas to Predict Behavior of Industrial Systems

## Attachment 1: MASTER Handout No. 1

---

### Objective(s):

Upon completion of this unit the student will be able to apply algebraic formulas such as those found in machining technology, electronics, electricity, fluid power, and technical physics, to identify the effects on a system of a change in a variable of the equation.

---

### Module Outline:

- I. Discuss the Organization and Rational for Expressing the Real World in Mathematical Formulas
  - A. History of expressing the real world in mathematics
  - B. How variables in an equation predict the outcome of events.
  - C. Discuss inverse and direct variation
- II. Using Formulas Such as "Two Resistors in Parallel" or "Thermal Transfer of Heat Energy Through an Insulation," Demonstrate How the Change of Variables in the Equation Effects the Outcome of the Result



**AET-A3-HO-2**  
**Use Variables in Algebraic Formulas**  
**to Predict Behavior of Industrial Systems**  
**Attachment 2: MASTER Handout No. 2**

---

**The Fifteen Rules of Math**  
**Necessary to Solve Any Technical Algebra Problem or Equation**  
**Definitions**

<b>Variable</b>	A general symbolic letter term used to define a mathematical relationship. Also a letter that represents an unknown number. A variable may be multiplied, divided, added, subtracted, etc., like any other real number.
<b>Coefficient</b>	A real number that indicates the quantity of variables in question. For example, $3x$ means that I have 3 of the $x$ variables. The number 3 is the coefficient of $x$ . A variable by itself has an implied coefficient of 1.
<b>Constant</b>	A real number whose value is known and can never change.
<b>Polynomial</b>	An algebraic expression containing two or more terms that are associated by addition or subtraction.
<b>Equation</b>	A monomial or polynomial that is set equal to another value (constant, monomial, or polynomial).
<b>Exponent</b>	A number that indicates how many times I need to multiply a number by itself. For example, $x^3$ means that I need to multiply $x$ by $x$ three times. The number 3 is the exponent.
<b>Reciprocal</b>	A number that is divided into 1.
<b>Base</b>	The number that will be raised to a power by an exponent.
<b>Negative number</b>	The mirror image of a positive number. For every positive real number, a negative counterpart exists. Negative numbers are used extensively in math, but have no realistic counterparts in the real world. However, most

important discoveries have been made using the negative number concept.

1. ***The rules of addition, subtraction, multiplication, and division of positive and negative numbers:***
  - A. When adding number that have like signs, add the numbers and give the result the same sign. When adding numbers of unlike signs, subtract the smaller number from the larger number and give the result the sign of the larger number.
  - B. When subtracting any combination of signed numbers, alike or unlike, change the sign of the number or expression that is being subtracted from another number to the opposite sign, and proceed as in addition. Use the following rules:
    - (1) If the sign of the number or expression is negative, change it to positive.
    - (2) If the sign is positive, change it to negative.
  - C. When multiplying signed numbers, if the signs are the same (both positive or negative) the result is positive. If the signs are unlike, the result is negative.
  - D. When dividing signed numbers, if the signs are the same (both positive or negative) the result is positive. If the signs are unlike, the result is negative.
2. ***The addition, subtraction, multiplication, and division axioms:***
  - A. If equals are added to equals, then the results will be equal.
  - B. If equals are subtracted from equals, then the results will be equal.
  - C. If equals are multiplied by equals, then the results will be equal.
  - D. If equals are divided by equals, then the results will be equal.
3. ***The order of operations - Please Excuse My Dear Aunt Sally***  
Parentheses, Exponents, Multiplication, Division, Addition, Subtraction.  
(Also perform operations from left to right).
4. ***The associative rule - The order of grouping is not important to the outcome for addition and multiplication.***  
Examples:  
$$a + b + c = (a + b) + c = a + (b + c)$$
$$a*b*c = (a*b)*c = a*(b*c)$$
5. ***The distributive rule - When a polynomial is multiplied by a variable, constant, or other polynomial, the variable, constant, or polynomial is multiplied by each term in the polynomial.***  
Examples:  
$$a(b + c + d) = ab + ac + ad$$
$$2x(a + b - c) = 2xa + 2xb - 2xc$$

$$5y(2y + 3x) = 10y^2 + 15xy$$

6. ***The identity rule - Equals are Equal to Equals.***

Examples:

$$a = a \quad x = x$$

If  $X = B$  and  $Y$  equals  $B$  then  $X = Y$

$$\text{If } X = 2a + 3c \text{ and } X = 4y + 5b \text{ then } 2a + 3c = 4y + 5b$$

7. ***If a number is multiplied by its reciprocal, the result is one.***

$$a * 1/a = 1$$

(also applies to dividing a number by itself)

8. ***If any number is multiplied by zero the result is zero.***

$$a * 0 = 0$$

9. ***All constants or variables have an implied coefficient of one.***

$$a = 1*a$$

$$14 = 1*(14)$$

(also applies to multiplying a number by one)

10. ***Division of a variable by zero is undefined and a illegal operation.***

$$x/0 = ?$$

11. ***Any number raised to the zero (0) power is one (1). Any number raised to the first (1) power is the number itself.***

Examples:

$$a^0 = 1$$

$$1,234,567,123,456,123,345,567,999^0 = 1$$

$$a^1 = a$$

$$10,234^1 = 10,234$$

12. ***When two equal number bases, raised to a power, are multiplied times each other, the exponents are added.***

Examples:

$$a^2 * a^4 = a^6$$

$$X^a * X^b = X^{(a+b)}$$

(the numbers *must* be the same base)

13. ***When two equal number bases, raised to a power, are divided, the exponents are subtracted.***

Examples:

$$a^2 / a^4 = a^{-2}$$

$$X^a / X^b = X^{(a-b)}$$

(the numbers *must* be the same base)

14. *When a number, raised to a power, is again raised to a power, the exponents are multiplied times each other.*

Examples:

$$(a^2)^3 = a^6$$

$$(x^3)^4 = x^{12}$$

15. *A number raised to a negative power is the reciprocal of the number multiplied by itself that number of times.*

Examples:

$$X^{-3} = 1/X * 1/X * 1/X = 1/X^3$$

$$10^{-4} = 1/10 * 1/10 * 1/10 * 1/10 = 1/10^4$$

**AET-A3-HO-3**  
**Use Variables in Algebraic Formulas**  
**to Predict Behavior of Industrial Systems**  
**Attachment 3: MASTER Handout No. 3**

---

**Math Quick Reference**

1. **Goal: To understand the convention for stating math formulas for mathematical rules (not applied math).**

x, y, z,... represents a variable in a math formula

a, b, c,... represents a number in a math formula

2. **Goal: To understand the rules for adding, subtracting, multiplying, and dividing signed numbers.**

**Addition: For a = 15 and b = 6**

When a is plus and b is plus:  $(+a)+(+b) = +(a+b)$

Example  $(+15)+(+6) = +(15+6) = +21$

When a is minus and b is minus:  $(-a)+(-b) = -(a+b)$

Example  $(-15)+(-6) = -(15+6) = -21$

When a or b is minus, and the remaining quantity is plus  $(-a)+(+b) =$   
or  $(+a)+(-b) = ?$  **Take the smaller number from the larger number**  
**and give the result the sign of the larger number.**

Example:  $(-15) + (+6) = -(15-6) = -9$  (the larger number is -15)

or

Example:  $(+15) + (-6) = +(15-6) = +9$  (the larger number is +15)

**Subtraction:**

When the subtrahend is "b"  $(a)-(b) = ?$

**To avoid confusion, always change the sign (plus or minus) of "b" and proceed as in addition.**

**To change the sign of b, use the following rules:**

If b is positive  $-(+b)$  then change to -b

If b is negative  $-(-b)$  then change to +b

Example: For a = +19 and b = +7

$(+19)-(+7) = (+19) + (-7) = +(19-7) = +12$

Example: For a = -19 and b = +7

$$(-19)-(+7) = (-19) + (-7) = -(19+7) = -26$$

### **Multiplication:**

If both a and b are positive  $(+a)*(+b) = +(ab)$

If both a and b are negative  $(-a)*(-b) = +(ab)$

If either a or b are negative:

$$(-a)*(+b) = -(ab)$$

or

$$(+a)*(-b) = -(ab)$$

Example: For a = 12 and b = 3

$$(+12)*(+3) = +(12*3) = +36$$

Example: For a = -12 and b = -3

$$(-12)*(-3) = +(12*3) = +36$$

Example: For a = -12 and b = +3

$$(-12)*(+3) = -(12*3) = -36$$

### **Division:**

If both a and b are positive  $(+a)/(+b) = +(a/b)$

If both a and b are negative  $(-a)/(-b) = +(a/b)$

If either a or b are negative:

$$(+a)/(-b) = -(a/b)$$

or

$$(-a)/(+b) = -(a/b)$$

Example: For a = 12 and b = 3

$$(+12)/(+3) = +(12/3) = +4$$

Example: For a = -12 and b = -3

$$(-12)/(-3) = +(12/3) = +4$$

Example: For a = -12 and b = +3

$$(-12)/(+3) = -(12/3) = -4$$

Example: For a = +12 and b = -3

$$(+12)/(-3) = -(12/3) = -4$$

### **3. Goal: To understand the rules for exponents**

For  $a^N$ : "a" is called the *base*. "N" is called the *exponent*.

If a is multiplied by itself " $N$ " number of times:  $a*a*a*a...a^N = a^N$

Example: For a = 4

$$4*4*4 = 4^3$$

$$a*a*a*a*a = a^5$$

$$(1/a)*(1/a)*(1/a)...*(1/a^N) = a^{-N}$$

Example: For  $a = 10$   
 $(1/10)*(1/10)*(1/10) = 10^{-3}$

Special cases of exponents:

$$a^0 = 1$$

$$a^1 = a$$

**Note: Bases must be the same!**

Multiplication of Exponents

$$a^b * a^c = a^{(b+c)}$$

Division of Exponents:

$$a^b / a^c = a^{(b-c)}$$

4. **Goal: To understand the reason for using scientific notation, and the rules for scientific notation.**

Scientific notation is primarily used to multiply and divide very large and very small numbers.

A number expressed in scientific notation consists of a *multiplier* equal to or greater than 1 and less than 10, and a *base* of 10 raised to a power.

Example: 12,560,000 and .000748

Multiplier	Times	Base 10
1.256	*	$10^7$
7.48	*	$10^{-4}$

**To combine the bases, use the rules for exponents and signed numbers.**

***A number expressed in scientific notation cannot be added or subtracted unless the bases and exponents of both numbers are equal.***

5. **Goal: To understand the reason for using engineering notation and the rules of engineering notation.**

Engineering notation is used to prevent confusion on blueprints.

Engineering notation is like scientific notation with the following exceptions:

- a. The multiplier can be any number greater than 0 and less than 1000.

b. The base is expressed as a *letter* which represents a power of 10.

$$G \text{ (Giga)} = 10^9$$

$$M \text{ (Mega)} = 10^6$$

$$k \text{ (kilo)} = 10^3$$

$$\text{units} = 10^0$$

$$m \text{ (milli)} = 10^{-3}$$

$$u \text{ (micro)} = 10^{-6}$$

$$n \text{ (nano)} = 10^{-9}$$

$$p \text{ (pico)} = 10^{-12}$$

Examples:

$$(a \text{ k}) * (b \text{ k}) = (a * b) \text{ M}$$

$$(a \text{ k}) * (b \text{ M}) = (a * b) \text{ G}$$

$$a/b \text{ k} = (a/b) \text{ m}$$

$$a/b \text{ M} = (a/b) \text{ u}$$

$$a \text{ M}/b \text{ k} = (a/b) \text{ k}$$



**AET-A3-LE**  
**Use Variables in Algebraic Formulas**  
**to Predict Behavior of Industrial Systems**  
**Attachment 4: MASTER Laboratory Exercise**

---

The student shall:

1. Use measurement instruments, measure a system, and apply the measurements to the proper parts of a formula;
2. Calculate expected results; and,
3. Measure the quantities that result from the calculations and compare to the formulas.

Name: \_\_\_\_\_

Date: \_\_\_\_\_

**AET-A3-QU-1**  
**Use Variables in Algebraic Formulas**  
**to Predict Behavior of Industrial Systems**  
**Quiz on Formulas**

1. In the formula  $F = P * A$ , A varies \_\_\_\_\_ with F
  - a. directly
  - b. inversely
  
2. In the formula  $I = V / R$ , I varies \_\_\_\_\_ with R
  - a. directly
  - b. inversely
  
3. In the formula  $X_C = 1/2\pi fC$ ,  $X_C$  varies \_\_\_\_\_ with f
  - a. directly
  - b. inversely
  
4. In the formula  $X_C = 1/2\pi fC$ ,  $\pi$  is a \_\_\_\_\_.
  
5. Using the formula for inductive reactance,  $X_L = 2\pi fL$ , find the value of L if  $X_L = 1000$  ohms, and  $f = 10$  k Hz.  
\_\_\_\_\_  
\_\_\_\_\_  
\_\_\_\_\_
  
6. Using the formula for capacitive reactance,  $X_C = 1/2\pi fC$ , find the value of C if  $X_C = 10$  ohms, and  $f = 1$  k Hz.  
\_\_\_\_\_  
\_\_\_\_\_  
\_\_\_\_\_
  
7. Using the formula for Impulse Momentum,  $Ft = mV$  (Force\*time = mass\*Velocity), find the value of V (V = meters/sec) if  $F = 980$  Newtons,  $m = 100$  Kg, and  $t = .1$  sec, for a mass brought to a complete stop. ( $F = \text{kg} * \text{m}/\text{sec}^2$ )  
\_\_\_\_\_  
\_\_\_\_\_  
\_\_\_\_\_

Solve the following equations for the given variable.

8.  $A = P + Prt$  (solve for  $r$ )

---

---

---

9.  $P = 2(e + w)$  (solve for  $e$ )

---

---

---

10.  $RT = \frac{R1 * R2}{R1 + R2}$  (solve for  $R1$ )

---

---

---

# **AUTOMATED EQUIPMENT REPAIR SERIES**

## **MASTER Technical Module No. AET-A4**

---

**Subject:** Automated Equipment Repair **Time:** 6 Hrs.

**Duty:** Apply Science to Solve Industrial Problems

**Task:** Manipulate Variables in Algebraic Formulas to Analyze Industrial Systems

---

**Objective(s):**

Upon completion of this unit the student will be able to transpose variables from one side of a formula to the other side of the formula to produce new relationships in the equation, and identify the relationship between the variables in the formula and the real world value that the variable represents.

---

**Instructional Materials:**

Mechanical, electronic or hydraulic set up to obtain measurements  
Multimeter, pressure gauges, flow meters, or machinists instruments to obtain measurements

MASTER Handout (AET-A4-HO-1)

MASTER Handout (AET-A4-HO-2) (The Fifteen Rules of Math Necessary to Solve Any Algebra Problem or Equation)

MASTER Handout (AET-A4-HO-3) (Math Quick Reference Sheet)

MASTER Laboratory Exercise (AET-A4-LE-1) (Predicting outcomes of measurements by transposing formulas)

MASTER Laboratory Exercise (AET-A4-LE-2)

**Video:** The Mechanical Universe - "The Miliken Experiment"

MASTER Quiz AET-A4-QU-1: Quiz on the manipulation of algebraic formulas

---

**References:**

*Elementary Technical Mathematics*, Ewen/Nelson, Latest Edition

*Physics for Career Education*, Ewen/Nelson/Schurter, Latest Edition

*Technical Mathematics with Calculus*, Peterson, Latest Edition

**Video:** *The Mechanical Universe*, Annenberg/CPB (PBS), Latest Edition

---

**Student Preparation:**

Students should have previously completed the following Technical Modules:

- AET-A1** “Apply Scientific Notation and Engineering Notation to Solve Technical Problems”  
**AET-A2** “Apply Algebraic Formulas to Solve Technical Problems”  
**AET-A3** “Use Variables in Algebraic Formulas to Predict Behavior of Industrial Systems”

---

---

**Introduction:**

The ability to interpret information that is presented in formulas, and change the formula to reflect new relationships, is a task that is often necessary in the predication of outcomes. The ability to predict an outcome of a physical process enables the technician to analyze a system and understand its operating principles. Automated equipment technicians must be prepared to recognize and use algebraic manipulation to solve industrial problems.

---

---

**Presentation Outline:**

- I. Discuss the Organization of an Algebraic Formula and the Methods That Scientists Use to Provide New Information about the Relationships in the Formula
  - A. Show video “The Mechanical Universe: “The Miliken Experiment”
  - B. Conduct discussions on the video and the role that algebraic manipulation played in the discovery of a basic physical concept
- II. Discuss the Algebraic Procedures for Transposing Variables (MASTER Handout AET-A1-HO-2)
  - A. Discuss the concept of polynomials
  - B. Demonstrate the addition of polynomials
  - C. Demonstrate the subtraction of polynomials
  - D. Demonstrate the multiplication of polynomials
  - E. Demonstrate the division of polynomials
- III. Demonstrate the Application of Polynomial Manipulation to the Transposing of Formulas by Solving a Formula for a Constant (K Variable)

---

---

**Practical Application:**

1. Transpose the variable for a complex formula found in physics, to produce a new relationship, and verify the new relationship by experimentation;
2. Choosing several physical formulas, establish new relationships. Insure that some of the new relationships reflect the value of a “k” constant as found in the formula; and,
3. Complete MASTER Laboratory Exercise (AET-A4-LE-2).

---

---

**Evaluation and/or Verification:**

Successful completion of this technical module will be based on the student's successful completion of the following components:

1. Ten question quiz on manipulation of algebraic formulas; and,
2. Satisfactory completion of MASTER Laboratory Exercise (AET-A4-LE-2).

---

---

**Summary:**

Review the main lesson points using the suggested texts listed in the reference section of this module. Hold class discussion and answer student questions.

---

---

**Next Lesson Assignment:**

**MASTER Technical Module (AET-A5)** dealing with measuring, calculating, and converting quantities in English and Metric (SI, mks) systems.

**AET-A4-HO-1**  
**Manipulate Variables in Algebraic Formulas**  
**to Analyze Industrial Systems**  
Attachment 1: MASTER Handout No. 1

---

**Objective(s):**

Upon completion of this unit the student will be able to transpose variables from one side of a formula to the other side of the formula to produce new relationships in the equation, and identify the relationship between the variables in the formula and the real world value that the variable represents.

---

**Module Outline:**

- I. Discuss the Organization of an Algebraic Formula and the Methods That Scientists Use to Provide New Information about the Relationships in the Formula
  - A. Show video "The Mechanical Universe: 'The Miliken Experiment'"
  - B. Conduct discussions on the video and the role that algebraic manipulation played in the discovery of a basic physical concept
- II. Discuss the Algebraic Procedures for Transposing Variables (MASTER Handout AET-A1-HO-2)
  - A. Discuss the concept of polynomials
  - B. Demonstrate the addition of polynomials
  - C. Demonstrate the subtraction of polynomials
  - D. Demonstrate the multiplication of polynomials
  - E. Demonstrate the division of polynomials
- III. Demonstrate the Application of Polynomial Manipulation to the Transposing of Formulas by Solving a Formula for a Constant (K Variable)

**AET-A4-HO-2**  
**Manipulate Variables in Algebraic Formulas**  
**to Analyze Industrial Systems**  
**Attachment 2: MASTER Handout No. 2**

---

**The Fifteen Rules of Math**  
**Necessary to Solve Any Technical Algebra Problem or Equation**  
**Definitions**

<b>Variable</b>	A general symbolic letter term used to define a mathematical relationship. Also a letter that represents an unknown number. A variable may be multiplied, divided, added, subtracted, etc., like any other real number.
<b>Coefficient</b>	A real number that indicates the quantity of variables in question. For example, $3x$ means that I have 3 of the $x$ variables. The number 3 is the coefficient of $x$ . A variable by itself has an implied coefficient of 1.
<b>Constant</b>	A real number whose value is known and can never change.
<b>Polynomial</b>	An algebraic expression containing two or more terms that are associated by addition or subtraction.
<b>Equation</b>	A monomial or polynomial that is set equal to another value (constant, monomial, or polynomial).
<b>Exponent</b>	A number that indicates how many times I need to multiply a number by itself. For example, $x^3$ means that I need to multiply $x$ by $x$ three times. The number 3 is the exponent.
<b>Reciprocal</b>	A number that is divided into 1.
<b>Base</b>	The number that will be raised to a power by an exponent.
<b>Negative number</b>	The mirror image of a positive number. For every positive real number, a negative counterpart exists. Negative numbers are used extensively in math, but have no realistic counterparts in the real world. However, most



important discoveries have been made using the negative number concept.

1. ***The rules of addition, subtraction, multiplication, and division of positive and negative numbers:***
  - A. When adding number that have like signs, add the numbers and give the result the same sign. When adding numbers of unlike signs, subtract the smaller number from the larger number and give the result the sign of the larger number.
  - B. When subtracting any combination of signed numbers, alike or unlike, change the sign of the number or expression that is being subtracted from another number to the opposite sign, and proceed as in addition. Use the following rules:
    - (1) If the sign of the number or expression is negative, change it to positive.
    - (2) If the sign is positive, change it to negative.
  - C. When multiplying signed numbers, if the signs are the same (both positive or negative) the result is positive. If the signs are unlike, the result is negative.
  - D. When dividing signed numbers, if the signs are the same (both positive or negative) the result is positive. If the signs are unlike, the result is negative.
2. ***The addition, subtraction, multiplication, and division axioms:***
  - A. If equals are added to equals, then the results will be equal.
  - B. If equals are subtracted from equals, then the results will be equal.
  - C. If equals are multiplied by equals, then the results will be equal.
  - D. If equals are divided by equals, then the results will be equal.
3. ***The order of operations - Please Excuse My Dear Aunt Sally***  
Parentheses, Exponents, Multiplication, Division, Addition, Subtraction.  
(Also perform operations from left to right).
4. ***The associative rule - The order of grouping is not important to the outcome for addition and multiplication.***  
Examples:  
$$a + b + c = (a + b) + c = a + (b + c)$$
$$a * b * c = (a * b) * c = a * (b * c)$$
5. ***The distributive rule - When a polynomial is multiplied by a variable, constant, or other polynomial, the variable, constant, or polynomial is multiplied by each term in the polynomial.***  
Examples:  
$$a(b + c + d) = ab + ac + ad$$
$$2x(a + b - c) = 2xa + 2xb - 2xc$$

$$5y(2y + 3x) = 10y^2 + 15xy$$

6. ***The identity rule - Equals are Equal to Equals.***

Examples:

$$a = a \quad x = x$$

If  $X = B$  and  $Y$  equals  $B$  then  $X = Y$

$$\text{If } X = 2a + 3c \text{ and } X = 4y + 5b \text{ then } 2a + 3c = 4y + 5b$$

7. ***If a number is multiplied by its reciprocal, the result is one.***

$$a * 1/a = 1$$

(also applies to dividing a number by itself)

8. ***If any number is multiplied by zero the result is zero.***

$$a * 0 = 0$$

9. ***All constants or variables have an implied coefficient of one.***

$$a = 1*a$$

$$14 = 1*(14)$$

(also applies to multiplying a number by one)

10. ***Division of a variable by zero is undefined and a illegal operation.***

$$x/0 = ?$$

11. ***Any number raised to the zero (0) power is one (1). Any number raised to the first (1) power is the number itself.***

Examples:

$$a^0 = 1$$

$$1,234,567,123,456,123,345,567,999^0 = 1$$

$$a^1 = a$$

$$10,234^1 = 10,234$$

12. ***When two equal number bases, raised to a power, are multiplied times each other, the exponents are added.***

Examples:

$$a^2 * a^4 = a^6$$

$$X^a * X^b = X^{(a+b)}$$

(the numbers *must* be the same base)

13. ***When two equal number bases, raised to a power, are divided, the exponents are subtracted.***

Examples:

$$a^2 / a^4 = a^{-2}$$

$$X^a / X^b = X^{(a-b)}$$

(the numbers *must* be the same base)

14. *When a number, raised to a power, is again raised to a power, the exponents are multiplied times each other.*

Examples:

$$(a^2)^3 = a^6$$

$$(x^3)^4 = x^{12}$$

15. *A number raised to a negative power is the reciprocal of the number multiplied by itself that number of times.*

Examples:

$$X^{-3} = 1/X * 1/X * 1/X = 1/X^3$$

$$10^{-4} = 1/10 * 1/10 * 1/10 * 1/10 = 1/10^4$$

AET-A4-HO-3  
Manipulate Variables in Algebraic Formulas  
to Analyze Industrial Systems  
Attachment 3: MASTER Handout No. 3

---

**Math Quick Reference**

1. **Goal: To understand the convention for stating math formulas for mathematical rules (not applied math).**

x, y, z,... represents a variable in a math formula

a, b, c,... represents a number in a math formula

2. **Goal: To understand the rules for adding, subtracting, multiplying, and dividing signed numbers.**

**Addition: For a = 15 and b = 6**

When a is plus and b is plus:  $(+a)+(+b) = +(a+b)$

Example  $(+15)+(+6) = +(15+6) = +21$

When a is minus and b is minus:  $(-a)+(-b) = -(a+b)$

Example  $(-15)+(-6) = -(15+6) = -21$

When a or b is minus, and the remaining quantity is plus  $(-a)+(+b) =$   
 $or (+a)+(-b) = ?$  **Take the smaller number from the larger number**  
**and give the result the sign of the larger number.**

Example:  $(-15) + (+6) = -(15-6) = -9$  (the larger number is -15)

or

Example:  $(+15) + (-6) = +(15-6) = +9$  (the larger number is +15)

**Subtraction:**

When the subtrahend is "b"  $(a)-(b) = ?$

**To avoid confusion, always change the sign (plus or minus) of "b" and proceed as in addition.**

**To change the sign of b, use the following rules:**

If b is positive  $-(+b)$  then change to  $-b$

If b is negative  $-(-b)$  then change to  $+b$

Example: For a = +19 and b = +7

$(+19)-(+7) = (+19) + (-7) = +(19-7) = +12$

Example: For a = -19 and b = +7

$$(-19)-(+7) = (-19) + (-7) = -(19+7) = -26$$

### Multiplication:

If both a and b are positive  $(+a)*(+b) = +(ab)$

If both a and b are negative  $(-a)*(-b) = +(ab)$

If either a or b are negative:

$$(-a)*(+b) = -(ab)$$

or

$$(+a)*(-b) = -(ab)$$

Example: For a = 12 and b = 3

$$(+12)*(+3) = +(12*3) = +36$$

Example: For a = -12 and b = -3

$$(-12)*(-3) = +(12*3) = +36$$

Example: For a = -12 and b = +3

$$(-12)*(+3) = -(12*3) = -36$$

### Division:

If both a and b are positive  $(+a)/(+b) = +(a/b)$

If both a and b are negative  $(-a)/(-b) = +(a/b)$

If either a or b are negative:

$$(+a)/(-b) = -(a/b)$$

or

$$(-a)/(+b) = -(a/b)$$

Example: For a = 12 and b = 3

$$(+12)/(+3) = +(12/3) = +4$$

Example: For a = -12 and b = -3

$$(-12)/(-3) = +(12/3) = +4$$

Example: For a = -12 and b = +3

$$(-12)/(+3) = -(12/3) = -4$$

Example: For a = +12 and b = -3

$$(+12)/(-3) = -(12/3) = -4$$

### 3. Goal: To understand the rules for exponents

For  $a^N$ : "a" is called the *base*. "N" is called the *exponent*.

If a is multiplied by itself " $N$ " number of times:  $a*a*a*...a^N = a^N$

Example: For a = 4

$$4*4*4 = 4^3$$

$$a*a*a*a*a = a^5$$

$$(1/a)*(1/a)*(1/a)...*(1/a^N) = a^{-N}$$

Example: For  $a = 10$   
 $(1/10)*(1/10)*(1/10) = 10^{-3}$

Special cases of exponents:

$$a^0 = 1$$

$$a^1 = a$$

**Note: Bases must be the same!**

Multiplication of Exponents

$$a^b * a^c = a^{(b+c)}$$

Division of Exponents:

$$a^b / a^c = a^{(b-c)}$$

4. **Goal: To understand the reason for using scientific notation, and the rules for scientific notation.**

Scientific notation is primarily used to multiply and divide very large and very small numbers.

A number expressed in scientific notation consists of a *multiplier* equal to or greater than 1 and less than 10, and a *base* of 10 raised to a power.

Example: 12,560,000 and .000748

Multiplier	Times	Base 10
1.256	*	$10^7$
7.48	*	$10^{-4}$

To combine the bases, use the rules for exponents and signed numbers.

*A number expressed in scientific notation cannot be added or subtracted unless the bases and exponents of both numbers are equal.*

5. **Goal: To understand the reason for using engineering notation and the rules of engineering notation.**

Engineering notation is used to prevent confusion on blueprints.

Engineering notation is like scientific notation with the following exceptions:

- a. The multiplier can be any number greater than 0 and less than 1000.

b. The base is expressed as a *letter* which represents a power of 10.

$$G \text{ (Giga)} = 10^9$$

$$M \text{ (Mega)} = 10^6$$

$$k \text{ (kilo)} = 10^3$$

$$\text{units} = 10^0$$

$$m \text{ (milli)} = 10^{-3}$$

$$u \text{ (micro)} = 10^{-6}$$

$$n \text{ (nano)} = 10^{-9}$$

$$p \text{ (pico)} = 10^{-12}$$

Examples:

$$(a \text{ k}) * (b \text{ k}) = (a * b) \text{ M}$$

$$(a \text{ k}) * (b \text{ M}) = (a * b) \text{ G}$$

$$a/b \text{ k} = (a/b) \text{ m}$$

$$a/b \text{ M} = (a/b) \text{ u}$$

$$a \text{ M}/b \text{ k} = (a/b) \text{ k}$$

**AET-A4-LE-1**  
**Manipulate Variables in Algebraic Formulas**  
**to Analyze Industrial Systems**  
**Attachment 4: MASTER Laboratory Exercise No. 1**

---

The student shall:

1. Transpose the variable for a complex formula found in physics, to produce a new relationship, and verify the new relationship by experimentation;
2. Choose several physical formulas and establish new relationships. Insure that some of the new relationships reflect the value of a "k" constant as found in the formula; and,
3. Complete MASTER Laboratory Exercise (AET-A4-LE-2).



**AET-A4-LE-2**  
**Manipulate Variables in Algebraic Formulas**  
**to Analyze Industrial Systems**  
**Attachment 5: MASTER Laboratory Exercise No. 2**

---

Name: \_\_\_\_\_

Date: \_\_\_\_\_

**AET-A4-QU-1**  
**Manipulate Variables in Algebraic Formulas**  
**to Analyze Industrial Systems**  
**Quiz on the Manipulation of Algebraic Formulas**

1. In the formula  $V \cdot I = P$ ,  $V$  = Voltage in volts,  $I$  = Current in amps, and  $P$  = Power in Watts, if 1 Watt of mechanical power = 1 Joule/1 Second, write a formula that expresses Voltage in terms of Joules, Seconds, and Current. (A Watt of mechanical power is equal to a Watt of electrical power.)

---

---

---

2. If power in watts is calculated by the formula, 1 Watt = 1 Joule/1 Second, how many Joules of energy are used when 1 watt is consumed in 5 seconds?

---

---

---

3. 1 Horsepower is equal to 746 Watts. Write a formula that will convert Horsepower into Joules if 1 Watt equals 1 Joule/ 1 Second.

---

---

---

4. 1 Horsepower equals 550 (Feet\*pounds(force))/1 second. Write a formula that will calculate the force produced in a system in terms of distance (feet) and time (seconds).

---

---

---

5. The formula for heat transferred from one side of a wall to another is  $Q = (KA t(T_2 - T_1))/L$ .  $Q$  = heat,  $A$  = Area,  $t$  = time,  $T_2$  = Temperature on one side of the wall,  $T_1$  = Temperature on the other side. Heat flows from hotter to colder. What happens if  $T_1$  is greater than  $T_2$ ?

- a. The heat is negative
- b. Heat flows from  $T_2$  to  $T_1$
- c. Heat flows from  $T_1$  to  $T_2$

6. The R value for insulation is expressed as  $R=L/K$ . R = the R value of insulation (this is the value that is printed on the insulation when you purchase it from a hardware store), L = the thickness of the insulation, K = the thermal conductivity. Using the formula in question 5, find the value of R in terms of Area, Time, Temperature<sub>1</sub>, Temperature<sub>2</sub>, and Q (heat).

---

---

---

7. The formula for inductive reactance is  $X_L = 2\pi fL$ . Create an expression that will find the value of L using this formula.

---

---

---

8. The formula for capacitive reactance is  $1/(2\pi fC)$ . Create an expression that will find the value of C using this formula.

---

---

---

9. The formula for Power in an electrical circuit is  $P = V * I$ . If  $V = I * R$ , create a formula that expresses Power in terms of I and R.

---

---

---

10. The formula for Power in an electrical circuit is  $P = V * I$ . If  $V = I * R$ , create a formula that expresses Power in terms of V and R.

---

---

---

# **AUTOMATED EQUIPMENT REPAIR SERIES**

## **MASTER Technical Module No. AET-A5**

---

**Subject:** Automated Equipment Repair **Time:** 12 Hrs.

**Duty:** Apply Science to Solve Industrial Problems

**Task:** Measure, Calculate, and Convert Quantities in English and Metric (SI, mks) Systems of Measurement

---

**Objective(s):**

Upon completion of this unit the student will be able to apply the rules of measuring systems in both the English and SI systems of measurement to calculate and convert quantities in both systems, including:

- a. Applying measurements in the English engineering system of measurement;
- b. Applying measurements in the Metric (mks S. I.) system of measurement; and,
- c. Applying the concept of dimensions to the measurement of quantities in the English engineering and Metric systems.

---

**Instructional Materials:**

Metric/Inch rule

Mass/weights ounces/pounds and grams/kilograms

Volumes-Cubic foot Quarts/gallons and liters (Soda bottles and milk bottles are ideal)

Temperature indicators, Celsius and Fahrenheit

MASTER Handout (AET-A5-HO-1)

MASTER Handout (AET-A5-HO-2) (Conversion Blocks)

MASTER Laboratory Exercise (AET-A5-LE) (Measurements)

MASTER Quiz AET-A5-QU-1: English/Metric conversions

MASTER Quiz AET-A5-QU-2: Dimensioning of physical quantities

---

**References:**

*Elementary Technical Mathematics*, Ewen/Nelson, Latest Edition

*Physics for Career Education*, Ewen/Nelson/Schurter, Latest Edition

*Technical Mathematics with Calculus*, Peterson, Latest Edition

Video: *The Mechanical Universe*, Annenberg/CPB (PBS)

---

## **Student Preparation:**

Students should have previously completed the following Technical Modules:

- AET-A1** "Apply Scientific Notation and Engineering Notation to Solve Technical Problems
- AET-A2** "Apply Algebraic Formulas to Solve Technical Problems"
- AET-A3** "Use Variables in Algebraic Formulas to Predict Behavior of Industrial Systems"
- AET-A4** "Manipulate Variables in Algebraic Formulas to Analyze Industrial Systems"

---

---

## **Introduction:**

The study of mechanics and electronics requires the ability to measure and convert quantities in the English Engineering system of measurement, and the Metric system of measurement. Both systems are used in industrial applications, and the automation technician may have to convert from one system to another many times while troubleshooting a complex problem. Since the world has become a global economy, and the Countries that use the Metric system are supplying industrial products to the United States, the technician must be able to recognize Metric quantities and apply these quantities to the manufacturing and repair of products. The Metric system has been the U.S. National Standard for measurement since the Civil War. The U.S. Bureau of Standards has in its vaults Metric standards, not English standards, and the English Engineering standards are defined in terms of Metric standards.

---

---

## **Presentation Outline:**

- I. Apply Measurements in the English Engineering System of Measurement
  - A. Discuss the component parts of the English Engineering system
    - 1. Discuss the concept of length and area
    - 2. Discuss the concept of volume
    - 3. Discuss the concept of mass and weight
    - 4. Discuss the concept of temperature
    - 5. Discuss the concept of time
  - B. Demonstrate the methods of measuring and calculating quantities
    - 1. Demonstrate the calculation of length and area
    - 2. Demonstrate the calculation of volume
    - 3. Demonstrate the calculation of weight and the relationship of mass to weight
    - 4. Demonstrate the measurement of temperature
    - 5. Demonstrate the measurement of time
- II. Apply Measurements In The Metric (Mks S. I.) System Of Measurement
  - A. Discuss the component parts of the Metric system
    - 1. Discuss the concept of length and area

2. Discuss the concept of volume
  3. Discuss the concept of mass and weight
  4. Discuss the concept of temperature
  5. Discuss the concept of time
- B. Demonstrate the methods of measuring and calculating quantities
1. Demonstrate the calculation of length and area
  2. Demonstrate the calculation of volume
  3. Demonstrate the calculation of weight and the relationship of mass to weight
  4. Demonstrate the measurement of temperature
- III. Apply The Concept Of Dimensions To The Measurement Of Quantities In The English Engineering And Metric Systems
- A. Discuss the concept of physical dimensions
1. Discuss the dimensioning of force
  2. Discuss the dimensioning of work
  3. Discuss the dimensioning of power
- B. Demonstrate the calculation of the above dimensions in the English Engineering and Metric systems

---

---

**Practical Application:**

1. Measure and compare items in the English Engineering system;
2. Convert quantities from mass, volume, force and temperature;
3. Measure and compare items in both the English Engineering system, and the Metric system;
4. Convert quantities from English to Metric and Metric to English;
5. Dimension the physical quantities in a simple machine such as a wheel and axle; and,
6. Dimension the power in an industrial crane.

---

---

**Evaluation and/or Verification:**

Successful completion of this technical module will be based on the student's successful completion of the following components:

1. Twenty question quiz on English/metric conversions;
2. MASTER Laboratory Exercise (AET-A5-LE) on measurement and conversion; and,
3. Ten question quiz on dimensioning of physical quantities.

---

---

**Summary:**

Review the main lesson points using the suggested texts listed in the reference section of this module. Hold class discussion and answer student questions.

---

---

**Next Lesson Assignment:**

**MASTER Technical Module (AET-A6)** dealing with using physics, algebra, and trigonometry to analyze simple vectored forces.

**AET-A5-HO-1**  
**Measure, Calculate, and Convert Quantities**  
**in English and Metric (SI, mks) Systems**  
**Attachment 1: MASTER Handout No. 1**

---

**Objective(s):**

Upon completion of this unit the student will be able to apply the rules of measuring systems in both the English and SI systems of measurement to calculate and convert quantities in both systems, including:

- a. Applying measurements in the English engineering system of measurement;
  - b. Applying measurements in the Metric (mks S. I.) system of measurement; and,
  - c. Applying the concept of dimensions to the measurement of quantities in the English engineering and Metric systems.
- 

**Module Outline:**

- I. Apply Measurements in the English Engineering System of Measurement
  - A. Discuss the component parts of the English Engineering system
    1. Discuss the concept of length and area
    2. Discuss the concept of volume
    3. Discuss the concept of mass and weight
    4. Discuss the concept of temperature
    5. Discuss the concept of time
  - B. Demonstrate the methods of measuring and calculating quantities
    1. Demonstrate the calculation of length and area
    2. Demonstrate the calculation of volume
    3. Demonstrate the calculation of weight and the relationship of mass to weight
    4. Demonstrate the measurement of temperature
    5. Demonstrate the measurement of time
- II. Apply Measurements In The Metric (Mks S. I.) System Of Measurement
  - A. Discuss the component parts of the Metric system
    1. Discuss the concept of length and area
    2. Discuss the concept of volume
    3. Discuss the concept of mass and weight
    4. Discuss the concept of temperature
    5. Discuss the concept of time
  - B. Demonstrate the methods of measuring and calculating quantities
    1. Demonstrate the calculation of length and area
    2. Demonstrate the calculation of volume



3. Demonstrate the calculation of weight and the relationship of mass to weight
  4. Demonstrate the measurement of temperature
- III. Apply The Concept Of Dimensions To The Measurement Of Quantities In The English Engineering And Metric Systems
- A. Discuss the concept of physical dimensions
    1. Discuss the dimensioning of force
    2. Discuss the dimensioning of work
    3. Discuss the dimensioning of power
  - B. Demonstrate the calculation of the above dimensions in the English Engineering and Metric systems

AET-A5-HO-2  
**Measure, Calculate, and Convert Quantities  
 in English and Metric (SI, mks) Systems**  
 Attachment 2: MASTER Handout No. 2

---

**Conversion Blocks**

It is frequently desirable to convert from the metric system to the English Engineering system and vice-versa. It is also just as desirable to convert from power to work to force within a system. The component parts of which each concept is composed, are known in mechanical physics as the **dimensions** of the quantity, or simply, **dimensioning**. For example, the dimensions of the watt are:

**1 watt = kg\*m<sup>2</sup>/sec<sup>3</sup> (1 kilogram times 1 meter times 1 meter divided by 1 second times 1 second times 1 second)**

Whenever we desire to convert from one dimension to another, we must multiply or divide by mass, length, area, volume, time, and/or temperature. This can be difficult. Do you multiply by time or divide by time to change from power to energy? To help organize the process, we can use a helper called a conversion block. The conversion block looks like this:

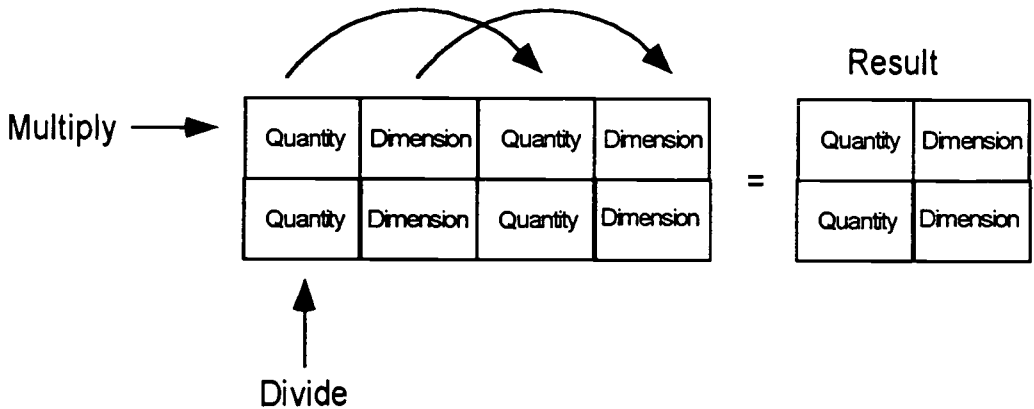

To use the conversion block, you enter the unit quantity of the dimension in the quantity block, and the type of dimension (mass, length, area, volume, time, and/or temperature) in the dimension block.

*Any like quantities that are in the divide columns are canceled, and become 1.*

*All unit values in the multiply rows are multiplied, including the dimensions.*

Therefore, you multiply quantity by quantity, and dimension by dimension. In the result block, the quantities are divided, and the dimensions are left intact.

For example:

If I have a force of 500 N, and a time of 2 seconds, what is the momentum?

$$500 \text{ N} = 500 \text{ kg}\cdot\text{m}/\text{sec}^2$$

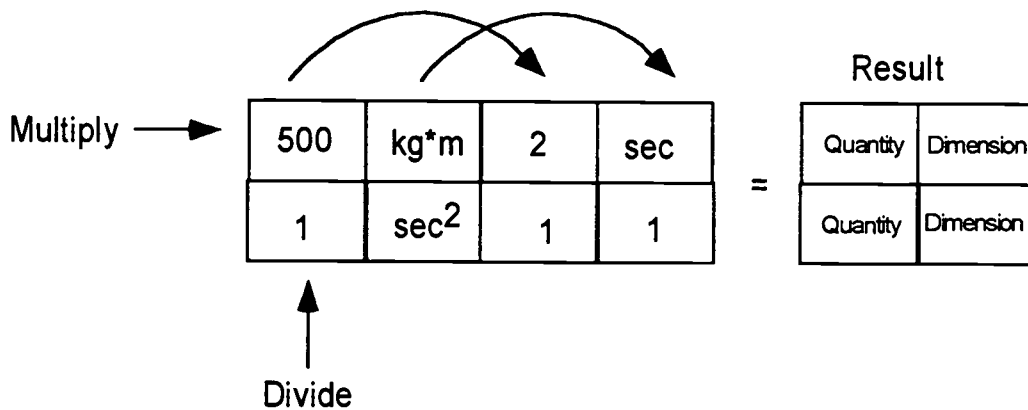

$$500 \text{ N} = 500 \text{ kg}\cdot\text{m}/\text{sec}^2$$

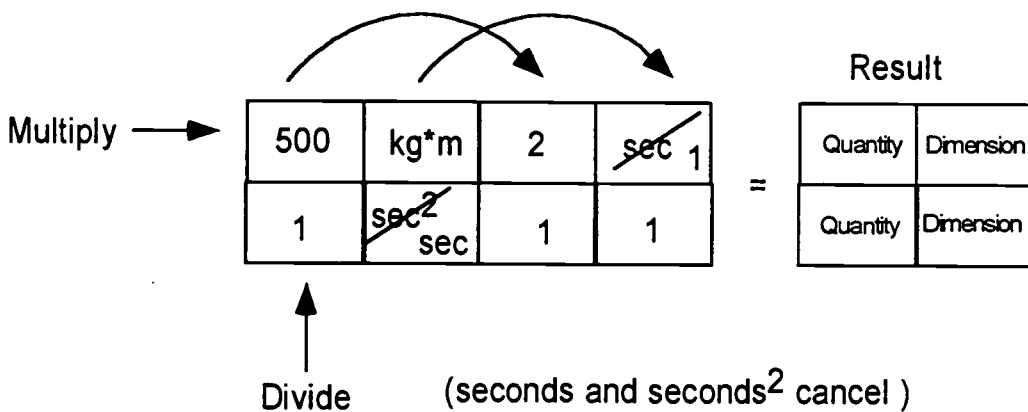

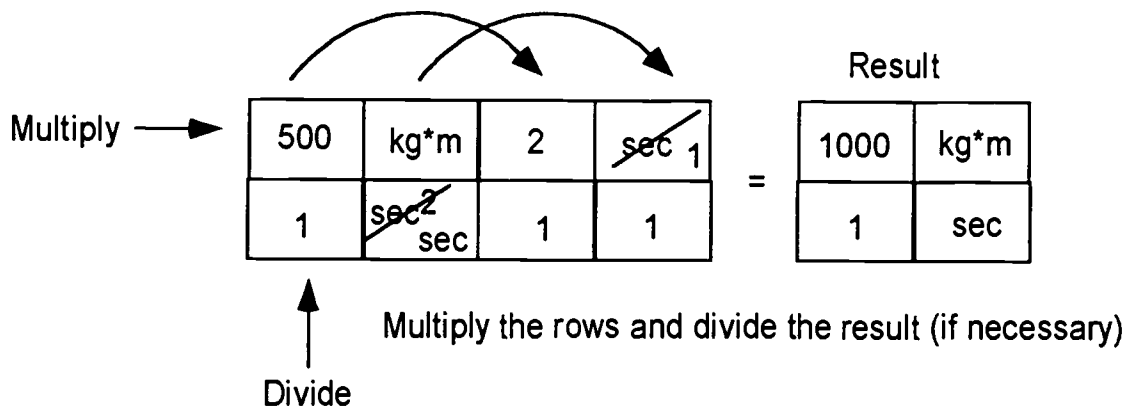

*Converting from the English Engineering to metric systems or vice-versa is done in the same manner, using the following conversion table.*

Example: Convert 50 kg to pounds of weight.

From the conversion table, 2.2 lbs/kg

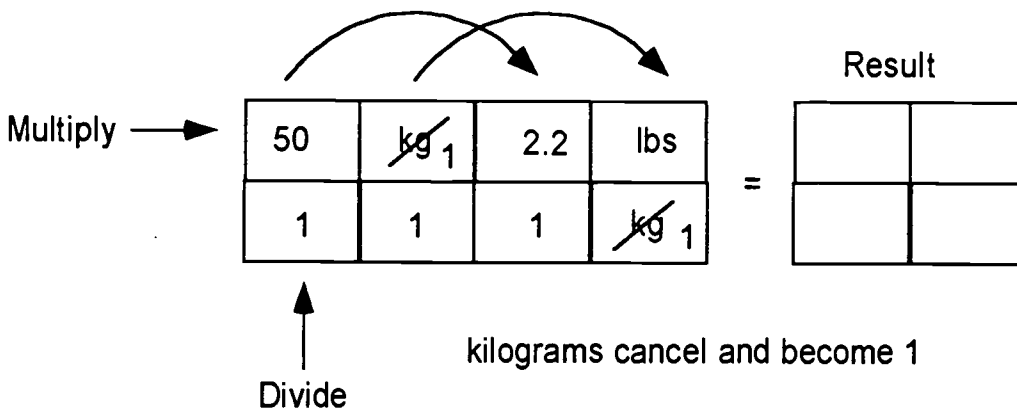
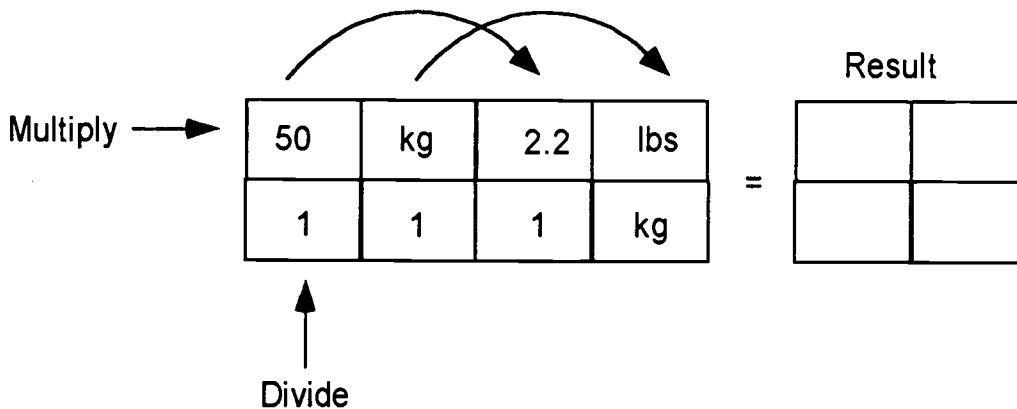

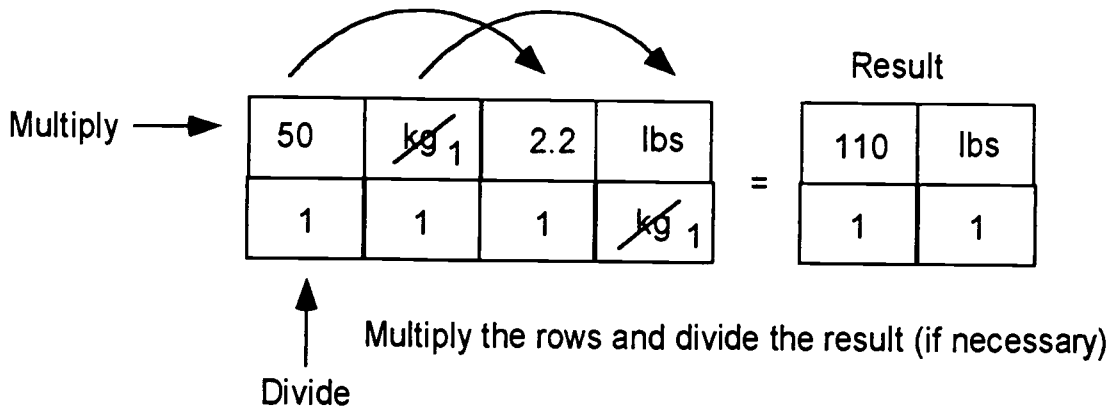

### Exercise

 = 



 = 



 = 



 = 



 = 



 = 



 = 



 = 

**AET-A5-LE**  
**Measure, Calculate, and Convert Quantities**  
**in English and Metric (SI, mks) Systems**  
**Attachment 3: MASTER Laboratory Exercise**

---

The student shall:

1. Measure and compare items in the English Engineering system;
2. Convert quantities from mass, volume, force and temperature;
3. Measure and compare items in both the English Engineering system, and the Metric system;
4. Convert quantities from English to Metric and Metric to English;
5. Dimension the physical quantities in a simple machine such as a wheel and axle; and,
6. Dimension the power in an industrial crane.

Name: \_\_\_\_\_

Date: \_\_\_\_\_

**AET-A5-QU-1**  
**Measure, Calculate, and Convert Quantities**  
**in English and Metric (SI, mks) Systems**  
**English/metric Conversions**

1. What is the weight in lbs of a 1000 kg mass?

---

---

---

2. What is the weight in Newtons of a 1000 kg mass?

---

---

---

3. A 4 kg mass weighs:

- a. 8.8 lbs
- b. 8.8 Newtons
- c. 8.8 joules
- d. 9.8 N\*m

4. A 3 kg mass weighs:

- a. 96 pounds
- b. 29.4 Newtons
- c. 96 Newtons
- d. 29.4 pounds

5. How many feet are there in 20 meters?

---

---

---

6. How many Newtons are in a 500 lb weight?

---

---

---

7. The two acceleration constants used in calculating weight force are:

---

---

---



8. Convert 21 degrees Celsius to Fahrenheit.

---

---

---

9. Convert 110 degrees Fahrenheit to Celsius.

---

---

---

10. How many gallons are in 1 ft<sup>3</sup>?

---

---

---

11. How many milliliters are in 1 kilogram of chemically pure water?

---

---

---

12. Convert 1 ft<sup>3</sup> into liters.

---

---

---

13. How many kilograms of mass are in a 1 ton weight?

---

---

---

14. How many pounds of weight force are in .5 liters of chemically pure water?

---

---

---

15. Convert 5 miles into meters.

---

---

---

16. Convert 300,000 kilometers into miles.

---

---

---

17. A  $1.5 \text{ ft}^3$  container is filled with chemically pure water. How many kilograms of mass are contained in the container?

---

---

---

18. How many inches<sup>2</sup> are in 1 meter<sup>2</sup>?

---

---

---

19. How many meter<sup>2</sup> are in 1 square mile?

---

---

---

20. Convert 2 liters of chemically pure water to pounds of weight force.

---

---

---

Name: \_\_\_\_\_

Date: \_\_\_\_\_

**AET-A5-QU-2**  
**Measure, Calculate, and Convert Quantities**  
**in English and Metric (SI, mks) Systems**  
**Dimensioning of Physical Quantities**

1. How much force in Newtons is needed to accelerate a 3000 kg automobile at a rate of  $10 \text{ m/sec}^2$  ?
  - a. 3000 N
  - b.  $3.0 \times 10^4 \text{ N}$
  - c.  $3.0 \times 10^{-4} \text{ N}$
  - d. 30,000 lbs
  
2. A 10 kg mass is moving at a velocity of 10 m/sec. We desire to bring the mass to a complete stop (relative to us) in 2 seconds. This will require the application of a force of:
  - a. 10 joules
  - b. 50 watts
  - c. 50 Newtons
  - d. 100 Newtons
  
3. How much time will it take to bring a 225 kg machine slide to a complete halt from a velocity of .3 m/sec if a force of 10 Newtons is applied to halt the slide?
  - a. 1 sec
  - b. .148 sec
  - c. 2 sec
  - d. 6.75 sec
  
4. How much force must be applied to a machine to stop it if it has a momentum of  $1 \text{ kg}\cdot\text{m/sec}$  and it is desired to stop it in .5 sec?
  - a. 1 N
  - b. 2 N
  - c. 3 N
  - d. 4 N
  
5. If I move a 1000 kg mass 25 meters at a rate of  $20 \text{ m/sec}^2$ , how much work have I accomplished?
  - a.  $5.0 \times 10^5 \text{ Joules}$
  - b. 5000 Joules
  - c.  $5.0 \times 10^5 \text{ ft}\cdot\text{lbs}$
  - d.  $5.0 \times 10^4 \text{ Joules}$

6. A hoist lifts a 550 pound weight one foot in .5 sec. How many horsepower is required to accomplish this?
- 1 horsepower
  - .5 horsepower
  - 10 horsepower
  - 2 horsepower
7. A 220 volt electrical motor consumes 10 amps. If power in watts in an electrical circuit is equal to voltage multiplied by current ( $V \cdot I$ ), how many horsepower is the motor consuming?
- 2.95 horsepower
  - 4 horsepower
  - 5.5 horsepower
  - 1 horsepower
8. A 110 volt electrical motor consumes 15 amps of current when lifting a weight on a hoist a distance of 1 meter in 2 sec. How much in Newtons does the weight weigh? (assume no losses in the system)
- 1650 N
  - 825 N
  - 1200 N
  - 3300 N
9. A 3,500 lb automobile accelerates to a velocity of 65 miles per hour in 5.5 seconds. What is the acceleration of the automobile in  $m/sec^2$ ?
- 5.28  $m/sec^2$
  - 29.06  $m/sec^2$
  - 1785  $m/sec$
  - 1590.0  $m/hr$
10. A 1000 lb weight is being hoisted on a hoist. It moves up three feet in 5 seconds. If power equals  $V \cdot I$ , what is the current required for the motor if the motor is operated at a voltage of 220 volts ?
- 3.7 amps
  - 10 amps
  - 5 amps
  - 15 amps

# **AUTOMATED EQUIPMENT REPAIR SERIES**

## **MASTER Technical Module No. AET-A6**

---

**Subject:** Automated Equipment Repair **Time:** 12 Hrs.

**Duty:** Apply Science to Solve Industrial Problems

**Task:** Use Physics, Algebra, and Trigonometry to Analyze Simple Vectored Forces

---

**Objective(s):**

Upon completion of this unit the student will be able to:

- a. Demonstrate the physics concept of force;
- b. Demonstrate the concept of vectored force;
- c. Apply algebra and geometry to the concept of vectored forces; and,
- d. Apply trigonometry to the concept of vectored forces.

---

**Instructional Materials:**

Vector table

Weights

MASTER Handout (AET-A6-HO)

MASTER Laboratory Exercise (AET-A6-LE1)

MASTER Laboratory Exercise (AET-A6-LE2) (Vectored Forces)

MASTER Quiz AET-A6-QU-1: Application and calculation of forces

MASTER Quiz AET-A6-QU-2: Identification of force vectors

MASTER Quiz AET-A6-QU-3: Geometric solution of vectored forces

MASTER Quiz AET-A6-QU-4: Trigonometry and trigonometric vectors

---

**References:**

*Elementary Technical Mathematics*, Ewen/Nelson, Latest Edition

*Physics for Career Education*, Ewen/Nelson/Schurter, Latest Edition

*Technical Mathematics with Calculus*, Peterson, Latest Edition

**Video:** *The Mechanical Universe*, Anenberg/CBP (PBS), Latest Edition

---

**Student Preparation:**

Students should have previously completed the following Technical Modules:

**AET-A1** "Apply Scientific Notation and Engineering Notation to Solve Technical Problems"

**AET-A2** "Apply Algebraic Formulas to Solve Technical Problems"

- AET-A3** “Use Variables in Algebraic Formulas to Predict Behavior of Industrial Systems”
- AET-A4** “Manipulate Variables in Algebraic Formulas to Analyze Industrial Systems”
- AET-A5** “Measure, Calculate, and Convert Quantities in English and Metric (SI, mks) Systems of Measurement”

---

---

### **Introduction:**

The study of mechanics and electronics requires the application of the concept of a vectored force. In mechanics, a complex mechanism has many forces acting upon it. These forces have both a magnitude, and a direction. In electronics, the analysis of complex Alternating Current (AC) circuits requires the application of vectors to solve problems. The ability to predict an outcome of a physical process enables the technician to analyze a system and understand its operating principles. Automated equipment technicians must be prepared to recognize and use vectored forces to solve industrial problems.

---

---

### **Presentation Outline:**

- I. Demonstrate the Physics Concept of Force**
  - A. Discuss the component parts of force and the importance of force in physical systems**
    - 1. Discuss the role of the concept of force in mechanical systems
    - 2. Demonstrate the nature of force in mechanical systems
    - 3. Demonstrate the application of force in mechanical systems
    - 4. Discuss the role of the concept of force in electrical/electronic systems
    - 5. Demonstrate the nature of force in electrical/electronic systems
    - 6. Demonstrate the application of force in electrical/electronic systems
  - B. Discuss the methods of calculating forces**
    - 1. Demonstrate the calculation of force in the English Engineering system
    - 2. Demonstrate the calculation of force in the Metric (mks S.I.) system
- II. Demonstrate the Concept of Vectored Force**
  - A. Discuss the component parts of a vector**
    - 1. Discuss the difference between scalar quantities and vectored quantities
    - 2. Discuss the rectangular coordinate system
    - 3. Demonstrate a two dimensional vector in a rectangular coordinate system
  - B. Discuss the methods of calculating vectored forces**

1. Demonstrate the calculation of vectored force using geometry and algebra
  2. Demonstrate the calculation of vectored force using trigonometry
- C. Show video The Mechanical Universe - "Vectors"
- III. Apply Algebra and Geometry to the Concept of Vectored Forces
- A. Discuss the geometrical concepts contained in a rectangular (Cartesian) coordinate system
    1. Discuss angles
    2. Discuss triangles and parallelograms
    3. Discuss right triangles and the Pythagorean Theorem
    4. Demonstrate a two dimensional vector in a rectangular coordinate system
  - B. Demonstrate the calculation of vectored force using geometry and algebra
- IV. Apply Trigonometry to the Concept of Vectored Forces
- A. Discuss the trigonometric ratios in a right triangle
    1. Discuss the origins of trigonometry
    2. Discuss the sine, cosine, and tangent functions
    3. Demonstrate the solution of sample industrial problems using the sine, cosine, and tangent functions
    4. Demonstrate a two dimensional vector in a rectangular coordinate system and label the parts used in trigonometric functions
  - B. Demonstrate the calculation of vectored forces using trigonometry

---



---

### **Practical Application:**

1. Identify the component parts of the forces of a mechanism or electrical/electronic system;
2. Calculate the simple resultant force of a mechanism acting in opposition;
3. Identify the component parts of the input vectored forces of a mechanism or electrical/electronic system;
4. Layout a vector diagram of three vectored forces in a rectangular coordinate system;
5. Construct a vector diagram of two vectored forces acting a right angles;
6. Using the Pythagorean Theorem, solve for the resultant force;
7. Complete the laboratory exercise AET-A6-LE2 (Vectored forces); and,
8. Using trigonometry, calculate the vectored force in selected industrial equipment.

---

---

**Evaluation and/or Verification:**

Successful completion of this technical module will be based on the student's successful completion of the following components:

1. Ten question quiz on the application and calculation of forces;
2. MASTER laboratory exercise AET-A6-LE2 (Vectored forces);
3. Ten question quiz on the identification of vectored forces;
4. Ten question quiz on the geometric solution of vectored forces; and,
5. Twenty question quiz on trigonometry and trigonometric vectors.

---

---

**Summary:**

Review the main lesson points using the suggested texts listed in the reference section of this module. Hold class discussion and answer student questions.

---

---

**Next Lesson Assignment:**

**MASTER Technical Module (AET-A7)** dealing with using mechanical physics to analyze mechanical industrial systems.



**AET-A6-HO**  
**Use Physics, Algebra, and Trigonometry**  
**to Analyze Simple Vectored Forces**  
**Attachment 1: MASTER Handout**

---

**Objective(s):**

Upon completion of this unit the student will be able to:

- a. Demonstrate the physics concept of force;
  - b. Demonstrate the concept of vectored force;
  - c. Apply algebra and geometry to the concept of vectored forces; and,
  - d. Apply trigonometry to the concept of vectored forces.
- 

**Module Outline:**

- I. Demonstrate the Physics Concept of Force
  - A. Discuss the component parts of force and the importance of force in physical systems
    1. Discuss the role of the concept of force in mechanical systems
    2. Demonstrate the nature of force in mechanical systems
    3. Demonstrate the application of force in mechanical systems
    4. Discuss the role of the concept of force in electrical/electronic systems
    5. Demonstrate the nature of force in electrical/electronic systems
    6. Demonstrate the application of force in electrical/electronic systems
  - B. Discuss the methods of calculating forces
    1. Demonstrate the calculation of force in the English Engineering system
    2. Demonstrate the calculation of force in the Metric (mks S.I.) system
- II. Demonstrate the Concept of Vectored Force
  - A. Discuss the component parts of a vector
    1. Discuss the difference between scalar quantities and vectored quantities
    2. Discuss the rectangular coordinate system
    3. Demonstrate a two dimensional vector in a rectangular coordinate system
  - B. Discuss the methods of calculating vectored forces
    1. Demonstrate the calculation of vectored force using geometry and algebra
    2. Demonstrate the calculation of vectored force using trigonometry
  - C. Show video The Mechanical Universe -"Vectors"

- III. Apply Algebra and Geometry to the Concept of Vectored Forces
  - A. Discuss the geometrical concepts contained in a rectangular (Cartesian) coordinate system
    - 1. Discuss angles
    - 2. Discuss triangles and parallelograms
    - 3. Discuss right triangles and the Pythagorean Theorem
    - 4. Demonstrate a two dimensional vector in a rectangular coordinate system
  - B. Demonstrate the calculation of vectored force using geometry and algebra
- IV. Apply Trigonometry to the Concept of Vectored Forces
  - A. Discuss the trigonometric ratios in a right triangle
    - 1. Discuss the origins of trigonometry
    - 2. Discuss the sine, cosine, and tangent functions
    - 3. Demonstrate the solution of sample industrial problems using the sine, cosine, and tangent functions
    - 4. Demonstrate a two dimensional vector in a rectangular coordinate system and label the parts used in trigonometric functions
  - B. Demonstrate the calculation of vectored forces using trigonometry

**AET-A6-LE1**  
**Use Physics, Algebra, and Trigonometry**  
**to Analyze Simple Vectored Forces**  
**Attachment 2: MASTER Laboratory Exercise**

---

The student shall:

1. Identify the component parts of the forces of a mechanism or electrical/electronic system;
2. Calculate the simple resultant force of a mechanism acting in opposition;
3. Identify the component parts of the input vectored forces of a mechanism or electrical/electronic system;
4. Layout a vector diagram of three vectored forces in a rectangular coordinate system;
5. Construct a vector diagram of two vectored forces acting a right angles;
6. Using the Pythagorean Theorem, solve for the resultant force;
7. Complete the laboratory exercise AET-A6-LE2 (Vectored forces); and,
8. Using trigonometry, calculate the vectored force in selected industrial equipment.

# **AUTOMATED EQUIPMENT REPAIR SERIES**

## **MASTER Technical Module No. AET-7**

---

**Subject:** Automated Equipment Repair **Time:** 24 Hrs.

**Duty:** Apply Science to Solve Industrial Problems

**Task:** Use Mechanical Physics to Analyze Mechanical Industrial Systems

---

### **Objective(s):**

Upon completion of this unit the student will be able to use the rules, formulas, and procedures found in the study of mechanical systems to:

- a. Identify simple machines found in complex machines;
- b. Calculate the mechanical advantages of these simple machines found in complex machines;
- c. Identify rotational machines found in complex machines, such as gear trains, pulleys, and wheel and axle systems;
- d. Calculate the mechanical advantages of these rotational machines found in complex machines; and,
- e. Apply the principles of force, work, power, momentum, impulse momentum, and friction to calculate and measure the result of these forces upon the complex machine.

---

### **Instructional Materials:**

**MASTER Handout (AET-A7-HO)**

**MASTER Laboratory Exercise (AET-A7-LE1)**

**MASTER Laboratory Exercise (AET-A7-LE2) (Linear simple machines)**

**MASTER Laboratory Exercise (AET-A7-LE3) (Rotational simple machines)**

**MASTER Laboratory Exercise (AET-A7-LE4) (Dimensioning complex machines)**

**MASTER Quiz AET-A7-QU-1: Simple machines**

**MASTER Quiz AET-A7-QU-2: Rotational machines**

**MASTER Quiz AET-A7-QU-3: Work, power, and friction**

Commercially available mechanical lab experiment equipment. (The author has no suggestions as to the quality or effectiveness of a particular manufacturer. Most commercially available mechanical lab equipment is overpriced, hard to work with, and easy to damage. The author recommends that the instructor build the equipment.)

A complex rotational machine (A bicycle or surplus exercycle is ideal. Surplus exercycles can be purchased from charity stores for as little as \$5.00 each.)

---

**References:**

*Elementary Technical Mathematics*, Ewen/Nelson, Latest Edition  
*Physics for Career Education*, Ewen/Nelson/Schurter, Latest Edition  
*Technical Mathematics with Calculus*, Peterson, Latest Edition  
Video: *The Mechanical Universe*, Anenberg/CBP (PBS), Latest Edition

---

**Student Preparation:**

Students should have previously completed the following Technical Modules:

- AET-A1 “Apply Scientific Notation and Engineering Notation to Solve Technical Problems”
- AET-A2 “Apply Algebraic Formulas to Solve Technical Problems”
- AET-A3 “Use Variables in Algebraic Formulas to Predict Behavior of Industrial Systems”
- AET-A4 “Manipulate Variables in Algebraic Formulas to Analyze Industrial Systems”
- AET-A5 “Measure, Calculate, and Convert Quantities in English and Metric (SI, mks) Systems of Measurement”
- AET-A6 “Use Physics, Algebra, and Trigonometry to Analyze Simple Vectored Forces”

---

---

**Introduction:**

Understanding the complex relationship between mechanisms and the electronic or electrical systems that control them is a difficult task. The problems become even more difficult when the mechanism itself is poorly or incompletely understood. One of the most effective troubleshooting tools that the technician can use is to characterize the mechanism before it becomes a potential problem. For example, the technician could use the following steps to define the mechanism, and establish base-line measurements:

1. Create a mechanical model of the machine;
2. Create a formula that can be used to calculate the expected behavior of the machine; and,
3. Measure the mechanism in its operational condition, and record the data.

The base line measurements and the following techniques can then be used to assess the relative mechanical soundness of the machine, enabling the technician to determine whether the problem is in the mechanism, or in the electronic control of the mechanism.

One of the most effective troubleshooting tools that the technician can possess is the ability to recognize where power is being used in a mechanical system. Power is

always manifested as heat. Friction can cause a machine to lose power and friction always produces heat. Friction also acts to apply deceleration to a mechanical system. This fact becomes vital when the technician is investigating a servo system.

---

---

**Presentation Outline:**

- I. **Analyze and Measure Simple Machines**
  - A. **Discuss and identify simple machines and the industrial equipment in which they can be found**
    - 1. **Levers**
    - 2. **Ramps**
    - 3. **Screws**
  - B. **Demonstrate the calculation of mechanical advantages/disadvantages, and speed advantages/disadvantages for each machine**
  - C. **Demonstrate the method of creating a complex machine from simple machines**
    - 1. **Demonstrate the methods of linking simple machines together into complex machines**
    - 2. **Demonstrate the calculation of the total effects upon the complex machine of the individual mechanical advantages/disadvantages and speed advantages/disadvantages of the simple machines**
  - D. **Demonstrate and measure the effects of the above simple machines upon industrial equipment such as lathes, mills, presses, or other types of complex machinery**
- II. **Analyze and Measure Rotational Machines**
  - A. **Discuss and identify rotational machines and the industrial equipment in which they can be found**
    - 1. **Wheel and axle**
    - 2. **Pulleys**
    - 3. **Gear trains**
  - B. **Demonstrate the calculation of mechanical advantages/disadvantages, and speed advantages/disadvantages for each machine**
  - C. **Demonstrate the method of creating a complex machine from rotational and simple machines. (Use as an example a surplus exercycle)**
    - 1. **Demonstrate the methods of linking rotational machines and linear machines together into complex machines**
    - 2. **Demonstrate the calculation of the total effects upon the complex machine of the individual mechanical advantages of the linear and rotational machines**
  - D. **Discuss the relationship between levers, screws, and rotational machines**

- E. Demonstrate and measure the effects of the above simple machines upon industrial equipment such as lathes, mills, presses, or other types of complex machinery
- III. Analyze, Dimension, and Measure Forces
- A. Discuss and identify physical attributes acting upon industrial machines (dimensions)
    - 1. Mass-slugs, kilograms
    - 2. Force-pounds, Newton
    - 3. Work-energy, foot-pounds, joules
    - 4. Momentum, impulse momentum
    - 5. Torque-foot-pounds, Newton-meters
    - 6. Angular momentum, impulse momentum
  - B. Discuss and identify power and friction acting upon industrial machines
    - 1. Discuss mechanical power in horsepower and watts for the English Engineering system and Metric System
    - 2. Demonstrate the calculation of rotary and linear power and the conversion of power from both systems of measurement
    - 3. Discuss the mechanical measurement of power and how power is manifested in a mechanical system (heat)
    - 4. Discuss the component parts of friction and the coefficient of friction
    - 5. Demonstrate the factors used and the calculation of friction
    - 6. Discuss the relationship between momentum, impulse momentum, and friction
  - C. Discuss the relationship of power and friction in levers, ramps, and rotational machines
  - D. Demonstrate and measure the effects of the above physical factors upon industrial equipment such as lathes, mills, presses, or other types of complex machinery

---

---

**Practical Application:**

- 1. Analyze an industrial machine such as a lathe, mill, crane, or press; and,
- 2. Measure the machine's mechanical attributes.

---

---

**Evaluation and/or Verification:**

Successful completion of this technical module will be based on the student's successful completion of the following components:

- 1. MASTER quiz AET-A7-QU-1: Simple machines;
- 2. MASTER Laboratory Exercise (AET-A7-LE2) (Linear simple machines);
- 3. MASTER quiz AET-A7-QU-2: Rotational machines;
- 4. MASTER Laboratory Exercise (AET-A7-LE3) (Rotational simple machines);

5. MASTER quiz AET-A7-QU-3: Work, power and friction; and,
6. MASTER Laboratory Exercise AET-A7-LE4) (Dimensioning complex machines).

---

---

**Summary:**

Review the main lesson points using the suggested texts listed in the reference section of this module. Hold class discussion and answer student questions.

---

---

**Next Lesson Assignment:**

**MASTER Technical Module (AET-A8)** dealing with using math and mechanical physics to analyze problems found in hydraulic and pneumatic systems.



## AET-A7-HO

### Use Mechanical Physics to Analyze Mechanical Industrial Systems Attachment 1: MASTER Handout

---

#### Objective(s):

Upon completion of this unit the student will be able to use the rules, formulas, and procedures found in the study of mechanical systems to:

- a. Identify simple machines found in complex machines;
  - b. Calculate the mechanical advantages of these simple machines found in complex machines;
  - c. Identify rotational machines found in complex machines, such as gear trains, pulleys, and wheel and axle systems;
  - d. Calculate the mechanical advantages of these rotational machines found in complex machines; and,
  - e. Apply the principles of force, work, power, momentum, impulse momentum, and friction to calculate and measure the result of these forces upon the complex machine.
- 

#### Module Outline:

- I. Analyze and Measure Simple Machines
  - A. Discuss and identify simple machines and the industrial equipment in which they can be found
    1. Levers
    2. Ramps
    3. Screws
  - B. Demonstrate the calculation of mechanical advantages/disadvantages, and speed advantages/disadvantages for each machine
  - C. Demonstrate the method of creating a complex machine from simple machines
    1. Demonstrate the methods of linking simple machines together into complex machines
    2. Demonstrate the calculation of the total effects upon the complex machine of the individual mechanical advantages/disadvantages and speed advantages/disadvantages of the simple machines
  - D. Demonstrate and measure the effects of the above simple machines upon industrial equipment such as lathes, mills, presses, or other types of complex machinery
- II. Analyze and Measure Rotational Machines
  - A. Discuss and identify rotational machines and the industrial equipment in which they can be found
    1. Wheel and axle

2. Pulleys
3. Gear trains
- B. Demonstrate the calculation of mechanical advantages/disadvantages, and speed advantages/disadvantages for each machine
- C. Demonstrate the method of creating a complex machine from rotational and simple machines. (Use as an example a surplus exercycle)
  1. Demonstrate the methods of linking rotational machines and linear machines together into complex machines
  2. Demonstrate the calculation of the total effects upon the complex machine of the individual mechanical advantages of the linear and rotational machines
- D. Discuss the relationship between levers, screws, and rotational machines
- E. Demonstrate and measure the effects of the above simple machines upon industrial equipment such as lathes, mills, presses, or other types of complex machinery
- III. Analyze, Dimension, and Measure Forces
  - A. Discuss and identify physical attributes acting upon industrial machines (dimensions)
    1. Mass-slugs, kilograms
    2. Force-pounds, Newton
    3. Work-energy, foot-pounds, joules
    4. Momentum, impulse momentum
    5. Torque-foot-pounds, Newton-meters
    6. Angular momentum, impulse momentum
  - B. Discuss and identify power and friction acting upon industrial machines
    1. Discuss mechanical power in horsepower and watts for the English Engineering system and Metric System
    2. Demonstrate the calculation of rotary and linear power and the conversion of power from both systems of measurement
    3. Discuss the mechanical measurement of power and how power is manifested in a mechanical system (heat)
    4. Discuss the component parts of friction and the coefficient of friction
    5. Demonstrate the factors used and the calculation of friction
    6. Discuss the relationship between momentum, impulse momentum, and friction
  - C. Discuss the relationship of power and friction in levers, ramps, and rotational machines
  - D. Demonstrate and measure the effects of the above physical factors upon industrial equipment such as lathes, mills, presses, or other types of complex machinery

**AET-A7-LE1**  
**Use Mechanical Physics to Analyze Mechanical Industrial Systems**  
**Attachment 2: MASTER Laboratory Exercise No. 1**

---

The student shall:

1. Analyze an industrial machine such as a lathe, mill, crane, or press; and,
2. Measure the machine's mechanical attributes.

**AET-A7-LE2**  
**Use Mechanical Physics to Analyze Mechanical Industrial Systems**  
**Attachment 3: MASTER Laboratory Exercise No. 2**

---

**Linear Simple Machines**

**Part 1: Levers**

**Equipment Needed:**

1. 1-12 inch or 30 mm lever arm with four holes spaced evenly along the length of the arm.
2. Aluminum mounting plate and stand, 24 in x 24 in or 40 mm x 40mm, drilled and tapped to accept a 1/4-20 or 6 mm bolt, with hole patterns spaced evenly every 1.0 inches or 3 cm on center, to mount the mechanical apparatus.
3. 1/4-20 or 6 mm Smooth shank bolt and nuts to act as fulcrum.
4. 2-Spring scales or pneumatic cylinders to act as the *effort force* and the *resistance force*.

**When pneumatic cylinders are used, a pressure gauge must be installed on the cylinders to record the pressure.**

5. Safety glasses. Safety glasses are required when using the pneumatic cylinder apparatus.

**Introduction**

There are three classes of levers. A class one (1) lever has the fulcrum between the effort force and the resistance force. A class two (2) lever has the resistance force between the fulcrum and the effort force. A class three (3) lever has the effort force between the fulcrum and the resistance force. Regardless of the class of lever, mechanical advantage and disadvantage is a function of the respective lengths from the fulcrum of the effort force and the resistance force. To determine mechanical advantage or disadvantage, one must measure the respective lengths of the application of the two forces.

## Part 1A: Class 1 Lever

### Apparatus:

#### 1. Mounting plate and stand

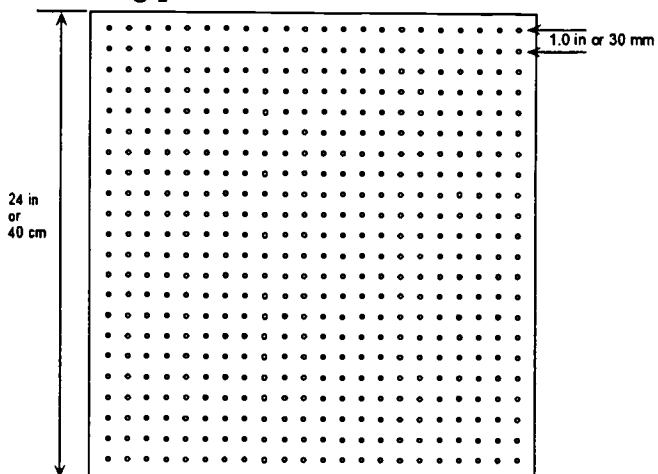

#### 2. Lever arm

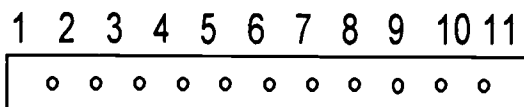

#### 3. Spring scale or pneumatic cylinder and pressure gauges

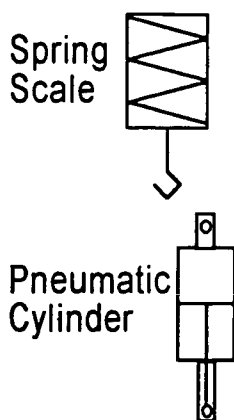

**Procedure:**

1. Construct the apparatus as shown. Use the holes on the lever arm as depicted in the following table.

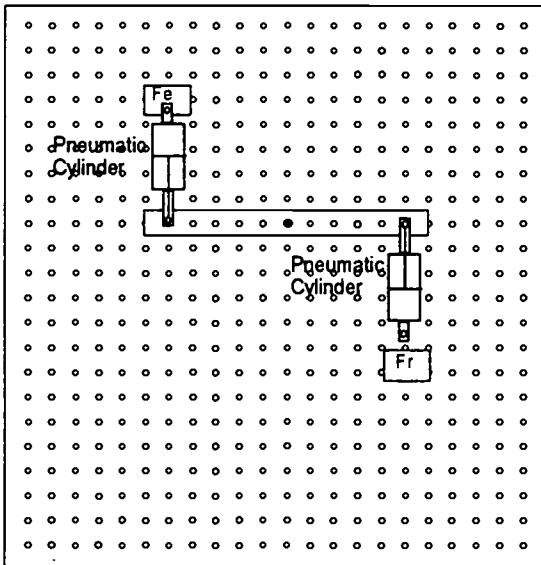
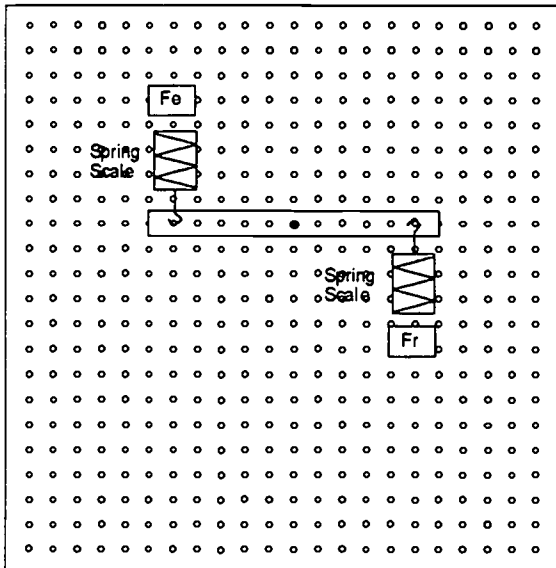

Table for class 1 lever			
Fulcrum hole	Length of Fr arm	Length of Fe arm	MA
2			
3			
4			
5			
6			
7			
8			
9			
10			

**For each fulcrum position in the table:**

2. Measure the length of the effort force from the fulcrum and the length of the resistance force from the fulcrum.
3. Calculate the expected MA.
4. Apply an effort force to the input of the lever, and record the effort and resistance forces. When using the pneumatic cylinders, a pressure gauge must be installed on the cylinders to record the pressure, and a compressor or hand pump must be used to apply the input pressure. Use the formula Force = Pressure Times Area ( $F = P * A$ ) to calculate the force. In the apparatus as shown above, for the **force of resistance**, you must subtract the *surface area of the rod* from the *surface area of the piston*, to obtain the correct value for surface area. This particular step may be eliminated if the output force cylinder is reversed to the top of the lever arm.
5. Compare the recorded data with the calculated values.

**Answer the following question(s):**

1. Does the measured MA match the calculated MA? If not, why?

---



---



---

2. What aspect of the system is lost or gained in the trade-off for a mechanical advantage or disadvantage?

---



---



---

## Part 1B: Class 2 Lever

### Apparatus:

#### 1. Mounting plate and stand

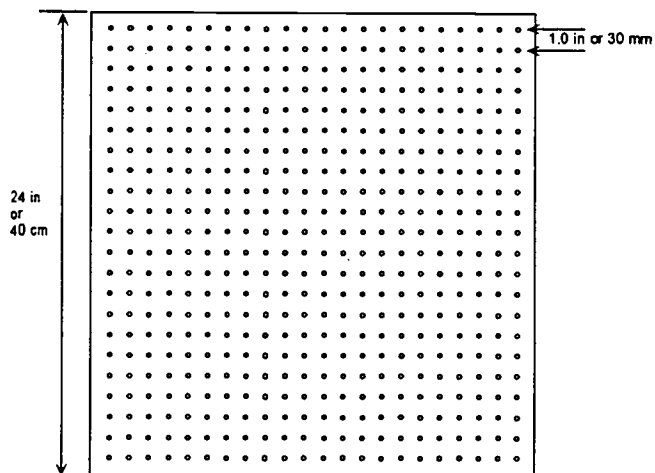

#### 2. Lever arm

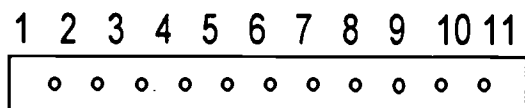

#### 3. Spring scale or pneumatic cylinder and pressure gauges

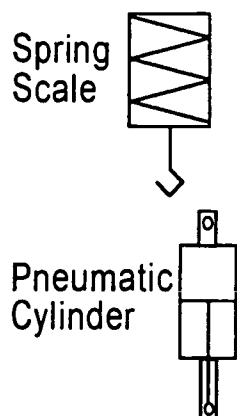



**Procedure:**

1. Construct the apparatus as shown. Use hole 1 as the fulcrum. Use the holes on the lever arm for the resistance force as depicted in the following table.

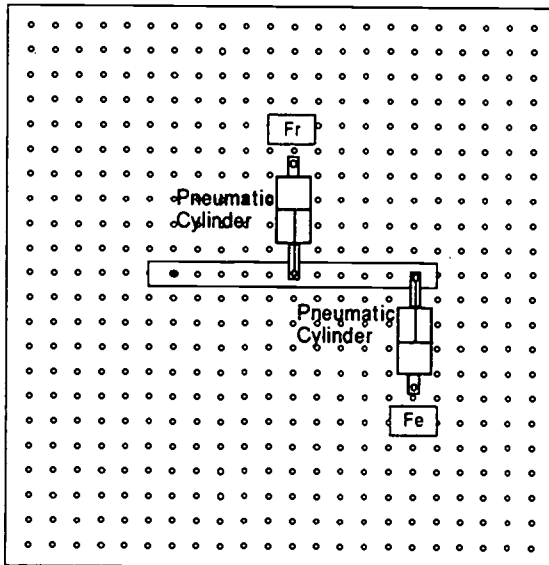
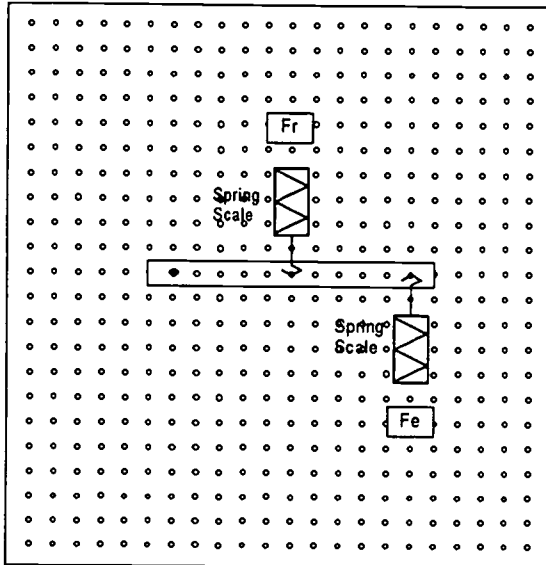

Table for class 2 lever			
ResistanceForce	Length of Fr arm	Length of Fe arm	MA
2			
3			
4			
5			
6			
7			
8			
9			
10			

**For each resistance force position in the table:**

2. Measure the length of the effort force from the fulcrum and the length of the resistance force from the fulcrum.
3. Calculate the expected MA.
4. Apply an effort force to the input of the lever, and record the effort and resistance forces. When using the pneumatic cylinders, a pressure gauge must be installed on the cylinders to record the pressure, and a compressor or hand pump must be used to apply the input pressure. Use the formula Force = Pressure Times Area ( $F = P * A$ ) to calculate the force.
5. Compare the recorded data with the calculated values.

**Answer the following:**

1. Give three industrial examples of a Class 2 Lever.

---



---



---

## Part 1C: Class 3 Lever

### Apparatus:

1. Mounting plate and stand

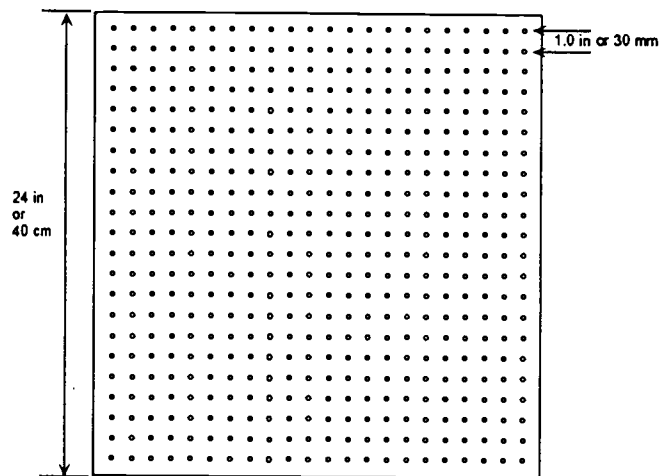

2. Lever arm

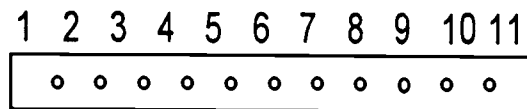

3. Spring scale or pneumatic cylinder and pressure gauges

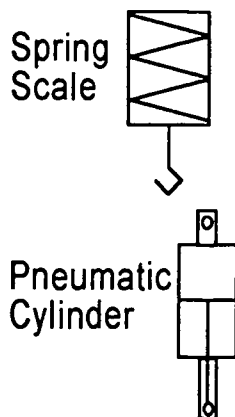

## Procedure:

1. Construct the apparatus as shown. Use hole 1 as the fulcrum. Use the holes on the lever arm for the effort force as depicted in the following table.

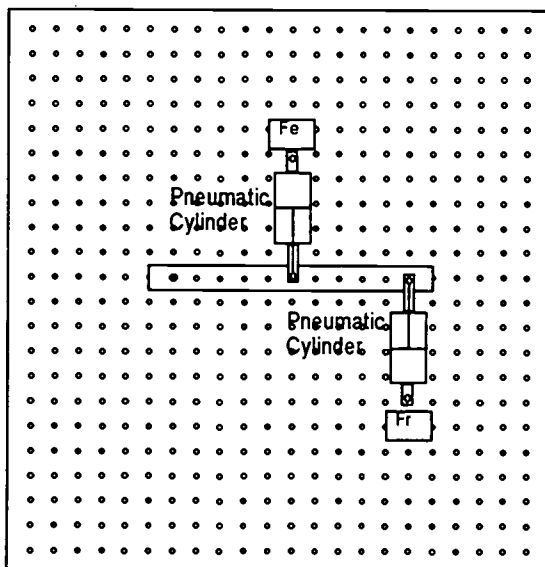
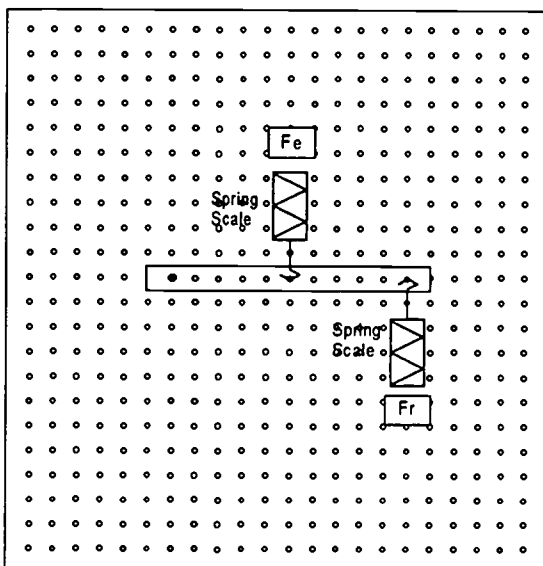

Table for class 3 lever			
Effort Force	Length of Fr arm	Length of Fe arm	MA
2			
3			
4			
5			
6			
7			
8			
9			
10			

**For each resistance force position in the table:**

2. Measure the length of the effort force from the fulcrum and the length of the resistance force from the fulcrum.
3. Calculate the expected MA.
4. Apply an effort force to the input of the lever, and record the effort and resistance forces. When using the pneumatic cylinders, a pressure gauge must be installed on the cylinders to record the pressure, and a compressor or hand pump must be used to apply the input pressure. Use the formula Force = Pressure Times Area ( $F = P * A$ ) to calculate the force.
5. Compare the recorded data with the calculated values.

**Answer the Following:**

1. Give an industrial example of a Class 3 Lever.

---



---



---

2. What kind of advantage does a class 3 lever provide?

---



---



---

Name: \_\_\_\_\_

Date: \_\_\_\_\_

**AET-A7-QU-1**

**Use Mechanical Physics to Analyze Mechanical Industrial Problems**  
**Quiz No. 1 (Simple Machines)**

1. In gear train shown below, the direction of motion of gear B will be:
- clockwise
  - counterclockwise

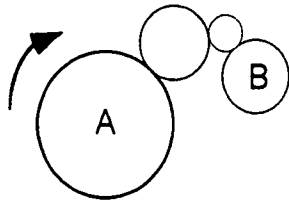

2. In gear train shown below, the direction of motion of gear B will be:
- clockwise
  - counterclockwise

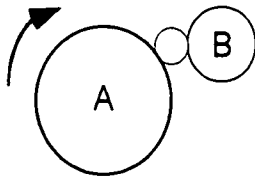

3. The mechanical advantage of an inclined plane that has a ramp of 12 ft. and a rise of 4 ft. is:
- $\frac{1}{3}$
  - 12
  - 4
  - 3
4. An inclined plane that is wrapped around a round shaft is known as a:
- rod
  - screw
  - shaft
  - ramp

5. In the gear assembly shown below, the force at point B is 200 Newtons, what is the torque at point A?
- 200 Newton \* meters
  - 40 Newton \* meters
  - 2 Newton \* meters
  - 100 Newton \* meters

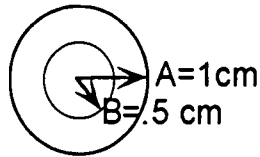

6. In the gear assembly shown below, the force at point B is 200 Newtons. What is the force at point A?
- 100 N
  - 200 N
  - 400 N
  - 50 N

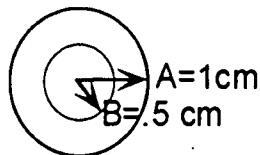

7. Which of the following diagrams is a Class 3 lever?
- diagram 1
  - diagram 2
  - diagram 3

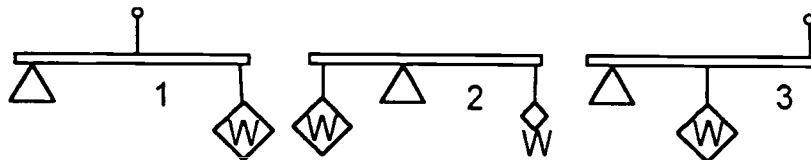

8. If a Class 1 lever has a resistance force of 100 Newtons at a distance of 10 cm from the fulcrum, how much effort force will be needed to exactly counterbalance the resistance force if the effort force is placed 5 cm from the fulcrum?
- 200 N
  - 50 N
  - 100 N
  - 400 N
9. If a lead screw has a diameter of 4 cm and a distance between leads of 250 mm, what is its approximate mechanical advantage?
- 50 to 1
  - 25 to 1
  - 16 to 1
  - 2 to 1
10. Identify the simple machines in the following diagram, and provide a formula to calculate the mechanical advantage of the entire system from point A to point B.

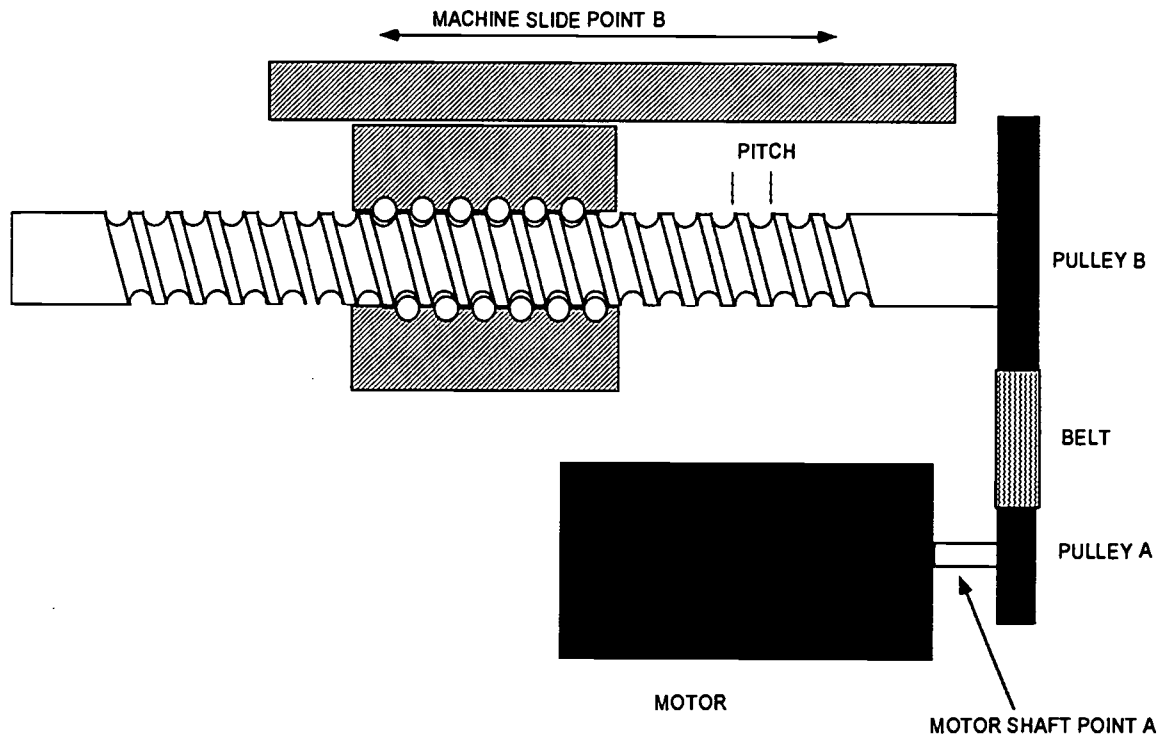

---



---



---



# **AUTOMATED EQUIPMENT REPAIR SERIES**

## **MASTER Technical Module No. AET-A8**

---

**Subject:** Automated Equipment Repair **Time:** 18 Hrs.

**Duty:** Apply Science to Solve Industrial Problems

**Task:** Use Math and Mechanical Physics to Analyze Problems Found in Hydraulic and Pneumatic Systems

---

**Objective(s):**

Upon completion of this unit the student will be able to:

- a. Use the rules of mathematics and the theories and formulas found in the study of gases and fluids to understand and calculate the effects on industrial machinery of the following properties of matter: Pascal's Law, Charles' and Boyle's Law (Ideal Gas Law), Bernoulli's Principle, pressure, flow, density, specific gravity, evaporation, sublimation, condensation, humidity, and relative humidity; and,
- b. Use the rules of mathematics and the theories and formulas found in the study of high pressure and high vacuum systems, to calculate and convert pressures in various pressure systems, including psi (vacuum), psig, psia, inches of water, inches of mercury, bar (absolute), bar (atmospheric), SI system (Pascal's and kilopascals), and the torr system.

---

**Instructional Materials:**

**MASTER Handout (AET-A8-HO)**

**MASTER Laboratory Exercise (AET-A8-LE1)**

**MASTER Laboratory Exercise (AET-A8-LE2) (Fluid power measurements)**

**MASTER Laboratory Exercise (AET-A8-LE3) (Pressure scales/conversions)**

**MASTER Quiz AET-A8-QU-1: Hydraulic/pneumatic principles**

**MASTER Quiz AET-A8-QU-2: Pressure conversions**

Commercially available hydraulic or pneumatic lab experiment equipment.

(The author has no suggestions as to the quality or effectiveness of a particular manufacturer. Most commercially available fluid power lab equipment is overpriced, hard to work with, and easy to damage. The author recommends that the instructor purchase equipment that employs industrial standard valves, pumps, and gauges.)

An industrial humidity oven, or a toaster oven with a pan of water, a commercially available temperature controller, and a commercially available temperature indicator.

Omega reference catalog set (bound set of eight books available free from Omega Corporation).

---

**References:**

*Elementary Technical Mathematics*, Ewen/Nelson, Latest Edition  
*Physics for Career Education*, Ewen/Nelson/Schurter, Latest Edition  
*Technical Mathematics with Calculus*, Peterson, Latest Edition  
Omega Reference Catalogs, Omega Engineering, One Omega Dr. P.O. Box  
2669, Stamford, CT 06906, Latest Edition  
Video: *The Mechanical Universe*, Annenberg/CPB (PBS), Latest  
Edition

---

**Student Preparation:**

Students should have previously completed the following Technical Modules:

- AET-A1 "Apply Scientific Notation and Engineering Notation to Solve Technical Problems"
- AET-A2 "Apply Algebraic Formulas to Solve Technical Problems"
- AET-A3 "Use Variables in Algebraic Formulas to Predict Behavior of Industrial Systems"
- AET-A4 "Manipulate Variables in Algebraic Formulas to Analyze Industrial Systems"
- AET-A5 "Measure, Calculate, and Convert Quantities in English and Metric (SI, mks) Systems of Measurement"
- AET-A6 "Use Physics, Algebra, and Trigonometry to Analyze Simple Vectored Forces"

---

---

**Introduction:**

To understand the complex processes that are used to manufacture products requires an understanding of the behavior of materials when they are subjected to high pressures or extremes of temperature. Both temperature and pressure are used to change the properties of metals, plastics, composite materials, and semiconductor materials used for integrated circuit manufacturing. In addition, the principles found in the study of pressure and flow are essential to the understanding of hydraulics and pneumatics. Finally, the behavior of fluids when they are subject to pressures less than atmospheric pressure is essential to the understanding of vacuum systems.

---

---

**Presentation Outline:**

- I. Gasses and Fluids
  - A. Explain the three states of matter (solids, liquids, gasses) and the phase diagram.

- B. Explain the principles of the following properties of gasses and fluids:
1. Pascal's Law
  2. Ideal Gas Laws
  3. Bernoulli's Principle
  4. Pressure
  5. Flow
- C. Explain the principles of the following properties of matter:
1. Density
  2. Specific gravity
  3. Evaporation
  4. Sublimation
  5. Condensation
  6. Humidity
- D. Demonstrate the application of formulas for the following and demonstrate the calculation of the effects of each concept on industrial machinery:
1. Pressure
  2. Density
  3. Specific gravity
  4. Pressure and force created by pressure
  5. Pressure created by flow and the results of flow
  6. Relative humidity

II. Calculate and convert pressures in various pressure systems

- A. Explain the formulas, dimensions, and principles of the following:
1. Force pressure scales English engineering system
    - a. Pounds per square inch absolute (PSIA)
    - b. Pounds per square inch gauge (PSIG)
  2. Force pressure scales metric mks system
    - a. Newtons per square meter absolute (pascals)(pa)
    - b. Kilo newtons per square meter absolute (kpaA)
    - c. Kilo newtons per square meter gauge (kpaG)
  3. Atmospheric pressure scales
    - a. Pressure of atmosphere
    - b. Bar (gauge)
    - c. Millibar (absolute)
  4. Length pressure scales
    - a. Inches of mercury (in Hg)
    - b. Millimeters of mercury (mm Hg)
    - c. Inches of water (in H<sub>2</sub>O)
  5. Vacuum pressure scales
    - a. Pounds per square inch vacuum (PSIV)
    - b. Microns
    - c. Torr
    - d. Bar
- B. Demonstrate the conversion from one pressure scale to another

---

---

**Practical Application:**

1. Measure the above quantities on industrial equipment such as:
  - a. Mechanical systems;
  - b. Heat treating systems;
  - c. Pneumatic systems;
  - d. Vacuum systems;
  - e. Hydraulic systems;
2. Measure the output of water of a compressor system and compare it to the daily relative humidity;
3. List the different pressure gauges on several different manufacturing systems; and,
4. List several manufacturing processes that employ pressure, heat, or vacuum.

---

---

**Evaluation and/or Verification:**

Successful completion of this technical module will be based on the student's successful completion of the following components:

1. MASTER Quiz AET-A8-QU-1: Hydraulic/pneumatic principles
2. MASTER Laboratory Exercise (AET-A8-LE2) (Fluid power measurements)
3. MASTER Quiz AET-A8-QU-2: Pressure conversions
4. MASTER Laboratory Exercise (AET-A8-LE3) (Pressure scales/conversions)

---

---

**Summary:**

Review the main lesson points using the suggested texts listed in the reference section of this module. Hold class discussion and answer student questions.

---

---

**Next Lesson Assignment:**

**MASTER Technical Module (AET-A9)** dealing with using math and thermodynamics to analyze problems found in industrial heat treating systems.

**AET-A8-HO**  
**Use Math and Mechanical Physics to Analyze Problems**  
**Found in Hydraulic and Pneumatic Systems**  
**Attachment 1: MASTER Handout**

---

**Objective(s):**

Upon completion of this unit the student will be able to:

- a. Use the rules of mathematics and the theories and formulas found in the study of gases and fluids to understand and calculate the effects on industrial machinery of the following properties of matter: Pascal's Law, Charles' and Boyle's Law (Ideal Gas Law), Bernoulli's Principle, pressure, flow, density, specific gravity, evaporation, sublimation, condensation, humidity, and relative humidity; and,
- b. Use the rules of mathematics and the theories and formulas found in the study of high pressure and high vacuum systems, to calculate and convert pressures in various pressure systems, including psi (vacuum), psig, psia, inches of water, inches of mercury, bar (absolute), bar (atmospheric), SI system (Pascal's and kilopascals), and the torr system.

---

**Module Outline:**

- I. Gasses and Fluids
  - A. Explain the three states of matter (solids, liquids, gasses) and the phase diagram.
  - B. Explain the principles of the following properties of gasses and fluids:
    1. Pascal's Law
    2. Ideal Gas Laws
    3. Bernoulli's Principle
    4. Pressure
    5. Flow
  - C. Explain the principles of the following properties of matter:
    1. Density
    2. Specific gravity
    3. Evaporation
    4. Sublimation
    5. Condensation
    6. Humidity
  - D. Demonstrate the application of formulas for the following and demonstrate the calculation of the effects of each concept on industrial machinery:
    1. Pressure
    2. Density

3. Specific gravity
  4. Pressure and force created by pressure
  5. Pressure created by flow and the results of flow
  6. Relative humidity
- II. Calculate and convert pressures in various pressure systems
- A. Explain the formulas, dimensions, and principles of the following:
1. Force pressure scales English engineering system
    - a. Pounds per square inch absolute (PSIA)
    - b. Pounds per square inch gauge (PSIG)
  2. Force pressure scales metric mks system
    - a. Newtons per square meter absolute (pascals)(pa)
    - b. Kilo newtons per square meter absolute (kpaA)
    - c. Kilo newtons per square meter gauge (kpaG)
  3. Atmospheric pressure scales
    - a. Pressure of atmosphere
    - b. Bar (gauge)
    - c. Millibar (absolute)
  4. Length pressure scales
    - a. Inches of mercury (in Hg)
    - b. Millimeters of mercury (mm Hg)
    - c. Inches of water (in H<sub>2</sub>O)
  5. Vacuum pressure scales
    - a. Pounds per square inch vacuum (PSIV)
    - b. Microns
    - c. Torr
    - d. Bar
- B. Demonstrate the conversion from one pressure scale to another

**AET-A8-LE1**  
**Use Math and Mechanical Physics to Analyze Problems**  
**Found in Hydraulic and Pneumatic Systems**  
**Attachment 2: MASTER Laboratory Exercise No. 1**

---

1. Measure the above quantities on industrial equipment such as:
  - a. Mechanical systems;
  - b. Heat treating systems;
  - c. Pneumatic systems;
  - d. Vacuum systems;
  - e. Hydraulic systems;
2. Measure the output of water of a compressor system and compare it to the daily relative humidity;
3. List the different pressure gauges on several different manufacturing systems; and,
4. List several manufacturing processes that employ pressure, heat, or vacuum.

# **AUTOMATED EQUIPMENT REPAIR SERIES**

## **MASTER Technical Module No. AET-A9**

---

**Subject:** Automated Equipment Repair **Time:** 12 Hrs.

**Duty:** Apply Science to Solve Industrial Problems

**Task:** Use Math and Thermodynamics to Analyze Problems Found in Industrial Heat Treating Systems

---

**Objective(s):**

Upon completion of this unit the student will be able to:

- a. Use the rules of mathematics and the theories and formulas found in the study of thermodynamics to understand, calculate, and convert quantities found in industrial heat treating equipment such as temperature scales, kilocalories, British Thermal Units, and specific heat;
- b. Understand the effects materials of the following: thermal conductivity and expansion and contraction of solids; and,
- c. Understand the functions of simple engines and entropy.

---

**Instructional Materials:**

**MASTER Handout (AET-A9-HO)**

**MASTER Laboratory Exercise (AET-A9-LE1)**

**MASTER Laboratory Exercise (AET-A9-LE2) (Temperature scales and heat)**

**MASTER Laboratory Exercise (AET-A9-LE3) (Exploring entropy)**

**MASTER Quiz AET-A9-QU-1: Temperature scale conversions**

**MASTER Quiz AET-A9-QU-2: Heating systems calculations**

**Commercially available oven, thermocouples, and temperature controller.**

(The author has no suggestions as to the quality or effectiveness of a particular educational equipment manufacturer. Most commercially available educational lab equipment is overpriced, hard to work with, and easy to damage. The author recommends that the instructor purchase or solicit donations of equipment that employs industrial standard ovens, thermocouples, Resistance temperature detectors, and controllers.)

**Temperature trend recorders to provide a permanent record of the temperature for a period of time**

**Omega reference catalog set (bound set of eight books available free from Omega Corporation)**

**Building compressor system or hydraulic system**



---

## References:

- Elementary Technical Mathematics*, Ewen/Nelson, Latest Edition  
*Physics for Career Education*, Ewen/Nelson/Schurter, Latest Edition  
*Technical Mathematics with Calculus*, Peterson, Latest Edition  
Omega Reference Catalogs, Omega Engineering, One Omega Dr. P.O. Box  
2669, Stamford, CT 06906, Latest Edition  
Video: *The Mechanical Universe*, Annenberg/CPB (PBS), Latest  
Edition

---

## Student Preparation:

Students should have previously completed the following Technical Modules:

- AET-A1 “Apply Scientific Notation and Engineering Notation to Solve Technical Problems”
- AET-A2 “Apply Algebraic Formulas to Solve Technical Problems”
- AET-A3 “Use Variables in Algebraic Formulas to Predict Behavior of Industrial Systems”
- AET-A4 “Manipulate Variables in Algebraic Formulas to Analyze Industrial Systems”
- AET-A5 “Measure, Calculate, and Convert Quantities in English and Metric (SI, mks) Systems of Measurement”
- AET-A6 “Use Physics, Algebra, and Trigonometry to Analyze Simple Vectored Forces”
- AET-A8 “Use Math and Chemical Physics to Analyze Problems Found in Hydraulic and Pneumatic Systems”

---

---

## Introduction:

One of the most fundamental manufacturing processes involves the heating of materials. Heating is used to combine metals into alloys, change the characteristics of materials, start chemical processes, and join dissimilar materials to create new assemblies. An automation technician must have the ability to understand the complex operation of a heating system to be able to setup and maintain the system. This requires the fundamental understanding of what heat is and how it propagates throughout the system. In addition, the understanding of heat engines and cooling systems requires basic knowledge of the principles of simple engines. Finally, the transfer of power throughout our society and its eventual usage and conversion at the point of performing work, helps to understand the role of power as a net producer of heat (entropy).

---

---

## Presentation Outline:

- I. Temperature Scales and Heat

- A. Explain the two temperature scales in common use and the methods by which they were derived.
  - B. Show video tape (*Mechanical Universe "Temperature"*)
  - C. Demonstrate the conversion from one temperature scale to another
  - D. Explain the principles of the physical dimensions of heat
    - 1. British Thermal Units (BTU)
    - 2. Calories and kilocalories
  - E. Demonstrate the application of formulas for heat on industrial heat treating equipment
  - F. Explain the principles of specific heat
  - G. Demonstrate the application of the principles of the application of specific heat to materials used in industrial processes
- II. Properties of Materials at Different Temperatures
- A. Explain the causes and effects of thermal conductivity
    - 1. Measure the thermal conductivity of various substances
    - 2. Demonstrate the calculation of heat transfer and insulation quality
  - B. Explain the causes and effects of thermal expansion and contraction of solids
- III. Simple Engines and Entropy
- A. Explain how the concept of simple heat engines applies to the understanding of:
    - 1. Air conditioners
    - 2. Internal combustion engines
    - 3. External combustion engines
  - B. Explain how the concept of entropy applies to the understanding of:
    - 1. Electrical power distribution systems
    - 2. Hydraulic and pneumatic power distribution

---



---

**Practical Application:**

- 1. Measure temperature in both the metric and English Engineering system, and convert from one to another;
- 2. By experimentation, determine the amount of heat needed to raise a material such as steel to a given temperature;
- 3. By calculation, determine the amount of power required to heat an oven to a given temperature;
- 4. Measure the expansion of metals that are exposed to heat;
- 5. Measure the transfer of heat through various solids;
- 6. Measure temperatures and power output of a simple heat engine or automobile engine; and,
- 7. Explore a power distribution system from the incoming electrical power to a facility to its usage and eventual conversion to heat in a hydraulic system or pneumatic system.

---

---

**Evaluation and/or Verification:**

Successful completion of this technical module will be based on the student's successful completion of the following components:

1. MASTER Quiz AET-A9-QU-1: Temperature and heat
2. MASTER Laboratory Exercise (AET-A9-LE2) (Temperature scales and heat)
3. MASTER Quiz AET-A9-QU-2: Heating systems calculations
4. MASTER Laboratory Exercise (AET-A9-LE3) (Exploring entropy)

---

---

**Summary:**

Review the main lesson points using the suggested texts listed in the reference section of this module. Hold class discussion and answer student questions.

---

---

**Next Lesson Assignment:**

**MASTER Technical Module (AET-A10)** dealing with using math, the physics of electromagnetism and optics to analyze industrial systems.

**AET-A9-HO**  
**Use Math and Thermodynamics to Analyze Problems**  
**Found in Industrial Heat Treating Systems**  
**Attachment 1: MASTER Handout**

---

**Objective(s):**

Upon completion of this unit the student will be able to:

- a. Use the rules of mathematics and the theories and formulas found in the study of thermodynamics to understand, calculate, and convert quantities found in industrial heat treating equipment such as temperature scales, kilocalories, British Thermal Units, and specific heat;
  - b. Understand the effects materials of the following: thermal conductivity and expansion and contraction of solids; and,
  - c. Understand the functions of simple engines and entropy.
- 

**Module Outline:**

- I. Temperature Scales and Heat
  - A. Explain the two temperature scales in common use and the methods by which they were derived.
  - B. Show video tape (*Mechanical Universe "Temperature"*)
  - C. Demonstrate the conversion from one temperature scale to another
  - D. Explain the principles of the physical dimensions of heat
    1. British Thermal Units (BTU)
    2. Calories and kilocalories
  - E. Demonstrate the application of formulas for heat on industrial heat treating equipment
  - F. Explain the principles of specific heat
  - G. Demonstrate the application of the principles of the application of specific heat to materials used in industrial processes
- II. Properties of Materials at Different Temperatures
  - A. Explain the causes and effects of thermal conductivity
    1. Measure the thermal conductivity of various substances
    2. Demonstrate the calculation of heat transfer and insulation quality
  - B. Explain the causes and effects of thermal expansion and contraction of solids
- III. Simple Engines and Entropy
  - A. Explain how the concept of simple heat engines applies to the understanding of:
    1. Air conditioners

2. Internal combustion engines
  3. External combustion engines
- B. Explain how the concept of entropy applies to the understanding of:
1. Electrical power distribution systems
  2. Hydraulic and pneumatic power distribution

**AET-A9-LE1**  
**Use Math and Thermodynamics to Analyze Problems**  
**Found in Industrial Heat Treating Systems**  
**Attachment 2: MASTER Laboratory Exercise No. 1**

---

1. Measure temperature in both the metric and English Engineering system, and convert from one to another;
2. By experimentation, determine the amount of heat needed to raise a material such as steel to a given temperature;
3. By calculation, determine the amount of power required to heat an oven to a given temperature;
4. Measure the expansion of metals that are exposed to heat;
5. Measure the transfer of heat through various solids;
6. Measure temperatures and power output of a simple heat engine or automobile engine; and,
7. Explore a power distribution system from the incoming electrical power to a facility to its usage and eventual conversion to heat in a hydraulic system or pneumatic system.

# **AUTOMATED EQUIPMENT REPAIR SERIES**

## **MASTER Technical Module No. AET-A10**

---

**Subject:** Automated Equipment Repair **Time:** 10 Hrs.

**Duty:** Apply Science to Solve Industrial Problems

**Task:** Use Math, the Physics of Electromagnetism and Optics to Analyze Industrial Systems

---

**Objective(s):**

Upon completion of this unit the student will be able to apply the knowledge of electromagnetic waves, light, and the rules of optics to understand optical systems, align optical systems, and use photo-spectrometer to:

- a. Define and understand the wave nature of light;
- b. Define polarization;
- c. Define monochromaticity;
- d. Define temporal and spatial coherence;
- e. Explain constructive and non-destructive interference; and,
- f. Define Brewster's Angle.

---

**Instructional Materials:**

HeNe laser, 1-3mw

Sodium Lamp

Green light filter

Two optical flats, 4-inch diameter, (/10 flatness)

Microscope slide

Set of double slits (such as Pasco OS-9123)

Laser beam expanding collimator

Two front surface mirrors

Beam splitter

Optical Bench

Three optical bench carriers with optical component mounts

Optical power meter

Linear translator

Set of precision apertures:

Single slits: 0.02, 0.04, 0.08, 0.16 mm slit width

Double slits: slit width 0.04 mm; slit spacing 0.25 mm

Multiple slits: 2,3,4,5 slits with slit width 0.04 mm and slit spacing 0.125 mm

Circular apertures: 0.04, 0.08, 0.150 mm

Square aperture: 0.25 mm x 0.25 mm

Grating: 5276 lines/cm  
Two Linear Polarizers  
Two 1/4 wave plates  
Two rotational stage assemblies  
Photo-electric power meter  
MASTER Handout (AET-A10-HO)  
MASTER Laboratory Exercise (AET-A10-LE)  
MASTER Laboratory Aid (AET-A10-LA)

*Note:* All components available inexpensively from Edmund Scientific, Inc.

---

### References:

- Light Sources and Wave Optics*, CORD Communications, Laser Electro-Optics Series, Latest Edition  
*Introduction to Classical and Modern Optics*, Meyer-Arendt, Jurgen R., Prentice Hall Publishing, Latest Edition  
*Introduction to Lasers*, CORD Communications, Laser Electro-Optics Series, Latest Edition  
ANSI-Z136.1 (1993), *Safe Use of Lasers*, Laser Institute of America, (Publication No. 106), Latest Edition  
*An Introduction to Lasers and Their Applications*, O'Shea, Callen, Rhodes, Addison-Wesley Publishers, Latest Edition  
*Industrial Applications of Lasers*, Ready, John, F., Academic Press, Latest Edition  
*Understanding Lasers - An Entry-Level Guide*, Hecht, Jeff, IEEE Press, Latest Edition  
Video(s): *Video Demonstrations in Lasers and Optics*, MIT Center for Advanced Engineering Study, Latest Edition  
*Introduction to Laser Safety and Laser Hazards Video Training Module*, Laser Institute of America, Publication No.115, Latest Edition

---

### Student Preparation:

Students should have previously completed the following Technical Modules:

- AET-A1 "Apply Scientific Notation and Engineering Notation to Solve Technical Problems"  
AET-A2 "Apply Algebraic Formulas to Solve Technical Problems"  
AET-A3 "Use Variables in Algebraic Formulas to Predict Behavior of Industrial Systems"  
AET-A4 "Manipulate Variables in Algebraic Formulas to Analyze Industrial Systems"



---

---

**Introduction:**

The ability to use the knowledge of electromagnetism, the wave principles of light propagation, and the mechanics of optics prepares the student for careers in integrated circuit manufacturing, industrial research and development, and repair of optically based equipment.

Light can be represented at several levels of sophistication. The simplest of these is to represent the light by rays. That is the domain of geometrical optics. But, if the wave length of the light can not be neglected in comparison to the dimensions of the system as a whole, we need to take into account the wave nature of light. We need to represent the light by waves. That is the domain of physical optics. In this module, we will review the basic characteristics of light as applied to lasers. Topics will include polarization, interference, and coherence. The intent is to reinforce the students understanding of light to prepare for the next sequence of technical modules in laser theory.

---

---

**Presentation Outline:**

- I. Discuss and Review the Characteristic of Light
  - A. Discuss the following wave properties of light
    1. Frequency
    2. Wavelength
    3. Phase
    4. Amplitude
    5. The electromagnetic spectrum
  - B. Define polarization
  - C. Define monochromaticity
  - D. Define temporal and spatial coherence
  - E. Explain constructive and non-destructive interference
  - F. Define and demonstrate Brewster's Angle
  - G. Practice and demonstration of skills listed above

---

---

**Practical Application:**

Review and discuss experiments to be performed.

---

---

**Evaluation and/or Verification:**

Successful completion of this technical module will be based on the students' successful completion of the following components:

- a. Define and understand the wave nature of light;
- b. Define polarization;

- c. Define monochromaticity;
- d. Define temporal and spatial coherence;
- e. Explain constructive and non-destructive interference;
- f. Define Brewster's Angle; and,
- g. Practice and demonstration of skills listed above.

---

---

**Summary:**

Review the main lesson points using the suggested texts listed in the reference section of this module. Hold class discussion and answer student questions.

---

---

**Next Lesson Assignment:**

**MASTER Technical Module (AET-A11)** pertaining to using chemical principles and formulas to predict and analyze reactions in chemical industrial processes.

**AET-A10-HO**  
**Use Math, the Physics of Electromagnetism and Optics**  
**to Analyze Industrial Systems**  
**Attachment 1: MASTER Handout**

---

**Objective(s):**

Upon completion of this unit the student will be able to apply the knowledge of electromagnetic waves, light, and the rules of optics to understand optical systems, align optical systems, and use photo-spectrometer to:

- a. Define and understand the wave nature of light;
- b. Define polarization;
- c. Define monochromaticity;
- d. Define temporal and spatial coherence;
- e. Explain constructive and non-destructive interference; and,
- f. Define Brewster's Angle.

---

**Module Outline:**

- I. Discuss and Review the Characteristic of Light
  - A. Discuss the following wave properties of light
    1. Frequency
    2. Wavelength
    3. Phase
    4. Amplitude
    5. The electromagnetic spectrum
  - B. Define polarization
  - C. Define monochromaticity
  - D. Define temporal and spatial coherence
  - E. Explain constructive and non-destructive interference
  - F. Define and demonstrate Brewster's Angle
  - G. Practice and demonstration of skills listed above

**AET-A10-LE**  
**Use Math, the Physics of Electromagnetism and Optics**  
**to Analyze Industrial Systems**  
**Attachment 2: MASTER Laboratory Exercise**

---

Successful completion of this technical module will be based on the students' successful completion of the following components:

- a. Define and understand the wave nature of light;
- b. Define polarization;
- c. Define monochromaticity;
- d. Define temporal and spatial coherence;
- e. Explain constructive and non-destructive interference;
- f. Define Brewster's Angle; and,
- g. Practice and demonstration of skills listed above.

**AET-A10-LA**  
**Use Math, the Physics of Electromagnetism and Optics**  
**to Analyze Industrial Systems**  
**Attachment 3: MASTER Laboratory Aid**

---

## **Rules of Conduct**

1. Absolutely no horseplay or practical joking will be tolerated.
2. Do not talk to anyone who is operating a machine.
3. Walk only in the designated traffic lanes.
4. Dress appropriately; at the absolute minimum, you must have:
  - a. No loose clothing, including ties;
  - b. Long hair properly stowed;
  - c. No jewelry;
  - d. Hard, closed-toe shoes;
  - e. Eye protection (safety glasses); and,
  - f. Ear protection (plugs or headset).
5. Follow all institutional safety rules.

# AUTOMATED EQUIPMENT REPAIR SERIES

## MASTER Technical Module No. AET-A11

---

**Subject:** Automated Equipment Repair **Time:** 48 Hrs.

**Duty:** Apply Science to Solve Industrial Problems  
**Task:** Use Chemical Principles and Formulas to Predict and Analyze Reactions in Chemical Industrial Processes

---

**Objective(s):**

Upon completion of this unit the student will be able to:

- a. Use math, physics, and chemical measurements to determine physical quantities;
- b. Use math and chemical measurements to determine compounds, solutions, or mixtures;
- c. Use chemical formulas to predict and analyze reactions in industrial processes;
- d. Use proper lab procedures to test chemicals used in industrial processes;
- e. Use the periodic table to identify elements;
- f. Use the periodic table to calculate molar quantities;
- g. Apply mixing formulas to produce proportions of various mixes, solutions, and compounds;
- h. Apply mixing formulas and the molar concept of chemistry to determine the quantities of elements need to produce a molar reaction;
- i. Apply the concept of ionization or valence and the periodic table to determine reactions;
- j. Apply reaction formulas to determine the number and type of elements needed, energy release or energy added, and if a catalyst is required;
- k. Explain the procedures used to determine the make-up of compounds; and,
- l. Explain the uses of bases or acids in manufacturing processes.

---

**Instructional Materials:**

Chemical laboratory equipment such as test tubes, flasks, mixers, Bunsen burners, stirrers, balance scales, etc.

Chemical elements, acids, and bases

Testing materials such as litmus papers, dyes, pH meters, etc.

Laboratory experiences that demonstrate the concepts covered in this module  
(A good reference for ideas for these labs is *The Extraordinary Chemistry of Ordinary Things* by Carl H Snyder)

MASTER Handout (AET-A11-HO-1)  
MASTER Handout (AET-A11-HO-2 (Mixing Formulas))  
MASTER Laboratory Exercise (AET-A11-LE)  
Safety equipment such as safety goggles, protective aprons and gloves

**Note:** Not all instructional environments may facilitate the use of the above materials, especially industrial sites. Under these circumstances, the laboratory experiences may be modified to include practice in analyzing industrial processes, or demonstrations of the principles covered in this module. The use of expensive laboratory chemicals may be further modified by substituting common household chemicals such as bleach, ammonia, salt, baking soda, steel wool, and chemicals used for swimming pool maintenance such as muriatic acid (sulfuric acid) and swimming pool test kits. The purpose of this module is to provide a basic understanding of the chemical processes that occur in an industrial plant, not as a substitute for a full, college-level chemistry course.

---

### References:

*Applied Chemistry*, Seine, William R., ISBN 0-669-32727-1, Latest Edition  
*The Camelot General Chemistry Primer*, Coop, Dwight W., ISBN 1-883316-19-7, Latest Edition  
*The Extraordinary Chemistry of Ordinary Things*, Snyder, Carl H., ISBN 0-471-31042-5, Latest Edition  
Video(s): *The Mechanical Universe*, Annenberg/CPB (PBS), Latest Edition  
*Chemistry*, Annenberg/CPB (PBS), Latest Edition

---

### Student Preparation:

Students should have previously completed the following Technical Modules:

- AET-A1 "Apply Scientific Notation and Engineering Notation to Solve Technical Problems"
- AET-A2 "Apply Algebraic Formulas to Solve Technical Problems"
- AET-A3 "Use Variables in Algebraic Formulas to Predict Behavior of Industrial Systems"
- AET-A4 "Manipulate Variables in Algebraic Formulas to Analyze Industrial Systems"
- AET-A5 "Measure, Calculate, and Convert Quantities in English and Metric (SI, mks) Systems"
- AET-A6 "Use Physics, Algebra, and Trigonometry to Analyze Simple Vectored Forces"

---

---

## Introduction:

There are many industries that rely upon chemical processes or chemicals to manufacture products. For example, integrated circuit manufacturers, the electronics industry in general, and beverage manufacturers use chemically pure water in many of their processes; electrical Discharge Machining (EDM) uses chemicals to act as an electrical medium for the cutting of metals; high vacuum technology equipment, requires fluids that have very specific chemical properties; manufacturers of glass, plastics, food products, steel, and metal alloys must use chemistry to determine the necessary ingredients for their products; and the petroleum industry requires chemistry to process natural oil into; gasoline, lubricating oils, and raw materials for many industries, including agriculture. The medical industry would be extinct without chemistry, and workers in an industrial environment must be able to read and understand Material Safety Data Sheets (MSDS) to protect themselves from chemical hazards. Knowledge of basic chemistry will prepare an automation technician to enter many diverse industrial fields, and provide an understanding of the manufacturing processes that the automated machines will control.

---

---

## Presentation Outline:

- I. Use, Math, Physics, and Chemical Measurements to Determine Physical Quantities
  - A. Explain the theory of atoms and the organization of matter
    1. Explain the evolution of the theories of matter
    2. Explain the modern model of the atom and its structure
    3. Show the video *The Mechanical Universe "The Atom"*
  - B. Explain the use of the periodic table to identify elements and their characteristics
    1. Explain the organization of the periodic table. or video *Chemistry "The Periodic Table"*, Annenberg CPB
    2. Demonstrate the application of the periodic table to understanding the number of atoms contained in a solid, liquid, or gas
  - C. Explain the methods used to determine weight, volume, and density
    1. Demonstrate the use of balance scales and electronic scales (if available), to determine physical quantities
    2. Demonstrate the methods of calculating mass from a given weight and explain the uncertainties surrounding the calculation
    3. Demonstrate the methods used to determine the volume of a substance
    4. Explain the uncertainties surrounding the measurement
- II. Use Math and Chemical Measurements to Determine Compounds, Solutions, or Mixtures



- A. Apply mixing formulas to produce proportions of various mixtures, and solutions
    - 1. Explain the difference between solutions, compounds, and mixtures
    - 2. Explain the methods used to calculate solutions and mixtures (MASTER Handout AET-A11-HO-2 (Mixing Formulas))
    - 3. Demonstrate the application of mixing formulas to industrial problems
  - B. Use the periodic table to calculate molar quantities
    - 1. Explain the concept of a molar quantity
    - 2. Demonstrate the application of the periodic table in the determining of molar quantities
    - 3. Show applications of molar concepts in industrial chemical processes
  - C. Apply mixing formulas and the molar concept of chemistry to determine the quantities of elements need to produce a molar reaction
- III. Use Chemical Formulas to Predict and Analyze Reactions in Industrial Processes
- A. Apply the concept of ionization or valence and the periodic table to determine reactions
    - 1. Explain the atomic methods by which atoms are linked together to create compounds and structures
    - 2. Explain the concepts of covalent bonding, ionic bonding, and metallic bonding
  - B. Explain the procedures used to determine the make-up of compounds
    - 1. Explain the methods of writing chemical formulas
    - 2. Explain the rationale behind the naming of compounds, and the exceptions to the rules
    - 3. Demonstrate the creation of formulas for the composition of selected compounds
  - C. Explain and demonstrate the application of reaction equations
    - 1. Explain the methods of writing reaction equations
      - a. Number and type of elements
      - b. Energy release or energy needed
      - c. Catalyst needed
      - d. Naming the resultant compound
    - 2. Demonstrate the creation of equations for the results of selected reactions
- IV. Use Proper Lab Procedures to Test Chemicals Used in Industrial Processes
- A. Explain chemical laboratory safety procedures
    - 1. Explain the types of safety equipment used in chemical processes
    - 2. Demonstrate the proper use of chemical safety equipment
    - 3. Explain and demonstrate the proper procedures for handling hazardous chemicals

4. Explain the rules for using flammable or explosive materials
5. Demonstrate the procedures used for handling and storing flammable or explosive materials
- B. Explain the use of Material Safety Data Sheets (MSDS)
  1. Explain the organization of a MSDS
  2. Demonstrate the application of MSDS
- C. Explain and demonstrate the methods used to determine acids or bases
  1. Explain the concept of an acid and a base
  2. Demonstrate and explain the application of the concept of pH in determining if a substance is an acid or a base
  3. Demonstrate the methods used to determine pH
- D. Explain the principles of oxidation and reduction and some of the industrial chemical methods used to achieve each
- E. Explain the methods used to produce raw chemicals and synthesize compounds
- F. Explain the types of modern instruments used to determine chemical compounds
  1. Explain the operating principles of a mass spectrometer
  2. Explain the operating principles of a photo-spectrometer
  3. Explain the methods used to determine the chemical make-up of compounds using the instruments

---

---

### **Practical Application:**

1. Using an industrial chemical process, determine the mass and volume of a quantity of raw materials for a given amount of production;
2. Using an industrial chemical process, determine the quantity of raw materials needed for a given amount of production; and,
3. Using an industrial chemical process, write a reaction equation that describes the manufacturing process.

---

---

### **Evaluation and/or Verification:**

Successful completion of this technical module will be based on the student's successful completion of the following components:

1. A ten question quiz on the industrial application of the concepts contained in this module (see *Applied Chemistry* by William R. Seine, ISBN 0-669-32727-1, Latest Edition);
2. Completion of selected laboratory experiences or completion of analysis of industrial application projects (reference *The Extraordinary Chemistry of Ordinary Things*);
3. Demonstrated competency in the application of measuring instruments to determine weight and volume;

4. Demonstrated competency in the application of mixing formulas and the use of the periodic table to determine molar quantities;
5. Demonstrate competency in the application of chemical formulas and reaction equations; and,
6. Demonstrated competency in the application of safety equipment, MSDS, and laboratory methods.

---

---

**Summary:**

Review the main lesson points using the texts and handouts listed in the reference section of this module. Stress the industrial applications of the concepts. Hold class discussion and answer student questions.

---

---

**Next Lesson Assignment:**

**MASTER Technical Module (AET-A12)** dealing with applying the knowledge of electrochemical effects to analyze chemical industrial processes.

**AET-A11-HO-1**  
**Use Chemical Principles and Formulas to Predict and Analyze**  
**Reactions in Chemical Industrial Processes**  
Attachment 1: MASTER Handout No. 1

---

**Objective(s):**

Upon completion of this unit the student will be able to:

- a. Use math, physics, and chemical measurements to determine physical quantities;
- b. Use math and chemical measurements to determine compounds, solutions, or mixtures;
- c. Use chemical formulas to predict and analyze reactions in industrial processes;
- d. Use proper lab procedures to test chemicals used in industrial processes;
- e. Use the periodic table to identify elements;
- f. Use the periodic table to calculate molar quantities;
- g. Apply mixing formulas to produce proportions of various mixes, solutions, and compounds;
- h. Apply mixing formulas and the molar concept of chemistry to determine the quantities of elements need to produce a molar reaction;
- i. Apply the concept of ionization or valence and the periodic table to determine reactions;
- j. Apply reaction formulas to determine the number and type of elements needed, energy release or energy added, and if a catalyst is required;
- k. Explain the procedures used to determine the make-up of compounds; and,
- l. Explain the uses of bases or acids in manufacturing processes.

---

**Module Outline:**

- I. Use, Math, Physics, and Chemical Measurements to Determine Physical Quantities
  - A. Explain the theory of atoms and the organization of matter
    1. Explain the evolution of the theories of matter
    2. Explain the modern model of the atom and its structure
    3. Show the video *The Mechanical Universe "The Atom"*
  - B. Explain the use of the periodic table to identify elements and their characteristics
    1. Explain the organization of the periodic table. or video *Chemistry "The Periodic Table"*, Annenberg CPB

2. Demonstrate the application of the periodic table to understanding the number of atoms contained in a solid, liquid, or gas
  - C. Explain the methods used to determine weight, volume, and density
    1. Demonstrate the use of balance scales and electronic scales (if available), to determine physical quantities
    2. Demonstrate the methods of calculating mass from a given weight and explain the uncertainties surrounding the calculation
    3. Demonstrate the methods used to determine the volume of a substance
    4. Explain the uncertainties surrounding the measurement
- II. Use Math and Chemical Measurements to Determine Compounds, Solutions, or Mixtures
- A. Apply mixing formulas to produce proportions of various mixtures, and solutions
    1. Explain the difference between solutions, compounds, and mixtures
    2. Explain the methods used to calculate solutions and mixtures (MASTER Handout AET-A11-HO-2 (Mixing Formulas))
    3. Demonstrate the application of mixing formulas to industrial problems
  - B. Use the periodic table to calculate molar quantities
    1. Explain the concept of a molar quantity
    2. Demonstrate the application of the periodic table in the determining of molar quantities
    3. Show applications of molar concepts in industrial chemical processes
  - C. Apply mixing formulas and the molar concept of chemistry to determine the quantities of elements need to produce a molar reaction
- III. Use Chemical Formulas to Predict and Analyze Reactions in Industrial Processes
- A. Apply the concept of ionization or valence and the periodic table to determine reactions
    1. Explain the atomic methods by which atoms are linked together to create compounds and structures
    2. Explain the concepts of covalent bonding, ionic bonding, and metallic bonding
  - B. Explain the procedures used to determine the make-up of compounds
    1. Explain the methods of writing chemical formulas
    2. Explain the rationale behind the naming of compounds, and the exceptions to the rules
    3. Demonstrate the creation of formulas for the composition of selected compounds
  - C. Explain and demonstrate the application of reaction equations

1. Explain the methods of writing reaction equations
    - a. Number and type of elements
    - b. Energy release or energy needed
    - c. Catalyst needed
    - d. Naming the resultant compound
  2. Demonstrate the creation of equations for the results of selected reactions
- IV. Use Proper Lab Procedures to Test Chemicals Used in Industrial Processes
- A. Explain chemical laboratory safety procedures
    1. Explain the types of safety equipment used in chemical processes
    2. Demonstrate the proper use of chemical safety equipment
    3. Explain and demonstrate the proper procedures for handling hazardous chemicals
    4. Explain the rules for using flammable or explosive materials
    5. Demonstrate the procedures used for handling and storing flammable or explosive materials
  - B. Explain the use of Material Safety Data Sheets (MSDS)
    1. Explain the organization of a MSDS
    2. Demonstrate the application of MSDS
  - C. Explain and demonstrate the methods used to determine acids or bases
    1. Explain the concept of an acid and a base
    2. Demonstrate and explain the application of the concept of pH in determining if a substance is an acid or a base
    3. Demonstrate the methods used to determine pH
  - D. Explain the principles of oxidation and reduction and some of the industrial chemical methods used to achieve each
  - E. Explain the methods used to produce raw chemicals and synthesize compounds
  - F. Explain the types of modern instruments used to determine chemical compounds
    1. Explain the operating principles of a mass spectrometer
    2. Explain the operating principles of a photo-spectrometer
    3. Explain the methods used to determine the chemical make-up of compounds using the instruments

AET-A11-HO-2  
Use Chemical Principles and Formulas to Predict and Analyze  
Reactions in Chemical Industrial Processes  
Attachment 2: MASTER Handout No. 2

---

### Mixing Formulas

Concentrations of solutions are frequently expressed as percentages. Solutions labeled 3% hydrogen peroxide, 97% inert ingredients, 14% alcohol 10% iodine, 0.67 % sodium chloride, and 4% boric acid are common. The specific meaning of these percentages varies with the type of solute and solvent.

#### Mass Percent

Mass percent is also called weight percent. It is the *mass* of solute present in **100 grams** of the solution. For example, a solution that contained 3 grams of salt in 100 grams of a liquid would have 3 grams of the salt and 97 grams of the liquid. The total mass would be 100 grams and the solution would therefore be

$$\frac{3\text{grams}}{100\text{grams}} * 100$$

1. The basic formula is:

$$\text{Mass. percent of solute} = \frac{\text{mass of solute}}{\text{total mass of solution}} * 100$$

2. Example:

35 grams of salt are dissolved in 500 grams of water

$$\frac{35\text{grams}}{500\text{grams}} = .07$$

3. Next: We multiply the result by 100

$$.07 * 100 = 7\%$$

4. This means that for every 100 grams of solution we have 7 grams of the salt.

### Mass Per Volume Percent

Frequently we desire to express the percentage of a mixture in terms of the *mass* of the solute and the *volume* of the solution. The result is expressed as the mass per 100 ml of the solution because the result is multiplied by 100.

The formula is:

$$\text{mass.per.volume.percent} = \frac{\text{gram.mass.of.solute}}{\text{volume.of.solution.(milli-liters)}}$$

5. Example:

How many grams of copper sulfate would be needed to prepare a 3% mass/volume solution in 500 milli-liters of liquid?

A 3% mass/vol. of the solution contains 3 grams of copper sulfide per 100 ml of the solution therefore:

$$\frac{500\text{ml}}{100\text{ml}} = 5$$

6. 500 ml would need 5 times as much copper sulfide as a solution of 3 grams per 100 ml therefore:

$$5 * 3\text{grams} = 15\text{grams}$$

7. And:

$$\frac{15\text{grams}}{500\text{ml}} * 100 = 3\%$$

8. These calculations are commonly used to prepare laboratory percentages and are used exclusively with the metric system.



However, it is important in industry to prepare large quantities of solutions that are expressed in the English engineering system or the metric system. Frequently, a solution of one mixture must be added to a solution of another mixture to increase or decrease the percentage of the resultant solution. In cases like these, the above formulas are not adequate.

A formula that will work in situations like this is the following:

$$1. \quad (\%Q1 * Q1) + (\%Q2 * Q2) = \%QT * (Q1 + Q2)$$

Where:

$\%Q1$  = the percentage of the first quantity

$\%Q2$  = the percentage of the second quantity

$\%QT$  = the percentage of the total quantity

$Q1$  = the total quantity of quantity one

$Q2$  = the total quantity of quantity two

All quantities must be expressed as the same (volume percentage, mass percentage, or mass per volume percentage).

To find the resultant percentage of a combined quantity:

$$2. \quad (\%Q1 * Q1) + (\%Q2 * Q2) / (Q1 + Q2) = \%QT$$

To find the total combined quantity:

$$3. \quad (\%Q1 * Q1) + (\%Q2 * Q2) / \%QT = (Q1 + Q2)$$

For example:

A tank of hydrochloric acid (HCL) is tested to determine its percentage. The test indicates that the solution is 4 percent HCL. How many 55 gallon drums of 12 percent acid must be added to the tank to bring the solution to 6 percent if the tank contains 1000 gallons?

Using formula 2:

$$4\% * 1000 + 12 * Q2 / 1000 + Q2 = 6\%$$

solving for  $Q2$ :

$$4000 + 12Q2 / 1000 + Q2 = 6\%$$

$$4000 + 12Q2 = 6000 + 6Q2$$

$$6Q2 = 2000$$

$$Q2 = 333.33 \text{ gal}$$

$$333.33 \text{ gallon}/55 \text{ gallon/drum} = 6.06 \text{ drums}$$

To cross check:

$$4\% * 1000 \text{ gal} + 12\% * 333.33 \text{ gal}/1000 \text{ gal} + 333.33 \text{ gal} = 5.9999 \text{ percent}$$

**AET-A11-LE**  
**Use Chemical Principles and Formulas to Predict and Analyze**  
**Reactions in Chemical Industrial Processes**  
**Attachment 3: MASTER Laboratory Exercise**

---

The student will:

1. Use an industrial chemical process to determine the mass and volume of a quantity of raw materials for a given amount of production;
2. Use an industrial chemical process to determine the quantity of raw materials needed for a given amount of production; and,
3. Use an industrial chemical process to write a reaction equation that describes the manufacturing process.

# AUTOMATED EQUIPMENT REPAIR SERIES

## MASTER Technical Module No. AET-A12

---

**Subject:** Automated Equipment Repair **Time:** 128 Hrs.

**Duty:** Apply Science to Solve Industrial Problems

**Task:** Apply the Knowledge of Electrochemical Effects to Analyze Chemical Industrial Processes

---

**Objective(s):**

Upon completion of this unit the student will be able to:

- a. Use math, physics, and chemical measurements to test and prepare batteries for use;
- b. Use math and chemical measurements to test and prepare chemicals and systems used in electro-plating processes;
- c. Use math and chemical measurements to test and prepare chemicals and systems used in chemical milling processes;
- d. Use math and chemical measurements to test and prepare chemicals and systems used in integrated circuit manufacturing;
- e. Use the principles of chemistry, physics and measurement to test and prepare batteries for use;
- f. Use the principles of chemistry, physics and measurement to test and prepare chemicals for use in industrial processes;
- g. Use the principles of chemistry, physics and measurement to test and prepare chemicals for use in integrated circuit manufacturing;
- h. List the steps used in industrial chemical processes and integrated circuit manufacturing processes; and,
- i. Identify the types of equipment and the principles of operation of the equipment used in industrial chemical processes.

---

**Instructional Materials:**

Chemical laboratory equipment such as test tubes, flasks, mixers, Bunsen burners, stirrers, balance scales, etc.

Chemical elements, acids, and bases

Testing materials such as litmus papers, dyes, pH meters, etc.

Safety equipment such as safety goggles, protective aprons and gloves

Laboratory experiences that demonstrate the concepts covered in this module (a good reference for ideas for these labs is *The Extraordinary Chemistry of Ordinary Things* by Carl H. Snyder)

Industrial test instruments such as pH testers, concentration analyzers, photo analyzers and hydrometers

**Videos:**    *Silicon Run* and *Silicon Run II*  
**MASTER** Handout (AET-A12-HO-1)  
**MASTER** Handout (AET-A12-HO-2) (Mixing Formulas)  
**MASTER** Laboratory Exercise (AET-A12-LE)

---

**References:**

*Applied Chemistry*, Seine, William R., ISBN 0-669-32727-1, Latest Edition  
*The Camelot General Chemistry Primer*, Coop, Dwight W., ISBN 1-883316-19-7, Latest Edition  
*The Extraordinary Chemistry of Ordinary Things*, Snyder, Carl H., ISBN 0-471-31042-5, Latest Edition  
*Integrated Circuit Fabrication*, Latest Edition  
**Video(s):**    *The Mechanical Universe*, Annenberg/CPB (PBS), Latest Edition  
                  *Chemistry*, Annenberg/CPB (PBS), Latest Edition  
                  *Silicon Run*, Latest Edition  
                  *Silicon Run II*, Latest Edition

---

**Student Preparation:**

Students should have previously completed the following Technical Modules:  
AET-A11 "Use Chemical Principles and Formulas to Predict and Analyze Reactions in Chemical Industrial Processes"

---

---

**Introduction:**

There are many industries that rely upon chemical processes or chemicals to manufacture products. For example, integrated circuit manufacturers, the electronics industry in general, and beverage manufacturers use chemically pure water in many of their processes; Electrical Discharge Machining (EDM) uses chemicals to act as an electrical medium for the cutting of metals; high vacuum technology equipment, requires fluids that have very specific chemical properties; manufacturers of glass, plastics, food products, steel, and metal alloys must use chemistry to determine the necessary ingredients for their products; and the petroleum industry requires chemistry to process natural oil into; gasoline, lubricating oils, and raw materials for many industries, including agriculture. The medical industry would be extinct without chemistry, and workers in an industrial environment must be able to read and understand Material Safety Data Sheets (MSDS) to protect themselves from chemical hazards. Knowledge of basic chemistry and the procedures used to test chemical mixtures will prepare an automation technician to enter many diverse industrial fields, and provide an understanding of the manufacturing processes that the automated machines will control.

---

---

## Presentation Outline:

- I. Use Math, Physics, and Chemical Measurements to Test and Prepare Batteries for Use
  - A. Explain chemical laboratory safety procedures
    1. Explain the types of safety equipment used in chemical processes
    2. Demonstrate the proper use of chemical safety equipment
    3. Explain and demonstrate the proper procedures for handling hazardous chemicals
    4. Explain the rules for using flammable or explosive materials
    5. Demonstrate the procedures used for handling and storing flammable or explosive materials
  - B. Explain the use of Material Safety Data Sheets (MSDS)
    1. Explain the organization of a MSDS
    2. Demonstrate the application of MSDS
  - C. Explain and demonstrate the methods used to determine acids or bases
    1. Explain the concept of an acid and a base
    2. Demonstrate and explain the application of the concept of pH in determining if a substance is an acid or a base
    3. Demonstrate the methods used to determine pH
  - D. Explain the principles of oxidation and reduction and some of the industrial chemical methods used to achieve each
  - E. Explain the types of modern instruments used to determine chemical compounds
    1. Explain the operating principles of a mass spectrometer
    2. Explain the operating principles of a photo-spectrometer
    3. Explain the methods used to determine the chemical make-up of compounds using the instruments
  - F. Explain the theory of electrochemical battery processes
    1. Explain the theory of operation of a battery
    2. Show the video *The Mechanical Universe "Batteries"*
    3. Demonstrate the charging process in a battery and the by products of the process
    4. List the types of batteries in use and their applications
  - G. Explain the effects of weight, volume, and density of the electrolyte a lead-acid electrochemical battery
  - H. Explain and demonstrate the use of measuring instruments to determine the state of charge or discharge of an electrochemical battery
- II. Use Math and Chemical Measurements to Test and Prepare Chemicals and Systems Used in Electro-plating Processes

- A. Apply electro-chemical concepts to produce proportions of solutions used in electro-plating processes
    - 1. Explain the electro-chemical plating process
      - a. Ionic exchange of metal elements
      - b. Chemicals used in electro-plating processes
      - c. Effects of plating current upon the process
      - d. Control systems used to plate metals
    - 2. Explain the methods used to calculate solutions and mixtures (MASTER Handout AET-A12-HO-2 (Mixing Formulas))
    - 3. Demonstrate the application of mixing formulas to electroplating
  - B. Use the periodic table to calculate molar quantities for electro-plating processes
  - C. Apply mixing formulas and the molar concept of chemistry to determine the quantities of elements need to plate metals
- III. Use Math and Chemical Measurements to Test and Prepare Chemicals and Systems Used in Chemical Milling Processes
  - A. Apply electro-chemical concepts to produce proportions of solutions used in chemical milling processes
    - 1. Explain the chemical milling process
      - a. Ionic exchange of metal elements
      - b. Chemicals used to remove and condition metal
      - c. Control systems used in chemical milling
    - 2. Explain the methods used to calculate solutions and mixtures (MASTER Handout AET-A12-HO-2 (Mixing Formulas))
    - 3. Demonstrate the application of mixing formulas to chemical milling
  - B. Use the periodic table to calculate molar quantities for chemical milling processes
  - C. Apply mixing formulas and the molar concept of chemistry to determine the quantities of elements need to chemically mill metals
- IV. Use Math and Chemical Measurements to Test and Prepare Chemicals and Systems Used in Integrated Circuit Manufacturing
  - A. Manufacturing processes and equipment
    - 1. Explain silicon crystal growth, wafer fabrication and identification
    - 2. Explain purposes of silicon dioxide in integrated circuit manufacturing
    - 3. Explain and demonstrate the chemistry of oxide formation
      - a. Oxidation reactions
      - b. Oxidation rate
    - 4. Explain the methods used for oxide formation processes
      - a. Rapid thermal oxidation
      - b. High pressure oxidation
    - 5. Explain the operation of tube furnaces for oxidation

6. Explain the photolithography process
    - a. Principles of electromagnetic waves and interference
    - b. Reflection and refraction
    - c. Photochemical principles
  7. Explain the etching processes and equipment
    - a. Plasma generation
    - b. Ion beam generation
  8. Explain the doping processes and equipment
    - a. Thermal diffusion equipment
    - b. Ion Implantation beam generation
  9. Explain the deposition processes and equipment
    - a. Chemical Vapor Deposition (CVD) overview
    - b. CVD equipment operating principles
      - (1) Atmospheric systems
      - (2) Low pressure systems
      - (3) Plasma systems
      - (4) Photochemical systems
    - c. Deposition films
      - (1) Types of films
      - (2) Molecular Beam Epitaxy (MBE)
      - (3) Vapor phase epitaxy (VPE)
      - (4) Metal-organic CVD (MOCVD)
      - (5) Polysilicon and amorphous silicon deposition
      - (6) Silicon on sapphire and silicon on insulator
      - (7) Silicon dioxide and silicon nitride
  10. Explain the metallization process and equipment
    - a. Materials
    - b. Deposition methods
      - (1) Vapor deposition
      - (2) Sputter deposition
  11. Wafer test and evaluation
    - a. Four point probe measurements
    - b. Thickness measurements
    - c. Junction depth measurements
    - d. Contamination and defect detection
    - e. Critical dimensions measurement
    - f. Device electrical measurement
    - g. Pinhole counting
- B. Principles of process control
1. Yield calculations
  2. Statistical Process Control (SPC)



---

---

**Practical Application:**

1. Using an industrial battery, determine the state of charge or discharge of the battery;
2. Using an industrial electro-plating process, determine the quantity of raw materials needed for a given amount of production;
3. Using an industrial chemical milling process, write a reaction equation that describes the manufacturing process; and,
4. Using a theoretical integrated circuit manufacturing process, determine the process steps, equipment needed, and the chemical processes used to fabricate the circuit.

---

---

**Evaluation and/or Verification:**

Successful completion of this technical module will be based on the student's successful completion of the following components:

1. A ten question quiz on the industrial application of the concepts contained in this module (see video *The Mechanical Universe "Batteries"; Applied Chemistry* by William R. Stine, ISBN 0-669-32727-1);
2. Completion of selected laboratory experiences or completion of analysis of industrial batteries and industrial application projects (reference *The Extraordinary Chemistry of Ordinary Things; Integrated Circuit Fabrication*);
3. Demonstrate competency in the application of measuring instruments to determine charge of a battery;
4. Demonstrate competency in the application of electro-chemical concepts to electroplating;
5. Demonstrate competency in the application of chemical formulas and reaction equations to chemical milling;
6. A comprehensive test on the industrial application of the concepts contained in this module (see *Integrated Circuit Fabrication*); and,
7. A written procedure for manufacturing an integrated circuit.

---

---

**Summary:**

Review the main lesson points using the texts and handouts listed in the reference section of this module. Stress the industrial applications of the concepts. Hold class discussion and answer student questions.

---

---

**Next Lesson Assignment:**

**MASTER Technical Module (AET-A13)** dealing with applying properties of water to analyze industrial water treatment processes.

**AET-A12-HO-1**  
**Apply the Knowledge of Electrochemical Effects**  
**to Analyze Chemical Industrial Processes**  
**Attachment 1: MASTER Handout No. 1**

---

**Objective(s):**

Upon completion of this unit the student will be able to:

- a. Use math, physics, and chemical measurements to test and prepare batteries for use;
- b. Use math and chemical measurements to test and prepare chemicals and systems used in electro-plating processes;
- c. Use math and chemical measurements to test and prepare chemicals and systems used in chemical milling processes;
- d. Use math and chemical measurements to test and prepare chemicals and systems used in integrated circuit manufacturing;
- e. Use the principles of chemistry, physics and measurement to test and prepare batteries for use;
- f. Use the principles of chemistry, physics and measurement to test and prepare chemicals for use in industrial processes;
- g. Use the principles of chemistry, physics and measurement to test and prepare chemicals for use in integrated circuit manufacturing;
- h. List the steps used in industrial chemical processes and integrated circuit manufacturing processes; and,
- i. Identify the types of equipment and the principles of operation of the equipment used in industrial chemical processes.

---

**Module Outline:**

- I. Use Math, Physics, and Chemical Measurements to Test and Prepare Batteries for Use
  - A. Explain chemical laboratory safety procedures
    1. Explain the types of safety equipment used in chemical processes
    2. Demonstrate the proper use of chemical safety equipment
    3. Explain and demonstrate the proper procedures for handling hazardous chemicals
    4. Explain the rules for using flammable or explosive materials
    5. Demonstrate the procedures used for handling and storing flammable or explosive materials
  - B. Explain the use of Material Safety Data Sheets (MSDS)
    1. Explain the organization of a MSDS
    2. Demonstrate the application of MSDS

- C. Explain and demonstrate the methods used to determine acids or bases
    - 1. Explain the concept of an acid and a base
    - 2. Demonstrate and explain the application of the concept of pH in determining if a substance is an acid or a base
    - 3. Demonstrate the methods used to determine pH
  - D. Explain the principles of oxidation and reduction and some of the industrial chemical methods used to achieve each
  - E. Explain the types of modern instruments used to determine chemical compounds
    - 1. Explain the operating principles of a mass spectrometer
    - 2. Explain the operating principles of a photo-spectrometer
    - 3. Explain the methods used to determine the chemical make-up of compounds using the instruments
  - F. Explain the theory of electrochemical battery processes
    - 1. Explain the theory of operation of a battery
    - 2. Show the video *The Mechanical Universe "Batteries"*
    - 3. Demonstrate the charging process in a battery and the by products of the process
    - 4. List the types of batteries in use and their applications
  - G. Explain the effects of weight, volume, and density of the electrolyte a lead-acid electrochemical battery
  - H. Explain and demonstrate the use of measuring instruments to determine the state of charge or discharge of an electrochemical battery
- II. Use Math and Chemical Measurements to Test and Prepare Chemicals and Systems Used in Electro-plating Processes
- A. Apply electro-chemical concepts to produce proportions of solutions used in electro-plating processes
    - 1. Explain the electro-chemical plating process
      - a. Ionic exchange of metal elements
      - b. Chemicals used in electro-plating processes
      - c. Effects of plating current upon the process
      - d. Control systems used to plate metals
    - 2. Explain the methods used to calculate solutions and mixtures (MASTER Handout AET-A12-HO-2 (Mixing Formulas))
    - 3. Demonstrate the application of mixing formulas to electroplating
  - B. Use the periodic table to calculate molar quantities for electro-plating processes
  - C. Apply mixing formulas and the molar concept of chemistry to determine the quantities of elements need to plate metals
- III. Use Math and Chemical Measurements to Test and Prepare Chemicals and Systems Used in Chemical Milling Processes

- A. Apply electro-chemical concepts to produce proportions of solutions used in chemical milling processes
    - 1. Explain the chemical milling process
      - a. Ionic exchange of metal elements
      - b. Chemicals used to remove and condition metal
      - c. Control systems used in chemical milling
    - 2. Explain the methods used to calculate solutions and mixtures (MASTER Handout AET-A12-HO-2 (Mixing Formulas))
    - 3. Demonstrate the application of mixing formulas to chemical milling
  - B. Use the periodic table to calculate molar quantities for chemical milling processes
  - C. Apply mixing formulas and the molar concept of chemistry to determine the quantities of elements need to chemically mill metals
- IV. Use Math and Chemical Measurements to Test and Prepare Chemicals and Systems Used in Integrated Circuit Manufacturing
- A. Manufacturing processes and equipment
    - 1. Explain silicon crystal growth, wafer fabrication and identification
    - 2. Explain purposes of silicon dioxide in integrated circuit manufacturing
    - 3. Explain and demonstrate the chemistry of oxide formation
      - a. Oxidation reactions
      - b. Oxidation rate
    - 4. Explain the methods used for oxide formation processes
      - a. Rapid thermal oxidation
      - b. High pressure oxidation
    - 5. Explain the operation of tube furnaces for oxidation
    - 6. Explain the photolithography process
      - a. Principles of electromagnetic waves and interference
      - b. Reflection and refraction
      - c. Photochemical principles
    - 7. Explain the etching processes and equipment
      - a. Plasma generation
      - b. Ion beam generation
    - 8. Explain the doping processes and equipment
      - a. Thermal diffusion equipment
      - b. Ion Implantation beam generation
    - 9. Explain the deposition processes and equipment
      - a. Chemical Vapor Deposition (CVD) overview
      - b. CVD equipment operating principles
        - (1) Atmospheric systems
        - (2) Low pressure systems
        - (3) Plasma systems
        - (4) Photochemical systems

- c. Deposition films
  - (1) Types of films
  - (2) Molecular Beam Epitaxy (MEB)
  - (3) Vapor phase epitaxy (VPE)
  - (4) Metal-organic CVD (MOCVD)
  - (5) Polysilicon and amorphous silicon deposition
  - (6) Silicon on sapphire and silicon on insulator
  - (7) Silicon dioxide and silicon nitride
- 10. Explain the metallization process and equipment
  - a. Materials
  - b. Deposition methods
    - (1) Vapor deposition
    - (2) Sputter deposition
- 11. Wafer test and evaluation
  - a. Four point probe measurements
  - b. Thickness measurements
  - c. Junction depth measurements
  - d. Contamination and defect detection
  - e. Critical dimensions measurement
  - f. Device electrical measurement
  - g. Pinhole counting
- B. Principles of process control
  - 1. Yield calculations
  - 2. Statistical Process Control (SPC)

AET-A12-HO-2  
Apply the Knowledge of Electrochemical Effects  
to Analyze Chemical Industrial Processes  
Attachment 2: MASTER Handout No. 2

---

### Mixing Formulas

Concentrations of solutions are frequently expressed as percentages. Solutions labeled 3% hydrogen peroxide, 97% inert ingredients, 14% alcohol 10% iodine, 0.67 % sodium chloride, and 4% boric acid are common. The specific meaning of these percentages varies with the type of solute and solvent.

#### Mass Percent

Mass percent is also called weight percent. It is the *mass* of solute present in **100 grams** of the solution. For example, a solution that contained 3 grams of salt in 100 grams of a liquid would have 3 grams of the salt and 97 grams of the liquid. The total mass would be 100 grams and the solution would therefore be

$$\frac{3\text{grams}}{100\text{grams}} * 100$$

1. The basic formula is:

$$\text{Mass percent of solute} = \frac{\text{mass of solute}}{\text{total mass of solution}} * 100$$

2. Example:

35 grams of salt are dissolved in 500 grams of water

$$\frac{35\text{grams}}{500\text{grams}} = .07$$

3. Next: We multiply the result by 100

$$.07 * 100 = 7\%$$

4. This means that for every 100 grams of solution we have 7 grams of the salt.

### Mass Per Volume Percent

Frequently we desire to express the percentage of a mixture in terms of the *mass* of the solute and the *volume* of the solution. The result is expressed as the mass per 100 ml of the solution because the result is multiplied by 100.

The formula is:

$$\text{mass.per. volume.perc ent} = \frac{\text{gram.mass. of.solute}}{\text{volume.of. solution.(milli - liters)}}$$

5. Example:

How many grams of copper sulfate would be needed to prepare a 3% mass/volume solution in 500 milli-liters of liquid?

A 3% mass/vol. of the solution contains 3 grams of copper sulfide per 100 ml of the solution therefore:

$$\frac{500\text{ml}}{100\text{ml}} = 5$$

6. 500 ml would need 5 times as much copper sulfide as a solution of 3 grams per 100 ml therefore:

$$5 * 3\text{grams} = 15\text{grams}$$

7. And:

$$\frac{15\text{grams}}{500\text{ml}} * 100 = 3\%$$

8. These calculations are commonly used to prepare laboratory percentages and are used exclusively with the metric system.

However, it is important in industry to prepare large quantities of solutions that are expressed in the English engineering system or the metric system. Frequently, a solution of one mixture must be added to a solution of another mixture to increase or decrease the percentage of the resultant solution. In cases like these, the above formulas are not adequate.

A formula that will work in situations like this is the following:

$$1. \quad (\%Q1 * Q1) + (\%Q2 * Q2) = \%QT * (Q1 + Q2)$$

Where:

$\%Q1$  = the percentage of the first quantity

$\%Q2$  = the percentage of the second quantity

$\%QT$  = the percentage of the total quantity

$Q1$  = the total quantity of quantity one

$Q2$  = the total quantity of quantity two

All quantities must be expressed as the same (volume percentage, mass percentage, or mass per volume percentage).

To find the resultant percentage of a combined quantity:

$$2. \quad (\%Q1 * Q1) + (\%Q2 * Q2) / (Q1 + Q2) = \%QT$$

To find the total combined quantity:

$$3. \quad (\%Q1 * Q1) + (\%Q2 * Q2) / \%QT = (Q1 + Q2)$$

For example:

A tank of hydrochloric acid (HCL) is tested to determine its percentage. The test indicates that the solution is 4 percent HCL. How many 55 gallon drums of 12 percent acid must be added to the tank to bring the solution to 6 percent if the tank contains 1000 gallons?

Using formula 2:

$$4\% * 1000 + 12 * Q2 / 1000 + Q2 = 6\%$$

solving for  $Q2$ :

$$4000 + 12Q2 / 1000 + Q2 = 6\%$$

$$4000 + 12Q2 = 6000 + 6Q2$$



$$6Q2 = 2000$$

$$Q2 = 333.33 \text{ gal}$$

$$333.33 \text{ gallon}/55 \text{ gallon/drum} = 6.06 \text{ drums}$$

To cross check:

$$4\% * 1000 \text{ gal} + 12\% * 333.33 \text{ gal}/1000 \text{ gal} + 333.33 \text{ gal} = 5.9999 \text{ percent}$$

**AET-A12-LE**  
**Apply the Knowledge of Electrochemical Effects**  
**to Analyze Chemical Industrial Processes**  
**Attachment 3: MASTER Laboratory Exercise**

---

The student will:

1. Use an industrial battery to determine the state of charge or discharge of the battery;
2. Use an industrial electro-plating process to determine the quantity of raw materials needed for a given amount of production;
3. Use an industrial chemical milling process to write a reaction equation that describes the manufacturing process; and,
4. Use a theoretical integrated circuit manufacturing process to determine the process steps, equipment needed, and the chemical processes used to fabricate the circuit.

# AUTOMATED EQUIPMENT REPAIR SERIES

## MASTER Technical Module No. AET-A13

---

**Subject:** Automated Equipment Repair **Time:** 48 Hrs.

**Duty:** Apply Science to Solve Industrial Problems

**Task:** Apply Properties of Water to Analyze Industrial Water Treatment Processes

---

### Objective(s):

Upon completion of this unit the student will be able to:

1. Describe the electrical properties of chemically pure water and water that contains solutions of acids or bases;
2. Explain the concept of PH and the determination of acidity or alkalinity of water;
3. Describe the industrial processes used to produce chemically pure water or de-ionized water; and,
4. Identify tests and equipment used to test the properties of water.

---

### Instructional Materials:

Chemical laboratory equipment such as test tubes, flasks, mixers, Bunsen burners, stirrers, balance scales, etc.

Chemical elements, acids, and bases

Testing materials such as litmus papers, dyes, pH meters, etc.

Safety equipment such as safety goggles, protective aprons and gloves

Laboratory experiences that demonstrate the concepts covered in this module

MASTER Handout (AET-A13-HO)

MASTER Laboratory Exercise (AET-A13-LE)

---

### References:

*Applied Chemistry*, Seine, William R., ISBN 0-669-32727-1, Latest Edition

*The Camelot General Chemistry Primer*, Coop, Dwight W., ISBN

1-883316-19-7, Latest Edition

*The Extraordinary Chemistry of Ordinary Things*, Snyder, Carl H.,

ISBN 0-471-31042-5, Latest Edition

*Integrated Circuit Fabrication*, Latest Edition

Information and reference material can be obtained from Culligan

International Company

Video(s): *The Mechanical Universe*, Annenberg/CPB (PBS), Latest Edition

### **Student Preparation:**

Students should have previously completed the following Technical Modules:

- AET-A1 "Apply Scientific Notation and Engineering Notation to Solve Technical Problems"
- AET-A2 "Apply Algebraic Formulas to Solve Technical Problems"
- AET-A3 "Use Variables in Algebraic Formulas to Predict Behavior of Industrial Systems"
- AET-A4 "Manipulate Variables in Algebraic Formulas to Analyze Industrial Systems"
- AET-A5 "Measure, Calculate, and Convert Quantities in English and Metric (SI, mks) Systems"
- AET-A6 "Use Physics, Algebra, and Trigonometry to Analyze Simple Vectored Forces"
- AET-A11 "Use Chemical Principles and Formulas to Predict and Analyze Reactions in Chemical Industrial Processes"

---

### **Introduction:**

There are many industries that rely upon chemical processes or chemicals to manufacture products. For example, integrated circuit manufacturers, the electronics industry in general, and beverage manufacturers use chemically pure water in many of their processes; Electrical Discharge Machining (EDM) uses chemicals to act as an electrical medium for the cutting of metals; high vacuum technology equipment, requires fluids that have very specific chemical properties; manufacturers of glass, plastics, food products, steel, and metal alloys must use chemistry to determine the necessary ingredients for their products; and the petroleum industry requires chemistry to process natural oil into; gasoline, lubricating oils, and raw materials for many industries, including agriculture. The medical industry would be extinct without chemistry, and workers in an industrial environment must be able to read and understand Material Safety Data Sheets (MSDS) to protect themselves from chemical hazards. Knowledge of basic chemistry will prepare an automation technician to enter many diverse industrial fields, and provide an understanding of the manufacturing processes that the automated machines will control.

---

### **Presentation Outline:**

- I. Demonstrate the Properties of Pure Water, De-ionized Water, and Water with Various Compounds in Solution

- A. Demonstrate the resistive properties of chemically pure water and ionized water
  - B. Explain the concept of pH in terms of hydroxyl and hydrogen ions
  - C. Apply the concept of ionization and pH to determine if water is ionized as an acid or a base
  - D. List the organic and inorganic contaminants of water and the industrial and household uses of pure water
- II. Demonstrate the Procedures Used to De-Ionize Water and Produce Chemically Pure Water
- A. List the methods used to produce chemically pure water and the basic theory of the process
    - 1. Removal of particulates
      - a. Types of filtration
      - b. Filtration principles
    - 2. Removal of volatile organic compounds (VOC)
      - a. Boiling
      - b. Oxidation
      - c. Distillation
      - d. Reverse osmosis
      - e. Absorption (activated carbon)
    - 3. Removal of micro-organisms
      - a. Protozoa, mold, fungi, and parasites
      - b. Algae
      - c. Bacteria
      - d. Virus
    - 4. Removal of inorganic contaminants
      - a. Acids
      - b. Bases
      - c. Iron, metal salts
    - 5. De-ionization of water
  - B. Demonstrate the reverse osmosis method of water filtration and explain the processes
    - 1. Types of R-O membranes
    - 2. Filtration
    - 3. Chemical treatment
    - 4. Demonstrate de-ionization techniques and explain the reaction
    - 5. Explain the procedures used to monitor and protect pure water systems
    - 6. Compare various R-O systems with the contaminants removed
  - C. Apply properties of water treatment to analyze industrial water treatment processes

---

---

**Practical Application:**

1. An analysis of industrial application of pure water applications; and,
2. Using an industrial water treatment requirement, determine the best method of water treatment.

---

---

**Evaluation and/or Verification:**

Successful completion of this technical module will be based on the student's successful completion of the following components:

1. A comprehensive test on the industrial application of the concepts contained in this module; and,
2. Completion of selected laboratory experiences or completion of analysis of industrial application projects.

---

---

**Summary:**

Review the main lesson points using the texts and handouts listed in the reference section of this module. Stress the industrial applications of the concepts. Hold class discussion and answer student questions.

---

---

**Next Lesson Assignment:**

**MASTER Technical Module (AET-B1)** dealing with using symbols, organization, and engineering values on mechanical drawings.

**AET-A13-HO**  
**Apply Properties of Water**  
**to Analyze Industrial Water Treatment Processes**  
**Attachment 1: MASTER Handout**

---

**Objective(s):**

Upon completion of this unit the student will be able to:

1. Describe the electrical properties of chemically pure water and water that contains solutions of acids or bases;
  2. Explain the concept of pH and the determination of acidity or alkalinity of water;
  3. Describe the industrial processes used to produce chemically pure water or de-ionized water; and,
  4. Identify tests and equipment used to test the properties of water.
- 

**Module Outline:**

- I. Demonstrate the Properties of Pure Water, De-ionized Water, and Water with Various Compounds in Solution
  - A. Demonstrate the resistive properties of chemically pure water and ionized water
  - B. Explain the concept of pH in terms of hydroxyl and hydrogen ions
  - C. Apply the concept of ionization and pH to determine if water is ionized as an acid or a base
  - D. List the organic and inorganic contaminants of water and the industrial and household uses of pure water
- II. Demonstrate the Procedures Used to De-Ionize Water and Produce Chemically Pure Water
  - A. List the methods used to produce chemically pure water and the basic theory of the process
    1. Removal of particulates
      - a. Types of filtration
      - b. Filtration principles
    2. Removal of volatile organic compounds (VOC)
      - a. Boiling
      - b. Oxidation
      - c. Distillation
      - d. Reverse osmosis
      - e. Absorption (activated carbon)
    3. Removal of micro-organisms
      - a. Protozoa, mold, fungi, and parasites
      - b. Algae
      - c. Bacteria

- d. Virus
    - 4. Removal of inorganic contaminants
      - a. Acids
      - b. Bases
      - c. Iron, metal salts
    - 5. De-ionization of water
- B. Demonstrate the reverse osmosis method of water filtration and explain the processes
  - 1. Types of R-O membranes
  - 2. Filtration
  - 3. Chemical treatment
  - 4. Demonstrate de-ionization techniques and explain the reaction
  - 5. Explain the procedures used to monitor and protect pure water systems
  - 6. Compare various R-O systems with the contaminants removed
- C. Apply properties of water treatment to analyze industrial water treatment processes



**AET-A13-LE**  
**Apply Properties of Water**  
**to Analyze Industrial Water Treatment Processes**  
**Attachment 2: MASTER Laboratory Exercise**

---

The student will:

1. Demonstrate an analysis of industrial application of pure water applications;  
and,
2. Use an industrial water treatment requirement to determine the best method  
of water treatment.

**AUTOMATED EQUIPMENT REPAIR TECHNICIAN ... operates, programs, maintains, and repairs automated machine tools and automated manufacturing processes.**

**Duties**

**Tasks**

Duties	A-1 Apply scientific notation and engineering notation to solve technical problems	A-2 Apply algebraic formulas to solve technical problems	A-3 Use symbols and formulas to predict behavior of industrial systems	A-4 Manipulate algebraic formulas to analyze industrial systems	A-5 Measure, calculate, and convert quantities in English and metric (SI) units of measurement	A-6 Use mechanical physics to analyze mechanical industrial systems	A-7 Use mechanical physics to analyze mechanical industrial systems	A-8 Use mathematical and mechanical physics to analyze hydraulic and pneumatic systems	A-9 Use mathematical and thermodynamic principles to analyze problems found in industrial systems	A-10 Use mathematical principles to analyze electrical systems	A-11 Use chemical formulas to predict reactions in industrial processes	A-12 Apply the chemical effects to analyze chemical industrial processes	A-13 Apply principles to analyze industrial water treatment processes
<b>A</b> Apply Science to Solve Industrial Problems													
<b>B</b> Use Drawings to Analyze and Repair Systems	B-1 Use symbols, organization, and engineering drawing on mechanical drawings	B-2 Use symbols, organization, and engineering drawing on power drawings	B-3 Use symbols, organization, and engineering drawing on hydraulic drawings	B-4 Use symbols, organization, and engineering drawing on fluid power drawings	B-5 Use symbols, organization, and engineering drawing on digital drawings								
<b>C</b> Use Calibrated Measuring Instruments to Test/Calibrate Components	C-1 Apply machine tool measurement and instruments in machine tools				C-2 Apply electrical measurement knowledge and instruments to test/calibrate electrical circuits								
<b>D</b> Resolve System Problems by Critical Thinking, Troubleshooting, and Metrology	D-1 Apply the resolution of malfunctions found in industrial manufacturing automated equipment												
<b>E</b> Use Techniques to Isolate Malfunctions of Electronic Systems	E-1 Calculate, predict, and measure the quantities in DC circuits	E-2 Calculate, predict, and measure the quantities in AC circuits	E-3 Calculate, predict, and measure impedance in AC circuits	E-4 Calculate, predict, and measure Phase AC circuits	E-5 Properly set up, calibrate, and use meters and oscilloscopes	E-6 Use components such as resistors, inductors, capacitors, and test components	E-7 Use meters/oscilloscope to measure phase relationships in AC circuits	E-8 Apply electromagnetic theory to determine characteristics of relays, solenoids, transformers, and electric motors for DC and AC circuits	E-9 Apply principles of electrical motors to troubleshoot motors	E-10 Apply semiconductor theory to determine characteristics of diodes, transistors, and semiconductors	E-11 Apply semiconductor theory and measurement techniques to determine characteristics of rectifiers, amplifiers and three phase DC power supplies	E-12 Apply semiconductor theory and measurement techniques to determine characteristics of amplifiers and sensors	E-13 Use schematic diagrams, meters, and oscilloscopes to troubleshoot and repair electrical control circuits
<b>F</b> Measure/Isolate Malfunctions of Mechanical/Fluid Power Systems	F-1 Identify and measure the theory and use of major systems that comprise a hydraulic or pneumatic system	F-2 Apply pneumatic values in a hydraulic system to troubleshoot or repair systems	F-3 Identify, assemble, and apply knowledge of operating characteristics of hydraulic and pneumatic actuators	F-4 Apply hydraulic and high vacuum systems knowledge to test, troubleshoot, and repair pneumatic systems/devices	F-5 Identify, assemble, and apply knowledge of operating characteristics of fluid power circuits								
<b>G</b> Apply Computer Science to Computer Controlled Industrial Equipment	G-1 Perform digital operations in troubleshooting systems	G-2 Perform Boolean operations in digital equipment	G-3 Solve digital logic circuits and programmable logic control circuits, express a problem in Boolean and convert it into ladder logic	G-4 Program computers and interfaced industrial equipment									
<b>H</b> Correct Malfunctions in PLC Controlled Industrial Equipment	H-1 Perform operations on PLC (programmable logic controller) or PLC (programmable logic controller) systems												
<b>I</b> Resolve Malfunctions Found in Computer Systems Controlling Manufacturing Processes	I-1 Use equipment specifications, and data entry/monitoring device, to troubleshoot set up of a computer control system												
<b>J</b> Assemble/Disassemble Mechanical/Electrical/Computer Systems	J-1 Safely assemble, disassemble, and adjust just subsystems or components of power systems	J-2 Safely assemble, disassemble, and adjust subsystems or components of power systems	J-3 Safely assemble, disassemble, or adjust electronic systems or components	J-4 Safely assemble, disassemble, or adjust electronic systems or components	J-5 Safely assemble or digital systems or components PLCs, CNCs, or computers								

# **AUTOMATED EQUIPMENT REPAIR SERIES**

## **MASTER Technical Module No. AET-B1**

---

**Subject:** Automated Equipment Repair **Time:** 18 Hrs.

**Duty:** Use Drawings to Analyze and Repair Systems

**Task:** Use Symbols, Organization, and Engineering Values on Mechanical Drawings

---

**Objective(s):**

Upon completion of this unit the student will be able to use the symbols and organization associated with mechanical drawings to identify features of the part from the drawing, the part's dimensions, and the tolerance of the part's features, on both standard and Geometric Dimensioning drawings, including:

- a. Identifying symbols on mechanical engineering drawings;
- b. Identifying the layout of a mechanical drawing;
- c. Applying manufacturing information from a mechanical drawing;
- d. Identifying Geometric Dimensioning and Tolerancing (GD&T) (ASME Y14.5) symbols on a mechanical drawing; and,
- e. Applying manufacturing information from GD&T symbology on a mechanical drawing.

---

**Instructional Materials:**

Mechanical parts that represent all of the concepts contained in this module

**MASTER Handout (AET-B1-HO-1)**

**MASTER Handout (AET-B1-HO-2) (Mechanical Drawing Symbols)**

**MASTER Handout (AET-B1-HO-3) (Mechanical Drawing Layout)**

**MASTER Handout (AET-B1-HO-4) (GD&T Drawing Symbols)**

**MASTER Laboratory Exercise (AET-B1-LE) (Apply Manufacturing Information from a Mechanical Drawing)**

**MASTER Quiz AET-B1-QU-1: Quiz on mechanical drawing symbols**

**MASTER Quiz AET-B1-QU-2: Quiz on mechanical drawing layout**

**MASTER Quiz AET-B1-QU-3: Quiz on applying information from a mechanical drawing**

**MASTER Quiz AET-B1-QU-4: Quiz on GD&T Drawing symbols**

**MASTER Quiz AET-B1-QU-5: Quiz on Applying information from a GD&T drawing**

---

## References:

There are no texts that present all of the information in the B skills category in a comprehensive manner. For the mechanical drawing section, the closest text that will serve, is:

*Print Reading for Industry*, Walter C. Brown, Latest Edition

**Video(s):** *Mechanical Drawings*, Bergwall Productions, Latest Edition

---

## Student Preparation:

Students should have previously completed the following Technical Modules:

**AET-A1** "Apply Scientific Notation and Engineering Notation to Solve Technical Problems"

**AET-A2** "Apply Algebraic Formulas to Solve Technical Problems"

---

---

## Introduction:

Drawings for automation are roughly divided into five categories. They are: mechanical drawings, electrical drawings, electronic drawings, digital electronic drawings, and hydraulic or pneumatic drawings. A competent automation technician must be comfortable in interpreting the information contained on all of these drawings. Mechanical drawings are used for all of the above categories to depict the mechanical features of an assembly or component. Therefore, the technician must be able to interpret the information contained on a mechanical drawing.

---

---

## Presentation Outline:

- I. Identify Symbols on Mechanical Engineering Drawings
  - A. Mechanical Drawing Symbols: MASTER Handout AET-B1-HO-2 (Mechanical Drawing Symbols) and MASTER Handout AET-B1-HO-3 (Mechanical Drawing Layout)
    1. Describe the types of lines used on mechanical drawings and their meaning
    2. Describe the symbols used to apply engineering information on mechanical drawings
    3. Describe the symbols used to apply welding information on mechanical drawings
    4. Describe the symbols used to apply finishing information on mechanical drawings
  - B. Demonstrate the methods used to apply the above symbols to the manufacturing of parts
- II. Identify the Layout of a Mechanical Drawing

- A. Mechanical Drawing Layout: MASTER Handout AET-B1-HO-2 (Mechanical Drawing Symbols) and MASTER Handout AET-B1-HO-3 (Mechanical Drawing Layout)
    - 1. Describe the informational areas on mechanical drawings and their meaning
    - 2. Describe the tables used to provide hole pattern information on mechanical drawings
    - 3. Describe the title block and its functions
    - 4. Describe the table of engineering notes and its organization
  - B. Demonstrate the methods used to apply the above information to the manufacturing of parts
- III. Apply Manufacturing Information From a Mechanical Drawing
- A. Demonstrate the methods used to apply manufacturing information from a mechanical drawing: MASTER Handout AET-B1-HO-2 (Mechanical Drawing Symbols) and MASTER Handout AET-B1-HO-3 (Mechanical Drawing Layout)
    - 1. Demonstrate the methods of applying dimensional information and tolerances from the drawing
    - 2. Demonstrate the methods of applying hole pattern information from the drawing
    - 3. Describe the title block and its functions
    - 4. Describe the table of engineering notes and its organization
  - B. Demonstrate the methods used to apply the above information to the manufacturing of parts
- IV. Identify Geometric Dimensioning and Tolerancing (GD&T) (ASME Y14.5) Symbols on a Mechanical Drawing
- A. Demonstrate the use of GD&T symbology to determine a datum plane or datum object
  - B. Demonstrate the use of GD&T symbology to determine the geometric characteristics of a feature
  - C. Demonstrate the use of GD&T symbology such as maximum material condition (MMC), least material condition (LMC), and regardless of feature size (RFS), to determine the possible size of a geometric feature
- V. Apply Manufacturing Information From GD&T Symbology on a Mechanical Drawing
- A. Demonstrate the determination of the tolerances of a feature from the application of the symbology of GD&T
  - B. Associate the principles of GD&T with the mathematical concepts of geometry

---



---

**Practical Application:**

**MASTER Laboratory Exercise (AET-B1-LE) (Apply Manufacturing Information from a Mechanical Drawing).**

---

---

**Evaluation and/or Verification:**

Successful completion of this technical module will be based on the student's successful completion of the following components:

1. Satisfactory completion of a ten question quiz, MASTER Quiz AET-B1-QU-1: Mechanical Drawing Symbols;
2. Satisfactory completion of a ten question quiz, MASTER Quiz AET-B1-QU-2: Mechanical Drawing Layout;
3. Satisfactory completion of a ten question quiz, MASTER Quiz AET-B1-QU-3: Apply Information from a Mechanical Drawing;
4. Satisfactory completion of a ten question quiz, MASTER Quiz, AET-B1-QU-4: GD&T Drawing Symbols;
5. Satisfactory completion of a ten question quiz, MASTER Quiz AET-B1-QU-5: Applying Information From a GD&T Drawing; and,
6. Demonstrate proficiency in interpreting mechanical drawing symbols: MASTER Laboratory Exercise AET-B1-LE (Apply Manufacturing Information from a Mechanical Drawing).

---

---

**Summary:**

Review the main lesson points using the suggested texts listed in the reference section of this module. Hold class discussion and answer student questions.

---

---

**Next Lesson Assignment:**

**MASTER Technical Module (AET-B2)** dealing with using symbols, organization, and engineering values on electrical drawings.

**AET-B1-HO-1**  
**Use Symbols, Organization, and Engineering Values**  
**on Mechanical Drawings**  
Attachment 1: MASTER Handout No. 1

---

**Objective(s):**

Upon completion of this unit the student will be able to use the symbols and organization associated with mechanical drawings to identify features of the part from the drawing, the part's dimensions, and the tolerance of the part's features, on both standard and Geometric Dimensioning drawings, including:

- a. Identifying symbols on mechanical engineering drawings;
- b. Identifying the layout of a mechanical drawing;
- c. Applying manufacturing information from a mechanical drawing;
- d. Identifying Geometric Dimensioning and Tolerancing (GD&T) (ASME Y14.5) symbols on a mechanical drawing; and,
- e. Applying manufacturing information from GD&T symbology on a mechanical drawing.

---

**Module Outline:**

- I. Identify Symbols on Mechanical Engineering Drawings
  - A. Mechanical Drawing Symbols: MASTER Handout AET-B1-HO-2 (Mechanical Drawing Symbols) and MASTER Handout AET-B1-HO-3 (Mechanical Drawing Layout)
    1. Describe the types of lines used on mechanical drawings and their meaning
    2. Describe the symbols used to apply engineering information on mechanical drawings
    3. Describe the symbols used to apply welding information on mechanical drawings
    4. Describe the symbols used to apply finishing information on mechanical drawings
  - B. Demonstrate the methods used to apply the above symbols to the manufacturing of parts
- II. Identify the Layout of a Mechanical Drawing
  - A. Mechanical Drawing Layout: MASTER Handout AET-B1-HO-2 (Mechanical Drawing Symbols) and MASTER Handout AET-B1-HO-3 (Mechanical Drawing Layout)
    1. Describe the informational areas on mechanical drawings and their meaning
    2. Describe the tables used to provide hole pattern information on mechanical drawings
    3. Describe the title block and its functions

- 4. Describe the table of engineering notes and its organization
  - B. Demonstrate the methods used to apply the above information to the manufacturing of parts
- III. Apply Manufacturing Information From a Mechanical Drawing
  - A. Demonstrate the methods used to apply manufacturing information from a mechanical drawing: MASTER Handout AET-B1-HO-2 (Mechanical Drawing Symbols) and MASTER Handout AET-B1-HO-3 (Mechanical Drawing Layout)
    - 1. Demonstrate the methods of applying dimensional information and tolerances from the drawing
    - 2. Demonstrate the methods of applying hole pattern information from the drawing
    - 3. Describe the title block and its functions
    - 4. Describe the table of engineering notes and its organization
  - B. Demonstrate the methods used to apply the above information to the manufacturing of parts
- IV. Identify Geometric Dimensioning and Tolerancing (GD&T) (ASME Y14.5) Symbols on a Mechanical Drawing
  - A. Demonstrate the use of GD&T symbology to determine a datum plane or datum object
  - B. Demonstrate the use of GD&T symbology to determine the geometric characteristics of a feature
  - C. Demonstrate the use of GD&T symbology such as maximum material condition (MMC), least material condition (LMC), and regardless of feature size (RFS), to determine the possible size of a geometric feature
- V. Apply Manufacturing Information From GD&T Symbology on a Mechanical Drawing
  - A. Demonstrate the determination of the tolerances of a feature from the application of the symbology of GD&T
  - B. Associate the principles of GD&T with the mathematical concepts of geometry



# **AUTOMATED EQUIPMENT REPAIR SERIES**

## **MASTER Technical Module No. AET-B2**

---

**Subject:** Automated Equipment Repair **Time:** 12 Hrs.

**Duty:** Use Drawings to Analyze and Repair Systems

**Task:** Use Symbols, Organization, and Engineering Values on Electrical Drawings

---

**Objective(s):**

Upon completion of this unit the student will be able to use the symbols and organization associated with electrical ladder diagrams, or electronic schematic diagrams and electrical/electronic layout diagrams to:

- a. Identify components by their symbol;
- b. Determine the location of the components;
- c. Apply engineering values obtained from the drawing to the solution of technical problems; and,
- d. Apply troubleshooting information from an electrical drawing.

---

**Instructional Materials:**

Electrical parts that represent all of the concepts contained in this module

MASTER Handout (AET-B2-HO-1)

MASTER Handout (AET-B2-HO-2) (Electrical Drawing Symbols)

MASTER Handout (AET-B2-HO-3) (Electrical Drawings)

MASTER Laboratory Exercise (AET-B2-LE1) (Apply Manufacturing Information from an Electrical Drawing)

MASTER Laboratory Exercise (AET-B2-LE2) (Apply Troubleshooting Information from an Electrical Ladder Drawing and an Electrical Assembly Drawing)

MASTER Quiz AET-B2-QU-1: Identify symbols on electrical drawings

MASTER Quiz AET-B2-QU-2: Identify the layout of an electrical assembly drawing

MASTER Quiz AET-B2-QU-3: Identify the layout of an electrical ladder drawing

MASTER Quiz AET-B2-QU-4: Apply troubleshooting information from an electrical drawing

---

## References:

There are no texts that present all of the information in the B skills category in a comprehensive manner. Some information for the electrical drawing section, is contained in:

*Print Reading for Industry*, Walter C. Brown, Latest Edition  
Additional information supplied by handouts  
American National Standards Institute (ANSI) standards for electrical diagrams

---

## Student Preparation:

Students should have previously completed the following Technical Modules:

- AET-A1 “Apply Scientific Notation and Engineering Notation to Solve Technical Problems”
- AET-A2 “Apply Algebraic Formulas to Solve Technical Problems”

---

---

## Introduction:

Drawings for automation are roughly divided into five categories. They are: mechanical drawings, electrical drawings, electronic drawings, digital electronic drawings, and hydraulic or pneumatic drawings. A competent automation technician must be comfortable in interpreting the information contained on all of these drawings. Electrical drawings are used to allow the technician to assemble and troubleshoot electrical systems. Therefore, the technician must be able to interpret the information contained on an electrical drawing.

---

---

## Presentation Outline:

- I. Identify Symbols on Electrical Drawings
  - A. Electrical Drawing Symbols: MASTER Handout AET-B2-HO-2 (Electrical Drawing Symbols)
    - 1. Describe the types of symbols used on electrical drawings and their meaning
    - 2. Provide examples of parts that relate to the symbol
    - 3. Explain the operation of each component in general terms
  - B. Demonstrate the interconnection of symbols
- II. Identify the Layout of an Electrical Assembly Drawing
  - A. Electrical Drawings: MASTER Handout AET-B2-HO-3 (Electrical Drawings)
  - B. Describe the purpose of an electrical layout and wiring drawing
  - C. Provide examples of an electrical layout and wiring drawing
  - D. Describe the procedure for following wires and determining terminal connections

- III. Identify the Layout of an Electrical Ladder Drawing
  - A. Explain the meaning and use of rungs and rails
  - B. Locate the primary power distribution and the ladder control logic
  - C. Locate the position on the rungs of relay coils and contacts
  - D. Identify wires and wire numbers on a electrical ladder diagram
  - E. Identify current sources, their type, and magnitude
- IV. Apply Troubleshooting Information From an Electrical Drawing
  - A. Determine the types of current sources and their magnitude (voltage, AC or DC)
  - B. Determine the specifications of the operational characteristics of an electronic assembly from the specifications section of a manual
  - C. Relate the electronic symbol to the component number on an electronic schematic diagram
  - D. Determine the value of components and their model or type number from the material specification list in the materials section of an electronic assembly from the equipment manual

---

---

**Practical Application:**

MASTER Laboratory Exercise (AET-B2-LE1) (Apply Manufacturing Information from an Electrical Drawing) and MASTER Laboratory Exercise (AET-B2-LE2) (Apply Troubleshooting Information from an Electrical Ladder Drawing and Electrical Assembly Drawing).

---

---

**Evaluation and/or Verification:**

Successful completion of this technical module will be based on the student's successful completion of the following components:

1. MASTER Quiz AET-B2-QU-1: Identify symbols on electrical drawings;
2. MASTER Quiz AET-B2-QU-2: Identify the layout of an electrical assembly drawing;
3. MASTER Quiz AET-B2-QU-3: Identify the layout of an electrical ladder drawing;
4. MASTER Quiz AET-B2-QU-4: Apply troubleshooting information from an electrical drawing;
5. Demonstrate proficiency in interpreting electrical drawing symbols (MASTER Laboratory Exercise AET-B2-LE1) (Apply Manufacturing Information from an Electrical Drawing); and,
6. Demonstrate proficiency in interpreting electrical assembly drawings (AET-B2-LE2) (Apply Troubleshooting Information from an Electrical Ladder Drawing and an Electrical Assembly Drawing).

---

---

**Summary:**

Review the main lesson points using the suggested texts listed in the reference section of this module. Hold class discussion and answer student questions.

---

---

**Next Lesson Assignment:**

**MASTER Technical Module (AET-B3)** dealing with using symbols, organization, and engineering values on electronic drawings.

**AET-B2-HO-1**  
**Use Symbols, Organization, and Engineering Values**  
**on Electrical Drawings**  
**Attachment 1: MASTER Handout No. 1**

---

**Objective(s):**

Upon completion of this unit the student will be able to use the symbols and organization associated with electrical ladder diagrams, or electronic schematic diagrams and electrical/electronic layout diagrams to:

- a. Identify components by their symbol;
  - b. Determine the location of the components;
  - c. Apply engineering values obtained from the drawing to the solution of technical problems; and,
  - d. Apply troubleshooting information from an electrical drawing.
- 

**Module Outline:**

- I. Identify Symbols on Electrical Drawings
  - A. Electrical Drawing Symbols: MASTER Handout AET-B2-HO-2 (Electrical Drawing Symbols)
    1. Describe the types of symbols used on electrical drawings and their meaning
    2. Provide examples of parts that relate to the symbol
    3. Explain the operation of each component in general terms
  - B. Demonstrate the interconnection of symbols
- II. Identify the Layout of an Electrical Assembly Drawing
  - A. Electrical Drawings: MASTER Handout AET-B2-HO-3 (Electrical Drawings)
  - B. Describe the purpose of an electrical layout and wiring drawing
  - C. Provide examples of an electrical layout and wiring drawing
  - D. Describe the procedure for following wires and determining terminal connections
- III. Identify the Layout of an Electrical Ladder Drawing
  - A. Explain the meaning and use of rungs and rails
  - B. Locate the primary power distribution and the ladder control logic
  - C. Locate the position on the rungs of relay coils and contacts
  - D. Identify wires and wire numbers on a electrical ladder diagram
  - E. Identify current sources, their type, and magnitude
- IV. Apply Troubleshooting Information From an Electrical Drawing
  - A. Determine the types of current sources and their magnitude (voltage, AC or DC)
  - B. Determine the specifications of the operational characteristics of an electronic assembly from the specifications section of a manual

- C. Relate the electronic symbol to the component number on an electronic schematic diagram
- D. Determine the value of components and their model or type number from the material specification list in the materials section of an electronic assembly from the equipment manual

## AET-B2-HO-2

### Use Symbols, Organization, and Engineering Values on Electrical Drawings

#### Attachment 2: MASTER Handout No. 2

---

## Reading Electrical or Electronic Drawings

### Amplifier

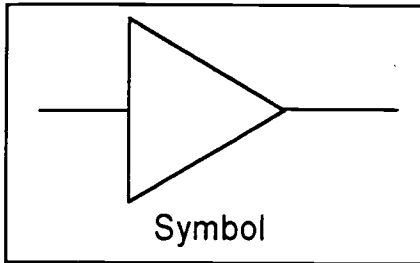

A device which increases the energy level of a physical value. The symbol shown above is the basic symbol for an amplifier. The symbol is always composed of an input and an output. The input is always drawn on the left, and the output is always drawn on the right. The term amplifier, can be applied to mechanical systems as well as it can be applied to electronic systems.

The symbol that depicts an amplifier is a general symbol that gives no indication of the size of the object, the amount of components used in the object, nor the type of system in which the object is used. The technician must infer these facts from the context in which the object is used.

An amplifier can have more than one input, and more than one output. For example:



Dual input  
single output

or



Dual input  
Dual output

or



Single input  
Dual output

In addition, the use of a small circle indicates that the amplifier inverts the results of its amplification.



Inverting output



Inverting input

Lines that are drawn to the symbol at right angles are usually power connections, or axillary connections. For example:

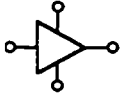

The two vertical lines represent connections to the power supply, or a control connection. The round circles indicate connection points, not inversion.

Various types of amplifier symbols:



The basic symbol for an amplifier provides no clue as to the nature of the device. An amplifier can have as few as four components associated with it, or can have more than one hundred complex electronic circuits. Amplifiers can be composed of discrete components, or be enclosed in an integrated circuit. The amplifier symbol covers a wide variety and scope of devices.

### Batteries (Generalized DC source)

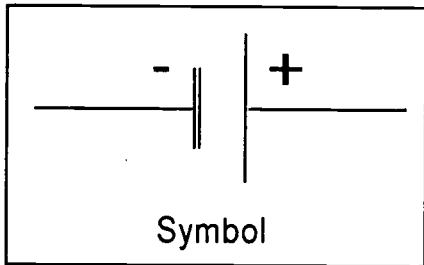

A battery is device that converts chemical energy to Direct Current electrical energy. Batteries are frequently constructed of cells that are electrically connected, one to another. Most cells produce from 1 to 1.5 volts DC. If the battery is only composed of one cell, the symbol will appear as its is above. If the battery is composed of many cells, the diagram will appear as it does below.

The battery symbol can also be used to depict a generalized Direct Current source of electrical power.

An automobile battery uses sulfuric acid and lead plates to generate DC electrical current. It is a multi-celled battery. Sources of DC current that are created by electronic methods ordinarily do not use the battery symbol.





**Multi-celled battery**

## Capacitors

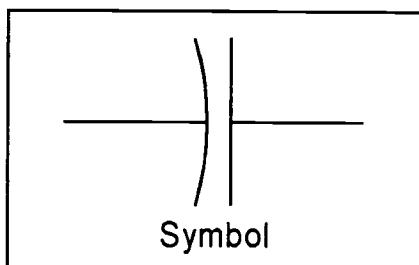

Capacitors are devices that perform several functions in electrical and electronic circuits. A capacitor can be used to store electrical energy and release it in a controlled fashion, a capacitor can be used as a variable opposition (resistance) in an Alternating Current (AC) application, and a capacitor can be used to filter electrical voltages. There are essentially three types of capacitors in use today. They are, variable capacitors, non-polarized capacitors, and electrolytic capacitors.

Various capacitor symbols:

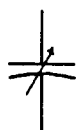

Variable Capacitor

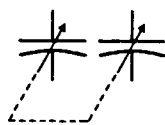

Variable Capacitors mechanically coupled (ganged)

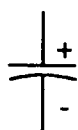

Electrolytic Capacitor



Non-polarized Capacitor (the curved end represents the most negative connection point)

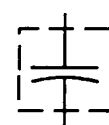

Shielded Capacitor



Feed-Through Capacitor

The capacitor symbols depicted above cover most of the various types of symbols that the technician may encounter in a machine or electronic circuit.

The variable capacitor is a capacitor whose capacitance can be varied by mechanical means. The variable capacitor that is mechanically coupled, is the type of capacitor that is used to tune the stations on a transistor radio.

The electrolytic capacitor is extremely sensitive to voltage polarities. The wise technician who installs this type of capacitor pays care full attention to detail and installs this device in the proper polarity. This type of capacitor can explode if it is installed backwards!

The shielded capacitor is use in sensitive television and radio applications. It is frequently found it computer monitors where it prevents stray electrical radiation.

The feed-through capacitor is used to filter stray electrical noise from wires that are used to connect circuits in radio and television equipment.

The non-polarized capacitor symbol is the most common type of capacitor symbol found in most circuits. The curved end of the capacitor symbol indicates the point at which the capacitor should be connected to the most negative voltage potential. Ordinarily, the manner in which the non-polarized capacitor is installed is unimportant. However, in certain sensitive applications, the capacitor should be installed with the polarity in mind. Many capacitors have a black ring that indicates this connection point.

Capacitors come in a wide variety of shapes and sizes. Generally, the size of a capacitor is determined by two factors. First, the amount of capacitance; and second, the working voltage of the capacitor. The larger the capacitance, the larger the capacitor, and the higher the voltage, the larger the capacitor. These two factors influence each other. For example, a high voltage capacitor that has a small amount of capacitance may be as large as a low voltage capacitor that has massive amounts of capacitance.

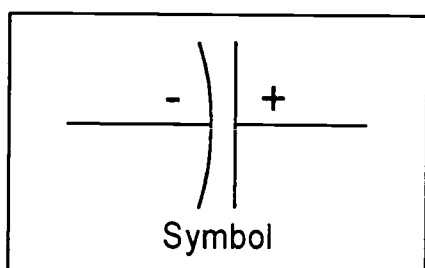

## Electrolytic Capacitor

An electrolytic capacitor is a capacitor that uses a chemical to create the capacitance effect. The chemical is used in the capacitor as an insulator. Electrolytic capacitors are designed to provide extremely large amounts of capacitance while maintaining a small size. The reason that this can be accomplished, is because the chemical involved,

(usually an oxide compound) enables the conductors of the capacitor (called plates) to be positioned extremely close together. For this reason, electrolytic capacitors are polarity sensitive; since the electrolyte (insulator) can be destroyed by an improper application of voltage.

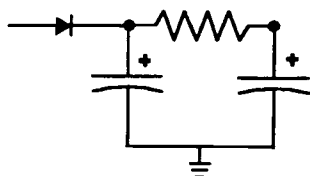

**Filter Circuit**

The above symbology depicts the capacitor symbol connected with other symbols to form a circuit. The circuit shown is designed to allow the capacitor to filter DC voltages.

### **Surface Mount Capacitors**

Surface mount technology is the way things are done today. It is the method that dictates that all components are mounted on a single side of the printed circuit board. Through hole technology required drilled circuit boards, adding many steps to the manufacturing process. Surface mount technology lends its self well to automation, allowing many parts per minute and very little hand work. Due to surface mount technology, sophisticated equipment has not only become more portable (lighter in weight and smaller in size) but also more economical.

Surface mount technology has changed the nature of electronics. Everything has been miniaturize to the point of non-recognition. Components do not look the same today as they did as recently as ten years ago. And even an experienced technician can no longer recognize what the capacitor really is without a symbol designator on the circuit board.

### **Circuit Breaker**

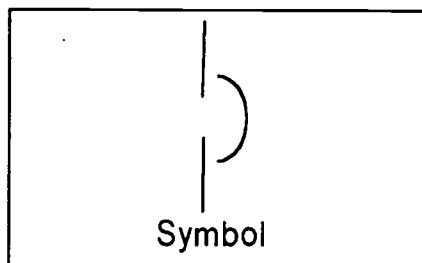

A circuit breaker is a device that interrupts the flow of electrical power. In your home, the circuit breaker is a switch designed to disconnect the primary power sources for appliances and lighting. In industry the circuit breaker works to interrupt power for high powered industrial equipment. Power for the home ordinarily requires that only one wire be disconnected, and so the circuit breaker has only one pole to perform the act. The term pole refers to the connection path for the conduction of electrical power. In industry, power is frequently supplied over three wires. For this reason many circuit breakers employed in factories application have three poles. The circuit breaker is frequently designed to automatically interrupt the electrical power if some equipment connected to the electrical power malfunctions. If the circuit breaker is designed to provide this function, the symbol will reflect it.

**Circuit breaker with a thermal overload trip.**

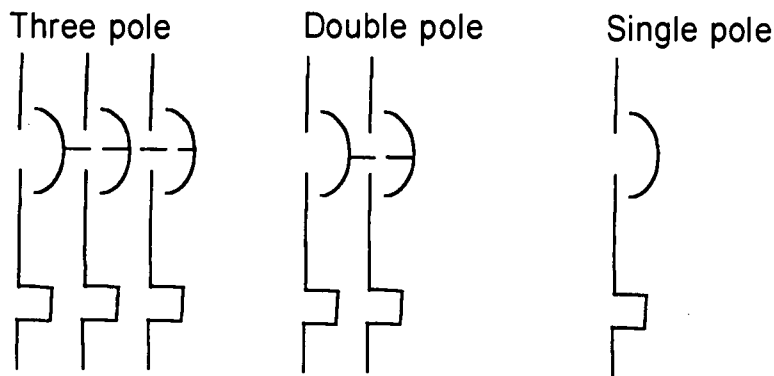

The single pole version of this symbol is the type of circuit breaker most often found in homes. The dashed line in the symbol of the circuit breaker signify that the multiple poles of the breaker are mechanically linked. When excessive electrical currents flow through the device, large amounts of heat are generated. The high heat is used to trip a mechanism in the breaker, thereby disconnecting the circuit.

**Circuit breaker with a bimetallic thermal overload trip.**

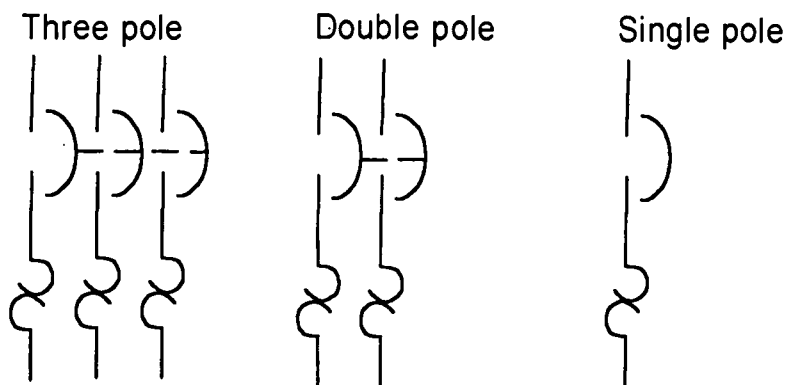

This type of circuit breaker works on the heat generated when excessive amounts of current flow through the breaker. The difference between this type of breaker and the one shown above, is that the heat causes two dissimilar types of metal to expand at different rates. When the bi-metallic actuator expands, it bends due to the unequal expansion of the two metals. This bending action operates a mechanism, and trips the breaker, thereby disconnecting the circuit.

**Circuit breaker with an electro-magnetic overload trip.**

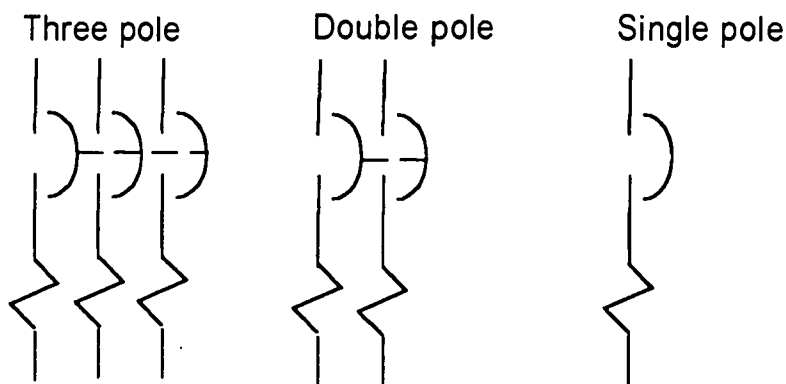

This type of circuit breaker works on the principle of an electro-magnet. When electrical currents flow through the conductors of the circuit, they create magnetic fields. The larger the current, the greater the field. The magnetic trip breaker is designed to trip the mechanism of the breaker when the currents and the magnetic field reach a certain magnitude, thereby disconnecting the circuit. In addition, some types of electro-magnetic trip breakers may be designed to be operated from a remote location using an emergency stop switch. These types of breakers may trip from excessive currents or from the action of the switch.

**Fuse type Circuit Breaker**

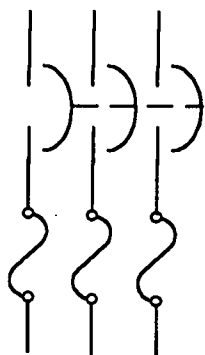

This is the symbol for a circuit breaker that uses fuses to protect the circuit. This breaker is a three pole breaker, and is capable of protecting three circuits. The brass objects located at the bottom of the picture are the contact surfaces of the fuses. Notice

the combination of the circuit breaker symbol, and the fuse symbol. Also notice the three wires that are connected to the circuit breaker.

This circuit breaker is typical of the type of circuit breaker that may be used in an electrical cabinet. The protection device used in this breaker is a fuse. In fact, there are three fuses used in this breaker to protect the three circuits. In addition, other types of protection devices can be used to prevent circuit damage and fires. Many circuit breakers are designed to disconnect two or three circuits. Fuses are frequently used to provide the necessary protection. A circuit breaker can interrupt large amounts of current. In addition, other types of protection devices can be used to prevent circuit damage and fires. Many circuit breakers are designed to disconnect two or three circuits. Fuses can be used to provide the necessary protection.

### Common Tie Point or Frame Ground

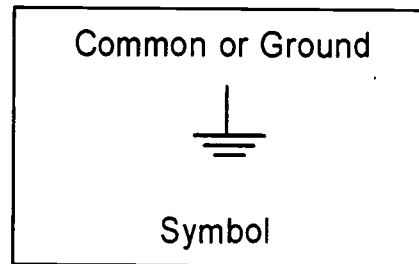
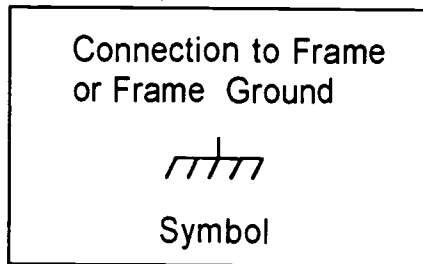

The "ground" symbol is the one most often ill used, and least understood. In reality, The concept of a "ground" as it is most often used, *does not exist*.

During the early years of electronic technology, the concept of a ground as a absolute point of reference for voltage was established. Certain types of electronic equipment, most notably, radio frequency equipment, used the earth as a point of reference. Over the years, the ground symbol has been used to symbolize many different points of voltage reference, none of which can be considered to be a true "ground". The Institute of Electrical and Electronic Engineers (IEEE) and the National Electrical Code (NEC) have established rules for the usage of the ground symbol, and for the connection to frame symbol. In the main, most manufacturers of electrical and electronic equipment have ignored these rules. The best that can be said about the ground symbol is that it is a common connection path for the conduction of electricity. For the purposes of this book, and for the *safety of the technician*, the following rules will apply to the "ground" symbol. The ground symbol will be considered to be a conductor of electrical currents. For this reason the "ground" symbol will be viewed as having *potentially lethal voltages attached to it, and may not be safely handled until it has been measured to determine the voltage potential (if any) that is has*. The connection to frame symbol will be considered to be a safety ground that is connected to a source such as a water pipe, or ground rod driven into the earth. In addition, the connection

to frame symbol is ordinarily connected to the facility's safety ground reference, and can be identified by the fact that the wires that are used for this purpose are green in color, or green with a yellow stripe. In some cases, for example, in home wiring, the safety ground is a bare (no insulation) copper or aluminum wire. The author has been witness to too many examples of damaged equipment, potentially lethal shock hazards, and poorly managed computer installations that suffered from the confusion as to what constitutes a "ground", to adopt any other interpretation of these symbols is to invite disaster.

Most electronics test equipment, for example an oscilloscope, has, as a part of its construction, a connection between the safety ground of the AC power cord, and the "ground" lead of the tests probes. For this reason, the "ground" lead of test equipment used in the troubleshooting of electronic equipment should not be connected to a circuit point that sports the "ground" symbol until:

- The technician has measured the voltage potential at the circuit point and has determined that the point is ZERO VOLTS in reference to the safety (frame) ground; and
- The technician understands the consequences of such connection to the equipment under test, and other equipment that may be connected to the same source of electrical power.

Some electrical technicians view the NEUTRAL wire (usually white) of an AC power source as a "ground". The neutral wire of an AC source of power is a conductor of electrical currents. It is *NEVER* to be viewed as being "grounded". *ALWAYS MEASURE, NEVER ASSUME!*

### Common Connection Point

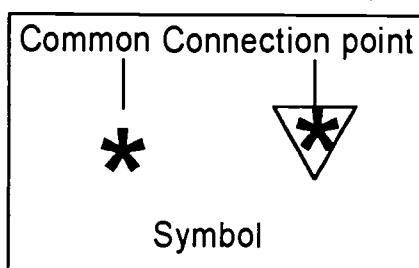

The common connection point symbol is most often used to indicate a connection to an electronic Direct Current (DC) power supply. In an electronic drawing, many circuits need a source of Direct Currents to operate. If the drawing contained a line to indicate all of these connections, the drawing would become very confusing. Therefore, the connection symbol will be used to indicate these connections. The asterisk shown in the symbol will be replaced by a letter or number to indicate the point of connection, in the

case of multiple sources of Direct Current. In some cases, the symbol will be used to indicate the common tie point of the circuit return path for the DC currents.

### Conduction Path for Electrical Currents

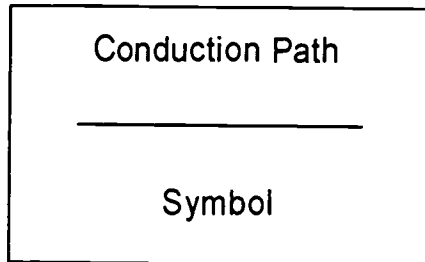

The symbol used to indicate a conduction path for electrical currents is a line. In an electrical or electronic drawing, many circuits will be connected to each other. These connections are paths for the conduction of electrical currents. The drawing contains lines to indicate these conduction paths. If the drawing contained lines to indicate all of the conduction paths, the drawing would become very confusing. Therefore, the conduction path symbol will be used along with the common tie point (ground) symbol, and the common connection point symbol.

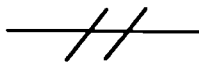

Two conduction paths  
(Electrical drawings)

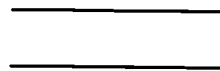

Two conduction paths  
(Electronic or electrical drawings)

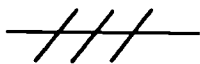

Three conduction paths  
(Electrical drawings)

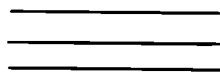

Three conduction paths  
(Electronic or electrical drawings)

### Connections of Conduction Paths for Electrical Currents

Two schemes are used to symbolically connect two or more conduction paths. In an electrical or electronic drawing, many circuits will be connected to each other. These connections must be unambiguous. The symbols below show the first method of indicating whether or not, two conduction paths are connected. In this scheme, a connected conduction path will be indicated by a large black dot showing the point of



connection. If the conduction paths are not connected the symbol will indicate that the path jumps over the alternate path. The drawing must never use both methods of indicating connects.

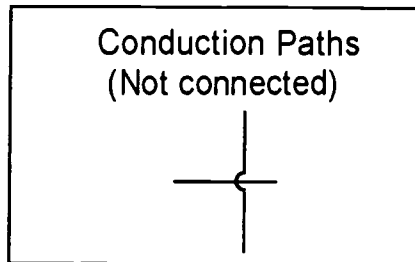
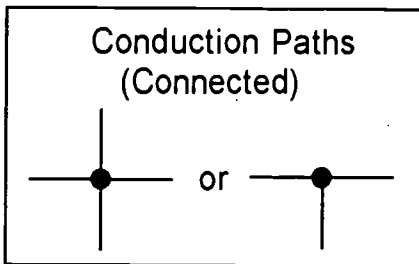

The symbols below show the second method of indicating whether or not, conduction paths are connected. This method dictates that a connecting path for conduction must indicate a clear termination at the point of connection. If the conduction paths are not connected, the lines will cross each other.

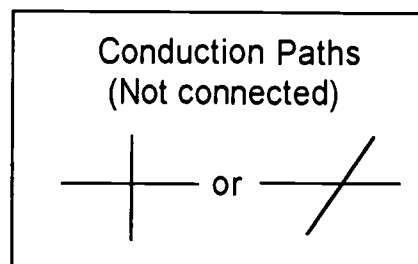
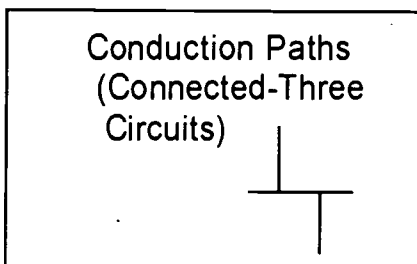

### General Circuit Element

The symbol below is the method of labeling an element of a circuit. The symbol may contain specifications for component values, voltages, currents, location of circuit elements, or other necessary data that pertains to the circuit operation. The rectangle may be as large as is necessary to contain the data.

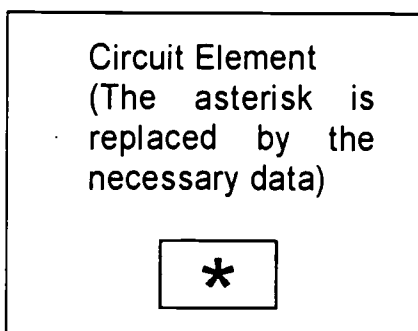

## Associated Conduction Paths for Electrical Currents (Cables)

The conduction paths in a complex electrical or electronic piece of equipment may be interconnected by groups of wires called cables. In many cases, the cables conduct sensitive electronic signals from one group of circuits to another. The paths are constructed in the cable such that the wires composing the paths are twisted around each other. When we depict associated conduction paths the paths are twisted unless otherwise specified. The twisting of the wires helps to eliminate unwanted signals from interfering with those being conducted through the conduction path.

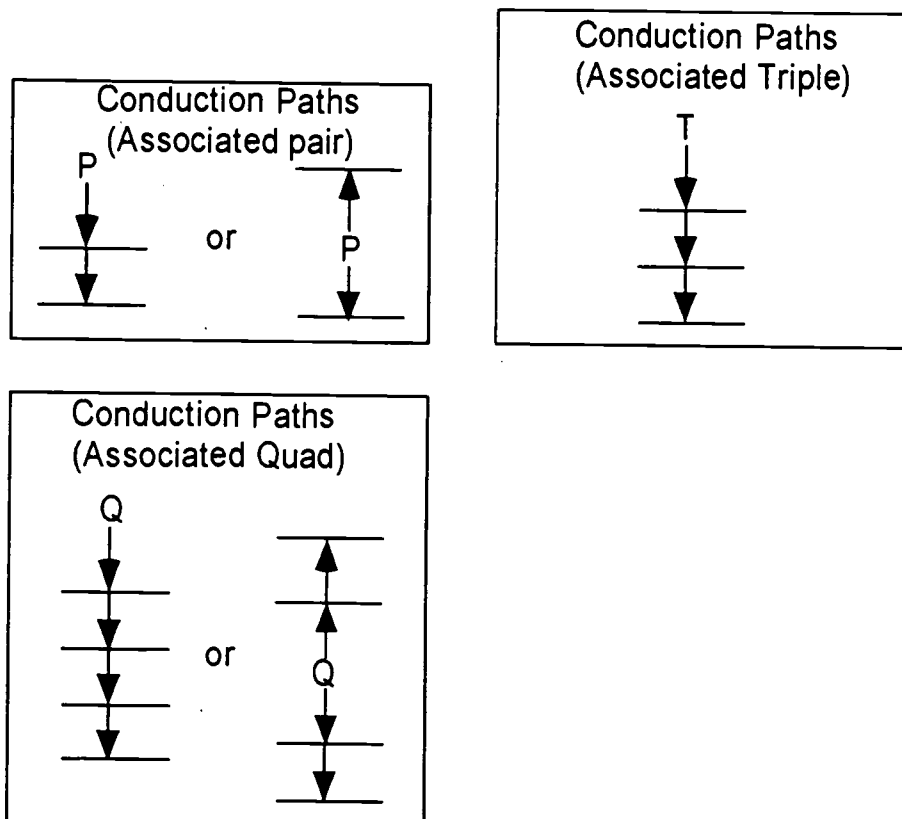

## Mechanical Connections of Electrical and Electronic Devices

The mechanical connection of components of electrical and electronic devices is depicted by a dotted line. If the devices are further operated by levers, a fulcrum symbol will be used.

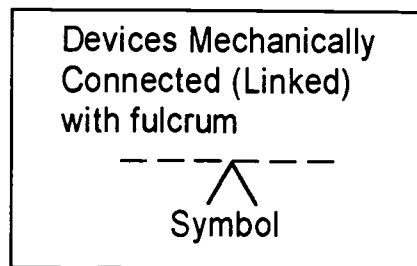
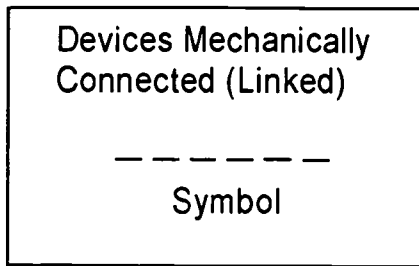

Three pole circuit breaker using the mechanical connection symbol

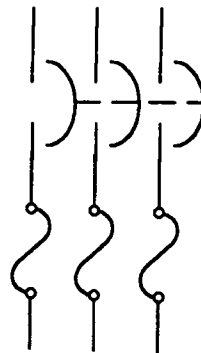

### Associated Conduction Paths for Electrical Currents (Shielded Cables)

The conduction paths in a complex electrical or electronic piece of equipment may be interconnected by groups of wires called cables. In many cases, the cables conduct sensitive electronic signals from one group of circuits to another. Many of these cables are shielded from unwanted interference by wire braids that surround the conductors. This wire braid is called a shield, and cables constructed in this manner are called shielded cables. Other types of cables are designed to be connected to circuits that have specific characteristics. One such group of cables is called coaxial cables. Coaxial cables are so named because the manner in which the conductors are arranged is one inside another. Unlike regular shielded cables, in which the shield does not conduct signals, the braid of the coaxial cable is one of the conduction paths and coaxial cables have specific electrical characteristics designed into the cable.

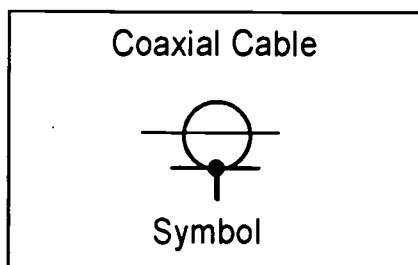

Shielded cables may contain many wires. A line will be added for each wire contained in the cable. The shield is a barrier against unwanted electrical interference from

outside electrical equipment, and is frequently connected to common (so-called ground) or the metal frame of the equipment.

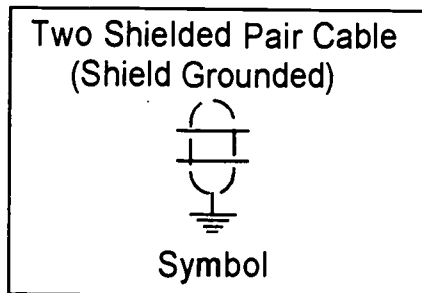
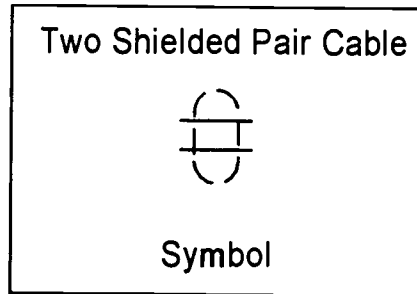
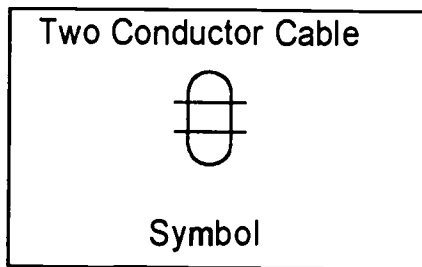

Another group of methods used to symbolically depict a cable or group of wires are the symbols shown below. Frequently the top symbol is used to depict a bundle of wires rather than a cable. The top symbol is frequently used in electrical layout diagrams and is designed to indicate when a wire leaves or joins the cable bundle.

The second group of symbols depicts a cable with many wires. It is used in electrical or electronic layout diagrams to show how the individual wires of the cable are led and distributed in the installation.

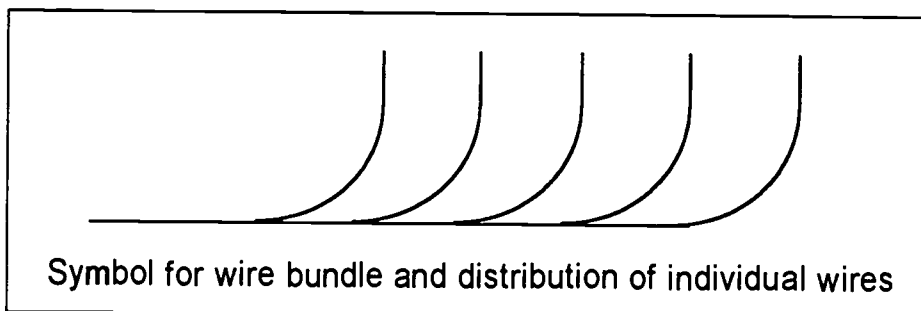

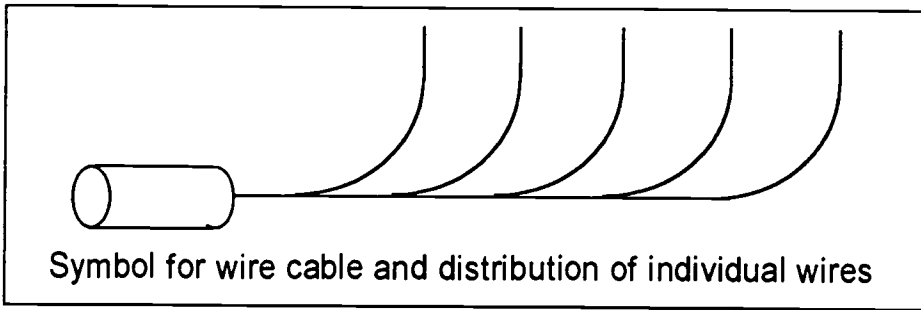

## Connectors

The basic connector symbol is depicted below. There are many different types of connectors in use. Some connectors attach one circuit board to another, some connectors attach cables to circuit boards, and some connectors attach conductors to each other. Regardless of the type of connection made, the same basic symbols will be used to depict the connection. There are two types of basic connector symbols used, both types may be used on the same drawing. The first type of symbol is used for general connections of all types. The second type of symbol usually depicts a plug connection. The female version of the second type of connector symbol is usually stationary, whereas the male version usually depicts a movable connector.

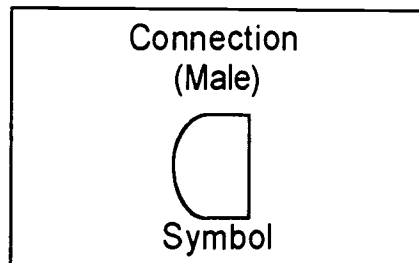
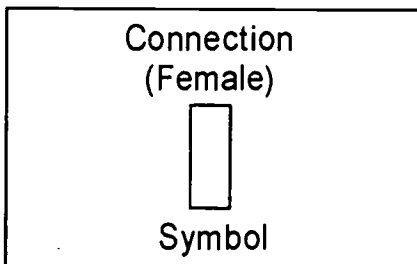
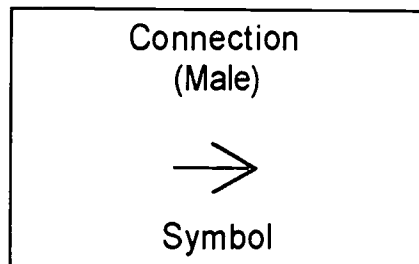
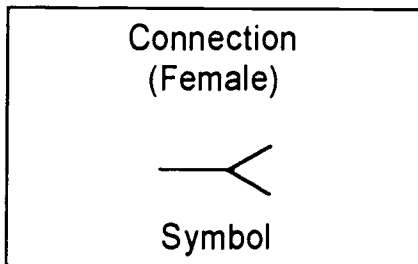

## Mated Connectors

When connectors are mated, the basic connector symbols are combined as depicted below. The basic symbol will be combined with letters or numbers to depict the individual connection points.

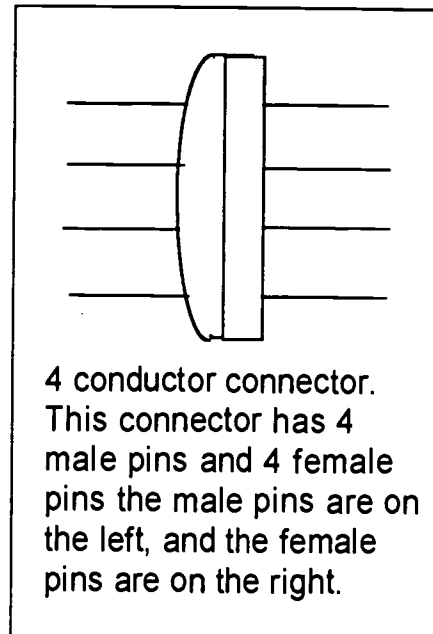
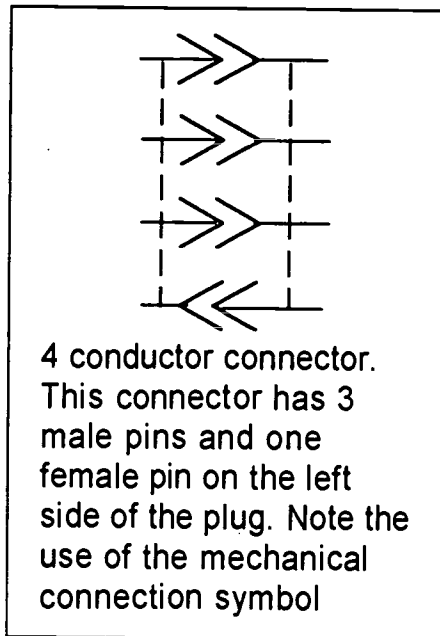
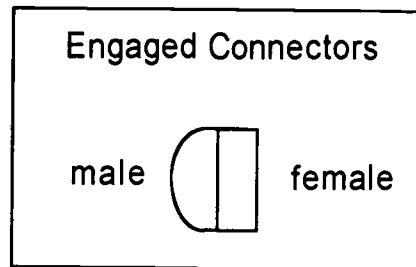
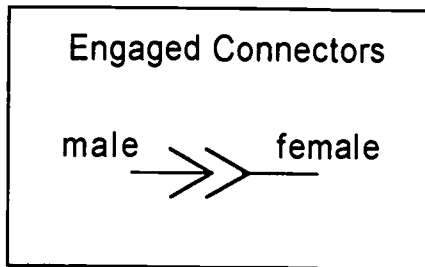

## Coaxial Connectors

Coaxial connectors are special connectors that are used when it is desired to connect circuits that have signals that can be influenced by other electrical or electronic equipment. Some of the signals that may be conducted using coaxial connectors are television signals, radio signals, certain types of computer signals, and other low energy level signals. The coaxial connector is usually mated to a type of cable called coaxial cable. Coaxial cable has an outer web of wire called a braid, and a single wire in the center. The outer braid is insulated from the inner wire by a non-conducting sleeve. The coaxial connector is constructed in a similar manner, but is usually made of solid metal. An example of a coaxial connector and coaxial cable is the wire and connector used on a standard television receiver which screws into the 75 ohm jack on the rear of the television. In the case of a television, the connector that plugs into the television, and the connector on the rear of the television, are both coaxial connectors.

The coaxial connector symbol can be combined with other symbols to modify the type of installation. In the example below, the coaxial connector symbol has been modified with the addition of a frame or equipment ground symbol to indicate that the connector is bolted or otherwise attached to the frame of the equipment.

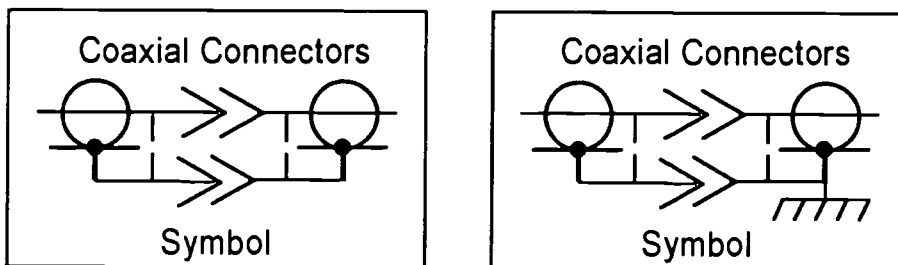

In some cases the outer braid of the coaxial connector is isolated from the circuit. If there is no conduction path between the outer braid of the connectors, the symbol will be modified with a X to indicate that the conduction path has been broken.

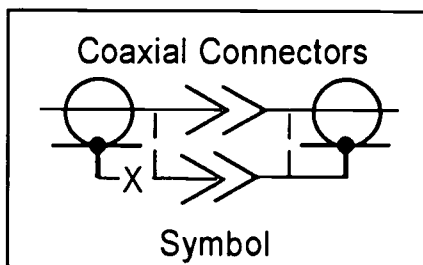

**Power Connectors (commonly called cord connectors, convenience outlets)**

Connectors designed for AC power applications have a specific symbol. A large variety of connectors are available with different voltage and current ratings. In addition, some connectors have curved blades that are designed to lock into the convenience outlet. Regardless of the type of connector used, the symbol will only depict the amount of connection points, using the symbols show below.

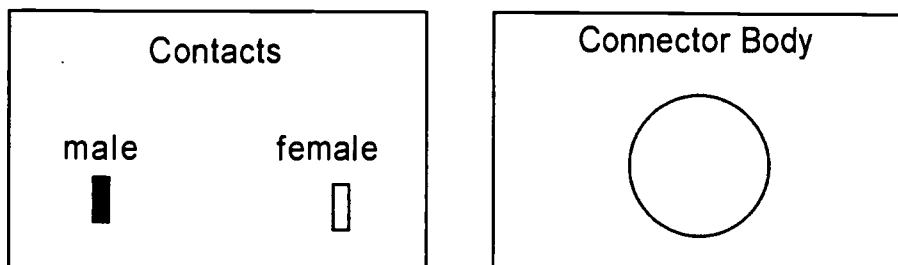

Examples of combined symbols. Note the conduction path symbols attached to the contact symbols.

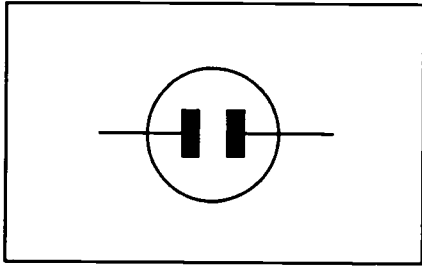

Two conductor non-polarized connector (male)

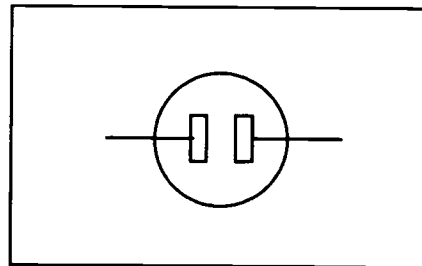

Two conductor non-polarized connector (female)

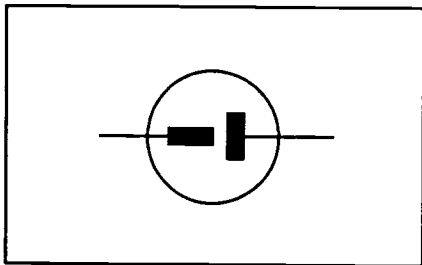

Two conductor polarized connector (male)

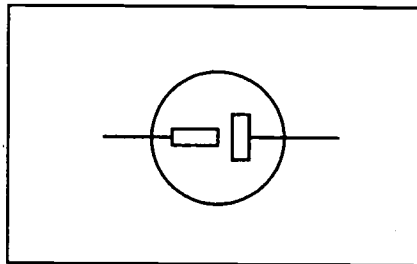

Two conductor polarized connector (female)

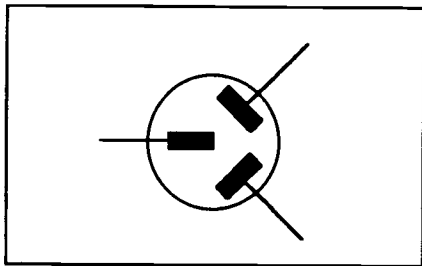

Three conductor polarized connector (female)

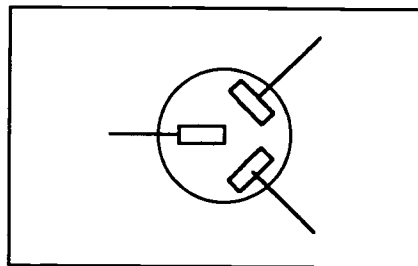

Three conductor polarized connector (male)



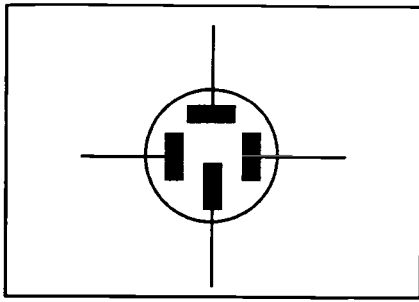

Four conductor polarized connector (male)

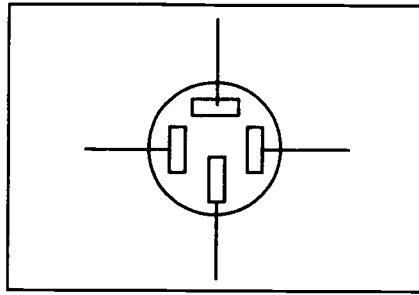

Four conductor polarized connector (female)

### Contacts (Electrical)

One of the most important symbols is the symbol used to indicate the contacts of a switch or relay. A switch is a device used to interrupt the conduction path for electrical currents. A relay is an automatic switch that can be operated by other sources of electrical currents. Switches and relays are used extensively in electrical and electronic equipment to control the flow of electrical currents. The contacts of a switch or relay have only two states. The contact can be *on or off*. If the contact is *on*, we identify its state as *closed*. If the switch is *off*, we identify its state as *open*. The concepts of open and closed in electrical work can be very confusing to a new student. The reason for this confusion is that the concepts run counter to ordinary experience. Most people are accustomed to the idea that if a valve such as a faucet is *closed*, *no water flows* from the faucet. If a faucet is *open*, then *water flows*. In electrical work, the concept is exactly the opposite. If the contact is *open*, *no current flows*. If the contact is *closed*, then *current flows*. It has been the authors experience that this state of affairs is only correctable by experience with the repeated usage of the symbols by the prospective technician. To fully understand the concept of open and closed contacts requires that the student change a lifetime of learning.

The below symbols represent the three types of basic symbols used to indicate contacts on electrical and electronic drawings notice that the symbols are represented in their normally open, and normally closed state. This representation of the contacts on a drawing refers only to the *state* of the contact *before* it is *operated*. It does not mean to imply that the contact is *always closed* or *always open*.

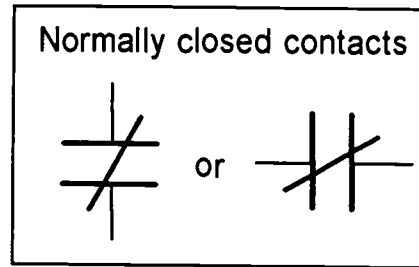
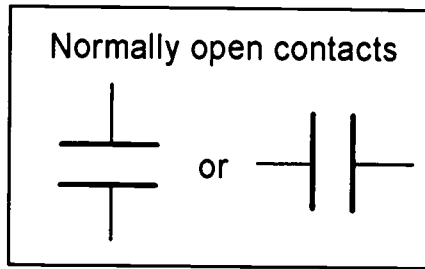

This symbol is used in electrical ladder diagrams and electronic diagrams

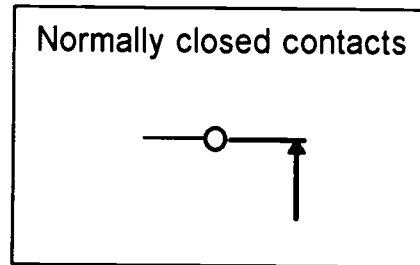
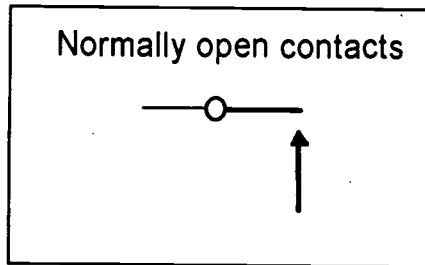

This symbol is primarily used in electronic schematics

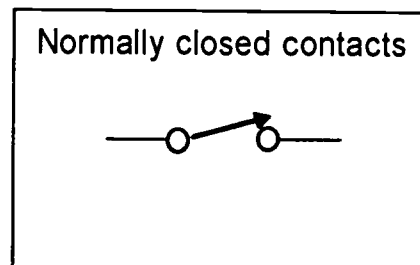
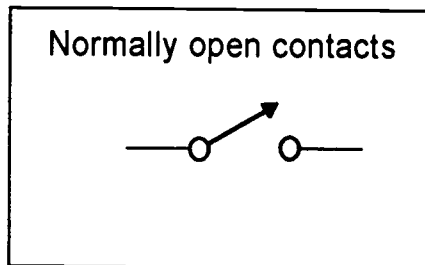

This symbol may be used in all types of electrical and electronic diagrams

All three of these symbol types can be used on electrical or electronic drawings the first set of symbols are the ones most commonly used on electrical ladder drawings.

### Contacts (Relays)

One of the most important devices that uses the contact symbol is the symbol used to indicate a relay. A relay is an automatic switch that can be operated by other sources of electrical currents. Relays are used extensively in electrical and electronic equipment to control the flow of electrical currents. Relays can be operated by either Direct Current (DC) or Alternating Current (AC). Regardless of the type of currents used to operate the relay, the relay contacts can be used to switch a large variety of electrical currents. The contacts of a relay have only two states. The states are controlled by the actuator of the relay. The actuator of a relay is an electromagnetic coil of wire. The electromagnet moves the switch contacts. If the contact is on, we identify its state as closed. If the contact is off, we identify its state as open. Before the relay is energized by an electrical current, the relay is identified as being in its normal

state. When the relay is in its normal state, some of the contacts may be closed, and some of the contacts may be open. Contacts that are closed in the normal state are said to be normally closed. Contacts that are open in the normal state, are said to be normally open. A relay can contain a large number of normally closed and normally open contacts. A relay can also contain only one normally open or normally closed contact. The amount and variety of normally open and normally closed contacts depends upon the design purpose of the relay. Regardless of the amount of contacts, the relay functions to switch the contacts by the action of the electromagnetic coil. The functions of the coil and the contacts are separate functions. The student must concentrate upon the fact that the coil moves the contacts and not vice-versa. The coil is the operator. The contacts respond to the actions of the coil. This representation of the contacts on a drawing refers only to the state of the contact before it is operated. It does not mean to imply that the contact is always closed or always open. On the drawing the contacts of a relay will be depicted in their normal state. A drawing is not a dynamic representation of the actions of the relay. To provide the maximum amount of information on the drawing, the contacts must be shown in their normal state. The interpreter of the drawing must imagine what will happen when the coil of the relay is energized. In electrical ladder diagrams, the coil of the relay and the contacts of the relay may be shown upon separate drawings. This is because the contacts of the relay will be used to switch other circuits, whereas the coil of the relay will be switched by other contacts or switches. This can be very confusing to the person who is required to interpret the drawing. It is a skill that requires a knowledge of electricity, and much practice.

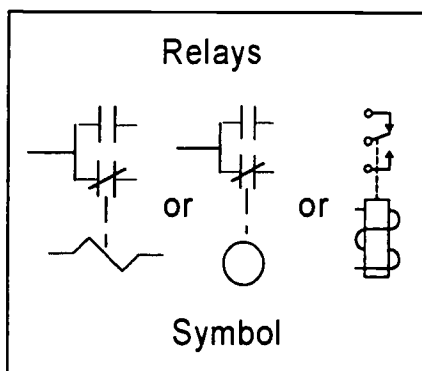

**The relay symbols depicted at the right are three of the many ways in which the same relay can be symbolized**

Note the use of the mechanical symbol. It indicates that the coil and contacts are mechanically linked

The symbols shown below are the various methods used to symbolize the electromagnetic coil of a relay. The choice of symbology is totally up to the company that manufactures the product. The top row of symbols is used extensively for electrical ladder drawings while the bottom row is used on electronic drawings. However, the symbols may be mixed on the same drawing. Each coil symbol will be accompanied by a letter and number designation for the relay coil in question. In the case of the circle, the asterisk will be replaced by the letter/number combination designator for the relay. The letters used to represent relays are frequently K, CR, R, and, M. The number can be any whole number.

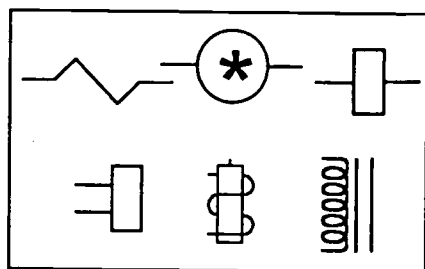

Relay Coil Symbols

### Contacts (Time Delay Relays)

Some relays are designed to be operated after a period of time. These relays are called "time Delay Relays". Time delay relays can have delay times as small as fractions of a second to times as large as minutes or hours. To accomplish this, the time delay relay may contain complex electronic circuits or mechanical actuators that delay the time that the relay actuates. Regardless of the method, the time delay relay closes or opens its contacts only after the coil of the relay has been actuated. The coil of the time delay relay may be identified by "TDR". Time delay relay contacts will be identified by "TDO" or "TDC". TDO means "Time Delay Open", TDC means "Time Delay Close". The TDO contacts will *open after* a period of time determined by the setting of the relay, and TDC contacts will *close after* a period of time determined by the setting of the relay. Regardless of the type of contacts involved, the coil of the relay is the governing factor. Some time delay relays, delay the time at which the relay coil will *energize*, and some time delay relays, delay the time at which the relay coil will *de-energize*. This action determines the manner in which the contacts will behave. The below symbols depict the various methods of symbolizing TDO and TDC relay contacts and coils.

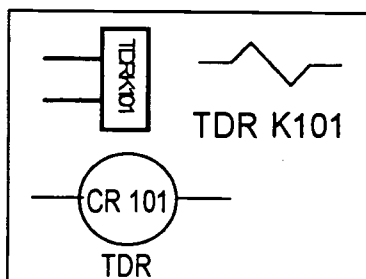

Symbols for coils

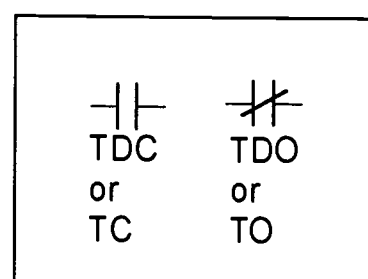
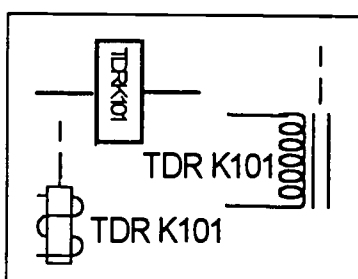

Symbols for contacts

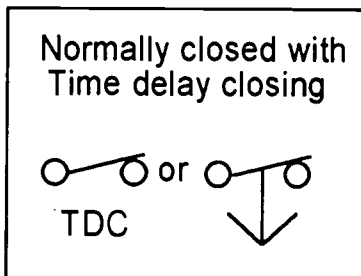
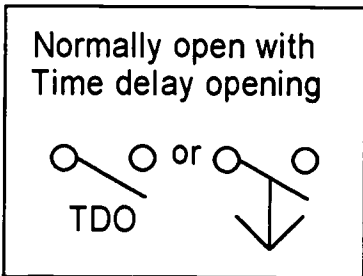
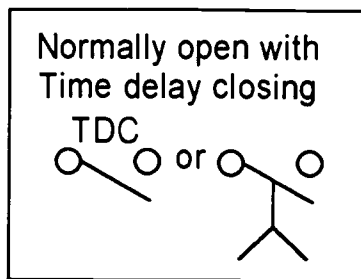
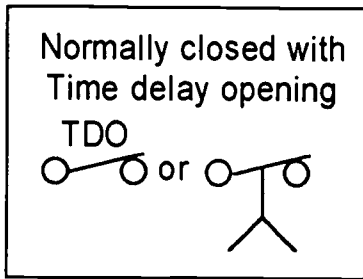

## Contacts (Switches)

Switches are circuit control devices that are used to apply power to a circuit or piece of equipment. Switches are manually operated devices that require physical effort in some form or another. Switches may be used to open or close any source of electrical current, including signals from complex electronic circuits. The basic switch symbol employs the symbols for contacts, as discussed earlier. A large variety of switches are manufactured for many different applications. The symbols used to depict switches attempt to depict the purpose of the switch rather than identify any particular type of switch. The next few pages will portray the various categories for switch symbols, and describe some of the nomenclature used to identify switches.

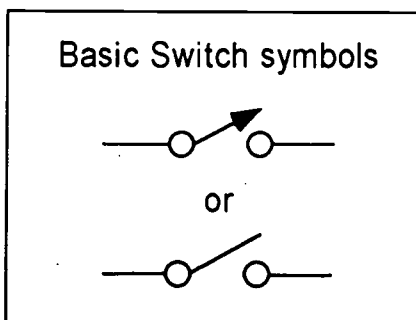

## Switch Categories

Switches are categorized according to the number of complete circuit paths than the switch can control. Conduction paths that the switch can control, are called poles. A

switch can have one or many poles. The above symbols depict a switch that has only one pole. The second criteria is the number of positions that the switch can assume. These positions are called throws. A throw is the position that the switch can move to and mechanically maintain contact. The above symbols depict a switch that has only one throw position. This switch would typically be found in applications in which an ON/OFF circuit needs to be controlled, such as a light switch. The words POLE and THROW are abbreviated with P and T, and the switch is categorized according to the number of each. To describe the number of the poles and throws, the words SINGLE, DOUBLE, and the numbers 3, 4, 5, 6, etc. are used. Each is abbreviated in a manner similar to the above method for poles and throws. Therefore, SINGLE becomes S, DOUBLE becomes D, and 3, 4, etc. are used to describe values above one and two. The letters and numbers are then combined to describe the switch. For example, the above switches are SINGLE POLE, SINGLE THROW, and they would be categorized as SPST. The below symbols depict some switches and the categories that they are assigned to.

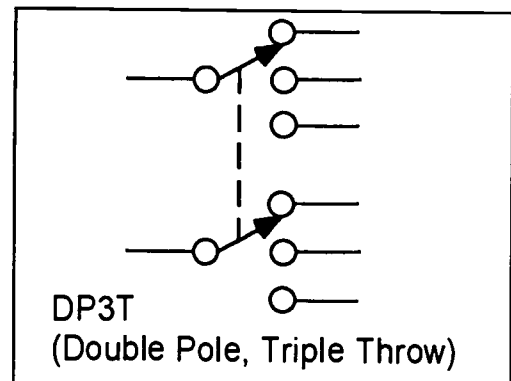
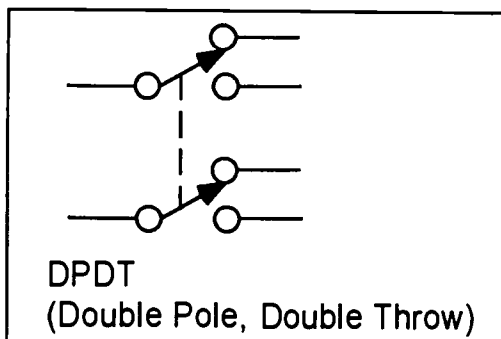
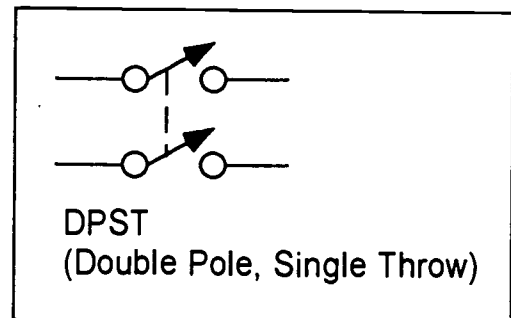
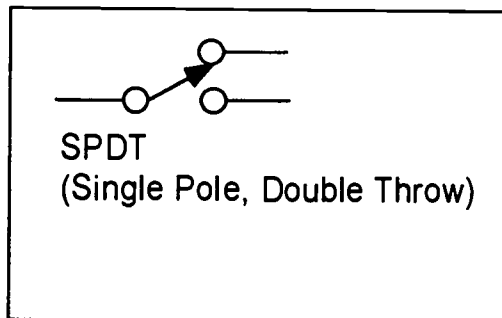

### Contacts (Switches-Interlocks)

Certain types of switches are used for safety features on machinery. The switches are called interlock switches, or just "interlocks." The symbols used for these switches are depicted below.

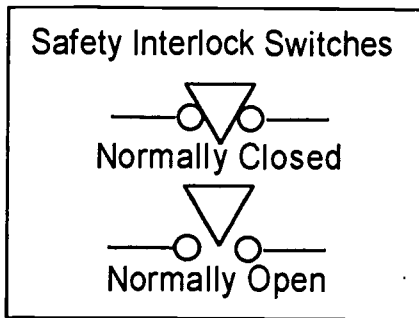

### Contacts (Switches-Momentary and Maintained)

Push-button switches are sometimes known as momentary switches. Momentary switches do not maintain CONTACT UNLESS MANUAL PRESSURE IS APPLIED TO THAT THE SWITCH. Usually a spring inside the switch returns the switch to its previous state. Since a momentary switch is normally in one position unless it is actuated, the push-button switch may have normally open and normally closed contacts. In addition the momentary switch can have one or many poles. Momentary switches such as push-button switches can be categorized as to their poles and throws, or as to the types of contacts. In many cases both descriptions are used. In addition, push-button switches can be manufactured to maintain a state of actuation after they are pushed in this case, the push-button switch is categorized as having maintained contacts. In addition, toggle switches can be manufactured containing momentary contacts. In other words, a switch may be momentary or maintained regardless of whether or not it is a push-button or toggle switch.

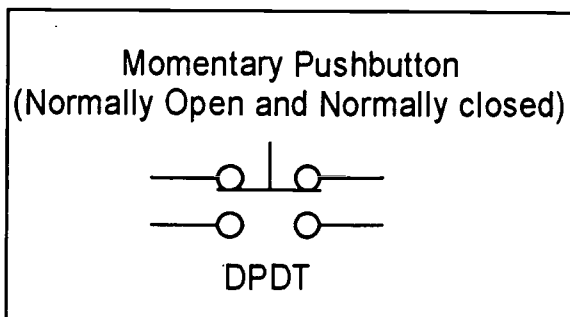
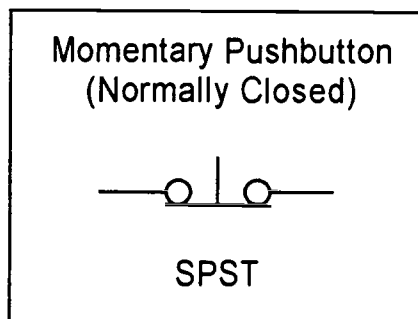
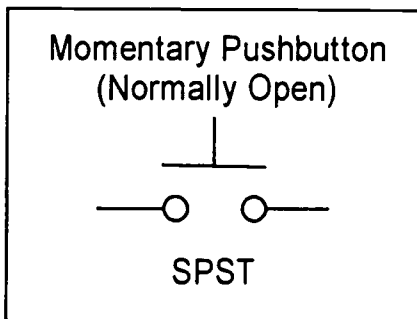

Maintained Pushbutton  
(Two sets of Normally Open and Normally closed)

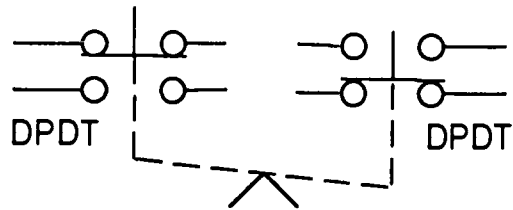

Note the mechanical symbols



**AET-B2-HO-3**  
**Use Symbols, Organization, and Engineering Values**  
**on Electrical Drawings**  
**Attachment 3: MASTER Handout No. 3**

---

**Electrical Drawings**

**Electrical Ladder Diagrams**

Most electrical control systems contain primary power, relays, solenoids, and wiring to control mechanical systems. The functional relationships between the electrical components determine the order and manner in which the mechanical system will be controlled by the electrical system.

The functional relationship of the electrical components is usually depicted by a drawing called a ladder diagram. The ability to quickly and accurately read and interpret a ladder diagram is what separates effective troubleshooting electrical technicians from mediocre ones.

There are many methods of reading a ladder diagram, but all of them require that the electrical technician understand the symbolism and organization embodied in the print. The following diagram depicts some of the symbols and their meaning.

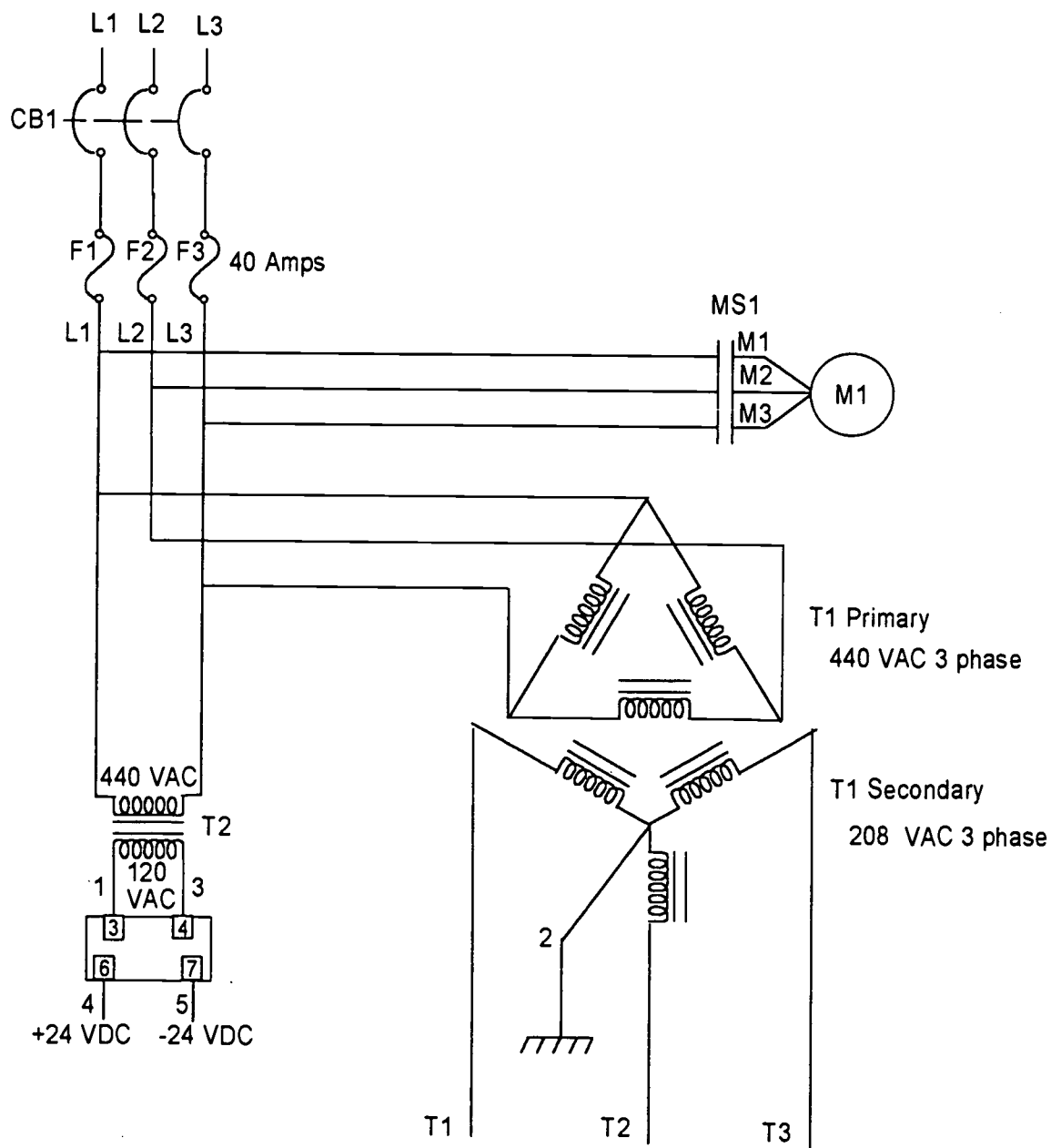

### Primary Power Ladder

Since the ladder diagram depicts a functional relationship, the layout of the symbols is not organized as to their physical location, but as to their function in the control system. Therefore a relay that is depicted upon one rung of the ladder diagram may contain contacts that may be used many rungs away. Also a set of contacts that are depicted on a rung may have a relay coil actuator that is depicted several rungs later.

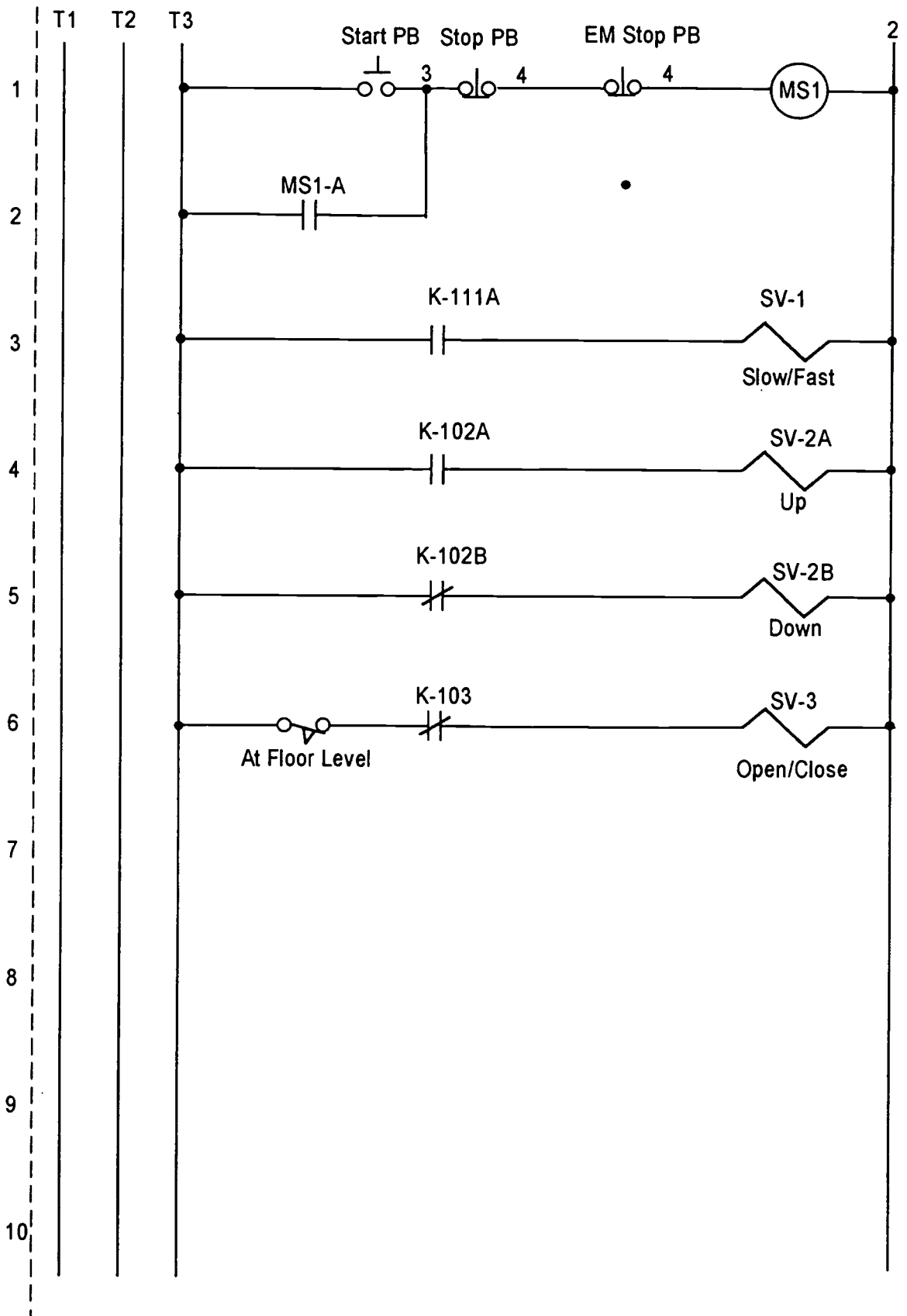

## **AC Ladder Diagram**

In a ladder diagram both DC ladders and AC ladders may be depicted upon the same blueprint. In the DC ladder, the components of the system will be operated by DC voltages, and in the AC ladder, the components of the system will be operated by AC voltages. In a complex diagram that includes DC and AC ladders, DC components such as relay contacts may operate AC components such as relay coils, solenoids or the power for electronic controls.

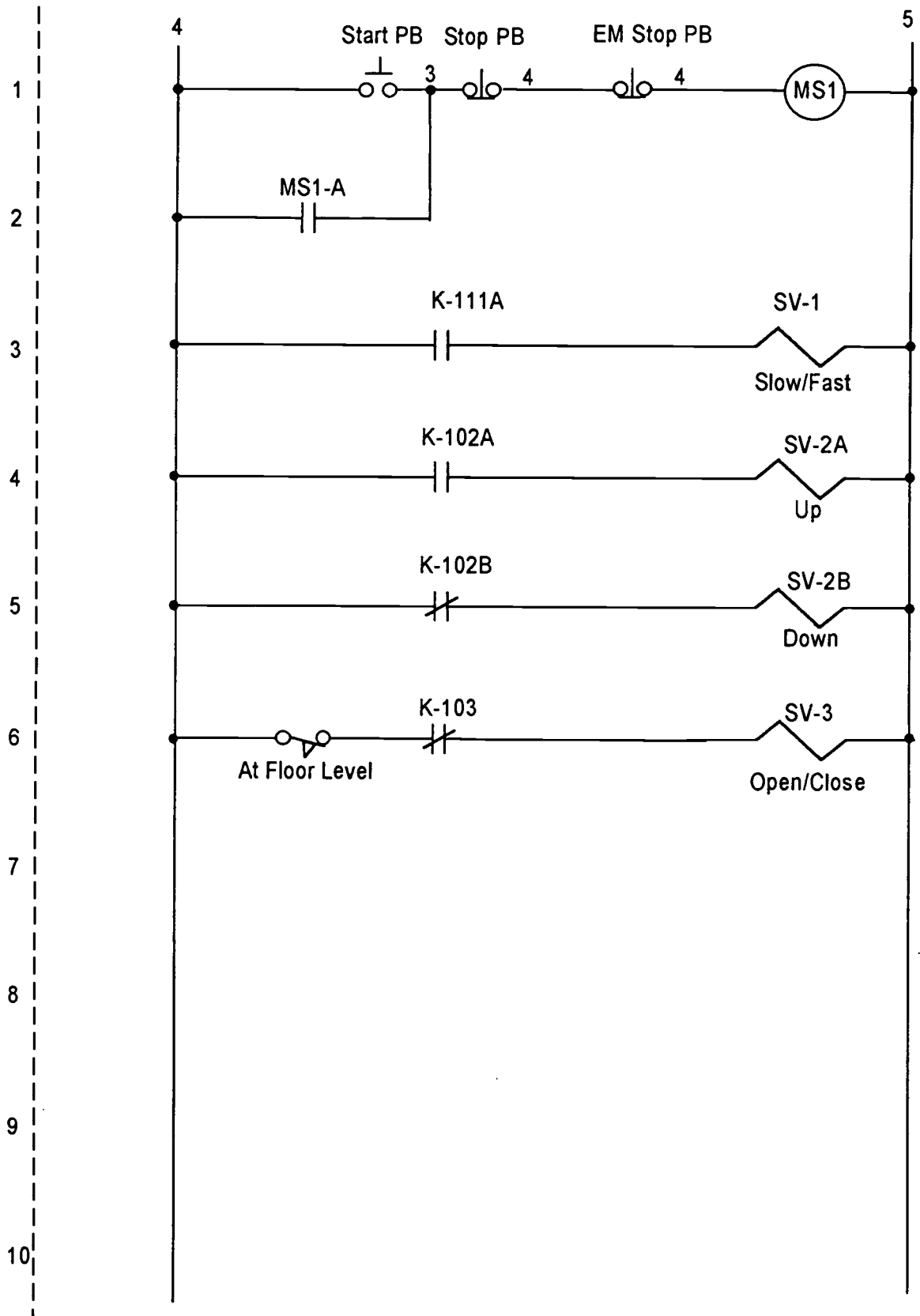

# **AUTOMATED EQUIPMENT REPAIR SERIES**

## **MASTER Technical Module No. AET-B3**

---

**Subject:** Automated Equipment Repair **Time:** 12 Hrs.

**Duty:** Use Drawings to Analyze and Repair Systems

**Task:** Use Symbols, Organization, and Engineering Values on Electronic Drawings

---

### **Objective(s):**

Upon completion of this unit the student will be able to use the symbols and organization associated with electronic schematic diagrams and electronic layout diagrams to:

- a. Identify components by their symbol;
- b. Determine the location of the components;
- c. Obtain electronic specifications from an electronic manual; and,
- d. Apply engineering values obtained from the drawing to the solution of technical problems.

---

### **Instructional Materials:**

Electronic parts that represent all of the concepts contained in this module  
MASTER Handout (AET-B3-HO-1)

MASTER Handout (AET-B3-HO-2) (Electronic Drawing Symbols)

MASTER Handout (AET-B3-HO-3) (Electronic Schematic Drawing)

MASTER Laboratory Exercise (AET-B3-LE) (Apply Troubleshooting Information from an Electronic Schematic Drawing)

MASTER Quiz AET-B3-QU-1: Electronic symbols

MASTER Quiz AET-B3-QU-2: Electronic schematic layout

MASTER Quiz AET-B3-QU-3: Electronic manual specifications

---

### **References:**

There are no texts that present all of the information in the B skills category in a comprehensive manner. Any text or reference that is based upon the American National Standards Institute specifications for electronic drawing is suitable for this module. Additional information must be supplied by handouts.

---

### **Student Preparation:**

Students should have previously completed the following Technical Modules:

- AET-A1** “Apply Scientific Notation and Engineering Notation to Solve Technical Problems”
- AET-A2** “Apply Algebraic Formulas to Solve Technical Problems”
- AET-B2** “Use Symbols, Organization, and Engineering Values on Electrical Drawings”

---

---

**Introduction:**

Drawings for automation are roughly divided into five categories. They are: mechanical drawings, electrical drawings, electronic drawings, digital electronic drawings, and hydraulic or pneumatic drawings. A competent automation technician must be comfortable in interpreting the information contained on all of these drawings. Electronic drawings are used for all of the above categories to depict the electronic features of an assembly or component. These drawings are frequently called schematic drawings. Therefore, the technician must be able to interpret the information contained on a electronic or schematic drawing.

---

---

**Presentation Outline:**

- I. Identify Symbols on Electronic Schematic Drawings
  - A. Drawing symbols: MASTER Handout AET-B3-HO-2 (Electronic Drawing Symbols) and MASTER Handout AET-B3-HO-3 (Electronic Schematic Drawing)
    1. Describe the meaning of each symbol and a general concept of how the device operates
    2. Display samples of the parts represented by the symbols
    3. Provide examples of specification sheets containing connection information, and electrical characteristics
  - B. Demonstrate the methods used to apply the above symbols to the troubleshooting of electronic systems
- II. Identify the Layout of an Electronic Schematic Drawing
  - A. Explain the layout and organization of electronic drawings: MASTER Handout AET-B3-HO-2 (Electronic Drawing Symbols) and MASTER Handout AET-B3-HO-3 (Electronic Schematic Drawing)
    1. Explain the types of drawing and documentation that comprise a set of electronic drawings
    2. Demonstrate the methods of locating components on a electronic schematic drawing
    3. Demonstrate the method of determining the types of current sources and their magnitude (voltage, AC or DC)
  - B. Demonstrate the methods used to apply the above information to the troubleshooting of electronic systems
- III. Obtain Electronic Specifications from an Electronic Manual

- A. Demonstrate how to determine the specifications of the operational characteristics of an electronic assembly from the specifications section of a manual
  - 1. Relate the electronic symbol to the component number on an electronic schematic diagram
  - 2. Determine the value of components and their model or type number from the material specification list in the materials section of an electronic assembly from the equipment manual
- B. Demonstrate the methods used to apply the above information to the troubleshooting of electronic systems

---

---

**Practical Application:**

**MASTER Laboratory Exercise (AET-B3-LE) (Apply Troubleshooting Information from an Electronic Schematic Drawing).**

---

---

**Evaluation and/or Verification:**

Successful completion of this technical module will be based on the student's successful completion of the following components:

- 1. A ten question quiz on electronic drawing symbols (MASTER Quiz AET-B3-QU-1: Electronic symbols);
- 2. A ten question quiz on electronic drawing layout and specifications (MASTER Quiz AET-B3-QU-2: Electronic schematic layout);
- 3. A ten question quiz on electronic drawing layout and specifications (MASTER Quiz AET-B3-QU-3: Electronic manual specifications); and,
- 4. Demonstrate proficiency in interpreting electronic schematic drawings symbols (MASTER Laboratory Exercise AET-B3-LE) (Apply Troubleshooting Information from an Electronic Schematic Drawing).

---

---

**Summary:**

Review the main lesson points using the suggested texts listed in the reference section of this module. Hold class discussion and answer student questions.

---

---

**Next Lesson Assignment:**

**MASTER Technical Module (AET-B4) dealing with using symbols, organization, and engineering values on fluid power drawings.**



**AET-B3-HO-1**  
**Use Symbols, Organization, and Engineering Values**  
**on Electronic Drawings**  
**Attachment 1: MASTER Handout No. 1**

---

**Objective(s):**

Upon completion of this unit the student will be able to use the symbols and organization associated with electronic schematic diagrams and electronic layout diagrams to:

- a. Identify components by their symbol;
  - b. Determine the location of the components;
  - c. Obtain electronic specifications from an electronic manual; and,
  - d. Apply engineering values obtained from the drawing to the solution of technical problems.
- 

**Module Outline:**

- I. Identify Symbols on Electronic Schematic Drawings
  - A. Drawing symbols: MASTER Handout AET-B3-HO-2 (Electronic Drawing Symbols) and MASTER Handout AET-B3-HO-3 (Electronic Schematic Drawing)
    1. Describe the meaning of each symbol and a general concept of how the device operates
    2. Display samples of the parts represented by the symbols
    3. Provide examples of specification sheets containing connection information, and electrical characteristics
  - B. Demonstrate the methods used to apply the above symbols to the troubleshooting of electronic systems
- II. Identify the Layout of an Electronic Schematic Drawing
  - A. Explain the layout and organization of electronic drawings: MASTER Handout AET-B3-HO-2 (Electronic Drawing Symbols) and MASTER Handout AET-B3-HO-3 (Electronic Schematic Drawing)
    1. Explain the types of drawing and documentation that comprise a set of electronic drawings
    2. Demonstrate the methods of locating components on a electronic schematic drawing
    3. Demonstrate the method of determining the types of current sources and their magnitude (voltage, AC or DC)
  - B. Demonstrate the methods used to apply the above information to the troubleshooting of electronic systems
- III. Obtain Electronic Specifications from an Electronic Manual

- A. Demonstrate how to determine the specifications of the operational characteristics of an electronic assembly from the specifications section of a manual
  - 1. Relate the electronic symbol to the component number on an electronic schematic diagram
  - 2. Determine the value of components and their model or type number from the material specification list in the materials section of an electronic assembly from the equipment manual
- B. Demonstrate the methods used to apply the above information to the troubleshooting of electronic systems

**AET-B3-HO-2**  
**Use Symbols, Organization, and Engineering Values**  
**on Electronic Drawings**  
**Attachment 2: MASTER Handout No. 2**

---

**Reading Electrical or Electronic Drawings**

**Amplifier**

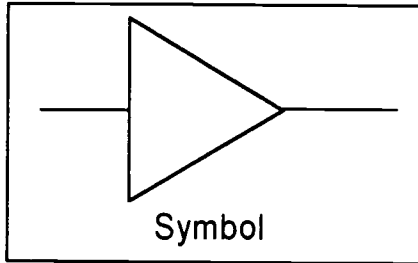

A device which increases the energy level of a physical value. The symbol shown above is the basic symbol for an amplifier. The symbol is always composed of an input and an output. The input is always drawn on the left, and the output is always drawn on the right. The term amplifier, can be applied to mechanical systems as well as it can be applied to electronic systems.

The symbol that depicts an amplifier is a general symbol that gives no indication of the size of the object, the amount of components used in the object, nor the type of system in which the object is used. The technician must infer these facts from the context in which the object is used.

An amplifier can have more than one input, and more than one output. For example:



Dual input  
single output

or



Dual input  
Dual output

or

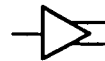

Single input  
Dual output

In addition, the use of a small circle indicates that the amplifier inverts the results of its amplification.



Inverting output



Inverting input

Lines that are drawn to the symbol at right angles are usually power connections, or axillary connections. For example:

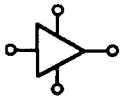

The two vertical lines represent connections to the power supply, or a control connection. The round circles indicate connection points, not inversion.

Various types of amplifier symbols:



The basic symbol for an amplifier provides no clue as to the nature of the device. An amplifier can have as few as four components associated with it, or can have more than one hundred complex electronic circuits. Amplifiers can be composed of discrete components, or be enclosed in an integrated circuit. The amplifier symbol covers a wide variety and scope of devices.

### Batteries (Generalized DC source)

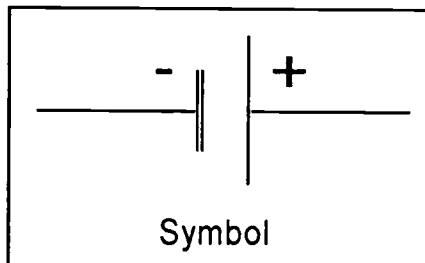

A battery is device that converts chemical energy to Direct Current electrical energy. Batteries are frequently constructed of cells that are electrically connected, one to another. Most cells produce from 1 to 1.5 volts DC. If the battery is only composed of one cell, the symbol will appear as its is above. If the battery is composed of many cells, the diagram will appear as it does below.

The battery symbol can also be used to depict a generalized Direct Current source of electrical power.

An automobile battery uses sulfuric acid and lead plates to generate DC electrical current. It is a multi-celled battery. Sources of DC current that are created by electronic methods ordinarily do not use the battery symbol.



**Multi-celled battery**

## Capacitors

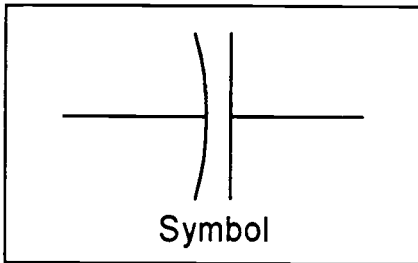

Capacitors are devices that perform several functions in electrical and electronic circuits. A capacitor can be used to store electrical energy and release it in a controlled fashion, a capacitor can be used as a variable opposition (resistance) in an Alternating Current (AC) application, and a capacitor can be used to filter electrical voltages. There are essentially three types of capacitors in use today. They are, variable capacitors, non-polarized capacitors, and electrolytic capacitors.

Various capacitor symbols:

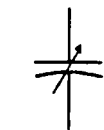

Variable Capacitor

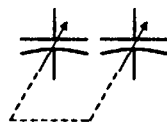

Variable Capacitors mechanically coupled (ganged)

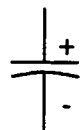

Electrolytic Capacitor



Non-polarized Capacitor (the curved end represents the most negative connection point)

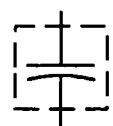

Shielded Capacitor



Feed-Through Capacitor

The capacitor symbols depicted above cover most of the various types of symbols that the technician may encounter in a machine or electronic circuit.

The variable capacitor is a capacitor whose capacitance can be varied by mechanical means. The variable capacitor that is mechanically coupled, is the type of capacitor that is used to tune the stations on a transistor radio.

The electrolytic capacitor is extremely sensitive to voltage polarities. The wise technician who installs this type of capacitor pays care full attention to detail and installs this device in the proper polarity. This type of capacitor can explode if it is installed backwards!

The shielded capacitor is use in sensitive television and radio applications. It is frequently found it computer monitors where it prevents stray electrical radiation.

The feed-through capacitor is used to filter stray electrical noise from wires that are used to connect circuits in radio and television equipment.

The non-polarized capacitor symbol is the most common type of capacitor symbol found in most circuits. The curved end of the capacitor symbol indicates the point at which the capacitor should be connected to the most negative voltage potential. Ordinarily, the manner in which the non-polarized capacitor is installed is unimportant. However, in certain sensitive applications, the capacitor should be installed with the polarity in mind. Many capacitors have a black ring that indicates this connection point.

Capacitors come in a wide variety of shapes and sizes. Generally, the size of a capacitor is determined by two factors. First, the amount of capacitance; and second, the working voltage of the capacitor. The larger the capacitance, the larger the capacitor, and the higher the voltage, the larger the capacitor. These two factors influence each other. For example, a high voltage capacitor that has a small amount of capacitance may be as large as a low voltage capacitor that has massive amounts of capacitance.

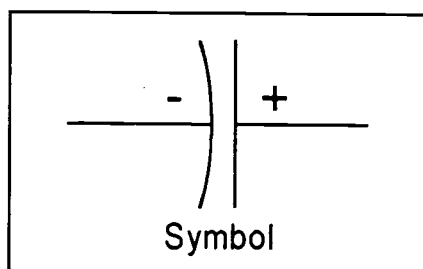

## Electrolytic Capacitor

An electrolytic capacitor is a capacitor that uses a chemical to create the capacitance effect. The chemical is used in the capacitor as an insulator. Electrolytic capacitors are designed to provide extremely large amounts of capacitance while maintaining a small size. The reason that this can be accomplished, is because the chemical involved,

(usually an oxide compound) enables the conductors of the capacitor (called plates) to be positioned extremely close together. For this reason, electrolytic capacitors are polarity sensitive; since the electrolyte (insulator) can be destroyed by an improper application of voltage.

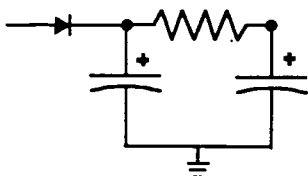

**Filter Circuit**

The above symbology depicts the capacitor symbol connected with other symbols to form a circuit. The circuit shown is designed to allow the capacitor to filter DC voltages.

### **Surface Mount Capacitors**

Surface mount technology is the way things are done today. It is the method that dictates that all components are mounted on a single side of the printed circuit board. Through hole technology required drilled circuit boards, adding many steps to the manufacturing process. Surface mount technology lends its self well to automation, allowing many parts per minute and very little hand work. Due to surface mount technology, sophisticated equipment has not only become more portable (lighter in weight and smaller in size) but also more economical.

Surface mount technology has changed the nature of electronics. Everything has been miniaturize to the point of non-recognition. Components do not look the same today as they did as recently as ten years ago. And even an experienced technician can no longer recognize what the capacitor really is without a symbol designator on the circuit board.

### **Circuit Breaker**

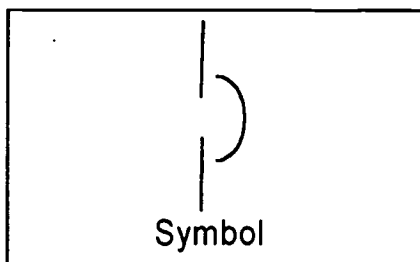

A circuit breaker is a device that interrupts the flow of electrical power. In your home, the circuit breaker is a switch designed to disconnect the primary power sources for appliances and lighting. In industry the circuit breaker works to interrupt power for high powered industrial equipment. Power for the home ordinarily requires that only one wire be disconnected, and so the circuit breaker has only one pole to perform the act. The term pole refers to the connection path for the conduction of electrical power. In industry, power is frequently supplied over three wires. For this reason many circuit breakers employed in factories application have three poles. The circuit breaker is frequently designed to automatically interrupt the electrical power if some equipment connected to the electrical power malfunctions. If the circuit breaker is designed to provide this function, the symbol will reflect it.

**Circuit breaker with a thermal overload trip.**

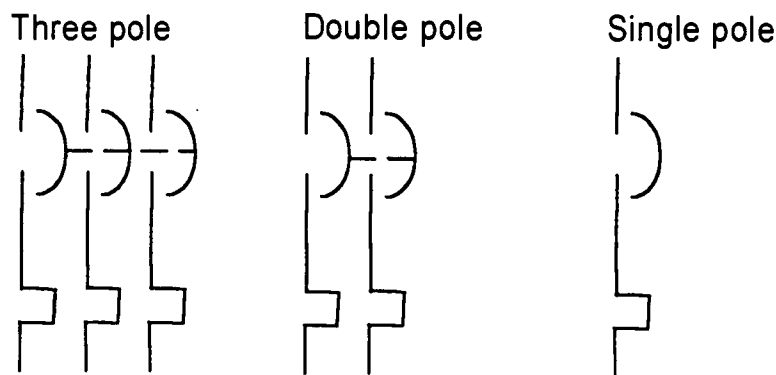

The single pole version of this symbol is the type of circuit breaker most often found in homes. The dashed line in the symbol of the circuit breaker signify that the multiple poles of the breaker are mechanically linked. When excessive electrical currents flow through the device, large amounts of heat are generated. The high heat is used to trip a mechanism in the breaker, thereby disconnecting the circuit.

**Circuit breaker with a bimetallic thermal overload trip.**

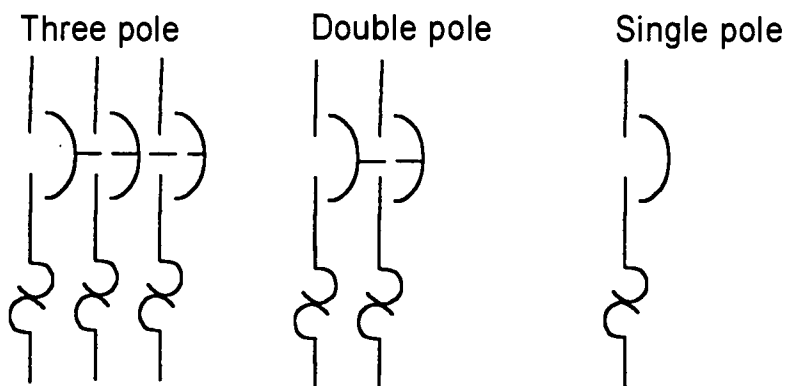



This type of circuit breaker works on the heat generated when excessive amounts of current flow through the breaker. The difference between this type of breaker and the one shown above, is that the heat causes two dissimilar types of metal to expand at different rates. When the bi-metallic actuator expands, it bends due to the unequal expansion of the two metals. This bending action operates a mechanism, and trips the breaker, thereby disconnecting the circuit.

**Circuit breaker with an electro-magnetic overload trip.**

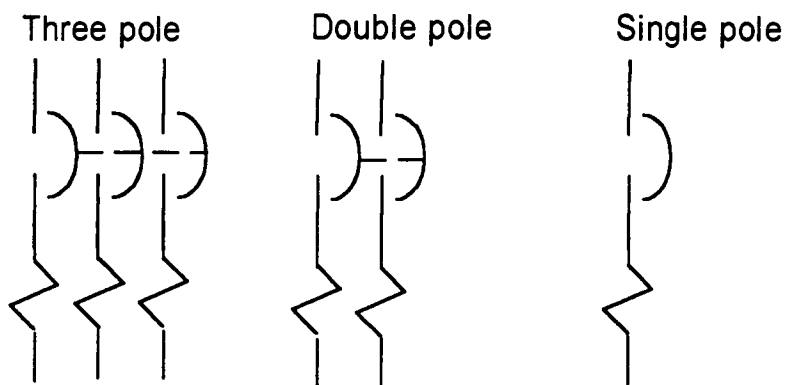

This type of circuit breaker works on the principle of an electro-magnet. When electrical currents flow through the conductors of the circuit, they create magnetic fields. The larger the current, the greater the field. The magnetic trip breaker is designed to trip the mechanism of the breaker when the currents and the magnetic field reach a certain magnitude, thereby disconnecting the circuit. In addition, some types of electro-magnetic trip breakers may be designed to be operated from a remote location using an emergency stop switch. These types of breakers may trip from excessive currents or from the action of the switch.

**Fuse type Circuit Breaker**

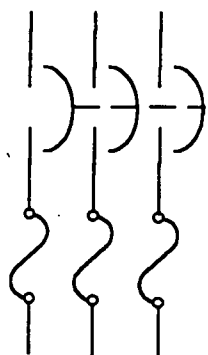

This is the symbol for a circuit breaker that uses fuses to protect the circuit. This breaker is a three pole breaker, and is capable of protecting three circuits. The brass objects located at the bottom of the picture are the contact surfaces of the fuses. Notice

the combination of the circuit breaker symbol, and the fuse symbol. Also notice the three wires that are connected to the circuit breaker.

This circuit breaker is typical of the type of circuit breaker that may be used in an electrical cabinet. The protection device used in this breaker is a fuse. In fact, there are three fuses used in this breaker to protect the three circuits. In addition, other types of protection devices can be used to prevent circuit damage and fires. Many circuit breakers are designed to disconnect two or three circuits. Fuses are frequently used to provide the necessary protection. A circuit breaker can interrupt large amounts of current. In addition, other types of protection devices can be used to prevent circuit damage and fires. Many circuit breakers are designed to disconnect two or three circuits. Fuses can be used to provide the necessary protection.

### Common Tie Point or Frame Ground

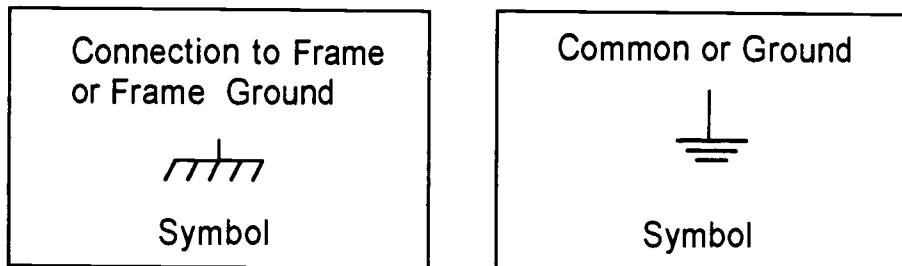

The "ground" symbol is the one most often ill used, and least understood. In reality, The concept of a "ground" as it is most often used, *does not exist*.

During the early years of electronic technology, the concept of a ground as a absolute point of reference for voltage was established. Certain types of electronic equipment, most notably, radio frequency equipment, used the earth as a point of reference. Over the years, the ground symbol has been used to symbolize many different points of voltage reference, none of which can be considered to be a true "ground". The Institute of Electrical and Electronic Engineers (IEEE) and the National Electrical Code (NEC) have established rules for the usage of the ground symbol, and for the connection to frame symbol. In the main, most manufacturers of electrical and electronic equipment have ignored these rules. The best that can be said about the ground symbol is that it is a common connection path for the conduction of electricity. For the purposes of this book, and for the *safety of the technician*, the following rules will apply to the "ground" symbol. The ground symbol will be considered to be a conductor of electrical currents. For this reason the "ground" symbol will be viewed as having *potentially lethal voltages attached to it, and may not be safely handled until it has been measured to determine the voltage potential (if any) that is has*. The connection to frame symbol will be considered to be a safety ground that is connected to a source such as a water pipe, or ground rod driven into the earth In addition, the connection

to frame symbol is ordinarily connected to the facility's safety ground reference, and can be identified by the fact that the wires that are used for this purpose are green in color, or green with a yellow stripe. In some cases, for example, in home wiring, the safety ground is a bare (no insulation) copper or aluminum wire. The author has been witness to too many examples of damaged equipment, potentially lethal shock hazards, and poorly managed computer installations that suffered from the confusion as to what constitutes a "ground", to adopt any other interpretation of these symbols is to invite disaster.

Most electronics test equipment, for example an oscilloscope, has, as a part of its construction, a connection between the safety ground of the AC power cord, and the "ground" lead of the tests probes. For this reason, the "ground" lead of test equipment used in the troubleshooting of electronic equipment should not be connected to a circuit point that sports the "ground" symbol until:

- The technician has measured the voltage potential at the circuit point and has determined that the point is ZERO VOLTS in reference to the safety (frame) ground; and
- The technician understands the consequences of such connection to the equipment under test, and other equipment that may be connected to the same source of electrical power.

Some electrical technicians view the NEUTRAL wire (usually white) of an AC power source as a "ground". The neutral wire of an AC source of power is a conductor of electrical currents. It is *NEVER* to be viewed as being "grounded". *ALWAYS MEASURE, NEVER ASSUME!*

### Common Connection Point

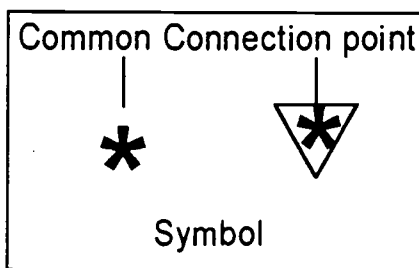

The common connection point symbol is most often used to indicate a connection to an electronic Direct Current (DC) power supply. In an electronic drawing, many circuits need a source of Direct Currents to operate. If the drawing contained a line to indicate all of these connections, the drawing would become very confusing. Therefore, the connection symbol will be used to indicate these connections. The asterisk shown in the symbol will be replaced by a letter or number to indicate the point of connection, in the

case of multiple sources of Direct Current. In some cases, the symbol will be used to indicate the common tie point of the circuit return path for the DC currents.

### Conduction Path for Electrical Currents

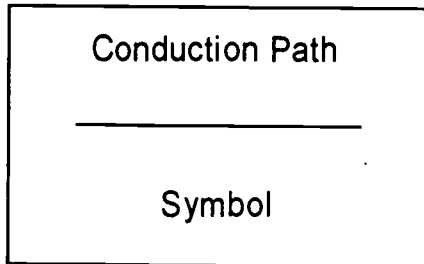

The symbol used to indicate a conduction path for electrical currents is a line. In an electrical or electronic drawing, many circuits will be connected to each other. These connections are paths for the conduction of electrical currents. The drawing contains lines to indicate these conduction paths. If the drawing contained lines to indicate all of the conduction paths, the drawing would become very confusing. Therefore, the conduction path symbol will be used along with the common tie point (ground) symbol, and the common connection point symbol.

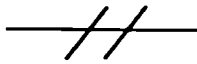

Two conduction paths  
(Electrical drawings)



Two conduction paths  
(Electronic or electrical drawings)

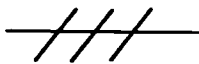

Three conduction paths  
(Electrical drawings)

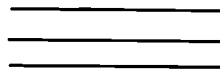

Three conduction paths  
(Electronic or electrical drawings)

### Connections of Conduction Paths for Electrical Currents

Two schemes are used to symbolically connect two or more conduction paths. In an electrical or electronic drawing, many circuits will be connected to each other. These connections must be unambiguous. The symbols below show the first method of indicating whether or not, two conduction paths are connected. In this scheme, a connected conduction path will be indicated by a large black dot showing the point of

connection. If the conduction paths are not connected the symbol will indicate that the path jumps over the alternate path. The drawing must never use both methods of indicating connects.

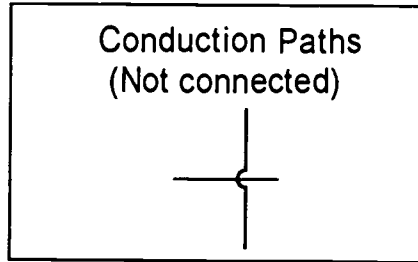
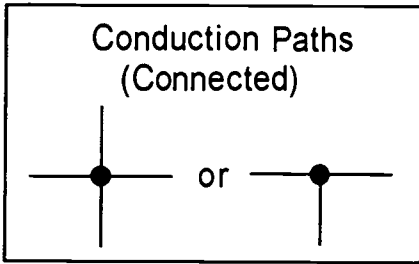

The symbols below show the second method of indicating whether or not, conduction paths are connected. This method dictates that a connecting path for conduction must indicate a clear termination at the point of connection. If the conduction paths are not connected, the lines will cross each other.

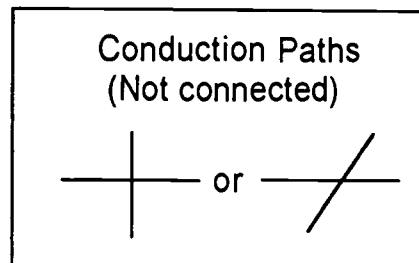
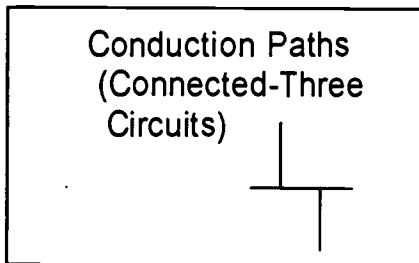

### General Circuit Element

The symbol below is the method of labeling an element of a circuit. The symbol may contain specifications for component values, voltages, currents, location of circuit elements, or other necessary data that pertains to the circuit operation. The rectangle may be as large as is necessary to contain the data.

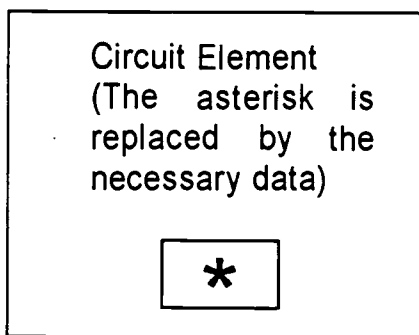

## Associated Conduction Paths for Electrical Currents (Cables)

The conduction paths in a complex electrical or electronic piece of equipment may be interconnected by groups of wires called cables. In many cases, the cables conduct sensitive electronic signals from one group of circuits to another. The paths are constructed in the cable such that the wires composing the paths are twisted around each other. When we depict associated conduction paths the paths are twisted unless otherwise specified. The twisting of the wires helps to eliminate unwanted signals from interfering with those being conducted through the conduction path.

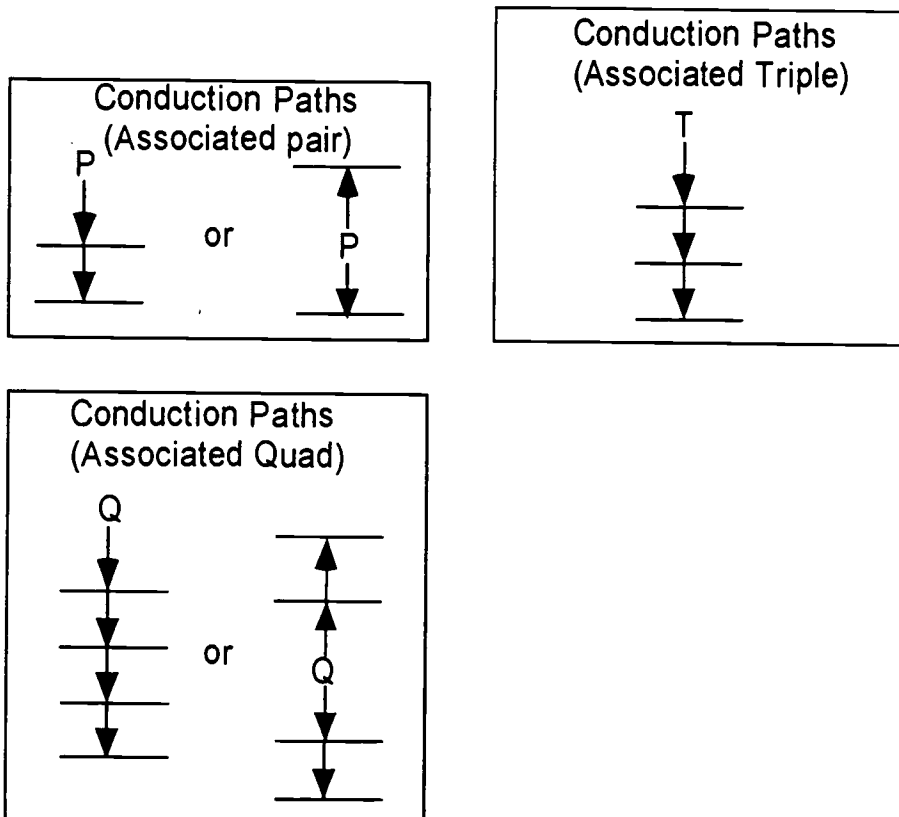

## Mechanical Connections of Electrical and Electronic Devices

The mechanical connection of components of electrical and electronic devices is depicted by a dotted line. If the devices are further operated by levers, a fulcrum symbol will be used.

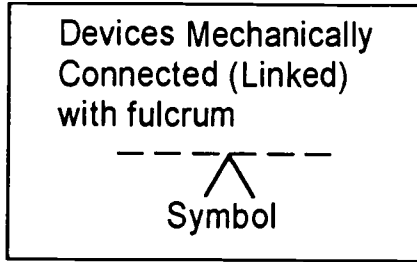
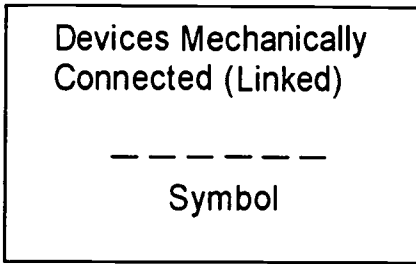

Three pole circuit breaker using the mechanical connection symbol

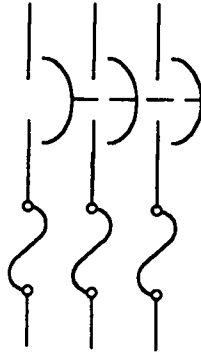

### Associated Conduction Paths for Electrical Currents (Shielded Cables)

The conduction paths in a complex electrical or electronic piece of equipment may be interconnected by groups of wires called cables. In many cases, the cables conduct sensitive electronic signals from one group of circuits to another. Many of these cables are shielded from unwanted interference by wire braids that surround the conductors. This wire braid is called a shield, and cables constructed in this manner are called shielded cables. Other types of cables are designed to be connected to circuits that have specific characteristics. One such group of cables is called coaxial cables. Coaxial cables are so named because the manner in which the conductors are arranged is one inside another. Unlike regular shielded cables, in which the shield does not conduct signals, the braid of the coaxial cable is one of the conduction paths and coaxial cables have specific electrical characteristics designed into the cable.

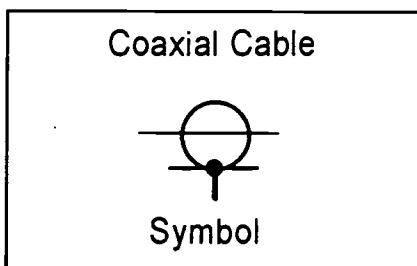

Shielded cables may contain many wires. A line will be added for each wire contained in the cable. The shield is a barrier against unwanted electrical interference from

outside electrical equipment, and is frequently connected to common (so-called ground) or the metal frame of the equipment.

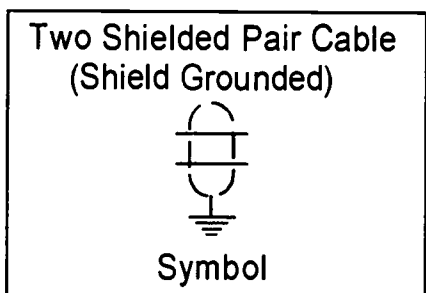
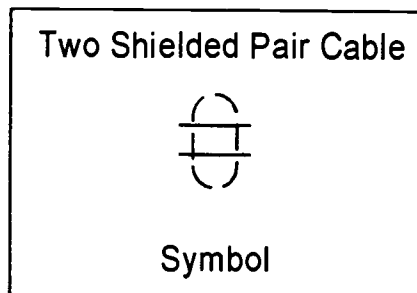
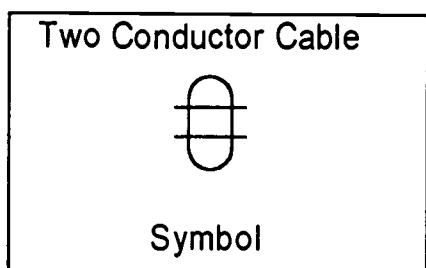

Another group of methods used to symbolically depict a cable or group of wires are the symbols shown below. Frequently the top symbol is used to depict a bundle of wires rather than a cable. The top symbol is frequently used in electrical layout diagrams and is designed to indicate when a wire leaves or joins the cable bundle.

The second group of symbols depicts a cable with many wires. It is used in electrical or electronic layout diagrams to show how the individual wires of the cable are led and distributed in the installation.

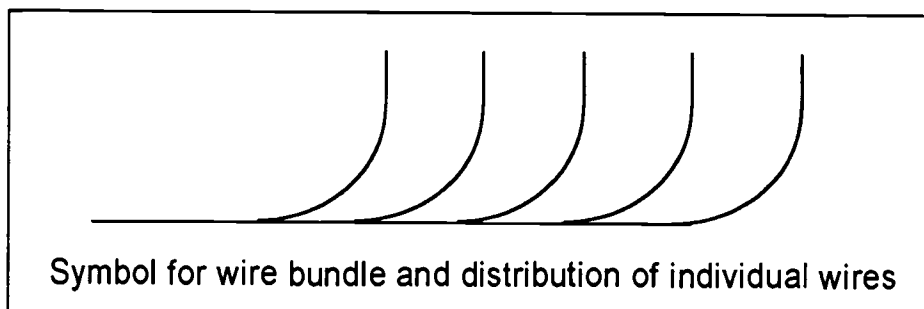



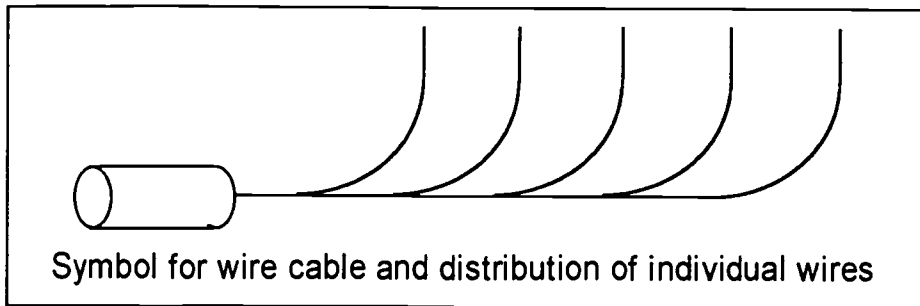

## Connectors

The basic connector symbol is depicted below. There are many different types of connectors in use. Some connectors attach one circuit board to another, some connectors attach cables to circuit boards, and some connectors attach conductors to each other. Regardless of the type of connection made, the same basic symbols will be used to depict the connection. There are two types of basic connector symbols used, both types may be used on the same drawing. The first type of symbol is used for general connections of all types. The second type of symbol usually depicts a plug connection. The female version of the second type of connector symbol is usually stationary, whereas the male version usually depicts a movable connector.

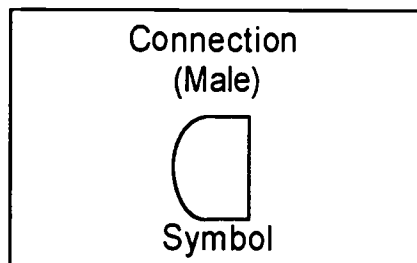
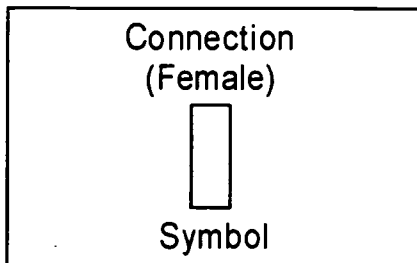
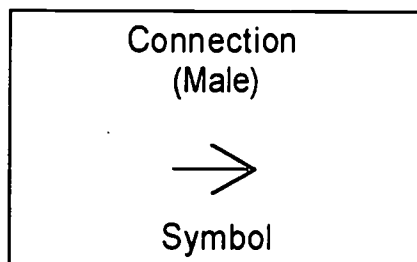
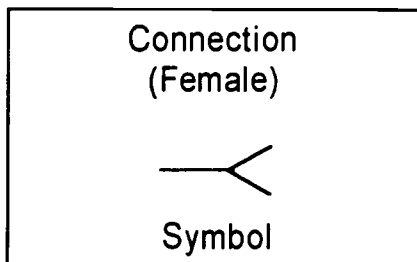

## Mated Connectors

When connectors are mated, the basic connector symbols are combined as depicted below. The basic symbol will be combined with letters or numbers to depict the individual connection points.

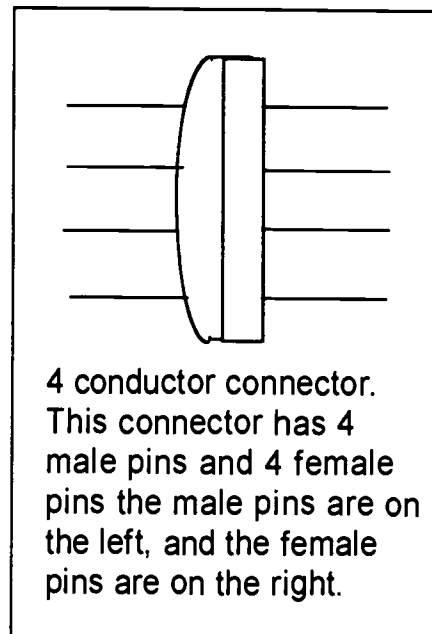
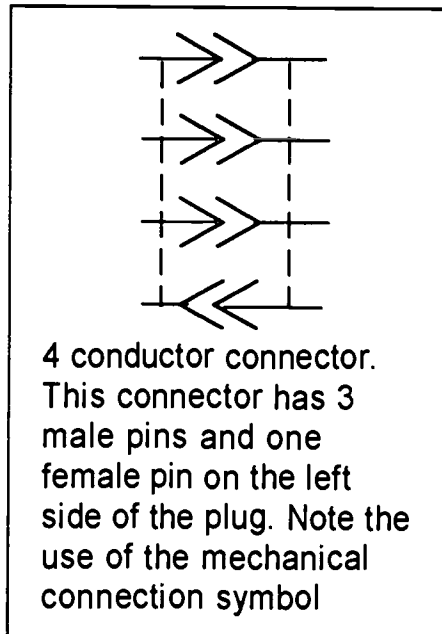
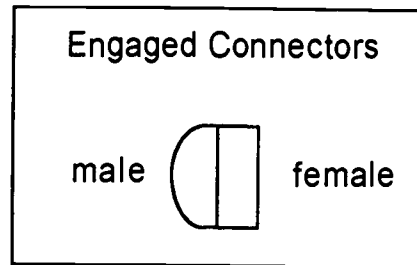
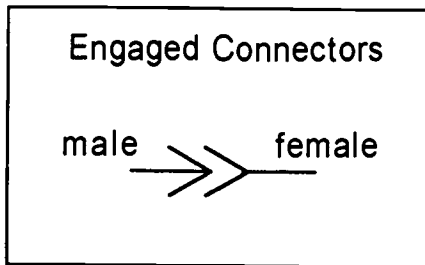

## Coaxial Connectors

Coaxial connectors are special connectors that are used when it is desired to connect circuits that have signals that can be influenced by other electrical or electronic equipment. Some of the signals that may be conducted using coaxial connectors are television signals, radio signals, certain types of computer signals, and other low energy level signals. The coaxial connector is usually mated to a type of cable called coaxial cable. Coaxial cable has an outer web of wire called a braid, and a single wire in the center. The outer braid is insulated from the inner wire by a non-conducting sleeve. The coaxial connector is constructed in a similar manner, but is usually made of solid metal. An example of a coaxial connector and coaxial cable is the wire and connector used on a standard television receiver which screws into the 75 ohm jack on the rear of the television. In the case of a television, the connector that plugs into the television, and the connector on the rear of the television, are both coaxial connectors.

The coaxial connector symbol can be combined with other symbols to modify the type of installation. In the example below, the coaxial connector symbol has been modified with the addition of a frame or equipment ground symbol to indicate that the connector is bolted or otherwise attached to the frame of the equipment.

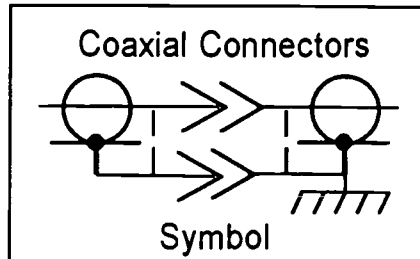
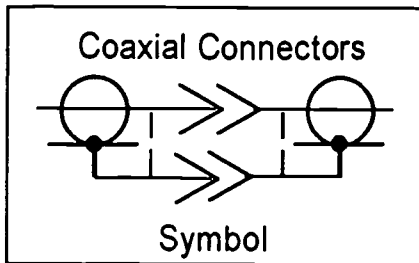

In some cases the outer braid of the coaxial connector is isolated from the circuit. If there is no conduction path between the outer braid of the connectors, the symbol will be modified with a X to indicate that the conduction path has been broken.

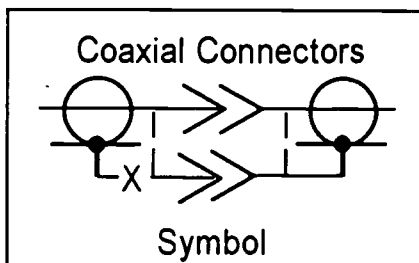

### Power Connectors (commonly called cord connectors, convenience outlets)

Connectors designed for AC power applications have a specific symbol. A large variety of connectors are available with different voltage and current ratings. In addition, some connectors have curved blades that are designed to lock into the convenience outlet. Regardless of the type of connector used, the symbol will only depict the amount of connection points, using the symbols show below.

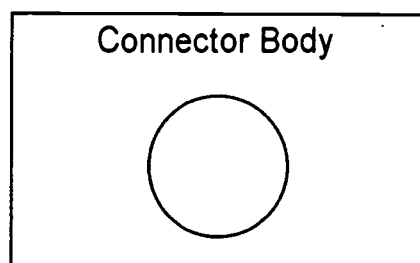
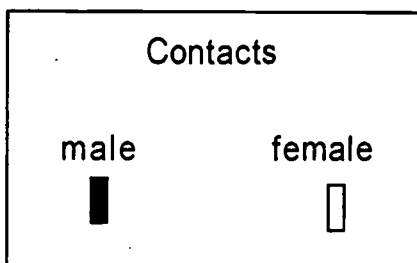

Examples of combined symbols. Note the conduction path symbols attached to the contact symbols.

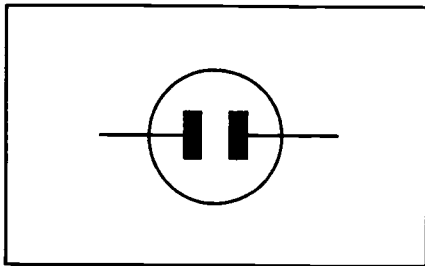

Two conductor non-polarized connector (male)

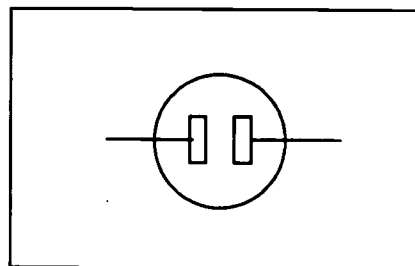

Two conductor non-polarized connector (female)

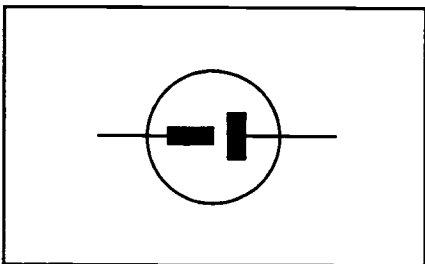

Two conductor polarized connector (male)

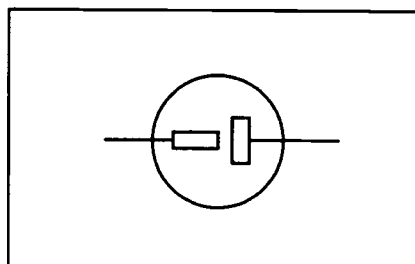

Two conductor polarized connector (female)

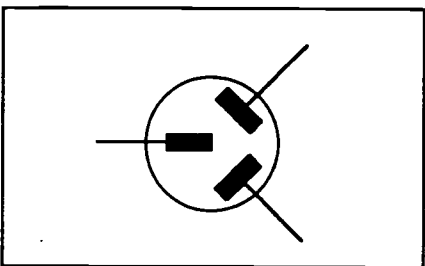

Three conductor polarized connector (female)

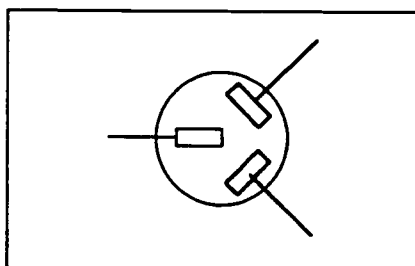

Three conductor polarized connector (male)

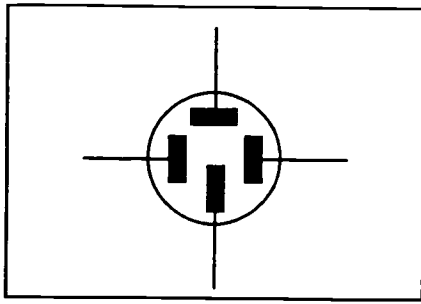

Four conductor polarized connector (male)

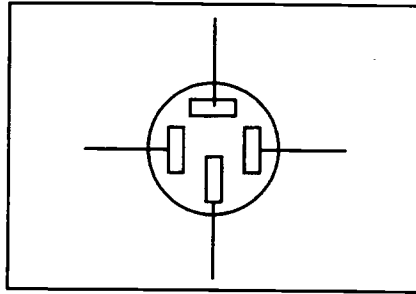

Four conductor polarized connector (female)

### Contacts (Electrical)

One of the most important symbols is the symbol used to indicate the contacts of a switch or relay. A switch is a device used to interrupt the conduction path for electrical currents. A relay is an automatic switch that can be operated by other sources of electrical currents. Switches and relays are used extensively in electrical and electronic equipment to control the flow of electrical currents. The contacts of a switch or relay have only two states. The contact can be *on or off*. If the contact is *on*, we identify its state as *closed*. If the switch is *off*, we identify its state as *open*. The concepts of open and closed in electrical work can be very confusing to a new student. The reason for this confusion is that the concepts run counter to ordinary experience. Most people are accustomed to the idea that if a valve such as a faucet is *closed*, *no water flows* from the faucet. If a faucet is *open*, then *water flows*. In electrical work, the concept is exactly the opposite. If the contact is *open*, *no current flows*. If the contact is *closed*, then *current flows*. It has been the authors experience that this state of affairs is only correctable by experience with the repeated usage of the symbols by the prospective technician. To fully understand the concept of open and closed contacts requires that the student change a lifetime of learning.

The below symbols represent the three types of basic symbols used to indicate contacts on electrical and electronic drawings notice that the symbols are represented in their normally open, and normally closed state. This representation of the contacts on a drawing refers only to the *state* of the contact *before* it is *operated*. It does not mean to imply that the contact is *always closed* or *always open*.

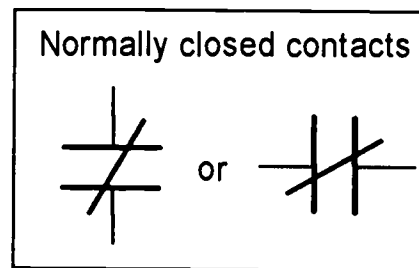
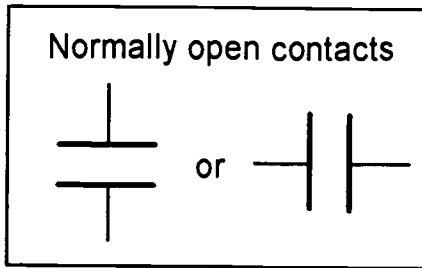

This symbol is used in electrical ladder diagrams and electronic diagrams

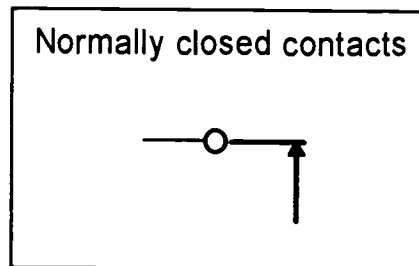
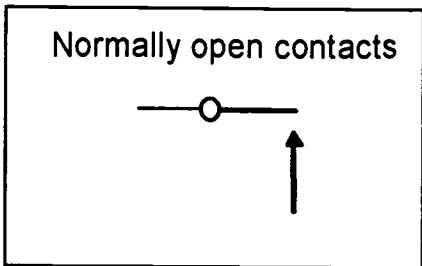

This symbol is primarily used in electronic schematics

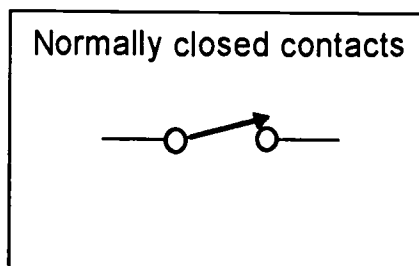
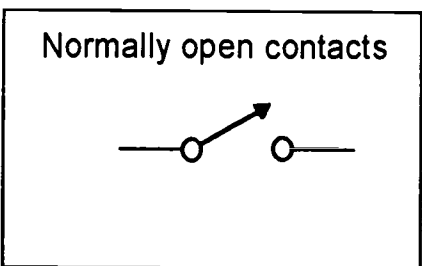

This symbol may be used in all types of electrical and electronic diagrams

All three of these symbol types can be used on electrical or electronic drawings the first set of symbols are the ones most commonly used on electrical ladder drawings.

### Contacts (Relays)

One of the most important devices that uses the contact symbol is the symbol used to indicate a relay. A relay is an automatic switch that can be operated by other sources of electrical currents. Relays are used extensively in electrical and electronic equipment to control the flow of electrical currents. Relays can be operated by either Direct Current (DC) or Alternating Current (AC). Regardless of the type of currents used to operate the relay, the relay contacts can be used to switch a large variety of electrical currents. The contacts of a relay have only two states. The states are controlled by the actuator of the relay. The actuator of a relay is an electromagnetic coil of wire. The electromagnet moves the switch contacts. If the contact is on, we identify its state as closed. If the contact is off, we identify its state as open. Before the relay is energized by an electrical current, the relay is identified as being in its normal

state. When the relay is in its normal state, some of the contacts may be closed, and some of the contacts may be open. Contacts that are closed in the normal state are said to be normally closed. Contacts that are open in the normal state, are said to be normally open. A relay can contain a large number of normally closed and normally open contacts. A relay can also contain only one normally open or normally closed contact. The amount and variety of normally open and normally closed contacts depends upon the design purpose of the relay. Regardless of the amount of contacts, the relay functions to switch the contacts by the action of the electromagnetic coil. The functions of the coil and the contacts are separate functions. The student must concentrate upon the fact that the coil moves the contacts and not vice-versa. The coil is the operator. The contacts respond to the actions of the coil. This representation of the contacts on a drawing refers only to the state of the contact before it is operated. It does not mean to imply that the contact is always closed or always open. On the drawing the contacts of a relay will be depicted in their normal state. A drawing is not a dynamic representation of the actions of the relay. To provide the maximum amount of information on the drawing, the contacts must be shown in their normal state. The interpreter of the drawing must imagine what will happen when the coil of the relay is energized. In electrical ladder diagrams, the coil of the relay and the contacts of the relay may be shown upon separate drawings. This is because the contacts of the relay will be used to switch other circuits, whereas the coil of the relay will be switched by other contacts or switches. This can be very confusing to the person who is required to interpret the drawing. It is a skill that requires a knowledge of electricity, and much practice.

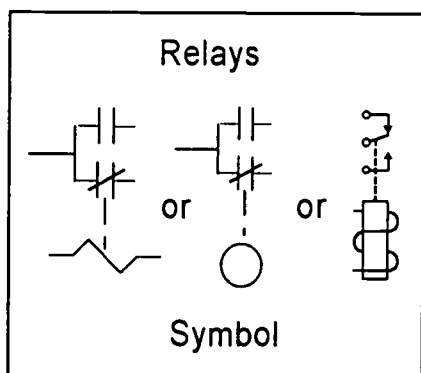

**The relay symbols depicted at the right are three of the many ways in which the same relay can be symbolized**

Note the use of the mechanical symbol. It indicates that the coil and contacts are mechanically linked

The symbols shown below are the various methods used to symbolize the electromagnetic coil of a relay. The choice of symbology is totally up to the company that manufactures the product. The top row of symbols is used extensively for electrical ladder drawings while the bottom row is used on electronic drawings. However, the symbols may be mixed on the same drawing. Each coil symbol will be accompanied by a letter and number designation for the relay coil in question. In the case of the circle, the asterisk will be replaced by the letter/number combination designator for the relay. The letters used to represent relays are frequently K, CR, R, and, M. The number can be any whole number.

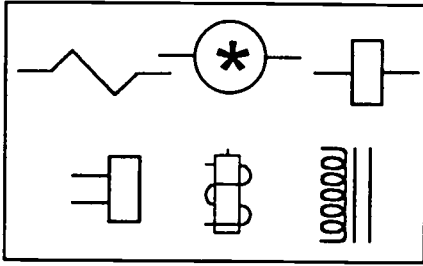

Relay Coil Symbols

### Contacts (Time Delay Relays)

Some relays are designed to be operated after a period of time. These relays are called "time Delay Relays". Time delay relays can have delay times as small as fractions of a second to times as large as minutes or hours. To accomplish this, the time delay relay may contain complex electronic circuits or mechanical actuators that delay the time that the relay actuates. Regardless of the method, the time delay relay closes or opens its contacts only after the coil of the relay has been actuated. The coil of the time delay relay may be identified by "TDR". Time delay relay contacts will be identified by "TDO" or "TDC". TDO means "Time Delay Open", TDC means "Time Delay Close". The TDO contacts will *open after* a period of time determined by the setting of the relay, and TDC contacts will *close after* a period of time determined by the setting of the relay. Regardless of the type of contacts involved, the coil of the relay is the governing factor. Some time delay relays, delay the time at which the relay coil will *energize*, and some time delay relays, delay the time at which the relay coil will *de-energize*. This action determines the manner in which the contacts will behave. The below symbols depict the various methods of symbolizing TDO and TDC relay contacts and coils.

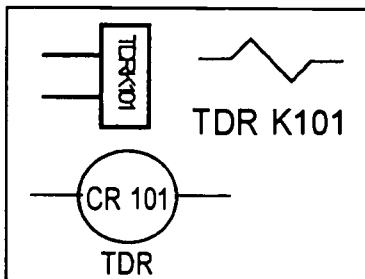

Symbols for coils

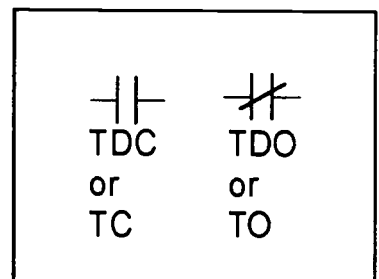
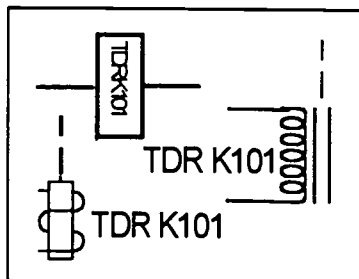

Symbols for contacts



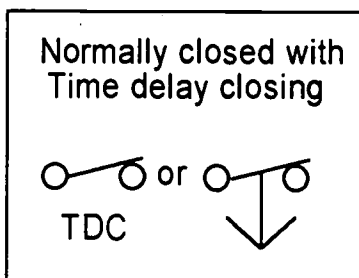
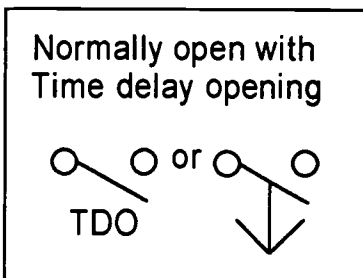
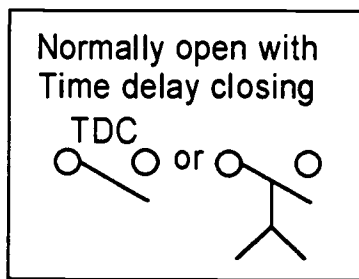
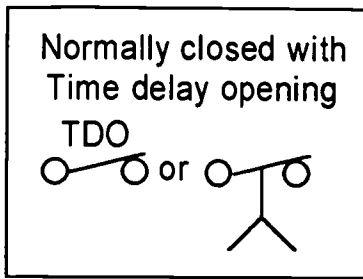

## Contacts (Switches)

Switches are circuit control devices that are used to apply power to a circuit or piece of equipment. Switches are manually operated devices that require physical effort in some form or another. Switches may be used to open or close any source of electrical current, including signals from complex electronic circuits. The basic switch symbol employs the symbols for contacts, as discussed earlier. A large variety of switches are manufactured for many different applications. The symbols used to depict switches attempt to depict the purpose of the switch rather than identify any particular type of switch. The next few pages will portray the various categories for switch symbols, and describe some of the nomenclature used to identify switches.

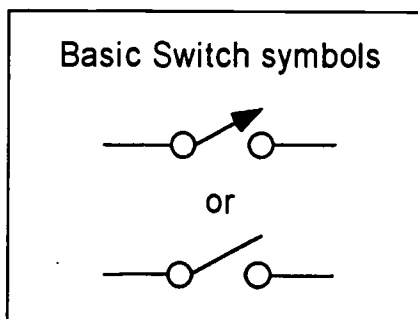

## Switch Categories

Switches are categorized according to the number of complete circuit paths than the switch can control. Conduction paths that the switch can control, are called poles. A

switch can have one or many poles. The above symbols depict a switch that has only one pole. The second criteria is the number of positions that the switch can assume. These positions are called throws. A throw is the position that the switch can move to and mechanically maintain contact. The above symbols depict a switch that has only one throw position. This switch would typically be found in applications in which an ON/OFF circuit needs to be controlled, such as a light switch. The words POLE and THROW are abbreviated with P and T, and the switch is categorized according to the number of each. To describe the number of the poles and throws, the words SINGLE, DOUBLE, and the numbers 3, 4, 5, 6, etc. are used. Each is abbreviated in a manner similar to the above method for poles and throws. Therefore, SINGLE becomes S, DOUBLE becomes D, and 3, 4, etc. are used to describe values above one and two. The letters and numbers are then combined to describe the switch. For example, the above switches are SINGLE POLE, SINGLE THROW, and they would be categorized as SPST. The below symbols depict some switches and the categories that they are assigned to.

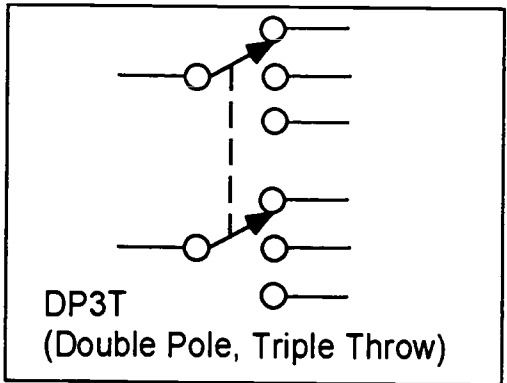
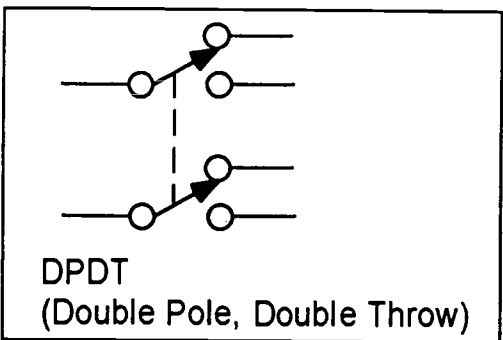
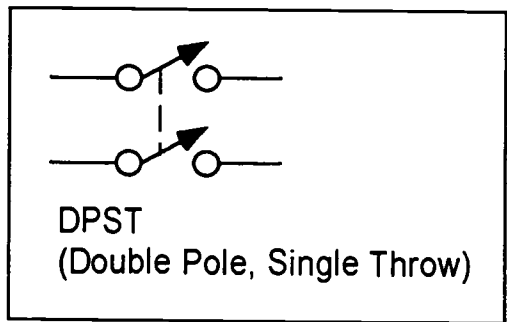
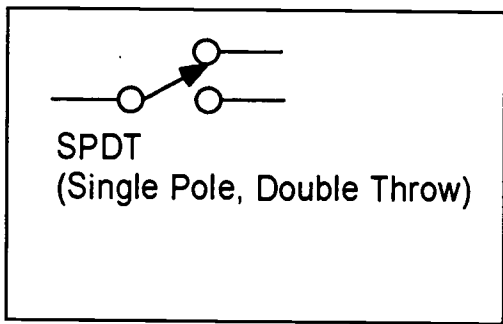

### Contacts (Switches-Interlocks)

Certain types of switches are used for safety features on machinery. The switches are called interlock switches, or just "interlocks." The symbols used for these switches are depicted below.

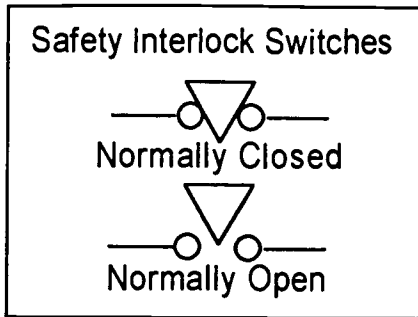

**Contacts (Switches-Momentary and Maintained)**

Push-button switches are sometimes known as momentary switches. Momentary switches do not maintain CONTACT UNLESS MANUAL PRESSURE IS APPLIED TO THAT THE SWITCH. Usually a spring inside the switch returns the switch to its previous state. Since a momentary switch is normally in one position unless it is actuated, the push-button switch may have normally open and normally closed contacts. In addition the momentary switch can have one or many poles. Momentary switches such as push-button switches can be categorized as to their poles and throws, or as to the types of contacts. In many cases both descriptions are used. In addition, push-button switches can be manufactured to maintain a state of actuation after they are pushed in this case, the push-button switch is categorized as having maintained contacts. In addition, toggle switches can be manufactured containing momentary contacts. In other words, a switch may be momentary or maintained regardless of whether or not it is a push-button or toggle switch.

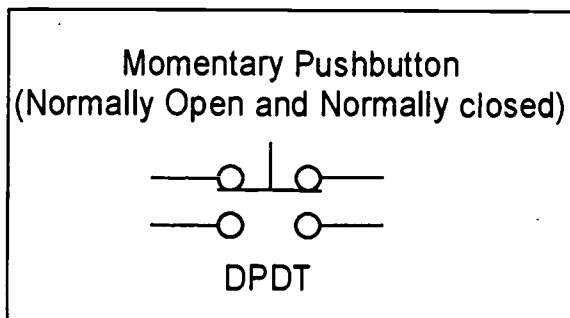
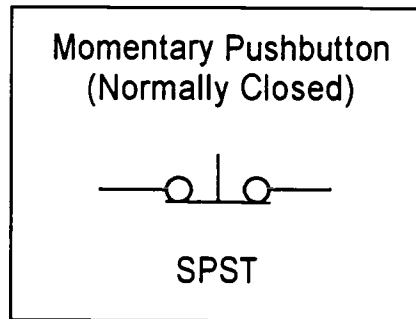
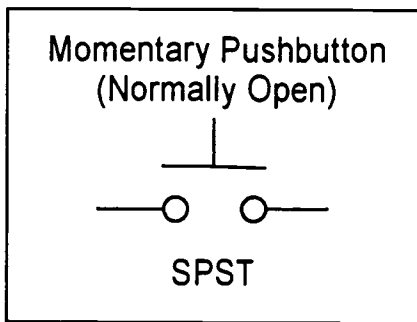

Maintained Pushbutton  
(Two sets of Normally Open and Normally closed)

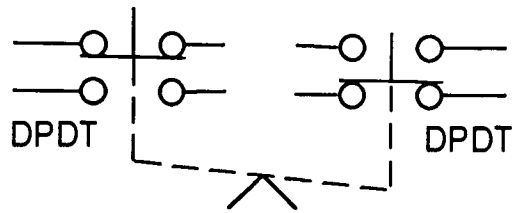

Note the mechanical symbols

**AET-B3-HO-3**  
**Use Symbols, Organization, and Engineering Values**  
**on Electronic Drawings**  
**Attachment 3: MASTER Handout No. 3**

---

**Electronic Drawing Symbols**

**Semiconductors, Diodes**

A diode is used to regulate the flow of electrical currents. In most cases, the diode is used to allow current flow in only one direction. The diode behaves much like the device called a check valve that is used in hydraulic or pneumatic systems. Another use of the diode is to change alternating current (AC) into direct current (DC). The diode is the simplest type of semiconductor device. A semiconductor is composed of a material that exhibits the following specific properties. A semiconductor is a metalloid. That is, it has some of the properties of metals such as luster, a crystalline structure, and the ability to partially conduct electricity. However, unlike a metal, a metalloid is not malleable, it is brittle. It does not have the strength of a metal, and unlike a metal, which is considered to be a conductor of electricity, a metalloid opposes the flow of electrical currents. Two of the elements that have been used to manufacture semiconductors are germanium and silicon. Considerable research is being conducted into the identification of other types of materials that can be used as semiconductors. The concept of a semiconductor is complex. The industries that manufacture semiconductors, and the industries that employ the semiconductor to manufacture modern electronic equipment such as computer, VCRs, and televisions are extensive and varied. Semiconductors are subjected to complex manufacturing processes that impart the desired properties to the semiconductor, and it is beyond the scope of this book to explain the concepts involved in this process or the theory of operation of a semiconductor. Instead, we will concentrate upon the symbols that are used in electronic schematics to depict the semiconductor. Below is the basic symbol for a diode. The direction in which the diode will allow unrestricted flow of electrical currents is against the direction of the arrow.

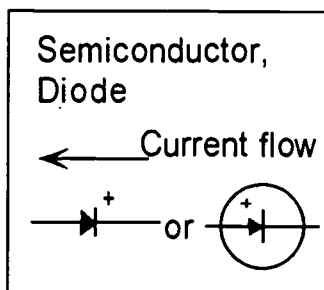

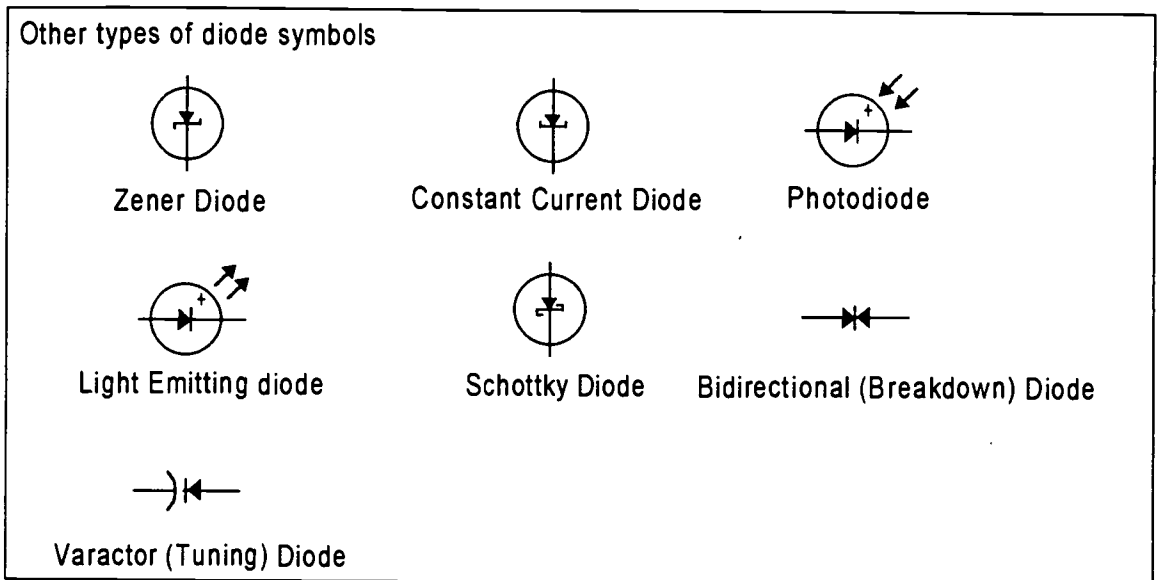

## Semiconductors, Transistor

The next stage of evolution of the semiconductor resulted in the invention of the transistor. Transistors are semiconductor amplifiers. That is, they can be used to increase the power level of an electronic voltage or current flow. The symbol for the basic and most common type of transistor, called the *bipolar transistor*, is depicted below. There are two types of bipolar transistors. One is called a *PNP bipolar transistor*. The other is called the *NPN bipolar transistor*. The NPN transistor can be identified by the arrow in the symbol which is *pointing out away* from the symbol. The PNP transistor is identified by the arrow that *points in towards* the symbol. The invention of the transistor led to the invention of many other types of transistor type semiconductor devices. Each device has different desirable properties that can be used to control electronic equipment. The symbols for some of the more prevalent of these devices are depicted below. New semiconductor devices are constantly being invented. Each device has a different symbol. To depict all of these devices would be impractical.

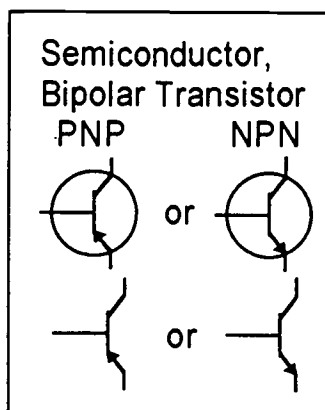

## Transistor Symbols

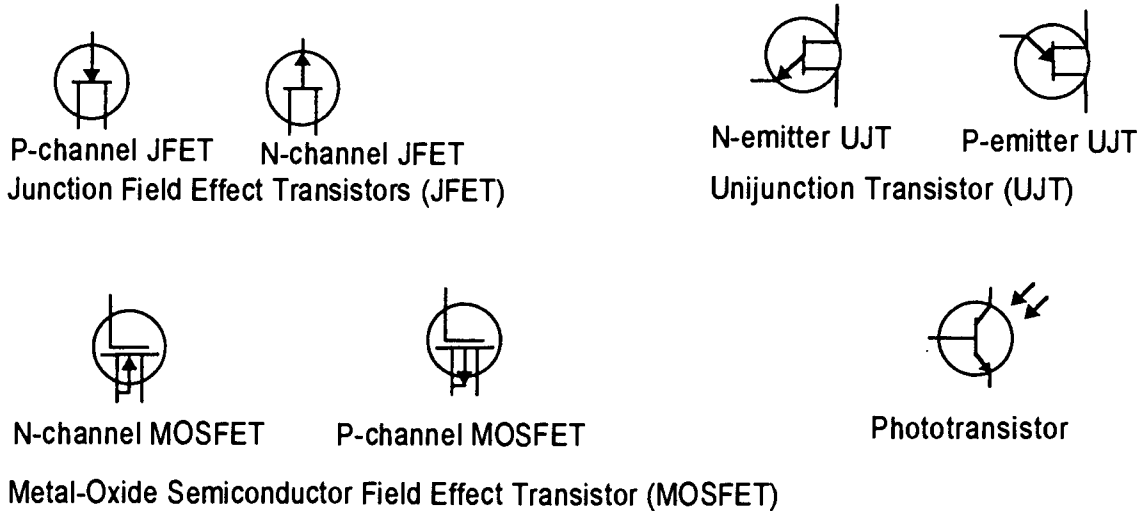

## Feedback Control Systems Symbology (Gain Block Algebra or Bode Diagrams)

To simplify the enormously complex subject of feedback control systems, the concept of gain block symbology was developed. The electronic modules, mechanical systems, and feedback systems of the modern Computerized Numerical Control (CNC) machine or robot, if depicted in detail, merely serve to confuse the technician or engineer. In a complex control system for a CNC or robot motion, a wide range of electronics, mechanical devices, and feedback systems are used. To symbologically depict the functions of each part of the system, rather than depict each highly complex component in a drawing, serves to simplify the system, and make it more understandable to the human mind. To accomplish this task, feedback control system symbology is used. The term feedback conceptualizes the idea of motion systems as being self regulating systems. That is, for every stimulus to the control system, there is a response that indicated the results of the stimulus. This response is called feedback. Feedback may be any device that measures the results of a physical event. For example, a thermocouple that measures temperature, can be used as a feedback device since it provides information as to the relative temperature of a system. In like manner, a device that measures distance can be a part of a feedback control systems that is intended to produce motion. In the process of designing the system the symbology becomes part of an algebraic equation. The equation, using a form of math called Laplace Transforms can be used to predict and tailor the desired response. The actual design of the system uses the equation as a blueprint. Frequently, the symbolic drawing is used to discuss the overall operation of the system in maintenance manuals. It must be understood that the symbols do not reflect the actual electronic or mechanical components. The feedback control system diagram is used to understand

the overall concept of the control system, and then the technician must investigate the individual modules, mechanisms or components that provide that function.

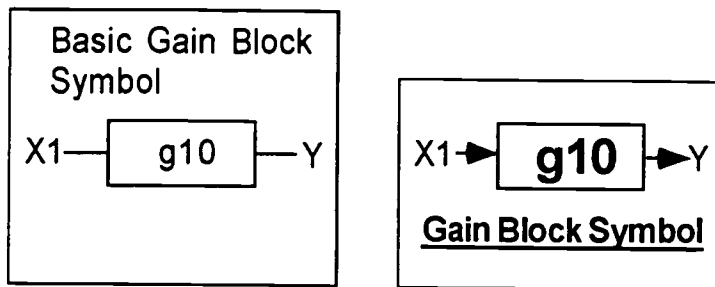

The basic gain block symbol indicates the magnitude by which a given input will be increased or decreased. The value is given by an amount equal to the number in the middle of the gain block next to the letter "g". A fractional or decimal value indicates a decrease in level. The function is read; "Y is a function of X1 such that  $Y=10 \cdot X1$ " or  $Y = f(X1) \ Y=10 \cdot X1$ . Any variable or variable scheme may be used for the equation. The arrows indicate the direction of information flow.

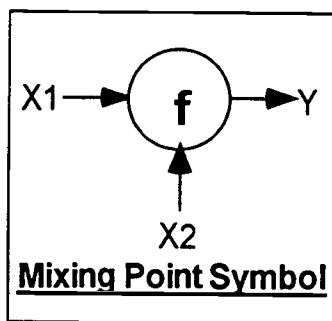

The mixing point symbol is used to indicate the combination of two or more inputs that are combined without regard as to their polarity or magnitude. No mathematical functions are performed. This symbol reads:  $Y=f(X1,X2)$  or Y is a function of X1 and X2.

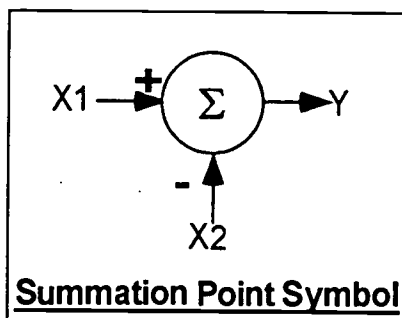

The summation point symbol depicts algebraic summation of two or more inputs. If more than three inputs are desired, the circle becomes a rectangle with as many inputs as are necessary. A polarity sign is used to indicate the algebraic sign of the



summation. The arrows indicate the direction of information flow. The summation point at the left reads:  $Y = (+X1) + (-X2)$ .

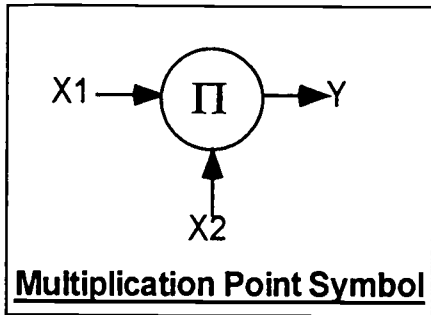

The multiplication point symbol depicts algebraic multiplication of two or more inputs. If more than three inputs are desired, the circle becomes a rectangle with as many inputs as are necessary. The arrows indicate the direction of information flow. The multiplication point at the left reads:  $Y = X1 * X2$ .

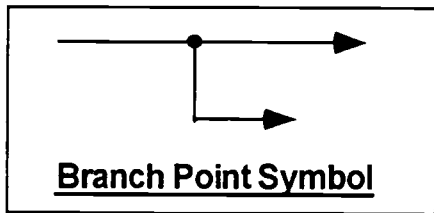

The branch point indicates a point at which the signal branches and follows a new path.

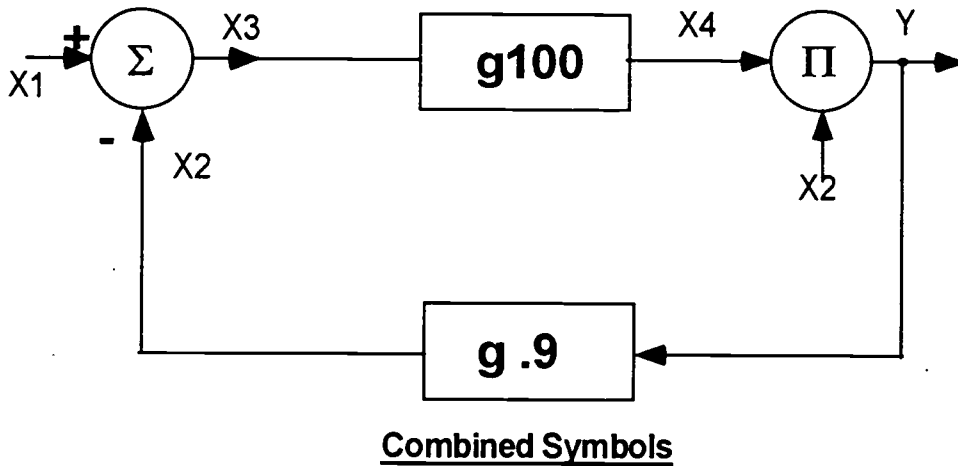

# **AUTOMATED EQUIPMENT REPAIR SERIES**

## **MASTER Technical Module No. AET-B4**

---

**Subject:** Automated Equipment Repair **Time:** 12 Hrs.

**Duty:** Use Drawings to Analyze and Repair Systems

**Task:** Use Symbols, Organization and Engineering Values on Fluid Power Drawings

---

### **Objective(s):**

Upon completion of this unit the student will be able to use the symbols and organization associated with fluid power schematic diagrams and fluid power layout diagrams to:

- a. Identify symbols on hydraulic or pneumatic drawings by their symbol;
- b. Identify the layout of a hydraulic or pneumatic drawing;
- c. Determine the location of the components; and,
- d. Apply engineering values obtained from the drawing to the solution of technical problems

---

### **Instructional Materials:**

Hydraulic or pneumatic parts that represent all of the concepts contained in this module

MASTER Handout (AET-B4-HO-1)

MASTER Handout (AET-B4-HO-2) (Hydraulic/Pneumatic Drawing Symbols)

MASTER Handout (AET-B4-HO-3 (Hydraulic/Pneumatic Schematic Drawing)

MASTER Laboratory Exercise (AET-B4-LE) (Apply Troubleshooting Information from a Hydraulic or Pneumatic Schematic Drawing)

MASTER Quiz AET-B4-QU-1: Hydraulic/pneumatic drawing symbols

MASTER Quiz AET-B4-QU-2: Hydraulic/pneumatic schematic drawing

---

### **References:**

There are no texts that present all of the information in the B skills category in a comprehensive manner. Information for the hydraulic drawing section is contained in:

*Industrial Hydraulic Technology*, Parker Hannifin, Inc., Latest Edition

Additional information may be obtained in:

*Print Reading for Industry*, Walter C. Brown, Latest Edition

More information may be supplied by handouts.

---

**Student Preparation:**

Students should have previously completed the following Technical Modules:

- AET-A1 "Apply Scientific Notation and Engineering Notation to Solve Technical Problems"
  - AET-A2 "Apply Algebraic Formulas to Solve Technical Problems"
- 
- 

**Introduction:**

Drawings for automation are roughly divided into five categories. They are: mechanical drawings, electrical drawings, electronic drawings, digital electronic drawings, and hydraulic or pneumatic drawings. A competent automation technician must be comfortable in interpreting the information contained on all of these drawings. Hydraulic and pneumatic drawings are used for fluid power components and systems, which are essential aspects of automation systems. Therefore, the technician must be able to interpret the information contained on a hydraulic or pneumatic drawing.

---

---

**Presentation Outline:**

- I. Identify Symbols on Hydraulic or Pneumatic Drawings
  - A. Identify symbols used to depict components in a hydraulic or pneumatic schematic drawing: MASTER Handout AET-B4-HO-2 (Hydraulic/Pneumatic Drawing Symbols) and MASTER Handout AET-B4-HO-3 (Hydraulic/Pneumatic Schematic Drawing)
    - 1. Identify basic symbols used to depict hydraulic or pneumatic components
    - 2. Describe the complex functions that are comprised from basic symbols
    - 3. Relate the symbols used in the depiction of hydraulic or pneumatic components with the actual components and their relative size and shape
  - B. Demonstrate the methods used to apply the above information to the troubleshooting of fluid power systems
- II. Identify the Layout of a Hydraulic or Pneumatic Drawing
  - A. Use hydraulic or pneumatic layout diagrams to locate the position and relative size of a component
    - 1. Explain the layout and organization of a hydraulic or pneumatic diagram
      - a. Explain the meaning and use of manifolds or enclosures
      - b. Locate the pumping and tank systems
      - c. Locate the fluid conditioning systems
      - d. Locate the control valves
      - e. Identify motion actuators, rotary and linear

2. Explain the layout and organization of hydraulic or pneumatic drawings
  - a. Explain the types of drawing and documentation that comprise a set of hydraulic or pneumatic drawings
  - b. Locate pressure and flow controls on a hydraulic or pneumatic schematic drawing
  - c. Determine the types of pressures and flows and their magnitude
- B. Demonstrate the methods used to apply the above information to the troubleshooting of fluid power systems

---

---

**Practical Application:**

MASTER Laboratory Exercise (AET-B4-LE) (Apply Troubleshooting Information from a Hydraulic or Pneumatic Schematic Drawing).

---

---

**Evaluation and/or Verification:**

Successful completion of this technical module will be based on the student's successful completion of the following components:

1. A ten question quiz (MASTER Quiz AET-B4-QU-1: Hydraulic/pneumatic drawing symbols);
2. A ten question quiz (MASTER Quiz AET-B4-QU-2: Hydraulic/pneumatic schematic drawing); and,
3. Demonstrate proficiency in interpreting mechanical drawing symbols (MASTER Laboratory Exercise AET-B4-LE) (Apply Troubleshooting Information from a Hydraulic or Pneumatic Schematic Drawing).

---

---

**Summary:**

Review the main lesson points using the suggested texts listed in the reference section of this module. Hold class discussion and answer student questions.

---

---

**Next Lesson Assignment:**

MASTER Technical Module (AET-B5) dealing with using symbols, organization, and engineering values on digital drawings.

**AET-B4-HO-1**  
**Use Symbols, Organization, and Engineering Values**  
**on Fluid Power Drawings**  
**Attachment 1: MASTER Handout No. 1**

---

**Objective(s):**

Upon completion of this unit the student will be able to use the symbols and organization associated with fluid power schematic diagrams and fluid power layout diagrams to:

- a. Identify symbols on hydraulic or pneumatic drawings by their symbol;
  - b. Identify the layout of a hydraulic or pneumatic drawing;
  - c. Determine the location of the components; and,
  - d. Apply engineering values obtained from the drawing to the solution of technical problems
- 

**Module Outline:**

- I. Identify Symbols on Hydraulic or Pneumatic Drawings
  - A. Identify symbols used to depict components in a hydraulic or pneumatic schematic drawing: MASTER Handout AET-B4-HO-2 (Hydraulic/Pneumatic Drawing Symbols) and MASTER Handout AET-B4-HO-3 (Hydraulic/Pneumatic Schematic Drawing)
    1. Identify basic symbols used to depict hydraulic or pneumatic components
    2. Describe the complex functions that are comprised from basic symbols
    3. Relate the symbols used in the depiction of hydraulic or pneumatic components with the actual components and their relative size and shape
  - B. Demonstrate the methods used to apply the above information to the troubleshooting of fluid power systems
- II. Identify the Layout of a Hydraulic or Pneumatic Drawing
  - A. Use hydraulic or pneumatic layout diagrams to locate the position and relative size of a component
    1. Explain the layout and organization of a hydraulic or pneumatic diagram
      - a. Explain the meaning and use of manifolds or enclosures
      - b. Locate the pumping and tank systems
      - c. Locate the fluid conditioning systems
      - d. Locate the control valves
      - e. Identify motion actuators, rotary and linear
    2. Explain the layout and organization of hydraulic or pneumatic drawings

- a. Explain the types of drawing and documentation that comprise a set of hydraulic or pneumatic drawings
  - b. Locate pressure and flow controls on a hydraulic or pneumatic schematic drawing
  - c. Determine the types of pressures and flows and their magnitude
- B. Demonstrate the methods used to apply the above information to the troubleshooting of fluid power systems

# AUTOMATED EQUIPMENT REPAIR SERIES

## MASTER Technical Module No. AET-B5

---

**Subject:** Automated Equipment Repair **Time:** 12 Hrs.

**Duty:** Use Drawings to Analyze and Repair Systems

**Task:** Use Symbols, Organization, and Engineering Values on Digital Drawings

---

### Objective(s):

Upon completion of this unit the student will be able to use the symbols and organization associated with electronic schematic diagrams and electronic layout diagrams to:

- a. Identify symbols on digital electronic drawings;
- b. Identify the layout of a digital electronic drawing;
- c. Determine the location of the components; and,
- d. Apply engineering values obtained from the drawing to the solution of technical problems.

---

### Instructional Materials:

Digital electronic parts that represent all of the concepts contained in this module

MASTER Handout (AET-B5-HO-1)

MASTER Handout (AET-B5-HO-2) (Digital Electronic Drawing Symbols)

MASTER Handout (AET-B5-HO-3) (Digital Electronic Schematic Drawing)

MASTER Laboratory Exercise (AET-B5-LE) (Apply Troubleshooting Information from an Electronic Digital Schematic Drawing)

MASTER Quiz AET-B5-QU-1: Quiz on digital electronic drawing symbols

MASTER Quiz AET-B5-QU-2: Quiz on digital electronic drawings

---

### References:

There are no texts that present all of the information in the B skills category in a comprehensive manner. Some information for the digital electronic drawing section, is contained in:

*Modern Industrial Electronics*, Revised and Expanded Edition by Schuler/MacNamee, Latest Edition

and other digital electronics text books. Since this module is an overview of digital electronic drawings, it is suggested that the instructor use handouts to present this module.

---

## **Student Preparation:**

Students should have previously completed the following Technical Modules:

- AET-A1** “Apply Scientific Notation and Engineering Notation to Solve Technical Problems”
- AET-A2** “Apply Algebraic Formulas to Solve Technical Problems”
- AET-B3** “Use Symbols, Organization, and Engineering Values on Electronic Drawings”

---

---

## **Introduction:**

Drawings for automation are roughly divided into five categories. They are: mechanical drawings, electrical drawings, electronic drawings, digital electronic drawings, and hydraulic or pneumatic drawings. A competent automation technician must be comfortable in interpreting the information contained on all of these drawings. Digital electronic drawings are used for control of the electrical systems that control the mechanisms found in industrial control systems. Therefore, the technician must be able to interpret the information contained on a digital electronic drawing.

---

---

## **Presentation Outline:**

- I. Identify Symbols on Digital Electronic Drawings
  - A. Digital electronic drawing symbols: MASTER Handout AET-B5-HO-2 (Digital Electronic Drawing Symbols) and MASTER Handout AET-B5-HO-3 (Digital Electronic Schematic Drawing)
    - 1. Describe the types symbols used on digital electronic drawings and their general meaning in terms of Boolean concepts
    - 2. Describe the symbols used to apply engineering information on digital electronic drawings
    - 3. Relate the symbols to the types of integrated circuits used in digitally controlled systems
  - B. Demonstrate the methods used to apply the above symbols to the control of industrial systems
- II. Identify the Layout of a Digital Electronic Drawing
  - A. Digital electronic drawing layout: MASTER Handout AET-B5-HO-2 (Digital Electronic Drawing Symbols) and MASTER Handout AET-B5-HO-3 (Digital Electronic Schematic Drawing)
    - 1. Describe the informational areas on digital electronic drawings and their meaning
    - 2. Describe the interconnection of the symbols and their relationship to the integrated circuits used in the modules of the digital electronic control system
  - B. Demonstrate the methods used to apply the above information to the control of industrial systems



---

---

**Practical Application:**

MASTER Laboratory Exercise (AET-B5-LE) (Apply Troubleshooting Information from an Electronic Digital Schematic Drawing).

---

---

**Evaluation and/or Verification:**

Successful completion of this technical module will be based on the student's successful completion of the following components:

1. A ten question quiz on digital electronic drawing symbols (MASTER Quiz AET-B5-QU-1: Digital electronic drawing symbols);
2. A ten question quiz on digital electronic drawings (MASTER Quiz AET-B5-QU-2: Digital electronic drawings); and,
2. Demonstrate proficiency in interpreting digital electronic drawing symbols (MASTER Laboratory Exercise AET-B5-LE) (Apply Troubleshooting Information from an Electronic Digital Schematic Drawing).

---

---

**Summary:**

Review the main lesson points using the suggested texts listed in the reference section of this module. Hold class discussion and answer student questions.

---

---

**Next Lesson Assignment:**

MASTER Technical Module (AET-C1) dealing with applying machine tool metrology and measurement instruments to align machine tools.

**AET-B5-HO-1**  
**Use Symbols, Organization, and Engineering Values**  
**on Digital Drawings**  
Attachment 1: **MASTER** Handout No. 1

---

**Objective(s):**

Upon completion of this unit the student will be able to use the symbols and organization associated with electronic schematic diagrams and electronic layout diagrams to:

- a. Identify symbols on digital electronic drawings;
  - b. Identify the layout of a digital electronic drawing;
  - c. Determine the location of the components; and,
  - d. Apply engineering values obtained from the drawing to the solution of technical problems.
- 

**Module Outline:**

- I. Identify Symbols on Digital Electronic Drawings
  - A. Digital electronic drawing symbols: MASTER Handout AET-B5-HO-2 (Digital Electronic Drawing Symbols) and MASTER Handout AET-B5-HO-3 (Digital Electronic Schematic Drawing)
    1. Describe the types symbols used on digital electronic drawings and their general meaning in terms of Boolean concepts
    2. Describe the symbols used to apply engineering information on digital electronic drawings
    3. Relate the symbols to the types of integrated circuits used in digitally controlled systems
  - B. Demonstrate the methods used to apply the above symbols to the control of industrial systems
- II. Identify the Layout of a Digital Electronic Drawing
  - A. Digital electronic drawing layout: MASTER Handout AET-B5-HO-2 (Digital Electronic Drawing Symbols) and MASTER Handout AET-B5-HO-3 (Digital Electronic Schematic Drawing)
    1. Describe the informational areas on digital electronic drawings and their meaning
    2. Describe the interconnection of the symbols and their relationship to the integrated circuits used in the modules of the digital electronic control system
  - B. Demonstrate the methods used to apply the above information to the control of industrial systems

**AET-B5-HO-2**  
**Use Symbols, Organization, and Engineering Values**  
**on Digital Drawings**  
**Attachment 2: MASTER Handout No. 2**

---

**Digital Electronic Drawing Symbols**

**Digital Logic Symboly (Boolean Algebra)**

In computers or other types of electronic equipment that use digital information to perform tasks, the control process is carried out by components that make decisions. The decisions performed by the electronic devices that we call digital logic are YES/NO decisions. That is, the components are only capable of recognizing two states of information, the information is either true or false. Components that provide that function have symbols associated with their purpose. In the past, the components contained within the circuit that performed the logic function were transistors, resistors, and capacitors. Through the years we have learned how to miniaturize these circuits so that now, we can pack millions of them into a device that is frequently referred to as a computer chip. A computer chip is, for all practical purposes, a collection of many logic circuits that perform true/false operations. There are only five logical functions that comprise the entire range of digital logic operations. However, by modifying the operations, and combining the digital operations in specific combinations we produce computer control systems that mimic human thought processes. Combining the digital operations is called combinational logic. The basic symbols for the logical functions and some of their variations are depicted below. Although there are other standards for logic symbols, the ANSI standard will be used.

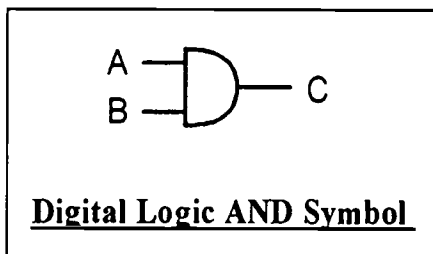

The AND symbol, sometimes called the and gate, is a digital logic device that requires two or more inputs to be true before the output can be true. In the case at the left, the inputs are on the left side of the symbol, designated A and B. The output is on the right side of the symbol, designated C. Both input A and input B must be true before output C is true.

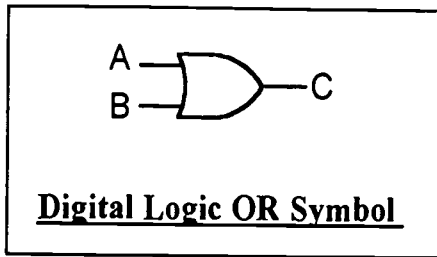

The OR symbol, sometimes called the OR gate, is a digital logic device that will produce an output when one of two or more inputs is true. In the case at the left, the inputs are on the left side of the symbol, designated A and B. The output is on the right side of the symbol, designated C. Either input A or input B must be true before output C is true.

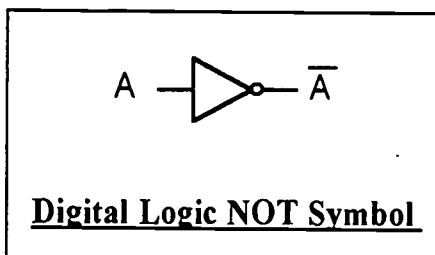

The NOT symbol, sometimes called the inverter gate, is a digital logic device that inverts the meaning of an input. The small circle on the end of the amplifier symbol indicates the inversion, and will be used with the other symbols. The meaning of the inverter is: input A equals not output A. The line above the output A is called a bar, and the output is frequently referred to as "bar A."

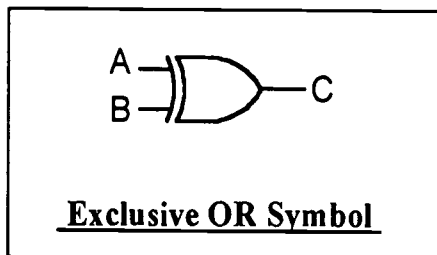

The Exclusive OR symbol, sometimes called the XOR gate, is a digital logic device that excludes the occurrence of two or more inputs that have the same logical state. That is, for the output C to be true, the inputs A, B must be in the opposite states. In the case at the left, the inputs are on the left side of the symbol, designated A and B. The output is on the right side of the symbol, designated C. Input A and input B must be in opposite states before output C is true. If input A and B are false, or A and B are true, output C will not be true.

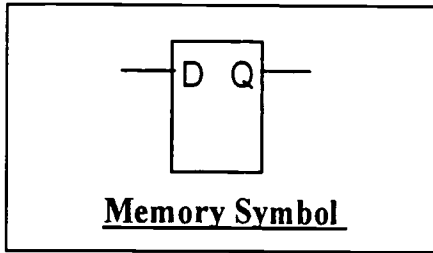

The memory symbol, sometimes called the *flip/flop*, is a digital logic device that remembers an input when one of the inputs is true or false. In the case at the left, the input is on the left side of the symbol, designated D. The output is on the right side of the symbol, designated Q. If D is true, then Q will be true and will remain that way until D becomes false. If D is false, Q will be false and will not change until D becomes true again.



# **AUTOMATED EQUIPMENT REPAIR SERIES**

## **MASTER Technical Module No. AET-C1**

---

<b>Subject:</b>	<b>Automated Equipment Repair</b>	<b>Time: 24 Hrs.</b>
<b>Duty:</b>	<b>Use Calibrated Measuring Instruments to Test/Calibrate Components</b>	
<b>Task:</b>	<b>Apply Machine Tool Metrology and Measurement Instruments to Align Machine Tools</b>	

---

### **Objective(s):**

Upon completion of this unit the student will be able to use conventional mechanical measuring instruments and apply modern mechanical metrology procedures to:

- a. Measure with steel rules (metric and inch);
- b. Measure with comparison measuring instruments (e.g., calipers, telescope gages);
- c. Measure with direct measuring instruments (e.g., vernier, dial and digital instruments);
- d. Measure with fixed gages (go and no-go gages);
- e. Use a dial indicator, to accurately measure run out, squareness, position, and distance on a machine tool;
- f. Use a outside micrometer, to accurately measure features of a part such as thickness and diameter, and test the accuracy of the micrometer with gauge blocks;
- g. Use an inside micrometer, to accurately measure distance, and circularity of the features of parts found on a machine tool;
- h. Use a height gauge, to accurately measure the height of a part and the distance traveled by a vertical machine slide;
- i. Use a dial or vernier caliper, to accurately measure dimensions and distances;
- j. Use a sine bar to accurately measure angles;
- k. Use a machining straight edge, to employ procedures such as the Straight Edge Reversal method to the measurement of squareness of a machine slide;
- l. Use a tooling ball, to employ methods, such as the Donaldson Reversal method to accurately measure the run out of a spindle;
- m. Use step gauges, to measure the accuracy of a machine slide; and,
- n. Use electronic dial indicators and ball-bars to test accuracy of a CNC machine.

---

## **Instructional Materials:**

The following measurement instruments:

- a. Dial and vernier calipers
- b. Inside and outside micrometers
- c. Height gauges
- d. Dial indicators

The following metrology instruments are very expensive and may not be available to many training institutions. Therefore the instructor may want to rely upon the handouts accompanying this module to present the material.

- a. Machining straight edge and machining square
- b. Step gauge
- c. Tooling balls
- d. LVDT dial indicators (electronic dial indicators)
- e. Ball-bar and accompanying software (available from Renshaw)
- f. Computers and interface modules to collect measurement data (Available from many dial indicator manufacturers)
- g. Laser interferometer (very expensive, should have accompanying optics for angularity measurements)

**MASTER Handout (AET-C1-HO-1)**

**MASTER Handout (AET-C1-HO-2) (Degrees of Freedom for Machine Tool Axis)**

**MASTER Handout (AET-C1-HO-3) (The Straight Edge Reversal Method for Testing the Alignment of a Machine Slide)**

**MASTER Handout (AET-C1-HO-4) (Electronic Dial Indicator Methods for Testing the Pitch and Roll of Machine Slides)**

**MASTER Handout (AET-C1-HO-5) (The Donaldson Reversal Method for Testing the Run out of a Machine Spindle)**

**MASTER Handout (AET-C1-HO-6) (Using a Ball-Bar to Test the Accuracy of a Machine Tool)**

**MASTER Handout (AET-C1-HO-7) (Using a Laser Interferometer to Check Accuracy and Alignment of Machine Tools)**

**MASTER Laboratory Exercise (AET-C1-LE1)**

**MASTER Laboratory Exercise (AET-C1-LE2)**

**MASTER Laboratory Aid (AET-C1-LA)**

**MASTER Quiz AET-C1-QU-1: Using metrology to align machine tools**

---

## **References:**

*Technology of Machine Tools*, Krar/Oswald, Latest Edition

*Machine Tools Processes and Applications*, Genevro/Heineman, Latest Edition

Texts and material for the advanced measurement techniques may be available from the Society of Manufacturing Engineers, Lawrence



Livermore National Labs, and the American National Standards Institute (ANSI).

**Video(s):** Videos for ball-bar applications may be obtained from Renshaw Incorporated, or the Society of Manufacturing Engineers (SME). Also, advanced alignment and measuring techniques may be obtained from SME.

Videos for conventional measurement instruments can be obtained from a large variety of educational companies.

---

### **Student Preparation:**

Students should have previously completed the following Technical Modules:

**AET-A6** "Use Physics, Algebra, and Trigonometry to Analyze Simple Vectored Forces"

**AET-B1** "Use Symbols, Organization, and Engineering Values on Mechanical Drawings"

---

---

### **Introduction:**

Every aspect of our lives, from the clothes we wear to the cars we drive, is greatly influenced by measurement. For the machinist, measurement is especially important since it is the machinist who is responsible for crafting the tools, fixtures, and components which make up or support virtually every part of our lives. Therefore, it is essential for the machinist to be a master in the use of not only the machine tools, but also the instruments which are used to measure the precision components demanded by consumers today. One of the most valuable assets you can possess is the expert use of the machinist measuring tools and a desire to practice quality consciousness in every aspect of your job performance.

The science of measurement is called metrology. This is not to be confused with meteorology, which is the science of weather. Metrology, and modern measurement devices, provide the accuracy demanded by today's machine tools. Current machine tool applications require the technician to align those tools to exacting tolerances. To achieve the results that are expected from modern machine tools, especially CNC machines, the technician must be able to use conventional measuring instruments, and apply new technology and methods to measure and align the machines.

---

---

### **Presentation Outline:**

- I. Discuss the Importance of Learning and Practicing Proper Measurement Techniques
  - A. Show the video "Measuring Tools"
  - B. Give each student a copy of the handout "Proper Measuring Techniques"

- II. Discuss and Demonstrate Proper Measurement Techniques Using the Steel Rule
- III. Discuss and Demonstrate the Use of Micrometer Type Measuring Instruments
  - A. Outside micrometers
  - B. Inside micrometers
  - C. Depth micrometers
  - D. Practice and demonstration of skills listed above
- IV. Discuss and Demonstrate the Use of Transfer Type Measuring Instruments
  - A. Spring calipers (inside and outside)
  - B. Telescope gages
  - C. Small hole gages
  - D. Practice and demonstration of skills listed above
- V. Discuss and Demonstrate the Use of Direct Measuring Instruments
  - A. Vernier calipers
  - B. Dial calipers
  - C. Digital calipers
  - D. Practice and demonstration of skills listed above
- VI. Discuss the Purpose of Fixed Gages and Demonstrate Their Use
  - A. Cylindrical plug and ring gages
  - B. Taper plug and ring gages
  - C. Snap gages
  - D. Thread plug gages
  - E. Practice and demonstration of skills listed above
- VII. Complete Practical Exercises (AET-C1-LE1) and (AET-C1-LE2) On All the Above Material
- VIII. Apply Modern Mechanical Metrology Procedures
  - A. Identify, demonstrate, and/or explain the use of the following mechanical metrology instruments.
    - 1. Machining straight edge
    - 2. Machining square
    - 3. Machining step gauge
    - 4. Tooling balls
    - 5. LVDT dial indicators (electronic dial indicators)
    - 6. Ball-bar
    - 7. Laser interferometer
  - B. Demonstrate and explain the degrees of freedom for a machine tool axis (MASTER Handout AET-C1-HO-2: Degrees of Freedom for Machine Tool Axis)
  - C. Demonstrate and/or explain the following procedures:
    - 1. Testing irregularities of machine slides (MASTER Handout AET-C1-HO-4: Electronic Dial Indicator Methods for Testing the Pitch and Roll of Machine Slides)
    - 2. Testing the accuracy of a machine slide using step gauges

3. Testing the alignment of a machine slide (MASTER Handout AET-C1-HO-3: The Straight Edge Reversal Method for Testing the Alignment of a Machine Slide)
4. Testing the run out of a machine spindle(MASTER Handout AET-C1-HO-5: The Donaldson Reversal Method for Testing the Run out of a Machine Spindle)
5. Overall tests for determining the accuracy of 3,4, and 5 axis CNC machine tools (MASTER Handout AET-C1-HO-6: Using a Ball-Bar to Test the Accuracy of a Machine Tool)
6. Using a laser interferometer to test machine tools (MASTER Handout AET-C1-HO-7: Using a Laser Interferometer to Check Accuracy and Alignment of Machine Tools)

---

---

**Practical Application:**

If possible, the instructor should provide experiences in applications identified by each of the handouts.

---

---

**Evaluation and/or Verification:**

Successful completion of this technical module will be based on the student's successful completion of the following components:

1. A twenty question quiz on the methods of aligning machine tools (MASTER Quiz AET-C1-QU-1: Using metrology to align machine tools);
2. Completion of Laboratory Exercise (AET-C1-LE1); and,
3. Completion of Laboratory Exercise (AET-C1-LE2).

---

---

**Summary:**

Review the main lesson points at each subsection of the module using the suggested texts and handouts listed in the reference section of this module. Hold class discussion and answer student questions.

---

---

**Next Lesson Assignment:**

**MASTER Technical Module (AET-C2)** dealing with applying electrical measurement knowledge and instruments to test/calibrate electrical circuits.

**AET-C1-HO-1**  
**Apply Machine Tool Metrology and Measurement Instruments**  
**to Align Machine Tools**  
**Attachment 1: MASTER Handout No. 1**

---

**Objective(s):**

Upon completion of this unit the student will be able to use conventional mechanical measuring instruments and apply modern mechanical metrology procedures to:

- a. Measure with steel rules (metric and inch);
- b. Measure with comparison measuring instruments (e.g., calipers, telescope gages);
- c. Measure with direct measuring instruments (e.g., vernier, dial and digital instruments);
- d. Measure with fixed gages (go and no-go gages);
- e. Use a dial indicator, to accurately measure run out, squareness, position, and distance on a machine tool;
- f. Use a outside micrometer, to accurately measure features of a part such as thickness and diameter, and test the accuracy of the micrometer with gauge blocks;
- g. Use an inside micrometer, to accurately measure distance, and circularity of the features of parts found on a machine tool;
- h. Use a height gauge, to accurately measure the height of a part and the distance traveled by a vertical machine slide;
- i. Use a dial or vernier caliper, to accurately measure dimensions and distances;
- j. Use a sine bar to accurately measure angles;
- k. Use a machining straight edge, to employ procedures such as the Straight Edge Reversal method to the measurement of squareness of a machine slide;
- l. Use a tooling ball, to employ methods, such as the Donaldson Reversal method to accurately measure the run out of a spindle;
- m. Use step gauges, to measure the accuracy of a machine slide; and,
- n. Use electronic dial indicators and ball-bars to test accuracy of a CNC machine.

---

**Module Outline:**

- I. Discuss the Importance of Learning and Practicing Proper Measurement Techniques
  - A. Show the video "Measuring Tools"
  - B. Give each student a copy of the handout "Proper Measuring Techniques"

- II. Discuss and Demonstrate Proper Measurement Techniques Using the Steel Rule
- III. Discuss and Demonstrate the Use of Micrometer Type Measuring Instruments
  - A. Outside micrometers
  - B. Inside micrometers
  - C. Depth micrometers
  - D. Practice and demonstration of skills listed above
- IV. Discuss and Demonstrate the Use of Transfer Type Measuring Instruments
  - A. Spring calipers (inside and outside)
  - B. Telescope gages
  - C. Small hole gages
  - D. Practice and demonstration of skills listed above
- V. Discuss and Demonstrate the Use of Direct Measuring Instruments
  - A. Vernier calipers
  - B. Dial calipers
  - C. Digital calipers
  - D. Practice and demonstration of skills listed above
- VI. Discuss the Purpose of Fixed Gages and Demonstrate Their Use
  - A. Cylindrical plug and ring gages
  - B. Taper plug and ring gages
  - C. Snap gages
  - D. Thread plug gages
  - E. Practice and demonstration of skills listed above
- VII. Complete Practical Exercises (AET-C1-LE1) and (AET-C1-LE2) On All the Above Material
- VIII. Apply Modern Mechanical Metrology Procedures
  - A. Identify, demonstrate, and/or explain the use of the following mechanical metrology instruments.
    - 1. Machining straight edge
    - 2. Machining square
    - 3. Machining step gauge
    - 4. Tooling balls
    - 5. LVDT dial indicators (electronic dial indicators)
    - 6. Ball-bar
    - 7. Laser interferometer
  - B. Demonstrate and explain the degrees of freedom for a machine tool axis (MASTER Handout AET-C1-HO-2: Degrees of Freedom for Machine Tool Axis)
  - C. Demonstrate and/or explain the following procedures:
    - 1. Testing irregularities of machine slides (MASTER Handout AET-C1-HO-4: Electronic Dial Indicator Methods for Testing the Pitch and Roll of Machine Slides)
    - 2. Testing the accuracy of a machine slide using step gauges

3. Testing the alignment of a machine slide (MASTER Handout AET-C1-HO-3: The Straight Edge Reversal Method for Testing the Alignment of a Machine Slide)
4. Testing the run out of a machine spindle(MASTER Handout AET-C1-HO-5: The Donaldson Reversal Method for Testing the Run out of a Machine Spindle)
5. Overall tests for determining the accuracy of 3,4, and 5 axis CNC machine tools (MASTER Handout AET-C1-HO-6: Using a Ball-Bar to Test the Accuracy of a Machine Tool)
6. Using a laser interferometer to test machine tools (MASTER Handout AET-C1-HO-7: Using a Laser Interferometer to Check Accuracy and Alignment of Machine Tools)

**AET-C1-HO-2**  
**Apply Machine Tool Metrology and Measurement Instruments**  
**to Align Machine Tools**  
**Attachment 2: MASTER Handout No. 2**

---

**Degrees of Freedom for Machine Tool Axis**

**Six Degrees of Freedom of a Positioner**

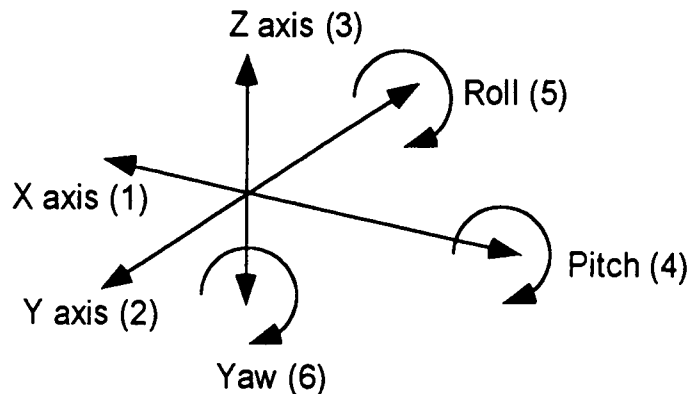

When performing metrology on a positioner, the effects of the Z axis (height) pitch, roll, and yaw, cannot be ignored. Pitch, roll and yaw are angular motions around the primary axis of motion; x, y, and z. Any of these factors can cause the image focus of the mask to fail to resolve to the required sharpness or orientation. Worse, the image could be blurred at the edges and in focus at the center. Laser interferometers have reflectors that are designed to detect angular motion on a linear axis of motion. By properly using these types of reflectors, the technician can detect any tendency of the axis to move in these angular dimensions. What is little understood when performing metrology at the millionth of an inch level, is that objects that may seem to be perfectly rigid, act like rubber at these resolutions.

AET-C1-HO-7  
Apply Machine Tool Metrology and Measurement Instruments  
to Align Machine Tools  
Attachment 7: MASTER Handout No. 7

---

**Using a Laser Interferometer to Check Accuracy  
and Alignment of Machine Tools**

### Laser Interferometer

The advent of integrated circuits with feature sizes that are less than 1 micron in width has led to the need for measuring instruments that can perform measurements in millionths of an inch. To gain a perspective of the relative sizes, a feature that is 1 micron in width is .000039 inches or 39 *millionths* of an inch. A rule of thumb of position accuracy is that the mask positioner that aligns the mask to the wafer must be at least ten times more accurate than the required tolerance of the part. Therefore, the positioner must be able to resolve to 3.9 millionths of an inch, or at least .1 micron. In practice, positioners of this caliber are usually accurate to 1 millionth of an inch or better.

The science of measurement is called **Metrology** (do not confuse this one with the science of weather, or *Meteorology*). When performing Metrology on a positioner, measuring instruments that can measure tolerances to .1 micron or better are necessary. One such instrument is the laser interferometer. The laser interferometer is a device that measures distance by using the *interference of wave lengths of light* that strike a reflective surface and are bounced back to the sending source. Light is an electromagnetic wave pattern that is essentially the same as the microwave energy that cooks the food in your microwave oven. The difference between light energy and the energy in your microwave oven is that light energy has a higher frequency than the microwave energy. Ordinarily, common light from the sun is composed of many different frequencies of light. If a beam of light energy can be created that is composed of only one frequency, that beam can be used to resolve distances to very fine increments by comparing the time that it takes for the beam to leave a sending source, and the time it takes to be reflected back to the sending source. Fortunately, we have invented a device that can produce light of only one frequency, or *coherent light*. That device is the laser.

Using the laser as a source of coherent light and an optically perfect reflecting object, we can reflect a laser beam back to the sending source and compare the difference in time, which is a function of distance. An electromagnetic wave of red light is about  $5 \times 10^{-7}$  meters long, or .5 microns (19.5 millionths of an inch) if we can resolve this wave down to one thousand parts, we can measure distances as small as .005 microns (.0195 millionths of an inch). In practice, most industrial laser interferometers resolve



distances to .000001 inches or 1 millionth of an inch, and this is adequate for a positioner that must move a minimum of 3.9 millionths of an inch.

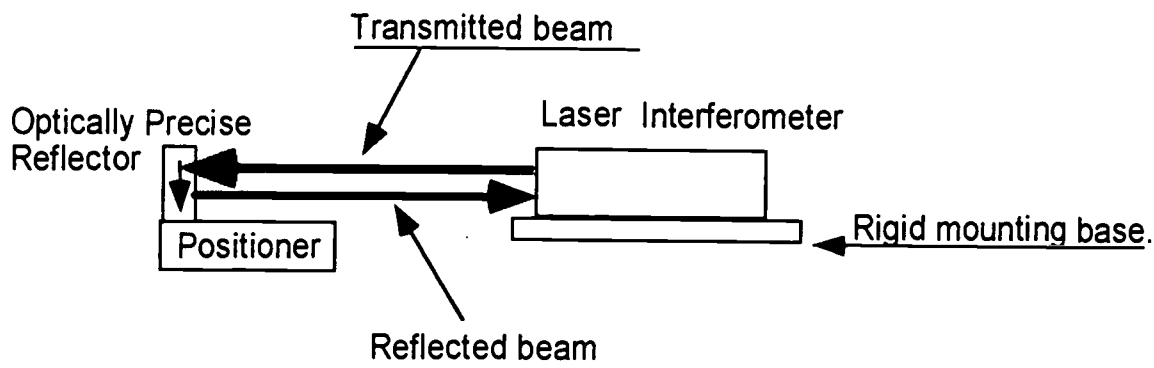

A typical laser interferometer setup will consist of a laser source and an optically precise reflector. The laser is set on a rigid mount and the reflector is mounted on the positioner. One of the tasks of the technician, is to align the laser and reflector such that the beam is accurately reflected back to the laser. This can be a time consuming process if the positioner and the laser are not set up properly. If the laser is mounted at a angle to the positioner and the reflector, the beam will not track properly as the positioner is moved, and the measurement will be lost. Initial setup requires that the devices should be mechanically aligned as closely as possible, and then a minimum of fine tuning of the setup will be necessary. Fortunately, most laser interferometers can tolerate moderate amounts of misalignment during the measuring process and still function properly because the reflector is designed to precisely reflect the beam back to the sending source. Care should be exercised in the handling of the reflector and the laser. If the reflector is dropped, the optics may be mis-aligned or damaged, resulting in inaccurate measurements or a ruined reflector.

Although usually a low energy device, the laser is a source of coherent light energy and can damage the eyes of people who are working nearby. Reflections of the laser beam from nearby reflective objects are equally as hazardous. *Do not point the beam at people and reflective objects.*

When performing metrology on a positioner, the effects of the Z axis (height): pitch, roll, and yaw, cannot be ignored. Pitch, roll and yaw are angular motions around the primary axis of motion; x, y, and z. Any of these factors can cause the image focus of the mask to fail to resolve to the required sharpness or orientation. Worse, the image could be blurred at the edges and in focus at the center. Laser interferometers have reflectors that are designed to detect angular motion on a linear axis of motion. By properly using these types of reflectors, the technician can detect any tendency of the axis to move in these angular dimensions. What is little understood when performing metrology at the millionth of an inch level, is that objects that may seem to be perfectly rigid, act like rubber at these resolutions.

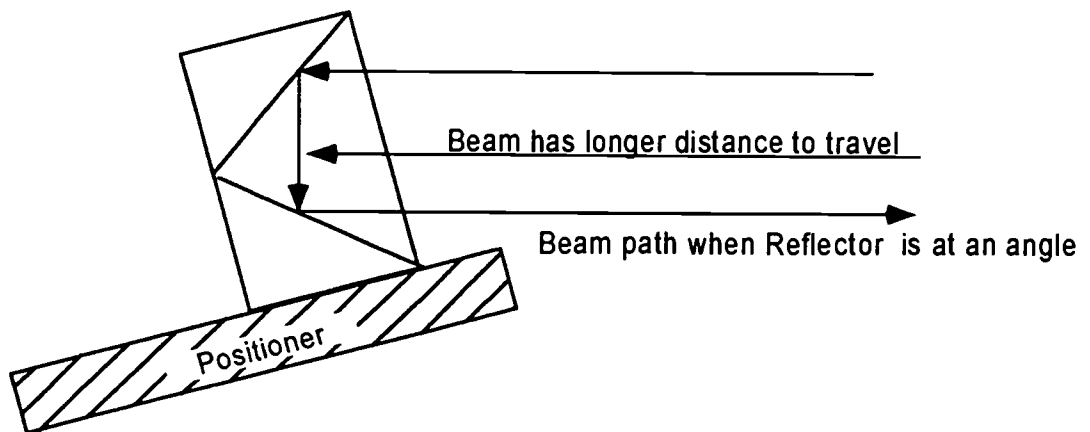
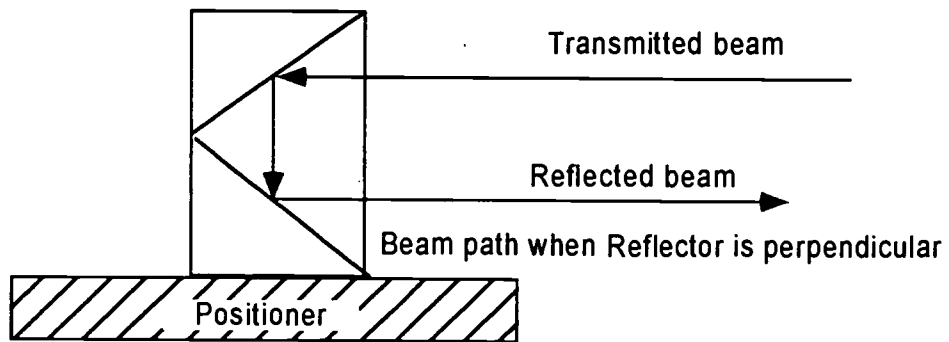
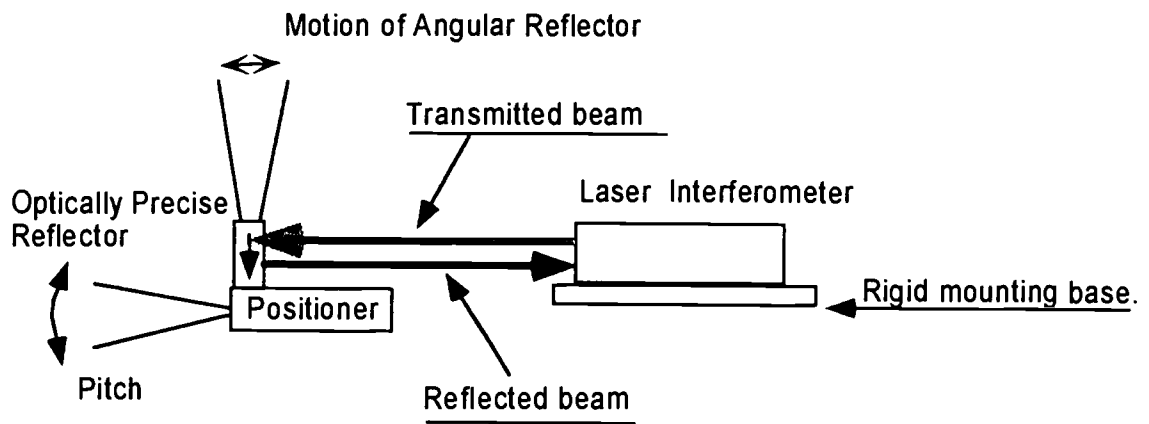

Name: \_\_\_\_\_

Date: \_\_\_\_\_

**AET-C1-LE1**  
**Apply Machine Tool Metrology and Measurement Instruments**  
**to Align Machine Tools**  
**Attachment 8: MASTER Laboratory Exercise No. 1**

---

1. What is the reading on the vernier caliper below?
- a. .642
  - b. 1.642
  - c. 1.645
  - d. 1.64

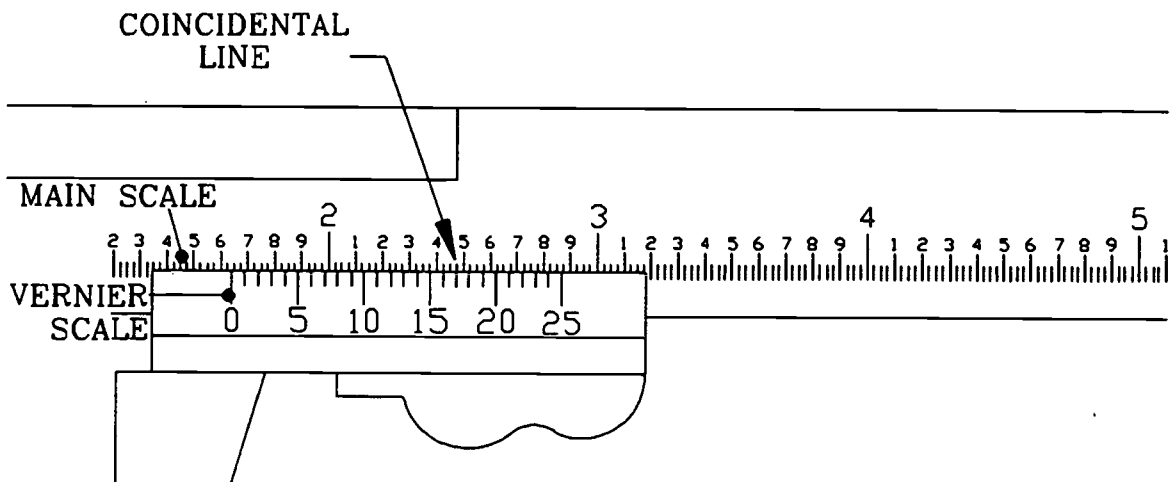

2. What is the reading on the vernier caliper below?
- a. .415
  - b. 3.125
  - c. 3.405
  - d. 3.412

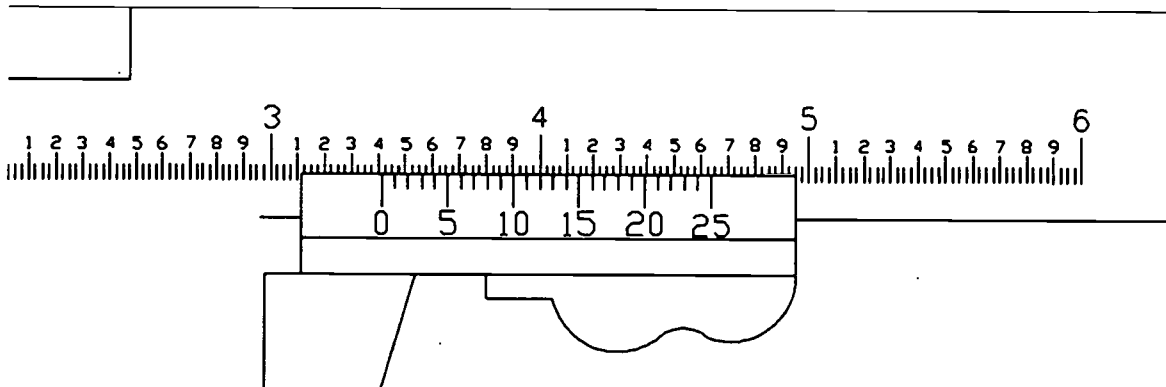

3. What is the reading on the vernier caliper below?
- 4.575
  - 4.250
  - 4.570
  - 4.275

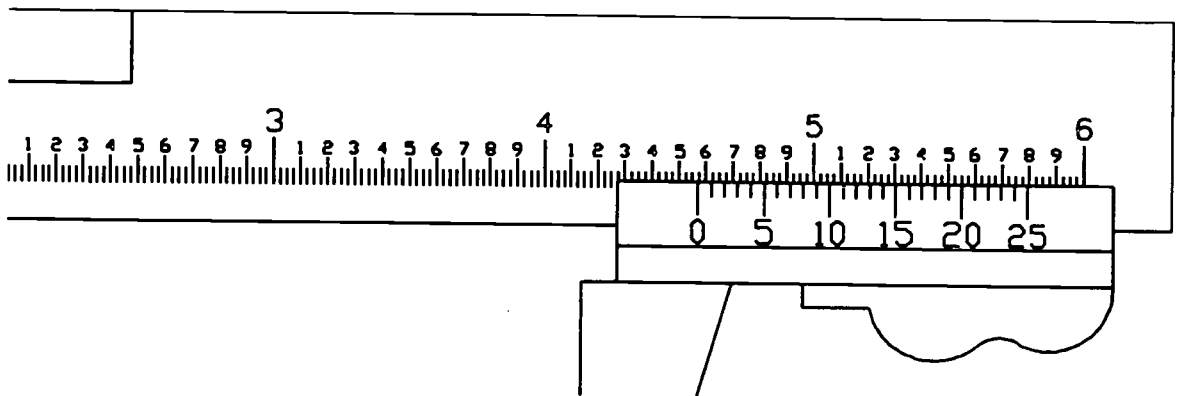

4. What is the reading on this vernier caliper?
- 3.785
  - 3.800
  - 3.473
  - 3.793

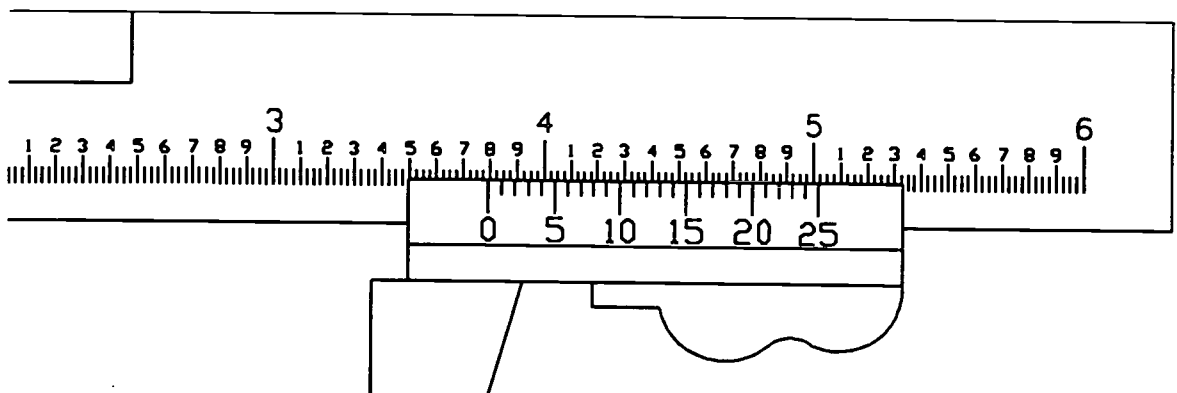

Name \_\_\_\_\_

Date \_\_\_\_\_

**AET-C1-LE2**  
**Apply Machine Tool Metrology and Measurement Instruments**  
**to Align Machine Tools**  
**Attachment 9: MASTER Laboratory Exercise No. 2**

---

Using the measuring instruments provided for you and the measuring specimens, measure for the following dimensions and record your answers in the space provided. Be sure to provide metric and inch answers for each dimension. Turn this sheet in to your instructor for evaluation.

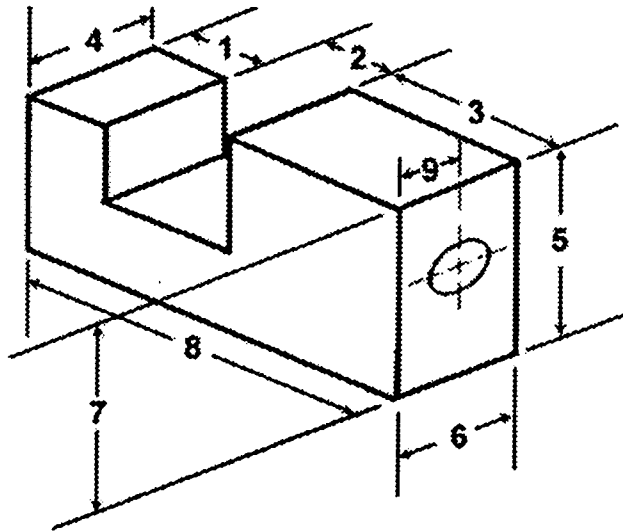

**Specimen Number** \_\_\_\_\_

Dimension	metric	inch	Dimension	metric	inch
1.	_____	_____	7.	_____	_____
2.	_____	_____	8.	_____	_____
3.	_____	_____	9.	_____	_____
4.	_____	_____	10.	_____	_____
5.	_____	_____	11.	_____	_____
6.	_____	_____			

**AET-C1-LA-1**  
**Apply Machine Tool Metrology and Measurement Instruments**  
**to Align Machine Tools**  
**Attachment 10: MASTER Laboratory Aid**

---

**Rules of Conduct**

1. Absolutely no horseplay or practical joking will be tolerated.
2. Do not talk to anyone who is operating a machine.
3. Walk only in the designated traffic lanes.
4. Dress appropriately; at the absolute minimum, you must have:
  - a. No loose clothing, including ties;
  - b. Long hair properly stowed;
  - c. No jewelry;
  - d. Hard, closed-toe shoes;
  - e. Eye protection (safety glasses); and,
  - f. Ear protection (plugs or headset).
5. Follow all institutional safety rules.

# **AUTOMATED EQUIPMENT REPAIR SERIES**

## **MASTER Technical Module No. AET-C2**

---

**Subject:** Automated Equipment Repair **Time:** 12 Hrs.

**Duty:** Use Calibrated Measuring Instruments to Test/Calibrate Components

**Task:** Apply Electrical Measurement Knowledge and Instruments to Test/Calibrate Electrical Circuits

---

**Objective(s):**

Upon completion of this unit the student will be able to:

- a. Properly connect a multimeter, ammeter, or clamp-on ammeter to a circuit; and use the instrument to safely measure DC current, RMS current, and Average current in a DC or AC circuit;
- b. Properly connect a multimeter, voltmeter, or clamp-on voltmeter to a circuit, and use the instrument to safely measure DC voltage, RMS voltage, and average voltage in a DC or AC circuit;
- c. Properly connect a multimeter or ohmmeter to a circuit and use the instrument to safely measure resistance in any circuit;
- d. Properly connect power factor meters to power distribution systems, and safely measure power factor;
- e. Properly connect phase meters to safely test phase rotation and phase angle; and,
- f. Safely test inductance and capacitance.

---

**Instructional Materials:**

Digital multimeters (if possible with capacitance and inductance scales)

Conventional analog voltmeters, ammeters, and ohmmeters (optional)

Clamp-on meters

Power factor meters

Phase rotation and phase angle meters

Capacitance and inductance meters (if multimeters with these scales are not available)

**MASTER Handout (AET-C2-HO)**

**MASTER Laboratory Exercise (AET-C2-LE)**

**MASTER Laboratory Aid (AET-C2-LA)**

**MASTER Quiz AET-C2-QU-1: Electrical measuring instruments**

---

## References:

- Electricity/Electronics Fundamentals*, Zbar/Sloop, Latest Edition
- Introductory DC/AC Electronics*, Nigel P. Cook, Latest Edition (with interactive software)
- Guide to Electrical Power Distribution Systems Equipment, Applications, Installation and Maintenance*, Pansini, Latest Edition
- Modern Industrial Electronics, Revised and Expanded Edition*, Schuler/MacNamee, Latest Edition (formerly, *Industrial Electronics and Robotics*, Schuler/MacNamee, 1987)
- The Complete Guide to Electronics Troubleshooting*, Perozzo, Latest Edition
- Video(s): *Multimeters Explained*, Bergwall Productions, 1-800-645-3565, Latest Edition
- Basic Electricity DC Circuits*, Bergwall Productions, 1-800-645-3565, Latest Edition
- Working Safely With Electricity*, Bergwall Productions, 1-800-645-3565, Latest Edition

Note: Bergwall Productions will be referenced frequently throughout the AET section because the company provides quality video productions at a reasonable price, unlike other video production companies.

The following items are *not recommended* because they detract from the hands-on nature of this module. These items may be used as a supplement for the module if the module contains actual interaction with real electrical and electronic parts, or used in an electronics design class. Electricity and electronics is a “messy” technology, because actual parts and measuring devices are not perfect. The following items are theoretically perfect, and therefore do not reflect the real world of electricity and electronics.

*PSPICE* - Program for modeling the behavior of electrical and electronic components, and circuits.

*Electronic Workbench* - Graphic Windows based program for constructing theoretical models of electrical and electronic circuits

---

## Student Preparation:

Students should have previously completed the following Technical Modules:

- AET-A6** “Use Physics, Algebra, and Trigonometry to Analyze Simple Vectored Forces



- AET-B2 "Use Symbols, Organization, and Engineering Values on Electrical Drawings
- AET-E1 "Calculate, Predict, and Measure the Response of Quantities in DC Circuits"
- AET-E2 "Calculate, Predict, and Measure the Response of Quantities in AC Circuits"
- AET-E3 "Calculate, Predict, and Measure Impedance and Phase Angle in AC Circuits"
- AET-E4 "Calculate, Predict, and Measure Quantities in Poly-Phase AC Circuits"

---

---

## **Introduction:**

The science of measurement is called metrology. This is not to be confused with meteorology, which is the science of weather. Metrology, and modern measurement devices, allow the modern automation technician to perform complex electrical measurements with relative ease and safety. However, measuring electrical currents, voltages, and resistance, must be done in a manner that does not expose the technician to electrical hazards and damage the equipment and/or the instrument. To achieve this goal, the technician must be aware of the parameters of the type of measure that is to be attempted, and the manner in which the instrument is connected for the measurement.

---

---

## **Presentation Outline:**

- I. Use Electrical Measuring Instruments
  - A. Demonstrate the procedure for safely measuring, current, voltage and resistance in DC circuits
    - 1. Explain the operation of digital multimeters
    - 2. Demonstrate the procedure for measuring DC voltage, DC current, and resistance
    - 3. Demonstrate the measurement of DC voltage, DC current and resistance on a representative machine control
  - B. Demonstrate the measurement of capacitive and inductive components
    - 1. Provide examples of occasions in which it may be necessary to measure capacitance and inductance
    - 2. Explain the operation of a capacitance and inductance test meter
    - 3. Demonstrate the procedure for measuring capacitance and inductance
    - 4. Demonstrate safety procedures for capacitive and inductive tests
    - 5. Demonstrate tests for capacitance on a DC power supply in a machine control system

6. Demonstrate the measurement of inductance on an AC inductive motor
- C. Demonstrate the procedures for safe measurement of single phase resistive AC currents voltages and resistance
  1. Demonstrate the use of multimeters and clamp-on ammeters in measuring AC voltage, AC current, and resistance
  2. Demonstrate the safety procedures and methods for performing voltage, current, and resistive tests on an AC power distribution system
- D. Demonstrate the measurement of voltage, current, and power in poly-phase AC systems
  1. Explain the purpose and use of; phase rotation meters, phase angle meters, and power factor meters
  2. Demonstrate the use of the above meters by performing tests on poly-phase AC power distribution systems

---

---

**Practical Application:**

1. Using all of the above instruments, perform a simulated preventative maintenance procedure on a machine tool.

---

---

**Evaluation and/or Verification:**

Successful completion of this technical module will be based on the student's successful completion of the following components:

1. A twenty question quiz on electrical measuring instruments (MASTER Quiz AET-C2-QU-1: Electrical measuring instruments; and,
2. Demonstrate competency in use of electrical measuring instruments.

---

---

**Summary:**

Review the main lesson points at each subsection of the module using the suggested texts and handouts listed in the reference section of this module. Hold class discussion and answer student questions.

---

---

**Next Lesson Assignment:**

**MASTER Technical Module (AET-C3)** dealing with applying electronic measurement knowledge and instruments to test/calibrate electronic circuits.

**AET-C2-HO**  
**Apply Electrical Measurement Knowledge and Instruments**  
**to Test/Calibrate Electrical Circuits**  
**Attachment 1: MASTER Handout**

---

**Objective(s):**

Upon completion of this unit the student will be able to:

- a. Properly connect a multimeter, ammeter, or clamp-on ammeter to a circuit; and use the instrument to safely measure DC current, RMS current, and Average current in a DC or AC circuit;
- b. Properly connect a multimeter, voltmeter, or clamp-on voltmeter to a circuit, and use the instrument to safely measure DC voltage, RMS voltage, and average voltage in a DC or AC circuit;
- c. Properly connect a multimeter or ohmmeter to a circuit and use the instrument to safely measure resistance in any circuit;
- d. Properly connect power factor meters to power distribution systems, and safely measure power factor;
- e. Properly connect phase meters to safely test phase rotation and phase angle; and,
- f. Safely test inductance and capacitance.

---

**Module Outline:**

- I. Use Electrical Measuring Instruments
  - A. Demonstrate the procedure for safely measuring, current, voltage and resistance in DC circuits
    1. Explain the operation of digital multimeters
    2. Demonstrate the procedure for measuring DC voltage, DC current, and resistance
    3. Demonstrate the measurement of DC voltage, DC current and resistance on a representative machine control
  - B. Demonstrate the measurement of capacitive and inductive components
    1. Provide examples of occasions in which it may be necessary to measure capacitance and inductance
    2. Explain the operation of a capacitance and inductance test meter
    3. Demonstrate the procedure for measuring capacitance and inductance
    4. Demonstrate safety procedures for capacitive and inductive tests
    5. Demonstrate tests for capacitance on a DC power supply in a machine control system
    6. Demonstrate the measurement of inductance on an AC inductive motor

- C. Demonstrate the procedures for safe measurement of single phase resistive AC currents voltages and resistance
  - 1. Demonstrate the use of multimeters and clamp-on ammeters in measuring AC voltage, AC current, and resistance
  - 2. Demonstrate the safety procedures and methods for performing voltage, current, and resistive tests on an AC power distribution system
- D. Demonstrate the measurement of voltage, current, and power in poly-phase AC systems
  - 1. Explain the purpose and use of; phase rotation meters, phase angle meters, and power factor meters
  - 2. Demonstrate the use of the above meters by performing tests on poly-phase AC power distribution systems

**AET-C2-LE**  
**Apply Electrical Measurement Knowledge and Instruments**  
**to Test/Calibrate Electrical Circuits**  
**Attachment 2: MASTER Laboratory Exercise**

---

The student will Use all of the above instruments to perform a simulated preventative maintenance procedure on a machine tool.

**AET-C2-LA**  
**Apply Electrical Measurement Knowledge and Instruments**  
**to Test/Calibrate Electrical Circuits**  
**Attachment 3: MASTER Laboratory Aid**

---

**Rules of Conduct**

1. Absolutely no horseplay or practical joking will be tolerated.
2. Do not talk to anyone who is operating a machine.
3. Walk only in the designated traffic lanes.
4. Dress appropriately; at the absolute minimum, you must have:
  - a. No loose clothing, including ties;
  - b. Long hair properly stowed;
  - c. No jewelry;
  - d. Hard, closed-toe shoes;
  - e. Eye protection (safety glasses); and,
  - f. Ear protection (plugs or headset).
5. Follow all institutional safety rules.

# **AUTOMATED EQUIPMENT REPAIR SERIES**

## **MASTER Technical Module No. AET-C3**

---

**Subject:** Automated Equipment Repair **Time:** 16 Hrs.

**Duty:** Use Calibrated Measuring Instruments to Test/Calibrate Components

**Task:** Apply Electronic Measurement Knowledge and Instruments to Test/Calibrate Electronic Circuits

---

**Objective(s):**

Upon completion of this unit the student will be able to:

- a. Use function generators to test/calibrate circuits;
- b. Use oscilloscopes to test/calibrate circuits;
- c. Adjust the frequency, amplitude and proper decibel level of a function generator and use the instrument to test electronic and electrical equipment; and,
- d. Properly set up an oscilloscope for calibrated measurements, and use the instrument to measure frequency, time, degrees of phase shift, DC voltages, voltage peak, and voltage peak-to-peak.

---

**Instructional Materials:**

Variable frequency function generators capable of dB switching, DC outputs, AC outputs, square wave outputs, triangular wave outputs, and sawtooth outputs

20 to 100 Megahertz dual trace oscilloscope with switchable manual/auto triggering, and 20 volts to 5 mV vertical deflection

20 to 100 Megahertz dual trace oscilloscope with isolated channels switchable manual/auto triggering, and 20 volts to 5 mV vertical deflection (optional)

**MASTER Handout (AET-C3-HO-1)**

**MASTER Handout (AET-C3-HO-2) (Decibels and Logarithms)**

**MASTER Laboratory Exercise (AET-C3-LE)**

**MASTER Laboratory Aid (AET-C3-LA)**

**MASTER Quiz AET-C3-QU-1: Function generators**

**MASTER Quiz AET-C3-QU-2: Oscilloscopes**

---

**References:**

*Elements of Electronic Instrumentation and Measurement*, Carr, ISBN 0-13-341686-0, Latest Edition

*Using the Oscilloscope*, Iddings, ISBN 0-13-148362-5, Latest Edition  
*Modern Industrial Electronics*, Schuler/MacNamee, (formerly Industrial Electronics and Robotics), Latest Edition  
*The Complete Guide to Electronics Troubleshooting*, Perozzo, Latest Edition  
*Troubleshooting Electronic Equipment the Right Way Without Using Expensive Test Instruments*, Douglas-Young, Latest Edition  
Video(s): *Using Dual Trace Oscilloscopes*, Bergwall Productions, Latest Edition

The following items are *not recommended* because they *detract from the hands-on nature of this module*. These items may be used as a supplement for the module if the module contains actual interaction with real electrical and electronic parts. Electricity and electronics is a "messy" technology because actual parts and measuring devices are not perfect. The following items are theoretically perfect, and therefore do not reflect the real world of electricity and electronics.

*PSPICE* - Program for modeling the behavior of electrical and electronic components.

*Electronic Workbench* - Graphic Windows based program for constructing theoretical models of electrical and electronic circuits.

---

### Student Preparation:

Students should have previously completed the following Technical Modules:

- AET-A6 "Use Physics, Algebra, and Trigonometry to Analyze Simple Vectored Forces"
- AET-B2 "Use Symbols, Organization, and Engineering Values on Electrical Drawings"
- AET-B3 "Use Symbols, Organization, and Engineering Values on Electronic Drawings"
- AET-E1 "Calculate, Predict, and Measure the Response of Quantities in DC Circuits"
- AET-E2 "Calculate, Predict, and Measure the Response of Quantities in AC Circuits"
- AET-E3 "Calculate, Predict, and Measure Impedance and Phase Angle in AC Circuits"
- AET-E4 "Calculate, Predict, and Measure Quantities in Poly-Phase AC Circuits"



---

---

## **Introduction:**

The science of measurement is called metrology. This is not to be confused with meteorology, which is the science of weather. Metrology, and measurement devices such as function generators and oscilloscopes, allow the modern automation technician to perform complex electronic measurements with relative ease and safety. However, measuring and calibrating electronic circuits, must be done in a manner that does not expose the technician to electrical hazards and damage the equipment and/or the instrument. This is especially true with oscilloscopes and function generators. To achieve this goal, the technician must be aware of the parameters of the type of measure that is to be attempted, and the manner in which the instrument is connected for the measurement. At a minimum, the technician must be able to use these devices effectively.

---

---

## **Presentation Outline:**

- I. Use Function Generators to Test/Calibrate Circuits
  - A. Identify and explain the purpose of the controls on a function generator
    - 1. Frequency range and variable frequency control
    - 2. Wave form selection control
    - 3. Amplitude control
    - 4. DC offset control
    - 5. Decibel (dB) switches (MASTER Handout AET-C3-HO-2)  
(Decibels and Logarithms)
  - B. Explain the safety procedures and grounding problems associated with the use of function generators
    - 1. Explain the concept of "ground loops" and the relation ship of the common connection point of the function generator to the common connection point of the circuit under test
    - 2. Explain the expected behavior of servo systems when subjected to signal injection and the safety procedures that must be followed
  - C. Demonstrate the use of the function generator for signal injection into a servo amplifier of a robot or CNC machine
    - 1. Explain the purpose of the test for each wave form
    - 2. Explain the expected outcome of the test
- II. Use Oscilloscopes to Test/Calibrate Circuits
  - A. Identify and explain the purpose of the controls on an oscilloscope
    - 1. Beam trace intensity and alignment
    - 2. Selecting dual or single channel
    - 3. Selecting alternate or chop frequency and the advantages/disadvantages of both
    - 4. Time base range and variable time base

5. Vertical deflection range and variable vertical deflection
  6. Triggering controls, internal and external triggering, selecting a triggering source
  7. Auto/manual triggering
- B. Explain the proper procedures for setting up the scope for calibrated measurements
- C. Explain the safety procedures and grounding problems associated with the use of an oscilloscope
1. Explain the concept of "ground loops" and the relationship of the common connection point of the oscilloscope to the common connection point of the circuit under test
  2. Explain the expected behavior of electronic systems when subjected to testing by the oscilloscope and the safety procedures that must be followed
- D. Demonstrate the use of the oscilloscope in conjunction with the function generator for signal injection into a servo amplifier of a robot or CNC machine
1. Explain the purpose of the test for each wave form
  2. Explain the expected outcome of the test
- E. Demonstrate the methods used to convert horizontal time on an oscilloscope to degrees of rotation of a sine wave, or a phase shift in complex inductive/capacitive circuits

---

---

**Practical Application:**

1. Use a function generator and an oscilloscope to inject and monitor a wave form in the servo amplifier of a CNC machine or robot; and,
2. Use the oscilloscope to monitor a wave form injected by a function generator in the servo amplifier of a CNC machine.

---

---

**Evaluation and/or Verification:**

Successful completion of this technical module will be based on the student's successful completion of the following components:

1. A ten question quiz on the use of the function generator (MASTER Quiz AET-C3-QU-1: Function generators);
2. A ten question quiz on the use of the oscilloscope (MASTER Quiz AET-C3-QU-2: Oscilloscopes);
3. Demonstrate competency in the use of function generators (may be measured by textbook labs); and,
4. Demonstrate competency in the use of oscilloscopes (may be measured by textbook labs).

---

---

**Summary:**

Review the main lesson points at each subsection of the module using the suggested texts and handouts listed in the reference section of this module. Hold class discussion and answer student questions.

---

---

**Next Lesson Assignment:**

**MASTER Technical Module (AET-C4)** dealing with applying fluid power measurement and instruments to test/calibrate hydraulic and pneumatic systems.

**AET-C3-HO-1**  
**Apply Electronic Measurement Knowledge and Instruments**  
**to Test/Calibrate Electronic Circuits**  
**Attachment 1: MASTER Handout No. 1**

---

**Objective(s):**

Upon completion of this unit the student will be able to:

- a. Use function generators to test/calibrate circuits;
  - b. Use oscilloscopes to test/calibrate circuits;
  - c. Adjust the frequency, amplitude and proper decibel level of a function generator and use the instrument to test electronic and electrical equipment; and,
  - d. Properly set up an oscilloscope for calibrated measurements, and use the instrument to measure frequency, time, degrees of phase shift, DC voltages, voltage peak, and voltage peak-to-peak.
- 

**Module Outline:**

- I. Use Function Generators to Test/Calibrate Circuits
  - A. Identify and explain the purpose of the controls on a function generator
    1. Frequency range and variable frequency control
    2. Wave form selection control
    3. Amplitude control
    4. DC offset control
    5. Decibel (dB) switches (MASTER Handout AET-C3-HO-2) (Decibels and Logarithms)
  - B. Explain the safety procedures and grounding problems associated with the use of function generators
    1. Explain the concept of "ground loops" and the relation ship of the common connection point of the function generator to the common connection point of the circuit under test
    2. Explain the expected behavior of servo systems when subjected to signal injection and the safety procedures that must be followed
  - C. Demonstrate the use of the function generator for signal injection into a servo amplifier of a robot or CNC machine
    1. Explain the purpose of the test for each wave form
    2. Explain the expected outcome of the test
- II. Use Oscilloscopes to Test/Calibrate Circuits
  - A. Identify and explain the purpose of the controls on an oscilloscope
    1. Beam trace intensity and alignment
    2. Selecting dual or single channel

3. Selecting alternate or chop frequency and the advantages/disadvantages of both
  4. Time base range and variable time base
  5. Vertical deflection range and variable vertical deflection
  6. Triggering controls, internal and external triggering, selecting a triggering source
  7. Auto/manual triggering
- B. Explain the proper procedures for setting up the scope for calibrated measurements
- C. Explain the safety procedures and grounding problems associated with the use of an oscilloscope
1. Explain the concept of "ground loops" and the relationship of the common connection point of the oscilloscope to the common connection point of the circuit under test
  2. Explain the expected behavior of electronic systems when subjected to testing by the oscilloscope and the safety procedures that must be followed
- D. Demonstrate the use of the oscilloscope in conjunction with the function generator for signal injection into a servo amplifier of a robot or CNC machine
1. Explain the purpose of the test for each wave form
  2. Explain the expected outcome of the test
- E. Demonstrate the methods used to convert horizontal time on an oscilloscope to degrees of rotation of a sine wave, or a phase shift in complex inductive/capacitive circuits

**AET-C3-HO-2**  
**Apply Electronic Measurement Knowledge and Instruments**  
**to Test/Calibrate Electronic Circuits**  
**Attachment 2: MASTER Handout No. 2**

---

**Decibels and Logarithms**

This is not the name of a big band, but it's a possibility. Decibels are a scaling system based on powers of ten. Decibels reflect a "figure of merit" describing voltages, current, or power over resistance or area. It can be applied to amplifiers, sensitivity of receivers, or the power of the sound in an industrial plant. It is simply a scale in powers of ten. For example, a function generator will add or subtract 20 decibels to a wave form if you turn the right switch.

Scales built using the decibel system have different ZERO POINTS. A decibel scale can have ANY point defined as "zero decibels" and the measuring method of the scale will be consistent starting with that base number. Audible sound, for example, uses as a zero decibel point, a value equivalent to "sound barely audible by the average human ear". This value is an intensity of  $10^{-12}$  Watts/meter<sup>2</sup>.

Starting with that number, every time the intensity of sound increases by one power of ten, ( $10^1$ ) we add TEN decibels to our value. So the *power/area* is actually:

**THE ZERO-DECIBELS VALUE multiplied by 10 raised to the power of (.1 times the number of decibels).**

For example:

If X is the zero value then:

+ 20 decibels is  $X \cdot 10^{2.0}$

or

**100X**

Notice you can have decimals in the power of ten exponent:

For example  $10^{2.5} = 316.227$ , which is the multiplier for 25 decibels.

For example, leaves rustling in the autumn breeze in the parking lot would have a sound intensity of about 10 decibels.

This means the intensity or power of that sound in Watts/m<sup>2</sup> would be:

$10^{-12}$  Watts per meter<sup>2</sup> times 10 to the first power

This equals  $10^{-12} * 10^{1.0}$  or  $10^{-11}$  or .01 Nanowatts/meter<sup>2</sup>. As you can imagine this is **not** a lot of power per square meter.

If we compare it to an ordinary conversation such as often occurs in the middle of lectures, we are comparing 10 decibels to 60 decibels.

This equals the “0 decibels” figure times 10 to the 6.0 power

or

$$1 \times 10^{-12} \times 1 \times 10^{6.0} = 1 \text{ microwatt/m}^2$$

Compared to this zero point, other decibel values of audible sound are:

Sound	Decibels	Calculation	Watts/m <sup>2</sup>
A lover whispering from 1 yard away	20	$1 \times 10^{-12} \times 1 \times 10^{2.0}$	.1 nanowatts
Standing at Market and 1st Ave.	40	$1 \times 10^{-12} \times 1 \times 10^{4.0}$	10 nanowatts
Conversation with the instructor on break	60	$1 \times 10^{-12} \times 1 \times 10^{6.0}$	10 microwatts
Conversation with Rohr Industries	85	$1 \times 10^{-12} \times 1 \times 10^{8.5}$	316.227 u watts
Niagra Falls from the little tour boat	90	$1 \times 10^{-12} \times 1 \times 10^{9.0}$	1 milliwatt
Loud rock band	110	$1 \times 10^{-12} \times 1 \times 10^{11.0}$	612.01 milliwatt
Sound painful to the ear	120	$1 \times 10^{-12} \times 1 \times 10^{12.0}$	1 watt

If you use decibels to measure some electronic value as in the gain delivered by a stereo amplifier, you will get totally different values depending on where the ZERO VALUE is. What is important to notice is that the decibel scale is not *linear* (each decibel adds a fixed amount) but *LOGARITHMIC* (each decibel adds a certain amount to the EXPONENT of 10). It increases exponentially.

A LOGARITHM is “*the number to which a base is raised to give another number*”. Logarithmic scales increase by powers rather than by fixed amounts. If you are using base 10, which is common, the logarithm of 100 is 2 (you raise 10 to the 2d power to get 100). The logarithm of 1000 is 3 (you raise 10 to the 3d power to get 1000) and the logarithm of 721.11 is *somewhere in between*. You can find out quickly if you have a calculator with a log key. For example, the number 721.11:

Using the calculator, the power of ten exponent for 721.11 is 2.858001518.

In other words ten raised to the 2.858001518 power will give you 721.11.

Logarithms are exponents, and can be mathematically manipulated like exponents which makes it easy to mathematically calculate very large and very small numbers.

The controls on the front panel of a function generator include decibel switches. Using a function generator, and switching the 10 db or 20 db switch on the unit, means that you are multiplying or dividing the current value of the generators output by 10 or 100.

The +10 db switch will multiply the output by 10, and the -10 db switch will divide the output by 10; or the -20 db switch will divide the output by 100, and turning it off will restore the output to its previous value.



**AET-C3-LE**  
**Apply Electronic Measurement Knowledge and Instruments**  
**to Test/Calibrate Electronic Circuits**  
**Attachment 3: MASTER Laboratory Exercise**

---

The student will:

1. Use a function generator and an oscilloscope to inject and monitor a wave form in the servo amplifier of a CNC machine or robot; and,
2. Use the oscilloscope to monitor a wave form injected by a function generator in the servo amplifier of a CNC machine.

**AET-C3-LA**  
**Apply Electronic Measurement Knowledge and Instruments**  
**to Test/Calibrate Electronic Circuits**  
**Attachment 4: MASTER Laboratory Aid**

---

**Rules of Conduct**

1. Absolutely no horseplay or practical joking will be tolerated.
2. Do not talk to anyone who is operating a machine.
3. Walk only in the designated traffic lanes.
4. Dress appropriately; at the absolute minimum, you must have:
  - a. No loose clothing, including ties;
  - b. Long hair properly stowed;
  - c. No jewelry;
  - d. Hard, closed-toe shoes;
  - e. Eye protection (safety glasses); and,
  - f. Ear protection (plugs or headset).
5. Follow all institutional safety rules.

# **AUTOMATED EQUIPMENT REPAIR SERIES**

## **MASTER Technical Module No. AET-C4**

---

**Subject:** Automated Equipment Repair

**Time:** 12 Hrs.

**Duty:** Use Calibrated Measuring Instruments To Test/Calibrate Components

**Task:** Apply Fluid Power Measurement and Instruments to Test/Calibrate Hydraulic and Pneumatic Systems

---

**Objective(s):**

Upon completion of this unit the student will be able to:

- a. Use flow meters and pressure gauges to test/calibrate hydraulic and pneumatic circuits;
- b. Use test apparatus to test/calibrate pressure control valves and hydraulic and pneumatic pumping systems;
- c. Use a hydraulic flow meter, properly connect the meter, and measure flow in quantities such as Gallons per Minute (GPM) or Liters per Minute (LPM) in a hydraulic system;
- d. Use a pneumatic flow meter, properly connect the meter and measure flow in quantities such as Standard Cubic Feet per Minute (SCFM), Standard Cubic Feet per Hour (SCFH), or Liters per Minute (LPM);
- e. Properly install the correct gauge, and measure pressures in both the English Engineering and SI systems of measurement for both hydraulic and pneumatic systems; and,
- f. Use a hydraulic or pneumatic test unit to measure temperature, flow, pressure, the cracking pressure on hydraulic or pneumatic pressure control valves, and the efficiency of a hydraulic or pneumatic pumping system.

---

**Instructional Materials:**

Hydraulic and pneumatic flow meters that measure in Gallons per Minute (GPM), Liters per Minute (LPM), or Standard Cubic Feet per Minute (SCFM) and Standard Cubic Feet per Hour (SCFH)

Pressure gauges that measure in Pounds per Square Inch Gauge (PSIG), and kilo Pascals (kPa)

Hydraulic and pneumatic test units consisting of temperature gauges, flow controls, pressure gauges, and flow meters

MASTER Handout (AET-C4-HO-1)

MASTER Handout (AET-C4-HO-2) (Test Apparatus for Testing Hydraulic and Pneumatic Systems)

**MASTER** Laboratory Exercise (AET-C4-LE-1)  
**MASTER** Laboratory Exercise (AET-C4-LE-2) (Testing Hydraulic or Pneumatic Systems)  
**MASTER** Laboratory Aid (AET-C4-LA)  
**MASTER** Quiz AET-C4-QU-1: Measuring pressures and flow  
**MASTER** Quiz AET-C4-QU-2: Measuring pressure control valves and pumping systems

---

**References:**

*Industrial Hydraulic Technology*, Parker Hannifin Inc., Latest Edition  
*Hydraulics for Engineering Technology*, Johnson, Latest Edition  
*Fluid Power with Applications*, Esposito, Latest Edition  
*Fluid Power Technology*, Kokernak, Latest Edition  
Video(s): *Fluid Power*, Bergwall Productions, Latest Edition

---

**Student Preparation:**

Students should have previously completed the following Technical Modules:

- AET-A5 "Measure, Calculate, and Convert Quantities in English and Metric (SI, mks) Systems of measurement"
- AET-A8 "Use Math and Mechanical Physics to Analyze Problems Found in Hydraulic and Pneumatic Systems"
- AET-B4 "Use Symbols, Organization, and Engineering Values on Fluid Power Drawings"
- AET-F1 "Identify and Explain the Theory and Use of Major Systems that Comprise a Hydraulic or Pneumatic System"
- AET-F2 "Apply purpose and Use of Valves in a Hydraulic or Pneumatic System to Troubleshoot Components or Systems"
- AET-F3 "Identify, Assemble, Measure, and Apply Knowledge of Operating Characteristics of Hydraulic and Pneumatic Actuators"
- AET-F4 "Apply Hydraulic, Pneumatic, and High Vacuum Systems Knowledge to Test, Troubleshoot, and Repair Special Components/Devices"

---

---

**Introduction:**

The science of measurement is called metrology. This is not to be confused with meteorology, which is the science of weather. Metrology, and measurement devices such as flow meters, pressure gauges, and temperature gauges, allow the modern automation technician to determine the relative health of hydraulic or pneumatic systems. However, measuring and calibrating fluid power circuits, must be done in a manner that does not expose the technician to hazards from pressurized systems and

damage the equipment and/or the instruments. To achieve this goal, the technician must be aware of the parameters of the type of measure that is to be attempted, and the manner in which the instrument is connected for the measurement.

---

---

**Presentation Outline:**

- I. Use Flow Meters and Pressure Gauges to Test/Calibrate Hydraulic and Pneumatic Circuits
  - A. Explain the various type of gauges available and their usefulness in testing flows and pressure
  - B. Demonstrate the various methods of connecting a flow meter, or pressure gauge to a hydraulic or pneumatic system
  - C. Demonstrate the proper methods for using the above gauges to test/calibrate hydraulic or pneumatic systems
- II. Use Test Apparatus to Test/Calibrate Pressure Control Valves and Hydraulic and Pneumatic Pumping Systems
  - A. Demonstrate the connection of a flow meter, pressure gage, flow control valve, and temperature gage to serve as a test apparatus
  - B. Demonstrate the proper methods for using the above setup to test hydraulic or pneumatic pressure control valves or pumping systems
  - C. Identify the correct points at which a test port should be installed in the system to allow the measurements
  - D. Explain the methods by which the effectiveness and calibration of a fluid power can be measured

---

---

**Practical Application:**

1. Connect flow and pressure gauges to a hydraulic and pneumatic system; read pressures and flows; and,
2. Connect a test apparatus to a hydraulic and pneumatic system; test pressure control valves, and pumping systems.

---

---

**Evaluation and/or Verification:**

Successful completion of this technical module will be based on the student's successful completion of the following components:

1. A ten question quiz on measuring flow and pressure (MASTER Quiz AET-C4-QU-1: Measuring pressures and flow);
2. A ten question quiz on using the test apparatus to measure fluid power systems (MASTER Quiz AET-C4-QU-2: Measuring pressure control valves and pumping systems); and,
3. Demonstrate competency in measuring flow and pressure (MASTER Laboratory Exercise AET-C4-LE-2) (Testing Hydraulic or Pneumatic Systems).

---

---

**Summary:**

Review the main lesson points at each subsection of the module using the suggested texts and handouts listed in the reference section of this module. Hold class discussion and answer student questions.

---

---

**Next Lesson Assignment:**

**MASTER Technical Module (AET-C5)** dealing with applying digital electronic measurement knowledge and instruments to test/calibrate digital electronic circuits.

## AET-C4-HO-1

### Apply Fluid Power Measurement and Instruments to Test/Calibrate Hydraulic and Pneumatic Systems

#### Attachment 1: MASTER Handout No. 1

---

#### Objective(s):

Upon completion of this unit the student will be able to:

- a. Use flow meters and pressure gauges to test/calibrate hydraulic and pneumatic circuits;
- b. Use test apparatus to test/calibrate pressure control valves and hydraulic and pneumatic pumping systems;
- c. Use a hydraulic flow meter, properly connect the meter, and measure flow in quantities such as Gallons per Minute (GPM) or Liters per Minute (LPM) in a hydraulic system;
- d. Use a pneumatic flow meter, properly connect the meter and measure flow in quantities such as Standard Cubic Feet per Minute (SCFM), Standard Cubic Feet per Hour (SCFH), or Liters per Minute (LPM);
- e. Properly install the correct gauge, and measure pressures in both the English Engineering and SI systems of measurement for both hydraulic and pneumatic systems; and,
- f. Use a hydraulic or pneumatic test unit to measure temperature, flow , pressure, the cracking pressure on hydraulic or pneumatic pressure control valves, and the efficiency of a hydraulic or pneumatic pumping system.

---

#### Module Outline:

- I. Use Flow Meters and Pressure Gauges to Test/Calibrate Hydraulic and Pneumatic Circuits
  - A. Explain the various type of gauges available and their usefulness in testing flows and pressure
  - B. Demonstrate the various methods of connecting a flow meter, or pressure gauge to a hydraulic or pneumatic system
  - C. Demonstrate the proper methods for using the above gauges to test/calibrate hydraulic or pneumatic systems
- II. Use Test Apparatus to Test/Calibrate Pressure Control Valves and Hydraulic and Pneumatic Pumping Systems
  - A. Demonstrate the connection of a flow meter, pressure gage, flow control valve, and temperature gage to serve as a test apparatus
  - B. Demonstrate the proper methods for using the above setup to test hydraulic or pneumatic pressure control valves or pumping systems
  - C. Identify the correct points at which a test port should be installed in the system to allow the measurements

- D. Explain the methods by which the effectiveness and calibration of a fluid power can be measured



**AET-C4-LE-1**

**Apply Fluid Power Measurement and Instruments  
to Test/Calibrate Hydraulic and Pneumatic Systems**

**Attachment 3: MASTER Laboratory Exercise No. 1**

---

The student shall:

1. Connect flow and pressure gauges to a hydraulic and pneumatic system; read pressures and flows; and,
2. Connect a test apparatus to a hydraulic and pneumatic system; test pressure control valves, and pumping systems.

**AET-C4-LA**  
**Apply Fluid Power Measurement and Instruments**  
**to Test/Calibrate Hydraulic and Pneumatic Systems**  
**Attachment 5: MASTER Laboratory Aid**

---

**Rules of Conduct**

1. Absolutely no horseplay or practical joking will be tolerated.
2. Do not talk to anyone who is operating a machine.
3. Walk only in the designated traffic lanes.
4. Dress appropriately; at the absolute minimum, you must have:
  - a. No loose clothing, including ties;
  - b. Long hair properly stowed;
  - c. No jewelry;
  - d. Hard, closed-toe shoes;
  - e. Eye protection (safety glasses); and,
  - f. Ear protection (plugs or headset).
5. Follow all institutional safety rules.

# AUTOMATED EQUIPMENT TECHNICIAN/CIM SERIES

## MASTER Technical Module No. AET-C5

---

<b>Subject:</b>	<b>Automated Equipment Repair</b>	<b>Time: 12 Hrs.</b>
<b>Duty:</b>	<b>Use Calibrated Measuring Instruments to Test/Calibrate Components</b>	
<b>Task:</b>	<b>Apply Digital Electronic Measurement Knowledge and Instruments to Test/Calibrate Digital Electronic Circuits</b>	

---

### Objective(s):

Upon completion of this unit the student will be able to:

- a. Use digital logic probes and digital logic analyzers to test digital circuits;
- b. Use a computer to simulate and troubleshoot digital logic circuits;
- c. Use an oscilloscope, to measure the properties of digital wave forms such as pulse time, rise and fall times, propagation delay times, and voltage levels;
- d. Use a function generator, to adjust the instrument to produce wave forms that are of the proper amplitude, frequency, and form to test various digital circuits;
- e. Use a digital logic analyzer, to set up tests to determine the functionality of a digital printed circuit board or complex integrated circuit such as an Application Specific Integrated Circuit (ASIC); and,
- f. Use a computer, to set up a simulation of the operation of a digital circuit to facilitate the troubleshooting of the circuit.

---

### Instructional Materials:

Variable frequency function generators capable of DB switching, DC outputs, AC outputs, square wave outputs, triangular wave outputs, and sawtooth outputs

20 to 100 Megahertz dual trace oscilloscope with switchable manual/auto triggering, and 20 volts to 5 mV vertical deflection

20 to 100 Megahertz dual trace oscilloscope with isolated channels switchable manual/auto triggering, and 20 volts to 5 mV vertical deflection (optional)

Logic probes

Digital logic analyzers (very expensive; the instructor may want to use handouts and lecture to accomplish this requirement)

Unix, Apple, or MSDOS based computer system with a minimum of  
Electronics Workbench (digital) (or equivalent) installed  
MASTER Handout (AET-C5-HO-1)  
MASTER Handout (AET-C5-HO-2) (Setting up a Test on a Digital System  
Using a Digital Logic Analyzer)  
MASTER Laboratory Exercise (AET-C5-LE)  
MASTER Laboratory Aid (AET-C5-LA)  
MASTER Quiz AET-C5-QU-1: Using logic probes and digital logic analyzers  
MASTER Quiz AET-C5-QU-2: Using computers to simulate/ troubleshoot  
digital logic systems

---

### References:

*Applied Electronic Instrumentation and Measurement*, Buchla and  
McLachlan, Latest Edition  
*Modern Industrial Electronics*, Revised and Expanded Edition by  
Schuler/MacNamee, Latest Edition, (formerly *Industrial Electronics  
and Robotics* by Schuler/MacNamee, 1987)  
*The Complete Guide to Electronics Troubleshooting*, Perozzo, Latest  
Edition  
*Troubleshooting Electronic Equipment the Right Way Without Using  
Expensive Test Instruments*, Douglas-Young, Latest Edition  
Operation manuals for computer-based digital modeling software

The instructor may want to supplement the text by using the handouts  
contained in this module.

---

### Student Preparation:

Students should have previously completed the following Technical Modules:

- AET-A6 "Use Physics, Algebra, and Trigonometry to Analyze Simple  
Vectored Forces"
- AET-B2 "Use Symbols, Organization, and Engineering Values on  
Electrical Drawings"
- AET-B3 "Use Symbols, Organization, and Engineering Values on  
Electronic Drawings"
- AET-B5 "Use Symbols, Organization, and Engineering Values on Digital  
Drawings"
- AET-C4 "Apply Fluid Power Measurement and Instruments to  
Test/Calibrate Hydraulic and Pneumatic Systems"
- AET-G1 "Perform Digital Operations in Digital Numbering Systems"
- AET-G2 "Perform Boolean Operations in Digital Equipment"

- AET-G3** “Solve Digital Logic Circuits and Ladder Diagrams in Electrical and Programmable Logic Control Circuits; Express a Complex Logic Problem in Boolean and Convert it into Ladder Logic”
- AET-I1** “Use Equipment Manuals, Manufacturer’s Specifications, and Data Entry/Monitoring Devices to Configure, Test and Troubleshoot Set Up of a Computer System and Solve Control Problems”

---

---

**Introduction:**

The science of measurement is called metrology. This is not to be confused with meteorology, which is the science of weather. Metrology, and measurement devices such as function generators, oscilloscopes, digital logic probes, digital logic analyzers and computer simulations allow the modern automation technician to perform complex digital electronic measurements with relative ease and safety. However, measuring and calibrating digital electronic circuits, must be done in a manner that does not expose the technician to electrical hazards and damage the equipment and/or the instrument. This is especially true with oscilloscopes and function generators. To achieve this goal, the technician must be aware of the parameters of the type of measure that is to be attempted, the setup of the test, and the manner in which the instrument is connected for the measurement. At a minimum, the digital electronics or automation technician must be able to use the above devices safely and effectively.

---

---

**Presentation Outline:**

- I. Use Logic Probes and Digital Logic Analyzers to Test Digital Circuits
  - A. Explain the criteria by which a digital signal is measured
  - B. Demonstrate the use and limitations of a logic probe in measuring a digital logic signal
  - C. Explain the concept of ground loops and measuring reference points
  - D. Demonstrate the use of an oscilloscope in measuring a digital logic signal
  - E. Demonstrate the procedure for setting up a digital test using a digital logic analyzer (MASTER Handout AET-C5-HO-2) (Setting up a Test on a Digital System Using a Digital Logic Analyzer)
- II. Use a Computer to Simulate and Troubleshoot a Digital Logic Circuit
  - A. Identify computer-based modeling software such as Electronic Work Bench suitable for digital circuit modeling
    1. Explain the concept of computer modeling of digital circuits
    2. Describe the type of software that will be used
    3. Explain the procedure for starting the software
    4. Describe the procedures for constructing circuits, and features of the software

5. List some other software available to accomplish computer modeling of digital circuits and the computer requirements
- B. Demonstrate the procedures for constructing circuits and using the test modes of the software

---

---

**Practical Application:**

1. Test the logical outputs of a microprocessor for a robot or CNC control system;
2. Create a test procedure for testing the microprocessor on a CNC or robotic control system; and,
3. Model a digital circuit from a schematic diagram for one of the sub-sections of a CNC or robot control system.

---

---

**Evaluation and/or Verification:**

Successful completion of this technical module will be based on the student's successful completion of the following components:

1. A ten question quiz on using logic probes and digital logic analyzers (MASTER Quiz AET-C5-QU-1: Using logic probes and digital logic analyzers);
2. A ten question quiz on using modeling software based upon the type of software used in this module;
3. Demonstrate competency in testing digital circuits with a logic probe; and,
4. Demonstrate competency in using the software, constructing circuits, and modeling the circuit.

---

---

**Summary:**

Review the main lesson points at each subsection of the module using the suggested texts and handouts listed in the reference section of this module. Hold class discussion and answer student questions.

---

---

**Next Lesson Assignment:**

**MASTER Technical Module (AET-D1)** dealing with applying the troubleshooting process to the resolution of malfunctions found in industrial machine tools and automated equipment.

**AET-C5-HO-1**  
**Use Calibrated Measuring Instruments**  
**to Test/Calibrate Components**  
Attachment 1: MASTER Handout No. 1

---

**Objective(s):**

Upon completion of this unit the student will be able to:

- a. Use digital logic probes and digital logic analyzers to test digital circuits;
- b. Use a computer to simulate and troubleshoot digital logic circuits;
- c. Use an oscilloscope, to measure the properties of digital wave forms such as pulse time, rise and fall times, propagation delay times, and voltage levels;
- d. Use a function generator, to adjust the instrument to produce wave forms that are of the proper amplitude, frequency, and form to test various digital circuits;
- e. Use a digital logic analyzer, to set up tests to determine the functionality of a digital printed circuit board or complex integrated circuit such as an Application Specific Integrated Circuit (ASIC); and,
- f. Use a computer, to set up a simulation of the operation of a digital circuit to facilitate the troubleshooting of the circuit.

---

**Module Outline:**

- I. Use Logic Probes and Digital Logic Analyzers to Test Digital Circuits
  - A. Explain the criteria by which a digital signal is measured
  - B. Demonstrate the use and limitations of a logic probe in measuring a digital logic signal
  - C. Explain the concept of ground loops and measuring reference points
  - D. Demonstrate the use of an oscilloscope in measuring a digital logic signal
  - E. Demonstrate the procedure for setting up a digital test using a digital logic analyzer (MASTER Handout AET-C5-HO-2) (Setting up a Test on a Digital System Using a Digital Logic Analyzer)
- II. Use a Computer to Simulate and Troubleshoot a Digital Logic Circuit
  - A. Identify computer-based modeling software such as Electronic Work Bench suitable for digital circuit modeling
    1. Explain the concept of computer modeling of digital circuits
    2. Describe the type of software that will be used
    3. Explain the procedure for starting the software
    4. Describe the procedures for constructing circuits, and features of the software

5. List some other software available to accomplish computer modeling of digital circuits and the computer requirements
- B. Demonstrate the procedures for constructing circuits and using the test modes of the software



**AET-C5-LE**  
**Use Calibrated Measuring Instruments**  
**to Test/Calibrate Components**  
**Attachment 3: MASTER Laboratory Exercise**

---

The students will:

1. Test the logical outputs of a microprocessor for a robot or CNC control system;
2. Create a test procedure for testing the microprocessor on a CNC or robotic control system; and,
3. Model a digital circuit from a schematic diagram for one of the sub-sections of a CNC or robot control system.

**AET-C5-LA**  
**Use Calibrated Measuring Instruments**  
**to Test/Calibrate Components**  
**Attachment 4: MASTER Laboratory Aid**

---

**Rules of Conduct**

1. Absolutely no horseplay or practical joking will be tolerated.
2. Do not talk to anyone who is operating a machine.
3. Walk only in the designated traffic lanes.
4. Dress appropriately; at the absolute minimum, you must have:
  - a. No loose clothing, including ties;
  - b. Long hair properly stowed;
  - c. No jewelry;
  - d. Hard, closed-toe shoes;
  - e. Eye protection (safety glasses); and,
  - f. Ear protection (plugs or headset).
5. Follow all institutional safety rules.

**AUTOMATED EQUIPMENT REPAIR TECHNICIAN ... operates, programs, maintains, and repairs automated machine tools and automated manufacturing processes.**

**Duties**

**Tasks**

Duties	A-1 Apply scientific notation and solve technical problems	A-2 Apply algebraic formulas to solve technical problems	A-3 Use scientific formulas to predict behavior of industrial systems	A-4 Magnitude variables in algebraic formulas to analyze industrial systems	A-5 Measure, convert, and use metric (SI) measurement	A-6 Use mechanical physics to analyze mechanical systems	A-7 Use mechanical physics to analyze industrial systems	A-8 Use mathematical dynamics to analyze problems found in industrial systems	A-9 Use mathematical dynamics to analyze problems found in industrial systems	A-10 Use mathematical and optics to analyze industrial systems	A-11 Use chemical formulas to predict and analyze reactions in industrial processes	A-12 Apply electrochemical effects to analyze industrial processes	A-13 Apply properties to analyze industrial water treatment processes
<b>A</b> Apply Science to Solve Industrial Problems	B-1 Use symbols, organization, and engineering drawings	B-2 Use symbols, organization, and engineering drawings	B-3 Use symbols, organization, and engineering drawings	B-4 Use symbols, organization, and engineering drawings	B-5 Use symbols, organization, and engineering drawings	B-6 Use symbols, organization, and engineering drawings	B-7 Use symbols, organization, and engineering drawings	B-8 Use symbols, organization, and engineering drawings	B-9 Use symbols, organization, and engineering drawings	B-10 Use symbols, organization, and engineering drawings	B-11 Use symbols, organization, and engineering drawings	B-12 Use symbols, organization, and engineering drawings	B-13 Use symbols, organization, and engineering drawings
<b>B</b> Use Drawings to Analyze Mechanical Systems	C-1 Apply mechanical knowledge to troubleshoot mechanical components	C-2 Apply electrical knowledge to troubleshoot electrical circuits	C-3 Apply electronic knowledge to troubleshoot electronic circuits	C-4 Apply fluid power knowledge to troubleshoot hydraulic and pneumatic systems	C-5 Apply digital electronic knowledge to troubleshoot digital electronic circuits	C-6 Apply digital electronic knowledge to troubleshoot digital electronic circuits	C-7 Apply digital electronic knowledge to troubleshoot digital electronic circuits	C-8 Apply digital electronic knowledge to troubleshoot digital electronic circuits	C-9 Apply digital electronic knowledge to troubleshoot digital electronic circuits	C-10 Apply digital electronic knowledge to troubleshoot digital electronic circuits	C-11 Apply digital electronic knowledge to troubleshoot digital electronic circuits	C-12 Apply digital electronic knowledge to troubleshoot digital electronic circuits	C-13 Apply digital electronic knowledge to troubleshoot digital electronic circuits
<b>C</b> Use Calibrated Instruments to Measure Mechanical Components	D-1 Apply the troubleshooting process to the resolution of malfunctions found in machine tools and automated equipment	D-2 Calculate, predict, and measure response of quantities in AC circuits	D-3 Calculate, predict, and measure response of quantities in AC circuits	D-4 Calculate, predict, and measure response of quantities in polyphase AC circuits	D-5 Properly set up, calibrate, and use oscilloscope	D-6 Apply electronic components	D-7 Use meters/oscilloscopes to troubleshoot series resistive-capacitive/inductive AC circuits	D-8 Apply electronic magnetism theory to troubleshoot solenoids, transformers, and electrical DC and AC circuits	D-9 Apply principles of operation to troubleshoot various types of motors	D-10 Apply semiconductor theory to troubleshoot power control semiconductors	D-11 Apply semiconductor theory to troubleshoot semiconductors	D-12 Apply semiconductor theory to troubleshoot semiconductors	D-13 Apply schematic diagrams, and other techniques to identify, troubleshoot and repair electronic motor control circuits
<b>D</b> Resolve System Failures with Critical Thinking, Troubleshooting, Memory, and Methodology	E-1 Identify and explain the theory and use of major systems that comprise a pneumatic system	E-2 Apply valve and use of pneumatic components or systems	E-3 Identify, assemble, measure, and apply knowledge of operating characteristics of pneumatic actuators	E-4 Apply hydraulic and pneumatic knowledge to troubleshoot special components/devices	E-5 Identify, assemble, measure, and apply knowledge of operating characteristics of specialized fluid power circuits	E-6 Identify, assemble, measure, and apply knowledge of operating characteristics of specialized fluid power circuits	E-7 Use laws of simple machines and physics to troubleshoot vacuum systems	E-8 Apply vacuum systems to troubleshoot and repair high purity, high vacuum systems	E-9 Apply vacuum systems to troubleshoot and repair high purity, high vacuum systems	E-10 Apply vacuum systems to troubleshoot and repair high purity, high vacuum systems	E-11 Apply vacuum systems to troubleshoot and repair high purity, high vacuum systems	E-12 Apply vacuum systems to troubleshoot and repair high purity, high vacuum systems	E-13 Apply vacuum systems to troubleshoot and repair high purity, high vacuum systems
<b>E</b> Use Techniques to Isolate Electrical/Electronic Systems	F-1 Perform digital operations and troubleshooting systems	F-2 Perform Boolean operations and troubleshooting equipment	F-3 Solve digital logic control circuit problems in Boolean logic	F-4 Program computers and troubleshoot industrial equipment	F-5 Identify, assemble, measure, and adjust components or components	F-6 Identify, assemble, measure, and adjust components or components	F-7 Identify, assemble, measure, and adjust components or components	F-8 Identify, assemble, measure, and adjust components or components	F-9 Identify, assemble, measure, and adjust components or components	F-10 Identify, assemble, measure, and adjust components or components	F-11 Identify, assemble, measure, and adjust components or components	F-12 Identify, assemble, measure, and adjust components or components	F-13 Identify, assemble, measure, and adjust components or components
<b>F</b> Measure/Isolate Malfunctions of Mechanical/Fluid Power Systems	G-1 Perform digital operations and troubleshooting systems	G-2 Perform Boolean operations and troubleshooting equipment	G-3 Solve digital logic control circuit problems in Boolean logic	G-4 Program computers and troubleshoot industrial equipment	G-5 Identify, assemble, measure, and adjust components or components	G-6 Identify, assemble, measure, and adjust components or components	G-7 Identify, assemble, measure, and adjust components or components	G-8 Identify, assemble, measure, and adjust components or components	G-9 Identify, assemble, measure, and adjust components or components	G-10 Identify, assemble, measure, and adjust components or components	G-11 Identify, assemble, measure, and adjust components or components	G-12 Identify, assemble, measure, and adjust components or components	G-13 Identify, assemble, measure, and adjust components or components
<b>G</b> Apply Computer Science to Computer Controlled Industrial Equipment	H-1 Perform operations on PLC (Programmable Logic Controller) interface equipment	H-2 Perform operations on PLC (Programmable Logic Controller) interface equipment	H-3 Perform operations on PLC (Programmable Logic Controller) interface equipment	H-4 Perform operations on PLC (Programmable Logic Controller) interface equipment	H-5 Perform operations on PLC (Programmable Logic Controller) interface equipment	H-6 Perform operations on PLC (Programmable Logic Controller) interface equipment	H-7 Perform operations on PLC (Programmable Logic Controller) interface equipment	H-8 Perform operations on PLC (Programmable Logic Controller) interface equipment	H-9 Perform operations on PLC (Programmable Logic Controller) interface equipment	H-10 Perform operations on PLC (Programmable Logic Controller) interface equipment	H-11 Perform operations on PLC (Programmable Logic Controller) interface equipment	H-12 Perform operations on PLC (Programmable Logic Controller) interface equipment	H-13 Perform operations on PLC (Programmable Logic Controller) interface equipment
<b>H</b> Correct Malfunctions in PLC Controlled Industrial Equipment	I-1 Perform operations on manufacturer's specifications, and data entry/troubleshooting set up of a computer control problems	I-2 Perform operations on manufacturer's specifications, and data entry/troubleshooting set up of a computer control problems	I-3 Perform operations on manufacturer's specifications, and data entry/troubleshooting set up of a computer control problems	I-4 Perform operations on manufacturer's specifications, and data entry/troubleshooting set up of a computer control problems	I-5 Perform operations on manufacturer's specifications, and data entry/troubleshooting set up of a computer control problems	I-6 Perform operations on manufacturer's specifications, and data entry/troubleshooting set up of a computer control problems	I-7 Perform operations on manufacturer's specifications, and data entry/troubleshooting set up of a computer control problems	I-8 Perform operations on manufacturer's specifications, and data entry/troubleshooting set up of a computer control problems	I-9 Perform operations on manufacturer's specifications, and data entry/troubleshooting set up of a computer control problems	I-10 Perform operations on manufacturer's specifications, and data entry/troubleshooting set up of a computer control problems	I-11 Perform operations on manufacturer's specifications, and data entry/troubleshooting set up of a computer control problems	I-12 Perform operations on manufacturer's specifications, and data entry/troubleshooting set up of a computer control problems	I-13 Perform operations on manufacturer's specifications, and data entry/troubleshooting set up of a computer control problems
<b>I</b> Resolve Malfunctions Found in Computer Systems Manufacturing Processes	J-1 Safely assemble, disassemble, and adjust systems such as shafts, couplings, bearings, etc.	J-2 Safely assemble, disassemble, and adjust systems such as shafts, couplings, bearings, etc.	J-3 Safely assemble, disassemble, and adjust systems such as shafts, couplings, bearings, etc.	J-4 Safely assemble, disassemble, and adjust systems such as shafts, couplings, bearings, etc.	J-5 Safely assemble, disassemble, and adjust systems such as shafts, couplings, bearings, etc.	J-6 Safely assemble, disassemble, and adjust systems such as shafts, couplings, bearings, etc.	J-7 Safely assemble, disassemble, and adjust systems such as shafts, couplings, bearings, etc.	J-8 Safely assemble, disassemble, and adjust systems such as shafts, couplings, bearings, etc.	J-9 Safely assemble, disassemble, and adjust systems such as shafts, couplings, bearings, etc.	J-10 Safely assemble, disassemble, and adjust systems such as shafts, couplings, bearings, etc.	J-11 Safely assemble, disassemble, and adjust systems such as shafts, couplings, bearings, etc.	J-12 Safely assemble, disassemble, and adjust systems such as shafts, couplings, bearings, etc.	J-13 Safely assemble, disassemble, and adjust systems such as shafts, couplings, bearings, etc.
<b>J</b> Assemble/Disassemble Mechanical/Electronic and Computer Systems													

BEST COPY AVAILABLE

# AUTOMATED EQUIPMENT REPAIR SERIES

## MASTER Technical Module No. AET-D1

---

**Subject:** Automated Equipment Repair **Time:** 48 Hrs.

**Duty:** Resolve System Failures With Critical Thinking, Troubleshooting, Theory, And Metrology

**Task:** Apply the Troubleshooting Process to the Resolution of Malfunctions Found in Industrial Machine Tools and Automated Equipment

---

### Objective(s):

Upon completion of this unit the student will be able to:

- a. Identify nature/purpose of a system, subsystem, module, or component in a complex manufacturing machine/process;
- b. Apply theory to predict behavior of a complex manufacturing machine or process;
- c. Measure complex manufacturing machine/process to determine if it is meeting theoretical expectations;
- d. Analyze results to determine if system, subsystem, module, or component is meeting manufacturer's specifications;
- e. Apply critical thinking to determine if system is malfunctioning or if process must be reapplied;
- f. Validate the process and apply corrective action;
- g. If corrective action does not result in repair of system, reapply the process;
- h. Identify major systems, subsystems, and components of a CNC system;
- i. Apply the theory of operation of the major systems, subsystems, and components of a CNC system;
- j. Determine the proper measurements to determine the operating condition of the major systems, subsystems, and components of a CNC system;
- k. Apply critical thinking to the determination of problems in the major systems, subsystems, and components of a CNC system; and,
- l. Analyze the results of the troubleshooting process and determine the nature and type of corrective action that must be applied or if the troubleshooting process must be reapplied.

---

### Instructional Materials:

A CNC controlled machine tool or robot

*Note:* Not all facilities can gain access to a CNC machine tool that can be experimented upon. Most CNCs are tied up in production

schedules, or they are educational machines that would require expensive repairs if something failed during experimentation. Under these circumstances, the instructor may want to use lab kits that provide experience in some of the major systems that comprise a CNC machine tool. However, the most desirable method of completing this module is hands-on experimentation with a real industrial CNC or robot.

Measuring instruments such as:

- Multimeters
- Oscilloscopes
- Function generators
- Clamp-on ammeters
- RPM meters
- Spring scales
- Pressure gauges
- Flow meters
- Dial indicators
- Dial calipers
- Micrometers

**MASTER Handout (AET-D1-HO-1)**

**MASTER Handout (AET-D1-HO-2) (Block Diagram of a Typical CNC System)**

**MASTER Handout (AET-D1-HO-3) (CNC Subsystems)**

**MASTER Handout (AET-D1-HO-4) (CNC Schematic Diagrams)**

**MASTER Handout (AET-D1-HO-5) (CNC Ladder Diagrams)**

**MASTER Handout (AET-D1-HO-6) (CNC Mechanical Systems)**

**MASTER Handout (AET-D1-HO-7) (CNC Hydraulic/Pneumatic Systems)**

**MASTER Handout (AET-D1-HO-8) (Operating Systems of a CNC)**

**MASTER Overhead (AET-D1-OV-1) (Block Diagram of a Typical CNC System)**

**MASTER Overhead (AET-D1-OV-2) (CNC Subsystems)**

**MASTER Overhead (AET-D1-OV-3) (CNC Schematic Diagrams)**

**MASTER Overhead (AET-D1-OV-4) (CNC Ladder Diagrams)**

**MASTER Overhead (AET-D1-OV-5) (CNC Mechanical Systems)**

**MASTER Overhead (AET-D1-OV-6) (CNC Hydraulic/Pneumatic Systems)**

**MASTER Laboratory Exercise (AET-D1-LE)**

**MASTER Laboratory Aid (AET-D1-LA)**

**MASTER Quiz AET-D1-QU-1: Identification of CNC systems**

**MASTER Quiz AET-D1-QU-2: Theory of operations of CNC machines**

**MASTER Quiz AET-D1-QU-3: Measurement of CNC subsystems**

**MASTER Quiz AET-D1-QU-4: Applying critical thinking to troubleshooting**

---

## References:

The author has not found a suitable text that covers the theory and maintenance of a CNC machine. Most texts only cover programming and machining practices for CNC equipment. For this reason the handouts and material that accompany this module will be rich with detail and practical applications.

---

## Student Preparation:

Students should have previously completed the following Technical Modules:

AET-A1 through AET-A13	“Apply Science to Solve Industrial Problems” series
AET-B1 through AET-B5	“Use Drawings to Analyze and Repair Systems” series
AET-C1 through AET-C5	“Use Calibrated Measuring Instruments to Test/Calibrate Components” series
AET-E1 through AET-E13	“Use Techniques to Isolate Malfunctions of Electrical/Electronic Systems” series
AET-F1 through AET-F7	“Measure/Isolate Malfunctions of Mechanical/Fluid Power Systems” series
AET-G1 through AET-G4	“Apply Computer Science to Computer Controlled Industrial Equipment” series
AET-H1	“Correct Malfunctions in PLC Controlled Industrial Equipment” series
AET-I1	“Resolve Malfunctions Found in Computer Systems Controlling Manufacturing Processes” series
AET-J1 through AET-J5	“Assemble/Disassemble Mechanical Electrical, Electronic, and Computer Systems” series

---

---

## Introduction:

The story is told of an old experienced technician, who was being quizzed repeatedly by a supervisor, as to when he would finish repairing the system that he was working on. After some hours of being interrupted in this fashion by the anxious foreman, the technician turned to the man, looked him squarely in the eye, and replied:

"About 15 minutes after I find the #%@!! problem! "

This is the part of repair and automation that most people, who are not automation technicians, do not understand. To the uninformed, the problem is simple. Fixing a piece of equipment simply means changing the bad component. Anyone who is a automation technician understands that replacing the bad component can be a matter of minutes, but *finding it*, can be a matter of *days*. Also, when a competent technician troubleshoots a large complex system, much of his or her time is spent on just staring

at the machine and thinking. Although this appears to be idle time, the technician is following a hard and fast rule that all good technicians learn by experience: **Use your head before you use your hands!**

Another story may serve to illustrate this concept:

A technician is contracted to repair a large, expensive, complex, automation system. As the nervous managers and team leaders look on, the technician studies the system. After a few minutes of contemplation, the technician takes a large screw driver out of the tool box and wacks the machine at one corner. To everyone's surprise, the machine starts to work, and continues to work perfectly. A few weeks later, the technician submits the bill for his services to the company. The bill totals \$10,001.47. The outraged manager of the company calls the technician, and says:

"Why is this bill so high? All that you did was to wack the machine and leave!"

The technician replied:

"The \$1.47 is for the use of the screw driver. The \$10,000 is for knowing were to hit it!"

There are no hard and fast rules that a technician must follow that will lead to efficient repair of automated systems. However, an analysis of what an competent CNC technician does when he or she is troubleshooting a piece of automated equipment, can reveal some common practices and procedures that result in the technician's effectiveness.

The model used for this module will be a CNC machine tool. A CNC machine tool is a robot, and contains the same technology that most automated systems use. The first numerical control machine (NC) was built in 1995 at MIT. This was the first true robot. All subsequent machine tools, including CNC machines and robots, used the same concepts, but employed advanced technology, and different geometries.

---

---

### **Presentation Outline:**

- I. Identify Nature/Purpose of a System, Subsystem, Module, or Component in a Complex Manufacturing Machine/Process
  - A. Explain the overall operation of a CNC machine tool (MASTER Handout AET-D1-HO-8) (Operating Systems of a CNC)
    1. Explain and demonstrate the purpose of a CNC
    2. Explain and demonstrate the geometry of a two, three, and five axis CNC and its relationship to the rectangular coordinate system
    3. Explain and demonstrate incremental and absolute positioning
    4. Explain and demonstrate the difference between point-to-point and continuous path servo systems



- B. Explain the major system blocks of a CNC system (MASTER Handout AET-D1-HO-2) (Block Diagram of a Typical CNC System) and (MASTER Overhead AET-D1-OV-1) (Block Diagram of a Typical CNC System)
    - 1. Identify the location and organization of the major subsystems of a CNC machine tool
    - 2. Demonstrate the identification of major subsystems of a CNC system
  - C. Explain the modules and components of CNC subsystems (MASTER Handout AET-D1-HO-3) (CNC Subsystems); (MASTER Handout AET-D1-HO-4) (CNC Schematic Diagrams); (MASTER Handout AET-D1-HO-5) (CNC Ladder Diagrams); (MASTER Handout AET-D1-HO-6) (CNC Mechanical Systems); and, (MASTER Handout AET-D1-HO-7) (CNC Hydraulic/Pneumatic Systems); see also, (MASTER Overhead AET-D1-OV-2) (CNC Subsystems); (MASTER Overhead AET-D1-OV-3) (CNC Schematic Diagrams); (MASTER Overhead AET-D1-OV-4) (CNC Ladder Diagrams); (MASTER Overhead AET-D1-OV-5) (CNC Mechanical Systems); and, (MASTER Overhead AET-D1-OV-6) (CNC Hydraulic/Pneumatic Systems)
    - 1. Identify the location of modules and components in CNC subsystems giving equal weight to electrical, electronic, mechanical, and hydraulic/pneumatic subsystems
    - 2. Demonstrate the identification of subsystem modules and components
- II. Apply Theory to Predict Behavior of a Complex Manufacturing Machine or Process
- A. Explain the theory of operation of major system blocks of a CNC system (MASTER Handout AET-D1-HO-2) (Block Diagram of a Typical CNC System) and (MASTER Overhead AET-D1-OV-1) (Block Diagram of a Typical CNC System)
    - 1. Explain the theory of operation of the major subsystems of a CNC machine tool
    - 2. Demonstrate the application of the theory of operation of major subsystems of a CNC system
  - B. Explain the theory of operation of modules and components of CNC subsystems (MASTER Handout AET-D1-HO-3) (CNC Subsystems); (MASTER Handout AET-D1-HO-4) (CNC Schematic Diagrams); (MASTER Handout AET-D1-HO-5) (CNC Ladder Diagrams); (MASTER Handout AET-D1-HO-6) (CNC Mechanical Systems); and, (MASTER Handout AET-D1-HO-7) (CNC Hydraulic/Pneumatic Systems); see also (MASTER Overhead AET-D1-OV-2) (CNC Subsystems); (MASTER Overhead AET-D1-OV-3) (CNC Schematic Diagrams); (MASTER Overhead AET-D1-OV-4) (CNC Ladder Diagrams); (MASTER Overhead AET-D1-OV-5) (CNC Mechanical



- Systems); and, (MASTER Overhead AET-D1-OV-6) (CNC Hydraulic/Pneumatic Systems)
1. Explain the theory of operation of modules and components in CNC subsystems giving equal weight to electrical, electronic, mechanical, and hydraulic/pneumatic subsystems
  2. Demonstrate the application of the theory of operation of subsystem modules and components
- III. Measure Complex Manufacturing Machine/Process to Determine if it is Meeting Theoretical Expectations
- A. Explain the critical measuring points for major system blocks of a CNC system (MASTER Handout AET-D1-HO-2) (Block Diagram of a Typical CNC System) and (MASTER Overhead AET-D1-OV-1) (Block Diagram of a Typical CNC System)
    1. Explain the points of measurement and types of measurements of the major subsystems of a CNC machine tool
    2. Demonstrate the application of measurements of major subsystems of a CNC system
  - B. Explain the critical measuring points for modules and components of CNC subsystems (MASTER Handout AET-D1-HO-3) (CNC Subsystems); (MASTER Handout AET-D1-HO-4) (CNC Schematic Diagrams); (MASTER Handout AET-D1-HO-5) (CNC Ladder Diagrams); (MASTER Handout AET-D1-HO-6) (CNC Mechanical Systems); and, (MASTER Handout AET-D1-HO-7) (CNC Hydraulic/Pneumatic Systems); see also (MASTER Overhead AET-D1-OV-2) (CNC Subsystems); (MASTER Overhead AET-D1-OV-3) (CNC Schematic Diagrams); (MASTER Overhead AET-D1-OV-4) (CNC Ladder Diagrams); (MASTER Overhead AET-D1-OV-5) (CNC Mechanical Systems); and, (MASTER Overhead AET-D1-OV-6) (CNC Hydraulic/Pneumatic Systems)
    1. Explain the points of measurement and types of measurements of modules and components in CNC subsystems giving equal weight to electrical, electronic, mechanical, and hydraulic/pneumatic subsystems
    2. Demonstrate the application of measurements of subsystem modules and components
- IV. Analyze Results to Determine if System, Subsystem, Module, or Component is Meeting Manufacturer's Specifications
- A. Explain the types of specifications for major system blocks of a CNC system (MASTER Handout AET-D1-HO-2) (Block Diagram of a Typical CNC System) and (MASTER Overhead AET-D1-OV-1) (Block Diagram of a Typical CNC System)
    1. Explain the nature of the specifications and the types of specifications of the major subsystems of a CNC machine tool
    2. Demonstrate the application of specifications of major subsystems of a CNC system

- B. Explain the types of specifications for modules and components of CNC subsystems (MASTER Handout AET-D1-HO-3) (CNC Subsystems); (MASTER Handout AET-D1-HO-4) (CNC Schematic Diagrams); (MASTER Handout AET-D1-HO-5) (CNC Ladder Diagrams); (MASTER Handout AET-D1-HO-6) (CNC Mechanical Systems); and, (MASTER Handout AET-D1-HO-7) (CNC Hydraulic/Pneumatic Systems); see also (MASTER Overhead AET-D1-OV-2) (CNC Subsystems); (MASTER Overhead AET-D1-OV-3) (CNC Schematic Diagrams); (MASTER Overhead AET-D1-OV-4) (CNC Ladder Diagrams); (MASTER Overhead AET-D1-OV-5) (CNC Mechanical Systems); and, (MASTER Overhead AET-D1-OV-6) (CNC Hydraulic/Pneumatic Systems)
  - 1. Explain the specifications of modules and components in CNC subsystems giving equal weight to electrical, electronic, mechanical, and hydraulic/pneumatic subsystems
  - 2. Demonstrate the application of specifications of subsystem modules and components
- V. Apply Critical Thinking to Determine if System is Malfunctioning or if Process Must Be Reapplied
  - A. Explain the procedures for applying critical thinking
    - 1. Explain the concept of critical thinking
      - a. Make no assumptions
      - b. Only apply common sense that is proven by hard facts
      - c. Verify the data
      - d. Allow the data to dictate the results
      - e. Apply the adage: "The simplest theory that meets all the known, observable facts is usually the correct theory"
      - f. Question all results until no other explanation is reasonable
    - 2. Demonstrate the application of critical thinking
  - B. Explain the point at which the results of a troubleshooting process must be reapplied
- VI. Validate the Process and Apply Corrective Action
  - A. Explain the point at which the troubleshooting process must be considered to be verified, and demonstrate the verification of the troubleshooting process
  - B. Demonstrate the application of corrective action
    - 1. Replacement of an entire subsystem
    - 2. Replacement of a module or component
    - 3. Troubleshooting to the component level
- VII. If Corrective Action Does Not Result in Repair of System, Reapply the Process
  - A. Explain the reasons that corrective action may not result in a solution to the problem
    - 1. More than one problem in the system

2. One system causing a problem in another system
  3. Demonstrate situations in which a corrective action may not result in repair to the system
    - a. Substituting bad components
    - b. Improper installation of components
    - c. One system affecting another system
- B. Explain the procedures for re-applying the troubleshooting process

---

---

**Practical Application:**

1. Using an industrial CNC machine, apply the concepts contained in this module.

---

---

**Evaluation and/or Verification:**

Successful completion of this technical module will be based on the student's successful completion of the following components:

1. A twenty question quiz on the industrial application of the concepts contained in this module (MASTER Quiz AET-D1-QU-1: Identification of CNC systems);
2. A twenty question quiz on the industrial application of the concepts contained in this module (MASTER Quiz AET-D1-QU-2: Theory of operations of CNC machines);
3. A twenty question quiz on the industrial application of the concepts contained in this module (MASTER Quiz AET-D1-QU-3: Measurement of CNC subsystems);
4. A twenty question quiz on the industrial application of the concepts contained in this module (MASTER Quiz AET-D1-QU-4: Applying critical thinking to troubleshooting);
5. Completion of selected laboratory experiences or completion of analysis of industrial CNC machines;
6. Demonstrate competency in the ability to **identify** major subsystems, modules and components of CNC machine tools;
7. Demonstrate competency in the ability to **apply** theory to major subsystems, modules and components of CNC machine tools;
8. Demonstrate competency in the ability to **measure** major subsystems, modules and components of CNC machine tools; and,
9. Demonstrate competency in the ability to **analyze** major subsystems, modules and components of CNC machine tools.

---

---

**Summary:**

Review the main lesson points using the texts and handouts listed in the reference section of this module. Stress the industrial applications of the concepts. Hold class discussion and answer student questions.

---

---

**Next Lesson Assignment:**

**MASTER Technical Module (AET-E1)** dealing with calculating, predicting, and measuring the response of quantities in DC circuits.

## AET-D1-HO-1

### Apply the Troubleshooting Process to the Resolution of Malfunctions Found in Industrial Machine Tools and Automated Equipment

#### Attachment 1: MASTER Handout No. 1

---

#### Objective(s):

Upon completion of this unit the student will be able to:

- a. Identify nature/purpose of a system, subsystem, module, or component in a complex manufacturing machine/process;
- b. Apply theory to predict behavior of a complex manufacturing machine or process;
- c. Measure complex manufacturing machine/process to determine if it is meeting theoretical expectations;
- d. Analyze results to determine if system, subsystem, module, or component is meeting manufacturer's specifications;
- e. Apply critical thinking to determine if system is malfunctioning or if process must be reapplied;
- f. Validate the process and apply corrective action;
- g. If corrective action does not result in repair of system, reapply the process;
- h. Identify major systems, subsystems, and components of a CNC system;
- i. Apply the theory of operation of the major systems, subsystems, and components of a CNC system;
- j. Determine the proper measurements to determine the operating condition of the major systems, subsystems, and components of a CNC system;
- k. Apply critical thinking to the determination of problems in the major systems, subsystems, and components of a CNC system; and,
- l. Analyze the results of the troubleshooting process and determine the nature and type of corrective action that must be applied or if the troubleshooting process must be reapplied.

---

#### Module Outline:

- I. Identify Nature/Purpose of a System, Subsystem, Module, or Component in a Complex Manufacturing Machine/Process
  - A. Explain the overall operation of a CNC machine tool (MASTER Handout AET-D1-HO-8) (Operating Systems of a CNC)
    1. Explain and demonstrate the purpose of a CNC
    2. Explain and demonstrate the geometry of a two, three, and five axis CNC and its relationship to the rectangular coordinate system
    3. Explain and demonstrate incremental and absolute positioning

4. Explain and demonstrate the difference between point-to-point and continuous path servo systems
  - B. Explain the major system blocks of a CNC system (MASTER Handout AET-D1-HO-2) (Block Diagram of a Typical CNC System) and (MASTER Overhead AET-D1-OV-1) (Block Diagram of a Typical CNC System)
    1. Identify the location and organization of the major subsystems of a CNC machine tool
    2. Demonstrate the identification of major subsystems of a CNC system
  - C. Explain the modules and components of CNC subsystems (MASTER Handout AET-D1-HO-3) (CNC Subsystems); (MASTER Handout AET-D1-HO-4) (CNC Schematic Diagrams); (MASTER Handout AET-D1-HO-5) (CNC Ladder Diagrams); (MASTER Handout AET-D1-HO-6) (CNC Mechanical Systems); and, (MASTER Handout AET-D1-HO-7) (CNC Hydraulic/Pneumatic Systems); see also, (MASTER Overhead AET-D1-OV-2) (CNC Subsystems); (MASTER Overhead AET-D1-OV-3) (CNC Schematic Diagrams); (MASTER Overhead AET-D1-OV-4) (CNC Ladder Diagrams); (MASTER Overhead AET-D1-OV-5) (CNC Mechanical Systems); and, (MASTER Overhead AET-D1-OV-6) (CNC Hydraulic/Pneumatic Systems)
    1. Identify the location of modules and components in CNC subsystems giving equal weight to electrical, electronic, mechanical, and hydraulic/pneumatic subsystems
    2. Demonstrate the identification of subsystem modules and components
- II. Apply Theory to Predict Behavior of a Complex Manufacturing Machine or Process
- A. Explain the theory of operation of major system blocks of a CNC system (MASTER Handout AET-D1-HO-2) (Block Diagram of a Typical CNC System) and (MASTER Overhead AET-D1-OV-1) (Block Diagram of a Typical CNC System)
    1. Explain the theory of operation of the major subsystems of a CNC machine tool
    2. Demonstrate the application of the theory of operation of major subsystems of a CNC system
  - B. Explain the theory of operation of modules and components of CNC subsystems (MASTER Handout AET-D1-HO-3) (CNC Subsystems); (MASTER Handout AET-D1-HO-4) (CNC Schematic Diagrams); (MASTER Handout AET-D1-HO-5) (CNC Ladder Diagrams); (MASTER Handout AET-D1-HO-6) (CNC Mechanical Systems); and, (MASTER Handout AET-D1-HO-7) (CNC Hydraulic/Pneumatic Systems); see also (MASTER Overhead AET-D1-OV-2) (CNC Subsystems); (MASTER Overhead AET-D1-OV-3) (CNC Schematic Diagrams); (MASTER Overhead AET-D1-OV-4) (CNC Ladder

Diagrams); (MASTER Overhead AET-D1-OV-5) (CNC Mechanical Systems); and, (MASTER Overhead AET-D1-OV-6) (CNC Hydraulic/Pneumatic Systems)

1. Explain the theory of operation of modules and components in CNC subsystems giving equal weight to electrical, electronic, mechanical, and hydraulic/pneumatic subsystems
2. Demonstrate the application of the theory of operation of subsystem modules and components

**III. Measure Complex Manufacturing Machine/Process to Determine if it is Meeting Theoretical Expectations**

**A.. Explain the critical measuring points for major system blocks of a CNC system (MASTER Handout AET-D1-HO-2) (Block Diagram of a Typical CNC System) and (MASTER Overhead AET-D1-OV-1) (Block Diagram of a Typical CNC System)**

1. Explain the points of measurement and types of measurements of the major subsystems of a CNC machine tool
2. Demonstrate the application of measurements of major subsystems of a CNC system

**B. Explain the critical measuring points for modules and components of CNC subsystems (MASTER Handout AET-D1-HO-3) (CNC Subsystems); (MASTER Handout AET-D1-HO-4) (CNC Schematic Diagrams); (MASTER Handout AET-D1-HO-5) (CNC Ladder Diagrams); (MASTER Handout AET-D1-HO-6) (CNC Mechanical Systems); and, (MASTER Handout AET-D1-HO-7) (CNC Hydraulic/Pneumatic Systems); see also (MASTER Overhead AET-D1-OV-2) (CNC Subsystems); (MASTER Overhead AET-D1-OV-3) (CNC Schematic Diagrams); (MASTER Overhead AET-D1-OV-4) (CNC Ladder Diagrams); (MASTER Overhead AET-D1-OV-5) (CNC Mechanical Systems); and, (MASTER Overhead AET-D1-OV-6) (CNC Hydraulic/Pneumatic Systems)**

1. Explain the points of measurement and types of measurements of modules and components in CNC subsystems giving equal weight to electrical, electronic, mechanical, and hydraulic/pneumatic subsystems
2. Demonstrate the application of measurements of subsystem modules and components

**IV. Analyze Results to Determine if System, Subsystem, Module, or Component is Meeting Manufacturer's Specifications**

**A. Explain the types of specifications for major system blocks of a CNC system (MASTER Handout AET-D1-HO-2) (Block Diagram of a Typical CNC System) and (MASTER Overhead AET-D1-OV-1) (Block Diagram of a Typical CNC System)**

1. Explain the nature of the specifications and the types of specifications of the major subsystems of a CNC machine tool



2. Demonstrate the application of specifications of major subsystems of a CNC system
- B. Explain the types of specifications for modules and components of CNC subsystems (MASTER Handout AET-D1-HO-3) (CNC Subsystems); (MASTER Handout AET-D1-HO-4) (CNC Schematic Diagrams); (MASTER Handout AET-D1-HO-5) (CNC Ladder Diagrams); (MASTER Handout AET-D1-HO-6) (CNC Mechanical Systems); and, (MASTER Handout AET-D1-HO-7) (CNC Hydraulic/Pneumatic Systems); see also (MASTER Overhead AET-D1-OV-2) (CNC Subsystems); (MASTER Overhead AET-D1-OV-3) (CNC Schematic Diagrams); (MASTER Overhead AET-D1-OV-4) (CNC Ladder Diagrams); (MASTER Overhead AET-D1-OV-5) (CNC Mechanical Systems); and, (MASTER Overhead AET-D1-OV-6) (CNC Hydraulic/Pneumatic Systems)
  1. Explain the specifications of modules and components in CNC subsystems giving equal weight to electrical, electronic, mechanical, and hydraulic/pneumatic subsystems
  2. Demonstrate the application of specifications of subsystem modules and components
- V. Apply Critical Thinking to Determine if System is Malfunctioning or if Process Must Be Reapplied
  - A. Explain the procedures for applying critical thinking
    1. Explain the concept of critical thinking
      - a. Make no assumptions
      - b. Only apply common sense that is proven by hard facts
      - c. Verify the data
      - d. Allow the data to dictate the results
      - e. Apply the adage: "The simplest theory that meets all the known, observable facts is usually the correct theory"
      - f. Question all results until no other explanation is reasonable
    2. Demonstrate the application of critical thinking
  - B. Explain the point at which the results of a troubleshooting process must be reapplied
- VI. Validate the Process and Apply Corrective Action
  - A. Explain the point at which the troubleshooting process must be considered to be verified, and demonstrate the verification of the troubleshooting process
  - B. Demonstrate the application of corrective action
    1. Replacement of an entire subsystem
    2. Replacement of a module or component
    3. Troubleshooting to the component level
- VII. If Corrective Action Does Not Result in Repair of System, Reapply the Process



- A. Explain the reasons that corrective action may not result in a solution to the problem
  - 1. More than one problem in the system
  - 2. One system causing a problem in another system
  - 3. Demonstrate situations in which a corrective action may not result in repair to the system
    - a. Substituting bad components
    - b. Improper installation of components
    - c. One system affecting another system
- B. Explain the procedures for re-applying the troubleshooting process

**AET-D1-LE**

**Apply the Troubleshooting Process to the Resolution of Malfunctions  
Found in Industrial Machine Tools and Automated Equipment  
Attachment 15: MASTER Laboratory Exercise**

---

The student will:

1. Use an industrial CNC machine to apply the concepts contained in this module.

## AET-D1-LA

# Apply the Troubleshooting Process to the Resolution of Malfunctions Found in Industrial Machine Tools and Automated Equipment

## Attachment 16: MASTER Laboratory Aid

---

### Rules of Conduct

1. Absolutely no horseplay or practical joking will be tolerated.
2. Do not talk to anyone who is operating a machine.
3. Walk only in the designated traffic lanes.
4. Dress appropriately; at the absolute minimum, you must have:
  - a. No loose clothing, including ties;
  - b. Long hair properly stowed;
  - c. No jewelry;
  - d. Hard, closed-toe shoes;
  - e. Eye protection (safety glasses); and,
  - f. Ear protection (plugs or headset).
5. Follow all institutional safety rules.

**AUTOMATED EQUIPMENT REPAIR TECHNICIAN ... operates, programs, maintains, and repairs automated machine tools and automated manufacturing processes.**

**Duties**

**Tasks**

Duties	A-1 Apply scientific notation and solve industrial problems	A-2 Apply algebraic formulas to solve technical problems	A-3 Use variables in algebraic formulas to predict behavior of industrial systems	A-4 Manipulate algebraic formulas to analyze industrial systems	A-5 Measure, calculate, and convert quantities in English units to metric units	A-6 Use mechanical physics to analyze mechanical systems	A-7 Use mechanical physics to analyze mechanical systems	A-8 Use mechanical physics to analyze problems found in pneumatic and hydraulic systems	A-9 Apply principles of dynamics to analyze various types of motors	A-10 Use mathematical formulas to predict and analyze reactions in industrial processes	A-11 Use chemical formulas to predict and analyze reactions in industrial processes	A-12 Apply knowledge of electrochemical effects to analyze industrial processes	A-13 Apply principles of electronics to analyze industrial processes
<b>A</b> Apply Science to Solve Industrial Problems													
<b>B</b> Use Drawings to Analyze and Repair Systems													
<b>C</b> Use Calibrated Measuring Instruments to Test/Calibrate Components													
<b>D</b> Resolve System Failures with Critical Thinking, Troubleshooting, and Metrology													
<b>E</b> Use Techniques to Isolate Functions of Electrical/Electronic Systems													
<b>F</b> Measure/Isolate Malfunctions of Mechanical/Fluid Power Systems													
<b>G</b> Apply Computer Science to Computer Controlled Industrial Equipment													
<b>H</b> Correct Malfunctions in PLC Controlled Industrial Equipment													
<b>I</b> Resolve Malfunctions Found in Computer Systems Manufacturing Processes													
<b>J</b> Assemble/Disassemble Mechanical/Electronic and Computer Systems													

# **AUTOMATED EQUIPMENT REPAIR SERIES**

## **MASTER Technical Module No. AET-E1**

---

**Subject:** Automated Equipment Repair

**Time:** 16 Hrs.

**Duty:** Use Techniques to Isolate Malfunctions of Electrical/Electronic Systems

**Task:** Calculate, Predict, and Measure the Response of Quantities in DC Circuits

---

**Objective(s):**

Upon completion of this unit the student will be able to:

- a. Use math and the theory of DC circuits to predict the behavior of DC circuits;
- b. Understand the different effects of voltage current and resistance on electrical hazards;
- c. Calculate any of the three quantities of DC current, DC voltage or resistance given any of the two values, and apply proper engineering terms to the results of the calculations;
- d. Predict the behavior of an electronic or electrical circuit for a change of any of the three values of DC current, DC voltage or resistance;
- e. Calculate the quantity of power produced in a circuit given a value of voltage and current, and apply proper engineering values to the calculations;
- f. Predict the effects of the power in the circuit given a measured or calculated value of power, and also predict the behavior of the circuit power for a change in voltage or current;
- g. Calculate the expected time of charge of a capacitor given a value of resistance and capacitance, and apply proper engineering values to the results of the calculations;
- h. Measure the time of charge and the voltage given a value of resistance and capacitance, to determine if the circuit is responding as predicted by the calculations; and,
- i. Identify inductive components, and measure their inductance.

---

**Instructional Materials:**

The following measurement instruments

Digital multimeters with capacitance and inductance scales

Conventional analog multimeters, voltmeters, ammeters, and ohmmeters (optional)

Conventional capacitance and inductance instruments (optional)

MASTER Handout (AET-E1-HO)  
MASTER Lesson Plan (AET-E1-LP) (Electrical Safety)  
MASTER Laboratory Exercise No. 1 (AET-E1-LE1)  
MASTER Laboratory Exercise No. 2 (AET-E1-LE2)  
MASTER Laboratory Exercise No. 3 (AET-E1-LE3)  
MASTER Laboratory Aid (AET-E1-LA)  
MASTER Quiz AET-E1-QU-1: DC Electrical/Electronic Concepts  
MASTER Quiz AET-E1-QU-2: Electrical Safety

---

**References:**

*Electricity/Electronics Fundamentals*, Zbar/Sloop, Latest Edition  
*Introductory DC/AC Electronics*, Nigel P. Cook, Latest Edition (with interactive software)  
*Modern Industrial Electronics, Revised and Expanded Edition*, Schuler/MacNamee, Latest Edition (formerly, *Industrial Electronics and Robotics*, Schuler/MacNamee, 1987)  
*The Complete Guide to Electronics Troubleshooting*, Perozzo, Latest Edition  
Video(s): *Basic Electricity DC Circuits*, Bergwall Productions, 1-800-645-3565, Latest Edition  
*Working Safely With Electricity*, Bergwall Productions, 1-800-645-3565, Latest Edition

Note: Bergwall Productions will be referenced frequently throughout the AET section because the company provides quality video productions at a reasonable price, unlike other video production companies.

The following items are *not recommended* because they detract from the hands-on nature of this module. These items may be used as a supplement for the module if the module contains actual interaction with real electrical and electronic parts. Electricity and electronics is a “messy” technology, because actual parts and measuring devices are not perfect. The following items are theoretically perfect, and therefore do not reflect the real world of electricity and electronics.

*PSPICE* - Program for modeling the behavior of electrical and electronic components.

*Electronic Workbench* - Graphic Windows based program for constructing theoretical models of electrical and electronic circuits.

---

## **Student Preparation:**

Students should have previously completed the following Technical Modules:

- AET-A6** "Use Physics, Algebra, and Trigonometry to Analyze Simple Vectored Forces"
- AET-B2** "Use Symbols, Organization, and Engineering Values on Electrical Drawings"
- AET-B3** "Use Symbols, Organization, and Engineering Values on Electronic Drawings"

---

---

## **Introduction:**

The science of electricity and electronics is at the heart of modern industrial control system. However, measuring a circuit's electrical currents, voltages, and resistances, must be done in a manner that does not expose the technician to electrical hazards and damage the equipment and/or the instrument. To achieve this goal, the technician must be aware of the parameters of the type of measure that is to be attempted, and the expected outcome of the measurement.

---

---

## **Presentation Outline:**

- I. Use Math and the Theory of DC Circuits to Predict the Behavior of DC Circuits
  - A. Units of measurement of electrical DC voltage current and resistance
    - 1. Explain the concepts of voltage, current, and resistance for DC circuits
    - 2. Explain the units of measurement for DC voltage current and resistance
    - 3. Provide examples of each quantity
    - 4. Explain the mathematical tools and procedures that can be used to solve problems in complex DC circuits, including resistive bridge circuits
    - 5. Demonstrate the mathematical solution of voltage ,current, resistance and power in DC systems
    - 6. Demonstrate the procedures for verifying the calculations by measurement
  - B. Explain the concept of inductance and capacitance for DC voltages and currents
    - 1. Explain the behavior of a capacitor in a DC circuit
    - 2. Explain the units of measurement of capacitors (capacitance and working voltage)
    - 3. Explain the behavior of an inductor in a DC circuit
    - 4. Explain the units of measurement of an inductor
    - 5. Demonstrate the magnetic field produced by an inductor

6. Explain how capacitors and inductors are used in electrical and electronic circuits, and provide examples of each use in a working control system for a robot or CNC machine
  7. Demonstrate the measurement of capacitive and inductive components
- C. Demonstrate the procedure for safely measuring, current, voltage, resistance, capacitance, and inductance in DC circuits
- II. Electrical/Electronics Safety
- A. Follow the lesson plan contained in MASTER Lesson Plan (AET-E1-LP) (Electrical Safety)

---

---

**Practical Application:**

1. Using an industrial control system demonstrate the measurement of voltage, current, resistance, power, capacitance, and inductance;
2. Calculate the parameters of the system from the measurements; and,
3. Using an industrial control system demonstrate electrical safety procedures.

---

---

**Evaluation And/or Verification:**

Successful completion of this technical module will be based on the student's successful completion of the following components:

1. A twenty question quiz on DC electricity/electronics (MASTER Quiz AET-E1-QU-1: DC Electrical/Electronic Concepts);
2. A twenty question quiz on Electrical Safety (MASTER Quiz AET-E1-QU-2: Electrical Safety); and,
3. Completion of practical labs on DC resistive, capacitive and inductive circuits.

---

---

**Summary:**

Review the main lesson points at each subsection of the module using the suggested texts and handouts listed in the reference section of this module. Hold class discussion and answer student questions.

---

---

**Next Lesson Assignment:**

**MASTER Technical Module (AET-E2)** dealing with calculating, predicting, and measuring the response of quantities in AC circuits.



**AET-E1-HO**  
**Calculate, Predict, and Measure**  
**the Response of Quantities in DC Circuits**  
**Attachment 1: MASTER Handout**

---

**Objective(s):**

Upon completion of this unit the student will be able to:

- a. Use math and the theory of DC circuits to predict the behavior of DC circuits;
- b. Understand the different effects of voltage current and resistance on electrical hazards;
- c. Calculate any of the three quantities of DC current, DC voltage or resistance given any of the two values, and apply proper engineering terms to the results of the calculations;
- d. Predict the behavior of an electronic or electrical circuit for a change of any of the three values of DC current, DC voltage or resistance;
- e. Calculate the quantity of power produced in a circuit given a value of voltage and current, and apply proper engineering values to the calculations;
- f. Predict the effects of the power in the circuit given a measured or calculated value of power, and also predict the behavior of the circuit power for a change in voltage or current;
- g. Calculate the expected time of charge of a capacitor given a value of resistance and capacitance, and apply proper engineering values to the results of the calculations;
- h. Measure the time of charge and the voltage given a value of resistance and capacitance, to determine if the circuit is responding as predicted by the calculations; and,
- i. Identify inductive components, and measure their inductance.

---

**Module Outline:**

- I. Use Math and the Theory of DC Circuits to Predict the Behavior of DC Circuits
  - A. Units of measurement of electrical DC voltage current and resistance
    1. Explain the concepts of voltage, current, and resistance for DC circuits
    2. Explain the units of measurement for DC voltage current and resistance
    3. Provide examples of each quantity
    4. Explain the mathematical tools and procedures that can be used to solve problems in complex DC circuits, including resistive bridge circuits

5. Demonstrate the mathematical solution of voltage ,current, resistance and power in DC systems
  6. Demonstrate the procedures for verifying the calculations by measurement
- B. Explain the concept of inductance and capacitance for DC voltages and currents
1. Explain the behavior of a capacitor in a DC circuit
  2. Explain the units of measurement of capacitors (capacitance and working voltage)
  3. Explain the behavior of an inductor in a DC circuit
  4. Explain the units of measurement of an inductor
  5. Demonstrate the magnetic field produced by an inductor
  6. Explain how capacitors and inductors are used in electrical and electronic circuits, and provide examples of each use in a working control system for a robot or CNC machine
  7. Demonstrate the measurement of capacitive and inductive components
- C. Demonstrate the procedure for safely measuring, current, voltage, resistance, capacitance, and inductance in DC circuits
- II. Electrical/Electronics Safety
- A. Follow the lesson plan contained in MASTER Lesson Plan (AET-E1-LP) (Electrical Safety)

**AET-E1-LP**  
**Calculate, Predict, and Measure**  
**the Response of Quantities in DC Circuits**  
**Attachment No. 2: MASTER Lesson Plan**

---

**Electrical Safety**

**Notes to the instructor:**

You will need the following materials:

The below handout  
Digital Multimeter  
Analog Multimeter  
Three plastic or metal bowls  
Distilled water or chemically pure water  
Tap water  
Salt

**Lesson Objectives:**

1. Discover that water does not have zero resistance;
2. Discover that electrical hazard is dependent upon body resistance, and if the source is high enough, or body resistance is low enough, injury can occur;
3. Understand the different effects of voltage current and resistance on electrical hazards; and,
4. Practice in measuring resistance and Ohm's Law calculations.

**This lesson is designed to be 2 to 3 hours in duration for beginning electrical or electronic students.**

**First hour**

During the first part, which is an ice breaker, the students will be exposed to measurements of water and body resistance using an analog and a digital meter. The students should be the experimenters and you may have to interpret the meter scale.

**Activities:**

1. Have students provide written respond to question:  
**Of the three components of Ohm's Law; voltage, current, and resistance; which one of the three is most useful in determining your potential electrical hazard ?**

2. Measure class body resistance, record and calculate class average (have students hold probes with the same pressure they would hold a pencil).
3. Measure resistance of three bowls of water with two meters.
4. Select four volunteers, have three dip hands into bowls, and one exercise, and re-measure resistance of each.

### **Second two hours**

The second part of the lesson is designed to present useful stories of real workers who were exposed to hazardous electrical potentials. The students should be allowed to discuss the stories and imagine the results.

### **Activities:**

1. Present facts about electrical hazard (you may want to add to the following):  
*mean human body resistance*  
**1 Milliamp -You can feel it**  
**10 Milliamps -You can't let go**  
**100 Milliamps -Is usually fatal**
2. Present four scenarios. **Do not** reveal the below results until after the students have performed the calculations.
  - a. In scenario one, the sailor contacted 24 volts DC from a boat radio. The sailor was drenched in salt water and the shock was very powerful. The area was confined, and the reaction caused bruises and a injured back when the sailor jerked away from the radio. The sailor lived.
  - b. In scenario two, the workman was facing a 440 volt three phase bus when he tried to measure the voltage of the bus with his meter set to the current scale. The mistake was the result of two safety violations. First, the workman was in a hurry, and second there was no one working with him; he was alone on the shift. Practically the entire current capacity of the bus conducted through the meter. The workman was in a confined area and was facing the contact point when the arc flash occurred. It felt like a hand grenade went off in his face, and the resultant flash temporarily blinded him. The workman suffered flash burns of the face and eyes. The workman lived.
  - c. In scenario three, the workman was troubleshooting an induction brazer and was working with a co-worker who was nearby. The 18,000 volts was the potential of the plate cap of a large power vacuum tube. The workman merely pointed to the plate cap to show his coworker

where it was, and the plate voltage arced to his finger. Unfortunately the current path was down the workers left side (he was left handed) and he went into cardiac arrest. Little was known about CPR when this event occurred, and before the ambulance could arrive, the worker died. (CPR would have saved his life)

- d. In scenario four the workman was troubleshooting a 20,000 volt power supply on an explosive forming machine. The machine was designed to hurl lightening bolts through a mold filled with de-ionized water. The resulting explosion formed metal parts in the mold. The machine was powered down, but due to a design flaw, the 20 KV supply was still energized. The workman grabbed the 20 KV bus and was knocked unconscious. The current arced through the workman's upper arm, where it was resting on the chassis, and through his crepe soled shoes, to a pool of de-ionized water which was surrounding the equipment. He received severe burns to his arm and foot. However, he lived to tell the tale.
3. Have the students perform the calculations as outlined in the below table in the handout. They should pay careful attention to the current their own body resistance causes. They should compare it to the above table of current and results.
4. Present the same question:  
**Of the three components of Ohm's Law; voltage, current, and resistance; which one of the three is most useful in determining your potential electrical hazard ?**
5. Describe the results of the scenarios and lead class discussion on the results.

**AET-E1-LE1**  
**Calculate, Predict, and Measure**  
**the Response of Quantities in DC Circuits**  
**Attachment 3: MASTER Laboratory Exercise No. 1**

---

Name: \_\_\_\_\_

**Introduction**

An essential portion of your job will involve working with electrical and electronics equipment. During the operations that you will perform, you *will* be exposed to electrical hazards. Electrical energy is frightening to many people. Anyone who has been shocked by an electrical circuit may learn to fear electrical energy. The following series of lectures is designed to remove the mystery that surrounds electricity and to determine the real facts that you will need to know to assess the danger that you will face when working around electrical circuits.

To determine the extent of the hazards that an industrial electrical/electronics technician must face, you need to know the following facts.

- A. **The *mean* human body resistance of the overall population is 250,000 ohms**
- B. **A rule of thumb for determining electrical hazard is the following:  
1 Milliamp -You can feel it  
10 Milliamps -You can't let go  
100 Milliamps -Is usually fatal**

1. **Of the three components of Ohm's Law; voltage, current, and resistance; which one of the three is most useful in determining your potential electrical hazard?**

Answer: \_\_\_\_\_

2. **Enter *your* body resistance.**

Answer: \_\_\_\_\_

3. **Enter the average body resistance of the class.**

Answer: \_\_\_\_\_

**AET-E1-LE2**  
**Calculate, Predict, and Measure**  
**the Response of Quantities in DC Circuits**  
**Attachment 4: MASTER Laboratory Exercise No. 2**

---

Name: \_\_\_\_\_

**Introduction**

In this section I will choose four volunteers to measure their body resistance when they have dipped their hands in water or otherwise lowered their body resistance. First, however, we will experiment with the actions of at least two different kinds of meters and determine how they react when measuring the resistance of water.

**Resistance of Water When Using Analog or Digital Meter**

	Digital	Analog
Resistance of tap water		
Resistance of distilled water		
Resistance of distilled water with salt		

Volunteer number 1 - Tap water

Body resistance = \_\_\_\_\_

Volunteer number 2 - Distilled water

Body resistance = \_\_\_\_\_

Volunteer number 3 - Distilled water plus salt

Body resistance = \_\_\_\_\_

Volunteer number 4 - Exercise

Body resistance = \_\_\_\_\_

**AET-E1-LE3**  
**Calculate, Predict, and Measure**  
**the Response of Quantities in DC Circuits**  
Attachment 5: MASTER Laboratory Exercise No. 3

---

Name: \_\_\_\_\_

**Introduction**

The following events actually occurred and involved workmen in the San Diego area. Several of the victims in these events sustained injuries as a result of electrical accidents. In one case, a person died. Your task is to examine the events and to predict:

1. What was the extent of the injuries?
2. Which person was killed as a result of contacting electrical hazard?

**Scenario Number 1**

A sailor working during foul weather is exposed to electrical hazard. The voltage source involved is 24 volts DC. The potential current of the source is 500 amps of current.

Was the sailor injured, and if so, what was the extent of the injuries? Did the sailor die as a result of the exposure?

**Injuries:**

---

---

---

---

**Scenario Number 2**

An electrical maintenance worker at a local company is testing 480 volts AC on a lathe. He inadvertently uses the current scale on his meter to test the voltage. He is exposed to electrical hazard. The potential current of the source voltage is 5000 amps.

Was the workman injured, and if so, what was the extent of the injuries? Did the workman die as a result of the exposure?

**Injuries:**

---

---

---

---



**Scenario Number 3**

An electronics worker at a local company is testing the circuitry of an induction brazer. The workman is exposed to electrical hazard. The voltage source is 18,000 volts DC. The current potential of the source is 20 milliamps (20 one thousandths of an amp).

Was the workman injured? If so, what were the extent of the injuries? Did the workman die as a result of the exposure?

**Injuries:**

---

---

---

---

**Scenario Number 4**

An electronics worker at a local company is testing the circuitry of electronic explosive forming machine. The voltage source of the machine is 20,000 volts DC. The potential current of the source is 5 amps. The worker is exposed to electrical hazard.

Was the workman injured? If so, what was the extent of his injuries? Did the workman die as a result of the exposure?

**Injuries:**

---

---

---

---

Using Ohm's Law, calculate the *current* flowing through the bodies of each of the victims in each of the Scenarios based upon:

1. Your body resistance;
2. The body resistance of each of the volunteers in the class; and,
3. The class average.

*Current* calculations:

**Scenario 1**

Your body resistance \_\_\_\_\_  
Resistance of volunteer 1 \_\_\_\_\_  
Resistance of volunteer 2 \_\_\_\_\_  
Resistance of volunteer 3 \_\_\_\_\_  
Resistance of volunteer 4 \_\_\_\_\_  
Class average resistance \_\_\_\_\_

**Scenario 2**

Your body resistance \_\_\_\_\_  
Resistance of volunteer 1 \_\_\_\_\_  
Resistance of volunteer 2 \_\_\_\_\_  
Resistance of volunteer 3 \_\_\_\_\_  
Resistance of volunteer 4 \_\_\_\_\_  
Class average resistance \_\_\_\_\_

**Scenario 3**

Your body resistance \_\_\_\_\_  
Resistance of volunteer 1 \_\_\_\_\_  
Resistance of volunteer 2 \_\_\_\_\_  
Resistance of volunteer 3 \_\_\_\_\_  
Resistance of volunteer 4 \_\_\_\_\_  
Class average resistance \_\_\_\_\_

**Scenario 4**

Your body resistance \_\_\_\_\_  
Resistance of volunteer 1 \_\_\_\_\_  
Resistance of volunteer 2 \_\_\_\_\_  
Resistance of volunteer 3 \_\_\_\_\_  
Resistance of volunteer 4 \_\_\_\_\_  
Class average resistance \_\_\_\_\_

**AET-E1-LA**  
**Calculate, Predict, and Measure**  
**the Response of Quantities in DC Circuits**  
**Attachment 6: MASTER Laboratory Aid**

---

**Rules of Conduct**

1. Absolutely no horseplay or practical joking will be tolerated.
2. Do not talk to anyone who is operating a machine.
3. Walk only in the designated traffic lanes.
4. Dress appropriately; at the absolute minimum, you must have:
  - a. No loose clothing, including ties;
  - b. Long hair properly stowed;
  - c. No jewelry;
  - d. Hard, closed-toe shoes;
  - e. Eye protection (safety glasses); and,
  - f. Ear protection (plugs or headset).
5. Follow all institutional safety rules.

# AUTOMATED EQUIPMENT REPAIR SERIES

## MASTER Technical Module No. AET-E2

---

<b>Subject:</b>	Automated Equipment Repair	<b>Time:</b> 12 Hrs.
<b>Duty:</b>	Use Techniques to Isolate Malfunctions of Electrical/Electronic Systems	
<b>Task:</b>	Calculate, Predict, and Measure the Response of Quantities in AC Circuits	

---

### Objective(s):

Upon completion of this unit the student will be able to:

- a. Calculate a value of AC current, AC voltage or resistance, in a resistive circuit, given any of the two quantities and apply proper engineering terms to the results of the calculations;
- b. Calculate a value of AC current or AC voltage in an inductive or capacitive circuit given the values of capacitance, inductance, resistance and frequency, and apply proper engineering terms to the results of the calculations;
- c. Predict the behavior of a circuit for a change of any of the values of current, voltage, resistance, capacitance, inductance or frequency, in a capacitive or inductive electronic or electrical AC circuit;
- d. Calculate and measure AC voltage, current and power expressed as peak values, peak-to-peak values, RMS values, and average values; and convert these quantities from one value to another; and,
- e. Predict the effects of power in the circuit, given the values of current, voltage or resistance in a resistive, capacitive, or inductive electronic or electrical AC circuit.

---

### Instructional Materials:

The following measurement instruments

Digital multimeters with capacitance and inductance scales

Variable frequency function generators capable of dB switching, DC outputs, AC outputs, square wave outputs, triangular wave outputs, and sawtooth outputs

20 to 100 Mega Hertz dual trace oscilloscope with switchable manual/auto triggering, and 20 volts to 5 mV vertical deflection

20 to 100 Mega Hertz dual trace oscilloscope with isolated channels switchable manual/auto triggering, and 20 volts to 5 mV vertical deflection (optional)

Textbook labs that provide practical applications of the concepts contained in this module

MASTER Handout (AET-E2-HO)

MASTER Laboratory Exercise (AET-E2-LE)

MASTER Laboratory Aid (AET-E2-LA)

MASTER Quiz AET-E2-QU-1: AC capacitive and inductive circuits

---

## References:

*Electricity/Electronics Fundamentals*, Zbar/Sloop, Latest Edition

*Introductory DC/AC Electronics*, Nigel P. Cook, Latest Edition (with interactive software)

*Modern Industrial Electronics, Revised and Expanded Edition*, Schuler/MacNamee, Latest Edition (formerly, *Industrial Electronics and Robotics*, Schuler/MacNamee, 1987)

*The Complete Guide to Electronics Troubleshooting*, Perozzo, Latest Edition

**Video(s):** *Alternating Current Fundamentals*, Bergwall Productions, 1-800-645-3565, Latest Edition

*Working Safely With Electricity*, Bergwall Productions, 1-800-645-3565, Latest Edition

Note: Bergwall Productions will be referenced frequently throughout the AET section because the company provides quality video productions at a reasonable price, unlike other video production companies.

The following items are *not recommended* because they detract from the **hands-on nature of this module**. These items may be used as a supplement for the module if the module contains actual interaction with real electrical and electronic parts. Electricity and electronics is a “messy” technology, because actual parts and measuring devices are not perfect. The following items are theoretically perfect, and therefore do not reflect the real world of electricity and electronics.

*PSPICE* - Program for modeling the behavior of electrical and electronic components.

*Electronic Workbench* - Graphic Windows based program for constructing theoretical models of electrical and electronic circuits.

---

## Student Preparation:

Students should have previously completed the following Technical Modules:

- AET-A6** “Use Physics, Algebra, and Trigonometry to Analyze Simple Vectored Forces”
- AET-B2** “Use Symbols, Organization, and Engineering Values on Electrical Drawings”
- AET-E1** “Calculate, Predict, and Measure the Response of Quantities in DC Circuits”

**Note:** This module is meant to be used in conjunction with module AET-C3 “Apply Electronic Measurement Knowledge and Instruments to Test/Calibrate Electronic Circuits.”

---

---

## **Introduction:**

The behavior of voltage and current in an AC circuit is not as straight forward as the behavior of DC voltages and currents under the same circumstances. Resistive circuits behave in a relatively straight forward manner when energized by AC voltages and currents. Capacitors and inductors in AC circuits can, and do, act like resistors that are sensitive to the periodic nature of the AC (frequency). Predicting how AC will react in these circuits requires the use of trigonometry and vectors. Measurements of the parameters of an AC circuit, and the behavior of AC in components such as transformers, motors, and AC solenoids, must be done in a manner that takes these behaviors into account. To achieve this goal, the technician must be able to predict the changes that may occur in the circuit to understand the results of any measurement of the parameters of the AC circuit.

---

---

## **Presentation Outline:**

- I. Use AC theory; Measure AC Voltages and Currents
  - A. Explain the concepts of voltage, current, and resistance for resistive, single phase AC circuits
    1. Explain the concepts of voltage, current, and resistance for AC circuits
    2. Explain the units of measurement for AC voltage and current (RMS, peak, peak-to-peak, average)
    3. Provide examples of each quantity
    4. Explain the mathematical tools and procedures that can be used to solve problems in complex resistive AC circuits
    5. Demonstrate the mathematical solution of voltage, current, resistance and power in resistive AC systems
    6. Demonstrate the procedures for verifying the calculations by measurement.
  - B. Explain the concept of inductance and capacitance for AC voltages and currents
    1. Explain the behavior of AC in a capacitive AC circuit

2. Explain the behavior of AC in an inductive AC circuit
  3. Demonstrate the magnetic field produced by an inductor when energized by AC current
  4. Explain how capacitors and inductors are used in AC electrical and electronic circuits, and provide examples of each use in a working control system for a robot or CNC machine
- C. Demonstrate the procedure for safely measuring, current, voltage, resistance, in complex AC circuits

---

---

**Practical Application:**

1. Using an industrial control system demonstrate the measurement of voltage, current, resistance, power, in AC circuits; and,
2. Calculate the parameters of the system from the measurements.

---

---

**Evaluation and/or Verification:**

Successful completion of this technical module will be based on the student's successful completion of the following components:

1. A ten question quiz on capacitance and inductance in AC circuits (MASTER Quiz AET-E2-QU-1: AC capacitive and inductive circuits); and,
2. Textbook labs on practical application of the concepts contained in this module.

---

---

**Summary:**

Review the main lesson points using the texts and handouts listed in the reference section of this module. Hold class discussion and answer student questions.

---

---

**Next Lesson Assignment:**

**MASTER Technical Module (AET-E3)** dealing with calculating, predicting, and measuring impedance and phase angle in AC circuits.

**AET-E2-HO**  
**Calculate, Predict, and Measure**  
**the Response of Quantities in AC Circuits**  
**Attachment 1: MASTER Handout**

---

**Objective(s):**

Upon completion of this unit the student will be able to:

- a. Calculate a value of AC current, AC voltage or resistance, in a resistive circuit, given any of the two quantities and apply proper engineering terms to the results of the calculations;
- b. Calculate a value of AC current or AC voltage in an inductive or capacitive circuit given the values of capacitance, inductance, resistance and frequency, and apply proper engineering terms to the results of the calculations;
- c. Predict the behavior of a circuit for a change of any of the values of current, voltage, resistance, capacitance, inductance or frequency, in a capacitive or inductive electronic or electrical AC circuit;
- d. Calculate and measure AC voltage, current and power expressed as peak values, peak-to-peak values, RMS values, and average values; and convert these quantities from one value to another; and,
- e. Predict the effects of power in the circuit, given the values of current, voltage or resistance in a resistive, capacitive, or inductive electronic or electrical AC circuit.

---

**Module Outline:**

- I. Use AC theory; Measure AC Voltages and Currents
  - A. Explain the concepts of voltage, current, and resistance for resistive, single phase AC circuits
    1. Explain the concepts of voltage, current, and resistance for AC circuits
    2. Explain the units of measurement for AC voltage and current (RMS, peak, peak-to-peak, average)
    3. Provide examples of each quantity
    4. Explain the mathematical tools and procedures that can be used to solve problems in complex resistive AC circuits
    5. Demonstrate the mathematical solution of voltage, current, resistance and power in resistive AC systems
    6. Demonstrate the procedures for verifying the calculations by measurement.
  - B. Explain the concept of inductance and capacitance for AC voltages and currents
    1. Explain the behavior of AC in a capacitive AC circuit



2. Explain the behavior of AC in an inductive AC circuit
  3. Demonstrate the magnetic field produced by an inductor when energized by AC current
  4. Explain how capacitors and inductors are used in AC electrical and electronic circuits, and provide examples of each use in a working control system for a robot or CNC machine
- C. Demonstrate the procedure for safely measuring, current, voltage, resistance, in complex AC circuits

**AET-E2-LE**  
**Calculate, Predict, and Measure**  
**the Response of Quantities in AC Circuits**  
**Attachment 2: MASTER Laboratory Exercise**

---

The student will:

1. Use an industrial control system to demonstrate the measurement of voltage, current, resistance, power, in AC circuits; and,
2. Calculate the parameters of the system from the measurements.

**AET-E2-LA**  
**Calculate, Predict, and Measure**  
**the Response of Quantities in AC Circuits**  
**Attachment 3: MASTER Laboratory Aid**

---

**Rules of Conduct**

1. Absolutely no horseplay or practical joking will be tolerated.
2. Do not talk to anyone who is operating a machine.
3. Walk only in the designated traffic lanes.
4. Dress appropriately; at the absolute minimum, you must have:
  - a. No loose clothing, including ties;
  - b. Long hair properly stowed;
  - c. No jewelry;
  - d. Hard, closed-toe shoes;
  - e. Eye protection (safety glasses); and,
  - f. Ear protection (plugs or headset).
5. Follow all institutional safety rules.

# **AUTOMATED EQUIPMENT REPAIR SERIES**

## **MASTER Technical Module No. AET-E3**

---

<b>Subject:</b>	<b>Automated Equipment Repair</b>	<b>Time: 12 Hrs.</b>
<b>Duty:</b>	<b>Use Techniques to Isolate Malfunctions of Electrical/Electronic Systems</b>	
<b>Task:</b>	<b>Calculate, Predict, and Measure Impedance and Phase Angle in AC Circuits</b>	

---

### **Objective(s):**

Upon completion of this unit the student will be able to:

- a. Calculate the values of inductive reactance, and capacitive reactance in an AC circuit;
- b. Predict the change in behavior of an AC circuit for a change in frequency or a change in capacitance/inductance;
- c. Calculate expected phase shifts in a capacitive or inductive AC circuit;
- d. Measure impedance/phase angle in AC circuits;
- e. Apply the knowledge of inductive reactance, capacitive reactance, and phase shifts, to the solution of power factor problems found in industrial installations; and,
- f. Apply the knowledge of inductive reactance, capacitive reactance, and phase shifts, to the prediction of the behavior of power in AC electrical/electronic circuits.

---

### **Instructional Materials:**

The following measurement instruments:

Digital multimeters with capacitance and inductance scales

Variable frequency function generators capable of dB switching, DC outputs, AC outputs, square wave outputs, triangular wave outputs, and sawtooth outputs

20 to 100 Mega Hertz dual trace oscilloscope with switchable manual/auto triggering, and 20 volts to 5 mV vertical deflection

20 to 100 Mega Hertz dual trace oscilloscope with isolated channels switchable manual/auto triggering, and 20 volts to 5 mV vertical deflection (optional)

Textbook labs on practical applications of the concepts contained in this module

**MASTER Handout (AET-E3-HO)**

**MASTER Laboratory Exercise (AET-E3-LE)**

**MASTER Laboratory Aid (AET-E3-LA)**

MASTER Quiz AET-E3-QU-1: Impedance and phase angle  
MASTER Quiz AET-E3-QU-2: Power factor measurement

---

**References:**

- Electricity/Electronics Fundamentals*, Zbar/Sloop, Latest Edition  
*Introductory DC/AC Electronics*, Nigel P. Cook, Latest Edition (with interactive software)  
*Guide to Electrical Power Distribution Systems Equipment, Applications, Installation, and Maintenance*, Pansini, Latest Edition  
*Modern Industrial Electronics, Revised and Expanded Edition*, Schuler/MacNamee, Latest Edition (formerly, *Industrial Electronics and Robotics*, Schuler/MacNamee, 1987)  
*The Complete Guide to Electronics Troubleshooting*, Perozzo, Latest Edition
- Video(s): *Advanced AC Circuits*, Bergwall Productions, 1-800-645-3565, Latest Edition  
*Working Safely With Electricity*, Bergwall Productions, 1-800-645-3565, Latest Edition

Note: Bergwall Productions will be referenced frequently throughout the AET section because the company provides quality video productions at a reasonable price, unlike other video production companies.

The following items are *not recommended* because they detract from the hands-on nature of this module. These items may be used as a supplement for the module if the module contains actual interaction with real electrical and electronic parts. Electricity and electronics is a “messy” technology, because actual parts and measuring devices are not perfect. The following items are theoretically perfect, and therefore do not reflect the real world of electricity and electronics.

*PSPICE* - Program for modeling the behavior of electrical and electronic components.

*Electronic Workbench* - Graphic Windows based program for constructing theoretical models of electrical and electronic circuits.

---

**Student Preparation:**

Students should have previously completed the following Technical Modules:  
AET-A6 “Use Physics, Algebra, and Trigonometry to Analyze Simple Vectored Forces”

- AET-B2** “Use Symbols, Organization, and Engineering Values on Electrical Drawings”
- AET-E1** “Calculate, Predict, and Measure the Response of Quantities in DC Circuits”
- AET-E2** “Calculate, Predict, and Measure the Response of Quantities in AC Circuits”

**Note:** This module is meant to be used in conjunction with modules AET-C2 “Apply Electrical Measurement Knowledge and Instruments to Test/Calibrate Electrical Circuits” and AET-C3 “Apply Electronic Measurement Knowledge and Instruments to Test/Calibrate Electronic Circuits.”

---

---

### **Introduction:**

The behavior of voltage, current, and power in an AC circuit depends upon the amount of inductive, capacitive and resistive components that are installed in the system. Resistive circuits behave in a relatively straight forward manner when energized by AC voltages and currents, but capacitors and inductors in AC circuits can, and do, act like resistors that are sensitive to the periodic nature of the AC (frequency). Predicting how AC will react in these circuits requires the knowledge and use of the concepts of impedance and phase shifts. Measurements of the parameters of an AC circuit, and the behavior of AC in components such as transformers, motors, and AC solenoids, must be done in a manner that takes these behaviors into account. The solution of industrial problems, such as power factor correction, requires the application of these concepts.

---

---

### **Presentation Outline:**

- I. Calculate/Predict Impedance and Phase Angle in AC Circuits
  - A. Explain the concept of impedance for AC circuits
    1. Explain the concept of impedance
    2. Explain the mathematical tools and procedures that can be used to solve problems in complex resistive, inductive, and capacitive AC circuits
    3. Demonstrate the mathematical solution of voltage, current, resistance and power in complex resistive, inductive, and capacitive AC systems
  - B. Explain the concept of inductance and capacitance for AC voltages and currents
    1. Demonstrate the phase shift of AC voltage and current in a resistive-capacitive AC circuit
    2. Demonstrate the phase shift of AC voltage and current in a resistive-inductive AC circuit
    3. Explain how capacitors and inductors are used in AC electrical and electronic circuits, and provide examples of each use in a working control system for a robot or CNC machine

- II. Measure Impedance/Phase Angle in AC Circuits
  - A. Demonstrate the measurement of phase shift and phase angle
    - 1. Explain the precautions that need to be observed when using an oscilloscope to measure AC circuits
    - 2. Demonstrate the measurement of phase shift and phase angle using an oscilloscope
  - B. Demonstrate the procedure for measuring power factor and the solution of power factor problems
    - 1. Explain the precautions that need to be observed when using instruments to measure AC line voltages
    - 2. Demonstrate the calculation of power factor and the determination of capacitors used to correct power factor problems

---

---

**Practical Application:**

- 1. Using a CNC or robotic control system, identify AC capacitive and inductive circuits and the methods of determining impedance, voltages, and currents in these circuits;
- 2. Using the power distribution system to a building or facility, measure voltage, current (clamp-on ammeter), power and power factor; and,
- 3. Calculate the type of power factor capacitors need to correct the power factor for the system.

---

---

**Evaluation and/or Verification:**

Successful completion of this technical module will be based on the student's successful completion of the following components:

- 1. A ten question quiz on impedance and phase shift (MASTER Quiz AET-E3-QU-1: Impedance and phase angle);
- 2. A ten question quiz on power factor measurement and correction (MASTER Quiz AET-E3-QU-2: Power factor measurement); and,
- 3. Textbook labs on practical applications of the concepts contained in this module.

---

---

**Summary:**

Review the main lesson points at each subsection of the module using the suggested texts and handouts listed in the reference section of this module. Hold class discussion and answer student questions.

---

---

**Next Lesson Assignment:**

**MASTER Technical Module (AET-E4)** dealing with calculating, predicting, and measuring quantities in poly-phase AC circuits.



**AET-E3-HO**  
**Calculate, Predict, and Measure**  
**Impedance and Phase Angle in AC Circuits**  
**Attachment 1: MASTER Handout**

---

**Objective(s):**

Upon completion of this unit the student will be able to:

- a. Calculate the values of inductive reactance, and capacitive reactance in an AC circuit;
  - b. Predict the change in behavior of an AC circuit for a change in frequency or a change in capacitance/inductance;
  - c. Calculate expected phase shifts in a capacitive or inductive AC circuit;
  - d. Measure impedance/phase angle in AC circuits;
  - e. Apply the knowledge of inductive reactance, capacitive reactance, and phase shifts, to the solution of power factor problems found in industrial installations; and,
  - f. Apply the knowledge of inductive reactance, capacitive reactance, and phase shifts, to the prediction of the behavior of power in AC electrical/electronic circuits.
- 

**Module Outline:**

- I. Calculate/Predict Impedance and Phase Angle in AC Circuits
  - A. Explain the concept of impedance for AC circuits
    1. Explain the concept of impedance
    2. Explain the mathematical tools and procedures that can be used to solve problems in complex resistive, inductive, and capacitive AC circuits
    3. Demonstrate the mathematical solution of voltage ,current, resistance and power in complex resistive, inductive, and capacitive AC systems
  - B. Explain the concept of inductance and capacitance for AC voltages and currents
    1. Demonstrate the phase shift of AC voltage and current in a resistive-capacitive AC circuit
    2. Demonstrate the phase shift of AC voltage and current in a resistive-inductive AC circuit
    3. Explain how capacitors and inductors are used in AC electrical and electronic circuits, and provide examples of each use in a working control system for a robot or CNC machine
- II. Measure Impedance/Phase Angle in AC Circuits
  - A. Demonstrate the measurement of phase shift and phase angle

1. Explain the precautions that need to be observed when using an oscilloscope to measure AC circuits
  2. Demonstrate the measurement of phase shift and phase angle using an oscilloscope
- B. Demonstrate the procedure for measuring power factor and the solution of power factor problems
1. Explain the precautions that need to be observed when using instruments to measure AC line voltages
  2. Demonstrate the calculation of power factor and the determination of capacitors used to correct power factor problems

**AET-E3-LE**  
**Calculate, Predict, and Measure**  
**Impedance and Phase Angle in AC Circuits**  
**Attachment 2: MASTER Laboratory Exercise**

---

The student will:

1. Use a CNC or robotic control system to identify AC capacitive and inductive circuits and the methods of determining impedance, voltages, and currents in these circuits;
2. Use the power distribution system to a building or facility to measure voltage, current (clamp-on ammeter), power and power factor; and,
3. Calculate the type of power factor capacitors need to correct the power factor for the system.

**AET-E3-LA**  
**Calculate, Predict, and Measure**  
**Impedance and Phase Angle in AC Circuits**  
**Attachment 3: MASTER Laboratory Aid**

---

**Rules of Conduct**

1. Absolutely no horseplay or practical joking will be tolerated.
2. Do not talk to anyone who is operating a machine.
3. Walk only in the designated traffic lanes.
4. Dress appropriately; at the absolute minimum, you must have:
  - a. No loose clothing, including ties;
  - b. Long hair properly stowed;
  - c. No jewelry;
  - d. Hard, closed-toe shoes;
  - e. Eye protection (safety glasses); and,
  - f. Ear protection (plugs or headset).
5. Follow all institutional safety rules.

# **AUTOMATED EQUIPMENT REPAIR SERIES**

## **MASTER Technical Module No. AET-E4**

---

**Subject:** Automated Equipment Repair **Time:** 12 Hrs.

**Duty:** Use Techniques to Isolate Malfunction of Electrical/Electronic Systems

**Task:** Calculate, Predict, and Measure Quantities in Poly-Phase AC Circuits

---

### **Objective(s):**

Upon completion of this unit the student will be able to:

- a. Apply the knowledge of poly-phase AC circuits to the calculation and measurement of voltage, current, and power in these circuits;
  - b. Measure phase angles in poly-phase AC circuits;
  - c. Determine the phase rotation for poly-phase AC motors;
  - d. Calculate power in poly-phase AC circuits;
  - e. Calculate and predict the voltages that can be obtained from a configuration of a delta or wye poly-phase AC circuit;
  - f. Determine reference points for measurement of voltages and currents in a delta or wye configuration poly-phase AC circuit; and,
  - g. Determine of the type of power distribution in effect for a configuration of a poly-phase AC circuit.
- 

### **Instructional Materials:**

The following measurement instruments:

Digital multimeters with capacitance and inductance scales

20 to 100 Mega Hertz dual trace oscilloscope with switchable manual/auto triggering, and 20 volts to 5 mV vertical deflection

20 to 100 Mega Hertz dual trace oscilloscope with isolated channels switchable manual/auto triggering, and 20 volts to 5 mV vertical deflection (optional)

Clamp-on meters

Power factor meters

Phase rotation and phase angle meters

Textbook labs on practical applications of the concepts contained in this module

**MASTER Handout (AET-E4-HO)**

**MASTER Laboratory Exercise (AET-E4-LE)**

**MASTER Laboratory Aid (AET-E4-LA)**

**MASTER Quiz AET-E4-QU-1: Poly-phase AC circuits**

---

## References:

- Electricity/Electronics Fundamentals*, Zbar/Sloop, Latest Edition
- Introductory DC/AC Electronics*, Nigel P. Cook, Latest Edition (with interactive software)
- Guide to Electrical Power Distribution Systems Equipment, Applications, Installation, and Maintenance*, Pansini, Latest Edition
- Modern Industrial Electronics, Revised and Expanded Edition*, Schuler/MacNamee, Latest Edition (formerly, *Industrial Electronics and Robotics*, Schuler/MacNamee, 1987)
- The Complete Guide to Electronics Troubleshooting*, Perozzo, Latest Edition
- Video(s): *Advanced AC Circuits*, Bergwall Productions, 1-800-645-3565, Latest Edition
- Working Safely With Electricity*, Bergwall Productions, 1-800-645-3565, Latest Edition

Note: Bergwall Productions will be referenced frequently throughout the AET section because the company provides quality video productions at a reasonable price, unlike other video production companies.

The following items are *not recommended* because they detract from the hands-on nature of this module. These items may be used as a supplement for the module if the module contains actual interaction with real electrical and electronic parts. Electricity and electronics is a “messy” technology, because actual parts and measuring devices are not perfect. The following items are theoretically perfect, and therefore do not reflect the real world of electricity and electronics.

*PSPICE* - Program for modeling the behavior of electrical and electronic components.

*Electronic Workbench* - Graphic Windows based program for constructing theoretical models of electrical and electronic circuits.

---

## Student Preparation:

Students should have previously completed the following Technical Modules:

- AET-A6** “Use Physics, Algebra, and Trigonometry to Analyze Simple Vectored Forces”
- AET-B2** “Use Symbols, Organization, and Engineering Values on Electrical Drawings”

- AET-E1 “Calculate, Predict, and Measure the Response of Quantities in DC Circuits”
- AET-E2 “Calculate, Predict, and Measure the Response of Quantities in AC Circuits”
- AET-E3 “Calculate, Predict, and Measure Impedance and Phase Angle in AC Circuits”

**Note:** This module is meant to be used in conjunction with modules AET-C2 “Apply Electrical Measurement Knowledge and Instruments to Test/Calibrate Electrical Circuits” and AET-C3 “Apply Electronic Measurement Knowledge and Instruments to Test/Calibrate Electronic Circuits.”

---

---

## Introduction:

In the early years of the practical implementation of electricity to power lights and electrical systems, Edison was a adamant proponent of the use of DC voltages and currents. In opposition, Nicholas Tesula, who at one time was a researcher at Edison’s labs, insisted that Alternating Current (AC) was the method of choice to deliver electrical power. Tesula had science and math on his side, and subsequent inventions such as the poly-phase AC motor, and transformers to convert the power, proved Tesula to be correct. Modern power distribution systems use Poly-phase AC distribution systems to deliver power to industrial plants and homes. Both two phase, poly-phase AC systems, and three phase, poly-phase AC systems have been used for the purpose of delivering AC power; but the three phase poly phase system has proven to be the most efficient method of accomplishing the task. Frequently, the three phase wye and the three phase delta system are used to deliver and transform power. Many variations on this theme exist, however, they tend to be hybrids of the two basic systems.

---

---

## Presentation Outline:

- I. Calculate, Predict, and Measure Voltage, Current, and Power in Three Phase AC Systems
  - A. Units of measurement for poly-phase AC
    - 1. Explain the concepts of phase shift in AC circuits
    - 2. Provide examples of the various types of poly-phase systems (delta and wye)
    - 3. Provide examples of the mathematical relationship between poly-phase AC voltages, currents, and power
    - 4. Demonstrate the application of mathematical concepts to the determination of voltage, current, and power in poly-phase AC systems
  - B. Measurement of AC voltage current, and power in three phase AC systems

1. Explain the reference points for measuring AC voltage and current in three phase AC systems.(wye and delta)
2. Demonstrate the measurement of voltage, current, power, and phase angle in three phase AC systems (wye and delta)

---

---

**Practical Application:**

1. Measure voltages in three phase AC power distribution systems; and,
2. Measure voltages and currents in three phase resistive and inductive AC circuits.

---

---

**Evaluation and/or Verification:**

Successful completion of this technical module will be based on the student's successful completion of the following components:

1. A ten question quiz on poly-phase AC power (MASTER Quiz AET-E4-QU-1: Poly-phase AC circuits); and,
2. Textbook labs on practical application of the information contained in this module.

---

---

**Summary:**

Review the main lesson points using the text and handouts listed in the reference section of this module. Hold class discussion and answer student questions.

---

---

**Next Lesson Assignment:**

**MASTER Technical Module (AET-E5)** dealing with properly setting up, calibrating, and using meters and oscilloscopes.



**AET-E4-HO**  
**Calculate, Predict, and Measure Quantities**  
**in Poly-Phase AC Circuits**  
**Attachment 1: MASTER Handout**

---

**Objective(s):**

Upon completion of this unit the student will be able to:

- a. Apply the knowledge of poly-phase AC circuits to the calculation and measurement of voltage, current, and power in these circuits;
- b. Measure phase angles in poly-phase AC circuits;
- c. Determine the phase rotation for poly-phase AC motors;
- d. Calculate power in poly-phase AC circuits;
- e. Calculate and predict the voltages that can be obtained from a configuration of a delta or wye poly-phase AC circuit;
- f. Determine reference points for measurement of voltages and currents in a delta or wye configuration poly-phase AC circuit; and,
- g. Determine of the type of power distribution in effect for a configuration of a poly-phase AC circuit.

---

**Module Outline:**

- I. Calculate, Predict, and Measure Voltage, Current, and Power in Three Phase AC Systems
  - A. Units of measurement for poly-phase AC
    1. Explain the concepts of phase shift in AC circuits
    2. Provide examples of the various types of poly-phase systems (delta and wye)
    3. Provide examples of the mathematical relationship between poly-phase AC voltages, currents, and power
    4. Demonstrate the application of mathematical concepts to the determination of voltage, current, and power in poly-phase AC systems
  - B. Measurement of AC voltage current, and power in three phase AC systems
    1. Explain the reference points for measuring AC voltage and current in three phase AC systems.(wye and delta)
    2. Demonstrate the measurement of voltage, current, power, and phase angle in three phase AC systems (wye and delta)

**AET-E4-LE**  
**Calculate, Predict, and Measure Quantities**  
**in Poly-Phase AC Circuits**  
Attachment 2: MASTER Laboratory Exercise

---

The student will:

1. Measure voltages in three phase AC power distribution systems; and,
2. Measure voltages and currents in three phase resistive and inductive AC circuits.

**AET-E4-LA**  
**Calculate, Predict, and Measure Quantities**  
**in Poly-Phase AC Circuits**  
**Attachment 3: MASTER Laboratory Aid**

---

**Rules of Conduct**

1. Absolutely no horseplay or practical joking will be tolerated.
2. Do not talk to anyone who is operating a machine.
3. Walk only in the designated traffic lanes.
4. Dress appropriately; at the absolute minimum, you must have:
  - a. No loose clothing, including ties;
  - b. Long hair properly stowed;
  - c. No jewelry;
  - d. Hard, closed-toe shoes;
  - e. Eye protection (safety glasses); and,
  - f. Ear protection (plugs or headset).
5. Follow all institutional safety rules.

# **AUTOMATED EQUIPMENT REPAIR SERIES**

## **MASTER Technical Module No. AET-E5**

---

**Subject:** Automated Equipment Repair **Time:** 28 Hrs.

**Duty:** Use Techniques to Isolate Malfunctions of Electrical/Electronic Systems

**Task:** Properly Set-up, Calibrate, and Use Meters and Oscilloscopes

---

### **Objective(s):**

Upon completion of this unit the student will be able to:

- a. Apply electrical measurement knowledge and instruments to test/calibrate electrical circuits;
- b. Apply electronic measurement knowledge and instruments to test/calibrate electronic circuits;
- c. Properly connect a multimeter, ammeter, or clamp-on ammeter to a circuit; and use the instrument to safely measure DC current, RMS current, and average current in a DC or AC circuit;
- d. Properly connect a multimeter, voltmeter, or clamp-on voltmeter to a circuit, and use the instrument to safely measure DC voltage, RMS voltage, and average voltage in a DC or AC circuit;
- e. Properly connect a multimeter or ohmmeter to a circuit and use the instrument to safely measure resistance in any circuit;
- f. Properly connect power factor meters to power distribution systems, and measure power factor;
- g. Properly connect phase meters to test phase rotation and phase angle;
- h. Properly connect a multimeter, capacitance meter, or inductance meter to a circuit to measure capacitance and inductance;
- i. Adjust the frequency, amplitude and proper decibel level of a function generator and use the instrument to test electronic and electrical equipment; and,
- j. Properly set up an oscilloscope for calibrated measurements, and use the instrument to measure frequency, time, degrees of phase shift, DC voltages, voltage peak, and voltage peak-to-peak.

---

### **Instructional Materials:**

Digital multimeters (if possible with capacitance and inductance scales)  
Conventional analog voltmeters, ammeters, and ohmmeters (optional)  
Clamp-on meters  
Power factor meters  
Phase rotation and phase angle meters

Capacitance and inductance meters (if multimeters with these scales are not available)

Variable frequency function generators capable of dB switching, DC outputs, AC outputs, square wave outputs, triangular wave outputs, and sawtooth outputs

20 to 100 Megahertz dual trace oscilloscope with switchable manual/auto triggering, and 20 volts to 5 mV vertical deflection

20 to 100 Megahertz dual trace oscilloscope with isolated channels switchable manual/auto triggering, and 20 volts to 5 mV vertical deflection (optional)

**MASTER Handout (AET-E5-HO-1)**

**MASTER Handout (AET-E5-HO-2) (Decibels and Logarithms)**

**MASTER Laboratory Exercise (AET-E5-LE)**

**MASTER Laboratory Aid (AET-E5-LA)**

**MASTER Quiz AET-E5-QU-1: Electrical measuring instruments**

**MASTER Quiz AET-E5-QU-2: Function generators**

**MASTER Quiz AET-E5-QU-3: Oscilloscopes**

---

#### References:

- Electricity/Electronics Fundamentals*, Zbar/Sloop, Latest Edition
- Introductory DC/AC Electronics*, Nigel P. Cook, Latest Edition (with interactive software)
- Elements of Electronic Instrumentation and Measurement*, Carr, ISBN 0-13-341686-0, Latest Edition
- Using the Oscilloscope*, Iddings, ISBN 0-13-148362-5, Latest Edition
- Guide to Electrical Power Distribution Systems Equipment, Applications, Installation and Maintenance*, Pansini, Latest Edition
- Modern Industrial Electronics, Revised and Expanded Edition*, Schuler/MacNamee, Latest Edition (formerly, *Industrial Electronics and Robotics*, Schuler/MacNamee, 1987)
- The Complete Guide to Electronics Troubleshooting*, Perozzo, Latest Edition
- Troubleshooting Electronic Equipment the Right Way Without Using Expensive Test Instruments*, Douglas-Young, Latest Edition
- Video(s):** *Multimeters Explained*, Bergwall Productions, 1-800-645-3565, Latest Edition
- Basic Electricity DC Circuits*, Bergwall Productions, 1-800-645-3565, Latest Edition
- Using Dual Trace Oscilloscopes*, Bergwall Productions, 1-800-645-3565, Latest Edition
- Working Safely With Electricity*, Bergwall Productions, 1-800-645-3565, Latest Edition

Note: Bergwall Productions will be referenced frequently throughout the AET section because the company provides quality video productions at a reasonable price, unlike other video production companies.

The following items are *not recommended* because they detract from the hands-on nature of this module. These items may be used as a supplement for the module if the module contains actual interaction with real electrical and electronic parts, or used in an electronics design class. Electricity and electronics is a “messy” technology, because actual parts and measuring devices are not perfect. The following items are theoretically perfect, and therefore do not reflect the real world of electricity and electronics.

*PSPICE* - Program for modeling the behavior of electrical and electronic components, and circuits.

*Electronic Workbench* - Graphic Windows based program for constructing theoretical models of electrical and electronic circuits

---

### Student Preparation:

Students should have previously completed the following Technical Modules:

- AET-A6 “Use Physics, Algebra, and Trigonometry to Analyze Simple Vectored Forces
- AET-B2 “Use Symbols, Organization, and Engineering Values on Electrical Drawings
- AET-B3 “Use Symbols, Organization, and Engineering Values on Electronic Drawings”
- AET-E1 “Calculate, Predict, and Measure the Response of Quantities in DC Circuits”
- AET-E2 “Calculate, Predict, and Measure the Response of Quantities in AC Circuits”
- AET-E3 “Calculate, Predict, and Measure Impedance and Phase Angle in AC Circuits”
- AET-E4 “Calculate, Predict, and Measure Quantities in Poly-Phase AC Circuits”

---

---

### Introduction:

To determine the operating condition of an electrical or electronic circuit requires the proper and safe use of measuring instruments such as multimeters, oscilloscopes, and function generators. These instruments are the minimum instruments necessary to effectively troubleshoot complex control systems. In addition, these instruments must be applied in a manner that prevents damage to the equipment that is being tested. Proper safe use of the equipment is an essential skill for any automation technician.

---

---

## **Presentation Outline:**

- I. Use Electrical Measuring Instruments**
  - A. Demonstrate the procedure for safely measuring, current, voltage and resistance in DC circuits**
    - 1. Explain the operation of digital multimeters
    - 2. Demonstrate the procedure for measuring DC voltage, DC current, and resistance
    - 3. Demonstrate the measurement of DC voltage, DC current and resistance on a representative machine control
  - B. Demonstrate the measurement of capacitive and inductive components**
    - 1. Provide examples of occasions in which it may be necessary to measure capacitance and inductance
    - 2. Explain the operation of a capacitance and inductance test meter
    - 3. Demonstrate the procedure for measuring capacitance and inductance
    - 4. Demonstrate safety procedures for capacitive and inductive tests
    - 5. Demonstrate tests for capacitance on a DC power supply in a machine control system
    - 6. Demonstrate the measurement of inductance on an AC inductive motor
  - C. Demonstrate the procedures for safe measurement of single phase resistive AC currents voltages and resistance**
    - 1. Demonstrate the use of multimeters and clamp-on ammeters in measuring AC voltage, AC current, and resistance
    - 2. Demonstrate the safety procedures and methods for performing voltage, current, and resistive tests on an AC power distribution system
  - D. Demonstrate the measurement of voltage, current, and power in poly-phase AC systems**
    - 1. Explain the purpose and use of; phase rotation meters, phase angle meters, and power factor meters
    - 2. Demonstrate the use of the above meters by performing tests on poly-phase AC power distribution systems
- II. Use Function Generators to Test/Calibrate Circuits**
  - A. Identify and explain the purpose of the controls on a function generator**
    - 1. Frequency range and variable frequency control
    - 2. Wave form selection control
    - 3. Amplitude control
    - 4. DC offset control

5. Decibel (dB) switches (MASTER Handout AET-E5-HO-2)  
(Decibels and Logarithms)
- B. Explain the safety procedures and grounding problems associated with the use of function generators
    1. Explain the concept of "ground loops" and the relation ship of the common connection point of the function generator to the common connection point of the circuit under test
    2. Explain the expected behavior of servo systems when subjected to signal injection and the safety procedures that must be followed
  - C. Demonstrate the use of the function generator for signal injection into a servo amplifier of a robot or CNC machine
    1. Explain the purpose of the test for each wave form
    2. Explain the expected outcome of the test
- III. Use Oscilloscopes to Test/Calibrate Circuits
- A. Identify and explain the purpose of the controls on an oscilloscope
    1. Beam trace intensity and alignment
    2. Selecting dual or single channel
    3. Selecting alternate or chop frequency and the advantages/disadvantages of both
    4. Time base range and variable time base
    5. Vertical deflection range and variable vertical deflection
    6. Triggering controls, internal and external triggering, selecting a triggering source
    7. Auto/manual triggering
  - B. Explain the proper procedures for setting up the scope for calibrated measurements
  - C. Explain the safety procedures and grounding problems associated with the use of an oscilloscope
    1. Explain the concept of "ground loops" and the relation ship of the common connection point of the oscilloscope to the common connection point of the circuit under test
    2. Explain the expected behavior of electronic systems when subjected to testing by the oscilloscope and the safety procedures that must be followed
  - D. Demonstrate the use of the oscilloscope in conjunction with the function generator for signal injection into a servo amplifier of a robot or CNC machine
    1. Explain the purpose of the test for each wave form
    2. Explain the expected outcome of the test
  - E. Demonstrate the methods used to convert horizontal time on an oscilloscope to degrees of rotation of a sine wave, or a phase shift in complex inductive/capacitive circuits



---

---

**Practical Application:**

1. Using all of the above instruments, perform a simulated preventative maintenance procedure on a machine tool;
2. Use a function generator and an oscilloscope to inject and monitor a wave form in the servo amplifier of a CNC machine or robot; and,
3. Use the oscilloscope to monitor a wave form injected by a function generator in the servo amplifier of a CNC machine.

---

---

**Evaluation and/or Verification:**

Successful completion of this technical module will be based on the student's successful completion of the following components:

1. A twenty question quiz on electrical measuring instruments (MASTER Quiz AET-E5-QU-1: Electrical measuring instruments);
2. Demonstrate competency in use of electrical measuring instruments.
3. A ten question quiz on the use of the function generator (MASTER Quiz AET-E5-QU-2: Function generators);
4. A ten question quiz on the use of the oscilloscope (MASTER Quiz AET-E5-QU-3: Oscilloscopes);
5. Demonstrate competency in the use of function generators (may be measured by textbook labs); and,
6. Demonstrate competency in the use of oscilloscopes (may be measured by textbook labs).

---

---

**Summary:**

Review the main lesson points at each subsection of the module using the suggested texts and handouts listed in the reference section of this module. Hold class discussion and answer student questions.

---

---

**Next Lesson Assignment:**

**MASTER Technical Module (AET-E6)** dealing with using components such as resistors, inductors, and capacitors; constructing circuits and test components.

**AET-E5-HO-1**  
**Properly Set Up, Calibrate, and Use Meters and Oscilloscopes**  
**Attachment 1: MASTER Handout No. 1**

---

**Objective(s):**

Upon completion of this unit the student will be able to:

- a. Apply electrical measurement knowledge and instruments to test/calibrate electrical circuits;
- b. Apply electronic measurement knowledge and instruments to test/calibrate electronic circuits;
- c. Properly connect a multimeter, ammeter, or clamp-on ammeter to a circuit; and use the instrument to safely measure DC current, RMS current, and average current in a DC or AC circuit;
- d. Properly connect a multimeter, voltmeter, or clamp-on voltmeter to a circuit, and use the instrument to safely measure DC voltage, RMS voltage, and average voltage in a DC or AC circuit;
- e. Properly connect a multimeter or ohmmeter to a circuit and use the instrument to safely measure resistance in any circuit;
- f. Properly connect power factor meters to power distribution systems, and measure power factor;
- g. Properly connect phase meters to test phase rotation and phase angle;
- h. Properly connect a multimeter, capacitance meter, or inductance meter to a circuit to measure capacitance and inductance;
- i. Adjust the frequency, amplitude and proper decibel level of a function generator and use the instrument to test electronic and electrical equipment; and,
- j. Properly set up an oscilloscope for calibrated measurements, and use the instrument to measure frequency, time, degrees of phase shift, DC voltages, voltage peak, and voltage peak-to-peak.

---

**Module Outline:**

- I. Use Electrical Measuring Instruments
  - A. Demonstrate the procedure for safely measuring, current, voltage and resistance in DC circuits
    1. Explain the operation of digital multimeters
    2. Demonstrate the procedure for measuring DC voltage, DC current, and resistance
    3. Demonstrate the measurement of DC voltage, DC current and resistance on a representative machine control
  - B. Demonstrate the measurement of capacitive and inductive components
    1. Provide examples of occasions in which it may be necessary to measure capacitance and inductance

2. Explain the operation of a capacitance and inductance test meter
  3. Demonstrate the procedure for measuring capacitance and inductance
  4. Demonstrate safety procedures for capacitive and inductive tests
  5. Demonstrate tests for capacitance on a DC power supply in a machine control system
  6. Demonstrate the measurement of inductance on an AC inductive motor
- C. Demonstrate the procedures for safe measurement of single phase resistive AC currents voltages and resistance
1. Demonstrate the use of multimeters and clamp-on ammeters in measuring AC voltage, AC current, and resistance
  2. Demonstrate the safety procedures and methods for performing voltage, current, and resistive tests on an AC power distribution system
- D. Demonstrate the measurement of voltage, current, and power in poly-phase AC systems
1. Explain the purpose and use of; phase rotation meters, phase angle meters, and power factor meters
  2. Demonstrate the use of the above meters by performing tests on poly-phase AC power distribution systems
- II. Use Function Generators to Test/Calibrate Circuits
- A. Identify and explain the purpose of the controls on a function generator
1. Frequency range and variable frequency control
  2. Wave form selection control
  3. Amplitude control
  4. DC offset control
  5. Decibel (dB) switches (MASTER Handout AET-E5-HO-2) (Decibels and Logarithms)
- B. Explain the safety procedures and grounding problems associated with the use of function generators
1. Explain the concept of "ground loops" and the relation ship of the common connection point of the function generator to the common connection point of the circuit under test
  2. Explain the expected behavior of servo systems when subjected to signal injection and the safety procedures that must be followed
- C. Demonstrate the use of the function generator for signal injection into a servo amplifier of a robot or CNC machine
1. Explain the purpose of the test for each wave form
  2. Explain the expected outcome of the test
- III. Use Oscilloscopes to Test/Calibrate Circuits
- A. Identify and explain the purpose of the controls on an oscilloscope

1. Beam trace intensity and alignment
  2. Selecting dual or single channel
  3. Selecting alternate or chop frequency and the advantages/disadvantages of both
  4. Time base range and variable time base
  5. Vertical deflection range and variable vertical deflection
  6. Triggering controls, internal and external triggering, selecting a triggering source
  7. Auto/manual triggering
- B. Explain the proper procedures for setting up the scope for calibrated measurements
- C. Explain the safety procedures and grounding problems associated with the use of an oscilloscope
1. Explain the concept of "ground loops" and the relationship of the common connection point of the oscilloscope to the common connection point of the circuit under test
  2. Explain the expected behavior of electronic systems when subjected to testing by the oscilloscope and the safety procedures that must be followed
- D. Demonstrate the use of the oscilloscope in conjunction with the function generator for signal injection into a servo amplifier of a robot or CNC machine
1. Explain the purpose of the test for each wave form
  2. Explain the expected outcome of the test
- E. Demonstrate the methods used to convert horizontal time on an oscilloscope to degrees of rotation of a sine wave, or a phase shift in complex inductive/capacitive circuits

AET-E5-HO-2  
Properly Set Up, Calibrate, and Use Meters and Oscilloscopes  
Attachment 2: MASTER Handout No. 2

---

**Decibels and Logarithms**

This is not the name of a big band, but it's a possibility. Decibels are a scaling system based on powers of ten. Decibels reflect a "figure of merit" describing voltages, current, or power over resistance or area. It can be applied to amplifiers, sensitivity of receivers, or the power of the sound in an industrial plant. It is simply a scale in powers of ten. For example, a function generator will add or subtract 20 decibels to a wave form if you turn the right switch.

Scales built using the decibel system have different ZERO POINTS. A decibel scale can have ANY point defined as "zero decibels" and the measuring method of the scale will be consistent starting with that base number. Audible sound, for example, uses as a zero decibel point, a value equivalent to "sound barely audible by the average human ear". This value is an intensity of  $10^{-12}$  Watts/meter<sup>2</sup>.

Starting with that number, every time the intensity of sound increases by one power of ten, ( $10^1$ ) we add TEN decibels to our value. So the *power/area* is actually:

**THE ZERO-DECIBELS VALUE multiplied by 10 raised to the power of (.1 times the number of decibels).**

For example:

If X is the zero value then:

+ 20 decibels is  $X \cdot 10^{2.0}$

or

**100X**

Notice you can have decimals in the power of ten exponent:

For example  $10^{2.5} = 316.227$ , which is the multiplier for 25 decibels.

For example, leaves rustling in the autumn breeze in the parking lot would have a sound intensity of about 10 decibels.

This means the intensity or power of that sound in Watts/m<sup>2</sup> would be:

$10^{-12}$  Watts per meter<sup>2</sup> times 10 to the first power

This equals  $10^{-12} \cdot 10^{1.0}$  or  $10^{-11}$  or .01 Nanowatts/meter<sup>2</sup>. As you can imagine this is **not** a lot of power per square meter.

If we compare it to an ordinary conversation such as often occurs in the middle of lectures, we are comparing 10 decibels to 60 decibels.

This equals the “0 decibels” figure times 10 to the 6.0 power

or

$$1 \times 10^{-12} \times 1 \times 10^{6.0} = 1 \text{ microwatt/m}^2$$

Compared to this zero point, other decibel values of audible sound are:

Sound	Decibels	Calculation	Watts/m <sup>2</sup>
A lover whispering from 1 yard away	20	$1 \times 10^{-12} \times 1 \times 10^{2.0}$	.1 nanowatts
Standing at Market and 1st Ave.	40	$1 \times 10^{-12} \times 1 \times 10^{4.0}$	10 nanowatts
Conversation with the instructor on break	60	$1 \times 10^{-12} \times 1 \times 10^{6.0}$	10 microwatts
Conversation with Rohr Industries	85	$1 \times 10^{-12} \times 1 \times 10^{8.5}$	316.227 u watts
Niagra Falls from the little tour boat	90	$1 \times 10^{-12} \times 1 \times 10^{9.0}$	1 milliwatt
Loud rock band	110	$1 \times 10^{-12} \times 1 \times 10^{11.0}$	612.01 milliwatt
Sound painful to the ear	120	$1 \times 10^{-12} \times 1 \times 10^{12.0}$	1 watt

If you use decibels to measure some electronic value as in the gain delivered by a stereo amplifier, you will get totally different values depending on where the **ZERO VALUE** is. What is important to notice is that the decibel scale is not *linear* (each decibel adds a fixed amount) but *LOGARITHMIC* (each decibel adds a certain amount to the EXPONENT of 10). It increases exponentially.

A LOGARITHM is “*the number to which a base is raised to give another number*”. Logarithmic scales increase by powers rather than by fixed amounts. If you are using base 10, which is common, the logarithm of 100 is 2 (you raise 10 to the 2d power to get 100). The logarithm of 1000 is 3 (you raise 10 to the 3d power to get 1000) and the logarithm of 721.11 is *somewhere in between*. You can find out quickly if you have a calculator with a log key. For example, the number 721.11:

Using the calculator, the power of ten exponent for 721.11 is **2.858001518**.

In other words ten raised to the 2.858001518 power will give you 721.11.

Logarithms are exponents, and can be mathematically manipulated like exponents which makes it easy to mathematically calculate very large and very small numbers.

The controls on the front panel of a function generator include decibel switches. Using a function generator, and switching the 10 db or 20 db switch on the unit, means that you are multiplying or dividing the current value of the generators output by 10 or 100.

The +10 db switch will multiply the output by 10, and the -10 db switch will divide the output by 10; or the -20 db switch will divide the output by 100, and turning it off will restore the output to its previous value.

**AET-E5-LE**  
**Properly Set Up, Calibrate, and Use Meters and Oscilloscopes**  
**Attachment 3: MASTER Laboratory Exercise**

---

The student will:

1. Use all of the above instruments to perform a simulated preventative maintenance procedure on a machine tool;
2. Use a function generator and an oscilloscope to inject and monitor a wave form in the servo amplifier of a CNC machine or robot; and,
3. Use the oscilloscope to monitor a wave form injected by a function generator in the servo amplifier of a CNC machine.



**AET-E5-LA**  
**Properly Set Up, Calibrate, and Use Meters and Oscilloscopes**  
**Attachment 4: MASTER Laboratory Aid**

---

**Rules of Conduct**

1. Absolutely no horseplay or practical joking will be tolerated.
2. Do not talk to anyone who is operating a machine.
3. Walk only in the designated traffic lanes.
4. Dress appropriately; at the absolute minimum, you must have:
  - a. No loose clothing, including ties;
  - b. Long hair properly stowed;
  - c. No jewelry;
  - d. Hard, closed-toe shoes;
  - e. Eye protection (safety glasses); and,
  - f. Ear protection (plugs or headset).
5. Follow all institutional safety rules.

# AUTOMATED EQUIPMENT REPAIR SERIES

## MASTER Technical Module No. AET-E6

---

<b>Subject:</b>	<b>Automated Equipment Repair</b>	<b>Time: 18 Hrs.</b>
<b>Duty:</b>	<b>Use Techniques to Isolate Malfunctions of Electrical/Electronic Systems</b>	
<b>Task:</b>	<b>Use Components Such as Resistors, Inductors, and Capacitors; Construct Circuits and Test Components</b>	

---

### Objective(s):

Upon completion of this unit the student will be able to:

- a. Conduct out-of-circuit tests of resistors, inductors, capacitors, and cables using the proper test equipment;
  - b. Conduct in-circuit tests of resistors, inductors, capacitors, and cables using the proper test equipment;
  - c. Construct circuits consisting of resistors, capacitors, and inductors for special or production purposes using the necessary components, a suitable circuit board or test breadboard, and a schematic diagram; and,
  - d. Construct cables using the necessary components and a schematic diagram.
- 

### Instructional Materials:

Breadboards, perf-boards, or other electronic component mounting boards  
Electronic components such as resistors, inductors (transformers, solenoids or relays), and capacitors  
DB-25 connectors and cables  
Schematic diagrams  
Soldering irons and tools  
Wire wrap/unwrap tools  
Hand tools such as needle-nosed pliers, wrenches, screw drivers, etc.  
**MASTER Handout (AET-E6-HO)**  
**MASTER Laboratory Exercise (AET-E6-LE)**  
**MASTER Laboratory Aid (AET-E6-LA)**

---

### References:

*Electronic Techniques Shop Practices and Construction*, Robert S. Villanucci, Alexander W. Avtgis, and William F. Megow, ISBN 0-13-361965-6, Latest Edition

### **Student Preparation:**

Students should have previously completed the following Technical Modules:

- AET-A5** "Measure, Calculate, and Convert Quantities in English and Metric (SI, mks) Systems of Measurement"
- AET-B2** "Use Symbols, Organization, and Engineering Values on Electrical Drawings"
- AET-B3** "Use Symbols, Organization, and Engineering Values on Electronic Drawings"
- AET-C2** "Apply Electrical Measurement Knowledge and Instruments to Test/Calibrate Electrical Circuits"
- AET-E1** "Calculate, Predict, and Measure the Response of Quantities in DC Circuits"
- AET-E2** "Calculate, Predict, and Measure the Response of Quantities in AC Circuits"

*Note:* This module is meant to be used in conjunction with module AET-J4 "Safely Assemble, Disassemble or Adjust Electronic Systems or Components"

---

---

### **Introduction:**

The ability to construct electronic circuits for prototype testing and measurement is an essential skill for success as an automation technician. Frequently, the technician will be required to create circuits from components, and test the components and circuits. In addition, the ability to construct circuits will provide the technician with the skills needed to repair malfunctioning circuits by replacing defective components. In the field of electricity or electronics, only four components are used. These components are semiconductors, resistors, capacitors, and inductors. These components are connected, one to another, by conductors. Understanding how to test, assemble, and disassemble; at the minimum, resistors, capacitors, inductors, and conductors provides the technician with the skills necessary to repair the majority of circuits used in automated equipment.

---

---

### **Presentation Outline**

- I. Construct Circuits and Test Components
  - A. Testing components out of circuit and in circuit
    - 1. Explain the procedure for testing resistors out of circuit
    - 2. Explain the procedure for testing resistors in circuit and the potential problems associated with the testing

3. Demonstrate the procedures for in circuit and out-of-circuit tests for resistors
  4. Explain the procedure for testing capacitors out of circuit
  5. Explain the procedure for testing capacitors in circuit and the potential problems associated with the testing
  6. Demonstrate the procedures for in circuit and out-of-circuit tests for capacitors
  7. Explain the procedure for testing inductors, including transformers and motors out of circuit
  8. Explain the procedure for testing inductors in circuit and the potential problems associated with the testing
  9. Demonstrate the procedures for in circuit and out-of-circuit tests for inductors
  10. Explain the procedures for testing conductors such as cables or conductors
  11. Demonstrate the procedures for testing conductors such as cables or conductors
- B. Demonstrate the construction procedures for creating electronic circuits and wiring assemblies
1. Demonstrate the procedures used to construct circuits using breadboards, and the layout of a breadboard
  2. Demonstrate the procedures used to construct circuits using a wire wrap board, wire wrap components, and wire wrap tools
  3. Explain the safety procedures that apply when using soldering equipment
  4. Explain the procedures used to remove components from through-hole printed circuit boards
  5. Conduct exercises on soldering components into through-hole printed circuit boards
  6. Explain the methods of removing components from surface mount (SMT) printed circuit boards
  7. Conduct exercises on soldering components onto surface mount (SMT) printed circuit boards
  8. Conduct exercises on constructing wiring assemblies using multi-conductor cables and connectors

---

---

**Practical Application:**

1. Using an industrial electronic system, apply the concepts contained in this module.

---

---

**Evaluation and/or Verification:**

Successful completion of this technical module will be based on the student's successful completion of the following components:

1. An instructor generated exam on the industrial application of the concepts contained in this module;
2. Completion of selected laboratory experiences in assembling/disassembling electronic systems/components; and,
3. Demonstrate competency in the ability to assemble/disassemble electronic systems/components.

---

---

**Summary:**

Review the main lesson points using the texts and handouts listed in the reference section of this module. Hold class discussion and answer student questions.

---

---

**Next Lesson Assignment:**

**MASTER Technical Module (AET-E7)** dealing with using meters/oscilloscopes to measure phase shift or angle in series resistive-capacitive resistive-inductive AC circuits.

**AET-E6-HO**  
**Use Components Such as Resistors, Inductors, and Capacitors;**  
**Construct Circuits and Test Components**  
Attachment 1: MASTER Handout

---

**Objective(s):**

Upon completion of this unit the student will be able to:

- a. Conduct out-of-circuit tests of resistors, inductors, capacitors, and cables using the proper test equipment;
- b. Conduct in-circuit tests of resistors, inductors, capacitors, and cables using the proper test equipment;
- c. Construct circuits consisting of resistors, capacitors, and inductors for special or production purposes using the necessary components, a suitable circuit board or test breadboard, and a schematic diagram; and,
- d. Construct cables using the necessary components and a schematic diagram.

---

**Module Outline:**

- I. Construct Circuits and Test Components
  - A. Testing components out of circuit and in circuit
    1. Explain the procedure for testing resistors out of circuit
    2. Explain the procedure for testing resistors in circuit and the potential problems associated with the testing
    3. Demonstrate the procedures for in circuit and out-of-circuit tests for resistors
    4. Explain the procedure for testing capacitors out of circuit
    5. Explain the procedure for testing capacitors in circuit and the potential problems associated with the testing
    6. Demonstrate the procedures for in circuit and out-of-circuit tests for capacitors
    7. Explain the procedure for testing inductors, including transformers and motors out of circuit
    8. Explain the procedure for testing inductors in circuit and the potential problems associated with the testing
    9. Demonstrate the procedures for in circuit and out-of-circuit tests for inductors
    10. Explain the procedures for testing conductors such as cables or conductors
    11. Demonstrate the procedures for testing conductors such as cables or conductors

- B. Demonstrate the construction procedures for creating electronic circuits and wiring assemblies**
- 1. Demonstrate the procedures used to construct circuits using breadboards, and the layout of a breadboard**
  - 2. Demonstrate the procedures used to construct circuits using a wire wrap board, wire wrap components, and wire wrap tools**
  - 3. Explain the safety procedures that apply when using soldering equipment**
  - 4. Explain the procedures used to remove components from through-hole printed circuit boards**
  - 5. Conduct exercises on soldering components into through-hole printed circuit boards**
  - 6. Explain the methods of removing components from surface mount (SMT) printed circuit boards**
  - 7. Conduct exercises on soldering components onto surface mount (SMT) printed circuit boards**
  - 8. Conduct exercises on constructing wiring assemblies using multi-conductor cables and connectors**

**AET-E6-LE**  
**Use Components Such as Resistors, Inductors, and Capacitors;**  
**Construct Circuits and Test Components**  
**Attachment 2: MASTER Laboratory Exercise**

---

The student will use an industrial electronic system to apply the concepts contained in this module.



**AET-E6-LA**  
**Use Components Such as Resistors, Inductors, and Capacitors;**  
**Construct Circuits and Test Components**  
**Attachment 3: MASTER Laboratory Aid**

---

**Rules of Conduct**

1. Absolutely no horseplay or practical joking will be tolerated.
2. Do not talk to anyone who is operating a machine.
3. Walk only in the designated traffic lanes.
4. Dress appropriately; at the absolute minimum, you must have:
  - a. No loose clothing, including ties;
  - b. Long hair properly stowed;
  - c. No jewelry;
  - d. Hard, closed-toe shoes;
  - e. Eye protection (safety glasses); and,
  - f. Ear protection (plugs or headset).
5. Follow all institutional safety rules.

# AUTOMATED EQUIPMENT REPAIR SERIES

## MASTER Technical Module No. AET-E7

---

<b>Subject:</b>	<b>Automated Equipment Repair</b>	<b>Time: 52 Hrs.</b>
<b>Duty:</b>	<b>Use Techniques to Isolate Malfunctions of Electrical/Electronic Systems</b>	
<b>Task:</b>	<b>Use Meters/Oscilloscopes to Measure Phase Shift or Angle in Series Resistive-Capacitive/Resistive-Inductive AC Circuits</b>	

---

### Objective(s):

Upon completion of this unit the student will be able to:

- a. Measure degrees on an ordinary dual trace oscilloscope as a function of time;
- b. Apply the knowledge of oscilloscope functions to the measurement of phase angles and phase shift in AC circuits;
- c. Use function generators to test/calibrate circuits;
- d. Use oscilloscopes to test/calibrate circuits;
- e. Adjust the frequency, amplitude and proper decibel level of a function generator and use the instrument to test electronic and electrical equipment;
- f. Properly set up an oscilloscope for calibrated measurements, and use the instrument to measure frequency, time, degrees of phase shift, DC voltages, voltage peak, and voltage peak-to-peak;
- g. Calculate a value of AC current, AC voltage or resistance, in a resistive circuit, given any of the two quantities and apply proper engineering terms to the results of the calculations;
- h. Calculate a value of AC current or AC voltage in an inductive or capacitive circuit given the values of capacitance, inductance, resistance and frequency, and apply proper engineering terms to the results of the calculations;
- i. Predict the behavior of a circuit for a change of any of the values of current, voltage, resistance, capacitance, inductance or frequency, in a capacitive or inductive electronic or electrical AC circuit;
- j. Calculate and measure AC voltage, current and power expressed as peak values, peak-to-peak values, RMS values, and average values; and convert these quantities from one value to another;
- k. Predict the effects of power in the circuit, given the values of current, voltage or resistance in a resistive, capacitive, or inductive electronic or electrical AC circuit;
- l. Calculate the values of inductive reactance, and capacitive reactance in an AC circuit;

- m. Predict the change in behavior of an AC circuit for a change in frequency or a change in capacitance/inductance;
- n. Calculate expected phase shifts in a capacitive or inductive AC circuit;
- o. Measure impedance/phase angle in AC circuits;
- p. Apply the knowledge of inductive reactance, capacitive reactance, and phase shifts, to the solution of power factor problems found in industrial installations;
- q. Apply the knowledge of inductive reactance, capacitive reactance, and phase shifts, to the prediction of the behavior of power in AC electrical/electronic circuits;
- r. Apply the knowledge of poly-phase AC circuits to the calculation and measurement of voltage, current, and power in these circuits;
- s. Measure phase angles in poly-phase AC circuits;
- t. Determine the phase rotation for poly-phase AC motors;
- u. Calculate power in poly-phase AC circuits;
- v. Calculate and predict the voltages that can be obtained from a configuration of a delta or wye poly-phase AC circuit;
- w. Determine reference points for measurement of voltages and currents in a delta or wye configuration poly-phase AC circuit; and,
- x. Determine of the type of power distribution in effect for a configuration of a poly-phase AC circuit.

---

### **Instructional Materials:**

The following measurement instruments:

- Variable frequency function generators capable of dB switching, DC outputs, AC outputs, square wave outputs, triangular wave outputs, and sawtooth outputs
- 20 to 100 Megahertz dual trace oscilloscope with switchable manual/auto triggering, and 20 volts to 5 mV vertical deflection
- 20 to 100 Megahertz dual trace oscilloscope with isolated channels switchable manual/auto triggering, and 20 volts to 5 mV vertical deflection (optional)
- Digital multimeters with capacitance and inductance scales
- Clamp-on meters
- Power factor meters
- Phase rotation and phase angle meters
- Textbook labs that provide practical applications of the concepts contained in this module

**MASTER Handout (AET-E7-HO-1)**

**MASTER Handout (AET-E7-HO-2) (Decibels and Logarithms)**

**MASTER Laboratory Exercise (AET-E7-LE)**

**MASTER Laboratory Aid (AET-E7-LA)**

**MASTER Quiz AET-E7-QU-1: Function generators**

**MASTER Quiz AET-E7-QU-2: Oscilloscopes**  
**MASTER Quiz AET-E7-QU-3: AC capacitive and inductive circuits**  
**MASTER Quiz AET-E7-QU-4: Impedance and phase angle**  
**MASTER Quiz AET-E7-QU-5: Power factor measurement**  
**MASTER Quiz AET-E7-QU-6: Poly-phase AC circuits**

---

**References:**

*Elements of Electronic Instrumentation and Measurement*, Carr, ISBN 0-13-341686-0, Latest Edition  
*Using the Oscilloscope*, Iddings, ISBN 0-13-148362-5, Latest Edition  
*Electricity/Electronics Fundamentals*, Zbar/Sloop, Latest Edition  
*Introductory DC/AC Electronics*, Nigel P. Cook, Latest Edition (with interactive software)  
*Guide to Electrical Power Distribution Systems Equipment, Applications, Installation, and Maintenance*, Pansini, Latest Edition  
*Modern Industrial Electronics*, Schuler/MacNamee, Latest Edition (formerly *Industrial Electronics and Robotics*, Schuler/MacNamee, 1987)  
*The Complete Guide to Electronics Troubleshooting*, Perozzo, Latest Edition  
*Troubleshooting Electronic Equipment the Right Way Without Using Expensive Test Instruments*, Douglas-Young, Latest Edition  
**Video(s):** *Using Dual Trace Oscilloscopes*, Bergwall Productions, Latest Edition  
*Alternating Current Fundamentals*, Bergwall Productions, 1-800-645-3565, Latest Edition  
*Working Safely With Electricity*, Bergwall Productions, 1-800-645-3565, Latest Edition  
*Advanced AC Circuits*, Bergwall Productions, 1-800-645-3565, Latest Edition

Note: Bergwall Productions will be referenced frequently throughout the AET section because the company provides quality video productions at a reasonable price, unlike other video production companies.

The following items are *not recommended* because they *detract from the hands-on nature of this module*. These items may be used as a supplement for the module if the module contains actual interaction with real electrical and electronic parts. Electricity and electronics is a "messy" technology because actual parts and measuring devices are not perfect. The

following items are theoretically perfect, and therefore do not reflect the real world of electricity and electronics.

*PSPICE* - Program for modeling the behavior of electrical and electronic components.

*Electronic Workbench* - Graphic Windows based program for constructing theoretical models of electrical and electronic circuits.

---

### **Student Preparation:**

Students should have previously completed the following Technical Modules:

- AET-A6** “Use Physics, Algebra, and Trigonometry to Analyze Simple Vectored Forces”
- AET-B2** “Use Symbols, Organization, and Engineering Values on Electrical Drawings”
- AET-B3** “Use Symbols, Organization, and Engineering Values on Electronic Drawings”
- AET-E1** “Calculate, Predict, and Measure the Response of Quantities in DC Circuits”
- AET-E2** “Calculate, Predict, and Measure the Response of Quantities in AC Circuits”
- AET-E3** “Calculate, Predict, and Measure Impedance and Phase Angle in AC Circuits”
- AET-E4** “Calculate, Predict, and Measure Quantities in Poly-Phase AC Circuits”

**Note:** This module is meant to be used in conjunction with modules AET-C2 “Apply Electrical Measurement Knowledge and Instruments to Test/Calibrate Electrical Circuits” and AET-C3 “Apply Electronic Measurement Knowledge and Instruments to Test/Calibrate Electronic Circuits.”

---

---

### **Introduction:**

The science of measurement is called metrology. This is not to be confused with meteorology, which is the science of weather. Metrology, and measurement devices such as function generators and oscilloscopes, allow the modern automation technician to perform complex electronic measurements with relative ease and safety. However, measuring and calibrating electronic circuits, must be done in a manner that does not expose the technician to electrical hazards and damage the equipment and/or the instrument. This is especially true with oscilloscopes and function generators. To achieve this goal, the technician must be aware of the parameters of the type of measure that is to be attempted, and the manner in which the instrument is connected for the measurement. At a minimum, the technician must be able to use these devices effectively.

The behavior of voltage and current in an AC circuit is not as straight forward as the behavior of DC voltages and currents under the same circumstances. Resistive circuits behave in a relatively straight forward manner when energized by AC voltages and currents. Capacitors and inductors in AC circuits can, and do, act like resistors that are sensitive to the periodic nature of the AC (frequency). Predicting how AC will react in these circuits requires the use of trigonometry and vectors. Measurements of the parameters of an AC circuit, and the behavior of AC in components such as transformers, motors, and AC solenoids, must be done in a manner that takes these behaviors into account. To achieve this goal, the technician must be able to predict the changes that may occur in the circuit to understand the results of any measurement of the parameters of the AC circuit.

The behavior of voltage, current, and power in an AC circuit depends upon the amount of inductive, capacitive and resistive components that are installed in the system. Resistive circuits behave in a relatively straight forward manner when energized by AC voltages and currents, but capacitors and inductors in AC circuits can, and do, act like resistors that are sensitive to the periodic nature of the AC (frequency). Predicting how AC will react in these circuits requires the knowledge and use of the concepts of impedance and phase shifts. Measurements of the parameters of an AC circuit, and the behavior of AC in components such as transformers, motors, and AC solenoids, must be done in a manner that takes these behaviors into account. The solution of industrial problems, such as power factor correction, requires the application of these concepts.

In the early years of the practical implementation of electricity to power lights and electrical systems, Edison was a adamant proponent of the use of DC voltages and currents. In opposition, Nicholas Tesula, who at one time was a researcher at Edison's labs, insisted that Alternating Current (AC) was the method of choice to deliver electrical power. Tesula had science and math on his side, and subsequent inventions such as the poly-phase AC motor, and transformers to convert the power, proved Tesula to be correct. Modern power distribution systems use Poly-phase AC distribution systems to deliver power to industrial plants and homes. Both two phase, poly-phase AC systems, and three phase, poly-phase AC systems have been used for the purpose of delivering AC power; but the three phase poly phase system has proven to be the most efficient method of accomplishing the task. Frequently, the three phase wye and the three phase delta system are used to deliver and transform power. Many variations on this theme exist, however, they tend to be hybrids of the two basic systems.

---

---

### **Presentation Outline:**

- I. Use Function Generators to Test/Calibrate Circuits
  - A. Identify and explain the purpose of the controls on a function generator

1. Frequency range and variable frequency control
  2. Wave form selection control
  3. Amplitude control
  4. DC offset control
  5. Decibel (dB) switches (MASTER Handout AET-E7-HO-2)  
(Decibels and Logarithms)
- B. Explain the safety procedures and grounding problems associated with the use of function generators
1. Explain the concept of "ground loops" and the relation ship of the common connection point of the function generator to the common connection point of the circuit under test
  2. Explain the expected behavior of servo systems when subjected to signal injection and the safety procedures that must be followed
- C. Demonstrate the use of the function generator for signal injection into a servo amplifier of a robot or CNC machine
1. Explain the purpose of the test for each wave form
  2. Explain the expected outcome of the test
- II. Use Oscilloscopes to Test/Calibrate Circuits
- A. Identify and explain the purpose of the controls on an oscilloscope
1. Beam trace intensity and alignment
  2. Selecting dual or single channel
  3. Selecting alternate or chop frequency and the advantages/disadvantages of both
  4. Time base range and variable time base
  5. Vertical deflection range and variable vertical deflection
  6. Triggering controls, internal and external triggering, selecting a triggering source
  7. Auto/manual triggering
- B. Explain the proper procedures for setting up the scope for calibrated measurements
- C. Explain the safety procedures and grounding problems associated with the use of an oscilloscope
1. Explain the concept of "ground loops" and the relation ship of the common connection point of the oscilloscope to the common connection point of the circuit under test
  2. Explain the expected behavior of electronic systems when subjected to testing by the oscilloscope and the safety procedures that must be followed
- D. Demonstrate the use of the oscilloscope in conjunction with the function generator for signal injection into a servo amplifier of a robot or CNC machine
1. Explain the purpose of the test for each wave form
  2. Explain the expected outcome of the test



- E. Demonstrate the methods used to convert horizontal time on an oscilloscope to degrees of rotation of a sine wave, or a phase shift in complex inductive/capacitive circuits
- III. Use AC theory; Measure AC Voltages and Currents
- A. Explain the concepts of voltage, current, and resistance for resistive, single phase AC circuits
    - 1. Explain the concepts of voltage, current, and resistance for AC circuits
    - 2. Explain the units of measurement for AC voltage and current (RMS, peak, peak-to-peak, average)
    - 3. Provide examples of each quantity
    - 4. Explain the mathematical tools and procedures that can be used to solve problems in complex resistive AC circuits
    - 5. Demonstrate the mathematical solution of voltage ,current, resistance and power in resistive AC systems
    - 6. Demonstrate the procedures for verifying the calculations by measurement.
  - B. Explain the concept of inductance and capacitance for AC voltages and currents
    - 1. Explain the behavior of AC in a capacitive AC circuit
    - 2. Explain the behavior of AC in an inductive AC circuit
    - 3. Demonstrate the magnetic field produced by an inductor when energized by AC current
    - 4. Explain how capacitors and inductors are used in AC electrical and electronic circuits, and provide examples of each use in a working control system for a robot or CNC machine
  - C. Demonstrate the procedure for safely measuring, current, voltage, resistance, in complex AC circuits
- IV. Calculate/Predict Impedance and Phase Angle in AC Circuits
- A. Explain the concept of impedance for AC circuits
    - 1. Explain the concept of impedance
    - 2. Explain the mathematical tools and procedures that can be used to solve problems in complex resistive, inductive, and capacitive AC circuits
    - 3. Demonstrate the mathematical solution of voltage ,current, resistance and power in complex resistive, inductive, and capacitive AC systems
  - B. Explain the concept of inductance and capacitance for AC voltages and currents
    - 1. Demonstrate the phase shift of AC voltage and current in a resistive-capacitive AC circuit
    - 2. Demonstrate the phase shift of AC voltage and current in a resistive-inductive AC circuit



3. Explain how capacitors and inductors are used in AC electrical and electronic circuits, and provide examples of each use in a working control system for a robot or CNC machine
- V. Measure Impedance/Phase Angle in AC Circuits
  - A. Demonstrate the measurement of phase shift and phase angle
    1. Explain the precautions that need to be observed when using an oscilloscope to measure AC circuits
    2. Demonstrate the measurement of phase shift and phase angle using an oscilloscope
  - B. Demonstrate the procedure for measuring power factor and the solution of power factor problems
    1. Explain the precautions that need to be observed when using instruments to measure AC line voltages
    2. Demonstrate the calculation of power factor and the determination of capacitors used to correct power factor problems
- VI. Calculate, Predict, and Measure Voltage, Current, and Power in Three Phase AC Systems
  - A. Units of measurement for poly-phase AC
    1. Explain the concepts of phase shift in AC circuits
    2. Provide examples of the various types of poly-phase systems (delta and wye)
    3. Provide examples of the mathematical relationship between poly-phase AC voltages, currents, and power
    4. Demonstrate the application of mathematical concepts to the determination of voltage, current, and power in poly-phase AC systems
  - B. Measurement of AC voltage current, and power in three phase AC systems
    1. Explain the reference points for measuring AC voltage and current in three phase AC systems.(wye and delta)
    2. Demonstrate the measurement of voltage, current, power, and phase angle in three phase AC systems (wye and delta)

---

---

### **Practical Application:**

1. Use a function generator and an oscilloscope to inject and monitor a wave form in the servo amplifier of a CNC machine or robot;
2. Use the oscilloscope to monitor a wave form injected by a function generator in the servo amplifier of a CNC machine;
3. Using an industrial control system demonstrate the measurement of voltage, current, resistance, power, in AC circuits;
4. Calculate the parameters of the system from the measurements;

5. Using a CNC or robotic control system, identify AC capacitive and inductive circuits and the methods of determining impedance, voltages, and currents in these circuits;
6. Using the power distribution system to a building or facility, measure voltage, current (clamp-on ammeter), power and power factor;
7. Calculate the type of power factor capacitors need to correct the power factor for the system;
8. Measure voltages in three phase AC power distribution systems; and,
9. Measure voltages and currents in three phase resistive and inductive AC circuits.

---

---

**Evaluation and/or Verification:**

Successful completion of this technical module will be based on the student's successful completion of the following components:

1. A ten question quiz on the use of the function generator (MASTER Quiz AET-E7-QU-1: Function generators);
2. A ten question quiz on the use of the oscilloscope (MASTER Quiz AET-E7-QU-2: Oscilloscopes);
3. A ten question quiz on capacitance and inductance in AC circuits (MASTER Quiz AET-E7-QU-3: AC capacitive and inductive circuits);
4. A ten question quiz on impedance and phase shift (MASTER Quiz AET-E7-QU-4: Impedance and phase angle);
5. A ten question quiz on power factor measurement and correction (MASTER Quiz AET-E7-QU-5: Power factor measurement);
6. A ten question quiz on poly-phase AC power (MASTER Quiz AET-E7-QU-6: Poly-phase AC circuits);
7. Demonstrate competency in the use of function generators (may be measured by textbook labs);
8. Demonstrate competency in the use of oscilloscopes (may be measured by textbook labs); and,
9. Textbook labs on practical application of the concepts contained in this module.

---

---

**Summary:**

Review the main lesson points using the text and handouts listed in the reference section of this module. Hold class discussion and answer student questions.

---

---

**Next Lesson Assignment:**

**MASTER Technical Module (AET-E8)** dealing with applying electromagnetism theory to determine operational characteristics of relays, solenoids, transformers, and electrical motors for DC and AC circuits.

**AET-E7-HO-1**  
**Use Meters/Oscilloscopes to Measure Phase Shift or Angle**  
**in Series Resistive-Capacitive/Resistive-Inductive AC Circuits**  
**Attachment 1: MASTER Handout No. 1**

---

**Objective(s):**

Upon completion of this unit the student will be able to:

- a. Measure degrees on an ordinary dual trace oscilloscope as a function of time;
- b. Apply the knowledge of oscilloscope functions to the measurement of phase angles and phase shift in AC circuits;
- c. Use function generators to test/calibrate circuits;
- d. Use oscilloscopes to test/calibrate circuits;
- e. Adjust the frequency, amplitude and proper decibel level of a function generator and use the instrument to test electronic and electrical equipment;
- f. Properly set up an oscilloscope for calibrated measurements, and use the instrument to measure frequency, time, degrees of phase shift, DC voltages, voltage peak, and voltage peak-to-peak;
- g. Calculate a value of AC current, AC voltage or resistance, in a resistive circuit, given any of the two quantities and apply proper engineering terms to the results of the calculations;
- h. Calculate a value of AC current or AC voltage in an inductive or capacitive circuit given the values of capacitance, inductance, resistance and frequency, and apply proper engineering terms to the results of the calculations;
- i. Predict the behavior of a circuit for a change of any of the values of current, voltage, resistance, capacitance, inductance or frequency, in a capacitive or inductive electronic or electrical AC circuit;
- j. Calculate and measure AC voltage, current and power expressed as peak values, peak-to-peak values, RMS values, and average values; and convert these quantities from one value to another;
- k. Predict the effects of power in the circuit, given the values of current, voltage or resistance in a resistive, capacitive, or inductive electronic or electrical AC circuit;
- l. Calculate the values of inductive reactance, and capacitive reactance in an AC circuit;
- m. Predict the change in behavior of an AC circuit for a change in frequency or a change in capacitance/inductance;
- n. Calculate expected phase shifts in a capacitive or inductive AC circuit;
- o. Measure impedance/phase angle in AC circuits;

- p. Apply the knowledge of inductive reactance, capacitive reactance, and phase shifts, to the solution of power factor problems found in industrial installations;
- q. Apply the knowledge of inductive reactance, capacitive reactance, and phase shifts, to the prediction of the behavior of power in AC electrical/electronic circuits;
- r. Apply the knowledge of poly-phase AC circuits to the calculation and measurement of voltage, current, and power in these circuits;
- s. Measure phase angles in poly-phase AC circuits;
- t. Determine the phase rotation for poly-phase AC motors;
- u. Calculate power in poly-phase AC circuits;
- v. Calculate and predict the voltages that can be obtained from a configuration of a delta or wye poly-phase AC circuit;
- w. Determine reference points for measurement of voltages and currents in a delta or wye configuration poly-phase AC circuit; and,
- x. Determine of the type of power distribution in effect for a configuration of a poly-phase AC circuit.

---

### Module Outline:

- I. Use Function Generators to Test/Calibrate Circuits
  - A. Identify and explain the purpose of the controls on a function generator
    - 1. Frequency range and variable frequency control
    - 2. Wave form selection control
    - 3. Amplitude control
    - 4. DC offset control
    - 5. Decibel (dB) switches (MASTER Handout AET-E7-HO-2) (Decibels and Logarithms)
  - B. Explain the safety procedures and grounding problems associated with the use of function generators
    - 1. Explain the concept of "ground loops" and the relation ship of the common connection point of the function generator to the common connection point of the circuit under test
    - 2. Explain the expected behavior of servo systems when subjected to signal injection and the safety procedures that must be followed
  - C. Demonstrate the use of the function generator for signal injection into a servo amplifier of a robot or CNC machine
    - 1. Explain the purpose of the test for each wave form
    - 2. Explain the expected outcome of the test
- II. Use Oscilloscopes to Test/Calibrate Circuits
  - A. Identify and explain the purpose of the controls on an oscilloscope
    - 1. Beam trace intensity and alignment

2. Selecting dual or single channel
  3. Selecting alternate or chop frequency and the advantages/disadvantages of both
  4. Time base range and variable time base
  5. Vertical deflection range and variable vertical deflection
  6. Triggering controls, internal and external triggering, selecting a triggering source
  7. Auto/manual triggering
- B. Explain the proper procedures for setting up the scope for calibrated measurements
- C. Explain the safety procedures and grounding problems associated with the use of an oscilloscope
1. Explain the concept of "ground loops" and the relationship of the common connection point of the oscilloscope to the common connection point of the circuit under test
  2. Explain the expected behavior of electronic systems when subjected to testing by the oscilloscope and the safety procedures that must be followed
- D. Demonstrate the use of the oscilloscope in conjunction with the function generator for signal injection into a servo amplifier of a robot or CNC machine
1. Explain the purpose of the test for each wave form
  2. Explain the expected outcome of the test
- E. Demonstrate the methods used to convert horizontal time on an oscilloscope to degrees of rotation of a sine wave, or a phase shift in complex inductive/capacitive circuits
- III. Use AC theory; Measure AC Voltages and Currents
- A. Explain the concepts of voltage, current, and resistance for resistive, single phase AC circuits
1. Explain the concepts of voltage, current, and resistance for AC circuits
  2. Explain the units of measurement for AC voltage and current (RMS, peak, peak-to-peak, average)
  3. Provide examples of each quantity
  4. Explain the mathematical tools and procedures that can be used to solve problems in complex resistive AC circuits
  5. Demonstrate the mathematical solution of voltage, current, resistance and power in resistive AC systems
  6. Demonstrate the procedures for verifying the calculations by measurement.
- B. Explain the concept of inductance and capacitance for AC voltages and currents
1. Explain the behavior of AC in a capacitive AC circuit
  2. Explain the behavior of AC in an inductive AC circuit

3. Demonstrate the magnetic field produced by an inductor when energized by AC current
4. Explain how capacitors and inductors are used in AC electrical and electronic circuits, and provide examples of each use in a working control system for a robot or CNC machine
- C. Demonstrate the procedure for safely measuring, current, voltage, resistance, in complex AC circuits
- IV. Calculate/Predict Impedance and Phase Angle in AC Circuits
  - A. Explain the concept of impedance for AC circuits
    1. Explain the concept of impedance
    2. Explain the mathematical tools and procedures that can be used to solve problems in complex resistive, inductive, and capacitive AC circuits
    3. Demonstrate the mathematical solution of voltage, current, resistance and power in complex resistive, inductive, and capacitive AC systems
  - B. Explain the concept of inductance and capacitance for AC voltages and currents
    1. Demonstrate the phase shift of AC voltage and current in a resistive-capacitive AC circuit
    2. Demonstrate the phase shift of AC voltage and current in a resistive-inductive AC circuit
    3. Explain how capacitors and inductors are used in AC electrical and electronic circuits, and provide examples of each use in a working control system for a robot or CNC machine
- V. Measure Impedance/Phase Angle in AC Circuits
  - A. Demonstrate the measurement of phase shift and phase angle
    1. Explain the precautions that need to be observed when using an oscilloscope to measure AC circuits
    2. Demonstrate the measurement of phase shift and phase angle using an oscilloscope
  - B. Demonstrate the procedure for measuring power factor and the solution of power factor problems
    1. Explain the precautions that need to be observed when using instruments to measure AC line voltages
    2. Demonstrate the calculation of power factor and the determination of capacitors used to correct power factor problems
- VI. Calculate, Predict, and Measure Voltage, Current, and Power in Three Phase AC Systems
  - A. Units of measurement for poly-phase AC
    1. Explain the concepts of phase shift in AC circuits
    2. Provide examples of the various types of poly-phase systems (delta and wye)

3. Provide examples of the mathematical relationship between poly-phase AC voltages, currents, and power
  4. Demonstrate the application of mathematical concepts to the determination of voltage, current, and power in poly-phase AC systems
- B. Measurement of AC voltage current, and power in three phase AC systems
1. Explain the reference points for measuring AC voltage and current in three phase AC systems.(wye and delta)
  2. Demonstrate the measurement of voltage, current, power, and phase angle in three phase AC systems (wye and delta)



**AET-E7-HO-2**  
**Use Meters/Oscilloscopes to Measure Phase Shift or Angle**  
**in Series Resistive-Capacitive/Resistive-Inductive AC Circuits**  
**Attachment 2: MASTER Handout No. 2**

---

**Decibels and Logarithms**

This is not the name of a big band, but it's a possibility. Decibels are a scaling system based on powers of ten. Decibels reflect a "figure of merit" describing voltages, current, or power over resistance or area. It can be applied to amplifiers, sensitivity of receivers, or the power of the sound in an industrial plant. It is simply a scale in powers of ten. For example, a function generator will add or subtract 20 decibels to a wave form if you turn the right switch.

Scales built using the decibel system have different ZERO POINTS. A decibel scale can have ANY point defined as "zero decibels" and the measuring method of the scale will be consistent starting with that base number. Audible sound, for example, uses as a zero decibel point, a value equivalent to "sound barely audible by the average human ear". This value is an intensity of  $10^{-12}$  Watts/meter<sup>2</sup>.

Starting with that number, every time the intensity of sound increases by one power of ten, ( $10^1$ ) we add **TEN decibels** to our value. So the *power/area* is actually:  
**THE ZERO-DECIBELS VALUE multiplied by 10 raised to the power of (.1 times the number of decibels).**

For example:

If X is the zero value then:

+ 20 decibels is  $X \cdot 10^{2.0}$

or

**100X**

Notice you can have decimals in the power of ten exponent:

For example  $10^{2.5} = 316.227$ , which is the multiplier for **25 decibels**.

For example, leaves rustling in the autumn breeze in the parking lot would have a sound intensity of about 10 decibels.

This means the intensity or power of that sound in Watts/m<sup>2</sup> would be:

$10^{-12}$  Watts per meter<sup>2</sup> times 10 to the first power

This equals  $10^{-12} \cdot 10^{1.0}$  or  $10^{-11}$  or .01 Nanowatts/meter<sup>2</sup>. As you can imagine this is **not** a lot of power per square meter.



If we compare it to an ordinary conversation such as often occurs in the middle of lectures, we are comparing 10 decibels to 60 decibels.

This equals the “0 decibels” figure times 10 to the 6.0 power

or

$$1 \times 10^{-12} \times 1 \times 10^{6.0} = 1 \text{ microwatt/m}^2$$

Compared to this zero point, other decibel values of audible sound are:

Sound	Decibels	Calculation	Watts/m <sup>2</sup>
A lover whispering from 1 yard away	20	$1 \times 10^{-12} \times 1 \times 10^{2.0}$	.1 nanowatts
Standing at Market and 1st Ave.	40	$1 \times 10^{-12} \times 1 \times 10^{4.0}$	10 nanowatts
Conversation with the instructor on break	60	$1 \times 10^{-12} \times 1 \times 10^{6.0}$	10 microwatts
Conversation with Rohr Industries	85	$1 \times 10^{-12} \times 1 \times 10^{8.5}$	316.227 u watts
Niagra Falls from the little tour boat	90	$1 \times 10^{-12} \times 1 \times 10^{9.0}$	1 milliwatt
Loud rock band	110	$1 \times 10^{-12} \times 1 \times 10^{11.0}$	612.01 milliwatt
Sound painful to the ear	120	$1 \times 10^{-12} \times 1 \times 10^{12.0}$	1 watt

If you use decibels to measure some electronic value as in the gain delivered by a stereo amplifier, you will get totally different values depending on where the ZERO VALUE is. What is important to notice is that the decibel scale is not *linear* (each decibel adds a fixed amount) but *LOGARITHMIC* (each decibel adds a certain amount to the EXPONENT of 10). It increases exponentially.

A LOGARITHM is “*the number to which a base is raised to give another number*”. Logarithmic scales increase by powers rather than by fixed amounts. If you are using base 10, which is common, the logarithm of 100 is 2 (you raise 10 to the 2d power to get 100). The logarithm of 1000 is 3 (you raise 10 to the 3d power to get 1000) and the logarithm of 721.11 is *somewhere in between*. You can find out quickly if you have a calculator with a log key. For example, the number 721.11:

Using the calculator, the power of ten exponent for 721.11 is  
2.858001518.

In other words ten raised to the 2.858001518 power will give you 721.11.

Logarithms are exponents, and can be mathematically manipulated like exponents which makes it easy to mathematically calculate very large and very small numbers.

The controls on the front panel of a function generator include decibel switches. Using a function generator, and switching the 10 db or 20 db switch on the unit, means that you are multiplying or dividing the current value of the generators output by 10 or 100.

The +10 db switch will multiply the output by 10, and the -10 db switch will divide the output by 10; or the -20 db switch will divide the output by 100, and turning it off will restore the output to its previous value.

**AET-E7-LE**  
**Use Meters/Oscilloscopes to Measure Phase Shift or Angle**  
**in Series Resistive-Capacitive/Resistive-Inductive AC Circuits**  
**Attachment 3: MASTER Laboratory Exercise**

---

The student will:

1. Use a function generator and an oscilloscope to inject and monitor a wave form in the servo amplifier of a CNC machine or robot;
2. Use the oscilloscope to monitor a wave form injected by a function generator in the servo amplifier of a CNC machine;
3. Use an industrial control system to demonstrate the measurement of voltage, current, resistance, power, in AC circuits;
4. Calculate the parameters of the system from the measurements;
5. Use a CNC or robotic control system to identify AC capacitive and inductive circuits and the methods of determining impedance, voltages, and currents in these circuits;
6. Use the power distribution system to a building or facility to measure voltage, current (clamp-on ammeter), power and power factor;
7. Calculate the type of power factor capacitors need to correct the power factor for the system;
8. Measure voltages in three phase AC power distribution systems; and,
9. Measure voltages and currents in three phase resistive and inductive AC circuits.

**AET-E7-LA**  
**Use Meters/Oscilloscopes to Measure Phase Shift or Angle**  
**in Series Resistive-Capacitive/Resistive-Inductive AC Circuits**  
**Attachment 4: MASTER Laboratory Aid**

---

**Rules of Conduct**

1. Absolutely no horseplay or practical joking will be tolerated.
2. Do not talk to anyone who is operating a machine.
3. Walk only in the designated traffic lanes.
4. Dress appropriately; at the absolute minimum, you must have:
  - a. No loose clothing, including ties;
  - b. Long hair properly stowed;
  - c. No jewelry;
  - d. Hard, closed-toe shoes;
  - e. Eye protection (safety glasses); and,
  - f. Ear protection (plugs or headset).
5. Follow all institutional safety rules.

# **AUTOMATED EQUIPMENT REPAIR SERIES**

## **MASTER Technical Module No. AET-E8**

---

<b>Subject:</b>	<b>Automated Equipment Repair</b>	<b>Time: 32 Hrs.</b>
<b>Duty:</b>	<b>Use Techniques to Isolate Malfunctions of Electrical/Electronic Systems</b>	
<b>Task:</b>	<b>Apply Electromagnetism Theory to Determine Operational Characteristics of Relays, Solenoids, Transformers, and Electrical Motors for DC and AC Circuits</b>	

---

### **Objective(s):**

Upon completion of this unit the student will be able to:

- a. Apply electromagnetism theory to determine operational characteristics of relays, and solenoids;
- b. Apply electromagnetism theory to determine operational characteristics of transformers;
- c. Apply electromagnetism theory to determine operational characteristics of electrical motors for DC and AC circuits;
- d. Apply the knowledge of magnetism to the solution of problems found in electrical/electronic control circuits;
- e. Apply the knowledge of the electromagnetic effect to the determination of the nature of the device under test;
- f. Apply the knowledge of the electromagnetic effect, the concept of inductive reactance, the knowledge of the theory of the operation of electrical motors, and Ohm's Law to the solution of problems found in electrical motors;
- g. Apply the knowledge of electromagnetic effect, the theory of transformers, Ohm's Law, and the concept of inductive reactance to the solution of problems found in transformers; and,
- h. Apply the knowledge of the electromagnetic effect, inductive reactance, and Ohm's Law to the solution of problems found in electromagnetic devices such as relays and solenoids.

---

### **Instructional Materials:**

The following measurement instruments:

Digital multimeters with capacitance and inductance scales  
20 to 100 Mega Hertz dual trace oscilloscope with switchable  
manual/auto triggering, and 20 volts to 5 mV vertical deflection

20 to 100 Mega Hertz dual trace oscilloscope with isolated channels switchable manual/auto triggering, and 20 volts to 5 mV vertical deflection (optional)

Clamp-on ammeters

Materials for demonstrating magnetic principles (magnets, iron filings, electromagnets)

Textbook labs on practical applications of the concepts contained in this module

**MASTER Handout (AET-E8-HO)**

**MASTER Laboratory Exercise (AET-E8-LE)**

**MASTER Laboratory Aid (AET-E8-LA)**

**MASTER Quiz AET-E8-QU-1: Electromagnetic theory**

**MASTER Quiz AET-E8-QU-2: Transformers**

**MASTER Quiz AET-E8-QU-3: Electrical motors**

---

### References:

*Electromechanics: Principles, Concepts and Devices*, James Harter, ISBN 0-02-351191-5, Latest Edition

*Modern Control Technology (Components and Systems)*, Kilian, ISBN 0-314-06631-4, Latest Edition

*Modern Industrial Electronics, Revised and Expanded Edition*, Schuler/MacNamee, Latest Edition (formerly *Industrial Electronics and Robotics*, Schuler/MacNamee, 1987)

*Electric Machines, Theory, Operation, Applications, Adjustment, and Control*, Hubert, ISBN 0-675-21236-0, Latest Edition

**Video(s):** *Rotating Machinery*, Bergwall Productions, 1-800-645-3565, Latest Edition

*Direct Current Generators*, Bergwall Productions, 1-800-645-3565, Latest Edition

Note: Bergwall Productions will be referenced frequently throughout the AET section because the company provides quality video productions at a reasonable price, unlike other video production companies.

---

### Student Preparation:

Students should have previously completed the following Technical Modules:

**AET-A5** "Measure, Calculate, and Convert Quantities in English and Metric (SI, mks) Systems of Measurement"

**AET-A6** "Use Physics, Algebra, and Trigonometry to Analyze Simple Vectored Forces"

- AET-B2** "Use Symbols, Organization, and Engineering Values on Electrical Drawings"
- AET-E1** "Calculate, Predict, and Measure the Response of Quantities in DC Circuits"
- AET-E2** "Calculate, Predict, and Measure the Response of Quantities in AC Circuits"
- AET-E3** "Calculate, Predict, and Measure Impedance and Phase Angle in AC Circuits"
- AET-E4** "Calculate, Predict, and Measure Quantities in Poly-Phase AC Circuits"
- AET-E5** "Properly Set Up, Calibrate, and Use Meters and Oscilloscopes"
- AET-E6** "Use Components Such as Resistors, Inductors, and Capacitors; Construct Circuits and Test Components"
- AET-E7** "Use Meters/Oscilloscopes to Measure Phase Shift or Angle in Series Resistive-Capacitive/Resistive-Inductive AC Circuits"

---

---

### **Introduction:**

Modern control systems use electromagnetic devices to switch currents, distribute power, move mechanisms, and convert electrical power into rotating mechanical power. To accomplish these tasks, we have invented many electromechanical devices; for example, relays, transformers, solenoids, and electrical motors. All of the devices have one thing in common, the use of electromagnetic principles to operate. Understanding the principles of electromagnetism will aid the technician in troubleshooting electromechanical components. In addition, each electromechanical device uses the principles of electromagnetism in unique ways. Therefore, the technician must learn the peculiarities of each device, and its principles of operation.

---

---

### **Presentation Outline:**

- I. Apply Electromagnetism Theory to Determine Operational Characteristics of Relays and Solenoids
  - A. Principles of electromagnetism
    - 1. Explain the concepts of magnets and magnetic fields
    - 2. Demonstrate magnetic lines of force for permanent magnets and electromagnets
    - 3. Explain and demonstrate the creation of a magnetic field from an electrical current
    - 4. Explain and demonstrate the relationship of magnetic field strength as a function of the following:
      - a. Magnitude of current
      - b. Cross sectional area of wire and wire resistance
      - c. Number of turns of wire
      - d. Electromagnet core

- e. Force created by the electromagnet
    - 5. Explain and demonstrate the differences between an AC electromagnet and a DC electromagnet
  - B. Explain the operating principles of relays and solenoids
    - 1. Describe the purpose of a relay and its component parts
    - 2. Demonstrate the operation of a relay
    - 3. Explain the parameters of a DC electromagnet for a DC relay
      - a. Resistance of the coil
      - b. Relay pick up current and relay drop out current
      - c. Wire size as compared to number of turns of wire
    - 4. Demonstrate and measure the inductive transient of a DC relay
      - a. Explain the principles of inductive transients
      - b. Construct a relay circuit and measure the inductive transient when the relay de-energizes
    - 5. Explain and demonstrate the parameters of an AC relay
      - a. Coil resistance as compared to inductive reactance
      - b. Relay pick up and drop out current
      - c. Phase relationships in AC relay coils (60Hz)
      - d. Behavior of a magnetic field in an AC relay coil
    - 6. Explain the parameters of a DC solenoid
      - a. Resistance of the coil
      - b. Solenoid actuation current and drop out current as a function of the bias spring
      - c. Wire size as compared to number of turns of wire
    - 7. Demonstrate and measure the inductive transient of a DC solenoid
      - a. Explain the principles of inductive transients
      - b. Construct a solenoid circuit and measure the inductive transient created when the solenoid de-energizes
    - 8. Explain and demonstrate the parameters of an AC solenoid
      - a. Coil resistance as compared to inductive reactance
      - b. Solenoid pick up and drop out current
      - c. Phase relationships in AC relay coils (60Hz)
  - C. Explain the principles of inductive transient suppression, and the devices used
    - 1. Explain the principles of inductive transient suppression
    - 2. Explain and demonstrate the devices used to suppress inductive transients in DC relays and solenoids
    - 3. Explain and demonstrate the devices used to suppress inductive transients in AC relays and solenoids
- II. Apply Electromagnetism Theory to Determine Operational Characteristics of Transformers
  - A. Principles of transformers
    - 1. Explain the concepts of magnetic induction



2. Explain the uses of transformers in the distribution and transformation of power. Stress and emphasize the fact that a transformer *only* works on AC
  3. Explain, demonstrate and identify the component parts of a transformer
  4. Explain and demonstrate the relationship of the primary magnetic field to the secondary current
    - a. Magnitude of current
    - b. Cross sectional area of wire and wire resistance
    - c. Number of turns of wire of primary and secondary
    - d. Electromagnet core
    - e. Inductive reactance
  5. Explain and demonstrate the relationship of the secondary magnetic field to the primary current
- B. Explain the operating principles of transformers
1. Describe the turns relationship between the primary and secondary
  2. Explain the relationship between the voltage and current in the primary and the voltage and current in the secondary
  3. Explain power transfer from primary to secondary and the phase relationship of primary and secondary voltage and current
  4. Demonstrate the calculation of voltage and current for step up and step down transformers
  5. Explain, identify, and demonstrate transformers with multiple secondaries and tapped primaries and secondaries
  6. Demonstrate the methods for wiring primary and secondaries of transformers
- C. Explain the principles of operation of three phase transformers
1. Describe the turns relationship between the primary and secondary
  2. Explain the relationship between the voltage and current in the primary and the voltage and current in the secondary
  3. Explain power transfer from primary to secondary and the phase relationship of primary and secondary voltage and current
  4. Demonstrate the calculation of voltage and current for step up and step down transformers
  5. Explain, identify, and demonstrate transformers with multiple secondaries and tapped primaries and secondaries
  6. Demonstrate the methods for wiring primary and secondaries of three phase transformers
- III. Apply Electromagnetism Theory to Determine Operational Characteristics of Electrical Motors for DC and AC Circuits
- A. Identify, explain, and demonstrate operating principles of motors

1. Explain the principles by which an electrical motor creates harmonic motion
    - a. Application of force through opposing and attracting rotating magnets
    - b. Types of magnets used to create magnetic fields (permanent and electromagnets)
    - c. Examples of harmonic motion (child's swing with adult pushing swing)
    - d. Switching of electrical currents in electromagnets to produce harmonic motion
    - e. Methods by which direction of electrical currents may be switched, to produce magnetic fields of opposite polarities (commutator and alternating current (AC))
  2. Provide examples of the various types of harmonic switching methods (commutator for DC motors, and phase shifting of AC currents for AC motors)
  3. Demonstrate the application of mathematical concepts to the determination of voltage, current, power, and efficiency in electrical motors
- B. Identify, explain, and demonstrate the principles of operation of DC motors
1. Explain the two methods of producing magnetic fields in DC motors
    - a. Permanent magnet (fixed field or rotating field) and electromagnet (fixed field or rotating field)
    - b. Electromagnet and electromagnet (fixed and rotating field)
  2. Explain the mechanisms by which the magnet fields are switched in DC motors
    - a. Commutator method for rotating fields and commutator timing for harmonic motion
    - b. Semiconductor method for fixed magnetic fields and timing methods for harmonic motion
  3. Identify and define the proper terms for the parts of a DC motor
    - a. Armature (rotating field)
    - b. Field magnet (fixed field)
    - c. Commutator and brushes (switching mechanism)
    - d. Determination of the number of poles in the armature of a motor and the relationship of the number of poles to force and smooth operation of the motor
    - e. Limitations of armature size to the number of poles in the armature
  4. Demonstrate the application of mathematical concepts to the determination of torque and speed in electrical motors

- C. Identify, explain, and demonstrate the principles of operation of inductive AC motors
1. Explain the method of producing magnetic fields in inductive AC motors
    - a. Electromagnetic field (stator) and phase shifted electromagnetic field (rotor)
    - b. Use as a model, a transformer in which the primary is the fixed magnetic field, (stator) and the secondary is a rotating secondary magnetic field (rotor)  
*Note:* At this level of training, this model has been found to be the most effective model for explaining the operating principles of AC motors. An in depth knowledge of AC motors is the subject of an entire book, and requires advanced mathematics to understand
  2. Explain the principles by which the magnet fields are switched in inductive, single phase, AC motors to produce harmonic motion
    - a. Fixed Primary (stator) is composed of many turns of wire while rotating secondary (rotor) is composed of only one turn
    - b. Relationship of fixed primary (stator) current to rotating secondary (rotor) current is 100 to 1 or greater
    - c. Primary (stator) AC phase currents have a phase shifted relationship to rotating secondary (rotor) currents which produce strong magnetic fields that are out of phase to the primary (stator)
    - d. Momentum of the secondary (rotor) shifts the magnetic field in relationship to the primary magnetic field (stator), producing harmonic motion
    - e. If the motor is not rotating during the first application of current to the primary (stator), the apparatus will exhibit the characteristics of an AC electromagnet and the rotor will lock in relationship to the stator (locked rotor) (Demonstrate this principle using a single phase inductive motor with the starting mechanism disabled)
    - f. Explain the methods by which momentum can be imparted to the motor to start the rotation
      - (1) Phase shifted magnetic fields produced by capacitive means
      - (2) Phase shifted magnetic fields produced by inductive principles
      - (3) Phase shift produced by three phase AC in three phase AC inductive motors
  3. Identify and define the proper terms for the parts of a AC motor
    - a. Squirrel cage rotor (rotating field)

- b. Stator windings (fixed field)
  - c. Start windings
  - d. Start mechanisms
4. Demonstrate the application of mathematical concepts to the determination of torque and speed in inductive AC electrical motors

---

---

**Practical Application:**

1. Identify the types relays found in an industrial control system and the suppression devices employed;
2. Measure voltages and currents in the relays found in an industrial control system;
3. Measure voltages and currents in single phase, split phase, and three phase AC power transformers;
4. Connect and properly wire single phase, split phase, and three phase power transformers;
5. Measure voltages and currents in single phase and three phase inductive AC motors; and,
6. Calculate power and efficiencies in single phase and three phase inductive AC motors.

---

---

**Evaluation and/or Verification:**

Successful completion of this technical module will be based on the student's successful completion of the following components:

1. A ten question quiz on relays and solenoids (MASTER Quiz AET-E8-QU-1: Electromagnetic theory);
2. A ten question quiz on transformers (MASTER Quiz AET-E8-QU-2: Transformers);
3. A ten question quiz on transformers (MASTER Quiz AET-E8-QU-3: Electrical motors); and,
4. Satisfactory completion of textbook labs on practical application of the information contained in this module.

---

---

**Summary:**

Review the main lesson points using the text and handouts listed in the reference section of this module. Hold class discussion and answer student questions.

---

---

**Next Lesson Assignment:**

**MASTER Technical Module (AET-E9)** dealing with applying principles of operation of electrical motors to identify various types of motors.

**AET-E8-HO**  
**Apply Electromagnetism Theory**  
**to Determine Operational Characteristics**  
**of Relays, Solenoids, Transformers, and Electrical Motors**  
**for DC and AC Circuits**  
**Attachment 1: MASTER Handout**

---

**Objective(s):**

Upon completion of this unit the student will be able to:

- a. Apply electromagnetism theory to determine operational characteristics of relays, and solenoids;
- b. Apply electromagnetism theory to determine operational characteristics of transformers;
- c. Apply electromagnetism theory to determine operational characteristics of electrical motors for DC and AC circuits;
- d. Apply the knowledge of magnetism to the solution of problems found in electrical/electronic control circuits;
- e. Apply the knowledge of the electromagnetic effect to the determination of the nature of the device under test;
- f. Apply the knowledge of the electromagnetic effect, the concept of inductive reactance, the knowledge of the theory of the operation of electrical motors, and Ohm's Law to the solution of problems found in electrical motors;
- g. Apply the knowledge of electromagnetic effect, the theory of transformers, Ohm's Law, and the concept of inductive reactance to the solution of problems found in transformers; and,
- h. Apply the knowledge of the electromagnetic effect, inductive reactance, and Ohm's Law to the solution of problems found in electromagnetic devices such as relays and solenoids.

---

**Module Outline:**

- I. Apply Electromagnetism Theory to Determine Operational Characteristics of Relays and Solenoids
  - A. Principles of electromagnetism
    1. Explain the concepts of magnets and magnetic fields
    2. Demonstrate magnetic lines of force for permanent magnets and electromagnets
    3. Explain and demonstrate the creation of a magnetic field from an electrical current
    4. Explain and demonstrate the relationship of magnetic field strength as a function of the following:
      - a. Magnitude of current

- b. Cross sectional area of wire and wire resistance
- c. Number of turns of wire
- d. Electromagnet core
- e. Force created by the electromagnet
- 5. Explain and demonstrate the differences between an AC electromagnet and a DC electromagnet
- B. Explain the operating principles of relays and solenoids
  - 1. Describe the purpose of a relay and its component parts
  - 2. Demonstrate the operation of a relay
  - 3. Explain the parameters of a DC electromagnet for a DC relay
    - a. Resistance of the coil
    - b. Relay pick up current and relay drop out current
    - c. Wire size as compared to number of turns of wire
  - 4. Demonstrate and measure the inductive transient of a DC relay
    - a. Explain the principles of inductive transients
    - b. Construct a relay circuit and measure the inductive transient when the relay de-energizes
  - 5. Explain and demonstrate the parameters of an AC relay
    - a. Coil resistance as compared to inductive reactance
    - b. Relay pick up and drop out current
    - c. Phase relationships in AC relay coils (60Hz)
    - d. Behavior of a magnetic field in an AC relay coil
  - 6. Explain the parameters of a DC solenoid
    - a. Resistance of the coil
    - b. Solenoid actuation current and drop out current as a function of the bias spring
    - c. Wire size as compared to number of turns of wire
  - 7. Demonstrate and measure the inductive transient of a DC solenoid
    - a. Explain the principles of inductive transients
    - b. Construct a solenoid circuit and measure the inductive transient created when the solenoid de-energizes
  - 8. Explain and demonstrate the parameters of an AC solenoid
    - a. Coil resistance as compared to inductive reactance
    - b. Solenoid pick up and drop out current
    - c. Phase relationships in AC relay coils (60Hz)
- C. Explain the principles of inductive transient suppression, and the devices used
  - 1. Explain the principles of inductive transient suppression
  - 2. Explain and demonstrate the devices used to suppress inductive transients in DC relays and solenoids
  - 3. Explain and demonstrate the devices used to suppress inductive transients in AC relays and solenoids
- II. Apply Electromagnetism Theory to Determine Operational Characteristics of Transformers

- A. Principles of transformers
1. Explain the concepts of magnetic induction
  2. Explain the uses of transformers in the distribution and transformation of power. Stress and emphasize the fact that a transformer *only* works on AC
  3. Explain, demonstrate and identify the component parts of a transformer
  4. Explain and demonstrate the relationship of the primary magnetic field to the secondary current
    - a. Magnitude of current
    - b. Cross sectional area of wire and wire resistance
    - c. Number of turns of wire of primary and secondary
    - d. Electromagnet core
    - e. Inductive reactance
  5. Explain and demonstrate the relationship of the secondary magnetic field to the primary current
- B. Explain the operating principles of transformers
1. Describe the turns relationship between the primary and secondary
  2. Explain the relationship between the voltage and current in the primary and the voltage and current in the secondary
  3. Explain power transfer from primary to secondary and the phase relationship of primary and secondary voltage and current
  4. Demonstrate the calculation of voltage and current for step up and step down transformers
  5. Explain, identify, and demonstrate transformers with multiple secondaries and tapped primaries and secondaries
  6. Demonstrate the methods for wiring primary and secondaries of transformers
- C. Explain the principles of operation of three phase transformers
1. Describe the turns relationship between the primary and secondary
  2. Explain the relationship between the voltage and current in the primary and the voltage and current in the secondary
  3. Explain power transfer from primary to secondary and the phase relationship of primary and secondary voltage and current
  4. Demonstrate the calculation of voltage and current for step up and step down transformers
  5. Explain, identify, and demonstrate transformers with multiple secondaries and tapped primaries and secondaries
  6. Demonstrate the methods for wiring primary and secondaries of three phase transformers



- III. Apply Electromagnetism Theory to Determine Operational Characteristics of Electrical Motors for DC and AC Circuits
- A. Identify, explain, and demonstrate operating principles of motors
1. Explain the principles by which an electrical motor creates harmonic motion
    - a. Application of force through opposing and attracting rotating magnets
    - b. Types of magnets used to create magnetic fields (permanent and electromagnets)
    - c. Examples of harmonic motion (child's swing with adult pushing swing)
    - d. Switching of electrical currents in electromagnets to produce harmonic motion
    - e. Methods by which direction of electrical currents may be switched, to produce magnetic fields of opposite polarities (commutator and alternating current (AC))
  2. Provide examples of the various types of harmonic switching methods (commutator for DC motors, and phase shifting of AC currents for AC motors)
  3. Demonstrate the application of mathematical concepts to the determination of voltage, current, power, and efficiency in electrical motors
- B. Identify, explain, and demonstrate the principles of operation of DC motors
1. Explain the two methods of producing magnetic fields in DC motors
    - a. Permanent magnet (fixed field or rotating field) and electromagnet (fixed field or rotating field)
    - b. Electromagnet and electromagnet (fixed and rotating field)
  2. Explain the mechanisms by which the magnet fields are switched in DC motors
    - a. Commutator method for rotating fields and commutator timing for harmonic motion
    - b. Semiconductor method for fixed magnetic fields and timing methods for harmonic motion
  3. Identify and define the proper terms for the parts of a DC motor
    - a. Armature (rotating field)
    - b. Field magnet (fixed field)
    - c. Commutator and brushes (switching mechanism)
    - d. Determination of the number of poles in the armature of a motor and the relationship of the number of poles to force and smooth operation of the motor
    - e. Limitations of armature size to the number of poles in the armature

4. Demonstrate the application of mathematical concepts to the determination of torque and speed in electrical motors
- C. Identify, explain, and demonstrate the principles of operation of inductive AC motors
1. Explain the method of producing magnetic fields in inductive AC motors
    - a. Electromagnetic field (stator) and phase shifted electromagnetic field (rotor)
    - b. Use as a model, a transformer in which the primary is the fixed magnetic field, (stator) and the secondary is a rotating secondary magnetic field (rotor)

*Note:* At this level of training, this model has been found to be the most effective model for explaining the operating principles of AC motors. An in depth knowledge of AC motors is the subject of an entire book, and requires advanced mathematics to understand
  2. Explain the principles by which the magnet fields are switched in inductive, single phase, AC motors to produce harmonic motion
    - a. Fixed Primary (stator) is composed of many turns of wire while rotating secondary (rotor) is composed of only one turn
    - b. Relationship of fixed primary (stator) current to rotating secondary (rotor) current is 100 to 1 or greater
    - c. Primary (stator) AC phase currents have a phase shifted relationship to rotating secondary (rotor) currents which produce strong magnetic fields that are out of phase to the primary (stator)
    - d. Momentum of the secondary (rotor) shifts the magnetic field in relationship to the primary magnetic field (stator), producing harmonic motion
    - e. If the motor is not rotating during the first application of current to the primary (stator), the apparatus will exhibit the characteristics of an AC electromagnet and the rotor will lock in relationship to the stator (locked rotor) (Demonstrate this principle using a single phase inductive motor with the starting mechanism disabled)
    - f. Explain the methods by which momentum can be imparted to the motor to start the rotation
      - (1) Phase shifted magnetic fields produced by capacitive means
      - (2) Phase shifted magnetic fields produced by inductive principles
      - (3) Phase shift produced by three phase AC in three phase AC inductive motors

3. Identify and define the proper terms for the parts of a AC motor
  - a. Squirrel cage rotor (rotating field)
  - b. Stator windings (fixed field)
  - c. Start windings
  - d. Start mechanisms
4. Demonstrate the application of mathematical concepts to the determination of torque and speed in inductive AC electrical motors

**AET-E8-LE**  
**Apply Electromagnetism Theory**  
**to Determine Operational Characteristics**  
**of Relays, Solenoids, Transformers, and Electrical Motors**  
**for DC and AC Circuits**  
**Attachment 2: MASTER Laboratory Exercise**

---

The student will:

1. Identify the types relays found in an industrial control system and the suppression devices employed;
2. Measure voltages and currents in the relays found in an industrial control system;
3. Measure voltages and currents in single phase, split phase, and three phase AC power transformers;
4. Connect and properly wire single phase, split phase, and three phase power transformers;
5. Measure voltages and currents in single phase and three phase inductive AC motors; and,
6. Calculate power and efficiencies in single phase and three phase inductive AC motors.

**AET-E8-LA**  
**Apply Electromagnetism Theory**  
**to Determine Operational Characteristics**  
**of Relays, Solenoids, Transformers, and Electrical Motors**  
**for DC and AC Circuits**  
**Attachment 3: MASTER Laboratory Aid**

---

**Rules of Conduct**

1. Absolutely no horseplay or practical joking will be tolerated.
2. Do not talk to anyone who is operating a machine.
3. Walk only in the designated traffic lanes.
4. Dress appropriately; at the absolute minimum, you must have:
  - a. No loose clothing, including ties;
  - b. Long hair properly stowed;
  - c. No jewelry;
  - d. Hard, closed-toe shoes;
  - e. Eye protection (safety glasses); and,
  - f. Ear protection (plugs or headset).
5. Follow all institutional safety rules.

# AUTOMATED EQUIPMENT REPAIR SERIES

## MASTER Technical Module No. AET-E9

---

<b>Subject:</b>	<b>Automated Equipment Repair</b>	<b>Time:</b> 12 Hrs.
<b>Duty:</b>	<b>Use Techniques to Isolate Malfunction of Electrical/Electronic Systems</b>	
<b>Task:</b>	<b>Apply Principles of Operation of Electrical Motors to Identify Various Types of Motors</b>	

---

### Objective(s):

Upon completion of this unit the student will be able to:

- a. Identify DC motors such as permanent magnetic DC motors, series field DC motors, shunt field DC motors, combination DC motors, and universal motors;
- b. Identify AC motors such as split phase capacitive start motors, split phase capacitive start-capacitive run motors, inductive start-inductive run motors, three phase squirrel cage motors, and universal motors;
- c. Explain the applications of each type of motor;
- d. Identify the various parts of a DC motor such as the armature, commutator, brushes, field windings or field magnets;
- e. Remove and replace brushes, clean commutators, and properly disassemble and wire a permanent magnet DC motor;
- f. Identify the various parts of an AC inductive motor such as starting capacitor, centrifugal switch, start windings, stator, and squirrel cage rotor; and,
- g. Remove and replace starting capacitors, centrifugal switch, and properly wire a three phase AC motor for proper rotation.

---

### Instructional Materials:

The following measurement instruments:

Digital multimeters with capacitance and inductance scales  
Clamp-on ammeters

Examples of the following types of motors:

DC shunt field  
Universal  
AC split phase capacitor-start  
AC capacitor-start, capacitor-run  
AC inductive-start, inductive-run  
AC three phase inductive, squirrel cage rotor

Junk motors to allow the students to remove parts and reassemble

**MASTER Handout (AET-E9-HO)**  
**MASTER Laboratory Exercise (AET-E9-LE)**  
**MASTER Laboratory Aid (AET-E9-LA)**  
**MASTER Quiz AET-E9-QU-1: DC electrical motors**  
**MASTER Quiz AET-E9-QU-2: AC electrical motors**

---

**References:**

*Electro-Mechanics: Principles, Concepts and Devices*, James Harter, ISBN 0-02-351191-5, Latest Edition  
*Modern Control Technology (Components and Systems)*, Kilian, ISBN 0-314-06631-4, Latest Edition  
*Modern Industrial Electronics, Revised and Expanded Edition*, Schuler/MacNamee, Latest Edition, (formerly, *Industrial Electronics and Robotics*, Schuler/MacNamee, 1987)  
*Electric Machines, Theory, Operation, Applications, Adjustment, and Control*, Hubert, ISBN 0-675-21136-0, Latest Edition  
**Video(s):** *Rotating Machinery*, Bergwall Productions, 1-800-645-3565, Latest Edition  
*Direct Current Generators*, Bergwall Productions, 1-800-645-3565, Latest Edition

Note: Bergwall Productions will be referenced frequently throughout the AET section because the company provides quality video productions at a reasonable price, unlike other video production companies.)

---

**Student Preparation:**

Students should have previously completed the following Technical Modules:

- AET-A6** "Use Physics, Algebra, and Trigonometry to Analyze Simple Vectored Forces"
- AET-B2** "Use Symbols, Organization, and Engineering Values on Electrical Drawings"
- AET-E1** "Calculate, Predict, and Measure the Response of Quantities in DC Circuits"
- AET-E2** "Calculate, Predict, and Measure the Response of Quantities in AC Circuits"
- AET-E3** "Calculate, Predict, and Measure Impedance and Phase Angle in AC Circuits"
- AET-E4** "Calculate, Predict, and Measure Quantities in Poly-Phase AC Circuits"
- AET-E5** "Properly Set Up, Calibrate, and Use Meters and Oscilloscopes"

- AET-E6** "Use Components Such as Resistors, Inductors, and Capacitors; Construct Circuits and Test Components"
- AET-E7** "Use Meters/Oscilloscopes to Measure Phase Shift or Angle in Series Resistive-Capacitive/Resistive-Inductive AC Circuits"

---

---

**Introduction:**

Motors are used in industrial applications to convert electrical power to rotary mechanical power and deliver the power to mechanisms such as hydraulic pumps, or compressors. A servo system for a CNC machine frequently uses permanent magnet motors to drive the machine's axis, and both DC and AC inductive motors are used to drive the CNC machine's work head. Both AC and DC motors are used along with complex electronic control systems to accomplish many tasks. To understand the operation of these complex systems, the technician must first understand the principles of operation of the electrical motors that provide the motive power.

---

---

**Presentation Outline:**

- I. Apply Principles of DC Electrical Motors to Identify and Assemble/Disassemble Various Types of DC Motors
  - A. Identify the parts of the following types of DC electrical motors
    1. Permanent magnet DC motors
    2. Shunt field DC motors
    3. Series field DC motors
    4. Universal motors
  - B. Explain and demonstrate the characteristics of the above types of DC motors
  - C. Demonstrate the application of mathematical concepts to the determination of torque and speed in the above motors
  - D. Demonstrate procedures to test the following motor components
    1. Brushes/armature
    2. Field windings
  - E. Demonstrate the assembly/disassembly of the following motor components
    1. Brushes/brush holder
    2. Armature bearings
- II. Apply Principles of AC Electrical Motors to Identify and Assemble/Disassemble Various Types of AC Motors
  - A. Identify the parts of the following types of inductive AC electrical motors
    1. Single phase/split phase, capacitor start motors
    2. Single phase/split phase, capacitor start/capacitor run motors
    3. Single phase/split phase, inductive start/inductive run motors
    4. Universal motors



5. Three phase inductive AC squirrel cage motors
- B. Explain and demonstrate the characteristics of the above types of AC motors
- C. Demonstrate the application of mathematical concepts to the determination of torque and speed in the above motors
- D. Demonstrate procedures to test the following motor components
  1. Start switches
  2. Stator windings
- E. Demonstrate the assembly/disassembly of the following motor components
  1. Start switches
  2. Armature bearings

---

---

**Practical Application:**

1. Demonstrate procedures to test the following DC motor components:
  - a. Brushes/armature;
  - b. Field windings;
2. Demonstrate the assembly/disassembly of the following DC motor components:
  - a. Brushes/brush holder;
  - b. Armature bearings;
3. Demonstrate procedures to test the following motor AC components:
  - a. Start switches;
  - b. Stator windings;
4. Demonstrate the assembly/disassembly of the following AC motor components:
  - a. Start switches;
  - b. Armature bearings;
5. Replace bearings and or start switches in industrial AC motors; and,
6. Measure voltages, currents and winding resistance in industrial motors.

---

---

**Evaluation and/or Verification:**

Successful completion of this technical module will be based on the student's successful completion of the following components:

1. A ten question quiz on DC motors (MASTER Quiz AET-E9-QU-1: DC electrical motors);
2. A ten question quiz on AC motors (MASTER Quiz AET-E9-QU-2: AC electrical motors); and,
3. Textbook labs on practical application of the information contained in this module.

---

---

**Summary:**

Review the main lesson points using the text and handouts listed in the reference section of this module. Hold class discussion and answer student questions.

---

---

**Next Lesson Assignment:**

**MASTER Technical Module (AET-E10)** dealing with applying semiconductor theory and measurement techniques to determine operational characteristics of diodes, transistors, and power control semiconductors.

**AET-E9-HO**  
**Apply Principles of Operation of Electrical Motors**  
**to Identify Various Types of Motors**  
Attachment 1: MASTER Handout

---

**Objective(s):**

Upon completion of this unit the student will be able to:

- a. Identify DC motors such as permanent magnetic DC motors, series field DC motors, shunt field DC motors, combination DC motors, and universal motors;
- b. Identify AC motors such as split phase capacitive start motors, split phase capacitive start-capacitive run motors, inductive start-inductive run motors, three phase squirrel cage motors, and universal motors;
- c. Explain the applications of each type of motor;
- d. Identify the various parts of a DC motor such as the armature, commutator, brushes, field windings or field magnets;
- e. Remove and replace brushes, clean commutators, and properly disassemble and wire a permanent magnet DC motor;
- f. Identify the various parts of an AC inductive motor such as starting capacitor, centrifugal switch, start windings, stator, and squirrel cage rotor; and,
- g. Remove and replace starting capacitors, centrifugal switch, and properly wire a three phase AC motor for proper rotation.

---

**Module Outline:**

- I. Apply Principles of DC Electrical Motors to Identify and Assemble/Disassemble Various Types of DC Motors
  - A. Identify the parts of the following types of DC electrical motors
    1. Permanent magnet DC motors
    2. Shunt field DC motors
    3. Series field DC motors
    4. Universal motors
  - B. Explain and demonstrate the characteristics of the above types of DC motors
  - C. Demonstrate the application of mathematical concepts to the determination of torque and speed in the above motors
  - D. Demonstrate procedures to test the following motor components
    1. Brushes/armature
    2. Field windings
  - E. Demonstrate the assembly/disassembly of the following motor components
    1. Brushes/brush holder

2. Armature bearings
- II. Apply Principles of AC Electrical Motors to Identify and Assemble/Disassemble Various Types of AC Motors
- A. Identify the parts of the following types of inductive AC electrical motors
    1. Single phase/split phase, capacitor start motors
    2. Single phase/split phase, capacitor start/capacitor run motors
    3. Single phase/split phase, inductive start/inductive run motors
    4. Universal motors
    5. Three phase inductive AC squirrel cage motors
  - B. Explain and demonstrate the characteristics of the above types of AC motors
  - C. Demonstrate the application of mathematical concepts to the determination of torque and speed in the above motors
  - D. Demonstrate procedures to test the following motor components
    1. Start switches
    2. Stator windings
  - E. Demonstrate the assembly/disassembly of the following motor components
    1. Start switches
    2. Armature bearings

**AET-E9-LE**  
**Apply Principles of Operation of Electrical Motors**  
**to Identify Various Types of Motors**  
**Attachment 2: MASTER Laboratory Exercise**

---

The student will:

1. Demonstrate procedures to test the following DC motor components:
  - a. Brushes/armature;
  - b. Field windings;
2. Demonstrate the assembly/disassembly of the following DC motor components:
  - a. Brushes/brush holder;
  - b. Armature bearings;
3. Demonstrate procedures to test the following motor AC components:
  - a. Start switches;
  - b. Stator windings;
4. Demonstrate the assembly/disassembly of the following AC motor components:
  - a. Start switches;
  - b. Armature bearings;
5. Replace bearings and or start switches in industrial AC motors; and,
6. Measure voltages, currents and winding resistance in industrial motors.

**AET-E9-LA**  
**Apply Principles of Operation of Electrical Motors**  
**to Identify Various Types of Motors**  
**Attachment 3: MASTER Laboratory Aid**

---

**Rules of Conduct**

1. Absolutely no horseplay or practical joking will be tolerated.
2. Do not talk to anyone who is operating a machine.
3. Walk only in the designated traffic lanes.
4. Dress appropriately; at the absolute minimum, you must have:
  - a. No loose clothing, including ties;
  - b. Long hair properly stowed;
  - c. No jewelry;
  - d. Hard, closed-toe shoes;
  - e. Eye protection (safety glasses); and,
  - f. Ear protection (plugs or headset).
5. Follow all institutional safety rules.

# Automated Equipment Repair Series

## MASTER Technical Module No. AET-E10

---

<b>Subject:</b>	<b>Automated Equipment Repair</b>	<b>Time: 32 Hrs.</b>
<b>Duty:</b>	<b>Use Techniques to Isolate Malfunctions of Electrical/Electronic Systems</b>	
<b>Task:</b>	<b>Apply Semiconductor Theory and Measurement Techniques to Determine Operational Characteristics of Diodes, Transistors, and Power Control Semiconductors</b>	

---

### Objective(s):

Upon completion of this unit the student will be able to:

- a. Explain the theory of operation of a semiconductor diode, the types of diodes used in electronic circuits, and the specifications of various semiconductor diodes;
- b. Use rules of semiconductor devices and meters or oscilloscopes to test semiconductor diodes, including zener diodes;
- c. Explain the theory of operation of a bipolar transistor, the types of transistors used in electronic circuits, and the specifications of various transistors;
- d. Use meters or oscilloscopes to test bipolar transistors;
- e. Explain the theory of operation of MOSFET (metal oxide field effect semiconductors) transistors, the types of power MOSFETs used in electronic circuits, and the specifications of various transistors;
- f. Use meters or oscilloscopes to test power MOSFET transistors;
- g. Explain the theory of operation of power control semiconductors such as SCRs (silicon controlled rectifiers) TRIACs, and GTOs (gate turn on devices) and the types of semiconductors used to trigger these devices such as UJT (unijunction transistors) and PUT (programmable unijunction transistors); and,
- h. Use meters/oscilloscopes to test the above power control semiconductors and their triggering devices.

---

### Instructional Materials:

The following measurement instruments:

- Digital multimeters with capacitance and inductance scales
- 20 to 100 Mega Hertz dual trace oscilloscope with switchable manual/auto triggering, and 20 volts to 5 mV vertical deflection

20 to 100 Mega Hertz dual trace oscilloscope with isolated channels  
switchable manual/auto triggering, and 20 volts to 5 mV vertical  
deflection (optional)

Analog multimeters

Representative semiconductors.

Textbook labs on practical applications of the concepts contained in this  
module

**MASTER** Handout (AET-E10-HO)

**MASTER** Laboratory Exercise (AET-E10-LE)

**MASTER** Laboratory Aid (AET-E10-LA)

**MASTER** Quiz AET-E10-QU-1: Diodes

**MASTER** Quiz AET-E10-QU-2: Transistors

**MASTER** Quiz AET-E10-QU-3: SCRs, TRIACs

---

### References:

*Electricity/Electronics Fundamentals*, Zbar/Sloop, Latest Edition

*Modern Control Technology (Components and Systems)*, Kilian, ISBN  
0-314-06631-4, Latest Edition

*Modern Industrial Electronics, Revised and Expanded Edition*,  
Schuler/MacNamee, Latest Edition, (formerly, *Industrial  
Electronics and Robotics*, Schuler/MacNamee, 1987)

**Video(s):** *Semiconductors Explained*, Bergwall Productions, 1-800-645-  
3565, Latest Edition

Note: Bergwall Productions will be referenced frequently  
throughout the AET section because the company  
provides quality video productions at a reasonable price,  
unlike other video production companies.)

---

### Student Preparation:

Students should have previously completed the following Technical Modules:

- AET-A5** "Measure, Calculate, and Convert Quantities in English and  
Metric (SI, mks) Systems of Measurement"
- AET-A6** "Use Physics, Algebra, and Trigonometry to Analyze Simple  
Vectored Forces"
- AET-B2** "Use Symbols, Organization, and Engineering Values on  
Electrical Drawings"
- AET-E1** "Calculate, Predict, and Measure the Response of Quantities in  
DC Circuits"
- AET-E2** "Calculate, Predict, and Measure the Response of Quantities in  
AC Circuits"



- AET-E3** “Calculate, Predict, and Measure Impedance and Phase Angle in AC Circuits”
- AET-E4** “Calculate, Predict, and Measure Quantities in Poly-Phase AC Circuits”
- AET-E5** “Properly Set Up, Calibrate, and Use Meters and Oscilloscopes”

---

---

## **Introduction:**

Semiconductors have revolutionized the world in which we live. The modern personal computer, industrial machines such as CNCs (computerized numerical controls), and industrial robots would not be possible without the advances in semiconductor technology. With the invention of each new semiconductor, the industrial automation technician has had to learn its characteristics, how to test it, and, if necessary, replace it. Some semiconductors such as diodes, transistors, SCRs, or TRIACs are used so extensively in power control circuits that the technician must pay careful attention to these types of semiconductors. In addition, new products are being invented each year that are based upon the theory of operation of these semiconductors. By understanding the basic principles of operation of the above semiconductors, and being able to test them, the technician will be better prepared to enter the world of industrial automation.

---

---

## **Presentation Outline:**

- I. Use Rules of Semiconductor Devices and Meters or Oscilloscopes to Test Diodes
  - A. Principles of semiconductors
    - 1. Explain the concepts of conductors and semiconductors and the material properties of elements used to construct semiconductors
    - 2. Explain the methods used to change the electrical properties of semiconductor material such as intrinsic silicon
    - 3. Explain the difference in the properties of N silicon material and P silicon material
    - 4. Explain the theory of the following properties of a junction semiconductor:
      - a. Semiconductor junction
      - b. Depletion region
      - c. Barrier potential
      - d. Electron flow through a semiconductor
  - B. Explain the operating principles of a silicon junction diode
    - 1. List the uses of a junction diode
    - 2. Describe the concept of biasing a junction diode
    - 3. Describe the behavior of a silicon junction diode when it is forward biased and reverse biased

4. Explain the parameters of a silicon junction diode
    - a. Barrier potential
    - b. Forward current
    - c. Peak inverse voltage (PIV)
  5. Demonstrate and measure the following parameters of a silicon junction diode
    - a. Forward conduction resistance as a function of forward current
    - b. Reverse current as a function of reverse voltage
    - c. Barrier potential voltage as a function of forward current
  6. Demonstrate the failure modes of a silicon junction diode by stressing the diode beyond its design limits
  7. Demonstrate the use of semiconductor specification manuals to research the properties of a given diode
- C. Explain the principles of operation of a zener diode
1. Explain the uses of a zener diode
  2. Explain the properties of a zener diode when it is forward biased and reverse biased
    - a. Forward conduction and forward barrier potential
    - b. Reverse conduction at designed break down potential
  3. Demonstrate the operation and testing of a zener diode
  4. Demonstrate the use of semiconductor specification manuals to research the properties of a given zener diode
- D. Conduct lab exercises in the principles of operation and measurement of junction diodes and zener diodes
- II. Use Meters or Oscilloscopes to Test Bipolar Transistors and Power MOSFETs
- A. Principles of bipolar transistors
1. Explain the construction of a bipolar transistor
  2. Explain the uses of transistors and the two types of bipolar transistors, NPN and PNP
  3. Explain the nomenclature and purpose of the parts of a bipolar transistor
    - a. Base
    - b. Emitter
    - c. Collector
  4. Explain, demonstrate and identify the three operating modes of a transistor:
    - a. Saturation (closed switch)
    - b. Cut off (open switch)
    - c. Resistive (resistor)
  5. Demonstrate the relationship of the parts of a bipolar transistor
    - a. Explain the concept of gain
    - b. Relationship of base to current of emitter and collector (gain)

- c. Proper biasing arrangement of emitter, base, and collector and application of source voltage
    - 6. Explain the failure modes of a bipolar transistor
    - 7. Demonstrate the testing and measurement of a bipolar transistor
  - B. Explain the operating principles of a MOSFET transistor
    - 1. Explain the uses for MOSFET transistors and the advantages of MOSFETs
    - 2. Describe the design and construction of a MOSFET and the parts of a MOSFET
    - 3. Describe the relationship between the gate and the channel of a MOSFET
    - 4. Explain the method by which current through the channel is controlled by the gate
    - 5. Describe the difference between enhancement mode MOSFETs and depletion mode MOSFETs
    - 6. Demonstrate the testing and measurement of MOSFET transistors
    - 7. Demonstrate the use of a specifications manual to determine the parameters of a MOSFET
  - C. Conduct lab exercises in the principles of operation and measurement of transistors
- III. Use Meters/Oscilloscopes to Test Power Control Semiconductors and Their Triggering Devices
- A. Identify, explain, and demonstrate operating principles of SCRs
    - 1. Explain the uses of SCRs in industrial applications
    - 2. Identify and explain the electrical properties of the parts of a SCR
      - a. Gate
      - b. Anode
      - c. Cathode
    - 3. Explain the methods used to turn on and turn off a SCR
    - 4. Explain and demonstrate the behavior of a SCR when used in a DC circuit
    - 5. Explain and demonstrate the behavior of a SCR when used in an AC circuit
    - 6. Identify and explain the operating parameters of an SCR and demonstrate the use of a technical specifications manual to obtain data on the properties of a SCR
  - B. Identify, explain, and demonstrate the principles of operation of TRIACs
    - 1. Explain the uses of TRIACs in industrial applications
    - 2. Identify and explain the electrical properties of the parts of a TRIAC
    - 3. Explain the methods used to turn on and turn off TRIACs

4. Explain and demonstrate the behavior of a TRIAC when used in a DC circuit
  5. Explain and demonstrate the behavior of a TRIACs when used in an AC circuit
  6. Identify and explain the operating parameters of a TRIAC and demonstrate the use of a technical specifications manual to obtain data on the properties of a TRIAC
- C. Identify, explain, and demonstrate the principles of operation of semiconductors used to trigger SCRs or TRIACs
1. Explain the use of unijunction transistor (UJT) in industrial applications
  2. Identify and explain the electrical properties of the parts of a UJT
  3. Explain the methods used to turn on and turn off UJTs
  4. Explain and demonstrate the behavior of a UJT when used in a DC circuit (relaxation oscillator)
  5. Explain and demonstrate the behavior of a UJT when used in an SCR or TRIAC firing circuit
  6. Identify and explain the operating parameters of a UJT and demonstrate the use of a technical specifications manual to obtain data on the properties of a UJT
  7. Explain the uses of programmable unijunction transistors (PUT) in industrial applications
  8. Identify and explain the electrical properties of the parts of a PUT
  9. Explain the methods used to turn on and turn off PUTs
  10. Explain and demonstrate the behavior of a PUT when used in a DC circuit
  11. Explain and demonstrate the behavior of a PUTs when used to trigger a SCR or TRIAC circuit
  13. Identify and explain the operating parameters of a PUT and demonstrate the use of a technical specifications manual to obtain data on the properties of a PUT
- D. Identify, explain, and demonstrate the principles of operation of other semiconductors used to trigger SCRs or TRIACs such as the Silicon bi-directional switch (SBS) or DIAC
- E. Conduct lab exercises in the principles of operation and measurement of SCRs, TRIACs, and their associated triggering devices

---



---

### **Practical Application:**

1. Identify the types of diodes found in an industrial control system and test the diodes;
2. Identify transistors used in CNC or robot control systems;

3. Measure the electrical behavior of transistors in the above control systems; and,
4. Measure voltages and currents in industrial power control circuits using oscilloscopes and meters.

---

---

**Evaluation and/or Verification:**

Successful completion of this technical module will be based on the student's successful completion of the following components:

1. MASTER Quiz AET-E10-QU-1: Diodes;
2. MASTER Quiz AET-E10-QU-2: Transistors;
3. MASTER Quiz AET-E10-QU-3: SCRs, TRIACS; and,
4. Satisfactory completion of textbook labs on practical application of the information contained in this module.

---

---

**Summary:**

Review the main lesson points using the text and handouts listed in the reference section of this module. Hold class discussion and answer student questions.

---

---

**Next Lesson Assignment:**

**MASTER Technical Module (AET-E11)** dealing with applying semiconductor theory and measurement techniques to determine operational characteristics of rectifiers/filtering circuits for single and three phase DC power supplies.

**AET-E10-HO**  
**Apply Semiconductor Theory and Measurement Techniques**  
**to Determine Operational Characteristics**  
**of Diodes, Transistors, and Power Control Semiconductors**  
**Attachment 1: MASTER Handout**

---

**Objective(s):**

Upon completion of this unit the student will be able to:

- a. Explain the theory of operation of a semiconductor diode, the types of diodes used in electronic circuits, and the specifications of various semiconductor diodes;
- b. Use rules of semiconductor devices and meters or oscilloscopes to test semiconductor diodes, including zener diodes;
- c. Explain the theory of operation of a bipolar transistor, the types of transistors used in electronic circuits, and the specifications of various transistors;
- d. Use meters or oscilloscopes to test bipolar transistors;
- e. Explain the theory of operation of MOSFET (metal oxide field effect semiconductors) transistors, the types of power MOSFETs used in electronic circuits, and the specifications of various transistors;
- f. Use meters or oscilloscopes to test power MOSFET transistors;
- g. Explain the theory of operation of power control semiconductors such as SCRs (silicon controlled rectifiers) TRIACs, and GTOs (gate turn on devices) and the types of semiconductors used to trigger these devices such as UJT (unijunction transistors) and PUT (programmable unijunction transistors); and,
- h. Use meters/oscilloscopes to test the above power control semiconductors and their triggering devices.

---

**Module Outline:**

- I. Use Rules of Semiconductor Devices and Meters or Oscilloscopes to Test Diodes
  - A. Principles of semiconductors
    1. Explain the concepts of conductors and semiconductors and the material properties of elements used to construct semiconductors
    2. Explain the methods used to change the electrical properties of semiconductor material such as intrinsic silicon
    3. Explain the difference in the properties of N silicon material and P silicon material
    4. Explain the theory of the following properties of a junction semiconductor:

- a. Semiconductor junction
  - b. Depletion region
  - c. Barrier potential
  - d. Electron flow through a semiconductor
- B. Explain the operating principles of a silicon junction diode
1. List the uses of a junction diode
  2. Describe the concept of biasing a junction diode
  3. Describe the behavior of a silicon junction diode when it is forward biased and reverse biased
  4. Explain the parameters of a silicon junction diode
    - a. Barrier potential
    - b. Forward current
    - c. Peak inverse voltage (PIV)
  5. Demonstrate and measure the following parameters of a silicon junction diode
    - a. Forward conduction resistance as a function of forward current
    - b. Reverse current as a function of reverse voltage
    - c. Barrier potential voltage as a function of forward current
  6. Demonstrate the failure modes of a silicon junction diode by stressing the diode beyond its design limits
  7. Demonstrate the use of semiconductor specification manuals to research the properties of a given diode
- C. Explain the principles of operation of a zener diode
1. Explain the uses of a zener diode
  2. Explain the properties of a zener diode when it is forward biased and reverse biased
    - a. Forward conduction and forward barrier potential
    - b. Reverse conduction at designed break down potential
  3. Demonstrate the operation and testing of a zener diode
  4. Demonstrate the use of semiconductor specification manuals to research the properties of a given zener diode
- D. Conduct lab exercises in the principles of operation and measurement of junction diodes and zener diodes
- II. Use Meters or Oscilloscopes to Test Bipolar Transistors and Power MOSFETs
- A. Principles of bipolar transistors
1. Explain the construction of a bipolar transistor
  2. Explain the uses of transistors and the two types of bipolar transistors, NPN and PNP
  3. Explain the nomenclature and purpose of the parts of a bipolar transistor
    - a. Base
    - b. Emitter
    - c. Collector



4. Explain, demonstrate and identify the three operating modes of a transistor:
    - a. Saturation (closed switch)
    - b. Cut off (open switch)
    - c. Resistive (resistor)
  5. Demonstrate the relationship of the parts of a bipolar transistor
    - a. Explain the concept of gain
    - b. Relationship of base to current of emitter and collector (gain)
    - c. Proper biasing arrangement of emitter, base, and collector and application of source voltage
  6. Explain the failure modes of a bipolar transistor
  7. Demonstrate the testing and measurement of a bipolar transistor
- B. Explain the operating principles of a MOSFET transistor
1. Explain the uses for MOSFET transistors and the advantages of MOSFETs
  2. Describe the design and construction of a MOSFET and the parts of a MOSFET
  3. Describe the relationship between the gate and the channel of a MOSFET
  4. Explain the method by which current through the channel is controlled by the gate
  5. Describe the difference between enhancement mode MOSFETs and depletion mode MOSFETs
  6. Demonstrate the testing and measurement of MOSFET transistors
  7. Demonstrate the use of a specifications manual to determine the parameters of a MOSFET
- C. Conduct lab exercises in the principles of operation and measurement of transistors
- III. Use Meters/Oscilloscopes to Test Power Control Semiconductors and Their Triggering Devices
- A. Identify, explain, and demonstrate operating principles of SCRs
1. Explain the uses of SCRs in industrial applications
  2. Identify and explain the electrical properties of the parts of a SCR
    - a. Gate
    - b. Anode
    - c. Cathode
  3. Explain the methods used to turn on and turn off a SCR
  4. Explain and demonstrate the behavior of a SCR when used in a DC circuit
  5. Explain and demonstrate the behavior of a SCR when used in an AC circuit



6. Identify and explain the operating parameters of an SCR and demonstrate the use of a technical specifications manual to obtain data on the properties of a SCR
- B. Identify, explain, and demonstrate the principles of operation of TRIACs
1. Explain the uses of TRIACs in industrial applications
  2. Identify and explain the electrical properties of the parts of a TRIAC
  3. Explain the methods used to turn on and turn off TRIACs
  4. Explain and demonstrate the behavior of a TRIAC when used in a DC circuit
  5. Explain and demonstrate the behavior of a TRIACs when used in an AC circuit
  6. Identify and explain the operating parameters of a TRIAC and demonstrate the use of a technical specifications manual to obtain data on the properties of a TRIAC
- C. Identify, explain, and demonstrate the principles of operation of semiconductors used to trigger SCRs or TRIACs
1. Explain the use of unijunction transistor (UJT) in industrial applications
  2. Identify and explain the electrical properties of the parts of a UJT
  3. Explain the methods used to turn on and turn off UJTs
  4. Explain and demonstrate the behavior of a UJT when used in a DC circuit (relaxation oscillator)
  5. Explain and demonstrate the behavior of a UJT when used in an SCR or TRIAC firing circuit
  6. Identify and explain the operating parameters of a UJT and demonstrate the use of a technical specifications manual to obtain data on the properties of a UJT
  7. Explain the uses of programmable unijunction transistors (PUT) in industrial applications
  8. Identify and explain the electrical properties of the parts of a PUT
  9. Explain the methods used to turn on and turn off PUTs
  10. Explain and demonstrate the behavior of a PUT when used in a DC circuit
  11. Explain and demonstrate the behavior of a PUTs when used to trigger a SCR or TRIAC circuit
  13. Identify and explain the operating parameters of a PUT and demonstrate the use of a technical specifications manual to obtain data on the properties of a PUT
- D. Identify, explain, and demonstrate the principles of operation of other semiconductors used to trigger SCRs or TRIACs such as the Silicon bi-directional switch (SBS) or DIAC

- E. Conduct lab exercises in the principles of operation and measurement of SCRs, TRIACs, and their associated triggering devices

**AET-E10-LE**  
**Apply Semiconductor Theory and Measurement Techniques**  
**to Determine Operational Characteristics**  
**of Diodes, Transistors, and Power Control Semiconductors**  
**Attachment 2: MASTER Laboratory Exercise**

---

The student will:

1. Identify the types of diodes found in an industrial control system and test the diodes;
2. Identify transistors used in CNC or robot control systems;
3. Measure the electrical behavior of transistors in the above control systems; and,
4. Measure voltages and currents in industrial power control circuits using oscilloscopes and meters.

**AET-E10-LA**  
**Apply Semiconductor Theory and Measurement Techniques**  
**to Determine Operational Characteristics**  
**of Diodes, Transistors, and Power Control Semiconductors**  
**Attachment 3: MASTER Laboratory Aid**

---

**Rules of Conduct**

1. Absolutely no horseplay or practical joking will be tolerated.
2. Do not talk to anyone who is operating a machine.
3. Walk only in the designated traffic lanes.
4. Dress appropriately; at the absolute minimum, you must have:
  - a. No loose clothing, including ties;
  - b. Long hair properly stowed;
  - c. No jewelry;
  - d. Hard, closed-toe shoes;
  - e. Eye protection (safety glasses); and,
  - f. Ear protection (plugs or headset).
5. Follow all institutional safety rules.

# AUTOMATED EQUIPMENT REPAIR SERIES

## MASTER Technical Module No. AET-E11

---

<b>Subject:</b>	<b>Automated Equipment Repair</b>	<b>Time:</b> 32 Hrs.
<b>Duty:</b>	<b>Use Techniques to Isolate Malfunctions of Electrical/Electronic Systems</b>	
<b>Task:</b>	<b>Apply Semiconductor Theory and Measurement Techniques to Determine Operational Characteristics of Rectifiers/Filtering Circuits for Single and Three Phase DC Power Supplies</b>	

---

### Objective(s):

Upon completion of this unit the student will be able to:

- a. Explain the theory of operation of AC rectification using semiconductor diodes for half wave, full wave, full wave bridge, and three phase full wave bridge, rectifier circuits;
  - b. Test half wave, full wave, full wave bridge, and three phase full wave bridge rectifier circuits;
  - c. Explain the theory of operation of filtering components used in electronic DC power supplies;
  - d. Test filtering components used in electronic DC power supplies such as capacitors and inductors;
  - e. Explain the theory of operation of semiconductor regulators used in electronic DC power supplies; and,
  - f. Test semiconductor regulators used in electronic DC power supplies
- 

### Instructional Materials:

The following measurement instruments:

Digital multimeters with capacitance and inductance scales

20 to 100 Mega Hertz dual trace oscilloscope with switchable manual/auto triggering, and 20 volts to 5 mV vertical deflection

20 to 100 Mega Hertz dual trace oscilloscope with isolated channels switchable manual/auto triggering, and 20 volts to 5 mV vertical deflection (optional)

Analog multimeters

Representative power supplies (switching power supplies can be salvaged from old computers) *(Be sure to provide a load for the computer power supply, otherwise it may fail catastrophically!)*

Textbook labs on practical applications of the concepts contained in this module

MASTER Handout (AET-E11-HO)

**MASTER** Laboratory Exercise (AET-E11-LE)  
**MASTER** Laboratory Aid (AET-E11-LA)  
**MASTER** Quiz AET-E11-QU-1: Rectification and filtration  
**MASTER** Quiz AET-E11-QU-2: Semiconductor regulators

---

**References:**

*Electricity/Electronics Fundamentals*, Zbar/Sloop, Latest Edition  
*Modern Control Technology (Components and Systems)*, Kilian, ISBN  
0-314-06631-4, Latest Edition  
*Modern Industrial Electronics, Revised and Expanded Edition*,  
Schuler/MacNamee, Latest Edition, (formerly, *Industrial  
Electronics and Robotics*, Schuler/MacNamee, 1987)  
**Video(s):** *Power Supplies Explained*, Bergwall Productions, 1-800-645-  
3565, Latest Edition

Note: Bergwall Productions will be referenced frequently throughout the AET section because the company provides quality video productions at a reasonable price, unlike other video production companies.)

---

**Student Preparation:**

Students should have previously completed the following Technical Modules:

- AET-A5** "Measure, Calculate, and Convert Quantities in English and Metric (SI, mks) Systems of Measurement"
- AET-A6** "Use Physics, Algebra, and Trigonometry to Analyze Simple Vectored Forces"
- AET-B2** "Use Symbols, Organization, and Engineering Values on Electrical Drawings"
- AET-E1** "Calculate, Predict, and Measure the Response of Quantities in DC Circuits"
- AET-E2** "Calculate, Predict, and Measure the Response of Quantities in AC Circuits"
- AET-E3** "Calculate, Predict, and Measure Impedance and Phase Angle in AC Circuits"
- AET-E4** "Calculate, Predict, and Measure Quantities in Poly-Phase AC Circuits"
- AET-E5** "Properly Set Up, Calibrate, and Use Meters and Oscilloscopes"
- AET-E6** "Use Components Such as Resistors, Inductors, and Capacitors; Construct Circuits and Test Components"
- AET-E7** "Use Meters/Oscilloscopes to Measure Phase Shift or Angle in Series Resistive-Capacitive/Resistive-Inductive AC Circuits"

- AET-E8** “Apply Electromagnetism Theory to Determine Operational Characteristics of Relays, Solenoids, Transformers, and Electrical Motors for DC and AC Circuits”
- AET-E10** “Apply Semiconductor Theory and Measurement Techniques to Determine Operational Characteristics of Diodes, Transistors, and Power Control Semiconductors”

---

---

**Introduction:**

One of the first subsystems in a control system that the technician should test is the DC power supply. Electronic DC power supplies are used to power the semiconductors in all control systems, and a malfunctioning power supply is the most common source of failure in any industrial control system. A good automation technician *always checks the power source first* before proceeding further in the troubleshooting process. The DC power supply is one of the few items in modern control systems that can be repaired in the field by the technician. The technician must learn its characteristics, how to test it, and, if necessary, replace it. Electronic DC power supplies use inductors, capacitors, and semiconductors such as diodes, transistors, and SCRs to rectify and regulate power. A sound knowledge of these electronic devices is essential to understanding the operation of electronic DC power supplies.

---

---

**Presentation Outline:**

- I. Use Meters/Oscilloscopes to Test Power Supply Circuits, Including Rectifiers/Filtering Circuits for Single and Three Phase DC Power Supplies
- A. Principles of rectification
1. Explain the concept of diodes used to convert AC to DC (rectification)
  2. Explain the methods used to reduce AC voltages to acceptable levels for power supplies (transformers)
  3. Explain the following methods of rectification:
    - a. Half wave
    - b. Full wave
    - c. Full wave bridge
    - d. Three phase full wave
    - e. Three phase full wave bridge
  4. Explain the principles of ripple on the rectified DC power and the parameters associated with rectification
    - a. Amplitude of ripple associated with type of rectification
    - b. Frequency of ripple associated with type of rectification
- B. Explain the principles of filtration
1. List the types of passive devices used to provide filtration (capacitors and inductors)
  2. Describe behavior of a capacitor in filtering the ripple frequency

3. Describe the behavior of an inductor in filtering the ripple frequency
  4. Explain the use of the combination of resistors, capacitors, and inductors in filtering voltage and current in a DC power supply
  5. Demonstrate and measure the following parameters of a passive filter circuit in a DC power supply
    - a. Current filtration
    - b. Voltage filtration
  - C. Conduct lab experiences in the principles of rectification and filtration for electronic DC power supplies
- II. Use Schematics and Meters or Oscilloscopes to Identify, Replace and/or Troubleshoot and Repair, Series, Shunt, and Switching Semiconductor, DC Power Supply, Regulator Circuits
- A. Principles of electronic semiconductor regulators for DC power supplies
    1. Explain the operating principles of a series regulator
    2. Explain the operating principles of a shunt regulator
    3. Explain the operating principles of a switching regulator
    4. Explain, demonstrate and identify the types of semiconductors used in DC power supply regulators and their operating modes
      - a. Series regulators
        - (1) Bipolar power transistors
        - (2) Resistive mode
        - (3) Circuits used to provide feedback for series regulator power supplies
      - b. Shunt regulators
        - (1) Bipolar power transistors
        - (2) Resistive mode
        - (3) Circuits used to provide feedback for shunt regulator power supplies
      - c. Switching regulators
        - (1) Theory of duty cycle
        - (2) Bipolar transistors and power MOSFETs
        - (3) Switching mode (closed switch and open switch)
        - (4) Circuits used to provide feedback and timing for switching power supplies
      - d. Other types of regulator circuits
  - B. Crowbar circuits using SCRs for electronic power supplies
  - C. Conduct lab experiences in the principles of semiconductor filtration and regulation for electronic DC power supplies



---

---

**Practical Application:**

1. Identify the types of diodes found in an industrial control system and test the diodes; and,
2. Identify and measure DC power supplies used in CNC or robot control systems.

---

---

**Evaluation and/or Verification:**

Successful completion of this technical module will be based on the student's successful completion of the following components:

1. MASTER Quiz AET-E11-QU-1: Rectification and filtration
2. MASTER Quiz AET-E11-QU-2: Semiconductor regulators
3. Satisfactory completion of textbook labs on practical application of the information contained in this module

---

---

**Summary:**

Review the main lesson points using the text and handouts listed in the reference section of this module. Hold class discussion and answer student questions.

---

---

**Next Lesson Assignment:**

**MASTER Technical Module (AET-E12)** dealing with applying semiconductor theory and measurement techniques to determine operational characteristics of amplifiers and sensors.

**AET-E11-HO**  
**Apply Semiconductor Theory and Measurement Techniques**  
**to Determine Operational Characteristics**  
**of Rectifiers/Filtering Circuits for Single and Three Phase**  
**DC Power Supplies**  
Attachment 1: MASTER Handout

---

**Objective(s):**

Upon completion of this unit the student will be able to:

- a. Explain the theory of operation of AC rectification using semiconductor diodes for half wave, full wave, full wave bridge, and three phase full wave bridge, rectifier circuits;
  - b. Test half wave, full wave, full wave bridge, and three phase full wave bridge rectifier circuits;
  - c. Explain the theory of operation of filtering components used in electronic DC power supplies;
  - d. Test filtering components used in electronic DC power supplies such as capacitors and inductors;
  - e. Explain the theory of operation of semiconductor regulators used in electronic DC power supplies; and,
  - f. Test semiconductor regulators used in electronic DC power supplies
- 

**Module Outline:**

- I. Use Meters/Oscilloscopes to Test Power Supply Circuits, Including Rectifiers/Filtering Circuits for Single and Three Phase DC Power Supplies
  - A. Principles of rectification
    1. Explain the concept of diodes used to convert AC to DC (rectification)
    2. Explain the methods used to reduce AC voltages to acceptable levels for power supplies (transformers)
    3. Explain the following methods of rectification:
      - a. Half wave
      - b. Full wave
      - c. Full wave bridge
      - d. Three phase full wave
      - e. Three phase full wave bridge
    4. Explain the principles of ripple on the rectified DC power and the parameters associated with rectification
      - a. Amplitude of ripple associated with type of rectification
      - b. Frequency of ripple associated with type of rectification
  - B. Explain the principles of filtration

1. List the types of passive devices used to provide filtration (capacitors and inductors)
  2. Describe behavior of a capacitor in filtering the ripple frequency
  3. Describe the behavior of an inductor in filtering the ripple frequency
  4. Explain the use of the combination of resistors, capacitors, and inductors in filtering voltage and current in a DC power supply
  5. Demonstrate and measure the following parameters of a passive filter circuit in a DC power supply
    - a. Current filtration
    - b. Voltage filtration
- C. Conduct lab experiences in the principles of rectification and filtration for electronic DC power supplies
- II. Use Schematics and Meters or Oscilloscopes to Identify, Replace and/or Troubleshoot and Repair, Series, Shunt, and Switching Semiconductor, DC Power Supply, Regulator Circuits
- A. Principles of electronic semiconductor regulators for DC power supplies
1. Explain the operating principles of a series regulator
  2. Explain the operating principles of a shunt regulator
  3. Explain the operating principles of a switching regulator
  4. Explain, demonstrate and identify the types of semiconductors used in DC power supply regulators and their operating modes
    - a. Series regulators
      - (1) Bipolar power transistors
      - (2) Resistive mode
      - (3) Circuits used to provide feedback for series regulator power supplies
    - b. Shunt regulators
      - (1) Bipolar power transistors
      - (2) Resistive mode
      - (3) Circuits used to provide feedback for shunt regulator power supplies
    - c. Switching regulators
      - (1) Theory of duty cycle
      - (2) Bipolar transistors and power MOSFETs
      - (3) Switching mode (closed switch and open switch)
      - (4) Circuits used to provide feedback and timing for switching power supplies
    - d. Other types of regulator circuits
- B. Crowbar circuits using SCRs for electronic power supplies
- C. Conduct lab experiences in the principles of semiconductor filtration and regulation for electronic DC power supplies

**AET-E11-LE**  
**Apply Semiconductor Theory and Measurement Techniques**  
**to Determine Operational Characteristics**  
**of Rectifiers/Filtering Circuits for Single and Three Phase**  
**DC Power Supplies**  
**Attachment 2: MASTER Laboratory Exercise**

---

The student will:

1. Identify the types of diodes found in an industrial control system and test the diodes; and,
2. Identify and measure DC power supplies used in CNC or robot control systems.

**AET-E11-LA**  
**Apply Semiconductor Theory and Measurement Techniques**  
**to Determine Operational Characteristics**  
**of Rectifiers/Filtering Circuits for Single and Three Phase**  
**DC Power Supplies**  
**Attachment 3: MASTER Laboratory Aid**

---

**Rules of Conduct**

1. Absolutely no horseplay or practical joking will be tolerated.
2. Do not talk to anyone who is operating a machine.
3. Walk only in the designated traffic lanes.
4. Dress appropriately; at the absolute minimum, you must have:
  - a. No loose clothing, including ties;
  - b. Long hair properly stowed;
  - c. No jewelry;
  - d. Hard, closed-toe shoes;
  - e. Eye protection (safety glasses); and,
  - f. Ear protection (plugs or headset).
5. Follow all institutional safety rules.

# AUTOMATED EQUIPMENT REPAIR SERIES

## MASTER Technical Module No. AET-E12

---

<b>Subject:</b>	<b>Automated Equipment Repair</b>	<b>Time: 32 Hrs.</b>
<b>Duty:</b>	<b>Use Techniques to Isolate Malfunctions of Electrical/Electronic Systems</b>	
<b>Task:</b>	<b>Apply Semiconductor Theory and Measurement Techniques to Determine Operational Characteristics of Amplifiers and Sensors</b>	

---

### Objective(s):

Upon completion of this unit the student will be able to:

- a. Apply the knowledge of amplification to the solution of problems found in electrical/electronic control circuits;
  - b. Apply the knowledge of semiconductor amplifiers to the determination of the nature of the device under test;
  - c. Apply the knowledge of the types of sensors employed in automation circuits and systems to repair the circuit or subsystem; and,
  - d. Test amplifiers and the sensors associated with them.
- 

### Instructional Materials:

The following measurement instruments:

Digital multimeters with capacitance and inductance scales

20 to 100 Mega Hertz dual trace oscilloscope with switchable manual/auto triggering, and 20 volts to 5 mV vertical deflection

20 to 100 Mega Hertz dual trace oscilloscope with isolated channels switchable manual/auto triggering, and 20 volts to 5 mV vertical deflection (optional)

Clamp-on ammeters

Semiconductor devices such as bipolar transistors and MOSFETs to construct amplifiers

Electronic sensors for measuring physical quantities such as:

Distance

Mass

Force

Pressure

Temperature

Humidity

pH acceleration

Velocity

Textbook labs on practical applications of the concepts contained in this module

**MASTER Handout (AET-E12-HO)**

**MASTER Laboratory Exercise (AET-E12-LE)**

**MASTER Laboratory Aid (AET-E12-LA)**

**MASTER Quiz AET-E12-QU-1: Amplifier theory**

**MASTER Quiz AET-E12-QU-2: Sensors**

---

### References:

*Electricity/Electronics Fundamentals*, Zbar/Sloop, Latest Edition

*Modern Control Technology (Components and Systems)*, Kilian, ISBN 0-314-06631-4, Latest Edition

*Modern Industrial Electronics, Revised and Expanded Edition*, Schuler/MacNamee, Latest Edition, (formerly, *Industrial Electronics and Robotics*, Schuler/MacNamee, 1987)

**Video(s):** *Operational Amplifiers Explained*, Bergwall Productions, 1-800-645-3565, Latest Edition

*A/D and D/A Converters*, Bergwall Productions, 1-800-645-3565, Latest Edition

Note: Bergwall Productions will be referenced frequently throughout the AET section because the company provides quality video productions at a reasonable price, unlike other video production companies.)

---

### Student Preparation:

Students should have previously completed the following Technical Modules:

- AET-A5** "Measure, Calculate, and Convert Quantities in English and Metric (SI, mks) Systems of Measurement"
- AET-A6** "Use Physics, Algebra, and Trigonometry to Analyze Simple Vectored Forces"
- AET-B2** "Use Symbols, Organization, and Engineering Values on Electrical Drawings"
- AET-E1** "Calculate, Predict, and Measure the Response of Quantities in DC Circuits"
- AET-E2** "Calculate, Predict, and Measure the Response of Quantities in AC Circuits"
- AET-E3** "Calculate, Predict, and Measure Impedance and Phase Angle in AC Circuits"
- AET-E4** "Calculate, Predict, and Measure Quantities in Poly-Phase AC Circuits"
- AET-E5** "Properly Set Up, Calibrate, and Use Meters and Oscilloscopes"

- AET-E6** “Use Components Such as Resistors, Inductors, and Capacitors; Construct Circuits and Test Components”
- AET-E7** “Use Meters/Oscilloscopes to Measure Phase Shift or Angle in Series Resistive-Capacitive/Resistive-Inductive AC Circuits”
- AET-E8** “Apply Electromagnetism Theory to Determine Operational Characteristics of Relays, Solenoids, Transformers, and Electrical Motors for DC and AC Circuits”
- AET-E10** “Apply Semiconductor Theory and Measurement Techniques to Determine Operational Characteristics of Diodes, Transistors, and Power Control Semiconductors”

---

---

## **Introduction:**

Electronic sensors are used to test and provide feedback for the real world applications of industrial machinery or industrial processes. Frequently, sensor provide weak electronic signals that need to be boosted in power in order to be used in an electronic circuit. To boost the power of these signals requires the use of an amplifier. Amplifiers are created by using semiconductor devices such as bipolar transistors, MOSFETs, or integrated circuits called operational amplifiers. The technician must learn the characteristics of amplifiers and sensors to test the system, and, if necessary, replace component parts. All industrial machines that are controlled by electronic controls use sensors or electrical devices to regulate their movements or functions. Therefore the technician must be familiar with their uses and functions.

---

---

## **Presentation Outline:**

- I. Apply Semiconductor Theory and Amplifier Concepts to Troubleshoot and Replace or Repair Amplifier Modules
  - A. Principles of amplification
    1. Explain the concept of current, voltage and power amplification
    2. Explain the methods used to create amplification
    3. Explain the following devices used to create amplification and the parameters of each circuit:
      - a. Transistor amplifiers
        - (1) Classes of operation
        - (2) Common emitter circuits
        - (3) Common collector circuits (emitter follower)
        - (4) Common base circuits
        - (5) Explain the current, voltage, and power characteristics of each of the above circuits
      - b. MOSFET amplifiers
    4. Explain the operation of the transistor differential amplifier circuit
  - B. Explain the principles of operational amplifiers



1. List the uses of the integrated circuit, operational amplifier
  2. Describe the behavior of an integrated circuit operational amplifier under open loop amplification
    - a. Gain
    - b. Input impedance
    - c. Slew rate
  3. Describe the methods for tailoring the gain of the operational amplifier and the calculation of gain for each configuration
    - a. Negative feedback (closed loop)
    - b. Inverting amplifiers
    - c. Non inverting amplifiers
    - d. Enhanced slew rate, positive feed back operational amplifiers
  4. Explain the use of the combination of resistors, capacitors, and inductors in filtering and tailoring the gain of an operational amplifier (active filters)
  5. Demonstrate and measure the parameters of a passive filter circuit in an operational amplifier circuit
  6. Demonstrate and measure the parameters of a active filter circuit in an operational amplifier circuit
- C. Conduct lab experiences in the principles of electronic amplification
- II. Use Schematic Diagrams and Meters or Oscilloscopes to Test Sensors and Sensor Circuits
- A. Principles of analog to digital (A/D) and digital to analog (D/A) decoders
1. Explain and demonstrate the principles of an analog to digital (A/D) decoder
  2. Explain and demonstrate the principles of a digital to analog (D/A) decoder
- B. Principles of electronic sensors
1. Explain the six methods of producing an electromotive force
    - a. Electromagnetic
    - b. Photovoltaic
    - c. Friction
    - d. Thermoelectric (seebeck) effect
    - e. Piezoelectric effect
    - f. Electrochemical effect
  2. Explain the operating principles of resistive sensors:
    - a. Strain gauges
    - b. Temperature resistive devices
    - c. Bridge circuits
  3. Demonstrate the application of the above concepts to the following types of sensors:
    - a. Pressure sensors
    - b. Acceleration sensors

- c. Force sensors
  - d. Temperature sensors
    - (1) Thermocouples
    - (2) RTDs (resistance temperature detectors)
    - (3) Semiconductor temperature sensors
  - e. Linear variable differential transformers (LVDT)
  - f. pH sensors
  - g. Photovoltaic sensors and semiconductor photosensors
    - (1) Photometers
    - (2) Photo switch
4. Explain, demonstrate and identify the types of position measuring sensors
- a. Optical transducers
    - (1) Linear optical transducers
    - (2) Rotary optical transducers
    - (3) Explain and demonstrate the concept of light interference and the theory of operation of optical positioning transducers
    - (4) Explain the theory of operation of the electronic circuits that amplify and decode optical transducer outputs
  - b. Inductive transducers
    - (1) Resolvers
    - (2) Linear inductosyns
    - (3) Explain and demonstrate the theory of operation of inductive positioning transducers
    - (4) Explain the theory of operation of the electronic circuits that amplify and decode inductive transducer outputs
- C. Conduct lab experiences on the principles of sensors and A/D D/A converters

---



---

### Practical Application:

1. Identify the types of amplifiers found in an industrial control system and test the amplifiers; and,
2. Identify and measure sensors used in a CNC or robot control systems.

---



---

### Evaluation and/or Verification:

Successful completion of this technical module will be based on the student's successful completion of the following components:

1. MASTER Quiz AET-E12-QU-1: Amplifier theory;
2. MASTER Quiz AET-E12-QU-2: Sensors; and,

3. Satisfactory completion of textbook labs on practical application of the information contained in this module.

---

---

**Summary:**

Review the main lesson points using the text and handouts listed in the reference section of this module. Hold class discussion and answer student questions.

---

---

**Next Lesson Assignment:**

**MASTER Technical Module (AET-E13)** dealing with using schematic diagrams, meters, and oscilloscopes to identify, troubleshoot and repair or replace various types of electronic motor control circuits.

**AET-E12-HO**  
**Apply Semiconductor Theory and Measurement Techniques**  
**to Determine Operational Characteristics**  
**of Amplifiers and Sensors**  
**Attachment 1: MASTER Handout**

---

**Objective(s):**

Upon completion of this unit the student will be able to:

- a. Apply the knowledge of amplification to the solution of problems found in electrical/electronic control circuits;
  - b. Apply the knowledge of semiconductor amplifiers to the determination of the nature of the device under test;
  - c. Apply the knowledge of the types of sensors employed in automation circuits and systems to repair the circuit or subsystem; and,
  - d. Test amplifiers and the sensors associated with them.
- 

**Module Outline:**

- I. Apply Semiconductor Theory and Amplifier Concepts to Troubleshoot and Replace or Repair Amplifier Modules
  - A. Principles of amplification
    1. Explain the concept of current, voltage and power amplification
    2. Explain the methods used to create amplification
    3. Explain the following devices used to create amplification and the parameters of each circuit:
      - a. Transistor amplifiers
        - (1) Classes of operation
        - (2) Common emitter circuits
        - (3) Common collector circuits (emitter follower)
        - (4) Common base circuits
        - (5) Explain the current, voltage, and power characteristics of each of the above circuits
      - b. MOSFET amplifiers
    4. Explain the operation of the transistor differential amplifier circuit
  - B. Explain the principles of operational amplifiers
    1. List the uses of the integrated circuit, operational amplifier
    2. Describe the behavior of an integrated circuit operational amplifier under open loop amplification
      - a. Gain
      - b. Input impedance
      - c. Slew rate

3. Describe the methods for tailoring the gain of the operational amplifier and the calculation of gain for each configuration
    - a. Negative feedback (closed loop)
    - b. Inverting amplifiers
    - c. Non inverting amplifiers
    - d. Enhanced slew rate, positive feed back operational amplifiers
  4. Explain the use of the combination of resistors, capacitors, and inductors in filtering and tailoring the gain of an operational amplifier (active filters)
  5. Demonstrate and measure the parameters of a passive filter circuit in an operational amplifier circuit
  6. Demonstrate and measure the parameters of a active filter circuit in an operational amplifier circuit
- C. Conduct lab experiences in the principles of electronic amplification
- II. Use Schematic Diagrams and Meters or Oscilloscopes to Test Sensors and Sensor Circuits
- A. Principles of analog to digital (A/D) and digital to analog (D/A) decoders
1. Explain and demonstrate the principles of an analog to digital (A/D) decoder
  2. Explain and demonstrate the principles of a digital to analog (D/A) decoder
- B. Principles of electronic sensors
1. Explain the six methods of producing an electromotive force
    - a. Electromagnetic
    - b. Photovoltaic
    - c. Friction
    - d. Thermoelectric (seebeck) effect
    - e. Piezoelectric effect
    - f. Electrochemical effect
  2. Explain the operating principles of resistive sensors:
    - a. Strain gauges
    - b. Temperature resistive devices
    - c. Bridge circuits
  3. Demonstrate the application of the above concepts to the following types of sensors:
    - a. Pressure sensors
    - b. Acceleration sensors
    - c. Force sensors
    - d. Temperature sensors
      - (1) Thermocouples
      - (2) RTDs (resistance temperature detectors)
      - (3) Semiconductor temperature sensors
    - e. Linear variable differential transformers (LVDT)

- f. pH sensors
  - g. Photovoltaic sensors and semiconductor photosensors
    - (1) Photometers
    - (2) Photo switch
4. Explain, demonstrate and identify the types of position measuring sensors
- a. Optical transducers
    - (1) Linear optical transducers
    - (2) Rotary optical transducers
    - (3) Explain and demonstrate the concept of light interference and the theory of operation of optical positioning transducers
    - (4) Explain the theory of operation of the electronic circuits that amplify and decode optical transducer outputs
  - b. Inductive transducers
    - (1) Resolvers
    - (2) Linear inductosyns
    - (3) Explain and demonstrate the theory of operation of inductive positioning transducers
    - (4) Explain the theory of operation of the electronic circuits that amplify and decode inductive transducer outputs
- C. Conduct lab experiences on the principles of sensors and A/D D/A converters

**AET-E12-LE**  
**Apply Semiconductor Theory and Measurement Techniques**  
**to Determine Operational Characteristics**  
**of Amplifiers and Sensors**  
**Attachment 2: MASTER Laboratory Exercise**

---

The student will:

1. Identify the types of amplifiers found in an industrial control system and test the amplifiers; and,
2. Identify and measure sensors used in a CNC or robot control systems.

**AET-E12-LA**  
**Apply Semiconductor Theory and Measurement Techniques**  
**to Determine Operational Characteristics**  
**of Amplifiers and Sensors**  
**Attachment 3: MASTER Laboratory Aid**

---

**Rules of Conduct**

1. Absolutely no horseplay or practical joking will be tolerated.
2. Do not talk to anyone who is operating a machine.
3. Walk only in the designated traffic lanes.
4. Dress appropriately; at the absolute minimum, you must have:
  - a. No loose clothing, including ties;
  - b. Long hair properly stowed;
  - c. No jewelry;
  - d. Hard, closed-toe shoes;
  - e. Eye protection (safety glasses); and,
  - f. Ear protection (plugs or headset).
5. Follow all institutional safety rules.



# **AUTOMATED EQUIPMENT REPAIR SERIES**

## **MASTER Technical Module No. AET-E13**

---

<b>Subject:</b>	<b>Automated Equipment Repair</b>	<b>Time: 36 Hrs.</b>
<b>Duty:</b>	<b>Use Techniques To Isolate Malfunction Of Electrical/Electronic Systems</b>	
<b>Task:</b>	<b>Use Schematic Diagrams, Meters, And Oscilloscopes To Identify, Troubleshoot And Repair Or Replace Various Types Of Electronic Motor Control Circuits</b>	

---

### **Objective(s):**

Upon completion of this unit the student will be able to:

- a. Identify a particular type of DC or AC motor control system by examination of a schematic diagram;
- b. Apply the knowledge of the theory of operation of the following types of motor controls to the process of troubleshooting the motor control: SCR controls, triac controls, pulse width modulated (PWM) controls, variable frequency inverter controls, and synchronous AC motor controls;
- c. Determine if the control can be repaired in the field, or if the control must be replaced, and repair or replace the control; and,
- d. Apply the knowledge of the following concepts to the troubleshooting of motor controls: IR compensation, instantaneous over current, volts per hertz ratio, max speed/min speed, standard control loops, duty cycle, field weakening, and regeneration.

---

### **Instructional Materials:**

The following measurement instruments:

Digital multimeters with capacitance and inductance scales

20 to 100 Mega Hertz dual trace oscilloscope with switchable manual/auto triggering, and 20 volts to 5 mV vertical deflection

20 to 100 Mega Hertz dual trace oscilloscope with isolated channels switchable manual/auto triggering, and 20 volts to 5 mV vertical deflection (optional)

Clamp-on ammeters

Motor control units to support the concepts contained in this module. Some or all of these controls will be found in a CNC machine or robot. At a minimum:

Variable frequency three phase inverter type AC motor

DC shunt field motor control

Stepper motor control

PWM permanent magnet DC motor control

PC based programmable motion control card with PC

Programmable motion control system

The "Basic Stamp." A programmable stand-alone micro controller that can be used as the basis for a wide number of control projects. The Basic Stamp can be obtained as a kit which includes the manual, a programming cable for a PC, software, and the module for about \$75 per kit.

Textbook labs on practical applications of the concepts contained in this module (see *Electricity-Electronic Fundamentals*, Zbar-Sloop, ISBN 0-02-800843-X)

MASTER Handout No. 1 (AET-E13-HO-1)

MASTER Handout No. 2 (AET-E13-HO-2) (Troubleshooting Process for Variable Frequency, Inverter Type, AC Motor Controls)

MASTER Laboratory Exercise (AET-E13-LE)

MASTER Laboratory Aid (AET-E13-LA)

MASTER Quiz AET-E13-QU-1: Electronic Motor Controls

---

## References:

*Electricity/Electronics Fundamentals*, Zbar/Sloop, ISBN 0-02-800843-X, Latest Edition

*Modern Control Technology (Components and Systems)*, Kilian, ISBN 0-314-06631-4, Latest Edition

*Modern Industrial Electronics, Revised and Expanded Edition*, Schuler/MacNamee, Latest Edition, (formerly, *Industrial Electronics and Robotics*, Schuler/MacNamee, 1987)

*The Complete Guide to Electronics Troubleshooting*, Perozzo, Latest Edition

Video(s): *Advanced AC Circuits*, Bergwall Productions, 1-800-645-3565, Latest Edition

*Working Safely With Electricity*, Bergwall Productions, 1-800-645-3565, Latest Edition

Note: Bergwall Productions will be referenced frequently throughout the AET section because the company provides quality video productions at a reasonable price, unlike other video production companies.)

The following items are *not recommended* because they *detract from the hands-on nature of this module*. These items may be used as a supplement for the module if the module contains actual interaction with real electrical and electronic parts. Electricity and electronics is a "messy"

technology because actual parts and measuring devices are not perfect. The following items are theoretically perfect, and therefore do not reflect the real world of electricity and electronics.

*PSPICE* - Program for modeling the behavior of electrical and electronic components.

*Electronic Workbench* - Graphic Windows based program for constructing theoretical models of electrical and electronic circuits.

---

### **Student Preparation:**

Students should have previously completed the following Technical Modules:

- AET-A6** "Use Physics, Algebra, and Trigonometry to Analyze Simple Vectored Forces"
- AET-B2** "Use Symbols, Organization, and Engineering Values on Electrical Drawings"
- AET-E1** "Calculate, Predict, and Measure the Response of Quantities in DC Circuits"
- AET-E2** "Calculate, Predict, and Measure the Response of Quantities in AC Circuits"
- AET-E3** "Calculate, Predict, and Measure Impedance and Phase Angle in AC Circuits"
- AET-E4** "Calculate, Predict, and Measure Quantities in Poly-Phase AC Circuits"
- AET-E5** "Properly Set Up, Calibrate, and Use Meters and Oscilloscopes"
- AET-E6** "Use Components Such as Resistors, Inductors, and Capacitors; Construct Circuits and Test Components"
- AET-E7** "Use Meters/Oscilloscopes to Measure Phase Shift or Angle in Series Resistive-Capacitive/Resistive-Inductive AC Circuits"
- AET-E8** "Apply Electromagnetism Theory to Determine Operational Characteristics of Relays, Solenoids, Transformers, and Electrical Motors for DC and AC Circuits"
- AET-E9** "Apply Principles of Operation of Electrical Motors to Identify Various Types of Motors"
- AET-E10** "Apply Semiconductor Theory and Measurement Techniques to Determine Operational Characteristics of Diodes, Transistors, and Power Control Semiconductors"
- AET-E11** "Apply Semiconductor Theory and Measurement Techniques to Determine Operational Characteristics of Rectifiers/Filtering Circuits for Single and Three Phase DC Power Supplies"
- AET-E12** "Apply Semiconductor Theory and Measurement Techniques to Determine Operational Characteristics of Amplifiers and Sensors"

**AET-II** "Use Equipment Manuals, Manufacturer's Specifications, and Data Entry/Monitoring Devices to Configure, Test and Troubleshoot Set Up of a Computer System and Solve Control Problems"

---

---

**Introduction:**

Precise control of electrical motors requires the use of complex electronic motor controls. In CNC machines or robots, rigid control of velocity and position for the machine slides or positioners is absolutely essential. These machine frequently must move hundreds of inches per minute, and position to within one hundred thousandths of an inch. The electronic control that drives the motor must have highly accurate electronic circuits to accomplish this task. To effectively troubleshoot and repair these subsystems, the technician must be familiar with standard circuits and control loops associated with the control of motion control systems. Since these electronic motor controls may be used on CNC systems or PLC controlled systems, technician must understand the procedures used to interface these controls with the machine tool control. For newer motor controls, this frequently requires the use of a computer system to communicate with the motor control system. The technology of motor control systems is changing drastically. New systems are being designed that require less electronics repair skills, and more computer configuration skills. To be an effective automation technician, and repair or configure motor controls, the student must be prepared to have both skills.

---

---

**Presentation Outline:**

- I. Use Schematics and Meters or Oscilloscopes to Differentiate Between Various Types of DC Motor Control Circuits and Replace And/or Troubleshoot and Repair These Motor Controls
  - A. Present theory of operation of DC motor controls
    1. Explain concepts of DC electronic motor control
      - a. Requirements for the control of DC motors
      - b. Types of motors controlled by the controller
      - c. Field weakening control for shunt field motors
      - d. Duty cycle and pulse width modulation (PWM)
      - e. Adjustments for DC motor controls
        - (1) IR compensation
        - (2) Current limit and instantaneous over current (IOC) protection
        - (3) Max speed/min speed
      - f. Standard control loops
    2. Explain the theory of operation of DC motor controls
      - a. SCR type, permanent magnet DC motor controls
      - b. SCR type, universal motor controls

- c. SCR type, shunt field controls with field weakening
  - d. Gate turn on (GTO) controls
  - e. Power semiconductor PWM controls for DC motors
    - (1) Darlington transistors
    - (2) Power MOSFETs
    - (3) GTO
  - 3. Explain the types of sensors used to measure the following:
    - a. IOC
    - b. IR compensation
  - B. Explain the computer interfaces that are used to program the motor control subsystems and the configuration of both stand-alone and PC based motor controls
  - C. Conduct exercises in wiring and setting up control loops for DC motor controls
- II. Use Schematic Diagrams and Meters or Oscilloscopes to Identify Advanced Motor Controls That Contain Newer Types of Semiconductor Devices, to Troubleshoot and Repair These Motor Controls
- A. Present theory of operation of AC motor controls
    - 1. Explain concepts of AC electronic motor control
      - a. Requirements for the control of AC motors
      - b. Types of motors controlled by the controller
      - c. Variable frequency control of AC inductive motors
      - d. Synchronous motor control of AC motors
      - e. Adjustments for AC motor controls
        - (1) IR compensation
        - (2) Current limit and instantaneous over current (IOC) protection
        - (3) Max speed/min speed
        - (4) Volts per hertz ratio
      - f. Explain the types of sensors used to measure the following:
        - (1) IOC
        - (2) IR compensation
        - (3) Commutation angle for synchronous motors
      - g. Standard control loops
    - 2. Explain the theory of operation of AC motor controls
      - a. SCR type, AC universal motor controls
      - b. SCR type, variable frequency motor controls
      - c. Power semiconductor variable frequency three phase controls for inductive AC motors
        - (1) Darlington transistors
        - (2) Power MOSFETs
        - (3) Gate turn on (GTO)
      - d. High precision, variable frequency, synchronous AC motor controls for CNC and robot machine slides (axis)

- B. Explain the theory of operation of stepper motors and stepper motor controls
  - 1. Explain the theory of operation of stepper motors
  - 2. Explain and identify stepper motor parameters
  - 3. Explain the theory of operation of electronic stepper motor drivers
  - 4. Identify integrated circuit stepper motor drivers
- C. Explain the computer interfaces that are used to program the motor control subsystems and the configuration of both stand-alone and PC based motor controls
- D. Conduct exercises in wiring and setting up control loops for AC motor controls

---

---

**Practical Application:**

- 1. Measure control loops and adjust motor control system; and,
- 2. Program an industrial motion control system.

---

---

**Evaluation and/or Verification:**

Successful completion of this technical module will be based on the student's successful completion of the following components:

- 1. Successful scores on MASTER Quiz AET-E13-QU-1: Electronic motor controls; and,
- 2. Instructor led labs on practical application of the information contained in this module or labs based upon the "Basic Stamp".

---

---

**Summary:**

Review the main lesson points using the text and handouts listed in the reference section of this module. Hold class discussion and answer student questions.

---

---

**Next Lesson Assignment:**

**MASTER Technical Module (AET-G1)** dealing with identifying and explaining the theory and use of major systems that comprise a hydraulic or pneumatic system.

**AET-E13-HO-1**  
**Use Schematic Diagrams, Meters, And Oscilloscopes**  
**To Identify, Troubleshoot And Repair Or Replace**  
**Various Types Of Electronic Motor Control Circuits**  
Attachment 1: MASTER Handout No. 1

---

**Objective(s):**

Upon completion of this unit the student will be able to:

- a. Identify a particular type of DC or AC motor control system by examination of a schematic diagram;
- b. Apply the knowledge of the theory of operation of the following types of motor controls to the process of troubleshooting the motor control: SCR controls, triac controls, pulse width modulated (PWM) controls, variable frequency inverter controls, and synchronous AC motor controls;
- c. Determine if the control can be repaired in the field, or if the control must be replaced, and repair or replace the control; and,
- d. Apply the knowledge of the following concepts to the troubleshooting of motor controls: IR compensation, instantaneous over current, volts per hertz ratio, max speed/min speed, standard control loops, duty cycle, field weakening, and regeneration.

---

**Module Outline:**

- I. Use Schematics and Meters or Oscilloscopes to Differentiate Between Various Types of DC Motor Control Circuits and Replace And/or Troubleshoot and Repair These Motor Controls
  - A. Present theory of operation of DC motor controls
    1. Explain concepts of DC electronic motor control
      - a. Requirements for the control of DC motors
      - b. Types of motors controlled by the controller
      - c. Field weakening control for shunt field motors
      - d. Duty cycle and pulse width modulation (PWM)
      - e. Adjustments for DC motor controls
        - (1) IR compensation
        - (2) Current limit and instantaneous over current (IOC) protection
        - (3) Max speed/min speed
      - f. Standard control loops
    2. Explain the theory of operation of DC motor controls
      - a. SCR type, permanent magnet DC motor controls
      - b. SCR type, universal motor controls
      - c. SCR type, shunt field controls with field weakening



- d. Gate turn on (GTO) controls
      - e. Power semiconductor PWM controls for DC motors
        - (1) Darlington transistors
        - (2) Power MOSFETs
        - (3) GTO
    - 3. Explain the types of sensors used to measure the following:
      - a. IOC
      - b. IR compensation
  - B. Explain the computer interfaces that are used to program the motor control subsystems and the configuration of both stand-alone and PC based motor controls
  - C. Conduct exercises in wiring and setting up control loops for DC motor controls
- II. Use Schematic Diagrams and Meters or Oscilloscopes to Identify Advanced Motor Controls That Contain Newer Types of Semiconductor Devices, to Troubleshoot and Repair These Motor Controls
- A. Present theory of operation of AC motor controls
    - 1. Explain concepts of AC electronic motor control
      - a. Requirements for the control of AC motors
      - b. Types of motors controlled by the controller
      - c. Variable frequency control of AC inductive motors
      - d. Synchronous motor control of AC motors
      - e. Adjustments for AC motor controls
        - (1) IR compensation
        - (2) Current limit and instantaneous over current (IOC) protection
        - (3) Max speed/min speed
        - (4) Volts per hertz ratio
      - f. Explain the types of sensors used to measure the following:
        - (1) IOC
        - (2) IR compensation
        - (3) Commutation angle for synchronous motors
      - g. Standard control loops
    - 2. Explain the theory of operation of AC motor controls
      - a. SCR type, AC universal motor controls
      - b. SCR type, variable frequency motor controls
      - c. Power semiconductor variable frequency three phase controls for inductive AC motors
        - (1) Darlington transistors
        - (2) Power MOSFETs
        - (3) Gate turn on (GTO)
      - d. High precision, variable frequency, synchronous AC motor controls for CNC and robot machine slides (axis)



- B. Explain the theory of operation of stepper motors and stepper motor controls
  - 1. Explain the theory of operation of stepper motors
  - 2. Explain and identify stepper motor parameters
  - 3. Explain the theory of operation of electronic stepper motor drivers
  - 4. Identify integrated circuit stepper motor drivers
- C. Explain the computer interfaces that are used to program the motor control subsystems and the configuration of both stand-alone and PC based motor controls
- D. Conduct exercises in wiring and setting up control loops for AC motor controls

**AET-E13-LE**  
**Use Schematic Diagrams, Meters, And Oscilloscopes**  
**To Identify, Troubleshoot And Repair Or Replace**  
**Various Types Of Electronic Motor Control Circuits**  
Attachment 3: MASTER Laboratory Exercise

---

The student will:

1. Measure control loops and adjust motor control system; and,
2. Program an industrial motion control system.

**AET-E13-LA**  
**Use Schematic Diagrams, Meters, And Oscilloscopes**  
**To Identify, Troubleshoot And Repair Or Replace**  
**Various Types Of Electronic Motor Control Circuits**  
Attachment 4: MASTER Laboratory Aid

---

**Rules of Conduct**

1. Absolutely no horseplay or practical joking will be tolerated.
2. Do not talk to anyone who is operating a machine.
3. Walk only in the designated traffic lanes.
4. Dress appropriately; at the absolute minimum, you must have:
  - a. No loose clothing, including ties;
  - b. Long hair properly stowed;
  - c. No jewelry;
  - d. Hard, closed-toe shoes;
  - e. Eye protection (safety glasses); and,
  - f. Ear protection (plugs or headset).
5. Follow all institutional safety rules.

**AUTOMATED EQUIPMENT REPAIR TECHNICIAN ... operates, programs, maintains, and repairs automated machine tools and automated manufacturing processes.**

**Duties**

**Tasks**

Duties	A-1 Apply scientific notation and engineering notation to solve technical problems	A-2 Apply algebraic formulas to solve technical problems	A-3 Use variables in algebraic formulas to predict or solve problems in industrial systems	A-4 Manipulate variables in algebraic formulas to solve problems in industrial systems	A-5 Measure, calculate, and convert units (SI and metric) systems (SI) measurement	A-6 Use mechanical physics to analyze mechanical and pneumatic systems	A-7 Use mechanical physics to analyze mechanical systems	A-8 Use math and physics to analyze hydraulic and pneumatic systems	A-9 Use math and thermodynamics to analyze fluid heat treating systems	A-10 Use math, physics, and electronics to analyze industrial systems	A-11 Use chemical principles and formulas to predict and analyze chemical industrial processes	A-12 Apply the knowledge of electrochemical processes to industrial processes	A-13 Apply principles of water treatment processes
<b>A</b> Apply Science to Solve Industrial Problems	B-1 Use symbols, organization, and drawing values on mechanical drawings	B-2 Use symbols, organization, and drawing values on electrical drawings	B-3 Use symbols, organization, and drawing values on electronic drawings	B-4 Use symbols, organization, and drawing values on power drawings	B-5 Use symbols, organization, and drawing values on digital drawings								
<b>B</b> Use Drawings to Analyze and Repair Systems	C-1 Apply machine tool measurements to align machine tools	C-2 Apply electronic measuring instruments to test/calibrate electrical circuits	C-3 Apply electronic measuring instruments to test/calibrate electronic circuits	C-4 Apply fluid measuring instruments to test/calibrate hydraulic and pneumatic systems	C-5 Apply digital electronic measuring instruments to test/calibrate digital electronic circuits								
<b>C</b> Use Calibrated Measuring Instruments to Test/Calibrate Components	D-1 Apply the troubleshooting process to the resolution of malfunctions in industrial machine tools and automated equipment	E-2 Calculate, predict, and measure the response of circuits in DC circuits	E-3 Calculate, predict, and measure quantities in AC circuits	E-4 Calculate, predict, and measure quantities in poly-phase AC circuits	E-5 Properly set up, calibrate, and use oscilloscopes								
<b>D</b> Resolve System Failures with Critical Thinking, Troubleshooting, and Metrology	E-1 Calculate, predict, and measure the response of quantities in DC circuits	E-2 Calculate, predict, and measure the response of quantities in AC circuits	E-3 Calculate, predict, and measure quantities in AC circuits	E-4 Calculate, predict, and measure quantities in poly-phase AC circuits	E-5 Properly set up, calibrate, and use oscilloscopes								
<b>E</b> Use Techniques to Isolate Malfunctions of Electrical/Electronic Systems	F-1 Identify and explain the theory and use of major systems that comprise a pneumatic system	F-2 Apply pneumatic theory and use of valves in a hydraulic or pneumatic system to troubleshoot their components or systems	F-3 Identify, assemble, measure, and apply knowledge of operating characteristics of pneumatic actuators	F-4 Apply hydraulic and pneumatic systems knowledge to test, troubleshoot, and repair specialized fluid power circuits/devices	F-5 Identify, assemble, measure, and apply knowledge of operating characteristics of specialized fluid power circuits								
<b>F</b> Measure/Isolate Malfunctions of Mechanical/Fluid Power Systems	G-1 Perform operations in digital numbering systems	G-2 Perform operations in digital numbering equipment	G-3 Solve digital ladder diagrams in electrical and programmable logic control circuits	G-4 Program computer controlled industrial equipment	G-5 Identify, assemble, measure, and apply knowledge of operating characteristics of specialized fluid power circuits								
<b>G</b> Apply Computer Science to Computer Controlled Industrial Equipment	H-1 Perform operations on PLC (programmable logic controller) equipment	H-2 Perform operations on PLC (programmable logic controller) equipment	H-3 Perform operations on PLC (programmable logic controller) equipment	H-4 Perform operations on PLC (programmable logic controller) equipment	H-5 Perform operations on PLC (programmable logic controller) equipment								
<b>H</b> Correct Malfunctions in PLC Controlled Industrial Equipment	I-1 Perform manufacturer's specifications, and data entry/updates to configure, test and troubleshoot set up of a computer control problems	I-2 Perform manufacturer's specifications, and data entry/updates to configure, test and troubleshoot set up of a computer control problems	I-3 Perform manufacturer's specifications, and data entry/updates to configure, test and troubleshoot set up of a computer control problems	I-4 Perform manufacturer's specifications, and data entry/updates to configure, test and troubleshoot set up of a computer control problems	I-5 Perform manufacturer's specifications, and data entry/updates to configure, test and troubleshoot set up of a computer control problems								
<b>I</b> Resolve Malfunctions Found in Computer Controlled Manufacturing Processes	J-1 Perform manufacturer's specifications, and data entry/updates to configure, test and troubleshoot set up of a computer control problems	J-2 Perform manufacturer's specifications, and data entry/updates to configure, test and troubleshoot set up of a computer control problems	J-3 Perform manufacturer's specifications, and data entry/updates to configure, test and troubleshoot set up of a computer control problems	J-4 Perform manufacturer's specifications, and data entry/updates to configure, test and troubleshoot set up of a computer control problems	J-5 Perform manufacturer's specifications, and data entry/updates to configure, test and troubleshoot set up of a computer control problems								
<b>J</b> Assemble/Disassemble Mechanical/Electronic, and Computer Systems													

# AUTOMATED EQUIPMENT REPAIR SERIES

## MASTER Technical Module No. AET-F1

---

**Subject:** Automated Equipment Repair **Time:** 32 Hrs.

**Duty:** Measure/Isolate Malfunctions of Mechanical/Fluid Power Systems

**Task:** Identify and Explain the Theory and Use of Major Systems That Comprise a Hydraulic or Pneumatic System

---

### Objective(s):

Upon completion of this unit the student will be able to:

- a. Identify and explain the use of major systems that comprise a hydraulic or pneumatic system such as pumps, tanks, plumbing, fluid, rotary actuators, linear actuators, flow control valves, pressure control valves, directional control valves, pilot-operated hydraulic and pneumatic components, and solenoid operated hydraulic and pneumatic components;
  - b. Apply formulas and mathematics to calculate force, pressure, volume, horsepower, rod speed for linear actuators, rotational speed for rotary actuators, pumping rates for pumps, and pressures in various scales for both hydraulic and pneumatic systems;
  - c. Demonstrate the effects of pressure upon the volume of fluid in a hydraulic system or air in a pneumatic system;
  - d. Explain the effects of system pressure upon actuator speed and force;
  - e. Explain the effects of system flow upon actuator speed and force; and,
  - f. Test hydraulic and pneumatic systems and components.
- 

### Instructional Materials:

Hydraulic and pneumatic lab equipment that contains hydraulic and pneumatic power sources, pressure, flow, and directional control valves, accumulators, pressure gauges, flow meters, and linear and rotary actuators. (Some of this equipment may be obtained as donations, and this is especially critical in terms of pneumatic fittings, tubing and components. Most automation is accomplished by the use of pneumatic systems and the student should be exposed to the construction of these systems.) A good source for quality systems is Hampden Engineering Corp. Phone 1-800-253-2133 E-mail sales@hampden.com, web site [www.hampden.com](http://www.hampden.com)

Safety glasses, cleaning rags or towels (very important), hand tools specific to the assembly/disassembly of hydraulic/pneumatic components (see MASTER module AET-J2)

**MASTER Handout (AET-F1-HO)**

**MASTER Laboratory Exercise No. 1 (AET-F1-LE1)**

**MASTER Laboratory Exercise No. 2 (AET-F1-LE2) (Basic Laws of Fluid Systems)**

**MASTER Laboratory Exercise No. 3 (AET-F1-LE3) (Hydraulic Power Sources)**

**MASTER Laboratory Exercise No. 4 (AET-F1-LE4) (Pneumatic Power Sources)**

**MASTER Laboratory Exercise No. 5 (AET-F1-LE5) (Hydraulic and Pneumatic Test Circuits)**

**MASTER Laboratory Exercise No. 6 (AET-F1-LE6) (Measurement and Test)**

**MASTER Laboratory Aid (AET-F1-LA)**

---

### References:

*Industrial Hydraulic Technology*, Parker Hannifin, Bulletin number 0221-B1, Latest Edition

*Hydraulics for Engineering Technology*, Johnson, ISBN 0-13-232513-6, Latest Edition

*Fluid Power With Applications*, Esposito, ISBN 0-13-7772468-3, Latest Edition

*Fluid Power Technology*, Kokernak, ISBN 0-02-305705-X, Latest Edition

**Video(s):** *Fluid Power*, Bergwall Productions, 1-800-645-3565, with interactive program activity sheets

Note: Bergwall Productions will be referenced frequently throughout the AET section because the company provides quality video productions at a reasonable price, unlike other video production companies.)

---

### Student Preparation:

Students should have previously completed the following Technical Modules:

- AET-A8** "Use Math and Mechanical Physics to Analyze Problems Found in Hydraulic and Pneumatic Systems"
- AET-B4** "Use Symbols, Organization, and Engineering Values on Fluid Power Drawings"

Note: This module should be used in conjunction with module AET-J2 "Safely Assemble, Disassemble, and Adjust Subsystems or Components of Fluid Power Systems"

---

---

## **Introduction:**

An industrial technician or automation technician has balanced skills that encompass four different areas; electronics, electricity, mechanics, and computer systems. The mechanical balance that we seek to achieve in an automation technician includes the ability to troubleshoot and repair fluid power systems, both hydraulic and pneumatic. Most automation systems use pneumatic actuators to move parts through the system during the manufacturing process. CNC processes use hydraulic clamping systems for holding tools and clamping fixtures. A successful automation technician should be a fluid power troubleshooter. It is not sufficient to be able to merely install or remove hydraulic or pneumatic components, any low skill person capable of handling a wrench can accomplish these skills. To be a competent technician, one must be able to properly diagnose problems in the systems.

---

---

## **Presentation Outline:**

- I. Hydraulic/Pneumatic Safety
  - A. Explain the safety rules for mechanical systems
    - 1. Use and requirements for safety glasses
    - 2. Use and requirements for ear protection
    - 3. Avoiding mechanical hazards
    - 4. Rules for confined spaces
  - B. Explain the rules for the working with fluid power systems
    - 1. Rules for pressurized systems
    - 2. Rules for cleanliness and hazardous materials
  - C. Provide lab experiences in the basic principles of safety when working with fluid power and fluid power sources (MASTER Laboratory Exercise AET-F1-LE2) (Basic Laws of Fluid Systems)
- II. Identify the Major Parts of a Hydraulic System and Explain Their Theory of Operation
  - A. Identify and explain the theory of operation of the following subsystems of a hydraulic system:
    - 1. Fixed and variable displacement pumps
      - a. Gear pumps
      - b. Vane pumps
      - c. Gearotor pumps
      - d. Piston pumps
    - 2. Centrifugal pumps
    - 3. Fluid reservoir (tank)
    - 4. Pressure controls and safety systems
      - a. Pressure regulation (pressure relief)
      - b. Back up pressure relief
  - B. Explain the rules for the working fluid in a hydraulic system
    - 1. Viscosity

2. Fluid conditioning (filtration)
  3. Fluid lines
    - a. Working lines
    - b. Pilot lines
    - c. Drain lines
  4. Heat exchanges
    - a. Hydraulic
    - b. Pneumatic
- C. Provide lab experiences in the basic principles of fluid power and fluid power sources (MASTER Laboratory Exercise AET-F1-LE2) (Basic Laws of Fluid Systems); MASTER Laboratory Exercise AET-F1-LE3) (Hydraulic Power Sources)
- III. Identify the Major Parts of a Pneumatic System and Explain Their Theory of Operation
- A. Identify and explain the theory of operation of the following subsystems of a pneumatic system:
1. Compressors
    - a. Piston compressors
    - b. Rotary screw compressors
    - c. Turbine compressors
  2. Air receiver (tank)
  3. De-humidifier/after cooler
  4. Pneumatic fluid conditioners
    - a. Separators
    - b. Filters
    - c. Lubricators
    - d. Pressure regulators (pressure reducing valves)
  5. Air lines
    - a. Working lines
    - b. Pilot lines
    - c. Exhaust lines
- B. Provide lab experiences in the basic principles of fluid power and fluid power sources (MASTER Laboratory Exercise AET-F1-LE2) (Basic Laws of Fluid Systems); (MASTER Laboratory Exercise AET-F1-LE4) (Pneumatic Power Sources)
- IV. Use Formulas and Mathematics to Calculate Quantities in Hydraulic and Pneumatic Systems
- A. Given pressure, surface area, and force demonstrate the calculation of each of the following:
1. Force
  2. Surface area
  3. Pressure
- B. Given pump displacement and rotational speed, motor displacement, or piston diameter and stroke demonstrate the calculation of each of the following:



1. Given displacement and rotational speed, calculate flow rate for various types of hydraulic pumps
    - a. Volume of fluid per unit of time gallons per minute (GPM)
    - b. Liters per minute (LPM)
  2. Given volumetric displacement and rotational speed, calculate through-put for compressors and vacuum pumps
    - a. Cubic feet per minute (CFM) or standard cubic feet per minute (SCFM)
    - b. Liters per minute (LPM)
  3. Given flow rate and displacement, calculate rotational speed and flow requirements for hydraulic motors
  4. Given flow rate, piston diameter, and stroke, calculate rod speed for linear hydraulic actuators (cylinders)
- C. Given flow and pressure demonstrate the calculation of the horsepower or mechanical watts of power generated in the system or subsystem
- D. Use pressure in a given scale, and demonstrate the conversion to the following pressure scales:
1. Kilopascals (Kpa)
  2. Pounds per square inch gage (PSIG)
  3. Pounds per square inch absolute (PSIA)
  4. Pounds per square inch vacuum (PSIV)
  5. Bar
  6. Inches of mercury (in Hg)
  7. Inches of water (in H<sub>2</sub>O)
  8. Inches of mercury vacuum (vacuum scale in Hg)
  9. Torr
  10. Micron
- V. Use Fluid Power Measuring Instruments to Test the Operating Condition of a Fluid Power System
- A. Use flow meters and pressure gages to demonstrate the measurement of flow and pressure
  - B. Use flow meters, pressure gages and a pressure relief valve to demonstrate the diversion of flow in a hydraulic system when regulating pressure
  - C. Use flow meters and pressure gages to demonstrate the leakage rate of control valves in a hydraulic system as a function of pressure
  - D. Connect a flow meter, pressure gage, flow control valve, and temperature gage to serve as a test apparatus
  - E. Demonstrate the proper methods for using the above setup to test hydraulic or pneumatic systems
    1. Test volumetric flow rates of hydraulic pumps
    2. Test cracking pressure of pressure control valves
    3. Test volumetric flow rates of compressors

4. Test heat build up in a hydraulic system and relate it to power losses for various types of pumping systems

---

---

**Practical Application:**

1. Using a working hydraulic and pneumatic system, apply safety rules to working with industrial fluid power systems;
2. Using a working hydraulic system, identify each of the subsystems and measure the pressure and flow of the system;
3. Using a working industrial compressor system, identify each of the subsystems and measure the pressure and flow of the system and calculate the parameters of the system from the measurements;
4. Using a working industrial hydraulic and compressor system, identify each of the subsystems and measure the pressure and flow of the system and calculate the parameters of the system from the measurements; and,
5. Using an industrial control system demonstrate the measurement of voltage, current, resistance, power, capacitance, and inductance, and calculate the parameters of the system from the measurements.

---

---

**Evaluation and/or Verification:**

Successful completion of this technical module will be based on the student's successful completion of the following components:

1. An instructor generated twenty question quiz on hydraulic systems
2. Completion of practical MASTER labs on fluid power systems (MASTER Laboratory Exercise AET-F1-LE2) (Basic Laws of Fluid Systems)
3. Completion of practical labs on hydraulic systems (MASTER Laboratory Exercise AET-F1-LE2) (Basic Laws of Fluid Systems); (MASTER Laboratory Exercise AET-F1-LE3) (Hydraulic Power Sources)
4. An instructor generated twenty question quiz on pneumatic systems
5. Completion of practical labs on pneumatic systems (MASTER Laboratory Exercise AET-F1-LE2) (Basic Laws of Fluid Systems); (MASTER Laboratory Exercise AET-F1-LE4) (Pneumatic Power Sources)
6. An instructor generated twenty question quiz on fluid power calculations
7. Completion of practical labs on hydraulic/pneumatic test circuits and measurements (MASTER Laboratory Exercise AET-F1-LE5) (Hydraulic and Pneumatic Test Circuits); (MASTER Laboratory Exercise AET-F1-LE6) (Measurement and Test)

---

---

**Summary:**

Review the main lesson points at each subsection of the module using the suggested texts and handouts listed in the reference section of this module. Hold class discussion and answer student questions.

---

---

**Next Lesson Assignment:**

**MASTER Technical Module (AET-F2)** dealing with applying purpose and use of valves in a hydraulic or pneumatic system to troubleshoot components or systems.

**AET-F1-HO**  
**Identify and Explain the Theory and Use of Major Systems**  
**That Comprise a Hydraulic or Pneumatic System**  
**Attachment 1: MASTER Handout**

---

**Objective(s):**

Upon completion of this unit the student will be able to:

- a. Identify and explain the use of major systems that comprise a hydraulic or pneumatic system such as pumps, tanks, plumbing, fluid, rotary actuators, linear actuators, flow control valves, pressure control valves, directional control valves, pilot-operated hydraulic and pneumatic components, and solenoid operated hydraulic and pneumatic components;
  - b. Apply formulas and mathematics to calculate force, pressure, volume, horsepower, rod speed for linear actuators, rotational speed for rotary actuators, pumping rates for pumps, and pressures in various scales for both hydraulic and pneumatic systems;
  - c. Demonstrate the effects of pressure upon the volume of fluid in a hydraulic system or air in a pneumatic system;
  - d. Explain the effects of system pressure upon actuator speed and force;
  - e. Explain the effects of system flow upon actuator speed and force; and,
  - f. Test hydraulic and pneumatic systems and components.
- 

**Module Outline:**

- I. Hydraulic/Pneumatic Safety
  - A. Explain the safety rules for mechanical systems
    1. Use and requirements for safety glasses
    2. Use and requirements for ear protection
    3. Avoiding mechanical hazards
    4. Rules for confined spaces
  - B. Explain the rules for the working with fluid power systems
    1. Rules for pressurized systems
    2. Rules for cleanliness and hazardous materials
  - C. Provide lab experiences in the basic principles of safety when working with fluid power and fluid power sources (MASTER Laboratory Exercise AET-F1-LE2) (Basic Laws of Fluid Systems)
- II. Identify the Major Parts of a Hydraulic System and Explain Their Theory of Operation
  - A. Identify and explain the theory of operation of the following subsystems of a hydraulic system:
    1. Fixed and variable displacement pumps
      - a. Gear pumps

- b. Vane pumps
      - c. Gearotor pumps
      - d. Piston pumps
    - 2. Centrifugal pumps
    - 3. Fluid reservoir (tank)
    - 4. Pressure controls and safety systems
      - a. Pressure regulation (pressure relief)
      - b. Back up pressure relief
  - B. Explain the rules for the working fluid in a hydraulic system
    - 1. Viscosity
    - 2. Fluid conditioning (filtration)
    - 3. Fluid lines
      - a. Working lines
      - b. Pilot lines
      - c. Drain lines
    - 4. Heat exchanges
      - a. Hydraulic
      - b. Pneumatic
  - C. Provide lab experiences in the basic principles of fluid power and fluid power sources (MASTER Laboratory Exercise AET-F1-LE2) (Basic Laws of Fluid Systems); MASTER Laboratory Exercise AET-F1-LE3) (Hydraulic Power Sources)
- III. Identify the Major Parts of a Pneumatic System and Explain Their Theory of Operation
  - A. Identify and explain the theory of operation of the following subsystems of a pneumatic system:
    - 1. Compressors
      - a. Piston compressors
      - b. Rotary screw compressors
      - c. Turbine compressors
    - 2. Air receiver (tank)
    - 3. De-humidifier/after cooler
    - 4. Pneumatic fluid conditioners
      - a. Separators
      - b. Filters
      - c. Lubricators
      - d. Pressure regulators (pressure reducing valves)
    - 5. Air lines
      - a. Working lines
      - b. Pilot lines
      - c. Exhaust lines
  - B. Provide lab experiences in the basic principles of fluid power and fluid power sources (MASTER Laboratory Exercise AET-F1-LE2) (Basic Laws of Fluid Systems); (MASTER Laboratory Exercise AET-F1-LE4) (Pneumatic Power Sources)

- IV. Use Formulas and Mathematics to Calculate Quantities in Hydraulic and Pneumatic Systems
- A. Given pressure, surface area, and force demonstrate the calculation of each of the following:
    - 1. Force
    - 2. Surface area
    - 3. Pressure
  - B. Given pump displacement and rotational speed, motor displacement, or piston diameter and stroke demonstrate the calculation of each of the following:
    - 1. Given displacement and rotational speed, calculate flow rate for various types of hydraulic pumps
      - a. Volume of fluid per unit of time gallons per minute (GPM)
      - b. Liters per minute (LPM)
    - 2. Given volumetric displacement and rotational speed, calculate through-put for compressors and vacuum pumps
      - a. Cubic feet per minute (CFM) or standard cubic feet per minute (SCFM)
      - b. Liters per minute (LPM)
    - 3. Given flow rate and displacement, calculate rotational speed and flow requirements for hydraulic motors
    - 4. Given flow rate, piston diameter, and stroke, calculate rod speed for linear hydraulic actuators (cylinders)
  - C. Given flow and pressure demonstrate the calculation of the horsepower or mechanical watts of power generated in the system or subsystem
  - D. Use pressure in a given scale, and demonstrate the conversion to the following pressure scales:
    - 1. Kilopascals (Kpa)
    - 2. Pounds per square inch gage (PSIG)
    - 3. Pounds per square inch absolute (PSIA)
    - 4. Pounds per square inch vacuum (PSIV)
    - 5. Bar
    - 6. Inches of mercury (in Hg)
    - 7. Inches of water (in H<sub>2</sub>O)
    - 8. Inches of mercury vacuum (vacuum scale in Hg)
    - 9. Torr
    - 10. Micron
- V. Use Fluid Power Measuring Instruments to Test the Operating Condition of a Fluid Power System
- A. Use flow meters and pressure gages to demonstrate the measurement of flow and pressure
  - B. Use flow meters, pressure gages and a pressure relief valve to demonstrate the diversion of flow in a hydraulic system when regulating pressure

- C. Use flow meters and pressure gages to demonstrate the leakage rate of control valves in a hydraulic system as a function of pressure
- D. Connect a flow meter, pressure gage, flow control valve, and temperature gage to serve as a test apparatus
- E. Demonstrate the proper methods for using the above setup to test hydraulic or pneumatic systems
  - 1. Test volumetric flow rates of hydraulic pumps
  - 2. Test cracking pressure of pressure control valves
  - 3. Test volumetric flow rates of compressors
  - 4. Test heat build up in a hydraulic system and relate it to power losses for various types of pumping systems

**AET-F1-LE1**  
**Identify and Explain the Theory and Use of Major Systems**  
**That Comprise a Hydraulic or Pneumatic System**  
**Attachment 2: MASTER Laboratory Exercise No. 1**

---

The student will:

1. Use a working hydraulic and pneumatic system to apply safety rules to working with industrial fluid power systems;
2. Use a working hydraulic system to identify each of the subsystems and measure the pressure and flow of the system;
3. Use a working industrial compressor system to identify each of the subsystems and measure the pressure and flow of the system and calculate the parameters of the system from the measurements;
4. Use a working industrial hydraulic and compressor system to identify each of the subsystems and measure the pressure and flow of the system and calculate the parameters of the system from the measurements; and,
5. Use an industrial control system to demonstrate the measurement of voltage, current, resistance, power, capacitance, and inductance, and calculate the parameters of the system from the measurements.



**AET-F1-LA**  
**Identify and Explain the Theory and Use of Major Systems**  
**That Comprise a Hydraulic or Pneumatic System**  
**Attachment 8: MASTER Laboratory Aid**

---

**Rules of Conduct**

1. Absolutely no horseplay or practical joking will be tolerated.
2. Do not talk to anyone who is operating a machine.
3. Walk only in the designated traffic lanes.
4. Dress appropriately; at the absolute minimum, you must have:
  - a. No loose clothing, including ties;
  - b. Long hair properly stowed;
  - c. No jewelry;
  - d. Hard, closed-toe shoes;
  - e. Eye protection (safety glasses); and,
  - f. Ear protection (plugs or headset).
5. Follow all institutional safety rules.

# **AUTOMATED EQUIPMENT REPAIR SERIES**

## **MASTER Technical Module No. AET-F2**

---

<b>Subject:</b>	<b>Automated Equipment Repair</b>	<b>Time: 32 Hrs.</b>
<b>Duty:</b>	<b>Measure/Isolate Malfunctions of Mechanical/Fluid Power Systems</b>	
<b>Task:</b>	<b>Apply Purpose and Use of Valves in a Hydraulic or Pneumatic System to Troubleshoot Components or Systems</b>	

---

### **Objective(s):**

Upon completion of this unit the student will be able to:

- a. Measure the cracking pressure and operating characteristics of pressure control valves in a pneumatic and hydraulic system;
  - b. Measure pressure drops as a function of flow, demonstrate the method of diverting flow, and the leakage rate of directional control valves in a pneumatic system, or hydraulic system;
  - c. Measure pressure drops as a function of flow and the operating characteristics of standard flow control valves and pressure or temperature compensated flow control valves; and,
  - d. Explain the principles of operation of all three types of valves.
- 

### **Instructional Materials:**

Hydraulic and pneumatic lab equipment that contains hydraulic and pneumatic power sources, pressure, flow, and directional control valves, accumulators, pressure gauges, flow meters, and linear and rotary actuators. (Some of this equipment may be obtained as donations, and this is especially critical in terms of pneumatic fittings, tubing and components. Most automation is accomplished by the use of pneumatic systems and the student should be exposed to the construction of these systems.) A good source for quality systems is Hampden Engineering Corp. Phone 1-800-253-2133 E-mail sales@hampden.com, web site *www.hampden.com*

Safety glasses, cleaning rags or towels (very important), hand tools specific to the assembly/disassembly of hydraulic/pneumatic components (see MASTER module AET-J2)

**MASTER Handout (AET-F2-HO)**

**MASTER Laboratory Exercise No. 1 (AET-F2-LE1)**

**MASTER Laboratory Exercise No. 2 (AET-F2-LE2) (Pressure Control Valves)**

**MASTER** Laboratory Exercise No. 3 (AET-F2-LE3) (Directional Control Valves)

**MASTER** Laboratory Exercise No. 4 (AET-F2-LE4) (Flow Control Valves)

**MASTER** Laboratory Aid (AET-F2-LA)

---

### References:

*Industrial Hydraulic Technology*, Parker Hannifin, Bulletin number 0221-B1, Latest Edition

*Hydraulics for Engineering Technology*, Johnson, ISBN 0-13-232513-6, Latest Edition

*Fluid Power With Applications*, Esposito, ISBN 0-13-7772468-3, Latest Edition

*Fluid Power Technology*, Kokernak, ISBN 0-02-305705-X, Latest Edition

**Video(s):** *Fluid Power*, Bergwall Productions, 1-800-645-3565, with interactive program activity sheets

Note: Bergwall Productions will be referenced frequently throughout the AET section because the company provides quality video productions at a reasonable price, unlike other video production companies.)

---

### Student Preparation:

Students should have previously completed the following Technical Modules:

**AET-A8** “Use Math and Mechanical Physics to Analyze Problems Found in Hydraulic and Pneumatic Systems”

**AET-B4** “Use Symbols, Organization, and Engineering Values on Fluid Power Drawings”

**AET-F1** “Identify and Explain the Theory and Use of Major Systems that Comprise a Hydraulic or Pneumatic System”

Note: This module should be used in conjunction with module AET-J2 “Safely Assemble, Disassemble, and Adjust Subsystems or Components of Fluid Power Systems”

---

---

### Introduction:

Understanding fluid power systems, both hydraulic and pneumatic requires a thorough understanding of valves. Valves are used to regulate pressures, flows, and provide directional control to actuators. To be a competent automation technician, one must be able to predict the behavior of valves in the systems.

---

---

**Presentation Outline:**

- I. Use Pressure Control Valves
  - A. Explain the theory of operation, construction, and use of the following pressure control valves
    - 1. Pressure relief
    - 2. Pressure reducing
    - 3. Sequence valves
  - B. Explain the theory of operation of the following valve actuators:
    - 1. Bias spring adjustment
    - 2. Pilot operator
    - 3. Poppet and seat
  - C. Conduct MASTER Laboratory Exercise No. 2 (AET-F2-LE2) (Pressure Control Valves)
- II. Use Directional Control Valves
  - A. Explain the theory of operation, construction, and use of the following directional control valves
    - 1. Check valves
    - 2. Two position on/off valves
    - 3. Two position on/off and bi-directional
    - 4. Three position on/off and bi-directional
  - B. Explain the theory of operation of the following valve actuators:
    - 1. Bias spring
    - 2. Pilot operator
    - 3. Spool
    - 4. Solenoid and pilot operator and/or solenoid or pilot operator
    - 5. Other operators
      - a. Lever
      - b. Temperature
      - c. Detent
      - d. Foot
      - e. Level
      - f. Motor
      - g. Mechanical
  - C. Conduct MASTER Laboratory Exercise No. 3 (AET-F2-LE3) (Directional Control Valves)
- III. Use Flow Control Valves
  - A. Explain the theory of operation, construction, and use of the following flow control valves
    - 1. Flow control with integral check valve
    - 2. Pressure compensated flow control valve
    - 3. Temperature compensated flow control valve
    - 4. Bypass flow control valves
  - B. Explain the theory of operation of a hydraulic and pneumatic system when controlling flow:

1. Interaction of pressure relief valve and flow control in a hydraulic system
  2. Effects of a bypass flow control in a hydraulic system
  3. Effects of flow control in a pneumatic system
- C. Conduct MASTER Laboratory Exercise No. 4 (AET-F2-LE4) (Flow Control Valves)

---

---

**Practical Application:**

1. Using a working hydraulic or pneumatic system, identify each of the types of pressure control valves and draw the symbol;
2. Measure the pressures, flows, and leakage rate of the pressure control valves;
3. Using a working hydraulic or pneumatic system, identify each of the types of directional control valves and draw the symbol;
4. Measure the pressures, flows, and leakage rate of the directional control valves;
5. Using a working hydraulic or pneumatic system, identify each of the types of flow control valves and draw the symbol; and,
6. Measure the pressures and flows of the flow control valves.

---

---

**Evaluation and/or Verification:**

Successful completion of this technical module will be based on the student's successful completion of the following components:

1. An instructor generated ten question quiz on pressure control valves;
2. Completion of practical MASTER Laboratory Exercise No 2 (AET-F2-LE2) (Pressure Control Valves);
3. An instructor generated ten question quiz on directional control valves;
4. Completion of practical MASTER Laboratory Exercise No. 3 (AET-F2-LE3) (Directional Control Valves);
5. An instructor generated ten question quiz on flow control valves; and,
6. Completion of practical MASTER Laboratory Exercise No. 4 (AET-F2-LE4) (Flow Control Valves).

---

---

**Summary:**

Review the main lesson points at each subsection of the module using the suggested texts and handouts listed in the reference section of this module. Hold class discussion and answer student questions.

---

---

**Next Lesson Assignment:**

**MASTER Technical Module (AET-F3)** dealing with identifying, assembling, measuring, and applying knowledge of operating characteristics of hydraulic and pneumatic actuators.

**AET-F2-HO**  
**Apply Purpose and Use of Valves**  
**in a Hydraulic or Pneumatic System**  
**to Troubleshoot Components or Systems**  
Attachment 1: MASTER Handout

---

**Objective(s):**

Upon completion of this unit the student will be able to:

- a. Measure the cracking pressure and operating characteristics of pressure control valves in a pneumatic and hydraulic system;
  - b. Measure pressure drops as a function of flow, demonstrate the method of diverting flow, and the leakage rate of directional control valves in a pneumatic system, or hydraulic system;
  - c. Measure pressure drops as a function of flow and the operating characteristics of standard flow control valves and pressure or temperature compensated flow control valves; and,
  - d. Explain the principles of operation of all three types of valves.
- 

**Module Outline:**

- I. Use Pressure Control Valves
  - A. Explain the theory of operation, construction, and use of the following pressure control valves
    1. Pressure relief
    2. Pressure reducing
    3. Sequence valves
  - B. Explain the theory of operation of the following valve actuators:
    1. Bias spring adjustment
    2. Pilot operator
    3. Poppet and seat
  - C. Conduct MASTER Laboratory Exercise No. 2 (AET-F2-LE2) (Pressure Control Valves)
- II. Use Directional Control Valves
  - A. Explain the theory of operation, construction, and use of the following directional control valves
    1. Check valves
    2. Two position on/off valves
    3. Two position on/off and bi-directional
    4. Three position on/off and bi-directional
  - B. Explain the theory of operation of the following valve actuators:
    1. Bias spring
    2. Pilot operator
    3. Spool

4. Solenoid and pilot operator and/or solenoid or pilot operator
  5. Other operators
    - a. Lever
    - b. Temperature
    - c. Detent
    - d. Foot
    - e. Level
    - f. Motor
    - g. Mechanical
- C. Conduct MASTER Laboratory Exercise No. 3 (AET-F2-LE3)  
(Directional Control Valves)
- III. Use Flow Control Valves
- A. Explain the theory of operation, construction, and use of the following flow control valves
1. Flow control with integral check valve
  2. Pressure compensated flow control valve
  3. Temperature compensated flow control valve
  4. Bypass flow control valves
- B. Explain the theory of operation of a hydraulic and pneumatic system when controlling flow:
1. Interaction of pressure relief valve and flow control in a hydraulic system
  2. Effects of a bypass flow control in a hydraulic system
  3. Effects of flow control in a pneumatic system
- C. Conduct MASTER Laboratory Exercise No. 4 (AET-F2-LE4) (Flow Control Valves)



**AET-F2-LE1**  
**Apply Purpose and Use of Valves**  
**in a Hydraulic or Pneumatic System**  
**to Troubleshoot Components or Systems**  
Attachment 2: MASTER Laboratory Exercise No. 1

---

The student will:

1. Use a working hydraulic or pneumatic system to identify each of the types of pressure control valves and draw the symbol;
2. Measure the pressures, flows, and leakage rate of the pressure control valves;
3. Use a working hydraulic or pneumatic system to identify each of the types of directional control valves and draw the symbol;
4. Measure the pressures, flows, and leakage rate of the directional control valves;
5. Use a working hydraulic or pneumatic system to identify each of the types of flow control valves and draw the symbol; and,
6. Measure the pressures and flows of the flow control valves.

**AET-F2-LA**  
**Apply Purpose and Use of Valves**  
**in a Hydraulic or Pneumatic System**  
**to Troubleshoot Components or Systems**  
**Attachment 6: MASTER Laboratory Aid**

---

**Rules of Conduct**

1. Absolutely no horseplay or practical joking will be tolerated.
2. Do not talk to anyone who is operating a machine.
3. Walk only in the designated traffic lanes.
4. Dress appropriately; at the absolute minimum, you must have:
  - a. No loose clothing, including ties;
  - b. Long hair properly stowed;
  - c. No jewelry;
  - d. Hard, closed-toe shoes;
  - e. Eye protection (safety glasses); and,
  - f. Ear protection (plugs or headset).
5. Follow all institutional safety rules.

# **AUTOMATED EQUIPMENT REPAIR SERIES**

## **MASTER Technical Module No. AET-F3**

---

**Subject:** Automated Equipment Repair **Time:** 32 Hrs.

**Duty:** Measure/Isolate Malfunctions of Mechanical/Fluid Power Systems

**Task:** Identify, Assemble, Measure, and Apply Knowledge of Operating Characteristics of Hydraulic and Pneumatic Actuators

---

**Objective(s):**

Upon completion of this unit the student will be able to:

- a. Use a pneumatic and hydraulic system, and identify and connect hydraulic and pneumatic linear actuators (cylinders) and rotary actuators (motors);
- b. Demonstrate the operating characteristics of hydraulic and pneumatic linear actuators (cylinders) and rotary actuators (motors); and,
- c. Measure pressures and flows of the above devices to determine the operating condition of the components.

---

**Instructional Materials:**

Hydraulic and pneumatic lab equipment that contains hydraulic and pneumatic power sources, pressure, flow, and directional control valves, accumulators, pressure gauges, flow meters, and linear and rotary actuators. (Some of this equipment may be obtained as donations, and this is especially critical in terms of pneumatic fittings, tubing and components. Most automation is accomplished by the use of pneumatic systems and the student should be exposed to the construction of these systems.) A good source for quality systems is Hampden Engineering Corp. Phone 1-800-253-2133 E-mail sales@hampden.com, web site *www.hampden.com*

Safety glasses, cleaning rags or towels (very important), hand tools specific to the assembly/disassembly of hydraulic/pneumatic components (see MASTER module AET-J2)

**MASTER Handout (AET-F3-HO)**

**MASTER Laboratory Exercise No. 1 (AET-F3-LE1)**

**MASTER Laboratory Exercise No. 2 (AET-F3-LE2) (Hydraulic and Pneumatic Actuators)**

**MASTER Laboratory Aid (AET-F3-LA)**

---

**References:**

- Industrial Hydraulic Technology*, Parker Hannifin, Bulletin number 0221-B1, Latest Edition
- Hydraulics for Engineering Technology*, Johnson, ISBN 0-13-232513-6, Latest Edition
- Fluid Power With Applications*, Esposito, ISBN 0-13-7772468-3, Latest Edition
- Fluid Power Technology*, Kokernak, ISBN 0-02-305705-X, Latest Edition
- Video(s):** *Fluid Power*, Bergwall Productions, 1-800-645-3565, with interactive program activity sheets

Note: Bergwall Productions will be referenced frequently throughout the AET section because the company provides quality video productions at a reasonable price, unlike other video production companies.)

---

**Student Preparation:**

Students should have previously completed the following Technical Modules:

- AET-A8** “Use Math and Mechanical Physics to Analyze Problems Found in Hydraulic and Pneumatic Systems”
- AET-B4** “Use Symbols, Organization, and Engineering Values on Fluid Power Drawings”
- AET-F1** “Identify and Explain the Theory and Use of Major Systems that Comprise a Hydraulic or Pneumatic System”
- AET-F2** “Apply Purpose and Use of Valves in a Hydraulic or Pneumatic System to Troubleshoot Components or Systems”

Note: This module should be used in conjunction with module AET-J2 “Safely Assemble, Disassemble, and Adjust Subsystems or Components of Fluid Power Systems”

---

---

**Introduction:**

Most automation systems use pneumatic actuators to move parts through the system during the manufacturing process. A plastics injection molding machine has a hydraulic ram cylinder that moves, clamps the molds together, and prevents them from moving during the injection process. Actuators may be linear or rotary. An example of a linear actuator is a hydraulic or pneumatic cylinder, and an example of a rotary actuator is a hydraulic or pneumatic motor. Both devices produce motion, and therefore accomplish work in the system. To generate power, both types of devices must produce a certain amount of force. This force is the force needed to move parts in the system, or create pressure to squeeze metal parts into complex shapes. Each device produces

the amount of power needed to accomplish the power requirements of the mechanical parts of the system. The sum total of all of the power requirements for each actuator equals the total power requirements for the hydraulic or pneumatic power supply.

---

---

**Presentation Outline:**

- I. Explain the Types of Actuators Used in a Fluid Power System, and Provide Examples of Each Type
  - A. Linear actuators (cylinders, all types)
  - B. Rotary actuators (vane and piston motors, fixed displacement and variable displacement)
- II. Explain the Operating Principles of the above Actuators, and Any Behaviors Unique to the Actuator in Question
- III. Demonstrate the Calculation of the Pressure and Flow Requirements for Each Type of Actuator
  - A. Given motor displacement, speed, and force requirement; calculate the flow and pressure required for a fluid power motor
  - B. Given piston diameter, stroke, and force requirement; calculate the flow and pressure required for a fluid power cylinder
  - C. Given the combined flow and pressure requirements for all actuators, calculate the horsepower or mechanical watts of power required in the system or subsystem
  - D. Given flow rate, piston diameter, and stroke, calculate rod speed for linear hydraulic actuators
  - E. Given flow rate and displacement, calculate rotational speed for hydraulic motors
- IV. Provide Lab Experiences in the Basic Principles of Fluid Power Actuators (MASTER Laboratory Exercise AET-F3-LE2) (Hydraulic and Pneumatic Actuators)

---

---

**Practical Application:**

1. Using a working industrial hydraulic or pneumatic installation, identify each of the actuators and measure the pressure and flow of the components; and,
2. Calculate the parameters of the actuators from the measurements

---

---

**Evaluation and/or Verification:**

Successful completion of this technical module will be based on the student's successful completion of the following components:

1. An instructor generated twenty question quiz on hydraulic and pneumatic actuators; and,
2. Completion of MASTER Laboratory Exercise No. 2 (AET-F3-LE2) (Hydraulic and Pneumatic Actuators).

---

---

**Summary:**

Review the main lesson points at each subsection of the module using the suggested texts and handouts listed in the reference section of this module. Hold class discussion and answer student questions.

---

---

**Next Lesson Assignment:**

**MASTER Technical Module (AET-F4)** dealing with applying hydraulic, pneumatic, and high vacuum systems knowledge to test, troubleshoot, and repair special components/devices.

**AET-F3-HO**  
**Identify, Assemble, Measure, and Apply**  
**Knowledge of Operating Characteristics**  
**of Hydraulic and Pneumatic Actuators**  
Attachment 1: MASTER Handout

---

**Objective(s):**

Upon completion of this unit the student will be able to:

- a. Use a pneumatic and hydraulic system, and identify and connect hydraulic and pneumatic linear actuators (cylinders) and rotary actuators (motors);
  - b. Demonstrate the operating characteristics of hydraulic and pneumatic linear actuators (cylinders) and rotary actuators (motors); and,
  - c. Measure pressures and flows of the above devices to determine the operating condition of the components.
- 

**Module Outline:**

- I. Explain the Types of Actuators Used in a Fluid Power System, and Provide Examples of Each Type
  - A. Linear actuators (cylinders, all types)
  - B. Rotary actuators (vane and piston motors, fixed displacement and variable displacement)
- II. Explain the Operating Principles of the above Actuators, and Any Behaviors Unique to the Actuator in Question
- III. Demonstrate the Calculation of the Pressure and Flow Requirements for Each Type of Actuator
  - A. Given motor displacement, speed, and force requirement; calculate the flow and pressure required for a fluid power motor
  - B. Given piston diameter, stroke, and force requirement; calculate the flow and pressure required for a fluid power cylinder
  - C. Given the combined flow and pressure requirements for all actuators, calculate the horsepower or mechanical watts of power required in the system or subsystem
  - D. Given flow rate, piston diameter, and stroke, calculate rod speed for linear hydraulic actuators
  - E. Given flow rate and displacement, calculate rotational speed for hydraulic motors
- IV. Provide Lab Experiences in the Basic Principles of Fluid Power Actuators (MASTER Laboratory Exercise AET-F3-LE2) (Hydraulic and Pneumatic Actuators)

**AET-F3-LE1**  
**Identify, Assemble, Measure, and Apply**  
**Knowledge of Operating Characteristics**  
**of Hydraulic and Pneumatic Actuators**  
Attachment 2: MASTER Laboratory Exercise No. 1

---

The student will:

1. Use a working industrial hydraulic or pneumatic installation to identify each of the actuators and measure the pressure and flow of the components; and,
2. Calculate the parameters of the actuators from the measurements.



**AET-F3-LA**  
**Identify, Assemble, Measure, and Apply**  
**Knowledge of Operating Characteristics**  
**of Hydraulic and Pneumatic Actuators**  
Attachment 4: MASTER Laboratory Aid

---

**Rules of Conduct**

1. Absolutely no horseplay or practical joking will be tolerated.
2. Do not talk to anyone who is operating a machine.
3. Walk only in the designated traffic lanes.
4. Dress appropriately; at the absolute minimum, you must have:
  - a. No loose clothing, including ties;
  - b. Long hair properly stowed;
  - c. No jewelry;
  - d. Hard, closed-toe shoes;
  - e. Eye protection (safety glasses); and,
  - f. Ear protection (plugs or headset).
5. Follow all institutional safety rules.

# AUTOMATED EQUIPMENT REPAIR SERIES

## MASTER Technical Module No. AET-F4

---

<b>Subject:</b>	<b>Automated Equipment Repair</b>	<b>Time:</b> 32 Hrs.
<b>Duty:</b>	<b>Measure/Isolate Malfunctions of Mechanical/Fluid Power Systems</b>	
<b>Task:</b>	<b>Apply Hydraulic, Pneumatic, and High Vacuum Systems Knowledge to Test, Troubleshoot, and Repair Special Components/Devices</b>	

---

### Objective(s):

Upon completion of this unit the student will be able to:

- a. Identify and explain the use of accumulators for hydraulic and pneumatic systems;
- b. Apply formulas and mathematics to calculate accumulator capacity and pressure;
- c. Identify types of intensifiers, and explain the use of intensifiers for hydraulic and pneumatic systems;
- d. Explain and calculate the effects of system pressure upon intensifier force and pressure;
- e. Define a high through-put, rough vacuum system;
- f. Identify the types of vacuum pumps and filtering systems for high through-put, rough vacuum systems;
- g. Apply vacuum pressure scales to the determination of vacuum system operation;
- h. Define an air-over-oil fluid power system; and,
- i. Apply principles of fluid power to the determination of pressure, flow, and power in an air-over-oil system.

---

### Instructional Materials:

Hydraulic and pneumatic lab equipment that contains hydraulic and pneumatic power sources, pressure, flow, and directional control valves, accumulators, pressure gauges, flow meters, and linear and rotary actuators. (Some of this equipment may be obtained as donations, and this is especially critical in terms of pneumatic fittings, tubing and components. Most automation is accomplished by the use of pneumatic systems and the student should be exposed to the construction of these systems.) A good source for quality systems is Hampden Engineering Corp. Phone 1-800-253-2133 E-mail [sales@hampden.com](mailto:sales@hampden.com), web site [www.hampden.com](http://www.hampden.com)

Safety glasses, cleaning rags or towels (very important), hand tools specific to the assembly/disassembly of hydraulic/pneumatic components (see MASTER module AET-J2)

**MASTER Handout (AET-F4-HO)**

**MASTER Laboratory Exercise No. 1 (AET-F4-LE1)**

**MASTER Laboratory Exercise No. 2 (AET-F4-LE2) (Specialized Fluid Circuits)**

**MASTER Laboratory Exercise No. 3 (AET-F4-LE3) (Intensifiers and Accumulators)**

**MASTER Laboratory Aid (AET-F4-LA)**

---

### References:

*Industrial Hydraulic Technology*, Parker Hannifin, Bulletin number 0221-B1, Latest Edition

*Hydraulics for Engineering Technology*, Johnson, ISBN 0-13-232513-6, Latest Edition

*Fluid Power With Applications*, Esposito, ISBN 0-13-7772468-3, Latest Edition

*Fluid Power Technology*, Kokernak, ISBN 0-02-305705-X, Latest Edition

**Video(s):** *Fluid Power*, Bergwall Productions, 1-800-645-3565, with interactive program activity sheets

Note: Bergwall Productions will be referenced frequently throughout the AET section because the company provides quality video productions at a reasonable price, unlike other video production companies.)

---

### Student Preparation:

Students should have previously completed the following Technical Modules:

- AET-A8** "Use Math and Mechanical Physics to Analyze Problems Found in Hydraulic and Pneumatic Systems"
- AET-B4** "Use Symbols, Organization, and Engineering Values on Fluid Power Drawings"
- AET-F1** "Identify and Explain the Theory and Use of Major Systems that Comprise a Hydraulic or Pneumatic System"
- AET-F2** "Apply Purpose and Use of Valves in a Hydraulic or Pneumatic System to Troubleshoot Components or Systems"
- AET-F3** "Identify, Assemble, Measure, and Apply Knowledge of Operating Characteristics of Hydraulic and Pneumatic Actuators"

Note: This module should be used in conjunction with module AET-J2 "Safely Assemble, Disassemble, and Adjust Subsystems or Components of Fluid Power Systems"

---

---

## Introduction:

Frequently, an automation systems will employ special fluid power circuits to accomplish parts of the manufacturing procedures. Accumulators can be used as a source of emergency power, to economize the performance of a hydraulic system, and to maintain relatively constant pressure and increased flow during movement of actuators. Intensifiers are used to increase hydrostatic pressures, and as a source of cutting power for water jet systems. Many automation systems use rough vacuum systems (about 28 inches of mercury) to clamp and hold parts in vacuum chucks, and at the end effector of a robot. Another popular type of fluid power system is the air-over-oil system, in which hydraulic fluid is "pumped" by the action of compressed air. Most automation systems use one or the other type of these systems during the manufacturing process. Since all of these systems have unique or unusual properties, it is wise to learn the operating principles of each.

---

---

## Presentation Outline:

- I. Calculate, Measure, and Troubleshoot Hydraulic and Pneumatic Accumulators
  - A. Explain and identify the various types of accumulators, and the principles of operation of each type
    1. Weight loaded accumulators
    2. Spring loaded accumulators
    3. Nitrogen pressurized accumulators
    4. Safety Rules for pressurized accumulators
  - B. Explain and demonstrate the calculation or determination of the parameters of a fluid power system accumulator
    1. Rules for accumulator force, system pressure, and the volume of oil or air contained in the accumulator
    2. Rules for pressurizing a nitrogen pressurized accumulator
  - C. Demonstrate the various roles that an accumulator plays in the operation of a fluid power system
    1. Emergency source of fluid power
    2. Hydraulic economizer
    3. Pressure regulation and temporary flow increase
  - D. Conduct MASTER Laboratory Exercise No. 3 (AET-F4-LE3) (Intensifiers and Accumulators)
- II. Calculate, Measure, and Troubleshoot Hydraulic and Pneumatic Intensifiers
  - A. Explain and identify the various types of intensifiers, and the principles of operation of each type

1. Piston/cylinder type intensifiers
  2. Double ended-shuttle valve type intensifiers
  3. Reciprocating piston type intensifiers driven by hydraulic motors
  4. Safety Rules for high pressure intensifier systems.
  - B. Explain and demonstrate the calculation or determination of the parameters of a fluid power system intensifier
    1. Rules for intensifier force, intensifier pressure, and the multiplication of pressure
    2. Rules for pressure verses flow in an intensifier
  - C. Explain the applications of intensifiers in industry
    1. Creation of high pressure for hydrostatic presses.
    2. Water jet cutting
  - D. Conduct MASTER Laboratory Exercise No. 3 (AET-F4-LE3) (Intensifiers and Accumulators)
- III. Calculate, Measure, and Troubleshoot High Through-Put, Rough Vacuum Systems
- A. Define a high through-put, rough vacuum, vacuum system
    1. Define the concept of vacuum and the various types of vacuum (rough, medium, high vacuum, ultra-high vacuum)
    2. Define the concept of through-put in a vacuum system
    3. Explain the uses of vacuum in an automation system, machine tool, and the end effector of a robot
      - a. Vacuum chuck
      - b. Contaminate and hazardous materials removal
      - c. Holding force for robot end effectors
    4. Safety rules for vacuum systems
  - B. Explain and demonstrate the calculation or determination of the parameters of rough vacuum, high through-put vacuum system
    1. Rules for vacuum system through-put and determination of pumping rates
    2. Rules for calculation of force generated on an object by vacuum pressure
  - C. Explain and demonstrate special considerations for high through-put vacuum systems.
    1. Vacuum pressure regulators
    2. Vacuum system filtering and contaminate removal
  - D. Conduct MASTER Laboratory Exercise No. 2 (AET-F4-LE2) (Specialized Fluid Circuits)
- IV. Calculate, Measure, and Troubleshoot Low Pressure, Air-Over-Oil Fluid Power Systems
- A. Define an air-over-oil, fluid power system
    1. Explain the purpose of pressurized gas in an air-over-oil system
    2. Explain the construction and operation of an air-over-oil system

- a. Pressurized gas acts like an accumulator, and provides pumping action in the system
- b. Volumetric pumping rate is determined by air/oil capacity of tank
- c. Hydrostatic pressure decreases with increased flow rate
3. Explain the uses of an air-over-oil system and its advantages or disadvantages
  - a. High flow rates for high speed hydraulic actuators (flow rate is determined by expansion of gas, Ideal Gas Laws)
  - b. Low contamination using dry, ultra-pure, nitrogen gas
  - c. Fast force transmittal through a hydraulic medium
  - d. Low holding force due to compression of gas
  - e. Explosive potential if air is inadvertently used in the system
4. Safety rules for air-over-oil systems
- B. Explain and demonstrate the calculation or determination of the parameters of an air-over-oil system
  1. Rules for determination of pumping rates
  2. Rules for calculation of force generated on an object by an air-over-oil system
- C. Explain and demonstrate special considerations for air-over-oil systems.
- D. Conduct MASTER Laboratory Exercise No. 2 (AET-F4-LE2) (Specialized Fluid Circuits)

---



---

### **Practical Application:**

1. Using a working hydraulic system, identify any accumulators and measure the pressure and flow of the system with the accumulator in and out of the system;
2. Calculate the parameters of the hydraulic system from measurements;
3. Using a working hydrostatic press identify the type of intensifier used in the system and calculate the maximum pressure that can be generated in the press;
4. Visit an industrial site that has a water jet cutting CNC machine, identify the intensifier and cutting head used, and calculate the parameters of the systems from the machines specifications;
5. Using an industrial control system demonstrate electrical safety procedures;
6. Visit an industrial site that employs an air-over-oil system and observe and record measurements; and,
7. Calculate the parameters of the air-over-oil system from the measurements.

---

---

**Evaluation and/or Verification:**

Successful completion of this technical module will be based on the student's successful completion of the following components:

1. An instructor generated ten question quiz on accumulators;
2. An instructor generated ten question quiz on intensifiers;
3. An instructor generated ten question quiz on rough vacuum systems;
4. An instructor generated ten question quiz on air-over-oil systems;
5. Completion of practical MASTER labs on hydraulic systems (MASTER Laboratory Exercise No. 2 (AET-F4-LE2) (Specialized Fluid Circuits); and,
6. Completion of MASTER Laboratory Exercise No. 3 (AET-F4-LE3) (Intensifiers and Accumulators).

---

---

**Summary:**

Review the main lesson points at each subsection of the module using the suggested texts and handouts listed in the reference section of this module. Hold class discussion and answer student questions.

---

---

**Next Lesson Assignment:**

**MASTER Technical Module (AET-F5)** dealing with identifying, assembling, measuring, and applying knowledge of operating characteristics of selected, specialized fluid power circuits.

**AET-F4-HO**  
**Apply Hydraulic, Pneumatic, and High Vacuum Systems Knowledge**  
**to Test, Troubleshoot, and Repair Special Components/Devices**  
**Attachment 1: MASTER Handout**

---

**Objective(s):**

Upon completion of this unit the student will be able to:

- a. Identify and explain the use of accumulators for hydraulic and pneumatic systems;
- b. Apply formulas and mathematics to calculate accumulator capacity and pressure;
- c. Identify types of intensifiers, and explain the use of intensifiers for hydraulic and pneumatic systems;
- d. Explain and calculate the effects of system pressure upon intensifier force and pressure;
- e. Define a high through-put, rough vacuum system;
- f. Identify the types of vacuum pumps and filtering systems for high through-put, rough vacuum systems;
- g. Apply vacuum pressure scales to the determination of vacuum system operation;
- h. Define an air-over-oil fluid power system; and,
- i. Apply principles of fluid power to the determination of pressure, flow, and power in an air-over-oil system.

---

**Module Outline:**

- I. Calculate, Measure, and Troubleshoot Hydraulic and Pneumatic Accumulators
  - A. Explain and identify the various types of accumulators, and the principles of operation of each type
    1. Weight loaded accumulators
    2. Spring loaded accumulators
    3. Nitrogen pressurized accumulators
    4. Safety Rules for pressurized accumulators
  - B. Explain and demonstrate the calculation or determination of the parameters of a fluid power system accumulator
    1. Rules for accumulator force, system pressure, and the volume of oil or air contained in the accumulator
    2. Rules for pressurizing a nitrogen pressurized accumulator
  - C. Demonstrate the various roles that an accumulator plays in the operation of a fluid power system
    1. Emergency source of fluid power
    2. Hydraulic economizer



3. Pressure regulation and temporary flow increase
  - D. Conduct MASTER Laboratory Exercise No. 3 (AET-F4-LE3) (Intensifiers and Accumulators)
- II. Calculate, Measure, and Troubleshoot Hydraulic and Pneumatic Intensifiers
- A. Explain and identify the various types of intensifiers, and the principles of operation of each type
    1. Piston/cylinder type intensifiers
    2. Double ended-shuttle valve type intensifiers
    3. Reciprocating piston type intensifiers driven by hydraulic motors
    4. Safety Rules for high pressure intensifier systems.
  - B. Explain and demonstrate the calculation or determination of the parameters of a fluid power system intensifier
    1. Rules for intensifier force, intensifier pressure, and the multiplication of pressure
    2. Rules for pressure verses flow in an intensifier
  - C. Explain the applications of intensifiers in industry
    1. Creation of high pressure for hydrostatic presses.
    2. Water jet cutting
  - D. Conduct MASTER Laboratory Exercise No. 3 (AET-F4-LE3) (Intensifiers and Accumulators)
- III. Calculate, Measure, and Troubleshoot High Through-Put, Rough Vacuum Systems
- A. Define a high through-put, rough vacuum, vacuum system
    1. Define the concept of vacuum and the various types of vacuum (rough, medium, high vacuum, ultra-high vacuum)
    2. Define the concept of through-put in a vacuum system
    3. Explain the uses of vacuum in an automation system, machine tool, and the end effector of a robot
      - a. Vacuum chuck
      - b. Contaminate and hazardous materials removal
      - c. Holding force for robot end effectors
    4. Safety rules for vacuum systems
  - B. Explain and demonstrate the calculation or determination of the parameters of rough vacuum, high through-put vacuum system
    1. Rules for vacuum system through-put and determination of pumping rates
    2. Rules for calculation of force generated on an object by vacuum pressure
  - C. Explain and demonstrate special considerations for high through-put vacuum systems.
    1. Vacuum pressure regulators
    2. Vacuum system filtering and contaminate removal
  - D. Conduct MASTER Laboratory Exercise No. 2 (AET-F4-LE2) (Specialized Fluid Circuits)

- IV. Calculate, Measure, and Troubleshoot Low Pressure, Air-Over-Oil Fluid Power Systems
- A. Define an air-over-oil, fluid power system
    - 1. Explain the purpose of pressurized gas in an air-over-oil system
    - 2. Explain the construction and operation of an air-over-oil system
      - a. Pressurized gas acts like an accumulator, and provides pumping action in the system
      - b. Volumetric pumping rate is determined by air/oil capacity of tank
      - c. Hydrostatic pressure decreases with increased flow rate
    - 3. Explain the uses of an air-over-oil system and its advantages or disadvantages
      - a. High flow rates for high speed hydraulic actuators (flow rate is determined by expansion of gas, Ideal Gas Laws)
      - b. Low contamination using dry, ultra-pure, nitrogen gas
      - c. Fast force transmittal through a hydraulic medium
      - d. Low holding force due to compression of gas
      - e. Explosive potential if air is inadvertently used in the system
    - 4. Safety rules for air-over-oil systems
  - B. Explain and demonstrate the calculation or determination of the parameters of an air-over-oil system
    - 1. Rules for determination of pumping rates
    - 2. Rules for calculation of force generated on an object by an air-over-oil system
  - C. Explain and demonstrate special considerations for air-over-oil systems.
  - D. Conduct MASTER Laboratory Exercise No. 2 (AET-F4-LE2) (Specialized Fluid Circuits)

## **AET-F4-LE1**

### **Apply Hydraulic, Pneumatic, and High Vacuum Systems Knowledge to Test, Troubleshoot, and Repair Special Components/Devices**

#### **Attachment 2: MASTER Laboratory Exercise No. 1**

---

The student will:

1. Using a working hydraulic system, identify any accumulators and measure the pressure and flow of the system with the accumulator in and out of the system;
2. Calculate the parameters of the hydraulic system from measurements;
3. Using a working hydrostatic press identify the type of intensifier used in the system and calculate the maximum pressure that can be generated in the press;
4. Visit an industrial site that has a water jet cutting CNC machine, identify the intensifier and cutting head used, and calculate the parameters of the systems from the machines specifications;
5. Using an industrial control system demonstrate electrical safety procedures;
6. Visit an industrial site that employs an air-over-oil system and observe and record measurements; and,
7. Calculate the parameters of the air-over-oil system from the measurements.

## AET-F4-LA

### Apply Hydraulic, Pneumatic, and High Vacuum Systems Knowledge to Test, Troubleshoot, and Repair Special Components/Devices

#### Attachment 5: MASTER Laboratory Aid

---

### Rules of Conduct

1. Absolutely no horseplay or practical joking will be tolerated.
2. Do not talk to anyone who is operating a machine.
3. Walk only in the designated traffic lanes.
4. Dress appropriately; at the absolute minimum, you must have:
  - a. No loose clothing, including ties;
  - b. Long hair properly stowed;
  - c. No jewelry;
  - d. Hard, closed-toe shoes;
  - e. Eye protection (safety glasses); and,
  - f. Ear protection (plugs or headset).
5. Follow all institutional safety rules.

# **AUTOMATED EQUIPMENT REPAIR SERIES**

## **MASTER Technical Module No. AET-F5**

---

**Subject:** Automated Equipment Repair **Time:** 32 Hrs.

**Duty:** Measure/Isolate Malfunctions of Mechanical/Fluid Power Systems

**Task:** Identify, Assemble, Measure, and Apply Knowledge of Operating Characteristics of Selected, Specialized Fluid Power Circuits

---

### **Objective(s):**

Upon completion of this unit the student will be able to:

- a. Use a pneumatic and hydraulic system, and identify and connect a regenerative circuit, an intensifier circuit, a counter balance circuit, a sequencing circuit, an unloading accumulator circuit, an accumulator emergency power circuit, an air bearing circuit, and a venturi circuit;
  - b. Demonstrate the operating characteristics of a regenerative circuit, an intensifier circuit, a counter balance circuit, a sequencing circuit, an unloading accumulator circuit, an accumulator emergency power circuit, an air bearing circuit and a venturi circuit;
  - c. Measure pressures and flows of the above circuits to determine the operating condition of the circuits; and,
  - d. Adjust pressures and flows of critical components of the above circuits.
- 

### **Instructional Materials:**

Hydraulic and pneumatic lab equipment that contains hydraulic and pneumatic power sources, pressure, flow, and directional control valves, accumulators, pressure gauges, flow meters, and linear and rotary actuators. (Some of this equipment may be obtained as donations, and this is especially critical in terms of pneumatic fittings, tubing and components. Most automation is accomplished by the use of pneumatic systems and the student should be exposed to the construction of these systems.) A good source for quality systems is Hampden Engineering Corp. Phone 1-800-253-2133 E-mail [sales@hampden.com](mailto:sales@hampden.com), web site [www.hampden.com](http://www.hampden.com)

Safety glasses, cleaning rags or towels (very important), hand tools specific to the assembly/disassembly of hydraulic/pneumatic components (see MASTER module AET-J2)

MASTER Handout (AET-F5-HO)

MASTER Laboratory Exercise No. 1 (AET-F5-LE1)

**MASTER Laboratory Exercise No. 2 (AET-F5-LE2) (Specialized Fluid Circuits)**  
**MASTER Laboratory Aid (AET-F5-LA)**

---

**References:**

- Industrial Hydraulic Technology*, Parker Hannifin, Bulletin number 0221-B1, Latest Edition  
*Hydraulics for Engineering Technology*, Johnson, ISBN 0-13-232513-6, Latest Edition  
*Fluid Power With Applications*, Esposito, ISBN 0-13-7772468-3, Latest Edition  
*Fluid Power Technology*, Kokernak, ISBN 0-02-305705-X, Latest Edition  
Video(s): *Fluid Power*, Bergwall Productions, 1-800-645-3565, with interactive program activity sheets

Note: Bergwall Productions will be referenced frequently throughout the AET section because the company provides quality video productions at a reasonable price, unlike other video production companies.)

---

**Student Preparation:**

Students should have previously completed the following Technical Modules:

- AET-A8** "Use Math and Mechanical Physics to Analyze Problems Found in Hydraulic and Pneumatic Systems"  
**AET-B4** "Use Symbols, Organization, and Engineering Values on Fluid Power Drawings"  
**AET-F1** "Identify and Explain the Theory and Use of Major Systems that Comprise a Hydraulic or Pneumatic System"  
**AET-F2** "Apply Purpose and Use of Valves in a Hydraulic or Pneumatic System to Troubleshoot Components or Systems"  
**AET-F3** "Identify, Assemble, Measure, and Apply Knowledge of Operating Characteristics of Hydraulic and Pneumatic Actuators"  
**AET-F4** "Apply Hydraulic, Pneumatic, and High Vacuum Systems Knowledge to Test, Troubleshoot, and Repair Special Components/Devices"

Note: This module should be used in conjunction with module AET-J2 "Safely Assemble, Disassemble, and Adjust Subsystems or Components of Fluid Power Systems"

---

---

**Introduction:**

Hydraulic and pneumatic components are connected together to form circuits. Some circuits are so widely used, that they must be able to be identified by their design and layout. For an inexperienced technician, some of these circuits can be very confusing. Therefore, the technician should be armed with the fore knowledge of the principles of operation of these circuits. In addition, some hydraulic or pneumatic circuits have special characteristics that the technician should be aware of, and be prepared to test and adjust components to insure proper operation of the circuit.

---

---

**Presentation Outline:**

- I. Demonstrate the Connection of Hydraulic or Pneumatic Components to Construct the Following Circuits:
  - A. Regenerative circuit
  - B. Intensifier circuit
  - C. Counter balance circuit
  - D. Sequencing circuit
  - E. Unloading accumulator circuit
  - F. Accumulator emergency power circuit
  - G. Air bearings
  - H. Venturi siphon
- II. Connect Flow Meters and Pressure Gages to the above Circuits to Demonstrate Their Operating Principles
- III. Demonstrate the Adjustments of Components of the above Circuits
- III. Provide Lab Experiences in the Basic Principles of the above Circuits (MASTER Laboratory Exercise No. 2 (AET-F5-LE2) (Specialized Fluid Circuits))

---

---

**Practical Application:**

1. Using a working industrial hydraulic or pneumatic installation, identify each of the subsystems and measure the pressure and flow of the system; and,
2. Calculate the parameters of the system from measurements.

---

---

**Evaluation and/or Verification:**

Successful completion of this technical module will be based on the student's successful completion of the following components:

1. An instructor generated twenty question quiz on specialized hydraulic and pneumatic circuits; and,
2. Completion of MASTER Laboratory Exercise No. 2 (AET-F5-LE2) (Specialized Fluid Circuits).

---

---

**Summary:**

Review the main lesson points at each subsection of the module using the suggested texts and handouts listed in the reference section of this module. Hold class discussion and answer student questions.

---

---

**Next Lesson Assignment:**

**MASTER Technical Module (AET-F6)** dealing with identifying, assembling, measuring, and applying knowledge of operating characteristics of electrically operated, specialized fluid power circuits.



**AET-F5-HO**  
**Identify, Assemble, Measure, and Apply Knowledge**  
**of Operating Characteristics of Selected,**  
**Specialized Fluid Power Circuits**  
Attachment 1: MASTER Handout

---

**Objective(s):**

Upon completion of this unit the student will be able to:

- a. Use a pneumatic and hydraulic system, and identify and connect a regenerative circuit, an intensifier circuit, a counter balance circuit, a sequencing circuit, an unloading accumulator circuit, an accumulator emergency power circuit, an air bearing circuit, and a venturi circuit;
  - b. Demonstrate the operating characteristics of a regenerative circuit, an intensifier circuit, a counter balance circuit, a sequencing circuit, an unloading accumulator circuit, an accumulator emergency power circuit, an air bearing circuit and a venturi circuit;
  - c. Measure pressures and flows of the above circuits to determine the operating condition of the circuits; and,
  - d. Adjust pressures and flows of critical components of the above circuits.
- 

**Module Outline:**

- I. Demonstrate the Connection of Hydraulic or Pneumatic Components to Construct the Following Circuits:
  - A. Regenerative circuit
  - B. Intensifier circuit
  - C. Counter balance circuit
  - D. Sequencing circuit
  - E. Unloading accumulator circuit
  - F. Accumulator emergency power circuit
  - G. Air bearings
  - H. Venturi siphon
- II. Connect Flow Meters and Pressure Gages to the above Circuits to Demonstrate Their Operating Principles
- III. Demonstrate the Adjustments of Components of the above Circuits
- III. Provide Lab Experiences in the Basic Principles of the above Circuits (MASTER Laboratory Exercise No. 2 (AET-F5-LE2) (Specialized Fluid Circuits)

**AET-F5-LE1**  
**Identify, Assemble, Measure, and Apply Knowledge**  
**of Operating Characteristics of Selected,**  
**Specialized Fluid Power Circuits**  
**Attachment 2: MASTER Laboratory Exercise No. 1**

---

The student will:

1. Using a working industrial hydraulic or pneumatic installation, identify each of the subsystems and measure the pressure and flow of the system; and,
2. Calculate the parameters of the system from measurements.

**AET-F5-LA**  
**Identify, Assemble, Measure, and Apply Knowledge**  
**of Operating Characteristics of Selected,**  
**Specialized Fluid Power Circuits**  
**Attachment 4: MASTER Laboratory Aid**

---

**Rules of Conduct**

1. Absolutely no horseplay or practical joking will be tolerated.
2. Do not talk to anyone who is operating a machine.
3. Walk only in the designated traffic lanes.
4. Dress appropriately; at the absolute minimum, you must have:
  - a. No loose clothing, including ties;
  - b. Long hair properly stowed;
  - c. No jewelry;
  - d. Hard, closed-toe shoes;
  - e. Eye protection (safety glasses); and,
  - f. Ear protection (plugs or headset).
5. Follow all institutional safety rules.

# **AUTOMATED EQUIPMENT REPAIR SERIES**

## **MASTER Technical Module No. AET-F6**

---

**Subject:** Automated Equipment Repair **Time:** 32 Hrs.

**Duty:** Measure/Isolate Malfunctions Of Mechanical/Fluid Power Systems

**Task:** Identify, Assemble, Measure, and Apply Knowledge of Operating Characteristics of Electrically Operated, Specialized Fluid Power Circuits

---

**Objective(s):**

Upon completion of this unit the student will be able to:

- a. Use a pneumatic and hydraulic system, and identify and connect an electrically operated regenerative circuit, intensifier circuit, counter balance circuit, sequencing circuit, unloading accumulator circuit, accumulator emergency power circuit, air bearing circuit, and hydraulic servo circuit;
- b. Demonstrate the operating characteristics of the above circuits;
- c. Measure voltages, currents, pressures and flows of the above circuits to determine the operating condition of the circuits; and,
- d. Construct an electrical ladder diagram to operate the above circuits.

---

**Instructional Materials:**

Hydraulic and pneumatic lab equipment that contains hydraulic and pneumatic power sources, pressure, flow, and directional control valves, accumulators, pressure gauges, flow meters, and linear and rotary actuators. (Some of this equipment may be obtained as donations, and this is especially critical in terms of pneumatic fittings, tubing and components. Most automation is accomplished by the use of pneumatic systems and the student should be exposed to the construction of these systems.) A good source for quality systems is Hampden Engineering Corp. Phone 1-800-253-2133 E-mail [sales@hampden.com](mailto:sales@hampden.com), web site [www.hampden.com](http://www.hampden.com)

In addition, for this module a servo valve operated circuit is important. Servo valves may be obtained as donations or may be purchased with the above systems.

Safety glasses, cleaning rags or towels (very important), hand tools specific to the assembly/disassembly of hydraulic/pneumatic components (see MASTER module AET-J2)

MASTER Handout (AET-F6-HO)

- MASTER** Laboratory Exercise No. 1 (AET-F6-LE1)  
**MASTER** Laboratory Exercise No. 2 (AET-F6-LE2) (Electrical Operation of Specialized Fluid Circuits)  
**MASTER** Laboratory Aid (AET-F6-LA)
- 

**References:**

- Industrial Hydraulic Technology*, Parker Hannifin, Bulletin number 0221-B1, Latest Edition  
*Hydraulics for Engineering Technology*, Johnson, ISBN 0-13-232513-6, Latest Edition  
*Fluid Power With Applications*, Esposito, ISBN 0-13-7772468-3, Latest Edition  
*Fluid Power Technology*, Kokernak, ISBN 0-02-305705-X, Latest Edition  
**Video(s):** *Fluid Power*, Bergwall Productions, 1-800-645-3565, with interactive program activity sheets

Note: Bergwall Productions will be referenced frequently throughout the AET section because the company provides quality video productions at a reasonable price, unlike other video production companies.)

---

**Student Preparation:**

Students should have previously completed the following Technical Modules:

- AET-A8** "Use Math and Mechanical Physics to Analyze Problems Found in Hydraulic and Pneumatic Systems"  
**AET-B2** "Use Symbols, Organization, and Engineering Values on Electrical Drawings"  
**AET-B4** "Use Symbols, Organization, and Engineering Values on Fluid Power Drawings"  
**AET-F1** "Identify and Explain the Theory and Use of Major Systems that Comprise a Hydraulic or Pneumatic System"  
**AET-F2** "Apply Purpose and Use of Valves in a Hydraulic or Pneumatic System to Troubleshoot Components or Systems"  
**AET-F3** "Identify, Assemble, Measure, and Apply Knowledge of Operating Characteristics of Hydraulic and Pneumatic Actuators"  
**AET-J5** "Safely Assemble or Disassemble Digital Systems or Components such as PLCs, CNCs, or Computers"

Note: This module should be used in conjunction with module AET-G2 "Perform Boolean Operations in Digital Equipment"

---

---

## **Introduction:**

Today, hydraulic and pneumatic circuits are controlled by electrical components or programmable logic control systems. Fluid power circuits that are electrically or electronically operated are widely used, and may be found in many machine tools. For an inexperienced technician, some of these circuits can be very confusing. Therefore, the technician should be armed with the fore knowledge of the principles of electrical and fluid operation of these circuits. In addition to the pressure and flow adjustments that these circuits require, the technician must be proficient in testing and measuring the electrical or electronic characteristics of the circuits.

---

---

## **Presentation Outline:**

- I. Demonstrate the Electrical and Mechanical Connection of Hydraulic or Pneumatic Components to Construct the Following Electrically Operated Circuits:
  - A. Regenerative circuit
  - B. Intensifier circuit
  - C. Counter balance circuit
  - D. Sequencing circuit
  - E. Unloading accumulator circuit
  - F. Accumulator emergency power circuit
  - G. Air bearings
  - H. Venturi siphon
  - I. Servo valve operation of linear and rotary bi-directional circuits.
- II. Have the Students Create an Electrical Ladder Diagram to Electrically Operate the Above Circuits
- III. Connect Electrical and Electronic Test Instruments to Measure the Electrical Characteristics of the Above Circuits
- IV. Provide lab experiences in the basic principles of the above circuits (MASTER Laboratory Exercise No. 2 (AET-F6-LE2) (Electrical Operation of Specialized Fluid Circuits))

---

---

## **Practical Application:**

1. Using a working industrial hydraulic or pneumatic installation, identify each of the subsystems and measure the voltages, currents, pressure and flow of the system; and,
2. Calculate the parameters of the system from measurements.

---

---

**Evaluation and/or Verification:**

Successful completion of this technical module will be based on the student's successful completion of the following components:

1. An instructor generated twenty question quiz on specialized, electrically operated, hydraulic and pneumatic circuits; and,
2. Completion of MASTER Laboratory Exercise No. 2 (AET-F6-LE2) (Electrical Operation of Specialized Fluid Circuits).

---

---

**Summary:**

Review the main lesson points at each subsection of the module using the suggested texts and handouts listed in the reference section of this module. Hold class discussion and answer student questions.

---

---

**Next Lesson Assignment:**

**MASTER Technical Module (AET-F7)** dealing with using laws of simple machines and physics to identify and troubleshoot complex machines.

**AET-F6-HO**  
**Identify, Assemble, Measure, and Apply Knowledge**  
**of Operating Characteristics of Electrically Operated,**  
**Specialized Fluid Power Circuits**  
Attachment 1: MASTER Handout

---

**Objective(s):**

Upon completion of this unit the student will be able to:

- a. Use a pneumatic and hydraulic system, and identify and connect an electrically operated regenerative circuit, intensifier circuit, counter balance circuit, sequencing circuit, unloading accumulator circuit, accumulator emergency power circuit, air bearing circuit, and hydraulic servo circuit;
  - b. Demonstrate the operating characteristics of the above circuits;
  - c. Measure voltages, currents, pressures and flows of the above circuits to determine the operating condition of the circuits; and,
  - d. Construct an electrical ladder diagram to operate the above circuits.
- 

**Module Outline:**

- I. Demonstrate the Electrical and Mechanical Connection of Hydraulic or Pneumatic Components to Construct the Following Electrically Operated Circuits:
  - A. Regenerative circuit
  - B. Intensifier circuit
  - C. Counter balance circuit
  - D. Sequencing circuit
  - E. Unloading accumulator circuit
  - F. Accumulator emergency power circuit
  - G. Air bearings
  - H. Venturi siphon
  - I. Servo valve operation of linear and rotary bi-directional circuits.
- II. Have the Students Create an Electrical Ladder Diagram to Electrically Operate the Above Circuits
- III. Connect Electrical and Electronic Test Instruments to Measure the Electrical Characteristics of the Above Circuits
- IV. Provide lab experiences in the basic principles of the above circuits (MASTER Laboratory Exercise No. 2 (AET-F6-LE2) (Electrical Operation of Specialized Fluid Circuits)



**AET-F6-LE1**  
**Identify, Assemble, Measure, and Apply Knowledge**  
**of Operating Characteristics of Electrically Operated,**  
**Specialized Fluid Power Circuits**  
**Attachment 2: MASTER Laboratory Exercise No. 1**

---

The student will:

1. Using a working industrial hydraulic or pneumatic installation, identify each of the subsystems and measure the voltages, currents, pressure and flow of the system; and,
2. Calculate the parameters of the system from measurements.

**AET-F6-LA**  
**Identify, Assemble, Measure, and Apply Knowledge**  
**of Operating Characteristics of Electrically Operated,**  
**Specialized Fluid Power Circuits**  
**Attachment 4: MASTER Laboratory Aid**

---

**Rules of Conduct**

1. Absolutely no horseplay or practical joking will be tolerated.
2. Do not talk to anyone who is operating a machine.
3. Walk only in the designated traffic lanes.
4. Dress appropriately; at the absolute minimum, you must have:
  - a. No loose clothing, including ties;
  - b. Long hair properly stowed;
  - c. No jewelry;
  - d. Hard, closed-toe shoes;
  - e. Eye protection (safety glasses); and,
  - f. Ear protection (plugs or headset).
5. Follow all institutional safety rules.

# AUTOMATED EQUIPMENT REPAIR SERIES

## MASTER Technical Module No. AET-F7

---

**Subject:** Automated Equipment Repair **Time:** 32 Hrs.

**Duty:** Measure/Isolate Malfunctions of Mechanical/Fluid Power Systems

**Task:** Use Laws of Simple Machines and Physics to Identify and Troubleshoot Complex Machines

---

**Objective(s):**

Upon completion of this unit the student will be able to:

- a. Identify the simple machines in a machine tool ball screw mechanism and write an equation describing the machine's mechanical advantage and or speed advantage;
- b. Measure the mechanism and apply the results of the measurement to the equations;
- c. Describe the torque and change of torque in each part of the mechanism;
- d. Determine the efficiency of the mechanism by relating the input power to the output power;
- e. Follow the transmission of force through a gearing system and determine the mechanical advantage or speed advantage of each gear;
- f. Measure each gear in the system and relate the measurement to the gear ratio, and tooth geometry; and,
- g. Describe the torque and change of torque in each part of the mechanism.

---

**Instructional Materials:**

A machine tool that contains a ball screw mechanism, and a gearing mechanism (gear box) or a laboratory setup that contains the above experimental devices. A CNC mill or a lathe is ideal for this type of equipment. A good source for quality systems is Hampden Engineering Corp., phone 1-800-253-2133, E-mail sales@hampden.com, web site [www.hampden.com](http://www.hampden.com)

Safety glasses, cleaning rags or towels (very important), hand tools specific to the removal of covers or other protective apparatus, and measuring instruments to measure diameters, distances, force (spring scales), RPM, voltage, and current (see MASTER modules AET-C1, AET-C2, and AET-J2)

MASTER Handout (AET-F7-HO)

**MASTER** Laboratory Exercise No. 1 (AET-F7-LE1)  
**MASTER** Laboratory Exercise No. 2 (AET-F7-LE2) (Measuring and Testing  
Complex Machines)  
**MASTER** Laboratory Aid (AET-F7-LA)

---

**References:**

*Physics for Career Education*, Ewen/Nelson/Schurter, Latest Edition  
**Video(s):** *The Mechanical Universe*, Anenberg/CBP (PBS), Latest  
Edition

---

**Student Preparation:**

Students should have previously completed the following Technical Modules:

- AET-A7** "Use Mechanical Physics to Analyze Mechanical Industrial Systems"
- AET-B1** "Use Symbols, Organization, and Engineering Values on Mechanical Drawings"
- AET-C1** "Apply Machine Tool Metrology and Measurement Instruments to Align Machine Tools"
- AET-C2** "Apply Electrical Measurement Knowledge and Instruments to Test/Calibrate Electrical Circuits"
- AET-C3** "Apply Electronic Measurement Knowledge and Instruments to Test/Calibrate Electronic Circuits"

---

---

**Introduction:**

To troubleshoot mechanical systems it is not sufficient to be able to merely install or remove mechanical components; any low skill person capable of handling a wrench can accomplish these skills. To be a competent technician, one must be able to properly diagnose problems in the systems. In a mechanical system, and most certainly in a CNC servo system, the technician must have a in-depth knowledge of the operating principles of the mechanism. The technician must know how the transmission of force in the system and the speed of the system results in an increase or decrease of the power required for the system, how the effects of maintaining constant servo velocity relate to momentum, acceleration, and impulse momentum; the role that friction plays in the requirements of the system, and how to apply the rules of physics to troubleshoot the system. In addition, the knowledge of how to properly measure the parameters of the system will allow the technician to interpret the system's anticipated performance. All good servo systems technicians are capable of relating the mechanical performance of a CNC servo to the electronic performance of the system to troubleshoot and repair the system.

---

---

**Presentation Outline:**

- I. Identify, Test and Troubleshoot Ball Screw Mechanisms
  - A. Identify the simple machines in the ball screw mechanism
  - B. Demonstrate the measurement of the rotational force of the motor pulley with the servo power off
  - C. Demonstrate the measurement of the rotational speed of the motor at a constant servo velocity
  - D. Demonstrate the measurement of voltage and current on the servo motor
  - E. Conduct MASTER Laboratory Exercise No. 2 (AET-F7-LE2) (Measuring and Testing Complex Machines)
- II. Identify, Test and Troubleshoot Gear Mechanisms
  - A. Identify and explain the theory of operation of a complex gearing mechanism:
    1. Driver gears and driven gears
      - a. Open gear train
      - b. Closed gear train
      - c. Rack and pinion
    2. Circumference of the gear as it relates to amount of gear teeth, tooth geometry, and gear ratio
    3. Transmission of force and torque through a gear train
    4. Mechanical advantage/disadvantage and speed advantage/disadvantage
  - B. Provide lab experiences in the basic principles of gear systems (MASTER Laboratory Exercise No. 2) (AET-F7-LE2) (Measuring and Testing Complex Machines)

---

---

**Practical Application:**

1. Using a working industrial CNC machine tool, identify each of the simple machines of ball-screw slide, and measure and calculate the parameters of the system; and,
2. Using a working industrial CNC machine tool that contains a gear box, identify the type of gear system, each of the gears and the gear ratio, and measure and calculate the parameters of the system.

---

---

**Evaluation and/or Verification:**

Successful completion of this technical module will be based on the student's successful completion of the following components:

1. An instructor generated ten question quiz on complex machines; and,
2. Satisfactory completion of MASTER Laboratory Exercise No. 2 (AET-F7-LE2) (Measuring and Testing Complex Machines).

---

---

**Summary:**

Review the main lesson points at each subsection of the module using the suggested texts and handouts listed in the reference section of this module. Hold class discussion and answer student questions.

---

---

**Next Lesson Assignment:**

**MASTER Technical Module (AET-F8)** dealing with applying hydraulic, pneumatic, and high vacuum systems knowledge to test, troubleshoot, and repair high purity, high vacuum systems.

**AET-F7-HO**  
**Use Laws of Simple Machines and Physics**  
**to Identify and Troubleshoot Complex Machines**  
**Attachment 1: MASTER Handout**

---

**Objective(s):**

Upon completion of this unit the student will be able to:

- a. Identify the simple machines in a machine tool ball screw mechanism and write an equation describing the machine's mechanical advantage and or speed advantage;
- b. Measure the mechanism and apply the results of the measurement to the equations;
- c. Describe the torque and change of torque in each part of the mechanism;
- d. Determine the efficiency of the mechanism by relating the input power to the output power;
- e. Follow the transmission of force through a gearing system and determine the mechanical advantage or speed advantage of each gear;
- f. Measure each gear in the system and relate the measurement to the gear ratio, and tooth geometry; and,
- g. Describe the torque and change of torque in each part of the mechanism.

---

**Module Outline:**

- I. Identify, Test and Troubleshoot Ball Screw Mechanisms
  - A. Identify the simple machines in the ball screw mechanism
  - B. Demonstrate the measurement of the rotational force of the motor pulley with the servo power off
  - C. Demonstrate the measurement of the rotational speed of the motor at a constant servo velocity
  - D. Demonstrate the measurement of voltage and current on the servo motor
  - E. Conduct MASTER Laboratory Exercise No. 2 (AET-F7-LE2) (Measuring and Testing Complex Machines)
- II. Identify, Test and Troubleshoot Gear Mechanisms
  - A. Identify and explain the theory of operation of a complex gearing mechanism:
    1. Driver gears and driven gears
      - a. Open gear train
      - b. Closed gear train
      - c. Rack and pinion

2. Circumference of the gear as it relates to amount of gear teeth, tooth geometry, and gear ratio
  3. Transmission of force and torque through a gear train
  4. Mechanical advantage/disadvantage and speed advantage/disadvantage
- B. Provide lab experiences in the basic principles of gear systems (MASTER Laboratory Exercise No. 2) (AET-F7-LE2) (Measuring and Testing Complex Machines)



**AET-F7-LE1**  
**Use Laws of Simple Machines and Physics**  
**to Identify and Troubleshoot Complex Machines**  
**Attachment 2: MASTER Laboratory Exercise No. 1**

---

The student will:

1. Using a working industrial CNC machine tool, identify each of the simple machines of ball-screw slide, and measure and calculate the parameters of the system; and,
2. Using a working industrial CNC machine tool that contains a gear box, identify the type of gear system, each of the gears and the gear ratio, and measure and calculate the parameters of the system.

**AET-F7-LA**  
**Use Laws of Simple Machines and Physics**  
**to Identify and Troubleshoot Complex Machines**  
**Attachment 4: MASTER Laboratory Aid**

---

**Rules of Conduct**

1. Absolutely no horseplay or practical joking will be tolerated.
2. Do not talk to anyone who is operating a machine.
3. Walk only in the designated traffic lanes.
4. Dress appropriately; at the absolute minimum, you must have:
  - a. No loose clothing, including ties;
  - b. Long hair properly stowed;
  - c. No jewelry;
  - d. Hard, closed-toe shoes;
  - e. Eye protection (safety glasses); and,
  - f. Ear protection (plugs or headset).
5. Follow all institutional safety rules.

# AUTOMATED EQUIPMENT REPAIR SERIES

## MASTER Technical Module No. AET-F8

---

<b>Subject:</b>	Automated Equipment Repair	<b>Time:</b> 2 Hrs.
<b>Duty:</b>	Measure/Isolate Malfunctions Of Mechanical/Fluid Power Systems	
<b>Task:</b>	Apply Hydraulic, Pneumatic, and High Vacuum Systems Knowledge to Test, Troubleshoot, and Repair High Purity, High Vacuum Systems	

---

### Objective(s):

Upon completion of this unit the student will be able to:

- a. Identify and explain the component parts of an industrial high purity, high vacuum system;
- b. List the sequence of operation of the subsystems of an industrial high purity, high vacuum system;
- c. Identify types of pumps used and their theory of operation, for an industrial high purity, high vacuum system;
- d. Explain and calculate the effects of system pressure upon pumping speed;
- e. Define the various levels of vacuum from rough vacuum to ultra-high vacuum;
- f. Identify and explain the theory of operation of instrumentation used in an industrial high purity, high vacuum system;
- g. Apply vacuum pressure scales to the determination of vacuum system operation; and,
- h. Explain the equipment, procedures, and corrective measures to detect and control leaks in an industrial high purity, high vacuum system.

---

### Instructional Materials:

An industrial high vacuum system (about  $1 \times 10^{-6}$  torr). (The author is lucky in that he has such a system as a donation from Advanced Micro Circuits Corporation (AMCC).) A system such as this expensive. Lacking the resources, lab exercises may be limited to demonstration and/or thought exercises. A helium leak detector (which is in reality a mass spectrometer) will serve for both the vacuum system aspect of the module, and the leak detection aspect. Many school physics labs have high purity vacuum systems or mass spectrometers that use high purity vacuum systems.

Safety glasses, cleaning rags or towels (very important), hand tools specific to the assembly/disassembly of vacuum fittings and components

Lab experiences should be determined by the instructor due to the uncertainty surrounding the availability of equipment

**MASTER** Handout (AET-F8-HO)

**MASTER** Laboratory Exercise (AET-F8-LE)

**MASTER** Laboratory Aid (AET-F8-LA)

---

### References:

*High Vacuum Technology*, Latest Edition

---

### Student Preparation:

Students should have previously completed the following Technical Modules:

- AET-A8** "Use Math and Mechanical Physics to Analyze Problems Found in Hydraulic and Pneumatic Systems"
- AET-B4** "Use Symbols, Organization, and Engineering Values on Fluid Power Drawings"
- AET-F1** "Identify and Explain the Theory and Use of Major Systems that Comprise a Hydraulic or Pneumatic System"
- AET-F2** "Apply Purpose and Use of Valves in a Hydraulic or Pneumatic System to Troubleshoot Components or Systems"
- AET-F3** "Identify, Assemble, Measure, and Apply Knowledge of Operating Characteristics of Hydraulic and Pneumatic Actuators"
- AET-F4** "Apply Hydraulic, Pneumatic, and High Vacuum Systems Knowledge to Test, Troubleshoot, and Repair Special Components/Devices"
- AET-F5** "Identify, Assemble, Measure, and Apply Knowledge of Operating Characteristics of Selected, Specialized Fluid Power Circuits"
- AET-F6** "Identify, Assemble, Measure, and Apply Knowledge of Operating Characteristics of Electrically Operated, Specialized Fluid Power Circuits"
- AET-F7** "Use Laws of Simple Machines and Physics to Identify and Troubleshoot Complex Machines"

---

---

### Introduction:

High vacuum systems are essential to a very wide number of modern manufacturing processes. New materials that are being invented to replace materials that were conventionally used for manufacturing cannot be fabricated in an atmospheric environment. To manufacture and bond these materials requires a high purity vacuum chamber or furnace, and the associated pumping systems to support it. The creation of modern integrated circuits cannot be accomplished without the use of ultra-pure,

ultra high vacuum systems. It is safe to say that our current level of technology, is the *result* of high vacuum technology. An automation technician, at one point in his or her career, will encounter high vacuum technology. Therefore, it is important that the technician should be prepared to cope with the extremely complex nature of the technology.

---

---

### **Presentation Outline:**

- I. Vacuum Systems
  - A. Present an overview of high vacuum systems
  - B. Explain the systems of pressure measurement for high vacuum systems
  - C. Explain the types of vacuum pumps used in ultra high vacuum systems
  - D. Explain the theory of operation and use of, a helium leak detector
- II. High Vacuum Systems and Instrumentation
  - A. Explain the types of mechanical vacuum pumps used and their theory of operation
  - B. Explain and demonstrate the theory of operation of diffusion pumps
  - C. Explain and demonstrate the theory of operation of cryogenic pumps
  - D. Explain and demonstrate the theory of operation of sputter pumps
  - E. Explain and demonstrate the theory of operation of turbo-molecular pumps
  - F. Explain and demonstrate the theory of operation of thermocouple vacuum sensors and gauges
  - G. Explain and demonstrate the theory of operation of hot cathode ion sensors and gauges
  - H. Explain and demonstrate the theory of operation of cold cathode ion sensors and gauges
- III. Helium Leak Detectors
  - A. Explain the concept of mass spectrometers
    - 1. Theory
    - 2. Operation
    - 3. Maintaining
  - B. Explain the procedure used to tune a helium leak detector
  - C. Explain and demonstrate leak detection methods
- IV. Explain the Theory of Operation and Use of Residual Gas Analyzers (RGA)
  - A. Theory
  - B. Operation
  - C. Maintaining
  - D. Using RGAs to analyze impurities in ultra-high vacuum systems

---

---

**Practical Application:**

1. Using a working high vacuum system, identify the subsystems and perform measurements of the instrumentation; and,
2. Calculate the parameters of the system from measurements.

---

---

**Evaluation and/or Verification:**

Successful completion of this technical module will be based on the student's successful completion of the following components:

1. An instructor generated test on high vacuum systems; and,
2. Completion of practical labs or system exercises on high vacuum systems.

---

---

**Summary:**

Review the main lesson points at each subsection of the module using the suggested texts and handouts listed in the reference section of this module. Hold class discussion and answer student questions.

---

---

**Next Lesson Assignment:**

**MASTER Technical Module (AET-G1)** dealing with performing digital operations in digital numbering systems.

## AET-F8-HO

### Apply Hydraulic, Pneumatic, and High Vacuum Systems Knowledge to Test, Troubleshoot, and Repair High Purity, High Vacuum Systems Attachment 1: MASTER Handout

---

#### Objective(s):

Upon completion of this unit the student will be able to:

- a. Identify and explain the component parts of an industrial high purity, high vacuum system;
  - b. List the sequence of operation of the subsystems of an industrial high purity, high vacuum system;
  - c. Identify types of pumps used and their theory of operation, for an industrial high purity, high vacuum system;
  - d. Explain and calculate the effects of system pressure upon pumping speed;
  - e. Define the various levels of vacuum from rough vacuum to ultra-high vacuum;
  - f. Identify and explain the theory of operation of instrumentation used in an industrial high purity, high vacuum system;
  - g. Apply vacuum pressure scales to the determination of vacuum system operation; and,
  - h. Explain the equipment, procedures, and corrective measures to detect and control leaks in an industrial high purity, high vacuum system.
- 

#### Module Outline:

- I. Vacuum Systems
  - A. Present an overview of high vacuum systems
  - B. Explain the systems of pressure measurement for high vacuum systems
  - C. Explain the types of vacuum pumps used in ultra high vacuum systems
  - D. Explain the theory of operation and use of, a helium leak detector
- II. High Vacuum Systems and Instrumentation
  - A. Explain the types of mechanical vacuum pumps used and their theory of operation
  - B. Explain and demonstrate the theory of operation of diffusion pumps
  - C. Explain and demonstrate the theory of operation of cryogenic pumps
  - D. Explain and demonstrate the theory of operation of sputter pumps
  - E. Explain and demonstrate the theory of operation of turbo-molecular pumps
  - F. Explain and demonstrate the theory of operation of thermocouple vacuum sensors and gauges

- G. Explain and demonstrate the theory of operation of hot cathode ion sensors and gauges
- H. Explain and demonstrate the theory of operation of cold cathode ion sensors and gauges
- III. Helium Leak Detectors
  - A. Explain the concept of mass spectrometers
    - 1. Theory
    - 2. Operation
    - 3. Maintaining
  - B. Explain the procedure used to tune a helium leak detector
  - C. Explain and demonstrate leak detection methods
- IV. Explain the Theory of Operation and Use of Residual Gas Analyzers (RGA)
  - A. Theory
  - B. Operation
  - C. Maintaining
  - D. Using RGAs to analyze impurities in ultra-high vacuum systems



## **AET-F8-HO**

### **Apply Hydraulic, Pneumatic, and High Vacuum Systems Knowledge to Test, Troubleshoot, and Repair High Purity, High Vacuum Systems Attachment 1: MASTER Handout**

---

The student will:

1. Using a working high vacuum system, identify the subsystems and perform measurements of the instrumentation; and,
2. Calculate the parameters of the system from measurements.

## AET-F8-LA

# Apply Hydraulic, Pneumatic, and High Vacuum Systems Knowledge to Test, Troubleshoot, and Repair High Purity, High Vacuum Systems

### Attachment 3: MASTER Laboratory Aid

---

## Rules of Conduct

1. Absolutely no horseplay or practical joking will be tolerated.
2. Do not talk to anyone who is operating a machine.
3. Walk only in the designated traffic lanes.
4. Dress appropriately; at the absolute minimum, you must have:
  - a. No loose clothing, including ties;
  - b. Long hair properly stowed;
  - c. No jewelry;
  - d. Hard, closed-toe shoes;
  - e. Eye protection (safety glasses); and,
  - f. Ear protection (plugs or headset).
5. Follow all institutional safety rules.

**AUTOMATED EQUIPMENT REPAIR TECHNICIAN ... operates, programs, maintains, and repairs automated machine tools and automated manufacturing processes.**

**Duties**

**Tasks**

Duties	A-1 Apply scientific notation and engineering notation to solve technical problems	A-2 Apply algebraic formulas to problems	A-3 Use variables in algebraic formulas to problems	A-4 Manipulate algebraic formulas in industrial systems	A-5 Measure, calculate, and convert quantities in digital systems (micro systems)	A-6 Use mechanical physics to analyze mechanical industrial systems	A-7 Use mechanical physics to analyze mechanical industrial systems	A-8 Use mathematical and mechanical physics to analyze problems found in pneumatic systems	A-9 Use mathematical and thermodynamic principles to analyze problems found in heat treating systems	A-10 Use mathematical physics to determine function and operation of industrial systems	A-11 Use chemical principles and formulas to predict and analyze chemical industrial processes	A-12 Apply the knowledge of electrochemical effects to analyze industrial processes	A-13 Apply principles of water treatment processes
<b>A</b> Apply Science to Solve Industrial Problems	B-1 Use symbols, organization, and engineering drawing values on mechanical drawings	B-2 Use symbols, organization, and engineering drawing values on electrical drawings	B-3 Use symbols, organization, and engineering drawing values on electronic drawings	B-4 Use symbols, organization, and engineering drawing values on fluid power drawings	B-5 Use symbols, organization, and engineering drawing values on digital drawings	B-6 Use mechanical physics to analyze mechanical industrial systems	B-7 Use mechanical physics to analyze mechanical industrial systems	B-8 Use mathematical and mechanical physics to analyze problems found in pneumatic systems	B-9 Use mathematical and thermodynamic principles to analyze problems found in heat treating systems	B-10 Use mathematical physics to determine function and operation of industrial systems	B-11 Use chemical principles and formulas to predict and analyze chemical industrial processes	B-12 Apply the knowledge of electrochemical effects to analyze industrial processes	B-13 Apply principles of water treatment processes
<b>B</b> Use Drawings to Analyze and Repair Systems	C-1 Apply mathematical measurement instruments to calibrate machine tools	C-2 Apply electronic measuring instruments to test/calibrate electrical circuits	C-3 Apply electronic measuring instruments to test/calibrate electronic circuits	C-4 Apply fluid power measuring instruments to test/calibrate pneumatic systems	C-5 Apply digital electronic measuring instruments to test/calibrate digital electronic circuits	C-6 Use mechanical physics to analyze mechanical industrial systems	C-7 Use mechanical physics to analyze mechanical industrial systems	C-8 Use mathematical and mechanical physics to analyze problems found in pneumatic systems	C-9 Use mathematical and thermodynamic principles to analyze problems found in heat treating systems	C-10 Use mathematical physics to determine function and operation of industrial systems	C-11 Use chemical principles and formulas to predict and analyze chemical industrial processes	C-12 Apply the knowledge of electrochemical effects to analyze industrial processes	C-13 Apply principles of water treatment processes
<b>C</b> Use Calibrated Instruments to Test/Calibrate Components	D-1 Apply troubleshooting process to the resolution of malfunctions in industrial machines tools and automated equipment	D-2 Calculate, measure, and respond to quantities in AC circuits	D-3 Calculate, measure, and respond to quantities in AC circuits	D-4 Calculate, measure, and respond to quantities in polyphase AC circuits	D-5 Properly set up and use meters and oscilloscopes	D-6 Use mechanical physics to analyze mechanical industrial systems	D-7 Use mechanical physics to analyze mechanical industrial systems	D-8 Use mathematical and mechanical physics to analyze problems found in pneumatic systems	D-9 Use mathematical and thermodynamic principles to analyze problems found in heat treating systems	D-10 Use mathematical physics to determine function and operation of industrial systems	D-11 Use chemical principles and formulas to predict and analyze chemical industrial processes	D-12 Apply the knowledge of electrochemical effects to analyze industrial processes	D-13 Apply principles of water treatment processes
<b>D</b> Resolve System Failures with Critical Thinking, Problem Solving, Theory and Metrology	E-1 Calculate, measure, and respond to quantities in DC circuits	E-2 Calculate, measure, and respond to quantities in AC circuits	E-3 Calculate, measure, and respond to quantities in AC circuits	E-4 Calculate, measure, and respond to quantities in polyphase AC circuits	E-5 Properly set up and use meters and oscilloscopes	E-6 Use mechanical physics to analyze mechanical industrial systems	E-7 Use mechanical physics to analyze mechanical industrial systems	E-8 Use mathematical and mechanical physics to analyze problems found in pneumatic systems	E-9 Use mathematical and thermodynamic principles to analyze problems found in heat treating systems	E-10 Use mathematical physics to determine function and operation of industrial systems	E-11 Use chemical principles and formulas to predict and analyze chemical industrial processes	E-12 Apply the knowledge of electrochemical effects to analyze industrial processes	E-13 Apply principles of water treatment processes
<b>E</b> Use Techniques Malfunctions of Electronic Systems	F-1 Identify and explain the theory and use of hydraulic or pneumatic systems	F-2 Apply numerical values in hydraulic or pneumatic systems	F-3 Identify, assemble, measure, and apply knowledge of operating hydraulic and pneumatic actuators	F-4 Apply hydraulic, pneumatic, and high vacuum systems knowledge to shoot, and repair special devices	F-5 Identify, assemble, measure, and apply knowledge of operating electrical, specialized fluid power circuits	F-6 Use mechanical physics to analyze mechanical industrial systems	F-7 Use mechanical physics to analyze mechanical industrial systems	F-8 Use mathematical and mechanical physics to analyze problems found in pneumatic systems	F-9 Use mathematical and thermodynamic principles to analyze problems found in heat treating systems	F-10 Use mathematical physics to determine function and operation of industrial systems	F-11 Use chemical principles and formulas to predict and analyze chemical industrial processes	F-12 Apply the knowledge of electrochemical effects to analyze industrial processes	F-13 Apply principles of water treatment processes
<b>F</b> Measure/Isolate Malfunctions of Field Power Systems	G-1 Perform digital operations in digital systems	G-2 Perform digital operations in digital equipment	G-3 Solve digital ladder diagrams and programmable logic control problems	G-4 Program and control industrial equipment	G-5 Identify, assemble, measure, and apply knowledge of operating electrical, specialized fluid power circuits	G-6 Use mechanical physics to analyze mechanical industrial systems	G-7 Use mechanical physics to analyze mechanical industrial systems	G-8 Use mathematical and mechanical physics to analyze problems found in pneumatic systems	G-9 Use mathematical and thermodynamic principles to analyze problems found in heat treating systems	G-10 Use mathematical physics to determine function and operation of industrial systems	G-11 Use chemical principles and formulas to predict and analyze chemical industrial processes	G-12 Apply the knowledge of electrochemical effects to analyze industrial processes	G-13 Apply principles of water treatment processes
<b>G</b> Apply Computer Science to Computer Controlled Equipment	H-1 Perform operations on PLC (Programmable Logic Controller) or PLC (Programmable Logic Controller) system	H-2 Safely assemble, disassemble, and adjust subsystems of fluid power systems	H-3 Safely assemble, disassemble, or adjust components or systems	H-4 Safely assemble, disassemble, or adjust components or equipment	H-5 Identify, assemble, measure, and apply knowledge of operating electrical, specialized fluid power circuits	H-6 Use mechanical physics to analyze mechanical industrial systems	H-7 Use mechanical physics to analyze mechanical industrial systems	H-8 Use mathematical and mechanical physics to analyze problems found in pneumatic systems	H-9 Use mathematical and thermodynamic principles to analyze problems found in heat treating systems	H-10 Use mathematical physics to determine function and operation of industrial systems	H-11 Use chemical principles and formulas to predict and analyze chemical industrial processes	H-12 Apply the knowledge of electrochemical effects to analyze industrial processes	H-13 Apply principles of water treatment processes
<b>H</b> Correct Malfunctions in PLC Controlled Equipment	I-1 Perform manufacturer's specifications and data entry/Computer Aided Manufacturing processes	I-2 Safely assemble, disassemble, and adjust subsystems of fluid power systems	I-3 Safely assemble, disassemble, or adjust components or systems	I-4 Safely assemble, disassemble, or adjust components or equipment	I-5 Identify, assemble, measure, and apply knowledge of operating electrical, specialized fluid power circuits	I-6 Use mechanical physics to analyze mechanical industrial systems	I-7 Use mechanical physics to analyze mechanical industrial systems	I-8 Use mathematical and mechanical physics to analyze problems found in pneumatic systems	I-9 Use mathematical and thermodynamic principles to analyze problems found in heat treating systems	I-10 Use mathematical physics to determine function and operation of industrial systems	I-11 Use chemical principles and formulas to predict and analyze chemical industrial processes	I-12 Apply the knowledge of electrochemical effects to analyze industrial processes	I-13 Apply principles of water treatment processes
<b>I</b> Resolve Malfunctions Found in Systems Computer Controlled Manufacturing Processes	J-1 Safely assemble, disassemble, and adjust subsystems of fluid power systems	J-2 Safely assemble, disassemble, or adjust components or systems	J-3 Safely assemble, disassemble, or adjust components or equipment	J-4 Safely assemble, disassemble, or adjust components or equipment	J-5 Identify, assemble, measure, and apply knowledge of operating electrical, specialized fluid power circuits	J-6 Use mechanical physics to analyze mechanical industrial systems	J-7 Use mechanical physics to analyze mechanical industrial systems	J-8 Use mathematical and mechanical physics to analyze problems found in pneumatic systems	J-9 Use mathematical and thermodynamic principles to analyze problems found in heat treating systems	J-10 Use mathematical physics to determine function and operation of industrial systems	J-11 Use chemical principles and formulas to predict and analyze chemical industrial processes	J-12 Apply the knowledge of electrochemical effects to analyze industrial processes	J-13 Apply principles of water treatment processes
<b>J</b> Assemble/Disassemble and Adjust Subsystems of Electronic, Electric, and Computer Systems													

# **AUTOMATED EQUIPMENT REPAIR SERIES**

## **MASTER Technical Module No. AET-G1**

---

**Subject:** Automated Equipment Repair **Time:** 12 Hrs.

**Duty:** Apply Computer Science to Computer Controlled Industrial Equipment

**Task:** Perform Digital Operations in Digital Numbering Systems

---

### **Objective(s):**

Upon completion of this unit the student will be able to:

- a. Create a numbering system to any base and count to at least twenty in the new system;
  - b. Convert numbers from any of the following numbering systems to a number in the group; decimal, binary, hexadecimal, octal, Binary Coded Decimal (BCD);
  - c. Convert the binary codes of the American Standard Code for Information Interchange (ASCII) and Gray Code to its alphanumeric or binary equivalent;
  - d. Perform mathematical operations such as addition, subtraction, multiplication and division in binary; and,
  - e. Create negative and positive numbers in the binary system, and convert the numbers to other numbering systems.
- 

### **Instructional Materials:**

**MASTER Handout No. 1 (AET-G1-HO-1)**

**MASTER Handout No. 2 (AET-G1-HO-2) (Creating Numbering Systems)**

**MASTER Laboratory Exercise (AET-G1-LE)**

**MASTER Quiz AET-G1-QU-1: Number Conversions**

**MASTER Quiz AET-G1-QU-2: Binary Mathematics**

---

### **References:**

*Modern Industrial Electronics, Revised and Expanded Edition,*  
Schuler/MacNamee, Latest Edition (formerly *Industrial Electronics and Robotics*, Schuler/MacNamee, 1987)

*Programmable Controllers (Theory and Implementation),* Bryan and Bryan, ISBN 0-944107-32-X, Latest Edition

**Video(s):** *Basic Digital Math*, Bergwall Productions, 1-800-645-3565, Latest Edition

*Basic Math for Electronics*, Bergwall Productions, 1-800-645-3565, Latest Edition

Note: Bergwall Productions will be referenced frequently throughout the AET section because the company provides quality video productions at a reasonable price, unlike other video production companies.)

The following item is *not recommended* because it *detracts from the hands-on nature of this module*. This item may be used as a supplement for the module if the module contains actual interaction with real electrical and electronic parts. Digital electronics is a "messy" technology because actual parts and measuring devices are not perfect. The following item is theoretically perfect, and therefore does not reflect the real world of electricity and electronics.

*Electronic Workbench* - Graphic Windows based program for constructing theoretical models of digital electrical and electronic circuits.

---

### Student Preparation:

Students should have previously completed the following Technical Modules:

AET-A1 "Apply Scientific Notation and Engineering Notation to Solve Technical Problems"

---

---

### Introduction:

The current trend in modern industrial controls for CNC machines or robots is to provide sophisticated software analysis and troubleshooting tools to aid in the timely repair of the systems. This has been made possible by the rapid advances in computer hardware and its wide spread availability and low cost. However, most control systems rely upon the ability of a trained automation technician to convert and interpret the data, which is presented in a binary based numbering system. This frequently requires the technician to convert hexadecimal octal, or binary data to real world events such as the digital state of a switch or contact, or the on/off state of a relay or solenoid. Also, to program digital devices such as computers or programmable controllers, it is *imperative to master* many different numbering systems.

---

---

### Presentation Outline:

- I. Convert Mathematical Quantities in Digital Numbering Systems
  - A. Explain the rules by which numbering systems are created (MASTER Handout No. 2 (AET-G1-HO-2) (Creating Numbering Systems)
    1. Explain the rules of the multiplier

2. Explain the rules of the base
  3. Provide examples of creating a numbering system to the base 5
  - B. Explain the binary numbering system
    1. Have the student create the binary numbering system, and count to twenty in the system
    2. Demonstrate the usage of the binary numbering system as a system of on/off, yes/no events
  - C. Explain the hexadecimal and octal numbering system
    1. Have the students attempt to create a numbering system to the base 16
    2. Explain the method by which numbers 10 through 15 are expressed
    3. Have the students create a numbering system to the base 8, and count to twenty in the new numbering system
  - D. Demonstrate the creation of a numbering system such as base 16 or 8 expressed as a binary number
  - E. Explain the nomenclature of a binary number for a hexadecimal computer system
    1. Bit
    2. Nibble
    3. Byte
    4. Word
    5. Double word
- II. Perform Mathematical Operations in Digital Numbering Systems
- A. Explain and demonstrate the rules by which binary numbers are added or subtracted
    1. Explain that the computer can only add
    2. Explain the rules of binary addition
    3. Demonstrate the complement of a binary number
    4. Demonstrate the conversion of a binary number to 2s complement
    5. Demonstrate two's complement subtraction (addition)
  - B. Explain and demonstrate the rules by which binary numbers can be multiplied or divided
    1. Demonstrate the multiplication of two binary numbers
    2. Demonstrate the multiplication by two of a binary number (left shift)
    3. Demonstrate division by two of a binary number (right shift)
    4. Demonstrate the multiplication or division of a binary number by successive addition of a positive or negative number
  - C. Explain the multiplication of hexadecimal and octal numbers by conversion to binary

---

---

**Practical Application:**

1. Determine the maximum and minimum binary numbers, both positive and negative, that can be reported by an analog input or output module for a 16 bit PLC; and,
2. Determine the current operating condition of a CNC machine or robot by converting the binary or hexadecimal data reported by the control.

---

---

**Evaluation and/or Verification:**

Successful completion of this technical module will be based on the student's successful completion of the following components:

1. A twenty question quiz on binary math; and,
2. A twenty question quiz on number conversion.

---

---

**Summary:**

Review the main lesson points using the text and handouts listed in the reference section of this module. Hold class discussion and answer student questions.

---

---

**Next Lesson Assignment:**

**MASTER Technical Module (AET-G2)** dealing with performing Boolean Operations in digital equipment.

**AET-G1-HO-1**  
**Perform Digital Operations in Digital Numbering Systems**  
**Attachment 1: MASTER Handout No. 1**

---

**Objective(s):**

Upon completion of this unit the student will be able to:

- a. Create a numbering system to any base and count to at least twenty in the new system;
  - b. Convert numbers from any of the following numbering systems to a number in the group; decimal, binary, hexadecimal, octal, Binary Coded Decimal (BCD);
  - c. Convert the binary codes of the American Standard Code for Information Interchange (ASCII) and Gray Code to its alphanumeric or binary equivalent;
  - d. Perform mathematical operations such as addition, subtraction, multiplication and division in binary; and,
  - e. Create negative and positive numbers in the binary system, and convert the numbers to other numbering systems.
- 

**Module Outline:**

- I. Convert Mathematical Quantities in Digital Numbering Systems
  - A. Explain the rules by which numbering systems are created (MASTER Handout No. 2 (AET-G1-HO-2) (Creating Numbering Systems)
    1. Explain the rules of the multiplier
    2. Explain the rules of the base
    3. Provide examples of creating a numbering system to the base 5
  - B. Explain the binary numbering system
    1. Have the student create the binary numbering system, and count to twenty in the system
    2. Demonstrate the usage of the binary numbering system as a system of on/off, yes/no events
  - C. Explain the hexadecimal and octal numbering system
    1. Have the students attempt to create a numbering system to the base 16
    2. Explain the method by which numbers 10 through 15 are expressed
    3. Have the students create a numbering system to the base 8, and count to twenty in the new numbering system
  - D. Demonstrate the creation of a numbering system such as base 16 or 8 expressed as a binary number
  - E. Explain the nomenclature of a binary number for a hexadecimal computer system



1. Bit
  2. Nibble
  3. Byte
  4. Word
  5. Double word
- II. Perform Mathematical Operations in Digital Numbering Systems
- A. Explain and demonstrate the rules by which binary numbers are added or subtracted
1. Explain that the computer can only add
  2. Explain the rules of binary addition
  3. Demonstrate the complement of a binary number
  4. Demonstrate the conversion of a binary number to 2s complement
  5. Demonstrate two's complement subtraction (addition)
- B. Explain and demonstrate the rules by which binary numbers can be multiplied or divided
1. Demonstrate the multiplication of two binary numbers
  2. Demonstrate the multiplication by two of a binary number (left shift)
  3. Demonstrate division by two of a binary number (right shift)
  4. Demonstrate the multiplication or division of a binary number by successive addition of a positive or negative number
- C. Explain the multiplication of hexadecimal and octal numbers by conversion to binary

**AET-G1-LE**  
**Perform Digital Operations in Digital Numbering Systems**  
**Attachment 3: MASTER Laboratory Exercise**

---

The student will:

1. Determine the maximum and minimum binary numbers, both positive and negative, that can be reported by an analog input or output module for a 16 bit PLC; and,
2. Determine the current operating condition of a CNC machine or robot by converting the binary or hexadecimal data reported by the control.

# AUTOMATED EQUIPMENT REPAIR SERIES

## MASTER Technical Module No. AET-G2

---

**Subject:** Automated Equipment Repair **Time:** 12 Hrs.

**Duty:** Apply Computer Science to Computer Controlled Industrial Equipment

**Task:** Perform Boolean Operations in Digital Equipment

---

### Objective(s):

Upon completion of this unit the student will be able to:

- a. Write a Boolean expression of a complex logical problem;
  - b. Convert the Boolean expression to symbolic logic;
  - c. Read a digital electronic diagram containing Boolean symbolic logic; and,
  - d. Identify and explain the function of complex logical functions such as decoders, encoders, counters, and registers.
- 

### Instructional Materials:

Textbook laboratory experiences in constructing and verifying Boolean functions and circuits

MASTER Handout (AET-G2-HO-1)

MASTER Handout (AET-G2-HO-2) (Boolean Logic Assignment)

MASTER Laboratory Exercise (AET-G2-LE)

MASTER Quiz AET-G2-QU-1: Boolean Logic Symbolology

MASTER Quiz AET-G2-QU-2: Boolean Combinational Logic

MASTER Quiz AET-G2-QU-3: Counters and Registers

---

### References:

*Modern Industrial Electronics, Revised and Expanded Edition,*

Schuler/MacNamee, Latest Edition (formerly *Industrial Electronics and Robotics*, Schuler/MacNamee, 1987)

*Programmable Controllers (Theory and Implementation)*, Bryan and Bryan, ISBN 0-944107-32-X, Latest Edition

*Electricity/Electronics Fundamentals*, Zbar/Sloop, ISBN 0-07-072817-8, Latest Edition

**Video(s):** *Understanding Digital Electronics*, Bergwall Productions, 1-800-645-3565, Latest Edition

Note: Bergwall Productions will be referenced frequently throughout the AET section because the company provides quality video productions at a reasonable price, unlike other video production companies.)

The following item is recommended unless it detracts from the hands-on nature of this module. This item may be used as a supplement for the module if the module contains actual interaction with real electrical and electronic parts. Digital electronics is a "messy" technology because actual parts and measuring devices are not perfect. The following item is theoretically perfect, and therefore does not reflect the real world of electricity and electronics.

*Electronic Workbench* - Graphic Windows based program for constructing theoretical models of digital electrical and electronic circuits.

---

### Student Preparation:

Students should have previously completed the following Technical Modules:

- AET-B5 "Use Symbols, Organization, and Engineering Values on Digital Drawings"
- AET-G1 "Perform Digital Operations in Digital Numbering Systems"

Note: This module should be presented in conjunction with module AET-C5 "Use Symbols, Organization, and Engineering Values on Digital Drawings"

---

---

### Introduction:

As amazing as it seems, nearly every aspect of our civilization is now controlled by four very basic Boolean concepts: AND, OR, NOT and EXCLUSIVE OR. No computer or control system could work without them. The marriage of Boolean algebra, the digital memory function, and binary arithmetic in computer systems has revolutionized our society because of the computer's wide spread availability and low cost. All control systems rely upon Boolean functions to work. Boolean functions are built into the microprocessors that run our computer systems. Boolean functions are provided for every programming language including ladder programming. Boolean functions provide the "intelligence" for a control system to determine real world events such as the digital state of a switch or contact, or the on/off state of a solenoid or relay. In addition, to program digital devices, such as computers or programmable logic controllers, it is imperative to *master all* of the Boolean functions.

---

---

### Presentation Outline:

- I. Express a Complex Logic Problem in Boolean, and Convert it into Symbolic Logic

- A. Explain the rules by which Boolean statements are created
  1. Explain the logical rules of Boolean
    - a. AND
    - b. OR (inclusive OR)
    - c. XOR (exclusive OR)
    - d. NOT
  2. Explain the use of a truth table
  3. Create the following Boolean rules from the above
    - a. NAND
    - b. NOR
    - c. Not XOR
  4. Demonstrate the rules of the NOT functions with a truth table
  5. Explain and demonstrate the depiction of the logical operators in an algebraic Boolean expression
  6. Conduct an exercise in converting a control problem into a Boolean expression (The two light switch problem is ideal. Both switches turn the same light on or off.)
    - a. Define the inputs and outputs
    - b. Define the logical processing that controls the system
  7. Explain the mathematical rules for manipulating Boolean expressions
    - a. Order of operations
    - b. Laws of distribution and association
    - c. Law of double complementation
    - d. Law of tautology
    - e. DeMorgan's Theorem
  8. Explain the relationship of Boolean to the binary numbering system
  9. Explain the method by which binary bits are stored in memory devices
- B. Demonstrate the conversion of a Boolean expression to symbolic logic
  1. Explain the concept and purpose of Boolean symbolic logic. Stress the importance of writing the Boolean expression *before* converting to symbolic logic
  2. Draw the Boolean symbols that are most commonly used to depict the above Boolean expressions, and explain the inputs and outputs of the symbols
  3. Draw the digital symbols for binary memory storage (multi vibrators, flip/flops) and explain the types of memory devices (flip/flops)
  4. Have the students convert the above control problem into symbolic logic

## II. Read Digital Symbology and Relate it to Control of Digitally Operated Equipment

- A. Explain and demonstrate methods for reading digital schematic drawings
    - 1. Demonstrate the use of a truth table to determine the possible states of outputs
    - 2. Explain the rules of static logic and dynamic logic
    - 3. Demonstrate the creation of a complete English sentence from a combinational logic circuit
  - B. Demonstrate how the ability to state a control problem as a sentence, by studying the digital symbology, can help a technician understand the operation of the equipment
    - 1. Conduct several exercises in converting digital symbology into Boolean expressions
    - 2. Convert the Boolean expressions into plain English sentences
    - 3. Use the sentences to describe the operation of the control system
    - 4. Demonstrate binary addition by the use of symbolic gates
- III. Identify Combinational Logic Devices Such as Decoders, Encoders, Counters and Registers
- A. Explain and demonstrate common combinational logic circuits
    - 1. Demonstrate the creation of a Gray code decoder circuit
    - 2. Demonstrate the creation of an ASCII encoder circuit
  - B. Explain and demonstrate how memory devices are used to create counters and registers
    - 1. Explain how memory devices are combined to store binary data
    - 2. Explain the operating principles of a binary storage register using binary storage elements (flip/flops)
    - 3. Explain the operating principles of a binary counter using binary storage elements (flip/flops)
    - 4. Demonstrate the count sequence of a binary counter

---



---

**Practical Application:**

- 1. Explore the digital symbology contained in a digital schematic diagram for a CNC or robot control system, and identify counters and registers.

---



---

**Evaluation and/or Verification:**

Successful completion of this technical module will be based on the student's successful completion of the following components:

- 1. The creation of a complex digital circuit (see MASTER Handout No. 2; AET-G2-HO-2: Boolean Logic Assignment;
- 2. A twenty question quiz on digital logic symbols and expressions (MASTER Quiz AET-G2-QU-1: Boolean Logic Symbology);
- 3. A twenty question quiz on Boolean symbolic logic (MASTER Quiz AET-G2-QU-2: Boolean Combinational Logic); and,

4. A ten question quiz on Boolean registers and counters (MASTER Quiz AET-G2-QU-3: Counters and Registers).

---

---

**Summary:**

Review the main lesson points using the text and handouts listed in the reference section of this module. Hold class discussion and answer student questions.

---

---

**Next Lesson Assignment:**

**MASTER Technical Module (AET-G3)** dealing with solving digital logic circuits and ladder diagrams in electrical and programmable logic control circuits; expressing a complex logic problem in Boolean and convert it into ladder logic.

**AET-G2-HO-1**  
**Perform Boolean Operations in Digital Equipment**  
**Attachment 1: MASTER Handout No. 1**

---

**Objective(s):**

Upon completion of this unit the student will be able to:

- a. Write a Boolean expression of a complex logical problem;
  - b. Convert the Boolean expression to symbolic logic;
  - c. Read a digital electronic diagram containing Boolean symbolic logic; and,
  - d. Identify and explain the function of complex logical functions such as decoders, encoders, counters, and registers.
- 

**Module Outline:**

- I. Express a Complex Logic Problem in Boolean, and Convert it into Symbolic Logic
  - A. Explain the rules by which Boolean statements are created
    1. Explain the logical rules of Boolean
      - a. AND
      - b. OR (inclusive OR)
      - c. XOR (exclusive OR)
      - d. NOT
    2. Explain the use of a truth table
    3. Create the following Boolean rules from the above
      - a. NAND
      - b. NOR
      - c. Not XOR
    4. Demonstrate the rules of the NOT functions with a truth table
    5. Explain and demonstrate the depiction of the logical operators in an algebraic Boolean expression
    6. Conduct an exercise in converting a control problem into a Boolean expression (The two light switch problem is ideal. Both switches turn the same light on or off.)
      - a. Define the inputs and outputs
      - b. Define the logical processing that controls the system
    7. Explain the mathematical rules for manipulating Boolean expressions
      - a. Order of operations
      - b. Laws of distribution and association
      - c. Law of double complementation
      - d. Law of tautology
      - e. DeMorgan's Theorem



8. Explain the relationship of Boolean to the binary numbering system
  9. Explain the method by which binary bits are stored in memory devices
- B. Demonstrate the conversion of a Boolean expression to symbolic logic
1. Explain the concept and purpose of Boolean symbolic logic. Stress the importance of writing the Boolean expression *before* converting to symbolic logic
  2. Draw the Boolean symbols that are most commonly used to depict the above Boolean expressions, and explain the inputs and outputs of the symbols
  3. Draw the digital symbols for binary memory storage (multi vibrators, flip/flops) and explain the types of memory devices (flip/flops)
  4. Have the students convert the above control problem into symbolic logic
- II. Read Digital Symbology and Relate it to Control of Digitally Operated Equipment
- A. Explain and demonstrate methods for reading digital schematic drawings
1. Demonstrate the use of a truth table to determine the possible states of outputs
  2. Explain the rules of static logic and dynamic logic
  3. Demonstrate the creation of a complete English sentence form a combinational logic circuit
- B. Demonstrate how the ability to state a control problem as a sentence, by studying the digital symbology, can help a technician understand the operation of the equipment
1. Conduct several exercises in converting digital symbology into Boolean expressions
  2. Convert the Boolean expressions into plain English sentences
  3. Use the sentences to describe the operation of the control system
  4. Demonstrate binary addition by the use of symbolic gates
- III. Identify Combinational Logic Devices Such as Decoders, Encoders, Counters and Registers
- A. Explain and demonstrate common combinational logic circuits
1. Demonstrate the creation of a Gray code decoder circuit
  2. Demonstrate the creation of an ASCII encoder circuit
- B. Explain and demonstrate how memory devices are used to create counters and registers
1. Explain how memory devices are combined to store binary data
  2. Explain the operating principles of a binary storage register using binary storage elements (flip/flops)

3. Explain the operating principles of a binary counter using binary storage elements (flip/flops)
4. Demonstrate the count sequence of a binary counter

**AET-G2-LE**  
**Perform Boolean Operations in Digital Equipment**  
**Attachment 3: MASTER Laboratory Exercise**

---

The student will:

1. Explore the digital symbology contained in a digital schematic diagram for a CNC or robot control system, and identify counters and registers.

# **AUTOMATED EQUIPMENT REPAIR SERIES**

## **MASTER Technical Module No. AET-G3**

---

**Subject:** Automated Equipment Repair **Time:** 12 Hrs.

**Duty:** Apply Computer Science to Computer Controlled Industrial Equipment

**Task:** Solve Digital Logic Circuits and Ladder Diagrams in Electrical and Programmable Logic Control Circuits .Express a Complex Logic Problem in Boolean and Convert it into Ladder Logic

---

### **Objective(s):**

Upon completion of this unit the student will be able to:

- a. Convert an electrical control ladder diagram into a set of Boolean expressions;
- b. Convert complex Boolean expressions into ladder logic; and,
- c. Convert Boolean expressions into program fragments and subroutines.

---

### **Instructional Materials:**

**MASTER Handout (AET-G3-HO)**

**MASTER Laboratory Exercise (AET-G3-LE)**

**MASTER Quiz AET-G3-QU-1: Boolean-Ladder Conversions**

**MASTER Quiz AET-G3-QU-2: Programming Boolean Expressions**

---

### **References:**

*Modern Industrial Electronics, Revised and Expanded Edition,*  
Schuler/MacNamee, Latest Edition (formerly *Industrial Electronics  
and Robotics*, Schuler/MacNamee, 1987)

*Programmable Controllers (Theory and Implementation)*, Bryan and  
Bryan, ISBN 0-944107-32-X, Latest Edition

**Video(s):** *Introduction to Programmable Logic Controllers*, Bergwall  
Productions, 1-800-645-3565, Latest Edition

Note: Bergwall Productions will be referenced frequently throughout the AET section because the company provides quality video productions at a reasonable price, unlike other video production companies.)

---

## **Student Preparation:**

Students should have previously completed the following Technical Modules:

- AET-G1 "Perform Digital Operations in Digital Numbering Systems"
- AET-G2 "Perform Boolean Operations in Digital Equipment"

---

---

## **Introduction:**

Learning to think in Boolean will provide a technician with the tools to create programs for many different types of control systems. Unfortunately, learning one programming language or mastering the programming of a microprocessor is not an effective method of accomplishing this task. The effort should be to provide the basics of Boolean programming, and then the technician can learn the language of an individual programming environment. It is a fact, that most programming concepts attempt to recreate the basic hardware functions of a central processor (CPU) for a computer. The difference is that whereas the microprocessor or CPU executes simple Boolean functions with electronic circuits, the programming language accomplishes the same task with software that provides more sophistication, using readable syntax or symbols. For example, using the Basic programming language, an AND function can be written that also contains complex mathematical operations, comparisons of alphanumeric codes, or comparisons of complex binary data. Although the AND function is eventually executed in the electronics of the microprocessor or CPU, it can be more intelligible and rich with detail when written using a higher order language such as BASIC, "C", or ladder programming.

---

---

## **Presentation Outline:**

- I. Convert an Electrical Ladder Control Drawing to a Set of Boolean Expressions
  - A. Explain the rules by which electrical ladder rungs can be converted to Boolean expressions
    - 1. Explain the rules of the ladder AND function
    - 2. Explain the rules of the ladder OR function
    - 3. Explain the rules of the ladder XOR function
    - 4. Explain the rules of the ladder NOT function
    - 5. Explain the rules of the ladder memory function
  - B. Demonstrate the conversion of a complex electrical ladder drawing into a set of Boolean expressions
- II. Express a Complex Logic Problem in Boolean, and Convert it into Ladder Logic
  - A. Explain and demonstrate the procedure for converting a Boolean expression into ladder logic
  - B. Conduct an exercise in converting a Boolean expression of a complex control problem into ladder logic

1. Demonstrate the conversion of the problem
  2. Explain the problems in the conversion that are peculiar to a programmable logic controller (PLC)
- III. Express a Complex Logic Problem in Boolean, and Convert it into a Program
- A. Explain and demonstrate the procedure for converting a Boolean expression and mathematical expression into a program fragment or subroutine
    1. Explain and demonstrate the concept of lower order and higher order programming languages
    2. Explain the concept of a subroutine
    3. Explain and demonstrate the program syntax and structure that is essential for programming Boolean expressions and math functions in both BASIC and "C"
  - B. Conduct an exercise in converting a Boolean expression of a complex control problem into program fragment or subroutine for both Basic and "C"
    1. Demonstrate the conversion of the problem
    2. Explain the problems in the conversion that are peculiar to a given programming language

---

---

**Practical Application:**

1. Convert an electrical ladder drawing for an electrical control system into a set of Boolean expressions;
2. Convert a symbolic digital drawing for a robot or CNC control into ladder logic; and,
3. Program a control function for a industrial control system.

---

---

**Evaluation and/or Verification:**

Successful completion of this technical module will be based on the student's successful completion of the following components:

1. A ten question quiz on Boolean ladder conversions (MASTER Quiz AET-G3-QU-1: Boolean-Ladder Conversions);
2. Demonstrate ability to convert electrical ladder diagrams into Boolean expressions;
3. Demonstrate ability to convert Boolean expressions into ladder diagrams;
4. A ten question quiz on programming Boolean expressions (MASTER Quiz AET-G3-QU-2: Programming Boolean Expressions); and,
5. Demonstrate ability to program Boolean expressions into a given programming language (BASIC or "C").

---

---

**Summary:**

Review the main lesson points using the text and handouts listed in the reference section of this module. Hold class discussion and answer student questions.

---

---

**Next Lesson Assignment:**

**MASTER Technical Module (AET-G4)** dealing with programming computers and computer controlled industrial equipment.

**AET-G3-HO**  
**Solve Digital Logic Circuits and Ladder Diagrams**  
**in Electrical and Programmable Logic Control Circuits;**  
**Express a Complex Logic Problem in Boolean**  
**and Convert it into Ladder Logic**  
**Attachment 1: MASTER Handout**

---

**Objective(s):**

Upon completion of this unit the student will be able to:

- a. Convert an electrical control ladder diagram into a set of Boolean expressions;
  - b. Convert complex Boolean expressions into ladder logic; and,
  - c. Convert Boolean expressions into program fragments and subroutines.
- 

**Module Outline:**

- I. Convert an Electrical Ladder Control Drawing to a Set of Boolean Expressions
  - A. Explain the rules by which electrical ladder rungs can be converted to Boolean expressions
    1. Explain the rules of the ladder AND function
    2. Explain the rules of the ladder OR function
    3. Explain the rules of the ladder XOR function
    4. Explain the rules of the ladder NOT function
    5. Explain the rules of the ladder memory function
  - B. Demonstrate the conversion of a complex electrical ladder drawing into a set of Boolean expressions
- II. Express a Complex Logic Problem in Boolean, and Convert it into Ladder Logic
  - A. Explain and demonstrate the procedure for converting a Boolean expression into ladder logic
  - B. Conduct an exercise in converting a Boolean expression of a complex control problem into ladder logic
    1. Demonstrate the conversion of the problem
    2. Explain the problems in the conversion that are peculiar to a programmable logic controller (PLC)
- III. Express a Complex Logic Problem in Boolean, and Convert it into a Program
  - A. Explain and demonstrate the procedure for converting a Boolean expression and mathematical expression into a program fragment or subroutine
    1. Explain and demonstrate the concept of lower order and higher order programming languages
    2. Explain the concept of a subroutine



3. Explain and demonstrate the program syntax and structure that is essential for programming Boolean expressions and math functions in both BASIC and "C"
- B. Conduct an exercise in converting a Boolean expression of a complex control problem into program fragment or subroutine for both Basic and "C"
1. Demonstrate the conversion of the problem
  2. Explain the problems in the conversion that are peculiar to a given programming language

**AET-G3-LE**  
**Solve Digital Logic Circuits and Ladder Diagrams**  
**in Electrical and Programmable Logic Control Circuits;**  
**Express a Complex Logic Problem in Boolean**  
**and Convert it into Ladder Logic**  
**Attachment 2: MASTER Laboratory Exercise**

---

The student will:

1. Convert an electrical ladder drawing for an electrical control system into a set of Boolean expressions;
2. Convert a symbolic digital drawing for a robot or CNC control into ladder logic; and,
3. Program a control function for an industrial control system.

# AUTOMATED EQUIPMENT REPAIR SERIES

## MASTER Technical Module No. AET-G4

---

<b>Subject:</b>	<b>Automated Equipment Repair</b>	<b>Time:</b> 12 Hrs.
<b>Duty:</b>	<b>Apply Computer Science to Computer Controlled Industrial Equipment</b>	
<b>Task:</b>	<b>Program Computers and Computer Controlled Industrial Equipment</b>	

---

### Objective(s):

Upon completion of this unit the student will be able to:

- a. Program a control statement, written as a Boolean expression, into a high order language such as BASIC or "C";
- b. Use a computer or hand-held terminal to program control statements into higher order programming languages such as ladder programming, BASIC, or "C"; and,
- c. Use the concepts of structured programming to write structured programs that contain proper documentation, and are relatively easy to read and modify.

---

### Instructional Materials:

Enough computers to handle the anticipated class load, two students per computer. The computers chosen should be capable of at least running Visual BASIC (Pentium 166 MHZ class, 16 Megs RAM, SVGA video cards, 1-4 Gigabytes hard drives, 1.44 floppy drives, mouse, and keyboard)

Windows 95, Visual BASIC, Visual "C", or PLC programming software (all of these packages are expensive. Several alternatives are available. Quick BASIC is provided with MS-DOS 4.0 and above, GWBASIC is provided with MS-DOS 3.3, tiny BASIC is provided with Lunix, as is a C++ compiler. In addition, PLC programming software is provided at low cost or at a one time cost from some PLC manufacturers. Most notably, the MYSTIC PLC controller manufactured by Opto-22, a company located at 43044 Temecula, California, web site [www.opto22.com](http://www.opto22.com)).

Lab procedures may be obtained from the suggested reading materials  
MASTER Handout (AET-G4-HO)  
MASTER Laboratory Exercise (AET-G4-LE)

---

**References:**

- Programmable Controllers (Theory and Implementation)*, Bryan and Bryan, ISBN 0-944107-32-X, Latest Edition
- Introducing Computers - Concepts, Systems, and Applications*, Blissmer, Latest Edition
- Problem Solving and Programming Concepts*, Sprankle, ISBN 0-02-415350-8, Latest Edition
- Structured Basic Applied to Technology*, Adamson, ISBN 0-02-300827-X, Latest Edition
- Structured C for Engineering and Technology*, Adamson/Antonakos/Mansfield, ISBN 0-02-300812-1, Latest Edition
- Video(s):** *Introduction to Programmable Logic Controllers*, Bergwall Productions, 1-800-645-3565

Note: Bergwall Productions will be referenced frequently throughout the AET section because the company provides quality video productions at a reasonable price, unlike other video production companies and trade associations.

---

**Student Preparation:**

Students should have previously completed the following Technical Modules:

- AET-G1** "Perform Digital Operations in Digital Numbering Systems"
- AET-G2** "Perform Boolean Operations in Digital Equipment"
- AET-G3** "Solve Digital Logic Circuits and Ladder Diagrams in Electrical and Programmable Logic Control Circuits; Express a Complex Logic Problem in Boolean and Convert it into Ladder Logic"

---

---

**Introduction:**

When converting Boolean expressions into various programming languages, the technician must be able to operate the equipment that allows access to the programmed device. This can include computers terminals, hand-held programming units, and other types of data entry devices. In addition, to write properly documented programs, the technician must adhere to the discipline of structured programming, to write programs that are clear and easily modified. As hardware becomes more throw-away and more reliable, the need for electronic hardware board-level repair skills will diminish, and the need for programming skills will increase. Although a technician deals primarily with hardware, a knowledge of programming, and programming concepts will provide upward mobility in his or her occupation. Three of the skills in high demand are the ability to program in programming languages such as ladder programming, visual BASIC programming, and visual C or C++ programming. To

avoid the risk of becoming obsolete, the technician must learn the skills necessary to program in many different languages.

---

---

**Presentation Outline:**

- I. Use Various Programming Devices to Program Computer Controlled Industrial Equipment
  - A. Explain the tools used to construct a program
    - 1. Explain the purpose of an editor and give examples of editors
    - 2. Explain the purpose of a compiler and give examples of compilers for different programming languages
    - 3. Describe the steps necessary to use a computer to run an editor
    - 4. Describe the steps necessary to use a computer to compile the program and the supporting programs that are necessary to make the compiler run properly
    - 5. Demonstrate the use of a hand-held terminal to program a PLC (programmable logic controller)
  - B. Provide lab exercises in the use of a computer to run programming tools
  - C. Provide lab exercises in the use of a hand-held terminal to program a PLC
- II. Use Structured Programming Concepts to Program Industrial Equipment
  - A. Explain the rules of structured programming (top-down programming)
    - 1. Explain the purpose of structured programming
    - 2. Describe proper documentation for structured programs and the purpose of the program header
    - 3. Describe the steps necessary to create structured programs
    - 4. Demonstrate the creation of a structured program
  - B. Provide lab exercises in structured programming using ladder programming and BASIC, or "C"

---

---

**Practical Application:**

- 1. Convert an electrical ladder drawing for an electrical control system into a ladder program; and,
- 2. Convert an electrical ladder drawing for an electrical control system into a BASIC or C program.

---

---

**Evaluation and/or Verification:**

Successful completion of this technical module will be based on the student's successful completion of the following components:

- 1. An instructor generated quiz on using computer devices to create programs;

2. An instructor generated quiz on structured programming; and,
3. Demonstrate ability to use a computer and/or hand-held terminal to program.

---

---

**Summary:**

Review the main lesson points using the text and handouts listed in the reference section of this module. Hold class discussion and answer student questions.

---

---

**Next Lesson Assignment:**

**MASTER Technical Module (AET-H1)** dealing with performing operations on PLC (programmable logic controller) or PIC (programmable interface controller) systems.

**AET-G4-HO**  
**Program Computers and Computer Controlled Industrial Equipment**  
**Attachment 1: MASTER Handout**

---

**Objective(s):**

Upon completion of this unit the student will be able to:

- a. Program a control statement, written as a Boolean expression, into a high order language such as BASIC or "C";
  - b. Use a computer or hand-held terminal to program control statements into higher order programming languages such as ladder programming, BASIC, or "C"; and,
  - c. Use the concepts of structured programming to write structured programs that contain proper documentation, and are relatively easy to read and modify.
- 

**Module Outline:**

- I. Use Various Programming Devices to Program Computer Controlled Industrial Equipment
  - A. Explain the tools used to construct a program
    1. Explain the purpose of an editor and give examples of editors
    2. Explain the purpose of a compiler and give examples of compilers for different programming languages
    3. Describe the steps necessary to use a computer to run an editor
    4. Describe the steps necessary to use a computer to compile the program and the supporting programs that are necessary to make the compiler run properly
    5. Demonstrate the use of a hand-held terminal to program a PLC (programmable logic controller)
  - B. Provide lab exercises in the use of a computer to run programming tools
  - C. Provide lab exercises in the use of a hand-held terminal to program a PLC
- II. Use Structured Programming Concepts to Program Industrial Equipment
  - A. Explain the rules of structured programming (top-down programming)
    1. Explain the purpose of structured programming
    2. Describe proper documentation for structured programs and the purpose of the program header
    3. Describe the steps necessary to create structured programs
    4. Demonstrate the creation of a structured program
  - B. Provide lab exercises in structured programming using ladder programming and BASIC, or "C"

**AET-G4-LE**  
**Program Computers and Computer Controlled Industrial Equipment**  
**Attachment 2: MASTER Laboratory Exercise**

---

The student will:

1. Convert an electrical ladder drawing for an electrical control system into a ladder program; and,
2. Convert an electrical ladder drawing for an electrical control system into a BASIC or C program.



**AUTOMATED EQUIPMENT REPAIR TECHNICIAN ... operates, programs, maintains, and repairs automated machine tools and automated manufacturing processes.**

**Duties**

**Tasks**

Duties	A-1 Apply scientific notation and engineering concepts to solve technical problems	A-2 Apply algebraic formulas to solve technical problems	A-3 Use variables in algebraic formulas to solve technical problems	A-4 Manipulate variables in algebraic formulas to solve technical problems	A-5 Measure, calculate, and convert quantities in metric (SI) systems of measurement	A-6 Use mechanical physics to analyze hydraulic and pneumatic systems	A-7 Use mechanical physics to analyze industrial systems	A-8 Use math and physics to analyze hydraulic and pneumatic systems	A-9 Use math and thermodynamics to analyze industrial heat treating systems	A-10 Use math, physics, and electronics to analyze industrial systems	A-11 Use chemical principles and formulas to predict and analyze chemical industrial processes	A-12 Apply the knowledge of electrochemical effects to analyze industrial water treatment processes	A-13 Apply principles of water analysis to analyze industrial water treatment processes
<b>A</b> Apply Science to Solve Industrial Problems	B-1 Use symbols, units, and engineering concepts to solve technical problems	B-2 Use symbols, units, and engineering concepts to solve technical problems	B-3 Use symbols, units, and engineering concepts to solve technical problems	B-4 Use symbols, units, and engineering concepts to solve technical problems	B-5 Use symbols, units, and engineering concepts to solve technical problems	B-6 Use symbols, units, and engineering concepts to solve technical problems	B-7 Use symbols, units, and engineering concepts to solve technical problems	B-8 Use symbols, units, and engineering concepts to solve technical problems	B-9 Use symbols, units, and engineering concepts to solve technical problems	B-10 Use symbols, units, and engineering concepts to solve technical problems	B-11 Use symbols, units, and engineering concepts to solve technical problems	B-12 Use symbols, units, and engineering concepts to solve technical problems	B-13 Use symbols, units, and engineering concepts to solve technical problems
<b>B</b> Use Drawings to Analyze and Repair Systems	C-1 Apply mathematical concepts to solve technical problems	C-2 Apply mathematical concepts to solve technical problems	C-3 Apply mathematical concepts to solve technical problems	C-4 Apply mathematical concepts to solve technical problems	C-5 Apply mathematical concepts to solve technical problems	C-6 Apply mathematical concepts to solve technical problems	C-7 Apply mathematical concepts to solve technical problems	C-8 Apply mathematical concepts to solve technical problems	C-9 Apply mathematical concepts to solve technical problems	C-10 Apply mathematical concepts to solve technical problems	C-11 Apply mathematical concepts to solve technical problems	C-12 Apply mathematical concepts to solve technical problems	C-13 Apply mathematical concepts to solve technical problems
<b>C</b> Use Calibrated Instruments to Test/Calibrate Components	D-1 Apply the process to the functional testing, Theory, and Metrology	D-2 Apply the process to the functional testing, Theory, and Metrology	D-3 Apply the process to the functional testing, Theory, and Metrology	D-4 Apply the process to the functional testing, Theory, and Metrology	D-5 Apply the process to the functional testing, Theory, and Metrology	D-6 Apply the process to the functional testing, Theory, and Metrology	D-7 Apply the process to the functional testing, Theory, and Metrology	D-8 Apply the process to the functional testing, Theory, and Metrology	D-9 Apply the process to the functional testing, Theory, and Metrology	D-10 Apply the process to the functional testing, Theory, and Metrology	D-11 Apply the process to the functional testing, Theory, and Metrology	D-12 Apply the process to the functional testing, Theory, and Metrology	D-13 Apply the process to the functional testing, Theory, and Metrology
<b>D</b> Resolve System Failures with Critical Thinking, Theory, and Metrology	E-1 Calculate, predict, and measure the response of quantities in DC circuits	E-2 Calculate, predict, and measure the response of quantities in AC circuits	E-3 Calculate, predict, and measure the response of quantities in AC circuits	E-4 Calculate, predict, and measure the response of quantities in AC circuits	E-5 Calculate, predict, and measure the response of quantities in AC circuits	E-6 Calculate, predict, and measure the response of quantities in AC circuits	E-7 Calculate, predict, and measure the response of quantities in AC circuits	E-8 Calculate, predict, and measure the response of quantities in AC circuits	E-9 Calculate, predict, and measure the response of quantities in AC circuits	E-10 Calculate, predict, and measure the response of quantities in AC circuits	E-11 Calculate, predict, and measure the response of quantities in AC circuits	E-12 Calculate, predict, and measure the response of quantities in AC circuits	E-13 Calculate, predict, and measure the response of quantities in AC circuits
<b>E</b> Use Techniques to Malfunctions of Electrical/Electronic Systems	F-1 Identify and explain the theory and use of valves in a hydraulic or pneumatic system	F-2 Apply pneumatic theory and use of valves in a hydraulic or pneumatic system	F-3 Identify, assemble, measure, and apply knowledge of hydraulic and pneumatic actuators	F-4 Apply hydraulic, pneumatic, and vacuum systems knowledge to troubleshoot and repair pneumatics	F-5 Identify, assemble, measure, and apply knowledge of electrical and electronic circuits	F-6 Identify, assemble, measure, and apply knowledge of electrical and electronic circuits	F-7 Use laws of simple machines and physics to identify and troubleshoot complex machines	F-8 Apply electrical and mechanical physics to determine operational characteristics of relays, solenoids, and AC circuits	F-9 Apply principles of electrical motors to identify various types of motors	F-10 Apply semiconductor theory and measurement techniques to determine operational characteristics of transistors, diodes, and power semiconductors	F-11 Apply semiconductor theory and measurement techniques to determine operational characteristics of amplifiers and sensors	F-12 Apply semiconductor theory and measurement techniques to determine operational characteristics of amplifiers and sensors	F-13 Use schematic diagrams, oscilloscopes to identify, troubleshoot, and repair various types of electronic motor control circuits
<b>F</b> Measure/olate Mechanical/Fluid Power Systems	G-1 Perform digital operations in digital numbering systems	G-2 Perform Boolean operations in digital numbering systems	G-3 Solve digital logic circuits and ladder diagrams in electrical and programmable logic controller (PLC) circuits	G-4 Program and control industrial equipment	G-5 Identify, assemble, measure, and apply knowledge of electrical and electronic circuits	G-6 Identify, assemble, measure, and apply knowledge of electrical and electronic circuits	G-7 Use laws of simple machines and physics to identify and troubleshoot complex machines	G-8 Apply electrical and mechanical physics to determine operational characteristics of relays, solenoids, and AC circuits	G-9 Apply principles of electrical motors to identify various types of motors	G-10 Apply semiconductor theory and measurement techniques to determine operational characteristics of transistors, diodes, and power semiconductors	G-11 Apply semiconductor theory and measurement techniques to determine operational characteristics of amplifiers and sensors	G-12 Apply semiconductor theory and measurement techniques to determine operational characteristics of amplifiers and sensors	G-13 Use schematic diagrams, oscilloscopes to identify, troubleshoot, and repair various types of electronic motor control circuits
<b>G</b> Apply Computer Science to Computer Control and Industrial Equipment	H-1 Perform operations on PLC (programmable logic controller) systems	H-2 Perform operations on PLC (programmable logic controller) systems	H-3 Perform operations on PLC (programmable logic controller) systems	H-4 Perform operations on PLC (programmable logic controller) systems	H-5 Perform operations on PLC (programmable logic controller) systems	H-6 Perform operations on PLC (programmable logic controller) systems	H-7 Perform operations on PLC (programmable logic controller) systems	H-8 Perform operations on PLC (programmable logic controller) systems	H-9 Perform operations on PLC (programmable logic controller) systems	H-10 Perform operations on PLC (programmable logic controller) systems	H-11 Perform operations on PLC (programmable logic controller) systems	H-12 Perform operations on PLC (programmable logic controller) systems	H-13 Perform operations on PLC (programmable logic controller) systems
<b>H</b> Correct Malfunctions in PLC Controlled Equipment	I-1 Use equipment specifications, and data entry devices to configure, test and troubleshoot set points and solve control problems	I-2 Safely assemble, disassemble, and adjust mechanical systems such as gears, shafts, couplings, fluid power systems	I-3 Safely assemble, disassemble, and adjust mechanical systems such as gears, shafts, couplings, fluid power systems	I-4 Safely assemble, disassemble, or adjust components or components	I-5 Safely assemble, disassemble, or adjust components or components	I-6 Safely assemble, disassemble, or adjust components or components	I-7 Safely assemble, disassemble, or adjust components or components	I-8 Safely assemble, disassemble, or adjust components or components	I-9 Safely assemble, disassemble, or adjust components or components	I-10 Safely assemble, disassemble, or adjust components or components	I-11 Safely assemble, disassemble, or adjust components or components	I-12 Safely assemble, disassemble, or adjust components or components	I-13 Safely assemble, disassemble, or adjust components or components
<b>I</b> Resolve Malfunctions Found in Manufacturing Processes	J-1 Safely assemble, disassemble, and adjust mechanical systems such as gears, shafts, couplings, fluid power systems	J-2 Safely assemble, disassemble, and adjust mechanical systems such as gears, shafts, couplings, fluid power systems	J-3 Safely assemble, disassemble, or adjust components or components	J-4 Safely assemble, disassemble, or adjust components or components	J-5 Safely assemble, disassemble, or adjust components or components	J-6 Safely assemble, disassemble, or adjust components or components	J-7 Safely assemble, disassemble, or adjust components or components	J-8 Safely assemble, disassemble, or adjust components or components	J-9 Safely assemble, disassemble, or adjust components or components	J-10 Safely assemble, disassemble, or adjust components or components	J-11 Safely assemble, disassemble, or adjust components or components	J-12 Safely assemble, disassemble, or adjust components or components	J-13 Safely assemble, disassemble, or adjust components or components
<b>J</b> Assemble/Disassemble Mechanical/Electrical/Electronic, and Computer Systems													

327

BEST COPY AVAILABLE

740

Duty H

# AUTOMATED EQUIPMENT REPAIR SERIES

## MASTER Technical Module No. AET-H1

---

**Subject:** Automated Equipment Repair **Time:** 72 Hrs.

**Duty:** Correct Malfunctions in PLC Controlled Industrial Equipment  
**Task:** Perform Operations on PLC (Programmable Logic Controller) or PIC (Programmable Interface Controller) Systems

---

### Objective(s):

Upon completion of this unit the student will be able to:

- a. Use a data entry device to set up and configure a PLC/PIC to control digital and analog input/output points;
- b. Set up/configure PIC/PLC as part of the control system of CNC machine/robot to control digital and analog I/O points;
- c. Use equipment manuals, manufacturer's specifications, and data entry/monitoring devices to connect and test digital and analog I/O points on a PLC or PIC;
- d. Use equipment manuals, manufacturer's specifications, and data entry/monitoring devices to test and troubleshoot set up of a PLC or PIC system and solve control problems
- e. Connect a data entry device such as a hand held terminal teach pendent, or programming computer to the communications port of a PLC or PIC and configure the controller for the types and quantities of control modules;
- f. Use the control system of a CNC machine tool or robot to configure a PLC or PIC that is part of the control system, or modify the parameters of the control to change specific machine functions;
- g. Install digital and analog input/output (I/O) modules in a PLC or PIC, connect field devices to the modules, and using a hand held terminal or personal computer to monitor the data, test the inputs and outputs for proper operation; and,
- h. Connect a hand held terminal or personal computer and programming/monitoring software to a PLC or PIC and use the device to monitor and correct problems on a fully configured and functioning, PLC or PIC system.

---

### Instructional Materials:

**Note:** The views discussed in this section are the opinions of the author. These statements represent experience in the selection of hardware to support a PLC lab. The statements in this section are not to be

**construed as being the opinions of the MASTER group, the National Science Foundation, nor of any Partner college.**

Enough Programmable Logic Controllers to handle the anticipated class load.

This is a trade off between cost, industrial needs, and class size. It requires careful balancing of cost, educational value and industrial standards. The author made the decision to use Allen Bradley SLC 500 class PLCs because the local industrial partners used the SLC 500 series or the Allen Bradley PLC-5 class, to create products or run automation systems, and because the SLC 500 series can be configured as a rack mounted PLC. This decision is costly, because Allen Bradley add-ons that provide communication between PLCs and computer systems are expensive, I/O modules are expensive, and programming software/hardware is expensive, although Allen Bradley does provide an educational discount. For example, to purchase one hand held programming terminal (HHT) with software, is almost three times the cost of the PLC alone! The author was lucky because Hewlett Packard donated a hand held programming terminal (HHT) and a complete SLC 502 rack mounted PLC with I/O modules. This brought the number of lab HHTs to a total of two, and the number of PLCs to a quantity of six! For a class size of 25 this means 12.5 students per HHT, and about four students per PLC. The author has augmented the lack of HHTs by providing off line programming experiences with computers. However, the student must eventually connect a HHT or computer to the PLC to download the programs. This decision has been very frustrating. There are better PLCs on the market that are programmed with superior software and provide RS-232C communication ports built into the PLC. An example is the family of PLC controllers manufactured by Opto-22, a company located at 43044 Temecula, California, web site [www.opto22.com](http://www.opto22.com). Opto-22 PLCs have communications ports built in, the programming concept is flow chart programming, and the programming software is a one-time charge regardless of how many PLCs you own. In addition, a PC based, ISA (Instrument Society of America) standard PLC module is available, and the company sells a self contained PLC trainer for about \$2000 per unit. The trainer has input and output components such as switches and lights to allow the student to program field devices. Compare this cost to Allen Bradley's trainer, which can be as high as \$20,000 or more! However, Allen Bradley has a significant share of the PLC market, and is widely used. For this and other reasons, the author decided to use Allen Bradley PLCs. Below is a table containing some comparisons of the features of the respective PLCs. The author feels that this information will be very valuable to an instructor who is desirous of starting a class in PLC programming. The initial cost of PLC hardware and software can break many school budgets and the instructor needs to

be well informed about these critical decisions. Before deciding upon the type of PLC that will be used in your lab, you should explore the market, contact your local industrial partners, and consider the educational value of the hardware. There are about 100 different PLC manufacturers. The author does **not** recommend Allen Bradley PLCs.

### **Allen Bradley**

**SLC-500 class PLC** (PLC-3 or 5 series PLCs are most likely beyond the reach of most educational institutions. One PLC-5 system can easily cost \$20,000 or more!)

**SLC-500 Stand alone controller** which requires a special module to communicate with a computer (1747-AIC module). Lacking this module, the PLC can only be programmed with a HHT. The SLC 500 1747-L20F has 12 inputs and 8 outputs, and can be expanded with a two slot expansion rack. (This is the least expensive PLC.)

**SLC-501 to 502 Rack Mounted PLC.** These PLCs can be ordered with racks of up to 16 slots for installing I/O modules. There is no provision for I/O points for the processor alone. Again, these PLCs must have special hardware to communicate with a computer. Each I/O module installed will increase the original cost of the PLC.

**SLC-503 or 504** This PLC is the only one of this series that will communicate with a computer through an RS-232C serial port. These PLCs can be ordered with racks of up to 16 slots for installing I/O modules. There is no provision for I/O points for the processor/power supply alone. Each I/O module installed will increase the original cost of the PLC. This is the most expensive PLC of this series.

### **Programming terminals and programming software**

**Allen Bradley Hand Held Terminal** The HHT communicates with the entire SLC-500 series and can be programmed off-line with an AC adapter. To program off line and then store the program, the HHT must be equipped with a battery backup (the battery costs \$40). With the necessary programming software (firmware on a EPROM or ROM) the HHT can cost at least three times more than the PLC!

**Allen Bradley programming software** The Allen Bradley programming package that the author purchased is hard to learn, non-intuitive, overly complicated and over priced. As of the time of the purchase, the company and its programming arm, ICOM, was in the process of being purchased by Rockwell. A programming package was being promised, by the company, that would be Windows based, more in line with current automation concepts, and easier to use. If such a package exists, the author is not aware of it. The last time that the author attempted to purchase new

software from Allen Bradley (now Rockwell) the cost was prohibitive. The reason that the old, MS-DOS based, Allen Bradley programming package is so miserable, is that it is based upon the old Taylor Software programming environment invented during the 1970s. The idea was "if it ain't broke, don't fix it." Many electrical engineers learned the software and didn't want to have to learn a new package. Therefore, the software retained the same look and feel of the package that used to function on an IBM XT! The original software was programmed in IBM BASIC, and as of 1993, still looked as if it had been programmed in BASIC! The truth is that many companies still use the same software to program PLCs (no wonder, since the cost was so high) so the student will not suffer from the struggle to learn it.

**Projected cost of hardware/software for a PLC class, based upon Allen Bradley SLC-500 series**

10 each SLC-500 PLCs (SLC 500 1747-L20F with 1747-AIC module)	\$520 per PLC (including tax)	total \$5,000.00
10 each 1784 KTx modules per programming computer to communicate with the 1747-AIC modules	about \$150 per module	total \$1,500.00
10 each seats of Controlview software per programming/control computer	about \$1,500 per seat	total \$15,000.00
Hardware to wire the above together		total \$1,000.00
2 Each SLC-503 or 504 PLCs with rack, two digital input, and two digital out modules	about \$1,500 per PLC	total \$3,000.00
10 each seats each of Rockwell ladder programming software	about \$800 per seat	total \$8,000.00
10 seats of Control View MMI (Man-Machine Interface) software	about \$1,500 per seat	total \$15,000.00
5 each HHTs	about \$1,200 per HHT	total \$6,000.00
Total cost for lab		\$53,000.00 (or more)

This figure dose not include the cost of the hardware of system that the PLC will control. Expect the cost of these items to total about twenty percent of the costs of the PLC system. A school should budget about \$75,000 for a good Allen Bradley lab).



**Opto-22 MYSTIC PLC** manufactured by Opto-22, a company located at 43044 Temecula, California, web site [www.opto22.com](http://www.opto22.com).

**Standard MYSTIC PLC**, the PLC has built-in communications ports for computer communications. It can be wired easily to a local area network. All expansion I/O racks and modules are “intelligent” and communicate with the processor by a two wire connection.

**ISA PC based PLC module** The industry is moving toward a PC solution for PLC control of CNCs robots and general automation, and to be in the forefront of the technology, it is wise to accept this trend. With the addition of a LAN card (Local Area Network) to the PC and Windows, the automation system can communicate with other PLCs on the system without additional expensive hardware.

**Software Programming and MMI software for OPTO-22 PLCs** is a bargain. The PLC programming software uses a flow chart programming model, and therefore does not provide experience in ladder programming concepts. This is actually an advantage in terms of technology, but does nothing for the standard, student ladder training. The MMI package is used to provide graphical representations of automation systems, and will control a complex manufacturing process.

The author is not aware of the current costs of an OPTO-22 system, but will guess that a system comparable to the AB system can be purchased for almost half of the cost of the Allen Bradley system.

Enough computers to handle the anticipated class load, two students per computer. The computers chosen should be capable of at least running Windows 95, and Visual BASIC (Pentium 166 MHZ class, 16 Megs RAM, SVGA video cards, 1-4 Gigabytes hard drives, 1.44 floppy drives, mouse, and keyboard

Input and output devices such as relays, solenoid valves, indicator lights, thermocouples, RTDs motors and pneumatic or hydraulic actuators

Since the type of PLC acquired will to a large extent determine the nature of quizzes and labs, it would be impractical to provide either for this MASTER module. Labs and quizzes can be generated from the PLC work book mentioned in “References”

A CNC machine tool that contains a PIC or PLC interface, and a programmable robot control

**MASTER Handout (AET-H1-HO)**

**MASTER Laboratory Exercise (AET-H1-LE)**

---

**References:**

- Modern Industrial Electronics, Revised and Expanded Edition*, Schuler/MacNamee, Latest Edition (formerly *Industrial Electronics and Robotics*, Schuler/MacNamee, 1987)
- Programmable Controllers (Theory and Implementation)*, Bryan and Bryan, ISBN 0-944107-32-X, Latest Edition
- Workbook for Programmable Controllers (Theory and Implementation)*, Latest Edition
- Video(s):** *Introduction to Programmable Logic Controllers*, Bergwall Productions, 1-800-645-3565, Latest Edition

Note: Bergwall Productions will be referenced frequently throughout the AET section because the company provides quality video productions at a reasonable price, unlike other video production companies.)

---

**Student Preparation:**

Students should have previously completed the following Technical Modules:

- AET-G1** "Perform Digital Operations in Digital Numbering Systems"
- AET-G2** "Perform Boolean Operations in Digital Equipment"
- AET-G3** "Solve Digital Logic Circuits and Ladder Diagrams in Electrical and Programmable Logic Control Circuits; Express a Complex Logic Problem in Boolean and Convert it into Ladder Logic"
- AET-G4** "Program Computers and Computer Controlled Industrial Equipment"

Note 1: This module is meant to be used in conjunction with the following modules:

- AET G1 through AET-G4** "Apply Computer Science to Computer Controlled Industrial Equipment" series
- AET-II** "Use Equipment Manuals, Manufacturer's Specifications, and Data Entry/Monitoring Devices to Configure, Test and Troubleshoot Set Up of a Computer System and Solve Control Problems"

Note 2: This module should have, as a precursor, the modules AET-E1 through AET-E13 "Use Techniques to Isolate Malfunctions of Electrical/Electronic Systems" series. A thorough knowledge of electricity and electronics is *required* for this module.

Note 3: Configuring, troubleshooting, and repairing a PLC controlled manufacturing system requires most of the drawing reading, electrical, electronic, mechanical and computer skills that are presented throughout the AET modules. Ideally, the student should have competency in all of the AET skills. This may be accomplished by attaining competency in *all* of the modules, or by demonstrated skills in *all* of the categories.

---

---

### Introduction:

The current trend in modern industrial controls for CNC machines or robots is to provide sophisticated software analysis and troubleshooting tools to aid in the timely repair of the systems. This has been made possible by the rapid advances in computer hardware and its wide spread availability and low cost. However, most control systems rely upon the ability of a trained automation technician to convert and interpret the data, which is presented in many different forms. A PLC presents data as a ladder diagram, a flow chart, a set of Boolean functions, or complex programming languages such as BASIC or "C". In addition, data that resides in a CNC or robot may be presented in the hexadecimal or binary numbering system. This frequently requires the technician to convert the data from the above forms to real world events such as the digital state of a switch or contact, the on/off state of a relay or solenoid, or the complex digital and analog data from an automated manufacturing process. After the data has been determined, the task reverts to one of relating the data to a complex machine tool or automated manufacturing process.

---

---

### Presentation Outline:

- I. Use a Data Entry Device to Set Up and Configure a PLC/PIC to Control Digital and Analog Input/Output Points
  - A. Review Binary, octal, and hexadecimal numbering systems and Boolean algebra. Emphasize the importance of these concepts to the use and programming of a PLC
  - B. Explain the basic design and operating theory of a Programmable Logic Controller (PLC) or Peripheral Interface Controller (PIC). Show Bergwall Productions *Introduction to Programmable Logic Controllers*, Parts 1-4
    1. Explain the basic concepts of a PLC or PIC
      - a. Inputs, processing, outputs
      - b. Uses of a PLC (general purpose controller)
      - c. Uses of a PIC (associated with CNC machine tools)
      - d. Explain the concept of field devices
    2. Explain the role of the processor
      - a. As a storage device
        - (1) Storing input/output states
        - (2) Storing counters/timers



- (3) Storing ladder programs
    - b. A logical decision making device
  - 3. Explain the role of programming as the processing part of inputs, outputs and processing
    - a. Explain the programming process
    - b. Explain the concept of processing as it relates to electrical ladder diagrams and ladder programs
    - c. List the various types of programming languages. Contrast and compare the advantages of each
      - (1) Ladder
      - (2) Statement list
      - (3) Flow chart
      - (4) BASIC or Visual BASIC
      - (5) C, C++ or Visual C
      - (6) Other types of PLC programming languages
  - 4. Explain the role of the input and output modules
    - a. List the types of digital input and output modules and their specifications
    - b. List the types of analog input and output modules and their specifications
    - c. Explain the role and purpose of the input/output modules as an interface between the processor and the machine tool
- B. Demonstrate assembling the PLC, system, connecting the programming device, and configuring the PLC
  - 1. Identify and explain the assembly of the rack, processor and power supply
  - 2. Demonstrate the installation of input and output modules
  - 3. Explain the concept and procedure of configuring the PLC for the type and number of modules in the system
  - 4. Demonstrate connecting the programming device and configuring the PLC
- II. Set Up/Configure PIC/PLC as Part of the Control System of CNC Machine/Robot to Control Digital and Analog I/O Points
- A. Explain and demonstrate the basic design of a PLC/PIC system that is used as a part of a CNC machine
    - 1. Explain the differences between a PLC and a PIC
      - a. Compare and contrast the design philosophy of the control interface
      - b. Compare and contrast the programming methods and program storage
    - 2. Compare and contrast the methods of connecting field devices to a PLC and PIC
    - 3. Explain and demonstrate methods of monitoring the states of field devices

- a. Explain and demonstrate the use of the CNC control to view and interpret field device status
    - b. Explain and demonstrate the concept of parameters as it relates to configuring a CNC control for a particular machine tool application
  - B. Explain and demonstrate the basic design of a programmable interface control (PIC) system that is used as a part of a robot
    - 1. Compare and contrast the design philosophy of the control interface with a CNC control
    - 2. Explain and demonstrate the connection of field devices
    - 3. Compare and contrast the programming methods and program storage with a PLC and CNC control
    - 4. Explain and demonstrate connecting the programming device and programming the robot
    - 5. Explain and demonstrate methods of monitoring the states of field devices
  - C. Compare and contrast a PLC with the above programmed interfaces
- III. Use Equipment Manuals, Manufacturer's Specifications, and Data Entry/Monitoring Devices to Connect and Test Digital and Analog I/O Points on a PLC or PIC
  - A. Explain and demonstrate the basic design of a PLC system
    - 1. Explain methods for determining the type of PLC and the number of inputs and outputs needed for the system
      - a. Write a Boolean expression that describes the system
      - b. Identify, list, and count the input and output variables associated with the expression
      - c. Determine the electrical design of the system
        - (1) Voltage levels
        - (2) DC or AC or both
      - d. Select model and make of PLC
        - (1) Determine time critical operations and minimum PLC scan rate desired based upon number and complexity of Boolean expressions
        - (2) Determine mathematical functions desired based upon control algorithms
          - (a) Analog servo control
          - (b) PID loop control
          - (c) Select PLC based upon number of control points, scan rate, and mathematical set desired
      - e. Select input and output modules from catalogs based upon electrical design and number and type of control variables
    - 2. Explain and demonstrate the methods of connecting field devices

- a. Explain and provide examples of the different types of input and output modules
        - (1) Digital inputs
          - (a) DC
          - (b) AC
        - (2) Digital outputs
          - (a) DC
          - (b) AC
        - (3) Analog inputs
        - (4) Analog outputs
      - b. Explain and demonstrate the connection of field device wiring to input and output modules
        - (1) Explain the concept of a field device and the types of field devices
          - (a) Passive devices
          - (b) Active (smart) devices
        - (2) Demonstrate wiring methods for connecting passive and active field devices
  - 3. Explain the programming of a PLC
    - a. Explain and demonstrate the method of programming PLC files.
      - (1) Input and output tables
      - (2) Software relay coils and contact tables (called "bits" in Allen Bradley PLCs)
      - (3) Counter or timer tables
      - (4) Analog variable tables
      - (5) Mathematical functions
      - (6) Variable scaling functions
    - b. Explain and demonstrate the documentation of PLC programs
      - (1) Labels and I/O addresses
      - (2) Comments and headers
- IV. Use Equipment Manuals, Manufacturer's Specifications, and Data Entry/Monitoring Devices to Test and Troubleshoot Set Up of a PLC or PIC System and Solve Control Problems
- A. Explain and demonstrate the method of connecting a monitor/programming terminal to a PLC to monitor the state of field devices
    - 1. Explain and demonstrate the connection of a HHT to a PLC to monitor the state of field devices
    - 2. Explain and demonstrate the methods of connecting a computer monitor/programming terminal to a PLC to monitor the state of field devices
    - 3. Explain the scaling of analog field devices and the methods used to monitor and test analog input and output modules

4. Explain the role of the input and output modules
- B. Demonstrate troubleshooting methods using the monitoring programming device
  1. Explain and demonstrate the concept of forcing and input or an output
  2. Explain the safety rules when forcing an input or an output
  3. Explain and demonstrate the method of monitoring the state of PLC files
    - a. Input and output tables
    - b. Software relay coils and contact tables (called “bits” in Allen Bradley PLCs)
    - c. Counter or timer tables
    - d. Analog variable tables
    - e. Mathematical functions
    - f. Variable scaling functions
  4. Demonstrate monitoring a ladder and checking the state of field devices

---

---

**Practical Application:**

1. Configure a PLC to control an automation system;
2. Monitor the state of field devices in a CNC control;
3. Monitor/configure the parameters to control a CNC system; and,
4. Monitor the state of field devices on an existing PLC installation.

---

---

**Evaluation and/or Verification:**

Successful completion of this technical module will be based on the student’s successful completion of the following components:

1. A twenty question quiz on PLC systems
2. Successful performance on an instructor generated basic PLC lab
3. A twenty question quiz on CNC and robot control systems

Note: Since the type of PLC acquired will to a large extent determine the nature of quizzes and labs, it would be impractical to provide either, for this MASTER module. Labs and quizzes can be generated from the PLC work book mentioned in “References”.

Note: Since the type of equipment investigated will, to a large extent, determine the nature of quizzes and labs, it would be impractical to provide either for this MASTER module.

---

---

**Summary:**

Review the main lesson points using the text and handouts listed in the reference section of this module. Hold class discussion and answer student questions.

---

---

**Next Lesson Assignment:**

**MASTER Technical Module (AET-I1)** dealing with using equipment manuals, manufacturer's specifications, and data entry/monitoring devices to configure, test and troubleshoot set up of a computer system and solve control problems.

**AET-H1-HO**  
**Perform Operations on PLC (Programmable Logic Controller)**  
**or PIC (Programmable Interface Controller) Systems**  
**Attachment 1: MASTER Handout**

---

**Objective(s):**

Upon completion of this unit the student will be able to:

- a. Use a data entry device to set up and configure a PLC/PIC to control digital and analog input/output points;
- b. Set up/configure PIC/PLC as part of the control system of CNC machine/robot to control digital and analog I/O points;
- c. Use equipment manuals, manufacturer's specifications, and data entry/monitoring devices to connect and test digital and analog I/O points on a PLC or PIC;
- d. Use equipment manuals, manufacturer's specifications, and data entry/monitoring devices to test and troubleshoot set up of a PLC or PIC system and solve control problems
- e. Connect a data entry device such as a hand held terminal teach pendent, or programming computer to the communications port of a PLC or PIC and configure the controller for the types and quantities of control modules;
- f. Use the control system of a CNC machine tool or robot to configure a PLC or PIC that is part of the control system, or modify the parameters of the control to change specific machine functions;
- g. Install digital and analog input/output (I/O) modules in a PLC or PIC, connect field devices to the modules, and using a hand held terminal or personal computer to monitor the data, test the inputs and outputs for proper operation; and,
- h. Connect a hand held terminal or personal computer and programming/monitoring software to a PLC or PIC and use the device to monitor and correct problems on a fully configured and functioning, PLC or PIC system.

---

**Module Outline:**

- I. Use a Data Entry Device to Set Up and Configure a PLC/PIC to Control Digital and Analog Input/Output Points
  - A. Review Binary, octal, and hexadecimal numbering systems and Boolean algebra. Emphasize the importance of these concepts to the use and programming of a PLC
  - B. Explain the basic design and operating theory of a Programmable Logic Controller (PLC) or Peripheral Interface Controller (PIC). Show

**Bergwall Productions *Introduction to Programmable Logic Controllers, Parts 1-4***

1. Explain the basic concepts of a PLC or PIC
    - a. Inputs, processing, outputs
    - b. Uses of a PLC (general purpose controller)
    - c. Uses of a PIC (associated with CNC machine tools)
    - d. Explain the concept of field devices
  2. Explain the role of the processor
    - a. As a storage device
      - (1) Storing input/output states
      - (2) Storing counters/timers
      - (3) Storing ladder programs
    - b. A logical decision making device
  3. Explain the role of programming as the processing part of inputs, outputs and processing
    - a. Explain the programming process
    - b. Explain the concept of processing as it relates to electrical ladder diagrams and ladder programs
    - c. List the various types of programming languages. Contrast and compare the advantages of each
      - (1) Ladder
      - (2) Statement list
      - (3) Flow chart
      - (4) BASIC or Visual BASIC
      - (5) C, C++ or Visual C
      - (6) Other types of PLC programming languages
  4. Explain the role of the input and output modules
    - a. List the types of digital input and output modules and their specifications
    - b. List the types of analog input and output modules and their specifications
    - c. Explain the role and purpose of the input/output modules as an interface between the processor and the machine tool
- B. Demonstrate assembling the PLC, system, connecting the programming device, and configuring the PLC**
1. Identify and explain the assembly of the rack, processor and power supply
  2. Demonstrate the installation of input and output modules
  3. Explain the concept and procedure of configuring the PLC for the type and number of modules in the system
  4. Demonstrate connecting the programming device and configuring the PLC

- II. Set Up/Configure PIC/PLC as Part of the Control System of CNC Machine/Robot to Control Digital and Analog I/O Points
  - A. Explain and demonstrate the basic design of a PLC/PIC system that is used as a part of a CNC machine
    - 1. Explain the differences between a PLC and a PIC
      - a. Compare and contrast the design philosophy of the control interface
      - b. Compare and contrast the programming methods and program storage
    - 2. Compare and contrast the methods of connecting field devices to a PLC and PIC
    - 3. Explain and demonstrate methods of monitoring the states of field devices
      - a. Explain and demonstrate the use of the CNC control to view and interpret field device status
      - b. Explain and demonstrate the concept of parameters as it relates to configuring a CNC control for a particular machine tool application
  - B. Explain and demonstrate the basic design of a programmable interface control (PIC) system that is used as a part of a robot
    - 1. Compare and contrast the design philosophy of the control interface with a CNC control
    - 2. Explain and demonstrate the connection of field devices
    - 3. Compare and contrast the programming methods and program storage with a PLC and CNC control
    - 4. Explain and demonstrate connecting the programming device and programming the robot
    - 5. Explain and demonstrate methods of monitoring the states of field devices
  - C. Compare and contrast a PLC with the above programmed interfaces
- III. Use Equipment Manuals, Manufacturer's Specifications, and Data Entry/Monitoring Devices to Connect and Test Digital and Analog I/O Points on a PLC or PIC
  - A. Explain and demonstrate the basic design of a PLC system
    - 1. Explain methods for determining the type of PLC and the number of inputs and outputs needed for the system
      - a. Write a Boolean expression that describes the system
      - b. Identify, list, and count the input and output variables associated with the expression
      - c. Determine the electrical design of the system
        - (1) Voltage levels
        - (2) DC or AC or both
      - d. Select model and make of PLC



- (1) Determine time critical operations and minimum PLC scan rate desired based upon number and complexity of Boolean expressions
  - (2) Determine mathematical functions desired based upon control algorithms
    - (a) Analog servo control
    - (b) PID loop control
    - (c) Select PLC based upon number of control points, scan rate, and mathematical set desired
  - e. Select input and output modules from catalogs based upon electrical design and number and type of control variables
2. Explain and demonstrate the methods of connecting field devices
  - a. Explain and provide examples of the different types of input and output modules
    - (1) Digital inputs
      - (a) DC
      - (b) AC
    - (2) Digital outputs
      - (a) DC
      - (b) AC
    - (3) Analog inputs
    - (4) Analog outputs
  - b. Explain and demonstrate the connection of field device wiring to input and output modules
    - (1) Explain the concept of a field device and the types of field devices
      - (a) Passive devices
      - (b) Active (smart) devices
    - (2) Demonstrate wiring methods for connecting passive and active field devices
3. Explain the programming of a PLC
  - a. Explain and demonstrate the method of programming PLC files.
    - (1) Input and output tables
    - (2) Software relay coils and contact tables (called "bits" in Allen Bradley PLCs)
    - (3) Counter or timer tables
    - (4) Analog variable tables
    - (5) Mathematical functions
    - (6) Variable scaling functions
  - b. Explain and demonstrate the documentation of PLC programs

- (1) Labels and I/O addresses
  - (2) Comments and headers
- IV. Use Equipment Manuals, Manufacturer's Specifications, and Data Entry/Monitoring Devices to Test and Troubleshoot Set Up of a PLC or PIC System and Solve Control Problems
- A. Explain and demonstrate the method of connecting a monitor/programming terminal to a PLC to monitor the state of field devices
    1. Explain and demonstrate the connection of a HHT to a PLC to monitor the state of field devices
    2. Explain and demonstrate the methods of connecting a computer monitor/programming terminal to a PLC to monitor the state of field devices
    3. Explain the scaling of analog field devices and the methods used to monitor and test analog input and output modules
    4. Explain the role of the input and output modules
  - B. Demonstrate troubleshooting methods using the monitoring programming device
    1. Explain and demonstrate the concept of forcing and input or an output
    2. Explain the safety rules when forcing an input or an output
    3. Explain and demonstrate the method of monitoring the state of PLC files
      - a. Input and output tables
      - b. Software relay coils and contact tables (called "bits" in Allen Bradley PLCs)
      - c. Counter or timer tables
      - d. Analog variable tables
      - e. Mathematical functions
      - f. Variable scaling functions
    4. Demonstrate monitoring a ladder and checking the state of field devices

**AET-H1-LE**  
**Perform Operations on PLC (Programmable Logic Controller)**  
**or PIC (Programmable Interface Controller) Systems**  
**Attachment 2: MASTER Laboratory Exercise**

---

The student will:

1. Configure a PLC to control an automation system;
2. Monitor the state of field devices in a CNC control;
3. Monitor/configure the parameters to control a CNC system; and,
4. Monitor the state of field devices on an existing PLC installation.

**AUTOMATED EQUIPMENT REPAIR TECHNICIAN ... operates, programs, maintains, and repairs automated machine tools and automated manufacturing processes.**

**Duties**

**Tasks**

Duties	Tasks
<b>A</b> Apply Science to Solve Industrial Problems	A-1 Apply scientific notation and engineering notation to solve technical problems A-2 Apply algebraic formulas to predict behavior of industrial systems A-3 Use variables in algebraic formulas to analyze industrial systems A-4 Manipulate algebraic formulas to analyze industrial systems A-5 Measure, calculate, and convert quantities in English (imperial) systems of measurement A-6 Use mechanical physics to analyze mechanical systems A-7 Use mechanical physics to analyze mechanical systems A-8 Use mathematical problems found in pneumatic systems A-9 Use mathematical dynamics to analyze pneumatic systems A-10 Use mathematical physics to analyze pneumatic systems A-11 Use chemical principles and formulas to predict and analyze chemical industrial processes A-12 Apply knowledge of electrochemical effects to analyze industrial processes A-13 Apply principles of water to analyze industrial processes
<b>B</b> Use Drawings to Analyze Mechanical Systems	B-1 Use symbols, organization, and engineering drawings to analyze mechanical systems B-2 Use symbols, organization, and engineering drawings to analyze mechanical systems B-3 Use symbols, organization, and engineering drawings to analyze mechanical systems B-4 Use symbols, organization, and engineering drawings to analyze mechanical systems B-5 Use symbols, organization, and engineering drawings to analyze mechanical systems B-6 Use symbols, organization, and engineering drawings to analyze mechanical systems
<b>C</b> Use Calibrated Measuring Instruments to Calibrate Components	C-1 Apply mechanical measurement knowledge to calibrate machine tools C-2 Apply electrical measurement knowledge to calibrate electrical circuits C-3 Apply electronic measurement knowledge to calibrate electronic circuits C-4 Apply fluid power measurement knowledge to calibrate hydraulic and pneumatic systems C-5 Apply digital electronic measurement knowledge to calibrate digital electronic circuits
<b>D</b> Resolve System Failures with Critical Thinking, Troubleshooting, Theory, and Metrology	D-1 Apply the scientific process to the resolution of malfunctions found in machine tools and automated equipment D-2 Calculate, predict, and measure response of quantities in DC circuits D-3 Calculate, predict, and measure response of quantities in AC circuits D-4 Calculate, predict, and measure response of quantities in polyphase AC circuits D-5 Identify assemblers such as resistors, capacitors, and test components D-6 Identify assemblers such as resistors, capacitors, and test components D-7 Use meters/oscilloscopes to identify shift or angle in series resistive-capacitive AC circuits D-8 Apply hydraulic and pneumatic systems knowledge to identify malfunctions D-9 Apply hydraulic and pneumatic systems knowledge to identify malfunctions D-10 Apply hydraulic and pneumatic systems knowledge to identify malfunctions D-11 Apply hydraulic and pneumatic systems knowledge to identify malfunctions D-12 Apply hydraulic and pneumatic systems knowledge to identify malfunctions D-13 Apply hydraulic and pneumatic systems knowledge to identify malfunctions
<b>E</b> Use Techniques to Isolate Malfunctions of Electronic Systems	E-1 Calculate, predict, and measure response of quantities in DC circuits E-2 Calculate, predict, and measure response of quantities in AC circuits E-3 Calculate, predict, and measure response of quantities in polyphase AC circuits E-4 Calculate, predict, and measure response of quantities in polyphase AC circuits E-5 Identify assemblers such as resistors, capacitors, and test components E-6 Identify assemblers such as resistors, capacitors, and test components E-7 Use meters/oscilloscopes to identify shift or angle in series resistive-capacitive AC circuits E-8 Apply hydraulic and pneumatic systems knowledge to identify malfunctions E-9 Apply hydraulic and pneumatic systems knowledge to identify malfunctions E-10 Apply hydraulic and pneumatic systems knowledge to identify malfunctions E-11 Apply hydraulic and pneumatic systems knowledge to identify malfunctions E-12 Apply hydraulic and pneumatic systems knowledge to identify malfunctions E-13 Apply hydraulic and pneumatic systems knowledge to identify malfunctions
<b>F</b> Measure/Isolate Malfunctions of Mechanical/Fluid Power Systems	F-1 Identify and explain the theory and use of major systems that comprise a pneumatic system F-2 Apply theory and use of pneumatic systems to identify malfunctions F-3 Identify assemblers such as resistors, capacitors, and test components F-4 Calculate, predict, and measure response of quantities in DC circuits F-5 Identify assemblers such as resistors, capacitors, and test components F-6 Identify assemblers such as resistors, capacitors, and test components F-7 Use meters/oscilloscopes to identify shift or angle in series resistive-capacitive AC circuits F-8 Apply hydraulic and pneumatic systems knowledge to identify malfunctions F-9 Apply hydraulic and pneumatic systems knowledge to identify malfunctions F-10 Apply hydraulic and pneumatic systems knowledge to identify malfunctions F-11 Apply hydraulic and pneumatic systems knowledge to identify malfunctions F-12 Apply hydraulic and pneumatic systems knowledge to identify malfunctions F-13 Apply hydraulic and pneumatic systems knowledge to identify malfunctions
<b>G</b> Apply Computer Science to Computer Controlled Industrial Equipment	G-1 Perform digital operations on PLC (programmable logic controller) or PLC (programmable logic controller) systems G-2 Perform Boolean operations on PLC (programmable logic controller) or PLC (programmable logic controller) systems G-3 Solve digital logic circuits and problems in electrical and programmable logic control circuits G-4 Program computers and PLC (programmable logic controller) equipment G-5 Identify assemblers such as resistors, capacitors, and test components G-6 Identify assemblers such as resistors, capacitors, and test components G-7 Use meters/oscilloscopes to identify shift or angle in series resistive-capacitive AC circuits G-8 Apply hydraulic and pneumatic systems knowledge to identify malfunctions G-9 Apply hydraulic and pneumatic systems knowledge to identify malfunctions G-10 Apply hydraulic and pneumatic systems knowledge to identify malfunctions G-11 Apply hydraulic and pneumatic systems knowledge to identify malfunctions G-12 Apply hydraulic and pneumatic systems knowledge to identify malfunctions G-13 Apply hydraulic and pneumatic systems knowledge to identify malfunctions
<b>H</b> Correct Malfunctions in PLC Controlled Industrial Equipment	H-1 Perform operations on PLC (programmable logic controller) or PLC (programmable logic controller) systems H-2 Perform Boolean operations on PLC (programmable logic controller) or PLC (programmable logic controller) systems H-3 Solve digital logic circuits and problems in electrical and programmable logic control circuits H-4 Program computers and PLC (programmable logic controller) equipment H-5 Identify assemblers such as resistors, capacitors, and test components H-6 Identify assemblers such as resistors, capacitors, and test components H-7 Use meters/oscilloscopes to identify shift or angle in series resistive-capacitive AC circuits H-8 Apply hydraulic and pneumatic systems knowledge to identify malfunctions H-9 Apply hydraulic and pneumatic systems knowledge to identify malfunctions H-10 Apply hydraulic and pneumatic systems knowledge to identify malfunctions H-11 Apply hydraulic and pneumatic systems knowledge to identify malfunctions H-12 Apply hydraulic and pneumatic systems knowledge to identify malfunctions H-13 Apply hydraulic and pneumatic systems knowledge to identify malfunctions
<b>I</b> Resolve Malfunctions Found in Computer Systems Controlling Manufacturing Processes	I-1 Use equipment in accordance with specifications I-2 Apply theory and use of pneumatic systems to identify malfunctions I-3 Identify assemblers such as resistors, capacitors, and test components I-4 Calculate, predict, and measure response of quantities in DC circuits I-5 Identify assemblers such as resistors, capacitors, and test components I-6 Identify assemblers such as resistors, capacitors, and test components I-7 Use meters/oscilloscopes to identify shift or angle in series resistive-capacitive AC circuits I-8 Apply hydraulic and pneumatic systems knowledge to identify malfunctions I-9 Apply hydraulic and pneumatic systems knowledge to identify malfunctions I-10 Apply hydraulic and pneumatic systems knowledge to identify malfunctions I-11 Apply hydraulic and pneumatic systems knowledge to identify malfunctions I-12 Apply hydraulic and pneumatic systems knowledge to identify malfunctions I-13 Apply hydraulic and pneumatic systems knowledge to identify malfunctions
<b>J</b> Assemble/Disassemble Mechanical/Electrical/Computer Systems	J-1 Safely assemble, disassemble, and adjust subsystems or components of fluid power systems J-2 Safely assemble, disassemble, and adjust subsystems or components of electrical systems J-3 Safely assemble, disassemble, and adjust subsystems or components of electronic systems J-4 Safely assemble, disassemble, and adjust subsystems or components of electronic systems J-5 Safely assemble, disassemble, and adjust subsystems or components of electronic systems J-6 Safely assemble, disassemble, and adjust subsystems or components of electronic systems J-7 Safely assemble, disassemble, and adjust subsystems or components of electronic systems J-8 Safely assemble, disassemble, and adjust subsystems or components of electronic systems J-9 Safely assemble, disassemble, and adjust subsystems or components of electronic systems J-10 Safely assemble, disassemble, and adjust subsystems or components of electronic systems J-11 Safely assemble, disassemble, and adjust subsystems or components of electronic systems J-12 Safely assemble, disassemble, and adjust subsystems or components of electronic systems J-13 Safely assemble, disassemble, and adjust subsystems or components of electronic systems

# **AUTOMATED EQUIPMENT REPAIR SERIES**

## **MASTER Technical Module No. AET-I1**

---

**Subject:** Automated Equipment Repair **Time:** 48 Hrs.

**Duty:** Resolve Malfunctions Found In Computer Systems Controlling Manufacturing Processes

**Task:** Use Equipment Manuals, Manufacturer's Specifications, and Data Entry/Monitoring Devices to Configure, Test and Troubleshoot Set Up of a Computer System and Solve Control Problems

---

### **Objective(s):**

Upon completion of this unit the student will be able to:

- a. Properly and safely install all of the operating hardware of a Pentium or Pentium class, personal computer in a computer case;
- b. Configure and test the operating hardware of a Pentium or Pentium class, personal computer;
- c. Modify/upgrade the operating hardware of a Pentium or Pentium class, personal computer;
- d. Install and maintain an operating system in a Pentium or Pentium class, personal computer;
- e. Install and maintain applications programs in a Pentium or Pentium class, personal computer;
- f. Operate the computer using MSDOS, LUNIX, WINDOWS, or WINDOWS 95 in a Pentium or Pentium class, personal computer;
- g. Configure and connect a serial communications interface based upon the RS-232-C standard or a compatible standard; and,
- h. Configure and connect Pentium or Pentium class, personal computers to a local area network based upon the WINDOWS for Work Groups 3.11 standard, the WINDOWS 95 standard, and/or the LUNIX operating system with the TCP/IP standard.

---

### **Instructional Materials:**

The following laboratory equipment:

Medium tower computer case with power supply  
Current, Pentium class (or other class CPU) mother boards with cache memory and the maximum amount of Random Access Memory (RAM) that can be afforded

Hard drives and floppy drives that are compatible with the current, state-of-the-art storage capacity

Video monitor modules that provide state-of-the art graphics, and a monitor that matches the capability of the module  
CD-ROM drive or other technology (i.e., DVD), combined with a sound module and speakers that provides state-of-the-art multimedia capabilities

State-of-the-art Local Area Network (LAN) card with cables, or other technology that may emerge

An operating system such as MS-DOS or LUNIX. The operating system should be chosen so that the computer works in a generic mode. Windows 95 or Windows NT is not recommended as the operating system because it hides too much of the computer's functions under the operating system. Later, the student can install an operating system such as Windows. LUNIX is recommended for the following reasons:

- (1) It is totally, completely free
- (2) It provides experience for the student in the UNIX operating system
- (3) UNIX is the operating system of the Internet and completely compatible with the Internet
- (4) A LUNIX version of NetScape is available
- (5) Many free software applications are available
- (6) It will run XWINDOWS along with many free XWINDOWS applications

Digital multimeters, and diagnostic modules plus software (optional)  
Instructor generated lab procedures to facilitate the installation and configuration of hardware/software components

Note: The author has created a generic specification for a computer system. In the next decade, no one can predict the type of hardware need for a state-of-the-art computer. All that can be accomplished is to procure the current state-of-the-art computer for a reasonable price. The author has specified a combination of hardware and price that will serve the classes needs for at least the next year, 1999. The specification reads as follows:

- (1) 430XT mother board with 512 cache
- (2) Pentium MMX, 166 Mega Hz CPU
- (3) 1.7 GB Hard drive
- (4) 32 MegaByte RAM
- (5) Local Area Network card
- (6) PCI, 2 MegaByte video RAM, video card
- (7) 14" SVGA Monitor
- (8) 1.44 MByte floppy
- (9) 24 speed CD-ROM drive and 16 bit sound card

The projected cost of the computer as of 1997, in San Diego, is \$765 plus tax. The students will purchase and build the computers, and they will gain valuable experience during the process. It is interesting to note that these computers will quite handily run all of the available software associated with automation systems, and can easily be transformed into a CNC control system. Future educators who read this paragraph, and the preceding specification, may well remark that the suggested computer is old fashioned or archaic. Good! I hope that the technology continues to improve and expand to accommodate the student of tomorrow, and the future contains many, many surprises.

Lab experiences on practical applications of the concepts contained in this module

MASTER Handout (AET-I1-HO)

MASTER Laboratory Exercise (AET-I1-LE)

Quizzes will be the responsibility of the instructor

---

## References:

*The Complete PC Upgrade & Maintenance Guide*, Minasi, ISBN 0-7821-1956-5, Latest Edition

*Introducing Computers—Concepts, Systems, and Applications*, Blissmer, Latest Edition

*Modern Industrial Electronics, Revised and Expanded Edition*, Schuler/MacNamee, Latest Edition (formerly *Industrial Electronics and Robotics*, Schuler/MacNamee, 1987)

**Video(s):** *Using Dual Trace Oscilloscopes*, Bergwall Productions, 1-800-645-3565, Latest Edition

*Multimeters Explained*, Bergwall Productions, 1-800-645-3565, Latest Edition

*PC Maintenance and Repair*, Bergwall Productions, 1-800-645-3565, Latest Edition

*Troubleshooting PC Hardware*, Bergwall Productions, 1-800-645-3565, Latest Edition

Note: Bergwall Productions will be referenced frequently throughout the AET section because the company provides quality video productions at a reasonable price, unlike other video production companies.)



---

## Student Preparation:

Students should have previously completed the following Technical Modules:

- AET-B3 "Use Symbols, Organization, and Engineering Values on Electronic Drawings"
- AET-B5 "Use Symbols, Organization, and Engineering Values on Digital Drawings"
- AET-C5 "Apply Digital Electronic Measurement Knowledge and Instruments to Test/Calibrate Digital Electronic Circuits"
- AET-D1 "Apply the Troubleshooting Process to the Resolution of Malfunctions Found in Industrial Machine Tools and Automated Equipment"
- AET-E1 "Calculate, Predict, and Measure the Response of Quantities in DC Circuits"
- AET-E2 "Calculate, Predict, and Measure the Response of Quantities in AC Circuits"
- AET-E3 "Calculate, Predict, and Measure Impedance and Phase Angle in AC Circuits"
- AET-E4 "Calculate, Predict, and Measure Quantities in Poly-Phase AC Circuits"
- AET-E5 "Properly Set Up, Calibrate, and Use Meters and Oscilloscopes"
- AET-E6 "Use Components such as Resistors, Inductors, and Capacitors; Construct Circuits and Test Components"
- AET-E7 "Use Meters/Oscilloscopes to Measure Phase Shift or Angle in Series Resistive-Capacitive/Resistive-Inductive AC Circuits"
- AET-E8 "Apply Electromagnetism Theory to Determine Operational Characteristics of Relays, Solenoids, Transformers, and Electrical Motors for DC and AC Circuits"
- AET-E9 "Apply Principles of Operation of Electrical Motors to Identify Various Types of Motors"
- AET-E10 "Apply Semiconductor Theory and Measurement Techniques to Determine Operational Characteristics of Diodes, Transistors, and Power Control Semiconductors"
- AET-E11 "Apply Semiconductor Theory and Measurement Techniques to Determine Operational Characteristics of Rectifiers/Filtering Circuits for Single and Three Phase DC Power Supplies"
- AET-G1 through AET-G4 "Measure/Isolate Malfunctions of Mechanical/Fluid Power Systems" series

---

---

## Introduction:

How many times have you heard some say that the ability to use and repair a computer is essential to anyone's future? As amazing as it seems, nearly every aspect of our civilization is now controlled by computer systems. Today, an automobile is a



rolling computer system. Your paycheck, and the cash that you withdraw from an ATM machine is the result of a computer. We can see Mars, close up and personal, via a computer system. All of the rides at the major amusement parks are run by computers. The Internet is a creation of the computer, and soon, television sets will become video computers. In the future, the computer will be an essential part of our lives, and *everyone* will use them. All automation systems rely upon the computer to function, and an automation technician must use the computer as a tool, to complete effective repairs of the system. For the technician of today, to insure a life long career, he or she must *master* computers, and computer technology.

---

---

**Presentation Outline:**

- I. Install Hardware/Software in a Personal Computer
  - A. Explain the purpose and specifications of the following types of hardware devices used in Intel/Windows based personal computer
    - 1. Motherboard, case, and power supply
    - 2. CPU and CPU fan
    - 3. RAM and ROM (BIOS) Memory
    - 4. Cache memory
    - 5. Disk drives (hard drive, floppy drive, CD-ROM drive)
    - 6. Video card and monitor
    - 7. Keyboard and mouse
    - 8. Local Area Network card (LAN)
    - 9. Modem card
    - 10. Small computer system interface (SCSI) card (SCSI interface)
    - 11. Input/output ports (parallel, serial)
  - B. Demonstrate the installation of the following computer hardware components, and the precautions that must be taken when installing these components
    - 1. Motherboard, case, and power supply
    - 2. CPU and CPU fan
    - 3. RAM and ROM Basic Input-Output System (BIOS) Memory
    - 4. Cache memory
    - 5. Disk drives (hard drive, floppy drive, CD-ROM drive)
    - 6. Video card and monitor
    - 7. Keyboard and mouse
    - 8. Local Area Network card (LAN)
    - 9. Modem card
    - 10. Small computer system interface (SCSI) card (SCSI interface)
  - C. Demonstrate the configuration of the following computer hardware components
    - 1. Motherboard/Basic Input-Output System (BIOS)
      - a. CPU
      - b. Cache memory

- c. Drive configuration
- d. Input/output ports
- e. Date/time
- f. RAM Memory
- 2. Complementary Metal Oxide Semiconductor (CMOS) memory
- 3. Disk drives (hard drive, floppy drive, CD-ROM drive)
- 4. Video card and monitor
- 5. Keyboard and mouse
- 6. Local Area Network card (LAN)
- 7. Modem card
- 8. Small computer system interface (SCSI) card (SCSI interface)
- 9. Input/output ports (parallel, serial)
- D. Demonstrate installation of the operating system
  - Note: Any operating system may be installed; however, the two operating systems that should be installed first, are MS-DOS or compatible, or LUNIX. The reason for this step, is that industry tends to be very conservative about replacing or upgrading computers. If a system performs as it was designed, the philosophy is "If it works, don't fix it." For this reason, an industrial automation technician may frequently find that the computers used to operate, program, and troubleshoot equipment are old MS-DOS based computers or UNIX based computers. LUNIX is a UNIX operating system designed to work on Intel/Windows class computers.
  - 1. Explain the purpose of the operating system and how it works with the BIOS
  - 2. Demonstrate the installation of the operating system
- E. Conduct Instructor generated lab procedures to facilitate the installation and configuration of hardware/software components
- II. Test the Hardware of a Personal Computer
  - A. Explain and demonstrate the procedures and hardware/software used to test the operation and specifications of the following types of hardware devices used in Intel/Windows based personal computers
    - 1. Motherboard and power supply
    - 2. CPU
    - 3. RAM and ROM (BIOS) Memory
    - 4. Cache memory
    - 5. Disk drives (hard drive, floppy drive, CD-ROM drive)
    - 6. Video card and monitor
    - 7. Keyboard and mouse
    - 8. Local Area Network card (LAN)
    - 9. Modem card
    - 10. Small computer system interface (SCSI) card (SCSI interface)
    - 11. Input/output ports (parallel, serial)

- B. Conduct Instructor generated lab procedures to test the operation and specifications of the above types of hardware devices used in Intel/Windows based personal computers
- III. Maintain Hardware/Software of a Personal Computer
- A. Explain and demonstrate the software/hardware tools and methods used to maintain the hardware and software of a personal computer at maximum performance
    - 1. Explain the most common hardware upgrades that can be performed on the computer without major revisions
      - a. More memory
      - b. Faster and larger drive storage
      - c. Faster CPU
      - d. More efficient video modules and larger/faster video memory
    - 2. Demonstrate the above upgrades
    - 3. Explain the most common procedures used to maintain software applications and operating systems at peak performance
      - a. More efficient operating system
      - b. Partitioning hard drives
      - c. Defragmenting hard drives
      - d. Eliminating unused files
      - e. Upgrading software applications
  - B. Provide practical lab experiences on the above concepts
- IV. Operate Different Classes of Personal Computers
- A. Explain and demonstrate the limitations and operations associated with the following personal computers/operating systems
    - 1. Intel/Windows based computer with a generic MS-DOS operating system
    - 2. Intel/Windows based computer with LUNIX operating system and XWINDOWS
    - 3. Intel/Windows based computer with Windows 95 or Windows NT operating system
    - 4. Apple Macintosh computer with Apple operating system  
 Note: If Apple computers are not available, the Windows operating system will provide enough experience in a windowing environment to satisfy this requirement. The author in no way intends to endorse one type of computer over another. However, the Apple computer and operating system is not widely used to run an automation system.
  - B. Conduct instructor generated lab procedures on the above platforms/operating systems  
 Note: The author views classes in "Keyboarding" as a waste of time. If the student wishes to improve his or her skills in typing, there are many good avenues to success in this endeavor. The author

has created the *entire* AET curriculum with two fingers. In addition, the author programs quite well with the same two fingers. The author does not intend to prevent the acquisition of good typing skills, but the above skills do not require that the student can type well

V. **Configure and Troubleshoot Communications Interfaces**

A. **Explain and demonstrate the various types of communication interfaces available to personal computer systems**

1. **Serial communications interfaces, RS-232C standard, RS-422 standard**
  - a. **Serial port configuration**
    - (1) **Baud rate**
    - (2) **Data configuration**
    - (3) **Hardware and software handshaking**
  - b. **Serial port hardware**
    - (1) **Hardware voltage levels**
    - (2) **Connectors, cables, pin configurations and signal requirements**
2. **Parallel communications interfaces**
  - a. **Parallel port configuration**
    - (1) **Baud rate**
    - (2) **Data configuration**
    - (3) **Hardware and software handshaking**
  - b. **Parallel port hardware**
    - (1) **Hardware voltage levels**
    - (2) **Connectors, cables, pin configurations and signal requirements**
3. **Ethernet based Local Area Networks (LAN)**
  - a. **LAN configuration**
    - (1) **Data transfer rate**
    - (2) **Data configuration and theory of operation**
    - (3) **Hardware and software handshaking**
  - b. **LAN hardware**
    - (1) **Hardware voltage levels**
    - (2) **Connectors, cables, pin configurations and signal requirements**
      - (a) **Thin wire Ethernet**
      - (b) **10 based T**
4. **Apple Macintosh versions of the above (if available)**

Note: If Apple computers are not available, the Intel/Windows platform and operating system will provide enough experience to satisfy this requirement. The author in no way intends to endorse one type of computer over

- another. However, the Apple computer and operating system is not widely used to run an automation system.
- B. Connect and configure serial and parallel communications interfaces to CNC machines and robots, and an Ethernet based Windows 95 or Windows NT Local Area Network (LAN)

---

---

**Practical Application:**

1. Build and configure a personal computer;
2. Using a working computer, test the installed hardware;
3. Maintain the hardware/software of a working industrial computer;
4. Operate different classes of personal computers;
5. Connect peripheral devices to a personal computer; and,
6. Connect a personal computer to a CNC, robot, or PLC using a communication interface.

---

---

**Evaluation and/or Verification:**

Successful completion of this technical module will be based on the student's successful completion of the following components:

1. Demonstrate competency in testing the hardware of a personal computer;
2. Demonstrate competency in the maintenance of a personal computer;
3. Demonstrate competency in the operation of a personal computer;
4. Demonstrate competency in connecting and configuring computer communications interfaces;
5. Instructor generated tests on hardware testing (optional);
6. Instructor generated tests on hardware/software maintenance (optional);
7. Instructor generated tests on computer operations (optional); and,
8. Instructor generated tests on computer communications interfaces.

Note 1: A module such as this is a "can do" or "can't do" module. The proof of competency is in the results. Either the student can accomplish the tasks or the student can't accomplish the tasks. In between is not desirable.

Note 2: Nothing in the above module is meant to restrict the extent of exploration. Rather, the intent is to provide ideas that can be come catalysts for other ideas. The instructor is free to invent ideas at each point of the presentation.

---

---

**Summary:**

Review the main lesson points at each subsection of the module using the suggested texts and handouts listed in the reference section of this module. Hold class discussion and answer student questions.

---

---

**Next Lesson Assignment:**

**MASTER Technical Module (AET-J1)** dealing with safely assembling, disassembling, and adjusting mechanical systems such as gearing systems, shafts, couplings, pulleys, and belts.

**AET-I1-HO**  
**Use Equipment Manuals, Manufacturer's Specifications,  
and Data Entry/Monitoring Devices  
to Configure, Test and Troubleshoot Set Up  
of a Computer System and Solve Control Problems**  
Attachment 1: MASTER Handout

---

Upon completion of this unit the student will be able to:

- a. Properly and safely install all of the operating hardware of a Pentium or Pentium class, personal computer in a computer case;
  - b. Configure and test the operating hardware of a Pentium or Pentium class, personal computer;
  - c. Modify/upgrade the operating hardware of a Pentium or Pentium class, personal computer;
  - d. Install and maintain an operating system in a Pentium or Pentium class, personal computer;
  - e. Install and maintain applications programs in a Pentium or Pentium class, personal computer;
  - f. Operate the computer using MSDOS, LUNIX, WINDOWS, or WINDOWS 95 in a Pentium or Pentium class, personal computer;
  - g. Configure and connect a serial communications interface based upon the RS-232-C standard or a compatible standard; and,
  - h. Configure and connect Pentium or Pentium class, personal computers to a local area network based upon the WINDOWS for Work Groups 3.11 standard, the WINDOWS 95 standard, and/or the LUNIX operating system with the TCP/IP standard.
- 

**Module Outline:**

- I. Install Hardware/Software in a Personal Computer
  - A. Explain the purpose and specifications of the following types of hardware devices used in Intel/Windows based personal computer
    1. Motherboard, case, and power supply
    2. CPU and CPU fan
    3. RAM and ROM (BIOS) Memory
    4. Cache memory
    5. Disk drives (hard drive, floppy drive, CD-ROM drive)
    6. Video card and monitor
    7. Keyboard and mouse
    8. Local Area Network card (LAN)
    9. Modem card
    10. Small computer system interface (SCSI) card (SCSI interface)
    11. Input/output ports (parallel, serial)

- B. Demonstrate the installation of the following computer hardware components, and the precautions that must be taken when installing these components
1. Motherboard, case, and power supply
  2. CPU and CPU fan
  3. RAM and ROM Basic Input-Output System (BIOS) Memory
  4. Cache memory
  5. Disk drives (hard drive, floppy drive, CD-ROM drive)
  6. Video card and monitor
  7. Keyboard and mouse
  8. Local Area Network card (LAN)
  9. Modem card
  10. Small computer system interface (SCSI) card (SCSI interface)
- C. Demonstrate the configuration of the following computer hardware components
1. Motherboard/Basic Input-Output System (BIOS)
    - a. CPU
    - b. Cache memory
    - c. Drive configuration
    - d. Input/output ports
    - e. Date/time
    - f. RAM Memory
  2. Complementary Metal Oxide Semiconductor (CMOS) memory
  3. Disk drives (hard drive, floppy drive, CD-ROM drive)
  4. Video card and monitor
  5. Keyboard and mouse
  6. Local Area Network card (LAN)
  7. Modem card
  8. Small computer system interface (SCSI) card (SCSI interface)
  9. Input/output ports (parallel, serial)
- D. Demonstrate installation of the operating system
- Note: Any operating system may be installed; however, the two operating systems that should be installed first, are MS-DOS or compatible, or LUNIX. The reason for this step, is that industry tends to be very conservative about replacing or upgrading computers. If a system performs as it was designed, the philosophy is "If it works, don't fix it." For this reason, an industrial automation technician may frequently find that the computers used to operate, program, and troubleshoot equipment are old MS-DOS based computers or UNIX based computers. LUNIX is a UNIX operating system designed to work on Intel/Windows class computers.
1. Explain the purpose of the operating system and how it works with the BIOS
  2. Demonstrate the installation of the operating system



- E. Conduct Instructor generated lab procedures to facilitate the installation and configuration of hardware/software components
- II. Test the Hardware of a Personal Computer
  - A. Explain and demonstrate the procedures and hardware/software used to test the operation and specifications of the following types of hardware devices used in Intel/Windows based personal computers
    - 1. Motherboard and power supply
    - 2. CPU
    - 3. RAM and ROM (BIOS) Memory
    - 4. Cache memory
    - 5. Disk drives (hard drive, floppy drive, CD-ROM drive)
    - 6. Video card and monitor
    - 7. Keyboard and mouse
    - 8. Local Area Network card (LAN)
    - 9. Modem card
    - 10. Small computer system interface (SCSI) card (SCSI interface)
    - 11. Input/output ports (parallel, serial)
  - B. Conduct Instructor generated lab procedures to test the operation and specifications of the above types of hardware devices used in Intel/Windows based personal computers
- III. Maintain Hardware/Software of a Personal Computer
  - A. Explain and demonstrate the software/hardware tools and methods used to maintain the hardware and software of a personal computer at maximum performance
    - 1. Explain the most common hardware upgrades that can be performed on the computer without major revisions
      - a. More memory
      - b. Faster and larger drive storage
      - c. Faster CPU
      - d. More efficient video modules and larger/faster video memory
    - 2. Demonstrate the above upgrades
    - 3. Explain the most common procedures used to maintain software applications and operating systems at peak performance
      - a. More efficient operating system
      - b. Partitioning hard drives
      - c. Defragmenting hard drives
      - d. Eliminating unused files
      - e. Upgrading software applications
  - B. Provide practical lab experiences on the above concepts
- IV. Operate Different Classes of Personal Computers
  - A. Explain and demonstrate the limitations and operations associated with the following personal computers/operating systems
    - 1. Intel/Windows based computer with a generic MS-DOS operating system

2. Intel/Windows based computer with LUNIX operating system and XWINDOWS
  3. Intel/Windows based computer with Windows 95 or Windows NT operating system
  4. Apple Macintosh computer with Apple operating system  
 Note: If Apple computers are not available, the Windows operating system will provide enough experience in a windowing environment to satisfy this requirement. The author in no way intends to endorse one type of computer over another. However, the Apple computer and operating system is not widely used to run an automation system.
- B. Conduct instructor generated lab procedures on the above platforms/operating systems
- Note: The author views classes in "Keyboarding" as a waste of time. If the student wishes to improve his or her skills in typing, there are many good avenues to success in this endeavor. The author has created the *entire* AET curriculum with two fingers. In addition, the author programs quite well with the same two fingers. The author does not intend to prevent the acquisition of good typing skills, but the above skills do not require that the student can type well
- V. Configure and Troubleshoot Communications Interfaces
- A. Explain and demonstrate the various types of communication interfaces available to personal computer systems
1. Serial communications interfaces, RS-232C standard, RS-422 standard
    - a. Serial port configuration
      - (1) Baud rate
      - (2) Data configuration
      - (3) Hardware and software handshaking
    - b. Serial port hardware
      - (1) Hardware voltage levels
      - (2) Connectors, cables, pin configurations and signal requirements
  2. Parallel communications interfaces
    - a. Parallel port configuration
      - (1) Baud rate
      - (2) Data configuration
      - (3) Hardware and software handshaking
    - b. Parallel port hardware
      - (1) Hardware voltage levels
      - (2) Connectors, cables, pin configurations and signal requirements
  3. Ethernet based Local Area Networks (LAN)

- a. LAN configuration
    - (1) Data transfer rate
    - (2) Data configuration and theory of operation
    - (3) Hardware and software handshaking
  - b. LAN hardware
    - (1) Hardware voltage levels
    - (2) Connectors, cables, pin configurations and signal requirements
      - (a) Thin wire Ethernet
      - (b) 10 based T
4. Apple Macintosh versions of the above (if available)  
Note: If Apple computers are not available, the Intel/Windows platform and operating system will provide enough experience to satisfy this requirement. The author in no way intends to endorse one type of computer over another. However, the Apple computer and operating system is not widely used to run an automation system.
- B. Connect and configure serial and parallel communications interfaces to CNC machines and robots, and an Ethernet based Windows 95 or Windows NT Local Area Network (LAN)

**AET-I1-LE**  
**Use Equipment Manuals, Manufacturer's Specifications,**  
**and Data Entry/Monitoring Devices**  
**to Configure, Test and Troubleshoot Set Up**  
**of a Computer System and Solve Control Problems**  
**Attachment 2: MASTER Laboratory Exercise**

---

The student will:

1. Build and configure a personal computer;
2. Using a working computer, test the installed hardware;
3. Maintain the hardware/software of a working industrial computer;
4. Operate different classes of personal computers;
5. Connect peripheral devices to a personal computer; and,
6. Connect a personal computer to a CNC, robot, or PLC using a communication interface.



# **AUTOMATED EQUIPMENT REPAIR SERIES**

## **MASTER Technical Module No. AET-J1**

---

<b>Subject:</b>	<b>Automated Equipment Repair</b>	<b>Time: 24 Hrs.</b>
<b>Duty:</b>	<b>Assemble/Disassemble Mechanical Electrical, Electronic, and Computer Systems</b>	
<b>Task:</b>	<b>Safely Assemble, Disassemble, and Adjust Mechanical Systems such as Gearing Systems, Shafts, Couplings, Pulleys, Belts</b>	

---

### **Objective(s):**

Upon completion of this unit the student will be able to:

- a. Identify the major assembly and disassembly procedures in mechanical assemblies;
- b. Identify the tools required for each mechanical assembly/disassembly;
- c. Properly apply the correct tool for each mechanical procedure;
- d. Plan and organize a mechanical assembly/disassembly;
- e. Identify the safety procedures required for each mechanical assembly/disassembly; and,
- f. Adjust major subassemblies and simple machines that comprise a mechanical assembly.

---

### **Instructional Materials:**

A CNC controlled machine tool or robot, or a conventional machine tool

Note: Not all facilities can gain access to a CNC machine tool that can be experimented upon. Most CNCs are tied up in production schedules, or they are educational machines that would require expensive repairs if something failed during assembly or disassembly. Under these circumstances, the instructor may want to use lab kits that provide experience in assembly or disassembly of the major systems that comprise a machine tool. However, the most desirable method of completing this module is hands-on experience with a real industrial machine tool, CNC or robot.

Measuring instruments such as: torque wrenches, feeler gauges, thread gauges, RPM meters, spring scales, pressure gauges, flow meters, dial indicators, dial calipers, and micrometers

Common mechanical hand tools such as: screw drivers, wrenches, hammers, saws, pry bars, chisels, drifts, pliers, drills, taps, and tap handles, punches, awls, files

Power tools such as drill motors, hand grinders, air impact wrenches

All tools and equipment can be found in Brodhead-Garrett catalog 1997  
(phone 1-800-321-6730)

**MASTER Handout (AET-J1-HO-1)**

**MASTER Handout (AET-J1-HO-2) (Fasteners)**

**MASTER Handout (AET-J1-HO-3) (Bearings and Bushings)**

**MASTER Handout (AET-J1-HO-4) (Gears and Pulleys)**

**MASTER Handout (AET-J1-HO-5) (Shafts and Shaft Alignment)**

**MASTER Handout (AET-J1-HO-6) (Mechanical Alignment and Adjustment)**

**MASTER Handout (AET-J1-HO-7) (Lockout and Tagout Procedures)**

**MASTER Laboratory Exercise (AET-J1-LE)**

**MASTER Laboratory Aid (AET-J1-LA)**

**MASTER Quiz AET-J1-QU-1: Safety Procedures**

---

### References:

The author has not found a suitable text that covers the assembly or disassembly of a machine tool. Most texts only cover programming and machining practices for CNC equipment or operation. For this reason the handouts and material that accompany this module will be rich with detail and practical applications.

---

### Student Preparation:

Students should have previously completed the following Technical Modules (at a minimum, the student should have competency in, or have completed all, of the following module categories):

**AET-A1 through AET-A13** “Apply Science to Solve Industrial Problems” series

**AET-B1 through AET-B5** “Use Drawings to Analyze and Repair Systems” series

**AET-C1** “Apply Machine Tool Metrology and Measurement Instruments to Align Machine Tools”

**AET D1** “Resolve System Failures with Critical Thinking, Troubleshooting, Theory, and Metrology” series

**AET-F1 through AET-F8** “Measure/Isolate Malfunctions of Mechanical/Fluid Power Systems” series

---

---

### Introduction:

After the trouble shooting process has resulted in the identification of a subsystem or component that is malfunctioning, the technician’s next job is to remove and repair or replace the defective component. This frequently involves the assembly or disassembly of mechanical parts. A mechanical break down of the equipment should be approached in a planned organized manner, with plenty of fore thought as to the steps that will be



taken during the process. Performing quality mechanical work requires the proper application of hand tools, and the ability to perform common major mechanical procedures such as; removal and installation of fasteners, removal and installation of bearings and bushings, removal and installation of shafts, and removal and installation of couplings, pulleys, and gears. After the defective component has been replaced, and the mechanism has been re-assembled, it frequently requires alignment and adjustment, so the technician must know the procedures that may be required for aligning and adjusting mechanisms such as; aligning shafts, setting torque specifications, shimming, checking end play and run-out, adjusting gibbs, checking and adjusting clearances, setting belt tension, and checking and adjusting squareness and parallelism.

---

---

**Presentation Outline:**

- I. **Safely Assemble or Disassemble Mechanical Systems Such as Gearing Systems, Shafts, Couplings, Pulleys, Belts**
  - A. **Explain the rules and safety procedures associated with mechanical assembly/disassembly**
    1. **Lockout, tagout**
    2. **Confined area rules**
    3. **Eye protection, protection of hands**
    4. **Hazardous chemicals**
  - B. **Explain the most common mechanical assembly/disassembly procedures and the tools required for each procedure**
    1. **Explain and demonstrate the removal and installation of fasteners and the tools required**
      - a. **Explain the purpose of fasteners, and the features of fasteners**
      - b. **Explain and demonstrate the most common types of fasteners**
      - c. **Explain and demonstrate the tools required for fasteners**
      - d. **Demonstrate the methods of removing and installing fasteners**
    2. **Explain and demonstrate the removal and installation of bushings and bearings and the tools required**
      - a. **Explain the purpose of bushings and bearings, the types of bearings, and identification of bearing specifications**
      - b. **Explain and demonstrate the types of tools required for the removal and installation of bushings and bearings**
      - c. **Demonstrate the methods of removing and installing bushings and bearings**
    3. **Explain and demonstrate the removal and installation of couplings, pulleys, or gears**



- a. Explain the purpose of pulleys and gears, and identification of pulley and gear specifications
  - b. Explain and demonstrate the types of tools required for the removal and installation of pulleys and gears
  - c. Demonstrate the methods of removing and installing pulleys and gears
  - 4. Explain and demonstrate the removal and installation of belts and lines for pulleys
    - a. Explain the purpose of belts and lines for pulleys, and identification of pulley and belt specifications
    - b. Demonstrate the methods of removing and installing belts and lines for pulleys
  - 5. Explain and demonstrate the removal and installation of couplings and shafts
    - a. Explain the purpose of couplings and shafts, and identification of coupling and shaft specifications
    - b. Explain and demonstrate the types of tools required for the removal and installation of couplings and shafts
    - c. Demonstrate the methods of removing and installing couplings and shafts
- II. Adjust Mechanical Systems Such as Gearing Systems, Shafts, Couplings, Pulleys, and Belts
- A. Explain the most common mechanical adjustment procedures and the tools required for each procedure
    - 1. Explain and demonstrate the torque of fasteners and the tools required
      - a. Explain the purpose of torquing fasteners, and the features of fasteners under torque
      - b. Explain the errors to avoid when tightening fasteners
      - c. Explain and demonstrate the use of a torque wrench
      - d. Demonstrate the methods of torquing fasteners
    - 2. Explain and demonstrate the methods of checking end play, run-out and clearances, and the tools/measuring instruments required
      - a. Explain the concept of end-play and run-out
      - b. Explain and demonstrate the types of measuring instruments used to check end-play and run-out.(see MASTER module AET-C1)
      - c. Demonstrate the methods of using shims, and adjusting end play and run-out
    - 3. Explain and demonstrate the checking and adjusting squareness and parallelism, and adjusting gibbs/hold-downs
      - a. Explain the purpose of gibbs, guide rails, and hold-downs

- b. Explain and demonstrate the types of measuring instruments required for measuring squareness and parallelism (see MASTER module AET-C1)
  - c. Demonstrate the methods of adjusting squareness, parallelism
4. Explain and demonstrate the methods of checking and setting belt tension
- a. Explain the purpose of belts and lines for pulleys, and identification of pulley and belt specifications
  - b. Demonstrate the methods of measuring and adjusting the tension of belts and lines for pulleys
5. Explain and demonstrate the methods of measuring clearances between gears and sliding mechanisms and the methods used to correct misalignment
- a. Explain the reasons for providing clearances between gears and sliding mechanisms
  - b. Demonstrate the methods of measuring and adjusting clearances between gears and sliding mechanisms
6. Explain and demonstrate the methods, measuring instruments and tools used to correct shaft misalignment
- a. Explain the methods and procedures used to measure, and correct shaft misalignment
  - b. Demonstrate the methods used to measure, and correct shaft misalignment

---

---

**Practical Application:**

1. Using an industrial machine tool, apply the concepts contained in this module.

---

---

**Evaluation and/or Verification:**

Successful completion of this technical module will be based on the student's successful completion of the following components:

1. A twenty question quiz on industrial mechanical safety;
2. A twenty question quiz on industrial mechanical adjustment;
3. Completion of selected assembly/disassembly procedures;
4. Completion of selected adjustment/alignment procedures; and,
5. Demonstrate competency in the ability to identify and use hand tools and measuring instruments.

---

---

**Summary:**

Review the main lesson points using the texts and handouts listed in the reference section of this module. Stress the industrial applications of the concepts. Hold class discussion and answer student questions.

---

---

**Next Lesson Assignment:**

**MASTER Technical Module (AET-J2)** dealing with safely assembling, disassembling, and adjusting subsystems or components of fluid power systems.

## AET-J1-HO-1

### Safely Assemble, Disassemble, and Adjust Mechanical Systems such as Gearing Systems, Shafts, Couplings, Pulleys, Belts Attachment 1: MASTER Handout No. 1

---

#### Objective(s):

Upon completion of this unit the student will be able to:

- a. Identify the major assembly and disassembly procedures in mechanical assemblies;
  - b. Identify the tools required for each mechanical assembly/disassembly;
  - c. Properly apply the correct tool for each mechanical procedure;
  - d. Plan and organize a mechanical assembly/disassembly;
  - e. Identify the safety procedures required for each mechanical assembly/disassembly; and,
  - f. Adjust major subassemblies and simple machines that comprise a mechanical assembly.
- 

#### Module Outline:

- I. Safely Assemble or Disassemble Mechanical Systems Such as Gearing Systems, Shafts, Couplings, Pulleys, Belts
  - A. Explain the rules and safety procedures associated with mechanical assembly/disassembly
    1. Lockout, tagout
    2. Confined area rules
    3. Eye protection, protection of hands
    4. Hazardous chemicals
  - B. Explain the most common mechanical assembly/disassembly procedures and the tools required for each procedure
    1. Explain and demonstrate the removal and installation of fasteners and the tools required
      - a. Explain the purpose of fasteners, and the features of fasteners
      - b. Explain and demonstrate the most common types of fasteners
      - c. Explain and demonstrate the tools required for fasteners
      - d. Demonstrate the methods of removing and installing fasteners
    2. Explain and demonstrate the removal and installation of bushings and bearings and the tools required
      - a. Explain the purpose of bushings and bearings, the types of bearings, and identification of bearing specifications

- b. Explain and demonstrate the types of tools required for the removal and installation of bushings and bearings
    - c. Demonstrate the methods of removing and installing bushings and bearings
  - 3. Explain and demonstrate the removal and installation of couplings, pulleys, or gears
    - a. Explain the purpose of pulleys and gears, and identification of pulley and gear specifications
    - b. Explain and demonstrate the types of tools required for the removal and installation of pulleys and gears
    - c. Demonstrate the methods of removing and installing pulleys and gears
  - 4. Explain and demonstrate the removal and installation of belts and lines for pulleys
    - a. Explain the purpose of belts and lines for pulleys, and identification of pulley and belt specifications
    - b. Demonstrate the methods of removing and installing belts and lines for pulleys
  - 5. Explain and demonstrate the removal and installation of couplings and shafts
    - a. Explain the purpose of couplings and shafts, and identification of coupling and shaft specifications
    - b. Explain and demonstrate the types of tools required for the removal and installation of couplings and shafts
    - c. Demonstrate the methods of removing and installing couplings and shafts
- II. Adjust Mechanical Systems Such as Gearing Systems, Shafts, Couplings, Pulleys, and Belts
  - A. Explain the most common mechanical adjustment procedures and the tools required for each procedure
    - 1. Explain and demonstrate the torque of fasteners and the tools required
      - a. Explain the purpose of torquing fasteners, and the features of fasteners under torque
      - b. Explain the errors to avoid when tightening fasteners
      - c. Explain and demonstrate the use of a torque wrench
      - d. Demonstrate the methods of torquing fasteners
    - 2. Explain and demonstrate the methods of checking end play, run-out and clearances, and the tools/measuring instruments required
      - a. Explain the concept of end-play and run-out
      - b. Explain and demonstrate the types of measuring instruments used to check end-play and run-out.(see MASTER module AET-C1)

- c. Demonstrate the methods of using shims, and adjusting end play and run-out
3. Explain and demonstrate the checking and adjusting squareness and parallelism, and adjusting gibbs/hold-downs
  - a. Explain the purpose of gibbs, guide rails, and hold-downs
  - b. Explain and demonstrate the types of measuring instruments required for measuring squareness and parallelism (see MASTER module AET-C1)
  - c. Demonstrate the methods of adjusting squareness, parallelism
4. Explain and demonstrate the methods of checking and setting belt tension
  - a. Explain the purpose of belts and lines for pulleys, and identification of pulley and belt specifications
  - b. Demonstrate the methods of measuring and adjusting the tension of belts and lines for pulleys
5. Explain and demonstrate the methods of measuring clearances between gears and sliding mechanisms and the methods used to correct misalignment
  - a. Explain the reasons for providing clearances between gears and sliding mechanisms
  - b. Demonstrate the methods of measuring and adjusting clearances between gears and sliding mechanisms
6. Explain and demonstrate the methods, measuring instruments and tools used to correct shaft misalignment
  - a. Explain the methods and procedures used to measure, and correct shaft misalignment
  - b. Demonstrate the methods used to measure, and correct shaft misalignment

**AET-J1-HO-2**  
**Safely Assemble, Disassemble, and Adjust Mechanical Systems**  
**such as Gearing Systems, Shafts, Couplings, Pulleys, Belts**  
**Attachment 2: MASTER Handout No. 2**

---

**Mechanical Assembly/Disassembly — Fasteners**

Mechanical assembly or disassembly should be approached as though the technician is a surgeon preparing for a delicate operation. To many times, a mechanical assembly is subject to dirty environments that contaminate mechanical parts. A work bench that is to be used for the break down and repair of mechanisms should be clean and free from metal particles and dirt that can affect the operation of the mechanism. One of the methods used to accomplish this is to use butcher paper or heavy duty waxed paper to cover the bench prior to disassembly and assembly. The use of cloth rags is not encouraged as a bench cover, because cloth fibers can be incorporated in to the assembly, causing binding of mechanisms, and/or contamination.

**Preparation and Identifying Components**

The first stage in preparation is to consult the manuals and mechanical drawings associated with the assembly or disassembly of the mechanism. Pay careful attention to the detailed sections of the drawing because they may contain information concerning adjustments that must be carried out during the maintenance process. Identify all of the component parts of the mechanism, and if the mechanism is under going a complete overhaul, have available the most likely parts that will be replaced. These parts include, but are not limited to the following: Bearings and bushings, seals and gaskets, belts, solvents, adhesives, and lubricants. Special items such as high vacuum lubricants or special adhesives should be determined beforehand. Assemble the most likely tools that will be used during the process; including metrology tools such as micrometers, feeler gauges, vernier calipers, and dial indicators. Also have available during the disassembly process, zip-lock bags, plastic or metal containers, labels and marking pens to store and organize the small parts and fasteners that are removed from the mechanism. Frequently a disassembly or assembly process will be interrupted by a shift change or a determination that a part necessary for the repair of the mechanism is not available. Under these circumstances, some time may elapse between the disassembly and assembly process. If the component parts are not organized, your memory may not be sufficient to repeat the original process. Do not get into the habit of tossing all of the parts into one area of the bench or a box. Fasteners that may look identical may have different characteristics and be suitable only for the part from which they were removed. Bearings that have identical inner and outer races may not be suitable in one area of the assembly. In addition, small parts that can be lost by being dropped on the floor, will waste large amounts of time in a hunt for the part. Plan in advance for this eventuality, and either have on hand a replacement for

the part, or a plan to assemble this part very carefully (small snap rings and roll pins are very likely candidates for this area).

## **Cleanliness**

Cleanliness cannot be over emphasized. As soon as a mechanical assembly is disassembled, it is no longer considered to be clean. If the problem is further compounded by disassembly and assembly of the mechanism in a dirty environment, the problem will become even more acute. Disassembly and assembly of a mechanism should be carried out in an area that is nearly as clean as a clean room. Before assembly, the parts should be thoroughly cleaned and dried and only that amount of lubricant, sealant, or adhesive necessary to re-assemble the mechanism applied.

## **Procedures**

*Removal and installation of fasteners requires, at a minimum, the following tools:*

### **Screw Drivers, Phillips and Slot**

At least five different types of *Phillips screwdrivers* are required, ranging from #0 through #3. Number zero is used for small Phillips screws with small heads while #3 is used for large screws with large shallow heads. In addition, a large Phillips screw driver, should be available for large screws.

Do not confuse spline head fasteners with Phillips screws, they are not compatible.

Phillips screw drivers range in length. Several different lengths should be available, from stubby sizes to long screw drivers capable of reaching inaccessible screws.

*Slot screw drivers* are identified by their dimensions. At a minimum, 5 sizes are required, ranging from 5/32 inch to 9/32 inch. In addition, a large bladed screw driver, sometimes called a mechanics screw driver, should be available for large screws.

Do not attempt to use a slot screw on a Phillips head screw. It will only ruin the screw head

Slot screw drivers range in length. Several different lengths should be available, from stubby sizes to long screw drivers capable of reaching inaccessible screws.



In addition, a good set of *jewelers screw drivers* that include Phillips head drivers should be available.

*Offset screw drivers* and *screw starters* can be obtained for both slot and Phillips head screws. They are very useful tools for screws in hard to reach places.

### **Allen head Wrenches and Spline Wrenches (Hex socket wrenches)**

*Allen head wrenches* are used to remove Allen head bolts. Allen head wrenches are sold in English and metric sizes. English wrenches range from 2/32 inch (very small, very fragile) to 7/8 of an inch or more. Metric sizes range from 2 mm to 10 mm or more. The most advantageous type of Allen head wrench is called a ball Allen. The tip of the wrench is shaped like a ball, making it possible to approach an Allen head screw at an angle. These wrenches can be purchased as a set that covers most of the sizes used for normal assembly and disassembly. A *complete set* of both English and metric wrenches should be available.

*Spline head wrenches* (sometimes called cotter wrenches or cotter keys) come in sizes that are keyed to the size of the fastener. Spline head wrenches are identified as T-5 through T-45, with T-5 being the smallest and T-45 being the largest. Do not confuse spline head fasteners with Allen head fasteners. Using an Allen head wrench in a spline head bolt or screw will ruin the fastener, making it impossible to remove.

### **Hex Head Wrenches (socket wrenches, closed, and open end wrenches)**

Hex head bolts are so-named because they have six sides. Hex head bolts are removed and installed by open end wrenches, closed end wrenches, and socket wrenches. Open end wrenches are so named because one side of the wrench is open to allow the wrench to approach the bolt from the side. Closed end wrenches must approach the bolt from the top, as must socket wrenches. Many variations in these wrenches exist to make the job of removing a bolt easier. Hex head wrenches come in English and metric sizes ranging from 5/32 inch to 1 inch or more (English) and 4 mm to 25 mm or more (metric).

Socket wrenches must be used with a socket handle. Socket handles come in sizes ranging from 1/4 inch drives to 1/2 inch drives or more. The socket head must match the size of the drive handle. Adapters exist to adapt a 1/4 inch socket to a 3/8 inch drive, and a 3/8 inch socket to a 1/2 inch drive. Both English sockets and metric sockets can be used with the drive handles. In addition, universal joints can be obtained that allow the wrench to access hard to get places. Many variations in drive handles

exist. Torque wrenches are frequently socket wrenches, although some may be closed end wrenches.

The Society of Automotive Engineers (SAE) has invented a new type of bolt and socket used for assembling automobiles. The bolt is an outside spline bolt with six points to the spline. This bolt can only be removed by a corresponding socket. Socket sizes range from E-8 to E-14 or more.

### **Adjustable Wrenches**

Adjustable wrenches are open end wrenches whose jaw size can be adjusted to the fastener. Adjustable wrenches are determined by the length of the handle. These wrenches can be obtained in sizes ranging from a 2 inch handle up to 18 inch handles or more.

*Removal and Installation of Couplings, Pulleys, or Gears requires at a minimum the following tools:* (In addition to the possible use of the before mentioned tools the following tools apply:)

### **Drifts (also called a pin punch)**

A drift is a flat headed punch meant to be used with a hammer. The head is machined to lie flat upon the intended target. Drifts come in various sizes ranging from 1/16 inch to 5/8 inch or more. Drifts are used to remove roll pins, solid machine pins, shafts, and other objects that require removal by force. Do not use a marking punch (pointed end) on a roll pin. It will only compound the problem of removing the roll pin. Always try to use the proper size drift for the hole, pin, or shaft size.

**AET-J1-HO-3**  
**Safely Assemble, Disassemble, and Adjust Mechanical Systems**  
**such as Gearing Systems, Shafts, Couplings, Pulleys, Belts**  
**Attachment 3: MASTER Handout No. 3**

---

**Mechanical Assembly/Disassembly — Bearings and Bushings**

Mechanical assembly or disassembly should be approached as though the technician is a surgeon preparing for a delicate operation. To many times, a mechanical assembly is subject to dirty environments that contaminate mechanical parts. A work bench that is to be used for the break down and repair of mechanisms should be clean and free from metal particles and dirt that can affect the operation of the mechanism. One of the methods used to accomplish this is to use butcher paper or heavy duty waxed paper to cover the bench prior to disassembly and assembly. The use of cloth rags is not encouraged as a bench cover, because cloth fibers can be incorporated in to the assembly, causing binding of mechanisms, and/or contamination.

**Preparation and Identifying Components**

The first stage in preparation is to consult the manuals and mechanical drawings associated with the assembly or disassembly of the mechanism. Pay careful attention to the detailed sections of the drawing because they may contain information concerning adjustments that must be carried out during the maintenance process. Identify all of the component parts of the mechanism, and if the mechanism is under going a complete overhaul, have available the most likely parts that will be replaced. These parts include, but are not limited to the following: Bearings and bushings, seals and gaskets, belts, solvents, adhesives, and lubricants. Special items such as high vacuum lubricants or special adhesives should be determined beforehand. Assemble the most likely tools that will be used during the process; including metrology tools such as micrometers, feeler gauges, vernier calipers, and dial indicators. Also have available during the disassembly process, zip-lock bags, plastic or metal containers, labels and marking pens to store and organize the small parts and fasteners that are removed from the mechanism. Frequently a disassembly or assembly process will be interrupted by a shift change or a determination that a part necessary for the repair of the mechanism is not available. Under these circumstances, some time may elapse between the disassembly and assembly process. If the component parts are not organized, your memory may not be sufficient to repeat the original process. Do not get into the habit of tossing all of the parts into one area of the bench or a box. Fasteners that may look identical may have different characteristics and be suitable only for the part from which they were removed. Bearings that have identical inner and outer races may not be suitable in one area of the assembly. In addition, small parts that can be lost by being dropped on the floor, will waste large amounts of time in a hunt for the part. Plan in advance for this eventuality, and either have on hand a replacement for

the part, or a plan to assemble this part very carefully (small snap rings and roll pins are very likely candidates for this area).

## **Cleanliness**

Cleanliness cannot be over emphasized. As soon as a mechanical assembly is disassembled, it is no longer considered to be clean. If the problem is further compounded by disassembly and assembly of the mechanism in a dirty environment, the problem will become even more acute. Disassembly and assembly of a mechanism should be carried out in an area that is nearly as clean as a clean room. Before assembly, the parts should be thoroughly cleaned and dried and only that amount of lubricant, sealant, or adhesive necessary to re-assemble the mechanism applied.

*Removal and Installation of Bearings or Bushings and Shafts requires at a minimum the following tools:*

### **Bearing Pullers**

Bearing pullers come in various sizes. They are used to remove bearings that have been press fitted to a shaft. The jaws of the puller must fit *squarely* against the inner race of the bearing and the worm screw of the puller presses against the shaft. The mechanical advantage of the worm screw forces the bearing from the shaft. Some bearings are fitted to shafts by mechanical or hydraulic presses. Those bearings may require a mechanical or hydraulic press to remove them. When using a puller, if a bearing does not respond to efforts to remove it; do not try to use excessive force on the puller (such as adding an extension, such as a pipe, to the wrench). The excessive force could cause the puller to break, ejecting parts or metal with great force. Use a mechanical or hydraulic press instead. *Never use a bearing puller with the jaws against the outer race of the bearing. You will damage the bearing or break it.*

**AET-J1-HO-4**  
**Safely Assemble, Disassemble, and Adjust Mechanical Systems**  
**such as Gearing Systems, Shafts, Couplings, Pulleys, Belts**  
**Attachment 4: MASTER Handout No. 4**

---

**Mechanical Assembly/Disassembly — Gears and Pulleys**

Mechanical assembly or disassembly should be approached as though the technician is a surgeon preparing for a delicate operation. To many times, a mechanical assembly is subject to dirty environments that contaminate mechanical parts. A work bench that is to be used for the break down and repair of mechanisms should be clean and free from metal particles and dirt that can affect the operation of the mechanism. One of the methods used to accomplish this is to use butcher paper or heavy duty waxed paper to cover the bench prior to disassembly and assembly. The use of cloth rags is not encouraged as a bench cover, because cloth fibers can be incorporated in to the assembly, causing binding of mechanisms, and/or contamination.

**Preparation and Identifying Components**

The first stage in preparation is to consult the manuals and mechanical drawings associated with the assembly or disassembly of the mechanism. Pay careful attention to the detailed sections of the drawing because they may contain information concerning adjustments that must be carried out during the maintenance process. Identify all of the component parts of the mechanism, and if the mechanism is under going a complete overhaul, have available the most likely parts that will be replaced. These parts include, but are not limited to the following: Bearings and bushings, seals and gaskets, belts, solvents, adhesives, and lubricants. Special items such as high vacuum lubricants or special adhesives should be determined beforehand. Assemble the most likely tools that will be used during the process; including metrology tools such as micrometers, feeler gauges, vernier calipers, and dial indicators. Also have available during the disassembly process, zip-lock bags, plastic or metal containers, labels and marking pens to store and organize the small parts and fasteners that are removed from the mechanism. Frequently a disassembly or assembly process will be interrupted by a shift change or a determination that a part necessary for the repair of the mechanism is not available. Under these circumstances, some time may elapse between the disassembly and assembly process. If the component parts are not organized, your memory may not be sufficient to repeat the original process. Do not get into the habit of tossing all of the parts into one area of the bench or a box. Fasteners that may look identical may have different characteristics and be suitable only for the part from which they were removed. Bearings that have identical inner and outer races may not be suitable in one area of the assembly. In addition, small parts that can be lost by being dropped on the floor, will waste large amounts of time in a hunt for the part. Plan in advance for this eventuality, and either have on hand a replacement for

the part, or a plan to assemble this part very carefully (small snap rings and roll pins are very likely candidates for this area).

## **Cleanliness**

Cleanliness cannot be over emphasized. As soon as a mechanical assembly is disassembled, it is no longer considered to be clean. If the problem is further compounded by disassembly and assembly of the mechanism in a dirty environment, the problem will become even more acute. Disassembly and assembly of a mechanism should be carried out in an area that is nearly as clean as a clean room. Before assembly, the parts should be thoroughly cleaned and dried and only that amount of lubricant, sealant, or adhesive necessary to re-assemble the mechanism applied.

## **Procedures:**

*Removal and installation of Gears or Pulleys requires, at a minimum, the following tools:*

### **Gear/Pulley Pullers**

Gear or pulley pullers come in various sizes. They are used to remove gears or pulleys that have been press fitted to a shaft. The jaws of the puller grip the gear or pulley and the shaft of the puller (which is a worm screw) presses against the shaft of the gear or pulley. The mechanical advantage of the worm screw forces the gear or pulley from the shaft. Some gears, pulleys, or couplings are fitted to shafts by mechanical or hydraulic presses. Those gears or pulleys may require a mechanical or hydraulic press to remove them. When using a puller, if a gear or pulley does not respond to efforts to remove it; do not try to use excessive force on the puller (such as adding an extension, such as a pipe, to the wrench). The excessive force could cause the puller to break, ejecting parts or metal with great force. Use a mechanical or hydraulic press instead.

*Removal and installation of belts and lines for pulleys requires at a minimum the following tools:* (In addition to the possible use of the before mentioned tools the following tools apply:)

### **Swaging or Crimping Tool**

Swaging or crimping tools are used to create loops at the end of wire rope that is used in a pulley system, affix an anchor to the rope, or to splice two ends of the rope. Swaging the rope is usually accomplished by placing the ends of the rope into the swag or crimp and placing the assembly into a form. The form is struck by a hammer and the swag or crimp is mashed

to the rope. Other types of tools that use the lever principle can be used to swag or crimp the rope. Do not use electrical crimping tools for this purpose, they cannot apply enough force, and the rope will come undone. For large steel crimps, a hydraulic tool is used.



**AET-J1-HO-5**  
**Safely Assemble, Disassemble, and Adjust Mechanical Systems**  
**such as Gearing Systems, Shafts, Couplings, Pulleys, Belts**  
**Attachment 5: MASTER Handout No. 5**

---

**Mechanical Assembly/Disassembly — Shafts and Shaft Alignment**

Mechanical assembly or disassembly should be approached as though the technician is a surgeon preparing for a delicate operation. To many times, a mechanical assembly is subject to dirty environments that contaminate mechanical parts. A work bench that is to be used for the break down and repair of mechanisms should be clean and free from metal particles and dirt that can affect the operation of the mechanism. One of the methods used to accomplish this is to use butcher paper or heavy duty waxed paper to cover the bench prior to disassembly and assembly. The use of cloth rags is not encouraged as a bench cover, because cloth fibers can be incorporated in to the assembly, causing binding of mechanisms, and/or contamination.

**Preparation and Identifying Components**

The first stage in preparation is to consult the manuals and mechanical drawings associated with the assembly or disassembly of the mechanism. Pay careful attention to the detailed sections of the drawing because they may contain information concerning adjustments that must be carried out during the maintenance process. Identify all of the component parts of the mechanism, and if the mechanism is under going a complete overhaul, have available the most likely parts that will be replaced. These parts include, but are not limited to the following: Bearings and bushings, seals and gaskets, belts, solvents, adhesives, and lubricants. Special items such as high vacuum lubricants or special adhesives should be determined beforehand. Assemble the most likely tools that will be used during the process; including metrology tools such as micrometers, feeler gauges, vernier calipers, and dial indicators. Also have available during the disassembly process, zip-lock bags, plastic or metal containers, labels and marking pens to store and organize the small parts and fasteners that are removed from the mechanism. Frequently a disassembly or assembly process will be interrupted by a shift change or a determination that a part necessary for the repair of the mechanism is not available. Under these circumstances, some time may elapse between the disassembly and assembly process. If the component parts are not organized, your memory may not be sufficient to repeat the original process. Do not get into the habit of tossing all of the parts into one area of the bench or a box. Fasteners that may look identical may have different characteristics and be suitable only for the part from which they were removed. Bearings that have identical inner and outer



pieces may not be suitable in one area of the assembly. In addition, small parts that can be lost by being dropped on the floor, will waste large amounts of time in a hunt for the part. Plan in advance for this eventuality, and either have on hand a replacement for the part, or a plan to assemble this part very carefully (small snap rings and roll pins are very likely candidates for this area).

## Cleanliness

Cleanliness cannot be over emphasized. As soon as a mechanical assembly is disassembled, it is no longer considered to be clean. If the problem is further compounded by disassembly and assembly of the mechanism in a dirty environment, the problem will become even more acute. Disassembly and assembly of a mechanism should be carried out in an area that is nearly as clean as a clean room. Before assembly, the parts should be thoroughly cleaned and dried and only that amount of lubricant, sealant, or adhesive necessary to re-assemble the mechanism applied.

*Removal and installation of bearings or bushings and shafts requires at a minimum the following tools:*

### Bearing Pullers

Bearing pullers come in various sizes. They are used to remove bearings that have been press fitted to a shaft. The jaws of the puller must fit *squarely against the inner race of the bearing* and the worm screw of the puller presses against the shaft. The mechanical advantage of the worm screw forces the bearing from the shaft. Some bearings are fitted to shafts by mechanical or hydraulic presses. Those bearings may require a mechanical or hydraulic press to remove them. When using a puller, if a bearing does not respond to efforts to remove it; do not try to use excessive force on the puller (such as adding an extension, such as a pipe, to the wrench). The excessive force could cause the puller to break, ejecting parts or metal with great force. Use a mechanical or hydraulic press instead. *Never use a bearing puller with the jaws against the outer race of the bearing. You will damage the bearing or break it.*

**AET-J1-HO-6**  
**Safely Assemble, Disassemble, and Adjust Mechanical Systems**  
**such as Gearing Systems, Shafts, Couplings, Pulleys, Belts**  
**Attachment 6: MASTER Handout No. 6**

---

**Mechanical Alignment and Adjustment**

*Alignment and Alignment Checks require at a minimum the following tools:*

**Feeler Gages**

Feeler gages consist of metal or (in some cases) plastic parts of varying thicknesses. Feeler gages are used to provide accurate distances between parts of a mechanism, and to check the clearances between parts of a mechanism. The gages can be wire type gages in which the gage is a calibrated length of wire at a certain thickness, or flat ribbons of metal or plastic. Plastic gages are used to avoid damage to machined metal parts that have fine finishes.

**Micrometers**

Micrometers are measuring instruments that provide accurate data about distances (inside micrometers) or thicknesses (outside micrometers).

**Vernier Calipers**

Vernier calipers provide information about distances, hole diameters, and thickness. The same device can be used for both measurements.

**Dial Indicators**

Dial indicators can be used for shaft alignment, measuring squareness of the travel of a slide, and position accuracy of a mechanism or feature.

**Spring Scales**

The spring scale is one of the least used, but one of the most effective measurement instruments for determining the health of mechanical systems. As mentioned before in the complex machines section, a mechanism that presents too much opposition force to the driver by virtue of friction or inertia, will simply cease to move. A spring scale attached to the input to the mechanism will provide an indication of the amount

of force that must be applied to the mechanism to make it move. The scale may be used to measure linear motion, or rotary motion.

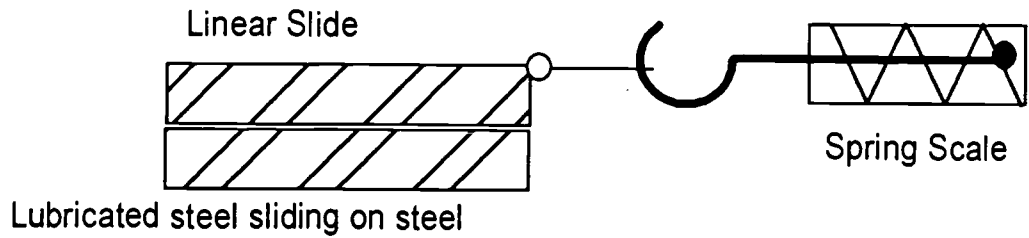

## Linear Motion

Attaching the spring scale to a slide mechanism can measure the force of motion of the slide. There are three elements of this measurement. First the inertia of the mechanism may be measured, but this will be complicated by the opposition force of the break-a-way friction of the slide. Second, the break-a-way friction of the slide can be measured but this is also complicated by the inertia of the mechanism. Last, the most reliable measurement is the sliding friction of the slide. This must be measured while the slide is in a state of uniform motion. To accomplish this measurement, the slide must be de-coupled from the driving mechanism and the slide moved evenly in a linear direction. The spring scale must be parallel to the direction of motion. Record the force necessary to start the slide in motion. This is a combination of the inertia of the slide (which never changes) and the break-a-way friction of the slide (which varies with wear and age). Next, start the slide moving in a uniform motion, and record the spring scale values. To compare the values, use the tables for the coefficient of friction found in most *Machinery Handbooks*. Remember, the friction of a mechanism is not dependent upon the amount of surface in contact, but upon the materials themselves. You should be able to calculate the weight of a slide that moves in a horizontal plane (not vertical) by using the coefficient of friction. This calculation will be complicated by an increase in normal force caused by hold down mechanisms or pre-loaded bearings. In most cases, you may only be able to obtain a relative measurement of the force of motion, but it should be sufficient to determine whether or not the driver should be able to move the mechanism. Also, the data can be recorded as a part of a preventative maintenance program and measured on a periodic basis. Any increase in the friction of motion is a good reason to investigate further. This can prevent unplanned down time.

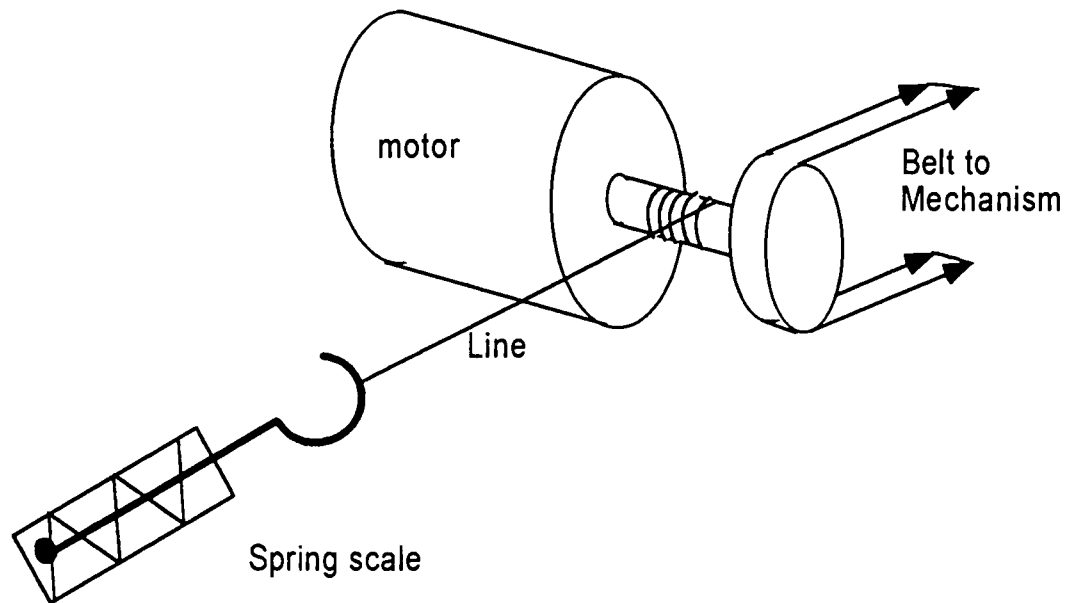

## Rotary Motion

In most cases, it is impractical to disassemble a mechanism to measure linear motion, and in those cases, it is a good practice to use a spring scale to measure rotary motion. Since the driver for the mechanism is usually a rotary device such as an electrical, hydraulic, or pneumatic motor, a line can be wound around the shaft of the motor, a spring scale can be attached, and the force of uniform motion can be determined by pulling on the line. *The system must have the power removed for this test!* This test will measure the bearing in the motor, the simple machines in the system, and the sliding force of the slide. It would be impractical to try to determine the individual frictional aspects of the mechanism, but excessive force of motion may be an indication that the mechanism must be disassembled to try and measure the component parts (again, with the spring scale) to determine if one of the parts requires excessive force to move it. To determine the force of rotary motion, you must carefully measure the distance from the center of rotation to determine the point of measurement of the force and the torque of the mechanism. A stepper motor can be measured in this fashion by energizing the stepper and winding a line around its shaft. The shaft diameter is measured, the spring scale is attached, and the stepper is moved one or two steps by pulling on the spring scale.

***Do not attempt this test with large, high horse power motors that are energized!***

Once the data is collected, a calculation based upon the radius of effort, and the required force can be compared to the torque specifications for the stepper motor.

Spring scales can also be used to determine that amount of torque that is applied to a screw or bolt when assembling a mechanism. In the absence of a proper torque wrench, a spring scale can be attached to a wrench and by calculating the distance from the center of rotation, the bolt can be tightened to the proper torque specifications.

## **RPM Meters**

RPM meters can be classified as contact meters or non-contact meters. Contact meters require that the drive shaft of the meter be in contact with the rotary object to be measured, while non-contact meters measure the speed of the rotary device by optical means. Both meters have their advantages and disadvantages.

Contact meters are reliable and can accurately measure the RPMs of a rotary device. However, a contact meter must be pressed to the rotating shaft of the mechanism to be measured. Frequently, contact meters have various types of rubber fittings to accomplish this task. If the contact point is not the center of rotation, the contact meter may have to be mathematically interpreted to determine the correct speed. In many cases, it is impractical to press the drive shaft of the contact meter to the rotating object in question. In these cases, the contact meter cannot be used, or may be used on another rotating member of the mechanism and the results mathematically interpreted. To accomplish this task, the relative diameters of the rotating members must be determined and the results calculated using the formulas for speed advantage. Contact meters that are pressed to an object with excessive force can affect the rotational speed of the object. In addition, a contact meter that is not aligned parallel to the axis of rotation will not measure accurately.

Non-contact RPM meters usually employ optical reflection of a strobed source of light to determine rotational speed. The advantage of this type of measurement is that the measured speed is independent of the size of the rotational object. Usually a reflective tape or painted surface is used to reflect the strobed light, and the frequency of the strobe is adjusted to provide an indication of the speed of the object. The advantage of the non-contact RPM meter is that objects that are inaccessible to contact meters can be measured by non-contact meters, and the speed of the object is not affected by the meter. Some of the disadvantages of the non-contact meter are the sensitivity to ambient light sources that prevents the technician from observing the reflected strobed light, and the difficulty in affixing

a reflective surface to the mechanism under test. In the case of a wafer spinner, a scrap test wafer can be equipped with reflective tape to observe the rotational speed of the spinner.

**AET-J1-HO-7**  
**Safely Assemble, Disassemble, and Adjust Mechanical Systems**  
**such as Gearing Systems, Shafts, Couplings, Pulleys, Belts**  
**Attachment 7: MASTER Handout No. 7**

---

**Lockout and Tagout Procedures**

Lockout and tagout procedures are designed to prevent equipment from being energized while maintenance is taking place. The types and uses are defined by the Occupational Safety and Health Administration, CFR 1910.147.

To lockout is to place a locking device on an energy-isolating device — a manually operated circuit breaker, for instance. The energy-isolating device and the equipment being controlled cannot be operated until the lockout device is removed. See Figure 1.

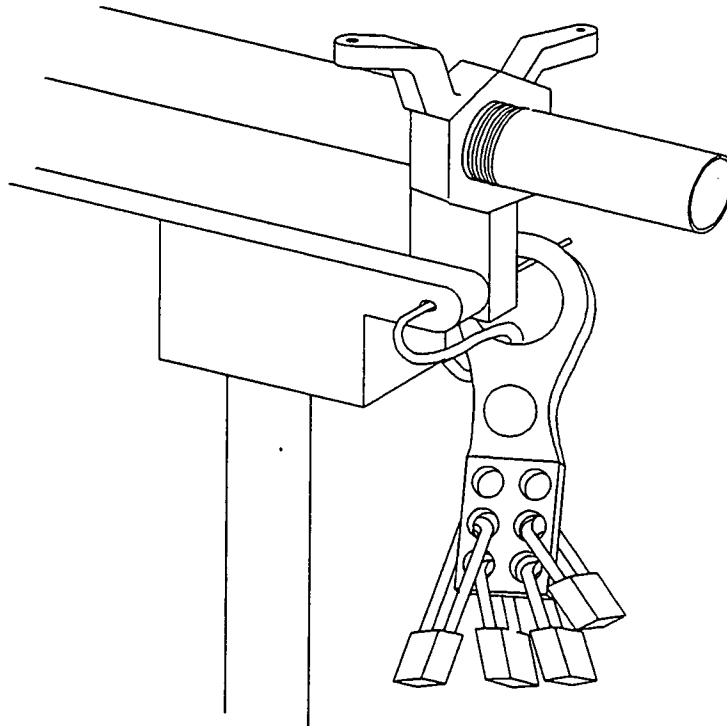

**1 - A Lockout Device**

Remote or interlocking switches may not be used to control circuits. The use of emergency stops are prohibited for lockout-tagout by OSHA. They do not offer positive protection.

Tagouts are placed on an energy-isolating device. They indicate that the energy-isolating device and the equipment being controlled may not be operated. Tagouts are red and have black lettering. A tag must be signed and dated by the individual who placed it. OSHA has two additional requirements for these tags. The purpose of the lockout/tagout (the procedure performed) must be written on the tag. Most companies put this information on the back of a tag. See Figure 2.

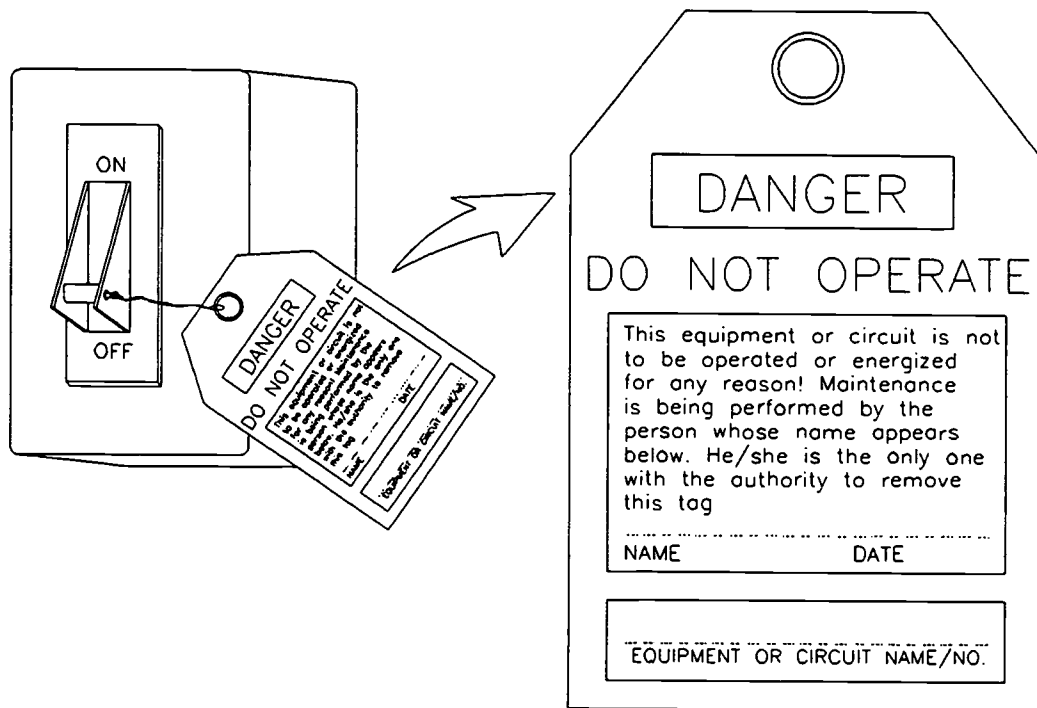

## 2 - Tagout

When more than one person is involved, each individual must place a lockout/tagout device on the isolation device. If a lockout device is used, it should be capable of accepting multiple locks. This is so each individual can place a lock on the device. Each lock should have a tag similar to the one used in the tagout procedure. The individual who puts the lock in place signs the tag. See Figure 3.



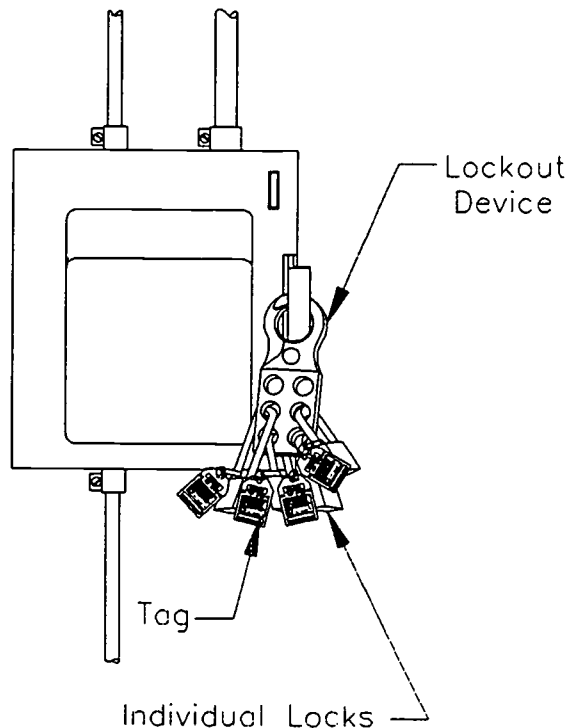

### 3 - Multiple-Lock Lockout Device

The lockout physically prohibits the operation of a piece of equipment. The tagout relies on those who read it. They must recognize its significance.

Wherever lockout/tagouts are used, there must be an established procedure for all to follow. All personnel must understand the importance and the use of the lockout/tagout system. The lockout/tagout devices used within an organization are standardized. So, anyone within the organization will recognize what they are.

The restrictions indicated by lockouts and tagouts remain in force until they are removed. The person putting the tagout or lockout in place is the person who has the authority to remove it.

The Occupational Safety and Health Act sets standards that are administered by the Occupational Safety and Health Administration (OSHA). OSHA has standard lockout/tagout procedures. The lockout/tagout procedures apply to all energy systems — air, hydraulic, mechanical, and electrical.

**AET-J1-LE**  
**Safely Assemble, Disassemble, and Adjust Mechanical Systems**  
**such as Gearing Systems, Shafts, Couplings, Pulleys, Belts**  
**Attachment 8: MASTER Laboratory Exercise**

---

The student will:

1. Using an industrial machine tool, apply the concepts contained in this module.

**AET-J1-LA**  
**Safely Assemble, Disassemble, and Adjust Mechanical Systems**  
**such as Gearing Systems, Shafts, Couplings, Pulleys, Belts**  
**Attachment 9: MASTER Laboratory Aid**

---

**Rules of Conduct**

1. Absolutely no horseplay or practical joking will be tolerated.
2. Do not talk to anyone who is operating a machine.
3. Walk only in the designated traffic lanes.
4. Dress appropriately; at the absolute minimum, you must have:
  - a. No loose clothing, including ties;
  - b. Long hair properly stowed;
  - c. No jewelry;
  - d. Hard, closed-toe shoes;
  - e. Eye protection (safety glasses); and,
  - f. Ear protection (plugs or headset).
5. Follow all institutional safety rules.

# **AUTOMATED EQUIPMENT REPAIR SERIES**

## **MASTER Technical Module No. AET-J2**

---

<b>Subject:</b>	<b>Automated Equipment Repair</b>	<b>Time: 48 Hrs.</b>
<b>Duty:</b>	<b>Assemble/Disassemble Mechanical, Electrical, Electronic, and Computer Systems</b>	
<b>Task:</b>	<b>Safely Assemble, Disassemble, and Adjust Subsystems or Components of Fluid Power Systems</b>	

---

### **Objective(s):**

Upon completion of this unit the student will be able to:

- a. Use the ordinary hand tools associated with installation and repair of hydraulic and pneumatic systems;
- b. Perform procedures such as cutting, flaring, and bending fluid power tubing;
- c. Perform procedures such as removing and installing fluid power fittings;
- d. Remove and install fluid power seals;
- e. Remove and properly install fluid power components such as pumps, valves cylinders, and motors;
- f. Properly disassemble and assemble fluid power components such as pumps, valves cylinders, and motors; and,
- g. Properly perform adjustments of pressures and flows.

---

### **Instructional Materials:**

A hydraulic and pneumatic system and component parts such as pressure control valves, directional control valves, pumps, motors, and cylinders

Note: Not all facilities can gain access to a hydraulic or pneumatic system that can be experimented upon. Most systems are tied up in production schedules, or they are educational facilities that would require expensive repairs if something failed during experimentation. Under these circumstances, the instructor may want to use lab equipment that provides experience in some of the major systems that comprise a hydraulic or pneumatic system. However, the most desirable method of completing this module is hands-on experimentation with working, industrial hydraulic or pneumatic equipment.

Hand tools such as tubing cutters, knives, flaring tools, thread cutters, pipe wrenches, water pump pliers, and standard hand tools (see MASTER module AET-J1)

**MASTER Handout No. 1 (AET-J2-HO-1)**  
**MASTER Handout No. 2 (AET-J2-HO-2) (Safely Assembling or Disassembling Fluid Power Components)**  
**MASTER Handout No. 3 (AET-J2-HO-3) (Safely Working with Pressurized Systems)**  
**MASTER Handout No. 4 (AET-J2-HO-4) (Do and Don'ts for Fluid Power Systems)**  
**MASTER Handout No. 5 (AET-J2-HO-5) (Internet References to Fluid Power Systems and Components)**  
**MASTER Laboratory Exercise (AET-J2-LE)**  
**MASTER Laboratory Aid (AET-J2-LA)**  
**MASTER Quiz AET-J2-QU-1: Do and don'ts's for fluid power systems**  
**MASTER Quiz AET-J2-QU-2: Adjusting fluid power systems**

---

### References:

The author has not found a suitable text that covers the assembly or disassembly of a machine tool. Most texts only cover theory and/or operation. For this reason the handouts and material that accompany this module will contain applications and references to Internet sources.

**Video(s):** *Fluid Power*, Bergwall Productions, 1-800-645-3565, Latest Edition

**Multimedia:** *Fluid Power*, Bergwall Productions, Phone 1-800-645-3565, ISBN 0-8064-1538-X, (CD-ROM), Latest Edition

Note: Bergwall Productions will be referenced frequently throughout the AET section because the company provides quality video productions at a reasonable price, unlike other video production companies.

---

### Student Preparation:

Students should have previously completed the following Technical Modules (at a minimum, the student should have competency in, or have completed all, of the following module categories):

- AET-A1 through AET-A13** "Apply Science to Solve Industrial Problems" series
- AET-B1 through AET-B5** "Use Drawings to Analyze and Repair Systems" series
- AET-C1** "Apply Machine Tool Metrology and Measurement Instruments to Align Machine Tools"

- AET-C2 “Apply Electrical Measurement Knowledge and Instruments to Test/Calibrate Electrical Circuits”
- AET-D1 “Resolve System Failures with Critical Thinking, Troubleshooting, Theory, and Metrology” series
- AET-F1 through AET-F8 “Measure/Isolate Malfunctions of Mechanical/Fluid Power Systems” series
- AET-J1 “Safely Assemble, Disassemble, and Adjust Mechanical Systems such as Gearing Systems, Shafts, Couplings, Pulleys, Belts”

---

---

## **Introduction:**

After the troubleshooting process has resulted in the identification of a subsystem or component that is malfunctioning, the technician's next job is to remove and repair or replace the defective mechanism. This frequently involves the assembly or disassembly of hydraulic or pneumatic systems or components. A mechanical break down of the equipment should be approached in a planned organized manner, with plenty of fore thought as to the steps that will be taken during the process. In this module, the term “fluid power” will be taken to include both hydraulic and pneumatic systems. Performing quality fluid power work requires the proper application of hand tools, and the ability to perform common major mechanical procedures such as; removal and installation of fittings, removal and installation of tubing, removal and installation of valves, and removal and installation of pumps, motors, and cylinders. After the defective component has been replaced, and the system or component has been re-assembled, it frequently requires adjustment of pressures and flows, so the technician must know the procedures that may be required for adjusting pressure controlled valves, flow controls, cushions and speed controls for cylinders, deceleration valves for fluid power motors, and complex servo or proportional control valves.

---

---

## **Presentation Outline:**

- I. Safely Assemble or Disassemble Subsystems or Components of Fluid Power Systems
  - A. Explain and demonstrate the removal and installation of fluid power fittings and tubing
    - 1. Explain and demonstrate the proper methods of removing and installing fluid power fittings (for both hydraulic and pneumatic systems)
    - 2. Explain and demonstrate the proper methods of cutting, flaring, bending, and installing fluid power tubing (for both hydraulic and pneumatic systems)
  - B. Explain and demonstrate the removal and installation of valves
    - 1. Explain demonstrate the removal and installation of directional control valves from/to fluid power manifolds

2. Explain the manifold ports on pneumatic systems and the installation of exhaust mufflers
  3. Explain and demonstrate the installation of "O" ring seals and valve seals for valve/manifold sealing
  4. Explain and demonstrate the installation of pressure control valves for fluid power systems
  - C. Explain and demonstrate the removal and installation of pumps, motors, and cylinders
  - D. Explain and demonstrate the proper assembly and disassembly of valves, pumps, motors, and cylinders
    1. Explain and demonstrate the proper methods of disassembling, assembling cleaning, and replacing seals for fluid power valves
    2. Explain and demonstrate the proper methods for disassembling, assembling, cleaning, and replacing seals for pumps and motors
    3. Explain the proper methods for disassembling, assembling, cleaning, and replacing seals for cylinders
- II. Adjust Subsystems or Components of Fluid Power Systems
- A. Explain and demonstrate the proper methods of adjusting pressure control valves
    1. Explain and demonstrate the proper method of adjusting pressure relief valves in hydraulic systems or pneumatic receivers
    2. Explain and demonstrate the proper method of adjusting pressure reducing valves in hydraulic or pneumatic systems
    3. Explain and demonstrate the proper method of adjusting sequencing valves in hydraulic systems
    4. Explain and demonstrate the proper method of adjusting pressure reducing valves in hydraulic or pneumatic systems
    5. Explain and demonstrate the proper methods for adjusting deceleration valves for hydraulic motors
  - B. Explain and demonstrate the proper methods of adjusting flow control valves
    1. Explain the effects of adjusting flow control valves for fluid power systems
    2. Demonstrate the adjustment of flow control valves for cushions and speed controls for cylinders and fluid power motors
  - C. Explain and demonstrate the proper methods for adjusting infinite positioning valves such as servo valves and proportional control valves

---



---

**Practical Application:**

1. Using an industrial fluid power system, apply the concepts contained in this module; and,

2. Adjust a servo valve or proportional control valve for an automated fluid power system.

---

---

**Evaluation and/or Verification:**

Successful completion of this technical module will be based on the student's successful completion of the following components:

1. A twenty question quiz on the industrial application of the concepts contained in this module (MASTER Quiz AET-J2-QU-1: Do and don't's for fluid power systems);
2. A twenty question quiz on the industrial application of the concepts contained in this module (MASTER Quiz AET-J2-QU-2: Adjusting fluid power systems);
3. Completion of selected laboratory experiences in assembling/disassembling fluid power systems/components;
4. Completion of selected laboratory experiences in adjusting fluid power systems/components;.
5. Demonstrate competency in the ability to assemble/disassemble fluid power systems/components; and,
6. Demonstrate competency in the ability to adjust fluid power systems/components.

---

---

**Summary:**

Review the main lesson points using the texts and handouts listed in the reference section of this module. Stress the industrial applications of the concepts. Hold class discussion and answer student questions.

---

---

**Next Lesson Assignment:**

**MASTER Technical Module (AET-J3)** dealing with safely assembling, disassembling or adjusting electrical systems or components.



**AET-J2-HO-1**  
**Safely Assemble, Disassemble, and Adjust**  
**Subsystems or Components of Fluid Power Systems**  
**Attachment 1: MASTER Handout No. 1**

---

**Objective(s):**

Upon completion of this unit the student will be able to:

- a. Use the ordinary hand tools associated with installation and repair of hydraulic and pneumatic systems;
  - b. Perform procedures such as cutting, flaring, and bending fluid power tubing;
  - c. Perform procedures such as removing and installing fluid power fittings;
  - d. Remove and install fluid power seals;
  - e. Remove and properly install fluid power components such as pumps, valves cylinders, and motors;
  - f. Properly disassemble and assemble fluid power components such as pumps, valves cylinders, and motors; and,
  - g. Properly perform adjustments of pressures and flows.
- 

**Module Outline:**

- I. Safely Assemble or Disassemble Subsystems or Components of Fluid Power Systems
  - A. Explain and demonstrate the removal and installation of fluid power fittings and tubing
    1. Explain and demonstrate the proper methods of removing and installing fluid power fittings (for both hydraulic and pneumatic systems)
    2. Explain and demonstrate the proper methods of cutting, flaring, bending, and installing fluid power tubing (for both hydraulic and pneumatic systems)
  - B. Explain and demonstrate the removal and installation of valves
    1. Explain demonstrate the removal and installation of directional control valves from/to fluid power manifolds
    2. Explain the manifold ports on pneumatic systems and the installation of exhaust mufflers
    3. Explain and demonstrate the installation of "O" ring seals and valve seals for valve/manifold sealing
    4. Explain and demonstrate the installation of pressure control valves for fluid power systems
  - C. Explain and demonstrate the removal and installation of pumps, motors, and cylinders

- D. Explain and demonstrate the proper assembly and disassembly of valves, pumps, motors, and cylinders
  - 1. Explain and demonstrate the proper methods of disassembling, assembling cleaning, and replacing seals for fluid power valves
  - 2. Explain and demonstrate the proper methods for disassembling, assembling, cleaning, and replacing seals for pumps and motors
  - 3. Explain the proper methods for disassembling, assembling, cleaning, and replacing seals for cylinders
- II. Adjust Subsystems or Components of Fluid Power Systems
  - A. Explain and demonstrate the proper methods of adjusting pressure control valves
    - 1. Explain and demonstrate the proper method of adjusting pressure relief valves in hydraulic systems or pneumatic receivers
    - 2. Explain and demonstrate the proper method of adjusting pressure reducing valves in hydraulic or pneumatic systems
    - 3. Explain and demonstrate the proper method of adjusting sequencing valves in hydraulic systems
    - 4. Explain and demonstrate the proper method of adjusting pressure reducing valves in hydraulic or pneumatic systems
    - 5. Explain and demonstrate the proper methods for adjusting deceleration valves for hydraulic motors
  - B. Explain and demonstrate the proper methods of adjusting flow control valves
    - 1. Explain the effects of adjusting flow control valves for fluid power systems
    - 2. Demonstrate the adjustment of flow control valves for cushions and speed controls for cylinders and fluid power motors
  - C. Explain and demonstrate the proper methods for adjusting infinite positioning valves such as servo valves and proportional control valves

**AET-J2-HO-2**  
**Safely Assemble, Disassemble, and Adjust**  
**Subsystems or Components of Fluid Power Systems**  
**Attachment 2: MASTER Handout No. 2**

---

**Safely Assembling or Disassembling Fluid Power Components —**  
**Fluid Power Safety**

**Hydraulic/Pneumatic Safety**

1. Hydraulic and pneumatic equipment can generate large amounts of force. *Avoid placing your hands in the path of a moving actuator or object that may be pressurized.*
2. Do not attempt to control or stop pressure leaks in hydraulic or pneumatic equipment with your hands or other parts of your body. *Pressurized oil can be forced into your skin, causing health problems.*
3. Pressurized air can be forced into your skin causing blood clots to form in your veins or arteries. These blood clots can migrate to your heart or brain resulting in death or stroke. *Never subject your skin to high pressure gasses.*
4. High pressure hydraulic pressure leaks can form a fine mist of oil. Organic oil and some synthetic oils are explosive under these conditions.
5. Control hydraulic leaks by covering the leak with a rag or other shield to prevent the oil from misting, and remove the power from the hydraulic pump.
6. Control pneumatic leaks by removing the pressure source before attempting to determine the source of the leak.

**Proper Pressure Testing**

1. Fittings or access hatches that will be pressurized can be subject to tremendous forces. A hatch cover that is 1 foot in diameter which is pressurized to 15 PSIG will be subject to a force of almost one ton! The design of this equipment may require a certain number of fasteners to affix the fitting or cover to the pressure vessel. *Do not, under any circumstances, attempt to pressure test a vessel without replacing the required number of fasteners.*

2. Vessels that are designed to withstand external forces such as vacuum equipment, may not be designed to withstand internal forces that may result from pressures greater than atmospheric pressure. Pressurizing these vessels internally can cause them to rupture. In addition, fittings on these vessels may not be designed to withstand internal pressures.

## **Pneumatic Safety**

### **Confined Area Rules**

1. Vacuum equipment or pressurized processing equipment that is filled or back filled with gasses such as argon, nitrogen, carbon dioxide, or other types of inert gasses. Must be subject to confined area rules. These gasses, because they are heavier than, or equal to, the weight of air, can collect in pockets. Although these gasses are not toxic, breathing these gasses will not sustain life. Frequently, the victim is usually unaware that he or she is breathing the inert gasses until unconsciousness, and eventually death, occurs. More industrial accidents, that result in death, are caused by ignoring the confined area rules.

*Any vessel that is being inspected, and which was at one time was filled with an inert or toxic gas must be ventilated with fresh air for the time and in the manner determined by OSHA rules before entering or confining the upper part of your body in the vessel.*

### **Proper Pressure Testing**

1. *Disconnecting pressurized pneumatic lines is hazardous.* Escaping high pressure air will cause the line to whip back and forth, in some cases, with a great deal of force. Remove the pressure source before removing lines.
2. *Do not point a pressurized line at anyone, and do not look into a pressurized line.* Parts from broken pneumatic valves or other objects can enter these lines. If the lines are then pressurized, the objects will be ejected at a high velocity. The object then becomes a bullet, and can cause as much damage as a bullet fired from a gun.
3. Make sure that air lines that are coupled with quick disconnects are firmly seated into the fitting. If the line is installed with flair or compression fittings, make sure that the fittings are properly tightened (do not over tighten these fittings). Lines that are improperly installed will come loose under pressure.

4. Combination hydro-pneumatic actuators that are commonly found in pneumatic pick and place robots have speed control and slowdown control valves. If these valves are not properly installed, they can be ejected from the actuator with a great deal of force. Consult the manuals for the equipment and only adjust these valves according to the specifications.

## **Mechanical/Hydraulic/Pneumatic Safety**

### **Mechanical Safety**

General safety requires that the technician know and obey the safety rules associated with his or her job and follow them consistently. When in doubt about the procedures to follow or about the safety of a particular operation, consult the available documentation associated with that procedure. Many sources exist to support this, including notices packed with equipment shipped from a vendor. *Save this safety information.* Make it a habit to establish a set of documents that contain these safety rules, and *make the documents available to all of the technicians in the organization.*

### **Avoid Pinch Points**

1. Mechanisms can generate large amounts of force from relatively low power driving devices. Using your hands to test the force generated by these devices can result in crushed fingers. *Do not put your hands in mechanisms that can amplify force, such as lead screws, gear trains, or lever systems.*
2. Tools such as pliers, diagonal cutters, or vice grip pliers can slip, pinching or cutting your skin. *Learn to properly apply these tools.*
3. Hammers can be misdirected, resulting in painful injuries. If you must support devices to be hammered with your hands, aim carefully to avoid injuries.
4. Hydraulic and pneumatic actuators or pressurized equipment, even at relatively low pressures can generate forces large enough to sever fingers or arms. Do not assume that, because a device is moving slowly, it is harmless. *Keep hands away from equipment under pressure.*
5. Die cutting equipment, forming presses or curing presses can sever fingers or hands. *Keep hands away from equipment under power.*

6. When moving large heavy pieces of equipment, keep hands from under the equipment. Use slings or other types of supporting devices to move the equipment.

### Moving Equipment Precautions

1. Automated equipment that is powered on can move at any time. Equipment that has stopped under unusual circumstances can move based upon changes in sensors or under the directions of a faulty controller. *Learn the safe shut-down procedures for the equipment, move the equipment to a safe condition and/or remove the power from the systems before placing your hands in the mechanism.*
2. Do not under any circumstances, try to remove objects such as broken parts or other obstructions from the equipment when it is in an automatic mode. Learn the safe shut-down procedures for the equipment, move the equipment to a safe condition and/or remove the power from the systems before placing your hands in the mechanism. Broken parts can be razor sharp. *If a part is wedged in the mechanism, remove the force holding it before attempting to remove the part.*

### Bench Work Safety

1. Although you may feel relatively safe when working on equipment at the work bench, industrial accidents can occur because the environment seems safe. *At a minimum, safety glasses are required when performing bench work.* Spring loaded objects such as valves or other mechanism under tension. These mechanisms can eject objects that can strike eyes causing severe injury. Using normal hand tools, puts mechanisms under tension when they are being assembled or disassembled.
2. In addition to safety glasses, when working on certain types of mechanisms with close tolerances, edges can be sharp. *Wear work gloves to handle such objects.*
3. Using solvents to clean mechanisms may require that the technician wear protective gloves to prevent the solvent from being absorbed into the skin. Highly volatile solvents may also require a respirator to prevent the inhalation of vapors. *Consult the Material Safety Data Sheets (MSDS) to determine the safety rules for using solvents or other chemicals.*

**AET-J2-HO-3**  
**Safely Assemble, Disassemble, and Adjust**  
**Subsystems or Components of Fluid Power Systems**  
**Attachment 3: MASTER Handout No. 3**

---

**Safely Working With Pressurized Systems — Fluid Power Safety**

**Hydraulic/Pneumatic Safety**

1. Hydraulic and pneumatic equipment can generate large amounts of force. *Avoid placing your hands in the path of a moving actuator or object that may be pressurized.*
2. Do not attempt to control or stop pressure leaks in hydraulic or pneumatic equipment with your hands or other parts of your body. *Pressurized oil can be forced into your skin, causing health problems.*
3. Pressurized air can be forced into your skin causing blood clots to form in your veins or arteries. These blood clots can migrate to your heart or brain resulting in death or stroke. *Never subject your skin to high pressure gasses.*
4. High pressure hydraulic pressure leaks can form a fine mist of oil. Organic oil and some synthetic oils are explosive under these conditions.
5. Control hydraulic leaks by covering the leak with a rag or other shield to prevent the oil from misting, and remove the power from the hydraulic pump.
6. Control pneumatic leaks by removing the pressure source before attempting to determine the source of the leak.

**Proper Pressure Testing**

1. Fittings or access hatches that will be pressurized can be subject to tremendous forces. A hatch cover that is 1 foot in diameter which is pressurized to 15 PSIG will be subject to a force of almost one ton! The design of this equipment may require a certain number of fasteners to affix the fitting or cover to the pressure vessel. *Do not, under any circumstances, attempt to pressure test a vessel without replacing the required number of fasteners.*



2. Vessels that are designed to withstand external forces such as vacuum equipment, may not be designed to withstand internal forces that may result from pressures greater than atmospheric pressure. Pressurizing these vessels internally can cause them to rupture. In addition, fittings on these vessels may not be designed to withstand internal pressures.

## **Pneumatic Safety**

### **Confined Area Rules**

1. Vacuum equipment or pressurized processing equipment that is filled or back filled with gasses such as argon, nitrogen, carbon dioxide, or other types of inert gasses. Must be subject to confined area rules. These gasses, because they are heavier than, or equal to, the weight of air, can collect in pockets. Although these gasses are not toxic, breathing these gasses will not sustain life. Frequently, the victim is usually unaware that he or she is breathing the inert gasses until unconsciousness, and eventually death, occurs. More industrial accidents, that result in death, are caused by ignoring the confined area rules.

*Any vessel that is being inspected, and which was at one time was filled with an inert or toxic gas must be ventilated with fresh air for the time and in the manner determined by OSHA rules before entering or confining the upper part of your body in the vessel.*

### **Proper Pressure Testing**

1. *Disconnecting pressurized pneumatic lines is hazardous.* Escaping high pressure air will cause the line to whip back and forth, in some cases, with a great deal of force. Remove the pressure source before removing lines.
2. *Do not point a pressurized line at anyone, and do not look into a pressurized line.* Parts from broken pneumatic valves or other objects can enter these lines. If the lines are then pressurized, the objects will be ejected at a high velocity. The object then becomes a bullet, and can cause as much damage as a bullet fired from a gun.
3. Make sure that air lines that are coupled with quick disconnects are firmly seated into the fitting. If the line is installed with flair or compression fittings, make sure that the fittings are properly tightened (do not over tighten these fittings). Lines that are improperly installed will come loose under pressure.



4. Combination hydro-pneumatic actuators that are commonly found in pneumatic pick and place robots have speed control and slowdown control valves. If these valves are not properly installed, they can be ejected from the actuator with a great deal of force. Consult the manuals for the equipment and only adjust these valves according to the specifications.

## Mechanical/Hydraulic/Pneumatic Safety

### Mechanical Safety

General safety requires that the technician know and obey the safety rules associated with his or her job and follow them consistently. When in doubt about the procedures to follow or about the safety of a particular operation, consult the available documentation associated with that procedure. Many sources exist to support this, including notices packed with equipment shipped from a vendor. *Save this safety information.* Make it a habit to establish a set of documents that contain these safety rules, and *make the documents available to all of the technicians in the organization.*

### Avoid Pinch Points

1. Mechanisms can generate large amounts of force from relatively low power driving devices. Using your hands to test the force generated by these devices can result in crushed fingers. *Do not put your hands in mechanisms that can amplify force, such as lead screws, gear trains, or lever systems.*
2. Tools such as pliers, diagonal cutters, or vice grip pliers can slip, pinching or cutting your skin. *Learn to properly apply these tools.*
3. Hammers can be misdirected, resulting in painful injuries. If you must support devices to be hammered with your hands, aim carefully to avoid injuries.
4. Hydraulic and pneumatic actuators or pressurized equipment, even at relatively low pressures can generate forces large enough to sever fingers or arms. Do not assume that, because a device is moving slowly, it is harmless. *Keep hands away from equipment under pressure.*
5. Die cutting equipment, forming presses or curing presses can sever fingers or hands. *Keep hands away from equipment under power.*

6. When moving large heavy pieces of equipment, keep hands from under the equipment. Use slings or other types of supporting devices to move the equipment.

### **Moving Equipment Precautions**

1. Automated equipment that is powered on can move at any time. Equipment that has stopped under unusual circumstances can move based upon changes in sensors or under the directions of a faulty controller. *Learn the safe shut-down procedures for the equipment, move the equipment to a safe condition and/or remove the power from the systems before placing your hands in the mechanism.*
2. Do not under any circumstances, try to remove objects such as broken parts or other obstructions from the equipment when it is in an automatic mode. Learn the safe shut-down procedures for the equipment, move the equipment to a safe condition and/or remove the power from the systems before placing your hands in the mechanism. Broken parts can be razor sharp. *If a part is wedged in the mechanism, remove the force holding it before attempting to remove the part.*

### **Bench Work Safety**

1. Although you may feel relatively safe when working on equipment at the work bench, industrial accidents can occur because the environment seems safe. *At a minimum, safety glasses are required when performing bench work.* Spring loaded objects such as valves or other mechanism under tension. These mechanisms can eject objects that can strike eyes causing severe injury. Using normal hand tools, puts mechanisms under tension when they are being assembled or disassembled.
2. In addition to safety glasses, when working on certain types of mechanisms with close tolerances, edges can be sharp. *Wear work gloves to handle such objects.*
3. Using solvents to clean mechanisms may require that the technician wear protective gloves to prevent the solvent from being absorbed into the skin. Highly volatile solvents may also require a respirator to prevent the inhalation of vapors. *Consult the Material Safety Data Sheets (MSDS) to determine the safety rules for using solvents or other chemicals.*

**AET-J2-HO-4**  
**Safely Assemble, Disassemble, and Adjust**  
**Subsystems or Components of Fluid Power Systems**  
**Attachment 4: MASTER Handout No. 4**

---

**Do and Don'ts for Fluid Power Systems — Fluid Power Safety**

**Hydraulic/Pneumatic Safety**

1. Hydraulic and pneumatic equipment can generate large amounts of force. *Avoid placing your hands in the path of a moving actuator or object that may be pressurized.*
2. Do not attempt to control or stop pressure leaks in hydraulic or pneumatic equipment with your hands or other parts of your body. *Pressurized oil can be forced into your skin, causing health problems.*
3. Pressurized air can be forced into your skin causing blood clots to form in your veins or arteries. These blood clots can migrate to your heart or brain resulting in death or stroke. *Never subject your skin to high pressure gasses.*
4. High pressure hydraulic pressure leaks can form a fine mist of oil. Organic oil and some synthetic oils are explosive under these conditions.
5. Control hydraulic leaks by covering the leak with a rag or other shield to prevent the oil from misting, and remove the power from the hydraulic pump.
6. Control pneumatic leaks by removing the pressure source before attempting to determine the source of the leak.

**Proper Pressure Testing**

1. Fittings or access hatches that will be pressurized can be subject to tremendous forces. A hatch cover that is 1 foot in diameter which is pressurized to 15 PSIG will be subject to a force of almost one ton! The design of this equipment may require a certain number of fasteners to affix the fitting or cover to the pressure vessel. *Do not, under any circumstances, attempt to pressure test a vessel without replacing the required number of fasteners.*

2. Vessels that are designed to withstand external forces such as vacuum equipment, may not be designed to withstand internal forces that may result from pressures greater than atmospheric pressure. Pressurizing these vessels internally can cause them to rupture. In addition, fittings on these vessels may not be designed to withstand internal pressures.

## **Pneumatic Safety**

### **Confined Area Rules**

1. Vacuum equipment or pressurized processing equipment that is filled or back filled with gasses such as argon, nitrogen, carbon dioxide, or other types of inert gasses. Must be subject to confined area rules. These gasses, because they are heavier than, or equal to, the weight of air, can collect in pockets. Although these gasses are not toxic, breathing these gasses will not sustain life. Frequently, the victim is usually unaware that he or she is breathing the inert gasses until unconsciousness, and eventually death, occurs. More industrial accidents, that result in death, are caused by ignoring the confined area rules.

*Any vessel that is being inspected, and which was at one time was filled with an inert or toxic gas must be ventilated with fresh air for the time and in the manner determined by OSHA rules before entering or confining the upper part of your body in the vessel.*

### **Proper Pressure Testing**

1. *Disconnecting pressurized pneumatic lines is hazardous.* Escaping high pressure air will cause the line to whip back and forth, in some cases, with a great deal of force. Remove the pressure source before removing lines.
2. *Do not point a pressurized line at anyone, and do not look into a pressurized line.* Parts from broken pneumatic valves or other objects can enter these lines. If the lines are then pressurized, the objects will be ejected at a high velocity. The object then becomes a bullet, and can cause as much damage as a bullet fired from a gun.
3. Make sure that air lines that are coupled with quick disconnects are firmly seated into the fitting. If the line is installed with flair or compression fittings, make sure that the fittings are properly tightened (do not over tighten these fittings). Lines that are improperly installed will come loose under pressure.

4. Combination hydro-pneumatic actuators that are commonly found in pneumatic pick and place robots have speed control and slowdown control valves. If these valves are not properly installed, they can be ejected from the actuator with a great deal of force. Consult the manuals for the equipment and only adjust these valves according to the specifications.

## Mechanical/Hydraulic/Pneumatic Safety

### Mechanical Safety

General safety requires that the technician know and obey the safety rules associated with his or her job and follow them consistently. When in doubt about the procedures to follow or about the safety of a particular operation, consult the available documentation associated with that procedure. Many sources exist to support this, including notices packed with equipment shipped from a vendor. *Save this safety information.* Make it a habit to establish a set of documents that contain these safety rules, and *make the documents available to all of the technicians in the organization.*

### Avoid Pinch Points

1. Mechanisms can generate large amounts of force from relatively low power driving devices. Using your hands to test the force generated by these devices can result in crushed fingers. *Do not put your hands in mechanisms that can amplify force, such as lead screws, gear trains, or lever systems.*
2. Tools such as pliers, diagonal cutters, or vice grip pliers can slip, pinching or cutting your skin. *Learn to properly apply these tools.*
3. Hammers can be misdirected, resulting in painful injuries. If you must support devices to be hammered with your hands, aim carefully to avoid injuries.
4. Hydraulic and pneumatic actuators or pressurized equipment, even at relatively low pressures can generate forces large enough to sever fingers or arms. Do not assume that, because a device is moving slowly, it is harmless. *Keep hands away from equipment under pressure.*
5. Die cutting equipment, forming presses or curing presses can sever fingers or hands. *Keep hands away from equipment under power.*

6. When moving large heavy pieces of equipment, keep hands from under the equipment. Use slings or other types of supporting devices to move the equipment.

### **Moving Equipment Precautions**

1. Automated equipment that is powered on can move at any time. Equipment that has stopped under unusual circumstances can move based upon changes in sensors or under the directions of a faulty controller. *Learn the safe shut-down procedures for the equipment, move the equipment to a safe condition and/or remove the power from the systems before placing your hands in the mechanism.*
2. Do not under any circumstances, try to remove objects such as broken parts or other obstructions from the equipment when it is in an automatic mode. Learn the safe shut-down procedures for the equipment, move the equipment to a safe condition and/or remove the power from the systems before placing your hands in the mechanism. Broken parts can be razor sharp. *If a part is wedged in the mechanism, remove the force holding it before attempting to remove the part.*

### **Bench Work Safety**

1. Although you may feel relatively safe when working on equipment at the work bench, industrial accidents can occur because the environment seems safe. *At a minimum, safety glasses are required when performing bench work.* Spring loaded objects such as valves or other mechanism under tension. These mechanisms can eject objects that can strike eyes causing severe injury. Using normal hand tools, puts mechanisms under tension when they are being assembled or disassembled.
2. In addition to safety glasses, when working on certain types of mechanisms with close tolerances, edges can be sharp. *Wear work gloves to handle such objects.*
3. Using solvents to clean mechanisms may require that the technician wear protective gloves to prevent the solvent from being absorbed into the skin. Highly volatile solvents may also require a respirator to prevent the inhalation of vapors. *Consult the Material Safety Data Sheets (MSDS) to determine the safety rules for using solvents or other chemicals.*

**AET-J2-LE**  
**Safely Assemble, Disassemble, and Adjust**  
**Subsystems or Components of Fluid Power Systems**  
**Attachment 6: MASTER Laboratory Exercise**

---

The student will:

1. Using an industrial fluid power system, apply the concepts contained in this module; and,
2. Adjust a servo valve or proportional control valve for an automated fluid power system.

**AET-J2-LA**  
**Safely Assemble, Disassemble, and Adjust**  
**Subsystems or Components of Fluid Power Systems**  
**Attachment 7: MASTER Laboratory Aid**

---

**Rules of Conduct**

1. Absolutely no horseplay or practical joking will be tolerated.
2. Do not talk to anyone who is operating a machine.
3. Walk only in the designated traffic lanes.
4. Dress appropriately; at the absolute minimum, you must have:
  - a. No loose clothing, including ties;
  - b. Long hair properly stowed;
  - c. No jewelry;
  - d. Hard, closed-toe shoes;
  - e. Eye protection (safety glasses); and,
  - f. Ear protection (plugs or headset).
5. Follow all institutional safety rules.



# **AUTOMATED EQUIPMENT REPAIR SERIES**

## **MASTER Technical Module No. AET-J3**

---

<b>Subject:</b>	<b>Automated Equipment Repair</b>	<b>Time: 24 Hrs.</b>
<b>Duty:</b>	<b>Assemble/Disassemble Mechanical, Electrical, Electronic, and Computer Systems</b>	
<b>Task:</b>	<b>Safely Assemble, Disassemble or Adjust Electrical Systems or Components</b>	

---

### **Objective(s):**

Upon completion of this unit the student will be able to:

- a. Use the ordinary hand tools associated with installation and repair of electrical systems;
- b. Perform procedures such as installing electrical panels and enclosures;
- c. Perform procedures such as installing and wiring electrical components such as switches, relays solenoids, fuse holders, terminal strips, and motor starters;
- d. Remove install, and properly wire electrical motors;
- e. Remove and install brushes for DC electrical motors;
- f. Install electrical metallic tubing and flexible conduits;
- g. Properly adjust overloads, power supplies, and time delay relays; and,
- h. Perform ordinary safety procedure such as lockout, tagout, and safe electrical adjustments.

---

### **Instructional Materials:**

An electrical system and component parts such as switches, motor starters, relays, solenoids, fuses, terminal strips, and motors.

Note: Not all facilities can gain access to an electrical system that can be experimented upon. Most systems are tied up in production schedules. Under these circumstances, the instructor may want to use junk electrical parts, educational systems, or as a last resort, lab equipment that provides experience in some of the major systems that comprise an electrical system. However, the most desirable method of completing this module is hands-on experimentation with working, industrial electrical equipment.

Hand tools such as diagonal cutters, knives, crimping tools, wire strippers, needle-nosed pliers, soldering irons, high temperature soldering equipment and standard hand tools (see MASTER module AET-J1)

**MASTER Handout (AET-J3-HO-1)**

**MASTER Handout (AET-J3-HO-2) (Installing and Wiring Electrical Systems or Components)**

**MASTER Laboratory Exercise (AET-J3-LE)**

**MASTER Laboratory Aid (AET-J3-LA)**

**MASTER Quiz AET-J3-QU-1: Installing and wiring electrical components and systems**

**MASTER Quiz AET-J3-QU-2: Adjusting electrical components and systems**

---

### **References:**

The author has not found a suitable text that covers the assembly, disassembly, and adjustment of electrical systems. Most texts only cover theory and/or operation. For this reason the handouts and material that accompany this module will contain applications and procedures.

Industrial lockout-tagout safety booklet available from U.S. Office of Safety and Health Administration (OSHA)

---

### **Student Preparation:**

Students should have previously completed the following Technical Modules (at a minimum, the student should have competency in, or have completed all, of the following module categories):

- AET-A1 through AET-A13** “Apply Science to Solve Industrial Problems” series
- AET-B1 through AET-B5** “Use Drawings to Analyze and Repair Systems” series
- AET-C2** “Apply Electrical Measurement Knowledge and Instruments to Test/Calibrate Electrical Circuits”
- AET-D1** “Resolve System Failures with Critical Thinking, Troubleshooting, Theory, and Metrology” series
- AET-E1 through AET-E13** “Use Techniques to Isolate Malfunctions of Electrical/Electronic Systems” series
- AET-J1** “Safely Assemble, Disassemble, and Adjust Mechanical Systems such as Gearing Systems, Shafts, Couplings, Pulleys, Belts”

---

---

### **Introduction:**

After the troubleshooting process has resulted in the identification of a subsystem or component that is malfunctioning, the technician's next job is to remove, repair, replace and/or adjust the defective component. This frequently involves the assembly or disassembly of electrical systems or components. An electrical procedure should be approached in a planned, organized manner, with plenty of forethought as to the steps that will be taken during the process. Performing quality electrical work requires the proper application of hand tools, and the ability to perform common mechanical

procedures. In addition, the technician must be proficient in performing procedures specific to electrical control systems such as; removing and installing wiring, switches, relays, solenoids, transformers, motor starters, and motors. After the defective component has been replaced, and the system or component has been re-assembled, components such as DC power supplies and control variables such as time delay relays must be set back to the values specified by the control documentation. Therefore the technician must know the procedures that may be required for adjusting various electrical components.

---

---

## **Presentation Outline:**

- I. **Safely Assemble or Disassemble Electrical Systems or Components**
  - A. **Explain and demonstrate the removal and installation of electrical components and assemblies (this may be accomplished by having the students assemble an electrical panel from component parts)**
    1. **Explain and demonstrate proper lock-out tag out procedures**
    2. **Explain and demonstrate the proper wiring methods for electrical control systems**
    3. **Demonstrate the procedures required for using knock-out punches**
    4. **Explain and demonstrate the proper methods for installing switches such as toggle switches, push-button switches, start/stop switch assemblies, and thumb wheel switches**
    5. **Explain and demonstrate the proper methods for installing terminal strips, relays, solenoids, and motor-starter contactors**
    6. **Explain and demonstrate the proper methods for soldering wiring and components, and the proper methods for installing high current soldered splices**
  - B. **Explain and demonstrate the removal and installation of transformers**
    1. **Explain and demonstrate the wiring of electrical control power transformers; both single phase, and three phase**
    2. **Explain and demonstrate the mounting of electrical control power transformers**
  - C. **Explain and demonstrate the removal and installation of electrical motors**
    1. **Explain and demonstrate the proper wiring methods for DC motors such as permanent magnet field, shunt field, series field, and universal motors**
    2. **Explain and demonstrate the proper replacement of brushes, and the renewing of commutators for DC electrical motors**
    3. **Explain and demonstrate the proper wiring methods for AC inductive motors; such as single phase AC capacitive start motors, AC inductive start motors and three phase AC motors**

4. Explain and demonstrate the removal and installation of start switches, capacitors, thermal overloads, and bearings on both DC motors and AC inductive motors
  5. Explain the concept of frame sizes of electrical motors, removing and replacing shaft couplings, and the mounting procedures for electrical motors
- II. Adjust Subsystems or Components of Electrical Systems
- A. Explain and demonstrate the proper methods of adjusting DC power supplies
  - B. Explain and demonstrate the proper methods of adjusting time delay relays
  - C. Explain and demonstrate common procedures for adjusting electrical over loads for motor starters and contactors
  - D. Explain and demonstrate the adjustment procedures for computer controlled electrical power distribution centers

---

---

**Practical Application:**

1. Using an industrial electrical system, apply the concepts contained in this module; and,
2. Adjust a power supply and time delay relays for an automated electrical system.

---

---

**Evaluation and/or Verification:**

Successful completion of this technical module will be based on the student's successful completion of the following components:

1. A twenty question quiz on the industrial application of the concepts contained in this module (MASTER Quiz AET-J3-QU-1: Installing and wiring electrical components and systems);
2. A twenty question quiz on the industrial application of the concepts contained in this module ( MASTER Quiz AET-J3-QU-2: Adjusting electrical components and systems);
3. Completion of selected laboratory experiences in assembling/disassembling electrical systems/components;
4. Completion of selected laboratory experiences in adjusting electrical systems/components;
5. Demonstrate competency in the ability to assemble/disassemble electrical systems/components;
6. Demonstrate competency in the ability to adjust electrical systems/components.

---

---

**Summary:**

Review the main lesson points using the texts and handouts listed in the reference section of this module. Hold class discussion and answer student questions.

---

---

**Next Lesson Assignment:**

**MASTER Technical Module (AET-J4)** dealing with safely assembling, disassembling or adjusting electronic systems or components.

**AET-J3-HO-1**  
**Safely Assemble, Disassemble or Adjust**  
**Electrical Systems or Components**  
**Attachment 1: MASTER Handout No. 1**

---

**Objective(s):**

Upon completion of this unit the student will be able to:

- a. Use the ordinary hand tools associated with installation and repair of electrical systems;
- b. Perform procedures such as installing electrical panels and enclosures;
- c. Perform procedures such as installing and wiring electrical components such as switches, relays solenoids, fuse holders, terminal strips, and motor starters;
- d. Remove install, and properly wire electrical motors;
- e. Remove and install brushes for DC electrical motors;
- f. Install electrical metallic tubing and flexible conduits;
- g. Properly adjust overloads, power supplies, and time delay relays; and,
- h. Perform ordinary safety procedure such as lockout, tagout, and safe electrical adjustments.

---

**Module Outline:**

- I. Safely Assemble or Disassemble Electrical Systems or Components
  - A. Explain and demonstrate the removal and installation of electrical components and assemblies (this may be accomplished by having the students assemble an electrical panel from component parts)
    1. Explain and demonstrate proper lock-out tag out procedures
    2. Explain and demonstrate the proper wiring methods for electrical control systems
    3. Demonstrate the procedures required for using knock-out punches
    4. Explain and demonstrate the proper methods for installing switches such as toggle switches, push-button switches, start/stop switch assemblies, and thumb wheel switches
    5. Explain and demonstrate the proper methods for installing terminal strips, relays, solenoids, and motor-starter contactors
    6. Explain and demonstrate the proper methods for soldering wiring and components, and the proper methods for installing high current soldered splices
  - B. Explain and demonstrate the removal and installation of transformers
    1. Explain and demonstrate the wiring of electrical control power transformers; both single phase, and three phase

2. Explain and demonstrate the mounting of electrical control power transformers
- C. Explain and demonstrate the removal and installation of electrical motors
  1. Explain and demonstrate the proper wiring methods for DC motors such as permanent magnet field, shunt field, series field, and universal motors
  2. Explain and demonstrate the proper replacement of brushes, and the renewing of commutators for DC electrical motors
  3. Explain and demonstrate the proper wiring methods for AC inductive motors; such as single phase AC capacitive start motors, AC inductive start motors and three phase AC motors
  4. Explain and demonstrate the removal and installation of start switches, capacitors, thermal overloads, and bearings on both DC motors and AC inductive motors
  5. Explain the concept of frame sizes of electrical motors, removing and replacing shaft couplings, and the mounting procedures for electrical motors
- II. Adjust Subsystems or Components of Electrical Systems
  - A. Explain and demonstrate the proper methods of adjusting DC power supplies
  - B. Explain and demonstrate the proper methods of adjusting time delay relays
  - C. Explain and demonstrate common procedures for adjusting electrical over loads for motor starters and contactors
  - D. Explain and demonstrate the adjustment procedures for computer controlled electrical power distribution centers

**AET-J3-LE**  
**Safely Assemble, Disassemble or Adjust**  
**Electrical Systems or Components**  
**Attachment 3: MASTER Laboratory Exercise**

---

The student will:

1. Using an industrial electrical system, apply the concepts contained in this module; and,
2. Adjust a power supply and time delay relays for an automated electrical system.



**AET-J3-LA**  
**Safely Assemble, Disassemble or Adjust**  
**Electrical Systems or Components**  
**Attachment 4: MASTER Laboratory Aid**

---

**Rules of Conduct**

1. Absolutely no horseplay or practical joking will be tolerated.
2. Do not talk to anyone who is operating a machine.
3. Walk only in the designated traffic lanes.
4. Dress appropriately; at the absolute minimum, you must have:
  - a. No loose clothing, including ties;
  - b. Long hair properly stowed;
  - c. No jewelry;
  - d. Hard, closed-toe shoes;
  - e. Eye protection (safety glasses); and,
  - f. Ear protection (plugs or headset).
5. Follow all institutional safety rules.

# **AUTOMATED EQUIPMENT REPAIR SERIES**

## **MASTER Technical Module No. AET-J4**

---

**Subject:** Automated Equipment Repair **Time:** 48 Hrs.

**Duty:** Assemble/Disassemble Mechanical, Electrical, Electronic, and Computer Systems

**Task:** Safely Assemble, Disassemble, or Adjust Electronic Systems or Components

---

### **Objective(s):**

Upon completion of this unit the student will be able to:

- a. Use the ordinary hand tools associated with installation and repair of electronic systems;
- b. Perform procedures such as removing and installing electronic modules and subsystems;
- c. Remove, install and solder electronic components such as resistors, capacitors, inductors, diodes, transistors, and integrated circuits;
- d. Repair, wire and test connectors;
- e. Perform anti-static discharge procedures to protect electronic components from electrical static discharge damage (ESD);
- f. Properly remove and install surface mount technology (SMT) electronic components;
- g. Remove and install high power semiconductors from heat sinks;
- h. Properly adjust electronic motor controls, servo systems, and proportional band, integral/derivative (PID) controls; and,
- i. Perform ordinary safety procedure such as lockout, tagout, and safe electronic adjustments.

---

### **Instructional Materials:**

An electronic system and component parts such as modules, connectors, and heat sink mounted parts

**Note:** Not all facilities can gain access to an electronic system that can be experimented upon. Most systems are tied up in production schedules. Under these circumstances, the instructor may want to use junk electronic parts, educational systems, or as a last resort, lab equipment that provides experience in some of the major systems that comprise an electronic system. However, the most desirable method of completing this module is hands-on experimentation with working, industrial electronic equipment.

Hand tools such as low temperature, miniature tip, soldering irons, soldering aids, diagonal cutters, knives, crimping tools, wire strippers, needle-nosed pliers, and standard hand tools (see MASTER modules AET-J1, AET-J3)

MASTER Handout (AET-J4-HO)

MASTER Laboratory Exercise (AET-J4-LE)

MASTER Laboratory Aid (AET-J4-LA)

MASTER Quiz AET-J4-QU-1: Installing and repairing electronic components and systems

MASTER Quiz AET-J4-QU-2: Adjusting electronic controls and systems

---

### References:

*Electronic Techniques: Shop Practices and Construction*, Robert S. Villanucci, Alexander W. Avtgl and William F. Megow, ISBN 0-13-361965-6, Latest Edition

*Electronic Assembly: Concepts and Experimentation*, Hughes, Fredrick W., ISBN 0-13-249731-X, Latest Edition

The author has not found a suitable text that covers the adjustment of electronic systems. Most texts only cover theory and/or operation. For this reason the handouts and material that accompany this module will contain applications and procedures.

Industrial lockout-tagout safety booklet available from U.S. Office of Safety and Health Administration (OSHA)

---

### Student Preparation:

Students should have previously completed the following Technical Modules (at a minimum, the student should have competency in, or have completed all, of the following module categories):

- AET-A1 through AET-A13 “Apply Science to Solve Industrial Problems” series
- AET-B1 through AET-B5 “Use Drawings to Analyze and Repair Systems” series
- AET-C2 “Apply Electrical Measurement Knowledge and Instruments to Test/Calibrate Electrical Circuits”
- AET-C3 “Apply Electronic Measurement Knowledge and Instruments to Test/Calibrate Electronic Circuits”
- AET-D1 “Resolve System Failures with Critical Thinking, Troubleshooting, Theory, and Metrology” series
- AET-E1 through AET-E13 “Use Techniques to Isolate Malfunctions of Electrical/Electronic Systems” series
- AET-J1 “Safely Assemble, Disassemble, and Adjust Mechanical Systems such as Gearing Systems, Shafts, Couplings, Pulleys, Belts”

## **AET-J3 “Safely Assemble, Disassemble or Adjust Electrical Systems or Components”**

Note: This module is meant to be used in conjunction with modules AET E1 through AET-E13.

---

---

### **Introduction:**

After the troubleshooting process has resulted in the identification of a subsystem or component that is malfunctioning, the technician's next job is to remove, repair, replace and/or adjust the defective component. This frequently involves the assembly or disassembly of electronic systems or components. An electronic procedure should be approached in a planned, organized manner, with plenty of fore thought as to the steps that will be taken during the process. Performing quality electronic work requires the proper application of hand tools, the ability to perform common mechanical procedures, and knowledge of electrical procedures. In addition, the technician must be proficient in performing procedures specific to electronic control systems such as; removing and installing electronic components by soldering, removing and installing modules from sub assemblies, removing and installing high power semiconductor components on heat sinks, and repairing or wiring connectors. After the defective component has been replaced, and the system or component has been re-assembled, subsystems or components such as electronic motor controls, PID loop controllers and servo systems must be set back to the values specified by the control documentation. Therefore the technician must know the procedures that may be required for adjusting various electronic components and subsystems.

---

---

### **Presentation Outline:**

- I. Safely Assemble or Disassemble Electronic Systems or Components
  - A. Explain and demonstrate the removal and installation of standard electronic components and assemblies (This may be accomplished by having the students assemble a working electronic module from component parts. The grade is predicated upon whether or not the module works.)
    1. Explain and demonstrate proper lock-out tag out procedures, and safety equipment required for electronic bench work
    2. Explain and demonstrate the proper methods for safely removing and installing electronic modules and subassemblies from enclosures
    3. Explain and demonstrate the proper methods for removing components from electronic modules
    4. Explain and demonstrate the proper methods for preparing electronic modules for resoldering

5. Explain and demonstrate the proper soldering tools and methods for resoldering components on electronic control modules and systems
  - B. Explain and demonstrate the removal and installation of power semiconductors
    1. Explain the purpose of air cooled, and fluid cooled heat sinks for power semiconductors and methods of heat conduction for insulated components
    2. Explain and demonstrate the removal and mounting of electronic power semiconductors for both types of heat sinks
  - C. Explain and demonstrate the removal and installation of surface mount technology (SMT) electronic components
    1. Explain the differences between through-hole technology electronic components, and SMT components
    2. Explain and demonstrate procedures for identifying SMT component parts such as resistors, capacitors, inductors, potentiometers, diodes, transistors, and integrated circuits
    3. Explain and demonstrate the proper tools used for removal and installation of SMT components
    4. Explain the methods of positioning, application of solder paste, heat application, and reflow of solder paste
    5. Explain the inspection of quality assurance of finished work
- II. Adjust Subsystems or Components of Electronic Systems
- A. Explain and demonstrate the proper methods of adjusting electronic motor controls
    1. Explain the purpose of the adjustments on the following types of electronic motor controls
      - a. Motor controls for DC shunt field and universal motors
        - (1) Current limit
        - (2) Current/resistance (IR) compensation
        - (3) Field weakening
        - (4) Max. speed/Min. speed
      - b. Motor controls for permanent magnet DC motors
        - (1) Current limit
        - (2) Current/resistance (IR) compensation
        - (3) Max. speed/Min. speed
      - c. Three phase, variable frequency controls for three phase AC motors
        - (1) Acceleration/deceleration
        - (2) Volts/Hertz ratio
        - (3) Instantaneous over current (IOC)
    2. Demonstrate the adjustment of the above controls and the effects of improper adjustment
  - B. Explain and demonstrate the proper methods of adjusting Proportional-band, Integral, and Derivative (PID) loops controllers

1. Explain the purpose and function of the following aspects of PID loop controllers
    - a. Proportional band
    - b. Integral
    - c. Derivative
  2. Explain the types of controllers that may belong to the PID control class
    - a. Bang-bang servos
    - b. Analog controllers
  3. Demonstrate the adjustment of the above and the expected results of improper adjustment
- C. Explain and demonstrate procedures for adjusting servo systems
1. Explain the electronic adjustments that are necessary for proper mechanical settings on various types of servo systems
    - a. Following error (steady state error)
    - b. Home position
    - c. Backlash compensation
  2. Explain the purpose of the following adjustments
    - a. Gain
    - b. Velocity stability
  3. Explain the interrelationships between the above adjustments and the effects upon the mechanism
  4. Demonstrate the adjustment of the above and the effects of improper adjustment

---

---

**Practical Application:**

1. Using an industrial electronic system, apply the concepts contained in this module; and,
2. Using an industrial electronic control process, such as a furnace or other process control, and a CNC servo system, apply the concepts contained in this module.

---

---

**Evaluation and/or Verification:**

Successful completion of this technical module will be based on the student's successful completion of the following components:

1. A twenty question quiz on the industrial application of the concepts contained in this module (MASTER Quiz AET-J4-QU-1: Installing and wiring, and soldering electronic components and systems);
2. A twenty question quiz on the industrial application of the concepts contained in this module ( MASTER Quiz AET-J4-QU-2: Adjusting electronic components and systems);

3. Completion of selected laboratory experiences in assembling/disassembling electronic systems/components;
4. Completion of selected laboratory experiences in adjusting electronic components and systems;
5. Demonstrate competency in the ability to assemble/disassemble electronic systems/components; and,
6. Demonstrate competency in the ability to adjust electronic systems/components.

---

---

**Summary:**

Review the main lesson points using the texts and handouts listed in the reference section of this module. Hold class discussion and answer student questions.

---

---

**Next Lesson Assignment:**

**MASTER Technical Module (AET-J5)** dealing with safely assembling or disassembling digital systems or components such as PLCs, CNCs, or computers.

**AET-J4-HO**  
**Safely Assemble, Disassemble, or Adjust**  
**Electronic Systems or Components**  
**Attachment 1: MASTER Handout**

---

**Objective(s):**

Upon completion of this unit the student will be able to:

- a. Use the ordinary hand tools associated with installation and repair of electronic systems;
- b. Perform procedures such as removing and installing electronic modules and subsystems;
- c. Remove, install and solder electronic components such as resistors, capacitors, inductors, diodes, transistors, and integrated circuits;
- d. Repair, wire and test connectors;
- e. Perform anti-static discharge procedures to protect electronic components from electrical static discharge damage (ESD);
- f. Properly remove and install surface mount technology (SMT) electronic components;
- g. Remove and install high power semiconductors from heat sinks;
- h. Properly adjust electronic motor controls, servo systems, and proportional band, integral/derivative (PID) controls; and,
- i. Perform ordinary safety procedure such as lockout, tagout, and safe electronic adjustments.

---

**Module Outline:**

- I. Safely Assemble or Disassemble Electronic Systems or Components
  - A. Explain and demonstrate the removal and installation of standard electronic components and assemblies (This may be accomplished by having the students assemble a working electronic module from component parts. The grade is predicated upon whether or not the module works.)
    1. Explain and demonstrate proper lock-out tag out procedures, and safety equipment required for electronic bench work
    2. Explain and demonstrate the proper methods for safely removing and installing electronic modules and subassemblies from enclosures
    3. Explain and demonstrate the proper methods for removing components from electronic modules
    4. Explain and demonstrate the proper methods for preparing electronic modules for resoldering



5. Explain and demonstrate the proper soldering tools and methods for resoldering components on electronic control modules and systems
  - B. Explain and demonstrate the removal and installation of power semiconductors
    1. Explain the purpose of air cooled, and fluid cooled heat sinks for power semiconductors and methods of heat conduction for insulated components
    2. Explain and demonstrate the removal and mounting of electronic power semiconductors for both types of heat sinks
  - C. Explain and demonstrate the removal and installation of surface mount technology (SMT) electronic components
    1. Explain the differences between through-hole technology electronic components, and SMT components
    2. Explain and demonstrate procedures for identifying SMT component parts such as resistors, capacitors, inductors, potentiometers, diodes, transistors, and integrated circuits
    3. Explain and demonstrate the proper tools used for removal and installation of SMT components
    4. Explain the methods of positioning, application of solder paste, heat application, and reflow of solder paste
    5. Explain the inspection of quality assurance of finished work
- II. Adjust Subsystems or Components of Electronic Systems
- A. Explain and demonstrate the proper methods of adjusting electronic motor controls
    1. Explain the purpose of the adjustments on the following types of electronic motor controls
      - a. Motor controls for DC shunt field and universal motors
        - (1) Current limit
        - (2) Current/resistance (IR) compensation
        - (3) Field weakening
        - (4) Max. speed/Min. speed
      - b. Motor controls for permanent magnet DC motors
        - (1) Current limit
        - (2) Current/resistance (IR) compensation
        - (3) Max. speed/Min. speed
      - c. Three phase, variable frequency controls for three phase AC motors
        - (1) Acceleration/deceleration
        - (2) Volts/Hertz ratio
        - (3) Instantaneous over current (IOC)
    2. Demonstrate the adjustment of the above controls and the effects of improper adjustment
  - B. Explain and demonstrate the proper methods of adjusting Proportional-band, Integral, and Derivative (PID) loops controllers

1. Explain the purpose and function of the following aspects of PID loop controllers
    - a. Proportional band
    - b. Integral
    - c. Derivative
  2. Explain the types of controllers that may belong to the PID control class
    - a. Bang-bang servos
    - b. Analog controllers
  3. Demonstrate the adjustment of the above and the expected results of improper adjustment
- C. Explain and demonstrate procedures for adjusting servo systems
1. Explain the electronic adjustments that are necessary for proper mechanical settings on various types of servo systems
    - a. Following error (steady state error)
    - b. Home position
    - c. Backlash compensation
  2. Explain the purpose of the following adjustments
    - a. Gain
    - b. Velocity stability
  3. Explain the interrelationships between the above adjustments and the effects upon the mechanism
  4. Demonstrate the adjustment of the above and the effects of improper adjustment

**AET-J4-LE**  
**Safely Assemble, Disassemble, or Adjust**  
**Electronic Systems or Components**  
**Attachment 2: MASTER Laboratory Exercise**

---

The student will:

1. Using an industrial electronic system, apply the concepts contained in this module; and,
2. Using an industrial electronic control process, such as a furnace or other process control, and a CNC servo system, apply the concepts contained in this module.

**AET-J4-LA**  
**Safely Assemble, Disassemble, or Adjust**  
**Electronic Systems or Components**  
**Attachment 3: MASTER Laboratory Aid**

---

**Rules of Conduct**

1. Absolutely no horseplay or practical joking will be tolerated.
2. Do not talk to anyone who is operating a machine.
3. Walk only in the designated traffic lanes.
4. Dress appropriately; at the absolute minimum, you must have:
  - a. No loose clothing, including ties;
  - b. Long hair properly stowed;
  - c. No jewelry;
  - d. Hard, closed-toe shoes;
  - e. Eye protection (safety glasses); and,
  - f. Ear protection (plugs or headset).
5. Follow all institutional safety rules.

# AUTOMATED EQUIPMENT REPAIR SERIES

## MASTER Technical Module No. AET-J5

---

<b>Subject:</b>	<b>Automated Equipment Repair</b>	<b>Time: 48 Hrs.</b>
<b>Duty:</b>	<b>Assemble/Disassemble Mechanical, Electrical, Electronic, and Computer Systems</b>	
<b>Task:</b>	<b>Safely Assemble or Disassemble Digital Systems or Components such as PLCs, CNCs, or Computers</b>	

---

### Objective(s):

Upon completion of this unit the student will be able to:

- a. Use the ordinary hand tools associated with installation and repair of industrial computer systems such as PLCs, CNC, Robot, and industrial computers;
- b. Identify computer subsystems such as; Central Processing Unit (CPU) modules or mother boards, power supplies, mass data storage devices, servo modules video cards, sound cards, and communication modules; and,
- c. Properly remove, install and configure common computer modules such as mother boards, power supplies, mass data storage devices, video cards, sound cards, and communication modules.

---

### Instructional Materials:

An industrial computer system and component parts such as a CNC or Robot control, and an industrial personal computer (PC)

Note: Not all facilities can gain access to an industrial computer system that can be experimented upon. Most systems are tied up in production schedules. Under these circumstances, the instructor may want to use common desk top PCS. Intel 286 based personal computers can be acquired as donations in quantity and a failure caused by a student is not critical. In addition, if the computer in question is an Intel based 386 or higher computer, experience in the UNIX based operating system can be obtained at no cost using the Linux operating system available on the Internet (search for keywords, "Linux"). Lab equipment such as the *"Graymark Commander PC Troubleshooting and Repair Training System"*, Latest Edition catalog (phone 1-800-854-7393) which provides experience in some of the major systems that comprise an computer system can be used. However, the most desirable

method of completing this module is hands-on experimentation with working, industrial CNC controls and computer equipment.

Hand tools such as chip extractors, and standard hand tools (see MASTER modules AET-J1, AET-J3, AET-J4)

MASTER Technical Module (AET-J5-HO)

MASTER Laboratory Exercise (AET-J5-LE)

MASTER Laboratory Aid (AET-J5-LA)

MASTER Quiz AET-J5-QU-1: Installing and configuring computer components and systems

---

## References:

In addition to the texts listed in modules AET H1 and AET I1, the following text is suggested:

*The Complete PC Upgrade & Maintenance Guide*, Minasi, Mark, ISBN 0-7821-1956-5, Latest Edition

*Graymark Commander PC Troubleshooting and Repair Training System*, Latest Edition

*Introducing Computers: Concepts, Systems, and Applications*, Robert H. Blissmer, ISBN 0-471-11360-3, Latest Edition

**Video(s):** *PC Maintenance & Repair*, Bergwall Productions, 1-800-645-3565, Latest Edition

*Troubleshooting PC Hardware*, Bergwall Productions, 1-800-645-3565, Latest Edition

---

## Student Preparation:

Students should have previously completed the following Technical Modules (at a minimum, the student should have competency in, or have completed all, of the following module categories):

**AET-A1 through AET-A13** “Apply Science to Solve Industrial Problems” series

**AET-B1 through AET-B5** “Use Drawings to Analyze and Repair Systems” series

**AET-C3** “Apply Electronic Measurement Knowledge and Instruments to Test/Calibrate Electronic Circuits”

**AET-C5** “Use Symbols, Organization, and Engineering Values on Digital Drawings”

**AET-D1** “Resolve System Failures with Critical Thinking, Troubleshooting, Theory, and Metrology” series

**AET-E1 through AET-E13** “Use Techniques to Isolate Malfunctions of Electrical/Electronic Systems” series

- AET-H1 "Correct Malfunctions in PLC Controlled Industrial Equipment" series
- AET-I1 "Resolve Malfunctions Found in Computer Systems Controlling Manufacturing Processes" series
- AET-J1 "Safely Assemble, Disassemble, and Adjust Mechanical Systems such as Gearing Systems, Shafts, Couplings, Pulleys, Belts"
- AET-J4 "Safely Assemble, Disassemble or Adjust Electronic Systems or Components"

Note: This module is meant to be used in conjunction with modules AET-H1 and AET-I1.

---

---

### **Introduction:**

After the troubleshooting process has resulted in the identification of a subsystem or component that is malfunctioning, the technician's next job is to remove, repair, replace and/or adjust the defective component. This frequently involves the assembly or disassembly of computer systems or computer based controls. A computer procedure should be approached in a planned, organized manner, with plenty of fore thought as to the steps that will be taken during the process. Performing quality computer work requires the proper application of hand tools, the ability to perform common mechanical procedures, and knowledge of electronic procedures. In addition, the technician must be proficient in performing procedures specific to computer control systems such as; removing, and installing, computer modules in computer based control systems, and industrial computers. After the defective module has been replaced, and the system has been re-assembled, subsystems must be configured to the values specified by the control documentation. In addition, the technician must know the software procedures such as use of the disk operating system (DOS) or graphic user interface (GUI) that may be required for configuring various computer components and subsystems.

---

---

### **Presentation Outline:**

- I. Safely Assemble or Disassemble Industrial Computer Systems such as Programmable Logic Controllers (PLC), CNC and Robot Controls, and Industrial Computer Systems
  - A. Explain and demonstrate the removal and installation of standard computer components and assemblies (This may be accomplished by having the students assemble a working computer from component parts. The grade is predicated upon whether or not the computer works properly.)
    - 1. Explain and demonstrate proper safety procedures and equipment required for computer bench work

2. Explain and demonstrate the proper methods for safely removing and installing computer modules and subassemblies from enclosures. such as Central Processing Unit (CPU) modules or motherboards, power supplies, mass data storage devices, servo modules video cards, sound cards, and communication modules
  3. Explain and demonstrate the use of disk operating systems in configuring computer components and modules such as. Central Processing Unit (CPU) modules or motherboards, power supplies, mass data storage devices, servo modules video cards, sound cards, and communication modules
- B. Explain and demonstrate the removal and installation of computer subassemblies from industrial CNC controls or robot controls
1. Identify subassemblies such as CPUs motherboards, power supplies, add-on modules and servo modules
  2. Explain and demonstrate the removal and mounting of Read Only Memory chips to configure the module for the application
  3. Demonstrate the removal of connectors and wiring harnesses and the proper identification and documentation of wiring harnesses
- C. Explain and demonstrate the removal and installation of programmable logic controller modules (PLC) and subassemblies (This may vary with the type of PLC. At least one example of a modular PLC should be used for training.)
1. Identify and explain the functions of each of the modules and their proper placement on the back plane (mother board or bus)
  2. Explain and demonstrate the proper tools used for removal and installation of PLC modules
  3. Explain and demonstrate procedures for wiring swing arms or edge connectors to field devices
  4. Explain the methods of mounting PLC enclosures
  5. Explain the inspection of quality assurance of finished work

---

---

**Practical Application:**

1. Using an industrial computer system, CNC or robot control, apply the concepts contained in this module.

---

---

**Evaluation and/or Verification:**

Successful completion of this technical module will be based on the student's successful completion of the following components:



1. A twenty question quiz on the industrial application of the concepts contained in this module (MASTER Quiz AET-J5-QU-1: Installing and wiring, and configuring computer components and modules);
2. Completion of selected laboratory experiences in assembling/disassembling computer systems/modules; and,
3. Demonstrate competency in the ability to assemble/disassemble computer systems/modules.

---

---

**Summary:**

Review the main lesson points using the texts and handouts listed in the reference section of this module. Hold class discussion and answer student questions.

---

---

**Next Lesson Assignment:**

This completes the Automated Equipment Repair Technical Modules.

**AET-J5-HO**  
**Safely Assemble or Disassemble Digital Systems or Components**  
**such as PLCs, CNCs, or Computers**  
**Attachment 1: MASTER Handout**

---

**Objective(s):**

Upon completion of this unit the student will be able to:

- a. Use the ordinary hand tools associated with installation and repair of industrial computer systems such as PLCs, CNC, Robot, and industrial computers;
- b. Identify computer subsystems such as; Central Processing Unit (CPU) modules or mother boards, power supplies, mass data storage devices, servo modules video cards, sound cards, and communication modules; and,
- c. Properly remove, install and configure common computer modules such as mother boards, power supplies, mass data storage devices, video cards, sound cards, and communication modules.

---

**Module Outline:**

- I. Safely Assemble or Disassemble Industrial Computer Systems such as Programmable Logic Controllers (PLC), CNC and Robot Controls, and Industrial Computer Systems
  - A. Explain and demonstrate the removal and installation of standard computer components and assemblies (This may be accomplished by having the students assemble a working computer from component parts. The grade is predicated upon whether or not the computer works properly.)
    1. Explain and demonstrate proper safety procedures and equipment required for computer bench work
    2. Explain and demonstrate the proper methods for safely removing and installing computer modules and subassemblies from enclosures. such as Central Processing Unit (CPU) modules or motherboards, power supplies, mass data storage devices, servo modules video cards, sound cards, and communication modules
    3. Explain and demonstrate the use of disk operating systems in configuring computer components and modules such as. Central Processing Unit (CPU) modules or motherboards, power supplies, mass data storage devices, servo modules video cards, sound cards, and communication modules
  - B. Explain and demonstrate the removal and installation of computer subassemblies from industrial CNC controls or robot controls

1. Identify subassemblies such as CPUs motherboards, power supplies, add-on modules and servo modules
  2. Explain and demonstrate the removal and mounting of Read Only Memory chips to configure the module for the application
  3. Demonstrate the removal of connectors and wiring harnesses and the proper identification and documentation of wiring harnesses
- C. Explain and demonstrate the removal and installation of programmable logic controller modules (PLC) and subassemblies (This may vary with the type of PLC. At least one example of a modular PLC should be used for training.)
1. Identify and explain the functions of each of the modules and their proper placement on the back plane (mother board or bus)
  2. Explain and demonstrate the proper tools used for removal and installation of PLC modules
  3. Explain and demonstrate procedures for wiring swing arms or edge connectors to field devices
  4. Explain the methods of mounting PLC enclosures
  5. Explain the inspection of quality assurance of finished work

**AET-J5-LE**  
**Safely Assemble or Disassemble Digital Systems or Components**  
**such as PLCs, CNCs, or Computers**  
**Attachment 2: MASTER Laboratory Exercise**

---

The student will:

1. Using an industrial computer system, CNC or robot control, apply the concepts contained in this module.

**AET-J5-LA**  
**Safely Assemble or Disassemble Digital Systems or Components**  
**such as PLCs, CNCs, or Computers**  
**Attachment 3: MASTER Laboratory Aid**

---

**Rules of Conduct**

1. Absolutely no horseplay or practical joking will be tolerated.
2. Do not talk to anyone who is operating a machine.
3. Walk only in the designated traffic lanes.
4. Dress appropriately; at the absolute minimum, you must have:
  - a. No loose clothing, including ties;
  - b. Long hair properly stowed;
  - c. No jewelry;
  - d. Hard, closed-toe shoes;
  - e. Eye protection (safety glasses); and,
  - f. Ear protection (plugs or headset).
5. Follow all institutional safety rules.

*a consortium of educators and industry*

EDUCATIONAL RESOURCES  
FOR THE  
MACHINE TOOL INDUSTRY



*Automated Equipment Repair Series*  
STUDENT LABORATORY MANUAL

BEST COPY AVAILABLE

853

Supported by the National Science Foundation's Advanced Technological Education Program

*a consortium of educators and industry*

EDUCATIONAL RESOURCES  
FOR THE  
MACHINE TOOL INDUSTRY



*Automated Equipment Repair Series*  
STUDENT LABORATORY MANUAL

*Supported by the National Science Foundation's Advanced Technological Education Program*



This material is based upon work supported by the  
National Science Foundation under Grant No. DUE-9553716

**National Science Foundation  
Advanced Technological  
Education Program**

"Any opinions, findings, and conclusions or recommendations  
expressed in this material are those of the author(s) and do  
not necessarily reflect the views of the Foundation."



**NOTE:**

Any references to **Handouts, Laboratory Exercises, Laboratory Aids, or Quizzes**, or any other materials that are not included in this book, may be obtained by contacting:

**Professor Douglas Welch**

***dwelch@cact-sd.org***  
(work web address)

**1-619-230-2080**  
(work phone number)

# ACKNOWLEDGEMENTS

This project was made possible by the cooperation and direct support of the following organizations:

National Science Foundation - Division of Undergraduate Education  
MASTER Consortia of Employers and Educators

*MASTER has built upon the foundation which was laid by the Machine Tool Advanced Skills Technology (MAST) Program. The MAST Program was supported by the U.S. Department of Education - Office of Vocational and Adult Education. Without this prior support MASTER could not have reached the level of quality and quantity that is contained in these project deliverables.*

## MASTER DEVELOPMENT CENTERS

Augusta Technical Institute - Central Florida Community College - Itawamba Community College - Moraine Valley Community College - San Diego City College (CACT) - Springfield Technical Community College - Texas State Technical College

## INDUSTRIES

AB Lasers - AIRCAP/MTD - ALCOA - American Saw - AMOCO Performance Products - Automatic Switch Company - Bell Helicopter - Bowen Tool - Brunner - Chrysler Corp. - Chrysler Technologies - Conveyor Plus - Darr Caterpillar - Davis Technologies - Delta International - Devon - D. J. Plastics - Eaton Leonard - EBTEC - Electro-Motive - Emergency One - Eureka - Foster Mold - GeoDiamond/Smith International - Greenfield Industries - Hunter Douglas - Industrial Laser - ITT Engineered Valve - Kaiser Aluminum - Krueger International - Laser Fare - Laser Services - Lockheed Martin - McDonnell Douglas - Mercury Tool - NASSCO - NutraSweet - Rapistan DEMAG - Reed Tool - ROHR, International - Searle - Solar Turbine - Southwest Fabricators - Smith & Wesson - Standard Refrigeration - Super Sagless - Taylor Guitars - Tecumseh - Teledyne Ryan - Thermal Ceramics - Thomas Lighting - FMC, United Defense - United Technologies Hamilton Standard

## COLLEGE AFFILIATES

Aiken Technical College - Bevil Center for Advanced Manufacturing Technology - Chicago Manufacturing Technology Extension Center - Great Lakes Manufacturing Technology Center - Indiana Vocational Technical College - Milwaukee Area Technical College - Okaloosa-Walton Community College - Piedmont Technical College - Pueblo Community College - Salt Lake Community College - Spokane Community College - Texas State Technical Colleges at Harlington, Marshall, Sweetwater

## FEDERAL LABS

Jet Propulsion Lab - Lawrence Livermore National Laboratory - L.B.J. Space Center (NASA) - Los Alamos Laboratory - Oak Ridge National Laboratory - Sandia National Laboratory - Several National Institute of Standards and Technology Centers (NIST) - Tank Automotive Research and Development Center (TARDEC) - Wright Laboratories

## SECONDARY SCHOOLS

Aiken Career Center - Chicopee Comprehensive High School - Community High School (Moraine, IL) - Connally ISD - Consolidated High School - Evans High - Greenwood Vocational School - Hoover Sr. High - Killeen ISD - LaVega ISD - Lincoln Sr. High - Marlin ISD - Midway ISD - Moraine Area Career Center - Morse Sr. High - Point Lamar Sr. High -

Pontotoc Ridge Area Vocational Center - Putnam Vocational High School - San Diego Sr. High - Tupelo-Lee Vocational Center - Waco ISD - Westfield Vocational High School

### **ASSOCIATIONS**

American Vocational Association (AVA) - Center for Occupational Research and Development (CORD) - CIM in Higher Education (CIMHE) - Heart of Texas Tech-Prep - Midwest (Michigan) Manufacturing Technology Center (MMTC) - National Coalition For Advanced Manufacturing (NACFAM) - National Coalition of Advanced Technology Centers (NCATC) - National Skills Standards Pilot Programs - National Tooling and Machining Association (NTMA) - New York Manufacturing Extension Partnership (NYMEP) - Precision Metalforming Association (PMA) - Society of Manufacturing Engineers (SME) - Southeast Manufacturing Technology Center (SMTC)

### **MASTER PROJECT EVALUATORS**

Dr. James Hales, East Tennessee State University and William Ruxton, formerly with the National Tooling and Machine Association (NTMA)

### **NATIONAL ADVISORY COUNCIL MEMBERS**

The National Advisory Council has provided input and guidance into the project since the beginning. Without their contributions, MASTER could not have been nearly as successful as it has been. Much appreciation and thanks go to each of the members of this committee from the project team.

Dr. Hugh Rogers-Dean of Technology-Central Florida Community College

Dr. Don Clark-Professor Emeritus-Texas A&M University

Dr. Don Edwards-Department of Management-Baylor University

Dr. Jon Botsford-Vice President for Technology-Pueblo Community College

Mr. Robert Swanson-Administrator of Human Resources-Bell Helicopter, TEXTRON

Mr. Jack Peck-Vice President of Manufacturing-Mercury Tool & Die

Mr. Don Hancock-Superintendent-Connally ISD

### **SPECIAL RECOGNITION**

Dr. Hugh Rogers recognized the need for this project, developed the baseline concepts and methodology, and pulled together industrial and academic partners from across the nation into a solid consortium. Special thanks and singular congratulations go to Dr. Rogers for his extraordinary efforts in this endeavor.

Dr. Don Pierson served as the Principal Investigator for the first two years of MASTER. His input and guidance of the project during the formative years was of tremendous value to the project team. Special thanks and best wishes go to Dr. Pierson during his retirement and all his worldly travels.

---

***All findings and deliverables resulting from MASTER are primarily based upon information provided by the above companies, schools and labs. We sincerely thank key personnel within these organizations for their commitment and dedication to this project. Including the national survey, more than 2,800 other companies and organizations participated in this project. We commend their efforts in our combined attempt to reach some common ground in precision manufacturing skills standards and curriculum development.***

---

**MASTER DEVELOPMENT CENTER, SAN DIEGO, CA**  
**Center for Applied Competitive Technologies**  
**San Diego City College**

Augustine P. Gallego, Chancellor  
San Diego Community College District  
Jerome Hunter, President  
San Diego City College  
Joan A. Stepsis, Dean/Director  
Center for Applied Competitive Technologies

1313 Twelfth Avenue  
San Diego, CA 92101-4787  
College phone: 619/230-2453, fax: 619/230-2063  
e-mail: [jhunter@sdccd.cc.ca.us](mailto:jhunter@sdccd.cc.ca.us)  
Center phone: 619/230-2080, fax: 619/230-2162  
e-mail: [jstopsis@sdccd.cc.ca.us](mailto:jstopsis@sdccd.cc.ca.us)

---

### **Manufacturing in the San Diego Region**

Manufacturing represents a major sector of the San Diego economy, accounting for almost one out of every four dollars (24%) of San Diego's gross regional product. The county is currently home to approximately 3,500 manufacturers employing roughly 110,000 San Diegans. During the first half of the 1990s, manufacturing in San Diego was hard hit by the downturn in military and defense spending which accompanied the end of the cold war. Many of the region's largest aerospace contractors rapidly downsized or moved their plants out of state, leaving a large supplier base that needed to modernize its manufacturing processes and convert to commercial markets. Rapid recovery of manufacturing in the region has been driven by San Diego's high tech research and development sectors in electronics, telecommunications, software, advanced materials, biotechnology, and medical instrumentation.

### **San Diego City College and its Center for Applied Competitive Technologies (CACT)**

San Diego City College is an urban, minority institution, serving a large population of students from immigrant, disadvantaged, and low income households. In 1990, the College saw an opportunity to modernize its technical programs and improve the employment outlook for many of its students by agreeing to host one of the State of California's eight new regional manufacturing extension centers, the Centers for Applied Competitive Technologies (CACTs). The advanced technology centers were designed to assist local companies to modernize their manufacturing processes and convert from defense to newly emerging, technology-based commercial markets. This strategic partnership between the College and its resident CACT has proven to be highly successful. In developing the programs and lab facilities to serve the needs of regional manufacturing companies, the San Diego CACT and City College have simultaneously modernized the manufacturing and machine technology credit offerings of the College, thereby providing a well-trained, technically competent workforce for industry and enhancing career opportunities for students.

### **Development Team**

- **Project Director:** Joan A. Stepsis, Ph.D., Dean/Director of the CACT-SD, served as programmatic manager and academic coordinator for the MASTER project.
- **Subject Matter Expert:** John C. Bollinger, Assoc. Prof. of Machine Technology, had programmatic responsibility for developing skill standards and course/program materials for the Advanced CNC and CAM component of the MASTER project. Professor Bollinger also served as the lead instructor for the MASTER instructional pilot for his specialty area.
- **Subject Matter Expert:** Douglas R. Welch, Assoc. Prof. of Manufacturing, had programmatic responsibility for developing skill standards and course/program materials for the Automated Equipment Technology (AET) and Machine Tool Integration (CIM) component of the MASTER project. Professor Welch also served as lead instructor for the MASTER instructional pilot for his specialty area.

# **Introduction:**

## **STUDENT LABORATORY MANUAL**

Prior to the development of this Student Laboratory Manual, MASTER project staff visited over 150 companies, conducted interviews with over 500 expert workers, and analyzed data from a national survey involving over 2800 participating companies. These investigations led to the development of a series of Instructor Handbooks, with each being fully industry-driven and specific to one of the technologies shown below:

Advanced CNC and CAM  
Automated Equipment Repair  
Computer Aided Design & Drafting  
Conventional Machining  
Industrial Maintenance  
Instrumentation  
LASER Machining  
Manufacturing Technology  
Mold Making  
Tool And Die  
Welding

Each Instructor's Handbook contains a collection of Technical Training Modules which are built around a Competency Profile for the specific occupation. **The Competency Profile which is the basis for this Student Laboratory Manual may be found on the following page (and on each of the tab pages in this book).**

This Student Laboratory Manual has been developed as an learning aid for both the instructor and for the student, and is intended to be used in conjunction with the Instructor's Handbook.

This Student Laboratory Manual is arranged by Duty groupings (Duty A, Duty B, etc.) with learning modules available for each Task Box on the Competency Profile.

This Student Laboratory Manual is supplied with an accompanying Instructor's Handbook for use by the instructor.

Each module in the Instructor's Handbook has a corresponding learning module in the Student Laboratory Manual.

**AUTOMATED EQUIPMENT REPAIR TECHNICIAN ... operates, programs, maintains, and repairs automated machine tools and automated manufacturing processes.**

**Duties**

**Tasks**

Duties	A-1 Apply scientific notation and solve technical problems	A-2 Apply algebraic formulas to solve technical problems	A-3 Use variables in algebraic formulas to predict behavior of mechanical systems	A-4 Manipulate variables in algebraic formulas to analyze industrial systems	A-5 Measure, convert, quantify, and use in English units	A-6 Use mechanical physics to analyze mechanical systems	A-7 Use mechanical physics to analyze mechanical systems	A-8 Use mathematical problems found in hydraulic and pneumatic systems	A-9 Use mathematical problems to analyze dynamic systems	A-10 Use mathematical physics to analyze industrial systems	A-11 Use chemical formulas to predict and analyze reactions in industrial processes	A-12 Apply the effects of electrochemical processes to analyze industrial water treatment processes	A-13 Apply properties of chemical processes to analyze industrial water treatment processes
<b>A</b> Apply Science to Industrial Problems	B-1 Use symbols, organization, and values on mechanical drawings	B-2 Use symbols, organization, and values on electrical drawings	B-3 Use symbols, organization, and values on electronic drawings	B-4 Use symbols, organization, and values on power drawings	B-5 Use organization, and values on digital drawings								
<b>B</b> Use Drawings to Analyze and Repair Systems	C-1 Apply mechanical measurement instruments to align machine tools	C-2 Apply electrical measurement instruments to test/calibrate electrical circuits	C-3 Apply electronic measurement instruments to test/calibrate electronic circuits	C-4 Apply fluid power measurement instruments to test/calibrate hydraulic and pneumatic systems	C-5 Apply digital electronic measurement instruments to test/calibrate digital electronic circuits								
<b>C</b> Use Calibrated Measuring Instruments to Test/Calibrate Components	D-1 Apply the troubleshooting process to the resolution of malfunctions in industrial machine tools and automated equipment												
<b>D</b> Resolve System Failures with Critical Thinking, Problem Solving, Theory, and Metrology	E-1 Calculate, measure, and respond to quantities in DC circuits	E-2 Calculate, measure, and respond to quantities in AC circuits	E-3 Calculate, measure, and phase angle in AC circuits	E-4 Calculate, measure, and quantities in poly-phase AC circuits	E-5 Properly set and use meters and oscilloscopes	E-6 Use components in series, parallel, and bridge circuits and test components	E-7 Use meters to measure phase shift or angle in series resistive, inductive, capacitive, resistive, and AC circuits	E-8 Apply electro-magnetic theory to electrical characteristics of relays, solenoids, transformers, and special motors for DC and AC circuits	E-9 Apply principles of operation to identify various types of motors	E-10 Apply semiconductor theory to determine operational characteristics of diodes, transistors, thyristors, and power control semiconductor devices	E-11 Apply semiconductor theory to determine operational characteristics of diodes, transistors, thyristors, and power control semiconductor devices	E-12 Apply semiconductor theory to determine operational characteristics of diodes, transistors, thyristors, and power control semiconductor devices	E-13 Use schematic diagrams, meters, and oscilloscopes to identify, troubleshoot, or replace variable components in electronic motor control circuits
<b>E</b> Use Techniques to Test/Calibrate Electrical/Electronic Systems	F-1 Explain the theory and use of valves in a hydraulic or pneumatic system	F-2 Apply purpose and use of valves in a hydraulic or pneumatic system	F-3 Identify, assemble, measure, and apply knowledge of hydraulic and pneumatic actuators	F-4 Apply hydraulic, pneumatic, and high vacuum systems knowledge to troubleshoot, repair, and special components	F-5 Identify, assemble, measure, and apply knowledge of specialized fluid power circuits	F-6 Identify, assemble, measure, and apply knowledge of operating electrical specialized fluid power circuits	F-7 Use laws of simple machines and physics to identify and troubleshoot complex machines	F-8 Apply hydraulic, pneumatic, and high vacuum systems test, troubleshoot, and repair high purity, high vacuum systems					
<b>F</b> Measure/Isolate Malfunctions of Mechanical/Fluid Power Systems	G-1 Perform digital operations in digital numbering systems	G-2 Perform Boolean operations in digital equipment	G-3 Solve digital logic diagrams in electrical and programmable logic circuits; express a complex logic problem in Boolean logic	G-4 Program computer controlled industrial equipment									
<b>G</b> Apply Computer Science to Computer and Industrial Equipment	H-1 Perform operations on PLC programmable logic controller or PLC (programmable interface controller) systems												
<b>H</b> Correct Malfunctions in Controlled Equipment	I-1 Use equipment manufacturer's specifications to monitor devices to configure, test, and troubleshoot set system and solve control problems												
<b>I</b> Resolve Malfunctions Found in Systems Controlling Manufacturing Processes	J-1 Safely assemble, disassemble, and adjust mechanical systems such as gearing systems, pumps, ball	J-2 Safely assemble, disassemble, and adjust components of fluid power systems	J-3 Safely assemble, disassemble, and adjust electrical systems or components	J-4 Safely assemble, disassemble, and adjust electronic systems or components	J-5 Safely assemble or disassemble PLCs, CNCs, or computers								
<b>J</b> Assemble/Disassemble Mechanical/Electrical/Electronic, and Computer Systems													



**AUTOMATED EQUIPMENT REPAIR TECHNICIAN ... operates, programs, maintains, and repairs automated machine tools and automated manufacturing processes.**

**Duties**

**Tasks**

Duties	A-1 Apply scientific notation and solve technical problems	A-2 Apply algebraic formulas to solve technical problems	A-3 Use symbols, formulas to predict behavior of industrial system	A-4 Manipulate algebraic formulas to analyze industrial systems	A-5 Measure, calculate, and convert quantities in English units to metric units of measurement	A-6 Use mechanical physics to analyze mechanical systems	A-7 Use mechanical physics to analyze mechanical systems	A-8 Use math and physics to analyze problems found in hydraulic and pneumatic systems	A-9 Use math and thermodynamics to analyze problems found in industrial systems	A-10 Use math, physics, and electrical engineering to analyze industrial systems	A-11 Use chemical principles and formulas to predict and analyze reactions in industrial processes	A-12 Apply chemical knowledge to analyze effects of chemical processes	A-13 Apply knowledge of water treatment processes
<b>A</b> Apply Science to Solve Industrial Problems													
<b>B</b> Use Drawings and Repair Systems													
<b>C</b> Use Calibrated Instruments to Measure Machine Components													
<b>D</b> Recognize System Failures with Critical Thinking, Troubleshooting, Theory, and Metrology													
<b>E</b> Use Techniques to Isolate Functions of Electronic Systems													
<b>F</b> Measure/Isolate Mechanical/Fluid Power Systems													
<b>G</b> Apply Computer Science to Computer Controlled Equipment													
<b>H</b> Correct Malfunctions in PLC Controlled Industrial Equipment													
<b>I</b> Resolve Malfunctions Found in Computer Systems and Manufacturing Processes													
<b>J</b> Assemble/Disassemble Mechanical and Electronic Computer Systems													

**AET-A1-HO-1**  
**Apply Scientific Notation and Engineering Notation**  
**to Solve Technical Problems**  
**Attachment 1: MASTER Handout No. 1**

---

**Objective(s):**

Upon completion of this unit the student will be able to use scientific notation and engineering notation to express mathematical values that are given or obtained by measurement, and apply these mathematical values to the solution of technical problems.

---

**Module Outline:**

- I. Apply Scientific Notation
  - A. Discuss the organization and rationale for the decimal system
    - 1. History, ten fingers, ten toes, other numbering systems
    - 2. Divide a multi-column decimal number into its component parts
    - 3. Show how each column is a power of ten with a multiplier
  - B. Discuss the organization of a decimal number in scientific notation
    - 1. Define the multiplier
    - 2. Define the powers of ten
  - C. Demonstrate the creation of a number in scientific notation
    - 1. Take examples from the audience
    - 2. Measure dimensions of mechanical parts and electronic measurements
    - 3. Use measurements taken from atoms and celestial objects
    - 4. Create numbers in scientific notation from examples
  - D. Demonstrate procedures for using a scientific calculator to calculate problems in scientific notation
- II. Apply Engineering Notation
  - A. Discuss the organization and rationale for the engineering notation system
    - 1. Used for clarity on engineering drawings and specifications
    - 2. Discuss alphabetical symbols associated with engineering notation
    - 3. Show how each symbol is a power of ten
    - 4. Discuss the numeric value of the multiplier
  - B. Discuss the organization of a decimal number in engineering notation
    - 1. Define the multiplier
    - 2. Define the alphabetic symbol for powers of ten
  - C. Demonstrate the creation of a number in engineering notation
    - 1. Take examples from the audience and examples from scientific notation



2. Explain the resistor color codes
  3. Use measurements taken from mechanisms, hydraulics, and electronics
  4. Create numbers in engineering notation from examples
  5. Demonstrate the results on the engineering notation symbols when engineering notation numbers are multiplied and divided
- D. Demonstrate procedures for using a scientific calculator to calculate problems in engineering notation

**AET-A1-HO-2**  
**Apply Scientific Notation and Engineering Notation**  
**to Solve Technical Problems**  
Attachment 2: MASTER Handout No. 2

---

**The Fifteen Rules of Math**  
**Necessary to Solve Any Technical Algebra Problem or Equation**  
**Definitions**

<b>Variable</b>	A general symbolic letter term used to define a mathematical relationship. Also a letter that represents an unknown number. A variable may be multiplied, divided, added, subtracted, etc., like any other real number.
<b>Coefficient</b>	A real number that indicates the quantity of variables in question. For example, $3x$ means that I have 3 of the $x$ variables. The number 3 is the coefficient of $x$ . A variable by itself has an implied coefficient of 1.
<b>Constant</b>	A real number whose value is known and can never change.
<b>Polynomial</b>	An algebraic expression containing two or more terms that are associated by addition or subtraction.
<b>Equation</b>	A monomial or polynomial that is set equal to another value (constant, monomial, or polynomial).
<b>Exponent</b>	A number that indicates how many times I need to multiply a number by itself. For example, $x^3$ means that I need to multiply $x$ by $x$ three times. The number 3 is the exponent.
<b>Reciprocal</b>	A number that is divided into 1.
<b>Base</b>	The number that will be raised to a power by an exponent.
<b>Negative number</b>	The mirror image of a positive number. For every positive real number, a negative counterpart exists. Negative numbers are used extensively in math, but have no

realistic counterparts in the real world. However, most important discoveries have been made using the negative number concept.

1. ***The rules of addition, subtraction, multiplication, and division of positive and negative numbers:***
  - A. When adding number that have like signs, add the numbers and give the result the same sign. When adding numbers of unlike signs, subtract the smaller number from the larger number and give the result the sign of the larger number.
  - B. When subtracting any combination of signed numbers, alike or unlike, change the sign of the number or expression that is being subtracted from another number to the opposite sign, and proceed as in addition. Use the following rules:
    - (1) If the sign of the number or expression is negative, change it to positive.
    - (2) If the sign is positive, change it to negative.
  - C. When multiplying signed numbers, if the signs are the same (both positive or negative) the result is positive. If the signs are unlike, the result is negative.
  - D. When dividing signed numbers, if the signs are the same (both positive or negative) the result is positive. If the signs are unlike, the result is negative.
2. ***The addition, subtraction, multiplication, and division axioms:***
  - A. If equals are added to equals, then the results will be equal.
  - B. If equals are subtracted from equals, then the results will be equal.
  - C. If equals are multiplied by equals, then the results will be equal.
  - D. If equals are divided by equals, then the results will be equal.
3. ***The order of operations - Please Excuse My Dear Aunt Sally***  
Parentheses, Exponents, Multiplication, Division, Addition, Subtraction.  
(Also perform operations from left to right).
4. ***The associative rule - The order of grouping is not important to the outcome for addition and multiplication.***  
Examples:  
$$a + b + c = (a + b) + c = a + (b + c)$$
$$a*b*c = (a*b)*c = a*(b*c)$$
5. ***The distributive rule - When a polynomial is multiplied by a variable, constant, or other polynomial, the variable, constant, or polynomial is multiplied by each term in the polynomial.***

Examples:

$$a(b + c + d) = ab + ac + ad$$

$$2x(a + b - c) = 2xa + 2xb - 2xc$$

$$5y(2y + 3x) = 10y^2 + 15xy$$

**6. *The identity rule - Equals are Equal to Equals.***

Examples:

$$a = a \quad x = x$$

If  $X = B$  and  $Y$  equals  $B$  then  $X = Y$

$$\text{If } X = 2a + 3c \text{ and } X = 4y + 5b \text{ then } 2a + 3c = 4y + 5b$$

**7. *If a number is multiplied by its reciprocal, the result is one.***

$$a * 1/a = 1$$

(also applies to dividing a number by itself)

**8. *If any number is multiplied by zero the result is zero.***

$$a * 0 = 0$$

**9. *All constants or variables have an implied coefficient of one.***

$$a = 1*a$$

$$14 = 1*(14)$$

(also applies to multiplying a number by one)

**10. *Division of a variable by zero is undefined and a illegal operation.***

$$x/0 = ?$$

**11. *Any number raised to the zero (0) power is one (1). Any number raised to the first (1) power is the number itself.***

Examples:

$$a^0 = 1$$

$$1,234,567,123,456,123,345,567,999^0 = 1$$

$$a^1 = a$$

$$10,234^1 = 10,234$$

**12. *When two equal number bases, raised to a power, are multiplied times each other, the exponents are added.***

Examples:

$$a^2 * a^4 = a^6$$

$$X^a * X^b = X^{(a+b)}$$

(the numbers *must* be the same base)

**13. *When two equal number bases, raised to a power, are divided, the exponents are subtracted.***

Examples:

$$a^2 / a^4 = a^{-2}$$

$$X^a / X^b = X^{(a-b)}$$

(the numbers *must* be the same base)

14. *When a number, raised to a power, is again raised to a power, the exponents are multiplied times each other.*

Examples:

$$(a^2)^3 = a^6$$

$$(x^3)^4 = x^{12}$$

15. *A number raised to a negative power is the reciprocal of the number multiplied by itself that number of times.*

Examples:

$$X^{-3} = 1/X * 1/X * 1/X = 1/X^3$$

$$10^{-4} = 1/10 * 1/10 * 1/10 * 1/10 = 1/10^4$$

**AET-A1-HO-3**  
**Apply Scientific Notation and Engineering Notation**  
**to Solve Technical Problems**  
**Attachment 3: MASTER Handout No. 3**

---

**Math Quick Reference**

1. **Goal: To understand the convention for stating math formulas for mathematical rules (not applied math).**  
x, y, z,... represents a variable in a math formula  
a, b, c,... represents a number in a math formula
  
2. **Goal: To understand the rules for adding, subtracting, multiplying, and dividing signed numbers.**

**Addition: For a = 15 and b = 6**

When a is plus and b is plus:  $(+a)+(+b) = +(a+b)$

Example  $(+15)+(+6) = +(15+6) = +21$

When a is minus and b is minus:  $(-a)+(-b) = -(a+b)$

Example  $(-15)+(-6) = -(15+6) = -21$

When a or b is minus, and the remaining quantity is plus  $(-a)+(+b) =$   
or  $(+a)+(-b) = ?$  **Take the smaller number from the larger number**  
**and give the result the sign of the larger number.**

Example:  $(-15) + (+6) = -(15-6) = -9$  (the larger number is -15)

or

Example:  $(+15) + (-6) = +(15-6) = +9$  (the larger number is +15)

**Subtraction:**

When the subtrahend is "b"  $(a)-(b) = ?$

**To avoid confusion, always change the sign (plus or minus) of "b" and proceed as in addition.**

**To change the sign of b, use the following rules:**

If b is positive  $-(+b)$  then change to -b

If b is negative  $-(-b)$  then change to +b

Example: For a = +19 and b = +7

$$(+19)-(+7) = (+19) + (-7) = +(19-7) = +12$$

Example: For a = -19 and b = +7

$$(-19)-(+7) = (-19) + (-7) = -(19+7) = -26$$

### Multiplication:

If both a and b are positive  $(+a)*(+b) = +(ab)$

If both a and b are negative  $(-a)*(-b) = +(ab)$

If either a or b are negative:

$$(-a)*(+b) = -(ab)$$

or

$$(+a)*(-b) = -(ab)$$

Example: For a = 12 and b = 3

$$(+12)*(+3) = +(12*3) = +36$$

Example: For a = -12 and b = -3

$$(-12)*(-3) = +(12*3) = +36$$

Example: For a = -12 and b = +3

$$(-12)*(+3) = -(12*3) = -36$$

### Division:

If both a and b are positive  $(+a)/(+b) = +(a/b)$

If both a and b are negative  $(-a)/(-b) = +(a/b)$

If either a or b are negative:

$$(+a)/(-b) = -(a/b)$$

or

$$(-a)/(+b) = -(a/b)$$

Example: For a = 12 and b = 3

$$(+12)/(+3) = +(12/3) = +4$$

Example: For a = -12 and b = -3

$$(-12)/(-3) = +(12/3) = +4$$

Example: For a = -12 and b = +3

$$(-12)/(+3) = -(12/3) = -4$$

Example: For a = +12 and b = -3

$$(+12)/(-3) = -(12/3) = -4$$

### 3. Goal: To understand the rules for exponents

For  $a^N$ : "a" is called the *base*. " $N$ " is called the *exponent*.

If a is multiplied by itself " $N$ " number of times:  $a*a*a*a...a^N = a^N$

Example: For a = 4

$$4*4*4 = 4^3$$

$$a*a*a*a*a = a^5$$

$$(1/a)*(1/a)*(1/a)...*(1/a^N) = a^{-N}$$

Example: For  $a = 10$   
 $(1/10) * (1/10) * (1/10) = 10^{-3}$

Special cases of exponents:

$$a^0 = 1$$

$$a^1 = a$$

**Note: Bases must be the same!**

Multiplication of Exponents

$$a^b * a^c = a^{(b+c)}$$

Division of Exponents:

$$a^b / a^c = a^{(b-c)}$$

4. **Goal: To understand the reason for using scientific notation, and the rules for scientific notation.**

Scientific notation is primarily used to multiply and divide very large and very small numbers.

A number expressed in scientific notation consists of a *multiplier* equal to or greater than 1 and less than 10, and a *base* of 10 raised to a power.

Example: 12,560,000 and .000748

Multiplier	Times	Base 10
1.256	*	$10^7$
7.48	*	$10^{-4}$

**To combine the bases, use the rules for exponents and signed numbers.**

***A number expressed in scientific notation cannot be added or subtracted unless the bases and exponents of both numbers are equal.***

5. **Goal: To understand the reason for using engineering notation and the rules of engineering notation.**

Engineering notation is used to prevent confusion on blueprints.

Engineering notation is like scientific notation with the following exceptions:

- The multiplier can be any number greater than 0 and less than 1000.
- The base is expressed as a *letter* which represents a power of 10.

$$G \text{ (Giga)} = 10^9$$



M (Mega) =  $10^6$   
k (kilo) =  $10^3$   
units =  $10^0$   
m (milli) =  $10^{-3}$   
u (micro) =  $10^{-6}$   
n (nano) =  $10^{-9}$   
p (pico) =  $10^{-12}$

Examples:

$$(a \text{ k}) * (b \text{ k}) = (a * b) \text{ M}$$

$$(a \text{ k}) * (b \text{ M}) = (a * b) \text{ G}$$

$$a / b \text{ k} = (a / b) \text{ m}$$

$$a / b \text{ M} = (a / b) \text{ u}$$

$$a \text{ M} / b \text{ k} = (a / b) \text{ k}$$

**AET-A1-LE**  
**Apply Scientific Notation and Engineering Notation**  
**to Solve Technical Problems**

---

The student shall:

1. Use a machinist's rule, measure mechanical parts, and express the results in scientific notation;
2. Calculate selected problems in scientific notation using a scientific calculator;
3. Use the resistor color codes, read resistors, and express the results in engineering notation; and,
4. Calculate selected problems in engineering notation using a scientific calculator.

**AET-A2-HO-1**  
**Apply Algebraic Formulas to Solve Technical Problems**  
**Attachment 1: MASTER Handout No. 1**

---

**Objective(s):**

Upon completion of this unit the student will be able to use algebraic formulas such as those used in machining technology, electronics, electricity, fluid power, and technical physics, and apply scientific notation or engineering notation values to the solution of these equations to aid in solving technical problems.

---

**Module Outline:**

- I. Discuss the organization and rationale for mathematics and formulas
  - A. History of formulas
  - B. Organization of formulas
  - C. What the alphabetic symbols represent in formulas
- II. Discuss the methods by which formulas are manipulated
  - A. The fifteen rules of math (MASTER Handout, AET-A2-HO-2 - The Fifteen Rules of Math Necessary to Solve Any Algebra Problem or Equation)
  - B. Demonstrate the applications of the rules
- III. Demonstrate the solution of formulas
  - A. Take examples from measurements on demonstration equipment
  - B. Demonstrate the organization of a solution
  - C. Using formulas, calculate expected results of measurements
- IV. Demonstrate procedures for using a scientific calculator to calculate results of measurements

**AET-A2-HO-2**  
**Apply Algebraic Formulas to Solve Technical Problems**  
**Attachment 2: MASTER Handout No. 2**

---

**The Fifteen Rules of Math**  
**Necessary to Solve Any Technical Algebra Problem or Equation**  
**Definitions**

<b>Variable</b>	A general symbolic letter term used to define a mathematical relationship. Also a letter that represents an unknown number. A variable may be multiplied, divided, added, subtracted, etc., like any other real number.
<b>Coefficient</b>	A real number that indicates the quantity of variables in question. For example, $3x$ means that I have 3 of the $x$ variables. The number 3 is the coefficient of $x$ . A variable by itself has an implied coefficient of 1.
<b>Constant</b>	A real number whose value is known and can never change.
<b>Polynomial</b>	An algebraic expression containing two or more terms that are associated by addition or subtraction.
<b>Equation</b>	A monomial or polynomial that is set equal to another value (constant, monomial, or polynomial).
<b>Exponent</b>	A number that indicates how many times I need to multiply a number by itself. For example, $x^3$ means that I need to multiply $x$ by $x$ three times. The number 3 is the exponent.
<b>Reciprocal</b>	A number that is divided into 1.
<b>Base</b>	The number that will be raised to a power by an exponent.
<b>Negative number</b>	The mirror image of a positive number. For every positive real number, a negative counterpart exists. Negative numbers are used extensively in math, but have no realistic counterparts in the real world. However, most

important discoveries have been made using the negative number concept.

1. ***The rules of addition, subtraction, multiplication, and division of positive and negative numbers:***
  - A. When adding number that have like signs, add the numbers and give the result the same sign. When adding numbers of unlike signs, subtract the smaller number from the larger number and give the result the sign of the larger number.
  - B. When subtracting any combination of signed numbers, alike or unlike, change the sign of the number or expression that is being subtracted from another number to the opposite sign, and proceed as in addition. Use the following rules:
    - (1) If the sign of the number or expression is negative, change it to positive.
    - (2) If the sign is positive, change it to negative.
  - C. When multiplying signed numbers, if the signs are the same (both positive or negative) the result is positive. If the signs are unlike, the result is negative.
  - D. When dividing signed numbers, if the signs are the same (both positive or negative) the result is positive. If the signs are unlike, the result is negative.
  
2. ***The addition, subtraction, multiplication, and division axioms:***
  - A. If equals are added to equals, then the results will be equal.
  - B. If equals are subtracted from equals, then the results will be equal.
  - C. If equals are multiplied by equals, then the results will be equal.
  - D. If equals are divided by equals, then the results will be equal.
  
3. ***The order of operations - Please Excuse My Dear Aunt Sally***  
Parentheses, Exponents, Multiplication, Division, Addition, Subtraction.  
(Also perform operations from left to right).
  
4. ***The associative rule - The order of grouping is not important to the outcome for addition and multiplication.***  
Examples:  
$$a + b + c = (a + b) + c = a + (b + c)$$
$$a * b * c = (a * b) * c = a * (b * c)$$
  
5. ***The distributive rule - When a polynomial is multiplied by a variable, constant, or other polynomial, the variable, constant, or polynomial is multiplied by each term in the polynomial.***  
Examples:  
$$a(b + c + d) = ab + ac + ad$$

$$2x(a + b - c) = 2xa + 2xb - 2xc$$

$$5y(2y + 3x) = 10y^2 + 15xy$$

6. *The identity rule - Equals are Equal to Equals.*

Examples:

$$a = a \quad x = x$$

If  $X = B$  and  $Y$  equals  $B$  then  $X = Y$

$$\text{If } X = 2a + 3c \text{ and } X = 4y + 5b \text{ then } 2a + 3c = 4y + 5b$$

7. *If a number is multiplied by its reciprocal, the result is one.*

$$a * 1/a = 1$$

(also applies to dividing a number by itself)

8. *If any number is multiplied by zero the result is zero.*

$$a * 0 = 0$$

9. *All constants or variables have an implied coefficient of one.*

$$a = 1*a$$

$$14 = 1*(14)$$

(also applies to multiplying a number by one)

10. *Division of a variable by zero is undefined and a illegal operation.*

$$x/0 = ?$$

11. *Any number raised to the zero (0) power is one (1). Any number raised to the first (1) power is the number itself.*

Examples:

$$a^0 = 1$$

$$1,234,567,123,456,123,345,567,999^0 = 1$$

$$a^1 = a$$

$$10,234^1 = 10,234$$

12. *When two equal number bases, raised to a power, are multiplied times each other, the exponents are added.*

Examples:

$$a^2 * a^4 = a^6$$

$$X^a * X^b = X^{(a+b)}$$

(the numbers *must* be the same base)

13. *When two equal number bases, raised to a power, are divided, the exponents are subtracted.*

Examples:

$$a^2 / a^4 = a^{-2}$$

$$X^a / X^b = X^{(a-b)}$$

(the numbers *must* be the same base)

- 14.** *When a number, raised to a power, is again raised to a power, the exponents are multiplied times each other.*

Examples:

$$(a^2)^3 = a^6$$

$$(x^3)^4 = x^{12}$$

- 15.** *A number raised to a negative power is the reciprocal of the number multiplied by itself that number of times.*

Examples:

$$X^{-3} = 1/X * 1/X * 1/X = 1/X^3$$

$$10^{-4} = 1/10 * 1/10 * 1/10 * 1/10 = 1/10^4$$

**AET-A2-HO-3**  
**Apply Algebraic Formulas to Solve Technical Problems**  
**Attachment 3: MASTER Handout No. 3**

---

**Math Quick Reference**

- 1. Goal: To understand the convention for stating math formulas for mathematical rules (not applied math).**  
x, y, z,... represents a variable in a math formula  
a, b, c,... represents a number in a math formula
- 2. Goal: To understand the rules for adding, subtracting, multiplying, and dividing signed numbers.**

**Addition: For a = 15 and b = 6**

When a is plus and b is plus:  $(+a)+(+b) = +(a+b)$

Example  $(+15)+(+6) = +(15+6) = +21$

When a is minus and b is minus:  $(-a)+(-b) = -(a+b)$

Example  $(-15)+(-6) = -(15+6) = -21$

When a or b is minus, and the remaining quantity is plus  $(-a)+(+b) =$   
or  $(+a)+(-b) = ?$  **Take the smaller number from the larger number**  
**and give the result the sign of the larger number.**

Example:  $(-15) + (+6) = -(15-6) = -9$  (the larger number is -15)

or

Example:  $(+15) + (-6) = +(15-6) = +9$  (the larger number is +15)

**Subtraction:**

When the subtrahend is "b"  $(a)-(b) = ?$

**To avoid confusion, always change the sign (plus or minus) of "b" and proceed as in addition.**

**To change the sign of b, use the following rules:**

If b is positive  $-(+b)$  then change to -b

If b is negative  $-(-b)$  then change to +b

Example: For a = +19 and b = +7

$(+19)-(+7) = (+19) + (-7) = +(19-7) = +12$



Example: For  $a = -19$  and  $b = +7$   
 $(-19) - (+7) = (-19) + (-7) = -(19+7) = -26$

### Multiplication:

If both  $a$  and  $b$  are positive  $(+a) * (+b) = +(ab)$

If both  $a$  and  $b$  are negative  $(-a) * (-b) = +(ab)$

If either  $a$  or  $b$  are negative:

$$(-a) * (+b) = -(ab)$$

or

$$(+a) * (-b) = -(ab)$$

Example: For  $a = 12$  and  $b = 3$   
 $(+12) * (+3) = +(12 * 3) = +36$

Example: For  $a = -12$  and  $b = -3$   
 $(-12) * (-3) = +(12 * 3) = +36$

Example: For  $a = -12$  and  $b = +3$   
 $(-12) * (+3) = -(12 * 3) = -36$

### Division:

If both  $a$  and  $b$  are positive  $(+a) / (+b) = +(a/b)$

If both  $a$  and  $b$  are negative  $(-a) / (-b) = +(a/b)$

If either  $a$  or  $b$  are negative:

$$(+a) / (-b) = -(a/b)$$

or

$$(-a) / (+b) = -(a/b)$$

Example: For  $a = 12$  and  $b = 3$   
 $(+12) / (+3) = +(12/3) = +4$

Example: For  $a = -12$  and  $b = -3$   
 $(-12) / (-3) = +(12/3) = +4$

Example: For  $a = -12$  and  $b = +3$   
 $(-12) / (+3) = -(12/3) = -4$

Example: For  $a = +12$  and  $b = -3$   
 $(+12) / (-3) = -(12/3) = -4$

### 3. Goal: To understand the rules for exponents

For  $a^N$ : " $a$ " is called the *base*. " $N$ " is called the *exponent*.

If  $a$  is multiplied by itself " $N$ " number of times:  $a * a * a * \dots * a^N = a^N$

Example: For  $a = 4$   
 $4 * 4 * 4 = 4^3$

$$a * a * a * a * a = a^5$$

$$(1/a) * (1/a) * (1/a) \dots * (1/a^N) = a^{-N}$$

Example: For  $a = 10$   
 $(1/10) * (1/10) * (1/10) = 10^{-3}$

Special cases of exponents:

$$a^0 = 1$$

$$a^1 = a$$

**Note: Bases must be the same!**

Multiplication of Exponents

$$a^b * a^c = a^{(b+c)}$$

Division of Exponents:

$$a^b / a^c = a^{(b-c)}$$

4. **Goal: To understand the reason for using scientific notation, and the rules for scientific notation.**

Scientific notation is primarily used to multiply and divide very large and very small numbers.

A number expressed in scientific notation consists of a *multiplier* equal to or greater than 1 and less than 10, and a *base* of 10 raised to a power.

Example: 12,560,000 and .000748

Multiplier	Times	Base 10
1.256	*	$10^7$
7.48	*	$10^{-4}$

**To combine the bases, use the rules for exponents and signed numbers.**

***A number expressed in scientific notation cannot be added or subtracted unless the bases and exponents of both numbers are equal.***

5. **Goal: To understand the reason for using engineering notation and the rules of engineering notation.**

Engineering notation is used to prevent confusion on blueprints.

Engineering notation is like scientific notation with the following exceptions:

- a. The multiplier can be any number greater than 0 and less than 1000.
- b. The base is expressed as a *letter* which represents a power of 10.

$$G \text{ (Giga)} = 10^9$$

$$M \text{ (Mega)} = 10^6$$

$$k \text{ (kilo)} = 10^3$$

$$\text{units} = 10^0$$

$$m \text{ (milli)} = 10^{-3}$$

$$u \text{ (micro)} = 10^{-6}$$

$$n \text{ (nano)} = 10^{-9}$$

$$p \text{ (pico)} = 10^{-12}$$

Examples:

$$(a \text{ k}) * (b \text{ k}) = (a * b) \text{ M}$$

$$(a \text{ k}) * (b \text{ M}) = (a * b) \text{ G}$$

$$a / b \text{ k} = (a / b) \text{ m}$$

$$a / b \text{ M} = (a / b) \text{ u}$$

$$a \text{ M} / b \text{ k} = (a / b) \text{ k}$$

**AET-A2-LE**  
**Apply Algebraic Formulas to Solve Technical Problems**  
**Attachment 4: MASTER Laboratory Exercise**

---

The student shall:

1. Use measurement instruments, measure a system, and apply the measurements to the proper parts of a formula; and,
2. Calculate selected problems using a scientific calculator.

## AET-A3-HO-1

# Use Variables in Algebraic Formulas to Predict Behavior of Industrial Systems

### Attachment 1: MASTER Handout No. 1

---

#### Objective(s):

Upon completion of this unit the student will be able to apply algebraic formulas such as those found in machining technology, electronics, electricity, fluid power, and technical physics, to identify the effects on a system of a change in a variable of the equation.

---

#### Module Outline:

- I. Discuss the Organization and Rational for Expressing the Real World in Mathematical Formulas
  - A. History of expressing the real world in mathematics
  - B. How variables in an equation predict the outcome of events.
  - C. Discuss inverse and direct variation
- II. Using Formulas Such as "Two Resistors in Parallel" or "Thermal Transfer of Heat Energy Through an Insulation," Demonstrate How the Change of Variables in the Equation Effects the Outcome of the Result

**AET-A3-HO-2**  
**Use Variables in Algebraic Formulas**  
**to Predict Behavior of Industrial Systems**  
**Attachment 2: MASTER Handout No. 2**

---

**The Fifteen Rules of Math**  
**Necessary to Solve Any Technical Algebra Problem or Equation**  
**Definitions**

<b>Variable</b>	A general symbolic letter term used to define a mathematical relationship. Also a letter that represents an unknown number. A variable may be multiplied, divided, added, subtracted, etc., like any other real number.
<b>Coefficient</b>	A real number that indicates the quantity of variables in question. For example, $3x$ means that I have 3 of the $x$ variables. The number 3 is the coefficient of $x$ . A variable by itself has an implied coefficient of 1.
<b>Constant</b>	A real number whose value is known and can never change.
<b>Polynomial</b>	An algebraic expression containing two or more terms that are associated by addition or subtraction.
<b>Equation</b>	A monomial or polynomial that is set equal to another value (constant, monomial, or polynomial).
<b>Exponent</b>	A number that indicates how many times I need to multiply a number by itself. For example, $x^3$ means that I need to multiply $x$ by $x$ three times. The number 3 is the exponent.
<b>Reciprocal</b>	A number that is divided into 1.
<b>Base</b>	The number that will be raised to a power by an exponent.
<b>Negative number</b>	The mirror image of a positive number. For every positive real number, a negative counterpart exists. Negative numbers are used extensively in math, but have no realistic counterparts in the real world. However, most

important discoveries have been made using the negative number concept.

1. ***The rules of addition, subtraction, multiplication, and division of positive and negative numbers:***
  - A. When adding number that have like signs, add the numbers and give the result the same sign. When adding numbers of unlike signs, subtract the smaller number from the larger number and give the result the sign of the larger number.
  - B. When subtracting any combination of signed numbers, alike or unlike, change the sign of the number or expression that is being subtracted from another number to the opposite sign, and proceed as in addition. Use the following rules:
    - (1) If the sign of the number or expression is negative, change it to positive.
    - (2) If the sign is positive, change it to negative.
  - C. When multiplying signed numbers, if the signs are the same (both positive or negative) the result is positive. If the signs are unlike, the result is negative.
  - D. When dividing signed numbers, if the signs are the same (both positive or negative) the result is positive. If the signs are unlike, the result is negative.
2. ***The addition, subtraction, multiplication, and division axioms:***
  - A. If equals are added to equals, then the results will be equal.
  - B. If equals are subtracted from equals, then the results will be equal.
  - C. If equals are multiplied by equals, then the results will be equal.
  - D. If equals are divided by equals, then the results will be equal.
3. ***The order of operations - Please Excuse My Dear Aunt Sally***  
Parentheses, Exponents, Multiplication, Division, Addition, Subtraction.  
(Also perform operations from left to right).
4. ***The associative rule - The order of grouping is not important to the outcome for addition and multiplication.***  
Examples:  
$$a + b + c = (a + b) + c = a + (b + c)$$
$$a * b * c = (a * b) * c = a * (b * c)$$
5. ***The distributive rule - When a polynomial is multiplied by a variable, constant, or other polynomial, the variable, constant, or polynomial is multiplied by each term in the polynomial.***  
Examples:  
$$a(b + c + d) = ab + ac + ad$$
$$2x(a + b - c) = 2xa + 2xb - 2xc$$

$$5y(2y + 3x) = 10y^2 + 15xy$$

6. ***The identity rule - Equals are Equal to Equals.***

Examples:

$$a = a \quad x = x$$

If  $X = B$  and  $Y$  equals  $B$  then  $X = Y$

$$\text{If } X = 2a + 3c \text{ and } X = 4y + 5b \text{ then } 2a + 3c = 4y + 5b$$

7. ***If a number is multiplied by its reciprocal, the result is one.***

$$a * 1/a = 1$$

(also applies to dividing a number by itself)

8. ***If any number is multiplied by zero the result is zero.***

$$a * 0 = 0$$

9. ***All constants or variables have an implied coefficient of one.***

$$a = 1*a$$

$$14 = 1*(14)$$

(also applies to multiplying a number by one)

10. ***Division of a variable by zero is undefined and a illegal operation.***

$$x/0 = ?$$

11. ***Any number raised to the zero (0) power is one (1). Any number raised to the first (1) power is the number itself.***

Examples:

$$a^0 = 1$$

$$1,234,567,123,456,123,345,567,999^0 = 1$$

$$a^1 = a$$

$$10,234^1 = 10,234$$

12. ***When two equal number bases, raised to a power, are multiplied times each other, the exponents are added.***

Examples:

$$a^2 * a^4 = a^6$$

$$X^a * X^b = X^{(a+b)}$$

(the numbers *must* be the same base)

13. ***When two equal number bases, raised to a power, are divided, the exponents are subtracted.***

Examples:

$$a^2 / a^4 = a^{-2}$$

$$X^a / X^b = X^{(a-b)}$$

(the numbers *must* be the same base)



- 14. When a number, raised to a power, is again raised to a power, the exponents are multiplied times each other.**

Examples:

$$(a^2)^3 = a^6$$

$$(x^3)^4 = x^{12}$$

- 15. A number raised to a negative power is the reciprocal of the number multiplied by itself that number of times.**

Examples:

$$X^{-3} = 1/X * 1/X * 1/X = 1/X^3$$

$$10^{-4} = 1/10 * 1/10 * 1/10 * 1/10 = 1/10^4$$

**AET-A3-HO-3**  
**Use Variables in Algebraic Formulas**  
**to Predict Behavior of Industrial Systems**  
**Attachment 3: MASTER Handout No. 3**

---

**Math Quick Reference**

1. **Goal: To understand the convention for stating math formulas for mathematical rules (not applied math).**  
x, y, z,... represents a variable in a math formula  
a, b, c,... represents a number in a math formula
  
2. **Goal: To understand the rules for adding, subtracting, multiplying, and dividing signed numbers.**

**Addition: For a = 15 and b = 6**

When a is plus and b is plus:  $(+a)+(+b) = +(a+b)$

Example  $(+15)+(+6) = +(15+6) = +21$

When a is minus and b is minus:  $(-a)+(-b) = -(a+b)$

Example  $(-15)+(-6) = -(15+6) = -21$

When a or b is minus, and the remaining quantity is plus  $(-a)+(+b) =$   
or  $(+a)+(-b) = ?$  **Take the smaller number from the larger number**  
**and give the result the sign of the larger number.**

Example:  $(-15) + (+6) = -(15-6) = -9$  (the larger number is -15)

or

Example:  $(+15) + (-6) = +(15-6) = +9$  (the larger number is +15)

**Subtraction:**

When the subtrahend is "b"  $(a)-(b) = ?$

**To avoid confusion, always change the sign (plus or minus) of "b" and proceed as in addition.**

**To change the sign of b, use the following rules:**

If b is positive  $-(+b)$  then change to -b

If b is negative  $-(-b)$  then change to +b

Example: For a = +19 and b = +7

$(+19)-(+7) = (+19) + (-7) = +(19-7) = +12$

Example: For a = -19 and b = +7

$$(-19)-(+7) = (-19) + (-7) = -(19+7) = -26$$

### **Multiplication:**

If both a and b are positive  $(+a)*(+b) = +(ab)$

If both a and b are negative  $(-a)*(-b) = +(ab)$

If either a or b are negative:

$$(-a)*(+b) = -(ab)$$

or

$$(+a)*(-b) = -(ab)$$

Example: For a = 12 and b = 3

$$(+12)*(+3) = +(12*3) = +36$$

Example: For a = -12 and b = -3

$$(-12)*(-3) = +(12*3) = +36$$

Example: For a = -12 and b = +3

$$(-12)*(+3) = -(12*3) = -36$$

### **Division:**

If both a and b are positive  $(+a)/(+b) = +(a/b)$

If both a and b are negative  $(-a)/(-b) = +(a/b)$

If either a or b are negative:

$$(+a)/(-b) = -(a/b)$$

or

$$(-a)/(+b) = -(a/b)$$

Example: For a = 12 and b = 3

$$(+12)/(+3) = +(12/3) = +4$$

Example: For a = -12 and b = -3

$$(-12)/(-3) = +(12/3) = +4$$

Example: For a = -12 and b = +3

$$(-12)/(+3) = -(12/3) = -4$$

Example: For a = +12 and b = -3

$$(+12)/(-3) = -(12/3) = -4$$

### **3. Goal: To understand the rules for exponents**

For  $a^N$ : "a" is called the *base*. "N" is called the *exponent*.

If a is multiplied by itself "N" number of times:  $a*a*a*a...a^N = a^N$

Example: For a = 4

$$4*4*4 = 4^3$$

$$a*a*a*a*a = a^5$$

$$(1/a) \cdot (1/a) \cdot (1/a) \dots \cdot (1/a^N) = a^{-N}$$

Example: For  $a = 10$   
 $(1/10) \cdot (1/10) \cdot (1/10) = 10^{-3}$

Special cases of exponents:

$$a^0 = 1$$

$$a^1 = a$$

**Note: Bases must be the same!**

Multiplication of Exponents

$$a^b \cdot a^c = a^{(b+c)}$$

Division of Exponents:

$$a^b / a^c = a^{(b-c)}$$

4. **Goal: To understand the reason for using scientific notation, and the rules for scientific notation.**

Scientific notation is primarily used to multiply and divide very large and very small numbers.

A number expressed in scientific notation consists of a *multiplier* equal to or greater than 1 and less than 10, and a *base* of 10 raised to a power.

Example: 12,560,000 and .000748

Multiplier	Times	Base 10
1.256	*	$10^7$
7.48	*	$10^{-4}$

To combine the bases, use the rules for exponents and signed numbers.

*A number expressed in scientific notation cannot be added or subtracted unless the bases and exponents of both numbers are equal.*

5. **Goal: To understand the reason for using engineering notation and the rules of engineering notation.**

Engineering notation is used to prevent confusion on blueprints.

Engineering notation is like scientific notation with the following exceptions:

- a. The multiplier can be any number greater than 0 and less than 1000.

- b. The base is expressed as a *letter* which represents a power of 10.

$$G \text{ (Giga)} = 10^9$$

$$M \text{ (Mega)} = 10^6$$

$$k \text{ (kilo)} = 10^3$$

$$\text{units} = 10^0$$

$$m \text{ (milli)} = 10^{-3}$$

$$u \text{ (micro)} = 10^{-6}$$

$$n \text{ (nano)} = 10^{-9}$$

$$p \text{ (pico)} = 10^{-12}$$

Examples:

$$(a \text{ k}) * (b \text{ k}) = (a * b) \text{ M}$$

$$(a \text{ k}) * (b \text{ M}) = (a * b) \text{ G}$$

$$a/b \text{ k} = (a/b) \text{ m}$$

$$a/b \text{ M} = (a/b) \text{ u}$$

$$a \text{ M}/b \text{ k} = (a/b) \text{ k}$$

**AET-A3-LE**  
**Use Variables in Algebraic Formulas**  
**to Predict Behavior of Industrial Systems**  
**Attachment 4: MASTER Laboratory Exercise**

---

The student shall:

1. Use measurement instruments, measure a system, and apply the measurements to the proper parts of a formula;
2. Calculate expected results; and,
3. Measure the quantities that result from the calculations and compare to the formulas.

**AET-A4-HO-1**  
**Manipulate Variables in Algebraic Formulas**  
**to Analyze Industrial Systems**  
Attachment 1: MASTER Handout No. 1

---

**Objective(s):**

Upon completion of this unit the student will be able to transpose variables from one side of a formula to the other side of the formula to produce new relationships in the equation, and identify the relationship between the variables in the formula and the real world value that the variable represents.

---

**Module Outline:**

- I. Discuss the Organization of an Algebraic Formula and the Methods That Scientists Use to Provide New Information about the Relationships in the Formula
  - A. Show video "The Mechanical Universe: "The Miliken Experiment"
  - B. Conduct discussions on the video and the role that algebraic manipulation played in the discovery of a basic physical concept
- II. Discuss the Algebraic Procedures for Transposing Variables (MASTER Handout AET-A1-HO-2)
  - A. Discuss the concept of polynomials
  - B. Demonstrate the addition of polynomials
  - C. Demonstrate the subtraction of polynomials
  - D. Demonstrate the multiplication of polynomials
  - E. Demonstrate the division of polynomials
- III. Demonstrate the Application of Polynomial Manipulation to the Transposing of Formulas by Solving a Formula for a Constant (K Variable)

**AET-A4-HO-2**  
**Manipulate Variables in Algebraic Formulas**  
**to Analyze Industrial Systems**  
**Attachment 2: MASTER Handout No. 2**

---

**The Fifteen Rules of Math**  
**Necessary to Solve Any Technical Algebra Problem or Equation**  
**Definitions**

<b>Variable</b>	A general symbolic letter term used to define a mathematical relationship. Also a letter that represents an unknown number. A variable may be multiplied, divided, added, subtracted, etc., like any other real number.
<b>Coefficient</b>	A real number that indicates the quantity of variables in question. For example, $3x$ means that I have 3 of the $x$ variables. The number 3 is the coefficient of $x$ . A variable by itself has an implied coefficient of 1.
<b>Constant</b>	A real number whose value is known and can never change.
<b>Polynomial</b>	An algebraic expression containing two or more terms that are associated by addition or subtraction.
<b>Equation</b>	A monomial or polynomial that is set equal to another value (constant, monomial, or polynomial).
<b>Exponent</b>	A number that indicates how many times I need to multiply a number by itself. For example, $x^3$ means that I need to multiply $x$ by $x$ three times. The number 3 is the exponent.
<b>Reciprocal</b>	A number that is divided into 1.
<b>Base</b>	The number that will be raised to a power by an exponent.
<b>Negative number</b>	The mirror image of a positive number. For every positive real number, a negative counterpart exists. Negative numbers are used extensively in math, but have no realistic counterparts in the real world. However, most



important discoveries have been made using the negative number concept.

1. ***The rules of addition, subtraction, multiplication, and division of positive and negative numbers:***
  - A. When adding number that have like signs, add the numbers and give the result the same sign. When adding numbers of unlike signs, subtract the smaller number from the larger number and give the result the sign of the larger number.
  - B. When subtracting any combination of signed numbers, alike or unlike, change the sign of the number or expression that is being subtracted from another number to the opposite sign, and proceed as in addition. Use the following rules:
    - (1) If the sign of the number or expression is negative, change it to positive.
    - (2) If the sign is positive, change it to negative.
  - C. When multiplying signed numbers, if the signs are the same (both positive or negative) the result is positive. If the signs are unlike, the result is negative.
  - D. When dividing signed numbers, if the signs are the same (both positive or negative) the result is positive. If the signs are unlike, the result is negative.
2. ***The addition, subtraction, multiplication, and division axioms:***
  - A. If equals are added to equals, then the results will be equal.
  - B. If equals are subtracted from equals, then the results will be equal.
  - C. If equals are multiplied by equals, then the results will be equal.
  - D. If equals are divided by equals, then the results will be equal.
3. ***The order of operations - Please Excuse My Dear Aunt Sally***  
Parentheses, Exponents, Multiplication, Division, Addition, Subtraction.  
(Also perform operations from left to right).
4. ***The associative rule - The order of grouping is not important to the outcome for addition and multiplication.***  
Examples:  
 $a + b + c = (a + b) + c = a + (b + c)$   
 $a * b * c = (a * b) * c = a * (b * c)$
5. ***The distributive rule - When a polynomial is multiplied by a variable, constant, or other polynomial, the variable, constant, or polynomial is multiplied by each term in the polynomial.***  
Examples:  
 $a(b + c + d) = ab + ac + ad$   
 $2x(a + b - c) = 2xa + 2xb - 2xc$

$$5y(2y + 3x) = 10y^2 + 15xy$$

6. ***The identity rule - Equals are Equal to Equals.***

Examples:

$$a = a \quad x = x$$

If  $X = B$  and  $Y$  equals  $B$  then  $X = Y$

$$\text{If } X = 2a + 3c \text{ and } X = 4y + 5b \text{ then } 2a + 3c = 4y + 5b$$

7. ***If a number is multiplied by its reciprocal, the result is one.***

$$a * 1/a = 1$$

(also applies to dividing a number by itself)

8. ***If any number is multiplied by zero the result is zero.***

$$a * 0 = 0$$

9. ***All constants or variables have an implied coefficient of one.***

$$a = 1*a$$

$$14 = 1*(14)$$

(also applies to multiplying a number by one)

10. ***Division of a variable by zero is undefined and a illegal operation.***

$$x/0 = ?$$

11. ***Any number raised to the zero (0) power is one (1). Any number raised to the first (1) power is the number itself.***

Examples:

$$a^0 = 1$$

$$1,234,567,123,456,123,345,567,999^0 = 1$$

$$a^1 = a$$

$$10,234^1 = 10,234$$

12. ***When two equal number bases, raised to a power, are multiplied times each other, the exponents are added.***

Examples:

$$a^2 * a^4 = a^6$$

$$X^a * X^b = X^{(a+b)}$$

(the numbers *must* be the same base)

13. ***When two equal number bases, raised to a power, are divided, the exponents are subtracted.***

Examples:

$$a^2 / a^4 = a^{-2}$$

$$X^a / X^b = X^{(a-b)}$$

(the numbers *must* be the same base)

- 14. When a number, raised to a power, is again raised to a power, the exponents are multiplied times each other.**

Examples:

$$(a^2)^3 = a^6$$

$$(x^3)^4 = x^{12}$$

- 15. A number raised to a negative power is the reciprocal of the number multiplied by itself that number of times.**

Examples:

$$X^{-3} = 1/X * 1/X * 1/X = 1/X^3$$

$$10^{-4} = 1/10 * 1/10 * 1/10 * 1/10 = 1/10^4$$

**AET-A4-HO-3**  
**Manipulate Variables in Algebraic Formulas**  
**to Analyze Industrial Systems**  
**Attachment 3: MASTER Handout No. 3**

---

**Math Quick Reference**

1. *Goal: To understand the convention for stating math formulas for mathematical rules (not applied math).*

x, y, z,... represents a variable in a math formula

a, b, c,... represents a number in a math formula

2. *Goal: To understand the rules for adding, subtracting, multiplying, and dividing signed numbers.*

**Addition:** For a = 15 and b = 6

When a is plus and b is plus:  $(+a)+(+b) = +(a+b)$

Example  $(+15)+(+6) = +(15+6) = +21$

When a is minus and b is minus:  $(-a)+(-b) = -(a+b)$

Example  $(-15)+(-6) = -(15+6) = -21$

When a or b is minus, and the remaining quantity is plus  $(-a)+(+b) =$   
or  $(+a)+(-b) = ?$  *Take the smaller number from the larger number*  
*and give the result the sign of the larger number.*

Example:  $(-15) + (+6) = -(15-6) = -9$  (the larger number is -15)

or

Example:  $(+15) + (-6) = +(15-6) = +9$  (the larger number is +15)

**Subtraction:**

When the subtrahend is "b"  $(a)-(b) = ?$

*To avoid confusion, always change the sign (plus or minus) of "b" and proceed as in addition.*

**To change the sign of b, use the following rules:**

If b is positive  $-(+b)$  then change to -b

If b is negative  $-(-b)$  then change to +b

Example: For a = +19 and b = +7

$(+19)-(+7) = (+19) + (-7) = +(19-7) = +12$

Example: For a = -19 and b = +7

$$(-19)-(+7) = (-19) + (-7) = -(19+7) = -26$$

### Multiplication:

If both a and b are positive  $(+a)*(+b) = +(ab)$

If both a and b are negative  $(-a)*(-b) = +(ab)$

If either a or b are negative:

$$(-a)*(+b) = -(ab)$$

or

$$(+a)*(-b) = -(ab)$$

Example: For a = 12 and b = 3

$$(+12)*(+3) = +(12*3) = +36$$

Example: For a = -12 and b = -3

$$(-12)*(-3) = +(12*3) = +36$$

Example: For a = -12 and b = +3

$$(-12)*(+3) = -(12*3) = -36$$

### Division:

If both a and b are positive  $(+a)/(+b) = +(a/b)$

If both a and b are negative  $(-a)/(-b) = +(a/b)$

If either a or b are negative:

$$(+a)/(-b) = -(a/b)$$

or

$$(-a)/(+b) = -(a/b)$$

Example: For a = 12 and b = 3

$$(+12)/(+3) = +(12/3) = +4$$

Example: For a = -12 and b = -3

$$(-12)/(-3) = +(12/3) = +4$$

Example: For a = -12 and b = +3

$$(-12)/(+3) = -(12/3) = -4$$

Example: For a = +12 and b = -3

$$(+12)/(-3) = -(12/3) = -4$$

### 3. Goal: To understand the rules for exponents

For  $a^N$ : "a" is called the *base*. "N" is called the *exponent*.

If a is multiplied by itself " $N$ " number of times:  $a*a*a*a...a^N = a^N$

Example: For a = 4

$$4*4*4 = 4^3$$

$$a*a*a*a*a = a^5$$

$$(1/a)*(1/a)*(1/a)...*(1/a^N) = a^{-N}$$

Example: For  $a = 10$   
 $(1/10)*(1/10)*(1/10) = 10^{-3}$

Special cases of exponents:

$$a^0 = 1$$

$$a^1 = a$$

**Note: Bases must be the same!**

Multiplication of Exponents

$$a^b * a^c = a^{(b+c)}$$

Division of Exponents:

$$a^b / a^c = a^{(b-c)}$$

4. **Goal: To understand the reason for using scientific notation, and the rules for scientific notation.**

Scientific notation is primarily used to multiply and divide very large and very small numbers.

A number expressed in scientific notation consists of a *multiplier* equal to or greater than 1 and less than 10, and a *base* of 10 raised to a power.

Example: 12,560,000 and .000748

Multiplier	Times	Base 10
1.256	*	$10^7$
7.48	*	$10^{-4}$

To combine the bases, use the rules for exponents and signed numbers.

*A number expressed in scientific notation cannot be added or subtracted unless the bases and exponents of both numbers are equal.*

5. **Goal: To understand the reason for using engineering notation and the rules of engineering notation.**

Engineering notation is used to prevent confusion on blueprints.

Engineering notation is like scientific notation with the following exceptions:

- a. The multiplier can be any number greater than 0 and less than 1000.

- b. The base is expressed as a *letter* which represents a power of 10.

$$G \text{ (Giga)} = 10^9$$

$$M \text{ (Mega)} = 10^6$$

$$k \text{ (kilo)} = 10^3$$

$$\text{units} = 10^0$$

$$m \text{ (milli)} = 10^{-3}$$

$$u \text{ (micro)} = 10^{-6}$$

$$n \text{ (nano)} = 10^{-9}$$

$$p \text{ (pico)} = 10^{-12}$$

Examples:

$$(a \text{ k}) * (b \text{ k}) = (a * b) \text{ M}$$

$$(a \text{ k}) * (b \text{ M}) = (a * b) \text{ G}$$

$$a/b \text{ k} = (a/b) \text{ m}$$

$$a/b \text{ M} = (a/b) \text{ u}$$

$$a \text{ M}/b \text{ k} = (a/b) \text{ k}$$

**AET-A4-LE-1**  
**Manipulate Variables in Algebraic Formulas**  
**to Analyze Industrial Systems**  
**Attachment 4: MASTER Laboratory Exercise No. 1**

---

The student shall:

1. Transpose the variable for a complex formula found in physics, to produce a new relationship, and verify the new relationship by experimentation;
2. Choose several physical formulas and establish new relationships. Insure that some of the new relationships reflect the value of a "k" constant as found in the formula; and,
3. Complete MASTER Laboratory Exercise (AET-A4-LE-2).



**AET-A4-LE-2**  
**Manipulate Variables in Algebraic Formulas**  
**to Analyze Industrial Systems**  
Attachment 5: MASTER Laboratory Exercise No. 2

---

**AET-A5-HO-1**  
**Measure, Calculate, and Convert Quantities**  
**in English and Metric (SI, mks) Systems**  
Attachment 1: MASTER Handout No. 1

---

**Objective(s):**

Upon completion of this unit the student will be able to apply the rules of measuring systems in both the English and SI systems of measurement to calculate and convert quantities in both systems, including:

- a. Applying measurements in the English engineering system of measurement;
  - b. Applying measurements in the Metric (mks S. I.) system of measurement; and,
  - c. Applying the concept of dimensions to the measurement of quantities in the English engineering and Metric systems.
- 

**Module Outline:**

- I. Apply Measurements in the English Engineering System of Measurement
  - A. Discuss the component parts of the English Engineering system
    1. Discuss the concept of length and area
    2. Discuss the concept of volume
    3. Discuss the concept of mass and weight
    4. Discuss the concept of temperature
    5. Discuss the concept of time
  - B. Demonstrate the methods of measuring and calculating quantities
    1. Demonstrate the calculation of length and area
    2. Demonstrate the calculation of volume
    3. Demonstrate the calculation of weight and the relationship of mass to weight
    4. Demonstrate the measurement of temperature
    5. Demonstrate the measurement of time
- II. Apply Measurements In The Metric (Mks S. I.) System Of Measurement
  - A. Discuss the component parts of the Metric system
    1. Discuss the concept of length and area
    2. Discuss the concept of volume
    3. Discuss the concept of mass and weight
    4. Discuss the concept of temperature
    5. Discuss the concept of time
  - B. Demonstrate the methods of measuring and calculating quantities
    1. Demonstrate the calculation of length and area
    2. Demonstrate the calculation of volume

3. Demonstrate the calculation of weight and the relationship of mass to weight
  4. Demonstrate the measurement of temperature
- III. Apply The Concept Of Dimensions To The Measurement Of Quantities In The English Engineering And Metric Systems
- A. Discuss the concept of physical dimensions
    1. Discuss the dimensioning of force
    2. Discuss the dimensioning of work
    3. Discuss the dimensioning of power
  - B. Demonstrate the calculation of the above dimensions in the English Engineering and Metric systems

**AET-A5-HO-2**  
**Measure, Calculate, and Convert Quantities**  
**in English and Metric (SI, mks) Systems**  
**Attachment 2: MASTER Handout No. 2**

---

**Conversion Blocks**

It is frequently desirable to convert from the metric system to the English Engineering system and vice-versa. It is also just as desirable to convert from power to work to force within a system. The component parts of which each concept is composed, are known in mechanical physics as the **dimensions** of the quantity, or simply, **dimensioning**. For example, the dimensions of the watt are:

**1 watt = kg\*m<sup>2</sup>/sec<sup>3</sup> (1 kilogram times 1 meter times 1 meter divided by 1 second times 1 second times 1 second)**

Whenever we desire to convert from one dimension to another, we must multiply or divide by mass, length, area, volume, time, and/or temperature. This can be difficult. Do you multiply by time or divide by time to change from power to energy? To help organize the process, we can use a helper called a conversion block. The conversion block looks like this:

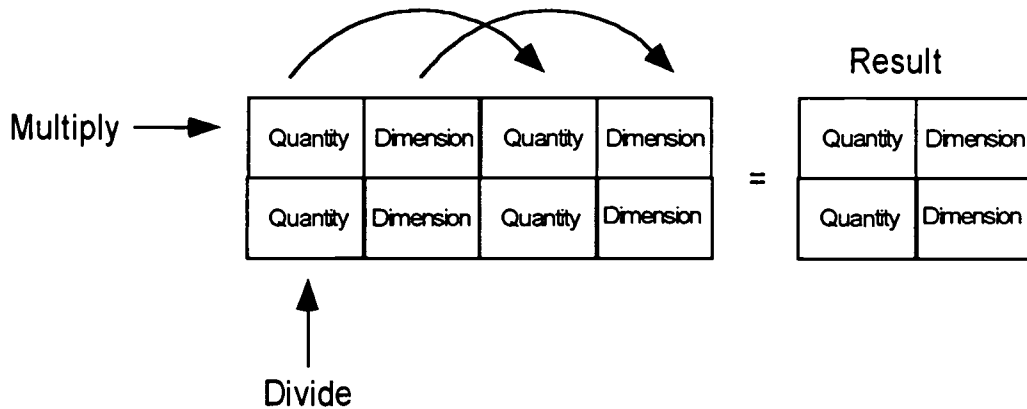

To use the conversion block, you enter the unit quantity of the dimension in the quantity block, and the type of dimension (mass, length, area, volume, time, and/or temperature) in the dimension block.

*Any like quantities that are in the divide columns are canceled, and become 1.*

*All unit values in the multiply rows are multiplied, including the dimensions.*

Therefore, you multiply quantity by quantity, and dimension by dimension. In the result block, the quantities are divided, and the dimensions are left intact.

For example:

If I have a force of 500 N, and a time of 2 seconds, what is the momentum?

$$500 \text{ N} = 500 \text{ kg}\cdot\text{m}/\text{sec}^2$$

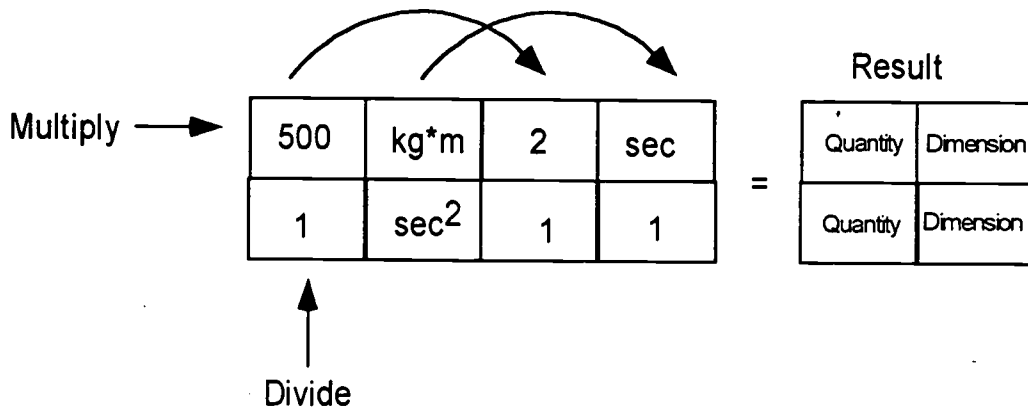

$$500 \text{ N} = 500 \text{ kg}\cdot\text{m}/\text{sec}^2$$

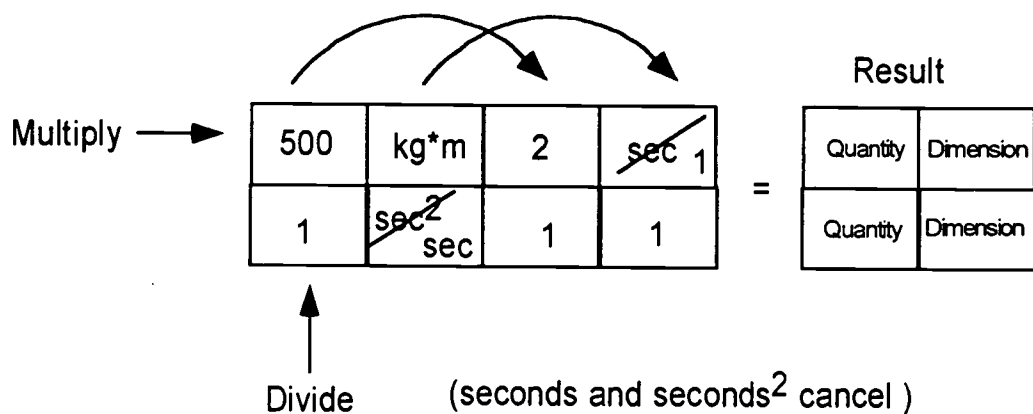

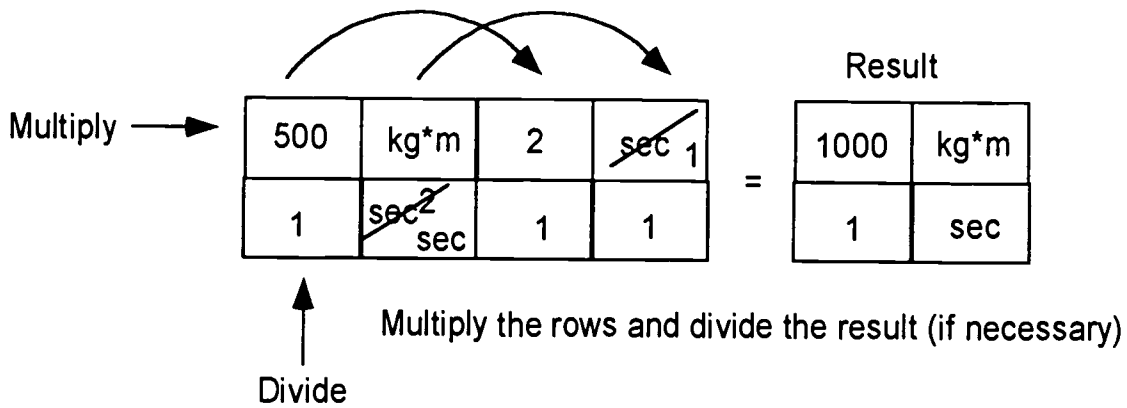

*Converting from the English Engineering to metric systems or vice-versa is done in the same manner, using the following conversion table.*

Example: Convert 50 kg to pounds of weight.

From the conversion table, 2.2 lbs/kg

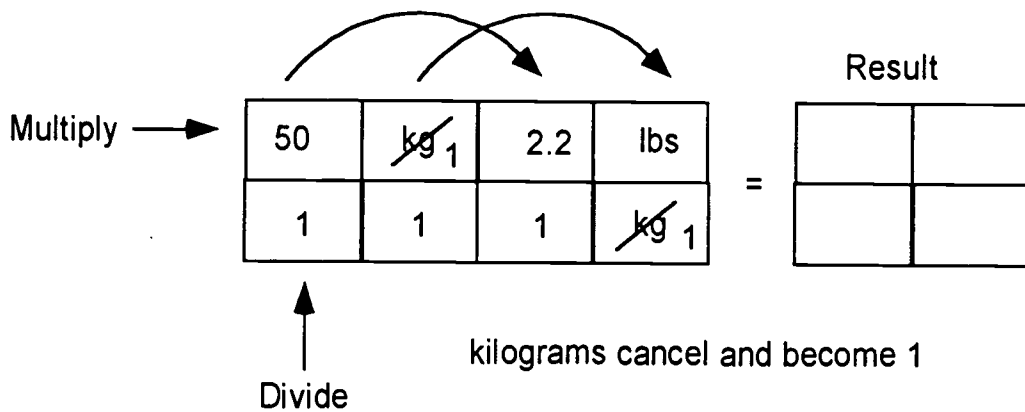
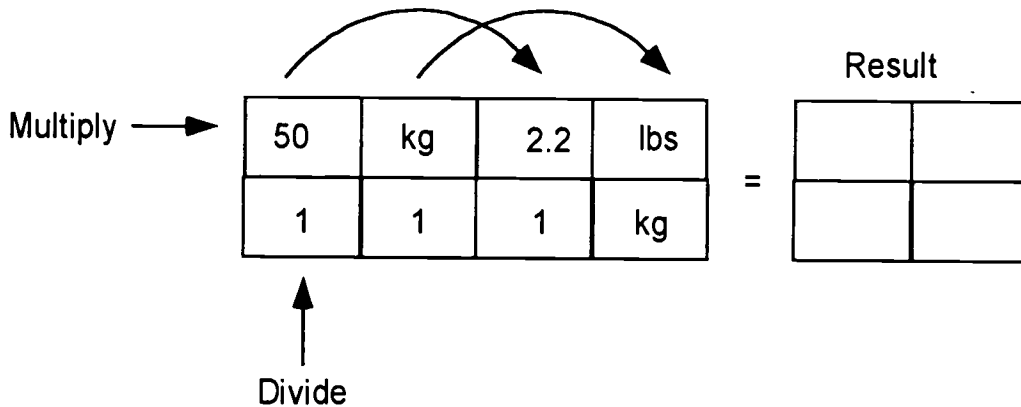

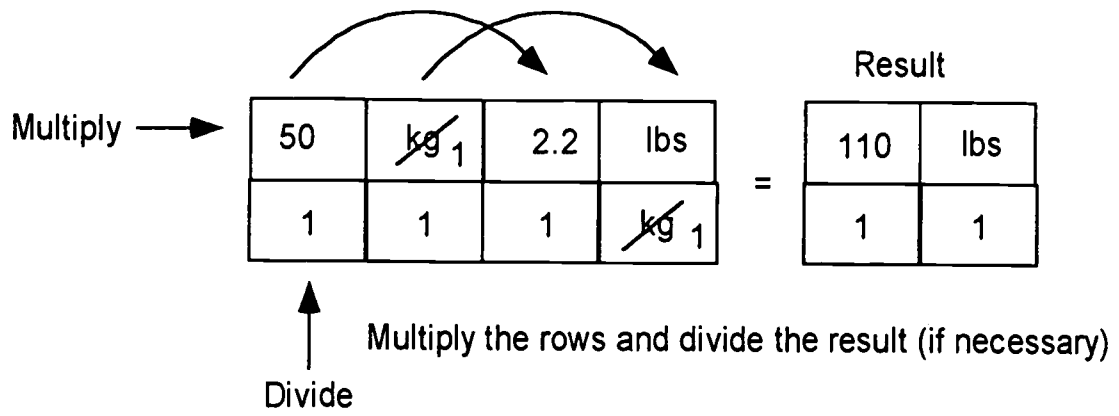

# Exercise

 = 



 = 



 = 



 = 



 = 



 = 



 = 



 = 



**AET-A5-LE**  
**Measure, Calculate, and Convert Quantities**  
**in English and Metric (SI, mks) Systems**  
**Attachment 3: MASTER Laboratory Exercise**

---

The student shall:

1. Measure and compare items in the English Engineering system;
2. Convert quantities from mass, volume, force and temperature;
3. Measure and compare items in both the English Engineering system, and the Metric system;
4. Convert quantities from English to Metric and Metric to English;
5. Dimension the physical quantities in a simple machine such as a wheel and axle; and,
6. Dimension the power in an industrial crane.

**AET-A6-HO**  
**Use Physics, Algebra, and Trigonometry**  
**to Analyze Simple Vectored Forces**  
**Attachment 1: MASTER Handout**

---

**Objective(s):**

Upon completion of this unit the student will be able to:

- a. Demonstrate the physics concept of force;
  - b. Demonstrate the concept of vectored force;
  - c. Apply algebra and geometry to the concept of vectored forces; and,
  - d. Apply trigonometry to the concept of vectored forces.
- 

**Module Outline:**

- I. Demonstrate the Physics Concept of Force
  - A. Discuss the component parts of force and the importance of force in physical systems
    1. Discuss the role of the concept of force in mechanical systems
    2. Demonstrate the nature of force in mechanical systems
    3. Demonstrate the application of force in mechanical systems
    4. Discuss the role of the concept of force in electrical/electronic systems
    5. Demonstrate the nature of force in electrical/electronic systems
    6. Demonstrate the application of force in electrical/electronic systems
  - B. Discuss the methods of calculating forces
    1. Demonstrate the calculation of force in the English Engineering system
    2. Demonstrate the calculation of force in the Metric (mks S.I.) system
- II. Demonstrate the Concept of Vectored Force
  - A. Discuss the component parts of a vector
    1. Discuss the difference between scalar quantities and vectored quantities
    2. Discuss the rectangular coordinate system
    3. Demonstrate a two dimensional vector in a rectangular coordinate system
  - B. Discuss the methods of calculating vectored forces
    1. Demonstrate the calculation of vectored force using geometry and algebra
    2. Demonstrate the calculation of vectored force using trigonometry
  - C. Show video The Mechanical Universe -"Vectors"

- III. Apply Algebra and Geometry to the Concept of Vectored Forces
  - A. Discuss the geometrical concepts contained in a rectangular (Cartesian) coordinate system
    - 1. Discuss angles
    - 2. Discuss triangles and parallelograms
    - 3. Discuss right triangles and the Pythagorean Theorem
    - 4. Demonstrate a two dimensional vector in a rectangular coordinate system
  - B. Demonstrate the calculation of vectored force using geometry and algebra
- IV. Apply Trigonometry to the Concept of Vectored Forces
  - A. Discuss the trigonometric ratios in a right triangle
    - 1. Discuss the origins of trigonometry
    - 2. Discuss the sine, cosine, and tangent functions
    - 3. Demonstrate the solution of sample industrial problems using the sine, cosine, and tangent functions
    - 4. Demonstrate a two dimensional vector in a rectangular coordinate system and label the parts used in trigonometric functions
  - B. Demonstrate the calculation of vectored forces using trigonometry

**AET-A6-LE1**  
**Use Physics, Algebra, and Trigonometry**  
**to Analyze Simple Vectored Forces**  
**Attachment 2: MASTER Laboratory Exercise**

---

The student shall:

1. Identify the component parts of the forces of a mechanism or electrical/electronic system;
2. Calculate the simple resultant force of a mechanism acting in opposition;
3. Identify the component parts of the input vectored forces of a mechanism or electrical/electronic system;
4. Layout a vector diagram of three vectored forces in a rectangular coordinate system;
5. Construct a vector diagram of two vectored forces acting a right angles;
6. Using the Pythagorean Theorem, solve for the resultant force;
7. Complete the laboratory exercise AET-A6-LE2 (Vectored forces); and,
8. Using trigonometry, calculate the vectored force in selected industrial equipment.

**AET-A7-HO**  
**Use Mechanical Physics to Analyze Mechanical Industrial Systems**  
**Attachment 1: MASTER Handout**

---

**Objective(s):**

Upon completion of this unit the student will be able to use the rules, formulas, and procedures found in the study of mechanical systems to:

- a. Identify simple machines found in complex machines;
  - b. Calculate the mechanical advantages of these simple machines found in complex machines;
  - c. Identify rotational machines found in complex machines, such as gear trains, pulleys, and wheel and axle systems;
  - d. Calculate the mechanical advantages of these rotational machines found in complex machines; and,
  - e. Apply the principles of force, work, power, momentum, impulse momentum, and friction to calculate and measure the result of these forces upon the complex machine.
- 

**Module Outline:**

- I. Analyze and Measure Simple Machines
  - A. Discuss and identify simple machines and the industrial equipment in which they can be found
    1. Levers
    2. Ramps
    3. Screws
  - B. Demonstrate the calculation of mechanical advantages/disadvantages, and speed advantages/disadvantages for each machine
  - C. Demonstrate the method of creating a complex machine from simple machines
    1. Demonstrate the methods of linking simple machines together into complex machines
    2. Demonstrate the calculation of the total effects upon the complex machine of the individual mechanical advantages/disadvantages and speed advantages/disadvantages of the simple machines
  - D. Demonstrate and measure the effects of the above simple machines upon industrial equipment such as lathes, mills, presses, or other types of complex machinery
- II. Analyze and Measure Rotational Machines
  - A. Discuss and identify rotational machines and the industrial equipment in which they can be found
    1. Wheel and axle

2. Pulleys
  3. Gear trains
  - B. Demonstrate the calculation of mechanical advantages/disadvantages, and speed advantages/disadvantages for each machine
  - C. Demonstrate the method of creating a complex machine from rotational and simple machines. (Use as an example a surplus exercycle)
    1. Demonstrate the methods of linking rotational machines and linear machines together into complex machines
    2. Demonstrate the calculation of the total effects upon the complex machine of the individual mechanical advantages of the linear and rotational machines
  - D. Discuss the relationship between levers, screws, and rotational machines
  - E. Demonstrate and measure the effects of the above simple machines upon industrial equipment such as lathes, mills, presses, or other types of complex machinery
- III. Analyze, Dimension, and Measure Forces
- A. Discuss and identify physical attributes acting upon industrial machines (dimensions)
    1. Mass-slugs, kilograms
    2. Force-pounds, Newton
    3. Work-energy, foot-pounds, joules
    4. Momentum, impulse momentum
    5. Torque-foot-pounds, Newton-meters
    6. Angular momentum, impulse momentum
  - B. Discuss and identify power and friction acting upon industrial machines
    1. Discuss mechanical power in horsepower and watts for the English Engineering system and Metric System
    2. Demonstrate the calculation of rotary and linear power and the conversion of power from both systems of measurement
    3. Discuss the mechanical measurement of power and how power is manifested in a mechanical system (heat)
    4. Discuss the component parts of friction and the coefficient of friction
    5. Demonstrate the factors used and the calculation of friction
    6. Discuss the relationship between momentum, impulse momentum, and friction
  - C. Discuss the relationship of power and friction in levers, ramps, and rotational machines
  - D. Demonstrate and measure the effects of the above physical factors upon industrial equipment such as lathes, mills, presses, or other types of complex machinery

**AET-A7-LE1**  
**Use Mechanical Physics to Analyze Mechanical Industrial Systems**  
**Attachment 2: MASTER Laboratory Exercise No. 1**

---

The student shall:

1. Analyze an industrial machine such as a lathe, mill, crane, or press; and,
2. Measure the machine's mechanical attributes.

**AET-A7-LE2**  
**Use Mechanical Physics to Analyze Mechanical Industrial Systems**  
**Attachment 3: MASTER Laboratory Exercise No. 2**

---

**Linear Simple Machines**

**Part 1: Levers**

**Equipment Needed:**

1. 1-12 inch or 30 mm lever arm with four holes spaced evenly along the length of the arm.
2. Aluminum mounting plate and stand, 24 in x 24 in or 40 mm x 40mm, drilled and tapped to accept a 1/4-20 or 6 mm bolt, with hole patterns spaced evenly every 1.0 inches or 3 cm on center, to mount the mechanical apparatus.
3. 1/4-20 or 6 mm Smooth shank bolt and nuts to act as fulcrum.
4. 2-Spring scales or pneumatic cylinders to act as the *effort force* and the *resistance force*.

**When pneumatic cylinders are used, a pressure gauge must be installed on the cylinders to record the pressure.**

5. Safety glasses. Safety glasses are required when using the pneumatic cylinder apparatus.

**Introduction**

There are three classes of levers. A class one (1) lever has the fulcrum between the effort force and the resistance force. A class two (2) lever has the resistance force between the fulcrum and the effort force. A class three (3) lever has the effort force between the fulcrum and the resistance force. Regardless of the class of lever, mechanical advantage and disadvantage is a function of the respective lengths from the fulcrum of the effort force and the resistance force. To determine mechanical advantage or disadvantage, one must measure the respective lengths of the application of the two forces.



## Part 1A: Class 1 Lever

### Apparatus:

#### 1. Mounting plate and stand

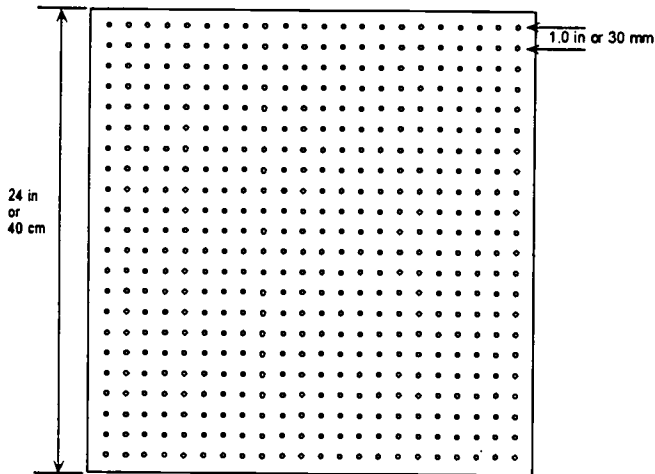

#### 2. Lever arm

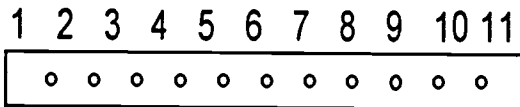

#### 3. Spring scale or pneumatic cylinder and pressure gauges

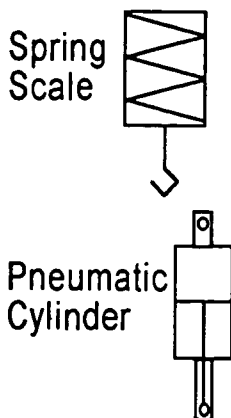

**Procedure:**

1. Construct the apparatus as shown. Use the holes on the lever arm as depicted in the following table.

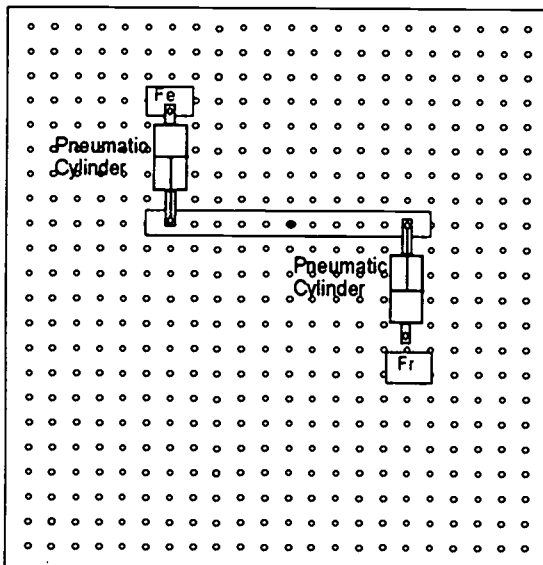
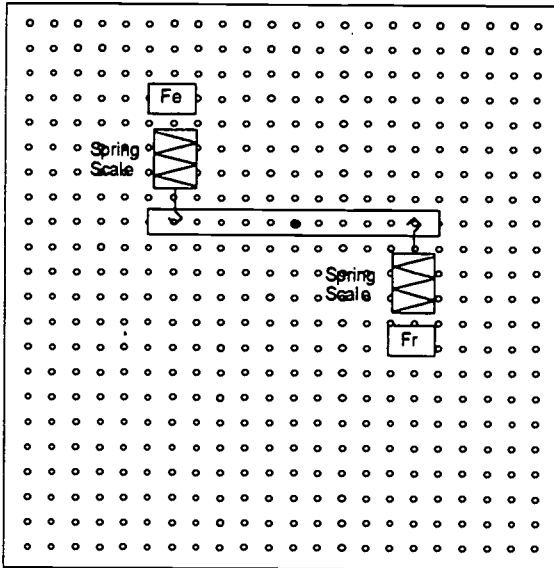

Table for class 1 lever			
Fulcrum hole	Length of Fr arm	Length of Fe arm	MA
2			
3			
4			
5			
6			
7			
8			
9			
10			

**For each fulcrum position in the table:**

2. Measure the length of the effort force from the fulcrum and the length of the resistance force from the fulcrum.
3. Calculate the expected MA.
4. Apply an effort force to the input of the lever, and record the effort and resistance forces. When using the pneumatic cylinders, a pressure gauge must be installed on the cylinders to record the pressure, and a compressor or hand pump must be used to apply the input pressure. Use the formula Force = Pressure Times Area ( $F = P * A$ ) to calculate the force. In the apparatus as shown above, for the **force of resistance**, you must subtract the *surface area of the rod* from the *surface area of the piston*, to obtain the correct value for surface area. This particular step may be eliminated if the output force cylinder is reversed to the top of the lever arm.
5. Compare the recorded data with the calculated values.

**Answer the following question(s):**

1. Does the measured MA match the calculated MA? If not, why?

---



---



---

2. What aspect of the system is lost or gained in the trade-off for a mechanical advantage or disadvantage?

---



---



---

## Part 1B: Class 2 Lever

### Apparatus:

#### 1. Mounting plate and stand

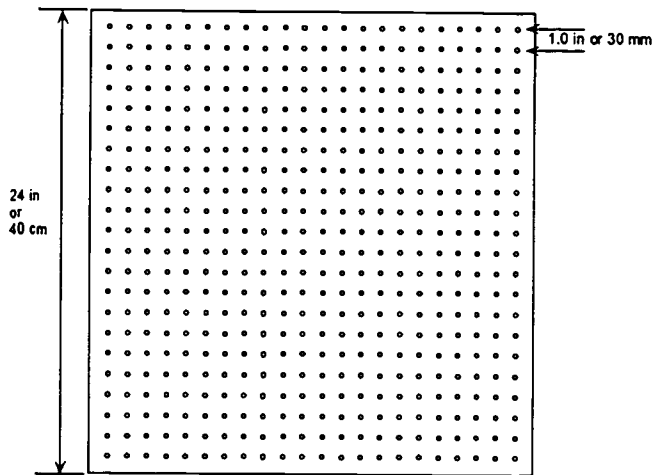

#### 2. Lever arm

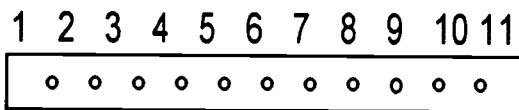

#### 3. Spring scale or pneumatic cylinder and pressure gauges

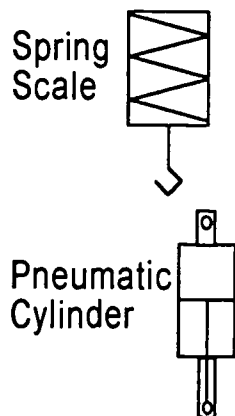

**Procedure:**

1. Construct the apparatus as shown. Use hole 1 as the fulcrum. Use the holes on the lever arm for the resistance force as depicted in the following table.

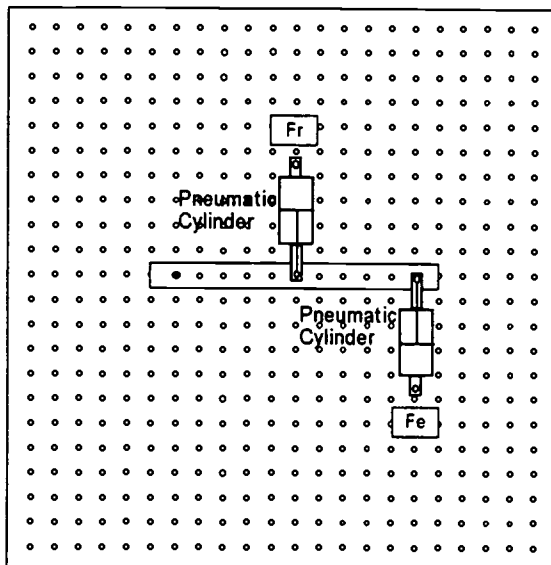
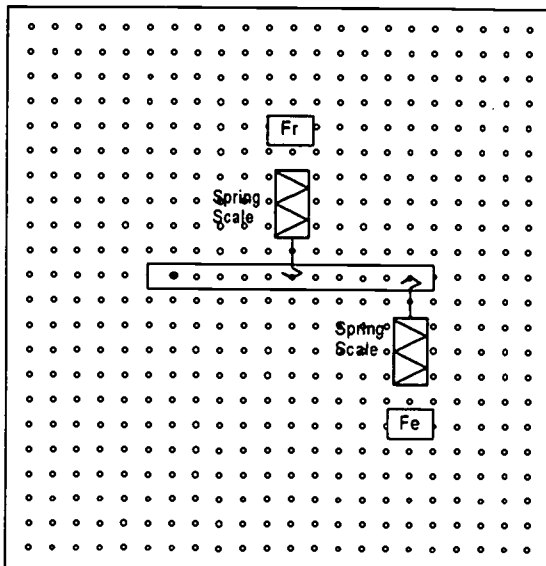

Table for class 2 lever			
Resistance Force	Length of Fr arm	Length of Fe arm	MA
2			
3			
4			
5			
6			
7			
8			
9			
10			

**For each resistance force position in the table:**

2. Measure the length of the effort force from the fulcrum and the length of the resistance force from the fulcrum.
3. Calculate the expected MA.
4. Apply an effort force to the input of the lever, and record the effort and resistance forces. When using the pneumatic cylinders, a pressure gauge must be installed on the cylinders to record the pressure, and a compressor or hand pump must be used to apply the input pressure. Use the formula Force = Pressure Times Area ( $F = P * A$ ) to calculate the force.
5. Compare the recorded data with the calculated values.

**Answer the following:**

1. Give three industrial examples of a Class 2 Lever.

---



---



---

## Part 1C: Class 3 Lever

### Apparatus:

1. Mounting plate and stand

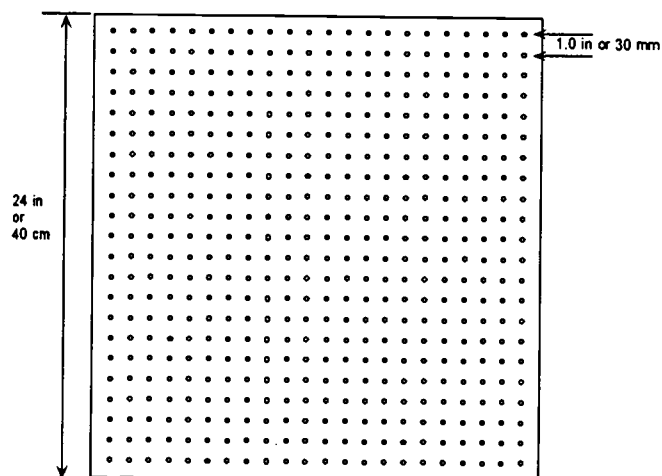

2. Lever arm

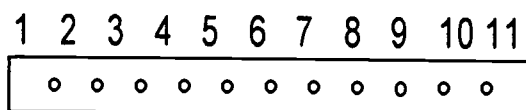

3. Spring scale or pneumatic cylinder and pressure gauges

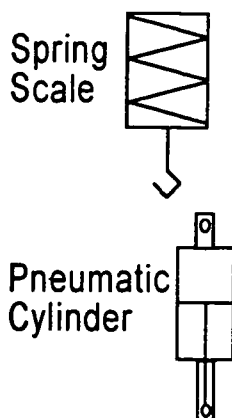

**Procedure:**

1. Construct the apparatus as shown. Use hole 1 as the fulcrum. Use the holes on the lever arm for the effort force as depicted in the following table.

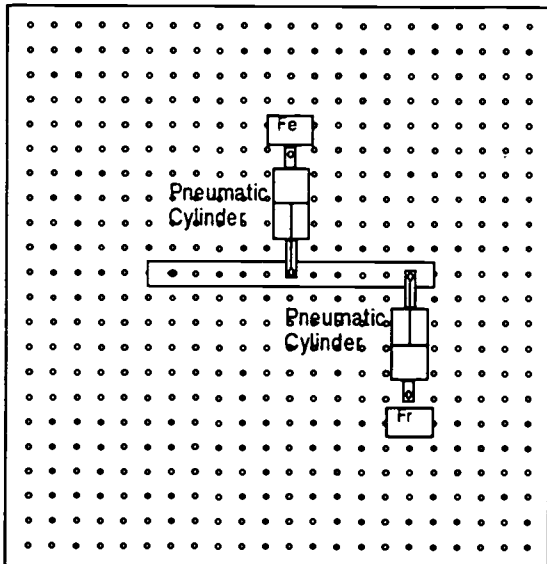
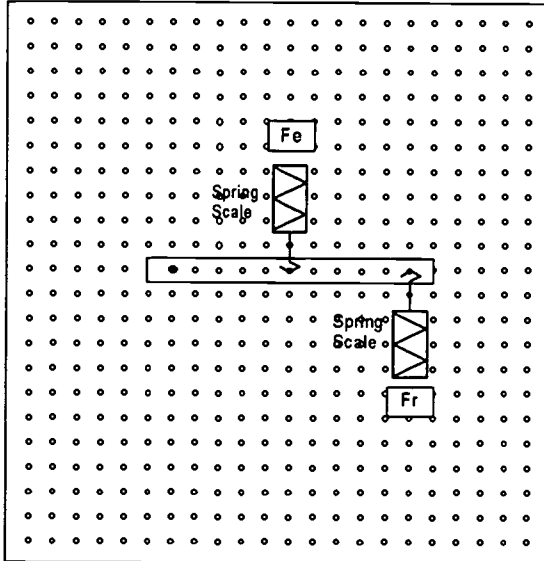



Table for class 3 lever			
Effort Force	Length of Fr arm	Length of Fe arm	MA
2			
3			
4			
5			
6			
7			
8			
9			
10			

**For each resistance force position in the table:**

2. Measure the length of the effort force from the fulcrum and the length of the resistance force from the fulcrum.
3. Calculate the expected MA.
4. Apply an effort force to the input of the lever, and record the effort and resistance forces. When using the pneumatic cylinders, a pressure gauge must be installed on the cylinders to record the pressure, and a compressor or hand pump must be used to apply the input pressure. Use the formula Force = Pressure Times Area ( $F = P * A$ ) to calculate the force.
5. Compare the recorded data with the calculated values.

**Answer the Following:**

1. Give an industrial example of a Class 3 Lever.

---



---



---

2. What kind of advantage does a class 3 lever provide?

---



---



---



---

**AET-A8-HO**  
**Use Math and Mechanical Physics to Analyze Problems**  
**Found in Hydraulic and Pneumatic Systems**  
**Attachment 1: MASTER Handout**

---

**Objective(s):**

Upon completion of this unit the student will be able to:

- a. Use the rules of mathematics and the theories and formulas found in the study of gases and fluids to understand and calculate the effects on industrial machinery of the following properties of matter: Pascal's Law, Charles' and Boyle's Law (Ideal Gas Law), Bernoulli's Principle, pressure, flow, density, specific gravity, evaporation, sublimation, condensation, humidity, and relative humidity; and,
- b. Use the rules of mathematics and the theories and formulas found in the study of high pressure and high vacuum systems, to calculate and convert pressures in various pressure systems, including psi (vacuum), psig, psia, inches of water, inches of mercury, bar (absolute), bar (atmospheric), SI system (Pascal's and kilopascals), and the torr system.

---

**Module Outline:**

- I. Gasses and Fluids
  - A. Explain the three states of matter (solids, liquids, gasses) and the phase diagram.
  - B. Explain the principles of the following properties of gasses and fluids:
    1. Pascal's Law
    2. Ideal Gas Laws
    3. Bernoulli's Principle
    4. Pressure
    5. Flow
  - C. Explain the principles of the following properties of matter:
    1. Density
    2. Specific gravity
    3. Evaporation
    4. Sublimation
    5. Condensation
    6. Humidity
  - D. Demonstrate the application of formulas for the following and demonstrate the calculation of the effects of each concept on industrial machinery:
    1. Pressure
    2. Density

3. Specific gravity
  4. Pressure and force created by pressure
  5. Pressure created by flow and the results of flow
  6. Relative humidity
- II. Calculate and convert pressures in various pressure systems
- A. Explain the formulas, dimensions, and principles of the following:
1. Force pressure scales English engineering system
    - a. Pounds per square inch absolute (PSIA)
    - b. Pounds per square inch gauge (PSIG)
  2. Force pressure scales metric mks system
    - a. Newtons per square meter absolute (pascals)(pa)
    - b. Kilo newtons per square meter absolute (kpaA)
    - c. Kilo newtons per square meter gauge (kpaG)
  3. Atmospheric pressure scales
    - a. Pressure of atmosphere
    - b. Bar (gauge)
    - c. Millibar (absolute)
  4. Length pressure scales
    - a. Inches of mercury (in Hg)
    - b. Millimeters of mercury (mm Hg)
    - c. Inches of water (in H<sub>2</sub>O)
  5. Vacuum pressure scales
    - a. Pounds per square inch vacuum (PSIV)
    - b. Microns
    - c. Torr
    - d. Bar
- B. Demonstrate the conversion from one pressure scale to another

**AET-A8-LE1**  
**Use Math and Mechanical Physics to Analyze Problems**  
**Found in Hydraulic and Pneumatic Systems**  
**Attachment 2: MASTER Laboratory Exercise No. 1**

---

1. Measure the above quantities on industrial equipment such as:
  - a. Mechanical systems;
  - b. Heat treating systems;
  - c. Pneumatic systems;
  - d. Vacuum systems;
  - e. Hydraulic systems;
2. Measure the output of water of a compressor system and compare it to the daily relative humidity;
3. List the different pressure gauges on several different manufacturing systems; and,
4. List several manufacturing processes that employ pressure, heat, or vacuum.

**AET-A9-HO**  
**Use Math and Thermodynamics to Analyze Problems**  
**Found in Industrial Heat Treating Systems**  
**Attachment 1: MASTER Handout**

---

**Objective(s):**

Upon completion of this unit the student will be able to:

- a. Use the rules of mathematics and the theories and formulas found in the study of thermodynamics to understand, calculate, and convert quantities found in industrial heat treating equipment such as temperature scales, kilocalories, British Thermal Units, and specific heat;
  - b. Understand the effects materials of the following: thermal conductivity and expansion and contraction of solids; and,
  - c. Understand the functions of simple engines and entropy.
- 

**Module Outline:**

- I. Temperature Scales and Heat
  - A. Explain the two temperature scales in common use and the methods by which they were derived.
  - B. Show video tape (*Mechanical Universe "Temperature"*)
  - C. Demonstrate the conversion from one temperature scale to another
  - D. Explain the principles of the physical dimensions of heat
    1. British Thermal Units (BTU)
    2. Calories and kilocalories
  - E. Demonstrate the application of formulas for heat on industrial heat treating equipment
  - F. Explain the principles of specific heat
  - G. Demonstrate the application of the principles of the application of specific heat to materials used in industrial processes
- II. Properties of Materials at Different Temperatures
  - A. Explain the causes and effects of thermal conductivity
    1. Measure the thermal conductivity of various substances
    2. Demonstrate the calculation of heat transfer and insulation quality
  - B. Explain the causes and effects of thermal expansion and contraction of solids
- III. Simple Engines and Entropy
  - A. Explain how the concept of simple heat engines applies to the understanding of:
    1. Air conditioners

2. Internal combustion engines
  3. External combustion engines
- B. Explain how the concept of entropy applies to the understanding of:
1. Electrical power distribution systems
  2. Hydraulic and pneumatic power distribution

**AET-A9-LE1**  
**Use Math and Thermodynamics to Analyze Problems**  
**Found in Industrial Heat Treating Systems**  
**Attachment 2: MASTER Laboratory Exercise No. 1**

---

1. Measure temperature in both the metric and English Engineering system, and convert from one to another;
2. By experimentation, determine the amount of heat needed to raise a material such as steel to a given temperature;
3. By calculation, determine the amount of power required to heat an oven to a given temperature;
4. Measure the expansion of metals that are exposed to heat;
5. Measure the transfer of heat through various solids;
6. Measure temperatures and power output of a simple heat engine or automobile engine; and,
7. Explore a power distribution system from the incoming electrical power to a facility to its usage and eventual conversion to heat in a hydraulic system or pneumatic system.

**AET-A10-HO**  
**Use Math, the Physics of Electromagnetism and Optics**  
**to Analyze Industrial Systems**  
**Attachment 1: MASTER Handout**

---

**Objective(s):**

Upon completion of this unit the student will be able to apply the knowledge of electromagnetic waves, light, and the rules of optics to understand optical systems, align optical systems, and use photo-spectrometer to:

- a. Define and understand the wave nature of light;
  - b. Define polarization;
  - c. Define monochromaticity;
  - d. Define temporal and spatial coherence;
  - e. Explain constructive and non-destructive interference; and,
  - f. Define Brewster's Angle.
- 

**Module Outline:**

- I. Discuss and Review the Characteristic of Light
  - A. Discuss the following wave properties of light
    1. Frequency
    2. Wavelength
    3. Phase
    4. Amplitude
    5. The electromagnetic spectrum
  - B. Define polarization
  - C. Define monochromaticity
  - D. Define temporal and spatial coherence
  - E. Explain constructive and non-destructive interference
  - F. Define and demonstrate Brewster's Angle
  - G. Practice and demonstration of skills listed above



**AET-A10-LE**  
**Use Math, the Physics of Electromagnetism and Optics**  
**to Analyze Industrial Systems**  
**Attachment 2: MASTER Laboratory Exercise**

---

Successful completion of this technical module will be based on the students' successful completion of the following components:

- a. Define and understand the wave nature of light;
- b. Define polarization;
- c. Define monochromaticity;
- d. Define temporal and spatial coherence;
- e. Explain constructive and non-destructive interference;
- f. Define Brewster's Angle; and,
- g. Practice and demonstration of skills listed above.

**AET-A10-LA**  
**Use Math, the Physics of Electromagnetism and Optics**  
**to Analyze Industrial Systems**  
**Attachment 3: MASTER Laboratory Aid**

---

## **Rules of Conduct**

1. Absolutely no horseplay or practical joking will be tolerated.
2. Do not talk to anyone who is operating a machine.
3. Walk only in the designated traffic lanes.
4. Dress appropriately; at the absolute minimum, you must have:
  - a. No loose clothing, including ties;
  - b. Long hair properly stowed;
  - c. No jewelry;
  - d. Hard, closed-toe shoes;
  - e. Eye protection (safety glasses); and,
  - f. Ear protection (plugs or headset).
5. Follow all institutional safety rules.

**AET-A11-HO-1**  
**Use Chemical Principles and Formulas to Predict and Analyze**  
**Reactions in Chemical Industrial Processes**  
Attachment 1: MASTER Handout No. 1

---

**Objective(s):**

Upon completion of this unit the student will be able to:

- a. Use math, physics, and chemical measurements to determine physical quantities;
- b. Use math and chemical measurements to determine compounds, solutions, or mixtures;
- c. Use chemical formulas to predict and analyze reactions in industrial processes;
- d. Use proper lab procedures to test chemicals used in industrial processes;
- e. Use the periodic table to identify elements;
- f. Use the periodic table to calculate molar quantities;
- g. Apply mixing formulas to produce proportions of various mixes, solutions, and compounds;
- h. Apply mixing formulas and the molar concept of chemistry to determine the quantities of elements need to produce a molar reaction;
- i. Apply the concept of ionization or valence and the periodic table to determine reactions;
- j. Apply reaction formulas to determine the number and type of elements needed, energy release or energy added, and if a catalyst is required;
- k. Explain the procedures used to determine the make-up of compounds; and,
- l. Explain the uses of bases or acids in manufacturing processes.

---

**Module Outline:**

- I. Use, Math, Physics, and Chemical Measurements to Determine Physical Quantities
  - A. Explain the theory of atoms and the organization of matter
    1. Explain the evolution of the theories of matter
    2. Explain the modern model of the atom and its structure
    3. Show the video *The Mechanical Universe "The Atom"*
  - B. Explain the use of the periodic table to identify elements and their characteristics
    1. Explain the organization of the periodic table. or video *Chemistry "The Periodic Table", Annenberg CPB*

2. Demonstrate the application of the periodic table to understanding the number of atoms contained in a solid, liquid, or gas
  - C. Explain the methods used to determine weight, volume, and density
    1. Demonstrate the use of balance scales and electronic scales (if available), to determine physical quantities
    2. Demonstrate the methods of calculating mass from a given weight and explain the uncertainties surrounding the calculation
    3. Demonstrate the methods used to determine the volume of a substance
    4. Explain the uncertainties surrounding the measurement
- II. Use Math and Chemical Measurements to Determine Compounds, Solutions, or Mixtures
- A. Apply mixing formulas to produce proportions of various mixtures, and solutions
    1. Explain the difference between solutions, compounds, and mixtures
    2. Explain the methods used to calculate solutions and mixtures (MASTER Handout AET-A11-HO-2 (Mixing Formulas))
    3. Demonstrate the application of mixing formulas to industrial problems
  - B. Use the periodic table to calculate molar quantities
    1. Explain the concept of a molar quantity
    2. Demonstrate the application of the periodic table in the determining of molar quantities
    3. Show applications of molar concepts in industrial chemical processes
  - C. Apply mixing formulas and the molar concept of chemistry to determine the quantities of elements need to produce a molar reaction
- III. Use Chemical Formulas to Predict and Analyze Reactions in Industrial Processes
- A. Apply the concept of ionization or valence and the periodic table to determine reactions
    1. Explain the atomic methods by which atoms are linked together to create compounds and structures
    2. Explain the concepts of covalent bonding, ionic bonding, and metallic bonding
  - B. Explain the procedures used to determine the make-up of compounds
    1. Explain the methods of writing chemical formulas
    2. Explain the rationale behind the naming of compounds, and the exceptions to the rules
    3. Demonstrate the creation of formulas for the composition of selected compounds
  - C. Explain and demonstrate the application of reaction equations

1. Explain the methods of writing reaction equations
    - a. Number and type of elements
    - b. Energy release or energy needed
    - c. Catalyst needed
    - d. Naming the resultant compound
  2. Demonstrate the creation of equations for the results of selected reactions
- IV. Use Proper Lab Procedures to Test Chemicals Used in Industrial Processes
- A. Explain chemical laboratory safety procedures
    1. Explain the types of safety equipment used in chemical processes
    2. Demonstrate the proper use of chemical safety equipment
    3. Explain and demonstrate the proper procedures for handling hazardous chemicals
    4. Explain the rules for using flammable or explosive materials
    5. Demonstrate the procedures used for handling and storing flammable or explosive materials
  - B. Explain the use of Material Safety Data Sheets (MSDS)
    1. Explain the organization of a MSDS
    2. Demonstrate the application of MSDS
  - C. Explain and demonstrate the methods used to determine acids or bases
    1. Explain the concept of an acid and a base
    2. Demonstrate and explain the application of the concept of pH in determining if a substance is an acid or a base
    3. Demonstrate the methods used to determine pH
  - D. Explain the principles of oxidation and reduction and some of the industrial chemical methods used to achieve each
  - E. Explain the methods used to produce raw chemicals and synthesize compounds
  - F. Explain the types of modern instruments used to determine chemical compounds
    1. Explain the operating principles of a mass spectrometer
    2. Explain the operating principles of a photo-spectrometer
    3. Explain the methods used to determine the chemical make-up of compounds using the instruments

AET-A11-HO-2  
Use Chemical Principles and Formulas to Predict and Analyze  
Reactions in Chemical Industrial Processes  
Attachment 2: MASTER Handout No. 2

---

**Mixing Formulas**

Concentrations of solutions are frequently expressed as percentages. Solutions labeled 3% hydrogen peroxide, 97% inert ingredients, 14% alcohol 10% iodine, 0.67 % sodium chloride, and 4% boric acid are common. The specific meaning of these percentages varies with the type of solute and solvent.

**Mass Percent**

Mass percent is also called weight percent. It is the *mass* of solute present in **100 grams** of the solution. For example, a solution that contained 3 grams of salt in 100 grams of a liquid would have 3 grams of the salt and 97 grams of the liquid. The total mass would be 100 grams and the solution would therefore be

$$\frac{3\text{grams}}{100\text{grams}} * 100$$

1. The basic formula is:

$$\text{Mass.percent.of.solute} = \frac{\text{mass.of.solute}}{\text{total.mass.of.solution}} * 100$$

2. Example:

35 grams of salt are dissolved in 500 grams of water

$$\frac{35\text{grams}}{500\text{grams}} = .07$$

3. Next: We multiply the result by 100

$$.07 * 100 = 7\%$$

4. This means that for every 100 grams of solution we have 7 grams of the salt.

### Mass Per Volume Percent

Frequently we desire to express the percentage of a mixture in terms of the *mass* of the solute and the *volume* of the solution. The result is expressed as the mass per 100 ml of the solution because the result is multiplied by 100.

The formula is:

$$\text{mass.per.volume.percent} = \frac{\text{gram.mass.of.solute}}{\text{volume.of.solution.(milli-liters)}}$$

5. Example:

How many grams of copper sulfate would be needed to prepare a 3% mass/volume solution in 500 milli-liters of liquid?

A 3% mass/vol. of the solution contains 3 grams of copper sulfide per 100 ml of the solution therefore:

$$\frac{500\text{ml}}{100\text{ml}} = 5$$

6. 500 ml would need 5 times as much copper sulfide as a solution of 3 grams per 100 ml therefore:

$$5 * 3\text{grams} = 15\text{grams}$$

7. And:

$$\frac{15\text{grams}}{500\text{ml}} * 100 = 3\%$$

8. These calculations are commonly used to prepare laboratory percentages and are used exclusively with the metric system.

However, it is important in industry to prepare large quantities of solutions that are expressed in the English engineering system or the metric system. Frequently, a solution of one mixture must be added to a solution of another mixture to increase or decrease the percentage of the resultant solution. In cases like these, the above formulas are not adequate.

A formula that will work in situations like this is the following:

$$1. \quad (\%Q1 * Q1) + (\%Q2 * Q2) = \%QT * (Q1 + Q2)$$

Where:

$\%Q1$  = the percentage of the first quantity

$\%Q2$  = the percentage of the second quantity

$\%QT$  = the percentage of the total quantity

$Q1$  = the total quantity of quantity one

$Q2$  = the total quantity of quantity two

All quantities must be expressed as the same (volume percentage, mass percentage, or mass per volume percentage).

To find the resultant percentage of a combined quantity:

$$2. \quad (\%Q1 * Q1) + (\%Q2 * Q2) / (Q1 + Q2) = \%QT$$

To find the total combined quantity:

$$3. \quad (\%Q1 * Q1) + (\%Q2 * Q2) / \%QT = (Q1 + Q2)$$

For example:

A tank of hydrochloric acid (HCL) is tested to determine its percentage. The test indicates that the solution is 4 percent HCL. How many 55 gallon drums of 12 percent acid must be added to the tank to bring the solution to 6 percent if the tank contains 1000 gallons?

Using formula 2:

$$4\% * 1000 + 12 * Q2 / 1000 + Q2 = 6\%$$

solving for  $Q2$ :

$$4000 + 12Q2 / 1000 + Q2 = 6\%$$

$$4000 + 12Q2 = 6000 + 6Q2$$



$$6Q2 = 2000$$

$$Q2 = 333.33 \text{ gal}$$

$$333.33 \text{ gallon}/55 \text{ gallon/drum} = 6.06 \text{ drums}$$

To cross check:

$$4\% * 1000 \text{ gal} + 12\% * 333.33 \text{ gal}/1000 \text{ gal} + 333.33 \text{ gal} = 5.9999 \text{ percent}$$

**AET-A11-LE**  
**Use Chemical Principles and Formulas to Predict and Analyze**  
**Reactions in Chemical Industrial Processes**  
**Attachment 3: MASTER Laboratory Exercise**

---

The student will:

1. Use an industrial chemical process to determine the mass and volume of a quantity of raw materials for a given amount of production;
2. Use an industrial chemical process to determine the quantity of raw materials needed for a given amount of production; and,
3. Use an industrial chemical process to write a reaction equation that describes the manufacturing process.

**AET-A12-HO-1**  
**Apply the Knowledge of Electrochemical Effects**  
**to Analyze Chemical Industrial Processes**  
**Attachment 1: MASTER Handout No. 1**

---

**Objective(s):**

Upon completion of this unit the student will be able to:

- a. Use math, physics, and chemical measurements to test and prepare batteries for use;
- b. Use math and chemical measurements to test and prepare chemicals and systems used in electro-plating processes;
- c. Use math and chemical measurements to test and prepare chemicals and systems used in chemical milling processes;
- d. Use math and chemical measurements to test and prepare chemicals and systems used in integrated circuit manufacturing;
- e. Use the principles of chemistry, physics and measurement to test and prepare batteries for use;
- f. Use the principles of chemistry, physics and measurement to test and prepare chemicals for use in industrial processes;
- g. Use the principles of chemistry, physics and measurement to test and prepare chemicals for use in integrated circuit manufacturing;
- h. List the steps used in industrial chemical processes and integrated circuit manufacturing processes; and,
- i. Identify the types of equipment and the principles of operation of the equipment used in industrial chemical processes.

---

**Module Outline:**

- I. Use Math, Physics, and Chemical Measurements to Test and Prepare Batteries for Use
  - A. Explain chemical laboratory safety procedures
    1. Explain the types of safety equipment used in chemical processes
    2. Demonstrate the proper use of chemical safety equipment
    3. Explain and demonstrate the proper procedures for handling hazardous chemicals
    4. Explain the rules for using flammable or explosive materials
    5. Demonstrate the procedures used for handling and storing flammable or explosive materials
  - B. Explain the use of Material Safety Data Sheets (MSDS)
    1. Explain the organization of a MSDS
    2. Demonstrate the application of MSDS

- C. Explain and demonstrate the methods used to determine acids or bases
    - 1. Explain the concept of an acid and a base
    - 2. Demonstrate and explain the application of the concept of pH in determining if a substance is an acid or a base
    - 3. Demonstrate the methods used to determine pH
  - D. Explain the principles of oxidation and reduction and some of the industrial chemical methods used to achieve each
  - E. Explain the types of modern instruments used to determine chemical compounds
    - 1. Explain the operating principles of a mass spectrometer
    - 2. Explain the operating principles of a photo-spectrometer
    - 3. Explain the methods used to determine the chemical make-up of compounds using the instruments
  - F. Explain the theory of electrochemical battery processes
    - 1. Explain the theory of operation of a battery
    - 2. Show the video *The Mechanical Universe "Batteries"*
    - 3. Demonstrate the charging process in a battery and the by products of the process
    - 4. List the types of batteries in use and their applications
  - G. Explain the effects of weight, volume, and density of the electrolyte a lead-acid electrochemical battery
  - H. Explain and demonstrate the use of measuring instruments to determine the state of charge or discharge of an electrochemical battery
- II. Use Math and Chemical Measurements to Test and Prepare Chemicals and Systems Used in Electro-plating Processes
- A. Apply electro-chemical concepts to produce proportions of solutions used in electro-plating processes
    - 1. Explain the electro-chemical plating process
      - a. Ionic exchange of metal elements
      - b. Chemicals used in electro-plating processes
      - c. Effects of plating current upon the process
      - d. Control systems used to plate metals
    - 2. Explain the methods used to calculate solutions and mixtures (MASTER Handout AET-A12-HO-2 (Mixing Formulas))
    - 3. Demonstrate the application of mixing formulas to electroplating
  - B. Use the periodic table to calculate molar quantities for electro-plating processes
  - C. Apply mixing formulas and the molar concept of chemistry to determine the quantities of elements need to plate metals
- III. Use Math and Chemical Measurements to Test and Prepare Chemicals and Systems Used in Chemical Milling Processes

- A. Apply electro-chemical concepts to produce proportions of solutions used in chemical milling processes
    - 1. Explain the chemical milling process
      - a. Ionic exchange of metal elements
      - b. Chemicals used to remove and condition metal
      - c. Control systems used in chemical milling
    - 2. Explain the methods used to calculate solutions and mixtures (MASTER Handout AET-A12-HO-2 (Mixing Formulas))
    - 3. Demonstrate the application of mixing formulas to chemical milling
  - B. Use the periodic table to calculate molar quantities for chemical milling processes
  - C. Apply mixing formulas and the molar concept of chemistry to determine the quantities of elements need to chemically mill metals
- IV. Use Math and Chemical Measurements to Test and Prepare Chemicals and Systems Used in Integrated Circuit Manufacturing
- A. Manufacturing processes and equipment
    - 1. Explain silicon crystal growth, wafer fabrication and identification
    - 2. Explain purposes of silicon dioxide in integrated circuit manufacturing
    - 3. Explain and demonstrate the chemistry of oxide formation
      - a. Oxidation reactions
      - b. Oxidation rate
    - 4. Explain the methods used for oxide formation processes
      - a. Rapid thermal oxidation
      - b. High pressure oxidation
    - 5. Explain the operation of tube furnaces for oxidation
    - 6. Explain the photolithography process
      - a. Principles of electromagnetic waves and interference
      - b. Reflection and refraction
      - c. Photochemical principles
    - 7. Explain the etching processes and equipment
      - a. Plasma generation
      - b. Ion beam generation
    - 8. Explain the doping processes and equipment
      - a. Thermal diffusion equipment
      - b. Ion Implantation beam generation
    - 9. Explain the deposition processes and equipment
      - a. Chemical Vapor Deposition (CVD) overview
      - b. CVD equipment operating principles
        - (1) Atmospheric systems
        - (2) Low pressure systems
        - (3) Plasma systems
        - (4) Photochemical systems

- c. Deposition films
  - (1) Types of films
  - (2) Molecular Beam Epitaxy (MBE)
  - (3) Vapor phase epitaxy (VPE)
  - (4) Metal-organic CVD (MOCVD)
  - (5) Polysilicon and amorphous silicon deposition
  - (6) Silicon on sapphire and silicon on insulator
  - (7) Silicon dioxide and silicon nitride
- 10. Explain the metallization process and equipment
  - a. Materials
  - b. Deposition methods
    - (1) Vapor deposition
    - (2) Sputter deposition
- 11. Wafer test and evaluation
  - a. Four point probe measurements
  - b. Thickness measurements
  - c. Junction depth measurements
  - d. Contamination and defect detection
  - e. Critical dimensions measurement
  - f. Device electrical measurement
  - g. Pinhole counting
- B. Principles of process control
  - 1. Yield calculations
  - 2. Statistical Process Control (SPC)

**AET-A12-HO-2**  
**Apply the Knowledge of Electrochemical Effects**  
**to Analyze Chemical Industrial Processes**  
**Attachment 2: MASTER Handout No. 2**

---

**Mixing Formulas**

Concentrations of solutions are frequently expressed as percentages. Solutions labeled 3% hydrogen peroxide, 97% inert ingredients, 14% alcohol 10% iodine, 0.67 % sodium chloride, and 4% boric acid are common. The specific meaning of these percentages varies with the type of solute and solvent.

**Mass Percent**

Mass percent is also called weight percent. It is the *mass* of solute present in *100 grams* of the solution. For example, a solution that contained 3 grams of salt in 100 grams of a liquid would have 3 grams of the salt and 97 grams of the liquid. The total mass would be 100 grams and the solution would therefore be

$$\frac{3\text{grams}}{100\text{grams}} * 100$$

1. The basic formula is:

$$\text{Mass.percent.of.solute} = \frac{\text{mass.of.solute}}{\text{total.mass.of.solution}} * 100$$

2. Example:

35 grams of salt are dissolved in 500 grams of water

$$\frac{35\text{grams}}{500\text{grams}} = .07$$

3. Next: We multiply the result by 100

$$.07 * 100 = 7\%$$

4. This means that for every 100 grams of solution we have 7 grams of the salt.

### Mass Per Volume Percent

Frequently we desire to express the percentage of a mixture in terms of the *mass* of the solute and the *volume* of the solution. The result is expressed as the mass per 100 ml of the solution because the result is multiplied by 100.

The formula is:

$$\text{mass per volume percent} = \frac{\text{gram mass of solute}}{\text{volume of solution (milli-liters)}}$$

5. Example:

How many grams of copper sulfate would be needed to prepare a 3% mass/volume solution in 500 milli-liters of liquid?

A 3% mass/vol. of the solution contains 3 grams of copper sulfide per 100 ml of the solution therefore:

$$\frac{500\text{ml}}{100\text{ml}} = 5$$

6. 500 ml would need 5 times as much copper sulfide as a solution of 3 grams per 100 ml therefore:

$$5 * 3\text{grams} = 15\text{grams}$$

7. And:

$$\frac{15\text{grams}}{500\text{ml}} * 100 = 3\%$$

8. These calculations are commonly used to prepare laboratory percentages and are used exclusively with the metric system.



However, it is important in industry to prepare large quantities of solutions that are expressed in the English engineering system or the metric system. Frequently, a solution of one mixture must be added to a solution of another mixture to increase or decrease the percentage of the resultant solution. In cases like these, the above formulas are not adequate.

A formula that will work in situations like this is the following:

$$1. \quad (\%Q1 * Q1) + (\%Q2 * Q2) = \%QT * (Q1 + Q2)$$

Where:

$\%Q1$  = the percentage of the first quantity

$\%Q2$  = the percentage of the second quantity

$\%QT$  = the percentage of the total quantity

$Q1$  = the total quantity of quantity one

$Q2$  = the total quantity of quantity two

All quantities must be expressed as the same (volume percentage, mass percentage, or mass per volume percentage).

To find the resultant percentage of a combined quantity:

$$2. \quad (\%Q1 * Q1) + (\%Q2 * Q2) / (Q1 + Q2) = \%QT$$

To find the total combined quantity:

$$3. \quad (\%Q1 * Q1) + (\%Q2 * Q2) / \%QT = (Q1 + Q2)$$

For example:

A tank of hydrochloric acid (HCL) is tested to determine its percentage. The test indicates that the solution is 4 percent HCL. How many 55 gallon drums of 12 percent acid must be added to the tank to bring the solution to 6 percent if the tank contains 1000 gallons?

Using formula 2:

$$4\% * 1000 + 12 * Q2 / 1000 + Q2 = 6\%$$

solving for  $Q2$ :

$$4000 + 12Q2 / 1000 + Q2 = 6\%$$

$$4000 + 12Q2 = 6000 + 6Q2$$

$$6Q2 = 2000$$

$$Q2 = 333.33 \text{ gal}$$

$$333.33 \text{ gallon}/55 \text{ gallon/drum} = 6.06 \text{ drums}$$

To cross check:

$$4\% * 1000 \text{ gal} + 12\% * 333.33 \text{ gal}/1000 \text{ gal} + 333.33 \text{ gal} = 5.9999 \text{ percent}$$

**AET-A12-LE**  
**Apply the Knowledge of Electrochemical Effects**  
**to Analyze Chemical Industrial Processes**  
**Attachment 3: MASTER Laboratory Exercise**

---

The student will:

1. Use an industrial battery to determine the state of charge or discharge of the battery;
2. Use an industrial electro-plating process to determine the quantity of raw materials needed for a given amount of production;
3. Use an industrial chemical milling process to write a reaction equation that describes the manufacturing process; and,
4. Use a theoretical integrated circuit manufacturing process to determine the process steps, equipment needed, and the chemical processes used to fabricate the circuit.

**AET-A13-HO**  
**Apply Properties of Water**  
**to Analyze Industrial Water Treatment Processes**  
**Attachment 1: MASTER Handout**

---

**Objective(s):**

Upon completion of this unit the student will be able to:

1. Describe the electrical properties of chemically pure water and water that contains solutions of acids or bases;
  2. Explain the concept of pH and the determination of acidity or alkalinity of water;
  3. Describe the industrial processes used to produce chemically pure water or de-ionized water; and,
  4. Identify tests and equipment used to test the properties of water.
- 

**Module Outline:**

- I. Demonstrate the Properties of Pure Water, De-ionized Water, and Water with Various Compounds in Solution
  - A. Demonstrate the resistive properties of chemically pure water and ionized water
  - B. Explain the concept of pH in terms of hydroxyl and hydrogen ions
  - C. Apply the concept of ionization and pH to determine if water is ionized as an acid or a base
  - D. List the organic and inorganic contaminants of water and the industrial and household uses of pure water
- II. Demonstrate the Procedures Used to De-Ionize Water and Produce Chemically Pure Water
  - A. List the methods used to produce chemically pure water and the basic theory of the process
    1. Removal of particulates
      - a. Types of filtration
      - b. Filtration principles
    2. Removal of volatile organic compounds (VOC)
      - a. Boiling
      - b. Oxidation
      - c. Distillation
      - d. Reverse osmosis
      - e. Absorption (activated carbon)
    3. Removal of micro-organisms
      - a. Protozoa, mold, fungi, and parasites
      - b. Algae
      - c. Bacteria

- d. Virus
    - 4. Removal of inorganic contaminants
      - a. Acids
      - b. Bases
      - c. Iron, metal salts
    - 5. De-ionization of water
- B. Demonstrate the reverse osmosis method of water filtration and explain the processes
  - 1. Types of R-O membranes
  - 2. Filtration
  - 3. Chemical treatment
  - 4. Demonstrate de-ionization techniques and explain the reaction
  - 5. Explain the procedures used to monitor and protect pure water systems
  - 6. Compare various R-O systems with the contaminants removed
- C. Apply properties of water treatment to analyze industrial water treatment processes

**AET-A13-LE**  
**Apply Properties of Water**  
**to Analyze Industrial Water Treatment Processes**  
**Attachment 2: MASTER Laboratory Exercise**

---

The student will:

1. Demonstrate an analysis of industrial application of pure water applications;  
and,
2. Use an industrial water treatment requirement to determine the best method  
of water treatment.

**AUTOMATED EQUIPMENT REPAIR TECHNICIAN ... operates, programs, maintains, and repairs automated machine tools and automated manufacturing processes.**

**Duties**

**Tasks**

Duties	A-1 Apply scientific engineering notation to solve technical problems	A-2 Apply algebra to solve technical problems	A-3 Use variables to solve basic formulas to predict behavior of industrial systems	A-4 Manipulate algebraic formulas to analyze industrial systems	A-5 Measure electrical quantities in metric (SI) units in a system of measurement	A-6 Use metric units to analyze mechanical systems	A-7 Use static and dynamic physics to analyze mechanical systems	A-8 Use static and dynamic physics to analyze hydraulic and pneumatic systems	A-9 Use math and thermodynamics to analyze problems found in industrial systems	A-10 Use math, the physics of electromagnetism and optics to analyze industrial systems	A-11 Use chemical principles and formulas to predict and analyze reactions in industrial processes	A-12 Apply the knowledge of electrochemical effects to analyze chemical industrial processes	A-13 Apply principles of water treatment processes
<b>A</b> Apply Science to Solve Industrial Problems													
<b>B</b> Use Drawings to Analyze and Repair Systems													
<b>C</b> Use Calibrated Measuring Instruments to Test/Calibrate Components													
<b>D</b> Resolve System Critical Thinking, Troubleshooting, Theory, and Metrology													
<b>E</b> Use Techniques to Isolate Malfunctions of Electronic Systems													
<b>F</b> Measure/Isolate Malfunctions of Mechanical/Fluid Power Systems													
<b>G</b> Apply Computer Science to Computer Controlled Industrial Equipment													
<b>H</b> Convert Malfunctions in PLC Controlled Industrial Equipment													
<b>I</b> Relative Malfunctions Found in Computer Systems Controlling Manufacturing Processes													
<b>J</b> Assemble/Disassemble Mechanical/Electrical/Electronic Systems													

**AET-B1-HO-1**  
**Use Symbols, Organization, and Engineering Values**  
**on Mechanical Drawings**  
**Attachment 1: MASTER Handout No. 1**

---

**Objective(s):**

Upon completion of this unit the student will be able to use the symbols and organization associated with mechanical drawings to identify features of the part from the drawing, the part's dimensions, and the tolerance of the part's features, on both standard and Geometric Dimensioning drawings, including:

- a. Identifying symbols on mechanical engineering drawings;
- b. Identifying the layout of a mechanical drawing;
- c. Applying manufacturing information from a mechanical drawing;
- d. Identifying Geometric Dimensioning and Tolerancing (GD&T) (ASME Y14.5) symbols on a mechanical drawing; and,
- e. Applying manufacturing information from GD&T symbology on a mechanical drawing.

---

**Module Outline:**

- I. Identify Symbols on Mechanical Engineering Drawings
  - A. Mechanical Drawing Symbols: MASTER Handout AET-B1-HO-2 (Mechanical Drawing Symbols) and MASTER Handout AET-B1-HO-3 (Mechanical Drawing Layout)
    1. Describe the types of lines used on mechanical drawings and their meaning
    2. Describe the symbols used to apply engineering information on mechanical drawings
    3. Describe the symbols used to apply welding information on mechanical drawings
    4. Describe the symbols used to apply finishing information on mechanical drawings
  - B. Demonstrate the methods used to apply the above symbols to the manufacturing of parts
- II. Identify the Layout of a Mechanical Drawing
  - A. Mechanical Drawing Layout: MASTER Handout AET-B1-HO-2 (Mechanical Drawing Symbols) and MASTER Handout AET-B1-HO-3 (Mechanical Drawing Layout)
    1. Describe the informational areas on mechanical drawings and their meaning
    2. Describe the tables used to provide hole pattern information on mechanical drawings
    3. Describe the title block and its functions



4. Describe the table of engineering notes and its organization
- B. Demonstrate the methods used to apply the above information to the manufacturing of parts
- III. Apply Manufacturing Information From a Mechanical Drawing
  - A. Demonstrate the methods used to apply manufacturing information from a mechanical drawing: MASTER Handout AET-B1-HO-2 (Mechanical Drawing Symbols) and MASTER Handout AET-B1-HO-3 (Mechanical Drawing Layout)
    1. Demonstrate the methods of applying dimensional information and tolerances from the drawing
    2. Demonstrate the methods of applying hole pattern information from the drawing
    3. Describe the title block and its functions
    4. Describe the table of engineering notes and its organization
  - B. Demonstrate the methods used to apply the above information to the manufacturing of parts
- IV. Identify Geometric Dimensioning and Tolerancing (GD&T) (ASME Y14.5) Symbols on a Mechanical Drawing
  - A. Demonstrate the use of GD&T symbology to determine a datum plane or datum object
  - B. Demonstrate the use of GD&T symbology to determine the geometric characteristics of a feature
  - C. Demonstrate the use of GD&T symbology such as maximum material condition (MMC), least material condition (LMC), and regardless of feature size (RFS), to determine the possible size of a geometric feature
- V. Apply Manufacturing Information From GD&T Symbology on a Mechanical Drawing
  - A. Demonstrate the determination of the tolerances of a feature from the application of the symbology of GD&T
  - B. Associate the principles of GD&T with the mathematical concepts of geometry

**AET-B2-HO-1**  
**Use Symbols, Organization, and Engineering Values**  
**on Electrical Drawings**  
**Attachment 1: MASTER Handout No. 1**

---

**Objective(s):**

Upon completion of this unit the student will be able to use the symbols and organization associated with electrical ladder diagrams, or electronic schematic diagrams and electrical/electronic layout diagrams to:

- a. Identify components by their symbol;
  - b. Determine the location of the components;
  - c. Apply engineering values obtained from the drawing to the solution of technical problems; and,
  - d. Apply troubleshooting information from an electrical drawing.
- 

**Module Outline:**

- I. Identify Symbols on Electrical Drawings
  - A. Electrical Drawing Symbols: MASTER Handout AET-B2-HO-2 (Electrical Drawing Symbols)
    1. Describe the types of symbols used on electrical drawings and their meaning
    2. Provide examples of parts that relate to the symbol
    3. Explain the operation of each component in general terms
  - B. Demonstrate the interconnection of symbols
- II. Identify the Layout of an Electrical Assembly Drawing
  - A. Electrical Drawings: MASTER Handout AET-B2-HO-3 (Electrical Drawings)
  - B. Describe the purpose of an electrical layout and wiring drawing
  - C. Provide examples of an electrical layout and wiring drawing
  - D. Describe the procedure for following wires and determining terminal connections
- III. Identify the Layout of an Electrical Ladder Drawing
  - A. Explain the meaning and use of rungs and rails
  - B. Locate the primary power distribution and the ladder control logic
  - C. Locate the position on the rungs of relay coils and contacts
  - D. Identify wires and wire numbers on a electrical ladder diagram
  - E. Identify current sources, their type, and magnitude
- IV. Apply Troubleshooting Information From an Electrical Drawing
  - A. Determine the types of current sources and their magnitude (voltage, AC or DC)
  - B. Determine the specifications of the operational characteristics of an electronic assembly from the specifications section of a manual

- C. Relate the electronic symbol to the component number on an electronic schematic diagram
- D. Determine the value of components and their model or type number from the material specification list in the materials section of an electronic assembly from the equipment manual

**AET-B2-HO-2**  
**Use Symbols, Organization, and Engineering Values**  
**on Electrical Drawings**  
**Attachment 2: MASTER Handout No. 2**

---

**Reading Electrical or Electronic Drawings**

**Amplifier**

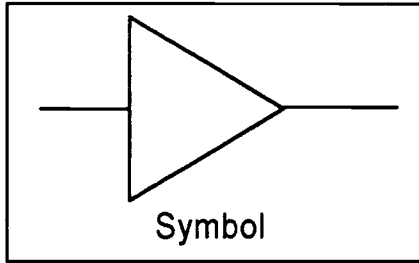

A device which increases the energy level of a physical value. The symbol shown above is the basic symbol for an amplifier. The symbol is always composed of an input and an output. The input is always drawn on the left, and the output is always drawn on the right. The term amplifier, can be applied to mechanical systems as well as it can be applied to electronic systems.

The symbol that depicts an amplifier is a general symbol that gives no indication of the size of the object, the amount of components used in the object, nor the type of system in which the object is used. The technician must infer these facts from the context in which the object is used.

An amplifier can have more than one input, and more than one output. For example:

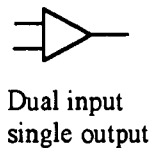

or

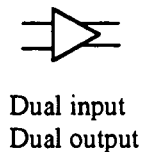

or

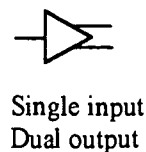

In addition, the use of a small circle indicates that the amplifier inverts the results of its amplification.

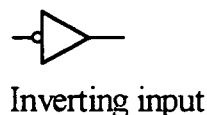
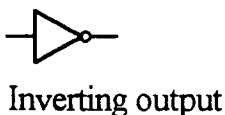

Lines that are drawn to the symbol at right angles are usually power connections, or axillary connections. For example:

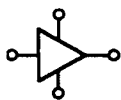

The two vertical lines represent connections to the power supply, or a control connection. The round circles indicate connection points, not inversion.

Various types of amplifier symbols:



The basic symbol for an amplifier provides no clue as to the nature of the device. An amplifier can have as few as four components associated with it, or can have more than one hundred complex electronic circuits. Amplifiers can be composed of discrete components, or be enclosed in an integrated circuit. The amplifier symbol covers a wide variety and scope of devices.

### Batteries (Generalized DC source)

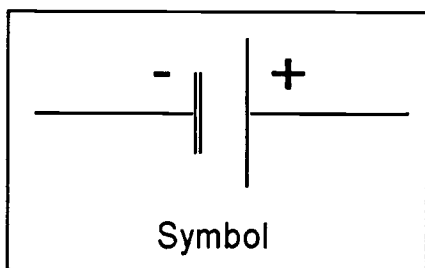

A battery is device that converts chemical energy to Direct Current electrical energy. Batteries are frequently constructed of cells that are electrically connected, one to another. Most cells produce from 1 to 1.5 volts DC. If the battery is only composed of one cell, the symbol will appear as its is above. If the battery is composed of many cells, the diagram will appear as it does below.

The battery symbol can also be used to depict a generalized Direct Current source of electrical power.

An automobile battery uses sulfuric acid and lead plates to generate DC electrical current. It is a multi-celled battery. Sources of DC current that are created by electronic methods ordinarily do not use the battery symbol.



**Multi-celled battery**

## Capacitors

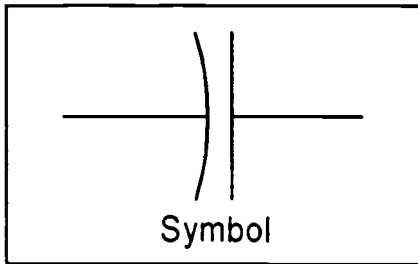

Capacitors are devices that perform several functions in electrical and electronic circuits. A capacitor can be used to store electrical energy and release it in a controlled fashion, a capacitor can be used as a variable opposition (resistance) in an Alternating Current (AC) application, and a capacitor can be used to filter electrical voltages. There are essentially three types of capacitors in use today. They are, variable capacitors, non-polarized capacitors, and electrolytic capacitors.

Various capacitor symbols:



Variable Capacitor

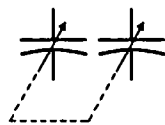

Variable Capacitors mechanically coupled (ganged)

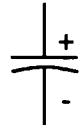

Electrolytic Capacitor



Non-polarized Capacitor (the curved end represents the most negative connection point)

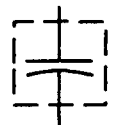

Shielded Capacitor

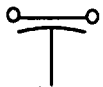

Feed-Through Capacitor

The capacitor symbols depicted above cover most of the various types of symbols that the technician may encounter in a machine or electronic circuit.

The variable capacitor is a capacitor whose capacitance can be varied by mechanical means. The variable capacitor that is mechanically coupled, is the type of capacitor that is used to tune the stations on a transistor radio.

The electrolytic capacitor is extremely sensitive to voltage polarities. The wise technician who installs this type of capacitor pays care full attention to detail and installs this device in the proper polarity. This type of capacitor can explode if it is installed backwards!

The shielded capacitor is use in sensitive television and radio applications. It is frequently found it computer monitors where it prevents stray electrical radiation.

The feed-through capacitor is used to filter stray electrical noise from wires that are used to connect circuits in radio and television equipment.

The non-polarized capacitor symbol is the most common type of capacitor symbol found in most circuits. The curved end of the capacitor symbol indicates the point at which the capacitor should be connected to the most negative voltage potential. Ordinarily, the manner in which the non-polarized capacitor is installed is unimportant. However, in certain sensitive applications, the capacitor should be installed with the polarity in mind. Many capacitors have a black ring that indicates this connection point.

Capacitors come in a wide variety of shapes and sizes. Generally, the size of a capacitor is determined by two factors. First, the amount of capacitance; and second, the working voltage of the capacitor. The larger the capacitance, the larger the capacitor, and the higher the voltage, the larger the capacitor. These two factors influence each other. For example, a high voltage capacitor that has a small amount of capacitance may be as large as a low voltage capacitor that has massive amounts of capacitance.

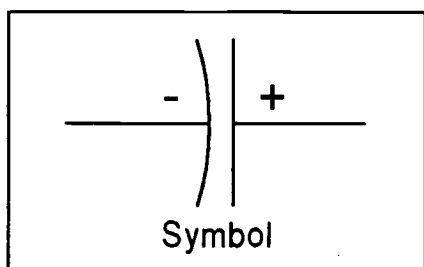

### Electrolytic Capacitor

An electrolytic capacitor is a capacitor that uses a chemical to create the capacitance effect. The chemical is used in the capacitor as an insulator. Electrolytic capacitors are designed to provide extremely large amounts of capacitance while maintaining a small size. The reason that this can be accomplished, is because the chemical involved,

(usually an oxide compound) enables the conductors of the capacitor (called plates) to be positioned extremely close together. For this reason, electrolytic capacitors are polarity sensitive; since the electrolyte (insulator) can be destroyed by an improper application of voltage.

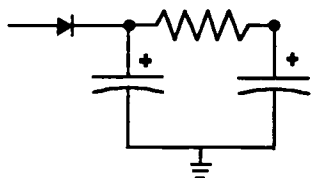

**Filter Circuit**

The above symbology depicts the capacitor symbol connected with other symbols to form a circuit. The circuit shown is designed to allow the capacitor to filter DC voltages.

### **Surface Mount Capacitors**

Surface mount technology is the way things are done today. It is the method that dictates that all components are mounted on a single side of the printed circuit board. Through hole technology required drilled circuit boards, adding many steps to the manufacturing process. Surface mount technology lends its self well to automation, allowing many parts per minute and very little hand work. Due to surface mount technology, sophisticated equipment has not only become more portable (lighter in weight and smaller in size) but also more economical.

Surface mount technology has changed the nature of electronics. Everything has been miniaturize to the point of non-recognition. Components do not look the same today as they did as recently as ten years ago. And even an experienced technician can no longer recognize what the capacitor really is without a symbol designator on the circuit board.

### **Circuit Breaker**

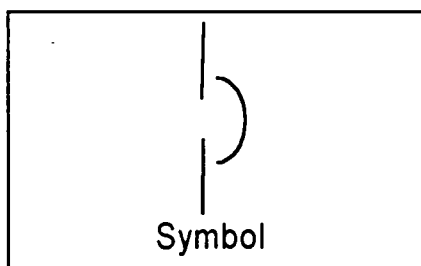



A circuit breaker is a device that interrupts the flow of electrical power. In your home, the circuit breaker is a switch designed to disconnect the primary power sources for appliances and lighting. In industry the circuit breaker works to interrupt power for high powered industrial equipment. Power for the home ordinarily requires that only one wire be disconnected, and so the circuit breaker has only one pole to perform the act. The term pole refers to the connection path for the conduction of electrical power. In industry, power is frequently supplied over three wires. For this reason many circuit breakers employed in factories application have three poles. The circuit breaker is frequently designed to automatically interrupt the electrical power if some equipment connected to the electrical power malfunctions. If the circuit breaker is designed to provide this function, the symbol will reflect it.

**Circuit breaker with a thermal overload trip.**

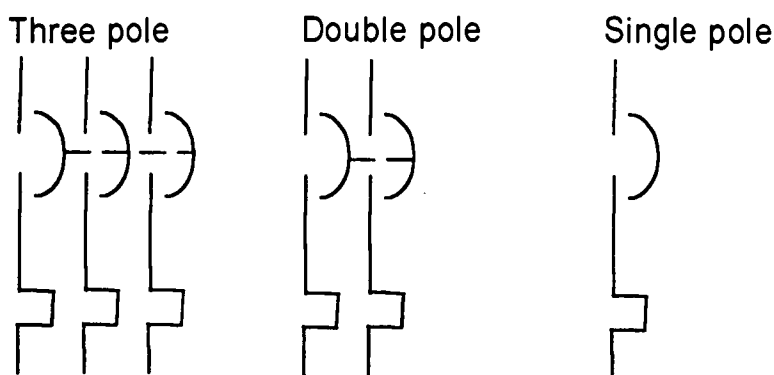

The single pole version of this symbol is the type of circuit breaker most often found in homes. The dashed line in the symbol of the circuit breaker signify that the multiple poles of the breaker are mechanically linked. When excessive electrical currents flow through the device, large amounts of heat are generated. The high heat is used to trip a mechanism in the breaker, thereby disconnecting the circuit.

**Circuit breaker with a bimetallic thermal overload trip.**

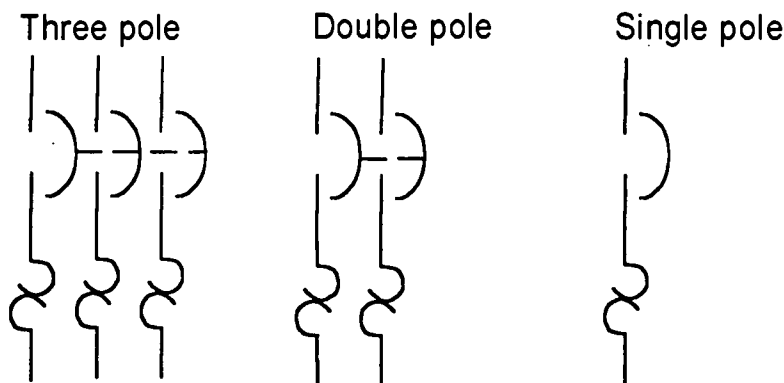

This type of circuit breaker works on the heat generated when excessive amounts of current flow through the breaker. The difference between this type of breaker and the one shown above, is that the heat causes two dissimilar types of metal to expand at different rates. When the bi-metallic actuator expands, it bends due to the unequal expansion of the two metals. This bending action operates a mechanism, and trips the breaker, thereby disconnecting the circuit.

**Circuit breaker with an electro-magnetic overload trip.**

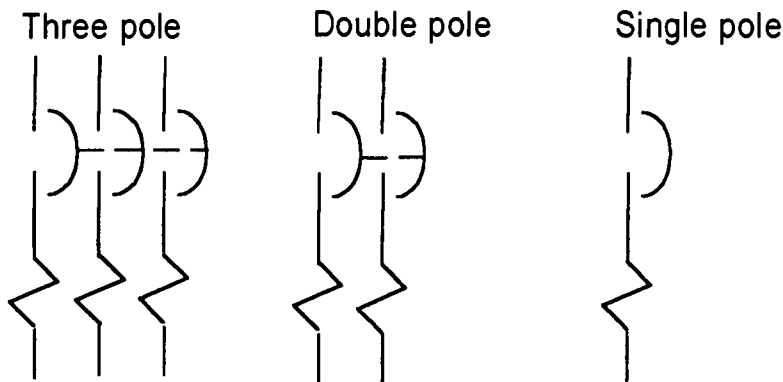

This type of circuit breaker works on the principle of an electro-magnet. When electrical currents flow through the conductors of the circuit, they create magnetic fields. The larger the current, the greater the field. The magnetic trip breaker is designed to trip the mechanism of the breaker when the currents and the magnetic field reach a certain magnitude, thereby disconnecting the circuit. In addition, some types of electro-magnetic trip breakers may be designed to be operated from a remote location using an emergency stop switch. These types of breakers may trip from excessive currents or from the action of the switch.

**Fuse type Circuit Breaker**

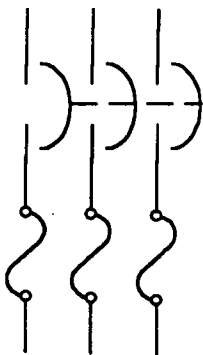

This is the symbol for a circuit breaker that uses fuses to protect the circuit. This breaker is a three pole breaker, and is capable of protecting three circuits. The brass objects located at the bottom of the picture are the contact surfaces of the fuses. Notice

the combination of the circuit breaker symbol, and the fuse symbol. Also notice the three wires that are connected to the circuit breaker.

This circuit breaker is typical of the type of circuit breaker that may be used in an electrical cabinet. The protection device used in this breaker is a fuse. In fact, there are three fuses used in this breaker to protect the three circuits. In addition, other types of protection devices can be used to prevent circuit damage and fires. Many circuit breakers are designed to disconnect two or three circuits. Fuses are frequently used to provide the necessary protection. A circuit breaker can interrupt large amounts of current. In addition, other types of protection devices can be used to prevent circuit damage and fires. Many circuit breakers are designed to disconnect two or three circuits. Fuses can be used to provide the necessary protection.

### Common Tie Point or Frame Ground

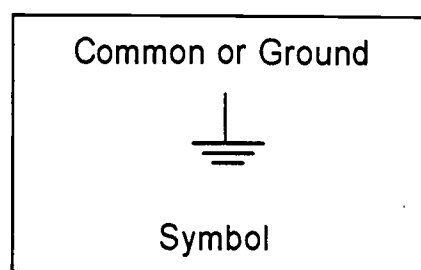
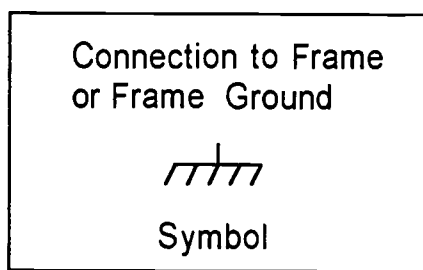

The "ground" symbol is the one most often ill used, and least understood. In reality, The concept of a "ground" as it is most often used, *does not exist*.

During the early years of electronic technology, the concept of a ground as a absolute point of reference for voltage was established. Certain types of electronic equipment, most notably, radio frequency equipment, used the earth as a point of reference. Over the years, the ground symbol has been used to symbolize many different points of voltage reference, none of which can be considered to be a true "ground". The Institute of Electrical and Electronic Engineers (IEEE) and the National Electrical Code (NEC) have established rules for the usage of the ground symbol, and for the connection to frame symbol. In the main, most manufacturers of electrical and electronic equipment have ignored these rules. The best that can be said about the ground symbol is that it is a common connection path for the conduction of electricity. For the purposes of this book, and for the *safety of the technician*, the following rules will apply to the "ground" symbol. The ground symbol will be considered to be a conductor of electrical currents. For this reason the "ground" symbol will be viewed as having *potentially lethal voltages attached to it, and may not be safely handled until it has been measured to determine the voltage potential (if any) that is has*. The connection to frame symbol will be considered to be a safety ground that is connected to a source such as a water pipe, or ground rod driven into the earth In addition, the connection

to frame symbol is ordinarily connected to the facility's safety ground reference, and can be identified by the fact that the wires that are used for this purpose are green in color, or green with a yellow stripe. In some cases, for example, in home wiring, the safety ground is a bare (no insulation) copper or aluminum wire. The author has been witness to too many examples of damaged equipment, potentially lethal shock hazards, and poorly managed computer installations that suffered from the confusion as to what constitutes a "ground", to adopt any other interpretation of these symbols is to invite disaster.

Most electronics test equipment, for example an oscilloscope, has, as a part of its construction, a connection between the safety ground of the AC power cord, and the "ground" lead of the tests probes. For this reason, the "ground" lead of test equipment used in the troubleshooting of electronic equipment should not be connected to a circuit point that sports the "ground" symbol until:

- The technician has measured the voltage potential at the circuit point and has determined that the point is ZERO VOLTS in reference to the safety (frame) ground; and
- The technician understands the consequences of such connection to the equipment under test, and other equipment that may be connected to the same source of electrical power.

Some electrical technicians view the NEUTRAL wire (usually white) of an AC power source as a "ground". The neutral wire of an AC source of power is a conductor of electrical currents. It is *NEVER* to be viewed as being "grounded". *ALWAYS MEASURE, NEVER ASSUME!*

### Common Connection Point

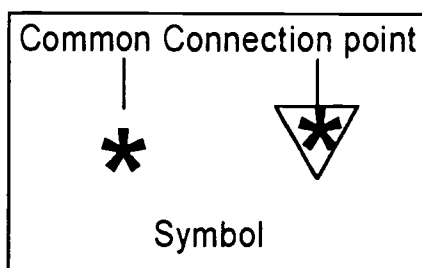

The common connection point symbol is most often used to indicate a connection to an electronic Direct Current (DC) power supply. In an electronic drawing, many circuits need a source of Direct Currents to operate. If the drawing contained a line to indicate all of these connections, the drawing would become very confusing. Therefore, the connection symbol will be used to indicate these connections. The asterisk shown in the symbol will be replaced by a letter or number to indicate the point of connection, in the

case of multiple sources of Direct Current. In some cases, the symbol will be used to indicate the common tie point of the circuit return path for the DC currents.

### Conduction Path for Electrical Currents

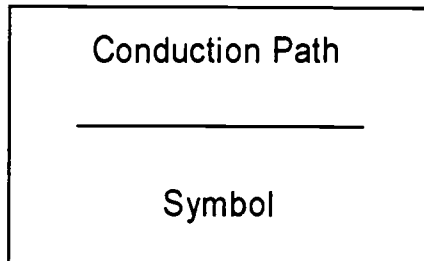

The symbol used to indicate a conduction path for electrical currents is a line. In an electrical or electronic drawing, many circuits will be connected to each other. These connections are paths for the conduction of electrical currents. The drawing contains lines to indicate these conduction paths. If the drawing contained lines to indicate all of the conduction paths, the drawing would become very confusing. Therefore, the conduction path symbol will be used along with the common tie point (ground) symbol, and the common connection point symbol.

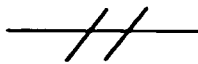

Two conduction paths  
(Electrical drawings)

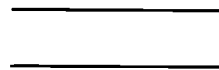

Two conduction paths  
(Electronic or electrical drawings)

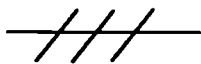

Three conduction paths  
(Electrical drawings)

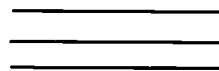

Three conduction paths  
(Electronic or electrical drawings)

### Connections of Conduction Paths for Electrical Currents

Two schemes are used to symbolically connect two or more conduction paths. In an electrical or electronic drawing, many circuits will be connected to each other. These connections must be unambiguous. The symbols below show the first method of indicating whether or not, two conduction paths are connected. In this scheme, a connected conduction path will be indicated by a large black dot showing the point of

connection. If the conduction paths are not connected the symbol will indicate that the path jumps over the alternate path. The drawing must never use both methods of indicating connects.

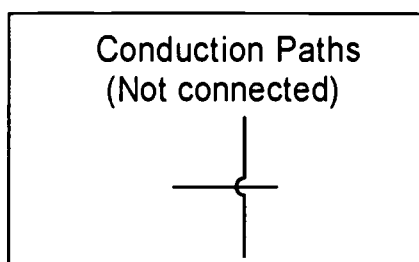
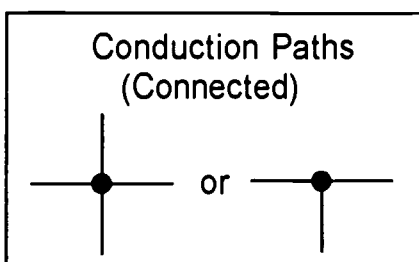

The symbols below show the second method of indicating whether or not, conduction paths are connected. This method dictates that a connecting path for conduction must indicate a clear termination at the point of connection. If the conduction paths are not connected, the lines will cross each other.

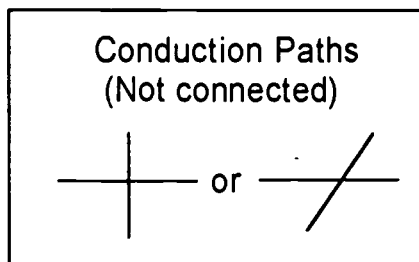
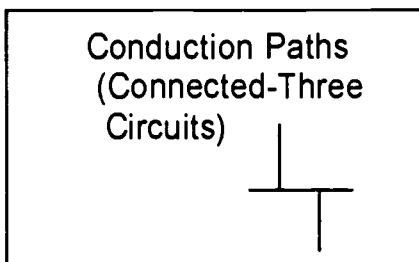

### General Circuit Element

The symbol below is the method of labeling an element of a circuit. The symbol may contain specifications for component values, voltages, currents, location of circuit elements, or other necessary data that pertains to the circuit operation. The rectangle may be as large as is necessary to contain the data.

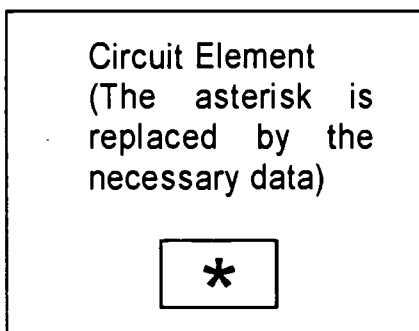

## Associated Conduction Paths for Electrical Currents (Cables)

The conduction paths in a complex electrical or electronic piece of equipment may be interconnected by groups of wires called cables. In many cases, the cables conduct sensitive electronic signals from one group of circuits to another. The paths are constructed in the cable such that the wires composing the paths are twisted around each other. When we depict associated conduction paths the paths are twisted unless otherwise specified. The twisting of the wires helps to eliminate unwanted signals from interfering with those being conducted through the conduction path.

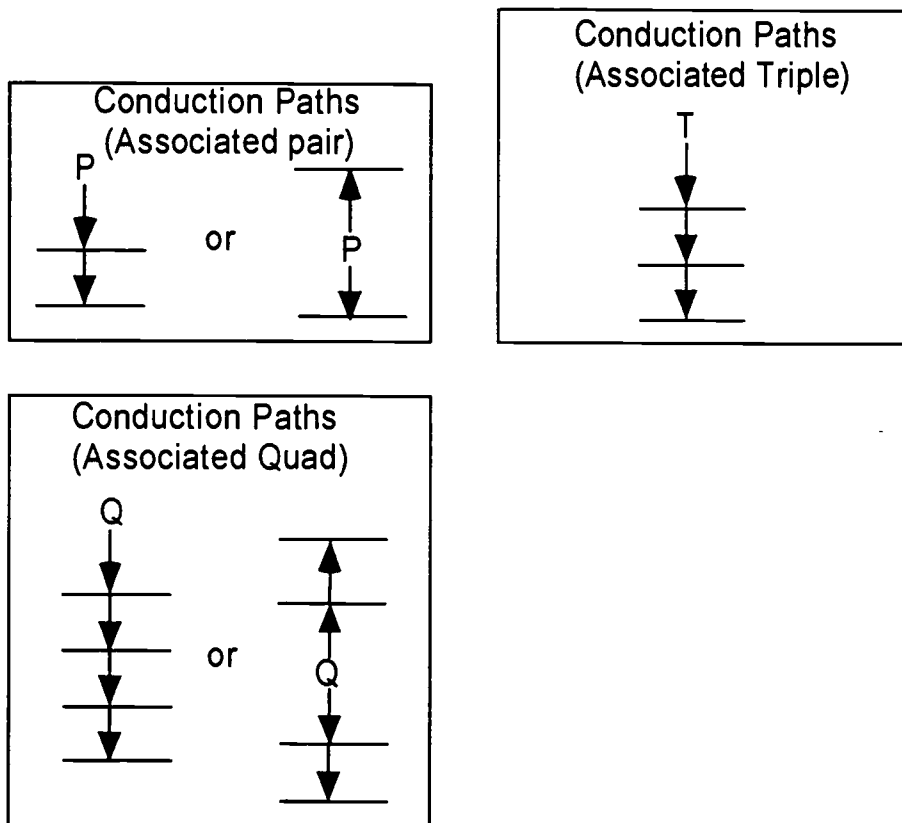

## Mechanical Connections of Electrical and Electronic Devices

The mechanical connection of components of electrical and electronic devices is depicted by a dotted line. If the devices are further operated by levers, a fulcrum symbol will be used.

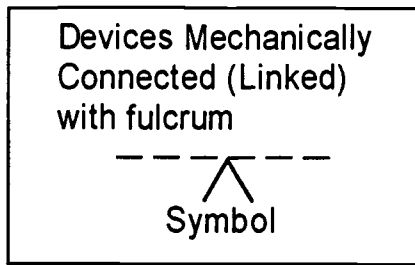
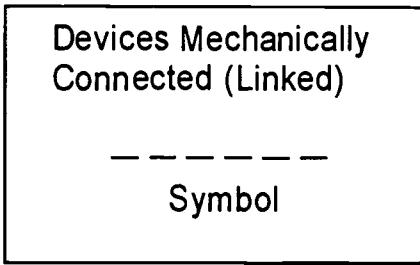

Three pole circuit breaker using the mechanical connection symbol

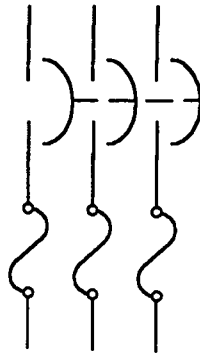

### Associated Conduction Paths for Electrical Currents (Shielded Cables)

The conduction paths in a complex electrical or electronic piece of equipment may be interconnected by groups of wires called cables. In many cases, the cables conduct sensitive electronic signals from one group of circuits to another. Many of these cables are shielded from unwanted interference by wire braids that surround the conductors. This wire braid is called a shield, and cables constructed in this manner are called shielded cables. Other types of cables are designed to be connected to circuits that have specific characteristics. One such group of cables is called coaxial cables. Coaxial cables are so named because the manner in which the conductors are arranged is one inside another. Unlike regular shielded cables, in which the shield does not conduct signals, the braid of the coaxial cable is one of the conduction paths and coaxial cables have specific electrical characteristics designed into the cable.

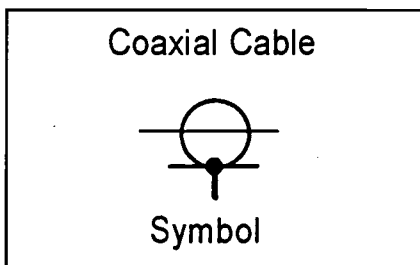

Shielded cables may contain many wires. A line will be added for each wire contained in the cable. The shield is a barrier against unwanted electrical interference from



outside electrical equipment, and is frequently connected to common (so-called ground) or the metal frame of the equipment.

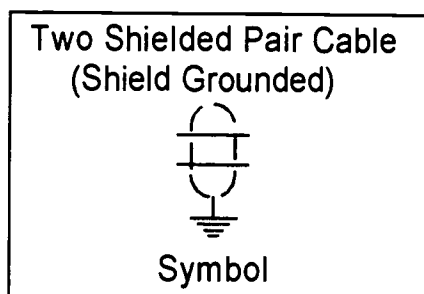
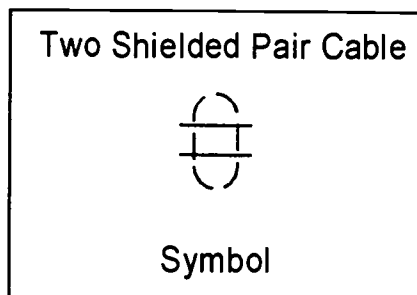
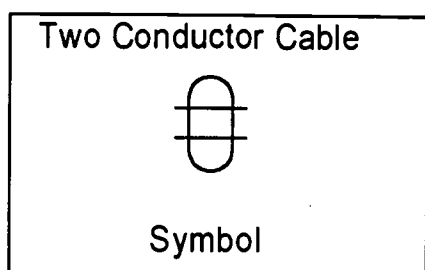

Another group of methods used to symbolically depict a cable or group of wires are the symbols shown below. Frequently the top symbol is used to depict a bundle of wires rather than a cable. The top symbol is frequently used in electrical layout diagrams and is designed to indicate when a wire leaves or joins the cable bundle.

The second group of symbols depicts a cable with many wires. It is used in electrical or electronic layout diagrams to show how the individual wires of the cable are led and distributed in the installation.

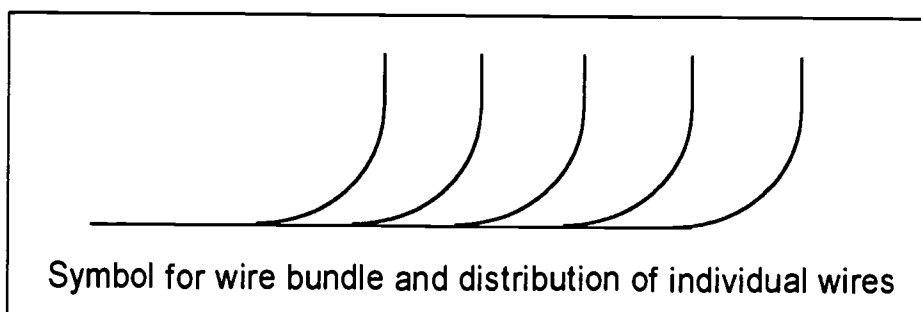

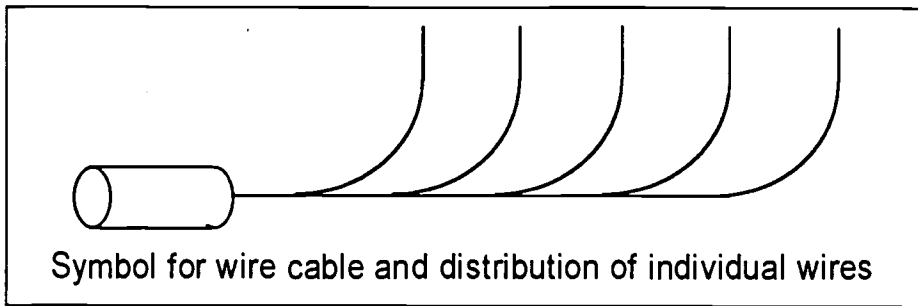

## Connectors

The basic connector symbol is depicted below. There are many different types of connectors in use. Some connectors attach one circuit board to another, some connectors attach cables to circuit boards, and some connectors attach conductors to each other. Regardless of the type of connection made, the same basic symbols will be used to depict the connection. There are two types of basic connector symbols used, both types may be used on the same drawing. The first type of symbol is used for general connections of all types. The second type of symbol usually depicts a plug connection. The female version of the second type of connector symbol is usually stationary, whereas the male version usually depicts a movable connector.

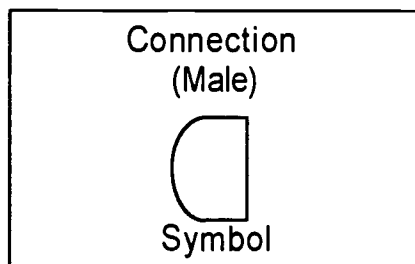
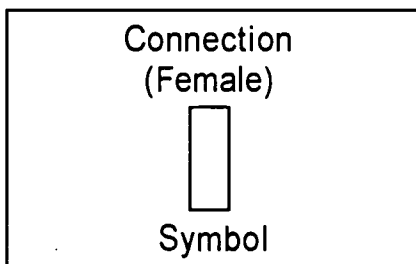
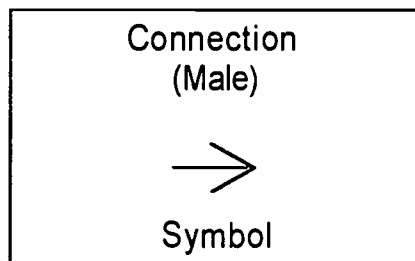
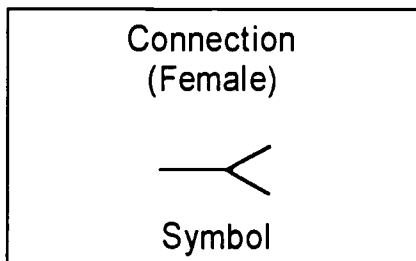

## Mated Connectors

When connectors are mated, the basic connector symbols are combined as depicted below. The basic symbol will be combined with letters or numbers to depict the individual connection points.

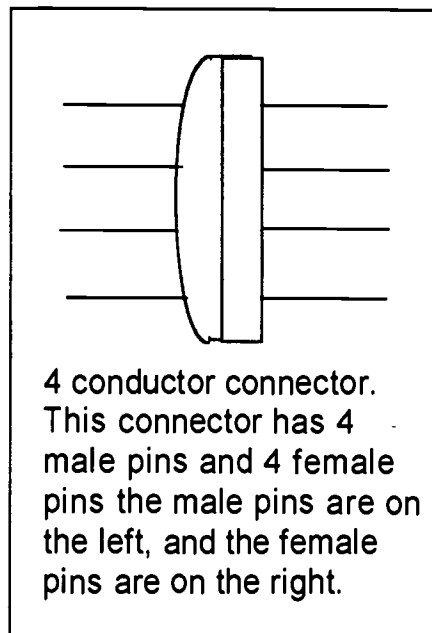
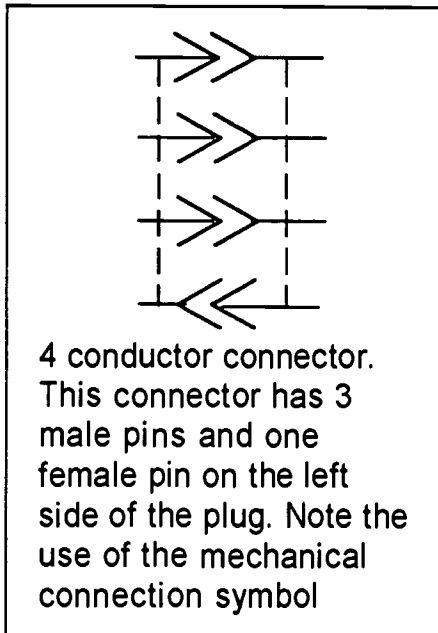
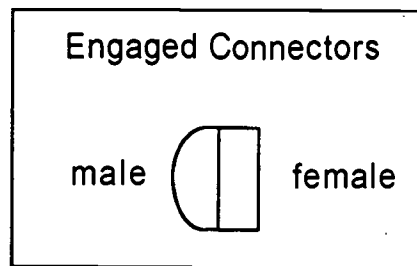
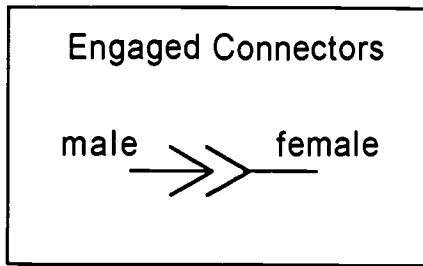

## Coaxial Connectors

Coaxial connectors are special connectors that are used when it is desired to connect circuits that have signals that can be influenced by other electrical or electronic equipment. Some of the signals that may be conducted using coaxial connectors are television signals, radio signals, certain types of computer signals, and other low energy level signals. The coaxial connector is usually mated to a type of cable called coaxial cable. Coaxial cable has an outer web of wire called a braid, and a single wire in the center. The outer braid is insulated from the inner wire by a non-conducting sleeve. The coaxial connector is constructed in a similar manner, but is usually made of solid metal. An example of a coaxial connector and coaxial cable is the wire and connector used on a standard television receiver which screws into the 75 ohm jack on the rear of the television. In the case of a television, the connector that plugs into the television, and the connector on the rear of the television, are both coaxial connectors.

The coaxial connector symbol can be combined with other symbols to modify the type of installation. In the example below, the coaxial connector symbol has been modified with the addition of a frame or equipment ground symbol to indicate that the connector is bolted or otherwise attached to the frame of the equipment.

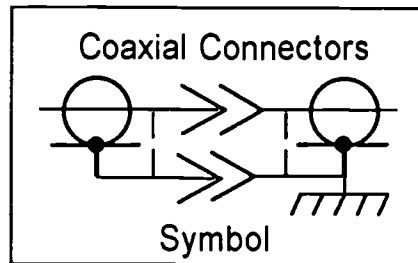
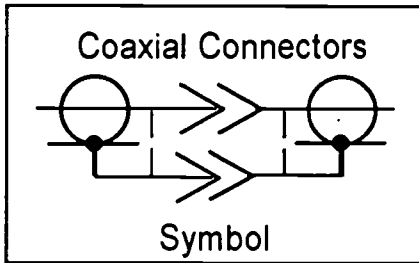

In some cases the outer braid of the coaxial connector is isolated from the circuit. If there is no conduction path between the outer braid of the connectors, the symbol will be modified with a X to indicate that the conduction path has been broken.

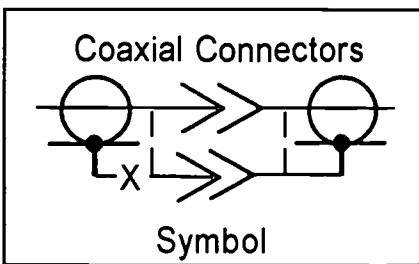

**Power Connectors (commonly called cord connectors, convenience outlets)**

Connectors designed for AC power applications have a specific symbol. A large variety of connectors are available with different voltage and current ratings. In addition, some connectors have curved blades that are designed to lock into the convenience outlet. Regardless of the type of connector used, the symbol will only depict the amount of connection points, using the symbols show below.

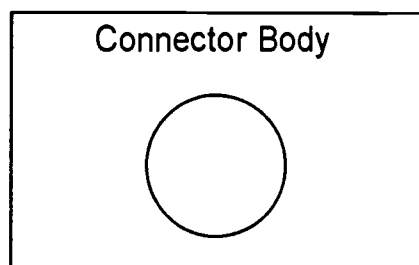
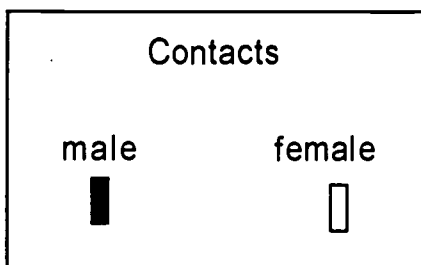

Examples of combined symbols. Note the conduction path symbols attached to the contact symbols.

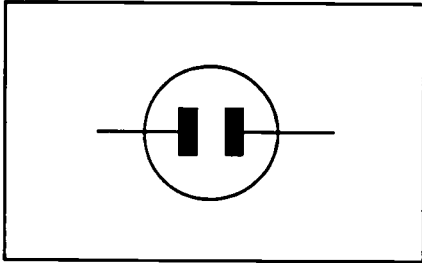

Two conductor non-polarized connector (male)

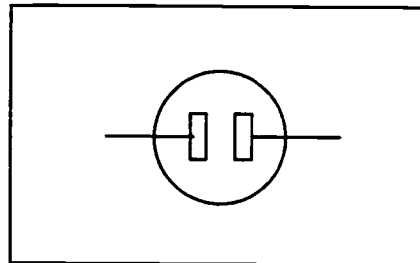

Two conductor non-polarized connector (female)

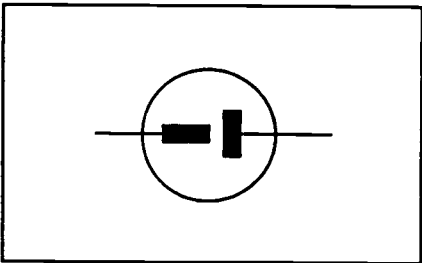

Two conductor polarized connector (male)

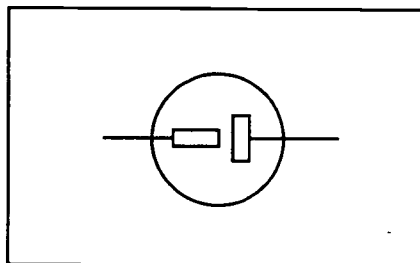

Two conductor polarized connector (female)

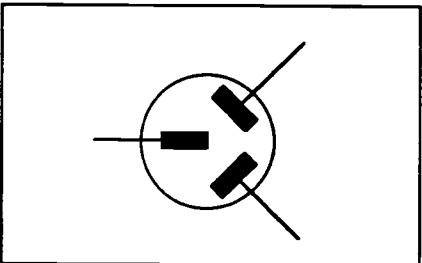

Three conductor polarized connector (female)

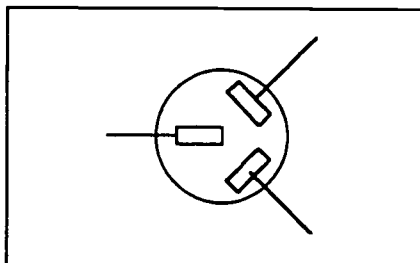

Three conductor polarized connector (male)

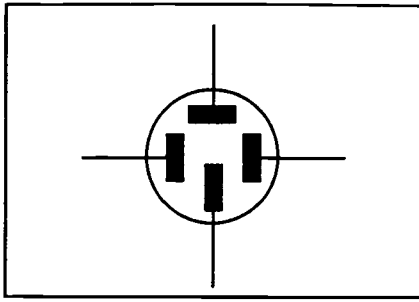

Four conductor polarized connector (male)

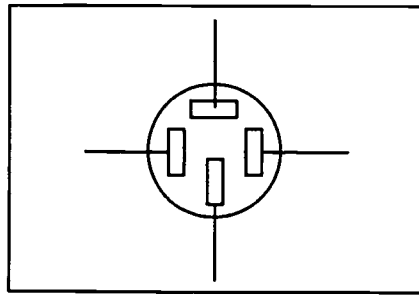

Four conductor polarized connector (female)

### Contacts (Electrical)

One of the most important symbols is the symbol used to indicate the contacts of a switch or relay. A switch is a device used to interrupt the conduction path for electrical currents. A relay is an automatic switch that can be operated by other sources of electrical currents. Switches and relays are used extensively in electrical and electronic equipment to control the flow of electrical currents. The contacts of a switch or relay have only two states. The contact can be *on or off*. If the contact is *on*, we identify its state as *closed*. If the switch is *off*, we identify its state as *open*. The concepts of open and closed in electrical work can be very confusing to a new student. The reason for this confusion is that the concepts run counter to ordinary experience. Most people are accustomed to the idea that if a valve such as a faucet is *closed*, *no water flows* from the faucet. If a faucet is *open*, then *water flows*. In electrical work, the concept is exactly the opposite. If the contact is *open*, *no current flows*. If the contact is *closed*, then *current flows*. It has been the authors experience that this state of affairs is only correctable by experience with the repeated usage of the symbols by the prospective technician. To fully understand the concept of open and closed contacts requires that the student change a lifetime of learning.

The below symbols represent the three types of basic symbols used to indicate contacts on electrical and electronic drawings notice that the symbols are represented in their normally open, and normally closed state. This representation of the contacts on a drawing refers only to the *state* of the contact *before* it is *operated*. It does *not* mean to imply that the contact is *always closed* or *always open*.

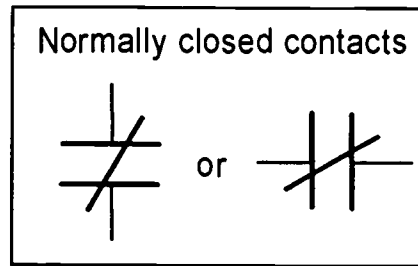
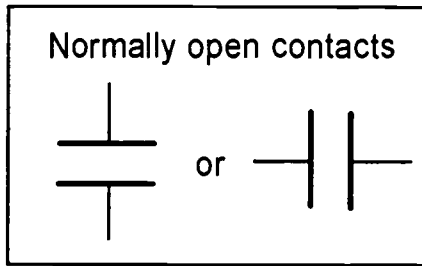

This symbol is used in electrical ladder diagrams and electronic diagrams

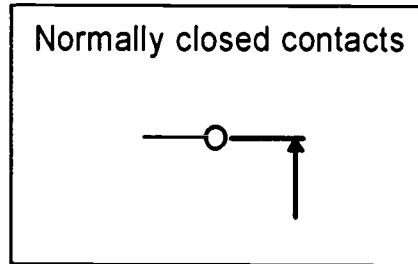
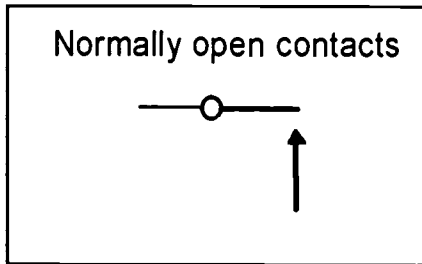

This symbol is primarily used in electronic schematics

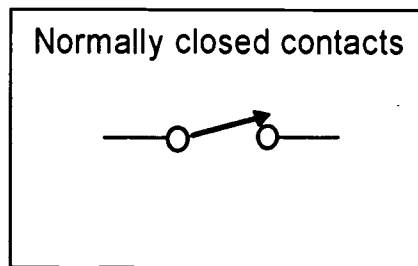
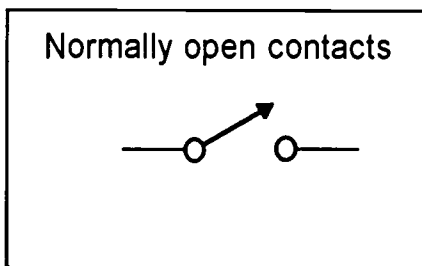

This symbol may be used in all types of electrical and electronic diagrams

All three of these symbol types can be used on electrical or electronic drawings the first set of symbols are the ones most commonly used on electrical ladder drawings.

### Contacts (Relays)

One of the most important devices that uses the contact symbol is the symbol used to indicate a relay. A relay is an automatic switch that can be operated by other sources of electrical currents. Relays are used extensively in electrical and electronic equipment to control the flow of electrical currents. Relays can be operated by either Direct Current (DC) or Alternating Current (AC). Regardless of the type of currents used to operate the relay, the relay contacts can be used to switch a large variety of electrical currents. The contacts of a relay have only two states. The states are controlled by the actuator of the relay. The actuator of a relay is an electromagnetic coil of wire. The electromagnet moves the switch contacts. If the contact is on, we identify its state as closed. If the contact is off, we identify its state as open. Before the relay is energized by an electrical current, the relay is identified as being in its normal

state. When the relay is in its normal state, some of the contacts may be closed, and some of the contacts may be open. Contacts that are closed in the normal state are said to be normally closed. Contacts that are open in the normal state, are said to be normally open. A relay can contain a large number of normally closed and normally open contacts. A relay can also contain only one normally open or normally closed contact. The amount and variety of normally open and normally closed contacts depends upon the design purpose of the relay. Regardless of the amount of contacts, the relay functions to switch the contacts by the action of the electromagnetic coil. The functions of the coil and the contacts are separate functions. The student must concentrate upon the fact that the coil moves the contacts and not vice-versa. The coil is the operator. The contacts respond to the actions of the coil. This representation of the contacts on a drawing refers only to the state of the contact before it is operated. It does not mean to imply that the contact is always closed or always open. On the drawing the contacts of a relay will be depicted in their normal state. A drawing is not a dynamic representation of the actions of the relay. To provide the maximum amount of information on the drawing, the contacts must be shown in their normal state. The interpreter of the drawing must imagine what will happen when the coil of the relay is energized. In electrical ladder diagrams, the coil of the relay and the contacts of the relay may be shown upon separate drawings. This is because the contacts of the relay will be used to switch other circuits, whereas the coil of the relay will be switched by other contacts or switches. This can be very confusing to the person who is required to interpret the drawing. It is a skill that requires a knowledge of electricity, and much practice.

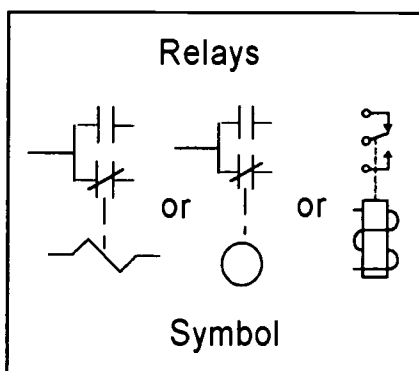

The relay symbols depicted at the right are three of the many ways in which the same relay can be symbolized

Note the use of the mechanical symbol. It indicates that the coil and contacts are mechanically linked

The symbols shown below are the various methods used to symbolize the electromagnetic coil of a relay. The choice of symbology is totally up to the company that manufactures the product. The top row of symbols is used extensively for electrical ladder drawings while the bottom row is used on electronic drawings. However, the symbols may be mixed on the same drawing. Each coil symbol will be accompanied by a letter and number designation for the relay coil in question. In the case of the circle, the asterisk will be replaced by the letter/number combination designator for the relay. The letters used to represent relays are frequently K, CR, R, and, M. The number can be any whole number.



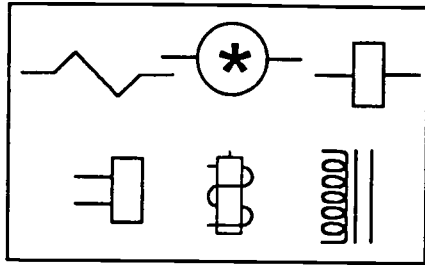

Relay Coil Symbols

### Contacts (Time Delay Relays)

Some relays are designed to be operated after a period of time. These relays are called "time Delay Relays". Time delay relays can have delay times as small as fractions of a second to times as large as minutes or hours. To accomplish this, the time delay relay may contain complex electronic circuits or mechanical actuators that delay the time that the relay actuates. Regardless of the method, the time delay relay closes or opens its contacts only after the coil of the relay has been actuated. The coil of the time delay relay may be identified by "TDR". Time delay relay contacts will be identified by "TDO" or "TDC". TDO means "Time Delay Open", TDC means "Time Delay Close". The TDO contacts will *open after* a period of time determined by the setting of the relay, and TDC contacts will *close after* a period of time determined by the setting of the relay. Regardless of the type of contacts involved, the coil of the relay is the governing factor. Some time delay relays, delay the time at which the relay coil will *energize*, and some time delay relays, delay the time at which the relay coil will *de-energize*. This action determines the manner in which the contacts will behave. The below symbols depict the various methods of symbolizing TDO and TDC relay contacts and coils.

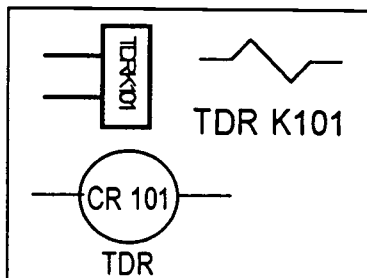

Symbols for coils

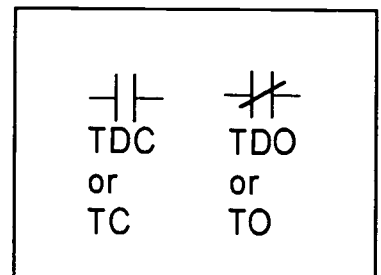
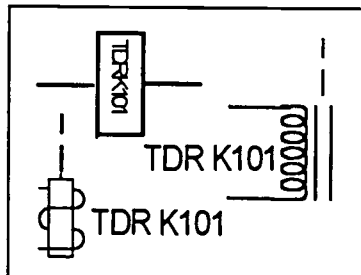

Symbols for contacts

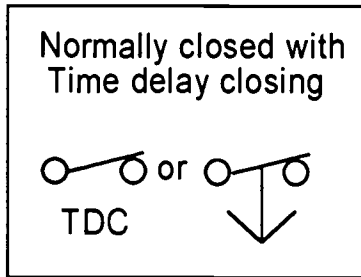
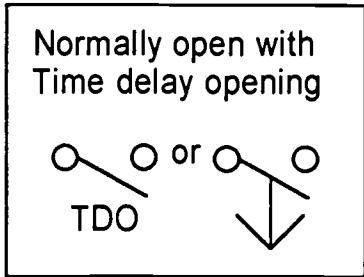
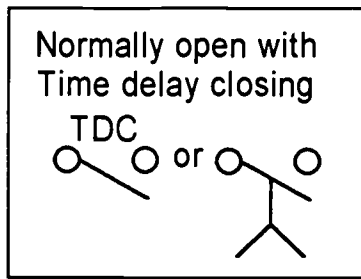
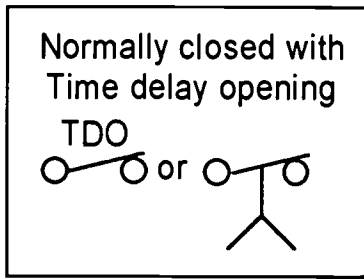

## Contacts (Switches)

Switches are circuit control devices that are used to apply power to a circuit or piece of equipment. Switches are manually operated devices that require physical effort in some form or another. Switches may be used to open or close any source of electrical current, including signals from complex electronic circuits. The basic switch symbol employs the symbols for contacts, as discussed earlier. A large variety of switches are manufactured for many different applications. The symbols used to depict switches attempt to depict the purpose of the switch rather than identify any particular type of switch. The next few pages will portray the various categories for switch symbols, and describe some of the nomenclature used to identify switches.

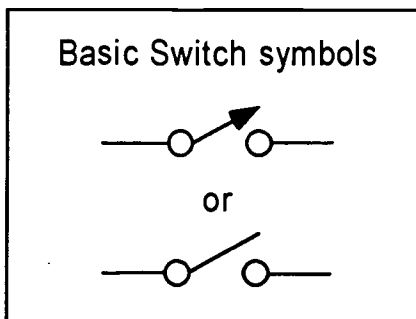

## Switch Categories

Switches are categorized according to the number of complete circuit paths than the switch can control. Conduction paths that the switch can control, are called poles. A

switch can have one or many poles. The above symbols depict a switch that has only one pole. The second criteria is the number of positions that the switch can assume. These positions are called throws. A throw is the position that the switch can move to and mechanically maintain contact. The above symbols depict a switch that has only one throw position. This switch would typically be found in applications in which an ON/OFF circuit needs to be controlled, such as a light switch. The words POLE and THROW are abbreviated with P and T, and the switch is categorized according to the number of each. To describe the number of the poles and throws, the words SINGLE, DOUBLE, and the numbers 3, 4, 5, 6, etc. are used. Each is abbreviated in a manner similar to the above method for poles and throws. Therefore, SINGLE becomes S, DOUBLE becomes D, and 3, 4, etc. are used to describe values above one and two. The letters and numbers are then combined to describe the switch. For example, the above switches are SINGLE POLE, SINGLE THROW, and they would be categorized as SPST. The below symbols depict some switches and the categories that they are assigned to.

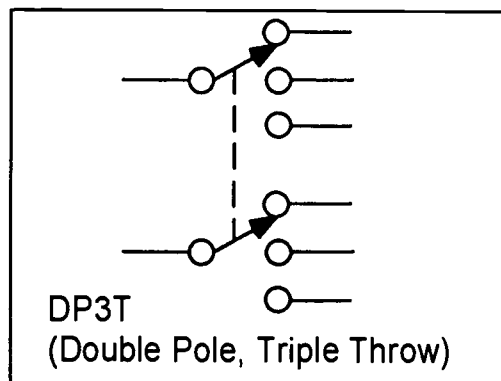
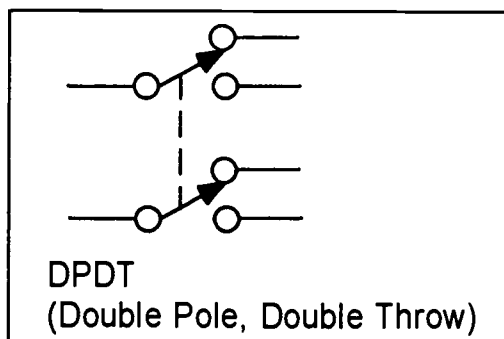
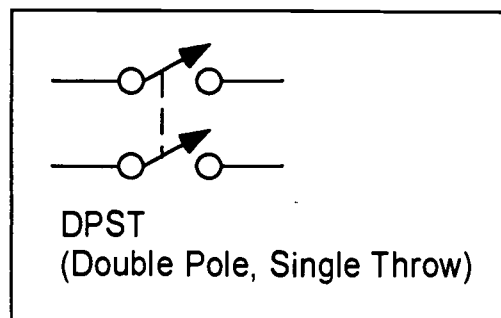
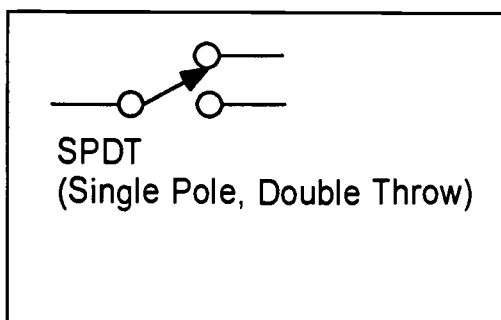

### Contacts (Switches-Interlocks)

Certain types of switches are used for safety features on machinery. The switches are called interlock switches, or just "interlocks." The symbols used for these switches are depicted below.

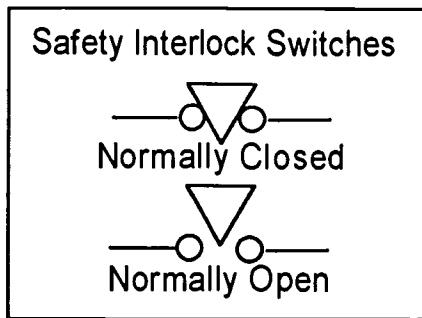

### Contacts (Switches-Momentary and Maintained)

Push-button switches are sometimes known as momentary switches. Momentary switches do not maintain CONTACT UNLESS MANUAL PRESSURE IS APPLIED TO THAT THE SWITCH. Usually a spring inside the switch returns the switch to its previous state. Since a momentary switch is normally in one position unless it is actuated, the push-button switch may have normally open and normally closed contacts. In addition the momentary switch can have one or many poles. Momentary switches such as push-button switches can be categorized as to their poles and throws, or as to the types of contacts. In many cases both descriptions are used. In addition, push-button switches can be manufactured to maintain a state of actuation after they are pushed in this case, the push-button switch is categorized as having maintained contacts. In addition, toggle switches can be manufactured containing momentary contacts. In other words, a switch may be momentary or maintained regardless of whether or not it is a push-button or toggle switch.

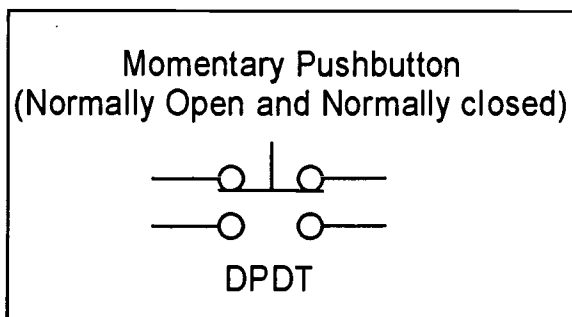
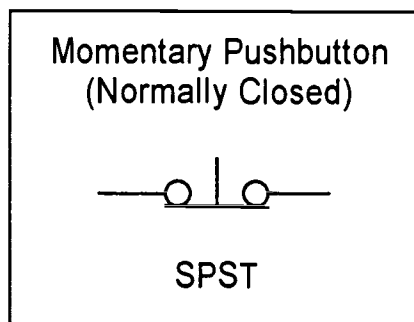
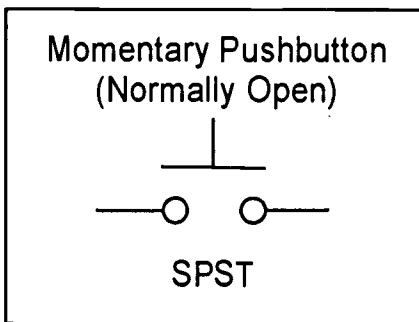

Maintained Pushbutton  
(Two sets of Normally Open and Normally closed)

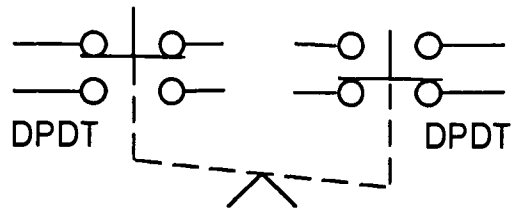

Note the mechanical symbols

**AET-B2-HO-3**  
**Use Symbols, Organization, and Engineering Values**  
**on Electrical Drawings**  
**Attachment 3: MASTER Handout No. 3**

---

**Electrical Drawings**

**Electrical Ladder Diagrams**

Most electrical control systems contain primary power, relays, solenoids, and wiring to control mechanical systems. The functional relationships between the electrical components determine the order and manner in which the mechanical system will be controlled by the electrical system.

The functional relationship of the electrical components is usually depicted by a drawing called a ladder diagram. The ability to quickly and accurately read and interpret a ladder diagram is what separates effective troubleshooting electrical technicians from mediocre ones.

There are many methods of reading a ladder diagram, but all of them require that the electrical technician understand the symbolism and organization embodied in the print. The following diagram depicts some of the symbols and their meaning.

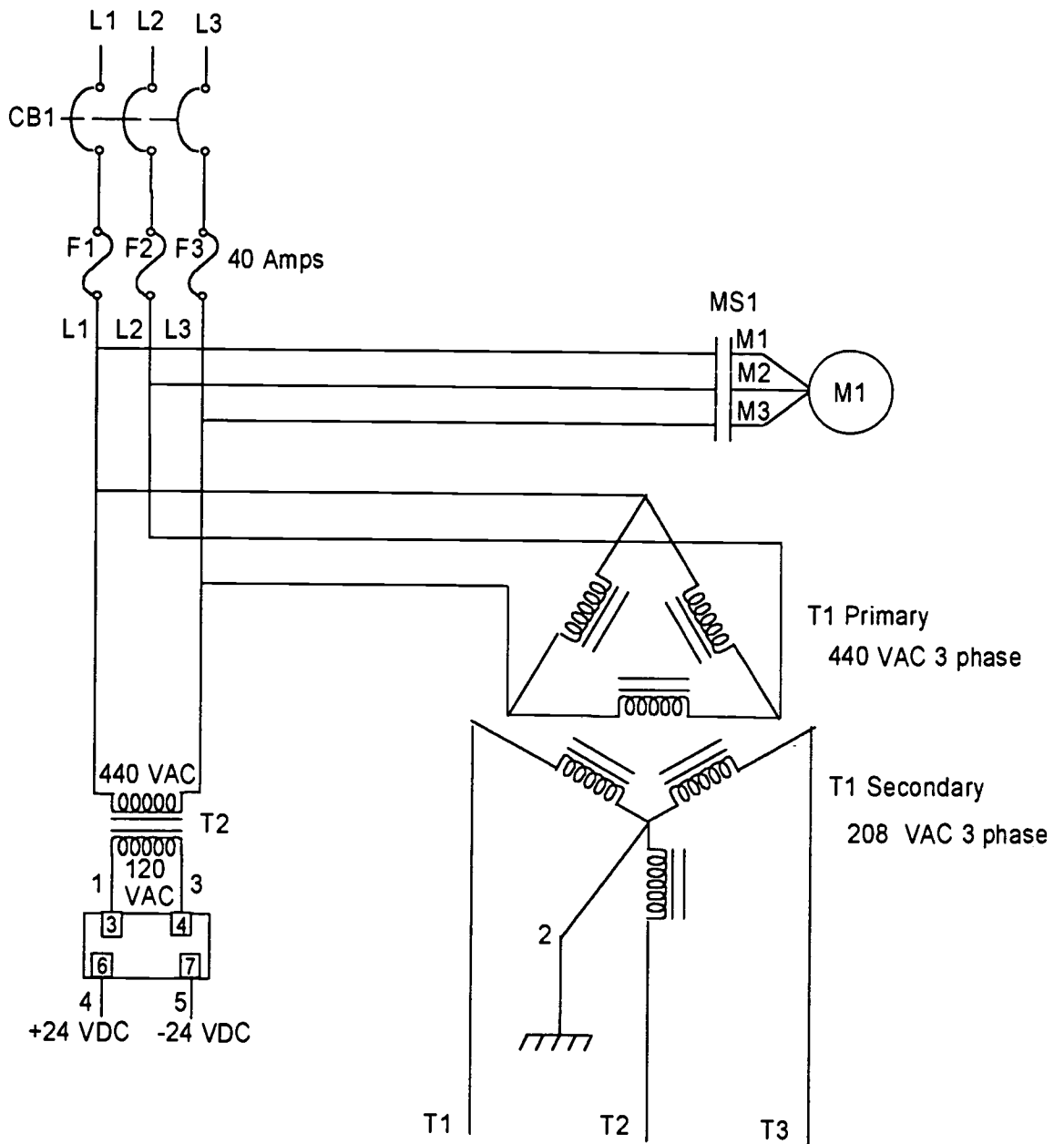

### Primary Power Ladder

Since the ladder diagram depicts a functional relationship, the layout of the symbols is not organized as to their physical location, but as to their function in the control system. Therefore a relay that is depicted upon one rung of the ladder diagram may contain contacts that may be used many rungs away. Also a set of contacts that are depicted on a rung may have a relay coil actuator that is depicted several rungs later.

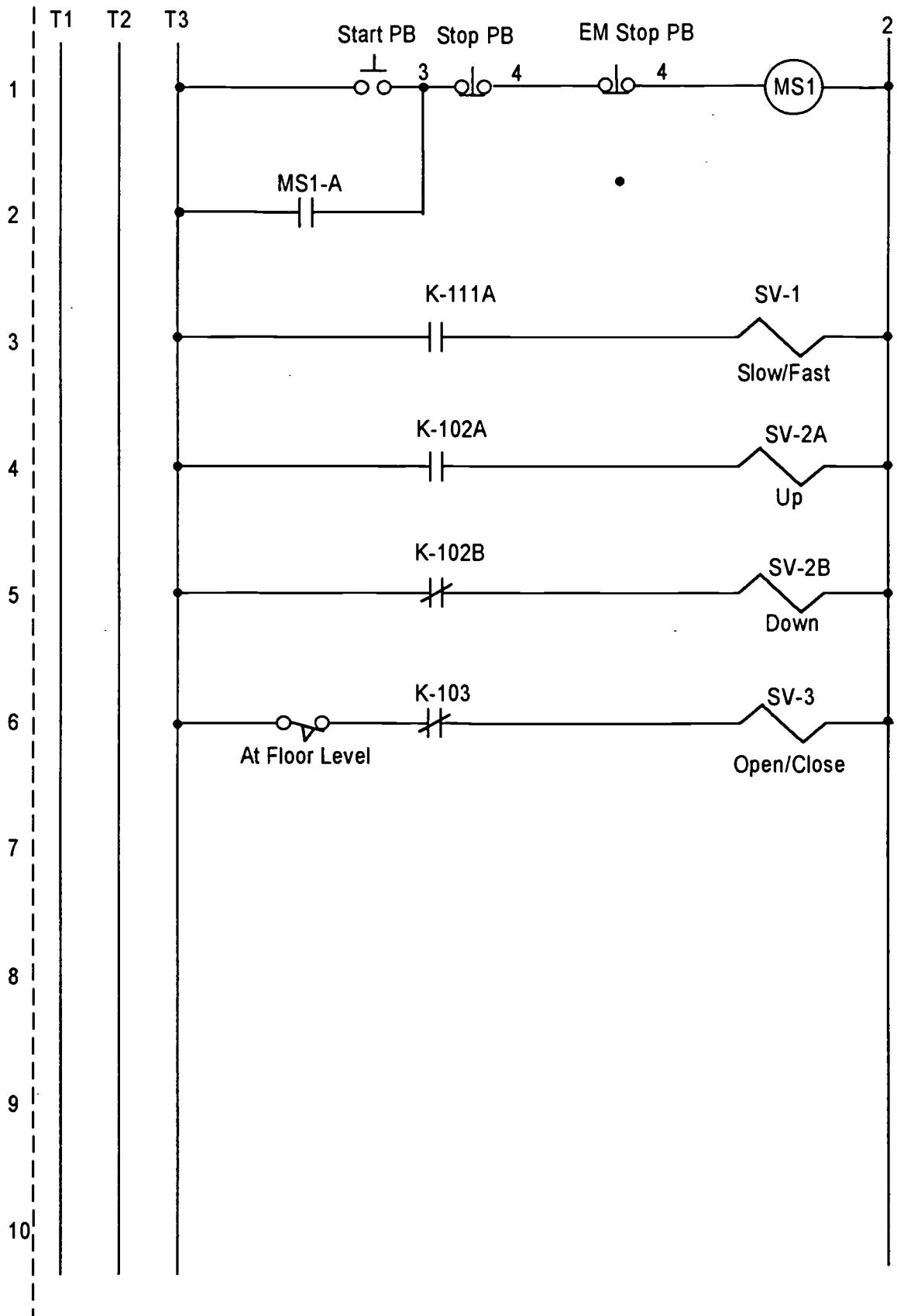

1000



## **AC Ladder Diagram**

In a ladder diagram both DC ladders and AC ladders may be depicted upon the same blueprint. In the DC ladder, the components of the system will be operated by DC voltages, and in the AC ladder, the components of the system will be operated by AC voltages. In a complex diagram that includes DC and AC ladders, DC components such as relay contacts may operate AC components such as relay coils, solenoids or the power for electronic controls.

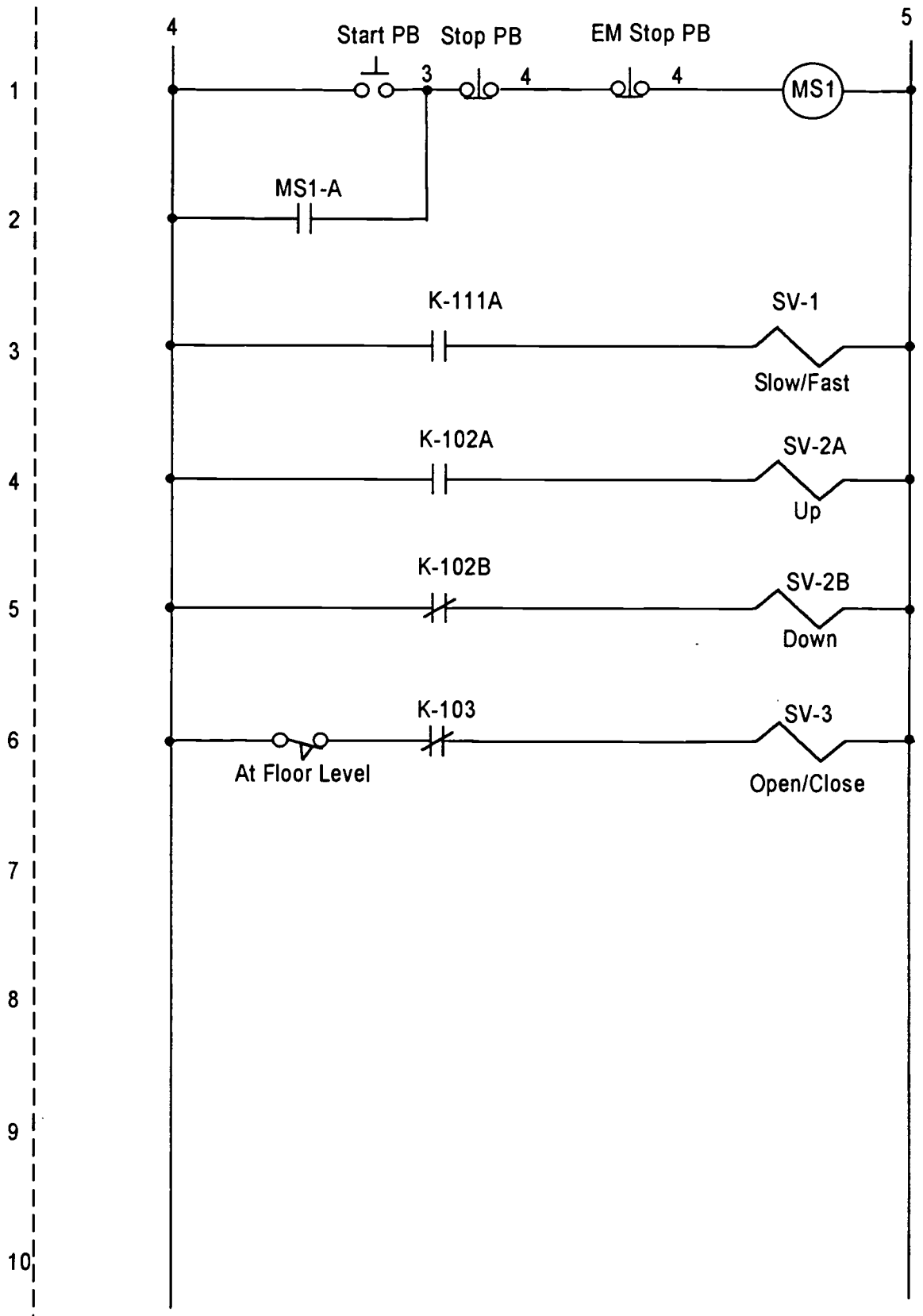

1002

**AET-B3-HO-1**  
**Use Symbols, Organization, and Engineering Values**  
**on Electronic Drawings**  
**Attachment 1: MASTER Handout No. 1**

---

**Objective(s):**

Upon completion of this unit the student will be able to use the symbols and organization associated with electronic schematic diagrams and electronic layout diagrams to:

- a. Identify components by their symbol;
  - b. Determine the location of the components;
  - c. Obtain electronic specifications from an electronic manual; and,
  - d. Apply engineering values obtained from the drawing to the solution of technical problems.
- 

**Module Outline:**

- I. Identify Symbols on Electronic Schematic Drawings
  - A. Drawing symbols: MASTER Handout AET-B3-HO-2 (Electronic Drawing Symbols) and MASTER Handout AET-B3-HO-3 (Electronic Schematic Drawing)
    1. Describe the meaning of each symbol and a general concept of how the device operates
    2. Display samples of the parts represented by the symbols
    3. Provide examples of specification sheets containing connection information, and electrical characteristics
  - B. Demonstrate the methods used to apply the above symbols to the troubleshooting of electronic systems
- II. Identify the Layout of an Electronic Schematic Drawing
  - A. Explain the layout and organization of electronic drawings: MASTER Handout AET-B3-HO-2 (Electronic Drawing Symbols) and MASTER Handout AET-B3-HO-3 (Electronic Schematic Drawing)
    1. Explain the types of drawing and documentation that comprise a set of electronic drawings
    2. Demonstrate the methods of locating components on a electronic schematic drawing
    3. Demonstrate the method of determining the types of current sources and their magnitude (voltage, AC or DC)
  - B. Demonstrate the methods used to apply the above information to the troubleshooting of electronic systems
- III. Obtain Electronic Specifications from an Electronic Manual

- A. Demonstrate how to determine the specifications of the operational characteristics of an electronic assembly from the specifications section of a manual
  - 1. Relate the electronic symbol to the component number on an electronic schematic diagram
  - 2. Determine the value of components and their model or type number from the material specification list in the materials section of an electronic assembly from the equipment manual
- B. Demonstrate the methods used to apply the above information to the troubleshooting of electronic systems

**AET-B3-HO-2**  
**Use Symbols, Organization, and Engineering Values**  
**on Electronic Drawings**  
**Attachment 2: MASTER Handout No. 2**

---

**Reading Electrical or Electronic Drawings**

**Amplifier**

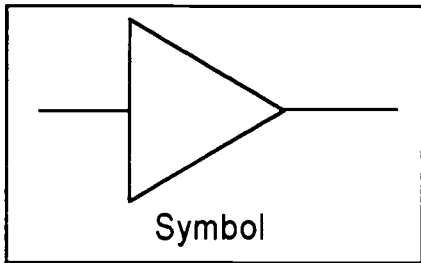

A device which increases the energy level of a physical value. The symbol shown above is the basic symbol for an amplifier. The symbol is always composed of an input and an output. The input is always drawn on the left, and the output is always drawn on the right. The term amplifier, can be applied to mechanical systems as well as it can be applied to electronic systems.

The symbol that depicts an amplifier is a general symbol that gives no indication of the size of the object, the amount of components used in the object, nor the type of system in which the object is used. The technician must infer these facts from the context in which the object is used.

An amplifier can have more than one input, and more than one output. For example:

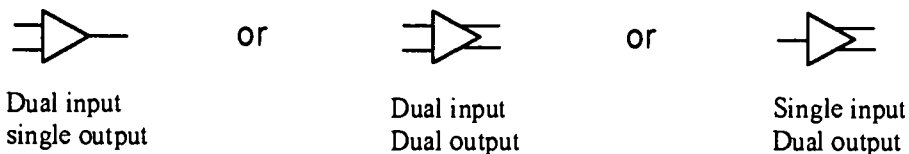

In addition, the use of a small circle indicates that the amplifier inverts the results of its amplification.

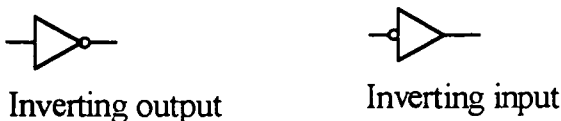

Lines that are drawn to the symbol at right angles are usually power connections, or auxiliary connections. For example:

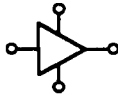

The two vertical lines represent connections to the power supply, or a control connection. The round circles indicate connection points, not inversion.

Various types of amplifier symbols:



The basic symbol for an amplifier provides no clue as to the nature of the device. An amplifier can have as few as four components associated with it, or can have more than one hundred complex electronic circuits. Amplifiers can be composed of discrete components, or be enclosed in an integrated circuit. The amplifier symbol covers a wide variety and scope of devices.

### Batteries (Generalized DC source)

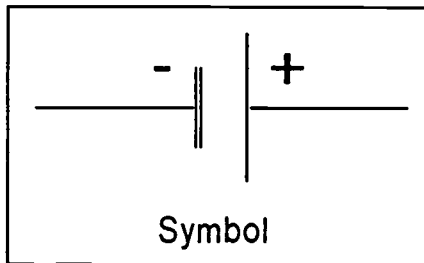

A battery is device that converts chemical energy to Direct Current electrical energy. Batteries are frequently constructed of cells that are electrically connected, one to another. Most cells produce from 1 to 1.5 volts DC. If the battery is only composed of one cell, the symbol will appear as its is above. If the battery is composed of many cells, the diagram will appear as it does below.

The battery symbol can also be used to depict a generalized Direct Current source of electrical power.

An automobile battery uses sulfuric acid and lead plates to generate DC electrical current. It is a multi-celled battery. Sources of DC current that are created by electronic methods ordinarily do not use the battery symbol.



**Multi-celled battery**

## Capacitors

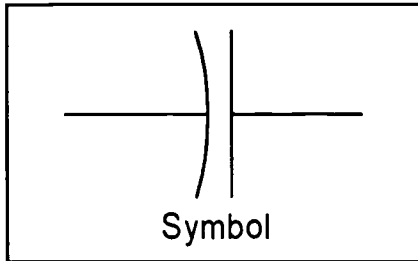

Capacitors are devices that perform several functions in electrical and electronic circuits. A capacitor can be used to store electrical energy and release it in a controlled fashion, a capacitor can be used as a variable opposition (resistance) in an Alternating Current (AC) application, and a capacitor can be used to filter electrical voltages. There are essentially three types of capacitors in use today. They are, variable capacitors, non-polarized capacitors, and electrolytic capacitors.

Various capacitor symbols:

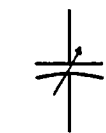

Variable Capacitor

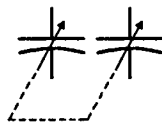

Variable Capacitors mechanically coupled (ganged)

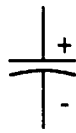

Electrolytic Capacitor



Non-polarized Capacitor (the curved end represents the most negative connection point)

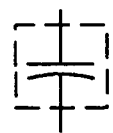

Shielded Capacitor

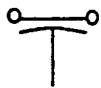

Feed-Through Capacitor

The capacitor symbols depicted above cover most of the various types of symbols that the technician may encounter in a machine or electronic circuit.

The variable capacitor is a capacitor whose capacitance can be varied by mechanical means. The variable capacitor that is mechanically coupled, is the type of capacitor that is used to tune the stations on a transistor radio.

The electrolytic capacitor is extremely sensitive to voltage polarities. The wise technician who installs this type of capacitor pays care full attention to detail and installs this device in the proper polarity. This type of capacitor can explode if it is installed backwards!

The shielded capacitor is use in sensitive television and radio applications. It is frequently found it computer monitors where it prevents stray electrical radiation.

The feed-through capacitor is used to filter stray electrical noise from wires that are used to connect circuits in radio and television equipment.

The non-polarized capacitor symbol is the most common type of capacitor symbol found in most circuits. The curved end of the capacitor symbol indicates the point at which the capacitor should be connected to the most negative voltage potential. Ordinarily, the manner in which the non-polarized capacitor is installed is unimportant. However, in certain sensitive applications, the capacitor should be installed with the polarity in mind. Many capacitors have a black ring that indicates this connection point.

Capacitors come in a wide variety of shapes and sizes. Generally, the size of a capacitor is determined by two factors. First, the amount of capacitance; and second, the working voltage of the capacitor. The larger the capacitance, the larger the capacitor, and the higher the voltage, the larger the capacitor. These two factors influence each other. For example, a high voltage capacitor that has a small amount of capacitance may be as large as a low voltage capacitor that has massive amounts of capacitance.

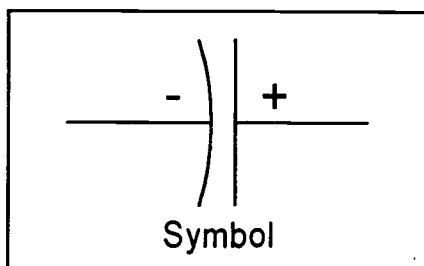

## Electrolytic Capacitor

An electrolytic capacitor is a capacitor that uses a chemical to create the capacitance effect. The chemical is used in the capacitor as an insulator. Electrolytic capacitors are designed to provide extremely large amounts of capacitance while maintaining a small size. The reason that this can be accomplished, is because the chemical involved,



(usually an oxide compound) enables the conductors of the capacitor (called plates) to be positioned extremely close together. For this reason, electrolytic capacitors are polarity sensitive; since the electrolyte (insulator) can be destroyed by an improper application of voltage.

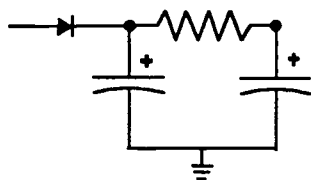

**Filter Circuit**

The above symbology depicts the capacitor symbol connected with other symbols to form a circuit. The circuit shown is designed to allow the capacitor to filter DC voltages.

### **Surface Mount Capacitors**

Surface mount technology is the way things are done today. It is the method that dictates that all components are mounted on a single side of the printed circuit board. Through hole technology required drilled circuit boards, adding many steps to the manufacturing process. Surface mount technology lends its self well to automation, allowing many parts per minute and very little hand work. Due to surface mount technology, sophisticated equipment has not only become more portable (lighter in weight and smaller in size) but also more economical.

Surface mount technology has changed the nature of electronics. Everything has been miniaturize to the point of non-recognition. Components do not look the same today as they did as recently as ten years ago. And even an experienced technician can no longer recognize what the capacitor really is without a symbol designator on the circuit board.

### **Circuit Breaker**

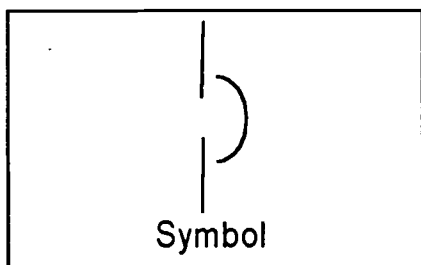

A circuit breaker is a device that interrupts the flow of electrical power. In your home, the circuit breaker is a switch designed to disconnect the primary power sources for appliances and lighting. In industry the circuit breaker works to interrupt power for high powered industrial equipment. Power for the home ordinarily requires that only one wire be disconnected, and so the circuit breaker has only one pole to perform the act. The term pole refers to the connection path for the conduction of electrical power. In industry, power is frequently supplied over three wires. For this reason many circuit breakers employed in factories application have three poles. The circuit breaker is frequently designed to automatically interrupt the electrical power if some equipment connected to the electrical power malfunctions. If the circuit breaker is designed to provide this function, the symbol will reflect it.

**Circuit breaker with a thermal overload trip.**

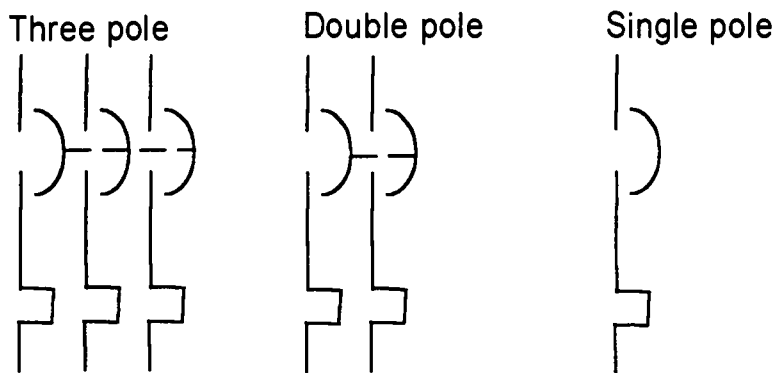

The single pole version of this symbol is the type of circuit breaker most often found in homes. The dashed line in the symbol of the circuit breaker signify that the multiple poles of the breaker are mechanically linked. When excessive electrical currents flow through the device, large amounts of heat are generated. The high heat is used to trip a mechanism in the breaker, thereby disconnecting the circuit.

**Circuit breaker with a bimetallic thermal overload trip.**

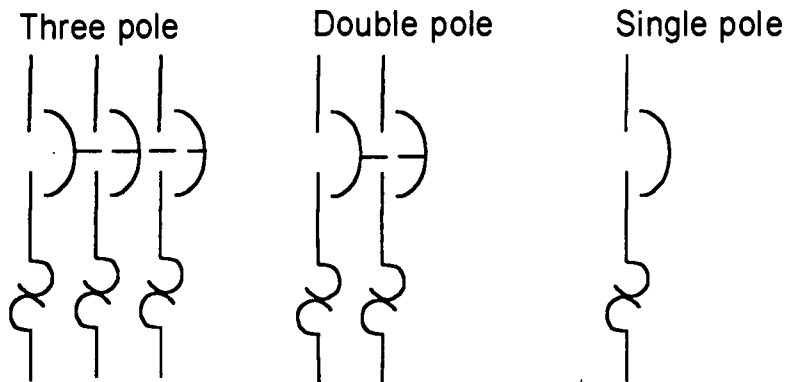

This type of circuit breaker works on the heat generated when excessive amounts of current flow through the breaker. The difference between this type of breaker and the one shown above, is that the heat causes two dissimilar types of metal to expand at different rates. When the bi-metallic actuator expands, it bends due to the unequal expansion of the two metals. This bending action operates a mechanism, and trips the breaker, thereby disconnecting the circuit.

**Circuit breaker with an electro-magnetic overload trip.**

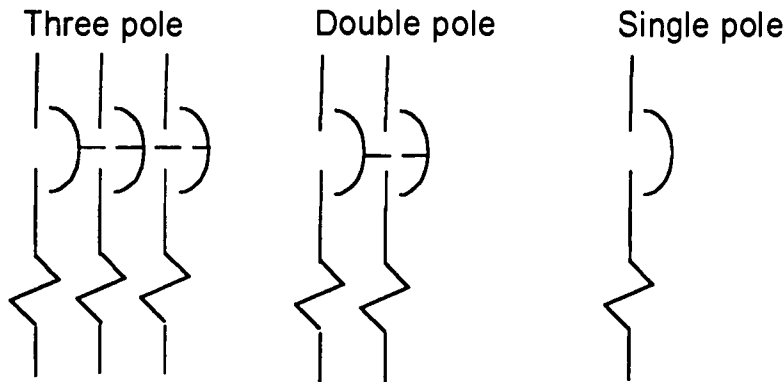

This type of circuit breaker works on the principle of an electro-magnet. When electrical currents flow through the conductors of the circuit, they create magnetic fields. The larger the current, the greater the field. The magnetic trip breaker is designed to trip the mechanism of the breaker when the currents and the magnetic field reach a certain magnitude, thereby disconnecting the circuit. In addition, some types of electro-magnetic trip breakers may be designed to be operated from a remote location using an emergency stop switch. These types of breakers may trip from excessive currents or from the action of the switch.

**Fuse type Circuit Breaker**

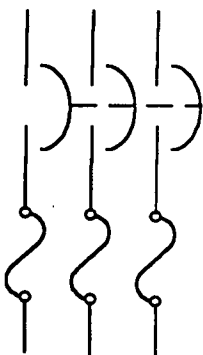

This is the symbol for a circuit breaker that uses fuses to protect the circuit. This breaker is a three pole breaker, and is capable of protecting three circuits. The brass objects located at the bottom of the picture are the contact surfaces of the fuses. Notice

the combination of the circuit breaker symbol, and the fuse symbol. Also notice the three wires that are connected to the circuit breaker.

This circuit breaker is typical of the type of circuit breaker that may be used in an electrical cabinet. The protection device used in this breaker is a fuse. In fact, there are three fuses used in this breaker to protect the three circuits. In addition, other types of protection devices can be used to prevent circuit damage and fires. Many circuit breakers are designed to disconnect two or three circuits. Fuses are frequently used to provide the necessary protection. A circuit breaker can interrupt large amounts of current. In addition, other types of protection devices can be used to prevent circuit damage and fires. Many circuit breakers are designed to disconnect two or three circuits. Fuses can be used to provide the necessary protection.

### Common Tie Point or Frame Ground

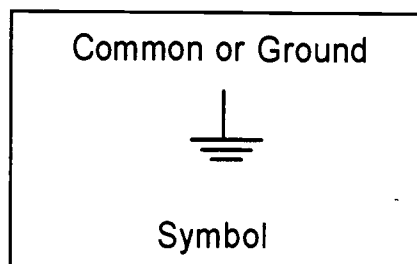
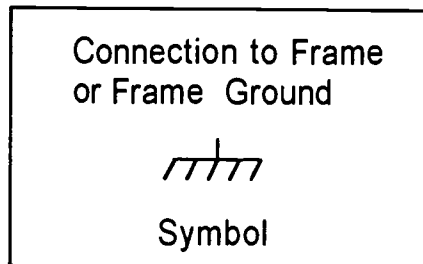

The "ground" symbol is the one most often ill used, and least understood. In reality, The concept of a "ground" as it is most often used, *does not exist*.

During the early years of electronic technology, the concept of a ground as a absolute point of reference for voltage was established. Certain types of electronic equipment, most notably, radio frequency equipment, used the earth as a point of reference. Over the years, the ground symbol has been used to symbolize many different points of voltage reference, none of which can be considered to be a true "ground". The Institute of Electrical and Electronic Engineers (IEEE) and the National Electrical Code (NEC) have established rules for the usage of the ground symbol, and for the connection to frame symbol. In the main, most manufacturers of electrical and electronic equipment have ignored these rules. The best that can be said about the ground symbol is that it is a common connection path for the conduction of electricity. For the purposes of this book, and for the *safety of the technician*, the following rules will apply to the "ground" symbol. The ground symbol will be considered to be a conductor of electrical currents. For this reason the "ground" symbol will be viewed as having *potentially lethal voltages attached to it, and may not be safely handled until it has been measured to determine the voltage potential (if any) that is has*. The connection to frame symbol will be considered to be a safety ground that is connected to a source such as a water pipe, or ground rod driven into the earth. In addition, the connection

to frame symbol is ordinarily connected to the facility's safety ground reference, and can be identified by the fact that the wires that are used for this purpose are green in color, or green with a yellow stripe. In some cases, for example, in home wiring, the safety ground is a bare (no insulation) copper or aluminum wire. The author has been witness to too many examples of damaged equipment, potentially lethal shock hazards, and poorly managed computer installations that suffered from the confusion as to what constitutes a "ground", to adopt any other interpretation of these symbols is to invite disaster.

Most electronics test equipment, for example an oscilloscope, has, as a part of its construction, a connection between the safety ground of the AC power cord, and the "ground" lead of the tests probes. For this reason, the "ground" lead of test equipment used in the troubleshooting of electronic equipment should not be connected to a circuit point that sports the "ground" symbol until:

- The technician has measured the voltage potential at the circuit point and has determined that the point is ZERO VOLTS in reference to the safety (frame) ground; and
- The technician understands the consequences of such connection to the equipment under test, and other equipment that may be connected to the same source of electrical power.

Some electrical technicians view the NEUTRAL wire (usually white) of an AC power source as a "ground". The neutral wire of an AC source of power is a conductor of electrical currents. It is *NEVER* to be viewed as being "grounded". *ALWAYS MEASURE, NEVER ASSUME!*

### Common Connection Point

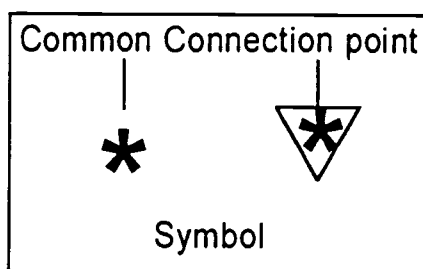

The common connection point symbol is most often used to indicate a connection to an electronic Direct Current (DC) power supply. In an electronic drawing, many circuits need a source of Direct Currents to operate. If the drawing contained a line to indicate all of these connections, the drawing would become very confusing. Therefore, the connection symbol will be used to indicate these connections. The asterisk shown in the symbol will be replaced by a letter or number to indicate the point of connection, in the

case of multiple sources of Direct Current. In some cases, the symbol will be used to indicate the common tie point of the circuit return path for the DC currents.

### Conduction Path for Electrical Currents

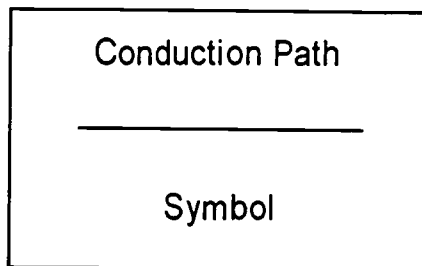

The symbol used to indicate a conduction path for electrical currents is a line. In an electrical or electronic drawing, many circuits will be connected to each other. These connections are paths for the conduction of electrical currents. The drawing contains lines to indicate these conduction paths. If the drawing contained lines to indicate all of the conduction paths, the drawing would become very confusing. Therefore, the conduction path symbol will be used along with the common tie point (ground) symbol, and the common connection point symbol.

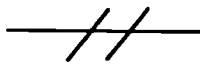

Two conduction paths  
(Electrical drawings)

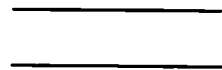

Two conduction paths  
(Electronic or electrical drawings)

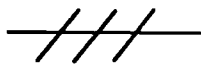

Three conduction paths  
(Electrical drawings)

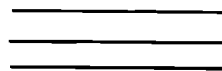

Three conduction paths  
(Electronic or electrical drawings)

### Connections of Conduction Paths for Electrical Currents

Two schemes are used to symbolically connect two or more conduction paths. In an electrical or electronic drawing, many circuits will be connected to each other. These connections must be unambiguous. The symbols below show the first method of indicating whether or not, two conduction paths are connected. In this scheme, a connected conduction path will be indicated by a large black dot showing the point of

connection. If the conduction paths are not connected the symbol will indicate that the path jumps over the alternate path. The drawing must never use both methods of indicating connects.

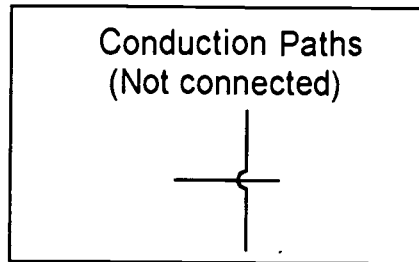
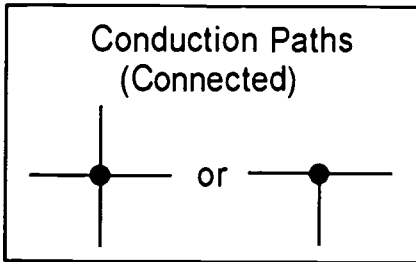

The symbols below show the second method of indicating whether or not, conduction paths are connected. This method dictates that a connecting path for conduction must indicate a clear termination at the point of connection. If the conduction paths are not connected, the lines will cross each other.

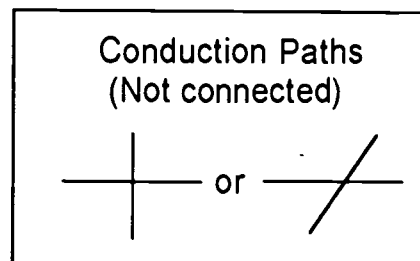
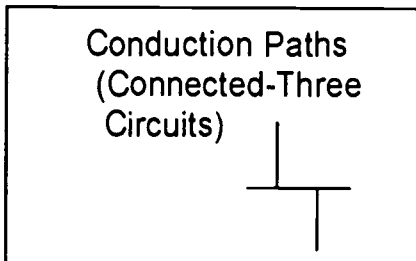

### General Circuit Element

The symbol below is the method of labeling an element of a circuit. The symbol may contain specifications for component values, voltages, currents, location of circuit elements, or other necessary data that pertains to the circuit operation. The rectangle may be as large as is necessary to contain the data.

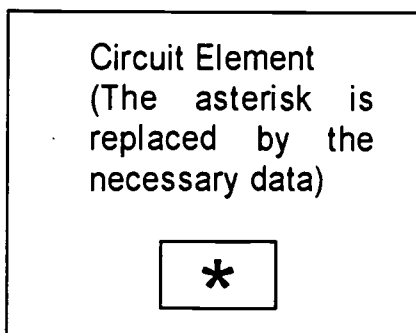

## Associated Conduction Paths for Electrical Currents (Cables)

The conduction paths in a complex electrical or electronic piece of equipment may be interconnected by groups of wires called cables. In many cases, the cables conduct sensitive electronic signals from one group of circuits to another. The paths are constructed in the cable such that the wires composing the paths are twisted around each other. When we depict associated conduction paths the paths are twisted unless otherwise specified. The twisting of the wires helps to eliminate unwanted signals from interfering with those being conducted through the conduction path.

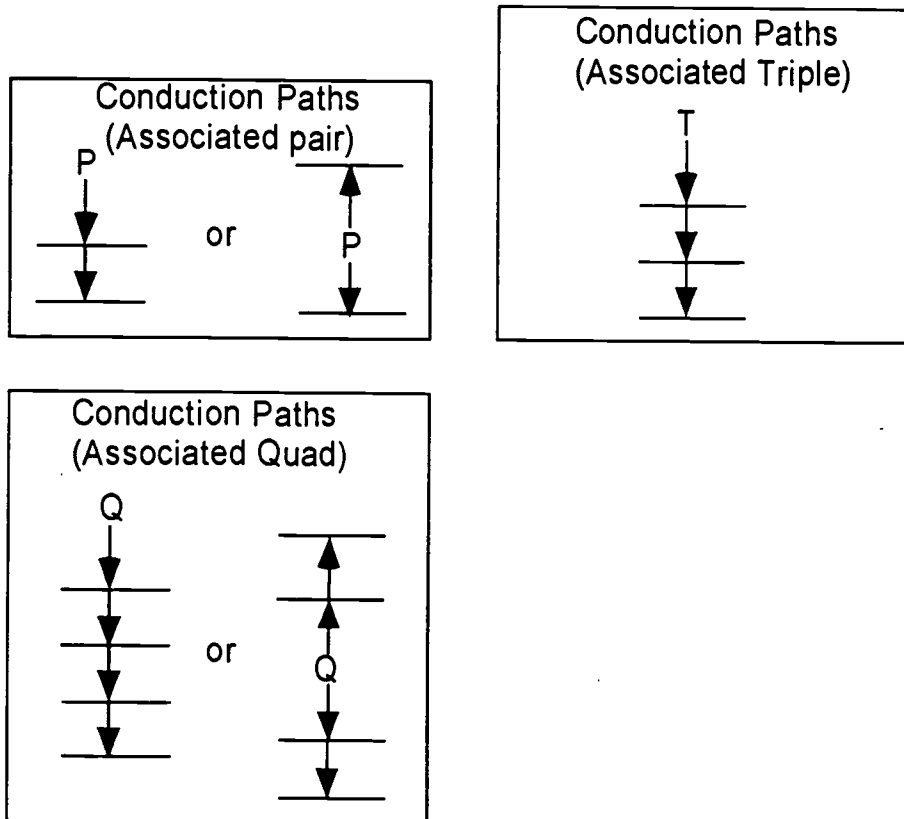

## Mechanical Connections of Electrical and Electronic Devices

The mechanical connection of components of electrical and electronic devices is depicted by a dotted line. If the devices are further operated by levers, a fulcrum symbol will be used.



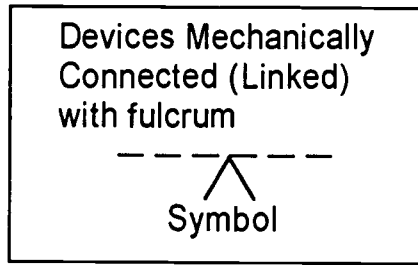
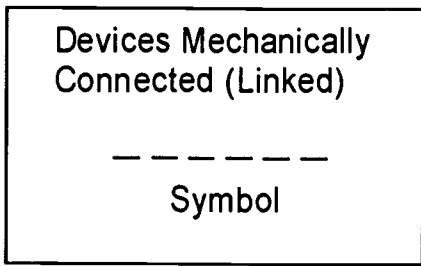

Three pole circuit breaker using the mechanical connection symbol

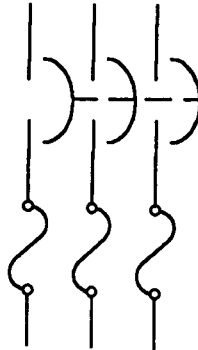

### Associated Conduction Paths for Electrical Currents (Shielded Cables)

The conduction paths in a complex electrical or electronic piece of equipment may be interconnected by groups of wires called cables. In many cases, the cables conduct sensitive electronic signals from one group of circuits to another. Many of these cables are shielded from unwanted interference by wire braids that surround the conductors. This wire braid is called a shield, and cables constructed in this manner are called shielded cables. Other types of cables are designed to be connected to circuits that have specific characteristics. One such group of cables is called coaxial cables. Coaxial cables are so named because the manner in which the conductors are arranged is one inside another. Unlike regular shielded cables, in which the shield does not conduct signals, the braid of the coaxial cable is one of the conduction paths and coaxial cables have specific electrical characteristics designed into the cable.

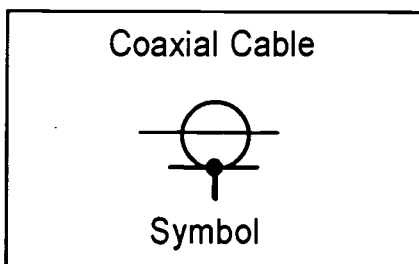

Shielded cables may contain many wires. A line will be added for each wire contained in the cable. The shield is a barrier against unwanted electrical interference from

outside electrical equipment, and is frequently connected to common (so-called ground) or the metal frame of the equipment.

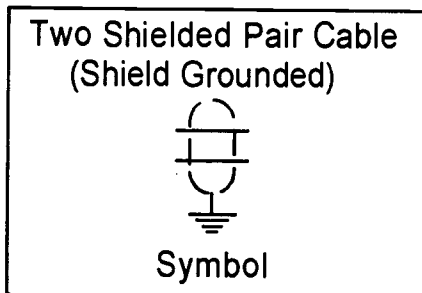
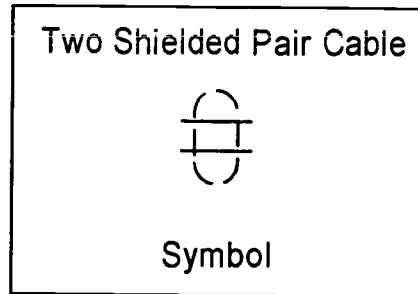
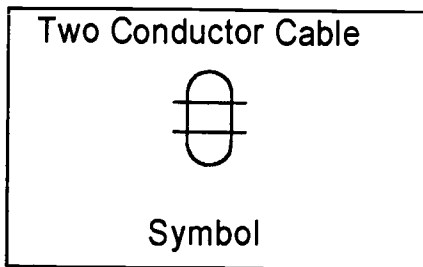

Another group of methods used to symbolically depict a cable or group of wires are the symbols shown below. Frequently the top symbol is used to depict a bundle of wires rather than a cable. The top symbol is frequently used in electrical layout diagrams and is designed to indicate when a wire leaves or joins the cable bundle.

The second group of symbols depicts a cable with many wires. It is used in electrical or electronic layout diagrams to show how the individual wires of the cable are led and distributed in the installation.

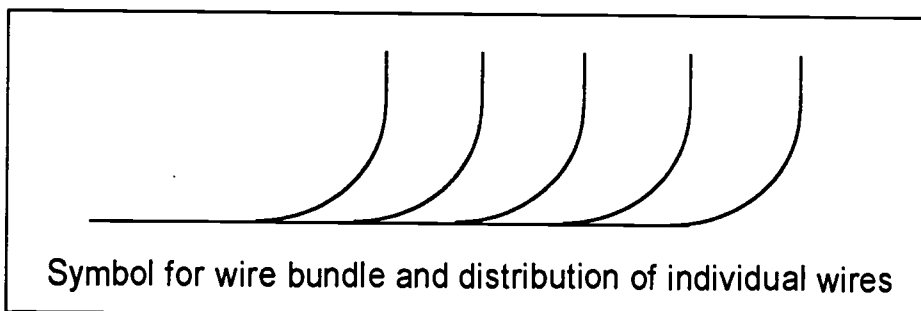

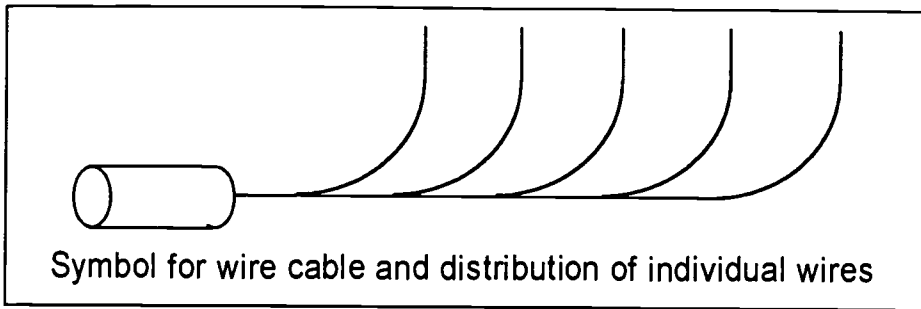

## Connectors

The basic connector symbol is depicted below. There are many different types of connectors in use. Some connectors attach one circuit board to another, some connectors attach cables to circuit boards, and some connectors attach conductors to each other. Regardless of the type of connection made, the same basic symbols will be used to depict the connection. There are two types of basic connector symbols used, both types may be used on the same drawing. The first type of symbol is used for general connections of all types. The second type of symbol usually depicts a plug connection. The female version of the second type of connector symbol is usually stationary, whereas the male version usually depicts a movable connector.

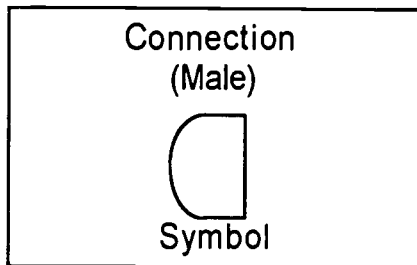
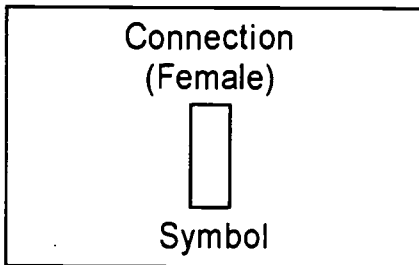
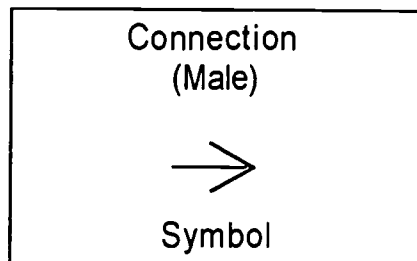
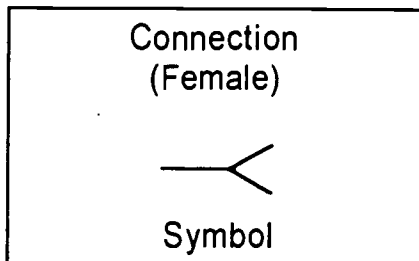

## Mated Connectors

When connectors are mated, the basic connector symbols are combined as depicted below. The basic symbol will be combined with letters or numbers to depict the individual connection points.

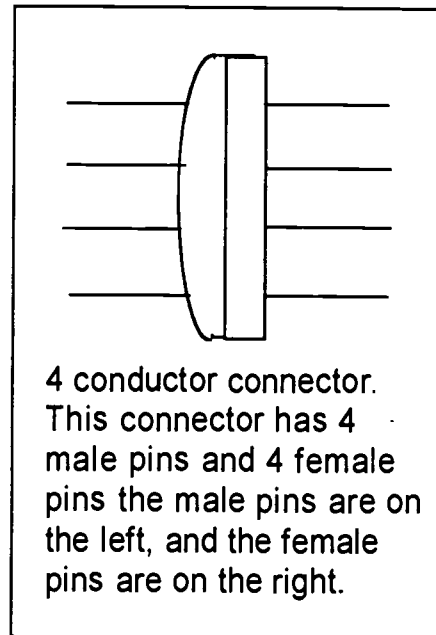
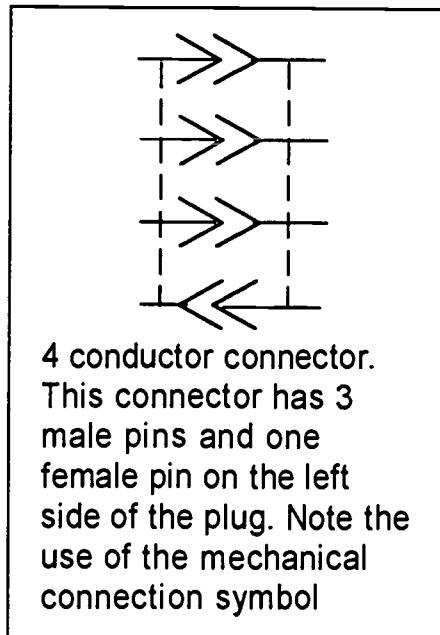
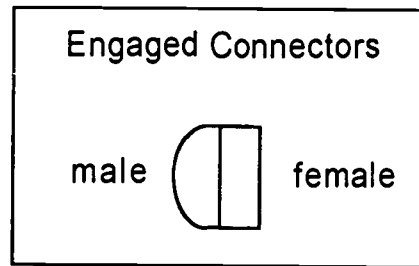
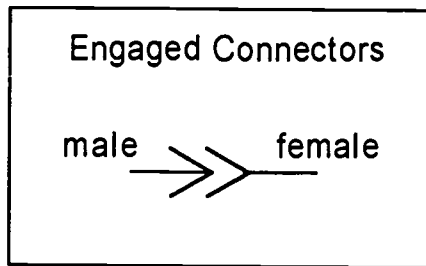

## Coaxial Connectors

Coaxial connectors are special connectors that are used when it is desired to connect circuits that have signals that can be influenced by other electrical or electronic equipment. Some of the signals that may be conducted using coaxial connectors are television signals, radio signals, certain types of computer signals, and other low energy level signals. The coaxial connector is usually mated to a type of cable called coaxial cable. Coaxial cable has an outer web of wire called a braid, and a single wire in the center. The outer braid is insulated from the inner wire by a non-conducting sleeve. The coaxial connector is constructed in a similar manner, but is usually made of solid metal. An example of a coaxial connector and coaxial cable is the wire and connector used on a standard television receiver which screws into the 75 ohm jack on the rear of the television. In the case of a television, the connector that plugs into the television, and the connector on the rear of the television, are both coaxial connectors.

The coaxial connector symbol can be combined with other symbols to modify the type of installation. In the example below, the coaxial connector symbol has been modified with the addition of a frame or equipment ground symbol to indicate that the connector is bolted or otherwise attached to the frame of the equipment.

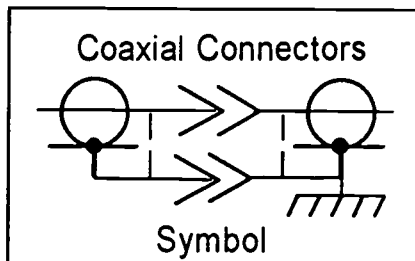
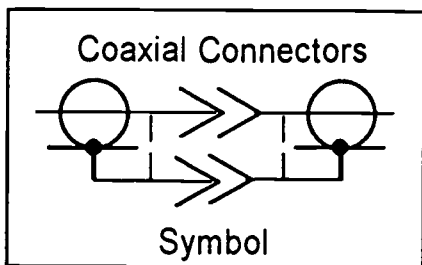

In some cases the outer braid of the coaxial connector is isolated from the circuit. If there is no conduction path between the outer braid of the connectors, the symbol will be modified with a X to indicate that the conduction path has been broken.

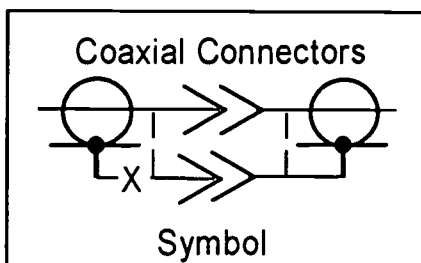

### Power Connectors (commonly called cord connectors, convenience outlets)

Connectors designed for AC power applications have a specific symbol. A large variety of connectors are available with different voltage and current ratings. In addition, some connectors have curved blades that are designed to lock into the convenience outlet. Regardless of the type of connector used, the symbol will only depict the amount of connection points, using the symbols show below.

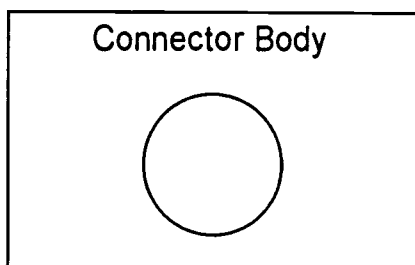
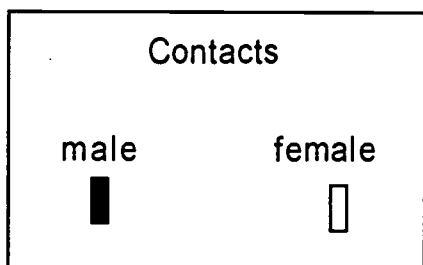

Examples of combined symbols. Note the conduction path symbols attached to the contact symbols.

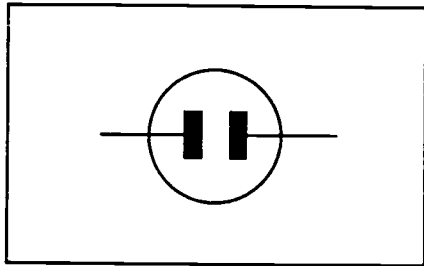

Two conductor non-polarized connector (male)

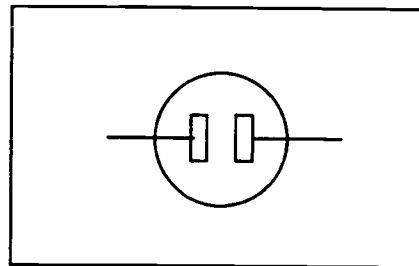

Two conductor non-polarized connector (female)

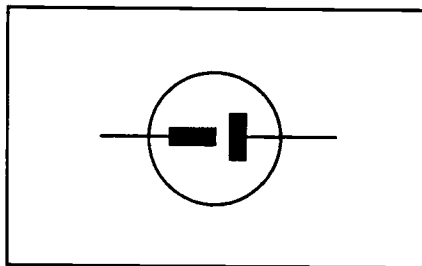

Two conductor polarized connector (male)

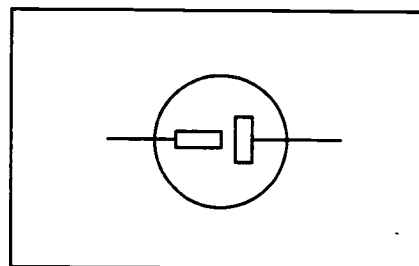

Two conductor polarized connector (female)

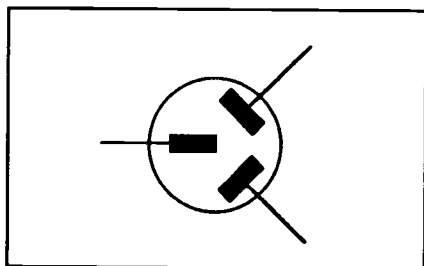

Three conductor polarized connector (female)

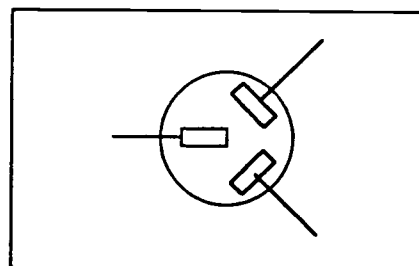

Three conductor polarized connector (male)

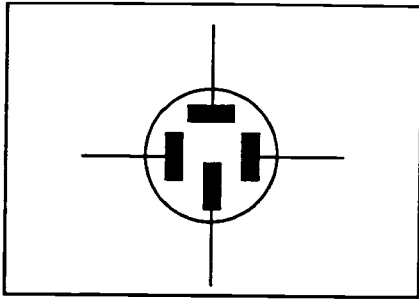

Four conductor polarized connector (male)

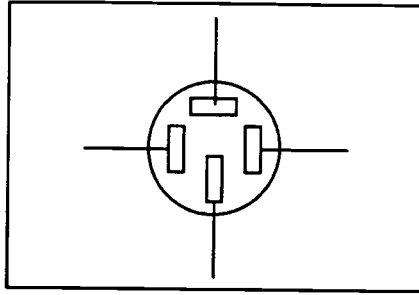

Four conductor polarized connector (female)

### Contacts (Electrical)

One of the most important symbols is the symbol used to indicate the contacts of a switch or relay. A switch is a device used to interrupt the conduction path for electrical currents. A relay is an automatic switch that can be operated by other sources of electrical currents. Switches and relays are used extensively in electrical and electronic equipment to control the flow of electrical currents. The contacts of a switch or relay have only two states. The contact can be *on or off*. If the contact is *on*, we identify its state as *closed*. If the switch is *off*, we identify its state as *open*. The concepts of open and closed in electrical work can be very confusing to a new student. The reason for this confusion is that the concepts run counter to ordinary experience. Most people are accustomed to the idea that if a valve such as a faucet is *closed*, *no water flows* from the faucet. If a faucet is *open*, then *water flows*. In electrical work, the concept is exactly the opposite. If the contact is *open*, *no current flows*. If the contact is *closed*, then *current flows*. It has been the authors experience that this state of affairs is only correctable by experience with the repeated usage of the symbols by the prospective technician. To fully understand the concept of open and closed contacts requires that the student change a lifetime of learning.

The below symbols represent the three types of basic symbols used to indicate contacts on electrical and electronic drawings notice that the symbols are represented in their normally open, and normally closed state. This representation of the contacts on a drawing refers only to the *state* of the contact *before* it is *operated*. It does not mean to imply that the contact is *always closed* or *always open*.

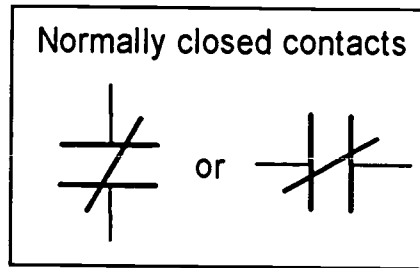
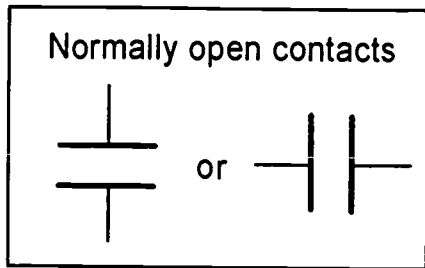

This symbol is used in electrical ladder diagrams and electronic diagrams

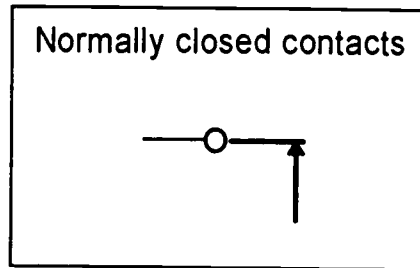
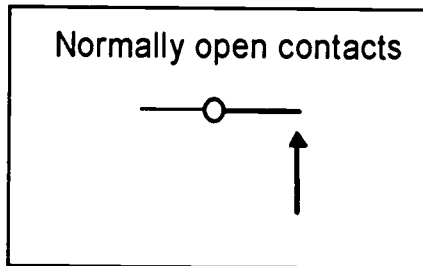

This symbol is primarily used in electronic schematics

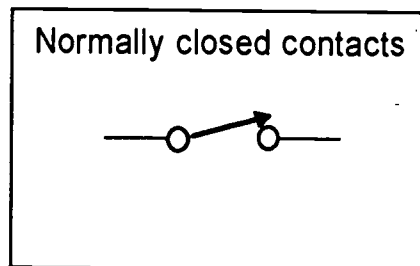
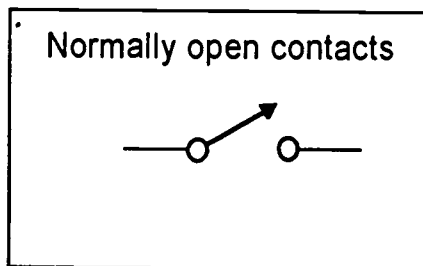

This symbol may be used in all types of electrical and electronic diagrams

All three of these symbol types can be used on electrical or electronic drawings the first set of symbols are the ones most commonly used on electrical ladder drawings.

### Contacts (Relays)

One of the most important devices that uses the contact symbol is the symbol used to indicate a relay. A relay is an automatic switch that can be operated by other sources of electrical currents. Relays are used extensively in electrical and electronic equipment to control the flow of electrical currents. Relays can be operated by either Direct Current (DC) or Alternating Current (AC). Regardless of the type of currents used to operate the relay, the relay contacts can be used to switch a large variety of electrical currents. The contacts of a relay have only two states. The states are controlled by the actuator of the relay. The actuator of a relay is an electromagnetic coil of wire. The electromagnet moves the switch contacts. If the contact is on, we identify its state as closed. If the contact is off, we identify its state as open. Before the relay is energized by an electrical current, the relay is identified as being in its normal



state. When the relay is in its normal state, some of the contacts may be closed, and some of the contacts may be open. Contacts that are closed in the normal state are said to be normally closed. Contacts that are open in the normal state, are said to be normally open. A relay can contain a large number of normally closed and normally open contacts. A relay can also contain only one normally open or normally closed contact. The amount and variety of normally open and normally closed contacts depends upon the design purpose of the relay. Regardless of the amount of contacts, the relay functions to switch the contacts by the action of the electromagnetic coil. The functions of the coil and the contacts are separate functions. The student must concentrate upon the fact that the coil moves the contacts and not vice-versa. The coil is the operator. The contacts respond to the actions of the coil. This representation of the contacts on a drawing refers only to the state of the contact before it is operated. It does not mean to imply that the contact is always closed or always open. On the drawing the contacts of a relay will be depicted in their normal state. A drawing is not a dynamic representation of the actions of the relay. To provide the maximum amount of information on the drawing, the contacts must be shown in their normal state. The interpreter of the drawing must imagine what will happen when the coil of the relay is energized. In electrical ladder diagrams, the coil of the relay and the contacts of the relay may be shown upon separate drawings. This is because the contacts of the relay will be used to switch other circuits, whereas the coil of the relay will be switched by other contacts or switches. This can be very confusing to the person who is required to interpret the drawing. It is a skill that requires a knowledge of electricity, and much practice.

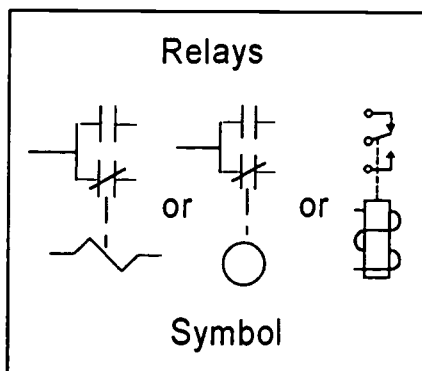

**The relay symbols depicted at the right are three of the many ways in which the same relay can be symbolized**

Note the use of the mechanical symbol. It indicates that the coil and contacts are mechanically linked

The symbols shown below are the various methods used to symbolize the electromagnetic coil of a relay. The choice of symbology is totally up to the company that manufactures the product. The top row of symbols is used extensively for electrical ladder drawings while the bottom row is used on electronic drawings. However, the symbols may be mixed on the same drawing. Each coil symbol will be accompanied by a letter and number designation for the relay coil in question. In the case of the circle, the asterisk will be replaced by the letter/number combination designator for the relay. The letters used to represent relays are frequently K, CR, R, and, M. The number can be any whole number.

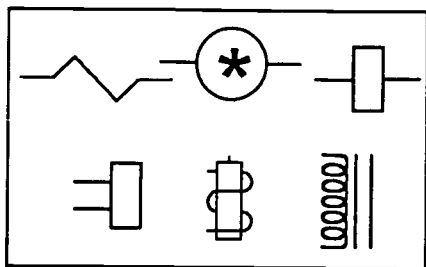

Relay Coil Symbols

### Contacts (Time Delay Relays)

Some relays are designed to be operated after a period of time. These relays are called "time Delay Relays". Time delay relays can have delay times as small as fractions of a second to times as large as minutes or hours. To accomplish this, the time delay relay may contain complex electronic circuits or mechanical actuators that delay the time that the relay actuates. Regardless of the method, the time delay relay closes or opens its contacts only after the coil of the relay has been actuated. The coil of the time delay relay may be identified by "TDR". Time delay relay contacts will be identified by "TDO" or "TDC". TDO means "Time Delay Open", TDC means "Time Delay Close". The TDO contacts will *open after* a period of time determined by the setting of the relay, and TDC contacts will *close after* a period of time determined by the setting of the relay. Regardless of the type of contacts involved, the coil of the relay is the governing factor. Some time delay relays, delay the time at which the relay coil will *energize*, and some time delay relays, delay the time at which the relay coil will *de-energize*. This action determines the manner in which the contacts will behave. The below symbols depict the various methods of symbolizing TDO and TDC relay contacts and coils.

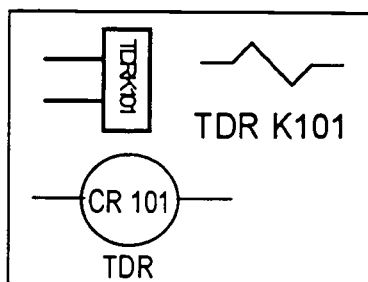

Symbols for coils

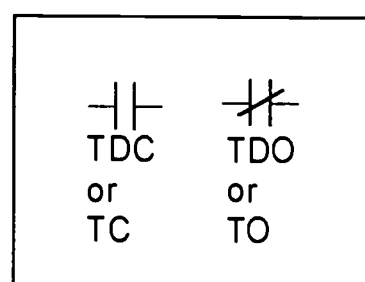
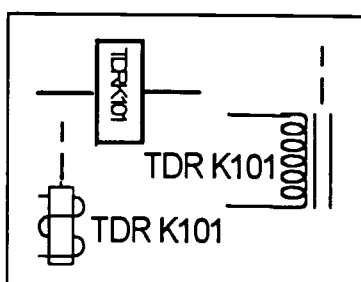

Symbols for contacts

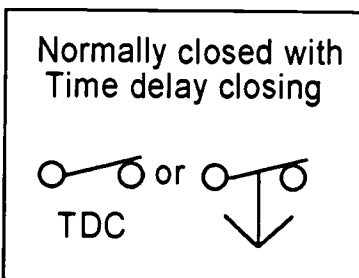
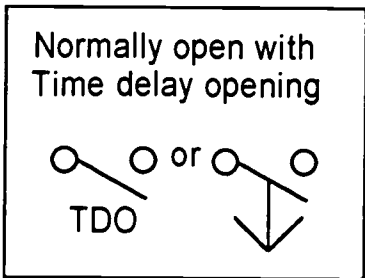
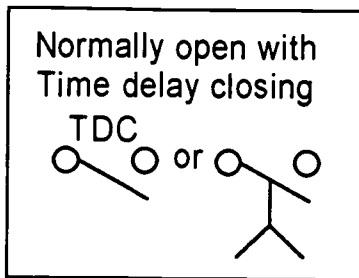
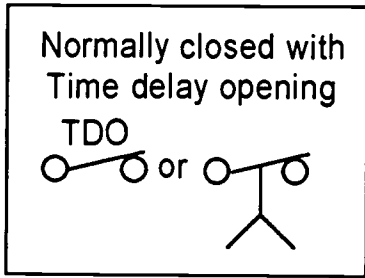

## Contacts (Switches)

Switches are circuit control devices that are used to apply power to a circuit or piece of equipment. Switches are manually operated devices that require physical effort in some form or another. Switches may be used to open or close any source of electrical current, including signals from complex electronic circuits. The basic switch symbol employs the symbols for contacts, as discussed earlier. A large variety of switches are manufactured for many different applications. The symbols used to depict switches attempt to depict the purpose of the switch rather than identify any particular type of switch. The next few pages will portray the various categories for switch symbols, and describe some of the nomenclature used to identify switches.

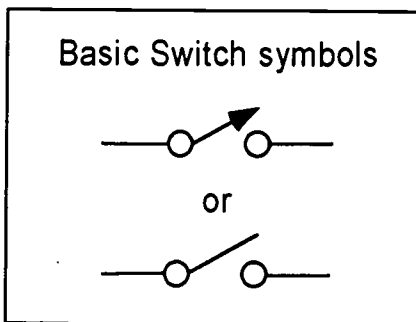

## Switch Categories

Switches are categorized according to the number of complete circuit paths than the switch can control. Conduction paths that the switch can control, are called poles. A

switch can have one or many poles. The above symbols depict a switch that has only one pole. The second criteria is the number of positions that the switch can assume. These positions are called throws. A throw is the position that the switch can move to and mechanically maintain contact. The above symbols depict a switch that has only one throw position. This switch would typically be found in applications in which an ON/OFF circuit needs to be controlled, such as a light switch. The words POLE and THROW are abbreviated with P and T, and the switch is categorized according to the number of each. To describe the number of the poles and throws, the words SINGLE, DOUBLE, and the numbers 3, 4, 5, 6, etc. are used. Each is abbreviated in a manner similar to the above method for poles and throws. Therefore, SINGLE becomes S, DOUBLE becomes D, and 3, 4, etc. are used to describe values above one and two. The letters and numbers are then combined to describe the switch. For example, the above switches are SINGLE POLE, SINGLE THROW, and they would be categorized as SPST. The below symbols depict some switches and the categories that they are assigned to.

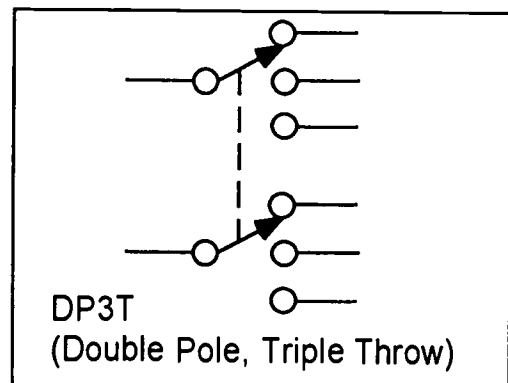
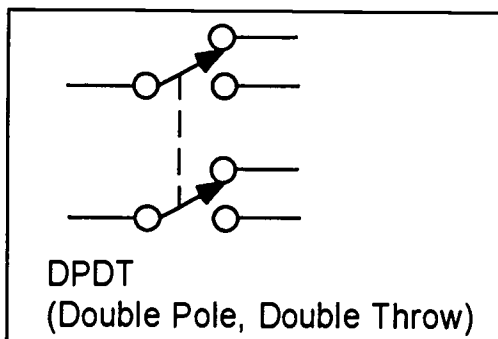
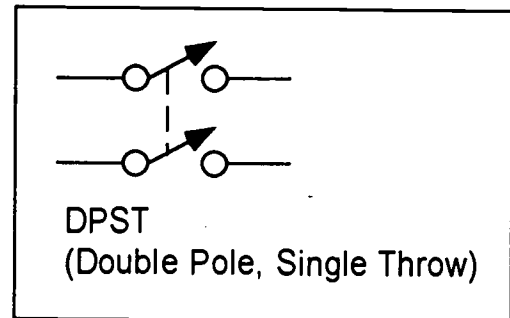
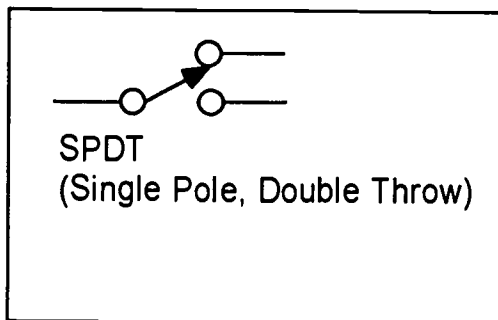

### Contacts (Switches-Interlocks)

Certain types of switches are used for safety features on machinery. The switches are called interlock switches, or just "interlocks." The symbols used for these switches are depicted below.

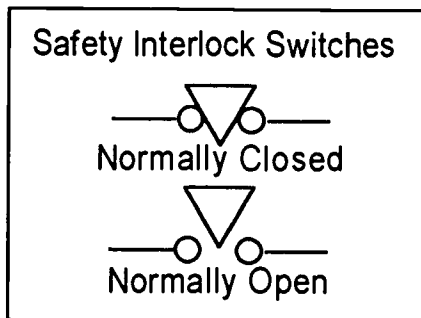

### Contacts (Switches-Momentary and Maintained)

Push-button switches are sometimes known as momentary switches. Momentary switches do not maintain CONTACT UNLESS MANUAL PRESSURE IS APPLIED TO THAT THE SWITCH. Usually a spring inside the switch returns the switch to its previous state. Since a momentary switch is normally in one position unless it is actuated, the push-button switch may have normally open and normally closed contacts. In addition the momentary switch can have one or many poles. Momentary switches such as push-button switches can be categorized as to their poles and throws, or as to the types of contacts. In many cases both descriptions are used. In addition, push-button switches can be manufactured to maintain a state of actuation after they are pushed in this case, the push-button switch is categorized as having maintained contacts. In addition, toggle switches can be manufactured containing momentary contacts. In other words, a switch may be momentary or maintained regardless of whether or not it is a push-button or toggle switch.

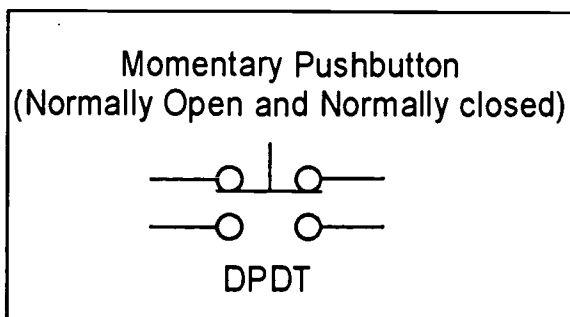
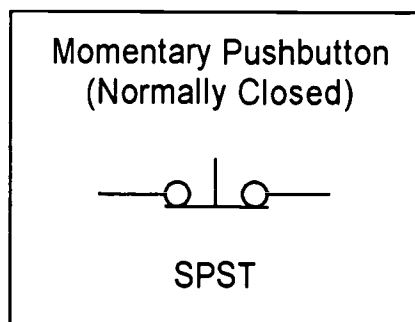
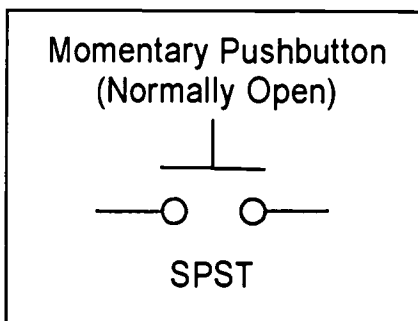

**AET-B3-HO-3**  
**Use Symbols, Organization, and Engineering Values**  
**on Electronic Drawings**  
**Attachment 3: MASTER Handout No. 3**

---

**Electronic Drawing Symbols**

**Semiconductors, Diodes**

A diode is used to regulate the flow of electrical currents. In most cases, the diode is used to allow current flow in only one direction. The diode behaves much like the device called a check valve that is used in hydraulic or pneumatic systems. Another use of the diode is to change alternating current (AC) into direct current (DC). The diode is the simplest type of semiconductor device. A semiconductor is composed of a material that exhibits the following specific properties. A semiconductor is a metalloid. That is, it has some of the properties of metals such as luster, a crystalline structure, and the ability to partially conduct electricity. However, unlike a metal, a metalloid is not malleable, it is brittle. It does not have the strength of a metal, and unlike a metal, which is considered to be a conductor of electricity, a metalloid opposes the flow of electrical currents. Two of the elements that have been used to manufacture semiconductors are germanium and silicon. Considerable research is being conducted into the identification of other types of materials that can be used as semiconductors. The concept of a semiconductor is complex. The industries that manufacture semiconductors, and the industries that employ the semiconductor to manufacture modern electronic equipment such as computer, VCRs, and televisions are extensive and varied. Semiconductors are subjected to complex manufacturing processes that impart the desired properties to the semiconductor, and it is beyond the scope of this book to explain the concepts involved in this process or the theory of operation of a semiconductor. Instead, we will concentrate upon the symbols that are used in electronic schematics to depict the semiconductor. Below is the basic symbol for a diode. The direction in which the diode will allow unrestricted flow of electrical currents is against the direction of the arrow.

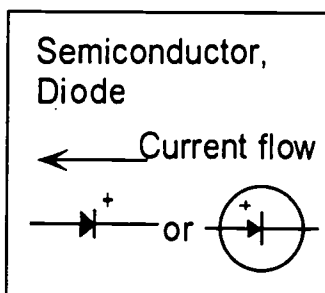

Maintained Pushbutton  
(Two sets of Normally Open and Normally closed)

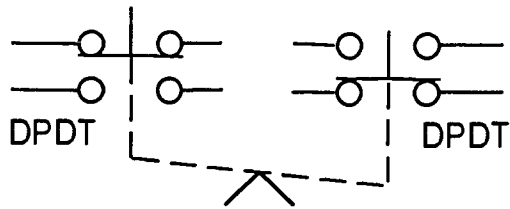

Note the mechanical symbols

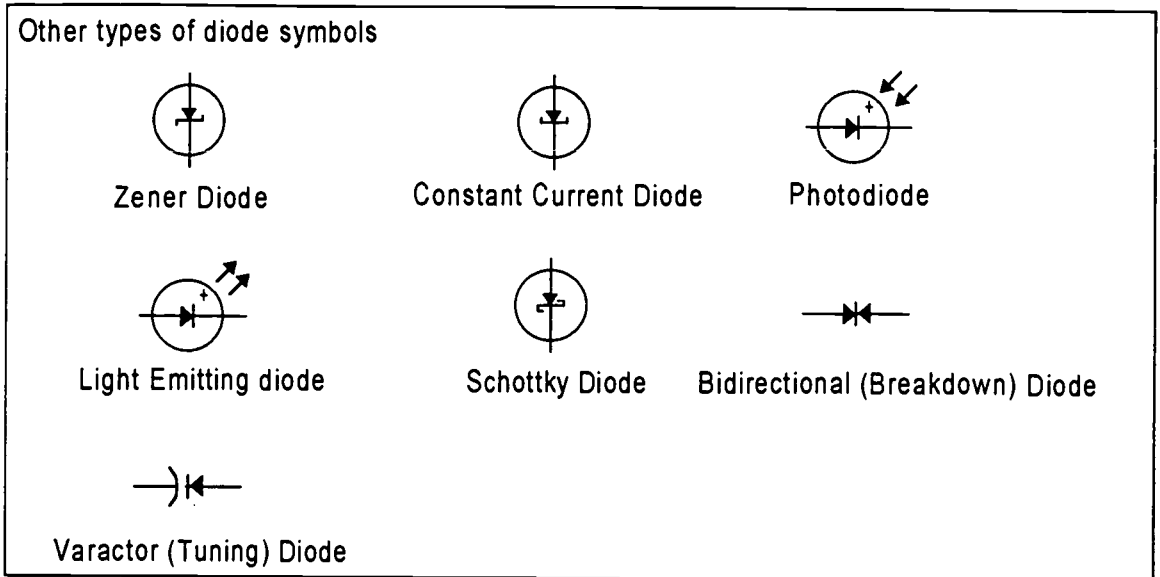

### Semiconductors, Transistor

The next stage of evolution of the semiconductor resulted in the invention of the transistor. Transistors are semiconductor amplifiers. That is, they can be used to increase the power level of an electronic voltage or current flow. The symbol for the basic and most common type of transistor, called the *bipolar transistor*, is depicted below. There are two types of bipolar transistors. One is called a *PNP bipolar transistor*. The other is called the *NPN bipolar transistor*. The NPN transistor can be identified by the arrow in the symbol which is *pointing out away* from the symbol. The PNP transistor is identified by the arrow that *points in towards* the symbol. The invention of the transistor led to the invention of many other types of transistor type semiconductor devices. Each device has different desirable properties that can be used to control electronic equipment. The symbols for some of the more prevalent of these devices are depicted below. New semiconductor devices are constantly being invented. Each device has a different symbol. To depict all of these devices would be impractical.

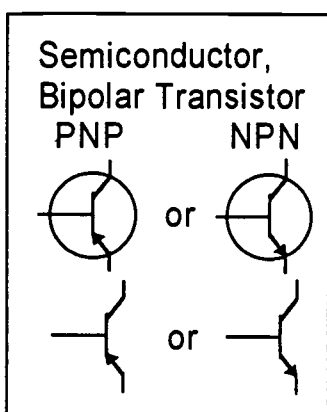



## Transistor Symbols

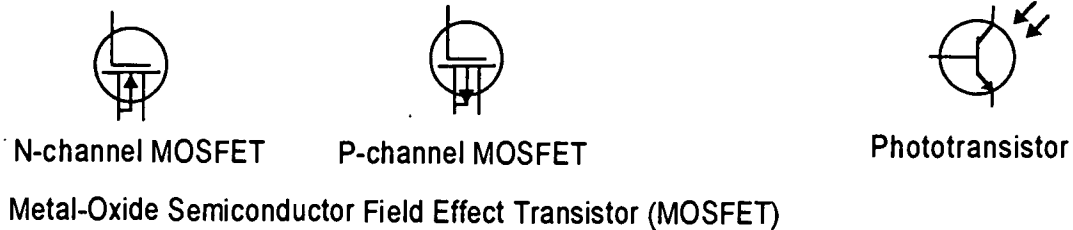
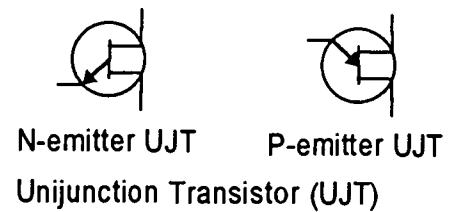
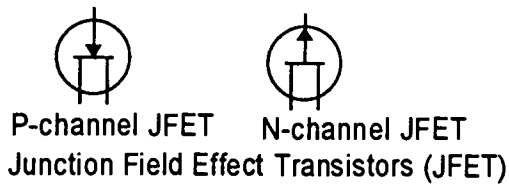

## Feedback Control Systems Symbology (Gain Block Algebra or Bode Diagrams)

To simplify the enormously complex subject of feedback control systems, the concept of gain block symbology was developed. The electronic modules, mechanical systems, and feedback systems of the modern Computerized Numerical Control (CNC) machine or robot, if depicted in detail, merely serve to confuse the technician or engineer. In a complex control system for a CNC or robot motion, a wide range of electronics, mechanical devices, and feedback systems are used. To symbologically depict the functions of each part of the system, rather than depict each highly complex component in a drawing, serves to simplify the system, and make it more understandable to the human mind. To accomplish this task, feedback control system symbology is used. The term feedback conceptualizes the idea of motion systems as being self regulating systems. That is, for every stimulus to the control system, there is a response that indicated the results of the stimulus. This response is called feedback. Feedback may be any device that measures the results of a physical event. For example, a thermocouple that measures temperature, can be used as a feedback device since it provides information as to the relative temperature of a system. In like manner, a device that measures distance can be a part of a feedback control systems that is intended to produce motion. In the process of designing the system the symbology becomes part of an algebraic equation. The equation, using a form of math called Laplace Transforms can be used to predict and tailor the desired response. The actual design of the system uses the equation as a blueprint. Frequently, the symbolic drawing is used to discuss the overall operation of the system in maintenance manuals. It must be understood that the symbols do not reflect the actual electronic or mechanical components. The feedback control system diagram is used to understand

the overall concept of the control system, and then the technician must investigate the individual modules, mechanisms or components that provide that function.

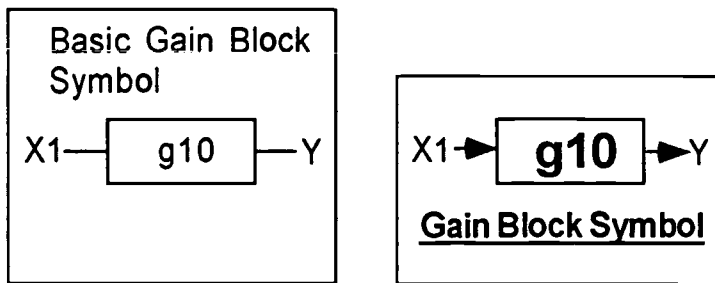

The basic gain block symbol indicates the magnitude by which a given input will be increased or decreased. The value is given by an amount equal to the number in the middle of the gain block next to the letter "g". A fractional or decimal value indicates a decrease in level. The function is read; "Y is a function of X1 such that  $Y=10 \cdot X1$ " or  $Y = f(X1) \ Y=10 \cdot X1$ . Any variable or variable scheme may be used for the equation. The arrows indicate the direction of information flow.

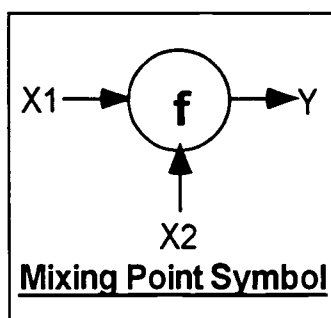

The mixing point symbol is used to indicate the combination of two or more inputs that are combined without regard as to their polarity or magnitude. No mathematical functions are performed. This symbol reads:  $Y=f(X1,X2)$  or Y is a function of X1 and X2.

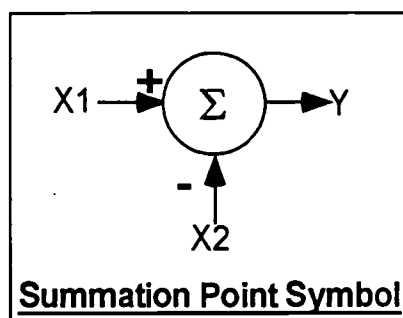

The summation point symbol depicts algebraic summation of two or more inputs. If more than three inputs are desired, the circle becomes a rectangle with as many inputs as are necessary. A polarity sign is used to indicate the algebraic sign of the

summation. The arrows indicate the direction of information flow. The summation point at the left reads:  $Y = (+X1) + (-X2)$ .

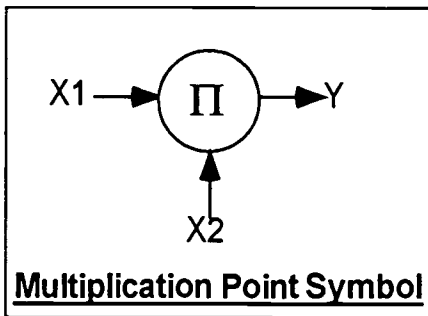

The multiplication point symbol depicts algebraic multiplication of two or more inputs. If more than three inputs are desired, the circle becomes a rectangle with as many inputs as are necessary. The arrows indicate the direction of information flow. The multiplication point at the left reads:  $Y = X1 * X2$ .

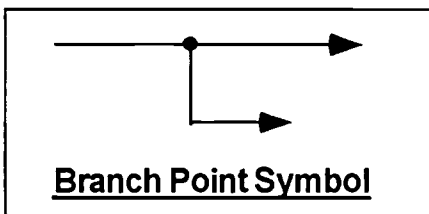

The branch point indicates a point at which the signal branches and follows a new path.

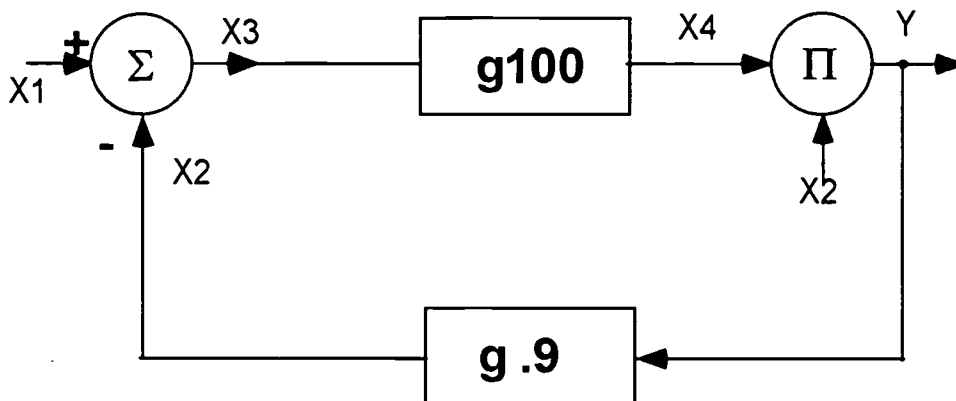

**Combined Symbols**

**AET-B4-HO-1**  
**Use Symbols, Organization, and Engineering Values**  
**on Fluid Power Drawings**  
**Attachment 1: MASTER Handout No. 1**

---

**Objective(s):**

Upon completion of this unit the student will be able to use the symbols and organization associated with fluid power schematic diagrams and fluid power layout diagrams to:

- a. Identify symbols on hydraulic or pneumatic drawings by their symbol;
  - b. Identify the layout of a hydraulic or pneumatic drawing;
  - c. Determine the location of the components; and,
  - d. Apply engineering values obtained from the drawing to the solution of technical problems
- 

**Module Outline:**

- I. Identify Symbols on Hydraulic or Pneumatic Drawings
  - A. Identify symbols used to depict components in a hydraulic or pneumatic schematic drawing: MASTER Handout AET-B4-HO-2 (Hydraulic/Pneumatic Drawing Symbols) and MASTER Handout AET-B4-HO-3 (Hydraulic/Pneumatic Schematic Drawing)
    1. Identify basic symbols used to depict hydraulic or pneumatic components
    2. Describe the complex functions that are comprised from basic symbols
    3. Relate the symbols used in the depiction of hydraulic or pneumatic components with the actual components and their relative size and shape
  - B. Demonstrate the methods used to apply the above information to the troubleshooting of fluid power systems
- II. Identify the Layout of a Hydraulic or Pneumatic Drawing
  - A. Use hydraulic or pneumatic layout diagrams to locate the position and relative size of a component
    1. Explain the layout and organization of a hydraulic or pneumatic diagram
      - a. Explain the meaning and use of manifolds or enclosures
      - b. Locate the pumping and tank systems
      - c. Locate the fluid conditioning systems
      - d. Locate the control valves
      - e. Identify motion actuators, rotary and linear
    2. Explain the layout and organization of hydraulic or pneumatic drawings

- a. Explain the types of drawing and documentation that comprise a set of hydraulic or pneumatic drawings
  - b. Locate pressure and flow controls on a hydraulic or pneumatic schematic drawing
  - c. Determine the types of pressures and flows and their magnitude
- B. Demonstrate the methods used to apply the above information to the troubleshooting of fluid power systems

**AET-B5-HO-1**  
**Use Symbols, Organization, and Engineering Values**  
**on Digital Drawings**  
Attachment 1: MASTER Handout No. 1

---

**Objective(s):**

Upon completion of this unit the student will be able to use the symbols and organization associated with electronic schematic diagrams and electronic layout diagrams to:

- a. Identify symbols on digital electronic drawings;
  - b. Identify the layout of a digital electronic drawing;
  - c. Determine the location of the components; and,
  - d. Apply engineering values obtained from the drawing to the solution of technical problems.
- 

**Module Outline:**

- I. Identify Symbols on Digital Electronic Drawings
  - A. Digital electronic drawing symbols: MASTER Handout AET-B5-HO-2 (Digital Electronic Drawing Symbols) and MASTER Handout AET-B5-HO-3 (Digital Electronic Schematic Drawing)
    1. Describe the types symbols used on digital electronic drawings and their general meaning in terms of Boolean concepts
    2. Describe the symbols used to apply engineering information on digital electronic drawings
    3. Relate the symbols to the types of integrated circuits used in digitally controlled systems
  - B. Demonstrate the methods used to apply the above symbols to the control of industrial systems
- II. Identify the Layout of a Digital Electronic Drawing
  - A. Digital electronic drawing layout: MASTER Handout AET-B5-HO-2 (Digital Electronic Drawing Symbols) and MASTER Handout AET-B5-HO-3 (Digital Electronic Schematic Drawing)
    1. Describe the informational areas on digital electronic drawings and their meaning
    2. Describe the interconnection of the symbols and their relationship to the integrated circuits used in the modules of the digital electronic control system
  - B. Demonstrate the methods used to apply the above information to the control of industrial systems

**AET-B5-HO-2**  
**Use Symbols, Organization, and Engineering Values**  
**on Digital Drawings**  
**Attachment 2: MASTER Handout No. 2**

---

**Digital Electronic Drawing Symbols**

**Digital Logic Symbology (Boolean Algebra)**

In computers or other types of electronic equipment that use digital information to perform tasks, the control process is carried out by components that make decisions. The decisions performed by the electronic devices that we call digital logic are YES/NO decisions. That is, the components are only capable of recognizing two states of information, the information is either true or false. Components that provide that function have symbols associated with their purpose. In the past, the components contained within the circuit that performed the logic function were transistors, resistors, and capacitors. Through the years we have learned how to miniaturize these circuits so that now, we can pack millions of them into a device that is frequently referred to as a computer chip. A computer chip is, for all practical purposes, a collection of many logic circuits that perform true/false operations. There are only five logical functions that comprise the entire range of digital logic operations. However, by modifying the operations, and combining the digital operations in specific combinations we produce computer control systems that mimic human thought processes. Combining the digital operations is called combinational logic. The basic symbols for the logical functions and some of their variations are depicted below. Although there are other standards for logic symbols, the ANSI standard will be used.

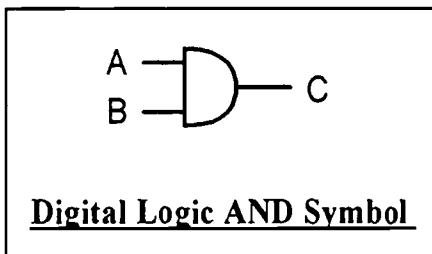

The AND symbol, sometimes called the and gate, is a digital logic device that requires two or more inputs to be true before the output can be true. In the case at the left, the inputs are on the left side of the symbol, designated A and B. The output is on the right side of the symbol, designated C. Both input A and input B must be true before output C is true.

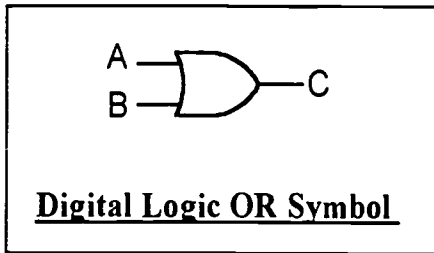

The OR symbol, sometimes called the OR gate, is a digital logic device that will produce an output when one of two or more inputs is true. In the case at the left, the inputs are on the left side of the symbol, designated A and B. The output is on the right side of the symbol, designated C. Either input A or input B must be true before output C is true.

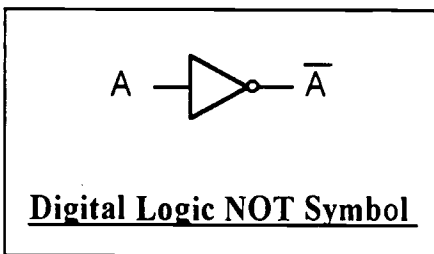

The NOT symbol, sometimes called the inverter gate, is a digital logic device that inverts the meaning of an input. The small circle on the end of the amplifier symbol indicates the inversion, and will be used with the other symbols. The meaning of the inverter is: input A equals not output A. The line above the output A is called a bar, and the output is frequently referred to as "bar A."

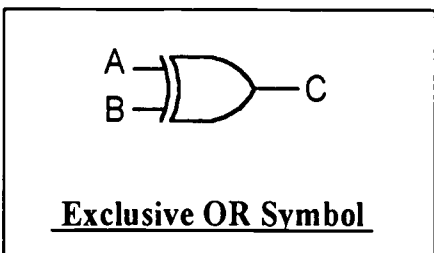

The Exclusive OR symbol, sometimes called the XOR gate, is a digital logic device that excludes the occurrence of two or more inputs that have the same logical state. That is, for the output C to be true, the inputs A, B must be in the opposite states. In the case at the left, the inputs are on the left side of the symbol, designated A and B. The output is on the right side of the symbol, designated C. Input A and input B must be in opposite states before output C is true. If input A and B are false, or A and B are true, output C will not be true.



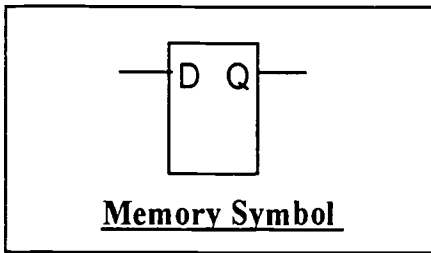

The memory symbol, sometimes called the *flip/flop*, is a digital logic device that remembers an input when one of the inputs is true or false. In the case at the left, the input is on the left side of the symbol, designated D. The output is on the right side of the symbol, designated Q. If D is true, then Q will be true and will remain that way until D becomes false. If D is false, Q will be false and will not change until D becomes true again.

**AUTOMATED EQUIPMENT REPAIR TECHNICIAN ... operates, programs, maintains, and repairs automated machine tools and automated manufacturing processes.**

**Duties**

**Tasks**

Duties	A-1 Apply scientific notation and algebraic formulas to solve technical problems	A-2 Apply algebraic formulas to predict behavior of industrial systems	A-3 Use variables in algebraic formulas to analyze industrial systems	A-4 Manipulate algebraic formulas to analyze industrial systems	A-5 Measure, calculate, and convert quantities in English (SI) units in digital measurement systems	A-6 Use mechanical physics to analyze mechanical systems	A-7 Use mechanical physics to analyze industrial systems	A-8 Use mathematical physics to analyze hydraulic and pneumatic systems	A-9 Use mathematical principles and thermodynamics to analyze systems	A-10 Use mathematical principles to analyze electrical systems	A-11 Use chemical principles and formulas to predict and analyze reactions in industrial processes	A-12 Apply chemical principles to analyze electrochemical effects in industrial processes	A-13 Apply chemical principles to analyze industrial water treatment processes
<b>A</b> Apply Science to Solve Industrial Problems	B-1 Use symbols, organization, and engineering drawings	B-2 Use symbols, organization, and engineering drawings	B-3 Use symbols, organization, and engineering drawings	B-4 Use symbols, organization, and engineering drawings	B-5 Use symbols, organization, and engineering drawings	B-6 Use symbols, organization, and engineering drawings	B-7 Use symbols, organization, and engineering drawings	B-8 Use symbols, organization, and engineering drawings	B-9 Use symbols, organization, and engineering drawings	B-10 Use symbols, organization, and engineering drawings	B-11 Use symbols, organization, and engineering drawings	B-12 Use symbols, organization, and engineering drawings	B-13 Use symbols, organization, and engineering drawings
<b>B</b> Use Drawings to Analyze and Repair Systems	C-1 Apply mechanical measurement instruments to align machine tools	C-2 Apply electrical measurement instruments to test electrical circuits	C-3 Apply electronic measurement instruments to test electronic circuits	C-4 Apply pneumatic measurement instruments to test pneumatic systems	C-5 Apply digital measurement instruments to test digital circuits	C-6 Apply electronic measurement instruments to test electronic circuits	C-7 Apply electronic measurement instruments to test electronic circuits	C-8 Apply electronic measurement instruments to test electronic circuits	C-9 Apply electronic measurement instruments to test electronic circuits	C-10 Apply electronic measurement instruments to test electronic circuits	C-11 Apply electronic measurement instruments to test electronic circuits	C-12 Apply electronic measurement instruments to test electronic circuits	C-13 Apply electronic measurement instruments to test electronic circuits
<b>C</b> Use Calibrated Measuring Instruments to Test/Calibrate Components	D-1 Apply troubleshooting process to the resolution of malfunctions found in machine tools and automated equipment	D-2 Calculate, predict, and respond to quantities in AC circuits	D-3 Calculate, predict, and respond to quantities in AC circuits	D-4 Calculate, predict, and respond to quantities in AC circuits	D-5 Calculate, predict, and respond to quantities in AC circuits	D-6 Calculate, predict, and respond to quantities in AC circuits	D-7 Calculate, predict, and respond to quantities in AC circuits	D-8 Calculate, predict, and respond to quantities in AC circuits	D-9 Calculate, predict, and respond to quantities in AC circuits	D-10 Calculate, predict, and respond to quantities in AC circuits	D-11 Calculate, predict, and respond to quantities in AC circuits	D-12 Calculate, predict, and respond to quantities in AC circuits	D-13 Calculate, predict, and respond to quantities in AC circuits
<b>D</b> Resolve System Failures with Critical Thinking, Troubleshooting, and Metrology	E-1 Calculate, predict, and respond to quantities in DC circuits	E-2 Calculate, predict, and respond to quantities in AC circuits	E-3 Calculate, predict, and respond to quantities in AC circuits	E-4 Calculate, predict, and respond to quantities in AC circuits	E-5 Calculate, predict, and respond to quantities in AC circuits	E-6 Calculate, predict, and respond to quantities in AC circuits	E-7 Calculate, predict, and respond to quantities in AC circuits	E-8 Calculate, predict, and respond to quantities in AC circuits	E-9 Calculate, predict, and respond to quantities in AC circuits	E-10 Calculate, predict, and respond to quantities in AC circuits	E-11 Calculate, predict, and respond to quantities in AC circuits	E-12 Calculate, predict, and respond to quantities in AC circuits	E-13 Calculate, predict, and respond to quantities in AC circuits
<b>E</b> Use Techniques to Diagnose Malfunctions of Electrical/Electronic Systems	F-1 Identify and explain the theory and use of hydraulic/pneumatic systems	F-2 Apply purpose and use of valves in a hydraulic/pneumatic system	F-3 Identify, assemble, measure, and apply knowledge of operating pneumatic actuators	F-4 Apply hydraulic/pneumatic systems knowledge to test, troubleshoot, and repair pneumatic systems/devices	F-5 Identify, assemble, measure, and apply knowledge of operating pneumatic actuators	F-6 Identify, assemble, measure, and apply knowledge of operating pneumatic actuators	F-7 Identify, assemble, measure, and apply knowledge of operating pneumatic actuators	F-8 Identify, assemble, measure, and apply knowledge of operating pneumatic actuators	F-9 Identify, assemble, measure, and apply knowledge of operating pneumatic actuators	F-10 Identify, assemble, measure, and apply knowledge of operating pneumatic actuators	F-11 Identify, assemble, measure, and apply knowledge of operating pneumatic actuators	F-12 Identify, assemble, measure, and apply knowledge of operating pneumatic actuators	F-13 Identify, assemble, measure, and apply knowledge of operating pneumatic actuators
<b>F</b> Measure/Isolate Malfunctions of Pneumatic/Fluid Power Systems	G-1 Perform calculations in digital numbering systems	G-2 Perform calculations in digital numbering systems	G-3 Solve digital ladder diagrams in programmable logic control circuits	G-4 Program and troubleshoot industrial equipment	G-5 Identify, assemble, measure, and apply knowledge of operating pneumatic actuators	G-6 Identify, assemble, measure, and apply knowledge of operating pneumatic actuators	G-7 Identify, assemble, measure, and apply knowledge of operating pneumatic actuators	G-8 Identify, assemble, measure, and apply knowledge of operating pneumatic actuators	G-9 Identify, assemble, measure, and apply knowledge of operating pneumatic actuators	G-10 Identify, assemble, measure, and apply knowledge of operating pneumatic actuators	G-11 Identify, assemble, measure, and apply knowledge of operating pneumatic actuators	G-12 Identify, assemble, measure, and apply knowledge of operating pneumatic actuators	G-13 Identify, assemble, measure, and apply knowledge of operating pneumatic actuators
<b>G</b> Apply Computer Science to Computer Controlled Equipment	H-1 Perform operations on PLC (programmable logic controller) equipment	H-2 Perform operations on PLC (programmable logic controller) equipment	H-3 Perform operations on PLC (programmable logic controller) equipment	H-4 Perform operations on PLC (programmable logic controller) equipment	H-5 Perform operations on PLC (programmable logic controller) equipment	H-6 Perform operations on PLC (programmable logic controller) equipment	H-7 Perform operations on PLC (programmable logic controller) equipment	H-8 Perform operations on PLC (programmable logic controller) equipment	H-9 Perform operations on PLC (programmable logic controller) equipment	H-10 Perform operations on PLC (programmable logic controller) equipment	H-11 Perform operations on PLC (programmable logic controller) equipment	H-12 Perform operations on PLC (programmable logic controller) equipment	H-13 Perform operations on PLC (programmable logic controller) equipment
<b>H</b> Correct Malfunctions in PLC Controlled Equipment	I-1 Resolve malfunctions found in systems controlling manufacturing processes	I-2 Resolve malfunctions found in systems controlling manufacturing processes	I-3 Resolve malfunctions found in systems controlling manufacturing processes	I-4 Resolve malfunctions found in systems controlling manufacturing processes	I-5 Resolve malfunctions found in systems controlling manufacturing processes	I-6 Resolve malfunctions found in systems controlling manufacturing processes	I-7 Resolve malfunctions found in systems controlling manufacturing processes	I-8 Resolve malfunctions found in systems controlling manufacturing processes	I-9 Resolve malfunctions found in systems controlling manufacturing processes	I-10 Resolve malfunctions found in systems controlling manufacturing processes	I-11 Resolve malfunctions found in systems controlling manufacturing processes	I-12 Resolve malfunctions found in systems controlling manufacturing processes	I-13 Resolve malfunctions found in systems controlling manufacturing processes
<b>I</b> Resolve Malfunctions Found in Systems Controlling Manufacturing Processes	J-1 Assemble/disassemble electrical/electronic, and computer systems	J-2 Assemble/disassemble, adjust, and troubleshoot fluid power systems	J-3 Assemble/disassemble, adjust, and troubleshoot pneumatic systems	J-4 Assemble/disassemble, adjust, and troubleshoot pneumatic systems	J-5 Assemble/disassemble, adjust, and troubleshoot pneumatic systems	J-6 Assemble/disassemble, adjust, and troubleshoot pneumatic systems	J-7 Assemble/disassemble, adjust, and troubleshoot pneumatic systems	J-8 Assemble/disassemble, adjust, and troubleshoot pneumatic systems	J-9 Assemble/disassemble, adjust, and troubleshoot pneumatic systems	J-10 Assemble/disassemble, adjust, and troubleshoot pneumatic systems	J-11 Assemble/disassemble, adjust, and troubleshoot pneumatic systems	J-12 Assemble/disassemble, adjust, and troubleshoot pneumatic systems	J-13 Assemble/disassemble, adjust, and troubleshoot pneumatic systems
<b>J</b> Assemble/Disassemble Electrical/Electronic, and Computer Systems													

**AET-C1-HO-1**  
**Apply Machine Tool Metrology and Measurement Instruments**  
**to Align Machine Tools**

**Attachment 1: MASTER Handout No. 1**

---

**Objective(s):**

Upon completion of this unit the student will be able to use conventional mechanical measuring instruments and apply modern mechanical metrology procedures to:

- a. Measure with steel rules (metric and inch);
- b. Measure with comparison measuring instruments (e.g., calipers, telescope gages);
- c. Measure with direct measuring instruments (e.g., vernier, dial and digital instruments);
- d. Measure with fixed gages (go and no-go gages);
- e. Use a dial indicator, to accurately measure run out, squareness, position, and distance on a machine tool;
- f. Use a outside micrometer, to accurately measure features of a part such as thickness and diameter, and test the accuracy of the micrometer with gauge blocks;
- g. Use an inside micrometer, to accurately measure distance, and circularity of the features of parts found on a machine tool;
- h. Use a height gauge, to accurately measure the height of a part and the distance traveled by a vertical machine slide;
- i. Use a dial or vernier caliper, to accurately measure dimensions and distances;
- j. Use a sine bar to accurately measure angles;
- k. Use a machining straight edge, to employ procedures such as the Straight Edge Reversal method to the measurement of squareness of a machine slide;
- l. Use a tooling ball, to employ methods, such as the Donaldson Reversal method to accurately measure the run out of a spindle;
- m. Use step gauges, to measure the accuracy of a machine slide; and,
- n. Use electronic dial indicators and ball-bars to test accuracy of a CNC machine.

---

**Module Outline:**

- I. Discuss the Importance of Learning and Practicing Proper Measurement Techniques
  - A. Show the video "Measuring Tools"
  - B. Give each student a copy of the handout "Proper Measuring Techniques"

- II. Discuss and Demonstrate Proper Measurement Techniques Using the Steel Rule
- III. Discuss and Demonstrate the Use of Micrometer Type Measuring Instruments
  - A. Outside micrometers
  - B. Inside micrometers
  - C. Depth micrometers
  - D. Practice and demonstration of skills listed above
- IV. Discuss and Demonstrate the Use of Transfer Type Measuring Instruments
  - A. Spring calipers (inside and outside)
  - B. Telescope gages
  - C. Small hole gages
  - D. Practice and demonstration of skills listed above
- V. Discuss and Demonstrate the Use of Direct Measuring Instruments
  - A. Vernier calipers
  - B. Dial calipers
  - C. Digital calipers
  - D. Practice and demonstration of skills listed above
- VI. Discuss the Purpose of Fixed Gages and Demonstrate Their Use
  - A. Cylindrical plug and ring gages
  - B. Taper plug and ring gages
  - C. Snap gages
  - D. Thread plug gages
  - E. Practice and demonstration of skills listed above
- VII. Complete Practical Exercises (AET-C1-LE1) and (AET-C1-LE2) On All the Above Material
- VIII. Apply Modern Mechanical Metrology Procedures
  - A. Identify, demonstrate, and/or explain the use of the following mechanical metrology instruments.
    - 1. Machining straight edge
    - 2. Machining square
    - 3. Machining step gauge
    - 4. Tooling balls
    - 5. LVDT dial indicators (electronic dial indicators)
    - 6. Ball-bar
    - 7. Laser interferometer
  - B. Demonstrate and explain the degrees of freedom for a machine tool axis (MASTER Handout AET-C1-HO-2: Degrees of Freedom for Machine Tool Axis)
  - C. Demonstrate and/or explain the following procedures:
    - 1. Testing irregularities of machine slides (MASTER Handout AET-C1-HO-4: Electronic Dial Indicator Methods for Testing the Pitch and Roll of Machine Slides)
    - 2. Testing the accuracy of a machine slide using step gauges

3. Testing the alignment of a machine slide (MASTER Handout AET-C1-HO-3: The Straight Edge Reversal Method for Testing the Alignment of a Machine Slide)
4. Testing the run out of a machine spindle(MASTER Handout AET-C1-HO-5: The Donaldson Reversal Method for Testing the Run out of a Machine Spindle)
5. Overall tests for determining the accuracy of 3,4, and 5 axis CNC machine tools (MASTER Handout AET-C1-HO-6: Using a Ball-Bar to Test the Accuracy of a Machine Tool)
6. Using a laser interferometer to test machine tools (MASTER Handout AET-C1-HO-7: Using a Laser Interferometer to Check Accuracy and Alignment of Machine Tools)

**AET-C1-HO-2**  
**Apply Machine Tool Metrology and Measurement Instruments**  
**to Align Machine Tools**  
Attachment 2: MASTER Handout No. 2

---

**Degrees of Freedom for Machine Tool Axis**

**Six Degrees of Freedom of a Positioner**

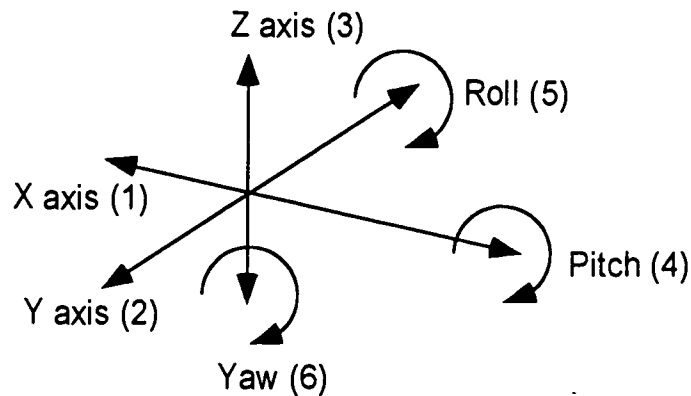

When performing metrology on a positioner, the effects of the Z axis (height) pitch, roll, and yaw, cannot be ignored. Pitch, roll and yaw are angular motions around the primary axis of motion; x, y, and z. Any of these factors can cause the image focus of the mask to fail to resolve to the required sharpness or orientation. Worse, the image could be blurred at the edges and in focus at the center. Laser interferometers have reflectors that are designed to detect angular motion on a linear axis of motion. By properly using these types of reflectors, the technician can detect any tendency of the axis to move in these angular dimensions. What is little understood when performing metrology at the millionth of an inch level, is that objects that may seem to be perfectly rigid, act like rubber at these resolutions.

AET-C1-HO-7  
Apply Machine Tool Metrology and Measurement Instruments  
to Align Machine Tools  
Attachment 7: MASTER Handout No. 7

---

**Using a Laser Interferometer to Check Accuracy  
and Alignment of Machine Tools**

**Laser Interferometer**

The advent of integrated circuits with feature sizes that are less than 1 micron in width has led to the need for measuring instruments that can perform measurements in millionths of an inch. To gain a perspective of the relative sizes, a feature that is 1 micron in width is .000039 inches or 39 *millionths* of an inch. A rule of thumb of position accuracy is that the mask positioner that aligns the mask to the wafer must be at least ten times more accurate than the required tolerance of the part. Therefore, the positioner must be able to resolve to 3.9 millionths of an inch, or at least .1 micron. In practice, positioners of this caliber are usually accurate to 1 millionth of an inch or better.

The science of measurement is called **Metrology** (do not confuse this one with the science of weather, or *Meteorology*). When performing Metrology on a positioner, measuring instruments that can measure tolerances to .1 micron or better are necessary. One such instrument is the laser interferometer. The laser interferometer is a device that measures distance by using the *interference of wave lengths of light* that strike a reflective surface and are bounced back to the sending source. Light is an electromagnetic wave pattern that is essentially the same as the microwave energy that cooks the food in your microwave oven. The difference between light energy and the energy in your microwave oven is that light energy has a higher frequency than the microwave energy. Ordinarily, common light from the sun is composed of many different frequencies of light. If a beam of light energy can be created that is composed of only one frequency, that beam can be used to resolve distances to very fine increments by comparing the time that it takes for the beam to leave a sending source, and the time it takes to be reflected back to the sending source. Fortunately, we have invented a device that can produce light of only one frequency, or *coherent light*. That device is the laser.

Using the laser as a source of coherent light and an optically perfect reflecting object, we can reflect a laser beam back to the sending source and compare the difference in time, which is a function of distance. An electromagnetic wave of red light is about  $5 \times 10^{-7}$  meters long, or .5 microns (19.5 millionths of an inch) if we can resolve this wave down to one thousand parts, we can measure distances as small as .005 microns (.0195 millionths of an inch). In practice, most industrial laser interferometers resolve

distances to .000001 inches or 1 millionth of an inch, and this is adequate for a positioner that must move a minimum of 3.9 millionths of an inch.

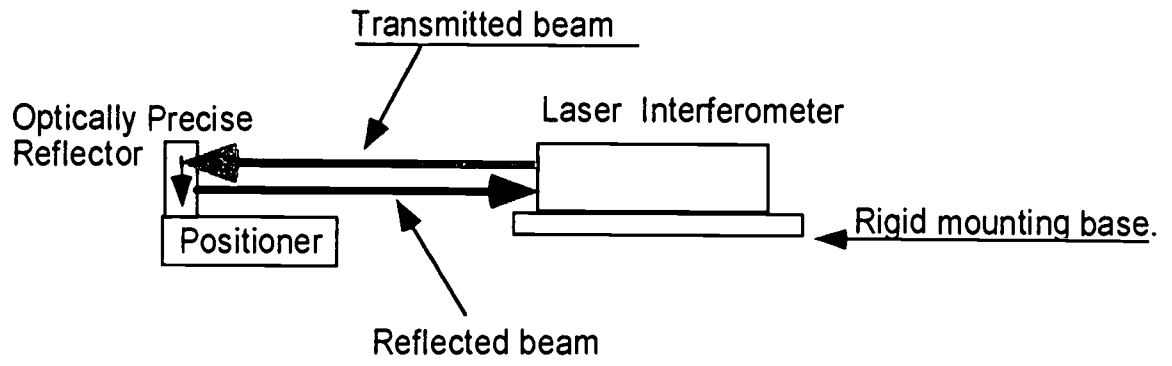

A typical laser interferometer setup will consist of a laser source and an optically precise reflector. The laser is set on a rigid mount and the reflector is mounted on the positioner. One of the tasks of the technician, is to align the laser and reflector such that the beam is accurately reflected back to the laser. This can be a time consuming process if the positioner and the laser are not set up properly. If the laser is mounted at a angle to the positioner and the reflector, the beam will not track properly as the positioner is moved, and the measurement will be lost. Initial setup requires that the devices should be mechanically aligned as closely as possible, and then a minimum of fine tuning of the setup will be necessary. Fortunately, most laser interferometers can tolerate moderate amounts of misalignment during the measuring process and still function properly because the reflector is designed to precisely reflect the beam back to the sending source. Care should be exercised in the handling of the reflector and the laser. If the reflector is dropped, the optics may be mis-aligned or damaged, resulting in inaccurate measurements or a ruined reflector.

Although usually a low energy device, the laser is a source of coherent light energy and can damage the eyes of people who are working nearby. Reflections of the laser beam from nearby reflective objects are equally as hazardous. *Do not point the beam at people and reflective objects.*

When performing metrology on a positioner, the effects of the Z axis (height): pitch, roll, and yaw, cannot be ignored. Pitch, roll and yaw are angular motions around the primary axis of motion; x, y, and z. Any of these factors can cause the image focus of the mask to fail to resolve to the required sharpness or orientation. Worse, the image could be blurred at the edges and in focus at the center. Laser interferometers have reflectors that are designed to detect angular motion on a linear axis of motion. By properly using these types of reflectors, the technician can detect any tendency of the axis to move in these angular dimensions. What is little understood when performing metrology at the millionth of an inch level, is that objects that may seem to be perfectly rigid, act like rubber at these resolutions.



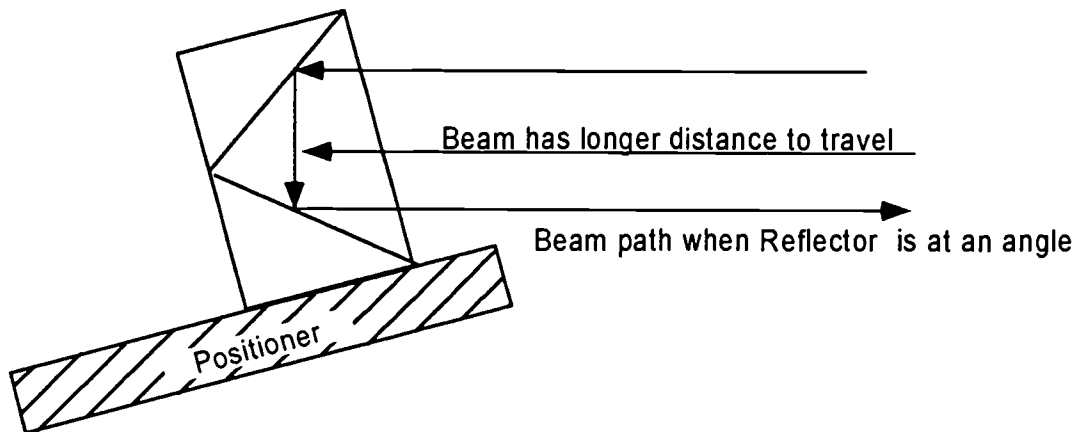
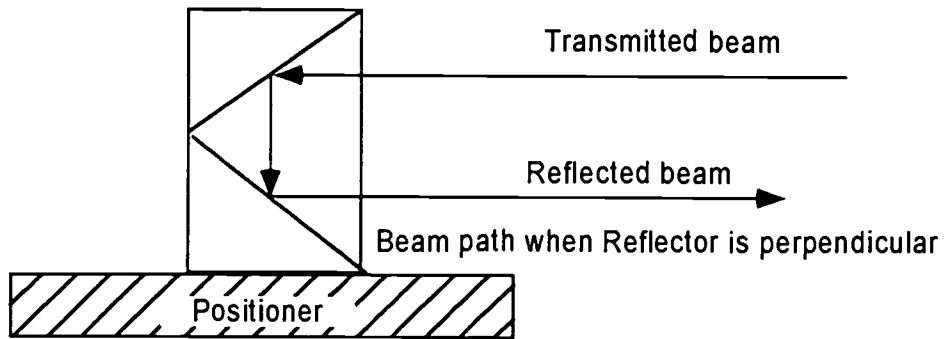
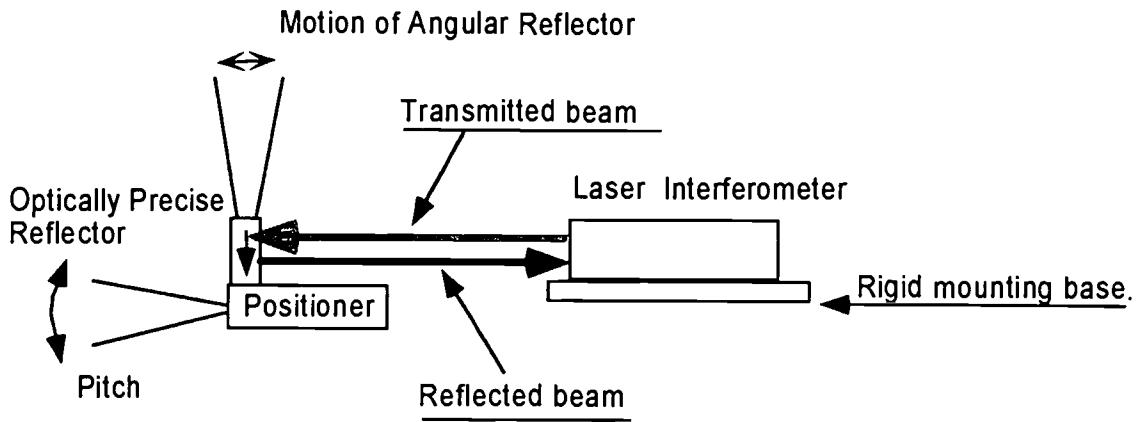

Name: \_\_\_\_\_

Date: \_\_\_\_\_

**AET-C1-LE1**  
**Apply Machine Tool Metrology and Measurement Instruments**  
**to Align Machine Tools**  
**Attachment 8: MASTER Laboratory Exercise No. 1**

---

1. What is the reading on the vernier caliper below?
- a. .642
  - b. 1.642
  - c. 1.645
  - d. 1.64

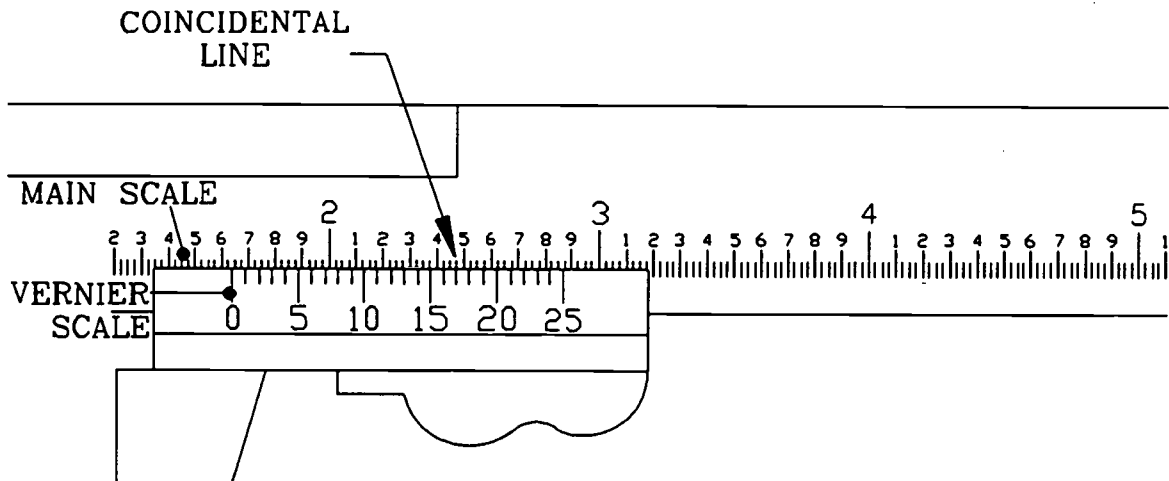

2. What is the reading on the vernier caliper below?
- a. .415
  - b. 3.125
  - c. 3.405
  - d. 3.412

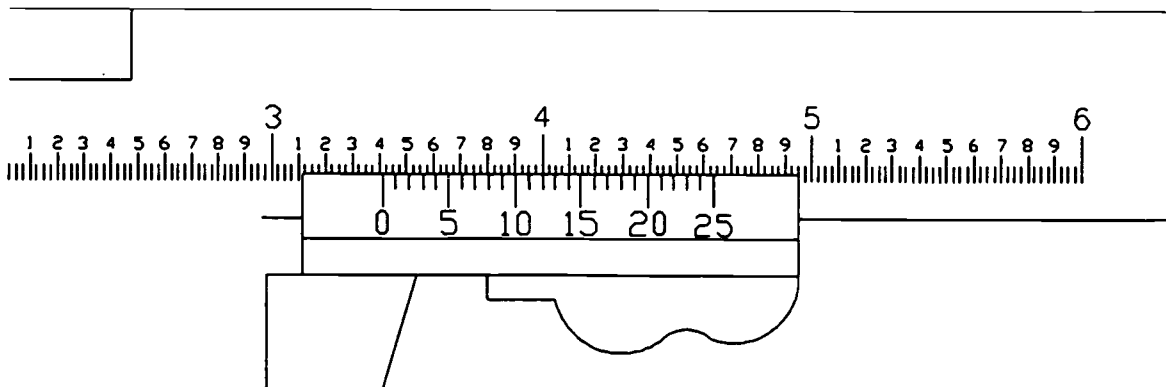

3. What is the reading on the vernier caliper below?
- a. 4.575
  - b. 4.250
  - c. 4.570
  - d. 4.275

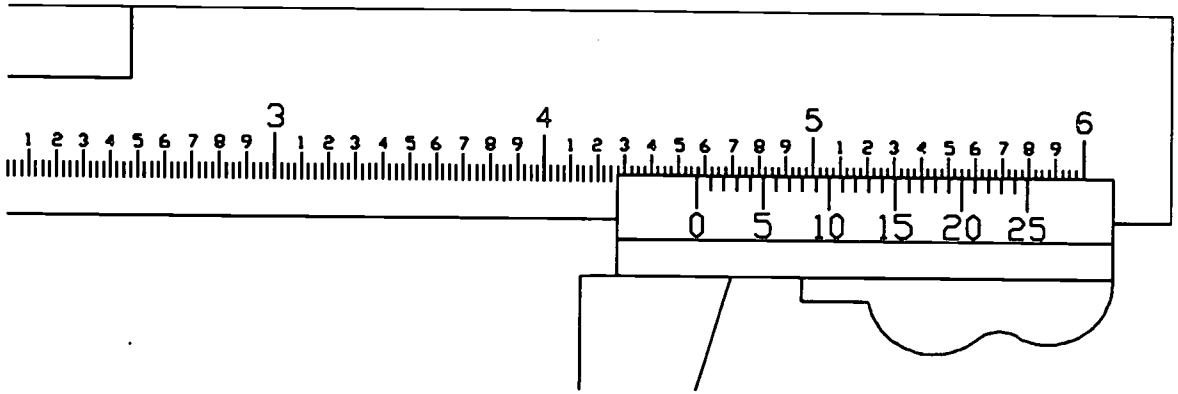

4. What is the reading on this vernier caliper?
- a. 3.785
  - b. 3.800
  - c. 3.473
  - d. 3.793

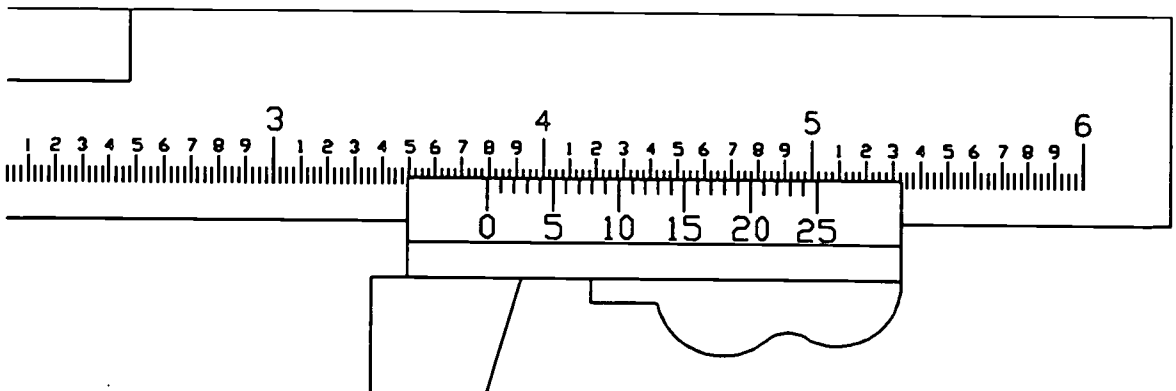

Name \_\_\_\_\_

Date \_\_\_\_\_

**AET-C1-LE2**  
**Apply Machine Tool Metrology and Measurement Instruments**  
**to Align Machine Tools**  
**Attachment 9: MASTER Laboratory Exercise No. 2**

---

Using the measuring instruments provided for you and the measuring specimens, measure for the following dimensions and record your answers in the space provided. Be sure to provide metric and inch answers for each dimension. Turn this sheet in to your instructor for evaluation.

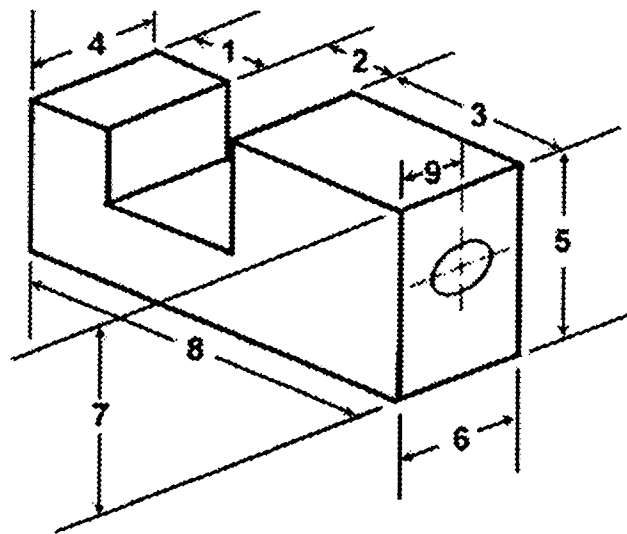

**Specimen Number** \_\_\_\_\_

Dimension	metric	inch	Dimension	metric	inch
1.	_____	_____	7.	_____	_____
2.	_____	_____	8.	_____	_____
3.	_____	_____	9.	_____	_____
4.	_____	_____	10.	_____	_____
5.	_____	_____	11.	_____	_____
6.	_____	_____			

AET-C1-LA-1  
**Apply Machine Tool Metrology and Measurement Instruments  
to Align Machine Tools**  
Attachment 10: MASTER Laboratory Aid

---

**Rules of Conduct**

1. Absolutely no horseplay or practical joking will be tolerated.
2. Do not talk to anyone who is operating a machine.
3. Walk only in the designated traffic lanes.
4. Dress appropriately; at the absolute minimum, you must have:
  - a. No loose clothing, including ties;
  - b. Long hair properly stowed;
  - c. No jewelry;
  - d. Hard, closed-toe shoes;
  - e. Eye protection (safety glasses); and,
  - f. Ear protection (plugs or headset).
5. Follow all institutional safety rules.

**AET-C2-HO**  
**Apply Electrical Measurement Knowledge and Instruments**  
**to Test/Calibrate Electrical Circuits**  
**Attachment 1: MASTER Handout**

---

**Objective(s):**

Upon completion of this unit the student will be able to:

- a. Properly connect a multimeter, ammeter, or clamp-on ammeter to a circuit; and use the instrument to safely measure DC current, RMS current, and Average current in a DC or AC circuit;
- b. Properly connect a multimeter, voltmeter, or clamp-on voltmeter to a circuit, and use the instrument to safely measure DC voltage, RMS voltage, and average voltage in a DC or AC circuit;
- c. Properly connect a multimeter or ohmmeter to a circuit and use the instrument to safely measure resistance in any circuit;
- d. Properly connect power factor meters to power distribution systems, and safely measure power factor;
- e. Properly connect phase meters to safely test phase rotation and phase angle; and,
- f. Safely test inductance and capacitance.

---

**Module Outline:**

- I. Use Electrical Measuring Instruments
  - A. Demonstrate the procedure for safely measuring, current, voltage and resistance in DC circuits
    1. Explain the operation of digital multimeters
    2. Demonstrate the procedure for measuring DC voltage, DC current, and resistance
    3. Demonstrate the measurement of DC voltage, DC current and resistance on a representative machine control
  - B. Demonstrate the measurement of capacitive and inductive components
    1. Provide examples of occasions in which it may be necessary to measure capacitance and inductance
    2. Explain the operation of a capacitance and inductance test meter
    3. Demonstrate the procedure for measuring capacitance and inductance
    4. Demonstrate safety procedures for capacitive and inductive tests
    5. Demonstrate tests for capacitance on a DC power supply in a machine control system
    6. Demonstrate the measurement of inductance on an AC inductive motor

- C. Demonstrate the procedures for safe measurement of single phase resistive AC currents voltages and resistance
  - 1. Demonstrate the use of multimeters and clamp-on ammeters in measuring AC voltage, AC current, and resistance
  - 2. Demonstrate the safety procedures and methods for performing voltage, current, and resistive tests on an AC power distribution system
- D. Demonstrate the measurement of voltage, current, and power in poly-phase AC systems
  - 1. Explain the purpose and use of; phase rotation meters, phase angle meters, and power factor meters
  - 2. Demonstrate the use of the above meters by performing tests on poly-phase AC power distribution systems

**AET-C2-LE**  
**Apply Electrical Measurement Knowledge and Instruments**  
**to Test/Calibrate Electrical Circuits**  
**Attachment 2: MASTER Laboratory Exercise**

---

The student will Use all of the above instruments to perform a simulated preventative maintenance procedure on a machine tool.



**AET-C2-LA**  
**Apply Electrical Measurement Knowledge and Instruments**  
**to Test/Calibrate Electrical Circuits**  
**Attachment 3: MASTER Laboratory Aid**

---

**Rules of Conduct**

1. Absolutely no horseplay or practical joking will be tolerated.
2. Do not talk to anyone who is operating a machine.
3. Walk only in the designated traffic lanes.
4. Dress appropriately; at the absolute minimum, you must have:
  - a. No loose clothing, including ties;
  - b. Long hair properly stowed;
  - c. No jewelry;
  - d. Hard, closed-toe shoes;
  - e. Eye protection (safety glasses); and,
  - f. Ear protection (plugs or headset).
5. Follow all institutional safety rules.

**AET-C3-HO-1**  
**Apply Electronic Measurement Knowledge and Instruments**  
**to Test/Calibrate Electronic Circuits**  
**Attachment 1: MASTER Handout No. 1**

---

**Objective(s):**

Upon completion of this unit the student will be able to:

- a. Use function generators to test/calibrate circuits;
  - b. Use oscilloscopes to test/calibrate circuits;
  - c. Adjust the frequency, amplitude and proper decibel level of a function generator and use the instrument to test electronic and electrical equipment; and,
  - d. Properly set up an oscilloscope for calibrated measurements, and use the instrument to measure frequency, time, degrees of phase shift, DC voltages, voltage peak, and voltage peak-to-peak.
- 

**Module Outline:**

- I. Use Function Generators to Test/Calibrate Circuits
  - A. Identify and explain the purpose of the controls on a function generator
    1. Frequency range and variable frequency control
    2. Wave form selection control
    3. Amplitude control
    4. DC offset control
    5. Decibel (dB) switches (MASTER Handout AET-C3-HO-2)  
(Decibels and Logarithms)
  - B. Explain the safety procedures and grounding problems associated with the use of function generators
    1. Explain the concept of "ground loops" and the relationship of the common connection point of the function generator to the common connection point of the circuit under test
    2. Explain the expected behavior of servo systems when subjected to signal injection and the safety procedures that must be followed
  - C. Demonstrate the use of the function generator for signal injection into a servo amplifier of a robot or CNC machine
    1. Explain the purpose of the test for each wave form
    2. Explain the expected outcome of the test
- II. Use Oscilloscopes to Test/Calibrate Circuits
  - A. Identify and explain the purpose of the controls on an oscilloscope
    1. Beam trace intensity and alignment
    2. Selecting dual or single channel

3. Selecting alternate or chop frequency and the advantages/disadvantages of both
  4. Time base range and variable time base
  5. Vertical deflection range and variable vertical deflection
  6. Triggering controls, internal and external triggering, selecting a triggering source
  7. Auto/manual triggering
- B. Explain the proper procedures for setting up the scope for calibrated measurements
- C. Explain the safety procedures and grounding problems associated with the use of an oscilloscope
1. Explain the concept of "ground loops" and the relationship of the common connection point of the oscilloscope to the common connection point of the circuit under test
  2. Explain the expected behavior of electronic systems when subjected to testing by the oscilloscope and the safety procedures that must be followed
- D. Demonstrate the use of the oscilloscope in conjunction with the function generator for signal injection into a servo amplifier of a robot or CNC machine
1. Explain the purpose of the test for each wave form
  2. Explain the expected outcome of the test
- E. Demonstrate the methods used to convert horizontal time on an oscilloscope to degrees of rotation of a sine wave, or a phase shift in complex inductive/capacitive circuits

**AET-C3-HO-2**  
**Apply Electronic Measurement Knowledge and Instruments**  
**to Test/Calibrate Electronic Circuits**  
**Attachment 2: MASTER Handout No. 2**

---

**Decibels and Logarithms**

This is not the name of a big band, but it's a possibility. Decibels are a scaling system based on powers of ten. Decibels reflect a "figure of merit" describing voltages, current, or power over resistance or area. It can be applied to amplifiers, sensitivity of receivers, or the power of the sound in an industrial plant. It is simply a scale in powers of ten. For example, a function generator will add or subtract 20 decibels to a wave form if you turn the right switch.

Scales built using the decibel system have different ZERO POINTS. A decibel scale can have ANY point defined as "zero decibels" and the measuring method of the scale will be consistent starting with that base number. Audible sound, for example, uses as a zero decibel point, a value equivalent to "sound barely audible by the average human ear". This value is an intensity of  $10^{-12}$  Watts/meter<sup>2</sup>.

Starting with that number, every time the intensity of sound increases by one power of ten, ( $10^1$ ) we add **TEN decibels** to our value. So the *power/area* is actually:

**THE ZERO-DECIBELS VALUE multiplied by 10 raised to the power of (.1 times the number of decibels).**

For example:

If X is the zero value then:

+ 20 decibels is  $X \cdot 10^{2.0}$

or

100X

Notice you can have decimals in the power of ten exponent:

For example  $10^{2.5} = 316.227$ , which is the multiplier for **25 decibels**.

For example, leaves rustling in the autumn breeze in the parking lot would have a sound intensity of about 10 decibels.

This means the intensity or power of that sound in Watts/m<sup>2</sup> would be:

$10^{-12}$  Watts per meter<sup>2</sup> times 10 to the first power

This equals  $10^{-12} \cdot 10^{1.0}$  or  $10^{-11}$  or .01 Nanowatts/meter<sup>2</sup>. As you can imagine this is **not** a lot of power per square meter.

If we compare it to an ordinary conversation such as often occurs in the middle of lectures, we are comparing 10 decibels to 60 decibels.

This equals the “0 decibels” figure times 10 to the 6.0 power

or

$$1 \times 10^{-12} \times 1 \times 10^{6.0} = 1 \text{ microwatt/m}^2$$

Compared to this zero point, other decibel values of audible sound are:

Sound	Decibels	Calculation	Watts/m <sup>2</sup>
A lover whispering from 1 yard away	20	$1 \times 10^{-12} \times 1 \times 10^{2.0}$	.1 nanowatts
Standing at Market and 1st Ave.	40	$1 \times 10^{-12} \times 1 \times 10^{4.0}$	10 nanowatts
Conversation with the instructor on break	60	$1 \times 10^{-12} \times 1 \times 10^{6.0}$	10 microwatts
Conversation with Rohr Industries	85	$1 \times 10^{-12} \times 1 \times 10^{8.5}$	316.227 u watts
Niagra Falls from the little tour boat	90	$1 \times 10^{-12} \times 1 \times 10^{9.0}$	1 milliwatt
Loud rock band	110	$1 \times 10^{-12} \times 1 \times 10^{11.0}$	612.01 milliwatt
Sound painful to the ear	120	$1 \times 10^{-12} \times 1 \times 10^{12.0}$	1 watt

If you use decibels to measure some electronic value as in the gain delivered by a stereo amplifier, you will get totally different values depending on where the ZERO VALUE is. What is important to notice is that the decibel scale is not *linear* (each decibel adds a fixed amount) but *LOGARITHMIC* (each decibel adds a certain amount to the EXPONENT of 10). It increases exponentially.

A LOGARITHM is “*the number to which a base is raised to give another number*”. Logarithmic scales increase by powers rather than by fixed amounts. If you are using base 10, which is common, the logarithm of 100 is 2 (you raise 10 to the 2d power to get 100). The logarithm of 1000 is 3 (you raise 10 to the 3d power to get 1000) and the logarithm of 721.11 is *somewhere in between*. You can find out quickly if you have a calculator with a log key. For example, the number 721.11:

Using the calculator, the power of ten exponent for 721.11 is 2.858001518.

In other words ten raised to the 2.858001518 power will give you 721.11.

Logarithms are exponents, and can be mathematically manipulated like exponents which makes it easy to mathematically calculate very large and very small numbers.

The controls on the front panel of a function generator include decibel switches. Using a function generator, and switching the 10 db or 20 db switch on the unit, means that you are multiplying or dividing the current value of the generators output by 10 or 100.

The +10 db switch will multiply the output by 10, and the -10 db switch will divide the output by 10; or the -20 db switch will divide the output by 100, and turning it off will restore the output to its previous value.

**AET-C3-LE**  
**Apply Electronic Measurement Knowledge and Instruments**  
**to Test/Calibrate Electronic Circuits**  
**Attachment 3: MASTER Laboratory Exercise**

---

The student will:

1. Use a function generator and an oscilloscope to inject and monitor a wave form in the servo amplifier of a CNC machine or robot; and,
2. Use the oscilloscope to monitor a wave form injected by a function generator in the servo amplifier of a CNC machine.

**AET-C3-LA**  
**Apply Electronic Measurement Knowledge and Instruments**  
**to Test/Calibrate Electronic Circuits**  
**Attachment 4: MASTER Laboratory Aid**

---

**Rules of Conduct**

1. Absolutely no horseplay or practical joking will be tolerated.
2. Do not talk to anyone who is operating a machine.
3. Walk only in the designated traffic lanes.
4. Dress appropriately; at the absolute minimum, you must have:
  - a. No loose clothing, including ties;
  - b. Long hair properly stowed;
  - c. No jewelry;
  - d. Hard, closed-toe shoes;
  - e. Eye protection (safety glasses); and,
  - f. Ear protection (plugs or headset).
5. Follow all institutional safety rules.



## AET-C4-HO-1

### Apply Fluid Power Measurement and Instruments to Test/Calibrate Hydraulic and Pneumatic Systems Attachment 1: MASTER Handout No. 1

---

#### Objective(s):

Upon completion of this unit the student will be able to:

- a. Use flow meters and pressure gauges to test/calibrate hydraulic and pneumatic circuits;
  - b. Use test apparatus to test/calibrate pressure control valves and hydraulic and pneumatic pumping systems;
  - c. Use a hydraulic flow meter, properly connect the meter, and measure flow in quantities such as Gallons per Minute (GPM) or Liters per Minute (LPM) in a hydraulic system;
  - d. Use a pneumatic flow meter, properly connect the meter and measure flow in quantities such as Standard Cubic Feet per Minute (SCFM), Standard Cubic Feet per Hour (SCFH), or Liters per Minute (LPM);
  - e. Properly install the correct gauge, and measure pressures in both the English Engineering and SI systems of measurement for both hydraulic and pneumatic systems; and,
  - f. Use a hydraulic or pneumatic test unit to measure temperature, flow , pressure, the cracking pressure on hydraulic or pneumatic pressure control valves, and the efficiency of a hydraulic or pneumatic pumping system.
- 

#### Module Outline:

- I. Use Flow Meters and Pressure Gauges to Test/Calibrate Hydraulic and Pneumatic Circuits
  - A. Explain the various type of gauges available and their usefulness in testing flows and pressure
  - B. Demonstrate the various methods of connecting a flow meter, or pressure gauge to a hydraulic or pneumatic system
  - C. Demonstrate the proper methods for using the above gauges to test/calibrate hydraulic or pneumatic systems
- II. Use Test Apparatus to Test/Calibrate Pressure Control Valves and Hydraulic and Pneumatic Pumping Systems
  - A. Demonstrate the connection of a flow meter, pressure gage, flow control valve, and temperature gage to serve as a test apparatus
  - B. Demonstrate the proper methods for using the above setup to test hydraulic or pneumatic pressure control valves or pumping systems
  - C. Identify the correct points at which a test port should be installed in the system to allow the measurements

- D. Explain the methods by which the effectiveness and calibration of a fluid power can be measured

**AET-C4-LE-1**

**Apply Fluid Power Measurement and Instruments  
to Test/Calibrate Hydraulic and Pneumatic Systems**  
Attachment 3: MASTER Laboratory Exercise No. 1

---

The student shall:

1. Connect flow and pressure gauges to a hydraulic and pneumatic system; read pressures and flows; and,
2. Connect a test apparatus to a hydraulic and pneumatic system; test pressure control valves, and pumping systems.

**Apply Fluid Power Measurement and Instruments  
to Test/Calibrate Hydraulic and Pneumatic Systems**  
Attachment 5: MASTER Laboratory Aid

---

**Rules of Conduct**

1. Absolutely no horseplay or practical joking will be tolerated.
2. Do not talk to anyone who is operating a machine.
3. Walk only in the designated traffic lanes.
4. Dress appropriately; at the absolute minimum, you must have:
  - a. No loose clothing, including ties;
  - b. Long hair properly stowed;
  - c. No jewelry;
  - d. Hard, closed-toe shoes;
  - e. Eye protection (safety glasses); and,
  - f. Ear protection (plugs or headset).
5. Follow all institutional safety rules.

**AET-C5-HO-1**  
**Use Calibrated Measuring Instruments**  
**to Test/Calibrate Components**  
**Attachment 1: MASTER Handout No. 1**

---

**Objective(s):**

Upon completion of this unit the student will be able to:

- a. Use digital logic probes and digital logic analyzers to test digital circuits;
- b. Use a computer to simulate and troubleshoot digital logic circuits;
- c. Use an oscilloscope, to measure the properties of digital wave forms such as pulse time, rise and fall times, propagation delay times, and voltage levels;
- d. Use a function generator, to adjust the instrument to produce wave forms that are of the proper amplitude, frequency, and form to test various digital circuits;
- e. Use a digital logic analyzer, to set up tests to determine the functionality of a digital printed circuit board or complex integrated circuit such as an Application Specific Integrated Circuit (ASIC); and,
- f. Use a computer, to set up a simulation of the operation of a digital circuit to facilitate the troubleshooting of the circuit.

---

**Module Outline:**

- I. Use Logic Probes and Digital Logic Analyzers to Test Digital Circuits
  - A. Explain the criteria by which a digital signal is measured
  - B. Demonstrate the use and limitations of a logic probe in measuring a digital logic signal
  - C. Explain the concept of ground loops and measuring reference points
  - D. Demonstrate the use of an oscilloscope in measuring a digital logic signal
  - E. Demonstrate the procedure for setting up a digital test using a digital logic analyzer (MASTER Handout AET-C5-HO-2) (Setting up a Test on a Digital System Using a Digital Logic Analyzer)
- II. Use a Computer to Simulate and Troubleshoot a Digital Logic Circuit
  - A. Identify computer-based modeling software such as Electronic Work Bench suitable for digital circuit modeling
    1. Explain the concept of computer modeling of digital circuits
    2. Describe the type of software that will be used
    3. Explain the procedure for starting the software
    4. Describe the procedures for constructing circuits, and features of the software

5. List some other software available to accomplish computer modeling of digital circuits and the computer requirements
- B. Demonstrate the procedures for constructing circuits and using the test modes of the software

**AET-C5-LE**  
**Use Calibrated Measuring Instruments**  
**to Test/Calibrate Components**  
**Attachment 3: MASTER Laboratory Exercise**

---

The students will:

1. Test the logical outputs of a microprocessor for a robot or CNC control system;
2. Create a test procedure for testing the microprocessor on a CNC or robotic control system; and,
3. Model a digital circuit from a schematic diagram for one of the sub-sections of a CNC or robot control system.

**AET-C5-LA**  
**Use Calibrated Measuring Instruments**  
**to Test/Calibrate Components**  
**Attachment 4: MASTER Laboratory Aid**

---

**Rules of Conduct**

1. Absolutely no horseplay or practical joking will be tolerated.
2. Do not talk to anyone who is operating a machine.
3. Walk only in the designated traffic lanes.
4. Dress appropriately; at the absolute minimum, you must have:
  - a. No loose clothing, including ties;
  - b. Long hair properly stowed;
  - c. No jewelry;
  - d. Hard, closed-toe shoes;
  - e. Eye protection (safety glasses); and,
  - f. Ear protection (plugs or headset).
5. Follow all institutional safety rules.



**AUTOMATED EQUIPMENT REPAIR TECHNICIAN ... operates, programs, maintains, and repairs automated machine tools and automated manufacturing processes.**

**Duties**

**Tasks**

Duties	A-1 Apply scientific notation and engineering notation to solve technical problems	A-2 Apply algebraic formulas to solve technical problems	A-3 Use variables in algebraic formulas to solve technical problems	A-4 Manipulate algebraic formulas in industrial systems	A-5 Measure, calculate, and convert quantities and metric (SI) systems of measurement	A-6 Use mechanical physics to analyze mechanical systems	A-7 Use mechanical physics to analyze mechanical systems	A-8 Use math and physics to analyze problems found in pneumatic systems	A-9 Use math and thermodynamics to analyze problems found in heat treating systems	A-10 Use math and physics of electromagnetism and optics to analyze mechanical systems	A-11 Use chemical principles and formulas to predict and analyze chemical industrial processes	A-12 Apply knowledge of electrochemical effects to analyze industrial processes	A-13 Apply principles of water treatment processes
<b>A</b> Apply Science to Solve Industrial Problems	B-1 Use symbols, organization, and values on mechanical drawings	B-2 Use symbols, organization, and values on electrical drawings	B-3 Use symbols, organization, and values on electronic drawings	B-4 Use symbols, organization, and values on power drawings	B-5 Use symbols, organization, and values on digital drawings	B-6 Use symbols, organization, and values on electronic measurements	B-7 Use symbols, organization, and values on mechanical measurements	B-8 Use symbols, organization, and values on pneumatic measurements	B-9 Use symbols, organization, and values on thermodynamic measurements	B-10 Use symbols, organization, and values on electromagnetic measurements	B-11 Use symbols, organization, and values on chemical measurements	B-12 Use symbols, organization, and values on electrochemical measurements	B-13 Use symbols, organization, and values on water treatment measurements
<b>B</b> Use Drawings to Analyze and Repair Systems	C-1 Apply mathematical formulas to solve technical problems	C-2 Apply mathematical formulas to solve technical problems	C-3 Apply mathematical formulas to solve technical problems	C-4 Apply mathematical formulas to solve technical problems	C-5 Apply mathematical formulas to solve technical problems	C-6 Apply mathematical formulas to solve technical problems	C-7 Apply mathematical formulas to solve technical problems	C-8 Apply mathematical formulas to solve technical problems	C-9 Apply mathematical formulas to solve technical problems	C-10 Apply mathematical formulas to solve technical problems	C-11 Apply mathematical formulas to solve technical problems	C-12 Apply mathematical formulas to solve technical problems	C-13 Apply mathematical formulas to solve technical problems
<b>C</b> Use Calibrated Instruments to Test/Calibrate Components	D-1 Apply the process to the resolution of malfunctions in industrial machine tools and automated equipment	D-2 Apply the process to the resolution of malfunctions in industrial machine tools and automated equipment	D-3 Apply the process to the resolution of malfunctions in industrial machine tools and automated equipment	D-4 Apply the process to the resolution of malfunctions in industrial machine tools and automated equipment	D-5 Apply the process to the resolution of malfunctions in industrial machine tools and automated equipment	D-6 Apply the process to the resolution of malfunctions in industrial machine tools and automated equipment	D-7 Apply the process to the resolution of malfunctions in industrial machine tools and automated equipment	D-8 Apply the process to the resolution of malfunctions in industrial machine tools and automated equipment	D-9 Apply the process to the resolution of malfunctions in industrial machine tools and automated equipment	D-10 Apply the process to the resolution of malfunctions in industrial machine tools and automated equipment	D-11 Apply the process to the resolution of malfunctions in industrial machine tools and automated equipment	D-12 Apply the process to the resolution of malfunctions in industrial machine tools and automated equipment	D-13 Apply the process to the resolution of malfunctions in industrial machine tools and automated equipment
<b>D</b> Resolve System Failures with Critical Thinking, Theory, and Metrology	E-1 Calculate, measure, and respond to quantities in DC circuits	E-2 Calculate, measure, and respond to quantities in AC circuits	E-3 Calculate, measure, and respond to quantities in AC circuits	E-4 Calculate, measure, and respond to quantities in AC circuits	E-5 Calculate, measure, and respond to quantities in AC circuits	E-6 Calculate, measure, and respond to quantities in AC circuits	E-7 Calculate, measure, and respond to quantities in AC circuits	E-8 Calculate, measure, and respond to quantities in AC circuits	E-9 Calculate, measure, and respond to quantities in AC circuits	E-10 Calculate, measure, and respond to quantities in AC circuits	E-11 Calculate, measure, and respond to quantities in AC circuits	E-12 Calculate, measure, and respond to quantities in AC circuits	E-13 Calculate, measure, and respond to quantities in AC circuits
<b>E</b> Use Techniques Malfunctions of Electrical/Electronic Systems	F-1 Identify and explain the theory and use of major systems such as hydraulic or pneumatic systems	F-2 Identify and explain the theory and use of major systems such as hydraulic or pneumatic systems	F-3 Identify and explain the theory and use of major systems such as hydraulic or pneumatic systems	F-4 Identify and explain the theory and use of major systems such as hydraulic or pneumatic systems	F-5 Identify and explain the theory and use of major systems such as hydraulic or pneumatic systems	F-6 Identify and explain the theory and use of major systems such as hydraulic or pneumatic systems	F-7 Identify and explain the theory and use of major systems such as hydraulic or pneumatic systems	F-8 Identify and explain the theory and use of major systems such as hydraulic or pneumatic systems	F-9 Identify and explain the theory and use of major systems such as hydraulic or pneumatic systems	F-10 Identify and explain the theory and use of major systems such as hydraulic or pneumatic systems	F-11 Identify and explain the theory and use of major systems such as hydraulic or pneumatic systems	F-12 Identify and explain the theory and use of major systems such as hydraulic or pneumatic systems	F-13 Identify and explain the theory and use of major systems such as hydraulic or pneumatic systems
<b>F</b> Measure/Isolate Malfunctions of Fluid Power Systems	G-1 Perform operations in digital numbering systems	G-2 Perform operations in digital numbering systems	G-3 Perform operations in digital numbering systems	G-4 Perform operations in digital numbering systems	G-5 Perform operations in digital numbering systems	G-6 Perform operations in digital numbering systems	G-7 Perform operations in digital numbering systems	G-8 Perform operations in digital numbering systems	G-9 Perform operations in digital numbering systems	G-10 Perform operations in digital numbering systems	G-11 Perform operations in digital numbering systems	G-12 Perform operations in digital numbering systems	G-13 Perform operations in digital numbering systems
<b>G</b> Apply Computer Science to Computer Controlled Equipment	H-1 Perform operations on PLC (Programmable Logic Controller) or PIC (Programmable Interface Controller) systems	H-2 Perform operations on PLC (Programmable Logic Controller) or PIC (Programmable Interface Controller) systems	H-3 Perform operations on PLC (Programmable Logic Controller) or PIC (Programmable Interface Controller) systems	H-4 Perform operations on PLC (Programmable Logic Controller) or PIC (Programmable Interface Controller) systems	H-5 Perform operations on PLC (Programmable Logic Controller) or PIC (Programmable Interface Controller) systems	H-6 Perform operations on PLC (Programmable Logic Controller) or PIC (Programmable Interface Controller) systems	H-7 Perform operations on PLC (Programmable Logic Controller) or PIC (Programmable Interface Controller) systems	H-8 Perform operations on PLC (Programmable Logic Controller) or PIC (Programmable Interface Controller) systems	H-9 Perform operations on PLC (Programmable Logic Controller) or PIC (Programmable Interface Controller) systems	H-10 Perform operations on PLC (Programmable Logic Controller) or PIC (Programmable Interface Controller) systems	H-11 Perform operations on PLC (Programmable Logic Controller) or PIC (Programmable Interface Controller) systems	H-12 Perform operations on PLC (Programmable Logic Controller) or PIC (Programmable Interface Controller) systems	H-13 Perform operations on PLC (Programmable Logic Controller) or PIC (Programmable Interface Controller) systems
<b>H</b> Correct Malfunctions in PLC Controlled Equipment	I-1 Use manufacturer's specifications, manuals, and monitoring devices to configure, test and troubleshoot set-up and solve control problems	I-2 Use manufacturer's specifications, manuals, and monitoring devices to configure, test and troubleshoot set-up and solve control problems	I-3 Use manufacturer's specifications, manuals, and monitoring devices to configure, test and troubleshoot set-up and solve control problems	I-4 Use manufacturer's specifications, manuals, and monitoring devices to configure, test and troubleshoot set-up and solve control problems	I-5 Use manufacturer's specifications, manuals, and monitoring devices to configure, test and troubleshoot set-up and solve control problems	I-6 Use manufacturer's specifications, manuals, and monitoring devices to configure, test and troubleshoot set-up and solve control problems	I-7 Use manufacturer's specifications, manuals, and monitoring devices to configure, test and troubleshoot set-up and solve control problems	I-8 Use manufacturer's specifications, manuals, and monitoring devices to configure, test and troubleshoot set-up and solve control problems	I-9 Use manufacturer's specifications, manuals, and monitoring devices to configure, test and troubleshoot set-up and solve control problems	I-10 Use manufacturer's specifications, manuals, and monitoring devices to configure, test and troubleshoot set-up and solve control problems	I-11 Use manufacturer's specifications, manuals, and monitoring devices to configure, test and troubleshoot set-up and solve control problems	I-12 Use manufacturer's specifications, manuals, and monitoring devices to configure, test and troubleshoot set-up and solve control problems	I-13 Use manufacturer's specifications, manuals, and monitoring devices to configure, test and troubleshoot set-up and solve control problems
<b>I</b> Resolve Malfunctions Found in Systems Controlling Manufacturing Processes	J-1 Safety assemble, disassemble, and adjust mechanical systems such as gears, shafts, couplings, and computer systems	J-2 Safety assemble, disassemble, and adjust electrical systems or components of fluid power systems	J-3 Safety assemble, disassemble, and adjust pneumatic systems or components	J-4 Safety assemble, disassemble, and adjust hydraulic systems or components	J-5 Safety assemble, disassemble, and adjust digital systems such as PLCs, CNCs, or computers	J-6 Safety assemble, disassemble, and adjust electronic systems or components	J-7 Safety assemble, disassemble, and adjust mechanical systems or components	J-8 Safety assemble, disassemble, and adjust pneumatic systems or components	J-9 Safety assemble, disassemble, and adjust thermodynamic systems or components	J-10 Safety assemble, disassemble, and adjust electromagnetic systems or components	J-11 Safety assemble, disassemble, and adjust chemical systems or components	J-12 Safety assemble, disassemble, and adjust electrochemical systems or components	J-13 Safety assemble, disassemble, and adjust water treatment systems or components
<b>J</b> Assemble/Disassemble Mechanical/Electrical/Electronic, and Computer Systems													

## AET-D1-HO-1

### Apply the Troubleshooting Process to the Resolution of Malfunctions Found in Industrial Machine Tools and Automated Equipment

#### Attachment 1: MASTER Handout No. 1

---

#### Objective(s):

Upon completion of this unit the student will be able to:

- a. Identify nature/purpose of a system, subsystem, module, or component in a complex manufacturing machine/process;
- b. Apply theory to predict behavior of a complex manufacturing machine or process;
- c. Measure complex manufacturing machine/process to determine if it is meeting theoretical expectations;
- d. Analyze results to determine if system, subsystem, module, or component is meeting manufacturer's specifications;
- e. Apply critical thinking to determine if system is malfunctioning or if process must be reapplied;
- f. Validate the process and apply corrective action;
- g. If corrective action does not result in repair of system, reapply the process;
- h. Identify major systems, subsystems, and components of a CNC system;
- i. Apply the theory of operation of the major systems, subsystems, and components of a CNC system;
- j. Determine the proper measurements to determine the operating condition of the major systems, subsystems, and components of a CNC system;
- k. Apply critical thinking to the determination of problems in the major systems, subsystems, and components of a CNC system; and,
- l. Analyze the results of the troubleshooting process and determine the nature and type of corrective action that must be applied or if the troubleshooting process must be reapplied.

---

#### Module Outline:

- I. Identify Nature/Purpose of a System, Subsystem, Module, or Component in a Complex Manufacturing Machine/Process
  - A. Explain the overall operation of a CNC machine tool (MASTER Handout AET-D1-HO-8) (Operating Systems of a CNC)
    1. Explain and demonstrate the purpose of a CNC
    2. Explain and demonstrate the geometry of a two, three, and five axis CNC and its relationship to the rectangular coordinate system
    3. Explain and demonstrate incremental and absolute positioning

4. Explain and demonstrate the difference between point-to-point and continuous path servo systems
- B. Explain the major system blocks of a CNC system (MASTER Handout AET-D1-HO-2) (Block Diagram of a Typical CNC System) and (MASTER Overhead AET-D1-OV-1) (Block Diagram of a Typical CNC System)
1. Identify the location and organization of the major subsystems of a CNC machine tool
  2. Demonstrate the identification of major subsystems of a CNC system
- C. Explain the modules and components of CNC subsystems (MASTER Handout AET-D1-HO-3) (CNC Subsystems); (MASTER Handout AET-D1-HO-4) (CNC Schematic Diagrams); (MASTER Handout AET-D1-HO-5) (CNC Ladder Diagrams); (MASTER Handout AET-D1-HO-6) (CNC Mechanical Systems); and, (MASTER Handout AET-D1-HO-7) (CNC Hydraulic/Pneumatic Systems); see also, (MASTER Overhead AET-D1-OV-2) (CNC Subsystems); (MASTER Overhead AET-D1-OV-3) (CNC Schematic Diagrams); (MASTER Overhead AET-D1-OV-4) (CNC Ladder Diagrams); (MASTER Overhead AET-D1-OV-5) (CNC Mechanical Systems); and, (MASTER Overhead AET-D1-OV-6) (CNC Hydraulic/Pneumatic Systems)
1. Identify the location of modules and components in CNC subsystems giving equal weight to electrical, electronic, mechanical, and hydraulic/pneumatic subsystems
  2. Demonstrate the identification of subsystem modules and components
- II. Apply Theory to Predict Behavior of a Complex Manufacturing Machine or Process
- A. Explain the theory of operation of major system blocks of a CNC system (MASTER Handout AET-D1-HO-2) (Block Diagram of a Typical CNC System) and (MASTER Overhead AET-D1-OV-1) (Block Diagram of a Typical CNC System)
1. Explain the theory of operation of the major subsystems of a CNC machine tool
  2. Demonstrate the application of the theory of operation of major subsystems of a CNC system
- B. Explain the theory of operation of modules and components of CNC subsystems (MASTER Handout AET-D1-HO-3) (CNC Subsystems); (MASTER Handout AET-D1-HO-4) (CNC Schematic Diagrams); (MASTER Handout AET-D1-HO-5) (CNC Ladder Diagrams); (MASTER Handout AET-D1-HO-6) (CNC Mechanical Systems); and, (MASTER Handout AET-D1-HO-7) (CNC Hydraulic/Pneumatic Systems); see also (MASTER Overhead AET-D1-OV-2) (CNC Subsystems); (MASTER Overhead AET-D1-OV-3) (CNC Schematic Diagrams); (MASTER Overhead AET-D1-OV-4) (CNC Ladder

Diagrams); (MASTER Overhead AET-D1-OV-5) (CNC Mechanical Systems); and, (MASTER Overhead AET-D1-OV-6) (CNC Hydraulic/Pneumatic Systems)

1. Explain the theory of operation of modules and components in CNC subsystems giving equal weight to electrical, electronic, mechanical, and hydraulic/pneumatic subsystems
2. Demonstrate the application of the theory of operation of subsystem modules and components

**III. Measure Complex Manufacturing Machine/Process to Determine if it is Meeting Theoretical Expectations**

**A.. Explain the critical measuring points for major system blocks of a CNC system (MASTER Handout AET-D1-HO-2) (Block Diagram of a Typical CNC System) and (MASTER Overhead AET-D1-OV-1) (Block Diagram of a Typical CNC System)**

1. Explain the points of measurement and types of measurements of the major subsystems of a CNC machine tool
2. Demonstrate the application of measurements of major subsystems of a CNC system

**B. Explain the critical measuring points for modules and components of CNC subsystems (MASTER Handout AET-D1-HO-3) (CNC Subsystems); (MASTER Handout AET-D1-HO-4) (CNC Schematic Diagrams); (MASTER Handout AET-D1-HO-5) (CNC Ladder Diagrams); (MASTER Handout AET-D1-HO-6) (CNC Mechanical Systems); and, (MASTER Handout AET-D1-HO-7) (CNC Hydraulic/Pneumatic Systems); see also (MASTER Overhead AET-D1-OV-2) (CNC Subsystems); (MASTER Overhead AET-D1-OV-3) (CNC Schematic Diagrams); (MASTER Overhead AET-D1-OV-4) (CNC Ladder Diagrams); (MASTER Overhead AET-D1-OV-5) (CNC Mechanical Systems); and, (MASTER Overhead AET-D1-OV-6) (CNC Hydraulic/Pneumatic Systems)**

1. Explain the points of measurement and types of measurements of modules and components in CNC subsystems giving equal weight to electrical, electronic, mechanical, and hydraulic/pneumatic subsystems
2. Demonstrate the application of measurements of subsystem modules and components

**IV. Analyze Results to Determine if System, Subsystem, Module, or Component is Meeting Manufacturer's Specifications**

**A. Explain the types of specifications for major system blocks of a CNC system (MASTER Handout AET-D1-HO-2) (Block Diagram of a Typical CNC System) and (MASTER Overhead AET-D1-OV-1) (Block Diagram of a Typical CNC System)**

1. Explain the nature of the specifications and the types of specifications of the major subsystems of a CNC machine tool

2. Demonstrate the application of specifications of major subsystems of a CNC system
- B. Explain the types of specifications for modules and components of CNC subsystems (MASTER Handout AET-D1-HO-3) (CNC Subsystems); (MASTER Handout AET-D1-HO-4) (CNC Schematic Diagrams); (MASTER Handout AET-D1-HO-5) (CNC Ladder Diagrams); (MASTER Handout AET-D1-HO-6) (CNC Mechanical Systems); and, (MASTER Handout AET-D1-HO-7) (CNC Hydraulic/Pneumatic Systems); see also (MASTER Overhead AET-D1-OV-2) (CNC Subsystems); (MASTER Overhead AET-D1-OV-3) (CNC Schematic Diagrams); (MASTER Overhead AET-D1-OV-4) (CNC Ladder Diagrams); (MASTER Overhead AET-D1-OV-5) (CNC Mechanical Systems); and, (MASTER Overhead AET-D1-OV-6) (CNC Hydraulic/Pneumatic Systems)
  1. Explain the specifications of modules and components in CNC subsystems giving equal weight to electrical, electronic, mechanical, and hydraulic/pneumatic subsystems
  2. Demonstrate the application of specifications of subsystem modules and components
- V. Apply Critical Thinking to Determine if System is Malfunctioning or if Process Must Be Reapplied
  - A. Explain the procedures for applying critical thinking
    1. Explain the concept of critical thinking
      - a. Make no assumptions
      - b. Only apply common sense that is proven by hard facts
      - c. Verify the data
      - d. Allow the data to dictate the results
      - e. Apply the adage: "The simplest theory that meets all the known, observable facts is usually the correct theory"
      - f. Question all results until no other explanation is reasonable
    2. Demonstrate the application of critical thinking
  - B. Explain the point at which the results of a troubleshooting process must be reapplied
- VI. Validate the Process and Apply Corrective Action
  - A. Explain the point at which the troubleshooting process must be considered to be verified, and demonstrate the verification of the troubleshooting process
  - B. Demonstrate the application of corrective action
    1. Replacement of an entire subsystem
    2. Replacement of a module or component
    3. Troubleshooting to the component level
- VII. If Corrective Action Does Not Result in Repair of System, Reapply the Process

- A. Explain the reasons that corrective action may not result in a solution to the problem
  - 1. More than one problem in the system
  - 2. One system causing a problem in another system
  - 3. Demonstrate situations in which a corrective action may not result in repair to the system
    - a. Substituting bad components
    - b. Improper installation of components
    - c. One system affecting another system
- B. Explain the procedures for re-applying the troubleshooting process

**AET-D1-LE**  
**Apply the Troubleshooting Process to the Resolution of Malfunctions**  
**Found in Industrial Machine Tools and Automated Equipment**  
**Attachment 15: MASTER Laboratory Exercise**

---

The student will:

1. Use an industrial CNC machine to apply the concepts contained in this module.

**Apply the Troubleshooting Process to the Resolution of Malfunctions  
Found in Industrial Machine Tools and Automated Equipment  
Attachment 16: MASTER Laboratory Aid**

---

**Rules of Conduct**

1. Absolutely no horseplay or practical joking will be tolerated.
2. Do not talk to anyone who is operating a machine.
3. Walk only in the designated traffic lanes.
4. Dress appropriately; at the absolute minimum, you must have:
  - a. No loose clothing, including ties;
  - b. Long hair properly stowed;
  - c. No jewelry;
  - d. Hard, closed-toe shoes;
  - e. Eye protection (safety glasses); and,
  - f. Ear protection (plugs or headset).
5. Follow all institutional safety rules.



**AUTOMATED EQUIPMENT REPAIR TECHNICIAN ... operates, programs, maintains, and repairs automated machine tools and automated manufacturing processes.**

**Duties**

**Tasks**

Duties	A-1 Apply scientific notation and engineering notation to solve technical problems	A-2 Apply algebraic formulas to solve technical problems	A-3 Use variables in algebraic formulas to solve technical problems	A-4 Manipulate algebraic formulas in industrial systems	A-5 Measure, calculate, and convert digital values in (SI and analog) systems of measurement	A-6 Use mechanical physics to analyze mechanical systems	A-7 Use mechanical physics to analyze mechanical systems	A-8 Use mathematical physics to analyze pneumatic systems	A-9 Use mathematical and thermodynamics to analyze pneumatic systems	A-10 Use mathematical physics of electronic systems and optical systems	A-11 Use chemical principles and formulas to predict and analyze chemical industrial processes	A-12 Apply knowledge of electrochemical effects to manufacturing processes	A-13 Apply principles of water to analyze industrial water treatment processes
<b>A</b> Apply Science to Solve Industrial Problems	B-1 Use symbols, organization, and drawing values on mechanical drawings	B-2 Use symbols, organization, and drawing values on electrical drawings	B-3 Use symbols, organization, and drawing values on electronic drawings	B-4 Use symbols, organization, and drawing values on fluid power drawings	B-5 Use symbols, organization, and drawing values on digital drawings	B-6 Use mechanical physics to analyze mechanical systems	B-7 Use mechanical physics to analyze mechanical systems	B-8 Use mathematical physics to analyze pneumatic systems	B-9 Use mathematical and thermodynamics to analyze pneumatic systems	B-10 Use mathematical physics of electronic systems and optical systems	B-11 Use chemical principles and formulas to predict and analyze chemical industrial processes	B-12 Apply knowledge of electrochemical effects to manufacturing processes	B-13 Apply principles of water to analyze industrial water treatment processes
<b>B</b> Use Drawings to Analyze and Repair Systems	C-1 Apply machine tool measurements to align machine tools	C-2 Apply electrical measurements and instruments to test/calibrate electrical circuits	C-3 Apply electronic measurements and instruments to test/calibrate electronic circuits	C-4 Apply fluid power measurements and instruments to test/calibrate hydraulic and pneumatic systems	C-5 Apply digital electronic measurements and instruments to test/calibrate digital electronic circuits	C-6 Use mechanical physics to analyze mechanical systems	C-7 Use mechanical physics to analyze mechanical systems	C-8 Use mathematical physics to analyze pneumatic systems	C-9 Use mathematical and thermodynamics to analyze pneumatic systems	C-10 Use mathematical physics of electronic systems and optical systems	C-11 Use chemical principles and formulas to predict and analyze chemical industrial processes	C-12 Apply knowledge of electrochemical effects to manufacturing processes	C-13 Apply principles of water to analyze industrial water treatment processes
<b>C</b> Use Calibrated Measuring Instruments to Test/Calibrate Components	D-1 Apply troubleshooting process to the resolution of malfunctions in industrial machine tools and automated equipment	D-2 Calculate, measure, and respond to quantities in DC circuits	D-3 Calculate, measure, and respond to quantities in AC circuits	D-4 Calculate, measure, and respond to quantities in polyphase AC circuits	D-5 Properly set, use meters and oscilloscopes	D-6 Use mechanical physics to analyze mechanical systems	D-7 Use mechanical physics to analyze mechanical systems	D-8 Use mathematical physics to analyze pneumatic systems	D-9 Use mathematical and thermodynamics to analyze pneumatic systems	D-10 Use mathematical physics of electronic systems and optical systems	D-11 Use chemical principles and formulas to predict and analyze chemical industrial processes	D-12 Apply knowledge of electrochemical effects to manufacturing processes	D-13 Apply principles of water to analyze industrial water treatment processes
<b>D</b> Resolve System Failures with Critical Thinking, Troubleshooting, and Metrology	E-1 Calculate, measure, and respond to quantities in DC circuits	E-2 Calculate, measure, and respond to quantities in AC circuits	E-3 Calculate, measure, and respond to quantities in AC circuits	E-4 Calculate, measure, and respond to quantities in polyphase AC circuits	E-5 Properly set, use meters and oscilloscopes	E-6 Use mechanical physics to analyze mechanical systems	E-7 Use mechanical physics to analyze mechanical systems	E-8 Use mathematical physics to analyze pneumatic systems	E-9 Use mathematical and thermodynamics to analyze pneumatic systems	E-10 Use mathematical physics of electronic systems and optical systems	E-11 Use chemical principles and formulas to predict and analyze chemical industrial processes	E-12 Apply knowledge of electrochemical effects to manufacturing processes	E-13 Apply principles of water to analyze industrial water treatment processes
<b>E</b> Use Techniques Malfunctions of Electronic Systems	F-1 Identify and explain the theory and use of hydraulic and pneumatic systems	F-2 Apply purpose and use of fluid or pneumatic components or systems	F-3 Identify, assemble, measure, and apply knowledge of hydraulic and pneumatic actuators	F-4 Apply hydraulic, pneumatic, and high vacuum systems knowledge to troubleshoot and repair special components/devices	F-5 Identify, assemble, measure, and apply knowledge of specialized fluid power circuits	F-6 Use mechanical physics to analyze mechanical systems	F-7 Use mechanical physics to analyze mechanical systems	F-8 Use mathematical physics to analyze pneumatic systems	F-9 Use mathematical and thermodynamics to analyze pneumatic systems	F-10 Use mathematical physics of electronic systems and optical systems	F-11 Use chemical principles and formulas to predict and analyze chemical industrial processes	F-12 Apply knowledge of electrochemical effects to manufacturing processes	F-13 Apply principles of water to analyze industrial water treatment processes
<b>F</b> Measure/Isolate Malfunctions of Fluid Power Systems	G-1 Perform digital operations in digital numbering systems	G-2 Perform Boolean operations in digital equipment	G-3 Solve digital logic circuits and ladder diagrams in electrical and programmable logic circuits, express a complex logic problem in Boolean logic and convert it into ladder logic	G-4 Program computer and computer controlled industrial equipment	G-5 Identify, assemble, measure, and apply knowledge of operating electrical systems	G-6 Use mechanical physics to analyze mechanical systems	G-7 Use mechanical physics to analyze mechanical systems	G-8 Use mathematical physics to analyze pneumatic systems	G-9 Use mathematical and thermodynamics to analyze pneumatic systems	G-10 Use mathematical physics of electronic systems and optical systems	G-11 Use chemical principles and formulas to predict and analyze chemical industrial processes	G-12 Apply knowledge of electrochemical effects to manufacturing processes	G-13 Apply principles of water to analyze industrial water treatment processes
<b>G</b> Apply Computer Science to Computer Industrial Equipment	H-1 Perform operations on PLC (programmable logic controller) or PLC (programmable controller) systems	H-2 Safely assemble, disassemble, and adjust subsystems of fluid power systems	H-3 Safely assemble, disassemble, and adjust components or systems	H-4 Safely assemble, disassemble, or adjust components or equipment	H-5 Identify, assemble, measure, and apply knowledge of operating electrical systems	H-6 Use mechanical physics to analyze mechanical systems	H-7 Use mechanical physics to analyze mechanical systems	H-8 Use mathematical physics to analyze pneumatic systems	H-9 Use mathematical and thermodynamics to analyze pneumatic systems	H-10 Use mathematical physics of electronic systems and optical systems	H-11 Use chemical principles and formulas to predict and analyze chemical industrial processes	H-12 Apply knowledge of electrochemical effects to manufacturing processes	H-13 Apply principles of water to analyze industrial water treatment processes
<b>H</b> Correct Malfunctions in PLC Controlled Equipment	I-1 Safely assemble, disassemble, and adjust subsystems of fluid power systems	I-2 Safely assemble, disassemble, and adjust components or systems	I-3 Safely assemble, disassemble, or adjust components or equipment	I-4 Safely assemble, disassemble, or adjust components or equipment	I-5 Identify, assemble, measure, and apply knowledge of operating electrical systems	I-6 Use mechanical physics to analyze mechanical systems	I-7 Use mechanical physics to analyze mechanical systems	I-8 Use mathematical physics to analyze pneumatic systems	I-9 Use mathematical and thermodynamics to analyze pneumatic systems	I-10 Use mathematical physics of electronic systems and optical systems	I-11 Use chemical principles and formulas to predict and analyze chemical industrial processes	I-12 Apply knowledge of electrochemical effects to manufacturing processes	I-13 Apply principles of water to analyze industrial water treatment processes
<b>I</b> Resolve Malfunctions Found in Controlling Manufacturing Processes	J-1 Safely assemble, disassemble, and adjust subsystems of fluid power systems	J-2 Safely assemble, disassemble, or adjust components or equipment	J-3 Safely assemble, disassemble, or adjust components or equipment	J-4 Safely assemble, disassemble, or adjust components or equipment	J-5 Identify, assemble, measure, and apply knowledge of operating electrical systems	J-6 Use mechanical physics to analyze mechanical systems	J-7 Use mechanical physics to analyze mechanical systems	J-8 Use mathematical physics to analyze pneumatic systems	J-9 Use mathematical and thermodynamics to analyze pneumatic systems	J-10 Use mathematical physics of electronic systems and optical systems	J-11 Use chemical principles and formulas to predict and analyze chemical industrial processes	J-12 Apply knowledge of electrochemical effects to manufacturing processes	J-13 Apply principles of water to analyze industrial water treatment processes
<b>J</b> Assemble/Disassemble/Adjust Electronic and Computer Systems													

**AET-E1-HO**  
**Calculate, Predict, and Measure**  
**the Response of Quantities in DC Circuits**  
**Attachment 1: MASTER Handout**

---

**Objective(s):**

Upon completion of this unit the student will be able to:

- a. Use math and the theory of DC circuits to predict the behavior of DC circuits;
- b. Understand the different effects of voltage current and resistance on electrical hazards;
- c. Calculate any of the three quantities of DC current, DC voltage or resistance given any of the two values, and apply proper engineering terms to the results of the calculations;
- d. Predict the behavior of an electronic or electrical circuit for a change of any of the three values of DC current, DC voltage or resistance;
- e. Calculate the quantity of power produced in a circuit given a value of voltage and current, and apply proper engineering values to the calculations;
- f. Predict the effects of the power in the circuit given a measured or calculated value of power, and also predict the behavior of the circuit power for a change in voltage or current;
- g. Calculate the expected time of charge of a capacitor given a value of resistance and capacitance, and apply proper engineering values to the results of the calculations;
- h. Measure the time of charge and the voltage given a value of resistance and capacitance, to determine if the circuit is responding as predicted by the calculations; and,
- i. Identify inductive components, and measure their inductance.

---

**Module Outline:**

- I. Use Math and the Theory of DC Circuits to Predict the Behavior of DC Circuits
  - A. Units of measurement of electrical DC voltage current and resistance
    1. Explain the concepts of voltage, current, and resistance for DC circuits
    2. Explain the units of measurement for DC voltage current and resistance
    3. Provide examples of each quantity
    4. Explain the mathematical tools and procedures that can be used to solve problems in complex DC circuits, including resistive bridge circuits

5. Demonstrate the mathematical solution of voltage ,current, resistance and power in DC systems
  6. Demonstrate the procedures for verifying the calculations by measurement
- B. Explain the concept of inductance and capacitance for DC voltages and currents
1. Explain the behavior of a capacitor in a DC circuit
  2. Explain the units of measurement of capacitors (capacitance and working voltage)
  3. Explain the behavior of an inductor in a DC circuit
  4. Explain the units of measurement of an inductor
  5. Demonstrate the magnetic field produced by an inductor
  6. Explain how capacitors and inductors are used in electrical and electronic circuits, and provide examples of each use in a working control system for a robot or CNC machine
  7. Demonstrate the measurement of capacitive and inductive components
- C. Demonstrate the procedure for safely measuring, current, voltage, resistance, capacitance, and inductance in DC circuits
- II. Electrical/Electronics Safety
- A. Follow the lesson plan contained in MASTER Lesson Plan (AET-E1-LP) (Electrical Safety)

**AET-E1-LP**  
**Calculate, Predict, and Measure**  
**the Response of Quantities in DC Circuits**  
**Attachment No. 2: MASTER Lesson Plan**

---

**Electrical Safety**

**Notes to the instructor:**

You will need the following materials:

The below handout  
Digital Multimeter  
Analog Multimeter  
Three plastic or metal bowls  
Distilled water or chemically pure water  
Tap water  
Salt

**Lesson Objectives:**

1. Discover that water does not have zero resistance;
2. Discover that electrical hazard is dependent upon body resistance, and if the source is high enough, or body resistance is low enough, injury can occur;
3. Understand the different effects of voltage current and resistance on electrical hazards; and,
4. Practice in measuring resistance and Ohm's Law calculations.

**This lesson is designed to be 2 to 3 hours in duration for beginning electrical or electronic students.**

**First hour**

During the first part, which is an ice breaker, the students will be exposed to measurements of water and body resistance using an analog and a digital meter. The students should be the experimenters and you may have to interpret the meter scale.

**Activities:**

1. Have students provide written respond to question:  
**Of the three components of Ohm's Law; voltage, current, and resistance; which one of the three is most useful in determining your potential electrical hazard ?**

2. Measure class body resistance, record and calculate class average (have students hold probes with the same pressure they would hold a pencil).
3. Measure resistance of three bowls of water with two meters.
4. Select four volunteers, have three dip hands into bowls, and one exercise, and re-measure resistance of each.

### **Second two hours**

The second part of the lesson is designed to present useful stories of real workers who were exposed to hazardous electrical potentials. The students should be allowed to discuss the stories and imagine the results.

### **Activities:**

1. Present facts about electrical hazard (you may want to add to the following):  
*mean human body resistance*  
**1 Milliamp -You can feel it**  
**10 Milliamps -You can't let go**  
**100 Milliamps -Is usually fatal**
2. Present four scenarios. **Do not** reveal the below results until after the students have performed the calculations.
  - a. In scenario one, the sailor contacted 24 volts DC from a boat radio. The sailor was drenched in salt water and the shock was very powerful. The area was confined, and the reaction caused bruises and a injured back when the sailor jerked away from the radio. The sailor lived.
  - b. In scenario two, the workman was facing a 440 volt three phase bus when he tried to measure the voltage of the bus with his meter set to the current scale. The mistake was the result of two safety violations. First, the workman was in a hurry, and second there was no one working with him; he was alone on the shift. Practically the entire current capacity of the bus conducted through the meter. The workman was in a confined area and was facing the contact point when the arc flash occurred. It felt like a hand grenade went off in his face, and the resultant flash temporally blinded him. The workman suffered flash burns of the face and eyes. The workman lived.
  - c. In scenario three, the workman was troubleshooting an induction brazer and was working with a co-worker who was nearby. The 18,000 volts was the potential of the plate cap of a large power vacuum tube. The workman merely pointed to the plate cap to show his coworker

where it was, and the plate voltage arced to his finger. Unfortunately the current path was down the workers left side (he was left handed) and he went into cardiac arrest. Little was known about CPR when this event occurred, and before the ambulance could arrive, the worker died. (CPR would have saved his life)

- d. In scenario four the workman was troubleshooting a 20,000 volt power supply on an explosive forming machine. The machine was designed to hurl lightening bolts through a mold filled with de-ionized water. The resulting explosion formed metal parts in the mold. The machine was powered down, but due to a design flaw, the 20 KV supply was still energized. The workman grabbed the 20 KV bus and was knocked unconscious. The current arced through the workman's upper arm, where it was resting on the chassis, and through his crepe soled shoes, to a pool of de-ionized water which was surrounding the equipment. He received severe burns to his arm and foot. However, he lived to tell the tale.
3. Have the students perform the calculations as outlined in the below table in the handout. They should pay careful attention to the current their own body resistance causes. They should compare it to the above table of current and results.
4. Present the same question:  
**Of the three components of Ohm's Law; voltage, current, and resistance; which one of the three is most useful in determining your potential electrical hazard ?**
5. Describe the results of the scenarios and lead class discussion on the results.

**AET-E1-LE1**  
**Calculate, Predict, and Measure**  
**the Response of Quantities in DC Circuits**  
**Attachment 3: MASTER Laboratory Exercise No. 1**

---

Name: \_\_\_\_\_

**Introduction**

An essential portion of your job will involve working with electrical and electronics equipment. During the operations that you will perform, you *will* be exposed to electrical hazards. Electrical energy is frightening to many people. Anyone who has been shocked by an electrical circuit may learn to fear electrical energy. The following series of lectures is designed to remove the mystery that surrounds electricity and to determine the real facts that you will need to know to assess the danger that you will face when working around electrical circuits.

To determine the extent of the hazards that an industrial electrical/electronics technician must face, you need to know the following facts.

- A. The *mean* human body resistance of the overall population is *250,000 ohms*
- B. A rule of thumb for determining electrical hazard is the following:
  - 1 Milliamp -You can feel it
  - 10 Milliamps -You can't let go
  - 100 Milliamps -Is usually fatal

1. Of the three components of Ohm's Law; voltage, current, and resistance; which one of the three is most useful in determining your potential electrical hazard?

Answer: \_\_\_\_\_

2. Enter *your* body resistance.

Answer: \_\_\_\_\_

3. Enter the average body resistance of the class.

Answer: \_\_\_\_\_

**AET-E1-LE2**  
**Calculate, Predict, and Measure**  
**the Response of Quantities in DC Circuits**  
**Attachment 4: MASTER Laboratory Exercise No. 2**

---

Name: \_\_\_\_\_

**Introduction**

In this section I will choose four volunteers to measure their body resistance when they have dipped their hands in water or otherwise lowered their body resistance. First, however, we will experiment with the actions of at least two different kinds of meters and determine how they react when measuring the resistance of water.

**Resistance of Water When Using Analog or Digital Meter**

	Digital	Analog
Resistance of tap water		
Resistance of distilled water		
Resistance of distilled water with salt		

Volunteer number 1 - Tap water

Body resistance = \_\_\_\_\_

Volunteer number 2 - Distilled water

Body resistance = \_\_\_\_\_

Volunteer number 3 - Distilled water plus salt

Body resistance = \_\_\_\_\_

Volunteer number 4 - Exercise

Body resistance = \_\_\_\_\_



**AET-E1-LE3**  
**Calculate, Predict, and Measure**  
**the Response of Quantities in DC Circuits**  
**Attachment 5: MASTER Laboratory Exercise No. 3**

---

Name: \_\_\_\_\_

**Introduction**

The following events actually occurred and involved workmen in the San Diego area. Several of the victims in these events sustained injuries as a result of electrical accidents. In one case, a person died. Your task is to examine the events and to predict:

1. What was the extent of the injuries?
2. Which person was killed as a result of contacting electrical hazard?

**Scenario Number 1**

A sailor working during foul weather is exposed to electrical hazard. The voltage source involved is 24 volts DC. The potential current of the source is 500 amps of current.

Was the sailor injured, and if so, what was the extent of the injuries? Did the sailor die as a result of the exposure?

**Injuries:**

---

---

---

---

**Scenario Number 2**

An electrical maintenance worker at a local company is testing 480 volts AC on a lathe. He inadvertently uses the current scale on his meter to test the voltage. He is exposed to electrical hazard. The potential current of the source voltage is 5000 amps.

Was the workman injured, and if so, what was the extent of the injuries? Did the workman die as a result of the exposure?

**Injuries:**

---

---

---

---

**Scenario Number 3**

An electronics worker at a local company is testing the circuitry of an induction brazer. The workman is exposed to electrical hazard. The voltage source is 18,000 volts DC. The current potential of the source is 20 milliamps (20 one thousandths of an amp).

Was the workman injured? If so, what were the extent of the injuries? Did the workman die as a result of the exposure?

**Injuries:**

---

---

---

---

**Scenario Number 4**

An electronics worker at a local company is testing the circuitry of electronic explosive forming machine. The voltage source of the machine is 20,000 volts DC. The potential current of the source is 5 amps. The worker is exposed to electrical hazard.

Was the workman injured? If so, what was the extent of his injuries? Did the workman die as a result of the exposure?

**Injuries:**

---

---

---

---

Using Ohm's Law, calculate the *current* flowing through the bodies of each of the victims in each of the Scenarios based upon:

1. Your body resistance;
2. The body resistance of each of the volunteers in the class; and,
3. The class average.

*Current* calculations:

**Scenario 1**

Your body resistance \_\_\_\_\_  
Resistance of volunteer 1 \_\_\_\_\_  
Resistance of volunteer 2 \_\_\_\_\_  
Resistance of volunteer 3 \_\_\_\_\_  
Resistance of volunteer 4 \_\_\_\_\_  
Class average resistance \_\_\_\_\_

**Scenario 2**

Your body resistance \_\_\_\_\_  
Resistance of volunteer 1 \_\_\_\_\_  
Resistance of volunteer 2 \_\_\_\_\_  
Resistance of volunteer 3 \_\_\_\_\_  
Resistance of volunteer 4 \_\_\_\_\_  
Class average resistance \_\_\_\_\_

**Scenario 3**

Your body resistance \_\_\_\_\_  
Resistance of volunteer 1 \_\_\_\_\_  
Resistance of volunteer 2 \_\_\_\_\_  
Resistance of volunteer 3 \_\_\_\_\_  
Resistance of volunteer 4 \_\_\_\_\_  
Class average resistance \_\_\_\_\_

**Scenario 4**

Your body resistance \_\_\_\_\_  
Resistance of volunteer 1 \_\_\_\_\_  
Resistance of volunteer 2 \_\_\_\_\_  
Resistance of volunteer 3 \_\_\_\_\_  
Resistance of volunteer 4 \_\_\_\_\_  
Class average resistance \_\_\_\_\_

**AET-E1-LA**  
**Calculate, Predict, and Measure**  
**the Response of Quantities in DC Circuits**  
**Attachment 6: MASTER Laboratory Aid**

---

**Rules of Conduct**

1. Absolutely no horseplay or practical joking will be tolerated.
2. Do not talk to anyone who is operating a machine.
3. Walk only in the designated traffic lanes.
4. Dress appropriately; at the absolute minimum, you must have:
  - a. No loose clothing, including ties;
  - b. Long hair properly stowed;
  - c. No jewelry;
  - d. Hard, closed-toe shoes;
  - e. Eye protection (safety glasses); and,
  - f. Ear protection (plugs or headset).
5. Follow all institutional safety rules.

**AET-E2-HO**  
**Calculate, Predict, and Measure**  
**the Response of Quantities in AC Circuits**  
**Attachment 1: MASTER Handout**

---

**Objective(s):**

Upon completion of this unit the student will be able to:

- a. Calculate a value of AC current, AC voltage or resistance, in a resistive circuit, given any of the two quantities and apply proper engineering terms to the results of the calculations;
- b. Calculate a value of AC current or AC voltage in an inductive or capacitive circuit given the values of capacitance, inductance, resistance and frequency, and apply proper engineering terms to the results of the calculations;
- c. Predict the behavior of a circuit for a change of any of the values of current, voltage, resistance, capacitance, inductance or frequency, in a capacitive or inductive electronic or electrical AC circuit;
- d. Calculate and measure AC voltage, current and power expressed as peak values, peak-to-peak values, RMS values, and average values; and convert these quantities from one value to another; and,
- e. Predict the effects of power in the circuit, given the values of current, voltage or resistance in a resistive, capacitive, or inductive electronic or electrical AC circuit.

---

**Module Outline:**

- I. Use AC theory; Measure AC Voltages and Currents
  - A. Explain the concepts of voltage, current, and resistance for resistive, single phase AC circuits
    1. Explain the concepts of voltage, current, and resistance for AC circuits
    2. Explain the units of measurement for AC voltage and current (RMS, peak, peak-to-peak, average)
    3. Provide examples of each quantity
    4. Explain the mathematical tools and procedures that can be used to solve problems in complex resistive AC circuits
    5. Demonstrate the mathematical solution of voltage, current, resistance and power in resistive AC systems
    6. Demonstrate the procedures for verifying the calculations by measurement.
  - B. Explain the concept of inductance and capacitance for AC voltages and currents
    1. Explain the behavior of AC in a capacitive AC circuit

2. Explain the behavior of AC in an inductive AC circuit
  3. Demonstrate the magnetic field produced by an inductor when energized by AC current
  4. Explain how capacitors and inductors are used in AC electrical and electronic circuits, and provide examples of each use in a working control system for a robot or CNC machine
- C. Demonstrate the procedure for safely measuring, current, voltage, resistance, in complex AC circuits

**AET-E2-LE**  
**Calculate, Predict, and Measure**  
**the Response of Quantities in AC Circuits**  
**Attachment 2: MASTER Laboratory Exercise**

---

The student will:

1. Use an industrial control system to demonstrate the measurement of voltage, current, resistance, power, in AC circuits; and,
2. Calculate the parameters of the system from the measurements.

**AET-E2-LA**  
**Calculate, Predict, and Measure**  
**the Response of Quantities in AC Circuits**  
**Attachment 3: MASTER Laboratory Aid**

---

**Rules of Conduct**

1. Absolutely no horseplay or practical joking will be tolerated.
2. Do not talk to anyone who is operating a machine.
3. Walk only in the designated traffic lanes.
4. Dress appropriately; at the absolute minimum, you must have:
  - a. No loose clothing, including ties;
  - b. Long hair properly stowed;
  - c. No jewelry;
  - d. Hard, closed-toe shoes;
  - e. Eye protection (safety glasses); and,
  - f. Ear protection (plugs or headset).
5. Follow all institutional safety rules.



**AET-E3-HO**  
**Calculate, Predict, and Measure**  
**Impedance and Phase Angle in AC Circuits**  
**Attachment 1: MASTER Handout**

---

**Objective(s):**

Upon completion of this unit the student will be able to:

- a. Calculate the values of inductive reactance, and capacitive reactance in an AC circuit;
  - b. Predict the change in behavior of an AC circuit for a change in frequency or a change in capacitance/inductance;
  - c. Calculate expected phase shifts in a capacitive or inductive AC circuit;
  - d. Measure impedance/phase angle in AC circuits;
  - e. Apply the knowledge of inductive reactance, capacitive reactance, and phase shifts, to the solution of power factor problems found in industrial installations; and,
  - f. Apply the knowledge of inductive reactance, capacitive reactance, and phase shifts, to the prediction of the behavior of power in AC electrical/electronic circuits.
- 

**Module Outline:**

- I. Calculate/Predict Impedance and Phase Angle in AC Circuits
  - A. Explain the concept of impedance for AC circuits
    1. Explain the concept of impedance
    2. Explain the mathematical tools and procedures that can be used to solve problems in complex resistive, inductive, and capacitive AC circuits
    3. Demonstrate the mathematical solution of voltage ,current, resistance and power in complex resistive, inductive, and capacitive AC systems
  - B. Explain the concept of inductance and capacitance for AC voltages and currents
    1. Demonstrate the phase shift of AC voltage and current in a resistive-capacitive AC circuit
    2. Demonstrate the phase shift of AC voltage and current in a resistive-inductive AC circuit
    3. Explain how capacitors and inductors are used in AC electrical and electronic circuits, and provide examples of each use in a working control system for a robot or CNC machine
- II. Measure Impedance/Phase Angle in AC Circuits
  - A. Demonstrate the measurement of phase shift and phase angle

1. Explain the precautions that need to be observed when using an oscilloscope to measure AC circuits
  2. Demonstrate the measurement of phase shift and phase angle using an oscilloscope
- B. Demonstrate the procedure for measuring power factor and the solution of power factor problems
1. Explain the precautions that need to be observed when using instruments to measure AC line voltages
  2. Demonstrate the calculation of power factor and the determination of capacitors used to correct power factor problems

**AET-E3-LE**  
**Calculate, Predict, and Measure**  
**Impedance and Phase Angle in AC Circuits**  
**Attachment 2: MASTER Laboratory Exercise**

---

The student will:

1. Use a CNC or robotic control system to identify AC capacitive and inductive circuits and the methods of determining impedance, voltages, and currents in these circuits;
2. Use the power distribution system to a building or facility to measure voltage, current (clamp-on ammeter), power and power factor; and,
3. Calculate the type of power factor capacitors need to correct the power factor for the system.

**AET-E3-LA**  
**Calculate, Predict, and Measure**  
**Impedance and Phase Angle in AC Circuits**  
Attachment 3: MASTER Laboratory Aid

---

**Rules of Conduct**

1. Absolutely no horseplay or practical joking will be tolerated.
2. Do not talk to anyone who is operating a machine.
3. Walk only in the designated traffic lanes.
4. Dress appropriately; at the absolute minimum, you must have:
  - a. No loose clothing, including ties;
  - b. Long hair properly stowed;
  - c. No jewelry;
  - d. Hard, closed-toe shoes;
  - e. Eye protection (safety glasses); and,
  - f. Ear protection (plugs or headset).
5. Follow all institutional safety rules.

**AET-E4-HO**  
**Calculate, Predict, and Measure Quantities**  
**in Poly-Phase AC Circuits**  
**Attachment 1: MASTER Handout**

---

**Objective(s):**

Upon completion of this unit the student will be able to:

- a. Apply the knowledge of poly-phase AC circuits to the calculation and measurement of voltage, current, and power in these circuits;
- b. Measure phase angles in poly-phase AC circuits;
- c. Determine the phase rotation for poly-phase AC motors;
- d. Calculate power in poly-phase AC circuits;
- e. Calculate and predict the voltages that can be obtained from a configuration of a delta or wye poly-phase AC circuit;
- f. Determine reference points for measurement of voltages and currents in a delta or wye configuration poly-phase AC circuit; and,
- g. Determine of the type of power distribution in effect for a configuration of a poly-phase AC circuit.

---

**Module Outline:**

- I. Calculate, Predict, and Measure Voltage, Current, and Power in Three Phase AC Systems
  - A. Units of measurement for poly-phase AC
    1. Explain the concepts of phase shift in AC circuits
    2. Provide examples of the various types of poly-phase systems (delta and wye)
    3. Provide examples of the mathematical relationship between poly-phase AC voltages, currents, and power
    4. Demonstrate the application of mathematical concepts to the determination of voltage, current, and power in poly-phase AC systems
  - B. Measurement of AC voltage current, and power in three phase AC systems
    1. Explain the reference points for measuring AC voltage and current in three phase AC systems.(wye and delta)
    2. Demonstrate the measurement of voltage, current, power, and phase angle in three phase AC systems (wye and delta)

**AET-E4-LE**  
**Calculate, Predict, and Measure Quantities**  
**in Poly-Phase AC Circuits**  
**Attachment 2: MASTER Laboratory Exercise**

---

The student will:

1. Measure voltages in three phase AC power distribution systems; and,
2. Measure voltages and currents in three phase resistive and inductive AC circuits.

**AET-E4-LA**  
**Calculate, Predict, and Measure Quantities**  
**in Poly-Phase AC Circuits**  
**Attachment 3: MASTER Laboratory Aid**

---

**Rules of Conduct**

1. Absolutely no horseplay or practical joking will be tolerated.
2. Do not talk to anyone who is operating a machine.
3. Walk only in the designated traffic lanes.
4. Dress appropriately; at the absolute minimum, you must have:
  - a. No loose clothing, including ties;
  - b. Long hair properly stowed;
  - c. No jewelry;
  - d. Hard, closed-toe shoes;
  - e. Eye protection (safety glasses); and,
  - f. Ear protection (plugs or headset).
5. Follow all institutional safety rules.

**AET-E5-HO-1**  
**Properly Set Up, Calibrate, and Use Meters and Oscilloscopes**  
**Attachment 1: MASTER Handout No. 1**

---

**Objective(s):**

- Upon completion of this unit the student will be able to:
- a. Apply electrical measurement knowledge and instruments to test/calibrate electrical circuits;
  - b. Apply electronic measurement knowledge and instruments to test/calibrate electronic circuits;
  - c. Properly connect a multimeter, ammeter, or clamp-on ammeter to a circuit; and use the instrument to safely measure DC current, RMS current, and average current in a DC or AC circuit;
  - d. Properly connect a multimeter, voltmeter, or clamp-on voltmeter to a circuit, and use the instrument to safely measure DC voltage, RMS voltage, and average voltage in a DC or AC circuit;
  - e. Properly connect a multimeter or ohmmeter to a circuit and use the instrument to safely measure resistance in any circuit;
  - f. Properly connect power factor meters to power distribution systems, and measure power factor;
  - g. Properly connect phase meters to test phase rotation and phase angle;
  - h. Properly connect a multimeter, capacitance meter, or inductance meter to a circuit to measure capacitance and inductance;
  - i. Adjust the frequency, amplitude and proper decibel level of a function generator and use the instrument to test electronic and electrical equipment; and,
  - j. Properly set up an oscilloscope for calibrated measurements, and use the instrument to measure frequency, time, degrees of phase shift, DC voltages, voltage peak, and voltage peak-to-peak.

---

**Module Outline:**

- I. Use Electrical Measuring Instruments
  - A. Demonstrate the procedure for safely measuring, current, voltage and resistance in DC circuits
    1. Explain the operation of digital multimeters
    2. Demonstrate the procedure for measuring DC voltage, DC current, and resistance
    3. Demonstrate the measurement of DC voltage, DC current and resistance on a representative machine control
  - B. Demonstrate the measurement of capacitive and inductive components
    1. Provide examples of occasions in which it may be necessary to measure capacitance and inductance



2. Explain the operation of a capacitance and inductance test meter
  3. Demonstrate the procedure for measuring capacitance and inductance
  4. Demonstrate safety procedures for capacitive and inductive tests
  5. Demonstrate tests for capacitance on a DC power supply in a machine control system
  6. Demonstrate the measurement of inductance on an AC inductive motor
- C. Demonstrate the procedures for safe measurement of single phase resistive AC currents voltages and resistance
1. Demonstrate the use of multimeters and clamp-on ammeters in measuring AC voltage, AC current, and resistance
  2. Demonstrate the safety procedures and methods for performing voltage, current, and resistive tests on an AC power distribution system
- D. Demonstrate the measurement of voltage, current, and power in poly-phase AC systems
1. Explain the purpose and use of; phase rotation meters, phase angle meters, and power factor meters
  2. Demonstrate the use of the above meters by performing tests on poly-phase AC power distribution systems
- II. Use Function Generators to Test/Calibrate Circuits
- A. Identify and explain the purpose of the controls on a function generator
1. Frequency range and variable frequency control
  2. Wave form selection control
  3. Amplitude control
  4. DC offset control
  5. Decibel (dB) switches (MASTER Handout AET-E5-HO-2) (Decibels and Logarithms)
- B. Explain the safety procedures and grounding problems associated with the use of function generators
1. Explain the concept of "ground loops" and the relation ship of the common connection point of the function generator to the common connection point of the circuit under test
  2. Explain the expected behavior of servo systems when subjected to signal injection and the safety procedures that must be followed
- C. Demonstrate the use of the function generator for signal injection into a servo amplifier of a robot or CNC machine
1. Explain the purpose of the test for each wave form
  2. Explain the expected outcome of the test
- III. Use Oscilloscopes to Test/Calibrate Circuits
- A. Identify and explain the purpose of the controls on an oscilloscope

1. Beam trace intensity and alignment
  2. Selecting dual or single channel
  3. Selecting alternate or chop frequency and the advantages/disadvantages of both
  4. Time base range and variable time base
  5. Vertical deflection range and variable vertical deflection
  6. Triggering controls, internal and external triggering, selecting a triggering source
  7. Auto/manual triggering
- B. Explain the proper procedures for setting up the scope for calibrated measurements
- C. Explain the safety procedures and grounding problems associated with the use of an oscilloscope
1. Explain the concept of "ground loops" and the relationship of the common connection point of the oscilloscope to the common connection point of the circuit under test
  2. Explain the expected behavior of electronic systems when subjected to testing by the oscilloscope and the safety procedures that must be followed
- D. Demonstrate the use of the oscilloscope in conjunction with the function generator for signal injection into a servo amplifier of a robot or CNC machine
1. Explain the purpose of the test for each wave form
  2. Explain the expected outcome of the test
- E. Demonstrate the methods used to convert horizontal time on an oscilloscope to degrees of rotation of a sine wave, or a phase shift in complex inductive/capacitive circuits

AET-E5-HO-2  
Properly Set Up, Calibrate, and Use Meters and Oscilloscopes  
Attachment 2: MASTER Handout No. 2

---

**Decibels and Logarithms**

This is not the name of a big band, but it's a possibility. Decibels are a scaling system based on powers of ten. Decibels reflect a "figure of merit" describing voltages, current, or power over resistance or area. It can be applied to amplifiers, sensitivity of receivers, or the power of the sound in an industrial plant. It is simply a scale in powers of ten. For example, a function generator will add or subtract 20 decibels to a wave form if you turn the right switch.

Scales built using the decibel system have different ZERO POINTS. A decibel scale can have ANY point defined as "zero decibels" and the measuring method of the scale will be consistent starting with that base number. Audible sound, for example, uses as a zero decibel point, a value equivalent to "sound barely audible by the average human ear". This value is an intensity of  $10^{-12}$  Watts/meter<sup>2</sup>.

Starting with that number, every time the intensity of sound increases by one power of ten, ( $10^1$ ) we add **TEN decibels** to our value. So the *power/area* is actually:

**THE ZERO-DECIBELS VALUE multiplied by 10 raised to the power of (.1 times the number of decibels).**

For example:

If X is the zero value then:

+ 20 decibels is  $X \cdot 10^{2.0}$

or

**100X**

Notice you can have decimals in the power of ten exponent:

For example  $10^{2.5} = 316.227$ , which is the multiplier for **25 decibels**.

For example, leaves rustling in the autumn breeze in the parking lot would have a sound intensity of about 10 decibels.

This means the intensity or power of that sound in Watts/m<sup>2</sup> would be:  
 $10^{-12}$  Watts per meter<sup>2</sup> times 10 to the first power

This equals  $10^{-12} * 10^{1.0}$  or  $10^{-11}$  or .01 Nanowatts/meter<sup>2</sup>. As you can imagine this is **not** a lot of power per square meter.

If we compare it to an ordinary conversation such as often occurs in the middle of lectures, we are comparing 10 decibels to 60 decibels.

This equals the “0 decibels” figure times 10 to the 6.0 power

or

$$1 \times 10^{-12} \times 1 \times 10^{6.0} = 1 \text{ microwatt/m}^2$$

Compared to this zero point, other decibel values of audible sound are:

Sound	Decibels	Calculation	Watts/m <sup>2</sup>
A lover whispering from 1 yard away	20	$1 \times 10^{-12} \times 1 \times 10^{2.0}$	.1 nanowatts
Standing at Market and 1st Ave.	40	$1 \times 10^{-12} \times 1 \times 10^{4.0}$	10 nanowatts
Conversation with the instructor on break	60	$1 \times 10^{-12} \times 1 \times 10^{6.0}$	10 microwatts
Conversation with Rohr Industries	85	$1 \times 10^{-12} \times 1 \times 10^{8.5}$	316.227 u watts
Niagra Falls from the little tour boat	90	$1 \times 10^{-12} \times 1 \times 10^{9.0}$	1 milliwatt
Loud rock band	110	$1 \times 10^{-12} \times 1 \times 10^{11.0}$	612.01 milliwatt
Sound painful to the ear	120	$1 \times 10^{-12} \times 1 \times 10^{12.0}$	1 watt

If you use decibels to measure some electronic value as in the gain delivered by a stereo amplifier, you will get totally different values depending on where the ZERO VALUE is. What is important to notice is that the decibel scale is not *linear* (each decibel adds a fixed amount) but *LOGARITHMIC* (each decibel adds a certain amount to the EXPONENT of 10). It increases exponentially.

A LOGARITHM is “*the number to which a base is raised to give another number*”. Logarithmic scales increase by powers rather than by fixed amounts. If you are using base 10, which is common, the logarithm of 100 is 2 (you raise 10 to the 2d power to get 100). The logarithm of 1000 is 3 (you raise 10 to the 3d power to get 1000) and the logarithm of 721.11 is *somewhere in between*. You can find out quickly if you have a calculator with a log key. For example, the number 721.11:

Using the calculator, the power of ten exponent for 721.11 is  
2.858001518.

In other words ten raised to the 2.858001518 power will give you 721.11.

Logarithms are exponents, and can be mathematically manipulated like exponents which makes it easy to mathematically calculate very large and very small numbers.

The controls on the front panel of a function generator include decibel switches. Using a function generator, and switching the 10 db or 20 db switch on the unit, means that you are multiplying or dividing the current value of the generators output by 10 or 100.

The +10 db switch will multiply the output by 10, and the -10 db switch will divide the output by 10; or the -20 db switch will divide the output by 100, and turning it off will restore the output to its previous value.

**AET-E5-LE**  
**Properly Set Up, Calibrate, and Use Meters and Oscilloscopes**  
**Attachment 3: MASTER Laboratory Exercise**

---

The student will:

1. Use all of the above instruments to perform a simulated preventative maintenance procedure on a machine tool;
2. Use a function generator and an oscilloscope to inject and monitor a wave form in the servo amplifier of a CNC machine or robot; and,
3. Use the oscilloscope to monitor a wave form injected by a function generator in the servo amplifier of a CNC machine.

AET-E5-LA  
**Properly Set Up, Calibrate, and Use Meters and Oscilloscopes**  
Attachment 4: MASTER Laboratory Aid

---

**Rules of Conduct**

1. Absolutely no horseplay or practical joking will be tolerated.
2. Do not talk to anyone who is operating a machine.
3. Walk only in the designated traffic lanes.
4. Dress appropriately; at the absolute minimum, you must have:
  - a. No loose clothing, including ties;
  - b. Long hair properly stowed;
  - c. No jewelry;
  - d. Hard, closed-toe shoes;
  - e. Eye protection (safety glasses); and,
  - f. Ear protection (plugs or headset).
5. Follow all institutional safety rules.

**AET-E6-HO**  
**Use Components Such as Resistors, Inductors, and Capacitors;**  
**Construct Circuits and Test Components**  
**Attachment 1: MASTER Handout**

---

**Objective(s):**

Upon completion of this unit the student will be able to:

- a. Conduct out-of-circuit tests of resistors, inductors, capacitors, and cables using the proper test equipment;
- b. Conduct in-circuit tests of resistors, inductors, capacitors, and cables using the proper test equipment;
- c. Construct circuits consisting of resistors, capacitors, and inductors for special or production purposes using the necessary components, a suitable circuit board or test breadboard, and a schematic diagram; and,
- d. Construct cables using the necessary components and a schematic diagram.

---

**Module Outline:**

- I. Construct Circuits and Test Components
  - A. Testing components out of circuit and in circuit
    1. Explain the procedure for testing resistors out of circuit
    2. Explain the procedure for testing resistors in circuit and the potential problems associated with the testing
    3. Demonstrate the procedures for in circuit and out-of-circuit tests for resistors
    4. Explain the procedure for testing capacitors out of circuit
    5. Explain the procedure for testing capacitors in circuit and the potential problems associated with the testing
    6. Demonstrate the procedures for in circuit and out-of-circuit tests for capacitors
    7. Explain the procedure for testing inductors, including transformers and motors out of circuit
    8. Explain the procedure for testing inductors in circuit and the potential problems associated with the testing
    9. Demonstrate the procedures for in circuit and out-of-circuit tests for inductors
    10. Explain the procedures for testing conductors such as cables or conductors
    11. Demonstrate the procedures for testing conductors such as cables or conductors



- B. Demonstrate the construction procedures for creating electronic circuits and wiring assemblies
1. Demonstrate the procedures used to construct circuits using breadboards, and the layout of a breadboard
  2. Demonstrate the procedures used to construct circuits using a wire wrap board, wire wrap components, and wire wrap tools
  3. Explain the safety procedures that apply when using soldering equipment
  4. Explain the procedures used to remove components from through-hole printed circuit boards
  5. Conduct exercises on soldering components into through-hole printed circuit boards
  6. Explain the methods of removing components from surface mount (SMT) printed circuit boards
  7. Conduct exercises on soldering components onto surface mount (SMT) printed circuit boards
  8. Conduct exercises on constructing wiring assemblies using multi-conductor cables and connectors

**AET-E6-LE**  
**Use Components Such as Resistors, Inductors, and Capacitors;**  
**Construct Circuits and Test Components**  
**Attachment 2: MASTER Laboratory Exercise**

---

The student will use an industrial electronic system to apply the concepts contained in this module.

**Use Components Such as Resistors, Inductors, and Capacitors;  
Construct Circuits and Test Components  
Attachment 3: MASTER Laboratory Aid**

---

**Rules of Conduct**

1. Absolutely no horseplay or practical joking will be tolerated.
2. Do not talk to anyone who is operating a machine.
3. Walk only in the designated traffic lanes.
4. Dress appropriately; at the absolute minimum, you must have:
  - a. No loose clothing, including ties;
  - b. Long hair properly stowed;
  - c. No jewelry;
  - d. Hard, closed-toe shoes;
  - e. Eye protection (safety glasses); and,
  - f. Ear protection (plugs or headset).
5. Follow all institutional safety rules.

## AET-E7-HO-1

### Use Meters/Oscilloscopes to Measure Phase Shift or Angle in Series Resistive-Capacitive/Resistive-Inductive AC Circuits

#### Attachment 1: MASTER Handout No. 1

---

#### Objective(s):

Upon completion of this unit the student will be able to:

- a. Measure degrees on an ordinary dual trace oscilloscope as a function of time;
- b. Apply the knowledge of oscilloscope functions to the measurement of phase angles and phase shift in AC circuits;
- c. Use function generators to test/calibrate circuits;
- d. Use oscilloscopes to test/calibrate circuits;
- e. Adjust the frequency, amplitude and proper decibel level of a function generator and use the instrument to test electronic and electrical equipment;
- f. Properly set up an oscilloscope for calibrated measurements, and use the instrument to measure frequency, time, degrees of phase shift, DC voltages, voltage peak, and voltage peak-to-peak;
- g. Calculate a value of AC current, AC voltage or resistance, in a resistive circuit, given any of the two quantities and apply proper engineering terms to the results of the calculations;
- h. Calculate a value of AC current or AC voltage in an inductive or capacitive circuit given the values of capacitance, inductance, resistance and frequency, and apply proper engineering terms to the results of the calculations;
- i. Predict the behavior of a circuit for a change of any of the values of current, voltage, resistance, capacitance, inductance or frequency, in a capacitive or inductive electronic or electrical AC circuit;
- j. Calculate and measure AC voltage, current and power expressed as peak values, peak-to-peak values, RMS values, and average values; and convert these quantities from one value to another;
- k. Predict the effects of power in the circuit, given the values of current, voltage or resistance in a resistive, capacitive, or inductive electronic or electrical AC circuit;
- l. Calculate the values of inductive reactance, and capacitive reactance in an AC circuit;
- m. Predict the change in behavior of an AC circuit for a change in frequency or a change in capacitance/inductance;
- n. Calculate expected phase shifts in a capacitive or inductive AC circuit;
- o. Measure impedance/phase angle in AC circuits;

- p. Apply the knowledge of inductive reactance, capacitive reactance, and phase shifts, to the solution of power factor problems found in industrial installations;
- q. Apply the knowledge of inductive reactance, capacitive reactance, and phase shifts, to the prediction of the behavior of power in AC electrical/electronic circuits;
- r. Apply the knowledge of poly-phase AC circuits to the calculation and measurement of voltage, current, and power in these circuits;
- s. Measure phase angles in poly-phase AC circuits;
- t. Determine the phase rotation for poly-phase AC motors;
- u. Calculate power in poly-phase AC circuits;
- v. Calculate and predict the voltages that can be obtained from a configuration of a delta or wye poly-phase AC circuit;
- w. Determine reference points for measurement of voltages and currents in a delta or wye configuration poly-phase AC circuit; and,
- x. Determine of the type of power distribution in effect for a configuration of a poly-phase AC circuit.

---

### Module Outline:

- I. Use Function Generators to Test/Calibrate Circuits
  - A. Identify and explain the purpose of the controls on a function generator
    - 1. Frequency range and variable frequency control
    - 2. Wave form selection control
    - 3. Amplitude control
    - 4. DC offset control
    - 5. Decibel (dB) switches (MASTER Handout AET-E7-HO-2) (Decibels and Logarithms)
  - B. Explain the safety procedures and grounding problems associated with the use of function generators
    - 1. Explain the concept of "ground loops" and the relation ship of the common connection point of the function generator to the common connection point of the circuit under test
    - 2. Explain the expected behavior of servo systems when subjected to signal injection and the safety procedures that must be followed
  - C. Demonstrate the use of the function generator for signal injection into a servo amplifier of a robot or CNC machine
    - 1. Explain the purpose of the test for each wave form
    - 2. Explain the expected outcome of the test
- II. Use Oscilloscopes to Test/Calibrate Circuits
  - A. Identify and explain the purpose of the controls on an oscilloscope
    - 1. Beam trace intensity and alignment

2. Selecting dual or single channel
  3. Selecting alternate or chop frequency and the advantages/disadvantages of both
  4. Time base range and variable time base
  5. Vertical deflection range and variable vertical deflection
  6. Triggering controls, internal and external triggering, selecting a triggering source
  7. Auto/manual triggering
- B. Explain the proper procedures for setting up the scope for calibrated measurements
- C. Explain the safety procedures and grounding problems associated with the use of an oscilloscope
1. Explain the concept of "ground loops" and the relationship of the common connection point of the oscilloscope to the common connection point of the circuit under test
  2. Explain the expected behavior of electronic systems when subjected to testing by the oscilloscope and the safety procedures that must be followed
- D. Demonstrate the use of the oscilloscope in conjunction with the function generator for signal injection into a servo amplifier of a robot or CNC machine
1. Explain the purpose of the test for each wave form
  2. Explain the expected outcome of the test
- E. Demonstrate the methods used to convert horizontal time on an oscilloscope to degrees of rotation of a sine wave, or a phase shift in complex inductive/capacitive circuits
- III. Use AC theory; Measure AC Voltages and Currents
- A. Explain the concepts of voltage, current, and resistance for resistive, single phase AC circuits
1. Explain the concepts of voltage, current, and resistance for AC circuits
  2. Explain the units of measurement for AC voltage and current (RMS, peak, peak-to-peak, average)
  3. Provide examples of each quantity
  4. Explain the mathematical tools and procedures that can be used to solve problems in complex resistive AC circuits
  5. Demonstrate the mathematical solution of voltage, current, resistance and power in resistive AC systems
  6. Demonstrate the procedures for verifying the calculations by measurement.
- B. Explain the concept of inductance and capacitance for AC voltages and currents
1. Explain the behavior of AC in a capacitive AC circuit
  2. Explain the behavior of AC in an inductive AC circuit

3. Demonstrate the magnetic field produced by an inductor when energized by AC current
4. Explain how capacitors and inductors are used in AC electrical and electronic circuits, and provide examples of each use in a working control system for a robot or CNC machine
- C. Demonstrate the procedure for safely measuring, current, voltage, resistance, in complex AC circuits
- IV. Calculate/Predict Impedance and Phase Angle in AC Circuits
  - A. Explain the concept of impedance for AC circuits
    1. Explain the concept of impedance
    2. Explain the mathematical tools and procedures that can be used to solve problems in complex resistive, inductive, and capacitive AC circuits
    3. Demonstrate the mathematical solution of voltage ,current, resistance and power in complex resistive, inductive, and capacitive AC systems
  - B. Explain the concept of inductance and capacitance for AC voltages and currents
    1. Demonstrate the phase shift of AC voltage and current in a resistive-capacitive AC circuit
    2. Demonstrate the phase shift of AC voltage and current in a resistive-inductive AC circuit
    3. Explain how capacitors and inductors are used in AC electrical and electronic circuits, and provide examples of each use in a working control system for a robot or CNC machine
- V. Measure Impedance/Phase Angle in AC Circuits
  - A. Demonstrate the measurement of phase shift and phase angle
    1. Explain the precautions that need to be observed when using an oscilloscope to measure AC circuits
    2. Demonstrate the measurement of phase shift and phase angle using an oscilloscope
  - B. Demonstrate the procedure for measuring power factor and the solution of power factor problems
    1. Explain the precautions that need to be observed when using instruments to measure AC line voltages
    2. Demonstrate the calculation of power factor and the determination of capacitors used to correct power factor problems
- VI. Calculate, Predict, and Measure Voltage, Current, and Power in Three Phase AC Systems
  - A. Units of measurement for poly-phase AC
    1. Explain the concepts of phase shift in AC circuits
    2. Provide examples of the various types of poly-phase systems (delta and wye)

3. Provide examples of the mathematical relationship between poly-phase AC voltages, currents, and power
  4. Demonstrate the application of mathematical concepts to the determination of voltage, current, and power in poly-phase AC systems
- B. Measurement of AC voltage current, and power in three phase AC systems
1. Explain the reference points for measuring AC voltage and current in three phase AC systems.(wye and delta)
  2. Demonstrate the measurement of voltage, current, power, and phase angle in three phase AC systems (wye and delta)



**AET-E7-HO-2**  
**Use Meters/Oscilloscopes to Measure Phase Shift or Angle**  
**in Series Resistive-Capacitive/Resistive-Inductive AC Circuits**  
**Attachment 2: MASTER Handout No. 2**

---

**Decibels and Logarithms**

This is not the name of a big band, but it's a possibility. Decibels are a scaling system based on powers of ten. Decibels reflect a "figure of merit" describing voltages, current, or power over resistance or area. It can be applied to amplifiers, sensitivity of receivers, or the power of the sound in an industrial plant. It is simply a scale in powers of ten. For example, a function generator will add or subtract 20 decibels to a wave form if you turn the right switch.

Scales built using the decibel system have different ZERO POINTS. A decibel scale can have ANY point defined as "zero decibels" and the measuring method of the scale will be consistent starting with that base number. Audible sound, for example, uses as a zero decibel point, a value equivalent to "sound barely audible by the average human ear". This value is an intensity of  $10^{-12}$  Watts/meter<sup>2</sup>.

Starting with that number, every time the intensity of sound increases by **one** power of ten, ( $10^1$ ) we add **TEN** decibels to our value. So the *power/area* is actually:

**THE ZERO-DECIBELS VALUE multiplied by 10 raised to the power of (.1 times the number of decibels).**

For example:

If X is the zero value then:

+ 20 decibels is  $X \cdot 10^{2.0}$

or

**100X**

Notice you can have decimals in the power of ten exponent:

For example  $10^{2.5} = 316.227$ , which is the multiplier for 25 decibels.

For example, leaves rustling in the autumn breeze in the parking lot would have a sound intensity of about 10 decibels.

This means the intensity or power of that sound in Watts/m<sup>2</sup> would be:

$10^{-12}$  Watts per meter<sup>2</sup> times 10 to the first power

This equals  $10^{-12} * 10^{1.0}$  or  $10^{-11}$  or .01 Nanowatts/meter<sup>2</sup>. As you can imagine this is **not** a lot of power per square meter.

If we compare it to an ordinary conversation such as often occurs in the middle of lectures, we are comparing 10 decibels to 60 decibels.

This equals the “0 decibels” figure times 10 to the 6.0 power

or

$$1 \times 10^{-12} \times 1 \times 10^{6.0} = 1 \text{ microwatt/m}^2$$

Compared to this zero point, other decibel values of audible sound are:

Sound	Decibels	Calculation	Watts/m <sup>2</sup>
A lover whispering from 1 yard away	20	$1 \times 10^{-12} \times 1 \times 10^{2.0}$	.1 nanowatts
Standing at Market and 1st Ave.	40	$1 \times 10^{-12} \times 1 \times 10^{4.0}$	10 nanowatts
Conversation with the instructor on break	60	$1 \times 10^{-12} \times 1 \times 10^{6.0}$	10 microwatts
Conversation with Rohr Industries	85	$1 \times 10^{-12} \times 1 \times 10^{8.5}$	316.227 u watts
Niagra Falls from the little tour boat	90	$1 \times 10^{-12} \times 1 \times 10^{9.0}$	1 milliwatt
Loud rock band	110	$1 \times 10^{-12} \times 1 \times 10^{11.0}$	612.01 milliwatt
Sound painful to the ear	120	$1 \times 10^{-12} \times 1 \times 10^{12.0}$	1 watt

If you use decibels to measure some electronic value as in the gain delivered by a stereo amplifier, you will get totally different values depending on where the ZERO VALUE is. What is important to notice is that the decibel scale is not *linear* (each decibel adds a fixed amount) but *LOGARITHMIC* (each decibel adds a certain amount to the EXPONENT of 10). It increases exponentially.

A LOGARITHM is “*the number to which a base is raised to give another number*”. Logarithmic scales increase by powers rather than by fixed amounts. If you are using base 10, which is common, the logarithm of 100 is 2 (you raise 10 to the 2d power to get 100). The logarithm of 1000 is 3 (you raise 10 to the 3d power to get 1000) and the logarithm of 721.11 is *somewhere in between*. You can find out quickly if you have a calculator with a log key. For example, the number 721.11:

Using the calculator, the power of ten exponent for 721.11 is  
2.858001518.

In other words ten raised to the 2.858001518 power will give you 721.11.

Logarithms are exponents, and can be mathematically manipulated like exponents which makes it easy to mathematically calculate very large and very small numbers.

The controls on the front panel of a function generator include decibel switches. Using a function generator, and switching the 10 db or 20 db switch on the unit, means that you are multiplying or dividing the current value of the generators output by 10 or 100.

The +10 db switch will multiply the output by 10, and the -10 db switch will divide the output by 10; or the -20 db switch will divide the output by 100, and turning it off will restore the output to its previous value.

**AET-E7-LE**  
**Use Meters/Oscilloscopes to Measure Phase Shift or Angle**  
**in Series Resistive-Capacitive/Resistive-Inductive AC Circuits**  
**Attachment 3: MASTER Laboratory Exercise**

---

The student will:

1. Use a function generator and an oscilloscope to inject and monitor a wave form in the servo amplifier of a CNC machine or robot;
2. Use the oscilloscope to monitor a wave form injected by a function generator in the servo amplifier of a CNC machine;
3. Use an industrial control system to demonstrate the measurement of voltage, current, resistance, power, in AC circuits;
4. Calculate the parameters of the system from the measurements;
5. Use a CNC or robotic control system to identify AC capacitive and inductive circuits and the methods of determining impedance, voltages, and currents in these circuits;
6. Use the power distribution system to a building or facility to measure voltage, current (clamp-on ammeter), power and power factor;
7. Calculate the type of power factor capacitors need to correct the power factor for the system;
8. Measure voltages in three phase AC power distribution systems; and,
9. Measure voltages and currents in three phase resistive and inductive AC circuits.

**Use Meters/Oscilloscopes to Measure Phase Shift or Angle  
in Series Resistive-Capacitive/Resistive-Inductive AC Circuits**  
Attachment 4: MASTER Laboratory Aid

---

**Rules of Conduct**

1. Absolutely no horseplay or practical joking will be tolerated.
2. Do not talk to anyone who is operating a machine.
3. Walk only in the designated traffic lanes.
4. Dress appropriately; at the absolute minimum, you must have:
  - a. No loose clothing, including ties;
  - b. Long hair properly stowed;
  - c. No jewelry;
  - d. Hard, closed-toe shoes;
  - e. Eye protection (safety glasses); and,
  - f. Ear protection (plugs or headset).
5. Follow all institutional safety rules.

**AET-E8-HO**  
**Apply Electromagnetism Theory**  
**to Determine Operational Characteristics**  
**of Relays, Solenoids, Transformers, and Electrical Motors**  
**for DC and AC Circuits**  
**Attachment 1: MASTER Handout**

---

**Objective(s):**

Upon completion of this unit the student will be able to:

- a. Apply electromagnetism theory to determine operational characteristics of relays, and solenoids;
- b. Apply electromagnetism theory to determine operational characteristics of transformers;
- c. Apply electromagnetism theory to determine operational characteristics of electrical motors for DC and AC circuits;
- d. Apply the knowledge of magnetism to the solution of problems found in electrical/electronic control circuits;
- e. Apply the knowledge of the electromagnetic effect to the determination of the nature of the device under test;
- f. Apply the knowledge of the electromagnetic effect, the concept of inductive reactance, the knowledge of the theory of the operation of electrical motors, and Ohm's Law to the solution of problems found in electrical motors;
- g. Apply the knowledge of electromagnetic effect, the theory of transformers, Ohm's Law, and the concept of inductive reactance to the solution of problems found in transformers; and,
- h. Apply the knowledge of the electromagnetic effect, inductive reactance, and Ohm's Law to the solution of problems found in electromagnetic devices such as relays and solenoids.

---

**Module Outline:**

- I. Apply Electromagnetism Theory to Determine Operational Characteristics of Relays and Solenoids
  - A. Principles of electromagnetism
    1. Explain the concepts of magnets and magnetic fields
    2. Demonstrate magnetic lines of force for permanent magnets and electromagnets
    3. Explain and demonstrate the creation of a magnetic field from an electrical current
    4. Explain and demonstrate the relationship of magnetic field strength as a function of the following:
      - a. Magnitude of current

- b. Cross sectional area of wire and wire resistance
  - c. Number of turns of wire
  - d. Electromagnet core
  - e. Force created by the electromagnet
  - 5. Explain and demonstrate the differences between an AC electromagnet and a DC electromagnet
  - B. Explain the operating principles of relays and solenoids
    - 1. Describe the purpose of a relay and its component parts
    - 2. Demonstrate the operation of a relay
    - 3. Explain the parameters of a DC electromagnet for a DC relay
      - a. Resistance of the coil
      - b. Relay pick up current and relay drop out current
      - c. Wire size as compared to number of turns of wire
    - 4. Demonstrate and measure the inductive transient of a DC relay
      - a. Explain the principles of inductive transients
      - b. Construct a relay circuit and measure the inductive transient when the relay de-energizes
    - 5. Explain and demonstrate the parameters of an AC relay
      - a. Coil resistance as compared to inductive reactance
      - b. Relay pick up and drop out current
      - c. Phase relationships in AC relay coils (60Hz)
      - d. Behavior of a magnetic field in an AC relay coil
    - 6. Explain the parameters of a DC solenoid
      - a. Resistance of the coil
      - b. Solenoid actuation current and drop out current as a function of the bias spring
      - c. Wire size as compared to number of turns of wire
    - 7. Demonstrate and measure the inductive transient of a DC solenoid
      - a. Explain the principles of inductive transients
      - b. Construct a solenoid circuit and measure the inductive transient created when the solenoid de-energizes
    - 8. Explain and demonstrate the parameters of an AC solenoid
      - a. Coil resistance as compared to inductive reactance
      - b. Solenoid pick up and drop out current
      - c. Phase relationships in AC relay coils (60Hz)
  - C. Explain the principles of inductive transient suppression, and the devices used
    - 1. Explain the principles of inductive transient suppression
    - 2. Explain and demonstrate the devices used to suppress inductive transients in DC relays and solenoids
    - 3. Explain and demonstrate the devices used to suppress inductive transients in AC relays and solenoids
- II. Apply Electromagnetism Theory to Determine Operational Characteristics of Transformers

- A. Principles of transformers
  - 1. Explain the concepts of magnetic induction
  - 2. Explain the uses of transformers in the distribution and transformation of power. Stress and emphasize the fact that a transformer *only* works on AC
  - 3. Explain, demonstrate and identify the component parts of a transformer
  - 4. Explain and demonstrate the relationship of the primary magnetic field to the secondary current
    - a. Magnitude of current
    - b. Cross sectional area of wire and wire resistance
    - c. Number of turns of wire of primary and secondary
    - d. Electromagnet core
    - e. Inductive reactance
  - 5. Explain and demonstrate the relationship of the secondary magnetic field to the primary current
- B. Explain the operating principles of transformers
  - 1. Describe the turns relationship between the primary and secondary
  - 2. Explain the relationship between the voltage and current in the primary and the voltage and current in the secondary
  - 3. Explain power transfer from primary to secondary and the phase relationship of primary and secondary voltage and current
  - 4. Demonstrate the calculation of voltage and current for step up and step down transformers
  - 5. Explain, identify, and demonstrate transformers with multiple secondaries and tapped primaries and secondaries
  - 6. Demonstrate the methods for wiring primary and secondaries of transformers
- C. Explain the principles of operation of three phase transformers
  - 1. Describe the turns relationship between the primary and secondary
  - 2. Explain the relationship between the voltage and current in the primary and the voltage and current in the secondary
  - 3. Explain power transfer from primary to secondary and the phase relationship of primary and secondary voltage and current
  - 4. Demonstrate the calculation of voltage and current for step up and step down transformers
  - 5. Explain, identify, and demonstrate transformers with multiple secondaries and tapped primaries and secondaries
  - 6. Demonstrate the methods for wiring primary and secondaries of three phase transformers



- III. Apply Electromagnetism Theory to Determine Operational Characteristics of Electrical Motors for DC and AC Circuits
- A. Identify, explain, and demonstrate operating principles of motors
1. Explain the principles by which an electrical motor creates harmonic motion
    - a. Application of force through opposing and attracting rotating magnets
    - b. Types of magnets used to create magnetic fields (permanent and electromagnets)
    - c. Examples of harmonic motion (child's swing with adult pushing swing)
    - d. Switching of electrical currents in electromagnets to produce harmonic motion
    - e. Methods by which direction of electrical currents may be switched, to produce magnetic fields of opposite polarities (commutator and alternating current (AC))
  2. Provide examples of the various types of harmonic switching methods (commutator for DC motors, and phase shifting of AC currents for AC motors)
  3. Demonstrate the application of mathematical concepts to the determination of voltage, current, power, and efficiency in electrical motors
- B. Identify, explain, and demonstrate the principles of operation of DC motors
1. Explain the two methods of producing magnetic fields in DC motors
    - a. Permanent magnet (fixed field or rotating field) and electromagnet (fixed field or rotating field)
    - b. Electromagnet and electromagnet (fixed and rotating field)
  2. Explain the mechanisms by which the magnet fields are switched in DC motors
    - a. Commutator method for rotating fields and commutator timing for harmonic motion
    - b. Semiconductor method for fixed magnetic fields and timing methods for harmonic motion
  3. Identify and define the proper terms for the parts of a DC motor
    - a. Armature (rotating field)
    - b. Field magnet (fixed field)
    - c. Commutator and brushes (switching mechanism)
    - d. Determination of the number of poles in the armature of a motor and the relationship of the number of poles to force and smooth operation of the motor
    - e. Limitations of armature size to the number of poles in the armature

4. Demonstrate the application of mathematical concepts to the determination of torque and speed in electrical motors
- C. Identify, explain, and demonstrate the principles of operation of inductive AC motors
1. Explain the method of producing magnetic fields in inductive AC motors
    - a. Electromagnetic field (stator) and phase shifted electromagnetic field (rotor)
    - b. Use as a model, a transformer in which the primary is the fixed magnetic field, (stator) and the secondary is a rotating secondary magnetic field (rotor)

*Note:* At this level of training, this model has been found to be the most effective model for explaining the operating principles of AC motors. An in depth knowledge of AC motors is the subject of an entire book, and requires advanced mathematics to understand
  2. Explain the principles by which the magnet fields are switched in inductive, single phase, AC motors to produce harmonic motion
    - a. Fixed Primary (stator) is composed of many turns of wire while rotating secondary (rotor) is composed of only one turn
    - b. Relationship of fixed primary (stator) current to rotating secondary (rotor) current is 100 to 1 or greater
    - c. Primary (stator) AC phase currents have a phase shifted relationship to rotating secondary (rotor) currents which produce strong magnetic fields that are out of phase to the primary (stator)
    - d. Momentum of the secondary (rotor) shifts the magnetic field in relationship to the primary magnetic field (stator), producing harmonic motion
    - e. If the motor is not rotating during the first application of current to the primary (stator), the apparatus will exhibit the characteristics of an AC electromagnet and the rotor will lock in relationship to the stator (locked rotor) (Demonstrate this principle using a single phase inductive motor with the starting mechanism disabled)
    - f. Explain the methods by which momentum can be imparted to the motor to start the rotation
      - (1) Phase shifted magnetic fields produced by capacitive means
      - (2) Phase shifted magnetic fields produced by inductive principles
      - (3) Phase shift produced by three phase AC in three phase AC inductive motors

3. Identify and define the proper terms for the parts of a AC motor
  - a. Squirrel cage rotor (rotating field)
  - b. Stator windings (fixed field)
  - c. Start windings
  - d. Start mechanisms
4. Demonstrate the application of mathematical concepts to the determination of torque and speed in inductive AC electrical motors

**AET-E8-LE**  
**Apply Electromagnetism Theory**  
**to Determine Operational Characteristics**  
**of Relays, Solenoids, Transformers, and Electrical Motors**  
**for DC and AC Circuits**  
**Attachment 2: MASTER Laboratory Exercise**

---

The student will:

1. Identify the types relays found in an industrial control system and the suppression devices employed;
2. Measure voltages and currents in the relays found in an industrial control system;
3. Measure voltages and currents in single phase, split phase, and three phase AC power transformers;
4. Connect and properly wire single phase, split phase, and three phase power transformers;
5. Measure voltages and currents in single phase and three phase inductive AC motors; and,
6. Calculate power and efficiencies in single phase and three phase inductive AC motors.

**AET-E8-LA**  
**Apply Electromagnetism Theory**  
**to Determine Operational Characteristics**  
**of Relays, Solenoids, Transformers, and Electrical Motors**  
**for DC and AC Circuits**  
**Attachment 3: MASTER Laboratory Aid**

---

**Rules of Conduct**

1. Absolutely no horseplay or practical joking will be tolerated.
2. Do not talk to anyone who is operating a machine.
3. Walk only in the designated traffic lanes.
4. Dress appropriately; at the absolute minimum, you must have:
  - a. No loose clothing, including ties;
  - b. Long hair properly stowed;
  - c. No jewelry;
  - d. Hard, closed-toe shoes;
  - e. Eye protection (safety glasses); and,
  - f. Ear protection (plugs or headset).
5. Follow all institutional safety rules.

**AET-E9-HO**  
**Apply Principles of Operation of Electrical Motors**  
**to Identify Various Types of Motors**  
**Attachment 1: MASTER Handout**

---

**Objective(s):**

Upon completion of this unit the student will be able to:

- a. Identify DC motors such as permanent magnetic DC motors, series field DC motors, shunt field DC motors, combination DC motors, and universal motors;
- b. Identify AC motors such as split phase capacitive start motors, split phase capacitive start-capacitive run motors, inductive start-inductive run motors, three phase squirrel cage motors, and universal motors;
- c. Explain the applications of each type of motor;
- d. Identify the various parts of a DC motor such as the armature, commutator, brushes, field windings or field magnets;
- e. Remove and replace brushes, clean commutators, and properly disassemble and wire a permanent magnet DC motor;
- f. Identify the various parts of an AC inductive motor such as starting capacitor, centrifugal switch, start windings, stator, and squirrel cage rotor; and,
- g. Remove and replace starting capacitors, centrifugal switch, and properly wire a three phase AC motor for proper rotation.

---

**Module Outline:**

- I. Apply Principles of DC Electrical Motors to Identify and Assemble/Disassemble Various Types of DC Motors
  - A. Identify the parts of the following types of DC electrical motors
    1. Permanent magnet DC motors
    2. Shunt field DC motors
    3. Series field DC motors
    4. Universal motors
  - B. Explain and demonstrate the characteristics of the above types of DC motors
  - C. Demonstrate the application of mathematical concepts to the determination of torque and speed in the above motors
  - D. Demonstrate procedures to test the following motor components
    1. Brushes/armature
    2. Field windings
  - E. Demonstrate the assembly/disassembly of the following motor components
    1. Brushes/brush holder

2. Armature bearings
- II. Apply Principles of AC Electrical Motors to Identify and Assemble/Disassemble Various Types of AC Motors
- A. Identify the parts of the following types of inductive AC electrical motors
    1. Single phase/split phase, capacitor start motors
    2. Single phase/split phase, capacitor start/capacitor run motors
    3. Single phase/split phase, inductive start/inductive run motors
    4. Universal motors
    5. Three phase inductive AC squirrel cage motors
  - B. Explain and demonstrate the characteristics of the above types of AC motors
  - C. Demonstrate the application of mathematical concepts to the determination of torque and speed in the above motors
  - D. Demonstrate procedures to test the following motor components
    1. Start switches
    2. Stator windings
  - E. Demonstrate the assembly/disassembly of the following motor components
    1. Start switches
    2. Armature bearings

**AET-E9-LE**  
**Apply Principles of Operation of Electrical Motors**  
**to Identify Various Types of Motors**  
**Attachment 2: MASTER Laboratory Exercise**

---

The student will:

1. Demonstrate procedures to test the following DC motor components:
  - a. Brushes/armature;
  - b. Field windings;
2. Demonstrate the assembly/disassembly of the following DC motor components:
  - a. Brushes/brush holder;
  - b. Armature bearings;
3. Demonstrate procedures to test the following motor AC components:
  - a. Start switches;
  - b. Stator windings;
4. Demonstrate the assembly/disassembly of the following AC motor components:
  - a. Start switches;
  - b. Armature bearings;
5. Replace bearings and or start switches in industrial AC motors; and,
6. Measure voltages, currents and winding resistance in industrial motors.



**AET-E9-LA**  
**Apply Principles of Operation of Electrical Motors**  
**to Identify Various Types of Motors**  
**Attachment 3: MASTER Laboratory Aid**

---

**Rules of Conduct**

1. Absolutely no horseplay or practical joking will be tolerated.
2. Do not talk to anyone who is operating a machine.
3. Walk only in the designated traffic lanes.
4. Dress appropriately; at the absolute minimum, you must have:
  - a. No loose clothing, including ties;
  - b. Long hair properly stowed;
  - c. No jewelry;
  - d. Hard, closed-toe shoes;
  - e. Eye protection (safety glasses); and,
  - f. Ear protection (plugs or headset).
5. Follow all institutional safety rules.

**AET-E10-HO**  
**Apply Semiconductor Theory and Measurement Techniques**  
**to Determine Operational Characteristics**  
**of Diodes, Transistors, and Power Control Semiconductors**  
**Attachment 1: MASTER Handout**

---

**Objective(s):**

Upon completion of this unit the student will be able to:

- a. Explain the theory of operation of a semiconductor diode, the types of diodes used in electronic circuits, and the specifications of various semiconductor diodes;
- b. Use rules of semiconductor devices and meters or oscilloscopes to test semiconductor diodes, including zener diodes;
- c. Explain the theory of operation of a bipolar transistor, the types of transistors used in electronic circuits, and the specifications of various transistors;
- d. Use meters or oscilloscopes to test bipolar transistors;
- e. Explain the theory of operation of MOSFET (metal oxide field effect semiconductors) transistors, the types of power MOSFETs used in electronic circuits, and the specifications of various transistors;
- f. Use meters or oscilloscopes to test power MOSFET transistors;
- g. Explain the theory of operation of power control semiconductors such as SCRs (silicon controlled rectifiers) TRIACs, and GTOs (gate turn on devices) and the types of semiconductors used to trigger these devices such as UJT (unijunction transistors) and PUT (programmable unijunction transistors); and,
- h. Use meters/oscilloscopes to test the above power control semiconductors and their triggering devices.

---

**Module Outline:**

- I. Use Rules of Semiconductor Devices and Meters or Oscilloscopes to Test Diodes
  - A. Principles of semiconductors
    1. Explain the concepts of conductors and semiconductors and the material properties of elements used to construct semiconductors
    2. Explain the methods used to change the electrical properties of semiconductor material such as intrinsic silicon
    3. Explain the difference in the properties of N silicon material and P silicon material
    4. Explain the theory of the following properties of a junction semiconductor:

- a. Semiconductor junction
  - b. Depletion region
  - c. Barrier potential
  - d. Electron flow through a semiconductor
- B. Explain the operating principles of a silicon junction diode
1. List the uses of a junction diode
  2. Describe the concept of biasing a junction diode
  3. Describe the behavior of a silicon junction diode when it is forward biased and reverse biased
  4. Explain the parameters of a silicon junction diode
    - a. Barrier potential
    - b. Forward current
    - c. Peak inverse voltage (PIV)
  5. Demonstrate and measure the following parameters of a silicon junction diode
    - a. Forward conduction resistance as a function of forward current
    - b. Reverse current as a function of reverse voltage
    - c. Barrier potential voltage as a function of forward current
  6. Demonstrate the failure modes of a silicon junction diode by stressing the diode beyond its design limits
  7. Demonstrate the use of semiconductor specification manuals to research the properties of a given diode
- C. Explain the principles of operation of a zener diode
1. Explain the uses of a zener diode
  2. Explain the properties of a zener diode when it is forward biased and reverse biased
    - a. Forward conduction and forward barrier potential
    - b. Reverse conduction at designed break down potential
  3. Demonstrate the operation and testing of a zener diode
  4. Demonstrate the use of semiconductor specification manuals to research the properties of a given zener diode
- D. Conduct lab exercises in the principles of operation and measurement of junction diodes and zener diodes
- II. Use Meters or Oscilloscopes to Test Bipolar Transistors and Power MOSFETs
- A. Principles of bipolar transistors
1. Explain the construction of a bipolar transistor
  2. Explain the uses of transistors and the two types of bipolar transistors, NPN and PNP
  3. Explain the nomenclature and purpose of the parts of a bipolar transistor
    - a. Base
    - b. Emitter
    - c. Collector

4. Explain, demonstrate and identify the three operating modes of a transistor:
    - a. Saturation (closed switch)
    - b. Cut off (open switch)
    - c. Resistive (resistor)
  5. Demonstrate the relationship of the parts of a bipolar transistor
    - a. Explain the concept of gain
    - b. Relationship of base to current of emitter and collector (gain)
    - c. Proper biasing arrangement of emitter, base, and collector and application of source voltage
  6. Explain the failure modes of a bipolar transistor
  7. Demonstrate the testing and measurement of a bipolar transistor
- B. Explain the operating principles of a MOSFET transistor
1. Explain the uses for MOSFET transistors and the advantages of MOSFETs
  2. Describe the design and construction of a MOSFET and the parts of a MOSFET
  3. Describe the relationship between the gate and the channel of a MOSFET
  4. Explain the method by which current through the channel is controlled by the gate
  5. Describe the difference between enhancement mode MOSFETs and depletion mode MOSFETs
  6. Demonstrate the testing and measurement of MOSFET transistors
  7. Demonstrate the use of a specifications manual to determine the parameters of a MOSFET
- C. Conduct lab exercises in the principles of operation and measurement of transistors
- III. Use Meters/Oscilloscopes to Test Power Control Semiconductors and Their Triggering Devices
- A. Identify, explain, and demonstrate operating principles of SCRs
1. Explain the uses of SCRs in industrial applications
  2. Identify and explain the electrical properties of the parts of a SCR
    - a. Gate
    - b. Anode
    - c. Cathode
  3. Explain the methods used to turn on and turn off a SCR
  4. Explain and demonstrate the behavior of a SCR when used in a DC circuit
  5. Explain and demonstrate the behavior of a SCR when used in an AC circuit

6. Identify and explain the operating parameters of an SCR and demonstrate the use of a technical specifications manual to obtain data on the properties of a SCR
- B. Identify, explain, and demonstrate the principles of operation of TRIACs
1. Explain the uses of TRIACs in industrial applications
  2. Identify and explain the electrical properties of the parts of a TRIAC
  3. Explain the methods used to turn on and turn off TRIACs
  4. Explain and demonstrate the behavior of a TRIAC when used in a DC circuit
  5. Explain and demonstrate the behavior of a TRIACs when used in an AC circuit
  6. Identify and explain the operating parameters of a TRIAC and demonstrate the use of a technical specifications manual to obtain data on the properties of a TRIAC
- C. Identify, explain, and demonstrate the principles of operation of semiconductors used to trigger SCRs or TRIACs
1. Explain the use of unijunction transistor (UJT) in industrial applications
  2. Identify and explain the electrical properties of the parts of a UJT
  3. Explain the methods used to turn on and turn off UJTs
  4. Explain and demonstrate the behavior of a UJT when used in a DC circuit (relaxation oscillator)
  5. Explain and demonstrate the behavior of a UJT when used in an SCR or TRIAC firing circuit
  6. Identify and explain the operating parameters of a UJT and demonstrate the use of a technical specifications manual to obtain data on the properties of a UJT
  7. Explain the uses of programmable unijunction transistors (PUT) in industrial applications
  8. Identify and explain the electrical properties of the parts of a PUT
  9. Explain the methods used to turn on and turn off PUTs
  10. Explain and demonstrate the behavior of a PUT when used in a DC circuit
  11. Explain and demonstrate the behavior of a PUTs when used to trigger a SCR or TRIAC circuit
  13. Identify and explain the operating parameters of a PUT and demonstrate the use of a technical specifications manual to obtain data on the properties of a PUT
- D. Identify, explain, and demonstrate the principles of operation of other semiconductors used to trigger SCRs or TRIACs such as the Silicon bi-directional switch (SBS) or DIAC

- E. Conduct lab exercises in the principles of operation and measurement of SCRs, TRIACs, and their associated triggering devices

**AET-E10-LE**  
**Apply Semiconductor Theory and Measurement Techniques**  
**to Determine Operational Characteristics**  
**of Diodes, Transistors, and Power Control Semiconductors**  
**Attachment 2: MASTER Laboratory Exercise**

---

The student will:

1. Identify the types of diodes found in an industrial control system and test the diodes;
2. Identify transistors used in CNC or robot control systems;
3. Measure the electrical behavior of transistors in the above control systems; and,
4. Measure voltages and currents in industrial power control circuits using oscilloscopes and meters.

**AET-E10-LA**  
**Apply Semiconductor Theory and Measurement Techniques**  
**to Determine Operational Characteristics**  
**of Diodes, Transistors, and Power Control Semiconductors**  
**Attachment 3: MASTER Laboratory Aid**

---

**Rules of Conduct**

1. Absolutely no horseplay or practical joking will be tolerated.
2. Do not talk to anyone who is operating a machine.
3. Walk only in the designated traffic lanes.
4. Dress appropriately; at the absolute minimum, you must have:
  - a. No loose clothing, including ties;
  - b. Long hair properly stowed;
  - c. No jewelry;
  - d. Hard, closed-toe shoes;
  - e. Eye protection (safety glasses); and,
  - f. Ear protection (plugs or headset).
5. Follow all institutional safety rules.



**AET-E11-HO**  
**Apply Semiconductor Theory and Measurement Techniques**  
**to Determine Operational Characteristics**  
**of Rectifiers/Filtering Circuits for Single and Three Phase**  
**DC Power Supplies**  
**Attachment 1: MASTER Handout**

---

**Objective(s):**

Upon completion of this unit the student will be able to:

- a. Explain the theory of operation of AC rectification using semiconductor diodes for half wave, full wave, full wave bridge, and three phase full wave bridge, rectifier circuits;
- b. Test half wave, full wave, full wave bridge, and three phase full wave bridge rectifier circuits;
- c. Explain the theory of operation of filtering components used in electronic DC power supplies;
- d. Test filtering components used in electronic DC power supplies such as capacitors and inductors;
- e. Explain the theory of operation of semiconductor regulators used in electronic DC power supplies; and,
- f. Test semiconductor regulators used in electronic DC power supplies

---

**Module Outline:**

- I. Use Meters/Oscilloscopes to Test Power Supply Circuits, Including Rectifiers/Filtering Circuits for Single and Three Phase DC Power Supplies
  - A. Principles of rectification
    1. Explain the concept of diodes used to convert AC to DC (rectification)
    2. Explain the methods used to reduce AC voltages to acceptable levels for power supplies (transformers)
    3. Explain the following methods of rectification:
      - a. Half wave
      - b. Full wave
      - c. Full wave bridge
      - d. Three phase full wave
      - e. Three phase full wave bridge
    4. Explain the principles of ripple on the rectified DC power and the parameters associated with rectification
      - a. Amplitude of ripple associated with type of rectification
      - b. Frequency of ripple associated with type of rectification
  - B. Explain the principles of filtration

1. List the types of passive devices used to provide filtration (capacitors and inductors)
  2. Describe behavior of a capacitor in filtering the ripple frequency
  3. Describe the behavior of an inductor in filtering the ripple frequency
  4. Explain the use of the combination of resistors, capacitors, and inductors in filtering voltage and current in a DC power supply
  5. Demonstrate and measure the following parameters of a passive filter circuit in a DC power supply
    - a. Current filtration
    - b. Voltage filtration
- C. Conduct lab experiences in the principles of rectification and filtration for electronic DC power supplies
- II. Use Schematics and Meters or Oscilloscopes to Identify, Replace and/or Troubleshoot and Repair, Series, Shunt, and Switching Semiconductor, DC Power Supply, Regulator Circuits
- A. Principles of electronic semiconductor regulators for DC power supplies
1. Explain the operating principles of a series regulator
  2. Explain the operating principles of a shunt regulator
  3. Explain the operating principles of a switching regulator
  4. Explain, demonstrate and identify the types of semiconductors used in DC power supply regulators and their operating modes
    - a. Series regulators
      - (1) Bipolar power transistors
      - (2) Resistive mode
      - (3) Circuits used to provide feedback for series regulator power supplies
    - b. Shunt regulators
      - (1) Bipolar power transistors
      - (2) Resistive mode
      - (3) Circuits used to provide feedback for shunt regulator power supplies
    - c. Switching regulators
      - (1) Theory of duty cycle
      - (2) Bipolar transistors and power MOSFETs
      - (3) Switching mode (closed switch and open switch)
      - (4) Circuits used to provide feedback and timing for switching power supplies
    - d. Other types of regulator circuits
- B. Crowbar circuits using SCRs for electronic power supplies
- C. Conduct lab experiences in the principles of semiconductor filtration and regulation for electronic DC power supplies

**AET-E11-LE**  
**Apply Semiconductor Theory and Measurement Techniques**  
**to Determine Operational Characteristics**  
**of Rectifiers/Filtering Circuits for Single and Three Phase**  
**DC Power Supplies**  
**Attachment 2: MASTER Laboratory Exercise**

---

The student will:

1. Identify the types of diodes found in an industrial control system and test the diodes; and,
2. Identify and measure DC power supplies used in CNC or robot control systems.

**AET-E11-LA**  
**Apply Semiconductor Theory and Measurement Techniques**  
**to Determine Operational Characteristics**  
**of Rectifiers/Filtering Circuits for Single and Three Phase**  
**DC Power Supplies**  
**Attachment 3: MASTER Laboratory Aid**

---

**Rules of Conduct**

1. Absolutely no horseplay or practical joking will be tolerated.
2. Do not talk to anyone who is operating a machine.
3. Walk only in the designated traffic lanes.
4. Dress appropriately; at the absolute minimum, you must have:
  - a. No loose clothing, including ties;
  - b. Long hair properly stowed;
  - c. No jewelry;
  - d. Hard, closed-toe shoes;
  - e. Eye protection (safety glasses); and,
  - f. Ear protection (plugs or headset).
5. Follow all institutional safety rules.

**AET-E12-HO**  
**Apply Semiconductor Theory and Measurement Techniques**  
**to Determine Operational Characteristics**  
**of Amplifiers and Sensors**  
**Attachment 1: MASTER Handout**

---

**Objective(s):**

Upon completion of this unit the student will be able to:

- a. Apply the knowledge of amplification to the solution of problems found in electrical/electronic control circuits;
  - b. Apply the knowledge of semiconductor amplifiers to the determination of the nature of the device under test;
  - c. Apply the knowledge of the types of sensors employed in automation circuits and systems to repair the circuit or subsystem; and,
  - d. Test amplifiers and the sensors associated with them.
- 

**Module Outline:**

- I. Apply Semiconductor Theory and Amplifier Concepts to Troubleshoot and Replace or Repair Amplifier Modules
  - A. Principles of amplification
    1. Explain the concept of current, voltage and power amplification
    2. Explain the methods used to create amplification
    3. Explain the following devices used to create amplification and the parameters of each circuit:
      - a. Transistor amplifiers
        - (1) Classes of operation
        - (2) Common emitter circuits
        - (3) Common collector circuits (emitter follower)
        - (4) Common base circuits
        - (5) Explain the current, voltage, and power characteristics of each of the above circuits
      - b. MOSFET amplifiers
    4. Explain the operation of the transistor differential amplifier circuit
  - B. Explain the principles of operational amplifiers
    1. List the uses of the integrated circuit, operational amplifier
    2. Describe the behavior of an integrated circuit operational amplifier under open loop amplification
      - a. Gain
      - b. Input impedance
      - c. Slew rate

3. Describe the methods for tailoring the gain of the operational amplifier and the calculation of gain for each configuration
    - a. Negative feedback (closed loop)
    - b. Inverting amplifiers
    - c. Non inverting amplifiers
    - d. Enhanced slew rate, positive feed back operational amplifiers
  4. Explain the use of the combination of resistors, capacitors, and inductors in filtering and tailoring the gain of an operational amplifier (active filters)
  5. Demonstrate and measure the parameters of a passive filter circuit in an operational amplifier circuit
  6. Demonstrate and measure the parameters of a active filter circuit in an operational amplifier circuit
- C. Conduct lab experiences in the principles of electronic amplification
- II. Use Schematic Diagrams and Meters or Oscilloscopes to Test Sensors and Sensor Circuits
- A. Principles of analog to digital (A/D) and digital to analog (D/A) decoders
1. Explain and demonstrate the principles of an analog to digital (A/D) decoder
  2. Explain and demonstrate the principles of a digital to analog (D/A) decoder
- B. Principles of electronic sensors
1. Explain the six methods of producing an electromotive force
    - a. Electromagnetic
    - b. Photovoltaic
    - c. Friction
    - d. Thermoelectric (seebeck) effect
    - e. Piezoelectric effect
    - f. Electrochemical effect
  2. Explain the operating principles of resistive sensors:
    - a. Strain gauges
    - b. Temperature resistive devices
    - c. Bridge circuits
  3. Demonstrate the application of the above concepts to the following types of sensors:
    - a. Pressure sensors
    - b. Acceleration sensors
    - c. Force sensors
    - d. Temperature sensors
      - (1) Thermocouples
      - (2) RTDs (resistance temperature detectors)
      - (3) Semiconductor temperature sensors
    - e. Linear variable differential transformers (LVDT)

- f. pH sensors
  - g. Photovoltaic sensors and semiconductor photosensors
    - (1) Photometers
    - (2) Photo switch
4. Explain, demonstrate and identify the types of position measuring sensors
- a. Optical transducers
    - (1) Linear optical transducers
    - (2) Rotary optical transducers
    - (3) Explain and demonstrate the concept of light interference and the theory of operation of optical positioning transducers
    - (4) Explain the theory of operation of the electronic circuits that amplify and decode optical transducer outputs
  - b. Inductive transducers
    - (1) Resolvers
    - (2) Linear inductosyns
    - (3) Explain and demonstrate the theory of operation of inductive positioning transducers
    - (4) Explain the theory of operation of the electronic circuits that amplify and decode inductive transducer outputs
- C. Conduct lab experiences on the principles of sensors and A/D D/A converters

**AET-E12-LE**  
**Apply Semiconductor Theory and Measurement Techniques**  
**to Determine Operational Characteristics**  
**of Amplifiers and Sensors**  
**Attachment 2: MASTER Laboratory Exercise**

---

The student will:

1. Identify the types of amplifiers found in an industrial control system and test the amplifiers; and,
2. Identify and measure sensors used in a CNC or robot control systems.



**AET-E12-LA**  
**Apply Semiconductor Theory and Measurement Techniques**  
**to Determine Operational Characteristics**  
**of Amplifiers and Sensors**  
**Attachment 3: MASTER Laboratory Aid**

---

**Rules of Conduct**

1. Absolutely no horseplay or practical joking will be tolerated.
2. Do not talk to anyone who is operating a machine.
3. Walk only in the designated traffic lanes.
4. Dress appropriately; at the absolute minimum, you must have:
  - a. No loose clothing, including ties;
  - b. Long hair properly stowed;
  - c. No jewelry;
  - d. Hard, closed-toe shoes;
  - e. Eye protection (safety glasses); and,
  - f. Ear protection (plugs or headset).
5. Follow all institutional safety rules.

**AET-E13-HO-1**  
**Use Schematic Diagrams, Meters, And Oscilloscopes**  
**To Identify, Troubleshoot And Repair Or Replace**  
**Various Types Of Electronic Motor Control Circuits**  
Attachment 1: MASTER Handout No. 1

---

**Objective(s):**

Upon completion of this unit the student will be able to:

- a. Identify a particular type of DC or AC motor control system by examination of a schematic diagram;
- b. Apply the knowledge of the theory of operation of the following types of motor controls to the process of troubleshooting the motor control: SCR controls, triac controls, pulse width modulated (PWM) controls, variable frequency inverter controls, and synchronous AC motor controls;
- c. Determine if the control can be repaired in the field, or if the control must be replaced, and repair or replace the control; and,
- d. Apply the knowledge of the following concepts to the troubleshooting of motor controls: IR compensation, instantaneous over current, volts per hertz ratio, max speed/min speed, standard control loops, duty cycle, field weakening, and regeneration.

---

**Module Outline:**

- I. Use Schematics and Meters or Oscilloscopes to Differentiate Between Various Types of DC Motor Control Circuits and Replace And/or Troubleshoot and Repair These Motor Controls
  - A. Present theory of operation of DC motor controls
    1. Explain concepts of DC electronic motor control
      - a. Requirements for the control of DC motors
      - b. Types of motors controlled by the controller
      - c. Field weakening control for shunt field motors
      - d. Duty cycle and pulse width modulation (PWM)
      - e. Adjustments for DC motor controls
        - (1) IR compensation
        - (2) Current limit and instantaneous over current (IOC) protection
        - (3) Max speed/min speed
      - f. Standard control loops
    2. Explain the theory of operation of DC motor controls
      - a. SCR type, permanent magnet DC motor controls
      - b. SCR type, universal motor controls
      - c. SCR type, shunt field controls with field weakening

- d. Gate turn on (GTO) controls
      - e. Power semiconductor PWM controls for DC motors
        - (1) Darlington transistors
        - (2) Power MOSFETs
        - (3) GTO
    - 3. Explain the types of sensors used to measure the following:
      - a. IOC
      - b. IR compensation
  - B. Explain the computer interfaces that are used to program the motor control subsystems and the configuration of both stand-alone and PC based motor controls
  - C. Conduct exercises in wiring and setting up control loops for DC motor controls
- II. Use Schematic Diagrams and Meters or Oscilloscopes to Identify Advanced Motor Controls That Contain Newer Types of Semiconductor Devices, to Troubleshoot and Repair These Motor Controls
- A. Present theory of operation of AC motor controls
    - 1. Explain concepts of AC electronic motor control
      - a. Requirements for the control of AC motors
      - b. Types of motors controlled by the controller
      - c. Variable frequency control of AC inductive motors
      - d. Synchronous motor control of AC motors
      - e. Adjustments for AC motor controls
        - (1) IR compensation
        - (2) Current limit and instantaneous over current (IOC) protection
        - (3) Max speed/min speed
        - (4) Volts per hertz ratio
      - f. Explain the types of sensors used to measure the following:
        - (1) IOC
        - (2) IR compensation
        - (3) Commutation angle for synchronous motors
      - g. Standard control loops
    - 2. Explain the theory of operation of AC motor controls
      - a. SCR type, AC universal motor controls
      - b. SCR type, variable frequency motor controls
      - c. Power semiconductor variable frequency three phase controls for inductive AC motors
        - (1) Darlington transistors
        - (2) Power MOSFETs
        - (3) Gate turn on (GTO)
      - d. High precision, variable frequency, synchronous AC motor controls for CNC and robot machine slides (axis)

- B. Explain the theory of operation of stepper motors and stepper motor controls
  - 1. Explain the theory of operation of stepper motors
  - 2. Explain and identify stepper motor parameters
  - 3. Explain the theory of operation of electronic stepper motor drivers
  - 4. Identify integrated circuit stepper motor drivers
- C. Explain the computer interfaces that are used to program the motor control subsystems and the configuration of both stand-alone and PC based motor controls
- D. Conduct exercises in wiring and setting up control loops for AC motor controls

**AET-E13-LE**  
**Use Schematic Diagrams, Meters, And Oscilloscopes**  
**To Identify, Troubleshoot And Repair Or Replace**  
**Various Types Of Electronic Motor Control Circuits**  
**Attachment 3: MASTER Laboratory Exercise**

---

The student will:

1. Measure control loops and adjust motor control system; and,
2. Program an industrial motion control system.

**AET-E13-LA**  
**Use Schematic Diagrams, Meters, And Oscilloscopes**  
**To Identify, Troubleshoot And Repair Or Replace**  
**Various Types Of Electronic Motor Control Circuits**  
**Attachment 4: MASTER Laboratory Aid**

---

**Rules of Conduct**

1. Absolutely no horseplay or practical joking will be tolerated.
2. Do not talk to anyone who is operating a machine.
3. Walk only in the designated traffic lanes.
4. Dress appropriately; at the absolute minimum, you must have:
  - a. No loose clothing, including ties;
  - b. Long hair properly stowed;
  - c. No jewelry;
  - d. Hard, closed-toe shoes;
  - e. Eye protection (safety glasses); and,
  - f. Ear protection (plugs or headset).
5. Follow all institutional safety rules.

**AUTOMATED EQUIPMENT REPAIR TECHNICIAN ... operates, programs, maintains, and repairs automated machine tools and automated manufacturing processes.**

**Duties**

**Tasks**

Duties	Tasks
<b>A</b> Apply Science to Solve Industrial Problems	A-1 Apply scientific notation and engineering notation to solve technical problems A-2 Apply algebraic formulas to predict behavior of industrial systems A-3 Use variables in algebraic formulas to predict behavior of industrial systems A-4 Manipulate variables in algebraic formulas to analyze industrial systems A-5 Measure, calculate, and convert quantities in English (make) systems of measurement A-6 Use mechanical physics to analyze mechanical problems found in industrial systems A-7 Use mechanical physics to analyze mechanical systems A-8 Apply electrical physics to analyze electrical systems A-9 Apply principles and formulas to predict and analyze reactions in industrial processes A-10 Use mathematical formulas to analyze industrial systems A-11 Use chemical principles and formulas to predict and analyze reactions in industrial processes A-12 Apply the knowledge of electrochemical effects to analyze chemical processes A-13 Apply the knowledge of electrochemical effects to analyze industrial water treatment processes
<b>B</b> Use Drawings to Organize and Repair Systems	B-1 Use symbols, organization, and engineering drawings to describe mechanical systems B-2 Use symbols, organization, and engineering drawings to describe electrical systems B-3 Apply electronic measurement knowledge to test/calibrate electronic circuits B-4 Use symbols, organization, and engineering drawings to describe hydraulic and pneumatic systems B-5 Use organization, and symbols, and values on digital drawings B-6 Apply digital electronic measurement instruments to test/calibrate digital electronic circuits
<b>C</b> Use Calibrated Measuring Instruments to Test/Calibrate Components	C-1 Apply mechanical measurement knowledge to test/calibrate electrical circuits C-2 Calculate, predict, and measure quantities in AC circuits C-3 Calculate, predict, and measure quantities in pneumatic or hydraulic systems C-4 Apply hydraulic, pneumatic, and special components/devices C-5 Identify, assemble, measure, and apply knowledge of operating characteristics of specialized fluid power circuits C-6 Properly set up, calibrate, and use oscilloscope
<b>D</b> Resolve System Failures with Critical Thinking, Troubleshooting, Theory, and Metrology	D-1 Apply the troubleshooting process to the resolution of malfunctions found in automated equipment E-1 Calculate, predict, and measure quantities in DC circuits E-2 Calculate, predict, and measure quantities in AC circuits E-3 Calculate, predict, and measure quantities in pneumatic or hydraulic systems E-4 Apply hydraulic, pneumatic, and special components/devices E-5 Identify, assemble, measure, and apply knowledge of operating characteristics of specialized fluid power circuits E-6 Properly set up, calibrate, and use oscilloscope
<b>E</b> Use Techniques to Isolate Malfunctions of Electrical/Electronic Systems	E-1 Calculate, predict, and measure quantities in DC circuits E-2 Calculate, predict, and measure quantities in AC circuits E-3 Calculate, predict, and measure quantities in pneumatic or hydraulic systems E-4 Apply hydraulic, pneumatic, and special components/devices E-5 Identify, assemble, measure, and apply knowledge of operating characteristics of specialized fluid power circuits E-6 Properly set up, calibrate, and use oscilloscope
<b>F</b> Measure/Isolate Malfunctions of Mechanical/Fluid Power Systems	F-1 Identify and explain the theory and use of major systems such as hydraulic and pneumatic systems F-2 Apply theory and use of valves in a hydraulic or pneumatic system F-3 Identify, assemble, measure, and apply knowledge of operating characteristics of specialized fluid power circuits F-4 Apply hydraulic, pneumatic, and special components/devices F-5 Identify, assemble, measure, and apply knowledge of operating characteristics of specialized fluid power circuits F-6 Properly set up, calibrate, and use oscilloscope
<b>G</b> Apply Computer Science to Computer Controlled Equipment	G-1 Perform operations in digital numbers being systems G-2 Perform operations in electrical and programmable logic control circuits G-3 Solve digital ladder diagrams in electrical and programmable logic control circuits G-4 Program computer controlled industrial equipment G-5 Identify, assemble, measure, and apply knowledge of operating characteristics of specialized fluid power circuits G-6 Properly set up, calibrate, and use oscilloscope
<b>H</b> Correct Malfunctions in PLC Controlled Industrial Equipment	H-1 Perform operations on PLC (programmable logic controller) or PC (personal computer) interface system H-2 Perform operations in digital numbers being systems H-3 Solve digital ladder diagrams in electrical and programmable logic control circuits H-4 Program computer controlled industrial equipment H-5 Identify, assemble, measure, and apply knowledge of operating characteristics of specialized fluid power circuits H-6 Properly set up, calibrate, and use oscilloscope
<b>I</b> Resolve Malfunctions Found in Computer Systems Manufacturing Processes	I-1 Perform operations on PLC (programmable logic controller) or PC (personal computer) interface system I-2 Perform operations in digital numbers being systems I-3 Solve digital ladder diagrams in electrical and programmable logic control circuits I-4 Program computer controlled industrial equipment I-5 Identify, assemble, measure, and apply knowledge of operating characteristics of specialized fluid power circuits I-6 Properly set up, calibrate, and use oscilloscope
<b>J</b> Assemble/Disassemble Mechanical/Electronic and Computer Systems	J-1 Safely assemble, disassemble, and adjust subsystems of components of fluid power systems J-2 Safely assemble, disassemble, and adjust subsystems of components of fluid power systems J-3 Safely assemble, disassemble, and adjust subsystems of components of fluid power systems J-4 Safely assemble, disassemble, and adjust subsystems of components of fluid power systems J-5 Identify, assemble, measure, and apply knowledge of operating characteristics of specialized fluid power circuits J-6 Properly set up, calibrate, and use oscilloscope

**AET-F1-HO**  
**Identify and Explain the Theory and Use of Major Systems**  
**That Comprise a Hydraulic or Pneumatic System**  
**Attachment 1: MASTER Handout**

---

**Objective(s):**

Upon completion of this unit the student will be able to:

- a. Identify and explain the use of major systems that comprise a hydraulic or pneumatic system such as pumps, tanks, plumbing, fluid, rotary actuators, linear actuators, flow control valves, pressure control valves, directional control valves, pilot-operated hydraulic and pneumatic components, and solenoid operated hydraulic and pneumatic components;
- b. Apply formulas and mathematics to calculate force, pressure, volume, horsepower, rod speed for linear actuators, rotational speed for rotary actuators, pumping rates for pumps, and pressures in various scales for both hydraulic and pneumatic systems;
- c. Demonstrate the effects of pressure upon the volume of fluid in a hydraulic system or air in a pneumatic system;
- d. Explain the effects of system pressure upon actuator speed and force;
- e. Explain the effects of system flow upon actuator speed and force; and,
- f. Test hydraulic and pneumatic systems and components.

---

**Module Outline:**

- I. Hydraulic/Pneumatic Safety
  - A. Explain the safety rules for mechanical systems
    1. Use and requirements for safety glasses
    2. Use and requirements for ear protection
    3. Avoiding mechanical hazards
    4. Rules for confined spaces
  - B. Explain the rules for the working with fluid power systems
    1. Rules for pressurized systems
    2. Rules for cleanliness and hazardous materials
  - C. Provide lab experiences in the basic principles of safety when working with fluid power and fluid power sources (MASTER Laboratory Exercise AET-F1-LE2) (Basic Laws of Fluid Systems)
- II. Identify the Major Parts of a Hydraulic System and Explain Their Theory of Operation
  - A. Identify and explain the theory of operation of the following subsystems of a hydraulic system:
    1. Fixed and variable displacement pumps
      - a. Gear pumps



- b. Vane pumps
      - c. Gearotor pumps
      - d. Piston pumps
    - 2. Centrifugal pumps
    - 3. Fluid reservoir (tank)
    - 4. Pressure controls and safety systems
      - a. Pressure regulation (pressure relief)
      - b. Back up pressure relief
  - B. Explain the rules for the working fluid in a hydraulic system
    - 1. Viscosity
    - 2. Fluid conditioning (filtration)
    - 3. Fluid lines
      - a. Working lines
      - b. Pilot lines
      - c. Drain lines
    - 4. Heat exchanges
      - a. Hydraulic
      - b. Pneumatic
  - C. Provide lab experiences in the basic principles of fluid power and fluid power sources (MASTER Laboratory Exercise AET-F1-LE2) (Basic Laws of Fluid Systems); MASTER Laboratory Exercise AET-F1-LE3) (Hydraulic Power Sources)
- III. Identify the Major Parts of a Pneumatic System and Explain Their Theory of Operation
  - A. Identify and explain the theory of operation of the following subsystems of a pneumatic system:
    - 1. Compressors
      - a. Piston compressors
      - b. Rotary screw compressors
      - c. Turbine compressors
    - 2. Air receiver (tank)
    - 3. De-humidifier/after cooler
    - 4. Pneumatic fluid conditioners
      - a. Separators
      - b. Filters
      - c. Lubricators
      - d. Pressure regulators (pressure reducing valves)
    - 5. Air lines
      - a. Working lines
      - b. Pilot lines
      - c. Exhaust lines
  - B. Provide lab experiences in the basic principles of fluid power and fluid power sources (MASTER Laboratory Exercise AET-F1-LE2) (Basic Laws of Fluid Systems); (MASTER Laboratory Exercise AET-F1-LE4) (Pneumatic Power Sources)

**IV. Use Formulas and Mathematics to Calculate Quantities in Hydraulic and Pneumatic Systems**

- A. Given pressure, surface area, and force demonstrate the calculation of each of the following:**
  - 1. Force
  - 2. Surface area
  - 3. Pressure
- B. Given pump displacement and rotational speed, motor displacement, or piston diameter and stroke demonstrate the calculation of each of the following:**
  - 1. Given displacement and rotational speed, calculate flow rate for various types of hydraulic pumps
    - a. Volume of fluid per unit of time gallons per minute (GPM)
    - b. Liters per minute (LPM)
  - 2. Given volumetric displacement and rotational speed, calculate through-put for compressors and vacuum pumps
    - a. Cubic feet per minute (CFM) or standard cubic feet per minute (SCFM)
    - b. Liters per minute (LPM)
  - 3. Given flow rate and displacement, calculate rotational speed and flow requirements for hydraulic motors
  - 4. Given flow rate, piston diameter, and stroke, calculate rod speed for linear hydraulic actuators (cylinders)
- C. Given flow and pressure demonstrate the calculation of the horsepower or mechanical watts of power generated in the system or subsystem**
- D. Use pressure in a given scale, and demonstrate the conversion to the following pressure scales:**
  - 1. Kilopascals (Kpa)
  - 2. Pounds per square inch gage (PSIG)
  - 3. Pounds per square inch absolute (PSIA)
  - 4. Pounds per square inch vacuum (PSIV)
  - 5. Bar
  - 6. Inches of mercury (in Hg)
  - 7. Inches of water (in H<sub>2</sub>O)
  - 8. Inches of mercury vacuum (vacuum scale in Hg)
  - 9. Torr
  - 10. Micron

**V. Use Fluid Power Measuring Instruments to Test the Operating Condition of a Fluid Power System**

- A. Use flow meters and pressure gages to demonstrate the measurement of flow and pressure**
- B. Use flow meters, pressure gages and a pressure relief valve to demonstrate the diversion of flow in a hydraulic system when regulating pressure**

- C. Use flow meters and pressure gages to demonstrate the leakage rate of control valves in a hydraulic system as a function of pressure
- D. Connect a flow meter, pressure gage, flow control valve, and temperature gage to serve as a test apparatus
- E. Demonstrate the proper methods for using the above setup to test hydraulic or pneumatic systems
  - 1. Test volumetric flow rates of hydraulic pumps
  - 2. Test cracking pressure of pressure control valves
  - 3. Test volumetric flow rates of compressors
  - 4. Test heat build up in a hydraulic system and relate it to power losses for various types of pumping systems

**AET-F1-LE1**  
**Identify and Explain the Theory and Use of Major Systems**  
**That Comprise a Hydraulic or Pneumatic System**  
**Attachment 2: MASTER Laboratory Exercise No. 1**

---

The student will:

1. Use a working hydraulic and pneumatic system to apply safety rules to working with industrial fluid power systems;
2. Use a working hydraulic system to identify each of the subsystems and measure the pressure and flow of the system;
3. Use a working industrial compressor system to identify each of the subsystems and measure the pressure and flow of the system and calculate the parameters of the system from the measurements;
4. Use a working industrial hydraulic and compressor system to identify each of the subsystems and measure the pressure and flow of the system and calculate the parameters of the system from the measurements; and,
5. Use an industrial control system to demonstrate the measurement of voltage, current, resistance, power, capacitance, and inductance, and calculate the parameters of the system from the measurements.

**AET-F1-LA**  
**Identify and Explain the Theory and Use of Major Systems**  
**That Comprise a Hydraulic or Pneumatic System**  
**Attachment 8: MASTER Laboratory Aid**

---

**Rules of Conduct**

1. Absolutely no horseplay or practical joking will be tolerated.
2. Do not talk to anyone who is operating a machine.
3. Walk only in the designated traffic lanes.
4. Dress appropriately; at the absolute minimum, you must have:
  - a. No loose clothing, including ties;
  - b. Long hair properly stowed;
  - c. No jewelry;
  - d. Hard, closed-toe shoes;
  - e. Eye protection (safety glasses); and,
  - f. Ear protection (plugs or headset).
5. Follow all institutional safety rules.

**AET-F2-HO**  
**Apply Purpose and Use of Valves**  
**in a Hydraulic or Pneumatic System**  
**to Troubleshoot Components or Systems**  
**Attachment 1: MASTER Handout**

---

**Objective(s):**

Upon completion of this unit the student will be able to:

- a. Measure the cracking pressure and operating characteristics of pressure control valves in a pneumatic and hydraulic system;
  - b. Measure pressure drops as a function of flow, demonstrate the method of diverting flow, and the leakage rate of directional control valves in a pneumatic system, or hydraulic system;
  - c. Measure pressure drops as a function of flow and the operating characteristics of standard flow control valves and pressure or temperature compensated flow control valves; and,
  - d. Explain the principles of operation of all three types of valves.
- 

**Module Outline:**

- I. Use Pressure Control Valves
  - A. Explain the theory of operation, construction, and use of the following pressure control valves
    1. Pressure relief
    2. Pressure reducing
    3. Sequence valves
  - B. Explain the theory of operation of the following valve actuators:
    1. Bias spring adjustment
    2. Pilot operator
    3. Poppet and seat
  - C. Conduct MASTER Laboratory Exercise No. 2 (AET-F2-LE2) (Pressure Control Valves)
- II. Use Directional Control Valves
  - A. Explain the theory of operation, construction, and use of the following directional control valves
    1. Check valves
    2. Two position on/off valves
    3. Two position on/off and bi-directional
    4. Three position on/off and bi-directional
  - B. Explain the theory of operation of the following valve actuators:
    1. Bias spring
    2. Pilot operator
    3. Spool

4. Solenoid and pilot operator and/or solenoid or pilot operator
  5. Other operators
    - a. Lever
    - b. Temperature
    - c. Detent
    - d. Foot
    - e. Level
    - f. Motor
    - g. Mechanical
- C. Conduct MASTER Laboratory Exercise No. 3 (AET-F2-LE3)  
(Directional Control Valves)
- III. Use Flow Control Valves
- A. Explain the theory of operation, construction, and use of the following flow control valves
1. Flow control with integral check valve
  2. Pressure compensated flow control valve
  3. Temperature compensated flow control valve
  4. Bypass flow control valves
- B. Explain the theory of operation of a hydraulic and pneumatic system when controlling flow:
1. Interaction of pressure relief valve and flow control in a hydraulic system
  2. Effects of a bypass flow control in a hydraulic system
  3. Effects of flow control in a pneumatic system
- C. Conduct MASTER Laboratory Exercise No. 4 (AET-F2-LE4) (Flow Control Valves)

**AET-F2-LE1**  
**Apply Purpose and Use of Valves**  
**in a Hydraulic or Pneumatic System**  
**to Troubleshoot Components or Systems**  
**Attachment 2: MASTER Laboratory Exercise No. 1**

---

The student will:

1. Use a working hydraulic or pneumatic system to identify each of the types of pressure control valves and draw the symbol;
2. Measure the pressures, flows, and leakage rate of the pressure control valves;
3. Use a working hydraulic or pneumatic system to identify each of the types of directional control valves and draw the symbol;
4. Measure the pressures, flows, and leakage rate of the directional control valves;
5. Use a working hydraulic or pneumatic system to identify each of the types of flow control valves and draw the symbol; and,
6. Measure the pressures and flows of the flow control valves.



**AET-F2-LA**  
**Apply Purpose and Use of Valves**  
**in a Hydraulic or Pneumatic System**  
**to Troubleshoot Components or Systems**  
**Attachment 6: MASTER Laboratory Aid**

---

**Rules of Conduct**

1. Absolutely no horseplay or practical joking will be tolerated.
2. Do not talk to anyone who is operating a machine.
3. Walk only in the designated traffic lanes.
4. Dress appropriately; at the absolute minimum, you must have:
  - a. No loose clothing, including ties;
  - b. Long hair properly stowed;
  - c. No jewelry;
  - d. Hard, closed-toe shoes;
  - e. Eye protection (safety glasses); and,
  - f. Ear protection (plugs or headset).
5. Follow all institutional safety rules.

**AET-F3-HO**  
**Identify, Assemble, Measure, and Apply**  
**Knowledge of Operating Characteristics**  
**of Hydraulic and Pneumatic Actuators**  
Attachment 1: MASTER Handout

---

**Objective(s):**

Upon completion of this unit the student will be able to:

- a. Use a pneumatic and hydraulic system, and identify and connect hydraulic and pneumatic linear actuators (cylinders) and rotary actuators (motors);
  - b. Demonstrate the operating characteristics of hydraulic and pneumatic linear actuators (cylinders) and rotary actuators (motors); and,
  - c. Measure pressures and flows of the above devices to determine the operating condition of the components.
- 

**Module Outline:**

- I. Explain the Types of Actuators Used in a Fluid Power System, and Provide Examples of Each Type
  - A. Linear actuators (cylinders, all types)
  - B. Rotary actuators (vane and piston motors, fixed displacement and variable displacement)
- II. Explain the Operating Principles of the above Actuators, and Any Behaviors Unique to the Actuator in Question
- III. Demonstrate the Calculation of the Pressure and Flow Requirements for Each Type of Actuator
  - A. Given motor displacement, speed, and force requirement; calculate the flow and pressure required for a fluid power motor
  - B. Given piston diameter, stroke, and force requirement; calculate the flow and pressure required for a fluid power cylinder
  - C. Given the combined flow and pressure requirements for all actuators, calculate the horsepower or mechanical watts of power required in the system or subsystem
  - D. Given flow rate, piston diameter, and stroke, calculate rod speed for linear hydraulic actuators
  - E. Given flow rate and displacement, calculate rotational speed for hydraulic motors
- IV. Provide Lab Experiences in the Basic Principles of Fluid Power Actuators (MASTER Laboratory Exercise AET-F3-LE2) (Hydraulic and Pneumatic Actuators)

**AET-F3-LE1**  
**Identify, Assemble, Measure, and Apply**  
**Knowledge of Operating Characteristics**  
**of Hydraulic and Pneumatic Actuators**  
**Attachment 2: MASTER Laboratory Exercise No. 1**

---

The student will:

1. Use a working industrial hydraulic or pneumatic installation to identify each of the actuators and measure the pressure and flow of the components; and,
2. Calculate the parameters of the actuators from the measurements.

**AET-F3-LA**  
**Identify, Assemble, Measure, and Apply**  
**Knowledge of Operating Characteristics**  
**of Hydraulic and Pneumatic Actuators**  
**Attachment 4: MASTER Laboratory Aid**

---

**Rules of Conduct**

1. Absolutely no horseplay or practical joking will be tolerated.
2. Do not talk to anyone who is operating a machine.
3. Walk only in the designated traffic lanes.
4. Dress appropriately; at the absolute minimum, you must have:
  - a. No loose clothing, including ties;
  - b. Long hair properly stowed;
  - c. No jewelry;
  - d. Hard, closed-toe shoes;
  - e. Eye protection (safety glasses); and,
  - f. Ear protection (plugs or headset).
5. Follow all institutional safety rules.

## AET-F4-HO

### Apply Hydraulic, Pneumatic, and High Vacuum Systems Knowledge to Test, Troubleshoot, and Repair Special Components/Devices Attachment 1: MASTER Handout

---

#### Objective(s):

Upon completion of this unit the student will be able to:

- a. Identify and explain the use of accumulators for hydraulic and pneumatic systems;
  - b. Apply formulas and mathematics to calculate accumulator capacity and pressure;
  - c. Identify types of intensifiers, and explain the use of intensifiers for hydraulic and pneumatic systems;
  - d. Explain and calculate the effects of system pressure upon intensifier force and pressure;
  - e. Define a high through-put, rough vacuum system;
  - f. Identify the types of vacuum pumps and filtering systems for high through-put, rough vacuum systems;
  - g. Apply vacuum pressure scales to the determination of vacuum system operation;
  - h. Define an air-over-oil fluid power system; and,
  - i. Apply principles of fluid power to the determination of pressure, flow, and power in an air-over-oil system.
- 

#### Module Outline:

- I. Calculate, Measure, and Troubleshoot Hydraulic and Pneumatic Accumulators
  - A. Explain and identify the various types of accumulators, and the principles of operation of each type
    1. Weight loaded accumulators
    2. Spring loaded accumulators
    3. Nitrogen pressurized accumulators
    4. Safety Rules for pressurized accumulators
  - B. Explain and demonstrate the calculation or determination of the parameters of a fluid power system accumulator
    1. Rules for accumulator force, system pressure, and the volume of oil or air contained in the accumulator
    2. Rules for pressurizing a nitrogen pressurized accumulator
  - C. Demonstrate the various roles that an accumulator plays in the operation of a fluid power system
    1. Emergency source of fluid power
    2. Hydraulic economizer

3. Pressure regulation and temporary flow increase
  - D. Conduct MASTER Laboratory Exercise No. 3 (AET-F4-LE3) (Intensifiers and Accumulators)
- II. Calculate, Measure, and Troubleshoot Hydraulic and Pneumatic Intensifiers
- A. Explain and identify the various types of intensifiers, and the principles of operation of each type
    1. Piston/cylinder type intensifiers
    2. Double ended-shuttle valve type intensifiers
    3. Reciprocating piston type intensifiers driven by hydraulic motors
    4. Safety Rules for high pressure intensifier systems.
  - B. Explain and demonstrate the calculation or determination of the parameters of a fluid power system intensifier
    1. Rules for intensifier force, intensifier pressure, and the multiplication of pressure
    2. Rules for pressure verses flow in an intensifier
  - C. Explain the applications of intensifiers in industry
    1. Creation of high pressure for hydrostatic presses.
    2. Water jet cutting
  - D. Conduct MASTER Laboratory Exercise No. 3 (AET-F4-LE3) (Intensifiers and Accumulators)
- III. Calculate, Measure, and Troubleshoot High Through-Put, Rough Vacuum Systems
- A. Define a high through-put, rough vacuum, vacuum system
    1. Define the concept of vacuum and the various types of vacuum (rough, medium, high vacuum, ultra-high vacuum)
    2. Define the concept of through-put in a vacuum system
    3. Explain the uses of vacuum in an automation system, machine tool, and the end effector of a robot
      - a. Vacuum chuck
      - b. Contaminate and hazardous materials removal
      - c. Holding force for robot end effectors
    4. Safety rules for vacuum systems
  - B. Explain and demonstrate the calculation or determination of the parameters of rough vacuum, high through-put vacuum system
    1. Rules for vacuum system through-put and determination of pumping rates
    2. Rules for calculation of force generated on an object by vacuum pressure
  - C. Explain and demonstrate special considerations for high through-put vacuum systems.
    1. Vacuum pressure regulators
    2. Vacuum system filtering and contaminate removal
  - D. Conduct MASTER Laboratory Exercise No. 2 (AET-F4-LE2) (Specialized Fluid Circuits)

- IV. Calculate, Measure, and Troubleshoot Low Pressure, Air-Over-Oil Fluid Power Systems
- A. Define an air-over-oil, fluid power system
    - 1. Explain the purpose of pressurized gas in an air-over-oil system
    - 2. Explain the construction and operation of an air-over-oil system
      - a. Pressurized gas acts like an accumulator, and provides pumping action in the system
      - b. Volumetric pumping rate is determined by air/oil capacity of tank
      - c. Hydrostatic pressure decreases with increased flow rate
    - 3. Explain the uses of an air-over-oil system and its advantages or disadvantages
      - a. High flow rates for high speed hydraulic actuators (flow rate is determined by expansion of gas, Ideal Gas Laws)
      - b. Low contamination using dry, ultra-pure, nitrogen gas
      - c. Fast force transmittal through a hydraulic medium
      - d. Low holding force due to compression of gas
      - e. Explosive potential if air is inadvertently used in the system
    - 4. Safety rules for air-over-oil systems
  - B. Explain and demonstrate the calculation or determination of the parameters of an air-over-oil system
    - 1. Rules for determination of pumping rates
    - 2. Rules for calculation of force generated on an object by an air-over-oil system
  - C. Explain and demonstrate special considerations for air-over-oil systems.
  - D. Conduct MASTER Laboratory Exercise No. 2 (AET-F4-LE2) (Specialized Fluid Circuits)

## **AET-F4-LE1**

### **Apply Hydraulic, Pneumatic, and High Vacuum Systems Knowledge to Test, Troubleshoot, and Repair Special Components/Devices**

#### **Attachment 2: MASTER Laboratory Exercise No. 1**

---

The student will:

1. Using a working hydraulic system, identify any accumulators and measure the pressure and flow of the system with the accumulator in and out of the system;
2. Calculate the parameters of the hydraulic system from measurements;
3. Using a working hydrostatic press identify the type of intensifier used in the system and calculate the maximum pressure that can be generated in the press;
4. Visit an industrial site that has a water jet cutting CNC machine, identify the intensifier and cutting head used, and calculate the parameters of the systems from the machines specifications;
5. Using an industrial control system demonstrate electrical safety procedures;
6. Visit an industrial site that employs an air-over-oil system and observe and record measurements; and,
7. Calculate the parameters of the air-over-oil system from the measurements.



**AET-F4-LA**

**Apply Hydraulic, Pneumatic, and High Vacuum Systems Knowledge  
to Test, Troubleshoot, and Repair Special Components/Devices  
Attachment 5: MASTER Laboratory Aid**

---

**Rules of Conduct**

1. Absolutely no horseplay or practical joking will be tolerated.
2. Do not talk to anyone who is operating a machine.
3. Walk only in the designated traffic lanes.
4. Dress appropriately; at the absolute minimum, you must have:
  - a. No loose clothing, including ties;
  - b. Long hair properly stowed;
  - c. No jewelry;
  - d. Hard, closed-toe shoes;
  - e. Eye protection (safety glasses); and,
  - f. Ear protection (plugs or headset).
5. Follow all institutional safety rules.

**AET-F5-HO**  
**Identify, Assemble, Measure, and Apply Knowledge**  
**of Operating Characteristics of Selected,**  
**Specialized Fluid Power Circuits**  
**Attachment 1: MASTER Handout**

---

**Objective(s):**

Upon completion of this unit the student will be able to:

- a. Use a pneumatic and hydraulic system, and identify and connect a regenerative circuit, an intensifier circuit, a counter balance circuit, a sequencing circuit, an unloading accumulator circuit, an accumulator emergency power circuit, an air bearing circuit, and a venturi circuit;
- b. Demonstrate the operating characteristics of a regenerative circuit, an intensifier circuit, a counter balance circuit, a sequencing circuit, an unloading accumulator circuit, an accumulator emergency power circuit, an air bearing circuit and a venturi circuit;
- c. Measure pressures and flows of the above circuits to determine the operating condition of the circuits; and,
- d. Adjust pressures and flows of critical components of the above circuits.

---

**Module Outline:**

- I. Demonstrate the Connection of Hydraulic or Pneumatic Components to Construct the Following Circuits:
  - A. Regenerative circuit
  - B. Intensifier circuit
  - C. Counter balance circuit
  - D. Sequencing circuit
  - E. Unloading accumulator circuit
  - F. Accumulator emergency power circuit
  - G. Air bearings
  - H. Venturi siphon
- II. Connect Flow Meters and Pressure Gages to the above Circuits to Demonstrate Their Operating Principles
- III. Demonstrate the Adjustments of Components of the above Circuits
- III. Provide Lab Experiences in the Basic Principles of the above Circuits (MASTER Laboratory Exercise No. 2 (AET-F5-LE2) (Specialized Fluid Circuits))

**AET-F5-LE1**  
**Identify, Assemble, Measure, and Apply Knowledge**  
**of Operating Characteristics of Selected,**  
**Specialized Fluid Power Circuits**  
**Attachment 2: MASTER Laboratory Exercise No. 1**

---

The student will:

1. Using a working industrial hydraulic or pneumatic installation, identify each of the subsystems and measure the pressure and flow of the system; and,
2. Calculate the parameters of the system from measurements.

**AET-F5-LA**  
**Identify, Assemble, Measure, and Apply Knowledge**  
**of Operating Characteristics of Selected,**  
**Specialized Fluid Power Circuits**  
**Attachment 4: MASTER Laboratory Aid**

---

**Rules of Conduct**

1. Absolutely no horseplay or practical joking will be tolerated.
2. Do not talk to anyone who is operating a machine.
3. Walk only in the designated traffic lanes.
4. Dress appropriately; at the absolute minimum, you must have:
  - a. No loose clothing, including ties;
  - b. Long hair properly stowed;
  - c. No jewelry;
  - d. Hard, closed-toe shoes;
  - e. Eye protection (safety glasses); and,
  - f. Ear protection (plugs or headset).
5. Follow all institutional safety rules.

**AET-F6-HO**  
**Identify, Assemble, Measure, and Apply Knowledge**  
**of Operating Characteristics of Electrically Operated,**  
**Specialized Fluid Power Circuits**  
Attachment 1: MASTER Handout

---

**Objective(s):**

Upon completion of this unit the student will be able to:

- a. Use a pneumatic and hydraulic system, and identify and connect an electrically operated regenerative circuit, intensifier circuit, counter balance circuit, sequencing circuit, unloading accumulator circuit, accumulator emergency power circuit, air bearing circuit, and hydraulic servo circuit;
  - b. Demonstrate the operating characteristics of the above circuits;
  - c. Measure voltages, currents, pressures and flows of the above circuits to determine the operating condition of the circuits; and,
  - d. Construct an electrical ladder diagram to operate the above circuits.
- 

**Module Outline:**

- I. Demonstrate the Electrical and Mechanical Connection of Hydraulic or Pneumatic Components to Construct the Following Electrically Operated Circuits:
  - A. Regenerative circuit
  - B. Intensifier circuit
  - C. Counter balance circuit
  - D. Sequencing circuit
  - E. Unloading accumulator circuit
  - F. Accumulator emergency power circuit
  - G. Air bearings
  - H. Venturi siphon
  - I. Servo valve operation of linear and rotary bi-directional circuits.
- II. Have the Students Create an Electrical Ladder Diagram to Electrically Operate the Above Circuits
- III. Connect Electrical and Electronic Test Instruments to Measure the Electrical Characteristics of the Above Circuits
- IV. Provide lab experiences in the basic principles of the above circuits (MASTER Laboratory Exercise No. 2 (AET-F6-LE2) (Electrical Operation of Specialized Fluid Circuits)

**AET-F6-LE1**  
**Identify, Assemble, Measure, and Apply Knowledge**  
**of Operating Characteristics of Electrically Operated,**  
**Specialized Fluid Power Circuits**  
Attachment 2: MASTER Laboratory Exercise No. 1

---

The student will:

1. Using a working industrial hydraulic or pneumatic installation, identify each of the subsystems and measure the voltages, currents, pressure and flow of the system; and,
2. Calculate the parameters of the system from measurements.

**AET-F6-LA**  
**Identify, Assemble, Measure, and Apply Knowledge**  
**of Operating Characteristics of Electrically Operated,**  
**Specialized Fluid Power Circuits**  
**Attachment 4: MASTER Laboratory Aid**

---

**Rules of Conduct**

1. Absolutely no horseplay or practical joking will be tolerated.
2. Do not talk to anyone who is operating a machine.
3. Walk only in the designated traffic lanes.
4. Dress appropriately; at the absolute minimum, you must have:
  - a. No loose clothing, including ties;
  - b. Long hair properly stowed;
  - c. No jewelry;
  - d. Hard, closed-toe shoes;
  - e. Eye protection (safety glasses); and,
  - f. Ear protection (plugs or headset).
5. Follow all institutional safety rules.

**AET-F7-HO**  
**Use Laws of Simple Machines and Physics**  
**to Identify and Troubleshoot Complex Machines**  
**Attachment 1: MASTER Handout**

---

**Objective(s):**

Upon completion of this unit the student will be able to:

- a. Identify the simple machines in a machine tool ball screw mechanism and write an equation describing the machine's mechanical advantage and or speed advantage;
- b. Measure the mechanism and apply the results of the measurement to the equations;
- c. Describe the torque and change of torque in each part of the mechanism;
- d. Determine the efficiency of the mechanism by relating the input power to the output power;
- e. Follow the transmission of force through a gearing system and determine the mechanical advantage or speed advantage of each gear;
- f. Measure each gear in the system and relate the measurement to the gear ratio, and tooth geometry; and,
- g. Describe the torque and change of torque in each part of the mechanism.

---

**Module Outline:**

- I. Identify, Test and Troubleshoot Ball Screw Mechanisms
  - A. Identify the simple machines in the ball screw mechanism
  - B. Demonstrate the measurement of the rotational force of the motor pulley with the servo power off
  - C. Demonstrate the measurement of the rotational speed of the motor at a constant servo velocity
  - D. Demonstrate the measurement of voltage and current on the servo motor
  - E. Conduct MASTER Laboratory Exercise No. 2 (AET-F7-LE2) (Measuring and Testing Complex Machines)
- II. Identify, Test and Troubleshoot Gear Mechanisms
  - A. Identify and explain the theory of operation of a complex gearing mechanism:
    1. Driver gears and driven gears
      - a. Open gear train
      - b. Closed gear train
      - c. Rack and pinion



2. Circumference of the gear as it relates to amount of gear teeth, tooth geometry, and gear ratio
  3. Transmission of force and torque through a gear train
  4. Mechanical advantage/disadvantage and speed advantage/disadvantage
- B. Provide lab experiences in the basic principles of gear systems (MASTER Laboratory Exercise No. 2) (AET-F7-LE2) (Measuring and Testing Complex Machines)

**AET-F7-LE1**  
**Use Laws of Simple Machines and Physics**  
**to Identify and Troubleshoot Complex Machines**  
**Attachment 2: MASTER Laboratory Exercise No. 1**

---

The student will:

1. Using a working industrial CNC machine tool, identify each of the simple machines of ball-screw slide, and measure and calculate the parameters of the system; and,
2. Using a working industrial CNC machine tool that contains a gear box, identify the type of gear system, each of the gears and the gear ratio, and measure and calculate the parameters of the system.

AET-F7-LA  
Use Laws of Simple Machines and Physics  
to Identify and Troubleshoot Complex Machines  
Attachment 4: MASTER Laboratory Aid

---

### **Rules of Conduct**

1. Absolutely no horseplay or practical joking will be tolerated.
2. Do not talk to anyone who is operating a machine.
3. Walk only in the designated traffic lanes.
4. Dress appropriately; at the absolute minimum, you must have:
  - a. No loose clothing, including ties;
  - b. Long hair properly stowed;
  - c. No jewelry;
  - d. Hard, closed-toe shoes;
  - e. Eye protection (safety glasses); and,
  - f. Ear protection (plugs or headset).
5. Follow all institutional safety rules.

## AET-F8-HO

### Apply Hydraulic, Pneumatic, and High Vacuum Systems Knowledge to Test, Troubleshoot, and Repair High Purity, High Vacuum Systems Attachment 1: MASTER Handout

---

#### Objective(s):

Upon completion of this unit the student will be able to:

- a. Identify and explain the component parts of an industrial high purity, high vacuum system;
  - b. List the sequence of operation of the subsystems of an industrial high purity, high vacuum system;
  - c. Identify types of pumps used and their theory of operation, for an industrial high purity, high vacuum system;
  - d. Explain and calculate the effects of system pressure upon pumping speed;
  - e. Define the various levels of vacuum from rough vacuum to ultra-high vacuum;
  - f. Identify and explain the theory of operation of instrumentation used in an industrial high purity, high vacuum system;
  - g. Apply vacuum pressure scales to the determination of vacuum system operation; and,
  - h. Explain the equipment, procedures, and corrective measures to detect and control leaks in an industrial high purity, high vacuum system.
- 

#### Module Outline:

- I. Vacuum Systems
  - A. Present an overview of high vacuum systems
  - B. Explain the systems of pressure measurement for high vacuum systems
  - C. Explain the types of vacuum pumps used in ultra high vacuum systems
  - D. Explain the theory of operation and use of, a helium leak detector
- II. High Vacuum Systems and Instrumentation
  - A. Explain the types of mechanical vacuum pumps used and their theory of operation
  - B. Explain and demonstrate the theory of operation of diffusion pumps
  - C. Explain and demonstrate the theory of operation of cryogenic pumps
  - D. Explain and demonstrate the theory of operation of sputter pumps
  - E. Explain and demonstrate the theory of operation of turbo-molecular pumps
  - F. Explain and demonstrate the theory of operation of thermocouple vacuum sensors and gauges

- G. Explain and demonstrate the theory of operation of hot cathode ion sensors and gauges
- H. Explain and demonstrate the theory of operation of cold cathode ion sensors and gauges
- III. Helium Leak Detectors
  - A. Explain the concept of mass spectrometers
    - 1. Theory
    - 2. Operation
    - 3. Maintaining
  - B. Explain the procedure used to tune a helium leak detector
  - C. Explain and demonstrate leak detection methods
- IV. Explain the Theory of Operation and Use of Residual Gas Analyzers (RGA)
  - A. Theory
  - B. Operation
  - C. Maintaining
  - D. Using RGAs to analyze impurities in ultra-high vacuum systems

## **AET-F8-HO**

### **Apply Hydraulic, Pneumatic, and High Vacuum Systems Knowledge to Test, Troubleshoot, and Repair High Purity, High Vacuum Systems Attachment 1: MASTER Handout**

---

The student will:

1. Using a working high vacuum system, identify the subsystems and perform measurements of the instrumentation; and,
2. Calculate the parameters of the system from measurements.

**Apply Hydraulic, Pneumatic, and High Vacuum Systems Knowledge  
to Test, Troubleshoot, and Repair High Purity, High Vacuum Systems**  
Attachment 3: MASTER Laboratory Aid

---

**Rules of Conduct**

1. Absolutely no horseplay or practical joking will be tolerated.
2. Do not talk to anyone who is operating a machine.
3. Walk only in the designated traffic lanes.
4. Dress appropriately; at the absolute minimum, you must have:
  - a. No loose clothing, including ties;
  - b. Long hair properly stowed;
  - c. No jewelry;
  - d. Hard, closed-toe shoes;
  - e. Eye protection (safety glasses); and,
  - f. Ear protection (plugs or headset).
5. Follow all institutional safety rules.

**AUTOMATED EQUIPMENT REPAIR TECHNICIAN ... operates, programs, maintains, and repairs automated machine tools and automated manufacturing processes.**

**Duties**

**Tasks**

Duties	A-1 Apply scientific notation and engineering calculation to solve technical problems	A-2 Apply algebraic formulas to solve technical problems	A-3 Use variables in algebraic formulas to predict behavior of mechanical systems	A-4 Manipulate algebraic formulas to analyze industrial systems	A-5 Measure, calculate, and convert quantities in English units	A-6 Use mechanical physics to analyze hydraulic and pneumatic systems	A-7 Use mechanical physics to analyze mechanical systems	A-8 Use mathematical physics to analyze hydraulic and pneumatic systems	A-9 Apply principles of dynamics to analyze mechanical systems	A-10 Use mathematical physics to analyze electrical systems	A-11 Use chemical formulas to predict and analyze reactions in industrial processes	A-12 Apply knowledge of electrochemical effects to analyze chemical processes	A-13 Apply principles of water treatment processes
<b>A</b> Apply Science to Industrial Problems													
<b>B</b> Use Drawings and Repair Systems													
<b>C</b> Use Calibrated Measuring Instruments to Test/Calibrate Components													
<b>D</b> Resolve System Failures with Critical Thinking, Troubleshooting, and Metrology													
<b>E</b> Use Techniques to Diagnose Electronic Systems													
<b>F</b> Measure/Isolate Malfunctions in Mechanical/Fluid Power Systems													
<b>G</b> Apply Computer Science to Computer Controlled Equipment													
<b>H</b> Correct Malfunctions in PLC Controlled Equipment													
<b>I</b> Resolve Malfunctions Found in Computer Systems Manufacturing Processes													
<b>J</b> Assemble/Disassemble Mechanical/Electronic Computer Systems													



**AET-G1-HO-1**  
**Perform Digital Operations in Digital Numbering Systems**  
**Attachment 1: MASTER Handout No. 1**

---

**Objective(s):**

Upon completion of this unit the student will be able to:

- a. Create a numbering system to any base and count to at least twenty in the new system;
  - b. Convert numbers from any of the following numbering systems to a number in the group; decimal, binary, hexadecimal, octal, Binary Coded Decimal (BCD);
  - c. Convert the binary codes of the American Standard Code for Information Interchange (ASCII) and Gray Code to its alphanumeric or binary equivalent;
  - d. Perform mathematical operations such as addition, subtraction, multiplication and division in binary; and,
  - e. Create negative and positive numbers in the binary system, and convert the numbers to other numbering systems.
- 

**Module Outline:**

- I. Convert Mathematical Quantities in Digital Numbering Systems
  - A. Explain the rules by which numbering systems are created (MASTER Handout No. 2 (AET-G1-HO-2) (Creating Numbering Systems)
    1. Explain the rules of the multiplier
    2. Explain the rules of the base
    3. Provide examples of creating a numbering system to the base 5
  - B. Explain the binary numbering system
    1. Have the student create the binary numbering system, and count to twenty in the system
    2. Demonstrate the usage of the binary numbering system as a system of on/off, yes/no events
  - C. Explain the hexadecimal and octal numbering system
    1. Have the students attempt to create a numbering system to the base 16
    2. Explain the method by which numbers 10 through 15 are expressed
    3. Have the students create a numbering system to the base 8, and count to twenty in the new numbering system
  - D. Demonstrate the creation of a numbering system such as base 16 or 8 expressed as a binary number
  - E. Explain the nomenclature of a binary number for a hexadecimal computer system

1. Bit
  2. Nibble
  3. Byte
  4. Word
  5. Double word
- II. Perform Mathematical Operations in Digital Numbering Systems
- A. Explain and demonstrate the rules by which binary numbers are added or subtracted
1. Explain that the computer can only add
  2. Explain the rules of binary addition
  3. Demonstrate the complement of a binary number
  4. Demonstrate the conversion of a binary number to 2s complement
  5. Demonstrate two's complement subtraction (addition)
- B. Explain and demonstrate the rules by which binary numbers can be multiplied or divided
1. Demonstrate the multiplication of two binary numbers
  2. Demonstrate the multiplication by two of a binary number (left shift)
  3. Demonstrate division by two of a binary number (right shift)
  4. Demonstrate the multiplication or division of a binary number by successive addition of a positive or negative number
- C. Explain the multiplication of hexadecimal and octal numbers by conversion to binary

**AET-G1-LE**  
**Perform Digital Operations in Digital Numbering Systems**  
**Attachment 3: MASTER Laboratory Exercise**

---

The student will:

1. Determine the maximum and minimum binary numbers, both positive and negative, that can be reported by an analog input or output module for a 16 bit PLC; and,
2. Determine the current operating condition of a CNC machine or robot by converting the binary or hexadecimal data reported by the control.

**AET-G2-HO-1**  
**Perform Boolean Operations in Digital Equipment**  
**Attachment 1: MASTER Handout No. 1**

---

**Objective(s):**

Upon completion of this unit the student will be able to:

- a. Write a Boolean expression of a complex logical problem;
  - b. Convert the Boolean expression to symbolic logic;
  - c. Read a digital electronic diagram containing Boolean symbolic logic; and,
  - d. Identify and explain the function of complex logical functions such as decoders, encoders, counters, and registers.
- 

**Module Outline:**

- I. Express a Complex Logic Problem in Boolean, and Convert it into Symbolic Logic
  - A. Explain the rules by which Boolean statements are created
    1. Explain the logical rules of Boolean
      - a. AND
      - b. OR (inclusive OR)
      - c. XOR (exclusive OR)
      - d. NOT
    2. Explain the use of a truth table
    3. Create the following Boolean rules from the above
      - a. NAND
      - b. NOR
      - c. Not XOR
    4. Demonstrate the rules of the NOT functions with a truth table
    5. Explain and demonstrate the depiction of the logical operators in an algebraic Boolean expression
    6. Conduct an exercise in converting a control problem into a Boolean expression (The two light switch problem is ideal. Both switches turn the same light on or off.)
      - a. Define the inputs and outputs
      - b. Define the logical processing that controls the system
    7. Explain the mathematical rules for manipulating Boolean expressions
      - a. Order of operations
      - b. Laws of distribution and association
      - c. Law of double complementation
      - d. Law of tautology
      - e. DeMorgan's Theorem

8. Explain the relationship of Boolean to the binary numbering system
  9. Explain the method by which binary bits are stored in memory devices
- B. Demonstrate the conversion of a Boolean expression to symbolic logic
1. Explain the concept and purpose of Boolean symbolic logic. Stress the importance of writing the Boolean expression *before* converting to symbolic logic
  2. Draw the Boolean symbols that are most commonly used to depict the above Boolean expressions, and explain the inputs and outputs of the symbols
  3. Draw the digital symbols for binary memory storage (multi vibrators, flip/flops) and explain the types of memory devices (flip/flops)
  4. Have the students convert the above control problem into symbolic logic
- II. Read Digital Symbology and Relate it to Control of Digitally Operated Equipment
- A. Explain and demonstrate methods for reading digital schematic drawings
1. Demonstrate the use of a truth table to determine the possible states of outputs
  2. Explain the rules of static logic and dynamic logic
  3. Demonstrate the creation of a complete English sentence form a combinational logic circuit
- B. Demonstrate how the ability to state a control problem as a sentence, by studying the digital symbology, can help a technician understand the operation of the equipment
1. Conduct several exercises in converting digital symbology into Boolean expressions
  2. Convert the Boolean expressions into plain English sentences
  3. Use the sentences to describe the operation of the control system
  4. Demonstrate binary addition by the use of symbolic gates
- III. Identify Combinational Logic Devices Such as Decoders, Encoders, Counters and Registers
- A. Explain and demonstrate common combinational logic circuits
1. Demonstrate the creation of a Gray code decoder circuit
  2. Demonstrate the creation of an ASCII encoder circuit
- B. Explain and demonstrate how memory devices are used to create counters and registers
1. Explain how memory devices are combined to store binary data
  2. Explain the operating principles of a binary storage register using binary storage elements (flip/flops)

3. Explain the operating principles of a binary counter using binary storage elements (flip/flops)
4. Demonstrate the count sequence of a binary counter

**AET-G2-LE**  
**Perform Boolean Operations in Digital Equipment**  
**Attachment 3: MASTER Laboratory Exercise**

---

The student will:

1. Explore the digital symbology contained in a digital schematic diagram for a CNC or robot control system, and identify counters and registers.

**AET-G3-HO**  
**Solve Digital Logic Circuits and Ladder Diagrams**  
**in Electrical and Programmable Logic Control Circuits;**  
**Express a Complex Logic Problem in Boolean**  
**and Convert it into Ladder Logic**  
**Attachment 1: MASTER Handout**

---

**Objective(s):**

Upon completion of this unit the student will be able to:

- a. Convert an electrical control ladder diagram into a set of Boolean expressions;
  - b. Convert complex Boolean expressions into ladder logic; and,
  - c. Convert Boolean expressions into program fragments and subroutines.
- 

**Module Outline:**

- I. Convert an Electrical Ladder Control Drawing to a Set of Boolean Expressions
  - A. Explain the rules by which electrical ladder rungs can be converted to Boolean expressions
    1. Explain the rules of the ladder AND function
    2. Explain the rules of the ladder OR function
    3. Explain the rules of the ladder XOR function
    4. Explain the rules of the ladder NOT function
    5. Explain the rules of the ladder memory function
  - B. Demonstrate the conversion of a complex electrical ladder drawing into a set of Boolean expressions
- II. Express a Complex Logic Problem in Boolean, and Convert it into Ladder Logic
  - A. Explain and demonstrate the procedure for converting a Boolean expression into ladder logic
  - B. Conduct an exercise in converting a Boolean expression of a complex control problem into ladder logic
    1. Demonstrate the conversion of the problem
    2. Explain the problems in the conversion that are peculiar to a programmable logic controller (PLC)
- III. Express a Complex Logic Problem in Boolean, and Convert it into a Program
  - A. Explain and demonstrate the procedure for converting a Boolean expression and mathematical expression into a program fragment or subroutine
    1. Explain and demonstrate the concept of lower order and higher order programming languages
    2. Explain the concept of a subroutine



3. Explain and demonstrate the program syntax and structure that is essential for programming Boolean expressions and math functions in both BASIC and "C"
- B. Conduct an exercise in converting a Boolean expression of a complex control problem into program fragment or subroutine for both Basic and "C"
1. Demonstrate the conversion of the problem
  2. Explain the problems in the conversion that are peculiar to a given programming language

**AET-G3-LE**  
**Solve Digital Logic Circuits and Ladder Diagrams**  
**in Electrical and Programmable Logic Control Circuits;**  
**Express a Complex Logic Problem in Boolean**  
**and Convert it into Ladder Logic**  
**Attachment 2: MASTER Laboratory Exercise**

---

The student will:

1. Convert an electrical ladder drawing for an electrical control system into a set of Boolean expressions;
2. Convert a symbolic digital drawing for a robot or CNC control into ladder logic; and,
3. Program a control function for a industrial control system.

**AET-G4-HO**  
**Program Computers and Computer Controlled Industrial Equipment**  
**Attachment 1: MASTER Handout**

---

**Objective(s):**

Upon completion of this unit the student will be able to:

- a. Program a control statement, written as a Boolean expression, into a high order language such as BASIC or "C";
  - b. Use a computer or hand-held terminal to program control statements into higher order programming languages such as ladder programming, BASIC, or "C"; and,
  - c. Use the concepts of structured programming to write structured programs that contain proper documentation, and are relatively easy to read and modify.
- 

**Module Outline:**

- I. Use Various Programming Devices to Program Computer Controlled Industrial Equipment
  - A. Explain the tools used to construct a program
    1. Explain the purpose of an editor and give examples of editors
    2. Explain the purpose of a compiler and give examples of compilers for different programming languages
    3. Describe the steps necessary to use a computer to run an editor
    4. Describe the steps necessary to use a computer to compile the program and the supporting programs that are necessary to make the compiler run properly
    5. Demonstrate the use of a hand-held terminal to program a PLC (programmable logic controller)
  - B. Provide lab exercises in the use of a computer to run programming tools
  - C. Provide lab exercises in the use of a hand-held terminal to program a PLC
- II. Use Structured Programming Concepts to Program Industrial Equipment
  - A. Explain the rules of structured programming (top-down programming)
    1. Explain the purpose of structured programming
    2. Describe proper documentation for structured programs and the purpose of the program header
    3. Describe the steps necessary to create structured programs
    4. Demonstrate the creation of a structured program
  - B. Provide lab exercises in structured programming using ladder programming and BASIC, or "C"

**AET-G4-LE**  
**Program Computers and Computer Controlled Industrial Equipment**  
**Attachment 2: MASTER Laboratory Exercise**

---

The student will:

1. Convert an electrical ladder drawing for an electrical control system into a ladder program; and,
2. Convert an electrical ladder drawing for an electrical control system into a BASIC or C program.

**AUTOMATED EQUIPMENT REPAIR TECHNICIAN ... operates, programs, maintains, and repairs automated machine tools and automated manufacturing processes.**

**Duties**

**Tasks**

Duties	A-1 Apply scientific notation and engineering notation to solve mechanical problems	A-2 Apply algebraic formulas to solve technical problems	A-3 Use variables in algebraic formulas to predict behavior of systems	A-4 Manipulate algebraic formulas to analyze industrial systems	A-5 Measure, calculate, and convert quantities in English units systems of measurement	A-6 Use mechanical physics to analyze mechanical systems	A-7 Use mechanical physics to analyze industrial systems	A-8 Use mathematical and mechanical physics to analyze hydraulic and pneumatic systems	A-9 Use mathematical and thermodynamics to analyze problems found in pneumatic systems	A-10 Use mathematical physics of electromagnetism and optics to analyze industrial systems	A-11 Use chemical formulas and chemical reactions in industrial processes	A-12 Apply chemical knowledge of electrochemical effects to analyze chemical processes	A-13 Apply scientific notation to analyze industrial water treatment processes	
<b>A</b> Apply Science to Industrial Problems	B-1 Use symbols, organization, and engineering drawings	B-2 Use symbols, organization, and engineering drawings	B-3 Use symbols, organization, and engineering drawings	B-4 Use symbols, organization, and engineering drawings	C-5 Use digital electronic measurement	E-5 Properly set up, calibrate, and use oscilloscopes	E-6 Use components such as resistors, capacitors, and test components	E-7 Use meters/oscilloscopes to shift or angle in series resistive-capacitive/inductive AC circuits	E-8 Apply electromagnetic theory to analyze solenoids, transformers, and AC circuits	E-9 Apply principles of operation to identify various types of motors	E-10 Apply semiconductor theory to determine operational characteristics of semiconductor power control devices	E-11 Apply semiconductor theory to determine operational characteristics of semiconductor devices for single phase and three phase UPS	E-12 Apply semiconductor knowledge to determine operational characteristics of sensors and transducers	E-13 Use schematic diagrams to identify, troubleshoot and repair electronic motor control circuits
<b>B</b> Use Drawings to Maintain and Repair Systems	C-1 Apply mechanical measurement methods to align machine tools	C-2 Apply electrical measurement methods to troubleshoot electrical circuits	C-3 Apply electronic measurement methods to troubleshoot electronic circuits	C-4 Apply fluid power measurement methods to troubleshoot hydraulic and pneumatic systems	E-5 Properly set up, calibrate, and use oscilloscopes	E-6 Use components such as resistors, capacitors, and test components	E-7 Use meters/oscilloscopes to shift or angle in series resistive-capacitive/inductive AC circuits	E-8 Apply electromagnetic theory to analyze solenoids, transformers, and AC circuits	E-9 Apply principles of operation to identify various types of motors	E-10 Apply semiconductor theory to determine operational characteristics of semiconductor power control devices	E-11 Apply semiconductor theory to determine operational characteristics of semiconductor devices for single phase and three phase UPS	E-12 Apply semiconductor knowledge to determine operational characteristics of sensors and transducers	E-13 Use schematic diagrams to identify, troubleshoot and repair electronic motor control circuits	
<b>C</b> Use Calibrated Measuring Instruments to Test/Calibrate Components	D-1 Apply troubleshooting process to the resolution of malfunctions found in machine tools and automated equipment	D-2 Calculate, predict, and measure the response of quantities in AC circuits	D-3 Calculate, predict, and measure the response of quantities in AC circuits	D-4 Calculate, predict, and measure the response of quantities in AC circuits	E-5 Properly set up, calibrate, and use oscilloscopes	E-6 Use components such as resistors, capacitors, and test components	E-7 Use meters/oscilloscopes to shift or angle in series resistive-capacitive/inductive AC circuits	E-8 Apply electromagnetic theory to analyze solenoids, transformers, and AC circuits	E-9 Apply principles of operation to identify various types of motors	E-10 Apply semiconductor theory to determine operational characteristics of semiconductor power control devices	E-11 Apply semiconductor theory to determine operational characteristics of semiconductor devices for single phase and three phase UPS	E-12 Apply semiconductor knowledge to determine operational characteristics of sensors and transducers	E-13 Use schematic diagrams to identify, troubleshoot and repair electronic motor control circuits	
<b>D</b> Resolve System Failures with Critical Thinking, Troubleshooting, and Metrology	E-1 Calculate, predict, and measure the response of quantities in DC circuits	E-2 Calculate, predict, and measure the response of quantities in AC circuits	E-3 Calculate, predict, and measure the response of quantities in AC circuits	E-4 Calculate, predict, and measure the response of quantities in AC circuits	E-5 Properly set up, calibrate, and use oscilloscopes	E-6 Use components such as resistors, capacitors, and test components	E-7 Use meters/oscilloscopes to shift or angle in series resistive-capacitive/inductive AC circuits	E-8 Apply electromagnetic theory to analyze solenoids, transformers, and AC circuits	E-9 Apply principles of operation to identify various types of motors	E-10 Apply semiconductor theory to determine operational characteristics of semiconductor power control devices	E-11 Apply semiconductor theory to determine operational characteristics of semiconductor devices for single phase and three phase UPS	E-12 Apply semiconductor knowledge to determine operational characteristics of sensors and transducers	E-13 Use schematic diagrams to identify, troubleshoot and repair electronic motor control circuits	
<b>E</b> Use Techniques to Troubleshoot Malfunctions of Electronic Systems	F-1 Identify and explain the theory and use of major systems such as hydraulic, pneumatic, and pneumatic systems	F-2 Apply purpose and use of valves in a hydraulic or pneumatic system	F-3 Identify, assemble, measure, and apply knowledge of operating principles of hydraulic and pneumatic actuators	F-4 Apply hydraulic, pneumatic, and high vacuum systems knowledge to troubleshoot and repair special devices	E-5 Properly set up, calibrate, and use oscilloscopes	E-6 Use components such as resistors, capacitors, and test components	E-7 Use meters/oscilloscopes to shift or angle in series resistive-capacitive/inductive AC circuits	E-8 Apply electromagnetic theory to analyze solenoids, transformers, and AC circuits	E-9 Apply principles of operation to identify various types of motors	E-10 Apply semiconductor theory to determine operational characteristics of semiconductor power control devices	E-11 Apply semiconductor theory to determine operational characteristics of semiconductor devices for single phase and three phase UPS	E-12 Apply semiconductor knowledge to determine operational characteristics of sensors and transducers	E-13 Use schematic diagrams to identify, troubleshoot and repair electronic motor control circuits	
<b>F</b> Measure/Isolate Malfunctions of Changing Fluid Power Systems	G-1 Perform calculations in digital numbering systems	G-2 Perform calculations in digital numbering systems	G-3 Solve digital logic problems in ladder diagrams and programmable logic control circuits	G-4 Program and troubleshoot industrial equipment	J-5 Safely assemble, disassemble, or adjust digital systems such as PLCs, CNCs, or computers	J-6 Safely assemble, disassemble, or adjust digital systems such as PLCs, CNCs, or computers	J-7 Safely assemble, disassemble, or adjust digital systems such as PLCs, CNCs, or computers	J-8 Safely assemble, disassemble, or adjust digital systems such as PLCs, CNCs, or computers	J-9 Safely assemble, disassemble, or adjust digital systems such as PLCs, CNCs, or computers	J-10 Safely assemble, disassemble, or adjust digital systems such as PLCs, CNCs, or computers	J-11 Safely assemble, disassemble, or adjust digital systems such as PLCs, CNCs, or computers	J-12 Safely assemble, disassemble, or adjust digital systems such as PLCs, CNCs, or computers	J-13 Safely assemble, disassemble, or adjust digital systems such as PLCs, CNCs, or computers	
<b>G</b> Apply Computer Science to Computer Controlled Equipment	H-1 Perform operations on PLC (programmable logic controller) and computer interface controller systems	H-2 Perform operations on PLC (programmable logic controller) and computer interface controller systems	H-3 Safely assemble, disassemble, or adjust digital systems such as PLCs, CNCs, or computers	H-4 Safely assemble, disassemble, or adjust digital systems such as PLCs, CNCs, or computers	J-5 Safely assemble, disassemble, or adjust digital systems such as PLCs, CNCs, or computers	J-6 Safely assemble, disassemble, or adjust digital systems such as PLCs, CNCs, or computers	J-7 Safely assemble, disassemble, or adjust digital systems such as PLCs, CNCs, or computers	J-8 Safely assemble, disassemble, or adjust digital systems such as PLCs, CNCs, or computers	J-9 Safely assemble, disassemble, or adjust digital systems such as PLCs, CNCs, or computers	J-10 Safely assemble, disassemble, or adjust digital systems such as PLCs, CNCs, or computers	J-11 Safely assemble, disassemble, or adjust digital systems such as PLCs, CNCs, or computers	J-12 Safely assemble, disassemble, or adjust digital systems such as PLCs, CNCs, or computers	J-13 Safely assemble, disassemble, or adjust digital systems such as PLCs, CNCs, or computers	
<b>H</b> Correct Malfunctions in PLC Controlled Industrial Equipment	I-1 Resolve malfunctions found in computer systems manufacturing processes	I-2 Resolve malfunctions found in computer systems manufacturing processes	I-3 Safely assemble, disassemble, or adjust digital systems such as PLCs, CNCs, or computers	I-4 Safely assemble, disassemble, or adjust digital systems such as PLCs, CNCs, or computers	J-5 Safely assemble, disassemble, or adjust digital systems such as PLCs, CNCs, or computers	J-6 Safely assemble, disassemble, or adjust digital systems such as PLCs, CNCs, or computers	J-7 Safely assemble, disassemble, or adjust digital systems such as PLCs, CNCs, or computers	J-8 Safely assemble, disassemble, or adjust digital systems such as PLCs, CNCs, or computers	J-9 Safely assemble, disassemble, or adjust digital systems such as PLCs, CNCs, or computers	J-10 Safely assemble, disassemble, or adjust digital systems such as PLCs, CNCs, or computers	J-11 Safely assemble, disassemble, or adjust digital systems such as PLCs, CNCs, or computers	J-12 Safely assemble, disassemble, or adjust digital systems such as PLCs, CNCs, or computers	J-13 Safely assemble, disassemble, or adjust digital systems such as PLCs, CNCs, or computers	
<b>I</b> Resolve Malfunctions Found in Computer Systems Manufacturing Processes	J-1 Safely assemble, disassemble, or adjust digital systems such as PLCs, CNCs, or computers	J-2 Safely assemble, disassemble, or adjust digital systems such as PLCs, CNCs, or computers	J-3 Safely assemble, disassemble, or adjust digital systems such as PLCs, CNCs, or computers	J-4 Safely assemble, disassemble, or adjust digital systems such as PLCs, CNCs, or computers	J-5 Safely assemble, disassemble, or adjust digital systems such as PLCs, CNCs, or computers	J-6 Safely assemble, disassemble, or adjust digital systems such as PLCs, CNCs, or computers	J-7 Safely assemble, disassemble, or adjust digital systems such as PLCs, CNCs, or computers	J-8 Safely assemble, disassemble, or adjust digital systems such as PLCs, CNCs, or computers	J-9 Safely assemble, disassemble, or adjust digital systems such as PLCs, CNCs, or computers	J-10 Safely assemble, disassemble, or adjust digital systems such as PLCs, CNCs, or computers	J-11 Safely assemble, disassemble, or adjust digital systems such as PLCs, CNCs, or computers	J-12 Safely assemble, disassemble, or adjust digital systems such as PLCs, CNCs, or computers	J-13 Safely assemble, disassemble, or adjust digital systems such as PLCs, CNCs, or computers	
<b>J</b> Assemble/Disassemble Mechanical, Electronic and Computer Systems	J-1 Safely assemble, disassemble, or adjust digital systems such as PLCs, CNCs, or computers	J-2 Safely assemble, disassemble, or adjust digital systems such as PLCs, CNCs, or computers	J-3 Safely assemble, disassemble, or adjust digital systems such as PLCs, CNCs, or computers	J-4 Safely assemble, disassemble, or adjust digital systems such as PLCs, CNCs, or computers	J-5 Safely assemble, disassemble, or adjust digital systems such as PLCs, CNCs, or computers	J-6 Safely assemble, disassemble, or adjust digital systems such as PLCs, CNCs, or computers	J-7 Safely assemble, disassemble, or adjust digital systems such as PLCs, CNCs, or computers	J-8 Safely assemble, disassemble, or adjust digital systems such as PLCs, CNCs, or computers	J-9 Safely assemble, disassemble, or adjust digital systems such as PLCs, CNCs, or computers	J-10 Safely assemble, disassemble, or adjust digital systems such as PLCs, CNCs, or computers	J-11 Safely assemble, disassemble, or adjust digital systems such as PLCs, CNCs, or computers	J-12 Safely assemble, disassemble, or adjust digital systems such as PLCs, CNCs, or computers	J-13 Safely assemble, disassemble, or adjust digital systems such as PLCs, CNCs, or computers	

BEST COPY AVAILABLE

**AET-H1-HO**  
**Perform Operations on PLC (Programmable Logic Controller)**  
**or PIC (Programmable Interface Controller) Systems**  
**Attachment 1: MASTER Handout**

---

**Objective(s):**

Upon completion of this unit the student will be able to:

- a. Use a data entry device to set up and configure a PLC/PIC to control digital and analog input/output points;
- b. Set up/configure PIC/PLC as part of the control system of CNC machine/robot to control digital and analog I/O points;
- c. Use equipment manuals, manufacturer's specifications, and data entry/monitoring devices to connect and test digital and analog I/O points on a PLC or PIC;
- d. Use equipment manuals, manufacturer's specifications, and data entry/monitoring devices to test and troubleshoot set up of a PLC or PIC system and solve control problems
- e. Connect a data entry device such as a hand held terminal teach pendent, or programming computer to the communications port of a PLC or PIC and configure the controller for the types and quantities of control modules;
- f. Use the control system of a CNC machine tool or robot to configure a PLC or PIC that is part of the control system, or modify the parameters of the control to change specific machine functions;
- g. Install digital and analog input/output (I/O) modules in a PLC or PIC, connect field devices to the modules, and using a hand held terminal or personal computer to monitor the data, test the inputs and outputs for proper operation; and,
- h. Connect a hand held terminal or personal computer and programming/monitoring software to a PLC or PIC and use the device to monitor and correct problems on a fully configured and functioning, PLC or PIC system.

---

**Module Outline:**

- I. Use a Data Entry Device to Set Up and Configure a PLC/PIC to Control Digital and Analog Input/Output Points
  - A. Review Binary, octal, and hexadecimal numbering systems and Boolean algebra. Emphasize the importance of these concepts to the use and programming of a PLC
  - B. Explain the basic design and operating theory of a Programmable Logic Controller (PLC) or Peripheral Interface Controller (PIC). Show

**Bergwall Productions *Introduction to Programmable Logic Controllers, Parts 1-4***

1. Explain the basic concepts of a PLC or PIC
    - a. Inputs, processing, outputs
    - b. Uses of a PLC (general purpose controller)
    - c. Uses of a PIC (associated with CNC machine tools)
    - d. Explain the concept of field devices
  2. Explain the role of the processor
    - a. As a storage device
      - (1) Storing input/output states
      - (2) Storing counters/timers
      - (3) Storing ladder programs
    - b. A logical decision making device
  3. Explain the role of programming as the processing part of inputs, outputs and processing
    - a. Explain the programming process
    - b. Explain the concept of processing as it relates to electrical ladder diagrams and ladder programs
    - c. List the various types of programming languages. Contrast and compare the advantages of each
      - (1) Ladder
      - (2) Statement list
      - (3) Flow chart
      - (4) BASIC or Visual BASIC
      - (5) C, C++ or Visual C
      - (6) Other types of PLC programming languages
  4. Explain the role of the input and output modules
    - a. List the types of digital input and output modules and their specifications
    - b. List the types of analog input and output modules and their specifications
    - c. Explain the role and purpose of the input/output modules as an interface between the processor and the machine tool
- B. Demonstrate assembling the PLC, system, connecting the programming device, and configuring the PLC**
1. Identify and explain the assembly of the rack, processor and power supply
  2. Demonstrate the installation of input and output modules
  3. Explain the concept and procedure of configuring the PLC for the type and number of modules in the system
  4. Demonstrate connecting the programming device and configuring the PLC

- II. Set Up/Configure PIC/PLC as Part of the Control System of CNC Machine/Robot to Control Digital and Analog I/O Points
  - A. Explain and demonstrate the basic design of a PLC/PIC system that is used as a part of a CNC machine
    - 1. Explain the differences between a PLC and a PIC
      - a. Compare and contrast the design philosophy of the control interface
      - b. Compare and contrast the programming methods and program storage
    - 2. Compare and contrast the methods of connecting field devices to a PLC and PIC
    - 3. Explain and demonstrate methods of monitoring the states of field devices
      - a. Explain and demonstrate the use of the CNC control to view and interpret field device status
      - b. Explain and demonstrate the concept of parameters as it relates to configuring a CNC control for a particular machine tool application
  - B. Explain and demonstrate the basic design of a programmable interface control (PIC) system that is used as a part of a robot
    - 1. Compare and contrast the design philosophy of the control interface with a CNC control
    - 2. Explain and demonstrate the connection of field devices
    - 3. Compare and contrast the programming methods and program storage with a PLC and CNC control
    - 4. Explain and demonstrate connecting the programming device and programming the robot
    - 5. Explain and demonstrate methods of monitoring the states of field devices
  - C. Compare and contrast a PLC with the above programmed interfaces
- III. Use Equipment Manuals, Manufacturer's Specifications, and Data Entry/Monitoring Devices to Connect and Test Digital and Analog I/O Points on a PLC or PIC
  - A. Explain and demonstrate the basic design of a PLC system
    - 1. Explain methods for determining the type of PLC and the number of inputs and outputs needed for the system
      - a. Write a Boolean expression that describes the system
      - b. Identify, list, and count the input and output variables associated with the expression
      - c. Determine the electrical design of the system
        - (1) Voltage levels
        - (2) DC or AC or both
      - d. Select model and make of PLC



- (1) Determine time critical operations and minimum PLC scan rate desired based upon number and complexity of Boolean expressions
    - (2) Determine mathematical functions desired based upon control algorithms
      - (a) Analog servo control
      - (b) PID loop control
      - (c) Select PLC based upon number of control points, scan rate, and mathematical set desired
  - e. Select input and output modules from catalogs based upon electrical design and number and type of control variables
2. Explain and demonstrate the methods of connecting field devices
  - a. Explain and provide examples of the different types of input and output modules
    - (1) Digital inputs
      - (a) DC
      - (b) AC
    - (2) Digital outputs
      - (a) DC
      - (b) AC
    - (3) Analog inputs
    - (4) Analog outputs
  - b. Explain and demonstrate the connection of field device wiring to input and output modules
    - (1) Explain the concept of a field device and the types of field devices
      - (a) Passive devices
      - (b) Active (smart) devices
    - (2) Demonstrate wiring methods for connecting passive and active field devices
3. Explain the programming of a PLC
  - a. Explain and demonstrate the method of programming PLC files.
    - (1) Input and output tables
    - (2) Software relay coils and contact tables (called "bits" in Allen Bradley PLCs)
    - (3) Counter or timer tables
    - (4) Analog variable tables
    - (5) Mathematical functions
    - (6) Variable scaling functions
  - b. Explain and demonstrate the documentation of PLC programs

- (1) Labels and I/O addresses
  - (2) Comments and headers
- IV. Use Equipment Manuals, Manufacturer's Specifications, and Data Entry/Monitoring Devices to Test and Troubleshoot Set Up of a PLC or PIC System and Solve Control Problems
- A. Explain and demonstrate the method of connecting a monitor/programming terminal to a PLC to monitor the state of field devices
    1. Explain and demonstrate the connection of a HHT to a PLC to monitor the state of field devices
    2. Explain and demonstrate the methods of connecting a computer monitor/programming terminal to a PLC to monitor the state of field devices
    3. Explain the scaling of analog field devices and the methods used to monitor and test analog input and output modules
    4. Explain the role of the input and output modules
  - B. Demonstrate troubleshooting methods using the monitoring programming device
    1. Explain and demonstrate the concept of forcing and input or an output
    2. Explain the safety rules when forcing an input or an output
    3. Explain and demonstrate the method of monitoring the state of PLC files
      - a. Input and output tables
      - b. Software relay coils and contact tables (called "bits" in Allen Bradley PLCs)
      - c. Counter or timer tables
      - d. Analog variable tables
      - e. Mathematical functions
      - f. Variable scaling functions
    4. Demonstrate monitoring a ladder and checking the state of field devices

**AET-H1-LE**  
**Perform Operations on PLC (Programmable Logic Controller)**  
**or PIC (Programmable Interface Controller) Systems**  
**Attachment 2: MASTER Laboratory Exercise**

---

The student will:

1. Configure a PLC to control an automation system;
2. Monitor the state of field devices in a CNC control;
3. Monitor/configure the parameters to control a CNC system; and,
4. Monitor the state of field devices on an existing PLC installation.

**AUTOMATED EQUIPMENT REPAIR TECHNICIAN ... operates, programs, maintains, and repairs automated machine tools and automated manufacturing processes.**

**Duties**

**Tasks**

Duties	A-1 Apply scientific notation and engineering notation to solve technical problems	A-2 Apply algebraic formulas to solve technical problems	A-3 Use variables in algebraic formulas to predict or solve industrial systems	A-4 Manipulate variables in algebraic formulas to analyze industrial systems	A-5 Measure, calculate, and convert quantities in English (imperial) and metric (SI) systems of measurement	A-6 Use mechanical and physics to analyze problems found in pneumatic systems	A-7 Use mechanical physics to analyze mechanical industrial systems	A-8 Use mathematics and physics to analyze problems found in pneumatic systems	A-9 Use mathematics and thermodynamics to analyze problems found in industrial heat treating systems	A-10 Use mathematics and physics of electromagnetism and optics in industrial systems	A-11 Use chemical principles and formulas to predict and analyze reactions in industrial processes	A-12 Apply knowledge of electrochemical effects to analyze industrial processes	A-13 Apply proper use of analytical equipment to analyze industrial processes
<b>A</b> Apply Science to Solve Industrial Problems	B-1 Use symbols, organization, and drawing values on mechanical drawings	B-2 Use symbols, organization, and drawing values on electrical drawings	B-3 Use symbols, organization, and drawing values on electronic drawings	B-4 Use symbols, organization, and drawing values on fluid power drawings	B-5 Use symbols, organization, and drawing values on digital drawings								
<b>B</b> Use Drawings to Analyze and Repair Systems	C-1 Apply machine tool measurement instruments to test/calibrate machine tools	C-2 Apply electrical measuring instruments to test/calibrate electrical circuits	C-3 Apply electronic measuring instruments to test/calibrate electronic circuits	C-4 Apply fluid power measuring instruments to test/calibrate hydraulic and pneumatic systems	C-5 Apply digital electronic measuring instruments to test/calibrate digital electronic circuits								
<b>C</b> Use Calibrated Instrumentation to Test/Calibrate Components	D-1 Apply the troubleshooting process to the resolution of malfunctions in industrial machine tools and automated equipment												
<b>D</b> Resolve System Failures with Critical Thinking, Problem Solving, Theory and Metrology	E-1 Calculate, measure, and compare quantities in DC circuits	E-2 Calculate, measure, and compare quantities in AC circuits	E-3 Calculate, measure, and compare quantities in AC circuits	E-4 Calculate, predict, and compare quantities in polyphase AC circuits	E-5 Properly set up, calibrate, and use an oscilloscope	E-6 Use components such as resistors, capacitors, and test components and test circuits	E-7 Use meters/oscilloscopes to measure, compare, and shift or angle in series resistive-capacitive/inductive AC circuits	E-8 Apply electromagnetic theory and principles of electrical characteristics of solenoids, transformers, and electrical circuits for DC and AC circuits	E-9 Apply principles of operation and dynamics to analyze various types of motors	E-10 Apply semiconductor theory and principles to determine operational characteristics of diodes, transistors, and power control semiconductors	E-11 Apply semiconductor theory and measurement techniques to determine operational characteristics of rectifiers, amplifiers, and three phase power supplies	E-12 Apply semiconductor theory and measurement techniques to determine operational characteristics of amplifiers and sensors	E-13 Use schematic diagrams, meters, and other tools to identify, troubleshoot, and repair various types of motor control circuits
<b>E</b> Use Techniques and Malfunctions of Electrical/Electronic Systems	F-1 Identify and explain the theory and use of hydraulic and pneumatic systems	F-2 Apply purpose and use of valves in a hydraulic or pneumatic system to troubleshoot components or systems	F-3 Identify, assemble, measure, and apply knowledge of operating characteristics of pneumatic actuators	F-4 Apply hydraulic and pneumatic systems knowledge to troubleshoot special components/devices	F-5 Identify, assemble, measure, and apply knowledge of operating characteristics of specialized fluid power circuits								
<b>F</b> Measure/Isolate Malfunctions of Pneumatic/Fluid Power Systems	G-1 Perform calculations in digital numbers being systems	G-2 Perform calculations in digital numbers in electrical equipment	G-3 Solve digital logic control circuit problems using a complex logic problem in Boolean ladder	G-4 Program computers and modified industrial equipment									
<b>G</b> Apply Computer Science to Computer Controlled Equipment	H-1 Perform operations on PLC (programmable logic controller) or PLC (programmable controller) system												
<b>H</b> Correct Malfunctions in PLC Controlled Equipment	I-1 Use equipment manual, manufacturer's specifications, and manufacturer's manuals to configure, test and troubleshoot set, and solve control problems												
<b>I</b> Resolve Malfunctions Found in Control Systems Controlling Manufacturing Processes	J-1 Safely assemble, disassemble, and adjust mechanical systems such as gears, shafts, bearings, couplings, millers, cutters, etc.	J-2 Safely assemble, disassemble, and adjust electrical components or systems (fluid power systems)	J-3 Safely assemble, disassemble, and adjust electronic components or systems	J-4 Safely assemble, disassemble, or adjust components or systems	J-5 Safely assemble or disassemble digital components such as PLCs, CNCs, or computers								
<b>J</b> Assemble/Disassemble and Adjust Mechanical, Electrical, Electronic, and Computer Systems													

**AET-I1-HO**  
**Use Equipment Manuals, Manufacturer's Specifications,  
and Data Entry/Monitoring Devices  
to Configure, Test and Troubleshoot Set Up  
of a Computer System and Solve Control Problems**  
Attachment 1: MASTER Handout

---

Upon completion of this unit the student will be able to:

- a. Properly and safely install all of the operating hardware of a Pentium or Pentium class, personal computer in a computer case;
- b. Configure and test the operating hardware of a Pentium or Pentium class, personal computer;
- c. Modify/upgrade the operating hardware of a Pentium or Pentium class, personal computer;
- d. Install and maintain an operating system in a Pentium or Pentium class, personal computer;
- e. Install and maintain applications programs in a Pentium or Pentium class, personal computer;
- f. Operate the computer using MSDOS, LUNIX, WINDOWS, or WINDOWS 95 in a Pentium or Pentium class, personal computer;
- g. Configure and connect a serial communications interface based upon the RS-232-C standard or a compatible standard; and,
- h. Configure and connect Pentium or Pentium class, personal computers to a local area network based upon the WINDOWS for Work Groups 3.11 standard, the WINDOWS 95 standard, and/or the LUNIX operating system with the TCP/IP standard.

---

**Module Outline:**

- I. Install Hardware/Software in a Personal Computer
  - A. Explain the purpose and specifications of the following types of hardware devices used in Intel/Windows based personal computer
    1. Motherboard, case, and power supply
    2. CPU and CPU fan
    3. RAM and ROM (BIOS) Memory
    4. Cache memory
    5. Disk drives (hard drive, floppy drive, CD-ROM drive)
    6. Video card and monitor
    7. Keyboard and mouse
    8. Local Area Network card (LAN)
    9. Modem card
    10. Small computer system interface (SCSI) card (SCSI interface)
    11. Input/output ports (parallel, serial)

- B. Demonstrate the installation of the following computer hardware components, and the precautions that must be taken when installing these components
1. Motherboard, case, and power supply
  2. CPU and CPU fan
  3. RAM and ROM Basic Input-Output System (BIOS) Memory
  4. Cache memory
  5. Disk drives (hard drive, floppy drive, CD-ROM drive)
  6. Video card and monitor
  7. Keyboard and mouse
  8. Local Area Network card (LAN)
  9. Modem card
  10. Small computer system interface (SCSI) card (SCSI interface)
- C. Demonstrate the configuration of the following computer hardware components
1. Motherboard/Basic Input-Output System (BIOS)
    - a. CPU
    - b. Cache memory
    - c. Drive configuration
    - d. Input/output ports
    - e. Date/time
    - f. RAM Memory
  2. Complementary Metal Oxide Semiconductor (CMOS) memory
  3. Disk drives (hard drive, floppy drive, CD-ROM drive)
  4. Video card and monitor
  5. Keyboard and mouse
  6. Local Area Network card (LAN)
  7. Modem card
  8. Small computer system interface (SCSI) card (SCSI interface)
  9. Input/output ports (parallel, serial)
- D. Demonstrate installation of the operating system
- Note: Any operating system may be installed; however, the two operating systems that should be installed first, are MS-DOS or compatible, or LUNIX. The reason for this step, is that industry tends to be very conservative about replacing or upgrading computers. If a system performs as it was designed, the philosophy is "If it works, don't fix it." For this reason, an industrial automation technician may frequently find that the computers used to operate, program, and troubleshoot equipment are old MS-DOS based computers or UNIX based computers. LUNIX is a UNIX operating system designed to work on Intel/Windows class computers.
1. Explain the purpose of the operating system and how it works with the BIOS
  2. Demonstrate the installation of the operating system

- E. Conduct Instructor generated lab procedures to facilitate the installation and configuration of hardware/software components
- II. Test the Hardware of a Personal Computer
  - A. Explain and demonstrate the procedures and hardware/software used to test the operation and specifications of the following types of hardware devices used in Intel/Windows based personal computers
    - 1. Motherboard and power supply
    - 2. CPU
    - 3. RAM and ROM (BIOS) Memory
    - 4. Cache memory
    - 5. Disk drives (hard drive, floppy drive, CD-ROM drive)
    - 6. Video card and monitor
    - 7. Keyboard and mouse
    - 8. Local Area Network card (LAN)
    - 9. Modem card
    - 10. Small computer system interface (SCSI) card (SCSI interface)
    - 11. Input/output ports (parallel, serial)
  - B. Conduct Instructor generated lab procedures to test the operation and specifications of the above types of hardware devices used in Intel/Windows based personal computers
- III. Maintain Hardware/Software of a Personal Computer
  - A. Explain and demonstrate the software/hardware tools and methods used to maintain the hardware and software of a personal computer at maximum performance
    - 1. Explain the most common hardware upgrades that can be performed on the computer without major revisions
      - a. More memory
      - b. Faster and larger drive storage
      - c. Faster CPU
      - d. More efficient video modules and larger/faster video memory
    - 2. Demonstrate the above upgrades
    - 3. Explain the most common procedures used to maintain software applications and operating systems at peak performance
      - a. More efficient operating system
      - b. Partitioning hard drives
      - c. Defragmenting hard drives
      - d. Eliminating unused files
      - e. Upgrading software applications
  - B. Provide practical lab experiences on the above concepts
- IV. Operate Different Classes of Personal Computers
  - A. Explain and demonstrate the limitations and operations associated with the following personal computers/operating systems
    - 1. Intel/Windows based computer with a generic MS-DOS operating system

2. Intel/Windows based computer with LUNIX operating system and XWINDOWS
  3. Intel/Windows based computer with Windows 95 or Windows NT operating system
  4. Apple Macintosh computer with Apple operating system  
 Note: If Apple computers are not available, the Windows operating system will provide enough experience in a windowing environment to satisfy this requirement. The author in no way intends to endorse one type of computer over another. However, the Apple computer and operating system is not widely used to run an automation system.
- B. Conduct instructor generated lab procedures on the above platforms/operating systems  
 Note: The author views classes in "Keyboarding" as a waste of time. If the student wishes to improve his or her skills in typing, there are many good avenues to success in this endeavor. The author has created the *entire* AET curriculum with two fingers. In addition, the author programs quite well with the same two fingers. The author does not intend to prevent the acquisition of good typing skills, but the above skills do not require that the student can type well
- V. Configure and Troubleshoot Communications Interfaces
- A. Explain and demonstrate the various types of communication interfaces available to personal computer systems
    1. Serial communications interfaces, RS-232C standard, RS-422 standard
      - a. Serial port configuration
        - (1) Baud rate
        - (2) Data configuration
        - (3) Hardware and software handshaking
      - b. Serial port hardware
        - (1) Hardware voltage levels
        - (2) Connectors, cables, pin configurations and signal requirements
    2. Parallel communications interfaces
      - a. Parallel port configuration
        - (1) Baud rate
        - (2) Data configuration
        - (3) Hardware and software handshaking
      - b. Parallel port hardware
        - (1) Hardware voltage levels
        - (2) Connectors, cables, pin configurations and signal requirements
    3. Ethernet based Local Area Networks (LAN)



- a. LAN configuration
    - (1) Data transfer rate
    - (2) Data configuration and theory of operation
    - (3) Hardware and software handshaking
  - b. LAN hardware
    - (1) Hardware voltage levels
    - (2) Connectors, cables, pin configurations and signal requirements
      - (a) Thin wire Ethernet
      - (b) 10 based T
4. Apple Macintosh versions of the above (if available)  
Note: If Apple computers are not available, the Intel/Windows platform and operating system will provide enough experience to satisfy this requirement. The author in no way intends to endorse one type of computer over another. However, the Apple computer and operating system is not widely used to run an automation system.
- B. Connect and configure serial and parallel communications interfaces to CNC machines and robots, and an Ethernet based Windows 95 or Windows NT Local Area Network (LAN)

**AET-I1-LE**  
**Use Equipment Manuals, Manufacturer's Specifications,  
and Data Entry/Monitoring Devices  
to Configure, Test and Troubleshoot Set Up  
of a Computer System and Solve Control Problems**  
**Attachment 2: MASTER Laboratory Exercise**

---

The student will:

1. Build and configure a personal computer;
2. Using a working computer, test the installed hardware;
3. Maintain the hardware/software of a working industrial computer;
4. Operate different classes of personal computers;
5. Connect peripheral devices to a personal computer; and,
6. Connect a personal computer to a CNC, robot, or PLC using a communication interface.

**AUTOMATED EQUIPMENT REPAIR TECHNICIAN ... operates, programs, maintains, and repairs automated machine tools and automated manufacturing processes.**

**Duties**

**Tasks**

Duties	←	→	Tasks	→									
<b>A</b> Apply Science to Solve Industrial Problems	A-1 Apply scientific notation and solve technical problems	A-2 Apply algebraic formulas to solve technical problems	A-3 Use variables in algebraic formulas to predict behavior of industrial systems	A-4 Manipulate variables in algebraic formulas to analyze industrial systems	A-5 Measure, calculate, and convert quantities in English (SI) units of measurement	A-6 Use mechanical physics to analyze mechanical systems	A-7 Use mechanical physics to analyze hydraulic and pneumatic systems	A-8 Use mathematical physics to analyze hydraulic and pneumatic systems	A-9 Use mathematical dynamics to analyze problems found in industrial systems	A-10 Use mathematics to analyze industrial systems	A-11 Use chemical formulas to predict reactions in chemical industrial processes	A-12 Apply electrochemical effects to analyze industrial processes	A-13 Apply properties to analyze industrial water treatment processes
<b>B</b> Use Drawings to Diagnose and Repair Systems	B-1 Use symbols, organization, and engineering drawings	B-2 Use symbols, organization, and engineering drawings	B-3 Use symbols, organization, and engineering drawings	B-4 Use symbols, organization, and engineering drawings	B-5 Use symbols, organization, and engineering drawings	B-6 Use symbols, organization, and engineering drawings	B-7 Use symbols, organization, and engineering drawings	B-8 Use symbols, organization, and engineering drawings	B-9 Use symbols, organization, and engineering drawings	B-10 Use symbols, organization, and engineering drawings	B-11 Use symbols, organization, and engineering drawings	B-12 Use symbols, organization, and engineering drawings	B-13 Use symbols, organization, and engineering drawings
<b>C</b> Use Calibrated Measuring Instruments to Test Machine Components	C-1 Apply measuring and measure instruments to align machine tools	C-2 Apply electronic measuring knowledge to test/calibrate electrical circuits	C-3 Apply electronic measuring knowledge to test/calibrate electronic circuits	C-4 Apply fluid power measurement and instrumentation to test/calibrate hydraulic and pneumatic systems	C-5 Apply digital electronic measurement and instrumentation to test/calibrate digital electronic circuits	C-6 Use electronic measuring instruments to test/calibrate digital electronic circuits	C-7 Use electronic measuring instruments to test/calibrate digital electronic circuits	C-8 Use electronic measuring instruments to test/calibrate digital electronic circuits	C-9 Use electronic measuring instruments to test/calibrate digital electronic circuits	C-10 Use electronic measuring instruments to test/calibrate digital electronic circuits	C-11 Use electronic measuring instruments to test/calibrate digital electronic circuits	C-12 Use electronic measuring instruments to test/calibrate digital electronic circuits	C-13 Use electronic measuring instruments to test/calibrate digital electronic circuits
<b>D</b> Resolve System Failures with Troubleshooting, Test, and Metrology	D-1 Apply the troubleshooting process to the resolution of malfunctions found in industrial systems	D-2 Calculate, predict, and response of quantities in DC circuits	D-3 Calculate, predict, and response of quantities in AC circuits	D-4 Calculate, predict, and response of quantities in poly-phase AC circuits	D-5 Properly set up, calibrate, and use oscilloscopes	D-6 Use components such as resistors and capacitors to construct circuits and test components	D-7 Use meters/oscilloscopes to measure phase series resistive, capacitive/inductive AC circuits	D-8 Use meters/oscilloscopes to measure phase series resistive, capacitive/inductive AC circuits	D-9 Apply principles of electrical operation to various types of motors	D-10 Apply semiconductor theory and measure characteristics of diodes, power transistors, and semiconductors	D-11 Apply semiconductor theory and measure characteristics of diodes, power transistors, and semiconductors	D-12 Apply semiconductor theory and measure characteristics of diodes, power transistors, and semiconductors	D-13 Apply semiconductor theory and measure characteristics of diodes, power transistors, and semiconductors
<b>E</b> Use Techniques to Isolate Malfunctions of Electrical/Electronic Systems	E-1 Identify and explain the theory and use of major systems	E-2 Apply valves in a hydraulic or pneumatic system	E-3 Identify, assemble, and apply knowledge of hydraulic and pneumatic actuators	E-4 Apply hydraulic and pneumatic systems	E-5 Identify, assemble, and apply knowledge of fluid power circuits	E-6 Apply hydraulic and pneumatic systems	E-7 Use laws of physics and physics to identify and troubleshoot vacuum systems	E-8 Apply vacuum systems knowledge to identify and troubleshoot vacuum systems	E-9 Apply vacuum systems knowledge to identify and troubleshoot vacuum systems	E-10 Apply vacuum systems knowledge to identify and troubleshoot vacuum systems	E-11 Apply vacuum systems knowledge to identify and troubleshoot vacuum systems	E-12 Apply vacuum systems knowledge to identify and troubleshoot vacuum systems	E-13 Apply vacuum systems knowledge to identify and troubleshoot vacuum systems
<b>F</b> Measure/Isolate Malfunctions of Fluid Power Systems	F-1 Perform calculations in digital numbering systems	F-2 Perform calculations in digital numbering systems	F-3 Solve digital logic problems in electrical and programmable logic circuits	F-4 Program computer controlled industrial equipment	F-5 Identify, assemble, and apply knowledge of fluid power circuits	F-6 Apply hydraulic and pneumatic systems	F-7 Use laws of physics and physics to identify and troubleshoot vacuum systems	F-8 Apply vacuum systems knowledge to identify and troubleshoot vacuum systems	F-9 Apply vacuum systems knowledge to identify and troubleshoot vacuum systems	F-10 Apply vacuum systems knowledge to identify and troubleshoot vacuum systems	F-11 Apply vacuum systems knowledge to identify and troubleshoot vacuum systems	F-12 Apply vacuum systems knowledge to identify and troubleshoot vacuum systems	F-13 Apply vacuum systems knowledge to identify and troubleshoot vacuum systems
<b>G</b> Apply Computer Science to Computer Controlled Industrial Equipment	G-1 Perform calculations in digital numbering systems	G-2 Perform calculations in digital numbering systems	G-3 Solve digital logic problems in electrical and programmable logic circuits	G-4 Program computer controlled industrial equipment	G-5 Identify, assemble, and apply knowledge of fluid power circuits	G-6 Apply hydraulic and pneumatic systems	G-7 Use laws of physics and physics to identify and troubleshoot vacuum systems	G-8 Apply vacuum systems knowledge to identify and troubleshoot vacuum systems	G-9 Apply vacuum systems knowledge to identify and troubleshoot vacuum systems	G-10 Apply vacuum systems knowledge to identify and troubleshoot vacuum systems	G-11 Apply vacuum systems knowledge to identify and troubleshoot vacuum systems	G-12 Apply vacuum systems knowledge to identify and troubleshoot vacuum systems	G-13 Apply vacuum systems knowledge to identify and troubleshoot vacuum systems
<b>H</b> Correct Malfunctions in PLC Controlled Equipment	H-1 Perform operations on PLC (Programmable Logic Controller) or PLC (programmable controller) systems	H-2 Perform operations on PLC (Programmable Logic Controller) or PLC (programmable controller) systems	H-3 Perform operations on PLC (Programmable Logic Controller) or PLC (programmable controller) systems	H-4 Perform operations on PLC (Programmable Logic Controller) or PLC (programmable controller) systems	H-5 Perform operations on PLC (Programmable Logic Controller) or PLC (programmable controller) systems	H-6 Perform operations on PLC (Programmable Logic Controller) or PLC (programmable controller) systems	H-7 Perform operations on PLC (Programmable Logic Controller) or PLC (programmable controller) systems	H-8 Perform operations on PLC (Programmable Logic Controller) or PLC (programmable controller) systems	H-9 Perform operations on PLC (Programmable Logic Controller) or PLC (programmable controller) systems	H-10 Perform operations on PLC (Programmable Logic Controller) or PLC (programmable controller) systems	H-11 Perform operations on PLC (Programmable Logic Controller) or PLC (programmable controller) systems	H-12 Perform operations on PLC (Programmable Logic Controller) or PLC (programmable controller) systems	H-13 Perform operations on PLC (Programmable Logic Controller) or PLC (programmable controller) systems
<b>I</b> Resolve Malfunctions Found in Manufacturing Processes	I-1 Perform operations on PLC (Programmable Logic Controller) or PLC (programmable controller) systems	I-2 Perform operations on PLC (Programmable Logic Controller) or PLC (programmable controller) systems	I-3 Perform operations on PLC (Programmable Logic Controller) or PLC (programmable controller) systems	I-4 Perform operations on PLC (Programmable Logic Controller) or PLC (programmable controller) systems	I-5 Perform operations on PLC (Programmable Logic Controller) or PLC (programmable controller) systems	I-6 Perform operations on PLC (Programmable Logic Controller) or PLC (programmable controller) systems	I-7 Perform operations on PLC (Programmable Logic Controller) or PLC (programmable controller) systems	I-8 Perform operations on PLC (Programmable Logic Controller) or PLC (programmable controller) systems	I-9 Perform operations on PLC (Programmable Logic Controller) or PLC (programmable controller) systems	I-10 Perform operations on PLC (Programmable Logic Controller) or PLC (programmable controller) systems	I-11 Perform operations on PLC (Programmable Logic Controller) or PLC (programmable controller) systems	I-12 Perform operations on PLC (Programmable Logic Controller) or PLC (programmable controller) systems	I-13 Perform operations on PLC (Programmable Logic Controller) or PLC (programmable controller) systems
<b>J</b> Assemble/Disassemble, Diagnose, and Test Industrial Electronic and Computer Systems	J-1 Perform operations on PLC (Programmable Logic Controller) or PLC (programmable controller) systems	J-2 Perform operations on PLC (Programmable Logic Controller) or PLC (programmable controller) systems	J-3 Perform operations on PLC (Programmable Logic Controller) or PLC (programmable controller) systems	J-4 Perform operations on PLC (Programmable Logic Controller) or PLC (programmable controller) systems	J-5 Perform operations on PLC (Programmable Logic Controller) or PLC (programmable controller) systems	J-6 Perform operations on PLC (Programmable Logic Controller) or PLC (programmable controller) systems	J-7 Perform operations on PLC (Programmable Logic Controller) or PLC (programmable controller) systems	J-8 Perform operations on PLC (Programmable Logic Controller) or PLC (programmable controller) systems	J-9 Perform operations on PLC (Programmable Logic Controller) or PLC (programmable controller) systems	J-10 Perform operations on PLC (Programmable Logic Controller) or PLC (programmable controller) systems	J-11 Perform operations on PLC (Programmable Logic Controller) or PLC (programmable controller) systems	J-12 Perform operations on PLC (Programmable Logic Controller) or PLC (programmable controller) systems	J-13 Perform operations on PLC (Programmable Logic Controller) or PLC (programmable controller) systems

BEST COPY AVAILABLE

**AET-J1-HO-1**  
**Safely Assemble, Disassemble, and Adjust Mechanical Systems**  
**such as Gearing Systems, Shafts, Couplings, Pulleys, Belts**  
**Attachment 1: MASTER Handout No. 1**

---

**Objective(s):**

Upon completion of this unit the student will be able to:

- a. Identify the major assembly and disassembly procedures in mechanical assemblies;
- b. Identify the tools required for each mechanical assembly/disassembly;
- c. Properly apply the correct tool for each mechanical procedure;
- d. Plan and organize a mechanical assembly/disassembly;
- e. Identify the safety procedures required for each mechanical assembly/disassembly; and,
- f. Adjust major subassemblies and simple machines that comprise a mechanical assembly.

---

**Module Outline:**

- I. Safely Assemble or Disassemble Mechanical Systems Such as Gearing Systems, Shafts, Couplings, Pulleys, Belts
  - A. Explain the rules and safety procedures associated with mechanical assembly/disassembly
    1. Lockout, tagout
    2. Confined area rules
    3. Eye protection, protection of hands
    4. Hazardous chemicals
  - B. Explain the most common mechanical assembly/disassembly procedures and the tools required for each procedure
    1. Explain and demonstrate the removal and installation of fasteners and the tools required
      - a. Explain the purpose of fasteners, and the features of fasteners
      - b. Explain and demonstrate the most common types of fasteners
      - c. Explain and demonstrate the tools required for fasteners
      - d. Demonstrate the methods of removing and installing fasteners
    2. Explain and demonstrate the removal and installation of bushings and bearings and the tools required
      - a. Explain the purpose of bushings and bearings, the types of bearings, and identification of bearing specifications

- b. Explain and demonstrate the types of tools required for the removal and installation of bushings and bearings
    - c. Demonstrate the methods of removing and installing bushings and bearings
  - 3. Explain and demonstrate the removal and installation of couplings, pulleys, or gears
    - a. Explain the purpose of pulleys and gears, and identification of pulley and gear specifications
    - b. Explain and demonstrate the types of tools required for the removal and installation of pulleys and gears
    - c. Demonstrate the methods of removing and installing pulleys and gears
  - 4. Explain and demonstrate the removal and installation of belts and lines for pulleys
    - a. Explain the purpose of belts and lines for pulleys, and identification of pulley and belt specifications
    - b. Demonstrate the methods of removing and installing belts and lines for pulleys
  - 5. Explain and demonstrate the removal and installation of couplings and shafts
    - a. Explain the purpose of couplings and shafts, and identification of coupling and shaft specifications
    - b. Explain and demonstrate the types of tools required for the removal and installation of couplings and shafts
    - c. Demonstrate the methods of removing and installing couplings and shafts
- II. Adjust Mechanical Systems Such as Gearing Systems, Shafts, Couplings, Pulleys, and Belts
  - A. Explain the most common mechanical adjustment procedures and the tools required for each procedure
    - 1. Explain and demonstrate the torque of fasteners and the tools required
      - a. Explain the purpose of torquing fasteners, and the features of fasteners under torque
      - b. Explain the errors to avoid when tightening fasteners
      - c. Explain and demonstrate the use of a torque wrench
      - d. Demonstrate the methods of torquing fasteners
    - 2. Explain and demonstrate the methods of checking end play, run-out and clearances, and the tools/measuring instruments required
      - a. Explain the concept of end-play and run-out
      - b. Explain and demonstrate the types of measuring instruments used to check end-play and run-out.(see MASTER module AET-C1)

- c. Demonstrate the methods of using shims, and adjusting end play and run-out
- 3. Explain and demonstrate the checking and adjusting squareness and parallelism, and adjusting gibbs/hold-downs
  - a. Explain the purpose of gibbs, guide rails, and hold-downs
  - b. Explain and demonstrate the types of measuring instruments required for measuring squareness and parallelism (see MASTER module AET-C1)
  - c. Demonstrate the methods of adjusting squareness, parallelism
- 4. Explain and demonstrate the methods of checking and setting belt tension
  - a. Explain the purpose of belts and lines for pulleys, and identification of pulley and belt specifications
  - b. Demonstrate the methods of measuring and adjusting the tension of belts and lines for pulleys
- 5. Explain and demonstrate the methods of measuring clearances between gears and sliding mechanisms and the methods used to correct misalignment
  - a. Explain the reasons for providing clearances between gears and sliding mechanisms
  - b. Demonstrate the methods of measuring and adjusting clearances between gears and sliding mechanisms
- 6. Explain and demonstrate the methods, measuring instruments and tools used to correct shaft misalignment
  - a. Explain the methods and procedures used to measure, and correct shaft misalignment
  - b. Demonstrate the methods used to measure, and correct shaft misalignment

**AET-J1-HO-2**  
**Safely Assemble, Disassemble, and Adjust Mechanical Systems**  
**such as Gearing Systems, Shafts, Couplings, Pulleys, Belts**  
**Attachment 2: MASTER Handout No. 2**

---

**Mechanical Assembly/Disassembly — Fasteners**

Mechanical assembly or disassembly should be approached as though the technician is a surgeon preparing for a delicate operation. To many times, a mechanical assembly is subject to dirty environments that contaminate mechanical parts. A work bench that is to be used for the break down and repair of mechanisms should be clean and free from metal particles and dirt that can affect the operation of the mechanism. One of the methods used to accomplish this is to use butcher paper or heavy duty waxed paper to cover the bench prior to disassembly and assembly. The use of cloth rags is not encouraged as a bench cover, because cloth fibers can be incorporated in to the assembly, causing binding of mechanisms, and/or contamination.

**Preparation and Identifying Components**

The first stage in preparation is to consult the manuals and mechanical drawings associated with the assembly or disassembly of the mechanism. Pay careful attention to the detailed sections of the drawing because they may contain information concerning adjustments that must be carried out during the maintenance process. Identify all of the component parts of the mechanism, and if the mechanism is under going a complete overhaul, have available the most likely parts that will be replaced. These parts include, but are not limited to the following: Bearings and bushings, seals and gaskets, belts, solvents, adhesives, and lubricants. Special items such as high vacuum lubricants or special adhesives should be determined beforehand. Assemble the most likely tools that will be used during the process; including metrology tools such as micrometers, feeler gauges, vernier calipers, and dial indicators. Also have available during the disassembly process, zip-lock bags, plastic or metal containers, labels and marking pens to store and organize the small parts and fasteners that are removed from the mechanism. Frequently a disassembly or assembly process will be interrupted by a shift change or a determination that a part necessary for the repair of the mechanism is not available. Under these circumstances, some time may elapse between the disassembly and assembly process. If the component parts are not organized, your memory may not be sufficient to repeat the original process. Do not get into the habit of tossing all of the parts into one area of the bench or a box. Fasteners that may look identical may have different characteristics and be suitable only for the part from which they were removed. Bearings that have identical inner and outer races may not be suitable in one area of the assembly. In addition, small parts that can be lost by being dropped on the floor, will waste large amounts of time in a hunt for the part. Plan in advance for this eventuality, and either have on hand a replacement for



the part, or a plan to assemble this part very carefully (small snap rings and roll pins are very likely candidates for this area).

## **Cleanliness**

Cleanliness cannot be over emphasized. As soon as a mechanical assembly is disassembled, it is no longer considered to be clean. If the problem is further compounded by disassembly and assembly of the mechanism in a dirty environment, the problem will become even more acute. Disassembly and assembly of a mechanism should be carried out in an area that is nearly as clean as a clean room. Before assembly, the parts should be thoroughly cleaned and dried and only that amount of lubricant, sealant, or adhesive necessary to re-assemble the mechanism applied.

## **Procedures**

*Removal and installation of fasteners requires, at a minimum, the following tools:*

### **Screw Drivers, Phillips and Slot**

At least five different types of *Phillips screwdrivers* are required, ranging from #0 through #3. Number zero is used for small Phillips screws with small heads while #3 is used for large screws with large shallow heads. In addition, a large Phillips screw driver, should be available for large screws.

Do not confuse spline head fasteners with Phillips screws, they are not compatible.

Phillips screw drivers range in length. Several different lengths should be available, from stubby sizes to long screw drivers capable of reaching inaccessible screws.

*Slot screw drivers* are identified by their dimensions. At a minimum, 5 sizes are required, ranging from 5/32 inch to 9/32 inch. In addition, a large bladed screw driver, sometimes called a mechanics screw driver, should be available for large screws.

Do not attempt to use a slot screw on a Phillips head screw. It will only ruin the screw head

Slot screw drivers range in length. Several different lengths should be available, from stubby sizes to long screw drivers capable of reaching inaccessible screws.



In addition, a good set of *jewelers screw drivers* that include Phillips head drivers should be available.

*Offset screw drivers* and *screw starters* can be obtained for both slot and Phillips head screws. They are very useful tools for screws in hard to reach places.

### **Allen head Wrenches and Spline Wrenches (Hex socket wrenches)**

*Allen head wrenches* are used to remove Allen head bolts. Allen head wrenches are sold in English and metric sizes. English wrenches range from 2/32 inch (very small, very fragile) to 7/8 of an inch or more. Metric sizes range from 2 mm to 10 mm or more. The most advantageous type of Allen head wrench is called a ball Allen. The tip of the wrench is shaped like a ball, making it possible to approach an Allen head screw at an angle. These wrenches can be purchased as a set that covers most of the sizes used for normal assembly and disassembly. A *complete set* of both English and metric wrenches should be available.

*Spline head wrenches* (sometimes called cotter wrenches or cotter keys) come in sizes that are keyed to the size of the fastener. Spline head wrenches are identified as T-5 through T-45, with T-5 being the smallest and T-45 being the largest. Do not confuse spline head fasteners with Allen head fasteners. Using an Allen head wrench in a spline head bolt or screw will ruin the fastener, making it impossible to remove.

### **Hex Head Wrenches (socket wrenches, closed, and open end wrenches)**

Hex head bolts are so-named because they have six sides. Hex head bolts are removed and installed by open end wrenches, closed end wrenches, and socket wrenches. Open end wrenches are so named because one side of the wrench is open to allow the wrench to approach the bolt from the side. Closed end wrenches must approach the bolt from the top, as must socket wrenches. Many variations in these wrenches exist to make the job of removing a bolt easier. Hex head wrenches come in English and metric sizes ranging from 5/32 inch to 1 inch or more (English) and 4 mm to 25 mm or more (metric).

Socket wrenches must be used with a socket handle. Socket handles come in sizes ranging from 1/4 inch drives to 1/2 inch drives or more. The socket head must match the size of the drive handle. Adapters exist to adapt a 1/4 inch socket to a 3/8 inch drive, and a 3/8 inch socket to a 1/2 inch drive. Both English sockets and metric sockets can be used with the drive handles. In addition, universal joints can be obtained that allow the wrench to access hard to get places. Many variations in drive handles

exist. Torque wrenches are frequently socket wrenches, although some may be closed end wrenches.

The Society of Automotive Engineers (SAE) has invented a new type of bolt and socket used for assembling automobiles. The bolt is an outside spline bolt with six points to the spline. This bolt can only be removed by a corresponding socket. Socket sizes range from E-8 to E-14 or more.

### **Adjustable Wrenches**

Adjustable wrenches are open end wrenches whose jaw size can be adjusted to the fastener. Adjustable wrenches are determined by the length of the handle. These wrenches can be obtained in sizes ranging from a 2 inch handle up to 18 inch handles or more.

*Removal and Installation of Couplings, Pulleys, or Gears requires at a minimum the following tools:* (In addition to the possible use of the before mentioned tools the following tools apply:)

### **Drifts (also called a pin punch)**

A drift is a flat headed punch meant to be used with a hammer. The head is machined to lie flat upon the intended target. Drifts come in various sizes ranging from 1/16 inch to 5/8 inch or more. Drifts are used to remove roll pins, solid machine pins, shafts, and other objects that require removal by force. Do not use a marking punch (pointed end) on a roll pin. It will only compound the problem of removing the roll pin. Always try to use the proper size drift for the hole, pin, or shaft size.

**AET-J1-HO-3**  
**Safely Assemble, Disassemble, and Adjust Mechanical Systems**  
**such as Gearing Systems, Shafts, Couplings, Pulleys, Belts**  
**Attachment 3: MASTER Handout No. 3**

---

**Mechanical Assembly/Disassembly — Bearings and Bushings**

Mechanical assembly or disassembly should be approached as though the technician is a surgeon preparing for a delicate operation. To many times, a mechanical assembly is subject to dirty environments that contaminate mechanical parts. A work bench that is to be used for the break down and repair of mechanisms should be clean and free from metal particles and dirt that can affect the operation of the mechanism. One of the methods used to accomplish this is to use butcher paper or heavy duty waxed paper to cover the bench prior to disassembly and assembly. The use of cloth rags is not encouraged as a bench cover, because cloth fibers can be incorporated in to the assembly, causing binding of mechanisms, and/or contamination.

**Preparation and Identifying Components**

The first stage in preparation is to consult the manuals and mechanical drawings associated with the assembly or disassembly of the mechanism. Pay careful attention to the detailed sections of the drawing because they may contain information concerning adjustments that must be carried out during the maintenance process. Identify all of the component parts of the mechanism, and if the mechanism is under going a complete overhaul, have available the most likely parts that will be replaced. These parts include, but are not limited to the following: Bearings and bushings, seals and gaskets, belts, solvents, adhesives, and lubricants. Special items such as high vacuum lubricants or special adhesives should be determined beforehand. Assemble the most likely tools that will be used during the process; including metrology tools such as micrometers, feeler gauges, vernier calipers, and dial indicators. Also have available during the disassembly process, zip-lock bags, plastic or metal containers, labels and marking pens to store and organize the small parts and fasteners that are removed from the mechanism. Frequently a disassembly or assembly process will be interrupted by a shift change or a determination that a part necessary for the repair of the mechanism is not available. Under these circumstances, some time may elapse between the disassembly and assembly process. If the component parts are not organized, your memory may not be sufficient to repeat the original process. Do not get into the habit of tossing all of the parts into one area of the bench or a box. Fasteners that may look identical may have different characteristics and be suitable only for the part from which they were removed. Bearings that have identical inner and outer races may not be suitable in one area of the assembly. In addition, small parts that can be lost by being dropped on the floor, will waste large amounts of time in a hunt for the part. Plan in advance for this eventuality, and either have on hand a replacement for

the part, or a plan to assemble this part very carefully (small snap rings and roll pins are very likely candidates for this area).

## **Cleanliness**

Cleanliness cannot be over emphasized. As soon as a mechanical assembly is disassembled, it is no longer considered to be clean. If the problem is further compounded by disassembly and assembly of the mechanism in a dirty environment, the problem will become even more acute. Disassembly and assembly of a mechanism should be carried out in an area that is nearly as clean as a clean room. Before assembly, the parts should be thoroughly cleaned and dried and only that amount of lubricant, sealant, or adhesive necessary to re-assemble the mechanism applied.

***Removal and Installation of Bearings or Bushings and Shafts requires at a minimum the following tools:***

### **Bearing Pullers**

Bearing pullers come in various sizes. They are used to remove bearings that have been press fitted to a shaft. The jaws of the puller must fit *squarely* against the inner race of the bearing and the worm screw of the puller presses against the shaft. The mechanical advantage of the worm screw forces the bearing from the shaft. Some bearings are fitted to shafts by mechanical or hydraulic presses. Those bearings may require a mechanical or hydraulic press to remove them. When using a puller, if a bearing does not respond to efforts to remove it; do not try to use excessive force on the puller (such as adding an extension, such as a pipe, to the wrench). The excessive force could cause the puller to break, ejecting parts or metal with great force. Use a mechanical or hydraulic press instead. *Never use a bearing puller with the jaws against the outer race of the bearing. You will damage the bearing or break it.*

**AET-J1-HO-4**  
**Safely Assemble, Disassemble, and Adjust Mechanical Systems**  
**such as Gearing Systems, Shafts, Couplings, Pulleys, Belts**  
**Attachment 4: MASTER Handout No. 4**

---

**Mechanical Assembly/Disassembly — Gears and Pulleys**

Mechanical assembly or disassembly should be approached as though the technician is a surgeon preparing for a delicate operation. To many times, a mechanical assembly is subject to dirty environments that contaminate mechanical parts. A work bench that is to be used for the break down and repair of mechanisms should be clean and free from metal particles and dirt that can affect the operation of the mechanism. One of the methods used to accomplish this is to use butcher paper or heavy duty waxed paper to cover the bench prior to disassembly and assembly. The use of cloth rags is not encouraged as a bench cover, because cloth fibers can be incorporated in to the assembly, causing binding of mechanisms, and/or contamination.

**Preparation and Identifying Components**

The first stage in preparation is to consult the manuals and mechanical drawings associated with the assembly or disassembly of the mechanism. Pay careful attention to the detailed sections of the drawing because they may contain information concerning adjustments that must be carried out during the maintenance process. Identify all of the component parts of the mechanism, and if the mechanism is under going a complete overhaul, have available the most likely parts that will be replaced. These parts include, but are not limited to the following: Bearings and bushings, seals and gaskets, belts, solvents, adhesives, and lubricants. Special items such as high vacuum lubricants or special adhesives should be determined beforehand. Assemble the most likely tools that will be used during the process; including metrology tools such as micrometers, feeler gauges, vernier calipers, and dial indicators. Also have available during the disassembly process, zip-lock bags, plastic or metal containers, labels and marking pens to store and organize the small parts and fasteners that are removed from the mechanism. Frequently a disassembly or assembly process will be interrupted by a shift change or a determination that a part necessary for the repair of the mechanism is not available. Under these circumstances, some time may elapse between the disassembly and assembly process. If the component parts are not organized, your memory may not be sufficient to repeat the original process. Do not get into the habit of tossing all of the parts into one area of the bench or a box. Fasteners that may look identical may have different characteristics and be suitable only for the part from which they were removed. Bearings that have identical inner and outer races may not be suitable in one area of the assembly. In addition, small parts that can be lost by being dropped on the floor, will waste large amounts of time in a hunt for the part. Plan in advance for this eventuality, and either have on hand a replacement for

the part, or a plan to assemble this part very carefully (small snap rings and roll pins are very likely candidates for this area).

## **Cleanliness**

Cleanliness cannot be over emphasized. As soon as a mechanical assembly is disassembled, it is no longer considered to be clean. If the problem is further compounded by disassembly and assembly of the mechanism in a dirty environment, the problem will become even more acute. Disassembly and assembly of a mechanism should be carried out in an area that is nearly as clean as a clean room. Before assembly, the parts should be thoroughly cleaned and dried and only that amount of lubricant, sealant, or adhesive necessary to re-assemble the mechanism applied.

## **Procedures:**

*Removal and installation of Gears or Pulleys requires, at a minimum, the following tools:*

### **Gear/Pulley Pullers**

Gear or pulley pullers come in various sizes. They are used to remove gears or pulleys that have been press fitted to a shaft. The jaws of the puller grip the gear or pulley and the shaft of the puller (which is a worm screw) presses against the shaft of the gear or pulley. The mechanical advantage of the worm screw forces the gear or pulley from the shaft. Some gears, pulleys, or couplings are fitted to shafts by mechanical or hydraulic presses. Those gears or pulleys may require a mechanical or hydraulic press to remove them. When using a puller, if a gear or pulley does not respond to efforts to remove it; do not try to use excessive force on the puller (such as adding an extension, such as a pipe, to the wrench). The excessive force could cause the puller to break, ejecting parts or metal with great force. Use a mechanical or hydraulic press instead.

*Removal and installation of belts and lines for pulleys requires at a minimum the following tools: (In addition to the possible use of the before mentioned tools the following tools apply:)*

### **Swaging or Crimping Tool**

Swaging or crimping tools are used to create loops at the end of wire rope that is used in a pulley system, affix an anchor to the rope, or to splice two ends of the rope. Swaging the rope is usually accomplished by placing the ends of the rope into the swag or crimp and placing the assembly into a form. The form is struck by a hammer and the swag or crimp is mashed

to the rope. Other types of tools that use the lever principle can be used to swag or crimp the rope. Do not use electrical crimping tools for this purpose, they cannot apply enough force, and the rope will come undone. For large steel crimps, a hydraulic tool is used.



**AET-J1-HO-5**  
**Safely Assemble, Disassemble, and Adjust Mechanical Systems**  
**such as Gearing Systems, Shafts, Couplings, Pulleys, Belts**  
**Attachment 5: MASTER Handout No. 5**

---

**Mechanical Assembly/Disassembly — Shafts and Shaft Alignment**

Mechanical assembly or disassembly should be approached as though the technician is a surgeon preparing for a delicate operation. To many times, a mechanical assembly is subject to dirty environments that contaminate mechanical parts. A work bench that is to be used for the break down and repair of mechanisms should be clean and free from metal particles and dirt that can affect the operation of the mechanism. One of the methods used to accomplish this is to use butcher paper or heavy duty waxed paper to cover the bench prior to disassembly and assembly. The use of cloth rags is not encouraged as a bench cover, because cloth fibers can be incorporated in to the assembly, causing binding of mechanisms, and/or contamination.

**Preparation and Identifying Components**

The first stage in preparation is to consult the manuals and mechanical drawings associated with the assembly or disassembly of the mechanism. Pay careful attention to the detailed sections of the drawing because they may contain information concerning adjustments that must be carried out during the maintenance process. Identify all of the component parts of the mechanism, and if the mechanism is under going a complete overhaul, have available the most likely parts that will be replaced. These parts include, but are not limited to the following: Bearings and bushings, seals and gaskets, belts, solvents, adhesives, and lubricants. Special items such as high vacuum lubricants or special adhesives should be determined beforehand. Assemble the most likely tools that will be used during the process; including metrology tools such as micrometers, feeler gauges, vernier calipers, and dial indicators. Also have available during the disassembly process, zip-lock bags, plastic or metal containers, labels and marking pens to store and organize the small parts and fasteners that are removed from the mechanism. Frequently a disassembly or assembly process will be interrupted by a shift change or a determination that a part necessary for the repair of the mechanism is not available. Under these circumstances, some time may elapse between the disassembly and assembly process. If the component parts are not organized, your memory may not be sufficient to repeat the original process. Do not get into the habit of tossing all of the parts into one area of the bench or a box. Fasteners that may look identical may have different characteristics and be suitable only for the part from which they were removed. Bearings that have identical inner and outer



pieces may not be suitable in one area of the assembly. In addition, small parts that can be lost by being dropped on the floor, will waste large amounts of time in a hunt for the part. Plan in advance for this eventuality, and either have on hand a replacement for the part, or a plan to assemble this part very carefully (small snap rings and roll pins are very likely candidates for this area).

## **Cleanliness**

Cleanliness cannot be over emphasized. As soon as a mechanical assembly is disassembled, it is no longer considered to be clean. If the problem is further compounded by disassembly and assembly of the mechanism in a dirty environment, the problem will become even more acute. Disassembly and assembly of a mechanism should be carried out in an area that is nearly as clean as a clean room. Before assembly, the parts should be thoroughly cleaned and dried and only that amount of lubricant, sealant, or adhesive necessary to re-assemble the mechanism applied.

*Removal and installation of bearings or bushings and shafts requires at a minimum the following tools:*

### **Bearing Pullers**

Bearing pullers come in various sizes. They are used to remove bearings that have been press fitted to a shaft. The jaws of the puller must fit *squarely against the inner race of the bearing* and the worm screw of the puller presses against the shaft. The mechanical advantage of the worm screw forces the bearing from the shaft. Some bearings are fitted to shafts by mechanical or hydraulic presses. Those bearings may require a mechanical or hydraulic press to remove them. When using a puller, if a bearing does not respond to efforts to remove it; do not try to use excessive force on the puller (such as adding an extension, such as a pipe, to the wrench). The excessive force could cause the puller to break, ejecting parts or metal with great force. Use a mechanical or hydraulic press instead. *Never use a bearing puller with the jaws against the outer race of the bearing. You will damage the bearing or break it.*

**AET-J1-HO-6**  
**Safely Assemble, Disassemble, and Adjust Mechanical Systems**  
**such as Gearing Systems, Shafts, Couplings, Pulleys, Belts**  
**Attachment 6: MASTER Handout No. 6**

---

**Mechanical Alignment and Adjustment**

*Alignment and Alignment Checks require at a minimum the following tools:*

**Feeler Gages**

Feeler gages consist of metal or (in some cases) plastic parts of varying thicknesses. Feeler gages are used to provide accurate distances between parts of a mechanism, and to check the clearances between parts of a mechanism. The gages can be wire type gages in which the gage is a calibrated length of wire at a certain thickness, or flat ribbons of metal or plastic. Plastic gages are used to avoid damage to machined metal parts that have fine finishes.

**Micrometers**

Micrometers are measuring instruments that provide accurate data about distances (inside micrometers) or thicknesses (outside micrometers).

**Vernier Calipers**

Vernier calipers provide information about distances, hole diameters, and thickness. The same device can be used for both measurements.

**Dial Indicators**

Dial indicators can be used for shaft alignment, measuring squareness of the travel of a slide, and position accuracy of a mechanism or feature.

**Spring Scales**

The spring scale is one of the least used, but one of the most effective measurement instruments for determining the health of mechanical systems. As mentioned before in the complex machines section, a mechanism that presents too much opposition force to the driver by virtue of friction or inertia, will simply cease to move. A spring scale attached to the input to the mechanism will provide an indication of the amount

of force that must be applied to the mechanism to make it move. The scale may be used to measure linear motion, or rotary motion.

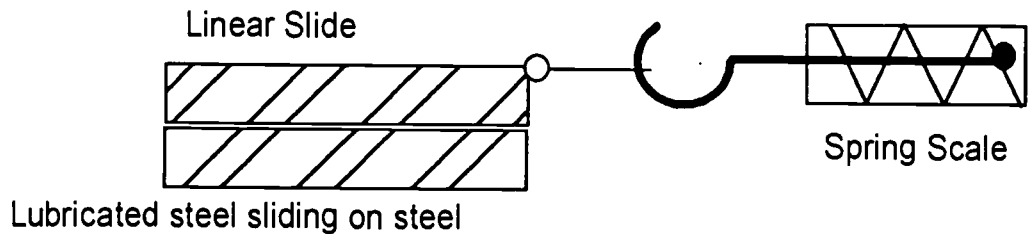

## Linear Motion

Attaching the spring scale to a slide mechanism can measure the force of motion of the slide. There are three elements of this measurement. First the inertia of the mechanism may be measured, but this will be complicated by the opposition force of the break-a-way friction of the slide. Second, the break-a-way friction of the slide can be measured but this is also complicated by the inertia of the mechanism. Last, the most reliable measurement is the sliding friction of the slide. This must be measured while the slide is in a state of uniform motion. To accomplish this measurement, the slide must be de-coupled from the driving mechanism and the slide moved evenly in a linear direction. The spring scale must be parallel to the direction of motion. Record the force necessary to start the slide in motion. This is a combination of the inertia of the slide (which never changes) and the break-a-way friction of the slide (which varies with wear and age). Next, start the slide moving in a uniform motion, and record the spring scale values. To compare the values, use the tables for the coefficient of friction found in most *Machinery Handbooks*. Remember, the friction of a mechanism is not dependent upon the amount of surface in contact, but upon the materials themselves. You should be able to calculate the weight of a slide that moves in a horizontal plane (not vertical) by using the coefficient of friction. This calculation will be complicated by an increase in **normal** force caused by hold down mechanisms or pre-loaded bearings. In most cases, you may only be able to obtain a relative measurement of the force of motion, but it should be sufficient to determine whether or not the driver should be able to move the mechanism. Also, the data can be recorded as a part of a preventative maintenance program and measured on a periodic basis. Any increase in the friction of motion is a good reason to investigate further. This can prevent unplanned down time.

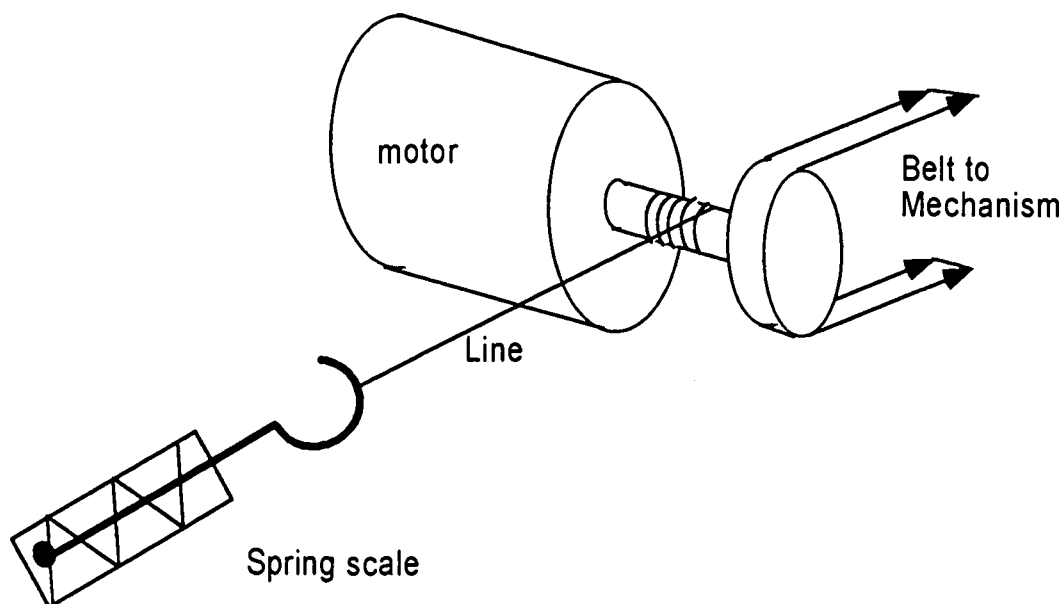

## Rotary Motion

In most cases, it is impractical to disassemble a mechanism to measure linear motion, and in those cases, it is a good practice to use a spring scale to measure rotary motion. Since the driver for the mechanism is usually a rotary device such as an electrical, hydraulic, or pneumatic motor, a line can be wound around the shaft of the motor, a spring scale can be attached, and the force of uniform motion can be determined by pulling on the line. *The system must have the power removed for this test!* This test will measure the bearing in the motor, the simple machines in the system, and the sliding force of the slide. It would be impractical to try to determine the individual frictional aspects of the mechanism, but excessive force of motion may be an indication that the mechanism must be disassembled to try and measure the component parts (again, with the spring scale) to determine if one of the parts requires excessive force to move it. To determine the force of rotary motion, you must carefully measure the distance from the center of rotation to determine the point of measurement of the force and the torque of the mechanism. A stepper motor can be measured in this fashion by energizing the stepper and winding a line around its shaft. The shaft diameter is measured, the spring scale is attached, and the stepper is moved one or two steps by pulling on the spring scale.

***Do not attempt this test with large, high horse power motors that are energized!***

Once the data is collected, a calculation based upon the radius of effort, and the required force can be compared to the torque specifications for the stepper motor.

Spring scales can also be used to determine that amount of torque that is applied to a screw or bolt when assembling a mechanism. In the absence of a proper torque wrench, a spring scale can be attached to a wrench and by calculating the distance from the center of rotation, the bolt can be tightened to the proper torque specifications.

## RPM Meters

RPM meters can be classified as contact meters or non-contact meters. Contact meters require that the drive shaft of the meter be in contact with the rotary object to be measured, while non-contact meters measure the speed of the rotary device by optical means. Both meters have their advantages and disadvantages.

Contact meters are reliable and can accurately measure the RPMs of a rotary device. However, a contact meter must be pressed to the rotating shaft of the mechanism to be measured. Frequently, contact meters have various types of rubber fittings to accomplish this task. If the contact point is not the center of rotation, the contact meter may have to be mathematically interpreted to determine the correct speed. In many cases, it is impractical to press the drive shaft of the contact meter to the rotating object in question. In these cases, the contact meter cannot be used, or may be used on another rotating member of the mechanism and the results mathematically interpreted. To accomplish this task, the relative diameters of the rotating members must be determined and the results calculated using the formulas for speed advantage. Contact meters that are pressed to an object with excessive force can affect the rotational speed of the object. In addition, a contact meter that is not aligned parallel to the axis of rotation will not measure accurately.

Non-contact RPM meters usually employ optical reflection of a strobed source of light to determine rotational speed. The advantage of this type of measurement is that the measured speed is independent of the size of the rotational object. Usually a reflective tape or painted surface is used to reflect the strobed light, and the frequency of the strobe is adjusted to provide an indication of the speed of the object. The advantage of the non-contact RPM meter is that objects that are inaccessible to contact meters can be measured by non-contact meters, and the speed of the object is not affected by the meter. Some of the disadvantages of the non-contact meter are the sensitivity to ambient light sources that prevents the technician from observing the reflected strobed light, and the difficulty in affixing

a reflective surface to the mechanism under test. In the case of a wafer spinner, a scrap test wafer can be equipped with reflective tape to observe the rotational speed of the spinner.

**AET-J1-HO-7**  
**Safely Assemble, Disassemble, and Adjust Mechanical Systems**  
**such as Gearing Systems, Shafts, Couplings, Pulleys, Belts**  
**Attachment 7: MASTER Handout No. 7**

---

**Lockout and Tagout Procedures**

Lockout and tagout procedures are designed to prevent equipment from being energized while maintenance is taking place. The types and uses are defined by the Occupational Safety and Health Administration, CFR 1910.147.

To lockout is to place a locking device on an energy-isolating device — a manually operated circuit breaker, for instance. The energy-isolating device and the equipment being controlled cannot be operated until the lockout device is removed. See Figure 1.

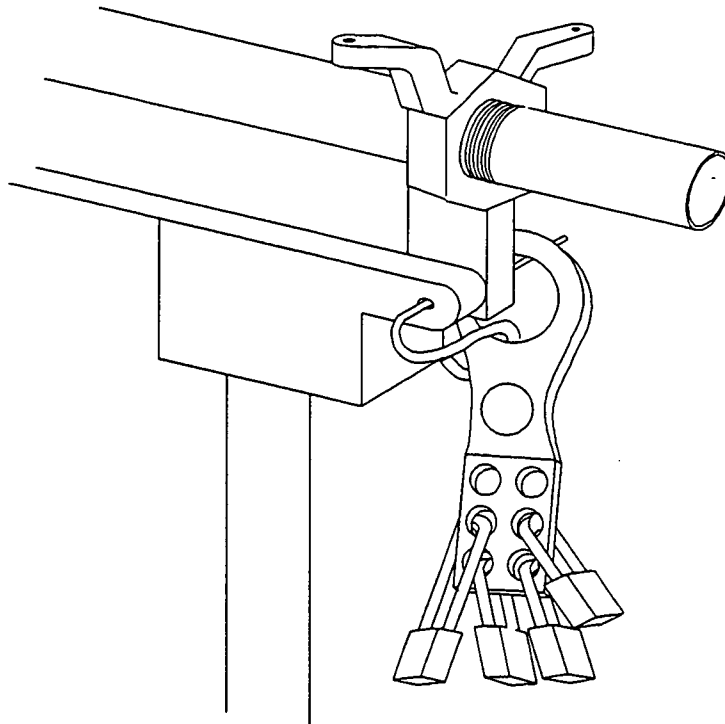

**1 - A Lockout Device**

Remote or interlocking switches may not be used to control circuits. The use of emergency stops are prohibited for lockout-tagout by OSHA. They do not offer positive protection.

Tagouts are placed on an energy-isolating device. They indicate that the energy-isolating device and the equipment being controlled may not be operated. Tagouts are red and have black lettering. A tag must be signed and dated by the individual who placed it. OSHA has two additional requirements for these tags. The purpose of the lockout/tagout (the procedure performed) must be written on the tag. Most companies put this information on the back of a tag. See Figure 2.

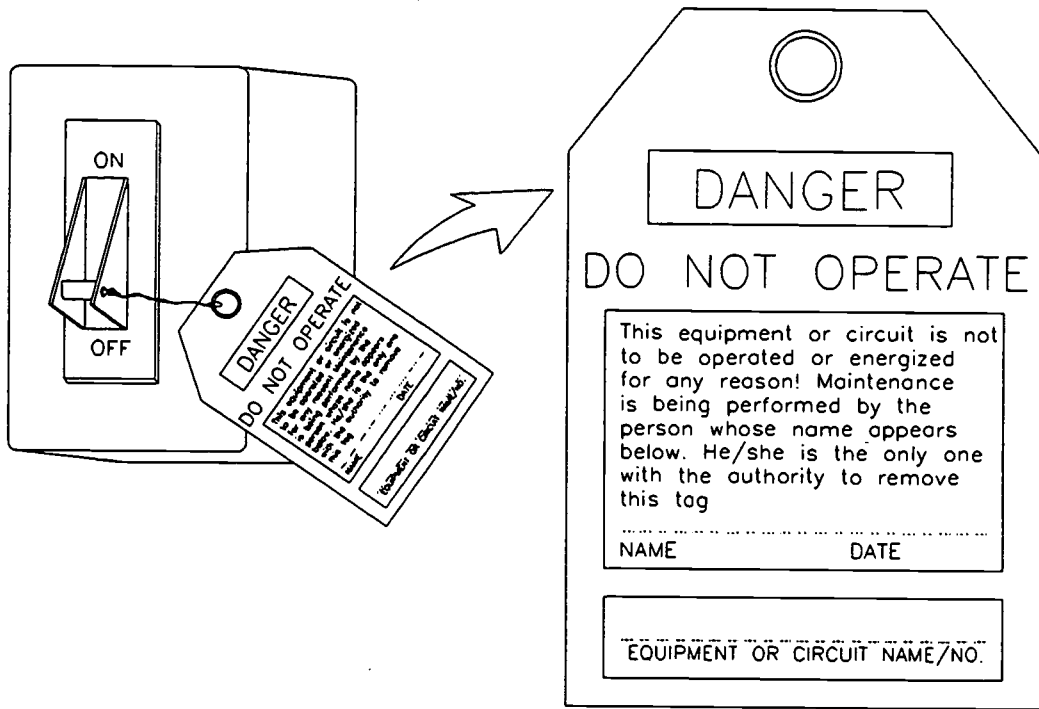

## 2 - Tagout

When more than one person is involved, each individual must place a lockout/tagout device on the isolation device. If a lockout device is used, it should be capable of accepting multiple locks. This is so each individual can place a lock on the device. Each lock should have a tag similar to the one used in the tagout procedure. The individual who puts the lock in place signs the tag. See Figure 3.



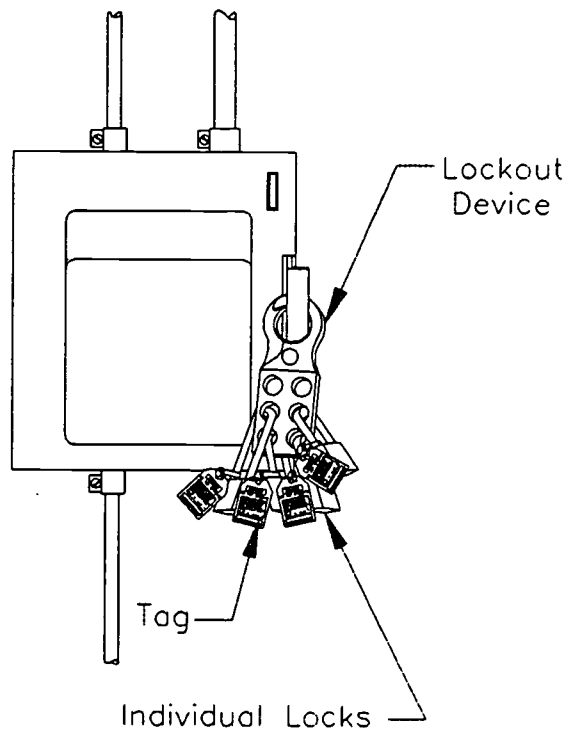

### **3 - Multiple-Lock Lockout Device**

The lockout physically prohibits the operation of a piece of equipment. The tagout relies on those who read it. They must recognize its significance.

Wherever lockout/tagouts are used, there must be an established procedure for all to follow. All personnel must understand the importance and the use of the lockout/tagout system. The lockout/tagout devices used within an organization are standardized. So, anyone within the organization will recognize what they are.

The restrictions indicated by lockouts and tagouts remain in force until they are removed. The person putting the tagout or lockout in place is the person who has the authority to remove it.

The Occupational Safety and Health Act sets standards that are administered by the Occupational Safety and Health Administration (OSHA). OSHA has standard lockout/tagout procedures. The lockout/tagout procedures apply to all energy systems — air, hydraulic, mechanical, and electrical.

**AET-J1-LE**  
**Safely Assemble, Disassemble, and Adjust Mechanical Systems**  
**such as Gearing Systems, Shafts, Couplings, Pulleys, Belts**  
**Attachment 8: MASTER Laboratory Exercise**

---

The student will:

1. Using an industrial machine tool, apply the concepts contained in this module.

**AET-J1-LA**  
**Safely Assemble, Disassemble, and Adjust Mechanical Systems**  
**such as Gearing Systems, Shafts, Couplings, Pulleys, Belts**  
**Attachment 9: MASTER Laboratory Aid**

---

**Rules of Conduct**

1. Absolutely no horseplay or practical joking will be tolerated.
2. Do not talk to anyone who is operating a machine.
3. Walk only in the designated traffic lanes.
4. Dress appropriately; at the absolute minimum, you must have:
  - a. No loose clothing, including ties;
  - b. Long hair properly stowed;
  - c. No jewelry;
  - d. Hard, closed-toe shoes;
  - e. Eye protection (safety glasses); and,
  - f. Ear protection (plugs or headset).
5. Follow all institutional safety rules.

**AET-J2-HO-1**  
**Safely Assemble, Disassemble, and Adjust**  
**Subsystems or Components of Fluid Power Systems**  
**Attachment 1: MASTER Handout No. 1**

---

**Objective(s):**

Upon completion of this unit the student will be able to:

- a. Use the ordinary hand tools associated with installation and repair of hydraulic and pneumatic systems;
- b. Perform procedures such as cutting, flaring, and bending fluid power tubing;
- c. Perform procedures such as removing and installing fluid power fittings;
- d. Remove and install fluid power seals;
- e. Remove and properly install fluid power components such as pumps, valves cylinders, and motors;
- f. Properly disassemble and assemble fluid power components such as pumps, valves cylinders, and motors; and,
- g. Properly perform adjustments of pressures and flows.

---

**Module Outline:**

- I. Safely Assemble or Disassemble Subsystems or Components of Fluid Power Systems
  - A. Explain and demonstrate the removal and installation of fluid power fittings and tubing
    1. Explain and demonstrate the proper methods of removing and installing fluid power fittings (for both hydraulic and pneumatic systems)
    2. Explain and demonstrate the proper methods of cutting, flaring, bending, and installing fluid power tubing (for both hydraulic and pneumatic systems)
  - B. Explain and demonstrate the removal and installation of valves
    1. Explain demonstrate the removal and installation of directional control valves from/to fluid power manifolds
    2. Explain the manifold ports on pneumatic systems and the installation of exhaust mufflers
    3. Explain and demonstrate the installation of "O" ring seals and valve seals for valve/manifold sealing
    4. Explain and demonstrate the installation of pressure control valves for fluid power systems
  - C. Explain and demonstrate the removal and installation of pumps, motors, and cylinders

- D. Explain and demonstrate the proper assembly and disassembly of valves, pumps, motors, and cylinders
  - 1. Explain and demonstrate the proper methods of disassembling, assembling cleaning, and replacing seals for fluid power valves
  - 2. Explain and demonstrate the proper methods for disassembling, assembling, cleaning, and replacing seals for pumps and motors
  - 3. Explain the proper methods for disassembling, assembling, cleaning, and replacing seals for cylinders
- II. Adjust Subsystems or Components of Fluid Power Systems
  - A. Explain and demonstrate the proper methods of adjusting pressure control valves
    - 1. Explain and demonstrate the proper method of adjusting pressure relief valves in hydraulic systems or pneumatic receivers
    - 2. Explain and demonstrate the proper method of adjusting pressure reducing valves in hydraulic or pneumatic systems
    - 3. Explain and demonstrate the proper method of adjusting sequencing valves in hydraulic systems
    - 4. Explain and demonstrate the proper method of adjusting pressure reducing valves in hydraulic or pneumatic systems
    - 5. Explain and demonstrate the proper methods for adjusting deceleration valves for hydraulic motors
  - B. Explain and demonstrate the proper methods of adjusting flow control valves
    - 1. Explain the effects of adjusting flow control valves for fluid power systems
    - 2. Demonstrate the adjustment of flow control valves for cushions and speed controls for cylinders and fluid power motors
  - C. Explain and demonstrate the proper methods for adjusting infinite positioning valves such as servo valves and proportional control valves

**AET-J2-HO-2**  
**Safely Assemble, Disassemble, and Adjust**  
**Subsystems or Components of Fluid Power Systems**  
**Attachment 2: MASTER Handout No. 2**

---

**Safely Assembling or Disassembling Fluid Power Components —**  
**Fluid Power Safety**

**Hydraulic/Pneumatic Safety**

1. Hydraulic and pneumatic equipment can generate large amounts of force. *Avoid placing your hands in the path of a moving actuator or object that may be pressurized.*
2. Do not attempt to control or stop pressure leaks in hydraulic or pneumatic equipment with your hands or other parts of your body. *Pressurized oil can be forced into your skin, causing health problems.*
3. Pressurized air can be forced into your skin causing blood clots to form in your veins or arteries. These blood clots can migrate to your heart or brain resulting in death or stroke. *Never subject your skin to high pressure gasses.*
4. High pressure hydraulic pressure leaks can form a fine mist of oil. Organic oil and some synthetic oils are explosive under these conditions.
5. Control hydraulic leaks by covering the leak with a rag or other shield to prevent the oil from misting, and remove the power from the hydraulic pump.
6. Control pneumatic leaks by removing the pressure source before attempting to determine the source of the leak.

**Proper Pressure Testing**

1. Fittings or access hatches that will be pressurized can be subject to tremendous forces. A hatch cover that is 1 foot in diameter which is pressurized to 15 PSIG will be subject to a force of almost one ton! The design of this equipment may require a certain number of fasteners to affix the fitting or cover to the pressure vessel. *Do not, under any circumstances, attempt to pressure test a vessel without replacing the required number of fasteners.*

2. Vessels that are designed to withstand external forces such as vacuum equipment, may not be designed to withstand internal forces that may result from pressures greater than atmospheric pressure. Pressurizing these vessels internally can cause them to rupture. In addition, fittings on these vessels may not be designed to withstand internal pressures.

## **Pneumatic Safety**

### **Confined Area Rules**

1. Vacuum equipment or pressurized processing equipment that is filled or back filled with gasses such as argon, nitrogen, carbon dioxide, or other types of inert gasses. Must be subject to confined area rules. These gasses, because they are heavier than, or equal to, the weight of air, can collect in pockets. Although these gasses are not toxic, breathing these gasses will not sustain life. Frequently, the victim is usually unaware that he or she is breathing the inert gasses until unconsciousness, and eventually death, occurs. More industrial accidents, that result in death, are caused by ignoring the confined area rules.

*Any vessel that is being inspected, and which was at one time was filled with an inert or toxic gas must be ventilated with fresh air for the time and in the manner determined by OSHA rules before entering or confining the upper part of your body in the vessel.*

### **Proper Pressure Testing**

1. *Disconnecting pressurized pneumatic lines is hazardous.* Escaping high pressure air will cause the line to whip back and forth, in some cases, with a great deal of force. Remove the pressure source before removing lines.
2. *Do not point a pressurized line at anyone, and do not look into a pressurized line.* Parts from broken pneumatic valves or other objects can enter these lines. If the lines are then pressurized, the objects will be ejected at a high velocity. The object then becomes a bullet, and can cause as much damage as a bullet fired from a gun.
3. Make sure that air lines that are coupled with quick disconnects are firmly seated into the fitting. If the line is installed with flair or compression fittings, make sure that the fittings are properly tightened (do not over tighten these fittings). Lines that are improperly installed will come loose under pressure.

4. Combination hydro-pneumatic actuators that are commonly found in pneumatic pick and place robots have speed control and slowdown control valves. If these valves are not properly installed, they can be ejected from the actuator with a great deal of force. Consult the manuals for the equipment and only adjust these valves according to the specifications.

## **Mechanical/Hydraulic/Pneumatic Safety**

### **Mechanical Safety**

General safety requires that the technician know and obey the safety rules associated with his or her job and follow them consistently. When in doubt about the procedures to follow or about the safety of a particular operation, consult the available documentation associated with that procedure. Many sources exist to support this, including notices packed with equipment shipped from a vendor. *Save this safety information.* Make it a habit to establish a set of documents that contain these safety rules, and *make the documents available to all of the technicians in the organization.*

### **Avoid Pinch Points**

1. Mechanisms can generate large amounts of force from relatively low power driving devices. Using your hands to test the force generated by these devices can result in crushed fingers. *Do not put your hands in mechanisms that can amplify force, such as lead screws, gear trains, or lever systems.*
2. Tools such as pliers, diagonal cutters, or vice grip pliers can slip, pinching or cutting your skin. *Learn to properly apply these tools.*
3. Hammers can be misdirected, resulting in painful injuries. If you must support devices to be hammered with your hands, aim carefully to avoid injuries.
4. Hydraulic and pneumatic actuators or pressurized equipment, even at relatively low pressures can generate forces large enough to sever fingers or arms. Do not assume that, because a device is moving slowly, it is harmless. *Keep hands away from equipment under pressure.*
5. Die cutting equipment, forming presses or curing presses can sever fingers or hands. *Keep hands away from equipment under power.*



6. When moving large heavy pieces of equipment, keep hands from under the equipment. Use slings or other types of supporting devices to move the equipment.

### **Moving Equipment Precautions**

1. Automated equipment that is powered on can move at any time. Equipment that has stopped under unusual circumstances can move based upon changes in sensors or under the directions of a faulty controller. *Learn the safe shut-down procedures for the equipment, move the equipment to a safe condition and/or remove the power from the systems before placing your hands in the mechanism.*
2. Do not under any circumstances, try to remove objects such as broken parts or other obstructions from the equipment when it is in an automatic mode. Learn the safe shut-down procedures for the equipment, move the equipment to a safe condition and/or remove the power from the systems before placing your hands in the mechanism. Broken parts can be razor sharp. *If a part is wedged in the mechanism, remove the force holding it before attempting to remove the part.*

### **Bench Work Safety**

1. Although you may feel relatively safe when working on equipment at the work bench, industrial accidents can occur because the environment seems safe. *At a minimum, safety glasses are required when performing bench work.* Spring loaded objects such as valves or other mechanism under tension. These mechanisms can eject objects that can strike eyes causing severe injury. Using normal hand tools, puts mechanisms under tension when they are being assembled or disassembled.
2. In addition to safety glasses, when working on certain types of mechanisms with close tolerances, edges can be sharp. *Wear work gloves to handle such objects.*
3. Using solvents to clean mechanisms may require that the technician wear protective gloves to prevent the solvent from being absorbed into the skin. Highly volatile solvents may also require a respirator to prevent the inhalation of vapors. *Consult the Material Safety Data Sheets (MSDS) to determine the safety rules for using solvents or other chemicals.*

**AET-J2-HO-3**  
**Safely Assemble, Disassemble, and Adjust**  
**Subsystems or Components of Fluid Power Systems**  
**Attachment 3: MASTER Handout No. 3**

---

**Safely Working With Pressurized Systems — Fluid Power Safety**

**Hydraulic/Pneumatic Safety**

1. Hydraulic and pneumatic equipment can generate large amounts of force. *Avoid placing your hands in the path of a moving actuator or object that may be pressurized.*
2. Do not attempt to control or stop pressure leaks in hydraulic or pneumatic equipment with your hands or other parts of your body. *Pressurized oil can be forced into your skin, causing health problems.*
3. Pressurized air can be forced into your skin causing blood clots to form in your veins or arteries. These blood clots can migrate to your heart or brain resulting in death or stroke. *Never subject your skin to high pressure gasses.*
4. High pressure hydraulic pressure leaks can form a fine mist of oil. Organic oil and some synthetic oils are explosive under these conditions.
5. Control hydraulic leaks by covering the leak with a rag or other shield to prevent the oil from misting, and remove the power from the hydraulic pump.
6. Control pneumatic leaks by removing the pressure source before attempting to determine the source of the leak.

**Proper Pressure Testing**

1. Fittings or access hatches that will be pressurized can be subject to tremendous forces. A hatch cover that is 1 foot in diameter which is pressurized to 15 PSIG will be subject to a force of almost one ton! The design of this equipment may require a certain number of fasteners to affix the fitting or cover to the pressure vessel. *Do not, under any circumstances, attempt to pressure test a vessel without replacing the required number of fasteners.*

2. Vessels that are designed to withstand external forces such as vacuum equipment, may not be designed to withstand internal forces that may result from pressures greater than atmospheric pressure. Pressurizing these vessels internally can cause them to rupture. In addition, fittings on these vessels may not be designed to withstand internal pressures.

## Pneumatic Safety

### Confined Area Rules

1. Vacuum equipment or pressurized processing equipment that is filled or back filled with gasses such as argon, nitrogen, carbon dioxide, or other types of inert gasses. Must be subject to confined area rules. These gasses, because they are heavier than, or equal to, the weight of air, can collect in pockets. Although these gasses are not toxic, breathing these gasses will not sustain life. Frequently, the victim is usually unaware that he or she is breathing the inert gasses until unconsciousness, and eventually death, occurs. More industrial accidents, that result in death, are caused by ignoring the confined area rules.

*Any vessel that is being inspected, and which was at one time was filled with an inert or toxic gas must be ventilated with fresh air for the time and in the manner determined by OSHA rules before entering or confining the upper part of your body in the vessel.*

### Proper Pressure Testing

1. *Disconnecting pressurized pneumatic lines is hazardous.* Escaping high pressure air will cause the line to whip back and forth, in some cases, with a great deal of force. Remove the pressure source before removing lines.
2. *Do not point a pressurized line at anyone, and do not look into a pressurized line.* Parts from broken pneumatic valves or other objects can enter these lines. If the lines are then pressurized, the objects will be ejected at a high velocity. The object then becomes a bullet, and can cause as much damage as a bullet fired from a gun.
3. Make sure that air lines that are coupled with quick disconnects are firmly seated into the fitting. If the line is installed with flair or compression fittings, make sure that the fittings are properly tightened (do not over tighten these fittings). Lines that are improperly installed will come loose under pressure.

4. Combination hydro-pneumatic actuators that are commonly found in pneumatic pick and place robots have speed control and slowdown control valves. If these valves are not properly installed, they can be ejected from the actuator with a great deal of force. Consult the manuals for the equipment and only adjust these valves according to the specifications.

## **Mechanical/Hydraulic/Pneumatic Safety**

### **Mechanical Safety**

General safety requires that the technician know and obey the safety rules associated with his or her job and follow them consistently. When in doubt about the procedures to follow or about the safety of a particular operation, consult the available documentation associated with that procedure. Many sources exist to support this, including notices packed with equipment shipped from a vendor. *Save this safety information.* Make it a habit to establish a set of documents that contain these safety rules, and *make the documents available to all of the technicians in the organization.*

### **Avoid Pinch Points**

1. Mechanisms can generate large amounts of force from relatively low power driving devices. Using your hands to test the force generated by these devices can result in crushed fingers. *Do not put your hands in mechanisms that can amplify force, such as lead screws, gear trains, or lever systems.*
2. Tools such as pliers, diagonal cutters, or vice grip pliers can slip, pinching or cutting your skin. *Learn to properly apply these tools.*
3. Hammers can be misdirected, resulting in painful injuries. If you must support devices to be hammered with your hands, aim carefully to avoid injuries.
4. Hydraulic and pneumatic actuators or pressurized equipment, even at relatively low pressures can generate forces large enough to sever fingers or arms. Do not assume that, because a device is moving slowly, it is harmless. *Keep hands away from equipment under pressure.*
5. Die cutting equipment, forming presses or curing presses can sever fingers or hands. *Keep hands away from equipment under power.*

6. When moving large heavy pieces of equipment, keep hands from under the equipment. Use slings or other types of supporting devices to move the equipment.

### **Moving Equipment Precautions**

1. Automated equipment that is powered on can move at any time. Equipment that has stopped under unusual circumstances can move based upon changes in sensors or under the directions of a faulty controller. *Learn the safe shut-down procedures for the equipment, move the equipment to a safe condition and/or remove the power from the systems before placing your hands in the mechanism.*
2. Do not under any circumstances, try to remove objects such as broken parts or other obstructions from the equipment when it is in an automatic mode. Learn the safe shut-down procedures for the equipment, move the equipment to a safe condition and/or remove the power from the systems before placing your hands in the mechanism. Broken parts can be razor sharp. *If a part is wedged in the mechanism, remove the force holding it before attempting to remove the part.*

### **Bench Work Safety**

1. Although you may feel relatively safe when working on equipment at the work bench, industrial accidents can occur because the environment seems safe. *At a minimum, safety glasses are required when performing bench work.* Spring loaded objects such as valves or other mechanism under tension. These mechanisms can eject objects that can strike eyes causing severe injury. Using normal hand tools, puts mechanisms under tension when they are being assembled or disassembled.
2. In addition to safety glasses, when working on certain types of mechanisms with close tolerances, edges can be sharp. *Wear work gloves to handle such objects.*
3. Using solvents to clean mechanisms may require that the technician wear protective gloves to prevent the solvent from being absorbed into the skin. Highly volatile solvents may also require a respirator to prevent the inhalation of vapors. *Consult the Material Safety Data Sheets (MSDS) to determine the safety rules for using solvents or other chemicals.*

**AET-J2-HO-4**  
**Safely Assemble, Disassemble, and Adjust**  
**Subsystems or Components of Fluid Power Systems**  
**Attachment 4: MASTER Handout No. 4**

---

**Do and Don'ts for Fluid Power Systems — Fluid Power Safety**

**Hydraulic/Pneumatic Safety**

1. Hydraulic and pneumatic equipment can generate large amounts of force. *Avoid placing your hands in the path of a moving actuator or object that may be pressurized.*
2. Do not attempt to control or stop pressure leaks in hydraulic or pneumatic equipment with your hands or other parts of your body. *Pressurized oil can be forced into your skin, causing health problems.*
3. Pressurized air can be forced into your skin causing blood clots to form in your veins or arteries. These blood clots can migrate to your heart or brain resulting in death or stroke. *Never subject your skin to high pressure gasses.*
4. High pressure hydraulic pressure leaks can form a fine mist of oil. Organic oil and some synthetic oils are explosive under these conditions.
5. Control hydraulic leaks by covering the leak with a rag or other shield to prevent the oil from misting, and remove the power from the hydraulic pump.
6. Control pneumatic leaks by removing the pressure source before attempting to determine the source of the leak.

**Proper Pressure Testing**

1. Fittings or access hatches that will be pressurized can be subject to tremendous forces. A hatch cover that is 1 foot in diameter which is pressurized to 15 PSIG will be subject to a force of almost one ton! The design of this equipment may require a certain number of fasteners to affix the fitting or cover to the pressure vessel. *Do not, under any circumstances, attempt to pressure test a vessel without replacing the required number of fasteners.*

2. Vessels that are designed to withstand external forces such as vacuum equipment, may not be designed to withstand internal forces that may result from pressures greater than atmospheric pressure. Pressurizing these vessels internally can cause them to rupture. In addition, fittings on these vessels may not be designed to withstand internal pressures.

## **Pneumatic Safety**

### **Confined Area Rules**

1. Vacuum equipment or pressurized processing equipment that is filled or back filled with gasses such as argon, nitrogen, carbon dioxide, or other types of inert gasses. Must be subject to confined area rules. These gasses, because they are heavier than, or equal to, the weight of air, can collect in pockets. Although these gasses are not toxic, breathing these gasses will not sustain life. Frequently, the victim is usually unaware that he or she is breathing the inert gasses until unconsciousness, and eventually death, occurs. More industrial accidents, that result in death, are caused by ignoring the confined area rules.

*Any vessel that is being inspected, and which was at one time was filled with an inert or toxic gas must be ventilated with fresh air for the time and in the manner determined by OSHA rules before entering or confining the upper part of your body in the vessel.*

### **Proper Pressure Testing**

1. *Disconnecting pressurized pneumatic lines is hazardous.* Escaping high pressure air will cause the line to whip back and forth, in some cases, with a great deal of force. Remove the pressure source before removing lines.
2. *Do not point a pressurized line at anyone, and do not look into a pressurized line.* Parts from broken pneumatic valves or other objects can enter these lines. If the lines are then pressurized, the objects will be ejected at a high velocity. The object then becomes a bullet, and can cause as much damage as a bullet fired from a gun.
3. Make sure that air lines that are coupled with quick disconnects are firmly seated into the fitting. If the line is installed with flair or compression fittings, make sure that the fittings are properly tightened (do not over tighten these fittings). Lines that are improperly installed will come loose under pressure.



4. Combination hydro-pneumatic actuators that are commonly found in pneumatic pick and place robots have speed control and slowdown control valves. If these valves are not properly installed, they can be ejected from the actuator with a great deal of force. Consult the manuals for the equipment and only adjust these valves according to the specifications.

## **Mechanical/Hydraulic/Pneumatic Safety**

### **Mechanical Safety**

General safety requires that the technician know and obey the safety rules associated with his or her job and follow them consistently. When in doubt about the procedures to follow or about the safety of a particular operation, consult the available documentation associated with that procedure. Many sources exist to support this, including notices packed with equipment shipped from a vendor. *Save this safety information.* Make it a habit to establish a set of documents that contain these safety rules, and *make the documents available to all of the technicians in the organization.*

### **Avoid Pinch Points**

1. Mechanisms can generate large amounts of force from relatively low power driving devices. Using your hands to test the force generated by these devices can result in crushed fingers. *Do not put your hands in mechanisms that can amplify force, such as lead screws, gear trains, or lever systems.*
2. Tools such as pliers, diagonal cutters, or vice grip pliers can slip, pinching or cutting your skin. *Learn to properly apply these tools.*
3. Hammers can be misdirected, resulting in painful injuries. If you must support devices to be hammered with your hands, aim carefully to avoid injuries.
4. Hydraulic and pneumatic actuators or pressurized equipment, even at relatively low pressures can generate forces large enough to sever fingers or arms. Do not assume that, because a device is moving slowly, it is harmless. *Keep hands away from equipment under pressure.*
5. Die cutting equipment, forming presses or curing presses can sever fingers or hands. *Keep hands away from equipment under power.*



6. When moving large heavy pieces of equipment, keep hands from under the equipment. Use slings or other types of supporting devices to move the equipment.

### **Moving Equipment Precautions**

1. Automated equipment that is powered on can move at any time. Equipment that has stopped under unusual circumstances can move based upon changes in sensors or under the directions of a faulty controller. *Learn the safe shut-down procedures for the equipment, move the equipment to a safe condition and/or remove the power from the systems before placing your hands in the mechanism.*
2. Do not under any circumstances, try to remove objects such as broken parts or other obstructions from the equipment when it is in an automatic mode. Learn the safe shut-down procedures for the equipment, move the equipment to a safe condition and/or remove the power from the systems before placing your hands in the mechanism. Broken parts can be razor sharp. *If a part is wedged in the mechanism, remove the force holding it before attempting to remove the part.*

### **Bench Work Safety**

1. Although you may feel relatively safe when working on equipment at the work bench, industrial accidents can occur because the environment seems safe. *At a minimum, safety glasses are required when performing bench work.* Spring loaded objects such as valves or other mechanism under tension. These mechanisms can eject objects that can strike eyes causing severe injury. Using normal hand tools, puts mechanisms under tension when they are being assembled or disassembled.
2. In addition to safety glasses, when working on certain types of mechanisms with close tolerances, edges can be sharp. *Wear work gloves to handle such objects.*
3. Using solvents to clean mechanisms may require that the technician wear protective gloves to prevent the solvent from being absorbed into the skin. Highly volatile solvents may also require a respirator to prevent the inhalation of vapors. *Consult the Material Safety Data Sheets (MSDS) to determine the safety rules for using solvents or other chemicals.*

**AET-J2-LE**  
**Safely Assemble, Disassemble, and Adjust**  
**Subsystems or Components of Fluid Power Systems**  
**Attachment 6: MASTER Laboratory Exercise**

---

The student will:

1. Using an industrial fluid power system, apply the concepts contained in this module; and,
2. Adjust a servo valve or proportional control valve for an automated fluid power system.

**AET-J2-LA**  
**Safely Assemble, Disassemble, and Adjust**  
**Subsystems or Components of Fluid Power Systems**  
**Attachment 7: MASTER Laboratory Aid**

---

**Rules of Conduct**

1. Absolutely no horseplay or practical joking will be tolerated.
2. Do not talk to anyone who is operating a machine.
3. Walk only in the designated traffic lanes.
4. Dress appropriately; at the absolute minimum, you must have:
  - a. No loose clothing, including ties;
  - b. Long hair properly stowed;
  - c. No jewelry;
  - d. Hard, closed-toe shoes;
  - e. Eye protection (safety glasses); and,
  - f. Ear protection (plugs or headset).
5. Follow all institutional safety rules.

**AET-J3-HO-1**  
**Safely Assemble, Disassemble or Adjust**  
**Electrical Systems or Components**  
**Attachment 1: MASTER Handout No. 1**

---

**Objective(s):**

Upon completion of this unit the student will be able to:

- a. Use the ordinary hand tools associated with installation and repair of electrical systems;
- b. Perform procedures such as installing electrical panels and enclosures;
- c. Perform procedures such as installing and wiring electrical components such as switches, relays solenoids, fuse holders, terminal strips, and motor starters;
- d. Remove install, and properly wire electrical motors;
- e. Remove and install brushes for DC electrical motors;
- f. Install electrical metallic tubing and flexible conduits;
- g. Properly adjust overloads, power supplies, and time delay relays; and,
- h. Perform ordinary safety procedure such as lockout, tagout, and safe electrical adjustments.

---

**Module Outline:**

- I. Safely Assemble or Disassemble Electrical Systems or Components
  - A. Explain and demonstrate the removal and installation of electrical components and assemblies (this may be accomplished by having the students assemble an electrical panel from component parts)
    1. Explain and demonstrate proper lock-out tag out procedures
    2. Explain and demonstrate the proper wiring methods for electrical control systems
    3. Demonstrate the procedures required for using knock-out punches
    4. Explain and demonstrate the proper methods for installing switches such as toggle switches, push-button switches, start/stop switch assemblies, and thumb wheel switches
    5. Explain and demonstrate the proper methods for installing terminal strips, relays, solenoids, and motor-starter contactors
    6. Explain and demonstrate the proper methods for soldering wiring and components, and the proper methods for installing high current soldered splices
  - B. Explain and demonstrate the removal and installation of transformers
    1. Explain and demonstrate the wiring of electrical control power transformers; both single phase, and three phase

2. Explain and demonstrate the mounting of electrical control power transformers
- C. Explain and demonstrate the removal and installation of electrical motors
  1. Explain and demonstrate the proper wiring methods for DC motors such as permanent magnet field, shunt field, series field, and universal motors
  2. Explain and demonstrate the proper replacement of brushes, and the renewing of commutators for DC electrical motors
  3. Explain and demonstrate the proper wiring methods for AC inductive motors; such as single phase AC capacitive start motors, AC inductive start motors and three phase AC motors
  4. Explain and demonstrate the removal and installation of start switches, capacitors, thermal overloads, and bearings on both DC motors and AC inductive motors
  5. Explain the concept of frame sizes of electrical motors, removing and replacing shaft couplings, and the mounting procedures for electrical motors
- II. Adjust Subsystems or Components of Electrical Systems
  - A. Explain and demonstrate the proper methods of adjusting DC power supplies
  - B. Explain and demonstrate the proper methods of adjusting time delay relays
  - C. Explain and demonstrate common procedures for adjusting electrical over loads for motor starters and contactors
  - D. Explain and demonstrate the adjustment procedures for computer controlled electrical power distribution centers

**AET-J3-LE**  
**Safely Assemble, Disassemble or Adjust**  
**Electrical Systems or Components**  
**Attachment 3: MASTER Laboratory Exercise**

---

The student will:

1. Using an industrial electrical system, apply the concepts contained in this module; and,
2. Adjust a power supply and time delay relays for an automated electrical system.

**AET-J3-LA**  
**Safely Assemble, Disassemble or Adjust**  
**Electrical Systems or Components**  
**Attachment 4: MASTER Laboratory Aid**

---

**Rules of Conduct**

1. Absolutely no horseplay or practical joking will be tolerated.
2. Do not talk to anyone who is operating a machine.
3. Walk only in the designated traffic lanes.
4. Dress appropriately; at the absolute minimum, you must have:
  - a. No loose clothing, including ties;
  - b. Long hair properly stowed;
  - c. No jewelry;
  - d. Hard, closed-toe shoes;
  - e. Eye protection (safety glasses); and,
  - f. Ear protection (plugs or headset).
5. Follow all institutional safety rules.

**AET-J4-HO**  
**Safely Assemble, Disassemble, or Adjust**  
**Electronic Systems or Components**  
**Attachment 1: MASTER Handout**

---

**Objective(s):**

Upon completion of this unit the student will be able to:

- a. Use the ordinary hand tools associated with installation and repair of electronic systems;
- b. Perform procedures such as removing and installing electronic modules and subsystems;
- c. Remove, install and solder electronic components such as resistors, capacitors, inductors, diodes, transistors, and integrated circuits;
- d. Repair, wire and test connectors;
- e. Perform anti-static discharge procedures to protect electronic components from electrical static discharge damage (ESD);
- f. Properly remove and install surface mount technology (SMT) electronic components;
- g. Remove and install high power semiconductors from heat sinks;
- h. Properly adjust electronic motor controls, servo systems, and proportional band, integral/derivative (PID) controls; and,
- i. Perform ordinary safety procedure such as lockout, tagout, and safe electronic adjustments.

---

**Module Outline:**

- I. Safely Assemble or Disassemble Electronic Systems or Components
  - A. Explain and demonstrate the removal and installation of standard electronic components and assemblies (This may be accomplished by having the students assemble a working electronic module from component parts. The grade is predicated upon whether or not the module works.)
    1. Explain and demonstrate proper lock-out tag out procedures, and safety equipment required for electronic bench work
    2. Explain and demonstrate the proper methods for safely removing and installing electronic modules and subassemblies from enclosures
    3. Explain and demonstrate the proper methods for removing components from electronic modules
    4. Explain and demonstrate the proper methods for preparing electronic modules for resoldering



5. Explain and demonstrate the proper soldering tools and methods for resoldering components on electronic control modules and systems
  - B. Explain and demonstrate the removal and installation of power semiconductors
    1. Explain the purpose of air cooled, and fluid cooled heat sinks for power semiconductors and methods of heat conduction for insulated components
    2. Explain and demonstrate the removal and mounting of electronic power semiconductors for both types of heat sinks
  - C. Explain and demonstrate the removal and installation of surface mount technology (SMT) electronic components
    1. Explain the differences between through-hole technology electronic components, and SMT components
    2. Explain and demonstrate procedures for identifying SMT component parts such as resistors, capacitors, inductors, potentiometers, diodes, transistors, and integrated circuits
    3. Explain and demonstrate the proper tools used for removal and installation of SMT components
    4. Explain the methods of positioning, application of solder paste, heat application, and reflow of solder paste
    5. Explain the inspection of quality assurance of finished work
- II. Adjust Subsystems or Components of Electronic Systems
- A. Explain and demonstrate the proper methods of adjusting electronic motor controls
    1. Explain the purpose of the adjustments on the following types of electronic motor controls
      - a. Motor controls for DC shunt field and universal motors
        - (1) Current limit
        - (2) Current/resistance (IR) compensation
        - (3) Field weakening
        - (4) Max. speed/Min. speed
      - b. Motor controls for permanent magnet DC motors
        - (1) Current limit
        - (2) Current/resistance (IR) compensation
        - (3) Max. speed/Min. speed
      - c. Three phase, variable frequency controls for three phase AC motors
        - (1) Acceleration/deceleration
        - (2) Volts/Hertz ratio
        - (3) Instantaneous over current (IOC)
    2. Demonstrate the adjustment of the above controls and the effects of improper adjustment
  - B. Explain and demonstrate the proper methods of adjusting Proportional-band, Integral, and Derivative (PID) loops controllers

1. Explain the purpose and function of the following aspects of PID loop controllers
    - a. Proportional band
    - b. Integral
    - c. Derivative
  2. Explain the types of controllers that may belong to the PID control class
    - a. Bang-bang servos
    - b. Analog controllers
  3. Demonstrate the adjustment of the above and the expected results of improper adjustment
- C. Explain and demonstrate procedures for adjusting servo systems
1. Explain the electronic adjustments that are necessary for proper mechanical settings on various types of servo systems
    - a. Following error (steady state error)
    - b. Home position
    - c. Backlash compensation
  2. Explain the purpose of the following adjustments
    - a. Gain
    - b. Velocity stability
  3. Explain the interrelationships between the above adjustments and the effects upon the mechanism
  4. Demonstrate the adjustment of the above and the effects of improper adjustment

**AET-J4-LE**  
**Safely Assemble, Disassemble, or Adjust**  
**Electronic Systems or Components**  
**Attachment 2: MASTER Laboratory Exercise**

---

The student will:

1. Using an industrial electronic system, apply the concepts contained in this module; and,
2. Using an industrial electronic control process, such as a furnace or other process control, and a CNC servo system, apply the concepts contained in this module.

**AET-J4-LA**  
**Safely Assemble, Disassemble, or Adjust**  
**Electronic Systems or Components**  
**Attachment 3: MASTER Laboratory Aid**

---

**Rules of Conduct**

1. Absolutely no horseplay or practical joking will be tolerated.
2. Do not talk to anyone who is operating a machine.
3. Walk only in the designated traffic lanes.
4. Dress appropriately; at the absolute minimum, you must have:
  - a. No loose clothing, including ties;
  - b. Long hair properly stowed;
  - c. No jewelry;
  - d. Hard, closed-toe shoes;
  - e. Eye protection (safety glasses); and,
  - f. Ear protection (plugs or headset).
5. Follow all institutional safety rules.

**AET-J5-HO**  
**Safely Assemble or Disassemble Digital Systems or Components**  
**such as PLCs, CNCs, or Computers**  
**Attachment 1: MASTER Handout**

---

**Objective(s):**

Upon completion of this unit the student will be able to:

- a. Use the ordinary hand tools associated with installation and repair of industrial computer systems such as PLCs, CNC, Robot, and industrial computers;
- b. Identify computer subsystems such as; Central Processing Unit (CPU) modules or mother boards, power supplies, mass data storage devices, servo modules video cards, sound cards, and communication modules; and,
- c. Properly remove, install and configure common computer modules such as mother boards, power supplies, mass data storage devices, video cards, sound cards, and communication modules.

---

**Module Outline:**

- I. Safely Assemble or Disassemble Industrial Computer Systems such as Programmable Logic Controllers (PLC), CNC and Robot Controls, and Industrial Computer Systems
  - A. Explain and demonstrate the removal and installation of standard computer components and assemblies (This may be accomplished by having the students assemble a working computer from component parts. The grade is predicated upon whether or not the computer works properly.)
    1. Explain and demonstrate proper safety procedures and equipment required for computer bench work
    2. Explain and demonstrate the proper methods for safely removing and installing computer modules and subassemblies from enclosures. such as Central Processing Unit (CPU) modules or motherboards, power supplies, mass data storage devices, servo modules video cards, sound cards, and communication modules
    3. Explain and demonstrate the use of disk operating systems in configuring computer components and modules such as. Central Processing Unit (CPU) modules or motherboards, power supplies, mass data storage devices, servo modules video cards, sound cards, and communication modules
  - B. Explain and demonstrate the removal and installation of computer subassemblies from industrial CNC controls or robot controls

1. Identify subassemblies such as CPUs motherboards, power supplies, add-on modules and servo modules
  2. Explain and demonstrate the removal and mounting of Read Only Memory chips to configure the module for the application
  3. Demonstrate the removal of connectors and wiring harnesses and the proper identification and documentation of wiring harnesses
- C. Explain and demonstrate the removal and installation of programmable logic controller modules (PLC) and subassemblies (This may vary with the type of PLC. At least one example of a modular PLC should be used for training.)
1. Identify and explain the functions of each of the modules and their proper placement on the back plane (mother board or bus)
  2. Explain and demonstrate the proper tools used for removal and installation of PLC modules
  3. Explain and demonstrate procedures for wiring swing arms or edge connectors to field devices
  4. Explain the methods of mounting PLC enclosures
  5. Explain the inspection of quality assurance of finished work

**AET-J5-LE**  
**Safely Assemble or Disassemble Digital Systems or Components**  
**such as PLCs, CNCs, or Computers**  
**Attachment 2: MASTER Laboratory Exercise**

---

The student will:

1. Using an industrial computer system, CNC or robot control, apply the concepts contained in this module.

**AET-J5-LA**  
**Safely Assemble or Disassemble Digital Systems or Components**  
**such as PLCs, CNCs, or Computers**  
**Attachment 3: MASTER Laboratory Aid**

---

**Rules of Conduct**

1. Absolutely no horseplay or practical joking will be tolerated.
2. Do not talk to anyone who is operating a machine.
3. Walk only in the designated traffic lanes.
4. Dress appropriately; at the absolute minimum, you must have:
  - a. No loose clothing, including ties;
  - b. Long hair properly stowed;
  - c. No jewelry;
  - d. Hard, closed-toe shoes;
  - e. Eye protection (safety glasses); and,
  - f. Ear protection (plugs or headset).
5. Follow all institutional safety rules.





**U.S. DEPARTMENT OF EDUCATION**  
*Office of Educational Research and Improvement (OERI)*  
*Educational Resources Information Center (ERIC)*



## NOTICE

### REPRODUCTION BASIS

This document is covered by a signed "Reproduction Release (Blanket)" form (on file within the ERIC system), encompassing all or classes of documents from its source organization and, therefore, does not require a "Specific Document" Release form.

This document is Federally-funded, or carries its own permission to reproduce, or is otherwise in the public domain and, therefore, may be reproduced by ERIC without a signed Reproduction Release form (either "Specific Document" or "Blanket").