

DOCUMENT RESUME

ED 419 561

JC 980 249

AUTHOR Browne, Joseph, Ed.
TITLE The AMATYC Review, 1997-1998.
INSTITUTION American Mathematical Association of Two-Year Colleges.;
Onondaga Community Coll., Syracuse, NY.
ISSN ISSN-0740-8404
PUB DATE 1998-00-00
NOTE 168p.; Published twice a year.
AVAILABLE FROM AMATYC Office, State Technical Institute at Memphis, 5983
Macon Cove, Memphis, TN 38134 (two issues free with \$50
membership).
PUB TYPE Collected Works - Serials (022) -- Reports - Descriptive
(141)
JOURNAL CIT AMATYC Review; v19 n1-2 Fall-Spr 1997-1998
EDRS PRICE MF01/PC07 Plus Postage.
DESCRIPTORS *College Mathematics; Community Colleges; Educational
Innovation; Mathematical Applications; *Mathematical
Concepts; Mathematics Curriculum; *Mathematics Education;
Mathematics Instruction; Problem Solving; Two Year Colleges

ABSTRACT

This document consists of the two issues of the "AMATYC Review" published during volume year 1997-1998. Designed as an avenue of communication for mathematics educators concerned with the views, ideas, and experiences of two-year college students and teachers, this journal contains articles on mathematics exposition and education, and regularly presents book and software reviews, descriptions of classroom activities, instructor experiences, and math problems. The first of two issues of volume 19 includes the following major articles: "An Introduction to Computer Algebra" (Philip Mahler); "Dust Particles and Rain" (Carroll Brandy, Ricardo Torrejon, and Stewart Welsh); "Exploring Directional Derivatives on the TI-82/83 Calculator" (Thomas Shilgalis); "A Unique Isosceles Triangle" (Michael Scott McClendon); "The Distribution of Zeros of a Complex Polynomial" (Jay M. Jahangiri and Herb Silverman); "From Divisibility By 6 to the Euclidean Algorithm and the RSA Cryptographic Method" (John Cosgrave); and "Obstacles for College Algebra Students in Understanding Functions" (Marilyn P. Carlson). The second issue contains the following major articles: "Personal Financial Planning" (Martin Vern Bonsangue and Maijian Qian); "On Periodic Alignment" (Paul O'Meara); "On a Simple Exercise in Linear Algebra" (T.W. Leung); "A Note on $f(x) f(n)(x)=0$ " (Russell Euler and Jawad Sadek); "A Construction of the Harmonic Sequence" (Dennis Gittinger); "Towards a New Precalculus" (Mako Haruta, Mark Turpin, and Ray McGivney); "Exploring Parametric Calculus and Elliptic Integrals with Real-World Data" (Christopher Brueningsen and Rebecca A. Stoudt); and "Why Use Radians in Calculus" (Carl E. Crockett, Lt. Col.). (YKH)

* Reproductions supplied by EDRS are the best that can be made *
* from the original document. *

ED 419 561

The AMATYC Review

Volume 19, Numbers 1-2
1997-98

Joseph Browne
Editor

Onondaga Community College

JC 980249

PERMISSION TO REPRODUCE THIS
MATERIAL HAS BEEN GRANTED BY
J. Browne
TO THE EDUCATIONAL RESOURCES
INFORMATION CENTER (ERIC)

PERMISSION TO REPRODUCE THIS
MATERIAL HAS BEEN GRANTED BY
J. Browne
TO THE EDUCATIONAL RESOURCES
INFORMATION CENTER (ERIC)

BEST COPY AVAILABLE

THE AMATYC REVIEW

Published by the
AMERICAN MATHEMATICAL ASSOCIATION OF TWO-YEAR COLLEGES

VOLUME 19, NUMBER 1

Fall 1997

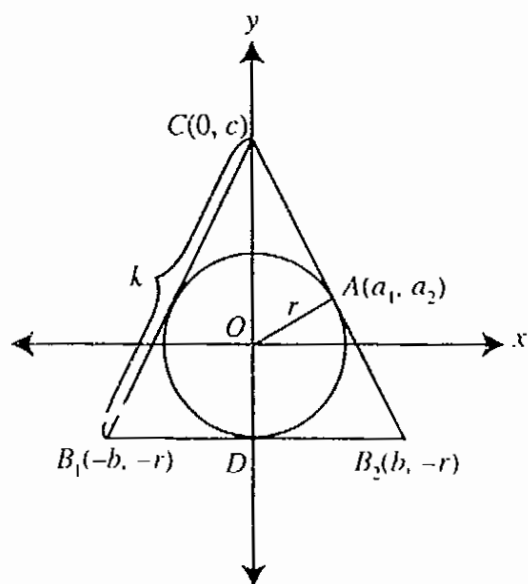

What isosceles triangle circumscribing a given circle has the shortest congruent legs?

Also in this issue

- What do our best students understand about functions?
 - Dust particles and rain
 - Directional derivatives on a handheld calculator
-



The Official Journal of the
**American Mathematical
 Association of
 Two-Year Colleges**



MISSION OF AMATYC: Recognizing the vital importance of the first two years of collegiate mathematical education to the future of our students and the welfare of our nations, AMATYC is committed to the following:

- to positively impact the preparation of scientifically and technologically literate citizens;
- to lead the development and implementation of curricular, pedagogical, assessment and professional standards for mathematics in the first two years of college;
- to assist in the preparation and continuing professional development of a quality mathematics faculty that is diverse with respect to ethnicity and gender;
- to provide a network for communication, policy determination, and action among faculty, other professional organizations, accrediting associations, governing agencies, industries, and the public sector.

The AMATYC Review provides an avenue of communication for all mathematics educators concerned with the views, ideas and experiences pertinent to two-year college teachers and students.

SUBMISSION OF MANUSCRIPTS: Manuscripts must be typed, doubled-spaced, on one side of 8-1/2" x 11" paper. They should not have been published before, nor should they be under consideration for publication elsewhere. To provide for anonymous reviews, the author's name and affiliation should appear on a separate title page. The title should also appear on the first page of the exposition. Authors are advised to consult the *Publication Manual of the American Psychological Association*. A guideline for authors is available from the editor and is also printed in the Fall 1993 issue. Five copies of each manuscript should be submitted to Joseph Browne, Onondaga Community College, Syracuse, NY 13215.

PHOTOCOPYING AND REPRINTS: General permission is granted to educators to photocopy material from *The AMATYC Review* for noncommercial instructional or scholarly use. Permission must be sought from the authors in order to charge for photocopies, to quote material in advertising, or to reprint articles in other educational publications. Once permission is obtained, credit should be given to the source of the material by citing a complete reference.

ADVERTISING: For information concerning advertising rates and schedules, contact the advertising manager, Max Cisneros, at the address given below.

STAFF

- Editor:* Joseph Browne, Onondaga Community College, Syracuse, NY 13215, (315) 469-2619, brownnej@aurora.sunyocc.edu
Production: Jane Covillion, Onondaga Community College, Syracuse, NY 13215, (315) 469-2159, covillij@aurora.sunyocc.edu
Advertising: Max Cisneros, Jr., Albuquerque Technical Vocational Institute, Albuquerque, NM 87106, (505) 224-3980, max@ddsp4.tvi.cc.nm.us

EDITORIAL PANEL

- Mike Davidson Cabrillo College Aptos, CA
 Michele Diel U. of New Mexico, Valencia Campus Los Lunos, NM
 James Fryell College of Lake County Grayslake, IL
 Brian Hickey East Central College Union, MO
 Dennis Reissig Suffolk County Community College Selden, NY
 Nelson G. Rich Nazareth College Rochester, NY
 Larry Runyon Shoreline Community College Seattle, WA
 Carla Thompson Tulsa Junior College Tulsa, OK
 Jacqueline Thornberry DeKalb College Clarkston, GA
 Margaret Willis Piedmont Virginia Community College Charlottesville, VA
 August Zarcone College of DuPage Glen Ellyn, IL

PUBLICATION: *The AMATYC Review* is published twice a year in the Fall and Spring.

ISSN 0740-8404

TABLE OF CONTENTS

ABOUT THE COVER AND EDITOR'S COMMENTS.....	p. 4
MATHEMATICAL EXPOSITION	
Factor $x^3 - 3x^5 - 4x^4 - 5x^3 + x^2 + 2x + 2$ — An Introduction to Computer Algebra.....	p. 6
by Philip Mahler	
Dust Particles and Rain.....	p. 21
by Carroll Bandy, Ricardo Torrejón and Stewart Welsh	
Exploring Directional Derivatives on the TI-82/83 Calculator.....	p. 28
by Thomas W. Shilgalis	
SHORT COMMUNICATIONS	
A Unique Isosceles Triangle.....	p. 32
by Michael Scott McClendon	
The Distribution of Zeros of a Complex Polynomial.....	p. 36
by Jay M. Jahangiri and Herb Silverman	
MATHEMATICS EDUCATION	
From Divisibility By 6 to the Euclidean Algorithm and the RSA Cryptographic Method.....	p. 38
by John B. Cosgrave	
Obstacles for College Algebra Students in Understanding Functions. What Do High-Performing Students Really Know?.....	p. 48
by Marilyn P. Carlson	
REGULAR FEATURES	
Snapshots of Applications in Mathematics.....	p. 60
Edited by Dennis Callas and David J. Hildreth	
Notes from the Mathematical Underground.....	p. 64
Edited by Alain Schreimner	
Book Reviews.....	p. 69
Edited by Sandra DeLozier Coleman	
The Problem Section.....	p. 73
Edited by Michael W. Ecker	
Advertiser's Index.....	p. 63

The new TI-86 is your best value for advanced mathematics. For a number of reasons.

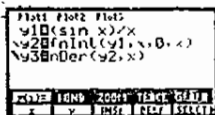
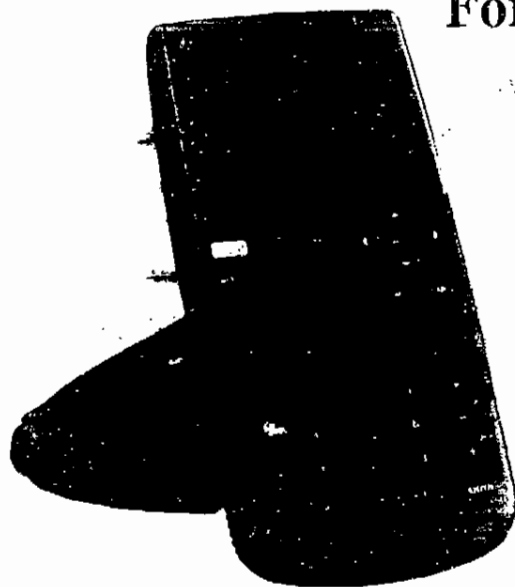

← Easily store up to 99 functions, polar, parametric, and differential equations.

▶ Graph functions in up to 7 different styles.

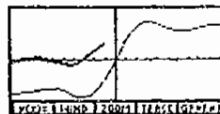

X	Y1	Y2
1	0.841471	0.817498
2	0.909297	0.578312
3	0.141884	0.173647
4	-0.756802	-0.820819
5	-0.960171	-0.959495
6	-0.625116	-0.989616
7	0.223768	-0.999999
8	0.717356	-0.999999
9	1.000000	-0.999999
10	0.984807	-0.999999

← View numeric results in the evaluation table for all four graph models.

▶ Explore differential equations with slope and direction fields.

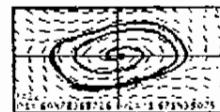

Here's all the power and functionality of the popular TI-85 with major enhancements for college mathematics, engineering and science.

Our newest graphing calculator provides more problem-solving power for everything from precalculus through differential equations: including linear algebra, calculus, trig, statistics and data analysis.

And, like all our advanced tools for the classroom, the TI-86 is backed by the industry's leading educator support programs, as well as training for T, and the College Short Course Programs.

Call 972-917-6411 to borrow a TI-86 for short term evaluation.

 TEXAS INSTRUMENTS

- ▶ Function evaluation table.
- ▶ Enhanced differential equations: slope and direction fields, RK and Euler solve methods, list of initial conditions.
- ▶ Advanced matrix operations for solving a variety of linear algebra problems: eigenvalues, eigenvectors, ref, rref.
- ▶ 128K RAM with 96K user available memory. Improved list and matrix editors.
- ▶ Assembly programming. ...and much more.

30

1-800-TI-CARES

ti_cares@ti.com

www.ti.com/calc

IH091997

©1997 TI

BEST COPY AVAILABLE

About the Cover



Some of the best mathematical problems to use with students are the ones which have an obvious answer which turns out to be wrong. The need for logic and careful reasoning is reinforced. A nice example of such a problem is given in the note "A Unique Isosceles Triangle" by Michael Scott McClendon in this issue and illustrated on the cover. The problem is "What isosceles triangle circumscribing a given circle has the shortest congruent legs?" Many would expect the equilateral triangle or, perhaps, the 45° - 45° - 90° triangle to fill the requirement, but neither is optimal.

I recommend that all readers look at the article by Marilyn Carlson in this issue concerning what our students know about functions when they finish a college algebra course. You may chuckle at some of the misconceptions expressed in the interviews she quotes, but they sound like things some of my students could say. The really disturbing thing, to me, was that Carlson was only looking at students who got high grades in the course. While this was just a small study at one college, if it is at all representative of students elsewhere, the teaching of this topic needs more attention.

It ain't so much what people don't know that makes trouble in this world
as it is what people do know that ain't so.

Mark Twain

Some Good Byes to Columnists

Michael Ecker is stepping down as editor of the Problem Section. Mike started the Problem Section some 16 years ago and has borne the load ever since. As a former Problem Editor myself (in another journal) I wish to thank and commend Mike for the excellent job he has done in this capacity. Mike continues to teach at Penn State Wilkes-Barre campus.

Also stepping down is Judy Cain who was responsible for starting the Chalkboard column. Judy is both a friend and a colleague and I have thoroughly enjoyed working with her on this project. Judy retired (early) from Tompkins Cortland Community College and expects to do a good deal of traveling with her husband.

The Problem Section will continue though, as I write this, I am not sure who the new editor will be. The Chalkboard has been receiving very few submissions recently, so Judy and I decided to let it go to its rest.

More useful for more classes than any calculator in its class.

TI-83. The one calculator for everything from algebra through calculus, including finance and statistics.

The TI-83 handles a host of functions for a variety of subjects with features like these, and much more:

- ▶ Differentiates graphs with a variety of line styles.
- ▶ Analyzes larger data sets with up to 999 elements.
- ▶ Solves for different variables interactively.
- ▶ New Statistics Handbook with activities and applications.
(Sold separately)

The affordable, portable TI-83. A calculator without equal.

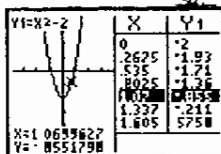

Math. Split screen allows you to trace the graph and scroll the table simultaneously.

Statistics. Display results of hypothesis tests graphically and numerically.

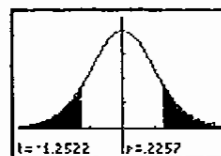

Finance. Financial functions: time-value-of-money, cash flows, and amortization.

N=48.00
I% = 14.90
PV = 9000.00
PMT = -250.00
FV = 0.00
P/Y = 12.00
C/Y = 12.00
PMT: **BEGIN**

ti TEXAS INSTRUMENTS

30
ANNIVERSARY
1958-1988

1-800-TI-CARES

ti-cares@ti.com

www.ti.com/colc

IH111997

©1997 TI

MATHEMATICAL EXPOSITION

$$\text{Factor } x^8 - 3x^5 - 4x^4 - 5x^2 + x^2 + 2x + 2$$

An Introduction to Computer Algebra

by

Philip Mahler
Middlesex Community College
Bedford MA 01730



Philip Mahler is a professor of mathematics and computer science at Middlesex Community College. He has taught for over 24 years in Florida, Michigan, and Massachusetts, is a past vice chair of the Michigan Section of the MAA, past newsletter editor and current two-year college representative for the Northeast Section of the MAA, is a past president of NEMATYC, was local arrangements chair for the 1993 AMATYC meeting in Boston, has written textbooks in intermediate algebra through precalculus mathematics, and has a strong interest in self-paced instruction, developmental mathematics, computer science, and foreign languages.

A computer algebra system (CAS) is a computer program which is capable of performing symbolic manipulations of algebraic objects. As these systems proliferate, mathematics educators should become aware of the mathematical knowledge base which makes them possible. It is the intention of this article to introduce mathematics educators to this relatively new area of mathematics.

I am fascinated by the algebraic power of these systems. What I present here grew out of curiosity about how CAS programs work their magic. It turns out that the search for answers opened a door for me to the rich subdiscipline of computer algebra. It is the intent of this exposition to introduce both CAS concepts and several examples from the field of computer algebra.

A few products which support computer algebra and which run on personal computers are Mathematica, Maple, Derive, and Mathview (formerly Theorist, and called MathPlus outside of the Americas), more or less in decreasing order of power. There are many other software packages which supply this capability in varying degrees. Some of us have already been using these systems on microcomputers -- there are educators that offer their calculus exclusively using Mathematica. Lately, the TEXAS INSTRUMENTS TI-92 has thrust computer algebra systems into our professional lives. For a price well below \$200 we and our students can have access to a powerful symbolic algebra system, based on Derive.

A few things which a CAS will do, with ease, are illustrated here.

- Solve $ax + b = c(mx - c)$ for x or for any of the literal constants.
- Solve $ax^2 + mx + nx + m^2 - c = 0$ for x .
- Give the set of exact solutions to $5 \cos(3x - b) = c$
- Compute $\int \frac{2x}{x^2+1} dx$ or $\sum_{i=1}^{\infty} \frac{1}{(x+1)^i}$.
- Factor $x^{26} + x^{13} + 1$, or $x^{25} + 1$, or $x^8 - 3x^5 - 4x^4 - 5x^3 + x^2 + 2x + 2$.
- Generate the terms in the Taylor series for $\sin x \cos x$ out to the term of a user-specified power.
- Find the formal solution to the inverse of a matrix whose elements are arbitrary expressions.
- Solve differential equations exactly or numerically.
- Find the generating function for dimensions of representations of the Lie group of type G_2 . (Heck, 1993, p. 12)

Factoring and Antidifferentiation

I don't believe it is widely appreciated how much is known in the field of computer algebra about factoring and anti-differentiation. The fact is that algorithms exist for factoring any polynomial over the integers, and for finding the antiderivative of any expression composed of algebraic and elementary transcendental functions, if it exists, or determining that no antiderivative exists (Steen, 1981). However, it is not easy to approach any of the algorithms for factoring or antidifferentiation. They are sophisticated and do not lend themselves to hand calculation. A flavor of this is given below, related to factoring.

Antidifferentiation

Pierre Simon de la Place formulated a conjecture about the integral of algebraic functions in the early nineteenth century. Niels Henrik Abel proved it about 1830. This led Joseph Liouville to formulate a general theorem about the integral of any elementary function - those built up from the standard transcendental and algebraic functions. This theorem tells which functions can be integrated, but does not produce the antiderivative. (Steen, 1981)

Early CAS efforts found antiderivatives by the heuristic rules presented in most calculus courses. Failure in these cases may only mean the practitioner is not skilled enough - if an expression does not have a formal antiderivative, in terms of elementary functions, these heuristics will not tell that. These same methods still provide the starting point for some CAS's.

An algorithm for generating the formal antiderivative, if it exists, of an expression of elementary functions, was completed in 1968 by Robert H. Risch of the System Development Corp. in Santa Monica, California (Steen, 1981). A full discussion of the Risch integration algorithm is found in Geddes (1992). This algorithm also determines that an antiderivative in the form of elementary functions does not exist, if that is the case.

It is worth noting that the algorithms of computer algebra involve many basic concepts of college algebra, such as rings and fields, vector spaces, eigenvalues and eigenvectors, and modular arithmetic of integers and polynomials. The algorithm of Risch is built on elliptical function theory.

Factoring Polynomials Over the Integers

To get a flavor of the study now called computer algebra, I present some of what is known about factoring polynomials over the integers.

Don Knuth cites first attempts at factoring polynomials in Isaac Newton's *Arithmetica Universalis* (1707) and to the astronomer Friedrich T. v. Schubert who, in 1793, presented a finite step algorithm to compute the factors of a univariate polynomial over the integers. L. Kronecker rediscovered Schubert's method in 1882, and also gave algorithms for factoring multivariate polynomials (Knuth, 1981). Kronecker's method can be very inefficient. In 1967 E. R. Berlekamp devised an algorithm that is more efficient. This can be extended to factor polynomials in any number of variables over the integers. These algorithms can require a long search process, and involve factoring the given polynomial over the integers modulo one or more prime numbers, but they do produce the factors or a determination that the given polynomial will not factor.

We will illustrate the process of factoring univariate, monic polynomials over the integers – that is, polynomials with leading coefficient one, in one variable. It will be seen that this uses interesting concepts in modular arithmetic, algebra, and linear algebra. The theory can be couched in the terminology of unique factorization domains, null spaces, and eigen values and vectors, but I prefer to keep the terminology as simple as possible. What I present is largely as presented in Knuth (1981) and Davenport (1988), with some modification and additional detail. Also, what follows does not always produce a complete factorization, but the method can be modified so it will always work. This is discussed later.

Finding Multiple Factors

It turns out to be easy to find factors which have multiplicity greater than one, and this is the first step. Consider a polynomial $P(x)$ with a factor $p(x)$ of multiplicity $k > 1$. Then $P(x) = q(x) \cdot p(x)^k$. Now consider the derivative of $P(x)$.

$$P'(x) = (q(x) \cdot p(x)^k)' = q(x) \cdot kp(x)^{k-1}p'(x) + q'(x) \cdot p(x)^k \quad [1]$$

It can be seen that $p(x)^{k-1}$ is a factor of $P'(x)$. Thus, finding the greatest common divisor of P and P' will produce at least two factors, one of which will include $p(x)^{k-1}$ as a factor. These two new factors can, in turn, be checked for multiple factors also. The Euclidean algorithm for finding the greatest common divisor of two natural numbers can be used to do the same thing with polynomials.

By way of example, consider $P(x) = x^8 + 6x^6 + 12x^4 + 10x^2 + 3$, whose factored form is $(x^2 + 1)^3(x^2 + 3)$. $P'(x) = 8x^7 + 36x^5 + 48x^3 + 20x$. Use Euclid's algorithm for finding the greatest common divisor of two integers, applied to P and P' . This process is illustrated in the following table. We begin by

applying long division to the problem $\frac{P}{P'}$, which shows in step 1 of the table, for example, that $P = \left(\frac{1}{8}x\right)(8x^5 + 36x^4 + 48x^3 + 20x) + \left(\frac{3}{2}x^2 + 6x + \frac{15}{2}x + 3\right)$. After repeated iterations, when the remainder is 0, (step 4) the previous remainder is the gcd, $3x^2 + 6x + 3$, or $3(x^2 + 2x + 1)$. The 3 is not relevant – in fact there are algorithms other than the long division algorithm which deal only with integers in the division process, and would not produce the factor of 3 – see Knuth (1981) page 402-408 for example.

Step	Division performed	Quotient	Remainder
1	$\frac{x^5 + 6x^4 + 12x^3 + 10x^2 + 3}{8x^4 + 36x^3 + 48x^2 + 20x}$	$\frac{1}{8}x$	$\frac{3}{2}x^2 + 6x + \frac{15}{2}x + 3$
2	$\frac{8x^4 + 36x^3 + 48x^2 + 20x}{\frac{3}{2}x^2 + 6x + \frac{15}{2}x + 3}$	$\frac{16}{3}x$	$4x^2 + 8x + 4x$
3	$\frac{\frac{3}{2}x^2 + 6x + \frac{15}{2}x + 3}{4x^2 + 8x + 4x}$	$\frac{3}{8}x$	$3x^2 + 6x + 3$
4	$\frac{4x^2 + 8x + 4x}{3x^2 + 6x + 3}$	$\frac{4}{3}x$	0

Observe that $x^2 + 2x + 1 = (x+1)^2$. Divide $x^2 + 2x + 1$ out of $P(x)$, producing $P(x) = (x^2 + 2x + 1)(x^3 + 4x^2 + 3)$. Each of these factors can now be factored in turn. If a polynomial does not have a multiple factor, we say that polynomial is square free – that is, all its polynomial factors appear exactly once. The factor $x^3 + 4x^2 + 3$ is square free – it is not too difficult to show that if $P(x)$ is written as $\text{GCF}(P, P') \cdot Q(x)$, then $Q(x)$ is square free.

Factoring a square free monic polynomial

All useful algorithms for factoring square free polynomials over the integers use the idea of factoring over the integers modulo p , for some prime p . The choice of p is pretty much arbitrary.

We will illustrate with the polynomial in [2], which can be shown to be square free by the method just described, i.e. $\text{GCD}(P, P') = 1$.

$$P(x) = x^8 - 3x^5 - 4x^3 - 5x^2 + x^2 + 2x + 2 \quad [2]$$

With Knuth as inspiration, we will use $p = 13$. Any prime p may be chosen, but it should not divide what is called the discriminant of P (Mignotte, 1992). We can avoid this problem, and this concept, by first finding all linear factors – using the methods of the rational zero theorem of precalculus level mathematics. It can be verified that [2] does not have any linear factors.

What follows is one version of Berlekamp's Algorithm. First we will present some of the theoretical underpinnings of the method, including various relatively well-known theorems, without proof. Two numerical examples follow, including factoring the polynomial in [2].

We first need a tool called the Chinese Remainder Theorem. Usually applied to sets of integers, it can be applied to polynomials. We use a wording which deals with our specific needs here. Note that in all of what follows, until otherwise noted, we are doing arithmetic modulo 13.

Chinese Remainder Theorem for Polynomials [3]

Let $p_1(x), p_2(x), \dots, p_r(x)$ be relatively prime monic polynomials and $P(x) = p_1(x) \cdot p_2(x) \cdot \dots \cdot p_r(x)$. Let s_1, s_2, \dots, s_r be integers modulo p , a prime. Then there is a unique polynomial $V(x)$ such that $V(x) \equiv s_1 \pmod{p_1(x)}$, $V(x) \equiv s_2 \pmod{p_2(x)}$, \dots , $V(x) \equiv s_r \pmod{p_r(x)}$ iff $V(x) \equiv s \pmod{P(x)}$ for some s , where s is an integer modulo p . Further, the degree of V is less than the degree of P (Knuth, 1981). Note that $\pmod{p_i(x)}$ means the remainder upon division by $p_i(x)$.

This theorem is useful to us if the polynomials p_i are the factors of [2]. Thus, assume

$$P(x) = p_1(x) \cdot p_2(x) \cdot \dots \cdot p_r(x)$$

is the factorization of [2], where the p_i are relatively prime, and each p_i appears once, since P is square free.

Theorem: $x^p \equiv x \pmod{p}$ for any integer x and prime p . [4]

Davenport (1988) notes that this theorem is sometimes called Fermat's little theorem.

Using [3] and [4], we conclude that $V(x)^p \equiv x^p \equiv s \equiv V(x) \pmod{p_i(x)}$ for each i . Thus, $V(x)^p \equiv V(x) \pmod{P(x)}$. Also, the gcd of $P(x)$ and $V(x)^p - s$ is non-trivial.

Theorem: modulo p , $X^p - X = (X - 0)(X - 1)(X - 2) \dots (X - (p - 1))$ [5]

This implies that $V(x)^{13} - V(x) = (V(x) - 0)(V(x) - 1)(V(x) - 2) \dots (V(x) - 12)$, and, since $p_i(x)$ divides $V(x)^{13} - V(x)$ for each i , and each p_i is prime, then each $p_i(x)$ divides one of $V(x) - s$ for some s , $0 \leq s < 12$.

This means that, if we could find V , then finding the GCF for $V(x) - s$ and $P(x)$ for each s will produce the factors of $P(x)$, mod 13. **This polynomial V is the key to factoring modulo p .** To find a solution for V we use the fact that $V(x)^p \equiv V(x) \pmod{P(x)}$. Remember that the degree of V is less than the degree of P (which is 8 in equation [2]) so we can describe V as follows.

$$\text{Let } V(x) = v_0x^0 + v_1x^1 + v_2x^2 + v_3x^3 + v_4x^4 + v_5x^5 + v_6x^6 + v_7x^7, v_j \in \{0, 1, 2, \dots, 12\} \quad [6]$$

Theorem: $P(x)^p - P(x)$ modulo p , for any polynomial P [7]

Replacing x by x^{11} in [6], and using [7] with $p = 13$, we obtain an expression for $V(x)^{11}$.

$$V(x)^{11} = V(x^{11}) = v_0x^0 + v_1x^{11} + v_2x^{26} + v_3x^{39} + v_4x^{52} + v_5x^{65} + v_6x^{77} + v_7x^{91} \quad [8]$$

Remember that we are interested in $V(x)^{11}$, and $V(x)$, modulo $P(x)$, so consider $x^0, x^{11}, x^{26}, x^{39}, \dots, x^{91}$, each modulo $P(x)$. This is 8 equations of the following form:

$$x^0 \equiv r_{0,0}x^0 + r_{1,0}x^{11} + r_{2,0}x^{26} + r_{3,0}x^{39} + r_{4,0}x^{52} + r_{5,0}x^{65} + r_{6,0}x^{77} + r_{7,0}x^{91} \pmod{P(x)} \quad [9]$$

$$x^{11} \equiv r_{0,1}x^0 + r_{1,1}x^{11} + r_{2,1}x^{26} + r_{3,1}x^{39} + r_{4,1}x^{52} + r_{5,1}x^{65} + r_{6,1}x^{77} + r_{7,1}x^{91} \pmod{P(x)}$$

$$x^{26} \equiv r_{0,2}x^0 + r_{1,2}x^{11} + r_{2,2}x^{26} + r_{3,2}x^{39} + r_{4,2}x^{52} + r_{5,2}x^{65} + r_{6,2}x^{77} + r_{7,2}x^{91} \pmod{P(x)}$$

...

$$x^{91} \equiv r_{0,7}x^0 + r_{1,7}x^{11} + r_{2,7}x^{26} + r_{3,7}x^{39} + r_{4,7}x^{52} + r_{5,7}x^{65} + r_{6,7}x^{77} + r_{7,7}x^{91} \pmod{P(x)}$$

Now replace $x^0, x^{11}, x^{26}, \dots, x^{91}$ in [8] with the corresponding values in [9].

$$\begin{aligned} V(x)^{11} \equiv & v_0 r_{0,0}x^0 + v_0 r_{1,0}x^{11} + v_0 r_{2,0}x^{26} + v_0 r_{3,0}x^{39} + \dots + v_0 r_{7,0}x^{91} + \\ & v_1 r_{0,1}x^0 + v_1 r_{1,1}x^{11} + v_1 r_{2,1}x^{26} + v_1 r_{3,1}x^{39} + \dots + v_1 r_{7,1}x^{91} + \\ & v_2 r_{0,2}x^0 + v_2 r_{1,2}x^{11} + v_2 r_{2,2}x^{26} + v_2 r_{3,2}x^{39} + \dots + v_2 r_{7,2}x^{91} + \dots + \\ & v_7 r_{0,7}x^0 + v_7 r_{1,7}x^{11} + v_7 r_{2,7}x^{26} + v_7 r_{3,7}x^{39} + \dots + v_7 r_{7,7}x^{91} \pmod{P(x)} \end{aligned} \quad [10]$$

If $V(x)^{11} \equiv V(x)$, then the equations in [10] are equivalent to [6]. Comparing the coefficients of corresponding powers of x , this means that

$$r_{0,0}v_0 + r_{0,1}v_1 + r_{0,2}v_2 + \dots + r_{0,7}v_7 = v_0$$

$$r_{1,0}v_0 + r_{1,1}v_1 + r_{1,2}v_2 + \dots + r_{1,7}v_7 = v_1$$

...

$$r_{7,0}v_0 + r_{7,1}v_1 + r_{7,2}v_2 + \dots + r_{7,7}v_7 = v_7$$

Remember that the r_{ij} are known, but not the v_j .

A matrix equation which expresses this system of linear equations is the following.

$$\begin{bmatrix} r_{0,0} & r_{0,1} & r_{0,2} & r_{0,3} & r_{0,4} & r_{0,5} & r_{0,6} & r_{0,7} \\ r_{1,0} & r_{1,1} & r_{1,2} & r_{1,3} & r_{1,4} & r_{1,5} & r_{1,6} & r_{1,7} \\ r_{2,0} & r_{2,1} & r_{2,2} & r_{2,3} & r_{2,4} & r_{2,5} & r_{2,6} & r_{2,7} \\ r_{3,0} & r_{3,1} & r_{3,2} & r_{3,3} & r_{3,4} & r_{3,5} & r_{3,6} & r_{3,7} \\ r_{4,0} & r_{4,1} & r_{4,2} & r_{4,3} & r_{4,4} & r_{4,5} & r_{4,6} & r_{4,7} \\ r_{5,0} & r_{5,1} & r_{5,2} & r_{5,3} & r_{5,4} & r_{5,5} & r_{5,6} & r_{5,7} \\ r_{6,0} & r_{6,1} & r_{6,2} & r_{6,3} & r_{6,4} & r_{6,5} & r_{6,6} & r_{6,7} \\ r_{7,0} & r_{7,1} & r_{7,2} & r_{7,3} & r_{7,4} & r_{7,5} & r_{7,6} & r_{7,7} \end{bmatrix} \begin{pmatrix} v_0 \\ v_1 \\ v_2 \\ v_3 \\ v_4 \\ v_5 \\ v_6 \\ v_7 \end{pmatrix} = \begin{pmatrix} v_0 \\ v_1 \\ v_2 \\ v_3 \\ v_4 \\ v_5 \\ v_6 \\ v_7 \end{pmatrix} \quad [11]$$

Observe that the columns of this matrix are the coefficients found in each line of [9].

Consider this matrix equation: $QV = V$, $QV - V = 0$, $(Q - I)V = 0$. Linear algebra provides a standard method for finding a representation of V using $Q - I$, the matrix which maps vector V to the vector 0, by row reducing $Q - I$ into a matrix with the properties which follow. Such a matrix is said to be in triangular idempotent form.

- It is upper triangular
- The main diagonal has only zeros or ones
- If a diagonal entry is 1, it is the only nonzero entry in that row
- If a diagonal entry is 0, then that entire column is zero.

Note that idempotent refers to the fact that such a matrix, Q , has the property that $Q^n = Q$ for positive integers n . We will see an example below.

An Example – Factor $x^8 - 3x^5 - 4x^4 - 5x^3 + x^2 + 2x + 2$

At this point we apply the theory above to factoring $P(x) = x^8 - 3x^5 - 4x^4 - 5x^3 + x^2 + 2x + 2$ ([2]), and say some things about the computations as we proceed. First, we determine the remainders when $x^0, x^{13}, x^{26}, \dots, x^{91}$ are divided by $P(x)$, modulo 13. These are in [12], and were determined with Maple. It would not be feasible to compute these by hand. In practice, there is a recurrence relation which can be exploited to determine these remainders, but it too is computationally intensive – see Knuth (1981) or Geddes (1992). Of course, one could write a calculator program to do the long division, modulo p , to extract the remainders. This would be an interesting project.

$$\begin{array}{ll}
 x^0 \equiv 1 & \text{mod } P(x) \\
 x^{13} \equiv 8x^7 + 9x^6 + 5x^5 + 11x^4 + 2x^3 + 7x^2 + 8x + 3 & \text{mod } P(x) \\
 x^{26} \equiv x^7 + 2x^6 + 6x^5 + 6x^4 + 6x^3 + 2x^2 + 9x + 7 & \text{mod } P(x) \\
 x^{39} \equiv x^7 + 7x^6 + 2x^5 + 4x^4 + 2x^3 + x^2 + 6x + 3 & \text{mod } P(x) \\
 x^{52} \equiv 3x^7 + 2x^6 + 6x^5 + 8x^4 + 2x^3 + 2x^2 + 4x + 5 & \text{mod } P(x) \\
 x^{65} \equiv 2x^7 + 3x^6 + 12x^5 + 11x^4 + 12x^3 + 3x^2 + x + 12 & \text{mod } P(x) \\
 x^{78} \equiv 11x^6 + 2x^5 + 4x^4 + 10x^3 + 12x^2 + 12x + 10 & \text{mod } P(x) \\
 x^{91} \equiv 9x^7 + 12x^6 + 8x^5 + 5x^4 + 2x^3 + 8x^2 + 1 & \text{mod } P(x)
 \end{array} \quad [12]$$

Comparing to [8] we are saying that for $V(x) = v_0 + v_1x + v_2x^2 + \dots + v_7x^7$,

$$\begin{aligned}
 V(x) \equiv & v_0(1) + \\
 & v_1(8x^7 + 9x^6 + 5x^5 + 11x^4 + 2x^3 + 7x^2 + 8x + 3) + \\
 & v_2(x^7 + 2x^6 + 6x^5 + 6x^4 + 6x^3 + 2x^2 + 9x + 7) + \dots + \\
 & v_7(9x^7 + 12x^6 + 8x^5 + 5x^4 + 2x^3 + 8x^2 + 1)
 \end{aligned} \quad [13]$$

As stated above, we will determine, from these, a more useful expression for $V(x)$, using the idea of [11]. The following procedure does this for us.

Create an array Q of the coefficients of the right hand expressions in [12], as shown. Observe that, conforming to [11], we use the columns, and we start with the term of lowest degree in each case.

$$Q = \begin{pmatrix} 1 & 3 & 7 & 3 & 5 & 12 & 10 & 1 \\ 0 & 8 & 9 & 6 & 4 & 1 & 12 & 0 \\ 0 & 7 & 2 & 1 & 2 & 3 & 12 & 8 \\ 0 & 2 & 6 & 2 & 2 & 12 & 10 & 2 \\ 0 & 11 & 6 & 4 & 8 & 11 & 4 & 5 \\ 0 & 5 & 6 & 2 & 6 & 12 & 2 & 8 \\ 0 & 9 & 2 & 7 & 2 & 3 & 11 & 12 \\ 0 & 8 & 1 & 1 & 3 & 2 & 0 & 9 \end{pmatrix}$$

Recall that we want the array $Q - I$, where I is the standard 8×8 identity matrix with 1's on the diagonal and 0 everywhere else. For convenience, call $Q - I$ by Q' .

$$Q' = Q - I = \begin{pmatrix} 0 & 3 & 7 & 3 & 5 & 12 & 10 & 1 \\ 0 & 7 & 9 & 6 & 4 & 1 & 12 & 0 \\ 0 & 7 & 1 & 1 & 2 & 3 & 12 & 8 \\ 0 & 2 & 6 & 1 & 2 & 12 & 10 & 2 \\ 0 & 11 & 6 & 4 & 7 & 11 & 4 & 5 \\ 0 & 5 & 6 & 2 & 6 & 11 & 2 & 8 \\ 0 & 9 & 2 & 7 & 2 & 3 & 10 & 12 \\ 0 & 8 & 1 & 1 & 3 & 2 & 0 & 8 \end{pmatrix}$$

Now we want to sweep out each column, starting with column 2. This is the standard procedure for producing a row reduced echelon form. One way is to proceed as shown below. Remember the objective is triangular idempotent form. Remember also that the arithmetic is done modulo 13. This is most easily done by first converting each pivot element into 1, then using standard row operations to sweep out the rest of that column. For this it is nice to know the reciprocals modulo 13 - that is, for a , the value a^{-1} such that $a \cdot a^{-1} \equiv 1 \pmod{13}$. The following lists a^{-1} for the non-zero values a .

Reciprocals modulo 13	
$1^{-1} = 1,$	$2^{-1} = 7,$
$3^{-1} = 9,$	$4^{-1} = 10,$
$5^{-1} = 8,$	$6^{-1} = 11,$
$7^{-1} = 2,$	$8^{-1} = 5,$
$9^{-1} = 3,$	$10^{-1} = 4,$
$11^{-1} = 6,$	$12^{-1} = 12$

First, multiply row 2 by $7^{-1} = 2$, so that element $Q'_{2,2}$ is a 1. Then, sweep out column 2.

$$Q' \equiv \begin{pmatrix} 0 & 0 & 5 & 6 & 7 & 6 & 3 & 1 \\ 0 & 1 & 5 & 12 & 8 & 2 & 11 & 0 \\ 0 & 0 & 5 & 8 & 11 & 2 & 0 & 8 \\ 0 & 0 & 9 & 3 & 12 & 8 & 1 & 2 \\ 0 & 0 & 3 & 2 & 10 & 2 & 0 & 5 \\ 0 & 0 & 7 & 7 & 5 & 1 & 12 & 8 \\ 0 & 0 & 9 & 3 & 8 & 11 & 2 & 12 \\ 0 & 0 & 0 & 9 & 4 & 12 & 3 & 8 \end{pmatrix}$$

Note: It is possible to perform these calculations on a TI-92, using an additional 8×8 matrix with all elements 13, the mod function, and a short program. In Maple it is only necessary to set the $Q'_{1,1}$ element to 1, to force sweeping out to start at element $Q'_{2,2}$, and invoke the Hermite function. No doubt most CAS systems provide this capability in one way or another.

Now multiply row 3 by 8, which is 5^{-1} , then sweep out column 3.

$$Q' \equiv \begin{pmatrix} 0 & 0 & 0 & 11 & 9 & 4 & 3 & 6 \\ 0 & 1 & 0 & 4 & 10 & 0 & 11 & 5 \\ 0 & 0 & 1 & 12 & 10 & 3 & 0 & 12 \\ 0 & 0 & 0 & 12 & 0 & 7 & 1 & 11 \\ 0 & 0 & 0 & 5 & 6 & 6 & 0 & 8 \\ 0 & 0 & 0 & 1 & 0 & 6 & 12 & 2 \\ 0 & 0 & 0 & 12 & 9 & 10 & 2 & 8 \\ 0 & 0 & 0 & 9 & 4 & 12 & 3 & 8 \end{pmatrix}$$

Multiply row 4 by 12, which is 12^{-1} , then sweep out column 3.

$$Q' \equiv \begin{pmatrix} 0 & 0 & 0 & 0 & 9 & 3 & 1 & 10 \\ 0 & 1 & 0 & 0 & 10 & 2 & 2 & 10 \\ 0 & 0 & 1 & 0 & 10 & 9 & 12 & 1 \\ 0 & 0 & 0 & 1 & 0 & 6 & 12 & 2 \\ 0 & 0 & 0 & 0 & 6 & 2 & 5 & 11 \\ 0 & 0 & 0 & 0 & 0 & 0 & 0 & 0 \\ 0 & 0 & 0 & 0 & 9 & 3 & 1 & 10 \\ 0 & 0 & 0 & 0 & 4 & 10 & 12 & 3 \end{pmatrix}$$

Multiply row 5 by 11, which is 6^{-1} , then sweep out column 5.

$$Q' \equiv \begin{pmatrix} 0 & 0 & 0 & 0 & 0 & 0 & 0 & 0 \\ 0 & 1 & 0 & 0 & 0 & 3 & 11 & 9 \\ 0 & 0 & 1 & 0 & 0 & 10 & 8 & 0 \\ 0 & 0 & 0 & 1 & 0 & 6 & 12 & 2 \\ 0 & 0 & 0 & 0 & 1 & 9 & 3 & 4 \\ 0 & 0 & 0 & 0 & 0 & 0 & 0 & 0 \\ 0 & 0 & 0 & 0 & 0 & 0 & 0 & 0 \\ 0 & 0 & 0 & 0 & 0 & 0 & 0 & 0 \end{pmatrix}$$

It is a theorem of linear algebra that a basis for V is the non-zero columns of $I - Q'$, which is calculated modulo 13 as usual.

$$I - Q' \equiv \begin{pmatrix} 1 & 0 & 0 & 0 & 0 & 0 & 0 & 0 \\ 0 & 0 & 0 & 0 & 0 & 10 & 2 & 4 \\ 0 & 0 & 0 & 0 & 0 & 3 & 5 & 0 \\ 0 & 0 & 0 & 0 & 0 & 7 & 1 & 11 \\ 0 & 0 & 0 & 0 & 0 & 4 & 10 & 9 \\ 0 & 0 & 0 & 0 & 0 & 1 & 0 & 0 \\ 0 & 0 & 0 & 0 & 0 & 0 & 1 & 0 \\ 0 & 0 & 0 & 0 & 0 & 0 & 0 & 1 \end{pmatrix}$$

The basis polynomials for $V(x)$ may be read from this last matrix.

$$b_1(x) = 1, b_2(x) = x^5 + 4x^4 + 7x^3 + 3x^2 + 10x, b_3(x) = x^6 + 10x^4 + x^3 + 5x^2 + 2x,$$

$$b_4(x) = x^7 + 9x^4 + 11x^3 + 4x.$$

In other words

$$V(x) = v_0(1) + v_1(x^5 + 4x^4 + 7x^3 + 3x^2 + 10x) + v_2(x^6 + 10x^4 + x^3 + 5x^2 + 2x) + v_3(x^7 + 9x^4 + 11x^3 + 4x) \quad [14]$$

Parenthetically, it is interesting to use a CAS to verify that $V(x)$ (for any values of $v_0, v_1, v_2, v_3, b_2(x), b_3(x)$ and $b_4(x)$) all have the property that $Q(x)^{13} \equiv Q(x) \pmod{P(x)}$. This means that $\gcd(P(x), b_i(x) - s)$, $i = 2, 3$, or 4 , $s = 0, 1, 2, \dots, 12$, are divisors of $P(x)$, mod 13. The following table shows the calculations of $\gcd(P(x), b_i(x) - s)$, with the results. These were also calculated with Maple.

s	$b_2(x)$	$b_3(x)$	$b_4(x)$
0	$x + 6$	1	1
1	1	$x^2 + 6x + 2$	$x^4 + 7x^3 + 6x^2 + 12x + 7$
2	1	$x + 6$	1
3	1	1	1
4	$x^5 + x^2 + 12$	$x^4 + x^2 + 12$	1
5	1	1	1
6	1	1	1
7	1	1	1
8	$x^2 + 6x + 2$	1	$x^2 + 6x + 2$
9	1	$x^2 + 2$	1
10	$x^2 + 2$	1	$x^2 + 2$
11	1	1	1
12	1	1	1

Note that $x^4 + 7x^3 + 6x^2 + 12x + 7 \equiv (x + 6)(x^3 + x^2 + 12)$, so it does not correspond to a prime factor of $P(x)$.

Potential factors $p_i(x)$, mod 13, of $P(x) = x^5 - 3x^4 - 4x^3 - 5x^2 + 2x + 2$ are $x + 6$, $x^2 + 2$, $x^2 + 6x + 2$, and $x^3 + x^2 + 12$. I will refer to these as the four *seed* factors.

Note that $(x + 6)(x^2 + 2)(x^2 + 6x + 2)(x^3 + x^2 + 12) \equiv x^5 + 10x^4 + 9x^3 + 8x^2 + 2x + 2 \equiv P(x) \pmod{13}$, so this is a complete factorization of $P(x)$, modulo 13. It is not a coincidence that there are four basis polynomials $b_1(x) - b_4(x)$ for $V(x)$ and the fact that $P(x)$ has four prime factors modulo 13.

We now use the four seed factors to find factors of $P(x)$, over the integers. We do this by trying all potential factors $p'(x)$ which are congruent to the four seed factors, modulo 13. In other words, we try these same four expressions, by dividing them into $P(x)$, but let the coefficients take on any values which correspond to those above, modulo 13.

First, consider $x + 6$. We reject this seed factor because $6 \equiv -20, -7, 6, 19, \dots$, none of which divide 2, the constant coefficient in $P(x)$. Thus, none of $\dots, x - 20, x - 7, x + 6, x + 19, \dots$ could be factors of $P(x)$. Also, it is easy to verify, with the rational zero theorem of precalculus, that $P(x)$ has no linear factors.

Consider $x^2 + 2$: $P(x) \div (x^2 + 2) = x^3 - 2x^2 - 3x^3 + x + 1$, so $x^2 + 2$ is a prime factor of $P(x)$.

Consider $x^2 + 6x + 2$. This does not divide into $P(x)$ (evenly of course) so it is not a prime factor of $P(x)$. Consider $x^2 - 7x + 2$, since $-7 \equiv 6 \pmod{13}$. This does not work either. After the discussion of the next paragraph we will drop $x^2 + 6x + 2$ as a seed for actual factors.

There are many expressions congruent to $x^2 + 6x + 2$, like $x^2 - 7x + 2$, found by trying coefficients congruent to the coefficients 1, 6, and 2, modulo 13. In practice, there is a theorem which dictates how large these coefficients can be, so the list of candidates is finite.

Theorem: Let $A(x) = a_n x^n + a_{n-1} x^{n-1} + \dots + a_1 x + a_0$ be a polynomial and $B(x) = b_r x^r + b_{r-1} x^{r-1} + \dots + b_1 x + b_0$ a proper factor of $A(x)$. Then $r < n$. Then for all j ,

$$|b_j| \leq \binom{r-1}{j} |A| + \binom{r-1}{j-1} |a_n|, \text{ where } |A| = (a_n^2 + a_{n-1}^2 + \dots + a_1^2 + a_0^2)^{1/2}$$

called the quadratic norm of a polynomial). (Cohen, 1995)

In this case we know that the leading coefficient is 1 and the trailing coefficient is ± 1 or ± 2 , and it would seem futile to try values for the coefficient of x larger than 7 in absolute value. This cannot be assumed in general, however. Coefficients of factors can be much larger than the coefficients of their product. (In the case of $x^2 + 6x + 2$ the theorem tells us that 8 is an upper limit for the absolute value of this coefficient.)

Now consider $x^3 + x^2 - 1 \equiv x^3 + x^2 + 12 \pmod{13}$. $P(x) \div (x^3 + x^2 - 1) = x^2 - x^4 + x^3 - 3x^2 - 2x - 2$, so $x^3 + x^2 - 1$ is a prime factor. We will not pursue this seed any further.

Thus we have $x^2 + 2$ and $x^3 + x^2 - 1$ as prime factors. Of course in this particular case, we could divide these out of $P(x)$ to see what's left, but the direct way in this method is to now try multiples of the seed factors, first two at a time, then if necessary three at a time, etc. In theory one may have to create new seeds by trying the products of all possible combinations of the original seeds, and then try all possible expressions congruent to these seeds modulo 13, up to the size limit for coefficients, as mentioned above.

In fact, $(x + 6)(x^2 + 2) \equiv x^3 + 6x^2 + 2x + 12 \equiv x^3 + 6x^2 + 2x - 1$, among others, but these do not work. However, $(x + 6)(x^2 + 6x + 2) \equiv x^3 + 12x^2 + 12x + 12 \equiv x^3 - x^2 - x - 1$, which divides $P(x)$.

$$\text{Thus, } P(x) = x^7 - 3x^6 - 4x^5 - 5x^4 + x^3 + 2x + 2 = (x^2 + 2)(x^4 + x^2 - 1)(x^3 - x^2 - x - 1).$$

A Less Tractable Example

An example which illustrates that the methodology above is not complete is to factor

$$x^8 + 10x^7 + 20x^6 - 39x^5 - 37x^4 + 190x^3 + 2x^2 - 69x - 14 \quad [16]$$

The factorization is $(x^2 + 5x + 2)(x^3 + 5x^2 - 3x - 1)(x^3 - 4x + 7)$. Using $p = 13$ and

the same techniques as above produces the matrix

$$\begin{pmatrix} 1 & 12 & 4 & 11 & 1 & 6 & 0 & 9 \\ 0 & 0 & 1 & 7 & 7 & 5 & 10 & 5 \\ 0 & 3 & 10 & 5 & 1 & 5 & 6 & 2 \\ 0 & 7 & 2 & 9 & 10 & 1 & 8 & 1 \\ 0 & 11 & 3 & 10 & 11 & 7 & 3 & 3 \\ 0 & 4 & 0 & 4 & 0 & 12 & 2 & 1 \\ 0 & 6 & 10 & 5 & 12 & 6 & 3 & 3 \\ 0 & 4 & 7 & 0 & 7 & 5 & 3 & 10 \end{pmatrix},$$

which reduces to

$$\begin{pmatrix} 1 & 0 & 0 & 0 & 0 & 0 & 0 & 0 \\ 0 & 0 & 0 & 0 & 2 & 6 & 11 & 7 \\ 0 & 0 & 0 & 0 & 9 & 7 & 10 & 4 \\ 0 & 0 & 0 & 0 & 11 & 1 & 8 & 9 \\ 0 & 0 & 0 & 0 & 1 & 0 & 0 & 0 \\ 0 & 0 & 0 & 0 & 0 & 1 & 0 & 0 \\ 0 & 0 & 0 & 0 & 0 & 0 & 1 & 0 \\ 0 & 0 & 0 & 0 & 0 & 0 & 0 & 1 \end{pmatrix} \text{ Computing the gcds as above}$$

produces the following seeds: $x + 3, x + 7, x + 10, x^2 + 3x + 12, x^3 + 9x + 7, x^5 + 3x^4 + 8x^3 + 8x^2 + 12x + 6$. Only $x^3 - 4x + 7 \equiv x^3 + 9x + 7$ produces a factor of the original polynomial, leaving the quotient

$$x^5 + 10x^4 + 24x^3 - 6x^2 - 11x - 2. \quad [17]$$

No other combination of seeds is productive.

Reproducing the procedure above for [17] yields the seeds $x + 3, x + 7, x + 8, x + 10, x^2 + 4, x^2 + 2x + 4$. This produces $(x + 8)(x + 10) \equiv x^2 + 5x + 2 \pmod{13}$.

which is a divisor, yielding $(x^2 + 5x + 2)(x^3 + 5x^2 - 3x - 1)$. This is a complete factorization of [17].

Another fact would be to factor [17] modulo a different prime. Using $p = 11$ produces the single basis polynomial $v(x) = x^4 + x^3 + 10x$, which yields the factors $x^3 + 5x^2 + 8x + 10$ and $x^2 + 5x + 2$, for $x = 7$ and 10 respectively. The second is a factor of [17], and $x^3 + 5x^2 + 8x + 10 \equiv x^3 + 5x^2 - 3x - 1$ modulo 11, which is the other factor of [17].

Other comments

As noted earlier, the process illustrated above is not guaranteed to provide a factorization. It can be made algorithmic by increasing the size of the prime p so that $\frac{p}{2}$ is greater than the size of any coefficient of any factor (Davenport, 1988). The necessary value of p can be determined by using the theorem in [15]. Unfortunately most such values increase the number of calculations to factor modulo p tremendously, as well as the number of potential factors implied by the seeds. Also, what has been presented here is very primitive with respect to other algorithms - there are many variations, and better, albeit not simpler, methods. One is called the continued fraction factoring algorithm (CFRAC), for example, and there are still newer, faster algorithms (Cohen, 1995).

We have presented two examples of monic, univariate polynomial factoring. Left unaddressed are factoring polynomials which are not monic, or which are multivariate. The procedures are related to the case illustrated here, but, as you might expect, get much more complicated.

Interestingly enough, Maple factors $P(x)$ in [2] successfully, but Derive, both in a PC environment or on the TI-92, only finds the quadratic factor of $P(x)$, yielding $(x^2 + 2)(x^6 - 2x^4 - 3x^3 + x + 1)$. Although Derive is manifestly very powerful as a factoring tool, it doesn't seem to handle all possible cases. And of course, given the complexity of the programming task and the theoretical complexity of these algorithms, there will be flaws in any CAS.

Summary

As can be seen, examples taken from the domain of computer algebra can provide interesting applications of college algebra and linear algebra. In fact, to fully study the theory presented here requires a great deal of mathematical sophistication. However, none of the mathematics presented above is more complicated than that found in precalculus level courses (even finding the formal derivative of a polynomial can be mastered quickly) and it would seem to me that good high school and undergraduate students could tackle interesting projects related to this topic. For example, students could try factoring the same polynomial relative to different prime numbers. They could write programs for the TI-92, or even a graphing calculator such as the TI-85, which implement the tedious parts of the algorithm. I would postulate that these kinds of projects would generate an interest in some students to learn more about the theory of all of this, and could provide the impetus to want to study college algebra (i.e. groups, rings, fields, etc.) and linear algebra.

References

- Buchberger, B., Collins, G.E., Loos, R. Ed. (1983). *Computer algebra : Symbolic and algebraic computation*. (2nd ed.). Wien: Springer-Verlag. (Extensive bibliography, introductory chapter about groups who are studying computer algebra)
- Cohen, H. (1995). *A course in computational algebraic number theory*. New York: Springer-Verlag.
- Davenport, J. H., Siret, Y., Tournier, E. (1988). *Computer algebra : Systems and algorithms for algebraic computation*. (2nd ed.). London: Academic Press. (Extensive bibliography.)
- Geddes, K., Czapor, S., Labahn, G. (1992) *Algorithms for computer algebra*. Boston: Kluwer Academic Publishers.
- Heck, A. (1993) *Introduction to Maple*. New York. Springer-Verlag. (Good bibliography.)
- Knuth, D.E. (1981). *The art of computer programming, vol. II, seminumerical algorithms*. (2nd ed.). Reading, MA: Addison-Wesley.
- Mignotte, M. (1992). *Mathematics for computer algebra*. Mignotte, C. trans. New York : Springer-Verlag.
- Steen, L. A. (1981) Computer calculus. *Science News*, 119, pg. 250-251.

Lucky Larry #28

Larry found a new way to do free fall motion problems which always works (provided the time is 2 sec). The problem was

If the acceleration due to gravity is -9.8 m/sec^2 and an object is launched upward at a velocity of 40 m/sec , find the object's height after 2 sec.

A standard approach might be this:

$$\begin{aligned} s &= \frac{1}{2}gt^2 + v_0t + s_0 \\ &= \frac{1}{2}(-9.8)(2)^2 + 40(2) + 0 \\ &= 60.4\text{m} \end{aligned}$$

Larry, however, "reasoned" this way:

$$\begin{aligned} s &= g \cdot t + v \cdot t \\ &= -9.8(2) + 40(2) \\ &= 60.4\text{m} \end{aligned}$$

Submitted by Phillip G. Hogg
Punxsutawney PA



Come Celebrate Our Dream

AMATYC '97

23RD ANNUAL CONFERENCE

November 13-16, 1997

FEATURED SPEAKERS

Jacquelyn Belcher
DeKalb College

"Let the Celebration Begin"

John Self
Georgia Institute of Technology
"The Rules We Live By"

Michael Barnsley
Iterated Systems, Inc.
"Fractals and Chaos in the Classroom"

INPUT PRIZE WINNERS

Innovative Programs Using Technology

*Sponsored by the Annenberg/CPB Project, The National Science Foundation,
and Central Michigan University*

web address: <http://www.de.peachnet.edu/~univcorn/amatyc97.htm>

CONFERENCE REGISTRATION

Early: Member - \$165, Non-Member - \$215

Regular: Member - \$195, Non-member - \$245

Early registration deadline is September 30, 1997.

HOTEL

Make hotel reservations directly with the hotel.
Hyatt Regency on Peachtree Street - 1-800-233-1234

TRAVEL

Austin Travel for Airline and Flight Information - 1-800-229-2182
American Airlines Star File #S61N7AB • Delta Airlines Meeting File #X1842
Avis Car Rental AWD #J945141 - 1-800-331-1600

Dust Particles and Rain

by

Carroll Bandy, Ricardo Torrejón and Stewart Welsh
Department of Mathematics
Southwest Texas State University
San Marcos TX 78666

Carroll Bandy received a Ph.D. in mathematics in 1973 from the University of Houston and held a postdoctoral fellowship from the University of Saskatchewan, Canada from 1973 to 1974. He was an instructor at the University of Houston, Victoria from 1974 to 1977. Since 1977, he has been a member of the Mathematics Department at Southwest Texas State University, where he is currently a professor. Research interests include topology and differential equations.



Ricardo M. Torrejón received a Ph.D. in mathematics in 1979 from the University of Iowa under the supervision of Prof. W. A. Kirk. He was a postdoctoral instructor at the University of Southern California from 1979 until 1981. In 1981, he joined the Mathematics Department at Southwest Texas State University where he is currently a professor. From 1986 until 1988 he was a visiting lecturer at the University of Texas at Austin. His research interests include nonlinear analysis, fixed point theory, and ordinary, partial and functional differential equations.

Stewart C. Welsh received a Ph.D. in mathematics in 1985 from the University of Glasgow, Scotland under the supervision of Prof. J. R. L. Webb. He was a Visiting Assistant Professor at Texas A. & M. University from 1985 until 1988. In 1988, he joined the Mathematics Department at Southwest Texas State University where he is currently a professor. His research interest is in the field of nonlinear functional analysis, particularly in the study of bifurcation theory.

Abstract

A model of rain development is formulated from a system of ordinary differential equations. Properties of periodic solutions are used to prove that if cumulus clouds are present but no free dust particles exist in the lower atmosphere, then no periodic rainfall is possible.

Introduction

We shall describe an application of elementary ordinary differential equations to the study of the formation and precipitation of raindrops in the atmosphere. Of

particular interest will be the role played by free dust particles. Our analysis is exclusively based on standard techniques and results from a first course in ordinary differential equations and has proved to be an eminently popular application with our undergraduate students.

Cumulus clouds are the white puffy clouds usually found at lower altitudes. In the classical theory of cloud physics, cf. (Pruppacher & Klett, 1978) and (Shaeffer & Day, 1981), three main ingredients are necessary for the initiation of cumulus cloud growth: sufficient water vapor, an updraft of air and dust particles suspended in the atmosphere. An important characteristic of the lower atmosphere is that there are always a sufficient number of dust particles to initiate cumulus cloud development. See (Rogers, 1976) for a detailed explanation.

Let $x(t)$, $y(t)$ and $z(t)$ denote, respectively, the number of raindrops, cloud droplets and dust particles at time t . The term raindrop is used to denote the accumulations of moisture which are heavy enough to possibly fall to the earth, while cloud droplet refers to the lighter accumulations suspended in the atmosphere. Our objective is to derive a mathematical model which represents the generation of cumulus clouds in terms of the interaction between $x(t)$, $y(t)$ and $z(t)$, assuming that initially, at time $t = 0$, each is positive. We obtain a three-dimensional system of ordinary differential equations each solution of which satisfies the positivity conditions, $x(t)$, $y(t)$ and $z(t) > 0$ for all $t \geq 0$. To keep the problem simple we then consider, in the presence of cumulus clouds, whether sustained periodic rainfall would be possible in the absence of free dust particles. Under these conditions, it is shown that the corresponding two-dimensional system does not possess a non-trivial periodic solution.

Main Derivation

Rain Drop Equation

If we choose two cloud droplets y_1 and y_2 at random, then the probability that they will coalesce, over some time interval dt , is given by the product of the probability that y_1 collides with y_2 and the conditional probability that y_1 coalesces with y_2 given that y_1 has collided with y_2 . To simplify the problem, we assume that any collision of cloud droplets leads to momentary coalescence, so that the conditional probability is equal to one. Furthermore, for small dt two cloud droplets will encounter each other only once. The number of ways that $y(t)$ objects can combine in pairs is represented by,

$$C(y(t), 2) = \frac{y(t)!}{2!(y(t)-2)!} = \frac{y^2(t) - y(t)}{2}.$$

Normally, in the presence of cumulus clouds, there are a large number of cloud droplets present in the atmosphere, so we can approximate $C(y(t), 2)$ by $\frac{1}{2}y^2(t)$. Thus, if a_1 is the probability that two cloud droplets collide to produce a single raindrop in time dt , then the number of raindrops produced by cloud droplet collision during the time interval dt is approximated by $\frac{a_1}{2}y^2(t)$.

A significant number of times when two raindrops have combined, the resulting raindrop is unstable and breakup will take place. We shall assume that, over the time interval dt , this raindrop breakup produces exactly one of the following three outcomes: two raindrops, a raindrop and a cloud droplet, or two cloud droplets; the corresponding probability that raindrop breakup occurs and one of these three outcomes ensues is denoted, respectively, by b_1 , c_1 and d_1 . So, the number of raindrops produced in time dt due to raindrop breakup is $b_1x(t) - d_1x(t)$. Hence, if e_1 is the probability that a raindrop will fall to the earth during time dt , then the total rate of growth of the raindrop population at time t will be given by,

$$\frac{dx}{dt} = \frac{a_1}{2}x^2(t) + (b_1 - d_1 - e_1)x(t).$$

Cloud Droplet Equation

The principal mechanism by which cloud droplets are formed is by condensation around dust particles. This happens when rising air cools and the relative humidity increases. Water vapor then begins to condense on the dust particles as the saturation point is approached (Pruppacher & Klett, 1978). Assuming moisture is plentiful, the rate of cloud droplet production is directly proportional to the number of dust particles, with proportionality constant a_2 .

The breakup of unstable raindrops will also have a positive influence on the cloud droplet population. During the time interval dt , the number of cloud droplet births is, therefore, seen to be $a_2z(t) + (2d_1 + c_1)x(t)$. These birth processes are accompanied by three death processes: coalescence between two cloud droplets to produce a single larger cloud droplet, with probability b_2 ; coalescence between two cloud droplets to produce a single raindrop, the probability a_1 (as in the derivation of the raindrop equation); and coalescence between a cloud droplet and a raindrop to produce a single raindrop, with probability c_2 . So, by a similar argument to that used for the raindrop equation, death processes for cloud droplets over the interval dt will be of the form $\left(a_1 + \frac{b_2}{2}\right)y^2(t) + c_2x(t)y(t)$.

Hence, the equation for the growth rate of cloud droplets at time t is given by,

$$\frac{dy}{dt} = a_2z(t) + (2d_1 + c_1)x(t) - c_2x(t)y(t) - \left(a_1 + \frac{b_2}{2}\right)y^2(t).$$

where all constants are positive real numbers.

Dust Particle Equation

The atmosphere has a limited carrying capacity for dust particles. We assume a logistic growth model in which the rate of growth of dust particles is proportional to the product of the current number of dust particles, $z(t)$, and the unutilized capacity of the atmosphere for dust growth. Thus, if $\frac{a_3}{b_3}$ is the upper limit of the number of dust particles that can possibly be contained in the lower atmosphere, then the rate of growth of dust particles at time t is represented by $a_3z(t) - b_3z^2(t)$. The numbers a_3 and b_3 are positive constants but do not represent probabilities. The death rate for dust particles is dependent upon the number of interactions between raindrops and dust particles, and between cloud droplets and dust

particles. Hence, the equation for the rate of growth of dust particles at time t may be written as,

$$\frac{dz}{dt} = z(t)(a_3 - b_3z(t) - c_3y(t) - d_3x(t)),$$

where c_3 and d_3 represent the probabilities that dust particles will adhere to, respectively, cloud droplets and raindrops.

Hence, our mathematical model for the generation of cumulus clouds in the lower atmosphere is represented by the following three-dimensional system of ordinary differential equations:

$$\left. \begin{aligned} \frac{dx}{dt} &= \frac{a_1}{2} y^2(t) + (b_1 - d_1 - c_1)x(t), \\ \frac{dy}{dt} &= a_2 z(t) + (2d_1 + c_1)x(t) - c_2 x(t)y(t) - \left(a_1 + \frac{b_2}{2}\right) y^2(t), \\ \frac{dz}{dt} &= z(t)(a_3 - b_3z(t) - c_3y(t) - d_3x(t)). \end{aligned} \right\} \quad (1)$$

Analysis of the System

Theorem 1. *If $x(0)$, $y(0)$ and $z(0)$ are positive, then any solution to system (1) will be positive; i.e., $x(t)$, $y(t)$ and $z(t) > 0$ for all times $t \geq 0$.*

Proof. The differential equation,

$$\frac{dz}{dt} = z(t)(a_3 - b_3z(t) - c_3y(t) - d_3x(t)),$$

can be written as the equivalent integral equation,

$$z(t) = z(0)e^{a_3 t} - \int_0^t [b_3 z(s) + c_3 y(s) + d_3 x(s)] z(s) ds.$$

Clearly, the sign of z is completely determined by the initial condition $z(0) > 0$. Thus, $z(t) > 0$ for all $t \geq 0$.

Similarly, the differential equation,

$$\frac{dx}{dt} = \frac{a_1}{2} y^2(t) + (b_1 - d_1 - c_1)x(t),$$

is linear in x and, therefore, has the solution,

$$x(t) = e^{(b_1 - d_1 - c_1)t} [x(0) + \int_0^t \frac{a_1}{2} y^2(s) e^{-(b_1 - d_1 - c_1)s} ds].$$

So, if $x(0) > 0$, then $x(t) > 0$ for all $t \geq 0$.

Finally, the differential equation,

$$\frac{dy}{dt} = a_2 z(t) + (2d_1 + c_1)x(t) - c_2 x(t)y(t) - \left(a_1 + \frac{b_2}{2}\right) y^2(t),$$

may be written as the equivalent integral equation,

$$y(t)y(t) = y(0) + \int_0^t [a_2 z(s) + (2d_1 + c_1)x(s)] y(s) ds,$$

where,

$$u(t) = e^{\int (c_2 x(t) + (a_1 + \frac{b_2}{2}) x(t)) dt}$$

Since $y(0)$, $u(t)$, $z(t)$ and $x(t)$ are positive for all $t \geq 0$, then $y(t)$ is positive for all $t \geq 0$. Hence, the theorem is proved.

A complete analysis of the three-dimensional system (1) is beyond the scope of this paper. However, we shall prove that in the absence of free dust particles, the corresponding system does not possess a non-trivial positive periodic solution.

Analysis of the system in the absence of free dust particles

When $\tau = 0$, the three-dimensional system reduces to the two-dimensional system,

$$\left. \begin{aligned} \frac{dx}{dt} &= \frac{a_1}{2} y^2(t) + (b_1 - d_1 - c_1)x(t), \\ \frac{dy}{dt} &= (2d_1 + c_1)x(t) - c_2x(t)y(t) - \left(a_1 + \frac{b_2}{2}\right) y^2(t). \end{aligned} \right\} \quad (2)$$

Due to the absence of dust particles, the existence of a solution to the two-dimensional system (2), will depend only on the coalescence of cloud droplets together with the breakup of raindrops. In order to ascertain the existence of periodic rainfall under these conditions, we need to seek non-trivial periodic solutions to system (2). It will be seen that no such solution exists. The following well-known theorem will yield our result.

Theorem 2. (Poincaré-Bendixon Theorem) For the system of differential equations $\frac{dx}{dt} = F(x,y)$ and $\frac{dy}{dt} = G(x,y)$, if $F(x,y)$ and $G(x,y)$ have continuous first order partial derivatives in a simply connected domain D of the xy -plane and $\frac{\partial F}{\partial x} + \frac{\partial G}{\partial y}$ has the same sign throughout D , then there is no periodic solution to the system $\frac{dx}{dt} = F(x,y)$ and $\frac{dy}{dt} = G(x,y)$ which lies entirely in D .

Theorem 3. If positive initial conditions are given and the coefficients of system (2) satisfy the inequality $b_1 \leq d_1 + c_1$, then system (2) does not possess a non-trivial positive periodic solution.

Proof.

Applying Theorem 2 to,

$$\frac{dx}{dt} = F(x,y) = \frac{a_1}{2} y^2(t) + (b_1 - d_1 - c_1)x(t)$$

and

$$\frac{dy}{dt} = G(x,y) = (2d_1 + c_1)x(t) - c_2x(t)y(t) - \left(a_1 + \frac{b_2}{2}\right) y^2,$$

we see that

$$\frac{\partial F}{\partial x} = (b_1 - d_1 - e_1)$$

and

$$\frac{\partial F}{\partial y} = -c_2 x(t) - (2a_1 + b_2)y(t).$$

Hence,

$$\frac{\partial F}{\partial x} + \frac{\partial F}{\partial y} = (b_1 - d_1 - e_1) - c_2 x(t) - (2a_1 + b_2)y.$$

From Theorem 1, if positive initial conditions are given then $x(t)$ and $y(t)$ are positive at any time $t \geq 0$. So, if $b_1 \leq d_1 + e_1$ then there is no periodic solution to system (2) contained in the region $x > 0$ and $y > 0$.

Conclusion

Theorem 3 tells us that in the absence of dust particles, there can be no periodic rainfall if $b_1 \leq d_1 + e_1$. According to (Pruppacher & Klett, 1978), raindrop breakup eventually produces many small cloud droplets along with a few larger cloud droplets and raindrops. Hence, we can assume that normally $b_1 < d_1$ and so the inequality $b_1 \leq d_1 + e_1$ is always satisfied. Hence, in the absence of dust particles, there can be no periodic rainfall.

References

- Pruppacher, H. and Klett, J. (1978). *Microphysics of clouds and precipitation*. Boston: D. Reidel Publishing Co.
- Rogers, R. (1976). *A short course in cloud physics*. New York, N.Y.: Pergamon Press.
- Shaeffer, V. and Day, J. (1981). *A field guide to the atmosphere*. Boston: Houghton Mifflin Co.

I have never let my schooling interfere with my education.

Mark Twain



Every time you stop a school, you will have to build a jail. What you gain at one end you lose at the other. It's like feeding a dog on his own tail. It won't fatten the dog.

Mark Twain (Speech 11/23/1900)

CONVERGE™ for Windows

Educational Software for Algebra through Calculus

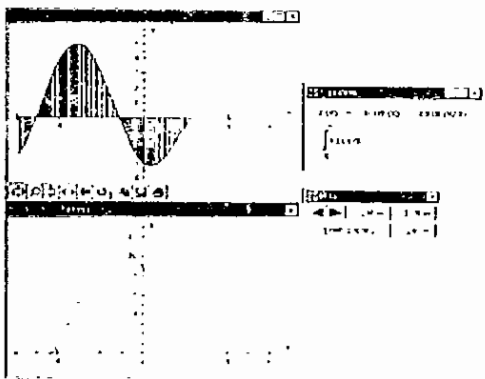
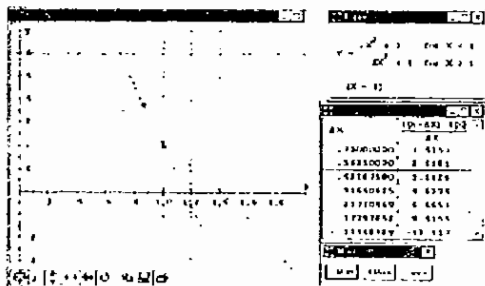
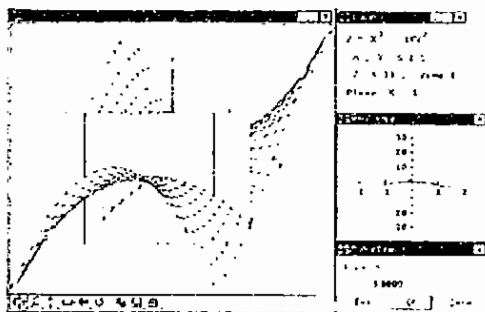
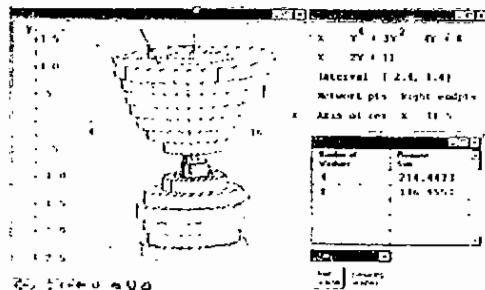

CONVERGE for Windows is here, including a 32-bit version developed for *Windows 95* that supports *Windows 95* features such as long file names and drag & drop (of functions). You can also transfer functions between *CONVERGE* and *DERIVE™ for Windows* with just one click. *CONVERGE* is now much more powerful, interactive, educational, and easy to use!

"*Converge* is very much a valuable tool for classroom demonstrations and student laboratory work." *The College Mathematics Journal*

"... the processes underlying some of the main ideas of algebra and calculus can effectively be illustrated... well worth the price for anyone teaching calculus." *The Mathematics Teacher*

"... quite an attractive tool. Students may gain a lot of insight into key concepts by using *Converge*... to illustrate almost any basic concept in calculus, you can find convenient tools in *Converge*." *Notices of the American Mathematics Society*

"*Converge* differentiates itself from the others with its emphasis on learning." *Recreational and Educational Computing*

"For Algebra, Precalculus and Calculus, I like *Converge*, both for its simplicity and its range of uses... is quite marvelous." *Multimedia Schools*

"... provides students the ability to conceptualize difficult topics. I highly recommend *Converge*." *Lawrence G. Gilligan, University of Cincinnati*

"... a wonderful pedagogical tool for classroom demonstration or individual student exploration." *Virginia Lee, Brookdale Community College*

JEMware

The Kawaiahao Plaza Executive Center
567 S. King St., Suite 178
Honolulu, HI 96813-3076
Phone: 808-521-9911
FAX (24 hr): 808-545-3503

Exploring Directional Derivatives on the TI-82/83 Calculator

by

Thomas W. Shilgalis
Illinois State University
Normal IL 61790-4520



Thomas W. Shilgalis has been at Illinois State University since 1967. His Ph.D. in mathematics education is from the University of Illinois at Urbana-Champaign. His interests are in secondary mathematics education, computers in mathematics, and the Illinois state high school mathematics contest.

One of the standard topics in multivariable calculus is that of directional derivative, of which partial derivatives are special cases. In this article we illustrate how directional derivatives can be approximated, and the underlying concept clarified, through the *Table* feature of the TI-82/83 graphics calculator.

First recall that, for a point $P_0(x_0, y_0)$ in the domain of a differentiable function f , the partial derivative of f with respect to x at P_0 is defined as follows:

$$D_x f(P_0) = \lim_{h \rightarrow 0} \frac{f(x_0 + h, y_0) - f(x_0, y_0)}{h}, \quad (I)$$

provided this limit exists.

Similarly, the partial derivative of f with respect to y at P_0 is defined as follows:

$$D_y f(P_0) = \lim_{k \rightarrow 0} \frac{f(x_0, y_0 + k) - f(x_0, y_0)}{k}, \quad (II)$$

provided this limit exists.

Let $\vec{v} = \langle a, b \rangle$ be a vector in the xy -plane. The directional derivative of f at P_0 in the direction \vec{v} is a scalar denoted by $D_{\vec{v}} f(P_0)$ and can be defined as follows:

$$D_{\vec{v}} f(P_0) = \lim_{t \rightarrow 0^+} \frac{f(P) - f(P_0)}{|P_0 P|}, \quad (III)$$

where $P_0 P$ is in the direction of \vec{v} , i.e., $P_0 P = t\vec{v}$, $t > 0$.

The ray from P_0 through P can be parametrized as follows: $x = x_0 + at$, $y = y_0 + bt$, $t \geq 0$. Definition (III) is thus equivalent to

$$D_{\vec{v}} f(P_0) = \lim_{t \rightarrow 0^+} \frac{f(x_0 + at, y_0 + bt) - f(x_0, y_0)}{t|\vec{v}|}. \quad (IV)$$

Note here that $|P_0 P| = t|\vec{v}|$. Note also that $b = 0$ gives an expression equivalent to (I) since $t \rightarrow 0$ in (IV) if and only if $h \rightarrow 0$ in (I), while $a = 0$ gives an expression equivalent to (II), confirming that the partial derivatives are indeed special cases of the directional derivative.

The gradient vector $\nabla f(P_0)$ is defined to be $\langle D_x f(P_0), D_y f(P_0) \rangle$, and a theorem in every calculus book says that $D_v f(P_0) = \nabla f(P_0) \cdot \hat{u}$, where \hat{u} is a unit vector in the direction of \vec{v} . This theorem is easy to apply in computing directional derivatives. If θ is the angle between $\nabla f(P_0)$ and \hat{u} , then $\nabla f(P_0) \cdot \hat{u} = \|\nabla f(P_0)\| \|\hat{u}\| \cos\theta$. This shows that $D_v f(P_0)$ is greatest when \vec{v} is in the direction of the gradient vector since $\cos\theta$ is then equal to 1.

As an example, let $f(x,y) = x^2 + xy - y^2$. Suppose that $f(x,y)$ represents the temperature at the point (x,y) in the xy -plane and that a bug is resting at P_0 . We then interpret $D_v f(P_0)$ as the instantaneous rate of temperature change experienced by the bug as it moves off in the direction defined by \vec{v} . Taking P_0 to be $(3,4)$ and $\vec{v} = \langle 1, -2 \rangle$ to illustrate, we compute $\nabla f(P) = \langle 2x + y, x - 2y \rangle$, so $\nabla f(P_0) = \langle 10, -5 \rangle$. Since the unit vector in the direction of \vec{v} is $\hat{u} = \left\langle \frac{1}{\sqrt{5}}, -\frac{2}{\sqrt{5}} \right\rangle$, we compute $D_v f(P_0) = \langle 10, -5 \rangle \cdot \left\langle \frac{1}{\sqrt{5}}, -\frac{2}{\sqrt{5}} \right\rangle = 4\sqrt{5} \approx 8.944$. If temperature is in Celsius degrees and distance is in meters, we conclude that the bug experiences an instantaneous increase in temperature of $8.944^\circ/\text{m}$ as it moves away from $(3,4)$ in the direction of $\langle 1, -2 \rangle$. Of course this is a local result. If the bug wishes to get warmer *as quickly as possible*, it should set out in the direction of $\nabla f(P_0) = \langle 10, -5 \rangle$, in which case its instantaneous rate of temperature change would be $\|\langle 10, -5 \rangle\| = 11.180^\circ/\text{m}$.

We now turn to the calculator to demonstrate computation of approximations to the directional derivative in a table. Referring to the example above, we use the calculator's $Y =$ key to set the following:

$$Y_1 = 3 + X/\sqrt{5}$$

$$Y_2 = 4 - 2X/\sqrt{5}$$

$$Y_3 = Y_1^2 + Y_1 Y_2 - Y_2^2$$

$$Y_4 = (Y_3 - Y_3(0))/\text{abs}(X)$$

Here X is the parameter usually denoted in books by t ; Y_1 is the abscissa of the variable point near $(3,4)$; Y_2 is the ordinate of the variable point; Y_3 is the value of the function f at the variable point; $Y_3(0)$ is the value of the function f at the point P_0 ; Y_4 is the difference quotient in (IV).

Choose Table Set on the TI-82/83. The user has the choice of Auto or Ask for the independent variable X and for the dependent variable(s) Y_i . I prefer Ask for X and Auto for the Y_i 's, though choosing Ask for the Y_i 's produces a slower, controlled output and may be pedagogically preferable in a first example.

The values given in Table 1 are obtained by pressing the Table key on the TI-82/83 and entering values for X from, say, 1 down to .001 in whatever steps the user chooses. If the Auto option is chosen for the dependent variables, the columns Y_1 through Y_4 are computed immediately. The calculator screen permits viewing

only two of the dependent variables at a time, along with X , so right and left arrow scrolling is necessary. Note the close agreement between the lower right entry and the value of the directional derivative computed above by the standard formula. Inspection of the Y_1 and Y_2 columns shows that the variable point approaches (3,4) from a more or less southeasterly direction. For example, comparing the abscissa Y_1 and the ordinate Y_2 as X changes from 1 to .5, we see that Y_1 decreases by .2236 and Y_2 increases by .4472, consistent with the slope -2 of the vector $\langle 1, -2 \rangle$.

It is instructive to let the parameter X approach 0 through negative values, say, from -1 to $-.001$. This causes the variable point P to approach P_0 along the vector $-\vec{v}$ and gives values approaching the opposite of the limit found with positive parameter values.

X	Y_1	Y_2	Y_3	Y_4
1.000	3.4472	3.1056	12.944	7.9443
.500	3.2236	3.5528	9.2221	8.4443
.100	3.0447	3.9106	5.8844	8.8443
.050	3.0224	3.9553	5.4447	8.8943
.010	3.0045	3.9911	5.0893	8.9343
.005	3.0022	3.9955	5.0447	8.9393
.001	3.0004	3.9991	5.0089	8.9433

Table 1

As a second example consider the function of three variables given by $f(x, y, z) = \ln(1 + x^2 + y^2 + z^2)$. Let $P_0 = (1, -1, 1)$ and let $\vec{v} = \langle 2, -2, 1 \rangle$. Then $\vec{u} = \left\langle \frac{2}{3}, -\frac{2}{3}, \frac{1}{3} \right\rangle$ is the unit vector in the direction of \vec{v} . The gradient of f is the vector $\left\langle \frac{2x}{1+x^2+y^2+z^2}, \frac{2y}{1+x^2+y^2+z^2}, \frac{2z}{1+x^2+y^2+z^2} \right\rangle$, so $\nabla f(P_0) = \langle 1, -1, -1 \rangle$ and the standard computation gives $D_{\vec{u}} f(P_0) = \langle 1, -1, -1 \rangle \cdot \left\langle \frac{2}{3}, -\frac{2}{3}, \frac{1}{3} \right\rangle = 1$. A set of parametric equations for the ray from P_0 in the direction \vec{v} is $x = 1 + \frac{2}{3}t$, $y = -1 + \left(-\frac{2}{3}\right)t$, $z = 1 + \frac{1}{3}t$, $t \geq 0$.

In the Table, X again is the parameter, Y_1 , Y_2 , and Y_3 are the coordinates x , y and z , respectively, Y_4 is the function expression, and Y_5 is the difference quotient in (IV). That is,

$$Y_1 = 1 + 2X/3$$

$$Y_2 = -1 - 2X/3$$

$$Y_3 = 1 + X/3$$

$$Y_4 = \text{Ln}(1 + Y_1^2 + Y_2^2 - Y_3^2)$$

$$Y_5 = (Y_1 - Y_1(0))/\text{abs}(X)$$

The computed results are shown in Table 2.

X	Y ₁	Y ₂	Y ₃	Y ₄	Y ₅
1.000	1.6667	-1.667	1.3333	1.5640	.87083
.500	1.3333	-1.333	1.1667	1.1614	.93653
.100	1.0667	-1.067	1.0333	.79199	.98839
.050	1.0333	-1.033	1.0167	.74286	.99431
.010	1.0067	-1.007	1.0033	.70314	.99888
.005	1.0033	-1.003	1.0017	.69814	.99944
.001	1.0007	-1.001	1.0003	.69415	.99989

Table 2

It goes without saying, of course, that a table of figures is of little instructional value if it is not accompanied by an instructor's explanatory comments. But a visual demonstration, with students' involvement using their own calculators, to produce tables like these can take some of the mystery out of the traditional formula application.

It is not knowledge, but the act of learning, not possession but the act of getting there, which grants the greatest enjoyment. When I have clarified and exhausted a subject, then I turn away from it, in order to go into darkness again: the never-satisfied man is so strange if he has completed a structure, then it is not in order to dwell in it peacefully, but in order to begin another. I imagine the world conqueror must feel thus, who, after one kingdom is scarcely conquered, stretches out his arms for others.

Karl Friedrich Gauss (Letter to Bolyai, 1808.)

SHORT COMMUNICATIONS

A Unique Isosceles Triangle

by

Michael Scott McClendon
Louisiana State University at Eunice
Eunice LA 70535



Michael Scott McClendon has received his mathematical training from Finger Lakes Community College, State University of New York (Brockport), Syracuse University and the University of Southwestern Louisiana. He currently teaches at Louisiana State University at Eunice.

In elementary geometry we become familiar with the four basic triangles: right, scalene, isosceles and equilateral. We would like to examine the isosceles triangle a little more closely. The isosceles triangle has two congruent legs and one base. Also, the angles opposite the congruent legs of an isosceles triangle are congruent. If we construct an isosceles triangle so that it is circumscribed about a circle of radius r , then we claim that there must be a unique isosceles triangle which minimizes the length of the congruent legs.

At first, one may be tempted to claim that the isosceles triangle which minimizes the lengths of each congruent leg of the isosceles triangle would be the equilateral triangle. However, as we shall see, this is not the case. Indeed, there is a unique triangle in which the congruent sides are of a minimal length, and it is not an equilateral triangle.

As shown in figure 1, we begin with a circle of radius r centered at the origin. We will circumscribe the isosceles triangle about the circle so that the base of the triangle runs along the line $y = -r$ from point $B_1(-b, -r)$ to point $B_2(b, -r)$, and the top of the triangle falls on the y -axis at the point $C(0, c)$. Let k be the length of one of the congruent legs of the triangle. Let point $A(a_1, a_2)$ be the point of tangency between the leg $\overline{CB_2}$ and the circle.

For a fixed r , as the value of c increases without bound, the value of k increases without bound. Also, for a fixed r , as the value of c approaches r , the value of k again increases without

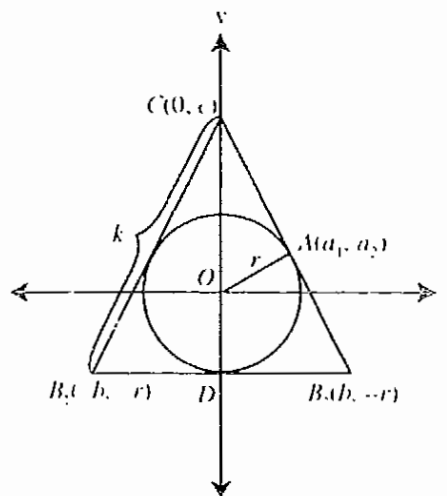

Figure 1

bound. For some value of c greater than r , there must be at least one minimum value of k . If there is only one minimum value of k , then that triangle would be the unique triangle for which we are searching.

Now, the slope of radius \overline{OA} is $\frac{a_2}{a_1}$. Since leg $\overline{CB_2}$ of the triangle is tangent to the circle at point $A(a_1, a_2)$, then leg $\overline{CB_2}$ is perpendicular to radius \overline{OA} . Thus, the slope of line $\overline{CB_2}$ is

$$-\frac{a_1}{a_2} = \frac{a_2 - c}{a_1} \quad (1)$$

This relationship can be expressed as

$$a_1^2 + a_2^2 = a_2c \quad (2)$$

Since point $A(a_1, a_2)$ lies on the circle of radius r , we also have

$$a_1^2 + a_2^2 = r^2 \quad (3)$$

Thus, from equations (2) and (3) we have $a_2c = r^2$. That is, we have

$$a_2 = \frac{r^2}{c} \quad (4)$$

From equations (3) and (4), we get

$$a_1 = \sqrt{r^2 - a_2^2} = \sqrt{r^2 - \left(\frac{r^2}{c}\right)^2} = \frac{r}{c} \sqrt{c^2 - r^2} \quad (5)$$

Thus, the slope of line $\overline{CB_2}$ is

$$\frac{a_1}{a_2} = \frac{\frac{r}{c} \sqrt{c^2 - r^2}}{\frac{r^2}{c}} = \frac{1}{r} \sqrt{c^2 - r^2} \quad (6)$$

and the equation describing line $\overline{CB_2}$ is

$$y = \frac{1}{r} \sqrt{c^2 - r^2} x + c \quad (7)$$

Thus, for any point (x, y) on the line $\overline{CB_2}$, equation (7) gives us

$$x = \frac{r(y - c)}{\sqrt{c^2 - r^2}} \quad (8)$$

Specifically for point $B_2(b, -r)$, we have

$$b = \frac{r(c + r)}{\sqrt{c^2 - r^2}} \quad (9)$$

By the Pythagorean theorem, and from equation (9), we have for right triangle CDB_2 that

$$k^2 = b^2 + (c+r)^2 = \left(\frac{r(c+r)}{\sqrt{c^2-r^2}} \right)^2 + (c+r)^2 = \frac{c^2(c+r)^2}{c^2-r^2}, \quad (10)$$

so that

$$k = \frac{c(c+r)}{\sqrt{c^2-r^2}}. \quad (11)$$

We want to determine the value of c which will minimize k . The derivative of k with respect to c is given by

$$\frac{dk}{dc} = \frac{c^3 - 2r^2c - r^4}{(c^2 - r^2)^{3/2}} = \frac{c^2 - rc - r^2}{(c-r)\sqrt{c^2-r^2}}. \quad (12)$$

Since $c > r$, we will not have division by zero. Thus, setting equation (12) equal to zero and solving for c yields

$$c = r \left(\frac{1 + \sqrt{5}}{2} \right). \quad (13)$$

Since $c > r$, the only solution is given by

$$c = r \left(\frac{1 + \sqrt{5}}{2} \right) = r\phi, \quad (14)$$

where ϕ is the golden ratio. Let the degree measure of $\angle OCA$ be w . Then, since $\frac{c}{r} = \phi$ and $\triangle CAO$ is a right triangle, we have $w = \csc^{-1}\phi$. Thus, for our unique isosceles triangle B_1CB_2 , we have the degree measure of $\angle B_1CB_2$ is given by $m\angle B_1CB_2 = 2w = 2\csc^{-1}\phi$. Also, the measure of each of the two congruent angles, $\angle CB_1B_2$ and $\angle CB_2B_1$, is $m\angle CB_1B_2 = m\angle CB_2B_1 = \frac{\pi}{2} - w = \frac{\pi}{2} - \csc^{-1}\phi$.

Finally, in order to get a better description of this triangle, we will approximate the degree measures of the three angles. We calculate that $\angle B_1CB_2$ is approximately equal to 76.3454° and the degree measure of each of the congruent angles, $\angle CB_1B_2$ and $\angle CB_2B_1$, is approximately equal to 51.8273° . Thus, $\triangle B_1CB_2$ is clearly not an equilateral triangle, and yet it is the unique isosceles triangle circumscribed about a circle of radius r in which the congruent legs are minimized.

The self taught man seldom knows anything accurately, and he does not know a tenth as much as he could have known if he had worked under teachers, and besides, he brags, and is the means of fooling other thoughtless people into going and doing as he himself has done.

Mark Twain in *Taming the Bicycle*, 1917

WILEY: The power is in the difference!

EXPLORATIONS IN COLLEGE ALGEBRA, First Edition

Linda Almgren Kime and Judith Clark, *both of University of Massachusetts - Boston*
10698-4, Paper, 1998

FUNCTIONS MODELING CHANGE: A PREPARATION FOR CALCULUS Preliminary Edition

Eric Cornally, *Wellesley College*, Deborah Hughes-Hallett, *Harvard University*,
Andrew M. Gleason, *Harvard University*, et al.
17081-X, Paper, 1998

CALCULUS, SINGLE VARIABLE, Second Edition

Deborah Hughes-Hallett and Andrew M. Gleason, *both of Harvard University*, et al.
16442-9, Paper, 1998

CALCULUS, SINGLE AND MULTIVARIABLE, Second Edition

Deborah Hughes-Hallett and Andrew M. Gleason, *both of Harvard University*,
William G. McCallum, *University of Arizona*, et al.
16443-7, Paper, 1998

MULTIVARIABLE CALCULUS

William G. McCallum, *University of Arizona*,
Deborah Hughes-Hallett, *Harvard University*,
Andrew M. Gleason, *Harvard University*, et al.
31151-0, Paper, 1997

CALCULUS: A New Horizon, Sixth Edition

Howard Anton, *Drexel University*
Vol. 1: 24331-0, Paper, 1998 • Vol. 2: 24348-5, Paper, 1998 • Vol. 3: 24349-3, Paper, 1998
Combined Edition: 15306-0, Cloth, 1998
Brief Edition: 15307-9, Cloth, 1998

LINEAR ALGEBRA: IDEAS AND APPLICATIONS

Richard C. Penney, *Purdue University*
15495-4, Cloth, 1998

DIFFERENTIAL EQUATIONS: A MODELING PERSPECTIVE, First Edition

Robert L. Borrelli and Courtney S. Coleman, *both of Harvey Mudd College*
04230-7, Cloth, 1998

For more information FAX us at (212) 850-6118. You can also Email us
at Math@wiley.com, or visit us on the World Wide Web <http://www.wiley.com/college>



John Wiley & Sons, Inc. • 605 Third Avenue • New York, New York • 10158

rhm/kef 2-0305

The Distribution of Zeros of a Complex Polynomial

by

Jay M. Jahangiri
Kent State University
Burton OH 44021

and

Herb Silverman
College of Charleston
Charleston SC 29424



Jay Massoud Jahangiri is a mathematics professor at Kent State University. Jay earned his M.S. in mathematics from University of London, England (1982) and his Ph.D. in Complex Analysis from University of York, England (1986). Jay is the recipient of the Stott Prize for Excellence in Research from University of York and Excellence in Teaching Award from University of California at Davis. To his credit he has over 25 pedagogical and pure mathematics publications.



Herb Silverman earned his B.A. from Temple University and his M.S. and Ph.D. from Syracuse University. Herb has been a mathematics professor at the College of Charleston since 1976. Herb has received the College of Charleston Outstanding Research Award and has been Speaker of the Faculty at the College of Charleston.

Euler (1996) showed that the zeros of the polynomial $(z + 1)^n = \pm z^n$ must satisfy $\text{Re} z = -\frac{1}{2}$. In this note, we give a simpler proof that is also more general. We consider polynomials of the form

$$(z + a)^n = bz^n, \tag{1}$$

where a is a non-zero real number, n is a positive integer, b is a complex constant and z is a complex variable. Dividing both sides of (1) by z^n and taking absolute values leads to $\left|1 + \frac{a}{z}\right| = |b|^{1/n}$. Thus, $1 + \frac{a}{z} = |b|^{1/n} e^{i\theta}$, θ real, or equivalently,

$$z = \frac{a}{|b|^{1/n} e^{i\theta} - 1}. \tag{2}$$

Note that the zeros of the polynomial (1) must be of the form (2). Moreover, (2) may be viewed as a bilinear mapping of the unit circle $|\zeta| = 1$ onto

$$w = \frac{a}{|b|^{1/n} \zeta - 1}, \tag{3}$$

so that the zeros of (1) lie on the image of this transformation.

If $|b| = 1$, the image of the unit circle under (3) is $\left\{w: \operatorname{Re} w = -\frac{a}{2}\right\}$.

If $|b| \neq 1$, then (3) maps the unit circle onto the circle in which the endpoints of a diameter are $\frac{a}{|b|^{2n}-1}$ and $\frac{a}{|b|^{2n}+1}$, i.e., the circle

$$\left\{w \mid \operatorname{Re} w = \frac{a}{|b|^{2n}-1}\right\} = \left\{\frac{ab|b|^{2n}}{|b|^{2n}-1}\right\}. \quad (4)$$

Conclusion

- i. If $|b| = 1$, the zeros of the polynomial $p(z) = (z + a)^n - bz^n$ in (1) all satisfy $\operatorname{Re} z = -\frac{a}{2}$. There are n such zeros if $b \neq 1$ and $n-1$ zeros if $b = 1$. The special case $b = \pm 1$ and $a = 1$ gives Euler's result [1].
- ii. If $|b| \neq 1$, the n zeros of $p(z)$ lie on the circle defined by (4). In particular, the real parts of the zeros of $p(z)$ are between $\frac{a}{|b|^{2n}-1}$ and $\frac{a}{|b|^{2n}+1}$, while the imaginary parts of the zeros of $p(z)$ are between $-\left|\frac{ab|b|^{2n}}{|b|^{2n}-1}\right|$ and $\left|\frac{ab|b|^{2n}}{|b|^{2n}-1}\right|$.

Remark

If the number a in the polynomial (1) is not real, the bilinear map (3) shows that the zeros of the polynomial will lie on a line that is not parallel to the imaginary axis when $|b| = 1$, and on a circle whose center is not on the real axis when $|b| \neq 1$.

Reference

Euler, R. (1996). The distribution of roots of an equation. *The AMATYC Review*, 17(2) p. 24-25.

Only two things are infinite: The universe and human stupidity, and I'm not sure about the former.

Albert Einstein



Not everything that can be counted counts; and not everything that counts can be counted.

Albert Einstein

MATHEMATICS EDUCATION

From Divisibility By 6 to the Euclidean Algorithm and the RSA Cryptographic Method

by

John B. Cosgrave
St. Patrick's College

Drumcondra, Dublin 9, Ireland



John B. Cosgrave first learned of the Euclidean Algorithm from his father, who taught the mechanics of it – on his own initiative – to his primary school pupils (aged 10-12) in rural Ireland. He studied at Royal Holloway College of London University (B.Sc. (1968), Ph.D. (1972) in Analytic Number Theory). He has worked at Royal Holloway College, Manchester University, the Jos Campus of Ibadan University (Nigeria), Carysfort College (Ireland) and St. Patrick's College. His research interests are in elementary number theory and in the past few years he has come to be a passionate user of computer algebra software in his teaching.

In a recent note (Francis, 1996) the author wrote: *Some divisibility tests are highly intuitive (as for 2, 5, 10, or 100) whereas others are more subtle (as in the case for 3, 9, or 11). No subsequent mention was made about a test for divisibility by 6 (perhaps because it was not felt worth commenting upon?).*

I would like to make a case for the quite rich development of mathematical ideas that can flow from considering the apparently simple question of finding a divisibility test for 6, and what I describe below is based on my experience over a number of years of teaching elementary number theory to my students (who are training to be primary school teachers). It is not an approach that I use every time as I don't wish to standardize my approach to teaching a given topic. I hope it will be of interest to other teachers.

For American readers I should point out that I teach in what might be called a three-year college, one that trains students to teach in the primary school sector (ages 4 to 12). My students are ones who are studying mathematics as one of their two "academic" subjects in their first year of studies, and those who continue with it as their single academic subject in their second and third years. Besides their academic subjects they all study a substantial Education programme.

The Normal Experience

Whenever I ask my students if they can tell how to decide if a number is divisible by 2, I always get the response: *a number is divisible by 2 if its final digit is divisible by 2*. I accept that, but I draw to their attention that the truth of that is

dependent on the number being expressed in an even base. It would be unreasonable of me to expect them to know that, since none of my students have any prior experience of *base*. However, when I do introduce them to the notions of base 2, base 3, etc., they quickly grasp the idea, and see that "4" (even), when expressed in the base 3, ends in an odd digit, or that "5" (odd), when expressed in the base 3, ends in an even digit.

When I ask my students if they can tell me how to decide if a number is divisible by 3. I generally find that a number of them have heard from some source that *a number is divisible by 3 if (and only if) the sum of its digits is divisible by 3*. I never let that one slip past and always spend some time bringing out a proof from them, as I have never encountered a student who has seen a proof of this simple result, or even seen the central idea of its proof which can be quickly conveyed by simple examples like:

$$\begin{aligned} 788,214 &= 700,000 + 80,000 + 8,000 + 200 + 10 + 4 \\ &= 7(99,999 + 1) + 8(9,999 + 1) + 8(999 + 1) + 2(99 + 1) + 1(9 + 1) + 4 \\ &= \text{an obvious multiple of } 3 + (7 + 8 + 8 + 2 + 1 + 4), \text{ etc.} \end{aligned}$$

Tests for divisibility by 4 and 5 always bring forth the standard replies, and then when I ask for a divisibility test for 6, I always get a reply along the lines of: *a number is divisible by 6 if it is divisible by 2 and 3*.

My question to them is then: how do you know that a number is divisible by 6 if it is divisible by 2 and 3? That question always causes some puzzlement amongst them, and I can almost hear them thinking: *is our teacher stupid?* I press them, and ask again: how can they be so sure that a number is divisible by 6 if it is divisible by both 2 and 3? The (reluctant) answer never varies: *It's obvious, six is two threes*.

Ah!, so six is two threes. And twelve is three fours, and fifteen is three fives, and thirty-five is five sevens, and twenty-four is four sixes, ... I ask if they are going to tell me that a number is divisible by *ab* if it is divisible by both *a* and *b*, on the grounds that "*it's obvious, ab is a times b*". Some bold ones will jump in and immediately say that of course it's true, it's obvious, but after a little while - having asked the question again - I invariably get some contributions along the lines of: *no, it's not always true. Twelve is divisible by four and six, but it is not divisible by twenty-four*.

The Start of Real Development

At that point even the weakest student in my class realizes that my original question really is a question after all. All of us who teach know that there is no hope whatever of getting students to think about a problem or a question until they accept that there really is a problem or question to think about.

So, how does one know that if a number is divisible by both 2 and 3 then it is divisible by 6? Now I generally get two answers:

1. *2 is even and 3 is odd.*

Is that an acceptable reason? I generally get a refutation like: *6 and 3 divide 12, but 6 times 3 does not divide 12.*

2. *2 and 3 are primes.*

Now that is a more subtle one to handle, because it happens to be true that if p and q are distinct primes then any number that is divisible by both p and q is also divisible by pq , and so one has now encountered a new question, namely: how does one know that that is true? (Incidentally this is a key step in the proof of the special case of the Euler-Fermat theorem which is needed in the Rivest-Shamir-Adleman cryptographic method, as I will show at the end of this note.)

I usually handle that response by saying that what has been suggested is close to the truth, but is not the entire truth. For example, any number that is divisible by 4 (not a prime) and 3 (prime) must also be divisible by 12, or any number that is divisible by 21 (not a prime) and 10 (not a prime) must also be divisible by 210. But how do I know that those claims are true?

Intervention is Now Necessary

I am now at a point where I have to introduce them to a new method, actually to two new methods. Both approaches will be seen to “work”, but it soon becomes clear that one of them is almost completely useless, whereas the other is very, very powerful indeed. I believe that it is a most important element in the development of a student’s appreciation of mathematics that they encounter the contrasting values of different approaches to solving a given problem.

Method One. If n is any integer, then, on division by 6, it must leave one of 6 possible remainders: 0, 1, 2, 3, 4 or 5. In symbols, if $n \in \mathbb{Z}$, then $n = 6A + 0, 1, 2, 3, 4$ or 5 , for some $A \in \mathbb{Z}$. But, if n is divisible by 2 then those six possibilities are reduced to three, namely: $n = 6A + 0, 2$, or 4 , and if n is divisible by 3 the original six possibilities are reduced to two, namely: $n = 6A + 0$ or 3 . It then follows immediately that if n is divisible by 2 and 3 then the only possibility is $n = 6A + 0 = 6A$, so n is divisible by 6.

To ensure that they have absorbed that approach I set routine exercises like:

if n is divisible by 4 and 7, does it follow that n must be divisible by 28?

if n is divisible by 4 and 10, does it follow that n must be divisible by 40?

With the first of those they will find that the answer is, of course, “yes”, and, with the second one, one of two things will happen: a student will either see immediately that the answer is “no” (“*twenty is divisible by four and ten but not by forty*”), or – and I almost prefer this to happen – will discover in an analysis that the answer is “no” as a result of doing this:

$$n = 40A + 0, 1, 2, 3, 4, 5, \dots, 38 \text{ or } 39 \text{ for some } A \in \mathbb{Z}.$$

But if n is divisible by 4 then:

$$n = 40A + 0, 4, 8, 12, 16, 20, 24, 28, 32 \text{ or } 36.$$

And if n is divisible by 10 then:

$$n = 40A + 0, 10, 20 \text{ or } 30.$$

It is then seen that if n is divisible by 4 and 10 then there are two possibilities, namely either $n = 40A$ or $n = 40A + 20$, and in the latter case n isn’t divisible by 40.

Method Two. We use the (apparently) trivial fact that 3 and 2 differ by 1. Now let n be an integer divisible by 2 and 3. Then $n = 2A$ and $n = 3B$, for some $A, B \in \mathbb{Z}$. From $3 - 2 = 1$ we obtain $3n - 2n = n = 3(2A) - 2(3B) = 6(A - B)$, and so n is divisible by 6 since $(A - B)$ is an integer.

Real Progress with Method Two

Many students are fascinated with the latter approach. Three minus two is one! It has a touch of magic about it, as it seems that one gets something from almost nothing. It is immediately apparent that it is certainly vastly superior to Method One when one uses it to prove results like:

if n is divisible by 10 and 11 then n is divisible by 110.

if n is divisible by 15 and 16 then n is divisible by 240.

and in fact students can immediately prove the non-trivial general result: if n is divisible by m and $(m + 1)$ then n is divisible by $m(m + 1)$.

How, though, does it compare with Method One with respect to other problems previously encountered? For example: if n is divisible by 4 and 7, does it follow that n must be divisible by 28?

This is the point at which weak students will say things like: *you can't use Method Two here because 7 and 4 don't differ by 1*. But it is also the point at which if I say something like: "true, 7 and 4 don't differ by 1, but can you see a way of getting a "1" from 4 and 7 that might be of some use to us", that at least one student will come up with: *you can still do it by using two fours minus seven is 1*.

The details: $2 \times 4 - 7 = 1$. Now let n be an integer that is divisible by 4 and 7. Then $n = 4A$ and $n = 7B$, for some $A, B \in \mathbb{Z}$. Since $2 \times 4n - 7n = n$ then $2 \times 4(7B) - 7(4A) = n$, and so $28(2B - A) = n$, and thus n is divisible by 28, because $(2B - A)$ is an integer.

That worked with 4 and 7, but how about 5 and 13? Or 8 and 11? ... Questions from me, and answers from them quickly lead to results like:

Simple Result. If $n \in \mathbb{Z}$ and $8|n$ and $11|n$ then $88|n$.

Proof. $3 \times 11 - 4 \times 8 = 1$ (or, if we wish, $7 \times 8 - 5 \times 11 = 1$; indeed any such combination of 8 and 11. I actually now use the standard terminology – as they are now prepared for it – of *integral linear combination*, and I say that "1 has been expressed as an integral linear combination of 8 and 11"), etc.

I lay special emphasis on the importance of "getting that 1", and I invite them to see what happens if one tried to prove (the false result): if $n \in \mathbb{Z}$ and $12|n$ and $15|n$ then $180|n$.

First attempted proof. Try using $15 - 12 = 3$. Then with $15n - 12n = 3n$, and $n = 12A$ and $n = 15B$ one has $15(12A) - 12(15B) = 3n$, and so $180(A - B) = 3n$. Thus $180|3n$. Does it follow from that, though, that $180|n$? And one quickly sees that it doesn't... So, using $15 - 12 = 3$ certainly doesn't work.

Another attempted proof. Can we express 1 as an integral linear combination of 12 and 15? That is, are there $x, y \in \mathbb{Z}$ with $12x + 15y = 1$? (The motivation for asking this is clear: if we can find such an integral linear combination then the above result would immediately have a proof. That would, of course, come as something of a shock as the result is false! My interest is not just that my students see it is false, but rather in seeing why it is false.) It is clear that there is no such combination because 12 and 15 are both divisible by 3, and so if $x, y \in \mathbb{Z}$ with $12x + 15y = 1$ were to happen then one would have that 1 was divisible by 3, which cannot be so.

Now students are ready for:

The Big Leap Forward

The big question now becomes: How should integers a and b be related so that whenever an integer n is divisible by a and b then n must be divisible by ab ? Or, to put it another way, what is it about 2 and 3, or 4 and 7, or 8 and 11, *etc.*, that made the earlier results true, and what is it about 4 and 6, or 6 and 9, or 15 and 25, *etc.* that made the corresponding possible results not be true?

The typical responses that I get are: *4 and 6 are divisible by 2 and so they are not correctly related, 6 and 9 are divisible by 3 and so they are not correctly related, etc. Also, 2 and 3 are not divisible by any number and so are correctly related, 4 and 7 are not divisible by any number and so are correctly related, etc.*

I praise their insight, but just correct their language slightly by pointing out that they should say of the latter cases: *2 and 3 are not divisible by any number greater than 1, and so are correctly related; 4 and 7 are not divisible by any number greater than 1, and so are correctly related, etc.*

But the question now is: is this the correct general observation to be making? In other words: if $a, b, n \in \mathbb{Z}$ with $\text{gcd}(a, b) = 1$ and $a|n$ and $b|n$, does it follow that $ab|n$?

At this point students do realize that this is a non-trivial question, and are able to prove it in concrete instances by finding appropriate integral linear combinations of the given a and b to give the number 1. That is done by simple trial and error, which they enjoy (especially the weaker students, as it gives them the satisfaction of thinking that they are achieving something).

It is now also abundantly clear that whereas one can quickly find a suitable combination for small values of a and b (or even when one of them is small and the other large) it is not a simple matter if one has large values for a and b . And – more importantly – it is not clear to them at this stage how one might give a proof of the general claim that if $a, b \in \mathbb{Z}$ with $\text{gcd}(a, b) = 1$ then there are $x, y \in \mathbb{Z}$ with $ax + by = 1$.

Another Direct Intervention: Enter the Euclidean Algorithm

This is the point at which I now make another direct intervention and tell them that I am going to introduce them to a method – discovered by Euclid – which is one of the very simplest ideas in all of mathematics, and yet is at the same time one

of the most valuable and powerful, namely the Euclidean Algorithm and the accompanying "extended Euclidean Algorithm". These enable one to calculate (with breathtaking speed) the greatest common divisor d of two integers a and b , and then – the "extended" part – express d as an integral linear combination of a and b .

Since the Euclidean Algorithm and the extended Euclidean Algorithm are so well known (see, for example, Rosen (1988), Bressoud (1989) or Koblitz (1994)) I will only record here the sort of standard exercises that I then expect all my students to be able to do with ease, and the sort of solutions that I expect from them. I will also record just one example of the sort of general theorem which I also expect them to be able to prove, and its proof.

Exercise. Calculate $\gcd(7541, 3680)$, express it as an integral linear combination of 7541 and 3680, and then decide if the following is true: if $n \in \mathbb{Z}$ with $3680|n$ and $7541|n$, does it follow that $(3680 \times 7541)|n$?

Solution. First we calculate the greatest common divisor by:

$$7541 = 3680 \times 2 + 181,$$

$$3680 = 181 \times 20 + 60,$$

$$181 = 60 \times 3 + 1,$$

$$60 = 1 \times 60.$$

$$\text{Thus } \gcd(7541, 3680) = \gcd(3680, 181) = \gcd(181, 60) = \gcd(60, 1) = 1.$$

Next we express the gcd as an integral linear combination by:

$$1 = 181 - 3 \times 60$$

$$= 181 - 3 \times (3680 - 20 \times 181) = 61 \times 181 - 3 \times 3680$$

$$= 61 \times (7541 - 2 \times 3680) - 3 \times 3680 = 61 \times 7541 - 125 \times 3680.$$

$$\text{Thus } 61 \times 7541 - 125 \times 3680 = 1.$$

Because the gcd is 1 then the divisibility result follows, and can be proved as above.

Important variation of the above exercise. Calculate $\gcd(7541, 3680)$, express it as an integral linear combination of 7541 and 3680, and then decide if the following is true:

$$\text{if } n \in \mathbb{Z} \text{ with } 7541|3680n, \text{ does it follow that } 7541|n?$$

Solution. As above, and yes the divisibility result does follow, and can be proved by: Since $n \in \mathbb{Z}$ and $7541|3680n$, then $3680n = 7541A$, some $A \in \mathbb{Z}$. Multiplying throughout $61 \times 7541 - 125 \times 3680 = 1$ by n gives $61 \times 7541n - 125 \times 3680n = n$. Replacing $3680n$ with $7541A$ gives $61 \times 7541n - 125 \times 7541A = n = 7541(61n - 125A)$, and so $7541|n$ since $(61n - 125A) \in \mathbb{Z}$.

Comment. The latter is exactly the sort of work that enables a student to then follow the classic proof of the "Fundamental Property of Prime Numbers": if p is prime and $m, n \in \mathbb{Z}$ with $p|mn$, then $p|m$ or $p|n$. And, in turn, that is exactly what one needs to give the classic proof of Fermat's "little" theorem: if p is prime and $a \in \mathbb{Z}$ with $a \not\equiv 0 \pmod{p}$ then $a^{p-1} \equiv 1 \pmod{p}$.

An example of a theorem. Let $A, B, C \in \mathbb{Z}$ with $A|BC$ and $\gcd(A, B) = 1$, then $A|C$.

Proof. Since $\gcd(A, B) = 1$ then, by the extended Euclidean Algorithm there are $x, y \in \mathbb{Z}$ with $Ax + By = 1$. Also, since $A|BC$, we have $BC = AD$ for some $D \in \mathbb{Z}$. Thus we have $AxC + ByC = C = AxC + ADy = A(xC + yD)$, and so $A|C$ since $(xC + yD) \in \mathbb{Z}$.

Comment. The "Fundamental Property of Prime Numbers" is, of course, a special case of this theorem.

The RSA Cryptographic Method

Almost no area of mathematics can have received greater publicity in recent years than the application of elementary number theory to the Rivest-Shamir-Adleman cryptographic method. I didn't realize until I tried for the first time to teach a course on number theory, with a large cryptography input, just how interested students would be in such a course. Central to the success of the course was the use of computer algebra software (we used MAPLE, though any other comparable package would do), which enabled my students to do realistic cases of encryption and decryption. I would unreservedly recommend colleagues to consider teaching a number theory and cryptography course.

The ideas involved in connection with the RSA method are so well known that I need not go over them here. I will just refer the interested reader who may not be familiar with the details of the method to Rivest-Shamir-Adleman (1978), Rosen (1988), Koblitz (1994) and Garfinkel (1995). RSA (1978) is the original trail-blazing paper of Rivest, Shamir and Adleman. Garfinkel's book is especially good on historical matters.

And what number theory does a student need to be familiar with to understand the fine detail of the RSA method?

1. Efficient modular exponentiation. That is, being able to quickly calculate $a^m \pmod{n}$.
2. Euler-Fermat theorem: if $n \in \mathbb{N}$ and $a \in \mathbb{Z}$ with $\gcd(a, n) = 1$ then $a^{\phi(n)} \equiv 1 \pmod{n}$, where $\phi(n)$ is the Euler *phi*-function (the number of integers x between 1 and $(n - 1)$ for which $\gcd(x, n) = 1$).
3. How to find two large primes p and q to form the "public modulus" n , with $n = pq$.
4. How to choose the public "encryption power" e so that $\gcd(e, (p - 1)(q - 1)) = 1$.
5. How to choose the private "decryption power" d so that $ed \equiv 1 \pmod{(p - 1)(q - 1)}$.

Comment on 1. Of course if one is using a computer algebra software package like MAPLE then one has a built-in command readily available, but one doesn't just

want to have students button pushing and it is easy to teach them the classic "square-and-multiply" technique, which is what MAPLE is using anyway.

Comments on 2. Since it requires quite a bit of work to prove this theorem, and since as far as the RSA method is concerned one only needs the special case where n is the product of two distinct primes p and q (in which case $\phi(n) = \phi(pq) = (p-1)(q-1)$), it might be of some interest to record a simple proof of this special case, since it can be done directly from Fermat's "little" theorem, and the very ideas discussed earlier in this note. So:

Theorem. Let p and q be distinct primes, let $n = pq$, and let $a \in \mathbb{Z}$ with $\gcd(a, n) = 1$, and $a^{p-1}y^{q-1} \equiv 1 \pmod{n}$.

Proof. Since $\gcd(a, n) = 1$ then $a \not\equiv 0 \pmod{p}$ and $a \not\equiv 0 \pmod{q}$, and thus by Fermat's "little" theorem we have $a^{p-1} \equiv 1 \pmod{p}$ and $a^{q-1} \equiv 1 \pmod{q}$. From the first of these we obtain $(a^{p-1})^q \equiv 1^q \equiv 1 \pmod{p}$, that is $a^{p-1}y^{q-1} \equiv 1 \pmod{p}$, and from the second we also obtain $a^{p-1}y^{q-1} \equiv 1 \pmod{q}$. It then follows that $a^{p-1}y^{q-1} \equiv 1 \pmod{pq (= n)}$. And the justification for that is precisely the theorem encountered in the earlier part of this article, namely: if p and q are distinct primes (in fact, it is sufficient that p and q satisfy $\gcd(p, q) = 1$) and $p|A$ and $q|A$, where $A \in \mathbb{Z}$, then $pq|A$. Here A is $a^{p-1}y^{q-1} - 1$.

Comment on 3. Finding large primes is a massive field of study (e.g., Bressoud (1989), Riesel (1994)), and a serious study begins with Fermat's "little" theorem and its possible converse.

Comment on 4 and 5. Both of these involve the Euclidean Algorithm and the extended Euclidean Algorithm in an essential way.

Summing Up

I have tried to show in this note that students can very quickly get into some very serious mathematics from very modest and accessible beginnings.

References

- Bressoud, D. M. (1989). *Factorization and primality testing*. New York: Springer-Verlag.
- Francis, R. L. (1996). Divisibility discoveries. *The AMATYC Review*, 17(2), 12-16.
- Garfinkel, S. (1995). *PGP: Pretty good privacy*. Sebastopol, CA: O'Reilly and Associates.
- Koblitz, N. (1994). *A course in number theory and cryptography*. New York: Springer-Verlag.
- Riesel, H. (1994). *Prime numbers and computer methods for factorization*. Boston: Birkhauser.
- Rosen, K. H. (1988). *Elementary number theory and its applications*. Reading, MA: Addison-Wesley.
- Rivest, R.L., Shamir A., and Adleman, L. (1978). A method for obtaining digital signatures and public-key cryptosystems. *Communications of the ACM*, 21(2), 120-126.

Houghton Mifflin Mathematics

Setting the Standard for Excellence

Prealgebra, 2/e • Aufmann • Barker • Lockwood

Available Nov. 1997 (©1998) • Paperback • 672 pages • ISBN 0-395-87093-3

Elementary and Intermediate Algebra

Discovery and Visualization, 2/e • Hubbard • Robinson

Available Aug. 1997 (©1998) • Hardcover • 800 pages • ISBN 0-395-87093-3

Elementary Algebra • Clarkson • Barone

Available Nov. 1997 (©1998) • Hardcover • 610 pages • ISBN 0-395-74121-5

Intermediate Algebra • Clarkson • Barone

Available Nov. 1997 (©1998) • Hardcover • 768 pages • ISBN 0-395-74125-3

Intermediate Algebra: Graphs and Functions, 2/e

Essentials of Intermediate Algebra

Graphs and Functions, 2/e • Larson • Hostetler • Neptune

Available Nov. 1997 (©1998) • Hardcover • *Complete Edition*: 928 pages •

ISBN 0-395-87615-X • *Essentials Edition*: 701 pages • ISBN 0-395-87616-8

STOP BY OUR BOOTH TO SEE OUR UPPER-LEVEL TEXTS...

Calculus with Analytic Geometry, 6/e • Larson • Hostetler • Edwards

Calculus Concepts: An Informal Approach to the Mathematics of Change

Calculus Concepts: An Informal Approach to the Mathematics of Change, Brief • LaTorre • Kennelly • Fetta • Harris • Carpenter

Contemporary Abstract Algebra, 4/e • Gallian

Calculus: Modeling and Application Multivariable Chapters, Final Preliminary Edition • Smith • Moore

AND VIEW A DEMONSTRATION OF OUR CD-ROM PRODUCTS!



HOUGHTON MIFFLIN

New Ways to Know™

- To request an examination copy, call or fax the Faculty Services Center:
Tel: 800/733-1717 • Fax: 800/733-1810 or contact your Houghton Mifflin sales representative.
- For more information, consult the College Division at Houghton Mifflin's home page: www.hmco.com



Faculty Development Programs

Practical, Relevant, Instructional Strategies

WORKSHOPS, CONSULTING, AND ON-CAMPUS TRAINING

NEW TEACHING EXCELLENCE AWARD

It is with great pleasure that Faculty Development Programs announces its sponsorship of the new AMATYC Teaching Excellence Award. This new award will be given biennially to an outstanding mathematics instructor in each of AMATYC's eight regions, and will be presented for the first time at the AMATYC conference in Atlanta, Georgia, in November.

Faculty Development Programs is committed to enhancing teaching and learning through its professional development workshops, consulting, and on-site training. We believe that recognizing excellence in teaching is the natural extension of our dedication to faculty.

WORKSHOP ENDORSEMENT

We are also very pleased to announce that the AMATYC board has voted to endorse our Developmental Math Workshops for the second consecutive year. The AMATYC Board recognizes that these workshops are based upon and reflect the "Crossroads in Mathematics Standards for College Mathematics Before Calculus" published by AMATYC. Members of AMATYC receive partial tuition waivers to attend all workshops.

1998 DEVELOPMENTAL MATH WORKSHOPS

- Dallas, Texas* March 12-13
- Atlanta, Georgia April 2-3
- Portland, Oregon April 16-17
- St. Louis, Missouri** April 30-May 1
- Denver, Colorado October 15-16

* To be held concurrently with our Developmental Writing Workshop

** To be held concurrently with our Developmental Writing and Developmental Reading Workshops

• For more information call 1-800-856-5727, fax 1-800-210-0212 or visit our home page on the World Wide Web at www.facultytraining.com

 HOUGHTON MIFFLIN
A Harcourt Company



Faculty Development Programs
2075 Foxfield Road, Suite 100
St. Charles, IL 60174

Obstacles for College Algebra Students in Understanding Functions: What Do High-Performing Students Really Know?

by

Marilyn P. Carlson
Arizona State University
Tempe AZ 85287-1804



Marilyn P. Carlson is an Assistant Professor in the Department of Mathematics at Arizona State University. She received her Ph.D. from the University of Kansas. Her research area is mathematics education.

Abstract

This paper reports results of investigating high-performing college algebra students' understanding of the function concept. Results reveal that these high-performing students possessed weak understanding of major aspects of the function concept. They did not understand the function language, were unable to interpret graphical function information, and did not know how to use function notation to represent "real world" relationships. They did not view functions as processes which accept input and produce output; rather they viewed them as a sequence of memorized operations to be carried out. In addition to their conceptual misunderstandings, the interview results revealed that high-performing college algebra students possess weak mathematical habits and little confidence in their mathematical abilities.

Introduction

As early as 1921, the National Committee on Mathematical Requirements of the Mathematical Association of America recommended that the study of functions be given central focus in secondary school mathematics (Cooney & Wilson, 1993). The NCTM (1989) *Curriculum and Evaluation Standards* called for the inclusion of function-related activities as early as fourth grade (p. 60), continuing through the high school mathematics curriculum where the concept of function is a unifying idea (p. 154). In *Everybody Counts* (National Research Council, 1988), the authors stated: "if undergraduate mathematics does nothing else, it should help students develop function sense" (p. 51). Additionally, the function concept is an important and unifying concept in modern mathematics (Leinhardt et al., 1990), central to different branches of mathematics (Kleiner, 1989), and essential to related areas of the sciences (Selden & Selden, 1992). Further, a strong understanding of the concept of function is a vital part of the background of any student hoping to

understand calculus (Breidenbach et al., 1992). Although curriculum reform efforts are beginning to respond to calls for change and researchers have begun to identify many of the difficulties students experience with understanding components of the function concept (MAA Notes, Volumes 25, 1992), ongoing analysis of student understanding is necessary for guiding future curriculum decisions. Without such analysis, there is little hope that curriculum decisions will be guided by informed judgments of how students acquire understanding of essential function information.

This study was designed to guide algebra teachers and curriculum developers by providing insights into how high performing college algebra students develop an understanding of major aspects of the function concept. More specifically, this research investigated students' abilities to:

- Characterize "real world" function relationships using function notation;
- Operate with a particular type of function representation, such as a formula, a table, or a graph;
- Move between different representations (graph, table, algebraic, etc.) of the same function;
- Interpret "static" graphical information for specific points and intervals of the domain;
- Interpret "dynamic" graphical information for specific points and intervals of the domain;
- Construct functions using formulas and other functions;
- Recognize functions, non-functions and general function types;
- Represent and interpret covariant aspects of the function situation (i.e. recognize and characterize how change in one variable affects change in another);
- Conceptualize a function as a process;
- Interpret and understand function notation, and
- Characterize the relationship between a function and an equation.

This list of abilities provides a framework for investigating changes in students' function conceptions.

Methods

The subjects for this study comprised 30 students just completing a function-integrated college algebra course with a grade of A. A twenty-five item written exam was developed to measure students' understandings of the above function abilities, and was administered at completion of the course. Five point rubrics, measuring the accuracy, strength of justification and degree of conceptual understanding were written for scoring each written exam question. Development of the written exam and rubrics involved a lengthy process of verification and refinement (Carlson, 1995).

Five students performing at different levels on the written exam were selected to

participate in follow-up interviews designed to determine how students acquire particular function information. During the subsequent interview each question was read aloud and general reference was made to the student's written response. If desired the student was given a few minutes to review her response. The student was then prompted to verbally describe her written solution, providing clarification and justification for the solution approach. After the student's summary of the written response, the researcher made general requests, such as, "explain" or "clarify", and continued to ask more specific questions, if necessary, until a response was elicited or it appeared that all knowledge had been provided. If one of the main components of the question was correctly answered, the student was prompted to recall when and how the concept was acquired. The researcher repeated the process for each question on the written exam.

Final results were obtained by analyzing both the quantitative and qualitative results from the written exam scorings and interview transcripts. The quantitative results report common written responses, and group means and standard deviations for each item. The qualitative results were obtained by repeatedly reading each interview transcript, while attempting to identify common student responses, misconceptions and the function knowledge motivating individual responses. The percentage of students providing each response type for each item were determined and common responses were noted.

Results

Because of the large amount of data collected, quantitative and detailed qualitative data represented for select written exams items and interviews are presented to reveal common student misunderstandings. These results suggest aspects of function instruction which need increased attention by both classroom instructors and curriculum developers and provide insights into the types of understandings that high performing college algebra students possess. For a full description of results of the twenty-five item exam see Carlson (1995).

Results - Item 1

Express the diameter of a circle as a function of its area and sketch its graph.

The mean score for this written exam item is 1.00 (out of 5.0) and standard deviation is 1.08, with 87% of the thirty college algebra students in this study making no attempt to isolate d .

The interview responses varied on this item, with only one student (of the five interview subjects) providing a correct algebraic response supported by a well-formulated verbal justification. Two of the interview subjects did not know the formula for the area of a circle and when provided with the formula made not attempt to solve for d . The other two students knew the area formula and successfully substituted $\frac{d}{2}$ for r , but did not attempt to isolate d . As a follow-up question during the interviews, each student was asked to explain what is meant by the statement, "express s as a function of t ". One student responded that this statement means you are trying to find where s and t are equal. Another student

responded that this statement means you are trying to find where s and t are equal. Another student responded with the statement, "find the zeros", another student said, "kind of how it related to", and two remaining students responded "write an equation with s 's and t 's". These responses suggest that high-performing college algebra students do not know what it means to represent one quantity as a function of another. More specifically, they did not know that when expressing s as a function of t , they should attempt to set s equal to some expression containing t .

Selected Interview - Item 1

Interviewer: Explain your written solution.

Student E: I remember that equation. $A = \pi r^2$. Then I figured out $r = \frac{d}{2}$. Now, area equals πr^2 . Now, I can't remember what I did. (Long pause)

Interviewer: Looks like you replaced $\frac{d}{2}$ for r .

Student E: Yes, I needed to replace r with d , I mean $\frac{d}{2}$. Now, I have it, I then wrote $A = \pi \left(\frac{d}{2}\right)^2$.

Interviewer: Is this the final answer? Is diameter expressed as a function of area?

Student E: Yes, this is my answer. Is this right?

Interviewer: What were you trying to achieve when asked to express "diameter as a function of area"?

Student E: I was trying to write an equation with A and d 's.

Interviewer: If I ask you to express s as a function of t , what does this mean to you?

Student E: Write an equation with s 's and t 's and then find the zeros.

Results - Item 2d

Compute $f(x + a)$ given $f(x) = 3x^2 + 2x - 4$.

High-performing college algebra students received a mean score of 2.07 (out of 5.0) and standard deviation of 2.32 on this item. The most common incorrect written exam response (43%) was $f(x) = 3x^2 + 2x - 4 + a$.

Although four of the five interview subjects provided a correct justification to their correct response, the justifications provided insights into how college algebra students think about the evaluation of $f(x + a)$. Each student described his/her solution either as a substitution of " $x + a$ " for x , or a procedure of adding a to every x . When prompted for a more in depth explanation, none of the interview subjects referred to computing $f(x + a)$ as evaluating f at " $x + a$ ", nor did they describe " $x + a$ " as the input to f . The student who simply added " a " to the expression on the right of the equal sign indicated that he/she arrived at this solution by substituting $3x^2 + 2x - 4$ into the x in $f(x + a)$. Additionally, two other students stated they once

had difficulty with this type of problem because they did not know "which one to plug into which one". They both also admitted that they had initially thought that the expression on the right was to be substituted for the x in $f(x + a)$, and only after some practice were they able to resolve this misconception. Although none of the interview subjects indicated that they viewed the problem as simply adding "a" to both sides of the equal sign, this justification did occur when piloting the interview procedures. These responses suggest that college algebra students do not view the expression inside the parentheses (in a function statement) as the input which is processed by the function to produce output. Instead, they appear to view the evaluation of a function as nothing more than a process of algorithmically carrying out a sequence of steps.

Results - Item 8a

The given graph represents speed vs. time for two cars.

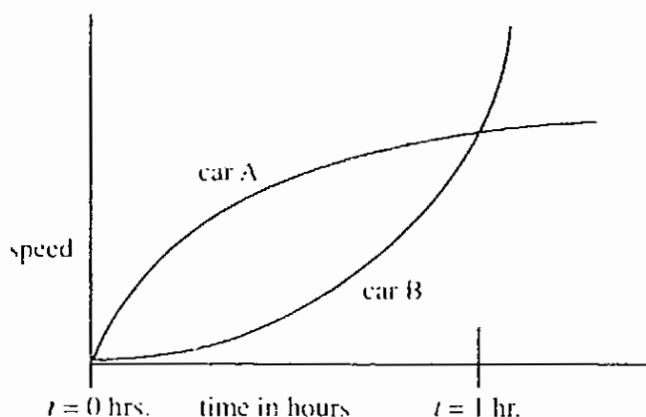

State the relationship between the position of car A and car B at $t = 1$ hr. (assume the two cars start from the same position and are traveling in the same direction). Explain.

The mean score for college algebra students was .83 (out of 5.0) and the standard deviation was 1.74, with 47% of college algebra students stating that the cars are in the same position and 34% responding that car B is passing car A. These responses suggest that 88% of the subjects interpreted the graphs literally as the paths of the cars, rather than interpreting the function information displayed by the graphs.

Two of the five interview subjects indicated that the cars collided at $t = 1$ hr., since their "paths" are intersecting. Another student stated that the cars are moving away from one another at $t = 1$ hr. The remaining two subjects provided a correct explanation, justifying that car A was ahead of car B since it had been traveling

faster for the entire time. Although the author made attempts to redirect students' attention to the function information displayed by the graphs, none of the students who provided incorrect responses attempted to rethink the problem. They all continued to provide responses suggesting they were interpreting the graphs as the paths of the cars.

Selected Interviews - Item 8a

Interview Transcript for Student A

Interviewer: Your response on question 8a is: "The position seems to be the same and hopefully a collision is taking place. They would both bounce off each other equally if they were the same mass and weight." Can you explain how you determined this result?

Student A: I say that as they cross path, it is the position of the wreck. Since they are on the same path they are going to collide.

Interviewer: Remember, the graph represents speed as a function of time.

Student A: Yes, this is why when the speeds are the same this is where the collision takes place.

Interview Transcript for Student B

Interviewer: You indicated that the two cars were moving away from each other at different speeds. Can you explain this?

Student B: Because this one (pointing to the graph for car B) is increasing speed and this one (pointing to the graph for car A) is constant, so they would go like opposite; not really opposite but they will go away from each other.

Results - Item 5

Does there exist a function all of whose values are equal to each other? Give an example to confirm the existence of a function. If one does not exist, explain why.

The mean score on the written exam was 1.07 (out of 5.0) and the standard deviation was 1.76, with only 7% of these college algebra students constructing a correct example.

Analysis of college algebra interview results reveal that four of the five interview subjects persisted with " $y = x$ " as the answer, when asked to construct a function all of whose values are equal to each other. The interviews for this question suggest that high-performing college algebra students do not understand that the function values represent the y values (assuming traditional labeling). When prompted to explain what is meant by the phrase, "all of whose values are equal to each other", two students gave responses indicating that all the x values are equal, and two students indicated that all x values must equal all y values. The

interview transcripts reveal that high performing college algebra students are not able to translate verbal function language to algebraic function notation for a basic, but essential aspect of functions.

Selected Interviews - Item 5

Interviewer: You said yes, and you constructed the function $y = x$. Explain to me why you think this function works.

Student C: I was thinking all x values are equal to all y values, like if you got one side of the equation, a number is the same number on the other side of the equation. That would fill in the whole chalk board. No, it would not fill in everything, it would be a line.

Interviewer: Does this meet the criteria that all values are equal to each other?

Student C: A function all whose values are equal. No, because what you want is something where y equals and all of the x would be equal, so you want x to be the same. That will be a straight line, a vertical line. But it would not be a function, because you cannot have a vertical line as a function, because it would not pass the vertical line test.

Interviewer: How did you determine that you wanted all the x values equal to each other?

Student C: y is just arbitrary. I mean, not arbitrary but a solution. If you want all values equal to each other, then the x values that you plug in the formula are equal to each other. So all x need to be the same.

Interviewer: It looks like you are still thinking.

Student C: Well, there is something that I am not quite grasping.

Results - Item 10

Sketch rough graphs of $f(x) = x^2 - 4$ and $g(x) = 3x$, and discuss the solution to the equation $f(x) = g(x)$ in terms of the graphs.

The mean score on this item was 3.30 and standard deviation was 1.26, with the majority of the written exam responses and 80% of the interview subjects indicating that the solutions to the equation are the points of intersection, and only 10% of the students responding correctly that the solutions are the x -values corresponding to where the y -values (function values) are equal. During the interviews the students showed no indication that they understood that graphically determining the solutions of $f(x) = g(x)$ corresponds to finding the values of the x -coordinates of the points where the two graphs intersect. The major obstacle for students in completing this problem appeared to be their inability to associate $f(x)$ and $g(x)$ with the y -values of the two graphs, and subsequently recognize that the solutions correspond to the x -values that make the equation true. Three of the interview subjects used the phrases "points of intersection" and "solutions to $f(x) = g(x)$ " interchangeably, making no distinction between the two.

Results - Item 3

If possible, describe the following situation using a function. If not, explain why.

The club members dues status.

<u>Name</u>	<u>Owed</u>
Sue	\$17
John	6
Sam	27
Bill	0
Iris	6
Eve	12
Henry	14
Louis	6
Jane	12

The written exam mean score was .7 (out of 5) with the majority of the written responses including an attempt to define a formula relating the name with the amount owed. When prompted during the interviews to explain their responses, three of the five interview subjects described an attempt to define a formula relating the name and the amount owed; further explaining that when they were unable to do so, they concluded that it was not possible to describe the situation with a function. It appears that these students believed that all function relationships must be definable by an algebraic formula.

Selected Interview - Item 3

Interviewer: Could you define this situation using a function?

Student D: No, because I did not understand a relationship that exists between each individual increase and decrease and amount. I cannot set it equal to anything I know.

Interviewer: Did you try to think of a formula?

Student D: Yes. Something to do, some way of doing that. I could not figure out the relationship between the names and how much money they owed. I could not do anything. No function exists.

Conclusions and Implications

High-performing college algebra students possess limited understanding of many aspects of the function concept. They appear to have little understanding of the function language and are unable to use function notation to represent "real world" function relationships. During the interviews they could not express one quantity as a function of another, and were unable to verbalize the meaning of $f(x + a)$ when given a quadratic function f . Although these students were able to algebraically evaluate functions for specific inputs, construct graphs of simple

algebra functions and interpret points of a graph, they demonstrated great difficulty interpreting graphical function information for intervals of the domain.

Further, the analysis of the interview results revealed that these students viewed the evaluation of a function as nothing more than a set of memorized steps. They did not view functions more generally as processes; rather they viewed them as a sequence of procedural operations to be carried out. They did not understand what it means to graphically find solutions to the equation $f(x) = g(x)$, and did not understand how to algebraically construct this equation by equating the defining expressions for the two functions. In summary, analysis of the quantitative results and interview transcripts (Carlson, 1995) indicates that these students do *not*:

- Understand the language of functions.
 - What it means for one quantity to be a function of another.
 - The role of the parentheses in an algebraic function representation.
 - That the "functional value" is the y-value (assuming conventional labeling).
- Know how to represent real world function relationships using algebraic and graphic function representations.
- Know how to interpret graphical information for intervals of the domain.
- Know how to interpret graphical information representing "rate of change".
- Understand the general nature of a function. They mistakenly think all functions must be definable by a single algebraic formula.
- Understand the role of the independent and dependent variable in an algebraic function representation.
- Distinguish between "solutions of an equation" and "roots of a function".
- Possess a process view of functions.

These results revealed that even the most talented students, at the completion of college algebra, still have many misconceptions and are unable to access much of the information explicitly taught during the course.

In addition to their conceptual misunderstandings, during the interviews students were unwilling to persist and appeared to have very little confidence in their mathematical abilities. They reported that they didn't like trying to figure out problems on their own, and appreciated teachers who showed them how to get the answers. They did not appear to trust the mathematics that they know when solving unfamiliar problems, nor did they engage in activities which demonstrate an expectation of "sense making" when constructing their responses. When prompted during the interviews to describe their mathematical experiences, four of the five interview subjects complained that the rapid pace of math courses had frequently encouraged them to resort to memorization and settle for superficial understanding.

This research identified many obstacles for college algebra students in understanding the function concept, with summary results and student interviews providing specific areas of concern and insights regarding the types of experiences and curriculum needed to guide future reforms.

Discussion and Recommendations

Gaining an understanding of the many aspects of the function concept appears to be complex, as even high performing students possessed numerous misconceptions regarding many simple but essential aspects of functions. It requires the acquisition of a language for talking about its many features and having the ability to translate that language into several different representations. Once students learn to translate between the various function representations, they must learn to interpret features of each representation for many different types of functions. Concurrently they are expected, on demand, to demonstrate the ability to construct each representation for a variety of real world situations. To further complicate matters, we ask that they learn a formal definition, at times inconsistent with the ways in which they use functions, and expect them to precisely apply this definition in arbitrary situations. At the same time, a process view of function must emerge for understanding to become complete. Even this daunting scenario is no doubt an over-simplification of what really takes place as an individual struggles to make sense of functions. However, it suggests that understanding and assimilating the many aspects of functions requires building essential function knowledge and the ability to orchestrate their function knowledge to work in concert.

This research offers insights regarding the function knowledge needed for students to "really" understand functions. It does so by revealing many of the misconceptions that college algebra students hold. Even though this research does not prescribe exact solutions for developing students' function understanding, it does provide numerous insights for curriculum developers and classroom teachers which may assist them in writing and delivering improved function curriculum. Some suggestions follow:

- College algebra students need to be engaged in activities which develop:
 - The vocabulary for referencing and constructing aspects of both algebraic and graphic function representations;
 - The ability to interpret graphical information and compare multiple graphs;
 - The ability to interpret (in the context of an applied problem) the "rate" information conveyed by the graph's shape, and compare relative rates/slopes for different intervals of the domain;
 - The ability to use functions to describe real world situations; including an ability to respond to probing questions that demonstrate an understanding of what each aspect of the graph represents in the context of the applied situation;

A view of functions as a process which accepts input and produces output;

- College algebra students appear to need extensive work with new concepts; otherwise they develop superficial understandings, replacing understanding with memorization.
- Teachers should not assume that students have acquired full understanding of even the most central aspects of concepts taught in a course; instead they should regularly probe students' understandings and make adjustments as needed.

It appears that curriculum developers and classroom teachers have underestimated the complexity of acquiring an understanding of many of the essential components of the function concept. Even high performing college algebra students do not understand essential aspects of the function concept at the completion of their course. The pace at which content is presented, the context in which it is presented, as well as the types of activities in which we engage students appear to have an enormous impact on what students know and what they can do when they exit a course. Consequently, it is recommended that curriculum developers and classroom teachers gain as much information as is currently available describing how students acquire the concepts specific to a course, as well as mathematical concepts in general. Once we have gained these insights, we have the challenge to use this information to develop new curriculum which will make real differences in developing students' function understandings, enhancing their confidence and improving their overall mathematical abilities.

References

- Breidenbach, D., Dubinsky, E., Hawks, J. & Nichols, D. (1992). *Development of the process conception of function*. Educational Studies in Mathematics.
- Carlson, M.P. (1995). *A cross-sectional investigation of the development of the function concept*. Unpublished Ph.D. dissertation, Department of Mathematics, University of Kansas.
- Cooney, T., Wilson, M. (1993). Teachers' thinking about functions: Historical and research perspectives (Chapter 6). *Integrating Research of the Graphical Representation of Functions*. New Jersey: Lawrence Erlbaum Associates.
- Dreyfus, T., & Eisenberg, T. (1988). Intuitive functional components. *Journal for Research in Mathematics Education*, 13(5).
- Kaput, J. (1992). Patterns in students' formalization of quantitative patterns. *The Function Concept*, MAA Notes, Vol. 25.
- Kleiner, I. (1989). Evolution of the function concept: A brief survey. *The College Mathematics Journal*. Vol. 20.
- Leinhardt, G., Zaslavsky, O., & Stein, M.K. (1990). Functions, graphs and graphing: Tasks, learning and teaching. *Review of Educational Research*, 60(1).
- Moschkovich, J., Schoenfeld, A., & Arcavi, A. (1993). Aspects of understanding: On multiple perspectives and representations of linear relations and connections among them. *Integrating Research on the Graphical Representation of Functions*. New Jersey: Lawrence Erlbaum Associates.
- Monk, S. (1987). *Students' understanding of functions in calculus courses*. Unpublished manuscript, University of Washington.
- Monk, S. (1992). Students' understanding of a function given by a physical model. *The Function Concept*, MAA Notes, Vol. 25.
- National Council of Teachers of Mathematics. (1989). *Curriculum and evaluation standards for school mathematics*.
- National Research Council. (1989). *Everybody counts*.

National Research Council. (1991). *Moving beyond myths: Revitalizing undergraduate mathematics.*

Schoenfeld, A.H. (1992). Aspects of understanding: On multiple perspectives and representations of linear relations, and connections among them. *Functions Group Report*, 92-01.

Selden, A. & Selden, J. (1992). Research perspectives on conceptions of functions: Summary and overview. *The Concept of Function*, MAA Notes, Vol. 25.

Sierpiska, A. (1992). On understanding the notation of function. *The Concept of Function*. MAA Notes, Vol. 25.

Vinner, S., & Dreyfus, T. (1989). Images and definitions for the concept of function. *Journal for Research in Math Ed.*, 20(4).

My grandfather once told me that there are two kinds of people: those who do the work and those who take the credit. He told me to try to be in the first group; there was less competition there.

Indira Gandhi



There are two kinds of people: those who believe they can, and those who believe they can't. Paradoxically, both are correct.

Unknown

Lucky Larry #29

The problem was to find the slope of the line that contains the points (-3, -5) and (-6, -10). Lucky Larry apparently used the "all purpose minus sign" (the one that does both negation and subtraction at the same time) and got the right answer as follows:

$$\begin{aligned}m &= \frac{y_2 - y_1}{x_2 - x_1} \\&= \frac{-10 - 5}{-6 - 3} \\&= \frac{-15}{-9} = \frac{5}{3}\end{aligned}$$

Submitted by Delores Anderson
Truett-McConnell College
Cleveland GA 30528

REGULAR FEATURES

Snapshots of Applications in Mathematics

Dennis Callas
State University College of Technology
Delhi NY 13753

David J. Hildreth
State University College
Oneonta NY 13820

The purpose of this feature is to showcase applications of mathematics designed to demonstrate to students how the topics under study are used in the "real world," or are used to solve simply "charming" problems. Typically one to two pages in length, including exercises, these snapshots are "teasers" rather than complete expositions. In this way they differ from existing examples produced by UMAP and COMAP. The intent of these snapshots is to convince the student of the usefulness of the mathematics. It is hoped that the instructor can cover the applications quickly in class or assign them to students. Snapshots in this column may be adapted from interviews, journal articles, newspaper reports, textbooks, or personal experiences. Contributions from readers are welcome, and should be sent to Professor Callas.

What's the Difference Between Debt and Deficit?

(to accompany the study of scientific notation)

by Dennis C. Runde, Manatee Community College, Bradenton, FL

A day does not go by without politicians talking about the national debt and the budget deficit. Elections can be won or lost on these issues. Yet, most Americans would find it difficult to define these terms or explain how they differ.

The following numbers were compiled by the Central Intelligence Agency (1995) and from the U.S. Treasury Department's Office of Public Debt Accounting (1996).

1995 U.S. Federal Expenditures.....	\$1.461 trillion
1995 U.S. Federal Revenues.....	\$1.258 trillion
U.S. Debt as of Dec. 30, 1994.....	\$4.800 trillion
U.S. Population as of July 1995	263.8 million

Table 1. U.S. National Debt and Deficit Facts

Discussion Questions

1. The federal budget deficit is the difference between the amount of money collected (revenues) and the amount of money spent (expenditures). What is the 1995 U.S. federal budget deficit?

$$\begin{aligned}1.258 \times 10^{12} - 1.461 \times 10^{12} &= -.203 \times 10^{12} \\ &= -2.03 \times 10^{11}\end{aligned}$$

The federal government spent about \$200 billion more than it took in. It borrowed the \$200 billion shortfall from investors through the issuing of government bonds.

2. The national debt is the sum total of all budget deficits. What will the 1995 national debt be?

$$\begin{aligned}4.800 \times 10^{12} + 2.03 \times 10^{11} &= \\ 4.800 \times 10^{12} + .203 \times 10^{12} &= 5.003 \times 10^{12}\end{aligned}$$

Our national debt is now over \$5 trillion. It should be noted that the political discussions taking place in Washington usually address reducing the budget deficit, not the national debt.

3. A first step in eliminating the national debt is to eliminate the budget deficit. If the federal budget deficit were to stay the same as it was in 1995, when would the national debt exceed \$10 trillion?

Let Y = the number of years, then we get:

$$4.800 \times 10^{12} + (2.03 \times 10^{11})Y = 1.00 \times 10^{13}$$

Which leads to:

$$\begin{aligned}Y &= \frac{1.00 \times 10^{13} - 4.800 \times 10^{12}}{2.03 \times 10^{11}} \\ &= \frac{1.00 \times 10^{13} - .4800 \times 10^{13}}{2.03 \times 10^{11}} \\ &= \frac{.52 \times 10^{13}}{2.03 \times 10^{11}} \\ &= .256 \times 10^2 \\ &= 25.6 \text{ years}\end{aligned}$$

Unless efforts to reduce the deficit are successful, at the 1995 rate, the national debt will surpass the \$10 trillion mark sometime during the year 2020.

4. Suppose everyone in the U.S. were to pitch in to retire the national debt. How much would each man, woman, and child need to contribute to retire the 1995 debt?

$$\begin{aligned}\frac{5.003 \times 10^{12}}{2.638 \times 10^8} &= 1.896513 \times 10^4 \\ &= \$18,965.13/\text{person}\end{aligned}$$

Obviously, this is not a feasible solution to reducing the debt. The debt should be discussed though for many reasons; not the least of which is the amount of interest paid by the government.

- Suppose the average interest rate on the national debt is 5%. Using the simple interest formula, $I = P * r * t$, how much interest would the government pay for the year 1995?

$$I = (4.800 \times 10^{12}) * (.05) * 1$$

$$I = 2.400 \times 10^{11}$$

The government therefore spends over \$200 billion each year just on paying interest on the national debt.

- What percentage of the federal revenues does this interest comprise?

$$\frac{2.400 \times 10^{11}}{1.258 \times 10^{12}} = 19.1\%$$

Almost one dollar in every five goes toward paying the interest on the debt of the federal government.

Exercises

- The following numbers were compiled by the Central Intelligence Agency (1995) with regard to the Canadian Government's debt and deficit. Use these data to answer the same questions asked above. How does the debt/deficit status of Canada compare to that of the U.S?

1994 Canadian Government Expenditures.....	\$115.3 billion
1994 Canadian Government Revenues.....	\$85.0 billion
Canadian Debt as of Dec. 30, 1993.....	\$243.0 billion
Canadian Population as of July 1995.....	28.43 million

Table 2. Canadian National Debt and Deficit Facts

- Given that a one inch thick stack of \$100 bills has about 225 bills, find the "height" of the U.S. debt in \$100 bills using inches, feet, and miles.
- Given that a \$100 bill is about 6.125 inches long, find the "length" of the U.S. debt in \$100 bills using inches, feet, and miles.
- Write a 2-3 page paper on how to reduce the deficit. Include numerical support for your proposed plan.

5. Using *The World Fact Book* (see URL below), compare the debt/person ratio of the U.S. to that of Canada, Mexico, Argentina, Brazil, Japan, Taiwan, United Kingdom, Germany, South Africa, Australia, Egypt, Saudi Arabia, and Israel (or include any other country of interest to you).

References

- Central Intelligence Agency. (1995). *The world fact book 1995*. Available: <http://www.odci.gov/cia/publications/95fact/us.html>
- Galbraith, J. K., & Darity, W. Jr. (1995). A guide to the deficit. *Challenge*, 38(4), 5-12.
- United States Treasury Department. (1996). *World wide web site*. Available: <http://www.ustreas.gov/treasury>

Common sense is the collection of prejudices acquired by age eighteen.

Albert Einstein



Mathematics is often erroneously referred to as the science of common sense. Actually, it may transcend common sense and go beyond either imagination or intuition. It has become a very strange and perhaps frightening subject from the ordinary point of view, but anyone who penetrates into it will find a veritable fairyland, a fairyland which is strange, but makes sense, if not common sense.

E. Kasner and J. Newman

Advertiser's Index

AMATYC Annual Conference.....	p. 20
AMATYC Office Information.....	p. 72
Faculty Development Programs.....	p. 47
Houghton Mifflin.....	p. 46, 47
JEMware.....	p. 27
John Wiley & Sons, Inc.....	p. 35
Texas Instruments.....	p. 3, 5

Notes from the Mathematical Underground

by

Alain Schremmer

Mathematics Department, Community College of Philadelphia

1700 Spring Garden Street

Philadelphia PA 19130

SchremmerA@aol.com

The opinions expressed here are those of the author and should not be construed as representing the position of AMATYC, its officers, or anyone else.

Posted: This column seeks to advocate (provoke?) an analysis and a discussion of the *mathematics* underlying the courses we teach, Basic Arithmetic, Calculus, Linear Algebra, ... and of exactly *what* the students get out of it and of *why* they should get it.

The reason we don't like to do this is that, to begin with, we don't understand much mathematics and, then, usually haven't given much thought to what little we assume we know. The late I. N. Herstein used to advocate the creation of a Ph.D. in mathematical *knowledge* alongside the conventional Ph.D. in mathematical *research*. Briefly, he argued that the research Ph.D. mostly resulted in infinite expertise in infinitesimal areas and that this was quite incompatible with the training of college students. As I recall, he said that the research Ph.D. produced people with no idea of how to present anything outside their area of expertise, if that. (Hence the need for the "fat text".) On the other hand, the Ed.D. produces people who claim to know all about "how to present" with no idea of what it is they are talking about. (Hence the need for... .) Predictably, his adjurations had no effect whatsoever. The only example I know of a thesis written along such lines is *A Proposed Sophomore-Level Experimental Course in Geometric Algebra Based Primarily on the Work of Emil Artin* (Judd, 1969) and, in fact, it was more a paraphrase of (Artin, 1957) than the construction of a real course.

But even distinguished mathematicians often don't seem to see that lesser beings might want to approach the subject in alternate ways. Not too long ago, a very well known mathematician wrote that "*the central notion of calculus is that of a limit*" and consequently complained about the lack of precision in the definition of limit in some text: How, under such circumstances, could the students be expected to learn what a limit is. I replied to him

"I would rather put it like (Gleason, 1967):

The course we teach in college which is usually called Calculus frequently hurries into such questions as differentiation and integration, and often fails to put the proper emphasis on what the subject is all about, namely functions of a real variable, or of several variables. The differential and integral calculus are, after all, techniques used to find out certain properties of functions, and should not be considered as ends in themselves.

"Thus, I would say that limits are just a tool. A powerful tool but not one indispensable to beginners. There was once an exchange among, I believe, Thom, Serre and Dieudonné about the latter's *A bas Euclide*: The question was the extent to which linear algebra and axiomatic affine geometry ought to replace Euclid's twelve books. One of Dieudonné's adversaries maintained that one could enter geometry at many different points and that what most mattered was that the point of entry be clearly delineated.

"I would argue that it is precisely the identification of 'the' calculus with its Bolzano-Cauchy-Weirstrass avatar that has doomed the 'calculus reform'. For instance, one can easily enter the calculus by way of little ohs given with their operating rules (rather than defined from limits). To be sure, even if, for a Freshman (Freshperson?), enough functions admit asymptotic expansions, not all do. For those who will continue, that very fact will be the 'raison d'être' for limits. Of course, at the level of *my* students, all little ohs are replaced by (...), read 'a little bit' and justified only by considerations of orders of magnitude for powers of 10: When they see h , they are to think of 0.1.

"Where I most disagree is in what constitutes 'le mot juste'. I think it was Church who pointed out that a perfectly correct definition of the human animal is that it is a featherless biped. Is a draughtman's drawing of an apple more specific, more evocative than a rendering by Cézanne? I can well imagine that a thousand counter-examples must have gone through your mind as you read the Harvard text but, much as I dislike the book, I must point out that no such counter-examples are likely to come to the mind of most of its readers, instructors included, so that what portion of the message *can* be transmitted will have been effectively transmitted. How precise the language should depend on the audience. The criteria for rigor imposed by research mathematicians on mathematics beginners have resulted, for instance, in basic algebra texts that, while they nowhere mention complex numbers, make sure that the equation $x^2 + 1 = 0$ is said to have no *real* solution. On the other hand, these same texts never discuss issues such as how \mathbb{Z} arises out of the manner in which, for instance, $3 + x = 2$ has no solution in \mathbb{Z} or how, with the equation $3x = 2$, we can either construct \mathbb{Q} and say the solution is $\frac{2}{3}$, which is exact but says nothing about its order of magnitude, or use approximate decimal solutions. In a different vein, that, for instance, constant functions are degenerate affine functions needs to be pointed out but taking it constantly into consideration complicates the language to the point where it becomes completely opaque. I would rather warn the students that my language is not foolproof and invite them to find the loopholes I left, wittingly or not.

"I also think that the current efforts to make calculus '*user friendly*' are misplaced: First Year Calculus has essentially no application to the real world; Differential Equations is the first course that does. If one insists to the contrary, then I am afraid that calculus will go the way of Greek and Latin, to be replaced by some kind of data analysis. For the most part, and certainly for beginners, mathematics can only be a labor of love, even when unrequited.

"As to proof versus justification or even plausibility, I think, again, that the issue is more the consistency of the level of rigor with the audience. In my experience,

'just plain folks' (*weak students*'?) will enjoy mathematics in general and calculus in particular when the idea of proof is presented as what attorneys do in front of a jury, namely give convincing arguments with the amount of supporting evidence depending largely on the challenges of the other side. Which is perhaps why I have a nostalgia for the oral examinations of my youth in which what we said might be challenged at any moment."

The above is slightly abbreviated but the extremely influential and very redoubtable mathematician's full answer was:

Professor Alain Schremmer.

I feel sorry for your students, who will evidently and sadly be misled.

Yours truly,

Already on several occasions I have raised the issue of contents architecture. Here is another. In his preface, the author of (Valenza, 1993) asks:

"What is the nature of linear algebra? One might give two antipodal and complementary replies: like wave and particle physics, both illuminate the truth:

THE STRUCTURAL REPLY. Linear algebra is the study of vector spaces and linear transformations. A vector space is a structure which abstracts and generalizes certain familiar notions of both geometry and algebra. A linear transformation is a function between vector spaces that preserves elements of this structure. In some sense, this discipline allows us to import some long-familiar and well understood ideas of geometry into settings which are not geometric in any obvious way.

THE COMPUTATIONAL REPLY. Linear Algebra is the study of linear systems and, in particular, of certain techniques of matrix algebra that arise in connection with such systems. The aims of the discipline are largely computational, and the computations are indeed complex."

Indeed, the computational approach, a historically well founded architecture, deriving as it does from what used to be called "Higher Algebra", starts with systems of equations to end with linear transformations. This has of course the merit that, for students thoroughly familiar with systems of at least two or three equations, as was generally the case once upon a time, it can make sense to engage in a careful, detailed generalization via Gauss elimination in matrix form. This is the route taken, inter alia, by (Anton & Rorres, 1994) (and I must admit that I rather liked this opus of the illustrious author of "*In defense of the Fat Calculus Text*") as well as by (Strang, 1980), an author I respect enormously – the introduction alone justifies acquiring the book. However, I contend that the only reason this route appears natural is that it is the historical one. (Just as the order which, in arithmetic, makes us teach fractions ahead of decimals and integers.) Then, there is the unfortunate fact that none of *my* students, even the very sharp ones, is well-grounded in the solution of systems of equations.

The much more recent structural approach usually begins with the study of \mathbb{R}^n as vector space and of matrix transformations $\mathbb{R}^m \rightarrow \mathbb{R}^n$. But a really natural

route would start with the coordinate-free notion of a geometric transformation, $\mathcal{T}: V^{(m)} \rightarrow W^{(n)}$, a distinguished, *once bases have been chosen* in $V^{(m)}$ and $W^{(n)}$, from its matrix representation $T: \mathbb{R}^{(m)} \rightarrow \mathbb{R}^{(n)}$:

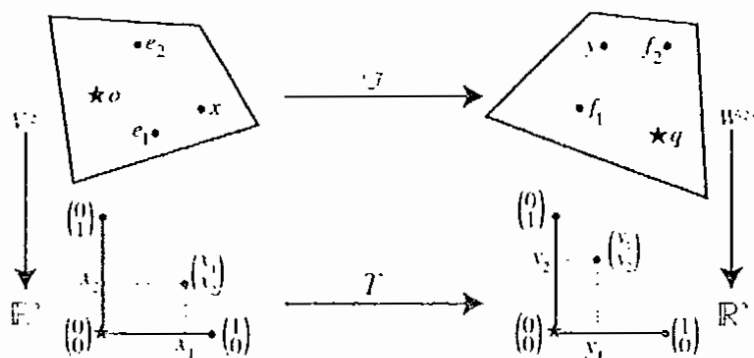

Then, given $b \in W^{(n)}$, and to quote Strang, "(the) goal is a genuine understanding, deeper than elimination can give, of the equation $\mathcal{T}(x) = b'$ " – as distinguished from the system of equations $\sum T_{ij}x_j = b_i$.

Admittedly, linear algebra is a very tough subject to organize *and* to make transparent. What I would like to see is something like *A proposed Sophomore-Level ... based on ...*, say, the first part of (Lax, 1997). No doubt, this route has structural problems of its own and this should be cause enough for an "exchange" to take place in this space.

Re mathematics' *relevance*: How come the issues that we absolutely avoid are absolutely the most relevant ones, namely those that regard the *polis*? Why couldn't we, for instance and at least those of us who have tenure, give to an arithmetic class the following "word problem" adapted from (Bartlett & Steele, 1996), a rich source of "applications":

A Federal Reserve Board study shows that the top 1 percent of households in the USA controls 30.4 percent of the nation's net worth and that the next 9 percent holds 36.8 percent of the nation's wealth. How much does the remaining 90 percent account for?

Re computers: I just read (Gordon, Fusaro & Meyer, 1989). It is worth rereading. Not because it purports to explain why I should computerize my classes but because it is such an excellent illustration of those "*methods of proof which do not appear in treatises [on formal mathematics], but, none the less, are used in many mathematics classrooms and textbooks: 1. Manus Flutterus, 2. Proof by*

Intimidation, 3. Proof by Circumvention, 4. Proof by Coercion." (Browne, 1989). There is not even a single reference to supporting research. Could it be that there isn't any? That the emperor has no clothes?

References

- Anton, H., & Rorres, C. (1994). *Elementary linear algebra - applications version*. (7th ed.). New York: John Wiley & Sons, Inc.
- Artin, E. (1957). *Geometric algebra*. New York: Interscience Publishers, Inc.
- Bartlett, D. L., & Steele, J. B. (1996, September 8-22). America: Who stole the dream? *Philadelphia Inquirer*.
- Browne, J. (1989). Methods of proof. *The AMATYC Review*, 10(2), 31.
- Gleason, A. M. (1967). *The geometric content of advanced calculus*. Paper presented at the CUPM Geometry Conference.
- Gordon, S. P., Fusaro, B. A., & Meyer, R.W. (1989). The role of computers in two year college mathematics. *The AMATYC Review*, 10(2), 42-51.
- Halmös, P. R. (1958). *Finite-dimensional vector spaces*. (2nd ed.). Princeton: D. Van Nostrand Company, Inc.
- Judd, W. B. (1969). *A proposed sophomore-level experimental course in geometric algebra based primarily on the work of Emil Artin*. Pennsylvania State University.
- Lax, P. D. (1997). *Linear algebra*. (1st ed.). New York: John Wiley & Sons, Inc.
- Strang, G. (1980). *Linear algebra and its applications*. (2nd ed.). New York: Academic Press.
- Valenza, R. J. (1993). *Linear algebra. An introduction to abstract mathematics*. New York: Springer.

Like the ski resort full of girls hunting for husbands and husbands hunting for girls, the situation is not as symmetrical as it might seem.

Alan Lindsay Mackay



All mankind is divided into three classes: those that are immovable, those that are moveable, and those that move.

Arabic proverb

Book Reviews

Edited by Sandra DeLozier Coleman

FLATLAND A Romance of Many Dimensions, Edwin A. Abbott, A Signet Classic, Penguin Books USA Inc., 1984, 160 pages, ISBN 0-451-52290-7, pbk.

ALICE IN QUANTUMLAND An Allegory of Quantum Physics, Robert Gilmore, Copernicus, an imprint of Springer-Verlag New York, Inc., 1995, ix + 184 pages, ISBN 0-387-91495-1.

The travel section of the local bookstore is packed with picture books designed to lure readers to exotic places or to help them make the most of any trip. Sometimes just imagining exploring some yet undiscovered city can serve to fill a quiet afternoon. For armchair travelers in the world of mathematics, I can recommend two books which won't be found in the travel section of the local bookstore, but which lead to exotic locations in the realm of the imagination that adventurous minds are sure to enjoy visiting.

Perhaps the best known among such travel guides is *Flatland, A Romance of Many Dimensions*, a classic tale written by Dr. Edwin A. Abbott in 1884. The book has been reissued many, many times and is currently offered by several different publishing houses. It is a "must read" for every mathematician, but would be a good choice for any reader who would enjoy having a slight push to reach beyond the everyday view of the world in which we live.

Within the pages of *Flatland*, we journey in our imaginations to an interesting two-dimensional realm in which the male inhabitants are polygons and the female inhabitants are line segments. There we discover a complicated society in which social position is clearly defined by one's shape, and in which prejudices abound. As we explore this new world, we learn about the housing, the weather, occupations, family relationships, and more. The interaction between the sexes in Flatland is particularly interesting as a reflection of Victorian values and customs. Abbott's work is a satire designed in part to amuse us by exposing some of the pettiness and ignorance to which we space inhabitants have sometimes fallen prey. Viewed from an historical point of view, it is interesting to note how much has changed in the last one hundred years.

To the mathematician, the elaborate social satire is of minimal interest, however, compared to the physical and philosophical implications of the central event of the story – an encounter between the story's narrator, a rather unsophisticated square, and a spherical visitor from the realm of three dimensions. The square, having no related experience to use as a point of reference, sees the sphere which passes through his plane as a phantom which suddenly appears out of nowhere. He sees no sphere, but, rather, only a point which first expands to a circle of increasing size and then diminishes until it disappears. When the sphere, frustrated by his inability to make his nature known, finally snatches the helpless square from his comfortable position of limited knowledge into a whole new world, the astonished square finds

that he is at a loss for words to describe what has taken place. His futile attempt to explain what he has seen to other Flatlanders earns him only a diagnosis of insanity.

The square is helped on his path to understanding by a dream in which he finds himself a visitor in a one-dimensional Lineland, where the inhabitants are points and line segments. Experiencing firsthand the frustration of not being able to explain his nature to the king of that world, he is better able to comprehend the problem encountered by the sphere. As the reader places himself and his perception of reality within the framework of the *Flatland* allegory, it is impossible not to consider the implications for three-dimensional beings. He finds himself wanting to comprehend the idea of a universe of four or more dimensions. The sphere provides some help by using inductive reasoning to relate the point to the line, the line to the square, the square to the cube, and the cube to the four-dimensional hypercube by comparing the number of vertices, edges, and faces and noting the patterns in these sequences. He challenges us to imagine a direction perpendicular to all three of the directions we commonly represent by the x , y , and z axes. Just when we are about to shout, "Nonsense," because we find such a direction incomprehensible, we hear the voice of the lowly square murmuring something about "Upward, not northward," and begin to see that to view the universe that we perceive with our senses as the ultimate reality is immodest to say the least. It is this revelation which makes the story worth the reading.

In addition to the many printed copies of *Flatland* available from various publishers, an unabridged version is also available as public domain electronic text and can be accessed, downloaded, and printed from the internet through the address: <ftp://wiretap.spies.com/Library/Classic/flatland.txt>.

Having ventured into the mind-expanding universe of multiple dimensions, adventurous travelers who find themselves hungry for more might want to hitch a ride with Robert Gilmore's heroine as her curiosity and restlessness lead her deep into the rabbit hole of subatomic particles. In *Alice in Quantumland - An Allegory of Quantum Physics*, Gilmore's Alice carries the experience of shrinking to the extreme as she enters a strange and wonderful world where she experiences firsthand the nature of quantum mechanics.

Greeted on her arrival by a rapidly-moving spin-up electron, Alice realizes immediately that she will have many new rules to learn in these unaccustomed surroundings. As her companion tries to comply with her request that he slow down so that she can see him, she is surprised to find that the very act of slowing down causes him to become so spread out and hazy that she can see him no better than when he was bouncing to and fro. As Alice and her companion wait to board the photon express, she soon begins to learn how sensitive an electron can be when asked to go against his principle (the Pauli principle) and occupy the same space as another electron.

As Alice encounters one strange character and event after another, she searches constantly for someone who can explain to her what is going on around her. Her first stop is at the Heisenberg Bank, where an accommodating bank manager

attempts to explain to her about energy loans. Here again the rules seem strangely at odds with what Alice had thought would be natural, since instead of allowing larger loans to be paid back over a greater amount of time than smaller loans – the larger the loan, the shorter the time a virtual particle is allowed to keep its borrowed energy. She learns that just as money can take the form of cash or a savings account or an investment, energy can take various forms such as *kinetic energy* or *potential energy*.

Just as poor Alice begins to think that she understands, she is introduced to the Uncertain Accountant, who tells her confidentially that the energy the bank is loaning doesn't really *come from* anywhere. It is a quantum fluctuation and the amount of energy that any system has is not absolutely definite. The fact that the energy is less well-conserved in the short run than in the long run, explains why it is taking him *forever* to balance the books.

Alice's many questions lead the accountant to suggest that she visit the Mechanics Institute, but he warns her that any door might lead there and that the best he can do for her is to arrange for a high probability that she will reach her destination. He proceeds to direct her to go through all of the available doors at once, which he insists she can do as long as he does not observe her going through any door in particular. Despite her protests that it is ridiculous to assume that whatever is not forbidden is compulsory, he convinces her that if she wants to get anywhere she must do *everything* she can possibly do and all at the same time! Alice opens the doors and steps through.

Along the many paths she travels, Alice meets a host of interesting characters who attempt to help her to understand the land that she is visiting. The Classical Mechanic and the Quantum Mechanic leave their game of billiards to introduce her to cause-and-effect relationships, the phenomenon of interference, and the concept of superposition of states. An encounter with Schrödinger's cat leads to more questions which she hopes to have answered in a university classroom if she can only determine how to get there.

At the Copenhagen School, delightful fairy tale characters make their cases for various hypotheses related to what we observe to be *real* in the universe in which we live. The philosophical implications are mind-boggling, making this chapter interesting reading even for those who do not care to learn about particle and energy relationships. The Emperor, for example, a proponent of the Mind over Matter hypothesis, suggests that any purely material system is always in a combination of states in which all that might be or might have been co-exist and that it is only when the situation is observed by a mind, which exists outside the laws of the quantum world, that a selection from among all of the possibilities is made. That which is observed is selected and becomes *reality*.

Throughout her journey Alice complains that there is too much that she does not fully understand. Apparently she is in good company, since Neils Bohr, the father of quantum mechanics once said that anyone who did not feel dizzy when thinking about quantum mechanics had not understood it. It's too bad that the converse doesn't follow.

Alice's creator, Robert Gilmore introduces his story by warning us that much of the way that quantum mechanics describes the world may seem at first sight to be

nonsense – and that possibly it may seem so at the second, third, and twenty-fifth sight as well. He tells us that the world seems to be stranger than we have imagined and possibly stranger than we *can* imagine. Yet, the quantum explanation, which seems to agree with all observations made, even while disputing that any observations can actually *be* made at all, seems to be the only game in town. If we would wish to understand the physical reality of our own existence, we can make a modest beginning by joining Alice as she explores this world within our world and then thank our host for the facts and the fantasy which we enjoy along the way.

Reviewed by the Editor, Sandra DeLozier Coleman.

The AMATYC Review welcomes contributions of book reviews by its readers. We would like to continue to have reviews of books that would be of interest to a broad spectrum of persons associated with or interested in the world of mathematics. Reviews of individual books are welcome, although we would like to know about groups of books which complement each other in shedding light on a particular topic. Occasionally, reviews from several readers may be combined in order to present this type of selection.

Send reviews to: Sandra DeLozier Coleman, 4531 Parkview Lane, Niceville, FL 32578-8734, SDColeman@AOL.COM

To know that what is impenetrable to us really exists, manifesting itself as the highest wisdom and the most radiant beauty, which our dull faculties can comprehend only in their most primitive forms – this knowledge, this feeling, is at the center of true religiousness.

Albert Einstein

AMATYC OFFICE INFORMATION

AMATYC
State Technical Institute at Memphis
5983 Macon Cove
Memphis, TN 38134

Phone: (901) 383-4643 • Fax: (901) 383-4651

E-MAIL:

Bill Kelly - amatyc@stim.tec.tn.us
Christy Hodge - ahodge@stim.tec.tn.us
Cheryl Cleaves, Executive Assistant - cleaves@stim.tec.tn.us

The Problem Section

Dr. Michael W. Ecker
Problem Section Editor
The AMATYC Review
909 Violet Terrace
Clarks Summit PA 18411

Dr. Robert E. Stong
Solution Editor
The AMATYC Review
150 Bennington Road
Charlottesville VA 22901

Greetings, and welcome to the AMATYC Review Problem Section! I usually reserve this space for instructions on problem submission. This time, however, after 16 years of doing this, I announce my retirement as the Founding Problem Section Editor of *The AMATYC Review*. This is my final column in that capacity.

An avid problem-solver and problem-poser in the late 1970s through the 1980s, I decided in 1981-82 to intensify my activity. Usually a participant in the ranks, I liked the idea of being in charge, a lieutenant. Alas, all of the magazines of the MAA and kindred organizations had well-established problem columns. Around 1981 I heard of a relatively new organization, AMATYC. After seeing *The AMATYC Review*, I pitched the idea of a problem section to the late Etta Mae Whitton, then *The AMATYC Review's* Editor. Perhaps I was brash, barely familiar with the new organization or the publication. However, I remember thinking that AMATYC's *Review* would look more like a collegiate mathematics publication by having its own problem section.

I've served under at least four editors in this space for the past 16 years. During most of the 1980s I continued to pose and solve problems, with recognition in the form of an invitation to join the Advisory Panel of the MAA Committee on High School Contests, and then later as member of the Committee on American Mathematics Competitions. Most of my later work for the committee was done for the AIME subcommittee. I've met lots of great problem-solvers, such as legendary Murray Klamkin, who has not hesitated to tell me once or twice when I was doing something boneheaded with this section! Heady times and great challenges!

However, in 1982 I was bitten by the computer bug as well. In 1978-82 I authored a dozen mathematics papers, but during 1982-1990 I authored 350 publications that were mostly columns, reviews, and articles of computer-related materials. In the course of writing for one PC magazine that lasted just half a year (*PC Clones*, first half of 1988), I got a letter from a modest fellow who simply signed his name Bob Stong. He wrote with mathematical information on permutations groups, but the authority with which he wrote gave him away as a mathematician. I looked him up in the MAA listings and found Dr. Robert Stong, professor of mathematics at the University of Virginia. I came to correspond with him and shortly thereafter asked him to serve as Solutions Editor. And now, my dirty little secret is out: Bob has done most of the real work for the second half of my tenure here! I have been blessed by his assistance, and so I thank him.

My wife warned me that people would assume that I am old and retiring overall. Not so! I'm still tenured at the Wilkes-Barre Campus of Penn State U., soon to be in PSU's new Commonwealth College. I won't retire for 20 years or so. I am in my twelfth year of a lifetime commitment of publishing my own newsletter/fanzine, **Recreational & Educational Computing (REC)**. Begun Jan. 1986 as an outgrowth of my former computer math recreations columns in *Byte*, *Popular Computing*, and *Creative Computing*. REC features the interplay of math and computers that I love enough to make my life's work. Dr. Stong continues to serve as a REC Senior Correspondent. He's in good company there, as this title is shared only by the renowned Martin Gardner!

I thank AMATYC, its officers, and its editors (past and present), and you readers, for the opportunity to have served in this capacity for so long. This is a volunteer organization of committed individuals, after all. What we get out is what we put in. It is time for me to step aside and let somebody else with knowledge and dedication take over, assuming AMATYC wishes to continue this department and pick a worthy successor.

If you have been enjoying this column, I would love to hear from you. Please write to me or e-mail me at MWE1@psu.edu, DrMWEcker@aol.com, or DrMichaelE@Juno.com.

We are pleased to announce that regular contributor to the Problem Department, Stephen Plett, has accepted the position as new editor of the department. Correspondence to the Problem Department should now be sent to

Stephen Plett
Fullerton College
321 East Chapman Avenue
Fullerton CA 92832

Ed.

New Problems

Set AG Problems are due for consideration April 1, 1998. However, regardless of deadline, no problem is ever closed permanently, and new insights to old problems are always welcome.

Problem AG-1. Proposed by Donald Fuller, Gainesville College, Gainesville, GA.

A jogging math professor wonders under what circumstances he can be absolutely certain in the course of a long run that he has covered at least 1.5 miles in some continuous 12-minute segment of his run. For example, if you ignore the limitations of current human performance, in which of the following cases must the individual have passed the following test?:

1. He runs 2.99 miles in 16 minutes.

or

2. He runs 3.0 miles in 24 minutes.

Can you generalize the result?

Problem AG-2. Proposed by Michael W. Ecker, Pennsylvania State University, Wilkes-Barre Campus, Lehman, PA.

Given an arbitrary vector space over the field of real numbers and any element x of the space, **must** $x + x = 2x$? (Take other fields if you wish to see whether the answer is affected.)

Problem AG-3. Proposed by Michael W. Ecker, Pennsylvania State University, Wilkes-Barre Campus, Lehman, PA.

You are given a function f differentiable on \mathbb{R} (i.e., the set of all real numbers) and a point $Q = (x_0, y_0)$ not on the graph of f . Consider the point $P = (x, y)$ on the graph that is closest to Q . It is intuitively clear that PQ is normal to the curve at P .

- After satisfying yourself that point P must exist, prove the claimed normality.
- By weakening the hypotheses, produce a counter-example to show that a more general function – even one with domain \mathbb{R} – need not have a point closest to a given external point.

Problem AG-4. Proposed by Kenneth G. Boback, Pennsylvania State University, Wilkes-Barre Campus, Lehman, PA.

Calculate $R = \sqrt{\sqrt{3} + \sqrt{-1}} + \sqrt{\sqrt{3} - \sqrt{-1}}$ exactly.

Problem AG-5. Proposed by Kenneth G. Boback, Pennsylvania State University, Wilkes-Barre Campus, Lehman, PA.

Define a *diameter* of an ellipse as the locus of midpoints of a system of parallel chords. Let an ellipse $\frac{x^2}{a^2} + \frac{y^2}{b^2} = 1$ be specified with $a^2 > b^2$ along with a set of parallel chords of slope m .

- Find in terms of a , b , and m the slope of the corresponding diameter. Also find its equation.

Suppose now that m is such that the parallel chords and the diameter meet at a 45-degree angle.

- What is the relation of m to a and b ?
- What is the greatest lower bound of $\frac{a}{b}$? (This defines the solution class of ellipses.)

Problem AG-6. Proposed by Loren Krienke, San Diego, California.

Given an investment portfolio of an amount M that produces a rate of return, r . At the beginning of the year you want to withdraw an amount x for living expenses in the first year. At the beginning of the second year you want to increase the amount you withdraw to provide for inflation, assumed to be p . In all subsequent years you want to continue giving yourself cost-of-living adjustments. (At the start of the first year, withdraw x . At the start of the second year, withdraw $x(1+p)$. At the start of the third year, withdraw $x(1+p)^2$, etc.).

What is the percentage of M you should withdraw at the beginning if you expect to live for n years? I.e., find a formula $x = f(M, r, p, n)$ where M = current value, r = periodic rate of return, p = periodic provision (rate) for inflation, n = number of periods, and x = amount to withdraw at the start to achieve a future value of zero at the end of the n th period. Then convert the result into the form $\frac{x}{M} = g(r, p, n)$.

Hints: At the start of the second period, the portfolio will have the value $(M-x)(1+r)$. Note also that at the start of the n th period, the withdrawal will be 100%. At the start of year $(n-1)$, the withdrawal will be approximately 50%. A special case is required when $p=r$.

Problem AG-7. Proposed by Vahagn H. Mikaelian, Department of Informatics, Yerevan State University, Armenia. (Note: Ken Boback independently sent a fairly similar proposal & solution.)

We have a homogeneous $10\text{mm} \times 18\text{mm} \times 50\text{mm}$ rectangular parallelepiped box of matches, $ABCD A' B' C' D'$, where $AB = 10\text{mm}$, $BC = 18\text{mm}$, $AA' = 50\text{mm}$. Two points, M and N , are given on faces $ABCD$ and $A' B' C' D'$, respectively, such that M and N are equidistant from edges AD and $B' C'$, respectively. This distance is equal to 1mm . M and N are equidistant from points A, D , and B', C' , too.

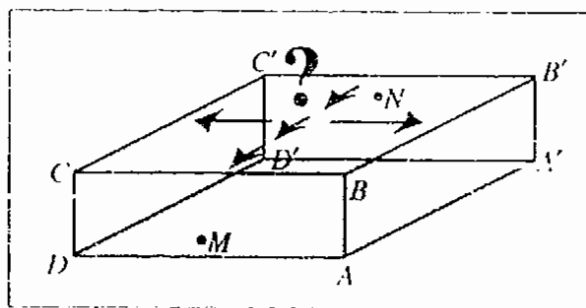

Can an ant (= a single mass point) go from point N to point M such that the length of the path is less than 60mm ?

(The ant **cannot** go inside the box!)

Problem AG-8¹. Proposed by Michael W. Ecker, Pennsylvania State University, Wilkes-Barre Campus, Lehman, PA.

Characterize all real-valued polynomial functions f of a single real variable x such that $f(x)$ is rational if and only if x is rational. (¹ I know the answer, but don't have my own proof.)

Set AE Solutions

Boxing Match

Problem AE-1. Proposed by the Problem Editor, but borrowed from elsewhere.

Find all rectangular solids whose sides have integral lengths and whose surface area is numerically equal to the volume (in that system of units).

Solutions by Robert Bernstein, Mohawk Valley Community College, Utica, NY; Donald Fuller, Gainesville College, Gainesville, GA; Randy K. Schwartz, Schoolcraft College, Livonia, MI; and the proposer.

Letting the sides be $a \leq b \leq c$, one has $abc = 2(ab + ac + bc)$ so $abc \leq 6bc$ and so $a \leq 6$. Fixing a , $(a - 2)bc = (2a)(b + c)$ which forces $a \geq 3$. Then $(4a)c \geq 2(b + c) \geq (4a)b$, so $(4a)c \geq (a - 2)bc \geq (4a)b$ giving $c \geq \frac{4a}{a-2} \geq b \geq a$. For

each fixed a and b with $3 \leq a \leq 6$ and $a \leq b \leq \frac{4a}{a-2}$ one then has a linear equation for c . Solving this list of equations, one finds 10 solutions given by:

(3, 7, 42), (3, 8, 24), (3, 9, 18), (3, 10, 15), (3, 12, 12), (4, 5, 20),
(4, 6, 12), (4, 8, 8), (5, 5, 10), and (6, 6, 6).

Side, Angle, Area?

Problem AE-2. Proposed by the Problem Editor and Jim Preston, Minneapolis, MN.

Given that a proposed triangle is to have a given area, one given side, and the opposite angle given, find the other parts. If necessary, consider discussion of existence and uniqueness of such a triangle based on the given information.

Solutions by Kenneth G. Boback, Penn State University, Wilkes-Barre Campus, Lehman, PA; Randy K. Schwartz, Schoolcraft College, Livonia, MI; and the proposer.

Let K be the area and suppose the sides are a , b , and c , with c and the angle C being given. Then $K = \frac{1}{2}absinC$ gives the value ab . From $c^2 = a^2 + b^2 - 2abcosC$, the value of $a^2 + b^2$ is then known. Then $(a + b)^2 = a^2 + b^2 \pm 2ab$ gives $a + b$ and $a - b$ (supposing $a \geq b$), and then a and b are known. The law of cosines will determine the angles A and B .

Random Angles

Problem AE-3. Proposed by the Problem Editor.

Suppose that you have an equiprobable choice of any one of the 180 angles of integral degree-measures 1 through 180. You randomly pick two such measures, one at a time, with replacement. In fact, after any one choice, the next choice is independent of the first.

What is the probability that the two chosen angles are complementary? ... supplementary?

Solutions by Robert Bernstein, Mohawk Valley Community College, Utica, NY; Kenneth G. Boback, Penn State University, Wilkes-Barre Campus, Lehman, PA; Bill Fox, Moberly Area Community College, Moberly, MO; Donald Fuller, Gainesville College, Gainesville, GA; Keith McAllister, City College of San Francisco, San Francisco, CA; Dennis Reissig, Suffolk Community College, Selden, NY; Randy K. Schwartz, Schoolcraft College, Livonia, MI; and the proposer.

There are 180×180 choices for the two angles. For complementary angles, one has a pair $(A, 90 - A)$ and must have $1 \leq A \leq 89$. The probability is then $\frac{89}{180 \times 180}$. For supplementary angles, one has a pair $(A, 180 - A)$ and must have $1 \leq A \leq 179$. The probability is $\frac{179}{180 \times 180}$.

Fermat Fun

Problem AE-4. Proposed by the Problem Editor, but borrowed from elsewhere.

Consider any right triangle with legs a, b and hypotenuse c . Of course, $a^2 + b^2 = c^2$. Let $n > 2$. What can you say about $a^n + b^n$ vs. c^n ? (Prove your answer.)

Solutions by Robert Bernstein, Mohawk Valley Community College, Utica, NY; Bill Fox, Moberly Area Community College, Moberly, MO; Donald Fuller, Gainesville College, Gainesville, GA; Randy K. Schwartz, Schoolcraft College, Livonia, MI; and the proposer.

Since $a^2 + b^2 = c^2$, one has $a < c$ and $b < c$. Then $a^n + b^n = a^2 a^{n-2} + b^2 b^{n-2} < a^2 c^{n-2} + b^2 c^{n-2} = (a^2 + b^2) c^{n-2} = c^n$. Thus $a^n + b^n < c^n$.

Persistent Resistance

Problem AE-5. Submitted by Don L. Lewis, Bee County College, Beeville, TX.

Each individual resistor below has resistance r . Find the equivalent resistance of the infinite network. (Option: Write a terminating continued-fraction expression for a network of n loops).

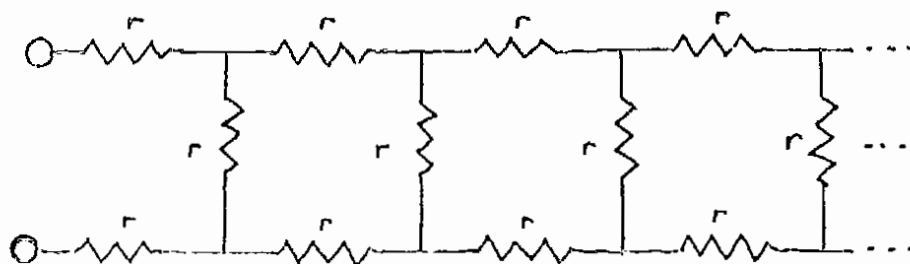

Solutions by Donald Fuller, Gainesville College, Gainesville, GA; James E. Kessler, Vermont Technical College, Randolph Center, VT; Randy K. Schwartz, Schoolcraft College, Livonia, MI; and the proposer.

Letting R be the resistance of the infinite network, one has

$$R = 2r + \frac{1}{\frac{1}{r} + \frac{1}{R}} = 2r + \frac{rR}{r+R}.$$

This gives the equation $R^2 - 2rR - 2r^2 = 0$, so $R = (1 \pm \sqrt{3})r$. Clearly only the positive root is a valid solution, so $R = (1 + \sqrt{3})r$.

Integral Polynomial

Problem AE-6. Proposed by the Problem Editor.

Let $p(x)$ be the monic polynomial of degree n that fixes the first n positive integers. That is, consider the monic polynomial p with $p(1) = 1$, $p(2) = 2$, $p(3) = 3$, ..., and $p(n) = n$. Find $p(n+1)$.

Solutions by Robert Bernstein, Mohawk Valley Community College, Utica, NY; Kenneth G. Boback, Penn State University, Wilkes-Barre Campus, Lehman, PA; Randy K. Schwartz, Schoolcraft College, Livonia, MI; and the proposer.

Let $p(x)$ be the indicated polynomial. Then $p(x) - x$ is zero for $x = 1, 2, \dots, n$ and so $p(x) - x = (x-1)(x-2) \dots (x-n)$. Then $p(n+1) = n! + (n+1)$.

Radical Rehash

Problem AE-7. Proposed by Frank P. Battles, Massachusetts Maritime Academy, Buzzards Bay, MA.

For which values of x is $\sqrt[3]{\sqrt{x^2+1}+x} + \sqrt[3]{\sqrt{x^2+1}-x}$ an integer?

Solutions by Robert Bernstein, Mohawk Valley Community College, Utica, NY; Bill Fox, Moberly Area Community College, Moberly, MO; Keith McAllister, City College of San Francisco, San Francisco, CA; Randy K. Schwartz, Schoolcraft College, Livonia, MI; Charles Stone, DeKalb College, Clarkston, GA; Wesley W. Tom, Chaffey College, Rancho Cucamonga, CA; and the proposer.

$$\text{Let } s = \sqrt[3]{\sqrt{x^2+1}+x} \text{ and } t = \sqrt[3]{\sqrt{x^2+1}-x}. \text{ Then}$$

$$(s-t)^3 = s^3 - t^3 - 3st(s-t)$$

with $s^3 - t^3 = 2x$ and $st = 1$. Thus $z = s - t$ satisfies $z^3 + 3z - 2x = 0$ with $x = \frac{z(z^2+3)}{2}$. If z is integral, one of z and z^2+3 is even, so x is integral. Thus x must be an integer of the form $\frac{k(k^2+3)}{2}$ for some integer k .

LIBRARY SUBSCRIPTION

Annual Library Subscription Fee: \$50 [Includes *The AMATYC Review* (Fall and Spring) and *The AMATYC News* (Fall, Winter and Spring)]

Name of Library

Name of Institution

Address

City

State

Zip

NOTE: This application form is your invoice for the subscription fee and payment must accompany the completed application. Retain a photocopy of this form for your records if necessary. Please make check payable in U.S. funds to AMATYC and mail to:

AMATYC Office, State Technical Institute at Memphis,
5983 Macon Cove, Memphis, TN 38134

P. 15. 7. 1

INSTITUTIONAL MEMBERSHIP

Colleges, publishers, and other institutions can support AMATYC by being Institutional Members. As indicated below, the annual membership fee is \$250. Subscriptions to *The AMATYC Review* and *The AMATYC News* are included in this fee. Of particular importance to collegiate institutional members is the AMATYC committee for mathematics department chairpersons.

An additional benefit of institutional membership is one *complimentary* AMATYC conference early registration. Future conventions, which are held in the Fall, will be in Atlanta (1997) and Portland (1998). Institutional members support the excellence of the programs at these annual conferences.

INSTITUTIONAL MEMBERSHIP APPLICATION/INVOICE

Mail to: AMATYC Office, State Technical Institute at Memphis,
5983 Macon Cove, Memphis, TN 38134

AMATYC College Contact Person

Position

Name of Institution

Address

City

State

Zip

Membership Fee: \$250 in U.S. funds payable to AMATYC (includes *The AMATYC Review*, *The AMATYC News*, membership in the Student Math League and one complimentary conference early registration)

Note: Institutional membership does not include any voting privileges.

Type of Payment: (No phone transactions. Please print credit card number clearly.)

Check # Visa Mastercard Discover Total Amount \$

Credit Card # Exp. Date

Signature

80

WHY JOIN AMATYC?

The American Mathematical Association of Two-Year Colleges (AMATYC) was established in 1974 to provide a unique, national forum for two-year college mathematics educators. Today, AMATYC is the only national organization that exclusively serves the needs and purposes of this group.

AMATYC holds a national conference annually in a major city. AMATYC encourages two-year college mathematicians to assume responsible leadership positions; to interact on an equal basis with four-year university personnel; to be members on a proportional basis of national steering or policy committees; to represent at the national level the concerns of two-year college mathematics educators. *The AMATYC Review*, published twice yearly, provides an opportunity to publish articles by and for two-year college faculty. A national newsletter is published three times yearly for all members. AMATYC is a member of the National Conference Board of the Mathematical Sciences.

REGULAR MEMBERSHIP APPLICATION The American Mathematical Association of Two-Year Colleges. Mail to: AMATYC Office, State Technical Institute at Memphis, 5983 Macon Cove, Memphis, TN 38134.

First Name _____ MI _____ Last Name _____ Position _____
 College _____ Phone _____
 College Address _____ E-Mail _____
 City _____ State _____ Zip _____
 Residence Address _____ Phone _____
 City _____ State _____ Zip _____

Indicate preferred mailing address: College Residence

All payments in U.S. funds payable to AMATYC. Membership fee: All memberships include one subscription to *The AMATYC Review* and *The AMATYC News*.

- \$50 Yearly Regular Membership (any person interested in mathematics education at the two-year college level)
 \$10 Yearly Associate Membership (full-time student, no voting privileges)
 Name of AMATYC Member Sponsor _____
 \$1000 Regular Life Membership

Note: Institutional Membership information available upon request

Special Membership Categories: (Full-time math faculty excluded) Special Membership categories DO NOT include receiving *The AMATYC Review*, membership drive information, voting rights, or eligibility for AMATYC office.

- \$25 Yearly Retired Membership \$25 Yearly Adjunct Faculty

In addition, the following journals are available at extra cost:

- Mathematics and Computer Education Journal* \$24 for 3 issues
 The College Mathematics Journal \$45 for 5 issues
 Primus \$30 for 4 issues



Type of Payment: (No phone transactions. Please print credit card number clearly)

Check # _____ Visa Mastercard Discover Total Amount \$ _____
 Credit Card # _____ Exp. Date _____

Signature _____

OPTIONAL DEMOGRAPHIC INFORMATION (Please check one in each category)

- | Category 1 | Category 2 | Category 3 |
|---|---------------------------------|--|
| <input type="checkbox"/> African American | <input type="checkbox"/> Female | <input type="checkbox"/> Two-year college |
| <input type="checkbox"/> American Indian/Alaskan Native | <input type="checkbox"/> Male | <input type="checkbox"/> Four-year college |
| <input type="checkbox"/> Asian | | <input type="checkbox"/> Other, please specify _____ |
| <input type="checkbox"/> Hispanic | | |
| <input type="checkbox"/> White, not Hispanic | | |
| <input type="checkbox"/> Other, please specify _____ | | |

I DO NOT wish to be listed in the AMATYC Directory Signature _____

AMATYC Institutional Members

(as of July 1997)

- Amarillo College, Amarillo, TX 79178
 Anoka Ramsey Comm. College, Coon Rapids, MN 55433
 Austin Comm. College (RGC Campus), Austin, TX 78701
 Ball State University/Math Dept., Muncie, IN 47306
 Bellevue Comm. College, Bellevue, WA 98007
 Borough of Manhattan Comm. College, New York City, NY 10007
 Bronx Comm. College, Bronx, NY 10453
 Brookdale Comm. College, Lincroft, NJ 07738
 Bucks County Comm. College, Newton, PA 18940
 Burlington County College, Pemberton, NJ 08068
 Butler County Comm. College, Butler, PA 16003-1203
 Butte College, Oroville, CA 95965
 Cabrillo College, Aptos, CA 95003
 Cerritos Comm. College, Norwalk, CA 90650
 Charles County Comm. College, La Plata, MD 20646
 Chattanooga State Tech Comm. College, Chattanooga, TN 37406
 City College of San Francisco, San Francisco, CA 94112
 Clark State Comm. College, Springfield, OH 45505
 Cochino County Comm. College, Flagstaff, AZ 86004
 College of DuPage, Glen Ellyn, IL 60137
 College of Lake County, Grayslake, IL 60030
 Columbus State Comm. College, Columbus, OH 43215
 Comm. College of Philadelphia, Philadelphia, PA 19130
 Delaware County Comm. College, Media, PA 19063
 Dona Ana Branch Comm. College, Las Cruces, NM 88003
 Elgin Comm. College, Elgin, IL 60123
 Erie Comm. College-South, Orchard Park, NY 14227
 Florida Comm. College at Jxon, Jacksonville, FL 32246
 Foothill College, Los Altos Hills, CA 94022
 Fox Valley Tech. Inst., Appleton, WI 54913
 Fullerton College, Fullerton, CA 92632
 Gainesville College, Gainesville, GA 30503
 Gateway Technical College, Batesville, AR 72501
 Genesee Comm. College, Batavia, NY 14020
 Grant Mac Ewen Comm. College, Edmonton, AB T5J 2P2
 Green River Comm. College, Auburn, WA 98002
 Harrisburg Area Comm. College, Harrisburg, PA 17110
 Houghton Mifflin Co., Boston, MA 02116
 Howard Comm. College, Columbia, MD 21034
 Illinois Central College, East Peoria, IL 61635
 Illinois State University, Normal, IL 61790
 Johnson County Comm. College, Overland Park, KS 66210
 Joliet Jr. College, Joliet, IL 60436
 Kaplanaui Comm. College, Honolulu, HI 96816
 Kennebec Valley Tech College, Fairfield, ME 04937
 Lane Comm. College, Eugene, OR 97405
 Langara College, Vancouver, BC V5Y 2Z6
 Lorain Comm. College, Elyria, OH 44035
 Madison Area Tech College, Madison, WI 53704
 Massachusetts Bay Comm. College, Wellesly Hills, MA 02181
 Massasoit Comm. College, Brockton, MA 02402
 Metropolitan Comm. College, Omaha, NE 68103
 Minneapolis Comm. College, Minneapolis, MN 55403
 Montgomery College, Takoma Park, MD 20912
 Moraine Valley Comm. College, Palos Hills, IL 60465
 Normandale Comm. College, Bloomington, MN 55431
 Northeast Comm. College, Norfolk, NE 68702
 Northeast Iowa Comm. College, Calmar, IA 52132
 Northeast State Tech. Comm. College, Blountville, TN 37617
 North Hennepin Comm. College, Brooklyn Park, MN 55445
 North Idaho College, Coeur D'Alene, ID 83814
 North Seattle Comm. College, Seattle, WA 98103
 Oakton Comm. College, Des Plaines, IL 60016
 Onondaga Comm. College, Syracuse, NY 13215
 Oregon Inst. of Technology, Klamath Falls, OR 97601
 Palomar College, San Marcos, CA 92069
 Parkland College, Champaign, IL 61821
 Pasadena City College, Pasadena, CA 91105
 Passaic Co. Comm. College, Paterson, NJ 07509
 Pima Comm. College, Tucson, AZ 85709
 Polk Comm. College, Winter Haven, FL 33881
 Portland Comm. College, Portland, OR 97280
 Prairie State College, Chicago Heights, IL 60411
 Prince George's Comm. College, Largo, MD 20774
 Richland Comm. College, Decatur, IL 62521
 Rock Valley College, Rockford, IL 61114
 San Francisco State University, San Francisco, CA 94132
 Santa Barbara City College, Santa Barbara, CA 93109
 Santa Fe Comm. College, Gainesville, FL 32606
 Schoolcraft College, Livonia, MI 48152
 Sierra College, Rocklin, CA 95577
 Southeastern Louisiana University, Hammond, LA 70402
 St. Charles Co. Comm. Coll., St. Peters, MO 63376
 State Tech Inst. at Memphis, Memphis, TN 38134
 Surry Comm. College, Dobson, NC 27017
 The College Board, Philadelphia, PA 19104
 Truckee Meadows Comm. College, Reno, NV 89512
 UND - Williston, Williston, ND 58801
 Univ. of Alaska-Anchorage, Anchorage, AK 99508
 University of Arkansas, Fayetteville, AR 72701
 UNM-Valencia Campus, Los Lunas, NM 87031
 Utah Valley Comm. College, Orem, UT 84058
 Westark Comm. College, Fort Smith, AR 72913
 Western Nebraska Comm. College, Scottsbluff, NE 68961
 William Rainey Harper College, Palatine, IL 60067

AMATYC Reviewers

Sunday A. Ajose	East Carolina University	Greenville, NC
Patricia Allaire	Queensborough C.C.	Bayside, NY
Michelle Askew	Lamar University	Port Arthur, TX
Robert D. Baer	Miami University	Hamilton, OH
John W. Bailey	Clark State C.C.	Springfield, OH
Richelle Blair	Lakeland Comm. College	Mentor, OH
Barbara Bohannon	Hofstra University	Hempstead, NY
Joann Bossenbroek	Columbus State Community College	Columbus, OH
Randall Brian	Vincennes University	Vincennes, IN
Sandra Pryor Clarkson	Hunter College	New York, NY
John DeCoursey	Vincennes University	Vincennes, IN
David Dyer	Prince George's C.C.	Largo, MD
Joseph R. Fiedler	California State University	Bakersfield, CA
Kathleen Finch	Shoals Comm. College	Muscle Shoals, AL
Gregory D. Foley	Sam Houston State University	Huntsville, TX
Richard Francis	Southeast Missouri State University	Cape Girardeau, MO
Florence Gordon	New York Institute of Technology	Old Westbury, NY
Sheldon Gordon	Suffolk County C.C.	Selden, NY
Chitra Gunawardena	Univ. of Wisconsin-Fox Valley	Menasha, WI
K. L. D. Gunawardena	Univ. of Wisconsin-Oshkosh	Oshkosh, WI
Russell Gusack	Suffolk County C.C.	Selden, NY
Ronald Harkins	Miami University	Hamilton, OH
Peter Herron	Suffolk County C.C.	Selden, NY
Larry Lance	Columbus State C.C.	Columbus, OH
Jim Langley	Northeast State Technical C.C.	Blountville, TN
Michael Lanstrum	Kent State University-Trumbull	Warren, OH
Edward Laughbaum	Columbus State C.C.	Columbus, OH
Ved P. Madan	Indiana University East	Richmond, IN
Richard F. Maruszewski	United States Naval Academy	Annapolis, MD
John Mathews	California State University	Fullerton, CA
George Matthews	Onondaga Community College	Syracuse, NY
Pamela E. Matthews		Washington, DC
Mary McCarty	Sullivan C.C.C.	Loch Sheldrake, NY
Susan McLoughlin	Union County College	Cranford, NJ
Art Merfield	Seneca College	Toronto, CANADA
Coreen Mett	Radford University	Radford, VA
Kylene Norman	Clark State C.C.	Springfield, OH
Terry A. Nyman	Univ. of Wisconsin-Fox Valley	Menasha, WI
Carol Olmstead	DeAnza College	Cupertino, CA
Deborah Parker	Mississippi County C.C.	Blytheville, AR
Don Pfaff	University of Nevada-Reno	Reno, NV
Stephen Plett	Fullerton College	Fullerton, CA
Ben Pollina	University of Hartford	W. Hartford, CT
Douglas Robertson	Univ. of Minnesota	Minneapolis, MN
Jack W. Rotman	Lansing C.C.	Lansing, MI
Alain Schremmer	Community College of Philadelphia	Philadelphia, PA
Gene Sellers	Sacramento City College	Sacramento, CA
Thomas Shilgalis	Illinois State University	Normal, IL
Brian Smith	Dawson College	Quebec, CANADA
J. Srisandarajah	Univ. of Wisconsin	Richland Center, WI
Sharon Testone	Onondaga Community College	Syracuse, NY
Marcia Weisser	New York Institute of Technology	Old Westbury, NY
John Williams	University of Hartford	W. Hartford, CT

American Mathematical Association of Two-Year Colleges

EXECUTIVE BOARD 1995-1997

President

Wanda Garner
Cabrillo College
6500 Soquel Drive
Aptos, CA 95003
(408) 479-6329
wagarner@cabrillo.cc.ca.us

President-Elect

Sadie Bragg
Borough of Manhattan
Community College
199 Chambers Street
New York, NY 10007
(212) 346-8820
sbragg@bcb.cunyvm.cuny.edu

Treasurer

Roben Malena
Community College of
Allegheny County
1750 Clariton Rd
W. Mifflin, PA 15122
(412) 469-6228
rmalena@ccac.edu

Secretary

Martha Clutter
Piedmont Virginia
Community College
501 College Drive
Charlottesville, VA
22902-8714
(804) 961-5337
mtc2@jadepvcc.cc.va.us

Past President

Marilyn Mays
North Lake College
5001 MacArthur Blvd
Irving, TX 75038-3891
(972) 273-3506
mcmays@nlcc.edu

Northeast Regional

Vice President
Philip Mahler
Middlesex Community
College
Springs Road
Bedford, MA 01730
(617) 280-3861
mahlerp@middlesex.cc.ma.us

Mid-Atlantic Regional

Vice President
Susan S. Wood
J. Sargeant Reynolds
Community College
Box 85622
Richmond, VA 23285-5622
(804) 371-3027 or 3275
swoodss@jrc.cc.va.us

Southeast Regional

Vice President
Mike Schachter
Coastal Carolina
Community College
444 Western Boulevard
Jacksonville, NC
28516-6899
(910) 938-6168
michaels@ncccs.cc.nc.us

Midwest Regional

Vice President
Rikki Blair
Lakeland Community
College
7700 Checktower Dr.
Kirtland, OH 44093-5198
(216) 953-7341
rblair@lakeland.cc.oh.us

Central Regional

Vice President
Carolyn Neptune
Johnson County
Community College
12345 College Boulevard
Overland Park, KS
66210-1299
(913) 469-8500 x3366
cneptune@johncoc.cc.ks.us

Southwest Regional

Vice President
Audrey Rose
Tulsa Junior College
10300 E. 81st Street
Tulsa, OK 74133-4513
(918) 595-7685
arose@tjvc.tulsa.cc.ok.us

Northwest Regional

Vice President
Ilga Ross
Portland Community
College
P.O. Box 19800
Portland, OR 97280-0900
(503) 977-4171
ross@pcc.edu

West Regional

Vice President
Randolph J. Taylor
Las Positas College
3033 Collier Canyon Road
Livermore, CA 94550-7650
(510) 373-1911
rtaylor@lpc.cc.ca.us

ACADEMIC COMMITTEES

Foundation/Developmental Mathematics

Jack Roman
Lansing Community
College
P.O. Box 40010
Lansing, MI 48901
(517) 483-1079
roman@lcc.edu

Student Mathematics League

Glenn Smith
Santa Fe Community
College
3000 NW 83rd St.
Gainesville, FL 32606
(804) 795-5297
glenn.smith@
santafe.cc.fl.us

Technical Mathematics/ AAS Program

Rob Kumbal
Wake Technical College
9101 Fayetteville Rd.
Raleigh, NC 27603-5696
(919) 772-0551 Ext. 285
rkumbal@wtec-gw.
wake.tec.nc.us

Technology In Mathematics Education

Brian Smith
McGill University
1001 Sherbrooke St. W.
Montreal, Quebec
Canada H3A 1G5
(514) 398-4007
smithb@management.
mcgill.ca

Equal Opportunity in Mathematics

Marcella Beacham
Richard J. Daley College
7500 S. Pulaski Rd
Chicago, IL 60652
(312) 838-7632

Grants

John Pazard
Capital Community Tech
College
61 Woodland Street
Hartford, CT 06105-2351
(203) 520-7851
pazard@commnet.edu

Placement and Assessment

Nancy Sattler
Terra Technical College
2830 Napoleon Rd.
Fremont, OH 43420
(419) 332-1002 Ext. 226
nsattler@terra.cc.oh.us

Faculty Development

Peg Pankowski
Community College of
Allegheny County
1750 Clariton Rd.
West Mifflin, PA 15122
(412) 469-6228
mpankows@ccac.edu

Program/ Curriculum Issues

Phil DeMarois
William Rainey
Harper College
1200 W. Algonquin Rd.
Palatine, IL 60067
(708) 925-6728
pdemaroi@harper.cc.il.us

Editorial Policy Review and Publicity

Geoffrey Akst
Borough of Manhattan
Community College
199 Chambers Street
New York, NY 10007
(212) 346-8530
akst@rdi.net

Electronic Services

John St. Clair
Moulton State Community
College
Ledford Mill Road
Tullahoma, TN 37388
(615) 668-7010
jstclair@mscc.cc.tn.us

The AMATYC REVIEW
Onondaga Community College
Syracuse, New York 13215



Non-Profit
Organization
U.S. Postage
PAID
Permit No. 973
Syracuse, New York

**1997 ATLANTA
AMATYC CONVENTION**

November 13-16, 1997

**Hyatt Regency Atlanta Hotel
Atlanta, Georgia**

Conference Committee Chairpersons

Linda Boyd DeKalb College 555 N. Indian Creek Drive Clarkston GA 30021 (404) 299-4167 lboyd@dekalb.dc.peachnet.edu	Linda Exley DeKalb College 3251 Panthersville Road Decatur GA 30034 (404) 244-2370 lexley@dekalb.dc.peachnet.edu
---	---



See page 20 for more details

ISSN 0740-8404

THE AMATYC REVIEW

Published by the
AMERICAN MATHEMATICAL ASSOCIATION OF TWO-YEAR COLLEGES

VOLUME 19, NUMBER 2

Spring 1998

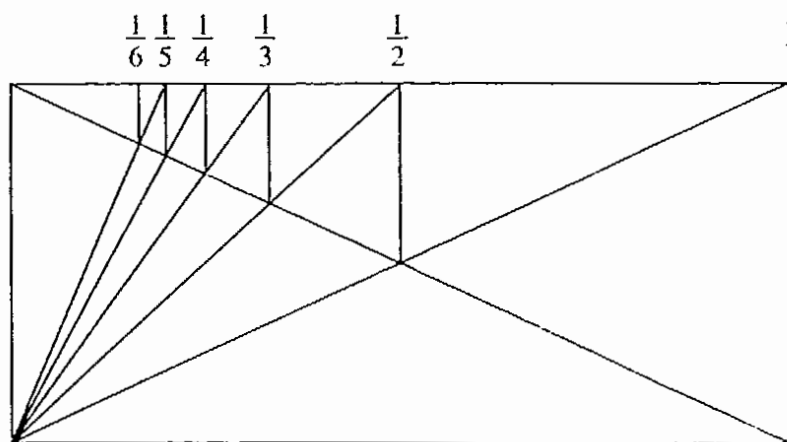

A Simple Construction of the Harmonic Sequence

Also in this issue

- Personal financial planning
 - Changes in precalculus
 - Can $A^2 = 0$ but $A \neq 0$ (for matrices)?
-

"How do you write tests, homework & classwork?"

"by hand?"
(The old way)

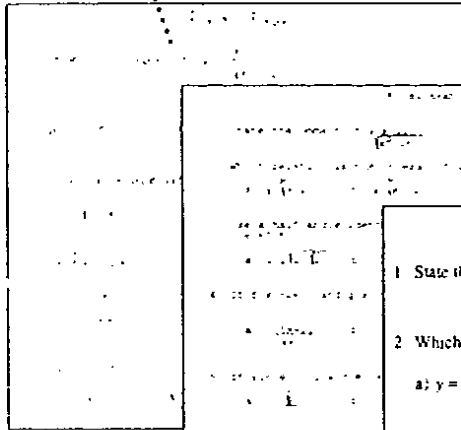

"struggling with your word processor?"
(The hard way)

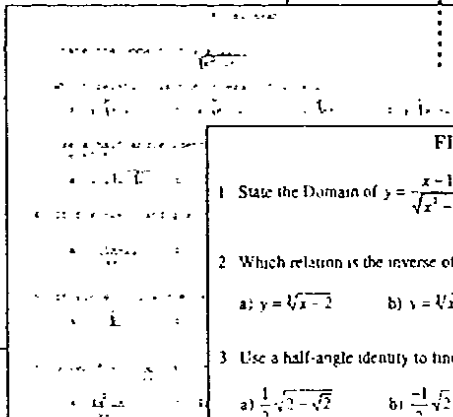

"With MathType!"
(The right way)

FINAL EXAM

- State the Domain of $y = \frac{x-10}{\sqrt{x^2-16}}$
- Which relation is the inverse of $y = (x-2)^3$?
a) $y = \sqrt[3]{x-2}$ b) $y = \sqrt[3]{x} - 2$ c) $y = \sqrt[3]{x} + 2$ d) $\sqrt[3]{x} + 2$
- Use a half-angle identity to find the exact value of $\cos 67.5^\circ$.
a) $\frac{1}{2}\sqrt{2-\sqrt{2}}$ b) $\frac{1}{2}\sqrt{2+\sqrt{2}}$ c) $\frac{1}{2}\sqrt{2-\sqrt{2}}$ d) $\sqrt{2+2\sqrt{2}}$
- If $f(x) = 2x - 5$ and $g(x) = \frac{2}{x+3}$, find $[g \circ f](x)$.
a) $\frac{-(5x+11)}{x+3}$ b) $\frac{1}{x-4}$ c) $\frac{5x+13}{x+3}$ d) $\frac{1}{x-1}$

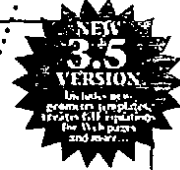

MathType works with any Windows and Macintosh word processor (and any other software) to create publication-quality equations in your documents. Use your mouse to point-and-click for the keyboard on over 280 math symbols — MathType does the rest — automatically formatting your equations according to the established rules of mathematical typesetting.

Upgrade your Equation Editor ...

MathType is the powerful, full featured version of the Equation Editor included in Microsoft Word, WordPerfect, ClarisWorks and many other Windows and Macintosh products. If you frequently include equations in your documents, you will find MathType is much better suited to your needs. MathType is as easy to use as Equation Editor and has many extra features to help you work faster and create better looking documents.

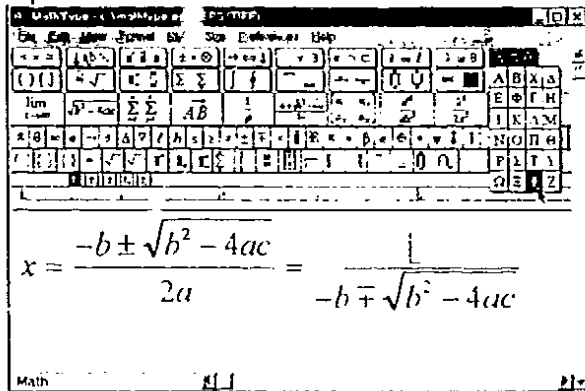

 MathType — The best thing for writing equations since chalk!

Order today: Call 800-827-0685

Academic pricing: \$149. Competitive upgrade & Equation Editor upgrade: \$89. Site licenses available. Email: sales@mathtype.com World Wide Web: www.mathtype.com

BEST COPY AVAILABLE 90



The Official Journal of the
**American Mathematical
 Association of
 Two-Year Colleges**



MISSION OF AMATYC: Recognizing the vital importance of the first two years of collegiate mathematical education to the future of our students and the welfare of our nations, AMATYC is committed to the following:

- to positively impact the preparation of scientifically and technologically literate citizens;
- to lead the development and implementation of curricular, pedagogical, assessment and professional standards for mathematics in the first two years of college;
- to assist in the preparation and continuing professional development of a quality mathematics faculty that is diverse with respect to ethnicity and gender;
- to provide a network for communication, policy determination, and action among faculty, other professional organizations, accrediting associations, governing agencies, industries, and the public sector.

The *AMATYC Review* provides an avenue of communication for all mathematics educators concerned with the views, ideas and experiences pertinent to two-year college teachers and students.

SUBMISSION OF MANUSCRIPTS: Manuscripts must be typed, doubled-spaced, on one side of 8-1/2" x 11" paper. They should not have been published before, nor should they be under consideration for publication elsewhere. To provide for anonymous reviews, the author's name and affiliation should appear on a separate title page. The title should also appear on the first page of the exposition. Authors are advised to consult the *Publication Manual of the American Psychological Association*. A guideline for authors is available from the editor and is also printed in the Fall 1993 issue. Five copies of each manuscript should be submitted to Virginia Carson, DeKalb College, Clarkston, GA 30021.

PHOTOCOPYING AND REPRINTS: General permission is granted to educators to photocopy material from *The AMATYC Review* for noncommercial instructional or scholarly use. Permission must be sought from the authors in order to charge for photocopies, to quote material in advertising, or to reprint articles in other educational publications. Once permission is obtained, credit should be given to the source of the material by citing a complete reference.

ADVERTISING: For information concerning advertising rates and schedules, contact the advertising manager, Audrey Rose, at the address given below.

STAFF

- Editor:** Joseph Browne, Onondaga Community College, Syracuse, NY 13215, (315) 469-2649, brownej@aurora.sunyocc.edu
- Production:** Jane Covillion, Onondaga Community College, Syracuse, NY 13215, (315) 469-2159, covillij@aurora.sunyocc.edu
- Advertising:** Audrey Rose, Tulsa Community College, Southeast Campus, 10300 E. 81st Street South, Tulsa, OK 74133, (918) 595-7865, arose@cm.tulsa.cc.ok.us

EDITORIAL PANEL

- | | | |
|-----------------------|-------------------------------------|---------------------|
| Mike Davidson | Cabrillo College | Aptos, CA |
| Michele Diehl | U. of New Mexico, Valencia Campus | Los Lunas, NM |
| James Fryxell | College of Lake County | Grayslake, IL |
| Brian Hickey | East Central College | Union, MO |
| Dennis Reissig | Suffolk County Community College | Selden, NY |
| Nelson G. Rich | Suzareth College | Rochester, NY |
| Larry Runyon | Shoreline Community College | Seattle, WA |
| Carla Thompson | Tulsa Junior College | Tulsa, OK |
| Jacqueline Thornberry | DeKalb College | Clarkston, GA |
| Margaret Willis | Piedmont Virginia Community College | Charlottesville, VA |
| August Zafone | College of DuPage | Glen Ellyn, IL |

PUBLICATION: *The AMATYC Review* is published twice a year in the Fall and Spring.

ISSN 0740-8404

TABLE OF CONTENTS

ABOUT THE COVER AND EDITOR'S COMMENTS.....	p. 4
LETTER TO THE EDITOR.....	p. 4
MATHEMATICAL EXPOSITION	
Personal Financial Planning.....	p. 6
by Martin Vern Bonsangue and Maijian Qian	
On Periodic Alignment.....	p. 11
by Paul O Meara	
On a Simple Exercise in Linear Algebra.....	p. 15
by T.W. Leung	
SHORT COMMUNICATIONS	
A Note on $f(x)/f'(x) = 0$	p. 20
by Russell Euler and Jawad Sadek	
A Construction of the Harmonic Sequence.....	p. 22
by Dennis J. Gittinger	
MATHEMATICS EDUCATION	
Towards a New Precalculus.....	p. 26
by Mako Haruta, Mark Turpin, and Ray McGivney	
Exploring Parametric Calculus and Elliptic Integrals with Real-World Data.....	p. 36
by Christopher Brueningsten and Rebecca A. Stoudt	
Why Use Radians in Calculus?.....	p. 44
by Carl E. Crockett, II Col.	
REGULAR FEATURES	
Snapshots of Applications in Mathematics.....	p. 49
Edited by Dennis Callas and David J. Hildreth	
Notes from the Mathematical Underground.....	p. 54
Edited by Alain Schremmer	
Book Reviews.....	p. 60
Edited by Sandra DeLozier Coleman	
The Problem Section.....	p. 64
Edited by Stephen Plett	
Advertiser's Index.....	p. 70

FUNCTIONALITY 101

Numeric and graphing solutions with a host of functions for a variety of subjects.

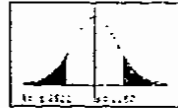
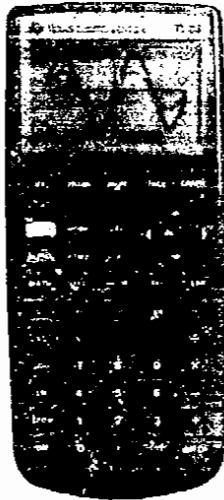

← The TI-83 is an easy-to-use graphing tool with powerful features, including inferential statistics and finance.

Matrix	1	2	3	4	5
Matrix 1	1	2	3	4	5
Matrix 2	6	7	8	9	0
Matrix 3	1	2	3	4	5
Matrix 4	6	7	8	9	0
Matrix 5	1	2	3	4	5

▲ The TI-86 is a powerful problem solver for advanced mathematics coursework including differential equations, linear algebra, and more.



TI-83: A powerful tool used for solving problems in algebra through calculus, including enhanced statistics and finance features.

TI-86: Your best value for technical mathematics coursework. From pre-calculus through differential equations, linear algebra, and calculus, and more. You can also download the powerful inferential statistics and finance feature sets FREE from website www.ti.com/cal/docs/86asapstat.htm and install them using TI GRAPH LINK. This tool provides the same inferential statistics and finance features found in the TI-83.

Whether we choose the TI-83 or the TI-86 for your class, you'll find it more useful for your classes than any other calculator in its class.

To find out more about TI tools for the college classroom and the industry, look for the new support programs at www.ti.com.



EXPLORATIONS™ Series Books. To make your TI graphing calculators even more functional, this series of classroom activities and applications was developed by leading educators for use within the context of your mathematics coursework.



1-800-TI-CARES

TI-CARES@TI.COM

WWW.TI.COM/101

BEST COPY AVAILABLE

About the Cover



The figure on the cover illustrates a construction of the terms of the harmonic sequence, $\left\{1, \frac{1}{2}, \frac{1}{3}, \frac{1}{4}, \dots\right\}$. The proof is given in a note by Dennis Gittinger in this issue. It's not quite a "proof without words" but certainly elegant.

New Problem Columnist

Whenever I discuss this journal with non-mathematicians and mention that we have a "Problem Column Editor" they offer condolences. They misunderstand and think I mean a "problem column editor." Removal of those capital letters makes a big difference. So let me welcome our new Problem Column Editor, Stephen Plett of Fullerton College in California. Readers of the Problem Column will recognize his name since he has been a major contributor of problems for several years.

New Editor Selected

At the Annual Conference in Atlanta last fall the AMATYC Executive Board appointed Virginia Carson of DeKalb College in Clarkston, Georgia, to be the next editor of *The AMATYC Review*. Technically her term begins next fall, but the fact is she is already gearing up and receiving new manuscripts for review. The new production manager will be Jackie Thorneberry, also of DeKalb College. We wish them well as they learn the ropes and continue the tradition of this journal.

Letter to the Editor

I was absolutely overjoyed to see in the Fall, 1997, issue Dennis C. Runde's "What's the Difference Between Debt and Deficit?" (Snapshots of Applications in Mathematics, pp.60-63) as a suggested accompaniment to the study of scientific notation. He rightfully says that for every man, woman, and child in the U.S. to pitch in to retire the national debt is not a feasible solution. I hope that, in forthcoming issues, he will analyze other, more equitable, if less egalitarian, solutions.

Alan Schremmer
Community College of Philadelphia

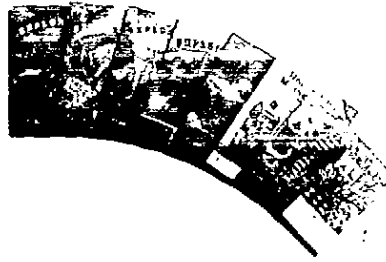

www.ti.com/calc

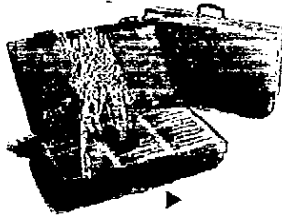
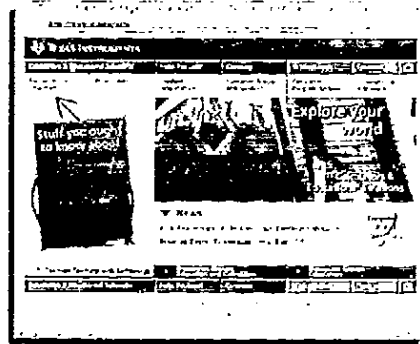

1-800-TI-CARES
1-COROS@TI.COM

YOU'VE TAUGHT US WELL.



At Texas Instruments, we are proud to provide the best products and services for today and tomorrow. But perhaps the most valuable tool we offer are our TI calculators. The most powerful, most accurate, and most precise that can help you and your students incorporate them into your classroom. Whether it's our scientific, graphing, or basic calculators from TI, we help you maximize each possible through our online TI eWorkshop, our mobile phone support, and our online course support. The success of these programs can be our own agents in the most successful way from your classroom. So, we made for you. To learn more about our TI eWorkshop support program, visit our website.

1-800-TI-CARES (US & CA) | 1-COROS@TI.COM | www.ti.com/calc

 **TEXAS
INSTRUMENTS**

MATHEMATICAL EXPOSITION

Personal Financial Planning

by

Martin Vern Bonsangue

and

Maijian Qian

California State University, Fullerton

Fullerton CA 92834

Marty Bonsangue received his PhD in Mathematics Education from The Claremont Graduate School in 1992, where he was awarded the Peter Lincoln Spenser Memorial Award for Outstanding Dissertation of the Year. He has taught mathematics to middle school, high school, and college students for twenty years, during which time he has faithfully contributed to a Tax-Shelter Annuity.



Maijian Qian received her PhD in Optimization from the University of Washington in 1992. She is interested in the development of applications relevant for Business Calculus, which she has taught for many semesters.

One of the great benefits of learning mathematics is not only to understand its power as a tool for characterizing and solving important real-world problems, but to realize that these problems can impact the learner directly. Among the most salient of these is the application of calculus to the financial world. The problem gets even more interesting when learning not about financial matters in general, but about *one's personal* finances. For example, this journal recently reported that persons who have Tax Shelter Annuities can rest assured knowing that TSA's are a good investment even if their post-retirement income level is not lower than it was when they were working (Shultz & Bonsangue, 1996). Like all good applications, it is the learning process that one goes through, rather than just the end result, that allows her or him to understand and appreciate the result enough to act upon it.

In this spirit, the purpose of this article is to develop the mathematics underlying the concept of Present and Future Values using basic ideas taken from first-semester calculus. We will develop the formulas with a real-world example that uses the exponential function as a solution to a simple differential equation. This is followed by the general solution to the question, "How much should I save now if I want to have plenty of money when I retire." Our hope is that readers will not only gain a deeper appreciation for the mathematics underlying the formulas, but will be able to use the derivations presented here in a meaningful way with their own students of mathematics.

The Case of Mara

Mara is a recent college graduate just starting out as a salesperson. After receiving her first paycheck, she puts \$100 into a savings account paying a rate of 5% compounded continuously. Of course, Mara would like to know how much money she will have at the end of the year. The change in her savings is the interest added into the account, and the amount of that interest is the rate times the current amount. If y is the amount of money in the bank at time x , she needs a function $y = f(x)$ such that

$$\frac{dy}{dx} = 5\% y = .05y. \quad (1)$$

Since Mara took a course in Business Calculus, she knows that the function $y = Ce^{.05x}$ has this property. Since she started with \$100, that is, $y(0) = Ce^0 = 100$, she knows that $C = 100$. Using equation (1), Mara sees that at the end of one year her \$100 will become $\$100e^{.05(1)} = \105.13 . Similarly, at the end of ten years her \$100 will have modestly grown to $\$100e^{.05(10)} = \164.87 .

Planning for Retirement

Like any bright young businessperson, Mara is interested in planning her financial future. She is 20 now (she graduated high school early), and plans to retire at the age of 65. She does not think that social security will be a dependable income resource after her retirement. Hence, she plans to save a certain amount of money each year to ensure a secure retirement. How much should she save each year? Mara hopes that after she retires she will have \$30,000 a year to enjoy up until she is 90 years old. In addition, she would like to have \$100,000 remaining in her bank account, so that she can either leave it to her children (or grandchildren) or she can use it as living expense if she is still alive at 90.

There are two patterns of changes in Mara's account, namely, the years during which she makes deposits, and the years during which she makes withdrawals. Consider now her working years. Assume the interest rate does not change and equals r percent per year. While Mara is working and depositing S dollars per year, the change of money in her account is the added interest plus her new deposits. Hence

$$\frac{dy}{dx} = ry + S. \quad (2)$$

It is easy to check that the function

$$y = Ce^{rx} - \frac{S}{r}$$

satisfies

$$\frac{dy}{dx} = Cre^{rx} = r\left(Ce^{rx} - \frac{S}{r}\right) + S = ry + S.$$

Since Mara has no money in her account at the beginning, $y(0) = 0$, giving the value of C as $C = \frac{S}{r}$. Therefore, while Mara is working, the amount of money in

her account at the x th year is

$$y(x) = \frac{S}{r}(e^{rx} - 1). \quad (3)$$

When Mara retires at 65, we have $x = 45$. Hence, the amount of money in her account will be

$$P = y(45) = \frac{S}{r}(e^{45r} - 1). \quad (4)$$

After Retirement

The second pattern of change in Mara's account occurs after she retires. Upon retirement, Mara will withdraw W dollars per year. Thus, the change in her account is the added interest less the amount of withdrawal. If z represents the amount of money in her account t years after retiring, then

$$\frac{dz}{dt} = rz - W.$$

It is easy to check that the function

$$z(t) = Be^{rt} + \frac{W}{r} \quad (5)$$

satisfies

$$\frac{dz}{dt} = Bre^{rt} = r\left(Be^{rt} + \frac{W}{r}\right) - W = rz - W.$$

When Mara retires at age 65 ($t = 0$), she has P dollars in her account. Evaluating equation (5) at $t = 0$ with $z = P$, we have $B = P - \frac{W}{r}$. Therefore, after Mara retires, the amount of money in her account t years after retirement is $z(t) = \left(P - \frac{W}{r}\right)e^{rt} + \frac{W}{r}$, or

$$z(t) = Pe^{rt} - \frac{W}{r}(e^{rt} - 1). \quad (6)$$

Now in order to find out how much Mara has to save each year while she is working, we first need to figure out how much she would like to have when she retires, that is, the amount P . Assume that after retirement she wishes to withdraw $W = \$30,000$ each year and that r remains (conservatively) 5% during her retirement years. At age 90 ($t = 25$) she would still like to have \$100,000 in her account, or $z(25) = 100,000$. Using these values in equation (6) gives

$$100,000 = Pe^{0.05(25)} - \frac{30,000}{0.05}(e^{0.05(25)} - 1),$$

or $P = 5456,748$.

With P known we can find the value S that Mara should save each year while she is working. Still assuming a constant interest rate of 5%, equation (4) gives

$$456,748 = y(45) = \frac{S}{0.05} (e^{0.05(45)} - 1),$$

or $S = \$2691$. Thus, Mara should save about \$225 each month to meet her retirement goals (of course, if she can get a better interest rate than 5%, she could afford to save even less!).

A General Observation

In general, we can determine how much a person will need for retirement assuming that he or she wishes to withdraw W dollars each year for T years and still have L dollars remaining in the account. Solving equation (6) for P gives

$$P = \frac{L + \frac{W}{r} (e^{rt} - 1)}{e^{rt}}. \quad (7)$$

Likewise, if one plans to work for K years and wishes to have P dollars upon retirement, then from equation (3) the amount one needs to save each month during the working years is

$$S = \frac{Pr}{12(e^{rK} - 1)}. \quad (8)$$

If we want to account for post-retirement inflation, we need only to reduce the interest rate r . In order to allow for taxes (or any other anticipated expenses), simply increase the value for W , the amount withdrawn each year.

Conclusion

The derivations presented here about personal financial planning have obvious applications for most of us (certainly for teachers). Typically these formulas are presented in calculus as definite integrals involving exponential functions (e.g., Bittinger, 1996, pp., 427-29). Our experience is that many students do not gain a clear understanding of what the integrals may mean, nor the application to their own financial situations. Too often the student's solution depends on pushing the right buttons on a financial calculator.

It is our hope that the derivations presented here may help students to more clearly understand the mathematics behind the black boxes of calculators and formulae. We hope likewise that teachers will feel encouraged to take their students through this mathematical sidetrip of Personal Financial Planning as a classroom lesson or perhaps as a mathematics project for student teams. The mathematics of Personal Financial Planning incorporates many of the critical elements of problem-solving described by the NCTM *Standards* (1991) and AMATYC *Standards* (1995), including exploration, critical thinking, and generalization. Moreover, the information is relevant not only because we can learn information about a person's financial future, but because we can gain the mathematical power needed to control our own.

References

- American Mathematical Association of Two-Year Colleges. (1995). *Crossroads in mathematics: Standards for introductory college mathematics before calculus*. Memphis, TN: AMATYC.
- Bittinger, M. *Calculus and its applications*, 6th Ed. (1996). Reading, MA: Addison Wesley.
- National Council of Teachers of Mathematics. (1991). *Professional standards for teaching mathematics*. Reston, VA: NCTM.
- Shultz, H., and Bonsangue, M. (1996). Tax shelter annuities. *The AMATYC Review*, 17(2), 18-20.

I constantly meet people who are doubtful, generally without due reason, about their potential capacity [as mathematicians]. The first test is whether you got anything out of geometry. To have disliked or failed to get on with other [mathematical] subjects need mean nothing; much drill and drudgery is unavoidable before they can get started, and bad teaching can make them unintelligible even to a born mathematician.

J. E. Littlewood
in *A Mathematician's Miscellany*

AMATYC OFFICE INFORMATION

AMATYC
State Technical Institute at Memphis
5983 Macon Cove
Memphis TN 38134

Phone: (901) 383-4643 • Fax: (901) 383-4651

E-MAIL:

AMATYC - amatyc@stim.tec.tn.us
Christy Hodge - ahodge@stim.tec.tn.us
Carol Stoy - estoy@stim.tec.tn.us
Cheryl Cleaves, Executive Assistant - ccleaves@stim.tec.tn.us

On Periodic Alignment

by

Paul O'Meara
Community College of Aurora
Aurora CO 80011-9036



Dr. Paul O'Meara has received the following degrees: B.S. in Mathematics from the University of Utah, M.S. in Mathematics from San Diego State College, and Ph.D. in Mathematics from the University of Alberta at Edmonton. He taught Mathematics at Bowling Green State University and at the University of Colorado at Denver. He took a part-time position at the Community College of Aurora and was appointed as chairman of the Mathematics Division there in 1995. He retired last year.

While looking at variations of the hypocycloid, I came across a family of smooth curves which appears to be constructible with a Spirograph®. There is an interesting connection between the points at which these curves cross themselves and the pairs of inverse elements in corresponding quotient groups. A curve of this family is given by the polar equation:

$$r = \sqrt{(a-b)^2 + b^2 + 2(b)(a-b)\cos\frac{at}{b}}.$$

This equation describes a sort of "hypocycloid with a slipped disk", which one could not really draw with a Spirograph®. The locus of points Q in the sketch below describe such a curve. We can imagine a circle of radius $b < a$ rolling counterclockwise, without slipping, along the inside of a circle of radius a . The path of the point P is a hypocycloid; the path of the point Q , a point the same distance from the center as P , but always on the line of centers, results in the foregoing equation. The points P and Q coincide at the outset ($t = 0$), and if $b < \frac{a}{2}$, at the end of every half revolution of the smaller circle thereafter.

The curve, like the hypocycloid, will close on itself if and only if the radii of the two circles have rational ratio. It is easier to

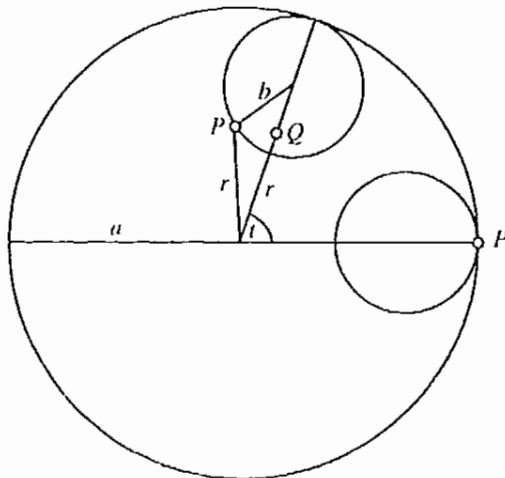

graph these curves on a graphing utility if we set $a = 1$ and $b = \frac{n}{m}$, with n and m relatively prime in \mathbb{N} , the natural numbers. Then the foregoing equation assumes the form:

$$r = \sqrt{\frac{c}{m^2} + \frac{m^2 - c}{m^2} \cos \frac{mt}{n}}$$

where $c = m^2 - 2mn + 2n^2$. A graph of this equation for $b = \frac{5}{8}$ looks like this:

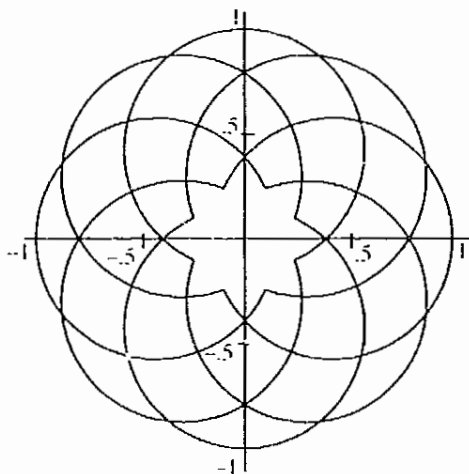

The points of intersection for $b = \frac{n}{m}$ form $n - 1$ "tiers". On each tier these points determine the vertices of a regular m -sided polygon. Each tier, from innermost to outermost is a rotation of its predecessor by $\frac{\pi}{m}$.

Now let us look into the reasons for this pattern. First we shall simplify a little by considering g to be an even, continuous, periodic function of period 1 which is strictly monotonic on $[0, \frac{1}{2}]$ and $[\frac{1}{2}, 1]$. Assume further that $g(0) = 0$ and that $g(0)$ is a maximum or a minimum value of g . If g had period $p > 1$, then we could consider, instead, $h(x) = g(px)$ which has period 1.

Then let $f(x) = g(\frac{mx}{n})$. Now $x = n$ is the least positive number for which $f(x) = f(0)$ and $g(x) = g(0)$. For, if $f(x) = f(0)$, then $x = \frac{kn}{m}$ for some integer k . And, if $g(x) = g(0)$, then $x = j$ for some integer j . Thus $kn = jm$ and since $(m, n) = 1$, mlk and $n|j$. The least positive k available is $k = m$, making $j = n$.

Let $I = [0, n]$. The "alignment" question is this:

For which pairs $(x, x') \in \mathbb{I} \times \mathbb{I}$ is it true that

$$f(x) = f(x') \text{ and } |x - x'| \in \mathbb{N}?$$

We are not looking to satisfy $f(x) = f(x')$ and $g(x) = g(x')$ only. In addition, we want the elements of a pair to differ by a multiple of the period of g .

The description of n in the last paragraph assures us that we shall not find any pairs of points in \mathbb{I} which differ by both a multiple of $\frac{n}{m}$ and, at the same time, an integer. However, because of the even character of f and g , we could consider pairs of the form x and $x' = \frac{kn}{m} - x$. Now

$$\left| x - \left(\frac{kn}{m} - x \right) \right| = i \in \mathbb{N} \text{ if and only if } x = \frac{i'm + kn}{2m}, \text{ where } i' = \pm i.$$

Let $j = i'm + kn$ and observe that $x = \frac{j}{2m} \in \mathbb{I}$ if and only if $0 \leq j \leq 2nm - 1$. The form of the choices for x , here, leads us to consider a relationship with the additive group $Z(2nm)$ of integers, mod $2nm$. We identify this group with the set $G = \left\{ \frac{j}{2m} : 0 \leq j \leq 2nm - 1 \right\} \subset \mathbb{T}$ via $j \mapsto \frac{j}{2m}$. The homomorphism $h: Z(2nm) \rightarrow Z(2n)$ which maps $j \pmod{2nm}$ to $j \pmod{2n}$ has kernel $K = \{0, 2n, 4n, \dots, 2(m-1)n\}$. The corresponding points in G are $K' = \left\{ 0, \frac{n}{m}, \frac{2n}{m}, \dots, \frac{(m-1)n}{m} \right\}$ which consists of the zeros of f in \mathbb{I} . Here $f(K') = 0$ and for any $x \in G$, $f(K' + x) = f(x)$.

With the identification mentioned above, we can consider

$$G/K' = \left\{ K' + \frac{j}{2m} : 0 \leq j \leq 2n - 1 \right\}$$

as a quotient group mod $2n$, each element (coset) of which contains m elements of the original group G . The element, $K' + \frac{n}{2m}$, of G/K' for which $f\left(K' + \frac{n}{2m}\right) = f\left(\frac{n}{2m}\right)$ is a maximum or a minimum of f , is the only non-zero self-inverse element of G/K' . Setting this element and K' itself aside, there are then $n-1$ pairs of non-zero inverse elements left in G/K' . They have the form $K' + \frac{j}{2m}$ and $K' + \frac{2n-j}{2m}$, $j \neq n$, on which, because f is even, $f\left(K' + \frac{j}{2m}\right) = f\left(K' + \frac{2n-j}{2m}\right) = f\left(\frac{j}{2m}\right)$.

There are $2m$ points in the union of these two elements of G/K' , and for a given point $x \in K' + \frac{j}{2m}$, we can find a corresponding point $x' \in K' + \frac{2n-j}{2m}$, such that $|x - x'| \in \mathbb{N}$. Let $x = \frac{kn}{m} + \frac{j}{2m} \in K' + \frac{j}{2m}$ and let $x' = \frac{k'n}{m} + \frac{2n-j}{2m} \in K' + \frac{2n-j}{2m}$. Then $x - x' = \frac{(k - k')m + j}{m}$ is an integer if and only if $(k - k')m + j \equiv 0 \pmod{m}$. Now the

appropriate k' can be found, since $(n, m) = 1$ implies that there are integer solutions to $nz \equiv -j \pmod{m}$ and any two are congruent, mod m . Thus there are m pairs of points in $(K' + \frac{j}{2m}) \cup (K' + \frac{2n-j}{2m})$ for which $f(x) = f(x')$ and $|x - x'| \in \mathbb{N}$. And, finally, there are $m(n-1)$ such pairs in \mathbb{I} . Note also that successive cosets $(K' + \frac{j-1}{2m})$ and $(K' + \frac{j}{2m})$ differ by a translation of $\frac{1}{2m}$.

Here is an algorithm for matching pairs:

For fixed k and j ,

1. Solve $nz \equiv -j \pmod{m}$
2. Set $(k - k' - 1) \equiv z \pmod{m}$
3. Let $-k \equiv (1 - k + z \pmod{m}) \pmod{m}$
4. $k' = (m - (-k')) \pmod{m}$.

Example: Let $g(x) = \cos(x)$, $f(x) = \cos(\frac{5}{4}x)$ on $[0, 8\pi)$. (Forget the period 2π for now; let us just do the arithmetic mod 5 and then multiply by 2π). Here $K' = \{0, \frac{4}{5}, \frac{2(4)}{5}, \frac{3(4)}{5}, \frac{4(4)}{5}\}$ and $j \in \{1, 2, 3, 5, 6, 7\}$. We skip 4 here because $K' + \frac{4}{10}$ is that singular, non-zero, self-inverse member of G/K' . Let us find the other element in a matched pair for $x = \frac{2(4)}{5} + \frac{3}{10}$. Here, $k = 2$ and $j = 3$. Solve $4z \equiv -3 \pmod{5}$, say $z = 8$. (Yes, 3 would be easier). With $k = 2$, set $(2 - k' - 1) \equiv 8 \pmod{5} = 3$. Then $-k' \equiv 2 \pmod{5}$, so $k' = 3$. Then $x = \frac{8}{5} + \frac{3}{10} = \frac{19}{10}$ and $x' = \frac{12}{5} + \frac{5}{10} = \frac{29}{10}$. Multiplying by 2π , we obtain $x = \frac{19}{5}\pi$ and $x' = \frac{29}{5}\pi$ in $[0, 8\pi)$. Note that $|x - x'| = 2\pi$ and $\cos(\frac{5}{4}x) = \cos \frac{19\pi}{4} = \cos \frac{3\pi}{4}$, while $\cos(\frac{5}{4}x') = \cos \frac{29\pi}{4} = \cos \frac{5\pi}{4} = \cos \frac{3\pi}{4}$.

You can watch the tiers of intersection points form on a graphing calculator this way: Use, for instance, the foregoing example $f(x) = \cos(\frac{5}{4}x)$ on $[0, 8\pi)$. Graph $y = \cos(\frac{5}{4}(x + 2k\pi))$; $k = 0, 1, 2, 3$, all on the same picture over $[0, 2\pi]$. Since the domain is taken to be $[0, 8\pi)$, when the picture is complete, simply identify the left and right edges.

[Criticized for using formal mathematical manipulations, without understanding how they worked:] Should I refuse a good dinner simply because I do not understand the process of digestion?

Oliver Heaviside (1850-1925)

On a Simple Exercise in Linear Algebra

by

T. W. Leung
Hong Kong Polytechnic University
Kowloon, Hong Kong



T. W. Leung did his undergraduate study at the University of Waterloo, Ontario and obtained his PhD from Queen's University. Since then he has devoted a lot of his time teaching mathematics to engineering students. He is interested in investigating why students make similar mistakes time and again. In mathematics he is interested in combinatorial optimization, elementary number theory and mathematics education.

I cannot recall where I first saw the following exercise in linear algebra:

Let A be a real 2×2 nonzero matrix and suppose $A^5 = 0$. Show that $A^2 = 0$.

It turns out that the exercise is useful to illustrate many ideas, and I want to describe a few of them here. But before that, let me stress that the exercise is for students with only elementary knowledge of matrices, determinants and eigenvalues, roughly at the level of Anton (1984). They know nothing about Jordan form nor minimal polynomial; otherwise the exercise will be too easy.

First, it is not unusual to find the following "proof" by a student. Because $A^5 = 0$, hence $A^4 = A^{-1}A^5 = A^{-1}0 = 0$, again, $A^3 = A^{-1}A^4 = A^{-1}0 = 0$, hence $A^2 = A^{-1}A^3 = A^{-1}0 = 0$. Unfortunately, the student does not go one step further to get $A = A^{-1}A^2 = A^{-1}0 = 0$, and realize the fallacy of the argument.

The above argument illustrates the sloppy attitude of the student; as a matter of convenience he simply assumes the inverse of A exists. But of course we know in this case, the inverse of A does not exist, as the determinant of A is zero.

The correct proof rests very much on the fact that the matrix A is 2×2 , and that the determinant of A is zero. In fact, $|A^5| = |A|^5 = 0$, and $|A|$, a real number, whose fifth power is zero, implies $|A| = 0$. Now suppose A is given by

$$\begin{bmatrix} a & b \\ c & d \end{bmatrix}$$

and $0 = |A| = ad - bc$. We try A^2 to get

$$A^2 = \begin{bmatrix} a^2 + bc & ab + bd \\ ac + cd & bc + d^2 \end{bmatrix}$$

$$\begin{aligned}
&= \begin{bmatrix} a^2 + ad & ab + bd \\ ac + cd & ad + d^2 \end{bmatrix} \\
&= (a + d) \begin{bmatrix} a & b \\ c & d \end{bmatrix} \\
&= (a + d)A.
\end{aligned}$$

Hence $A^3 = A^2A = (a + d)A^2 = (a + d)^2A$; and $A^4 = (a + d)^3A$, $A^5 = (a + d)^4A$. Because $A^5 = 0$ and $A \neq 0$, we have $(a + d)^4 = 0$, which implies $(a + d) = 0$. Thus $A^2 = (a + d)A = 0$.

From the above proof it is immediately clear that the "5" in the exercise may be replaced by any integer 3 or above. It is meant only to confuse the students; some students think it is not so bad to try multiplying out A^5 .

A few students manage to find another (longer proof). First it is observed that $|A| = ad - bc = 0$. Now the characteristic polynomial of A is

$$\begin{aligned}
&\begin{vmatrix} \lambda - a & -b \\ -c & \lambda - d \end{vmatrix} \\
&= \lambda^2 - (a + d)\lambda + (ad - bc) \\
&= \lambda(\lambda - (a + d)).
\end{aligned}$$

Hence the eigenvalues of the matrix are 0 and $a + d$. Suppose now $a + d \neq 0$, then A is diagonalizable, thus we find an invertible P such that

$$P^{-1}AP = \begin{bmatrix} \lambda_1 & 0 \\ 0 & \lambda_2 \end{bmatrix} = D.$$

Hence $A = PDP^{-1}$, and $0 = A^5 = P D^5 P^{-1}$, forcing $D^5 = 0$, or $\lambda_1^5 = \lambda_2^5 = 0$, which implies $\lambda_1 = \lambda_2 = 0$, or $A = P D P^{-1} = 0$, a contradiction. We must then have $a + d = 0$, from $A^2 = (a + d)A$, get $A^2 = 0$. This proof is correct, but it is a bit indirect.

Besides obtaining a correct proof, there are things that may be considered.

The exercise does not specify whether such a matrix exists. In fact, we cannot find a 1×1 real nonzero matrix A such that $A^5 = 0$. However, it is possible to find a 2×2 nonzero matrix with the required property. In fact we see that 0 is the only eigenvalue of A ; after some experimentation, we see

$$\begin{bmatrix} 0 & 1 \\ 0 & 0 \end{bmatrix} \quad \text{or} \quad \begin{bmatrix} 0 & 0 \\ 1 & 0 \end{bmatrix}$$

will satisfy the hypotheses of the exercise.

After that a student may be led to discover it is necessary to specify the size of the matrix. A student may be asked to find a real nonzero 3×3 matrix B , such that $B^5 = 0$, yet $B^2 \neq 0$. Now it is natural for a student to consider 3×3 upper or lower

triangular matrices, with zero diagonal elements. He may find out the matrices

$$\begin{bmatrix} 0 & 1 & 0 \\ 0 & 0 & 1 \\ 0 & 0 & 0 \end{bmatrix} \text{ or } \begin{bmatrix} 0 & 0 & 0 \\ 1 & 0 & 0 \\ 0 & 1 & 0 \end{bmatrix}$$

possess the above mentioned property.

The proof of the exercise has another purpose. Namely it can be used to prove if a matrix equation has any solution. If A is a matrix as in the exercise, it is impossible to find a real C such that $C^2 = A$. Because if $C^2 = A$ then $C^4 = A^2 = 0$, but arguing as in the proof, $C^4 = 0$ implies $C^2 = 0$, or $A = 0$, a contradiction. By the same token, we see that A is not any n^{th} power, when $n \geq 3$. In fact if $C^n = A$, then $C^{2n} = A^2 = 0$, but $C^{2n} = 0$ implies $C^2 = 0$, hence $C^n = 0$. The idea is nothing new: it was described in Halmos (1991) and various aspects of this type of matrix equations may be found in Flanders (1986) or Winter (1980).

Now we see for matrices of larger size, the situation may be more complicated. A student may then see the relevancy of the concept of rank. For a nonzero 2×2 matrix, if its certain power is zero, then its rank is 1. But for a nonzero $n \times n$ matrix, if its determinant is zero, its rank may lie between 1 and $n - 1$. Nevertheless, let's consider an $n \times n$ ($n \geq 3$) matrix of rank 1. In fact, if A is an $n \times n$ ($n \geq 3$) rank 1 matrix, then

$$A = \begin{bmatrix} b_1 a_1 & b_1 a_2 & \dots & b_1 a_n \\ b_2 a_1 & b_2 a_2 & \dots & b_2 a_n \\ \vdots & \vdots & \ddots & \vdots \\ b_n a_1 & b_n a_2 & \dots & b_n a_n \end{bmatrix}$$

$$= \begin{bmatrix} b_1 \\ b_2 \\ \vdots \\ b_n \end{bmatrix} (a_1 \dots a_n)$$

Hence

$$A^2 = \begin{bmatrix} b_1 \\ \vdots \\ b_n \end{bmatrix} (a_1 \dots a_n) \begin{bmatrix} b_1 \\ \vdots \\ b_n \end{bmatrix} (a_1 \dots a_n)$$

$$= (\sum a_i b_i) \begin{bmatrix} b_1 \\ \vdots \\ b_n \end{bmatrix} (a_1 \dots a_n) = KA$$

for some constant K .

Using this, it is of course trivial to prove our original exercise, but it may also be said that it demonstrates the subtlety of the rank concept. After trying to get through the exercise, a student may in fact see or discover the concept or its relevancy himself.

Now it would be nice for a student to observe:

Let A be a rank 1 $n \times n$ matrix ($n \geq 3$) such that $A^m = 0$ ($m \geq 3$). Then $A^2 = 0$.

One should nevertheless note that a rank 1 $n \times n$ matrix does not necessarily imply $A^m = 0$. For instance no power of the rank 1 matrix

$$\begin{bmatrix} 1 & 0 & 0 & \dots & 0 \\ 0 & . & . & . & 0 \\ 0 & . & . & . & 0 \end{bmatrix}$$

is ever zero.

We also cannot claim that such an A is not a power of some B , using the previous argument, because B may not be of rank 1. For instance if $B = \begin{bmatrix} 0 & 1 & 0 \\ 0 & 0 & 1 \\ 0 & 0 & 0 \end{bmatrix}$, and

$A = \begin{bmatrix} 0 & 0 & 1 \\ 0 & 0 & 0 \\ 0 & 0 & 0 \end{bmatrix}$, then $B^2 = A$. It is more difficult to find a matrix B such that

$$B^2 = \begin{bmatrix} 0 & 1 & 0 \\ 0 & 0 & 0 \\ 0 & 0 & 0 \end{bmatrix}.$$

We should try a suitable matrix of rank 2.

One may then consider the matrix over certain rings to see if the statement is still valid, or consider the exercise in the context of transformation. Readers may, of course, conjure up other variations from this exercise.

References

- Anton, H. (1984). *Elementary linear algebra*. (4th ed.). New York: John Wiley & Sons.
- Flanders, H. (1986). On polynomial matrix equations. *College Mathematics Journal*, 17(5), 388-391.
- Halmos, P.R. (1991). *Problems for mathematicians young and old*. Washington: Mathematical Association of America.
- Winter, J.L. (1980). The matrix equation $X^n = A$. *Journal of Algebra*, 67, 82-87.

A proof tells us where to concentrate our doubts.

Morris Kline

THREE CALCULATORS. ONE COMMON DENOMINATOR.



STAY AHEAD IN MATH

Students stay ahead in math is tough enough. Calculators that are technologically behind?

THE CALCULATOR OFFERS

Sharp's Algebraic Logic allows students to enter expressions the way they appear in the textbook. With R.A.L., there's

each part of the expression. And that's a visible advantage.

EL-9600 GRAPHING CALCULATOR WITH UNIQUE PEN-TOUCH SCREEN

Sharp's EL-9600 is nothing short of genius. It puts easy navigation and operation at your student's fingertips. It also shows equations exactly as they appear in textbooks, thanks to the unique displaying power of Sharp's Equation Editor. The way we see it, the harder a calculator works, the easier it is to teach math.

SHARP.
FROM SHARP MINDS
COME SHARP PRODUCTS

© 1998 Sharp Electronics Corp. 01/98

1-800-855-8848

SHORT COMMUNICATIONS

A Note on $f(x)f^{(n)}(x) = 0$

by

Russell Euler and Jawad Sadek
Northwest Missouri State University
Maryville MO 64468

Russell Euler is a professor in the department of mathematics and statistics at Northwest Missouri State University where he has taught since 1982. In addition to various scholarly activities, Russell enjoys woodworking and trying to keep up with his three daughters.



Jawad Sadek is an assistant professor of mathematics at Northwest Missouri State University. He got his Ph.D. in Complex Analysis in 1993. When he is not doing research or chatting with his students, he is either running, reading novels, or longing for the outdoors of Northern Michigan.

This short paper was motivated by the following simple, yet stimulating calculus problem:

If $f(x)f'(x) = 0$ for all $x \in (a, b)$, then f is constant on (a, b) (where a and b can be finite or infinite).

The solution to this problem is straightforward once students realize that $[f^2(x)]' = 2f(x)f'(x)$. The purpose of this paper is to give a higher-order derivative generalization to this problem. More precisely, the following result will be proved.

Theorem: Let f be an n -differentiable real-valued function on (a, b) . Then

$$f(x)f^{(n)}(x) = 0$$

for all $x \in (a, b)$ if and only if

$$f(x) = a_{n-1}x^{n-1} + a_{n-2}x^{n-2} + \dots + a_1x + a_0$$

where $a_i \in \mathbb{R}$ for $i = 0, 1, \dots, n-1$.

First, we need the following result.

Proposition: Let

$$f(x) = \begin{cases} b_n x^n + b_{n-1} x^{n-1} + \dots + b_1 x + b_0 & \text{for } x < r \\ c_n x^n + c_{n-1} x^{n-1} + \dots + c_1 x + c_0 & \text{for } x \geq r \end{cases}$$

for all x in an open interval (a, b) containing r . If f is n -differentiable at $x = r$, then $b_i = c_i$ for $i = 0, 1, \dots, n$.

Proof: Let $g(x) = b_n x^n + b_{n-1} x^{n-1} + \dots + b_1 x + b_0$ and $h(x) = c_n x^n + c_{n-1} x^{n-1} + \dots + c_1 x + c_0$. Since $g^{(n)}(r) = h^{(n)}(r)$, $b_n = c_n$. Then, since $g^{(n-1)}(r) = h^{(n-1)}(r)$, $b_{n-1} = c_{n-1}$. Proceeding in this fashion gives $b_i = c_i$ for $i = 0, 1, \dots, n$.

We are now ready to prove our theorem.

Proof: If $f(x) = a_{n-1} x^{n-1} + \dots + a_1 x + a_0$, then $f^{(n)}(x) = 0$ and so $f(x) f^{(n)}(x) = 0$ for all $x \in (a, b)$.

Now assume that $f(x) f^{(n)}(x) = 0$ for all $x \in (a, b)$. If $f(x) = 0$ for all $x \in (a, b)$, then the desired result follows by choosing $a_i = 0$ for $i = 0, 1, \dots, n-1$. So, suppose that $f(x_0) \neq 0$ for some $x_0 \in \mathbb{R}$. Since f is continuous at x_0 , there exists some $h_1 > 0$ such that $f(x) \neq 0$ for all $x \in (x_0 - h_1, x_0 + h_1)$. It follows from the assumption of the theorem that $f^{(n)}(x) = 0$ for all $x \in (x_0 - h_1, x_0 + h_1)$. By integrating n times, $f(x) = a_{n-1} x^{n-1} + \dots + a_1 x + a_0$ for all $x \in (x_0 - h_1, x_0 + h_1)$.

Let $V = \{x \in (a, b) : f(x) \neq 0\}$. Then V is an open set and can be written as a countable union of disjoint open intervals, say $V = \bigcup_{i=1}^{\infty} I_i$. Repeat the previous argument

on each I_i to get a polynomial of degree at most $n-1$. The polynomials over two consecutive intervals, I_i and I_{i+1} , intersect at a point r_i such that $f(r_i) = 0$. By the previous proposition, these two polynomials must be identical. Therefore,

$$f(x) = a_{n-1} x^{n-1} + \dots + a_1 x + a_0$$

on (a, b) .

Finally, it can be noted that the theorem can be readily generalized to complex-valued functions on an open disk D . The proof is almost identical to the one presented above with only some appropriate changes in terminology.

A human being is a part of the whole, called by us "Universe," a part limited in time and space. He experiences himself, his thoughts and feelings as something separated from the rest, a kind of optical delusion of his consciousness. This delusion is a kind of prison for us, restricting us to our personal desires and to affection for a few persons nearest to us. Our task must be to free ourselves from this prison by widening our circle of compassion to embrace all living creatures and the whole of nature in its beauty. Nobody is able to achieve this completely, but the striving for such achievement is in itself a part of the liberation and a foundation for inner security.

Albert Einstein (1879-1955)
 In H. Eves *Mathematical Circles Adieu*,
 Boston: Prindle, Weber and Schmidt, 1977

A Construction of the Harmonic Sequence

by

Dennis J. Gittinger
Northwest Vista College
San Antonio TX 78204-1429



Dennis Gittinger is a native Texan. He holds BA and MS degrees in mathematics from St. Mary's University and a PhD in mathematics education from the University of Texas at Austin. Dennis was a mathematics professor at St. Philip's College in San Antonio from 1972-1998. He is currently the chief academic officer at Northwest Vista, the newest college in the Alamo Community College District.

A geometric representation of the harmonic sequence can be constructed rather simply. We will lead up to this through an elementary construction and its generalization. These will be stated as problems for the benefit of those who would like to work out their own proofs.

Construction: Start with any rectangle $ABCD$ (see Fig. 1.). Let E be the midpoint of BC . Draw diagonal BD and line segment AE , intersecting at G . Construct FH through G and perpendicular to AD . Prove that AH is one-third of AD .

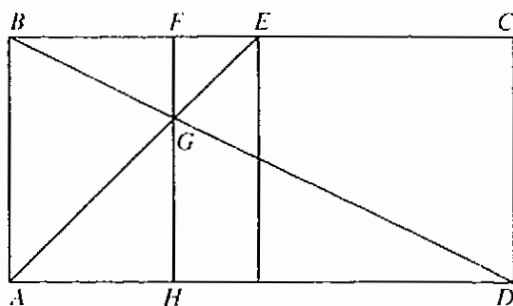

Fig. 1

Proof: Triangles ADG and EBG are similar. Segment BE is half of AD . Because of the similar triangles, BF is half of DH , and since $AH = BF$, AH must also be half of DH . Thus $DH = 2AH$ and AH is one-third of AD .

Generalization: If point E is constructed so that $BE = \frac{AD}{n}$, prove that $AH = \frac{AD}{n+1}$.

112

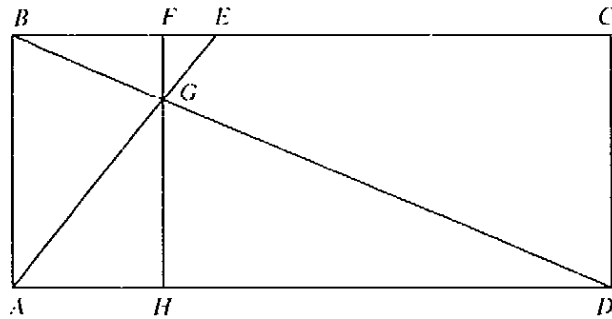

Fig. 2

Proof: (See Fig. 2.) Again triangles ADG and EBG are similar, this time with proportionality constant n . Thus $BF = \frac{DH}{n}$. Since $AH = BF$, we have $AH = \frac{DH}{n}$ or $DH = nAH$. Then

$$\begin{aligned} DH + AH &= AD \\ nAH + AH &= AD \\ AH(n + 1) &= AD \\ AH &= \frac{AD}{n + 1}. \end{aligned}$$

Now if we set $AD = 1$ and carry out the construction process repeatedly, the points (H) will be at distances of $\frac{1}{2}, \frac{1}{3}, \frac{1}{4}, \dots$ from A (see Fig. 3.), giving us the harmonic sequence.

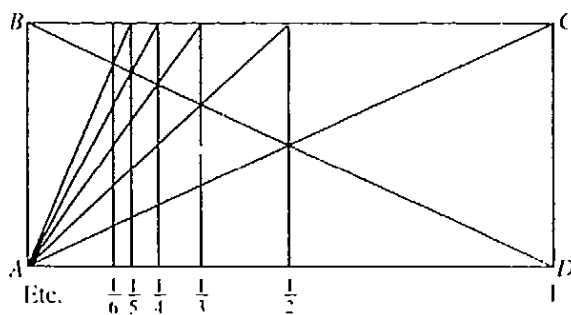

Fig. 3

A less cluttered generation of the points is shown in Figure 4.

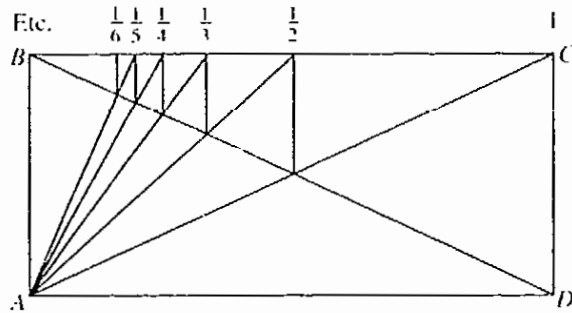

Fig. 4

Notice that just as the horizontal segments divide AD into halves, thirds, fourths, etc., so also do the vertical segments, those perpendicular to BC , divide CD by the same ratios. Thus, this single construction can be used to divide, simultaneously, two line segments into n equal parts.

Biographical history, as taught in our public schools, is still largely a history of boneheads: ridiculous kings and queens, paranoid political leaders, compulsive voyagers, ignorant generals — the flotsam and jetsam of historical currents. The men who radically altered history, the great scientists and mathematicians, are seldom mentioned, if at all.

Martin Gardner



In the index to the six hundred odd pages of Arnold Toynbee's *A Study of History*, abridged version, the names of Copernicus, Galileo, Descartes and Newton do not occur yet their cosmic quest destroyed the medieval vision of an immutable social order in a walled-in universe and transformed the European landscape, society, culture, habits and general outlook, as thoroughly as if a new species had arisen on this planet.

Arthur Koestler



Unfortunately what is little recognized is that the most worthwhile scientific books are those in which the author clearly indicates what he does not know; for an author most hurts his readers by concealing difficulties

Evariste Galois

Lucky Larry #30

The problem: The expected low temperature, T , in Fairbanks may be approximated by $T = 36 \sin \left[\frac{2\pi}{365}(t - 101) \right] + 14$ where t is in days with $t = 0$ corresponding to January 1. Find on which day the expected low temperature first reaches $0^\circ F$.

Larry's Solution: $36 \sin \left[\frac{2\pi}{365}(t - 101) \right] + 14 = 0$

$$\sin \left[\frac{2\pi}{365}(t - 101) \right] = \frac{-7}{18}$$

$$t - 101 = \frac{-7}{18 \sin \frac{2\pi}{365}}$$

$$t - 101 = -22.6 \rightarrow t = 78$$

Linda's Solution: $36 \sin \left[\frac{2\pi}{365}(t - 101) \right] + 14 = 0$

$$\sin \left[\frac{2\pi t}{365} - \frac{202\pi}{365} \right] = \frac{-14}{36}$$

$$\sin \left(\frac{2\pi t}{365} \right) = \frac{202\pi}{365} - \frac{14}{36}$$

$$365 \sin \left(\frac{2\pi t}{365} \right) = 365 \cdot \frac{202\pi}{365} - 365 \cdot \frac{14}{36}$$

$$\sin(2\pi t) = 202\pi - \frac{5110}{36}$$

$$\frac{\sin(2\pi t)}{2\pi} = \frac{6346}{2\pi} - \frac{141.9}{2\pi}$$

$$\sin t = 101 - 22.6$$

$$t = 78.4 \text{ i.e. the 78th day of the year}$$

The correct solution is based on $\frac{2\pi}{365}(t - 101) = \sin^{-1} \left(-\frac{14}{36} \right)$, from which $t = 78$.

Submitted by Keith McAllister
City College of San Francisco

MATHEMATICS EDUCATION

Towards A New Precalculus

by

Mako Haruta, Mark Turpin, and Ray McGivney
University of Hartford
West Hartford CT 06117

Mako Haruta received her A.B. from Smith College and her M.A. and Ph.D. from Boston University. She taught mathematics at Buckingham Browne and Nichols Upper School in Cambridge, MA and in 1992 she came to the University of Hartford. She has published several articles in curriculum reform of precalculus and in research mathematics and is currently heading an NSF grant for institution-wide curriculum reform. She has given talks and workshops at over a dozen local, regional, and national meetings.

Mark Turpin received his B.A. from Rensselaer Polytechnic Institute and his Ph.D. from Boston University. He came to the University of Hartford in 1992. He has published four articles and is currently working on the reform of a calculus course for business and health science majors, as well as working on his interests in research mathematics. He has given over a dozen talks at local, regional, and national meetings.

Ray McGivney received his B.A. and M.A. in mathematics from Clark University and his Ph.D. from Lehigh University. He taught at Lafayette College and in 1970 came to the University of Hartford. He has published over a dozen articles and is the co-author of two texts. He is currently working on a precalculus text integrating the use of the TI-86 graphics calculator. He has given dozens of talks to secondary school audiences at local, regional and national meetings.

UNIVERSITY
OF HARTFORD

Abstract

Two publications in the late 1980's (NCTM, 1989 and MAA, 1988) sparked a nationwide call to rejuvenate the teaching of mathematics. Since then, most reform attempts at the post-secondary level have been aimed at calculus. Recently, however, various groups, including the College Board, have been considering ways in which precalculus might be "re-formed" in order to

- place more emphasis on realistic applications, including those based on data sets;

- increase the use of technology, especially graphing calculators;
- foster group data gathering and exploratory activities; and
- require extensive oral and written reporting about key concepts.

Such changes would permit mathematics faculty to respond more effectively to the changing requirements of majors served by precalculus, as well as to the growing influence of calculus reform, and the changing environment of the marketplace. In addition, a reformed precalculus would provide an alternative approach for students disenchanted with a traditional presentation of the course. This paper describes the five year evolution of a multi-sectioned precalculus course for business and health professions majors at the University of Hartford, which attempts to meet the goals described above.

History

For over two decades, the vast majority of students enrolled in our precalculus course (M110) were business majors who were required to take a subsequent one-semester course in calculus. During that time our presentation of M110 had been traditional both in content and pedagogy, mirroring to a large extent what students had experienced (often unsuccessfully) in high school. The demographics shifted abruptly five years ago when we admitted large groups of students to new programs in occupational and physical therapy, causing our audience to tilt towards 50% health professions, 35% business, and 15% liberal arts and education majors.

In the fall of 1992 the authors of this article, who had been involved with departmental efforts to revise our three semester calculus sequence, began to plan a revision of precalculus with intent of making it more useful to our client departments as well as more interesting and valuable to our students. One year later we offered three pilot sections of precalculus using a modified syllabus that depended heavily on the use of a graphing calculator. Encouraged by our students' positive reactions, we continued to revise our material and enlist more full-time faculty to teach the course. Last fall we ran eight sections of the course (four taught by full-time faculty), all of which used the graphing calculator.

Guiding Principles

Our redesign of M110 is guided by the following four principles:

1. *Realistic applications.* Our first goal is to *engage* our audience, many of whom have not enjoyed prior success in mathematics and, consequently, are often taking this course under a combination of stress and duress. Thus, we want to convince students early on that math really is "good for something" worth their commitment of time and energy. To this end, we set about designing a collection of classroom examples, homework problems, and lab exercises that were easy to understand, that used real data, and that the students (we hoped) would find interesting and meaningful.
2. *Use of technology.* To review once again topics commonly found in high school algebra and precalculus courses, as we had done for years,

had proved not only to be fruitless, but a guaranteed "turn-off" as well. Major problem-solving skills that we wish to emphasize, including the ability to solve a variety of types of equations and to graph linear, quadratic, and exponential functions, can be done quickly and easily on a graphing calculator. We omit a review of traditional topics including completing the square, the quadratic formula, a study of logarithms, and several techniques of solving systems of linear equations, to allow more time for developing calculator skills and exploring interesting problems in greater depth.

3. *Present material numerically, graphically, symbolically, and verbally.* We had enjoyed success using this four-part strategy, termed the Harvard Calculus "Principle of Four," for several years in our calculus sequence. Whenever possible we first ask students to look at a problem numerically by studying a list of data that we distribute (e.g. the number of miles of railroad tracks in this country from 1870 to present) or collect such data themselves (e.g. gather the lengths of ulna and heights of classmates to determine one's height as a function of ulna length). Then students are asked to plot these data in a scattergram, generate the functional model that best fits the data, explain why they chose that model, draw the model, and use it to answer questions about the original data set using language that refers to the variables described in the problem. At the same time certain algebraic features of the model can be observed (e.g. the role of the parameters in determining the shape and important properties of the graph) which help to complete a final form of the graph. Finally, students prepare a written summary of their methods and results.
4. *"Less is more."* Implicit in the first three items is that we cover fewer precalculus topics. In particular, factoring, completing the square, the quadratic formula, solutions of inequalities, compositions of functions, inverse functions, synthetic division, radical and rational expressions, complex numbers, theory of equations, properties of logarithms, matrices, and certain techniques of solving systems of linear equations have been eliminated. We also omit trigonometry because each semester we offer one section of a companion course, "Precalculus for Scientists and Engineers," which treats this topic in detail.

So far these choices appear to be good ones. By concentrating on a smaller set of topics, and taking advantage of the available technology, we are able to "uncover" topics in more depth, which, in turn, provides our students with a better understanding of the material.

Syllabus

Some of the same questions that face reform calculus instructors — "Which topics to emphasize? Which to de-emphasize? Which to eliminate?" — now face precalculus instructors as well. After some experimentation, we have settled (at least for now) on the following table of contents:

1. Command of the following utilities of the graphing calculator:
 - a) the GRAPH menu (entering functions, setting proper graphing windows, tracing graphs, and evaluating functions)
 - b) the STAT menu (editing, graphing, and analyzing data sets)
 - c) much of the MATH menu (finding relative optimum points for polynomials, roots of equations, and intersections of curves)
2. Linear models
3. Quadratic models
4. Exponential models of growth and decay
5. Finance formulas (compound interest, amortization, and annuities)
6. Systems of linear equations
7. Solving equations in several variables
8. Polynomial models of higher degree

We have found it helpful to begin with data sets and linear regression as early as the second day of classes because these topics naturally introduce the concept of a mathematical model (in this case linear models) and underscore our intent on using the graphing calculator as an integral part of the course. The next section, quadratic models, continues the study of data sets and introduces the important topic of optimization. Students are expected to defend their choice of a quadratic model for a data set over that of a linear model (and vice-versa). Exponential models of growth and decay are of particular interest to students majoring in the health professions because of their use in physics and chemistry. A discussion of compound interest leads to more elaborate applications from the field of finance for which solutions can easily be found using a powerful equation solver on the calculator. The semester finishes with systems of linear equations and a discussion of polynomials of higher order. Since recent experience has shown that the first three topics can be covered more quickly than we thought, we plan to add sections on power, logistic, and simulation models next semester.

Examples of Exercises and Lab Problems

To give some idea of the flavor of the exercises that we are constructing, consider the following example:

Experts estimate that the population of a certain owl has been decreasing exponentially since 1990. In 1994, best estimates indicated that there were 1400 of the species in a county in northeastern Oregon. In 1995, there were 1250 in the same area, and in 1996 there were 1125.

- a) Write a best-fit exponential model ($y = ab^x$) for this owl population. (Don't round the parameter values.)
- b) Complete the following sentence: "In this model, the variable x represents _____ in _____."
- c) Complete the following sentences using terms appropriate for this problem.

- (1) What is the practical significance of the parameter "a"?
- (2) What is the practical significance of the parameter "b"?
- d) How many owls were there in northeast Oregon in 1990? (nearest integer)
- e) If the exponential trend of these data were to continue, in what year would the population first fall below 200 owls?
- f) At what annual percentage rate are the owls decreasing? (one decimal place)
- g) What are the long-term expectations for this owl population according to this model? Explain.
- h) If experts believed that the population were best described by a quadratic model, what would be the long-term expectations for this owl population? Explain.
- i) What might cause the owl population to deviate from the exponential model in the future?

An example of a lab, used as a culminating experience in the section on quadratic functions, is

"In order to raise scholarship funds, a group of students plans a casino night in the cafeteria. One of the games consists of tossing a disc of diameter D onto the floor, which consists of $12'' \times 12''$ linoleum tiles. The player pays \$1 for each toss. If the disc falls entirely within any tile, the player wins a dollar; otherwise, the player loses the dollar that he/she had bet. Find the value of D so that the probability that a player wins is 0.45." (Haruta, et al, 1996)

Students toss a number of discs of varying sizes one hundred times each to collect ordered pairs relating the diameter to the probability of winning. A quadratic regression model is then found from which the answer can be determined.

Assessment

A variety of assessment measures are used to determine students' progress in the course. Generally 2-3 tests and 5-6 quizzes are given during the semester together with a common final exam for all sections. These exercises contribute to 60-75% percent of a student's grade. Homework is assigned but not graded. Group exercises, which ask students to investigate topics developed in class, are graded in some sections.

A major component of a student's grade is lab projects. These team exercises often involve the collection of data, which are analyzed using the graphing calculator. After an appropriate model is chosen and graphed, students complete a list of questions and write a summary statement of their work following a set of guidelines that is distributed early in the semester. Some teams assign different tasks to each member (gathering the data, performing the analysis, writing up the final report); in other groups all members do everything, come together and pool their results and then decide who is to do the final write-up. Labs are generally started in class and final write-ups are due within 7-10 days. On average, 4-5 labs are assigned during the semester and constitute 25-40% of the grade.

The Graphing Calculator

The course is based heavily on the graphing calculator. All students are notified by mail before the semester begins to bring one on the first day of class, and 80% do so. The TI-85 was chosen over other graphing calculators for several reasons. First, we had used it successfully for several years in our calculus sequence. Second, we saw advantages to having a uniform calculator requirement that would facilitate student movement from one major to another without further expense or having to endure repeated learning curves since the TI-85 is also used in chemistry, physics and biology courses at the university. It is also relatively affordable (< \$100 at many retail stores). More advanced machines, such as the TI-92 and several of the Hewlett-Packard series, were considered, but the extra features they offered did not seem to compensate for their cost and complexity. The TI-82 and TI-83 have built-in tables and the ability to graph several easy-to-read scattergrams simultaneously, but neither has a powerful set of equations solvers as the TI-85. (We use two programs for the TI-85, one of which enables the user to create tables and the other prints scattergrams with large dots). Since the TI-82 is the calculator of choice at many high schools, students who arrive with them are allowed to use them. Although all class presentations are based on the TI-85, those few students who use the TI-82 fare as well as the others.

The TI-85 offers a number of highly attractive features. First and foremost, its statistics package allows students to enter data; calculate any of seven regression models; plot a scattergram and regression model; and forecast other values based on that model, all without leaving that utility. In addition, it has a powerful equations utility (SOLVER), which allows a student to solve complicated multi-variable equations at any stage in the syllabus. The SIMULT feature enables students to solve systems of equations that would be difficult using more commonly taught methods. Finally, the TI-85 has a polynomial solver which provides all roots to any polynomial equation of degree greater than 1 and less than 31.

At the time of our decision, we had some concern that TI-85 with its abundant features and two-level menu format might overwhelm less technologically inclined students, but we were pleasantly surprised by how quickly they learned, and enjoyed using, this new piece of equipment. In addition, we thought that as soon as the course was over students would rush to sell their calculators, but this apparently is not the case either. Several students regretted not having the TI-85 in high school ("Where was it when I needed it?"), and others said that they weren't sure where they would need it in the future, but they were holding on to it "just in case."

All in all, the TI-85 is a tremendously powerful teaching tool, which has been a primary catalyst in stimulating our new approach to precalculus. Contrary to the concerns of some, we found that the use of graphing calculators did not reduce students to "button pushing robots", but forced them to think carefully about which tools had to be used, and when in order to solve a relative complex problem.

Other Technology

Additionally, TI has produced the Calculator Based Laboratory (CBL), a data gathering device together with three scientific probes that measure temperature,

light, and voltage. Other types of probes can be ordered. With the TI-85/CBL combination, students can conduct short scientific experiments in class, store the appropriate data, and do the required mathematical analysis all with the same combined unit. The following lab has been used in several sections:

"Foam sleeves with open tops and bottoms (in some locales called "coozies") are sold to keep cans of beverage cold. How effective are they? In particular, suppose that soda is deemed undrinkable if its temperature is above 55°F. If two cans of soda are removed from a cooler whose inside temperature is 42°F, how much longer will the one protected by the sleeve remain drinkable?"

Since 35-40 minutes are needed and since there is a fair amount of "dead time" while the liquids warm, we begin the experiment in class with a CBL and run it for 10 minutes to see initial trends. Then we distribute a complete set of data gathered outside of class. The pattern of the data requires that a vertical shift and rotation through the x-axis be performed before the exponential regression can be found. The resulting model must then be appropriately rotated and shifted to fit the data.

Staffing and Student Help

Until recently, most sections of M110 were taught by adjunct instructors who, although willing and able, required substantial training and on-going support. This year, however, a majority of sections were taught by full-time faculty, all of whom have had several years experience teaching our three-semester reform calculus course.

During the first three weeks of each semester, 5-6 TI-85 "help sessions" are run by full-time professors. These drop-in tutorials are open to students from all courses using the graphing calculator, and have been moderately well-attended. The majority of those attending are first-time users, many of whom are enrolled in precalculus. To increase the opportunity for students to take advantage of these sessions we intend to experiment with student-run help sessions next year. We have found that approximately two weeks of in-class instruction, interspersed with lectures and problem solving exercises, together with these help-sessions, give students a working familiarity with their calculators.

In addition, for the past two years we have introduced "Supplemental Instruction" into a total of 6 sections of M110. Several out-of-class sessions are offered each week by an SI leader, often a student who has taken the course before, during which students compare notes, discuss readings, develop organizational tools, and predict test items. The results this far have been positive.

Textbook

Although new precalculus texts seem to arrive weekly, we have not found one to date that suits our needs. Most books that claim to be "a graphing (calculator) approach" to precalculus, in fact provide a thin calculator veneer over a standard precalculus approach. The best published material we have seen is in a calculus text — the first two chapters of *Contemporary Calculus* by LaTorre et al, D. C. Heath, 1995 — which we are piloting in our one semester calculus course.

Until recently, we had been using *Finite Mathematics and Calculus with Applications*, by Lial, Miller and Greenwell (Harper and Collins, 4th ed.). Although it presents a traditional treatment of precalculus, it does cover the topics in our syllabus, has a fairly extensive set of exercises, and costs no more than that of either of the M110 or one-semester calculus texts used in previous years. This savings, at least for students going on to calculus, helps reduce the extra cost of the calculator. This past year we used *Precalculus: A Graphing Approach* by Varberg and Varberg (Prentice-Hall), which has proved to be better suited for our needs. Next year, however, we will use a manuscript prepared by Ray McGivney, titled *Precalculus Through Modeling*, which I use as an accompanying lab manual.

Group Work

The ability to work effectively in a group is a valuable skill sought by employers. As simple as this may sound, it is not easy to find in the products of an American education since our system's emphasis has been strong on individual achievement. Recently, however, studies have shown that many students learn more in group situations than in a strictly lecture format. Although there is a place for lecturing, we have made more effort to integrate group learning into M110. Our faculty have experimented with group efforts that range from short problem solving sessions to longer laboratory type exercises and even to group quizzes. The graphing calculator has been instrumental in encouraging interaction among students as they compare graphs and computational results. We regularly encourage students to form their own study groups outside of class.

Our collective impression is that the vast majority of students work responsibly in group situations. There were isolated instances of students shirking duties assigned by the group and some evidence that not all members fully understood the group's written report. From time to time several of the instructors rearranged team membership, which seemed to alleviate these problems, at least temporarily. Next semester one of the authors plans to hold periodic 20-30 minute interviews with randomly chosen teams to go over their reports. It should be noted that the lab reports themselves were generally of high quality, several exceeding those that we received from students in our calculus classes.

Conclusion

The results of our work to date indicate that our students have benefited in several ways from the revised course. Scores were generally higher on our exams which we felt were at least as challenging as those we had given in the past. Many students say that for the first time they understood the usefulness of mathematics; some even said that the course was fun. In addition, students are overwhelmingly enthusiastic (and grateful) about the use of the graphing calculator. Finally, faculty teaching M110 are generally excited about the direction that the course is taking.

Regarding future directions, there has been some dissonance by frequently alternating between the text and the labs we are preparing. We believe this will be resolved by the manuscript specifically designed for the course that we will use next fall. We also plan to design several labs of special interest to the health

professions students since the only non-generic labs we have developed have a strong business flavor. In addition, we are revising, in parallel fashion, the one-semester calculus sequel to M110. Finally, we plan to emphasize group work and stress oral presentations (perhaps class presentations of final projects) more than we have.

In closing, we are eager to learn about similar projects and would be delighted to share the material we have developed with interested parties. You can contact us via e-mail at haruta@uhavax.hartford.edu, mturpin@uhavax.hartford.edu, or mcgivney@uhavax.hartford.edu.

References

Haruta, M. et al. (1996). Coin tossing. *Mathematics Teacher*, 89(8), 643-645.

Mathematical Association of America. (1988). *Calculus for a new century: A pump, not a filter*. Washington: MAA.

National Council of Teachers of Mathematics. (1989). *Curriculum and evaluations standards for school mathematics*. Reston: NCTM.

Lucky Larry #31

On a logarithm test Lucky Larry responded this way:

$$2 \ln(x + 3) = \ln 4$$

$$2(x + 3) = 4$$

$$x + 3 = 2$$

$$x = -1$$

Lucky Linda had a different idea:

$$2 \ln(x + 3) = \ln 4$$

$$\frac{2 \ln(x + 3)}{2 \ln} = \frac{\ln 4}{2 \ln}$$

$$x + 3 = \frac{1.386...}{.693...} = 2$$

$$x = -1$$

Submitted by Joan Page
Onondaga Community College
Syracuse NY 13215

CONVERGETM for Windows

Educational Software for Algebra through Calculus

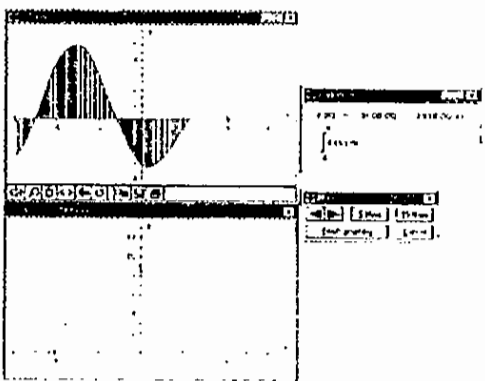
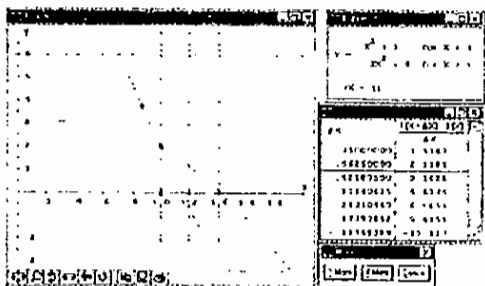
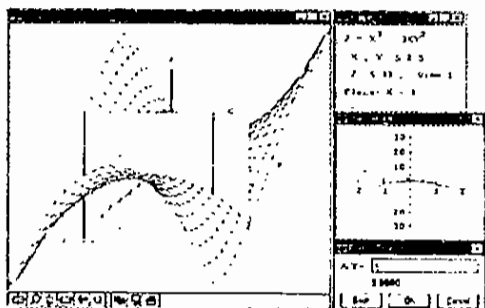
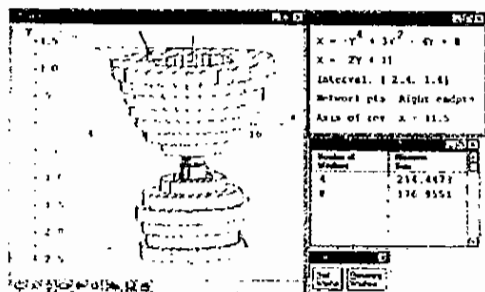

CONVERGE is now even more powerful, interactive, educational, and easy to use!

Professional, Network, and Student versions are available for *Windows 95* as well as *Windows 3.1*. (The *Windows 95* versions support *Windows 95* features such as long file names and drag & drop.) You can also transfer functions between *CONVERGE for Windows* and *DERIVETM for Windows* with just one click.

"*Converge* is very much a valuable tool for classroom demonstrations and student laboratory work." — The College Mathematics Journal

"... the processes underlying some of the main ideas of algebra and calculus can effectively be illustrated — well worth the price for anyone teaching calculus." — The Mathematics Teacher

"... quite an attractive tool. Students may gain a lot of insight into key concepts by using *Converge* to illustrate almost any basic concept in calculus; you can find convenient tools in *Converge*." — Notices of the American Mathematics Society

"*Converge* differentiates itself from the others with its emphasis on learning." — Recreational and Educational Computing

"For Algebra, Precalculus and Calculus, *Like: Converge* both for its simplicity and its range of uses — is quite marvelous." — Multimedia Schools

"... provides students the ability to conceptualize difficult topics. I highly recommend *Converge*." — Lawrence G. Gilligan, University of Cincinnati

"... a wonderful pedagogical tool for classroom demonstration or individual student exploration." — Virginia Lee, Brookdale Community College

JEMware
The Kawahao Plaza Executive Center
567 S. King St., Suite 178
Honolulu, HI 96813-1076
Phone: 808-523-9911
FAX: (24hr) 808-515-1503

BEST COPY AVAILABLE

Exploring Parametric Calculus and Elliptic Integrals with Real-World Data

by

Christopher Brueningsen and
Brunswick School
Greenwich CT

Rebecca A. Stoudt
Indiana University of PA
Indiana PA



Christopher Brueningsen is a teacher and Chairman of the Mathematics Department at Brunswick School in Greenwich, Connecticut. He received The Presidential Award for Excellence in Mathematics Teaching in 1996. He has written a number of articles for professional journals and is a frequent speaker at mathematics and science conferences.



Rebecca A. Stoudt received her Ph.D. in Applied Mathematics from Lehigh University. She is an Associate Professor at Indiana University of Pennsylvania where she received the 1996 Distinguished Faculty Award for Teaching. Her areas of interest are operations research, simulation, and the integration of technology into the mathematics curriculum.

Arguably the most frequently asked question by mathematics students is: "Is there any connection between all of these equations and the real world?" Actually this may be asked in various forms such as "Will I ever use this stuff when I get a real job?" or "Who on earth thought up all of this?" Yet the sentiment is the same. Over the past decade it has been recognized that this common sentiment is an indication that much effort must be devoted to making the study of mathematics a hands-on, real-world, and even interesting experience.

Microcomputer-based labs exhibit several positive features of concrete, active learning. The Mokros and Tinker (1987) results indicated that this type of learning

- pairs, in real time, events with their symbolic graphical representation
- provides genuine scientific experiences, and
- eliminates the drudgery often associated with graph production.

However, a negative feature, and in some cases a substantial weakness, is the expense involved in setting up a microcomputer-based lab.

The Calculator-Based Laboratory (CBL) system, which is used in conjunction with the TI-82, TI-83, TI-85, TI-86, or TI-92 graphics calculators, is a relatively low-cost alternative to the microcomputer-based system. An added, positive feature of the pocket-size CBL system is its portability. This allows for the study of a large spectrum of real-life problems. Inexpensive probes such as a motion detector, a heat

sensor, a pressure probe, and pH gauge allow for real-time, real-world data collection of position, temperature, pressure, and pH levels. Having students collect the data and mathematically analyze it at least partially eliminates a student's need to ask the aforementioned questions regarding relevance.

Is it possible to use a motion detector to record the positions of an object moving through the x and y plane in two dimensions? In this paper, we are interested in extending the idea of collecting single-dimension motion data to accommodate collection of two-dimensional motion data. Since a standard motion detector can only record back-and-forth movements, it is necessary to use a pair of detectors, arranged as shown in Figure 1. Detector #1 records back and forth movements (x -components of position) while detector #2 simultaneously records side-to-side movements (y -components of position). The path traced out by an object moving in two-dimensions is recorded in the "active grid," the square region (about 12 by 12 cm) where the sonic beams from each detector overlap.

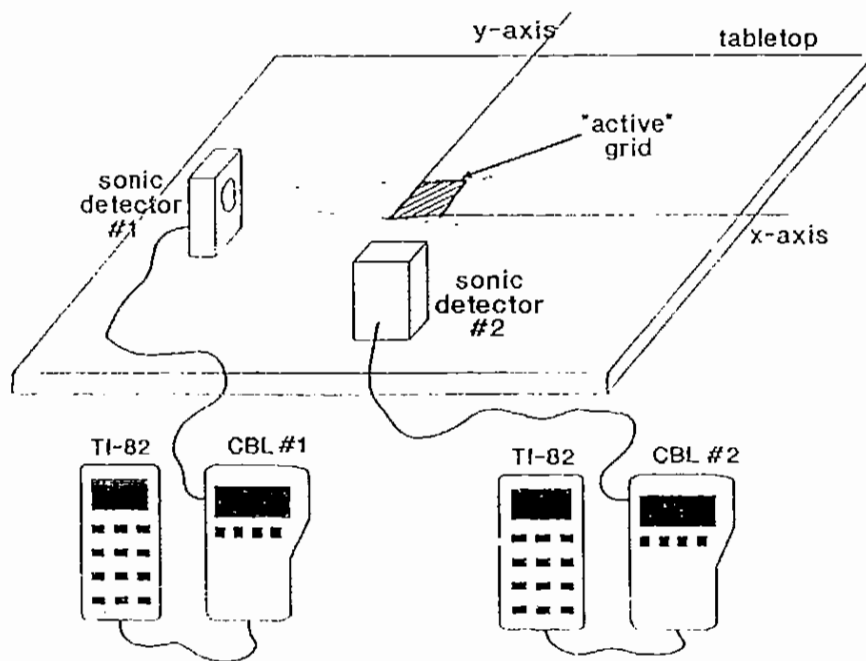

Figure 1

In this activity, the path of a pendulum bob swinging in an elliptical path (as shown in Figure 2) is recorded using the method described. The x -position data is retrieved to the calculator linked to CBL #1; the y -position data is retrieved to the calculator linked to CBL #2. The two calculators are then linked with each other and all of the data - x - and y -positions, time, and even velocities in each direction are

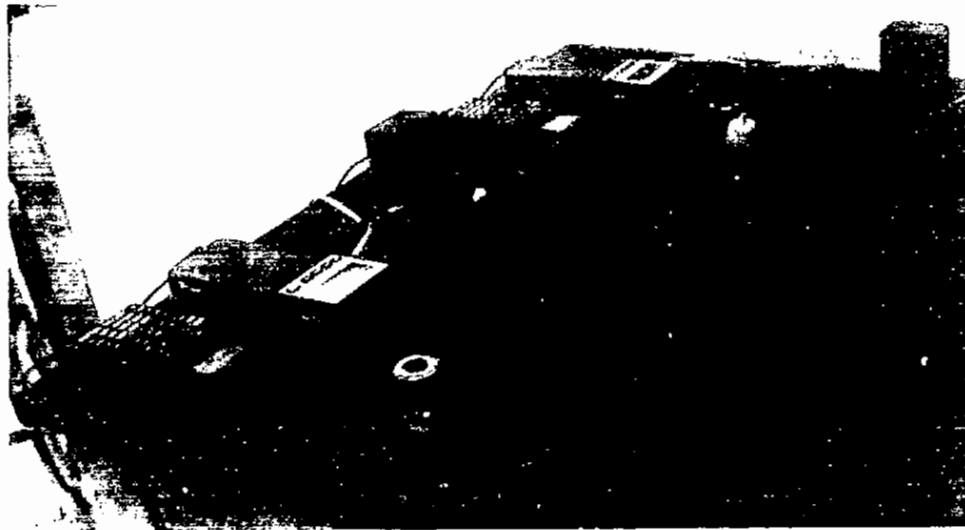

Figure 2

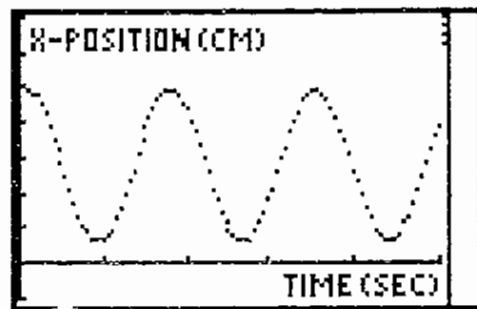

Figure 3a

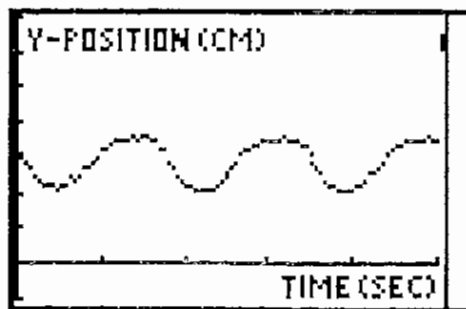

Figure 3b

loaded to a single calculator. It is then possible to view plots of any combinations of these data. Figures 3a-b show plots of x versus t and y versus t data.

First, we wish to parameterize these curves. That is, we want to develop equations for x and y as functions of time:

$$\begin{aligned} x &= f_1(t) \\ \text{and} \quad y &= f_2(t). \end{aligned} \quad (1)$$

By tracing on the data plots, it is possible to determine the common period, as well as the individual amplitudes and vertical shifts. The resulting equations are:

$$\begin{aligned} f_1(t) &= a_1 \cos(bt) + c_1 \\ \text{and} \quad f_2(t) &= a_2 \sin(bt) + c_2 \end{aligned} \quad (2)$$

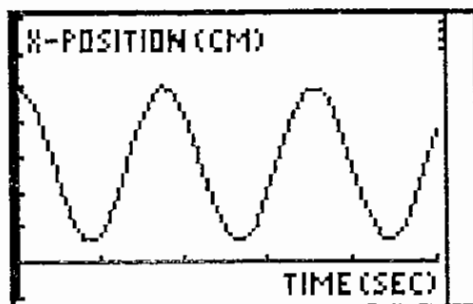

Figure 4a

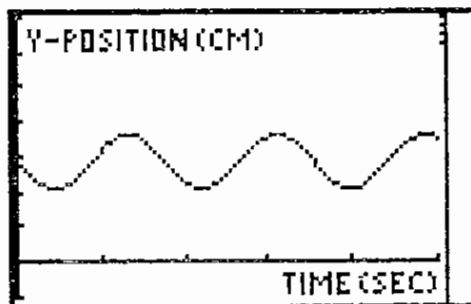

Figure 4b

where $a_1 = 4.39$ cm, $a_2 = -1.55$ cm, $b = 3.55$ Hz, $c_1 = 5.62$ cm, and $c_2 = 5.73$ cm. These equations are entered into the calculator in "function" mode and graphed individually. The resulting curves are depicted in Figures 4a-b. Note their close agreement to the data plots in Figures 3a-b.

But what about the actual two-dimensional elliptical path traced out by the swinging pendulum? A plot of y versus x is shown in Figure 5. Is it possible to find an equation to model this path? Actually, we already have. Since $f_x(t)$ and $f_y(t)$ describe x and y positions as functions of an independent time parameter, this pair of equations constitutes a parametric model of the pendulum's path. The equations $f_x(t)$ and $f_y(t)$ are entered with the calculator in "parametric" mode. The equations are shown in Figure 6a; the resulting parametric curve is shown in Figure 6b. The data-based path in Figure 5 and our parametric model in Figure 6b are in close agreement. After developing this model, it seems natural to consider applications involving parametric calculus ideas.

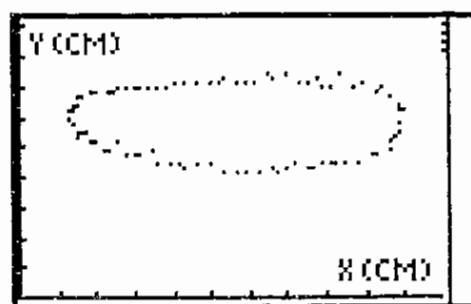

Figure 5

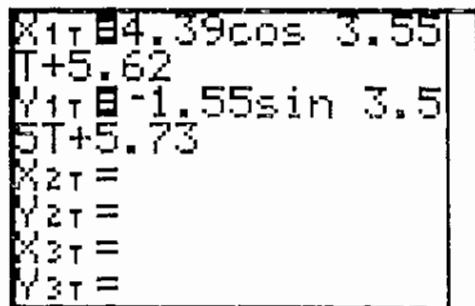

Figure 6a

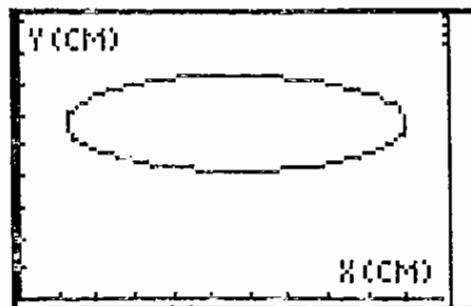

Figure 6b

Recall that directed velocities, $\frac{dx}{dt}$ and $\frac{dy}{dt}$, were recorded by the CBL and downloaded to the calculator. These data are stored in the calculator as lists, much the same way sets of data are recorded on spreadsheet programs. In similar fashion, it is possible to operate on these lists mathematically. Particularly, we are interested in computing the slope of the elliptical path at any given time:

$$\frac{dy}{dx} = \frac{dy/dt}{dx/dt} \quad (3)$$

A new list is created; it is defined as the quotient of the directional velocities and represents $\frac{dy}{dx}$. A plot of $\frac{dy}{dx}$ versus t is shown in Figure 7. As would be expected, the plot has period $\frac{T}{2}$, where T represents the time required for the elliptical pendulum to complete one full swing. It can be modeled with a modified cotangent function.

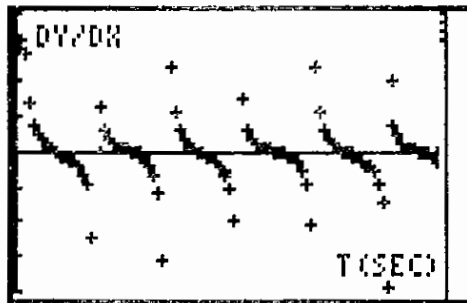

Figure 7

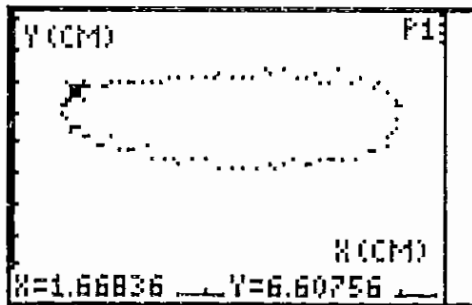

Figure 8a

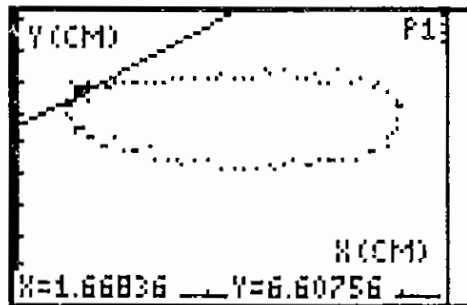

Figure 8b

For any point on the elliptical data plot, we then can easily find the equation of the line tangent to the path. Consider the point (1.67, 6.61) marked on the elliptical path, shown in Figure 8a. The corresponding $\frac{dy}{dx}$ list value is:

$$\left. \frac{dy}{dx} \right|_{t=1.67} = 0.67 \quad (4)$$

The equation

$$y = 0.67(x - 1.67) + 6.61 \quad (5)$$

is then graphed. The resulting tangent line is shown in Figure 8b. The topic of parametric derivatives is made interesting for students by using real-world data. They are truly amazed and excited when the mathematical concepts they have studied actually work in this application.

Another interesting extension of this activity involves finding the length of the path traced by the elliptical pendulum during one oscillation. First, we ask students to estimate the path length using the x - and y -position data collected. Let x_i and y_i denote the i^{th} data points in the x -position and y -position lists respectively. To find the distance, d_i , between the i^{th} and $(i + 1)^{\text{th}}$ data points, simply apply the distance formula:

$$d_i = \sqrt{(x_{i+1} - x_i)^2 + (y_{i+1} - y_i)^2}. \quad (6)$$

If one complete elliptical path is traced in m data points, the path length, L , can be approximated by:

$$L \approx \sum_{i=1}^{m-1} \sqrt{(x_{i+1} - x_i)^2 + (y_{i+1} - y_i)^2}. \quad (7)$$

It is possible to sum list sequences in much the same way one would proceed using a spreadsheet. The resulting sum yields:

$$L \approx 20.69 \text{ cm}. \quad (8)$$

Next, students are asked how they might compute the elliptical arc length theoretically, using the parametric model developed earlier. For a smooth curve, $x = f_1(t)$ and $y = f_2(t)$, traveled exactly once for $t_1 \leq t \leq t_2$, the curve's length is:

$$L = \int_{t_1}^{t_2} \sqrt{\left(\frac{dx}{dt}\right)^2 + \left(\frac{dy}{dt}\right)^2} dt. \quad (9)$$

Note that the elliptical curve (2) has eccentricity, e :

$$e = \frac{\sqrt{a_1^2 - a_2^2}}{a_1}. \quad (10)$$

Without losing generality, we take $t_1 = 0$ and $t_2 = T$, where $T = \frac{2\pi}{b}$, the period of oscillation for the ellipse. Clearly:

$$\frac{dx}{dt} = -a_1 b \sin(bt)$$

and

$$\frac{dy}{dt} = a_2 b \cos(bt) \quad (11)$$

After substitution and simplification, (9) reduces to:

$$L = a_1 b \int_0^{2\pi} \sqrt{1 - e^2 \cos^2 bt} dt \quad (12)$$

which is appropriately called an elliptic integral.

Integrals of the form (12) are quite interesting. As there are no closed-form antiderivatives for elliptic integrals in general, we use numerical techniques to evaluate (12). The integral is estimated by numerical integration (the Gauss-Kronrod Adaptive Quadrature algorithm). The expression in Figure 9 is evaluated with:

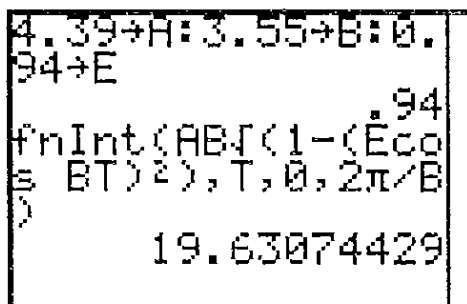

Figure 9

$$\begin{aligned} a_1 &= 4.39 \text{ cm} \\ b &= 3.55 \text{ Hz} \\ \text{and } e &= 0.94. \end{aligned} \quad (13)$$

These values are based on our previous modeling equations. Notice the result, $L = 19.63$ cm, is in close agreement with our distance formula approximation. Again, students are impressed to see real-world data modeled by mathematical theory.

All sciences, including mathematics, are currently indicating a decline in enrollments, especially beyond the undergraduate level. In addition, the National Assessment of Education Process' *The 1990 Science Report Card* (NAEP, 1992) reported that a low percentage of twelfth graders demonstrated the ability to interpret graphs and tables, evaluate and design experiments, or make use of detailed scientific knowledge. Both of these facts support the need to make the study of mathematics (and sciences in general) a more hands-on, real-world related, and interesting experience. We believe that experiments, such as those described in this article, satisfy these criteria. Furthermore, these experiments can be adapted for all levels (elementary through college) and therefore provide the opportunity to capture and cultivate the interest of students in the rich connection between "their" world and the scientific/mathematical world.

References

- Mokros, J., and Tinker, R. (1987). The impact of microcomputer-based tabs with children's ability to interpret graphs. *Journal of Research in Science Teaching*, 24(4), 369-383.
- National Assessment of Educational Process. (1992). *The 1990 Science Report Card*.

WILEY:
THE POWER IS IN THE DIFFERENCE!

**CALCULUS, Single Variable,
Second Edition**

Deborah Hughes-Hallett,
Andrew M. Gleason, *both of
Harvard University, et al.*

16412-9, 682 Pages, Paper, 1998
16413-7, 682 Pages, Cloth, 1998

**CALCULUS,
Single & Multivariable,
Second Edition**

Deborah Hughes-Hallett,
Andrew M. Gleason, *both of
Harvard University*
William G. McCallum,
University of Arizona, et al.

19190-5, 972 Pages, Cloth, 1998

**CALCULUS: A New Horizon,
Sixth Edition**

Howard Anton, *Drexel University*

Vol. 1, 24331-0, Paper, 1998

Vol. 2, 24348-5, Paper, 1998

Vol. 3, 24349-3, Paper, 1998

Complete Edition: 15306-0, Cloth, 1998

Brief Edition: 15307-9, Cloth, 1998

**FUNCTIONS
MODELING CHANGE:
A Preparation For Calculus
Preliminary Edition**

Eric Connally, *Wellesley College*
Deborah Hughes-Hallett and
Andrew M. Gleason, *both of
Harvard University, et al.*

17081-X, 624 Pages, Paper, 1998

**EXPLORATIONS IN
COLLEGE ALGEBRA,
First Edition**

Linda Almgren Kime and Judith
Clark, *both of University of
Massachusetts, Boston*

10698-4, 640 Pages, Paper, 1998

**LINEAR ALGEBRA:
Ideas and Applications**

Richard C. Penney,
Purdue University

18179-X, 525 Pages, Cloth, 1998

**DIFFERENTIAL EQUATIONS:
A Modeling Perspective,
First Edition**

Robert L. Borrelli and
Courtney S. Coleman,
both of Harvey Mudd College

04230-7, Cloth, 1998

FOR MORE INFORMATION:

Please contact your local Wiley representative, or write to John Wiley &
Sons, Inc., attn: L. Hines, Dept. S-0342, 605 Third Avenue, New York,
New York 10158. FAX us at (212) 850-6118, or E-mail us at Math@wiley.com
Wiley on the World Wide Web: <http://www.wiley.com/college>



S-0342 rhm/kel

Why Use Radians in Calculus?

by

Carl E. Crockett, Lt. Col.
United States Air Force Academy
USAF Academy CO 80840-6252



Lt. Col. Carl E. Crockett is an Associate Professor of Mathematics at The United States Air Force Academy in Colorado Springs, Colorado. He was awarded the Ph.D. degree in 1990 from the Air Force Institute of Technology, Dayton, OH. For the last seven years, he has been active in the rejuvenation of the calculus curriculum at USAFA. His other interests include ODEs, PDEs, and astrodynamics. He currently serves as the Deputy Head for Academics in the 50 member Department of Mathematical Sciences.

Students often want to know why they must use radians, instead of degrees, in calculus. It is not easy to give an explanation which is both thorough and concise. This note presents, in dialogue form, progressively more detailed answers. Inconveniently, the question typically arises before the tools are available to give the most thorough answer.

Q. *Why do we use radians in calculus?*

A. Convenience.

Q. *Why is it convenient?*

A. Radians can be interpreted as a measure of angle or distance. That is, on the circle of radius one used to define trigonometric functions, one radian of angle identifies the same change in position as one unit of arc length. Thus, the use of radians avoids the necessity of a conversion factor.

Q. *What if I don't mind unit conversions?*

A. That's fine — just be sure you do them all the time.

Q. *You make it sound as if I'm likely to forget sometime. Is that what you mean?*

A. Maybe. Some people claim that if $f(x) = \sin x$, then $f'(x) = \cos x$. You may be one of them.

Q. *Please, don't insult me. Of course I do. Are you off your rocker?*

A. Not at all. And, in radians, you're right. But, if your $f(x) = \sin x$ has x in degrees, then $f'(x) = \frac{\pi}{180} \cos x$. That's the conversion factor I was afraid you might forget.

131

Q. You'll need to show me where the $\frac{\pi}{180}$ comes from before I'll be a believer. Will that be complicated?

A. It is a bit complicated, and tedious too. Before we look at the details, it may be advantageous to consider a different example. Here's one that exposes the need for a conversion factor. We'll find the average value of $\cos x$ over $\frac{1}{4}$ of a period. A quick glance at the graph leads to an estimate of the answer between $\frac{1}{2}$ and 1. The formula for the average value of a function $f(x)$ from a to b is $\frac{1}{b-a} \int_a^b f(x) dx$.

So, using degrees, we have

$$\begin{aligned} & \frac{1}{90-0} \int_0^{90} \cos x \, dx \\ & \frac{1}{90} \sin x \Big|_0^{90} \\ & \frac{1}{90} = 0.1 \end{aligned}$$

If we use radians, we obtain

$$\begin{aligned} & \frac{1}{\frac{\pi}{2}-0} \int_0^{\frac{\pi}{2}} \cos x \, dx \\ & \frac{2}{\pi} \sin x \Big|_0^{\frac{\pi}{2}} \\ & \frac{2}{\pi} \approx 0.6. \end{aligned}$$

The radian version seems more likely to be correct, and indeed it is. Note that the two results differ by a factor of $\frac{\pi}{180}$.

Q. You've shown me $\frac{\pi}{180}$ twice now. Would you show me the details of where the $\frac{\pi}{180}$ came from?

A. Gladly. We'll use the definition of the derivative to explore what happens in the original example.

$$f'(x) = \lim_{h \rightarrow 0} \frac{\sin(x+h) - \sin x}{h}$$

$$\begin{aligned}
&= \lim_{h \rightarrow 0} \frac{\sin x \cosh h + \cos x \sinh h - \sin x}{h} \\
&= \lim_{h \rightarrow 0} \frac{\cos x \sinh h + \sin x (1 - \cosh h)}{h} \\
&= \cos x \lim_{h \rightarrow 0} \frac{\sinh h}{h} + \sin x \lim_{h \rightarrow 0} \frac{1 - \cosh h}{h}
\end{aligned}$$

At this point, we pause to evaluate the two limits. Then, we'll substitute their values.

First consider $\lim_{h \rightarrow 0} \frac{\sinh h}{h}$. This is a difficult limit to evaluate. We can't use L'Hôpital's Rule because we're in the middle of trying to find the derivative of the sine function. We need a direct approach. I propose to use "the squeeze theorem." The basis for my squeeze is derived geometrically. It will then be manipulated algebraically. Observe, from the sketch,

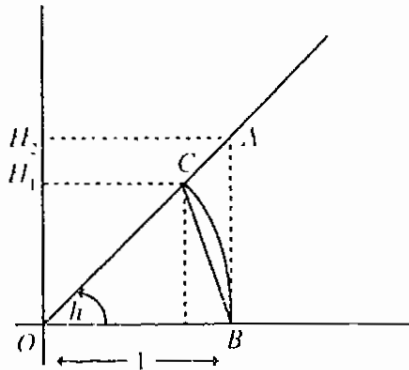

area of $\triangle OBC \leq$ area of sector $OBC \leq$ area of $\triangle OBA$, and $\frac{H_1}{2} \leq \frac{\text{length of arc } BC}{2} \leq \frac{H_2}{2}$.

Here we face the critical issue. If h is in radians, then the length of the arc from B to C is also h . When h is in degrees, then the length of the arc is $\frac{\pi}{180} h$. Using degrees, we obtain

$$\begin{aligned}
\frac{H_1}{2} &\leq \frac{\frac{\pi}{180} h}{2} \leq \frac{H_2}{2} \\
\frac{\sin h}{2} &\leq \frac{\frac{\pi}{180} h}{2} \leq \frac{\tanh h}{2}
\end{aligned}$$

$$\sin h \leq \frac{\pi}{180} h \leq \tan h$$

$$1 \leq \frac{\frac{\pi}{180} h}{\sin h} \leq \frac{1}{\cos h}$$

$$1 \geq \frac{\sin h}{\frac{\pi}{180} h} \geq \cos h$$

$$\frac{\pi}{180} \geq \frac{\sin h}{h} \geq \frac{\pi}{180} \cos h$$

Now, as $h \rightarrow 0$, $\frac{\sin h}{h}$ is trapped between $\frac{\pi}{180}$ and $\frac{\pi}{180} \cos h$. Since $\cos h \rightarrow 1$ as $h \rightarrow 0$,

we see $\lim_{h \rightarrow 0} \frac{\sin h}{h} = \frac{\pi}{180}$. Note: For h in radians, $\lim_{h \rightarrow 0} \frac{\sin h}{h} = 1$.

We now turn to the other limit.

$$\begin{aligned} \lim_{h \rightarrow 0} \frac{1 - \cos h}{h} &= \lim_{h \rightarrow 0} \frac{1 - \cos h}{h} \cdot \frac{1 + \cos h}{1 + \cos h} \\ &= \lim_{h \rightarrow 0} \frac{1 - \cos^2 h}{h(1 + \cos h)} \\ &= \lim_{h \rightarrow 0} \frac{\sin^2 h}{h(1 + \cos h)} \\ &= \lim_{h \rightarrow 0} \frac{\sin h}{h} \cdot \lim_{h \rightarrow 0} \frac{\sin h}{1 + \cos h} \\ &= \frac{\pi}{180} \cdot \frac{0}{1 + 1} \\ &= 0 \end{aligned}$$

Finally, we substitute the limits to obtain

$$f'(x) = \frac{\pi}{180} \cos x.$$

Q. *So, you seem to be saying we'll avoid lots of $\frac{\pi}{180}$ terms (that we're likely to forget) if we use radians. Is that true?*

A. Yes, convenience.

A Mathematician is a machine for turning coffee into theorems.

Paul Erdős

PORTLAND, OREGON

$\pi \pi \pi \pi \pi \pi \pi \pi$

1998

November 5-8

AMATYC BRIDGES

**K-12 TO UNIVERSITY
PROFESSIONS
VOCATIONAL
TECHNICAL
DIVERSITY
AND MORE**

<http://www.cocc.edu/fhelfenstein/bridges>
for information & answers

Sponsored and hosted by:
ORMATYC
and

Community Colleges of Oregon & Southern Washington

KEYNOTE SPEAKER

Miriam Leiva
University of North Carolina at Charlotte

BREAKFAST SPEAKER

Richard Minnix
Department of Physics and Astronomy
Virginia Military Institute at Lexington

BRIDGE COPY AVAILABLE

REGULAR FEATURES

Snapshots of Applications in Mathematics

Dennis Callas
State University College of Technology
Delhi NY 13753

David J. Hildreth
State University College
Oneonta NY 13820

The purpose of this feature is to showcase applications of mathematics designed to demonstrate to students how the topics under study are used in the "real world," or are used to solve simply "charming" problems. Typically one to two pages in length, including exercises, these snapshots are "teasers" rather than complete expositions. In this way they differ from existing examples produced by UMAP and COMAP. The intent of these snapshots is to convince the student of the usefulness of the mathematics. It is hoped that the instructor can cover the applications quickly in class or assign them to students. Snapshots in this column may be adapted from interviews, journal articles, newspaper reports, textbooks, or personal experiences. Contributions from readers are welcome, and should be sent to Professor Callas.

Thermal Systems and the Solar Oven

(to accompany exponential functions and engineering applications)
by Carl Bickford, San Juan College, Farmington, NM

Thermal Systems

A simple thermal system is composed of an object, its surroundings (the environment), and a path for heat energy to flow. These systems, like many aspects of society and nature, resist change. Eventually we all get used to the "new" way, but it takes awhile, and the period of transition depends on many aspects of the system and its environment. Very often, this transient behavior isn't very productive and we find ourselves asking, "How long will it be until a *steady state* is achieved?" A good example is the body temperature thermometer. You can't just put one in your mouth and expect instant results, you must wait until the sensor itself adjusts to its new environment. The amount of time this takes depends on the size, mass, and composition of the temperature sensor as well as your skill at protecting it from the ambient air.

On a much larger scale consider a coal-fired electric power generating facility, such as the 2,040 megawatt Four Corners Power Plant operated by Arizona Public Service on the Navajo Indian reservation outside of Shiprock, NM. All the equipment used to generate power (combustors and associated emission controls, boilers, steam turbines, pumps, and electric generators) is designed to operate

most efficiently under specific conditions and in a steady state. If a change occurs in any one part of this complex chain, all the other components are affected. An environmental consultant at the Four Corners plant reports that changing the operating point of such a system (often dictated by major consumers all over the western United States) takes a significant amount of time. During this change, equipment operates less efficiently and the level of pollutants going up the exhaust stack increases. Pollutant emission may even exceed legal limits during transient periods, but will drop back below those limits when the system again reaches steady state. For this reason pollution laws are designed to apply to average emissions over time.

Solar Ovens

A solar oven is a simple thermal device which traps radiant energy from the sun in a small, enclosed space. The resulting temperature rise inside the oven can easily be enough to cook food. Temperatures of 350° F are not uncommon with small, collapsible designs. The nature of the temperature versus time behavior of the oven interior depends on the relative magnitudes of energy gain and energy loss. This way of looking at a thermal problem is called an energy balance.

Initially, when the oven is cool, the energy gain from the sun is much greater than that lost to the environment. The temperature rises quickly. Eventually, however, the oven gets hot enough so that the energy loss occurs at the same rate as the energy gain. At this point the temperature levels out and the oven will be in a steady state. The temperature will remain constant as long as the energy coming in equals the energy going out. If clouds suddenly roll in, or the oven is turned away from the sun, the energy loss will take over and the temperature will fall rapidly. As the oven cools off and the temperature approaches that of the environment, the cooling rate slows dramatically. Such is the nature of heat transfer. The rate of transfer is proportional to temperature difference, much the same way as water flow rate through a hose is proportional to pressure (the potential for energy transport).

Actual temperature versus time data for a simple solar oven located in Farmington, NM (latitude 36° 44') is included below. Both environmental and oven temperatures are monitored by a data acquisition device and stored in the memory of a programmable calculator. Figure 1 shows the experimental apparatus. Two sets of data are included. Table 1 gives temperature (in degrees Fahrenheit) versus time (in seconds) for the warm-up phase of operation. Table 2 gives temperature versus



Figure 1. Solar Oven and Data Acquisition Equipment

Warm Up	
Ambient	81 [F]
Time [s]	Oven [F]
0	81
30	101
60	126
90	149
120	170
150	187
180	202
210	213
240	223
270	234
330	250
390	259
450	267
540	273
630	281
720	287
810	293
930	299
1200	307
1470	311

Table 1

Cool Down	
Ambient	79 [F]
Time [s]	Oven [F]
0	310
30	292
60	270
90	249
120	231
180	205
240	186
300	171
390	152
480	139
570	129
690	119
840	109
990	103
1140	98
1290	95
1440	93
1590	92
1740	91
2070	88

Table 2

time data for the cool-down phase, where the hot oven is shaded from sunlight. Average environmental temperatures (ambient) for each data set are included.

Exercises

1. Use a graphing calculator, spreadsheet, or other software (Mathead, Maple, etc.) to plot the data given in the tables. Make separate plots and do not connect the points with lines.
2. Now use an exponential function to model the actual behavior. Start with the cool down data. Important information in the model includes the initial temperature, final temperature, and a constant in the exponent which can be varied. Such a model may look like:

$$T(t) = T_f + (T_i - T_f)e^{-kt}$$

Use a calculator or software to plot this function along with the actual data points. Use appropriate values of T_i and T_f , then vary k until you have a good match between the data and the model. Record these values.

3. Now try the warm up data and, again, include T_i , T_f , and k . A new form of the model equation must be found, however. Remember: temperature starts at an initial value and rises, at a decreasing rate, until the final temperature is reached. Record the values of the variables which model the data acceptably.
4. Compare the two exponential constants (k 's) from above. How much do they differ (%)? Is this difference significant? What effect does " k " have on the shape of the function?
5. An important concept in describing the behavior of transient systems is the *time constant*, τ . The time constant represents the time for the response (temperature in this case) to get to the final value if it were allowed to change at the initial rate. The time constant, therefore, is much shorter than the time it takes the response to *actually* reach the final value. The diagram below represents this idea graphically.

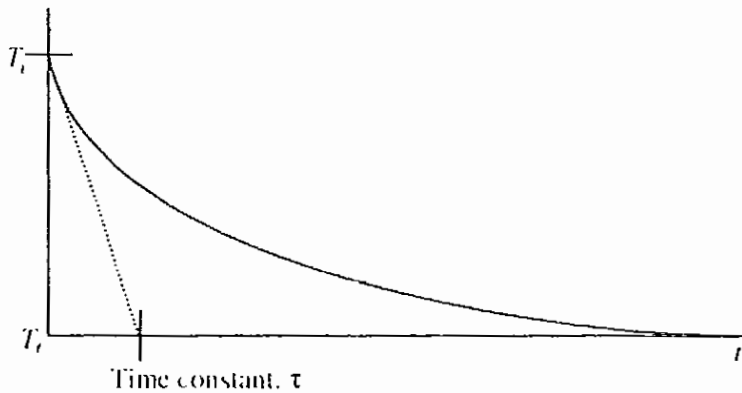

A function which represents the behavior in the diagram is $T(t) = (T_i - T_f)e^{-t/\tau} + T_f$.

Specification of instrumentation often includes a value for the time constant. Physically, this indicates how long the sensor will take to adjust to a new environment.

Substitute τ in for t in the $T(t)$ function. This simulates the response at one time constant. What percentage of $(T_i - T_f)$ is left after one time constant? After two? After three? How many time constants would have to go by before you're at the final response (T_f)? Hint: there is no one correct answer, engineers usually assume five. For example, if a temperature sensor has a time constant of 2 seconds, it would take at least 10 seconds for it to adjust to the new environment.

6. Use your plots to graphically estimate the time constants for both the warm-up and cool-down oven data. Compare the values. *Hint: Remember that at 1 TC (time constant) 36.8% (e^{-1}) of the response is left. So, look at the plot and ask*

where does it start and where does it end (temperature)? Calculate 36.8% of that difference. Determine the time at which 36.8% of the response is left. That time is the TC.

7. Explain (in words) how the time constant and the exponential coefficient, k , are related? (When one changes, how does it affect the other?)
8. What environmental and design factors affect the time constant? How (qualitatively) do these affect τ ? Hint: Wind speed and its consistency play a role; how would this affect the shape of the plotted data?
9. Use the factors listed above to optimize the design of a solar oven.

What's to do in Portland?

**Come early and stay late to enjoy
the magnificent Northwest,
the "End of the Oregon Trail."**

You will want to explore:

- Fort Clatsop just outside of Astoria, Oregon (about 90 miles from Portland)
- The salt kiln made by the Lewis and Clark expedition in Seaside (about 75 miles from Portland on the way to Astoria)
- "Trails End" expo in Oregon City, the first capital of Oregon territory
- "The Gorge" where the Columbia River separates Oregon and Washington upon which many pioneers rafted part of their journey
- Multnomah Falls is one of the highest and most beautiful in the United States
- Bonneville Dam and fish hatchery (about 40 miles east of Portland)

Enjoy:

- A walk in the Tom McCall Waterfront Park along the Willamette River
- A visit to the Saturday Market for a taste of Oregon (nearby is the fireman's museum)
- The nationally acclaimed zoo
- OMSI with its planetarium and other scientific wonders including the submarine from "Hunt for Red October"
- The museums with their many themes
- Many play companies, operas and other cultural events

Truly there is something for everyone to enjoy!

Notes from the Mathematical Underground

by

Alain Schremmer

Mathematics Department, Community College of Philadelphia

1700 Spring Garden Street

Philadelphia PA 19130

SchremmerA@aol.com

The opinions expressed here are those of the author and should not be construed as representing the position of AMATYC, its officers, or anyone else.

Many reasons have been adduced for the 50% failure rate in first semester calculus — lack of ... , lack of ... , lack of ... , but I would submit that not only must a theory in which limits are “the central notion” necessarily fail, *globally*, to impart the differential calculus of functions with a “story line” — as I have intimated before and will discuss in the Fall issue — but, *locally*, it also makes it brutal, right from the start. To dispense with proofs, as is now usually the case, leaves the students no recourse other than to memorize. So, in order to reinstate proofs as something helpful to the students, it is *limits* that ought to be dispensed with. Consider, for instance, the following

Theorem. If f is differentiable at x_0 , then f is continuous at x_0 .

whose Bolzano-Cauchy-Weierstrass (BCW) proof now runs something as follows

Proof. To show that $\lim_{h \rightarrow 0} f(x_0 + h) = f(x_0)$, we will show that $\lim_{h \rightarrow 0} [f(x_0 + h) - f(x_0)] = 0$.

$$\begin{aligned}\lim_{h \rightarrow 0} [f(x_0 + h) - f(x_0)] &= \lim_{h \rightarrow 0} \left[\frac{f(x_0 + h) - f(x_0)}{h} \cdot h \right] \\ &= \lim_{h \rightarrow 0} \left[\frac{f(x_0 + h) - f(x_0)}{h} \right] \cdot \lim_{h \rightarrow 0} h \\ &= f'(x_0) \cdot 0 = 0\end{aligned}$$

END OF PROOF

Now, how can we expect “just plain folks” to *come up* with that? Not being already adept at reducing binary relations to unary ones by way of difference operations, as in “ $x > y$ iff $x - y$ is positive” or “ p entails q iff $p \supset q$ is tautological”, how can they be expected to think of replacing $\lim_{h \rightarrow 0} f(x_0 + h) = f(x_0)$ by $\lim_{h \rightarrow 0} [f(x_0 + h) - f(x_0)] = 0$? Or of dividing and multiplying by h ? Worst of all though because it does not argue straightforward from differentiability to continuity, the proof does not *convince* them: *At this stage*, proofs ought to have some *inevitability* — some logic? — to them. So, indeed, why bother?

On the other hand, since constant functions are the simplest functions with no jump in output and affine functions the simplest ones with no jump in rate of

change, why not present continuous functions as locally approximately constant and differentiable functions as locally approximately affine? The proof of the above theorem is now straightforward: In "words",

Proof. Since f is approximately affine and affine functions are approximately constant, f is approximately constant. END OF PROOF

or, in "approximate" algebra, with (...) read "a little bit",

Proof. Since f is differentiable, $f(x_0 + h) = A_0 + A_1 h + (\dots) = A_0 + (\dots)$ which says that f is continuous. END OF PROOF

To make sense, the calculus of (...) needs only be based on heuristic considerations of powers of $\frac{1}{10}$: e.g. h^3 is negligible relative to h^2 just as $\frac{1}{1000}$ is negligible relative to $\frac{1}{100}$ and is thus quite within the reach of just plain folks.

But what we are really doing is to define the *order of magnitude* of a function and we do it in exactly the same manner as with numbers: Just as powers of 10 are ordered by the exponent — e.g. when $p > q$, $(\frac{1}{10})^p$ is smaller than $(\frac{1}{10})^q$, so are power functions near 0 (and ∞): When $p > q$, h^p approaches 0 faster than h^q in that Graph $\{h^p\}$ lies under Graph $\{h^q\}$. More precisely, when $p > q$, there is for any λ a neighborhood of 0 in which Graph $\{h^p\}$ lies under Graph $\{\lambda h^q\}$. Then, we can gauge a function f by its position relative to $\{h^q\}$ and write $f(h) = o\{h^q\}$ to mean that $f(h)$ approaches 0 faster than h^q — Graph $f(h)$ lies under Graph $\{h^q\}$. In BCW, we would say that $\lim_{h \rightarrow 0} \frac{f(h)}{h^q} = 0$. For example, if $p > q$, $h^p = o\{h^q\}$. In particular, $f(h) = o\{h^0\}$ means that $\lim_{h \rightarrow 0} f(h) = 0$. Writing $o\{1\}$ for $o\{h^0\}$, note that $o\{1\}$ behaves like 0 and that it is all we need as $o\{h^p\} = h^p \cdot o\{1\}$:

$$(o\{1\})^\alpha = o\{1\} \text{ for any positive rational } \alpha,$$

$$(1 + o\{1\})^\alpha = 1 + o\{1\} \text{ for any integer } \alpha.$$

However, using $o\{h^p\}$ is much more intuitive and requires essentially only

$$\text{If } p > q, \text{ then } \alpha o\{h^p\} + \beta o\{h^q\} = o\{h^q\} \text{ for all real } \alpha, \beta$$

We can either postulate these identities or derive them from BCW but, even then, this would be the last we would need of limits. Note that this allows us to adapt the degree of "rigor" of the proof to the "mathematical maturity" of the students.

Once we can expand a function f near any given point x_0 , that is once we can express $f(x_0 + h)$ as a linear combination of gauge functions plus a remainder $R_0(h)$ of which all we need to know is that $R_0(h) = o\{h^n\}$, the local analysis of f is trivial: For instance, we have that f is continuous at x_0 iff $f(x_0 + h) = A_0 + o\{1\}$ and f is differentiable at x_0 iff $f(x_0 + h) = A_0 + A_1 h + o\{h^1\}$ whence the "rigorous"

Proof. To show that if $f(x_0 + h) = A_0 + A_1 h + o\{h\}$ then $f(x_0 + h) = A_0 + o\{1\}$ we must show that $A_1 h + o\{h\} = o\{1\}$. Since $A_1 h = o\{1\}$, we have $A_1 h + o\{h\} = o\{1\} + o\{h\} = o\{1\}$. END OF PROOF

Since letting $h = 0$ gives $A_0 = f(x_0)$, define the **derivative** of f as the function f' such that $f'(x_0) = A_1$. Then, you can reasonably expect students to *come up* with the proofs of the "derivative rules" since $[f * g]'(x_0)$ is the coefficient of h in $[f * g]'(x_0 + h) = [f(x_0) + f'(x_0)h + o[h^1]] * [g(x_0) + g'(x_0)h + o[h^1]]$. If $*$ is defined pointwise, the computations are straightforward: if $*$ is composition, you still have

$$\begin{aligned} [g \circ f](x_0 + h) &= g(f(x_0 + h)) = g(f(x_0) + f'(x_0)h + o[h^1]) \\ &= g(f(x_0)) + g'(x_0)[f'(x_0)h + o[h^1]] + o[h^1] \\ &= g(f(x_0)) + g'(x_0)f'(x_0)h + o[h^1]. \end{aligned}$$

Of course, you will be glad to note that $f'(x_0) = \frac{f(x_0 + h) - f(x_0)}{h} + o[1]$ and that we obviously do not need L'Hôpital's Rule.

How we expand a function depends of course on its nature. Starting with the positive-power functions as gauge functions, we index polynomial functions with Low d^q , the exponent of the *lowest* power term to get a comparison theorem near 0: When Low $d^q P >$ Low $d^q Q$, P approaches 0 faster than Q . As a result, $P(h)$ is approximated by any truncation. Ditto near infinity with High d^q . We get $P(x_0 + h)$ from the binomial theorem and find that, *locally*, polynomial functions are approximately polynomial everywhere!

Gauging rational functions requires division in *ascending* powers, except at infinity where powers must descend. Since positive-power functions are not closed for division, rational functions are approximately polynomial only *almost* everywhere. To gauge rational functions near their poles — and near infinity when High $d^q < 0$, we must include the negative-power functions among the gauges.

Beyond that, even though functions cannot be defined by a rule giving the output in terms of the input but, again like numbers, only as solution of — functional — equations, the finite local theory remains elementary because little ohs now do what d^q did for polynomial and rational functions: To say of a function that it is $o[h^q]$ is the same as saying of a polynomial function that its Low d^q is q : If $f(h) = o[h^p]$ and $g(h) = o[h^q]$ with $p > q$, then $f(h)$ approaches 0 faster than $g(h)$.

For example, ROOT(x) is defined as solution of the equation $f^2(x) = x$ which gives the approximate solution $\text{ROOT}_2(x_0 + h) = \sqrt{x_0} + \frac{1}{2\sqrt{x_0}}h - \frac{1}{8x_0\sqrt{x_0}}h^2$ by the method of undetermined coefficients and, with a leap of faith, that it is an approximation of the exact solution: $\text{ROOT}(x_0 + h) = \text{ROOT}_2(x_0 + h) + o[h^2]$. So, ROOT is approximately polynomial everywhere except near the origin and near ∞ so that we now must include the fractional-power functions among the gauges.

Define EXP(x) as solution of the initial value problem $f'(x) = f(x)$, $f(0) = 1$. We can expect students to *come up* with $\text{EXP}_n(h) = 1 + h + \frac{h^2}{2} + \frac{h^3}{3!} + \dots + \frac{h^n}{n!}$ and, when x_0 is small, with the addition formula: $\text{EXP}_n(x_0 + h) = \text{EXP}_n(x_0) \cdot \text{EXP}_n(h) + o[h^n]$ from which a leap of faith gives $\text{EXP}(x_1 + x_2) = \text{EXP}(x_1) \cdot \text{EXP}(x_2)$. In particular, $\text{EXP}(n) = \text{EXP}(1)^n$ and, with another leap, $\text{EXP}(x) = e^x$. EXP is approximately polynomial everywhere except at infinity where, since it beats any power function,

EXP cannot be gauged. So, it too must be included among the gauges.

Defining $\text{SIN}(x)$ as solution of $f''(x) = -f(x)$, $f(0) = 0$, $f'(0) = 1$, we can again expect students to *come up* with, say $\text{SIN}_h h = h - \frac{h^3}{3!}$ and similarly $\text{COS}_h h = 1 - \frac{h^2}{2}$ along with their addition formulas: For instance, $\text{COS}_h(h+k)$ involves $h \cdot k$ which can only come from $\text{SIN}_h h \cdot \text{SIN}_k k$. Also, note that $\frac{\text{SIN}_h h}{h} = 1 + o[|h|]$. Etc.

I can already hear the shrieks of anguish and terror: "*Mathematics is not a matter of faith*", "*You are evidently and sadly misleading your students!*" Even if, between leaps, students can *prove* things *for and by themselves*? Even the leaps are clearly indicated as such and if they can, in fact, be fruitfully discussed?

In particular, many of these gaps occur in situations where we would need to know that some infinite process reduces in fact to a finite one. (In other words, situations that involve *compactness*.) For example, say we wanted to compute $\text{EXP}(x)$ for some finite x . Start with a small x_0 and compute $\text{EXP}(x_0) = 1 + x_0 + \frac{x_0^2}{2} + \dots + \frac{x_0^{n_0}}{n_0!}$ for some n_0 . Now let $x_1 = x_0$ plus some h_1 and compute $\text{EXP}(x_1) = \text{EXP}(x_0) \cdot \left\{ 1 + h_1 + \frac{h_1^2}{2} + \frac{h_1^3}{3!} + \dots + \frac{h_1^{n_1}}{n_1!} \right\}$ for some n_1 . Then let $x_2 = x_1 + h_2$ and compute $\text{EXP}(x_2)$. Etc. The question is whether the x_i will reach x and, if so, what the error on $\text{EXP}(x)$ will be. We can try to take larger and larger n_i but, even so, we may still need to take smaller and smaller h_i to control the size of the error but with the result that the x_i may approach x by diminishing increments and not even get close to x .

Similarly, our definition of continuity at x_0 shows very clearly where the difficulty is in proving theorems such as *a function that is continuous on a closed bounded interval $[a, b]$ is itself bounded*. We have that $\forall x_0 \in [a, b]$, $f(x_0 + h) = f(x_0) + o(1)$. Suppose h is in a neighborhood of 0 whose size depends on x_0 , say such that $o(1) < 0.1$. If we could cover $[a, b]$ with some *finite* number N of such intervals, then $|f(x) - f(a)|$ would be bounded by $\frac{N}{10}$ and the theorem proved.

What then are the little ohs' ... limitations? The obvious ones are actually those of the gauges. For instance, just as, near $+\infty$, EXP is too steep and LN too flat to be gauged by power functions, $\text{EXP}\left(-\frac{1}{x^2}\right)$ is too flat near 0: but all this means is that it requires finer gauges. However, there are other ways in which functions can misbehave. For instance $f(x) = \cos x + x^3 \sin \frac{1}{x}$ is approximated near 0 by $1 - \frac{x^2}{2}$ while $f''(0)$ does not exist in BCW. But then, this is rather an advantage if the concavity of f at 0 is what we are after! The real challenge is *global* analysis. However, as I showed in a previous column, even there, little ohs allow for a much clearer analysis of the situation than the unusual mechanical reliance on critical points. So:

"Little ohs anyone?"

"You may be right but I already made up my mind!"

Friends are deriding us for not submitting (Mattei & Schremmer, 1996) to Messrs. Wiley and Sons: Rumor has it they are fishing for a *new* calculus author.

COMPUTER AND DATA ANALYSIS DEPARTMENT. Speaking of the Wileys. In their indefatigable effort to promote the Harvard Calculus, they publish "site reports" in one of which, a Fall 1997 report on the Multivariable Calculus installment of the Magnum Opus, we can read: "*One way in which Multivariable Calculus could be enhanced, from my perspective, would be to make available many problems that are realistically impossible without a computer.*" My undercover agent at Wiley tells me that they are contemplating problems such as:

According to the Census Bureau, the wealthiest 5 percent of American households increased their share of the nation's income from 15.6 percent in 1981 to 21.4 percent in 1996. The same top 5 percent holds an even larger share of the nation's accumulated wealth, accounting for 60 percent of all the net worth of the nation. (Molly Ivins in the *Progressive*, December 1997).

1. Going on the Internet, get the full Census Bureau data as well as that for the Federal Reserve Board data quoted in the Fall 1997 issue of these Notes.
2. Using a mathematical modeling program, plot the relevant functions and, in particular, find their limit as t approaches infinity.
3. Using your brain, discuss the implications for "just plain folks" in general and for their mathematical education in particular.

More seriously, there appeared in a monthly — not *the* Monthly of course, *they* wouldn't be caught dead publishing that sort of thing — an article that should be required reading for anybody even dreaming of bringing the computer to her/his classroom (Oppenheimer, 1997). Here is how it starts:

In 1922 Thomas Edison predicted that "the motion picture is destined to revolutionize our educational system and ... in a few years it will supplant largely, if not entirely, the use of textbooks." Twenty-three years later, in 1945, William Levenson, the director of the Cleveland public school's radio station, claimed that "the time may come when a portable radio receiver will be as common in the classroom as is the blackboard." Forty years after that, the noted psychologist B. F. Skinner, referring to the first days of his "teaching machines," in the late 1950s and early 1960s, wrote, "I was soon saying that, with the help of teaching machines and programmed instruction, students could learn twice as much in the same time and with the same effort as in a standard classroom."

And then there was television and then there were calculators and now there is...

References

- Mattei, F., & Schremmer, A. (1996). *Elements of differential calculus: A Lagrangian introduction to the theory of functions*. (5.3 ed.). Rutledge, PA: Courtland Press.
- Oppenheimer, T. (1997, July). The computer delusion. *The Atlantic Monthly*, 45-62.

Cyclone 98

A revolutionary way of viewing graphs

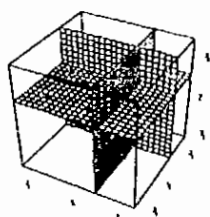

"I used Cyclone to show tangent planes to implicit 3D surfaces. For example, find the tangent plane to the surface $\sin(x + y) + \tan(x + y) - 1$ at the point $(\pi/4, \pi/4, -\pi/4)$. Students agreed that $y - z = 0$ is the equation of the plane. I drew both surfaces with Cyclone and it led to an investigation of other points of tangency I don't know any other program that could show this so easily. I haven't been this excited about a program since I first saw Derive@."

Jerry Thornhill, Southwest Virginia Community College

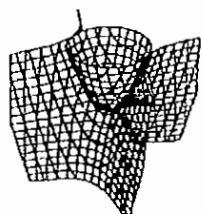

"By far the fastest 3D implicit surface plots I've ever seen. Rotate, zoom, and change parameters on the fly. Perfect for real-time classroom explorations."

C. Henry Edwards, The University of Georgia

MathWare's Cyclone 98, programmed by David Parker, is a world class program which runs on Win95 or WinNT ver 4 or later (a true 32 bit program). It can create mathematical images from implicit statements in three variables like $x^2 + y^2 + z^2 = 9$ which produces a sphere of radius three. It is not necessary that the equation be transformed into a function of z and be graphed twice with an upper and lower part.

Features in Cyclone 98

1) **Slice a surface** in the x , y , or z direction and move the slice back and forth using a scroll bar.

2) **Parameters a , b , c , and d** are available when creating an equation which leads to a graph. The value of the parameter(s) can be changed in real-time using a scroll bar. For example, graph3d ($a*x^2 + b*x*y = z^2$).

3) **Graph 3D inequalities.** Graph3d($x^2 + y^2 + z^2 <= 7$) will color the inside of the sphere blue (TRUE) and the outside of the sphere red (FALSE).

4) **Create intersections of 3D regions.** For example, the intersection of 3 cylinders graph3d($x^2 + y^2 <= 1 \& y^2 + z^2 <= 1 \& z^2 + x^2 <= 1$).

5) **The ability to embed Cyclone graphs** into other programs. For example, most word processing programs (such as Word or WordPad) or any other program (such as Mathematica) that supports OLE (Object Linking and Embedding).

6) **Labels on the edges of the box** that show where the x , y , and z axes are, and what the minimum and maximum values are.

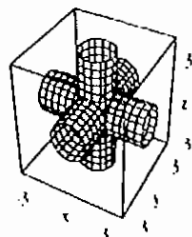
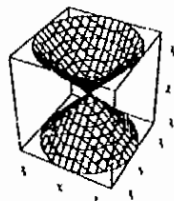

Price \$99

License for 10 machines \$799

Demo available on the internet

(www.mathware.com)

MathWare P.O. Box 3025, Urbana, IL. 61803

(800)255-2468, Fax (217)384-7043, e-mail info@mathware.com

Book Reviews

Edited by Sandra DeLozier Coleman

POETRY OF THE UNIVERSE, A Mathematical Exploration of the Cosmos. Robert Osserman, Anchor Books-Doubleday, 1995, xiv + 210 pages, ISBN 0-385-47340-0.

The Illustrated A BRIEF HISTORY OF TIME, Updated and Expanded Edition. Stephen Hawking, Bantam Books, 1996, iv + 248 pages, ISBN 0-553-10374-1.

That mathematics is a part of everything we experience in the physical world can scarcely be denied. What a human mind interprets as a lovely piece of music, is actually but a pleasing arrangement of harmonious notes, which differ from one another in essentially a purely mathematical way. Differences in color, form, and texture, too, are primarily visual and tangible manifestations of mathematical variation. As we wonder at the beauty of some natural scene, or at the work of some artist's hand, we are observing, in a subtle and mysterious way, another masterpiece involving number. Every sight, sound, scent, texture, and taste which we perceive with our senses depends in some way on mathematical arrangement. One could spend a lifetime just exploring and analyzing the mathematics in those things which we experience as we go about the business of living in a three-dimensional, sensual world. Yet, beyond the surface of our everyday perceptions, in the microcosm of the quantum substructure and the macrocosm of the known universe, mathematics is being asked to play an even more exciting and interesting role. Mathematics is being asked to help us discover and understand, more fully than ever before, the overall structure and nature of the universe itself.

Robert Osserman in his book *Poetry of the Universe* examines and unfolds the crucial role which mathematics has played in the on-going human endeavor to know and describe the space in which we exist. He begins with a reflection on the history of map-making. His emphasis is on the inherent difficulty in the task of representing accurately, on a two-dimensional surface, relationships among the points on a three-dimensional sphere. The information is expressed clearly and would be a good beginning for understanding Mercator projections and other map forms which have been accepted and used effectively over time. His reason for telling about the *imperfections* which must exist in such maps, however, is not actually to educate about cartography, so much as to prepare the reader to understand something of the difficulty of trying to describe certain aspects of a curved universe. He is preparing us to understand that, in a similar way, it is quite impossible to illustrate the structure of the universe, completely and accurately, by means of any sort of picture or map. Just as we have learned to connect in our minds the points farthest to the left and right on a map of the world, we find that we must adjust to the necessity of using our imaginations to make connections in the "maps" of the universe which he presents.

Throughout his book, Osserman includes "glimpses of the lives and personalities" of those who have made significant contributions to our current view

of our world and the universe in which it exists. He reaches back to the time of the ancient Greeks, in which Eratosthenes first introduced mathematics into the art of map-making. He brings us forward to the universe as seen through Einstein's eyes and Hubble's telescope. The interim roles played by such well-known mathematicians as Euler, Gauss, Lobachevsky, and Riemann are discussed in some detail. Even M. C. Escher, whose drawings often helped to clarify difficult mathematical concepts, is given credit for his role. Osserman includes interesting stories of interaction, even competition, among contemporaries, and he speculates on what might have been, had not "noncommunication and missed opportunities" been so much a part of mathematical history. In his discussion of the development of some of the ideas influencing our currently accepted models of the universe, he also helps us to see that, in mathematics, very often, the thought process which leads to a result is quite as valuable and as interesting as the result itself.

Osserman makes an attempt in his book to tackle the very task which he has convinced us is difficult, if not impossible, to do well. He makes an attempt to *illustrate* various models of the universe and to include the essential factor of time in the illustrations. As he tries, through a two-dimensional drawing of two three-dimensional spheres, to show Riemann's vision of the relationship between the observable universe and all that may lie beyond, he admits that it "stretches our imaginations to the limit." To that truth I can bear witness, since, try as I might, I found that I could not see even the *observable* part clearly in *my* mind. It was again quite a challenge, in a later illustration, to see the outermost ring, in a series of concentric rings intended to represent billion-year leaps back in time, as a single point, having grown accustomed in a Euclidean context to seeing a circle as consisting of an infinite set of points. To Osserman's credit, I made that leap, but found myself hungry for still greater understanding.

Stephen Hawking's new version of his best-selling book about space-time seemed a logical choice for a complement to Osserman's efforts. In *The Illustrated A Brief History of Time*, an updated and expanded version of the original publication, Hawking addresses many of the same ideas, but with illustrations which make the concepts somewhat easier to understand.

Hawking has often said that the limits imposed on his verbal communication by his disabling motor neuron disease have prompted him to think in terms of pictures and diagrams, which he could visualize in his mind. Many of these visions he shares with us in this beautiful new edition, in which over 250 full-color illustrations help us to see more clearly the ideas he hopes to convey. That he considers the illustrations to be an important part of his message is evident in his introduction, in which he says, "Even if you only look at the pictures and their captions, you should get some idea of what is going on." With the help of the illustrations he hopes to shed light on the answers to such questions as: where do we come from? And why is the universe the way it is?

The first chapter of Hawking's book tells the story of how our view of the universe has developed over time. The history is interesting — enlightening. What is perhaps more interesting, however, is his explanation of what constitutes a scientific theory, and his discussion of the process by which theories are developed, modified, and often abandoned. He presents the general theory of relativity and quantum mechanics as the two great intellectual achievements of the first half of

this century. Together, these two theories form the basis for our current model of the universe. Since there are certain inconsistencies which appear if we accept both, however, we must conclude that they cannot both be completely correct. Thus, the search for a unified theory, which will satisfy humanity's deep desire for answers to the great fundamental questions, continues.

In subsequent chapters, Hawking displays his great talent for making complicated concepts in physics clear and understandable. He explains very simply why no object with mass can travel faster than the speed of light, why observers who are moving relative to each other will assign different times and positions to the same event, why we know that the stars are moving away from us, and many other concepts which are essential to an understanding of modern cosmology.

Hawking's comment on the fact that his readers should be able to gather a good bit of understanding simply by looking at the pictures and reading the captions is well-founded, but since theories which have long since been abandoned are illustrated as effectively as currently accepted ideas, a bit of caution is in order. An unwary learner who would skip the careful reading and trip lightly through the illustrations alone could find himself stating as accepted theory some ideas which have been discarded for one reason or another along the way. For the most part, though, the wonderland built of satellite images, photographs from the Hubble Space Telescope, computer-generated images of illusive structures, and carefully drawn diagrams, together with Hawking's explanations, serve to make some of the most complicated concepts in the scientific world seem almost deceptively accessible to anyone with an interest.

Reviewed by the Editor, Sandra DeLozier Coleman.

The AMATYC Review welcomes contributions of book reviews by its readers. We would like to continue to have reviews of books that would be of interest to a broad spectrum of persons associated with or interested in the world of mathematics. Reviews of individual books are welcome, although we would like to know about groups of books which complement each other in shedding light on a particular topic. Occasionally, reviews from several readers may be combined in order to present this type of selection.

Send reviews or comments to: Sandra DeLozier Coleman, P.O. Box 3651, Groton Long Point, CT 06340 or e-mail SDColeman@AOL.COM

One of the big misapprehensions about mathematics that we perpetrate in our classrooms is that the teacher always seems to know the answer to any problem that is discussed. This gives students the idea that there is a book somewhere with all the right answers to all of the interesting questions, and that teachers know those answers. And if one could get hold of the book, one would have everything settled. That's so unlike the true nature of mathematics.

Leon Henkin

The Ohio State University College Short Course Program

The Ohio State University Technology College Short Course Program, part of the K - 12 Teachers Teaching With Technology Program (T³), has scheduled sixty-five 1½ to 5-day hand-held technology-based short courses for 1998 at colleges and universities in twenty-four states.

Enhancing Teaching & Learning

Courses offered are:

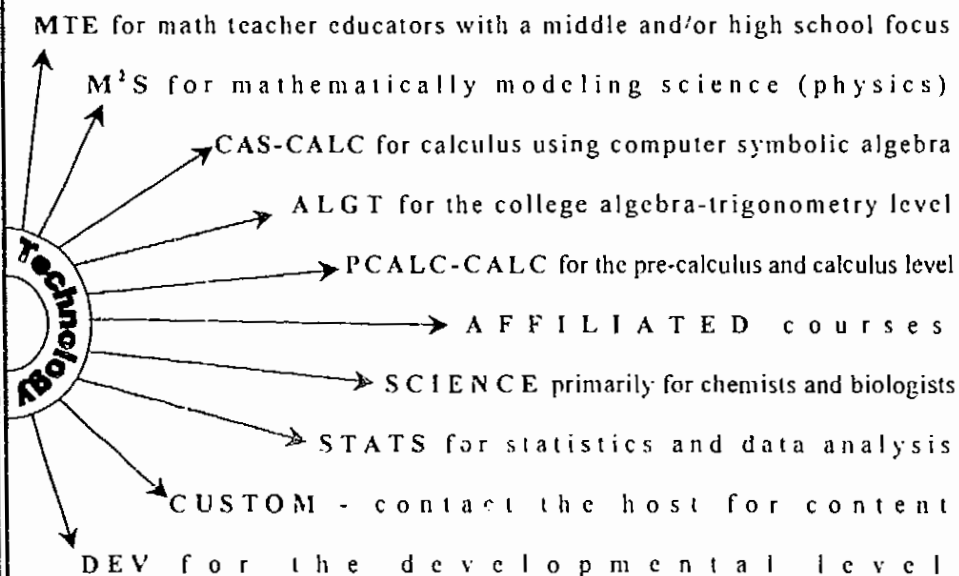

Participants will learn how to use Texas Instruments hand-held technology to enhance the teaching and learning of mathematics and science. Each math course contains some use of the CBL and CBR to collect data for the purpose of mathematical analysis. Pedagogical, testing, and implementation issues are addressed in all courses. Academic year courses are 1½ - 3 days and summer courses are 3 or 5-days.

If you are interested in attending a course, contact the local college organizer. Please see full Program details at <<http://www.math.ohio-state.edu/shortcourse>>.

Hard copies of the course list can be obtained from Bert Waits and Frank Demana (Program founders) through Ed Laughbaum at The Ohio State University, 231 West 18th Avenue, Columbus, OH 43210, or via e-mail at <elaughba@math.ohio-state.edu>.

The College Short Course Program is endorsed by the American Mathematical Association of Two Year Colleges (AMATYC) and has offered nearly 100 courses in 27 states in the last 4 years.

The Problem Section

Stephen Plett
Problem Section Editor
The AMATYC Review
321 East Chapman Avenue
Fullerton CA 92832

Robert Stong
Solution Editor
The AMATYC Review
150 Bennington Road
Charlottesville VA 22901

Hello there readers!

We invite you to enjoy this section and to participate in it by sending in solutions to and/or extensions of the problems posed in this issue. **The Problem Section** also seeks lively and interesting problem proposals from all areas of mathematics encountered at two-year colleges, particularly explorations and challenges of an intermediate level that have applicability to the lives of mathematics faculty and their students.

We need all of the good problems that you have! Please submit **one copy** of your problem proposal by U.S. Mail to the Problem Editor soon. You may print neatly or type, and please put your name, affiliation and address on every page. Include **one copy** of your solution (if you have one), along with any pertinent comments, history, generalizations, special cases, diagrams, and/or observations.

We wish to encourage your participation in this section and we welcome your comments as well as your contributions. Solutions to others' proposals should be sent directly to the Solution Editor, all other materials should be sent to the Problem Editor.

Stephen Plett, Fullerton College
Robert Stong, University of Virginia

New Problems

The solutions to Set AII Problems are due for ordinary consideration September 30, 1998. Remember, send solutions to the Solution Editor, Robert Stong. However, regardless of deadline, no problem is closed permanently and new insights and/or extensions of old problems are always appreciated.

Problem AH-1. Proposed by C. C. Hanna, United States Naval Academy.

The towns of Alpha, Bravo, and Charlie are connected to each other by several roads, with at least one road connecting each pair of towns. In going from Alpha to Bravo, one can go directly on one of the roads joining them, or, one can travel along any one of the roads that go directly from Alpha to Charlie and then to Bravo along any one of the roads that go directly from Charlie to Bravo. In all, there are 33 routes from Alpha to Bravo, including those that go via Charlie. Similarly, there are 23 routes from Bravo to Charlie, including those that go via Alpha. How many routes are there from Alpha to Charlie, including those that go via Bravo?

Problem AH-2. Proposed by Dana Clahane, Fullerton College, Fullerton, CA.

Find a polynomial sequence function whose values are $1, 2, 3, 4, x, \dots$.

Follow-up Challenge: Do the same for the values $1, 2, 3, \dots, n, x, \dots$.

Note: This extends Problem AE-6 from the Fall 1996 issue.

Problem AH-3. Proposed by Rich Zucker, Irvine Valley College, Irvine, CA.

Show that the intersection of a plane with a right circular cylinder is an ellipse.

Problem AH-4. Proposed by Bill Leonard, California State University, Fullerton

Select four non-negative integers a_1, b_1, c_1, d_1 , for "row 1" of a list. Form new rows as follows: $a_{n+1} = |a_n - b_n|$, $b_{n+1} = |b_n - c_n|$, $c_{n+1} = |c_n - d_n|$, $d_{n+1} = |d_n - a_n|$ for each $n = 1, 2, 3, \dots$, stopping when a row of "all zeros" is obtained. Will this process always terminate? Can four such numbers be found which produce an arbitrarily long list?

Problem AH-5. Proposed by Stephen Plett, Fullerton College, Fullerton, CA.

Prove that the inflection point of a non-monotonic cubic polynomial is the midpoint of the line segment joining the two extrema.

Set AF Solutions

Mile Markers

Problem AF-1. Proposed by Jerry P. Kehn, Brookdale Community College, Lincroft, NJ.

Tim leaves Paris, driving at a constant speed. After a while he passes a mile-marker displaying a two-digit number. (Mile-markers start at 0 in Paris.) An hour later he passes a mile-marker displaying the same two digits, but in reversed order. In another hour he passes a third mile-marker with the same two digits (backward or forward) separated by a zero. What is the speed of Tim's car?

Solutions by Charles Ashbacher, Charles Ashbacher Technologies, Hiawatha, IA; Frank P. Battles, Massachusetts Maritime Academy, Buzzards Bay, MA; Robert Bernstein, Mohawk Valley Community College, Utica, NY; Habibollah Y. Far, Laredo Community College, Laredo, TX; Donald Fuller, Gainesville College, Gainesville, GA; Earl P. Jones, University of Maryland - Yongsan Education Center, Korea; Steve Kahn, Anne Arundel Community College, Arnold, MD; Keith McAllister, City College of San Francisco, San Francisco, CA; Randy K. Schwartz, Schoolcraft College, Livonia, MI; Wesley W. Tom, Chaffey College, Rancho Cucamonga, CA; and the proposer.

Let a and b be the two digits. The speed in miles per hour is then given by $ba - ab = a0b - ba$ (or $b0a - ba$) in decimal notation. The first of these possibilities gives $10b + a - (10a + b) = 100a + b - (10b + a)$ which reduces to $b = 6a$, so $a = 1$ and $b = 6$. This gives a speed of 45 miles per hour. Similar analysis of the second

possibility shows it to be impossible.

Note: Several solvers commented that the French use kilometers rather than miles. Frank Battles suggests that Paris must refer to Paris, Texas.

“Bonjour”

Problem AF-2. Proposed by Jerry P. Kehn, Brookdale Community College, Lincroft, NJ.

The French Ambassador gives a reception. Half his guests are foreigners, whose official language is not French. Each guest says “Bonjour” to the ambassador. To be polite, each guest says hello to every other guest in the official language of the person he is addressing. The French Ambassador answers “Soyez le bienvenu” to every guest. In all, 78 “bonjours” are said.

How many guests were at this reception?

Solutions by Charles Ashbacher, Charles Ashbacher Technologies, Hiawatha, IA; Frank P. Battles, Massachusetts Maritime Academy, Buzzards Bay, MA; Robert Bernstein, Mohawk Valley Community College, Utica, NY; Peter Collinge, Monroe Community College, Rochester, NY; Habibollah Y. Far, Laredo Community College, Laredo, TX; Donald Fuller, Gainesville College, Gainesville, GA; Earl P. Jones, University of Maryland – Yongsan Education Center, Korea; Steve Kahn, Anne Arundel Community College, Arnold, MD; Michael Lanstrum, Kent State University – Trumbull Campus, Warren, OH; Keith McAllister, City College of San Francisco, San Francisco, CA; Randy K. Schwartz, Schoolcraft College, Livonia, MI; Wesley W. Tom, Chaffey College, Rancho Cucamonga, CA; and the proposer.

Let x be the number of guests. Then x “bonjours” are said to the ambassador. The $\frac{x}{2}$ French guests each say $\left(\frac{x}{2} - 1\right)$ “bonjours” to other guests, and the $\frac{x}{2}$ non-French guests each say $\frac{1}{2}$ “bonjours” to French guests. Thus, $x + \frac{1}{2} \left(\frac{x}{2} - 1\right) + \frac{x}{2} \left(\frac{x}{2}\right) = 78$. The positive solution is $x = 12$.

Digits Count!

Problem AF-3. Proposed by Michael W. Ecker, Pennsylvania State University, Wilkes-Barre Campus, Lehman, PA.

In mid-1996 the largest prime number known to humanity was the Mersenne prime $2^{1257787} - 1$. Alas, I’ve forgotten how many decimal digits its base-10 representation has. How many are there?

Solutions by Charles Ashbacher, Charles Ashbacher Technologies, Hiawatha, IA; Robert Bernstein, Mohawk Valley Community College, Utica, NY; Habibollah Y. Far, Laredo Community College, Laredo, TX; Donald Fuller, Gainesville College, Gainesville, GA; Earl P. Jones, University of Maryland – Yongsan Education Center, Korea; Keith McAllister, City College of San Francisco, San Francisco, CA; Randy K. Schwartz, Schoolcraft College, Livonia, MI; Wesley W. Tom,

Chaffey College, Rancho Cucamonga, CA; and the proposer.

Let $N = 2^{1257787}$. Then taking base-10 logarithms, $\log N = 1257787 \log 2 = 378631.6152 \dots$, so N has 378632 digits. Since the final digit of N is not zero, $N - 1$ also has 378632 digits.

Integral Parts

Problem AF-4. Proposed by the Michael W. Ecker, Pennsylvania State University, Wilkes-Barre Campus, Lehman, PA, based on a discovery of Gary Adamson, San Diego, CA.

Let the sequence $\langle a_n \rangle$ be defined by specifying $a_1 = 1$ and $a_{n+1} = na_n + 1$ thereafter. Show that $a_n = \lfloor (n-1)! e \rfloor$ for $n > 1$.

Solutions by Robert Bernstein, Mohawk Valley Community College, Utica, NY; Donald Fuller, Gainesville College, Gainesville, GA; Earl P. Jones, University of Maryland - Yongsan Education Center, Korea; Keith McAllister, City College of San Francisco, San Francisco, CA; Randy K. Schwartz, Schoolcraft College, Livonia, MI; Wesley W. Tom, Chaffey College, Rancho Cucamonga, CA; and the proposer.

One readily verifies that $a_n = (n-1)! \sum_{k=0}^{n-1} \frac{1}{k!}$ satisfies the recursive definition.

Then $(n-1)! e - a_n = (n-1)! \left(\sum_{k=0}^{\infty} \frac{1}{k!} - \sum_{k=0}^{n-1} \frac{1}{k!} \right)$ and we can see that $0 < (n-1)! \sum_{k=n}^{\infty} \frac{1}{k!} < \sum_{k=1}^{\infty} \frac{1}{n^k} = \frac{1}{n-1} < 1$.

Crossed Chords

Problem AF-5. Proposed by Russell Euler and Jawad Sadek, Northwest Missouri State University, Maryville, MO.

Let P be a fixed point interior to a circle with center O and radius r . Let A, B, C, D be any four points on the circle such that AB and CD are perpendicular chords intersecting at P .

Find the maximum and minimum values of $AB + CD$ in terms of radius r and fixed length OP .

Solutions by Robert Bernstein, Mohawk Valley Community College, Utica, NY; Earl P. Jones, University of Maryland - Yongsan Education Center, Korea; Keith McAllister, City College of San Francisco, San Francisco, CA; Randy K. Schwartz, Schoolcraft College, Livonia, MI; and the proposers.

Let a be the fixed length OP and let θ be the acute angle formed by one of the chords and the segment \overline{OP} . The distances from O to the two chords are now $a \sin \theta$ and $a \cos \theta$, so the sum of the lengths of the chords, $L(\theta)$, is $L(\theta) = 2\sqrt{r^2 - a^2 \sin^2 \theta} + 2\sqrt{r^2 - a^2 \cos^2 \theta}$ and its derivative is then $L'(\theta) = 2a^2 \sin \theta \cos \theta \left(\frac{r^2 - a^2 \cos^2 \theta}{r^2 - a^2 \sin^2 \theta} - \frac{r^2 - a^2 \sin^2 \theta}{r^2 - a^2 \cos^2 \theta} \right)$ which is zero if either

$\sin \theta \cos \theta = 0$ or $\sin \theta = \cos \theta$. Thus θ is 0 or $\frac{\pi}{4}$. The maximum is $L\left(\frac{\pi}{4}\right) = 4\sqrt{r^2 - \frac{a^2}{2}}$ and the minimum is $L(0) = 2r + 2\sqrt{r^2 - a^2}$.

Palindrome Times

Problem AF-6. Proposed by Frank P. Battles, Massachusetts Maritime Academy, Buzzards Bay, MA.

While attending a mathematics convention, I stayed in a motel room that featured a large digital clock. I first noticed it when it was 2:12, which, ignoring the colon, is palindromic.

When reviewed at random, the clock has what probability of displaying a palindromic time?

Solutions by Charles Ashbacher, Charles Ashbacher Technologies, Hiawatha, IA; Robert Bernstein, Mohawk Valley Community College, Utica, NY; Peter Collinge, Monroc Community College, Rochester, NY; Donald Fuller, Gainesville College, Gainesville, GA; Earl P. Jones, University of Maryland – Yongsan Education Center, Korea; Keith McAllister, City College of San Francisco, San Francisco, CA; Randy K. Schwartz, Schoolcraft College, Livonia, MI; and the proposer.

The clock displays 12 hours (1 to 12) and 60 minutes (00 to 59) for each hour, giving 720 possible times. For each of the hours 1 through 9, there are 6 palindromes which are given by the middle digits 0 through 5. For each of the hours 10 through 12, there is one palindrome, making a total of 57 palindromic times. The probability is then $\frac{57}{720} = \frac{19}{240} \approx 0.8\%$

Smarandache Decimal

Problem AF-7. Proposed by Charles Ashbacher, Charles Ashbacher Technologies, Hiawatha, IA.

For any positive integer n , the Smarandache function S is defined by $S(n) =$ the smallest nonnegative integer m such that n divides $m!$.

The first few values are $S(1) = 0$, $S(2) = 2$, $S(3) = 3$, $S(4) = 4$, $S(5) = 5$, $S(6) = 3$, ...

Form the number $r = .023453\dots$ by concatenating the function values. Prove that r is irrational.

Solutions by Earl P. Jones University of Maryland - Yongsan Education Center, Korea; and the proposer.

If r is rational, the decimal expansion of r is eventually periodic with some period k . Since $S(t!) = t$, then for all sufficiently large t , the digits of t appear in the periodic part of r . Because arbitrarily large integers are not periodic, this is ridiculous. Thus r must be irrational.

Dirty Pool

Problem AF-8. Proposed by Michael W. Ecker, Pennsylvania State University, Wilkes-Barre Campus, Lehman, PA.

- a) In the pool game variant called Chicago, you get points in a round by adding all the values (1, 2, ..., 15) of the balls that you successfully shoot into a pocket. Suppose you have a general number of balls, n , with values 1, 2, ..., n , to be sunk in one round. For which values of n is it possible to have a tie at the successful completion of one round if there are two players?
- b) What if there are three players? For which values of n can there be a three-way tie?

Solutions by Robert Bernstein, Mohawk Valley Community College, Utica, NY; Earl P. Jones, University of Maryland – Yongsan Education Center, Korea; Randy K. Schwartz, Schoolcraft College, Livonia, MI; and the proposer.

The sum of the numbers on the n balls is $\frac{n(n+1)}{2}$. Thus a necessary condition for a tie is that n be congruent to 0 or to 3 (modulo 4). If a tie occurs for n , then a tie can occur for $n+4$ by giving one player the additional balls $n+1$ and $n+4$, and the other player $n+2$ and $n+3$. For $n=3$ one has $1+2=3$ and for $n=4$ one has $1+4=2+3$, both giving ties. Therefore, ties occur for n being congruent to 0 or to 3 (modulo 4) and being at least 3.

For a three-way tie one must have n be congruent to 0 or to 2 (modulo 3). If a three-way tie occurs for n , then a three-way tie occurs for $n+6$ by giving the players the sets of additional balls: $\{n+1, n+6\}$, $\{n+2, n+5\}$, $\{n+3, n+4\}$. For $n=5$, $1+4=2+3=5$. For $n=6$, $1+6=2+5=3+4$. For $n=8$, $1+5+6=2+3+7=4+8$. For $n=9$, $1+5+9=2+6+7=3+4+8$. No three-way tie can occur if $n=2$ or if $n=3$, so three-way ties occur for n being congruent to 0 or to 2 (modulo 3) and being at least 5.

Choosing Couples

Problem AF-9. Proposed by Michael Andreoli, Miami-Dade Community College, Miami, FL.

A random sample of n people is taken from N married couples, with $2 < n < N$. Find the expected number of married couples in the sample.

Solutions by Robert Bernstein, Mohawk Valley Community College, Utica, NY; Earl P. Jones, University of Maryland – Yongsan Education Center, Korea; Randy K. Schwartz, Schoolcraft College, Livonia, MI; and the proposer.

For any two people, the probability that both belong to the sample of size n is $p = \frac{n(n-1)}{2N(2N-1)}$ since the probability that the first is in the sample is $\frac{n}{2N}$ and then, the probability that the second is also in the sample is $\frac{n-1}{2N-1}$. Thus each of the N couples contributes p to the expected number of couples, which is then $\frac{n(n-1)}{2(2N-1)}$.

Cube Roots

Problem AF-10. Proposed by Kenneth Boback, Pennsylvania State University, Wilkes-Barre Campus, Lehman, PA.

Suppose the zeros of $ax^2 + bx + c$ are r and s . For the zeros of $x^2 + px + q$ to be r^3 and s^3 , find p and q .

Solutions by Frank P. Battles, Massachusetts Maritime Academy, Buzzards Bay, MA; Robert Bernstein, Mohawk Valley Community College, Utica, NY; James S. Culliver and Ji Sheng Wang, Community College of Southern Nevada, Las Vegas, NV; Earl P. Jones, University of Maryland – Yongsan Education Center, Korea; Keith McAllister, City College of San Francisco, San Francisco, CA; Randy K. Schwartz, Schoolcraft College, Livonia, MI; Wesley W. Tom, Chaffey College, Rancho Cucamonga, CA; and the proposer.

One has $r + s = -\frac{b}{a}$ and $rs = \frac{c}{a}$. Then $(r + s)^3 = r^3 + s^3 + 3rs(r + s)$ gives $p = -(r^3 + s^3) = -\left(-\frac{b}{a}\right)^3 + 3\left(\frac{c}{a}\right)\left(-\frac{b}{a}\right) = \frac{b^3 - 3abc}{a^3}$ and $q = r^3s^3 = (rs)^3 = \frac{c^3}{a^3}$.

Addenda

After the solutions to set AE were sent for processing, a solution was received for problem AE-5 by Kenneth G. Boback, Penn State University, Wilkes-Barre Campus, Lehman, PA and solutions to problems AE-1, -2, -3, -4, -6, and AE-7 were received from Stephen Plett, Fullerton College, Fullerton, CA.

Advertiser's Index

AMATYC Annual Conference.....	p. 48, 53, 76
AMATYC Office Information.....	p. 10
Faculty Development Programs.....	p. 71
Houghton Mifflin.....	p. 71
JEMware.....	p. 35
John Wiley & Sons, Inc.....	p. 43
MathType.....	Inside Front Cover
MathWare.....	p. 59
The Ohio State University College Short Course Program.....	p. 63
Sharp.....	p. 19
Texas Instruments.....	p. 3, 5

MAKING IT ALL ADD UP:

Applying the AMATYC Standards in the Developmental Math Classroom

A Professional Development Training Series for Mathematics Instructors

Series Components

3 Live Interactive Events

LIVE! Via Satellite - Learning and Teaching Styles
Wednesday, May 6
2-4 p.m. ET
Repeats on
Wednesday, October 7,
1:30 - 3:30 p.m. ET

LIVE! Via Satellite - Creating a Positive Learning Environment
Thursday, October 1
2-4 p.m. ET

LIVE! Via Satellite - Math Study Skills
Wednesday, November 18,
2-4 p.m. ET

Three-part Resource Series
Wednesday, October 7
Noon - 1:30 p.m. ET
Repeats on
Wednesday, November 11
Noon - 1:30 p.m. ET



Is your institution an AMATYC member?

If so, you qualify for a 20% discount on the license fee for this series.

The series license fee, which includes all six programs plus extensive print materials is \$1,895. AMATYC institutional members, as well as Associates of the Adult Learning Satellite Service pay only \$1,495.

To acquire this series through off-satellite taping, contact: PBS Adult Learning Satellite Service
1-800-257-2578
Fax: 703-739-8471 or
703-739-8495

Or for content details and information, call: Monica Jenkins, Faculty Development Programs
1-800-856-5727

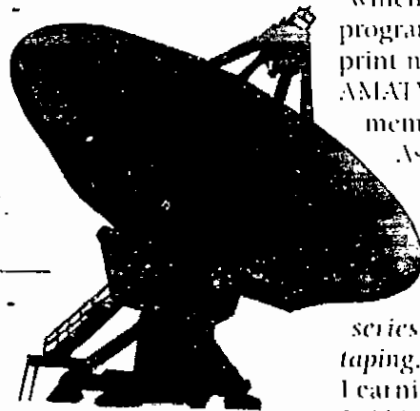

For more information about Faculty Development Programs, other services, call
1-800-856-5727.

PBS ADULT LEARNING
SATELLITE SERVICE



Faculty Development Programs
HOUGHTON MIFFLIN COMPANY

2001 North River Street, Suite 11601
LEE, U.S. 800-856-5727 FAX 1-800-210-0212

LIBRARY SUBSCRIPTION

Annual Library Subscription Fee: \$50 [Includes *The AMATYC Review* (Fall and Spring) and *The AMATYC News* (Fall, Winter and Spring)]

Name of Library _____

Name of Institution _____

Address _____

City _____

State _____

Zip _____

NOTE: This application form is your invoice for the subscription fee and payment must accompany the completed application. Retain a photocopy of this form for your records if necessary. Please make check payable in U.S. funds to AMATYC and mail to:

AMATYC Office, State Technical Institute at Memphis,
5983 Macon Cove, Memphis, TN 38134

INSTITUTIONAL MEMBERSHIP

Colleges, publishers, and other institutions can support AMATYC by being Institutional Members. As indicated below, the annual membership fee is \$250. Subscriptions to *The AMATYC Review* and *The AMATYC News* are included in this fee. Of particular importance to collegiate institutional members is the AMATYC committee for mathematics department chairpersons.

An additional benefit of institutional membership is one *complimentary* AMATYC conference early registration. Future conventions, which are held in the Fall, will be in Portland (1998) and Pittsburgh (1999). Institutional members support the excellence of the programs at these annual conferences.

INSTITUTIONAL MEMBERSHIP APPLICATION/INVOICE

Mail to: AMATYC Office, State Technical Institute at Memphis,
5983 Macon Cove, Memphis, TN 38134

AMATYC College Contact Person _____

Position _____

Name of Institution _____

Address _____

City _____

State _____

Zip _____

Membership Fee: \$250 in U.S. funds payable to AMATYC (includes *The AMATYC Review*, *The AMATYC News*, membership in the Student Math League and one complimentary conference early registration)

Note: Institutional membership does not include any voting privileges.

Type of Payment: (No phone transactions. Please print credit card number clearly.)

Check # _____ Visa Mastercard Discover Total Amount \$ _____

Credit Card # _____ Exp. Date _____

Signature _____

Rev. 8/98

WHY JOIN AMATYC?

The American Mathematical Association of Two-Year Colleges (AMATYC) was established in 1974 to provide a unique, national forum for two-year college mathematics educators. Today, AMATYC is the only national organization that exclusively serves the needs and purposes of this group.

AMATYC holds a national conference annually in a major city. AMATYC encourages two-year college mathematicians to assume responsible leadership positions, to interact on an equal basis with four-year university personnel; to be members on a proportional basis of national steering or policy committees; to represent at the national level the concerns of two-year college mathematics educators. *The AMATYC Review*, published twice yearly, provides an opportunity to publish articles by and for two-year college faculty. A national newsletter is published three times yearly for all members. AMATYC is a member of the National Conference Board of the Mathematical Sciences.

REGULAR MEMBERSHIP APPLICATION The American Mathematical Association of Two-Year Colleges, Mail to: AMATYC Office, State Technical Institute at Memphis, 5983 Macon Cove, Memphis, TN 38134.

First Name	MI	Last Name	Position
College			Phone
College Address			E-Mail
City		State	Zip
Residence Address			Phone
City		State	Zip

Indicate preferred mailing address: College Residence

All payments in U.S. funds payable to AMATYC, Membership fee. All memberships include one subscription to *The AMATYC Review* and *The AMATYC News*.

- \$50 Yearly Regular Membership (any person interested in mathematics education at the two-year college level)
- \$10 Yearly Associate Membership (full-time student, no voting privileges)
Name of AMATYC Member Sponsor: _____
- \$1000 Regular Life Membership

Note: Institutional Membership information available upon request

Special Membership Categories: (Full-time math faculty excluded) Special Membership categories DO NOT include receiving *The AMATYC Review* membership drive information, voting rights, or eligibility for AMATYC office.

- \$25 Yearly Retired Membership
- \$25 Yearly Adjunct Faculty

In addition, the following journals are available at extra cost.

- Mathematics and Computer Education Journal* \$24 for 3 issues
- The College Mathematics Journal* \$45 for 5 issues
- Prints* \$30 for 4 issues



Type of Payment: (No phone transactions. Please print credit card number clearly.)

Check # _____ Visa MasterCard Discover Total Amount \$ _____

Credit Card # _____ Exp. Date _____

Signature _____

OPTIONAL DEMOGRAPHIC INFORMATION (Please check one in each category)

- | | | |
|--|---|--|
| Category 1
<input type="checkbox"/> African American
<input type="checkbox"/> American Indian/Alaskan Native
<input type="checkbox"/> Asian
<input type="checkbox"/> Hispanic
<input type="checkbox"/> White, not Hispanic
<input type="checkbox"/> Other, please specify _____ | Category 2
<input type="checkbox"/> Female
<input type="checkbox"/> Male | Category 3
<input type="checkbox"/> Two-year college
<input type="checkbox"/> Four-year college
<input type="checkbox"/> Other, please specify _____ |
|--|---|--|

I DO NOT wish to be listed in the AMATYC Directory Signature _____

REV 1/87

AMATYC Institutional Members

(as of July 1997)

- Amarillo College, Amarillo, TX 79178
Anoka Ramsey Comm. College, Coon Rapids, MN 55433
Austin Comm. College (RGC Campus), Austin, TX 78701
Ball State University/Math Dept., Muncie, IN 47306
Bellevue Comm. College, Bellevue, WA 98007
Bermuda College, Paget Pk Bx, Bermuda
Borough of Manhattan Comm. College, New York City, NY 10007
Bristol Comm. College, Fall River, MA 02720
Brookdale Comm. College, Lincroft, NJ 07738
Bucks County Comm. College, Newton, PA 18940
Burlington County College, Pemberton, NJ 08068
Butler County Comm. College, Butler, PA 16003-1203
Butte College, Oroville, CA 95965
Cabot College of Applied Arts, St. John's, N.E. AIC 5P7
Cabrillo College, Aptos, CA 95003
Carroll Technical Institute, Carrollton, GA 30117
Cerritos Comm. College, Norwalk, CA 90650
Charles County Comm. College, 1-a Plaza, MD 20646
Chattanooga State Tech Comm. College, Chattanooga, TN 37406
City College of San Francisco, San Francisco, CA 94112
Clark State Comm. College, Springfield, OH 45505
Coconino County Comm. College, Flagstaff, AZ 86004
College of DuPage, Glen Ellyn, IL 60137
College of Lake County, Graylake, IL 60030
Columbus State Comm. College, Columbus, OH 43215
Comm. College of Philadelphia, Philadelphia, PA 19130
Comm. College of So. Nevada, North Las Vegas, NV 89030-4296
Cuyahoga Comm. College, Parma, OH 44130
DeKalb College-North Campus, Dunwoody, GA 30338
Delaware County Comm. College, Media, PA 19063-1094
Delaware Tech Comm. College, Dover, DE 19901
Eric Comm. College-South, Orchard Park, NY 14127-2199
Florida Comm. College at Jxon, Jacksonville, FL 32246
Fox Valley Tech. Inst., Appleton, WI 54913
Fullerton College, Fullerton, CA 92832
Gainesville College, Gainesville, GA 30503
Gateway Technical College, Batesville, AR 72503
Genesee Comm. College, Batavia, NY 14020
Grant Mae Ewen Comm. College, Edmontou, AB T5J 2P2
Green River Comm. College, Auburn, WA 98092
Hagerstown Jr. College, Hagerstown, MD 21742
Harrisburg Area Comm. College, Harrisburg, PA 17110
Houghton Mifflin Co., Boston, MA 02116
Howard Comm. College, Columbia, MD 21044
Illinois Central College, Pekin, IL 61554-2633
Illinois State University, Normal, IL 61790-5520
Inver Hills Comm. College, Inver Grove Heights, MN 55076
Ivy Tech State College-Wabash, Terre Haute, IN 47802
Ivy Tech State College, Sellersburg, TN 47172
JS Reynolds Comm. College, Richmond, VA 23285-5622
Kaplan Comm. College, Honolulu, HI 96816
Kennebec Valley Tech College, Fairfield, ME 04937
Lane Comm. College, Eugene, OR 97405-0640
Langara College, Vancouver, BC V5Y 2Z6
Laredo Comm. College, Laredo, TX 78040
Lorain Comm. College, Elyria, OH 44035
Madison Area Tech.-College, Madison, WI 53704
Manchester Comm.-Tech. College, Manchester, CT 06045-1046
Massachusetts Bay Comm. College, Wellesly Hills, MA 02181
Massasoit Comm. College, Brockton, MA 02402
Metropolitan Comm. College, Omaha, NE 68103-0777
Middlesex County College, Edison, NJ 08818
Minneapolis Comm. College, Minneapolis, MN 55403-1722
Mohawk Valley Comm. College, Utica, NY 13501-5394
Montgomery College, Takoma Park, MD 20912
Moraine Valley Comm. College, Palos Hills, IL 60465
Normandale Comm. College, Bloomington, MN 55431-4399
Northeast Comm. College, Norfolk, NE 68702
Northeast Iowa Comm. College, Peosta, IA 52068
Northeast State Tech. Comm. College, Blountville, TN 37617-0246
North Hennepin Comm. College, Brooklyn Park, MN 55445
North Lake College, Irving, TX 75038-3899
North Seattle Comm. College, Seattle, WA 98103
North Shore Comm. College, Danvers, MA 01923-0840
Oakton Comm. College, Des Plaines, IL 60016
Onondaga Comm. College, Syracuse, NY 13215-2099
Oregon Inst. of Technology, Klamath Falls, OR 97601-8801
Palomar College, San Marcos, CA 92069-1487
Parkland College, Champaign, IL 61821
Pasadena City College, Pasadena, CA 91106
Passaic Co. Comm. College, Paterson, NJ 07509
Polk Comm. College, Winter Haven, FL 33881
Portland Comm. College, Portland, OR 97280-0990
Prairie State College, Chicago Heights, IL 60411
Prince George's Comm. College, Largo, MD 20774-2199
Richard J. Daley College, Chicago, IL 60652
Richland Comm. College, Decatur, IL 62521
Rock Valley College, Rockford, IL 61114
San Francisco State University, San Francisco, CA 94132
Santa Barbara City College, Santa Barbara, CA 93109
Santa Fe Comm. College, Gainesville, FL 32606-6200
Schoolcraft College, Livonia, MI 48152
Sierra College, Rocklin, CA 95677
Southeastern Louisiana University, Hammond, LA 70402-0529
St. Charles Co. Comm. Coll., St. Peters, MO 63376
Surry Comm. College, Dobson, NC 27017
The College Board, Philadelphia, PA 19104
Three Rivers Comm. College, Poplar Bluff, MO 63901
Truckee Meadows Comm. College, Reno, NV 89512
Tulsa Junior College, Southeast Campus, Tulsa, OK 74133
UND - Williston, Williston, ND 58801
United Tribes Tech. College, Bismarck, ND 58504
Univ. of Alaska-Anchorage, Anchorage, AK 99508
University of Wyoming, Laramie, WY 82071
UNM-Valencia Campus, Los Lunas, NM 87031
Utah Valley Comm. College, Orem, UT 84058-5999
Westark Comm. College, Fort Smith, AR 72913
Western Nebraska Comm. College, Scottsbluff, NE 68961
William Rainey Harper College, Palatine, IL 60067

AMATYC Reviewers

Sunday A. Ajose	East Carolina University	Greenville, NC
Patricia Allaire	Queensborough C.C.	Bayside, NY
Michelle Askew	Lamar University	Port Arthur, TX
Robert D. Baer	Miami University	Hamilton, OH
John W. Bailey	Clark State C.C.	Springfield, OH
Richelle Blair	Lakeland Comm. College	Mentor, OH
Barbara Bohannon	Hofstra University	Hempstead, NY
Joann Bossenbroek	Columbus State Community College	Columbus, OH
Randall Brian	Vincennes University	Vincennes, IN
Sandra Pryor Clarkson	Hunter College	New York, NY
John DeCoursey	Vincennes University	Vincennes, IN
David Dyer	Prince George's C.C.	Largo, MD
Joseph R. Fiedler	California State University	Bakersfield, CA
Kathleen Finch	Shoals Comm. College	Muscle Shoals, AL
Gregory D. Foley	Sam Houston State University	Huntsville, TX
Richard Francis	Southeast Missouri State University	Cape Girardeau, MO
Florence Gordon	New York Institute of Technology	Old Westbury, NY
Sheldon Gordon	Suffolk County C.C.	Selden, NY
Chitra Gunawardena	Univ. of Wisconsin-Fox Valley	Menasha, WI
K. L. D. Gunawardena	Univ. of Wisconsin-Oshkosh	Oshkosh, WI
Russell Gusack	Suffolk County C.C.	Selden, NY
Ronald Harkins	Miami University	Hamilton, OH
Larry Lance	Columbus State C.C.	Columbus, OH
Jim Langley	Northeast State Technical C.C.	Blountville, TN
Michael Lanstrum	Independence C.C.	Independence, KS
Edward Laughbaum	Columbus State C.C.	Columbus, OH
Ved P. Madan	Indiana University East	Richmond, IN
Richard F. Maruszewski	United States Naval Academy	Annapolis, MD
John Mathews	California State University	Fullerton, CA
Pamela E. Matthews		Washington, DC
Mary McCarty	Sullivan C.C.C.	Loch Sheldrake, NY
Susan McLoughlin	Union County College	Cranford, NJ
Art Merifield	Seneca College	Toronto, CANADA
Coreen Mett	Radford University	Radford, VA
Kylene Norman	Clark State C.C.	Springfield, OH
Terry A. Nyman	Univ. of Wisconsin Fox Valley	Menasha, WI
Carol Olmstead	De Anza College	Cupertino, CA
Deborah Parker	Mississippi County C.C.	Blytheville, AR
Don Pfaff	University of Nevada-Reno	Reno, NV
Stephen Plett	Fullerton College	Fullerton, CA
Ben Pollina	University of Hartford	W. Hartford, CT
Douglas Robertson	Univ. of Minnesota	Minneapolis, MN
Jack W. Rotman	Lansing C.C.	Lansing, MI
Alan Schremmer	Community College of Philadelphia	Philadelphia, PA
Gene Sellers	Sacramento City College	Sacramento, CA
Thomas Shulgals	Illinois State University	Normal, IL
Brian Smith	Dawson College	Quebec, CANADA
J. Sriskandarajah	Univ. of Wisconsin	Richland Center, WI
Sharon Testone	Onondaga Community College	Syracuse, NY
Marcia Weisser	New York Institute of Technology	Old Westbury, NY
John Williams	University of Hartford	W. Hartford, CT

Find out about the
1998 AMATYC CONVENTION
to be held November 5-8
in Portland, Oregon
by visiting
<http://www.cocc.edu/fhelfenstein/bridges>



- *"Who's Who"* – specifics about the conference
- *"Schedule"* – see it before you come
- *"F.A.Q.'s"* – facts and questions
- *"Things to Do"* – in and around Portland
- *"Maps and More"* – become oriented with the area before you arrive
- *"Other Links"*
- *"Exhibitors, Vendors and Advertisers"*
- *Access to the weather*
- *Pictures and history of the many bridges in Portland*
- *Other information and trivia*

American Mathematical Association of Two-Year Colleges

EXECUTIVE BOARD 1997-1999

President
Sadic Bragg
Borough of Manhattan
Community College
199 Chambers Street
New York, NY 10007
(212) 346-8820
bmacdsch@cunyvm.
cuny.edu

President-Elect
Susan S. Wood
J. Sargeant Reynolds
Community College
Box 85622
Richmond, VA 23285-5622
(804) 371-3027 or 3225
srwoods@jstr.cc.va.us

Treasurer
Robert Malena
Community College of
Allegheny County
1750 Clairton Rd.
W. Mifflin, PA 15122
(412) 469-6228
bmalena@ccac.edu

Secretary
Martha Clutter
Piedmont Virginia
Community College
501 College Drive
Charlottesville, VA
22902-8714
(804) 961-5337
mte2cl@jade.pvcc.edu

Past President
Wanda Garner
Cabrillo College
6500 Soquel Drive
Aptos, CA 95003
(408) 479-6329
wagarner@cabrillo.cc.ca.us

**Northeast Regional
Vice President**
Philip Mahler
Middlesex Community
College
591 Springs Road
Bedford, MA 01730
(781) 280-3861
mahlerp@middlesex.
cc.ma.us

**Mid-Atlantic Regional
Vice President**
Judy Ackerman
Montgomery College
51 Mannakee Street
Rockville, MD 20850
(301) 279-5027
jackerma@mc.cc.md.us

**Southeast Regional
Vice President**
John Peterson
Chattanooga State Tech
Community College
4501 Amnicola Highway
Chattanooga, TN
37406-1097
(423) 697-2404
jpeterson@estcc.cc.tn.us

**Midwest Regional
Vice President**
Kathy Mowers
Owensboro Community
College
4800 New Hartford Road
Owensboro, KY
42303-1899
(502) 686-4564
kamowe0@pop.uky.edu

**Central Regional
Vice President**
Carolyn Neptune
Johnson County
Community College
12345 College Boulevard
Overland Park, KS
66210-1299
(913) 469-8500 x3366
cneptune@johnco.cc.ks.us

**Southwest Regional
Vice President**
David Dudley
Phoenix College
1202 W. Thomas Road
Phoenix, AZ 85013
(602) 285-7153
dudley@pc.maricopa.edu

**Northwest Regional
Vice President**
Iga Ross
Portland Community
College
P.O. Box 19000
Portland, OR 97280-0990
(503) 977-4171
iross@pcc.edu

**West Regional
Vice President**
Sue Parsons
Cerritos College
11110 Alondra Blvd
Norwalk, CA 90650
(562) 860-2451 x 2671
parsons@cerritos.edu

ACADEMIC COMMITTEES

**Foundation/Developmental
Mathematics**
William Thomas, Jr
University of Toledo
Community & Technical
College
2801 W. Bancroft St
Toledo, OH 43606-3390
(419) 530-3338
William.thomas@
utoledo.edu

**Student Mathematics
League**
Glenn Smith
Santa Fe Community
College
3000 NW 83rd St.
Gainesville, FL 32606
(352) 395-5297
glenn.smith@
santafe.cc.fl.us

**Technical Mathematics/
AAS Program**
Franz Helfenstein
Central Oregon
Community College
2600 College Way
Bend, OR 97701
(541) 383-7730
fhelfenstein@cocc.edu

**Technology in
Mathematics Education**
Brian Smith
McGill University
1001 Sherbrooke St. W
Montreal, Quebec,
Canada H3A 1G5
(514) 398-4007
smithb@management.
mcgill.ca

**Equal Opportunity in
Mathematics**
Sylvester Roehuck, Jr
Olive-Harvey College
10001 S. Woodlawn
Chicago, IL 60680-7919
(773) 291-6466
sroehuck@ccc.edu

Grants
John Pazdar
Capital Community Tech
College
61 Woodland Street
Hartford, CT 06105-2354
(860) 520-7851
pazdar@commnet.edu

Placement and Assessment
Bill Worpenberg
University of Cincinnati
5515 French Hall
Cincinnati, OH 45223
(513) 556-0716

Faculty Development
Peg Pankowski
Community College of
Allegheny County
1750 Clairton Rd.
West Mifflin, PA 15122
(412) 469-6228
mpankows@ccac.edu

**Program/
Curriculum Issues**
Phil DeMarois
William Rainey
Harper College
1200 W. Algonquin Rd
Palatine, IL 60067
(847) 925-6728
pdemaro@harper.cc.il.us

**Editorial Policy Review
and Publicity**
Geoffrey Akst
Borough of Manhattan
Community College
199 Chambers Street
New York, NY 10007
(212) 346-8530
akst@idi.net

Electronic Services
John St. Clair
Motlow State Community
College
PO Box 88100
Tullahoma, TN 37388
(931) 665-7010
stclair@mscc.cc.tn.us

The AMATYC REVIEW
Onondaga Community College
Syracuse, New York 13215



Non-Profit
Organization
U.S. Postage
PAID
Permit No. 973
Syracuse, New York

1998 Portland AMATYC Convention

NOVEMBER 5-8, 1998

Headquarters Hotel:

DOUBLETREE LLOYD CENTER
Portland, Oregon

Conference Chairperson:

DICK CLARK
Portland Community College
12000 SW 49th • Portland, OR 97219
Phone (503) 977-4668
dclark@pcc.edu

$\pi \pi \pi \pi \pi \pi \pi \pi \pi$

*See pages
48, 53, and 76
for more details*

ISSN 0740-8404