

DOCUMENT RESUME

ED 416 222

TM 028 074

AUTHOR Hood, Paul  
TITLE Simulation As a Tool in Education Research and Development.  
A Technical Paper. EdTalk.  
INSTITUTION Council for Educational Development and Research,  
Washington, DC.; WestEd, San Francisco, CA.  
SPONS AGENCY Department of Education, Washington, DC.  
PUB DATE 1997-00-00  
NOTE 93p.  
CONTRACT RJ96006001; RJ96006101; RJ96006301; RJ96006701; RJ96006801;  
RJ96006901  
PUB TYPE Reports - Evaluative (142)  
EDRS PRICE MF01/PC04 Plus Postage.  
DESCRIPTORS \*Computer Software; Educational Practices; \*Educational  
Research; Elementary Secondary Education; Game Theory;  
Higher Education; Models; \*Research and Development;  
Research Methodology; Simulated Environment; \*Simulation;  
Teaching Methods; Training

ABSTRACT

This document introduces simulation as a field of endeavor that has great potential for education research, development, and training. Simulation allows education developers to explore, develop, and test new educational programs and practices before communities, educators, and students are asked to participate in them. Simulation technologies exist in at least four major forms: (1) gaming, formalized play with rules players follow; (2) role-playing, in which participants assume specific parts in defined situations; (3) simulators, systems in which operators and machines interact in ways that approximate real life; and (4) modeling, experimentation with representations of a system. Some uses of these approaches in education research are given. These applications include a change game, in which change in a school district is presented as a game and a role-playing simulation in program planning at WestEd. Another example is a task simulation at the Far West Consortium for Educational Development, Dissemination, and Evaluation. Simulation and its modern-day companion, virtual reality, will play a major role in entertainment and science for the foreseeable future. These new applications will be useful in education research through constructing artificial prototypes, studying living systems, and imitating how the brain works. Three appendixes provide two examples of simulation in use in education research settings and a list of modeling software vendors. Contains a 32-item annotated bibliography. (Contains 1 figure and 23 references.) (SLD)

\*\*\*\*\*  
\* Reproductions supplied by EDRS are the best that can be made \*  
\* from the original document. \*  
\*\*\*\*\*

# SIMULATION SIMULATION

**As a Tool in Education Research and Development**

**A Technical Paper**

**by Paul Hood**

U.S. DEPARTMENT OF EDUCATION  
Office of Education Research and Improvement  
EDUCATIONAL RESOURCES INFORMATION  
CENTER (ERIC)  
 This document has been reproduced as  
received from the person or organization  
originating it.  
 Minor changes have been made to  
improve reproduction quality.

---

• Points of view or opinions stated in this  
document do not necessarily represent  
official OERI position or policy.

BEST COPY AVAILABLE

ED 416 222

TM28074



TW

# SIMULATION



Council for Educational Development and Research  
with WestEd  
1997



*EdTalk* is published by the  
Council for Educational Development and Research  
2000 L Street, NW • Suite 601 • Washington, DC 20036  
(202) 223-1593

Dena G. Stoner, Executive Director  
Üllik Rouk, Editor  
Jessica N. Kennedy, Layout Artist

---

*This project has been funded at least in part with federal funds from the U.S. Department of Education under contract numbers RJ96006001, RJ96006101, RJ96006301, RJ96006701, RJ96006801, and RJ96006901. The content of this publication does not necessarily reflect the views or policies of the U.S. Department of Education nor does mention of trade names, commercial products, or organizations imply endorsement by the U.S. Government.*

---

***Simulation: As a Tool for Education Research and Development***  
**is published in conjunction with the following**  
**education R&D institutions:**

**Appalachia Educational Laboratory**

P.O. Box 1348 • Charleston, West Virginia 25325 • 304/347-0400

**Mid-continent Regional Educational Laboratory**

2550 South Parker Road, Suite 500 • Aurora, Colorado 80014 • 303/337-0990

**North Central Regional Educational Laboratory**

1900 Spring Road, Suite 300 • Oak Brook, Illinois 60521 • 630/571-4700

**Pacific Resources for Education and Learning**

828 Fort Street Mall, Suite 500 • Honolulu, Hawaii 96813 • 808/533-6000

**SouthEastern Regional Vision for Education**

P.O. Box 5367 • Greensboro, North Carolina 27412 • 910/334-3211

**Southwest Educational Development Laboratory**

211 East Seventh Street • Austin, Texas 78701 • 512/476-6861

**WestEd**

730 Harrison Street • San Francisco, California 94107 • 415/565-3000



# Table of Contents

Preface .....	1
Introduction .....	3
Four Types of Simulation .....	4
An Example: Simulation Generates Ideas for OERI Education Research Priorities .....	6
Gaming.....	8
Gaming in Education, Training, and Business .....	8
Benefits and Drawbacks of Gaming .....	9
An Example: The Change Game Simulates Change in Education Settings .....	11
Role-Playing .....	12
Benefits and Drawbacks of Role-Playing .....	12
An Example: Role-Playing Simulation Readies Education Lab for RFP .....	14
Simulators.....	16
Benefits and Drawbacks of Simulators .....	16
Some Examples of Simulators .....	17
Simulation's Role in Assessment .....	20
An Example: Simulation Validates Training.....	22
Modeling .....	24
Kinds of Models.....	25
Benefits and Drawbacks of Modeling .....	26
Subfields of Modeling .....	28
Modeling Tools .....	28
Ways of Modeling a Process Through Simulation.....	30
New Uses of Simulation .....	33
References .....	35
Bibliography .....	37
Appendices (1-3).....	41

# Preface

This publication introduces the scope of simulation as a field of endeavor. We believe that simulation holds great potential as a tool for education research, development, and training.

The far-reaching and idiosyncratic problems of education at the turn of this century demand new research and development tools with which to create innovative solutions. Although simulation has been widely used by the military and in business to explore and test new ideas, so far, little use has been made of simulation in education. Yet, the advantages of using simulation are clear. It allows education developers to explore, develop, and test new educational programs and practices before communities, educators, and students are asked to participate in them. It allows us to provide training to teachers and other education professionals in a manner that is more in-depth and true-to-life than traditional training can ever be. Most important, simulation is a tool that helps education developers confront the perplexing reality of school reform.

The Council for Educational Development and Research (CEDaR) publishes the *EdTalk* series to

promote dialogue about important topics in education. We believe the potential of simulation as a development strategy is one such topic.

This particular publication is a collaboration between the Council and WestEd, one of its member institutions, where Dr. Paul Hood has explored some of the uses of simulation in education R&D. The Council's membership consists of some of the foremost education research and development organizations in the country. Many of these institutions incorporate the best educational research findings into school programs and practices. No group of institutions is more familiar with the history of education R&D, and its triumphs and disappointments. It has become clear to them that traditional research tools are inadequate and that there is an urgent need for designing and testing new techniques of development itself. By publishing this overview of simulation, we hope to provide R&D organizations and others with a base of information with which to begin exploring the use of this exciting and potentially powerful tool for applying research knowledge in education.

BEST COPY AVAILABLE

# Introduction

Trends and conditions are taking shape that will affect education and education research and development well into the first decade of the next millennium. Our once-industrial economy has given way to a knowledge-based economy. Advances in computing and telecommunications technology are challenging our ability to integrate, synthesize, and use massive amounts of information. Population growth is straining the environment with a multitude of problems including inadequate housing, excessive solid waste, diminishing wetlands and wilderness, inadequate water supplies, and steady loss of prime agricultural lands.

Social critics go so far as to argue that our moral center has collapsed. As evidence, they point to the disintegration of the family, rising crime and violence, increasing inter-group tensions, cultural insensitivity, and an anger and hostility that cuts across class, racial, gender, economic, and other social lines. There is a pervasive fear that the current younger generation may be the first generation of Americans whose standard of living will actually be lower than their parents'. The huge disparity between the proportions of

minority and white children living in poverty is becoming wider still.

Historically, we have turned to government to lead us toward a better, more affluent, and just society. But with today's distrust of government, voters are repeatedly making the point that "high" taxes are a debit, rather than a credit, toward the future. And they emphatically state that there is only so much from their incomes that they are willing to give to government.

Not surprisingly, all of these forces are exerting tremendous pressure on elementary and secondary schools to reform. These schools are being asked to respond to problems larger and more complex than they've ever encountered before.

Solving the problems that these conditions pose for schools requires new tools and technologies in education research and development. One set of "process" tools, little used in education research and development but employed extensively in business, industrial, military, and other training settings is collectively known as simulation technologies.

We will be examining four types of simulation:

- gaming
- role-playing
- simulators
- modeling



## Four Types of Simulation

Since early childhood, we have learned by playing games, engaging in “let’s pretend” role playing, and building and playing with toys and models. These kinds of learning by doing are examples of simulation. Today, analogous forms of simulation “play” have become serious business and valuable tools for educators and trainers in many fields.

Simulation technologies exist in at least four major forms:

- **Gaming** is formalized play, with preset rules that players must follow. Used for professional training and education in a variety of fields, gaming is particularly valuable in supporting the learning of competition or cooperation strategies.
- **Role-playing** calls for participants to assume specific parts in defined social situations. It enables persons to perceive and interpret social situations, and to develop and try out alternative ways to cope more effectively in interpersonal interactions.
- **Simulators** are systems in which human operators and machines interact in situations that approximate real life. Simulators allow us to test

and validate models, and experiment with organizational structures and functions, procedures, strategies, and tactics where human actors are an intrinsic part of the system.

- **Modeling** is experimentation with physical representations of a system. We use modeling to understand systems and how components of a system interact.

Figure 1 one the following page depicts the domain of simulation

Figure 1 divides the domain of simulation into four quadrants along two major dimensions. We can distinguish simulations vertically by degrees ranging from high fidelity and low inference to low fidelity and high inference. Horizontally, we can distinguish them according to whether the simulation depends more on “rules” or “roles.” Using these two dimensions, we can identify four conceptually different types of simulation:

- high-fidelity, rule-based (Modeling)
- high-fidelity, role-based (Simulators)
- high-inference, rule-based (Gaming)
- high-inference, role-based (Role-playing)

Although depicted as dichotomies, each of these dimensions is better conceptualized as a

### *Definition Please . . .*

#### **Fidelity** —

the degree to which a simulation accurately reproduces the phenomenon that it models. High-fidelity simulations have great accuracy in recreating the phenomenon that is simulated. Low-fidelity simulations are much more abstract and symbolic in their representation of reality.

#### **Inference** —

the degree to which participants must infer, imagine, or “fill in” details that may be lacking in a simulation. Low-inference simulations closely approximate real situations and are rich in detail or experience. High-inference simulations may be highly abstract, symbolic representations of reality that require participants to imagine or “fill in” many of the details that the simulation may lack.

continuum. There are intermediate levels of fidelity/inference possible within each type of simulation. Also, some simulations may be based on mixtures of rules and roles.

Finally, in Figure 1, a dotted diagonal axis separates one-player simulations from multi-player simulations. Modeling is usually a one player activity whereas role-playing almost always involves two or more players.

However, games may be played by one individual alone or by two or more players (or teams of players). Likewise, simulators may involve one or more players (not counting the persons who controls the simulator's operations).

The power of these tools for education R&D lies in their ability to model, explore, and try out options and strategies within complex social, organizational, and educational systems, and to do so in an environment that is "safe." Researchers are able to produce the necessary knowledge

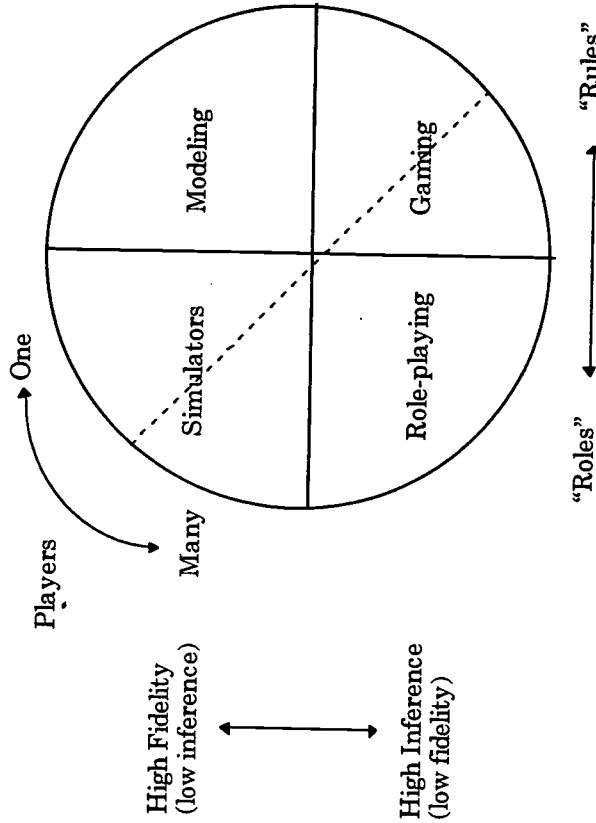

Figure 1: The Domain of Simulation

about, for example, whether an innovation works or does not work within particular settings or if it has unintended consequences, without having to subject students to lost learning time or teachers to unnecessary frustration if the experiment fails.

While this example was a role-playing simulation, the next section describes perhaps an even more familiar form of simulation — gaming.

**Rules —** prescribed guides for conduct or action. "Rule-based" simulations are guided by human observance of rules in the case of games or the execution of computer program instructions (usually representing mathematical formulas) in the case of computer simulation modeling.

**Roles —** characters assigned or assumed; parts played by actors, as in role-playing simulations. Human-machine simulators are also "role-based" in the sense that each participant performs specified roles or functions within the simulation human-machine system.

## AN EXAMPLE

### **Simulation Generates Ideas for OERI Education Research Priorities**

The Council for Educational Development and Research (CEDaR) recently engaged in two role-playing simulation exercises to generate ideas for a more appropriate education R&D system. Its purpose was to respond to OERI's priorities plan for education research. A major premise behind the simulations was that, compared with many other fields, most education R&D is plagued with an almost unbelievably short time horizon, relatively small-scale programs and projects, and little concern for the efficiency of its knowledge production and utilization processes or the adequacy of its supporting "infrastructures." The simulations were a way to begin to grapple with these issues without becoming deeply entangled in the complex realities or rationales of current education R&D programs. Participants included regional educational laboratory and R&D center executive directors, senior staff members from the laboratories and centers, several OERI staff members, and representatives of the National Educational Research Policy and Priorities Board.

The draft education research priorities plan contained no explicit conception of how an education research program might be "staged" or "phased" over a 10 or 15-year period. Nor did it analyze the adequacy of current education R&D processes or R&D infrastructure, or discuss what might be needed in the future. Moreover, the plan lacked an explicit, unmistakable conception of how the many current programs and projects it described would work together to focus, with "requisite variety," on truly BIG problems in education — problems of a magnitude and significance that would exact support for education R&D from educators, the public and the Congress.

A dialog to begin to redress these serious omissions would challenge educational R&D performers to take a longer-term and larger-scale view of alternative "futures" for educational R&D. The goals of the two simulation exercises were:

1. To produce, in the first simulation exercise, a "prospectus" for a five-year program of work, circa 1997-2001, funded at \$20,000,000 per year (inflation adjusted dollars), comprising a balanced portfolio of activities aimed at significantly strengthening R&D production and utilization processes and aspects of the education R&D infrastructure.
2. To use the first simulation experience as a foundation for confronting the much larger and more complex challenge of developing a "prospectus" for a 10-year program of work, to be conducted circa 2002-2011, and funded at \$30,000,000 per year (inflation adjusted dollars), comprising a comprehensive program of activities aimed at addressing just one BIG educational problem content area, but in a way that integrates R&D content with improved R&D production and utilization processes and infrastructures.
3. To provide an opportunity for participants to discuss long-term education R&D development issues and education R&D production and utilization infrastructures.
4. To use the simulation exercises and the ensuing discussion as a foundation for recommending immediate and long-term education research priorities to OERI and the National Education Research Policy and Priorities Board.

The premise for the simulations was that a quasi-governmental agency (combining the support of several federal agencies, a number of foundations, and commercial and private interests) had created a national trust. The trust was going to fund a two-part, 15-year program that would significantly improve education R&D production and utilization in the United States. The proposed work was not to duplicate or merely extend currently funded education R&D or related school improvement efforts such as those supported by the U.S. Department of Education, the New American Schools, Annenberg, Carnegie, or other foundations and education R&D sponsors.

Five teams (of approximately 6 to 7 persons each) brainstormed possible R&D activities, evaluated them, selected the most promising "mix" and, finally, formulated a powerful, balanced portfolio. Each prospectus: (1) briefly described the major activities proposed, (2) stated the relevance, significance, or potential impact and payoff for each activity, (3) indicated how the \$20,000,000 would be allocated among the proposed activities (simple pie charts satisfied this requirement), and (4) commented on any special characteristics of the portfolio (e.g., how education research would be linked to development, or how production would be linked to utilization).

The second simulation was similar in structure, except that it challenged teams to develop a comprehensive "prospectus" for addressing just one BIG problem, of their own selection, in education over a 10-year period. The goal would be achieving a solution to the BIG educational content problem with improved R&D production and utilization processes and R&D infrastructures.

In the interest of time (and also because logically, each prospectus was to be designed as a coherent, integrated entity), no effort was made to meld or integrate the best of these five prospectuses. Also, although the five teams might consider themselves "competitors" in attempting to design the "best" prospectus for the second simulation, the Trust would pick no winners. Since this was make believe, the Trust could make multiple awards!

A description of the simulation exercise and two background papers were prepared and mailed to participants several days before the CEDaR meeting. The intent of the first paper was to bring the planning teams "up to speed" for the first simulation exercise in a background discussion of needs and opportunities for improving education R&D processes and infrastructures. The second paper reviewed trends and conditions in the United States and the world that might affect education and science and technology during the next 15 years. This was to give the teams an environmental context for their planning, especially in the second simulation exercise.

The five planning teams met in separate rooms to do their work but came together in plenary sessions once or twice during the day to report progress and exchange ideas. At the end of each simulation exercise, each team reported on the highlights of their prospectus.

The results of the simulation became the foundation for CEDaR's recommendations to the OERI Priorities Board on education research priorities.



# Gaming

Gaming is formalized play with pre-set rules that players must follow. Gaming has the longest tradition in the field of simulation and also the largest number of adherents. Children have played games through the millennia. Because games depend on rules, this particular form of play has probably existed since the evolution of human language made it possible for people to agree on the rules of the game. Ball games and dice games date back at least four thousand years. In Mesoamerica, the Aztecs and Incas played ball games where the outcome might result in the death of the losing team. In virtually every civilization, athletic games have enjoyed great popular support and recognition — a tradition that is true for sports throughout the world today.

However, simulation gaming serves a more serious (if less deadly) purpose. It supports learning, especially learning strategies for competition or cooperation. By the end of the 19th century, versions of *Kriegspiel* were widely used in military training across Europe. Miniature wargaming, still popular, evolved out of the *Kriegspiel* tradition. Though board games (e.g., checkers) were commercially published in

Europe and the United States in the latter part of the 19th century, the commercial board war game industry began in 1953 with the publication of *Tactics*. These board war games laid the foundation for a wide variety of modern strategy games.

## Gaming in Education, Training, and Business

Figure 1 arbitrarily distinguishes between gaming and role-playing according to whether “rules” and “roles” predominate. Some “high-inference” simulations are structured on the basis of both “rules” and “roles,” that is, gamers observe many rules about what constitutes permissible or prohibited behavior while playing well-defined roles. Advanced training programs for professionals and consensus building for decisionmakers relies heavily on role-playing games, sometimes involving large groups working with a trained facilitator.

In the early 1960s, James Coleman and colleagues at Johns Hopkins University employed “social simulation” games to advance social theory and improve education practice. One of the Johns Hopkins games, *Ghetto*, was

Gaming is formalized play with pre-set rules that players must follow.

used to reveal the logic of inner-city life to minority youth. The developers' intent was to use their games to define the underlying rules of urban social reform; as a tool of school reform, the games would provide an engaging, participatory method of learning for students who did not respond well to conventional instruction.

Another early role-playing game simulated urban conflict over resource allocation. In 1964, Richard Duke designed a game called *Metropolis* for the city of Lansing, Michigan. The game used role-playing to work through cycles of policymaking, employing computers to track the effects on resources as the group went through one cycle of decisionmaking after another. By the mid-1970s, a later version of the game, *Metro-Apex*, gave the use of computers in gaming a central, rather than supporting role. Games and their computer-based analogs have become a standard and highly popular technique for professional training in management courses in business schools and also as a more general means to teach conflict resolution and to deal with other complex policy issues.

**Board Games.** Businesses and schools widely use role-playing board games to support and enhance education and training. These games compress time and space so that players can assume roles and experience the consequences of

their decisions. The dynamic interaction between players creates a complex and unpredictable scenario that is difficult to replicate in a single person game. Single person games can introduce unpredictability through random generators (e.g., dice, shuffled cards, spinners, or random number generators); however, multi-person role-playing board games have the advantage of introducing the element of competing or cooperative strategies. Games that emphasize learning through teamwork in simulations of real-life situations are becoming increasingly popular.

**Computer games.** Most computer-based games emphasize the formulation of objectives and strategy. Computer-based games give businesses the opportunity to implement policies that will lead to the realization of objectives.

## Benefits and Drawbacks of Gaming

Business games have a number of appealing features which make them particularly useful for training. Depending on the degree to which they simulate real-life organizations, business games offer substantial transfer of learning from the game to on-the-job applications. Typically, the games deal simultaneously with a variety of factors relevant to the total management of a

Gaming teaches:

- competition strategies
- cooperation and teamwork
- conflict resolution
- consensus building
- implementing policy

business operation. This enables them to stage the interplay of finance, personnel, R&D, marketing, manufacturing, quality control, distribution, customer services and other aspects of an enterprise, sometimes including competitive, economic, political, social, regulatory, and other aspects of the environment. The games are dynamic and permit gamers to see the immediate consequences of their decisions (which — simulated in compressed time — may reveal consequences after days, months, or even years of simulated time). A particularly attractive feature is the fact that the games are not punitive. Mistakes, errors of judgment, or bad decisions do not result in actual loss. The games are intrinsically motivating and usually create high levels of participant involvement.

Hinrichs (1976, 855) identifies some of the problems with business games:

1. "They often do not encourage or allow normal approaches, but limit behavior to those programmed in the situation." [Computer-mediated business games have significantly relaxed these earlier restrictions that were often imposed in manual versions to make play control more manageable.]

2. "Trainees may become too involved in the game per se and neglect to critique the effectiveness of their behavior.
3. "There is a tendency to 'lock in' to whatever strategy proves effective in order to win the game.
4. "There may be some questions of the degree of realism of the gaming situation as well as the degree to which the game situation is related to the trainees' at-home situation.
5. "Participation in the game may be costly, particularly where extensive computer time is entailed." [Today, computer costs are rarely a problem.]

## AN EXAMPLE

### *The Change Game Simulates Change in Education Settings*

The Change Game is a tool for educators to try out real life strategies for changing policies and practices in a fictional school district complete with administration, school staff, and members of the community. The game has a triangular conceptual foundation based on three important pieces of educational research on change — Adopter Type, which defines how individuals' personalities affect how they will adopt new ideas; the Concerns Based Adoption Model, which describes the process people go through as they adopt a new idea or innovation; and the Study of Dissemination Efforts Supporting School Improvement, which describes the kinds of support that schools need in every phase of change.

The Change Game has two basic objectives:

- To learn to plan and manage change efforts and use effective strategies to implement change, and
- To learn to work as a team to promote change.

The game takes approximately three hours to play. The goal of the game is to move as many pieces across the board and to conduct those activities that have an impact on students. The game provides the opportunity for trial and error experimentation in a safe environment for exploring and practicing new behaviors.

During the simulation, participants choose to implement strategies for change as if they were doing them in real life, and they receive feedback based on what the results would likely be in real life. Thus,

the simulation provides experiences participants are able to readily incorporate into their own school situations. Because the game is based on moderately complex sets of contingent rules (based on the research cited above), a game moderator who is thoroughly familiar with these rules can make the game an easier experience for players.

Key issues that the game addresses are:

- building capacities for managing systemic change
- creating communities of learners — building external and internal support systems
- ensuring success for all students through individual and organizational development
- hands-on and interactive learning environment

As is the case in many simulations, some of the most important and valuable aspects of the game occur during a post-game playing discussion when participants share how they changed their understanding of the game situation, modified their strategies during the course of the game, drew conclusions about more and less effective strategies and tactics for playing the game, and appraised the things they learned in the process of playing the game. During this debriefing and discussion period, the game moderator changes roles from rule interpreter to skilled discussion leader (or alternately, someone else may be able to play this important role).



# Role-Playing

Modern role-playing has its origin in psychotherapy (Kelley, 1991), where it enables persons to perceive and interpret social situations, and to develop and try out alternative ways of coping more effectively in interpersonal interactions. However, the approach quickly spread to industrial settings for developing sales, supervision, leadership, and interviewing skills.

The essence of role-playing is to create realistic situations in which trainees assume specific parts (often with prescribed personalities) in defined social situations. As participants in role-playing exercises interact to solve the problem presented to them, they receive substantial and immediate feedback about their behavior by seeing how it affects the behavior of other participants.

## Benefits and Drawbacks of Role-Playing

A very substantial body of research on role-playing has grown over the past 40 years. One of the findings of these studies is that the strength of prior attitudes about role-playing can be an important determinant of the degree of attitude change. For example, there is a greater degree of

attitude change when people play roles at variance with their own points of view, but greater acceptance of the technique when participants are in roles that are congruent with their original views. When participants confront a succession of novel and difficult situations, but in ways that progressively build on previously mastered understandings, perceptions, and interpersonal skills, learning becomes cumulative.

As was true in the original psychotherapeutic applications, cumulative role-playing is a powerful and relatively low-risk way for people in organizations to collaboratively invent, explore, evaluate, and master new behaviors and interactions that enable them to cope more effectively with high stress or other critical types of situations. Many organizations are employing complex role-playing in this way to “prepare for the future,” especially if they see the future as increasingly uncertain or risky.

In a role-playing exercise, participants imagine that they are someone else. The success of a performance is heavily contingent on the players’ ability to imagine their personalities and the situation they are in well enough to behave as

*Participants in role-playing assume specific parts in defined social situations.*

persons would actually behave in the real situation. In fantasy role-playing this may not pose a problem (except perhaps for lack of creativity and spontaneous behavior), but it may pose serious limitations when using role-playing for educational purposes.

To overcome such limitations, extensive descriptions of the nature of each role and other background information often support role-playing exercises. Free simulation is an approach to role-playing that has been in use since the early 1960s (Guetzkow, 1962). A free simulation is a method where participants: (1) are placed in complex simulated environments; (2) are free to behave within the boundaries of established rules and the evolving interaction of simulation conditions, participants' own past behavior and the past behaviors of others with whom the participants are interacting; (3) attempt through their actions to cope with the dynamics of the behavior of other participants and changes that may be made in the simulated environment; and (4) mix their free behavior with the role-playing trainer-imposed conditions to determine ongoing events.

Setting up this kind of role-playing exercise requires substantial knowledge of the situation being simulated. Here, in contrast to the complex human-machine "high-fidelity"

simulators described later in this paper, human interaction is the dominant dynamic and machines (hardware) may have little or no role (except perhaps to provide environmental cue inputs; record, synthesize, and play back previous performance; or perform other supporting functions).

Beyond the problems discussed above, other problems that may be encountered in role-playing are the following: (1) participants may feel that the exercise is childish, (2) they may revert to overacting and fail to focus on the goals of the exercise, (3) trainers have no control over the immediate feedback or rewards that are largely contingent on the behavior of other participants, (4) the number of people that can be involved directly is limited, and (5) well-designed exercises may be time consuming to prepare for and expensive to execute. As in most other forms of simulation, post-exercise debriefing and discussion can be highly rewarding and significantly increase the value of the exercise.

Role-playing develops skills in:

- sales
- supervision
- leadership
- interviewing
- other human interactions

## AN EXAMPLE

### Role-Playing Simulation Readies Education Lab for RFP

This simulation was developed for WestEd staff several months before the Office of Educational Research and Improvement (OERI) issued its 1995 Request for Proposal (RFP) for operation of regional educational laboratories (RELs). The intent of the simulation was to impart several types of long-range program planning skills and understandings that might better prepare the WestEd staff to respond to the RFP.

The simulation is an organizational learning exercise intended to provide semi-realistic experience in planning and replanning a coherent portfolio of work for a regional educational laboratory over a multi-year period. (The following is an extract from the simulation instructions.)

The simulation assumes that the members of each proposal team are already experienced in project design and management. The simulation thus focuses on the following challenges:

1. Propose and maintain a balanced portfolio of work that responds to high-priority, systemic reform needs of the region, meets all the requirements of the RFP, responds to the REL Board of Directors' Guidance, and is consistent with the laboratory mission. The major challenge throughout the simulation will be to create and maintain a balanced portfolio of work that responds to all these requirements.

2. Propose a plan for a program portfolio that supports and is supported by two Laboratory institutional capacity development (game) plans as requested by the initial Board of Directors Program Guidance Statement.

3. Satisfy expectations of OERI/ORAD and key stakeholders in the region over the duration of the simulation. Modify program plans on the basis of organizational learning and feedback from the field, the Board of Directors, and ORAD [OERI Office of Reform Assistance and Dissemination]. Adjust program priorities and allocation of resources to meet these demands and emerging opportunities while maintaining the integrity of program objectives and institutional capacity development plans.

4. Maximize short-term and long-term program impacts in the field, satisfy the expectations of key clients and stakeholders, meet "OERI" requirements and Board of Directors' Guidance, and significantly increase Laboratory institutional capacity in selected areas.

5. Have a good time and perhaps learn something about program planning in turbulent environments.

The REL planning simulation responded to a mock RFP highly similar to one that we anticipated would be issued. This RFP was used to conduct a pilot test of the simulation in January 1995.

However, Section B, Statement of Work, as originally written in January 1995, was replaced with a draft Statement of Work issued by OERI in March 1995. The remainder of the RFP is fictitious.

To simplify the simulation, the mock RFP solicited proposals only for programs of work for Task 2, Development and Applied Research; Task 3, Services to the Field; Task 4, Participate in Formation of a Nationwide System of Education Information and Assistance, and Task 7, Specialty Development Area, because these tasks are the programmatic core of laboratory operations. Proposals for work to be accomplished under Task 1, Management; Task 5, Laboratory Network Program, and Task 6, Assistance to OERI, "were to be separately submitted at a later date." The level of effort for the tasks to be proposed was set at \$3,000,000 per year. "However, SPT [the Simulation Planning Team, simulating a "OERI"] will not be bound by this planning estimate in negotiating the contract for the Western Region."

Specific instructions for allocating funds among tasks and technical proposal instructions were similar to those anticipated from OERI. To simplify proposal preparation and reporting requirements, a number of forms were developed along with completed examples of each form. All interested staff received the entire package of participants' materials (description of the simulation, the mock RFP, detailed simulation instructions for preparation work and for each

program planning team at the simulation, the set of proposal forms and completed examples of each form) several days before the simulation exercise.

The simulation was a day-long exercise. In the morning session, five proposal planning teams developed and submitted their REL proposal (forms) to the SPT (representing OERI) and their institutional capacity building plans to a representative of the REL Board of Directors. Over lunch, the SPT and Board representative reviewed the proposals and developed "clarification questions" or Board "guidance" tailored to each team's submissions. Approximately 30 minutes were allowed to prepare responses (again on forms designed to reduce writing time). During the remainder of the afternoon, sessions simulated the first year of operations (including simulated feedback from the field and OERI instructions for conduct of work in the second year), preparation of a revised second-year plan, second-year activities, preparation of plans for the third year, and finally a debriefing session. During the debriefing all teams concluded that they needed to define a "robust" core of work around which other REL work could be expanded or contracted depending on OERI budget changes. Every team succeeded (to some degree) in creating and maintaining balanced portfolios of work that met most of the simulation's requirements. Several teams, however, experienced difficulty in creating or maintaining their organizational capacity building plans that satisfied the REL "Board" requirements.

# Simulators

Simulators are systems in which human operators and machines interact in situations that approximate real life.

Most true simulators involve complex and continuous interaction between human operators and a "machine."

Human-machine simulators employ computers to simulate environments in which humans must act and make decisions. They are used to test and validate models, and experiment with organizational structures and functions, procedures, strategies, and tactics.

Simulators may be conceptualized as residing mainly in one or another quadrant depending on the degree of interaction that takes place between the operators, modelers, or game players and the simulation "model."

Simulators first appeared to train pilots to use aircraft instruments. Today, their use ranges from training individuals or crews to perform simple tasks, or even parts of tasks, to employing massive interactive systems to simultaneously train hundreds of persons at many different locations throughout the world.

The use of simulators is becoming one of the fastest growing approaches to training.

According to recent estimates, annual military and civilian expenditures for simulator R&D, procurement, and training may now be in the three to five billion dollar range. And, they are likely to continue to grow at a substantial rate despite (and perhaps partially because of) retrenchment in military budgets and downsizing in business and industry.

## Benefits and Drawbacks of Simulators

Several factors account for the popularity of simulators. One has to do with what we know about adult learners. Adult learners require significantly high-quality stimulation, and they need to "put solutions into action" in both their personal and professional lives. Consequently, training adults takes far more than abstract theory and traditional book learning. These learners prefer applications and utilization of skills that they perceive as pertinent and of immediate use. Studies repeatedly show that most adults strongly prefer self-directed learning systems over group-directed work led by an instructor. Furthermore, if they are to retain and use new information, adults must be instructed

with methods that allow them to easily synthesize new ideas with previously acquired knowledge and skills.

Given these characteristics of adult learners, it should be no surprise that by far the most popular and cost-effective method of adult training is interactive and multimedia-based. These methods, which work particularly well for training with technology, have largely replaced the delivery of training in classroom settings. For large corporations and the military, the cost of having people out in the field to assemble in the classroom is very high. In addition, the effectiveness of classroom training is coming into question because of our increasingly heterogeneous workforce. International Data Corp., a market research firm in Framingham, Massachusetts, says computer and multimedia-based training are the fastest growing segments of the training market. Especially popular is Just-In-Time Training or JITT, a 24-hour field service cafeteria approach where employees can select exactly the type of learning they need on demand.

Another distinguishing characteristic of most simulators is that they strive for fairly high degrees of fidelity in recreating work stations and other functional aspects of the environment. Operators in a high-fidelity simulator will sometimes say that the simulator experience

approximates interacting with the real machine system. By contrast, nearly all games and simulation models, even if having some “flight simulator” characteristics, are much more abstract and symbolic in their representation of reality.

The simulator approach is particularly useful whenever there are complex interdependencies among groups of people and hardware that require highly skilled teamwork for effective operation. Moreover, because there may be so many ways that performance (of people or hardware) may fail, testing and practicing to deal with many conceivable and unanticipated failure situations has become a common training approach (e.g., submarine emergencies, emergency shutdown of nuclear energy stations, space stations emergencies, oil refinery fires).

## Some Examples of Simulators

**Air Defense Simulators.** From 1952 to 1954, in order to study the processes of adaptation in organizations, scientists at the RAND Corporation set up a series of human-machine simulations of air defense direction centers. In the simulation, an air defense direction center maintained radar surveillance over an assigned area, identified aircraft as friendly or unfriendly, and in cases of the latter, directed interceptor

Simulators can:

- test and validate strategies, tactics, or procedures
- experiment with organizational structures and functions
- try out different procedures, strategies, and tactics

Simulators are popular in training because they:

- respond to how adults learn
- are cost-effective
- have high fidelity
- can pose a variety of “unanticipated” problems

aircraft against it. The project involved elaborate workplace simulation apparatus, computers, and experienced Air Force personnel (Chapman, et al., 1959). The RAND researchers simulated a center’s physical, cultural, and task environments as closely as possible, even using actual radar scopes to display computer generated tracks of simulated aircraft. By overloading beyond normal aircraft tracking loads (e.g., simulating large raids of enemy aircraft overlaid on normal commercial, military, and private aviation traffic), the experimenters were able to study how the crews responded to simulated air defense conditions. Debriefing sessions followed each experimental run so that participants could review their actions and the consequences. As the tasks that the crews had to accomplish increased, crew griping about poor performance often led to the development of new procedures. As the experiments progressed, the crews learned to focus on the most important classes of stimuli and not attempt to cope with unimportant information. Thus, even though loads were increased three-fold during the experiments, the crews continued to operate effectively (Cohen & Cyert, 1965).

When the Air Force reviewed these experiments, it requested that all air defense center crews be provided this simulation experience as routine training. Fulfilling such a request, however,

became too much for RAND and led to the creation of a spin-off organization, the System Development Corporation. During the late 1950s and early 1960s, SDC became the largest single employer of computer programmers and clinical psychologists in the nation. The role of the programmers was to tailor simulated aircraft traffic exercises for each center. Clinical psychologists, SDC soon discovered, were best equipped to conduct the intensive and sometime highly emotional debriefing sessions.

#### Mission Oriented Terminal Area Simulator.

This facility, a modern-day relative of the RAND air defense simulator, provides an environment in which to conduct flight management and flight operations research studies with a high degree of realism. (The simulator represents the Denver Stapleton International Airport and surrounding area.) It combines the use of several aircraft simulators along with pseudo pilot stations in order to fly multiple aircraft in the terminal area. The simulator allows full aircraft crews to fly realistic missions in the airport terminal area. Pseudo pilot stations control the flight of the remaining aircraft in the airport terminal area. The final components of the simulator are air traffic controller stations. This simulator research facility tests aircraft tracking, communication, and control procedures in highly congested traffic environments. Such

research can obviously be conducted at markedly lower costs (and risks) while probing traffic density limits under various environmental and workload conditions and dealing with various kinds of emergency conditions.

### **Compressed experience workplace simulator.**

This is a general workplace training approach that stimulates “real” experience but in compressed time spans. Participants actually organize, lead, manage, or operate businesses or industrial systems. They learn how to plan, manage, make decisions, and get “real” feedback. They learn from their mistakes and from their successes. The work is practical, engaging, intense, and real. And the learning is thorough, long-lasting, and directly applicable to the job. These kinds of workplace simulators are now in use in business, professional, and military schools and in job settings throughout the world.

**Business “Flight Simulators.”** Business flight simulators serve as general purpose management education and training tools for use in business schools and for inservice training in industry throughout the world. Simulations have been designed to serve a bewildering array of educational and strategic research purposes ranging from teaching basic principles of operating small businesses or nonprofit organizations to

developing and testing long-term global enterprise strategies. These massively larger simulations may be systematically run under a variety of global economic, political, and social scenarios. Thus, beyond educational uses, business simulators are employed to address real business problems of many types and on many scales, and to demonstrate how a specific organization could benefit from various business environmental scenarios.

**Simulated surgery.** “The ‘patient’ undergoing prostate cancer surgery isn’t real — just a mannequin — but the operating room crew says the tension can be very real in the Simulation Center for Crisis Management, which opened in July [1995] at the Veterans Affairs Palo Alto Health Care System.” A joint project of Stanford University and the Veterans Administration, the center is the first fully equipped facility of its kind in western North America using “flight simulator” technology to help anesthesiologists, other operating room personnel, and students learn to deal with patient emergencies in the operating room. To simulate complex emergencies, the mannequin offers such realistic touches as breathing sounds and simulated blood that flows and “clots.”

Unlike some computer simulations, this system requires the operating room crew to do more than make the right decision; the team must

Some uses of simulators:

- briefings and demonstrations
- practice in the performance of a task or tasks
- performance analysis
- performance assessment
- learning enhancement
- crew coordination and team training
- practice in dealing with malfunctions or failures
- practice under adverse operating conditions
- development and validation of standard operating procedures



actually perform appropriate interventions, such as starting IV lines with medications (Goodlad, 1995).

## Simulation's Role in Assessment

Performance assessment simulations go back to officer assessment situational tests used in the Prussian Army prior to World War I. Performance assessment centers in the United States can be traced to psychological assessment centers operated by the Office of Strategic Services (OSS) Assessment Staff (1948) during World War II to assess the fitness of OSS candidates to operate under stress in enemy territory. Shortly following the end of that war, *The Assessment of Men* detailed the OSS' development and employment of this technique.

**Leader reaction tests.** This form of assessment traces back to the pre-World War I Prussian Army tests mentioned earlier. It represents a specialized type of job sample test. Unlike most other job sample testing, leader reaction tests usually require a small group of persons who are placed in a situation, often with various kinds of physical props, to solve a problem posed to them (e.g., bridging a small stream, removing a barrier from a road, dealing with a simulated medical emergency). In some cases, the assessee is placed in charge of the group and the other members

are instructed to follow his or her directions (see discussion of role-playing earlier in this paper). In a variant, the leaderless reaction test, no one is designated as the leader. Participants may be evaluated on their interactions and leadership or cooperative behavior as the group confronts the task. The U.S. military services have employed these situational reaction tests in commissioned and noncommissioned officer training and assessment since the 1950s. In civilian situations, the tests are sometimes part of the industrial assessment centers' test batteries. Typically, trained raters employ a number of behavioral rating scales to rate various dimensions of these simulated task.

**In-baskets.** The In-basket exercise was introduced in the early 1950s by Norman Frederiksen (1957). The In-basket is a specialized form of assessment simulation that is a cross between a case study and a game. The subject works through a collection of typical messages and correspondence and responds to the problems raised by writing brief notations or messages in a manner that is assumed to model the kind of behavior needed in a real-life situation. In-basket assessment has been used extensively in business school settings and for some personnel selection purposes. Using special in-basket tests designed to reflect in-baskets that school principals might confront, Educational

Testing Service researchers demonstrated that the decisionmaking styles of experienced male and female principals were markedly different, and that these tests had value both for training and assessing school administrator performance.

**Assessment centers.** In 1956, Douglas Bray, following the OSS model, established a managerial assessment center for the American Telephone & Telegraph Company. The center became well known in industrial psychology because Bray (1964a) conducted long-term follow-up studies of AT&T hires. Subsequent uses of the assessment center approach included selection of first-level foremen and higher-level management in some of the Bell companies (Bray, 1964b). During the early 1960s Standard Oil of Ohio, IBM, Sears, General Electric, and J.C. Penny established similar assessment centers (Finkle, 1976).

By the 1970s, over a thousand organizations employed the assessment center approach. The approach was characterized by: (1) fixed-size groups of assessees (e.g., 12 persons); (2) multiple methods of assessment (including objective tests, projective tests, situational exercises, in-basket problems, questionnaires, interviews, group problem discussions, and peer ratings); and (3) high face validity of its assessment instruments, an impressive body of validation

studies, and wide adoption. Most assessment programs gave assessees in-depth feedback about the evaluation of their performance, which served to increase the favorable reaction to them (Finkle, 1976). Assessment centers were adapted and used extensively by the University Council for Educational Administration and the National Association of Secondary School Principals (Pantili, et al., 1991).

**Business simulation assessment.** Obviously, many of the business simulations discussed above may be used for assessment purposes similar to the situational reaction tests described immediately above.

**Job sample simulation tests.** These tests rest on the premise that "the best predictor of future performance is past performance." They are grounded in careful analysis of the critical performance requirements of job tasks and the construction of simulated work sample tasks that will elicit behavior relevant to those performance capabilities. An illustration of this approach is discussed below as part of the DD&E Assessment Simulation.

## AN EXAMPLE

### Simulation Validates Training

In the early 1970s, the Far West Consortium for Educational Development, Dissemination and Evaluation (DD&E) Training, a consortium of five major development firms and three institutions of higher education, developed, evaluated and implemented training programs for paraprofessionals and professionals. These programs were for community colleges, bachelor degree programs, and graduate-level training. Along with 23 performance-based training modules, the consortium developed a model competency assessment battery that was made up of ratings, written tests of knowledge, and performance tests of skills in job sample simulations. The elements of the assessment battery were validated in two ways: first by a panel of experts, including DD&E work supervisors, who judged face validity and relevance, and then by requiring that measured differences in performance between groups known to have markedly different competence levels be significant and of practically meaningful magnitudes (Hood & Blackwell, 1975). The following exercise in education development focuses on the simulation test.

This simulation test consists of four related tasks. Task 1 is concerned with preparing guidelines for the development of a simple product (a section of a toy librarian's manual for parent training). Task 2 deals with preparing to try out the parent training resources kit. Task 3 requires responding to the tryout evaluation report by critiquing the tryout and recommending revisions in the product and the tryout procedure. Task 4 requires preparing a rough outline for a sound filmstrip script. Time limits were: Task 1, 75 minutes; Task 2, 30 minutes; Task 3, 60 minutes; and Task 4, 60 minutes. In each simulation task, instructions and other background

information are provided. The following is a partial extract from the introductory instructions.

"This simulation will require you to perform many things that an educational product developer would need to accomplish. The tasks have been chosen to provide a 'sample' of a number of specific development competencies that are frequently encountered in product development work. The tasks included in this simulation exercise have been designed to focus on essentials and bypass a lot of the less relevant detail. This has been accomplished in several ways.

First, a relatively simple, and yet not trivial, development task is used. You will find that the subject matter is sufficiently simple that no special content expertise is required. Second, the sequence of tasks is organized so that the information you receive in earlier tasks can be used in performing later tasks. This saves you from having to do a lot of reading about entirely unrelated tasks, but importantly, you will find that the information available to you (although never enough to answer all your questions) will accumulate until, in the later tasks, you are confronted with a fairly realistic development situation which has a meaningful and relevant 'history.' Third, various kinds of information are provided (e.g., 'models,' instructions, lists of questions, etc.) which help you define what you are to do and which supply a continuity of sorts in terms of what 'happened' between each task.

Something we've kept in mind in constructing this exercise is that development is a team effort, with usually some degree of

specialization of work. Almost always you can count on being able to interact with others for advice or assistance. The information and instructions you will be given in this simulation attempt to serve as the interaction you would ordinarily have with your supervisor or other team members. Furthermore, you will find that several 'team decisions' will be made during the simulation. These decisions in effect say, 'Your work has been considered and the team has decided that this is what we should do next ....'

You will find that nearly all instructions and 'communications' have been preplanned and are in written form. Obviously, we are unable to anticipate every problem you may encounter. You should try to work on the basis of the written information and instructions given you .... But, if you have a significant problem that cannot be handled in writing, ask the test administrator for help.

Note that this is not a strictly speeded test, but there are time limits. At nearly every stage, you may feel that the time allotted is insufficient. Do the best you can. Make sure you finish the essentials. The time limits have been set so that most beginning developers can complete at least a 'rough draft' if they have been efficient in their use of time .... Scoring will be based on the quality of your work accomplished within the time limit.

Please note that your performance will be assessed on several dimensions: completeness; appropriateness to instructions and background information provided; originality of ideas; sensitivity to problems and issues; technical quality of products, and quality of writing. Each task required of you focuses on a related set of product development knowledge and skills. The tasks cover a broad range of competence levels, but are focused primarily on the kinds of tasks

a beginning developer (at least a college graduate with one year of experience or training in product development) would be expected to perform with some, but not a great amount of supervision. The total novice to product development may find the task difficult but not impossible.

We hope you'll find this exercise a challenging and useful experience.

You should now read 'Your Role as a Member of the Development Team.'

Each task was scored on pass-fail (P-F), fractional score (F), scope (SC), and the extent to which participants followed the simulation directions. Hence there were four comparable scores for each of the four tasks. In addition, tasks were scored on a total of 11 specific elements (e.g., quality of writing of the guidelines produced in Task 1, the quality of the tryout questions prepared in Task 2, the quality of suggested revisions in Task 3, the handling of visual elements in the script outline of Task 4). Factor analysis of these scores produced six factors, indicating that the simulation exercise represents a complex of several performance dimensions.

From their examination of validation data for the entire DD&E battery, researchers concluded that all three types of instruments in the battery (self-ratings, knowledge tests, and simulation test) discriminated at statistically significant levels between those with no R&D work experience and those with some work experience. What's more, their data showed that the three types of instruments provided different kinds and amounts of information. The lack of strong correlation among the three types of instruments suggested that one type of instrument can not be substituted for another.

Modeling is experimentation with physical or symbolic representations of a system.

# Modeling

Modeling involves designing some form of physical or symbolic representation of a system, experimenting with it, and analyzing the results. We model to understand systems and how components of a system interact.

For education research and development, modeling provides several benefits. First, it may substantially reduce development costs and time. It permits us to explore the design and testing of many different potential solutions to problems in order to find the best one. It also lets us identify possible design flaws. Modeling helps find solutions before costly development and implementation work is begun. Finally, modeling increases flexibility. It lets us ask “what if we did this instead of that” and evaluate the outcome.

## Modeling:

- cuts down development time
- reduces costs
- reveals design flaws
- increases flexibility in experiments

Systems can be simulated at many different levels of fidelity and abstraction. Models provide answers at a given level of abstraction. In developing models, we always have a trade-off. Many details may be left out. The question is always what to include and what to drop. Omitting relevant components or functions may make the model too simple to produce any understanding of the dynamics of the system. Including too much detail may make implementing it overly complicated and inhibit its performance.

Generally speaking, however, the more detailed the model, the more detailed the output. Thus, very high degrees of fidelity usually demand much greater time and effort in model design (and validation), much more intensive computation, and more detailed and complex analyses.

For many educational and training applications, a lower level of model fidelity may have advantages, e.g., simpler modeling, faster computation, and perhaps easier to interpret output. The important thing is that the model simulate the essential features of the system that needs to be examined. When we do not know much about a system, an intermediate or lower

Whether a model is right or wrong is initially a value judgment. Whether it is correct or incorrect is something that may become evident in time. The basis for determining the value of a particular model is the extent to which the model aids in the development of understanding a system.

level of fidelity may actually produce a more “robust” model since it is less likely to be influenced by highly detailed system components and interactions that, in fact, may not be valid.

**On mental models of the modeler.** Educators and others who work with complex social systems have learned that change in a school takes place only when those who carry out the change understand and internalize what must be done and why. Prescriptions from experts, no matter how detailed, fail. The use of models is a powerful way of training large numbers of professionals to develop the understanding that precedes change. According to Barry Richmond (1994): “Systems Thinking is the art and science of making reliable inferences about behavior by developing an increasingly deep understanding of underlying structure.” Richmond understood that mental models do not change on the basis of logical argument. The early practice of hiring a “consultant” analyst to study a corporation, go away and build a model, and come back with recommendations based on experiments with that model did little to change the mental models that people use to represent the real world. To do this, a person must become sufficiently involved in the modeling process to internalize lessons about dynamic feedback behavior. Thus, Richmond spearheaded a major shift in dynamic

simulation away from the stance that “as experts, we privileged modelers have seen more deeply and we’ll tell you how it works,” to we should “help the world by showing them the way.”

Modeling is a tool that can give power to the people and let them figure out how to improve things or save themselves.

## Kinds of Models

There are many different kinds of models, each with its own characteristics and purposes.

Physical models are one kind of model. They are tangible representations (often at some scale of miniaturization or magnification) of real objects. Symbolic models are another kind of model. They differ from physical models in that they are logical or mathematical abstractions. Their usefulness is in their ability to advise us on our choices in, for example, resource allocation. Symbolic models also enable us to test assumptions with “what if” analyses, and to play out sets of possible events based on an abstract model of the real world.

Static models are fixed representations (a plan, map, or blue print, a static three-dimensional miniature). Some types of static models may be tested (e.g., for aerodynamic performance in a

### *Definition Please . . .*

#### **Mental models** —

the internalized images or understandings that we all have about how certain things behave.

Models can be:

- physical or symbolic (logical/mathematical)
- static or dynamic
- certain (deterministic) or uncertain (stochastic)
- normative or descriptive

wind tunnel, or for hydrodynamic performance in a water tank).

Mathematical modeling may involve static representations (e.g., spreadsheets, flow charting) or dynamic modeling. Spreadsheets allow us to calculate many different interrelated functions. However, spreadsheets are limited to only one scenario or set of parameters at a time. In order to represent changing conditions, we must repeatedly change a spreadsheet's parameters and recalculate manually.

Static models do not explicitly take time into account. Dynamic models, in contrast, allow changes with time. Dynamic modeling provides a tremendous advantage over static representations such as spreadsheets because it can calculate and display the results of thousands of different scenarios. It can store each result in a database, and often allows us to make new sets of calculations based on previous outcomes. For example, a model ecology and wetlands restoration would simulate hydrology and the growth and decay of species populations in a given geographic region. In astronomy, we might simulate the collision of galaxies.

In certain or deterministic models no variable can take more than one value at a time. Stochastic models explicitly model uncertainty

about data or relationships, using probability functions. In some cases, an analytic solution may be available, but in many cases, we must use Monte Carlo or other simulation modeling methods. These experiments may require hundreds of simulation runs.

Normative models produce one best answer. Once we run the model, we have our answer. Descriptive models produce one or more satisfactory answers according to the criteria applied to them. Then it's up to us to decide which answer is best.

## Benefits and Drawbacks of Modeling

There are many reasons to use simulation modeling. One of its great advantages is that it enables us to see the connections between the parts of a system and to visualize their interactions (usually through time and/or space compression). Modeling also allows us to experiment with a representation of a system without affecting or disrupting the real system it so we can develop theories about how it operates. The ability to predict the behavior of a complex system is just as important in decision making in education as it is in industry and in many fields of scientific research.

### *Definitions Please . . .*

**Mathematical modeling** — the use of mathematical equations to define or create a model.

**Monte Carlo** — a numerical method of solving mathematical problems through random sampling of values for selected variables.

**Understanding of the system.** By experimenting with a model, we can better understand a system's operation, how its components interact, how users interface, and the role of the system in its environment.

**Ease of experimenting.** It is usually easier to design, implement, and run a computer simulation program than to build a complete technological device (such as a small-scale real system) and test its operation in a real world. Using models, we can experiment with systems in early stages of their development. We can identify and correct design errors before beginning costly engineering work and prototype development.

**Safety and security.** Running a model and experimenting with various "what if" scenarios allows us to test a system's operation in conditions and environments that go beyond safety limits; we can determine the system's operational ranges without endangering life, risking loss or damage to expensive equipment, or undertaking expensive developments that might prove to be nonoperational.

In addition, modeling:

- Reveals a system's structure and the dynamics behind problems;

- Demonstrates the implications of using various intervention strategies;
- Shows how short-term change strategies may affect longer-term system dynamics;
- Permits one to perform many experiments at very low cost to determine how to improve performance;
- Enables sensitivity analysis to explore the effects of various factors on model behavior and outcomes.

Modeling is often essential when:

- The system is very complex and has many variable and interacting components;
- The underlying relationships among variables are not linear;
- The system contains random variables; or
- The output desired is visual as in a 2D or 3D computer animation.

But modeling has pitfalls. To take advantage of the many benefits of modeling, we must avoid tumbling into them. One of the most dangerous pitfalls is "garbage in, garbage out." Modeling can fail if the system being modeled isn't represented correctly, when input data are inaccurate, when the theories being validated are flawed, when the simulation generator in computer modeling is not correctly programmed, or when output that describes the simulation is incorrect.

For modeling to be successful:

- the system is must be represented correctly
- input data must be accurate
- the theories being validated are correct
- the simulator generator must be correctly programmed
- the analysis of results is must be correct



### *Definitions Please . . .*

**A declarative model** —

a verbal description of the system and its operations.

**A spatial model** —

a pictorial or graphic representation of a system, usually depicted in two or three dimensions.

**A functional model** —

a physical or symbolic representation of the system that portrays functional relationships.

**A multimodel** —

a model that is composed of several integrated submodels.

## Subfields in Modeling

As a discipline, modeling has three subfields: model design, model execution, and model analysis.

**Model design.** To simulate something physical, we first need to create a model that represents the physical system. Models can take many forms including declarative, spatial, functional, or multimodel. As its name implies, multimodel contains several integrated models.

**Model execution.** Once a model has been developed, the task is to execute it (now usually on a computer). To do this, we need a process sequence, such as a computer program, which steps through time to update the variables in the model. There are many ways to move through time. We can “leap” through time with an event scheduler or we can “crawl” through time in small standard time increments. For extremely large problems, we may need to use massively parallel computers, each computer unit solving part of the simulation program (e.g., in modeling a seismic geology or weather systems).

**Model analysis.** Early modeling often churned out hundreds of pages of tabular data, which was then subjected to various forms of statistical analysis, data reduction, and sometimes

conversion to figures and graphs. Only the engineers and programmers who designed the models could interpret much of the output. Today’s modeling applications offer a variety of easy-to-interpret ways to produce graphic and tabular outputs. These graphs typically show how selected sets of variables change their values over the time span of the simulation. In some modeling applications, the graphic displays may provide symbolic two or three-dimensional moving picture-like animation of how the system changes dynamically throughout the simulation time period. These visual displays, along with experimentation with changes in variable values, can significantly help novice modelers to interpret and comprehend the dynamics of the simulation without necessarily having to resort to intensive study and analysis of large volumes of tabular data. (See Appendix 2 for an example.)

## Modeling Tools

The modeling of complex systems used to require highly skilled mathematical programmers, often working with scientists or engineers. Coding and debugging a simulation computer program was highly labor-intensive. Now software products reduce the mathematical complexity and provide the tools to design and construct personal simulation models without having to

write program code. Even relatively novice experimenters can combine their knowledge of the system directly with the computer software modeling package to obtain almost immediate results.

Using Microsoft Windows or the Macintosh, modeling packages such as Extend (see Appendix 1), ithink, or STELLA (see Appendix 2), make full use of the graphical user interface. All of these programs provide drawing tools for placing and linking different components of the model into a diagram. While each software package contains a different set of model components, they can all model systems of differential or nondifferential equations, as well as stochastic and event-driven systems. Once the model has been constructed and its values calculated, the results can be presented as tables, graphs, or data and exported to other software packages for further analysis or presentation. In addition to calculating model values, many modeling packages offer tools that allow in-depth analysis of model characteristics.

Nathaniel Palmer (1996) of the Delphi Consulting Group in Cambridge, Massachusetts provides the following descriptions of business process simulation modeling tools:

Process simulation tools are rooted in electrical and industrial engineering disciplines and targeted at processes that are well-defined and understood, such as manufacturing, inventory and distribution systems. They help quantify and diagnose existing processes and analyze and predict the impact if these processes were to be redesigned.

Application simulation tools test and validate complex computer-based applications. They are often linked to specific development environments, e.g., workflow in a particular type of process environment. Thus the capabilities of the parent application model may limit the input, output, and process parameters of these tools.

Management flight simulators are targeted at managers and nontechnical users. They are useful for modeling proposed changes in processes or procedures. (Many are available as mid to low-cost applications that typically run on Macintosh or Windows platforms, e.g., Workflow BPR, High Performance System's STELLA and ithink., Microworld's Microworld Creator and S<sup>4</sup>.)

Appendix 2 gives examples of:

- How variables in a dynamic simulation model of "team learning" change over the simulated time period
- How changes in the initial values of key variables affect the simulation
- How the introduction of external "shocks" affect the simulation

*Definitions Please . . .*

- Process environment** — the inputs, outputs, and other factors in a system that need to be taken into account when a process is being modeled.
- Development environment** — the problem formulation, knowledge, strategies, tactics, market assumptions, uses, and other factors that go into building and using a simulation model.
- Parent application model** — Application simulation models that are used to create a number of more specific models of a particular class or type of process (e.g., customer order processing).

Forecasting and risk analysis applications are used to model processes with very substantial amounts of historic data. They define a process model and test the outcome of a large data run through proven statistical models such as an econometric model or a network analysis model (e.g., Palisade's @Risk). These applications are generally inappropriate for more dynamic applications because of the large amount of recoding and data manipulation that would be required.

**General purpose simulation systems (GPSS)** provide development tools for creating simulation models independent of any application type. GPSS typically require users to have modeling expertise and rigorous programming skills. GPSS is best suited for applications with static process parameters (e.g., Simulation Software's GPSS).

## Ways of Modeling a Process Through Simulation

There are several ways that we can model a process. Often there is only one choice among the three; sometimes there is more than one.

**Discrete event modeling.** Discrete event simulation uses computer models to examine scheduling activities that are too complex for direct analysis. Discrete time simulation

demonstrates the rate of change in populations, individuals, or physical features. Some of these models function by incrementing time in fixed steps using the current time (or some other initial time) as input into the equations.

Petri net modeling is another way of discrete event modeling. It operates by flowing "tokens" through a system process network and having them encounter various resources (the resources "process" a token as it passes by). This kind of modeling helps us to examine workflow or manufacturing processes. If the Petri model is stochastic (uses random variables), which is often the case, then a large number of simulation runs may be needed to examine the behavior of the system. Industrial process engineers have long employed this type of discrete event modeling. More recently, it has become highly popular as a tool for business process reengineering (BPR).

There is not much evidence of the use of discrete event modeling (outside of teaching process engineering, workflow, or BPR applications) in the field of education; nor do there appear to be applications directly relevant to education R&D program planning, although improving workflows in proposal preparation, R&D project management and control, or any routine process in R&D are easily imaginable. Appendix 1 illustrates this form of modeling

through a simple “school guidance counselor” simulation (modeled in Extend).

**Continuous process modeling.** Continuous process modeling graphically reveals system behavior over time, usually by solving a set of differential equations. Continuous simulation methods were developed in the 1950s for simulations run on analogue computers. Much of this was tedious work and often error prone. Today virtually all continuous process simulation is performed on digital computers, which perform the necessary functions easily.

Continuous process modeling, has been made highly accessible to educators by Jay W. Forrester and Barry Richmond. More recently, Peter Senge has popularized it even more under the term, systems dynamics. Systems dynamics is a method for studying how complex systems change over time.

According to Forrester, “Systems dynamics is an approach to observing and analyzing any complex organization in a comprehensive manner: seeking to understand its structure, the interconnections between its components, and how changes in any area will affect the whole system and its constituent parts over time.” The discipline has its roots in engineering science, particularly in the development of feedback

amplifiers for long-distance telephone lines in the 1930s. The basic building blocks of any system are simple “feedback loops” or “causal loops” such as those found in the home thermostat. Since the early 1960s, the principles of systems dynamics have been extended to social systems such as corporations, cities, and regional economies (Forrester, 1989).

Forrester’s first book on this subject was *Industrial Dynamics*, published in 1961. In 1968, Forrester teamed up with John F. Collins, who had been mayor of Boston for eight years, and was at MIT with a one-year appointment as Visiting Professor of Urban Affairs. Collins and Forrester combined their talents to take systems dynamics into a new domain. Together they published *Urban Dynamics* (1969), an analysis of how government policies aimed at alleviating urban poverty often made cities poorer. Low-income housing projects, for instance, were intended to help the poor in economically depressed cities, but actually succeeded only in concentrating low-skilled people in cities where manufacturing jobs were declining. Constructing low-cost housing was a powerful process for creating poverty, not alleviating it. The results suggested that all of the major urban policies that the United States was following “lay somewhere between neutral and highly detrimental, from the viewpoint either of the city as an

Processes may be modeled as:

- discrete event simulations
- continuous simulations
- a hybrid that combines the two

*Definitions please...*

**Hybrid modeling** — combining discrete event modeling with continuous process modeling.

institution, or from the viewpoint of the low-income, unemployed resident” (Forrester, 1989).

Up until Forrester’s exploration of systems dynamics modeling, case studies, pioneered by the Harvard Business School beginning around 1910, served as the predominant method for studying systems. That approach is still widely used in business and other professional schools around the world. The case study, however, leaves information in a descriptive form that cannot reliably cope with the dynamic complexity that may be involved. Forrester saw systems dynamics modeling as being able to “organize the descriptive information, retain the richness of the real processes, build on the experiential knowledge of managers, and reveal the variety of dynamic behaviors that follow from different choices of policies.”

Forrester’s *World Dynamics*, (1971; 1973, 2nd ed.) included simulation models that showed how exponential increases in population and consumption of natural resources would lead to crises from pollution, crowding, and hunger, unless there were major changes in economic policies. *Limits to Growth* (Meadows et al. 1972) provided the first systems dynamics model of world ecology. Forrester is now developing a huge, two volume, nationwide model of the U.S. economy.

Appendix 2 illustrates a systems dynamics model, executed in ithink that simulates the dynamics of teams given auxiliary feedback that may or may not be aligned with the goals of the team.

# New Uses of Simulation

Simulation and its modern-day companion, Virtual Reality, will dominate entertainment and science for the foreseeable future. For example, "Trekkies" know that Star Trek's "Holodeck" creates digital replicas of everything a person might see as he or she looks around, including entire digital worlds and immersive construction tools. Some of this work is being carried out in real life within major R&D and training thrusts by the Department of Defense. Other new applications are taking place through virtual prototyping, the simulation of artificial life, the construction of complex adaptive systems, and neural computing.

**Virtual prototyping.** Boeing developed its newest commercial aircraft, the Boeing 777, without building a physical mock-up. The digital prototype was designed and tested on computers, then went straight to the design floor for construction. For a number of years, the military has focused on leveraging virtual reality to "build" prototype combat systems with computers, test their performance in a synthetic battlefield environment, conduct trade-off evaluations between existing, modified, and

new systems, and make choices all before the construction of a prototype.

**Artificial life.** The study of artificial systems that exhibit characteristics of natural living systems attempts to understand the laws that govern natural processes. As a field, it has existed for centuries but only since the late 1980s has it begun to flourish as a discipline due to the need for immense computing power to model even the simplest living systems. Current modeling (Lindenmayer Systems, genetic algorithms, cellular automata) emphasizes highly localized interactions as opposed to global control. The life-like activity using these models is usually the result of unprogrammed emergent behavior.

**Complex adaptive systems.** These model systems predict the future. They are constructed with a network of many "agents" acting in parallel; each agent finds itself in an environment produced by its interactions with other agents in the system; control of the system is highly dispersed; the system has many levels of organization; agents at one level serve as the building blocks for agents at a higher level; the

Some new applications of simulation are:

- constructing virtual prototypes
- studying living systems
- imitating how the brain solves problems

system constantly revises and rearranges its building blocks as it gains experience with its environment. Each system typically has many niches which are exploited by agents adapted to fill them. The result is a system characterized by perpetual novelty. Systems evolve toward optimum states which are dynamic rather than static. A complex adaptive system evolves through self-organization toward "the edge of chaos" where it maintains its identity while dynamically changing to remain at a far-from-equilibrium state, neither falling into a stable nonadaptive equilibrium nor into chaotic behavior.

**Neural computing.** Operating on a similar principle, neural computing imitates the structure and operation of the human brain. Central to this approach is a device known as a neural network, which is made up of a very large number of simple processing units connected together into a complex net-like structure. While conventional computing requires someone to work out a step-by-step solution and then program the steps into a computer, a neural network can be "trained" to solve many kinds of problems. Thus, a neural network effectively programs itself. Training a neural network involves presenting the network with a series of examples of a problem and the desired solution in each case. Given enough training material, the

neural network is able to learn the underlying principles involved in the solution, which it can then use to tackle other similar problems. Although the original idea dates back to the 1940s, it was not until the 1980s that computer hardware and software techniques capable of implementing neural computers became generally available. Users of IBM PC compatibles and workstations have a wide choice of software products. Apple Macintosh users have a more restricted choice, but still have access to some powerful tools (NeuroBook, 1996). Examples of applications in modeling, prediction, and control include identification of general linear and nonlinear processes; forecasting river levels, stock market prices, currency exchange rates; and controlling of time-delayed industrial processes.

# References

Bray, D.W. (1994). "The Assessment Center Method of Appraising Management Potential." In J. W. Blood (Ed.), *The Personnel Job in a Changing World*. New York: American Management Association, (a).

Bray, D. W. (1994). "The Management Progress Study." *American Psychologist*, 19, 419-420, (b).

Chapman, R.L., Kennedy, J.L., Newell, A., & Biel, W.C. "The Systems Research Laboratory's Air Defense Experiments." *Management Science*, 5, (3), 250-269.

Cohen, K.J. & Cyert, R.M. (1965). "Simulation of Organizational Behavior." In J. G. March, (Ed.). *Handbook of Organizations*. Chicago: Rand McNally College Publishing Company.

Finkle, R.G. (1976). "Managerial Assessment Centers." In M. D. Dunnet (Ed.) *Handbook of Industrial and Organizational Psychology*. Chicago: Rand McNally College Publishing Company.

Forrester, J.W. (1961). *Industrial Dynamics*. Portland, OR: Productivity Press.

Forrester, J.W. (1969). *Urban Dynamics*. Portland, OR: Productivity Press.

Forrester, J.W. (1971; second edition, 1973). *World Dynamics*. Portland, OR: Productivity Press.

Forrester, J.W. (1989). "The Beginning of System Dynamics" (Banquet talk at the international meeting of the Systems Dynamics Society, Stuttgart, Germany, July 13, 1989). (Edited, January 30, 1996 and available on MIT web site,)

Frederiksen, N., Saunders, D.R., & Wand, B. (1957). "The In-basket Test." *Psychological Monographs*, 71 (9), (Whole No. 438).

Goodlad, M. (1995). "Simulated Surgery: Real Adrenaline." *Stanford Medicine*, Fall. (Stanford Medical Center Press Release)

Guetzkow, H. (Ed.) (1962). *Simulation in Social Science: Readings*. Englewood Cliffs, NJ: Prentice-Hall.



Hinrichs, J.D. (1976). "Personnel Training." In M.D. Dunnet (Ed.) *Handbook of Industrial and Organizational Psychology*. Chicago: Rand McNally College Publishing Company.

Hood, P.D. & Blackwell, L. (1975). *An Assessment System for Competence Based Education: The Educational Development, Dissemination, & Evaluation Training Program*. San Francisco, CA: Far West Laboratory for Educational Research and Development.

Hood, P.D. & Hutchins, C.L. (1996). "Research-Based Development in Education." *Educational Technology*, January-February, 6-12.

Kelley, G.A. (1991). *The Psychology of Personal Constructs*. New York: Routledge.

Meadows, D.H., Meadows, D.L., Randers, J. & Behrens III, W.W. (1972). *Limits to Growth*. New York: Universe Books

Neurobook (1996). (NeuroBook is a "hypertext" book, on the DTI NeuroComputing Web — <http://www.clients.globalweb.co.uk/nctt/book/>)

Office of Strategic Services (OSS) Assessment Staff (1948). *Assessment of Men*. Niwot, CO: Rinehart.

Palmer, N. (1996). "Business Process Simulation and Modeling: An Introduction and Survey of Tools," *Enterprise Reengineering*, January-February.

Pantili, L. et al. (1991). Principal Assessment: Effective or Not? A Meta-Analytic Model, 43 pages (ERIC ED 333540).

Richmond, B. (1994). *Systems Dynamics/ Systems Thinking: Let's Just Get On With It*. (Delivered at the 1994 International Systems Dynamics Conference in Sterling, Scotland.) Hanover, NH: High Performance Systems, Inc.

Senge, P.M. (1990). *The Fifth Discipline: The Art and Practice of the Learning Organization*. New York: Doubleday.

# Bibliography

Anderson, J.E. & Rosenfeld, E. (Eds.), (1988). *Neurocomputing: Foundations of Research*. Cambridge, MA: Bradford Books. (A collection of reprints of the classic research papers up to 1987.)

Beale, R. & Jackson, T. (1990). *Neural Computing: An Introduction*. Philadelphia, PA : IOP Publishing Limited. (A basic textbook providing an introduction to the main neural network algorithms. Aimed at undergraduate courses.)

Christopher, E. & Smith, L. (1991). *Negotiation Training Through Gaming: Strategies, Tactics, and Manoeuvres*. East Brunswick, NJ: Nichols Publishing Co. (Provides extensive, step by step, instruction on the design and use of gaming to improve negotiation skills.)

Costikyan, G. (1994a). *A Short History of Paper Gaming*. New York: Crossover Technologies, Inc. (As titled, provides a brief history.)

Costikyan, G. (1994b). "I Have No Words & I Must Design," *Interactive Fantasy #2*. New York: Crossover Technologies, Inc. (An essay on game design.)

Fishwick, P.A. (1995). *Simulation Model Design and Execution: Building Digital Worlds*. Englewood Cliffs, NJ: Prentice Hall. (A useful place to start if you are interested in simulation modeling.)

Forrester, J.W. (1968, 1990). *Principles of Systems*. Portland, OR: Productivity Press. (The classic text on systems dynamics. Provides a general foundation for study of systems dynamics in corporate, urban, and other complex systems.)

Forrester, J.W. (1969). *Urban Dynamics*. Portland, OR: Productivity Press. (Classical text on urban development systems dynamics with an emphasis on effects of job training programs, housing, and employment programs compared to industrial development programs.)

Forrester, J.W. (1973). *World Dynamics*. Portland, OR: Productivity Press. (This controversial book discusses growth in a finite world. See also Meadows et al., 1992, below.)

Fripp, J. (1994). *Learning Through Simulations: A Guide to the Design and Use of Simulations in Business and Education*. New York: McGraw-Hill. (A recent paperback providing a general introduction to the subject.)

Gilbert, N. & Conte, R. (Eds.) (1995). *Artificial Societies: The Computer Simulation of Social Life*. London, England: UCL Press. (Worth examination if your interests include social simulations.)

Gilbert, N. & Doran, J. (Eds.) (1994). *Simulating Societies: The Computer Simulation of Social Phenomena*. London, England: UCL Press. (A companion volume to the above book.)

Gredler, M. (1994). *Designing and Evaluating Games and Simulations: A Process Approach*. Houston, TX: Gulf Publishing Co. (A highly practical discussion of academic games and simulations, including computer and noncomputer games, tactical decisionmaking and social interaction simulations, the role of debriefing, and methods for evaluating and improving games and simulations.)

Greenblat, C.S. & Duke, R.D. (1981). *Principles and Practices of Gaming-Simulation*. Thousand Oaks, CA: Sage Publications, Inc. (A basic text on the subject.)

Hannon, B. & Matthias, R. (1994). *Dynamic Modeling*. New York: Springer-Verlag. (A recent textbook on the subject.)

Hecht-Nielsen, R. (1989). *Neurocomputing*. Redding, MA: Addison-Wesley. (A textbook, but industry oriented. The author is the founder of a major neural computing software company as well as an academic. The book describes commercial projects as well as theory.)

Hertz, J., Krough, A. & Palmer, R.G., (1991). *Introduction to the Theory of Neural Computing*. Redding, MA: Addison-Wesley. (An advanced undergraduate/ postgraduate textbook, with a comprehensive mathematical treatment of the theory of neural networks.)

Kirk, L. & Kirk, J. (1996). *Training Games for the Learning Organization: 50 Experiential Learning Activities*. New York: McGraw-Hill. (Publication date: November 1996; may be worth a look.)

Law, A.M. & Kelton, W.D. (1991). *Simulation Modeling*. New York: McGraw-Hill. (A general text on the subject.)

Meadows, D.H., Meadows, D.L. & Randers, J. (1992). *Beyond the Limits*. Post Mills, VT: Chelsea Green Publishing Company. (A follow on work to Forrester's World Dynamics and a 1972 work by Meadows et al., The Limits to Growth.)

Morecraft, J.D.W. & Sterman, J.D. (Eds.) (1994). *Modeling for Learning Organizations*. Portland, OR: Productivity Press. (Twenty-eight authorities cover recent systems dynamics work in modeling business and other organizations. Describes how to develop and use simulation models and use that information to guide organizational change. Includes case studies and software reviews.)

Pantili, L. et al. (1991). Principal Assessment: Effective or Not? A Meta-Analytic Model, 43 pages (ERIC ED 333540). (Analysis of the National Association of Secondary School Principals (NAASP) assessment process. A convenient source for information on the use of assessment centers in educational administration.)

Richmond, B., Peterson, S. & Vescuso, P. (1987). *An Academic User's Guide to STELLA*. Hanover, NH: High Performance Systems. (The best place to start to learn to design dynamic systems simulation models using STELLA or ithink.)

Saunders, D. (Ed.) (1996). *The Simulation and Gaming Yearbook: Applications of Simulations and Games to Business*. (Annual Yearbook Series, Vol. 3). East Brunswick, NJ: Nichols Publishing Co. (An excellent current source of ideas about simulation and gaming applications.)

Senge, P.M. (1990). *The Fifth Discipline: The Art and Practice of the Learning Organization*. New York: Doubleday. (A popular and readable book covering many conceptual issues regarding systems dynamics and systems thinking.)

Shannon, R. (1975). *Systems Simulation: The Art and Science*. Englewood Cliffs, NJ: Prentice Hall. (A bit dated, but still a useful guide to the subject.)

Starr, P. (1994). "Seduction of Sim: Policy as a Simulation Game," *The American Prospect*, 17, Spring, 19-29. (Available as: <http://epn.org/prospect/17/17star.html>; this article provides a provocative view on the uses of simulation games.)

Thornton, G.C. (1992). *Assessment Centers in Human Resource Management*. Addison-Wesley Pub. Co. (This recent paperback discusses the uses of assessment centers for managerial selection and promotion, diagnosis of training needs, and team building.)

Towne, D.M. (1995). *Learning and Instruction in Simulation Environments*. Englewood Cliffs, NJ: Educational Technology Publications. (One of the best recent sources for instructional uses of simulation. Includes a simulation development case study and a glossary.)

Van Ments, M. (1983). *The Effective Use of Role-Play: A Handbook for Teachers and Trainers*. East Brunswick, NJ: Nichols Publishing Co. (A good, general guide to role-playing applications.)

Wolstenholme, E.F. (1990). *Systems Enquiry: A Systems Dynamic Approach*. New York: John Wiley & Sons. (Contains a number of real world examples of dynamic systems modeling.)

# APPENDIX 1. THE SCHOOL GUIDANCE COUNSELOR: A DISCRETE EVENT WORKFLOW SIMULATION



Guidance Services model: Shows what happens when two processes are not independent. The telephone calls (from parents) process takes precedence over the student guidance process, causing the student guidance process to shutdown whenever a call comes in. This results in fewer students being counseled. Results at the end of the day shown below.

## Process 1: Student Counseling Problems

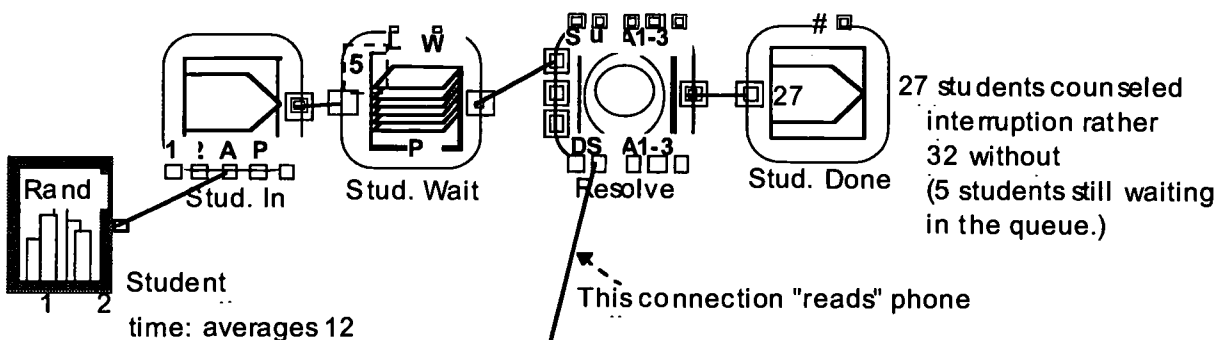

## Process 2: Phone Calls from Parents

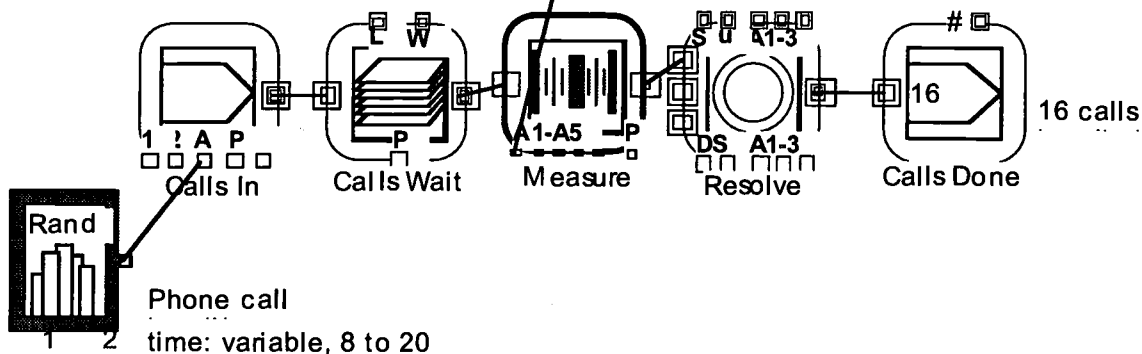

This simple workflow model (executed in Extend) shows the results at the end of one day (480 minutes) of simulation. There are two parallel processes. In Process 1: Student Counseling Problems, a random generator assigns a student problem resolution time (a normal distribution with mean of 12 minutes and standard deviation of 2 minutes). The Stud. In block produces a “student” token once every 15 minutes with a processing time selected by the random generator. Students proceed to a Stud. Wait queue where they wait until the counselor is not busy. The next student in line then proceeds to the Resolve (counselor) block for counseling. When through, the student moves to the Stud. Done block (which provides a running count of the number of students processed). In Process 2: Phone Calls from Parents, the random generator assigns variable call processing times (50%, 8 minutes; 20%, 12 minutes; 20%, 17 minutes; and 10%, 20 minutes.) The calls come in once every half hour, and are similarly processed. However, in this work flow there is a Measure block that tags the call with a priority status that interrupts the counselor processing of students in Resolve block in Process 1, until a parent call is completed.

The results shown at the end of the day for this simulation indicate that 16 parent calls were handled and 27 students were counseled. However, five students were still waiting in the queue at the end of the day.

In this simple simulation all 16 parents’ calls (one every half hour) will be processed since they create priority interrupts for the counselor. However, repeated simulations demonstrate that different numbers of student are processed and different numbers of students are still waiting in the queue at the end of the day, and that an average of 25 students will be processed and 7 students will be left in the queue at the end of the day. Thus, the depicted simulation is a little better in terms of the number of students left waiting than the average for a large number of simulations.

By separating the two processes (such as by assigning someone else to handle the parent telephone calls) the counselor would nearly always be able to process all 32 students (one every 15 minutes). Simulation of this model is accomplished simply by removing the “phone call” line connection between the Resolve block in Process 1 and the Measure block in Process 2 (just click on the connecting line and hit the delete key), and then running the simulation again.

One can manipulate this model in a number of ways, e.g., by changing the statistical properties of the two random generators to change the processing times for calls and for students, by modifying the token input times for calls and students, or by assigning different levels of interrupt priorities to parent calls.

What cannot be shown in the figure is the ability of Extend to display in fast or slow animation the movement of the student tokens and call tokens as they move from one block to the next through the network, the changing counts for tokens in the Wait blocks and in the Done blocks, or the time elapsed and simulation step count displays. The tokens appear in the animation as green circles inside the small squares next to the lines connecting the processing blocks. The final count numbers are seen inside the Done blocks. In animation, these numbers are incremented with the arrival of each token. This School Guidance Counselor model is a direct adaptation of Extend's demonstration SUPPSERV (Support Services) model.

Extend's model building blocks (such as ones depicted in The School Guidance Counselor simulation example are grouped into libraries according to function; i.e., blocks commonly used in discrete event models can be found in the Discrete Event library. You place these process specific blocks on your model worksheet by selecting them from the library menu (merely drag and drop). Then connect them with the mouse, set appropriate parameters in the dialog boxes, and the model is ready to run.

Since each Extend block has a pre-defined functionality, you merely need to enter parameters into each block's dialog box (which opens when you double click on the building block icon). For example, set the delay time, establish a maximum queue length, or select a distribution (exponential, normal, Poisson, triangular, Erlang, uniform, Weibull, constant, LogNormal, HyperExponential, etc.) just by typing in numbers or clicking buttons in the Dialog box. Dialog boxes also provide you with simulation information like utilization rate, number of items entering or leaving the block, queue length, etc.

For custom effects, you can combine the function of several blocks into one through hierarchy (build either top-down or bottom-up) or by using an equation editor. Or, custom blocks can be built using Extend's built-in scripting language and dialog editor. This multiple hierarchy feature means that you can build a model as large as you want since there are virtually no limits with Extend. For example, processes (such as the student counseling problems or the phone calls from parents in The School Guidance Counselor simulation) can be combined into one at the next higher level in a hierarchical model; these larger components can be connected together, and then combined again to create new modeling units for a third level, and so on for as many levels as may be needed. Since units at any level can be saved, users can create their own custom libraries of model components.

You can track items in your model by assigning attributes (such as part type, color, or cost) which can be recalled at any point in your model, or set a priority to items. With Extend, you can import data files, cut and paste to spreadsheets, or create a "live link" and update an Excel spreadsheet as your model runs.



Results of running your simulation are provided in numerous forms. You may use blocks from Extend's Plotter library to produce tables and plots of simulation results. You can choose from a variety of plots: bar, histogram, worm, strip, scatter, multiple run, and more. For in-depth analysis and presentation, you can develop custom reports of model data. Simulation results and important statistics can be "cloned" to a Notebook (Control Panel interface) and combined with your own text and graphics to provide a unique and accessible interface to your model. To investigate how a parameter change impacts the pattern of behavior for the entire model, you can use Extend's sensitivity analysis feature to sensitize specific parameters. Other Extend features include animation (both built-in and custom), interruptible processes, full connectivity with the outside world (spreadsheets, databases, I/O boards, etc.), plus interactive model execution.

## APPENDIX 2. DYNAMICS OF TEAMS GIVEN AUXILIARY FEEDBACK: A SIMULATION OF AN EDUCATIONAL SYSTEM

Paul Hood, WestEd

In *Research-Based Development in Education: Its History and Future*, Larry Hutchins and I suggested three alternative views of the future role of R&D in education in a Post-Modern, Constructivist environment.

One alternative took a revisionist perspective — more traditional forms of product, program, and system development are still needed. We should be creative and complex in our thinking about how an R&D-based innovation is adapted to local conditions. Some of the New American Schools “break the mold” models seem to be following this approach.

A second perspective called for systemic change support — a productive line of attack would be to complement comprehensive technical assistance efforts with the development of educational system components that could be systematically combined and configured to fit local conditions. While each school is unique there are enough similarities among types of schools that highly sophisticated sets of combinable components, much like construction toys (the metaphor is the Erector Set, Tinker Toys, or Lego), developed for a particular group or type of school could easily be adapted (in mix and match combinations) to other schools of a similar type. This approach combines the reliability and efficiency of development of tested and validated components with the ability to combine and adapt these components, perhaps adding additional components over time, to meet particular needs and resources of local school communities.

A third perspective, suggested by the concept of authoring in computer programming, envisions the development of support tools that allow a school (or even an individual teacher) to develop unique designs for education, but ones not possible without external support provided through educational systems design tools. The question is not so much whether schools need and can profit from such external support. Rather, the question is whether the external support is controlling or empowering. We saw the possibility of creating sophisticated “authoring” systems (the metaphor is CAD — Computer Aided Design) that could support local systems design. We acknowledged that “authoring” approaches to local innovation, design and development that empowered, rather than controlled the user would be a complex undertaking, but a task that a new generation of development could undertake. Such a challenge would require a level of complexity that matches the complexity of the school — no mean task, but one that R&D would be capable of. One part of such an authoring system would be the ability to simulate educational system operations in order to evaluate design alternatives.

When we wrote about that “authoring system” alternative, we knew that there was already more than a five-decade history of systems simulation R&D. In the 1950s, I had patched together four different training simulators (a flight simulator, a radar bombing/navigation training simulator, an electronic countermeasures simulator, and a gunnery simulator) to create the first B-52 air crew coordination training laboratory for the Strategic Air Command. Shortly later, Jay Forrester at MIT began his social systems simulations (employing a simulation language, DYNAMO, operating on a large MIT mainframe computer).

At the Far West Laboratory, we had carefully studied Forrester’s 1969 book on *Urban Dynamics* and his 1971 book on *World Dynamics*. Encouraged by those simulations, more than 15 years ago, we had invited a number of scholars to convene at the Far West Laboratory to make an assessment of the state-of-the-art in systems simulation and the prospects for developing useful simulations of educational systems. Among the presenters, was a professor from Boston University who, working with some of Forrester’s students, had developed a simple educational simulation, using the DYNAMO language and the MIT computer. Although his simulation was interesting, our panel concluded that we did not yet have sufficient understanding of educational systems to warrant an R&D effort to develop such models.

Peter Senge’s 1990 book, *The Fifth Discipline*, served to bring Forrester’s work on dynamic social simulations before a much larger audience. A related development was the adaptation of the DYNAMO mainframe computer simulation language to an application that would operate on a personal computer. In the late 1980s, STELLA became available for use on the Macintosh. A couple of years later, itthink, a business simulation version of STELLA, was developed for PCs. STELLA and itthink are almost identical, and they are immensely easier to learn and use than DYNAMO.

Having recently acquired a demonstration version of itthink, I began searching for a simulation model that would be both interesting and instructive in actually modeling an educational system. Most of the models I found were simulations of business, manufacturing, sales, or ecological systems.

However, late last year Brent deMerville posted on the Internet a team dynamics model that was just what I was searching for. The model portrays the interaction of support, knowledge, understanding, motivation (team members’ desire for teams), maturity, and success.

The attached graphs were produced using the team training dynamics simulator model developed by Brent deMerville (San Angelo, TX).

The systems dynamic model involves five interrelated difference equations. Symbolically these are depicted in the following diagram as involving valved changes in rates of flows into (or out of) five reservoirs, thus affecting the levels in those reservoirs, labeled in the diagram below as: Knowledge, Employee desire for teams, Team Maturity, Team Success, and Supervisor Support of Teams. The levels in those reservoirs generate signals for control circuits that connect through various converters (the circles) to valves that affect the flows for other reservoirs.

deMerville's model involves three manipulable variables: (a) level of supervisor support, (b) initial level of team success, and (c) amount of team training offered, [see the three levers and their settings above any of the attached graphs], as well as the number of problems (created by a random generator) that may occur during the process of work.

In addition, deMerville set a measure he called team success (the sum total of the team's ability to overcome problems). He also set up a state he called the desire factor (desire for teams). This state is increased or decreased by a flow called change in desire which in turn is the result of the team's level of understanding of the team process (as a function the level of knowledge generated through the rate of training offered) combined with the level of supervisor support and the level of problems encountered. The level of desire for teams (created by the change in desire flow) then influences the team's growth rate which in turn determines the team's maturity level. This team maturity level is combined with the problems encountered to determine the changes in team success. The level of team success (and the three-month trend line of the rate of the team's success) directly influences, positively or negatively, the rate of change in supervisor support. (And the level of supervisor support, in turn, acts as a feedback to influence, positively or negatively, the rate of change in desire for teams.)



I set the simulation to run for an eight-year period (scaled in months). Note that the scales along the left hand side of the graphs (see following pages) correspond to the five variables graphed. Supervisor Support (1), and Team Success (3) have both been scaled and fixed so that their zero values are at the mid-point of the vertical axis of the graph and their minimum and maximum values are held constant for all simulations. (This is not true for the other three variables, so please note their particular values for each simulation.)

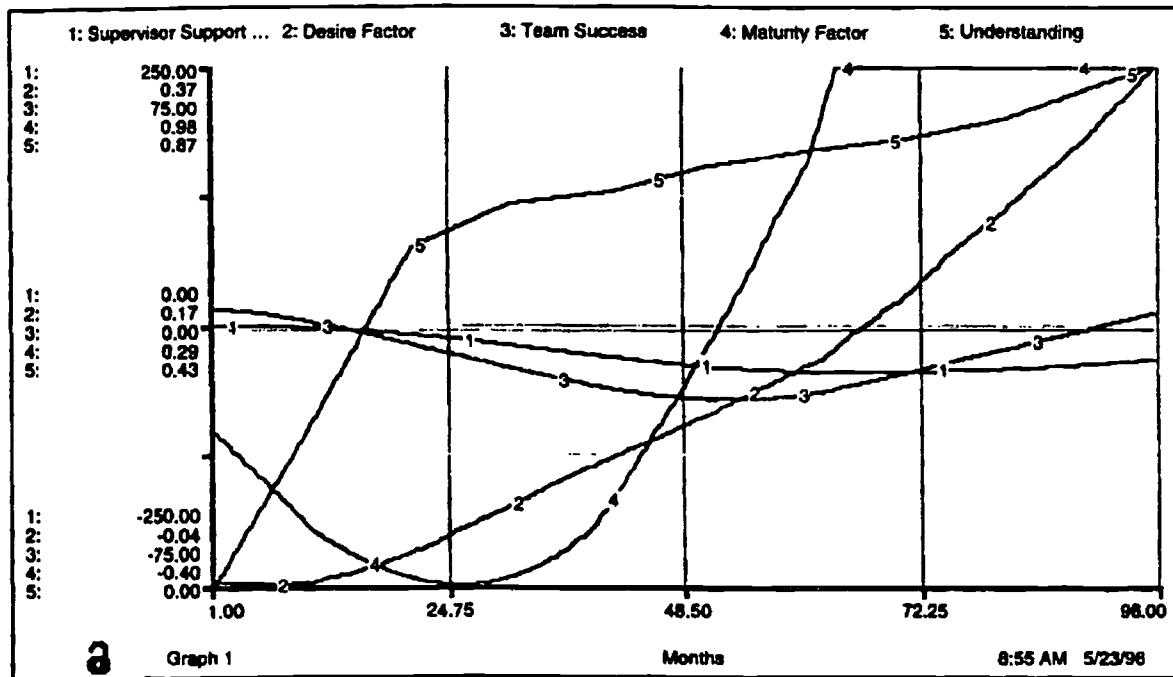
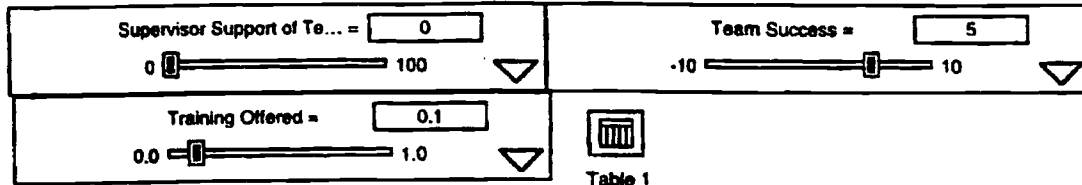

In the first graph, you see the “nominal” run with Supervisor Support set at zero, Training Offered at 0.1, and Team Success at 5. (I have left Team Success at 5 for all the remaining simulation runs.) In this simulation, Understanding (5) does not reach its maximum value until the end of the simulation. However, the Maturity Factor (4) reaches its maximum early in the sixth year. Starting at plus 5, by

the end of the first year, Team Success (3) develops a negative value and remains negative until late in the eighth year. It is late in the fifth year before the Team Success curve even turns upward in direction. Supervisor Support (1), which was set initially at zero trends downward until late in the seventh year. Despite this lack of support and a dismal success record, the team's motivation, see Desire Factor (2), maintains an upward curve throughout the simulation (but the scale range is only from -0.04 to 0.37).

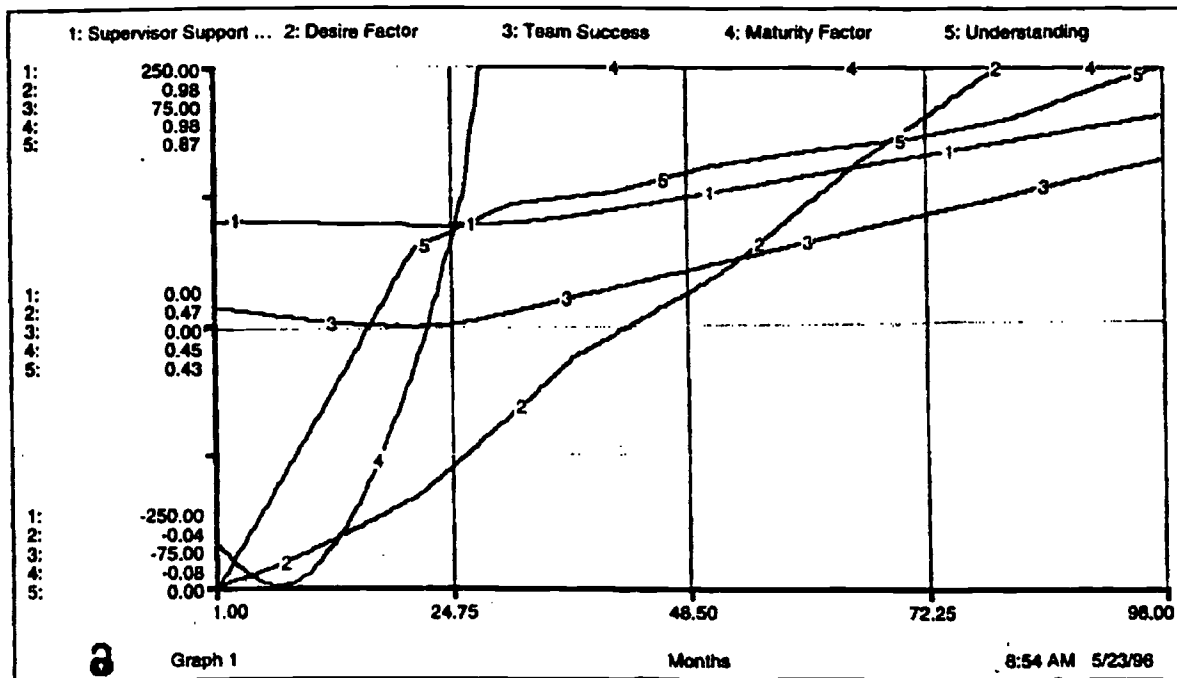
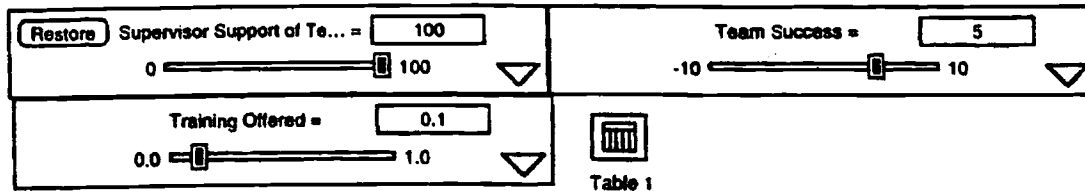

In the second graph, you see the effect of raising Supervisor Support to its maximum value of 100, while Training Offered remains at 0.1. Since Training Offered is still set at 0.1, the curve for Understanding (5) is identical to that of the previous simulation. However, as might be expected with

maximum support, the other simulation results are dramatically different. The Maturity Factor (4) reaches its maximum early in the third year. After a mild downturn in the first and second year, Team Success (3) turns upward and continues to show improvement in performance throughout the remainder of the simulation. Supervisor Support, starting at 100, dips almost imperceptibly and then trends upward toward 200.

For the next three simulations I set Supervisor Support at 50 (exactly halfway between the extremes of zero and 100 in the previous simulations), but increased Training Offered to 0.3. (And the initial level of Team Success remains at plus 5.) With these modest levels of training and support, we see in the next graph that both the Maturity Factor (4) and Understanding (5) reach maximum values at almost identical times toward the end of the third year. Team Success (3) initially trends downward until the middle of the third year and then trends upward, improving through the remainder of the simulation. While starting at plus 5 and indicating negative values (as low as minus 5) in the second and third years, Team Success ends the simulation at a value of 41, more than eight times its starting point.

To summarize, with these modest but perhaps realistic levels of support and training, it took the team almost three years to master understanding of team work and reach full team maturity. Knowledge rose rapidly in the first year and then trended upward through the second and third year to achieve its maximum value late in the third year. The Maturity Factor took a sharp drop in the first year, and then rose precipitously throughout the second and third year until it too reached its maximum value. Although motivation (the desire factor) continued to climb, the objective measure of Team Success slipped slightly downward until the middle of the third year and actually assumed small negative values throughout almost all of the second and third year. However, from the turn-around in the third year, the team training effort continues to pay off throughout the remaining years.



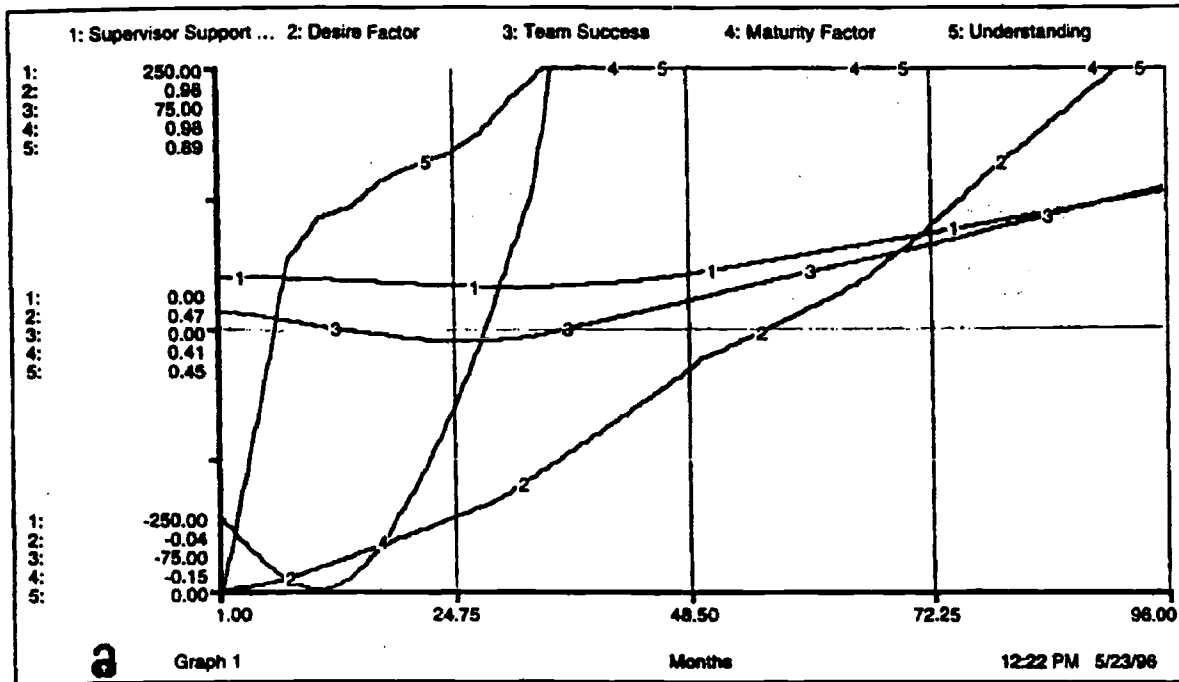
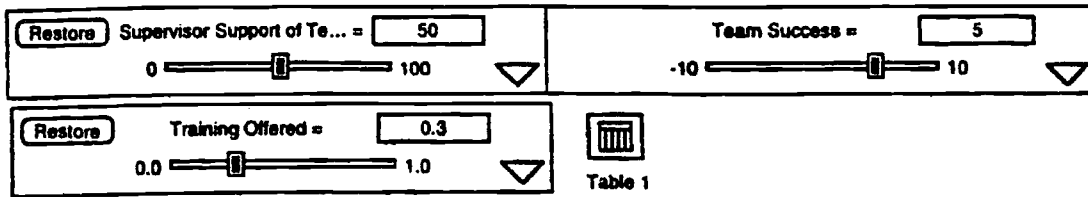

Given this “base line” simulation graphed immediately above, I next modified the simulation slightly to introduce the effect of a powerful annual accountability report that either was NOT aligned or was aligned with the goals of the team. (Think of the report as a system-level report or perhaps a student testing report, not a team performance report, that might or might not be aligned with the aims of the team.)

My “accountability report” modification simulates the effect of an annual report, published in the eighth month of each simulation year, that is added as an annual pulse to the team’s problem input. If aligned, it acts as a powerful problem reducer during the week the report is published. If NOT aligned, it substantially multiplies the particular level of the problem faced by the team during the week the report is published. The “report” pulse

directly influences the Desire Factor (2), and indirectly influences the Team Success (3), the Supervisor Support (1) and the Maturity Factor (4). However, it has no effect on Understanding (5). The next graph shows the effect of the annual accountability report if it is NOT aligned.

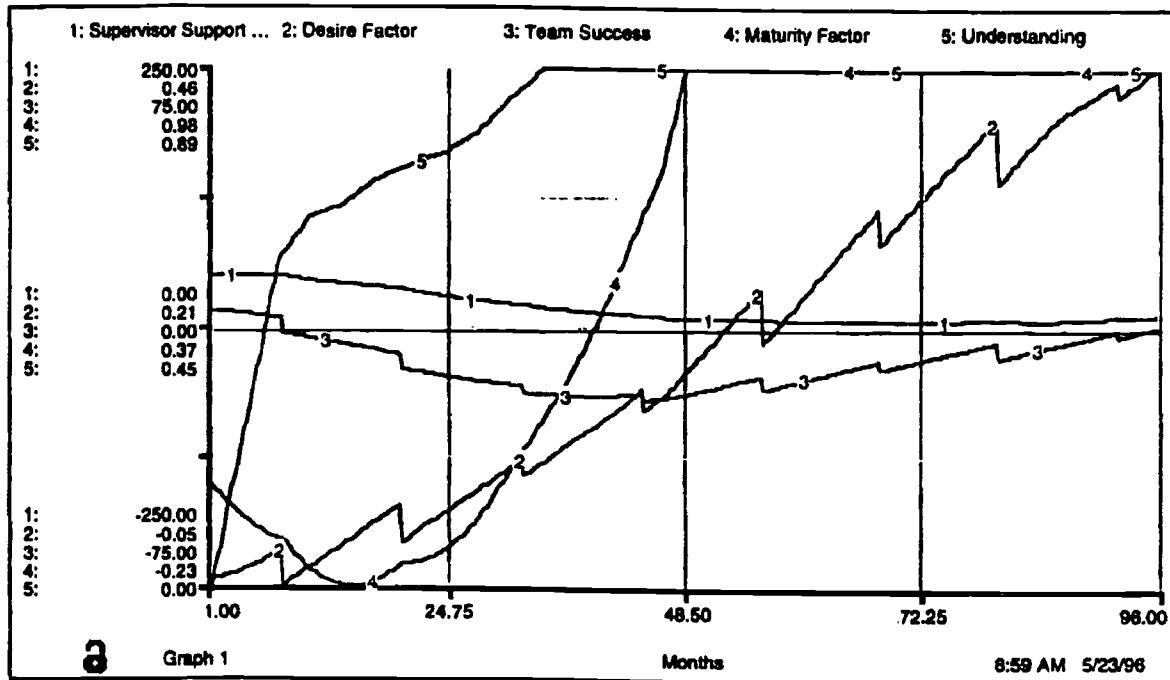
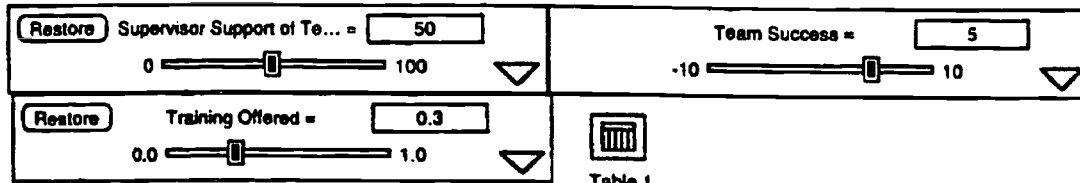

Given the powerful negative effect of the annual report in the NOT aligned graph, Supervisor Support (1) remains on a downward trend throughout the eight-year period, and Team Success (3) does not make a turn-around in its downward slope until late in the fourth year. Team Success goes into negative values immediately after publication of the first accountability report in the first year and remains negative throughout the remainder of the simulation. (The curve suggests that Team Success might finally cross the zero line into positive values sometime, off the chart, late in the tenth year.)

Supervisor support, although trending downward throughout the eight years, remains positive, although very close to a zero value by the end of the simulation. (Since Supervisor Support lags Team Success, the Supervisor Support curve might begin to trend upward in the tenth or eleventh year. By that time, who would care!)

Next, in the simulation below, we display the effect if the accountability report is perfectly aligned with the team's goals.

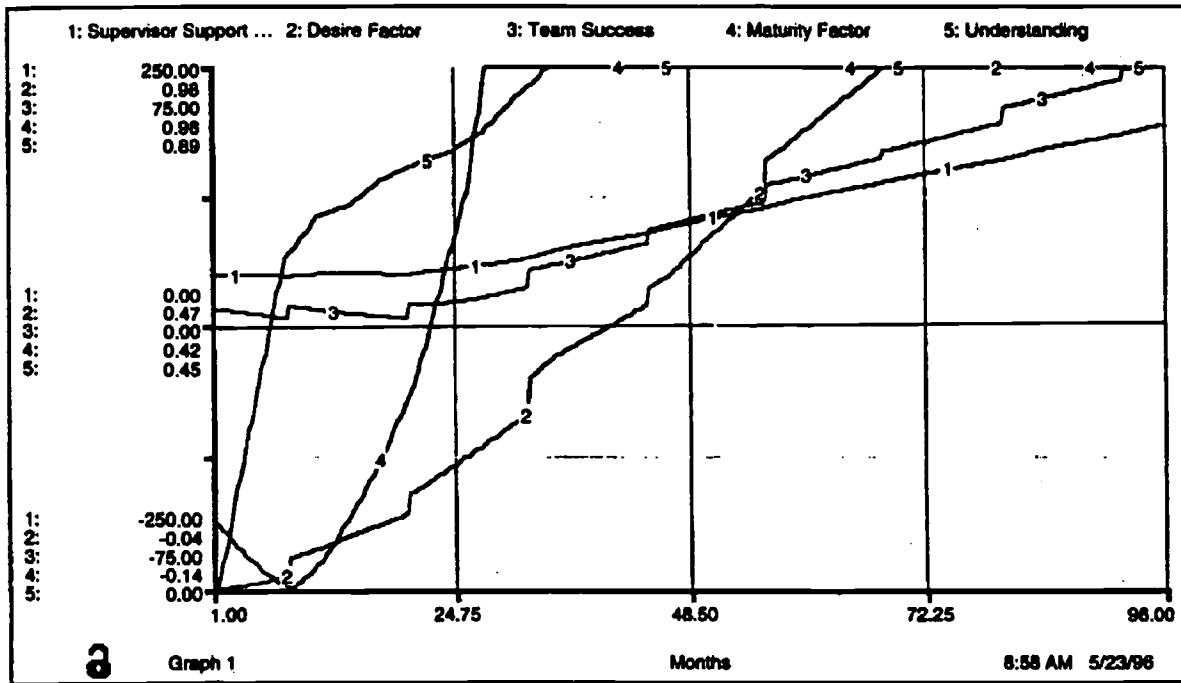
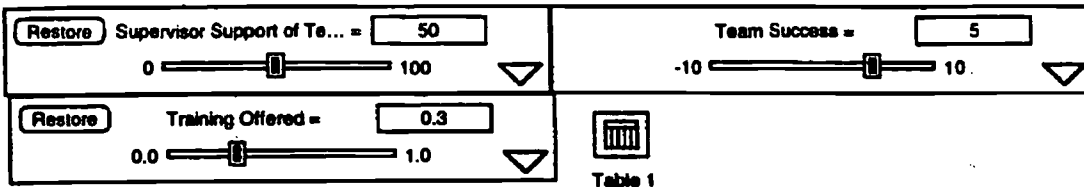

BEST COPY AVAILABLE

Given the powerful positive effect of the annual report in the above “aligned” graph, Team Success (3) and Supervisor Support (1) dip only slightly downward in the first two years and then both climb higher throughout the remaining six years. Neither measure is ever negative in value.

Note these last three simulations use exactly identical starting values for all system factors (levels and flow rate settings). Note that Supervisor Support of Teams remains set at 50, (initial) Team Success at 5, and Training Offered at 0.3.

The only difference between the last two simulations is in the Problems generator in just one sign (+) or (-) in the formula for the annual pulse generator that simulates the publication of the report in the eighth month of each year.

In both simulations, Understanding (5) (of team work) reaches a maximum value late in the third year at identical times. However, the maximum value for the team Maturity Factor (4) is delayed by almost two years in the NOT aligned simulation when compared to the aligned simulation.

These two simulations are undoubtedly extreme situations. In both, we have assumed that the accountability report would have a very powerful effect on the team and the supervisor. (Please note that the factors operating within this team training simulation have no effect on the input value of the “accountability report.” It acts as an exogenous input pulse [that is amplified by a random generator]. Note the differences in the magnitude of the “jolts” in the curves, which are particularly easy to see in the Desire Factor (2) curve.) Because the annual effects are cumulative, two very different sets of simulations are created. Although these last two simulations are extreme cases, I believe that they make a compelling case for the need for alignment between external performance indicators and team success.

As a final note, excluding the changes I made in the formula for the Problems generator, simply changing the settings for the three controls seen directly above each graph in this simulation model enables the user to run as many as 23,331 different combinations of initial settings for this team training simulation. Moreover, since the Problems generator includes a random generator, repeated simulation runs at any particular combination of settings for the three controls will not produce exactly identical results (although the differences are usually very small).

However, through systematic experimentation, one may quickly learn that changes in the Team Success variable act mainly to raise or lower the elevation of the Team Success curve but do little to change its shape. Changes in the settings of Training Offered act mainly to advance or retard the slope of the Understanding curve and the date at which it reaches its maximum value (if that date is contained within the duration of the length of the simulation). The really powerful “leverage point” in

this simulation is found in the setting of the Supervisor Support of Teams. Please examine the first two graphs again in which Support was first set at zero and then at 100 (percent). When I asked myself where else in this dynamic system might there be another high leverage point, I concluded that it would be in the Problem generator, so that is where I introduced my “accountability report” pulse generator.

Paul Hood, 5/23/96

### APPENDIX 3. LIST OF LOW-COST MODELING SOFTWARE VENDORS

All of the following modeling tools employ a Windows click and place or drag and drop metaphor to place shapes, connect lines, and place text on a drawing page or surface. Shapes are placed on the diagram, representing process steps or functions, and lines connect the shapes to show relationships. (Prices quoted are those published in 1996. But please call the vendor before ordering.)

Extend (\$695), Extend+BPR (\$990).

Imagine That, Inc. 6830 Via Del Oro, Suite 230, San Jose, CA 95119. Phone: 408-365-0305.

An object-oriented environment for dynamically modeling, analyzing, reengineering, and documenting business processes. (See Appendix 1 for an example model.)

ithink [and STELLA] (Standard Version: Retail \$599; University faculty \$259; Pre-college faculty \$219) (Research/Analysts: Retail \$1099; University faculty \$479; Pre-college faculty \$399). Prices do not include shipping (add \$5 for one package by UPS ground shipping).

High Performance Systems, Inc., 45 Lyme Rd., Suite 300, Hanover, NH 03755 Phone: 800-332-1202 for Information & Ordering.

ithink and STELLA are among the most popular and widely used programs for educational applications of continuous process simulations. (See Appendix 2 for an example model.)

Optima! 2.0 (\$695) Optima! Express 2.0 (\$345)

AdvanEdge Technologies Inc., 10170 SW Hedges Court, Tualatin, OR 97062. Phone: 503-692-8162

Optima! Express is a highly automated discrete process mapping tool. Users create process maps by defining functional groups as horizontal bands, then place the appropriate flow chart symbol into the functional group that performs the process steps and then connect the symbols with lines and add text to show the flow of the process. Advanced features include the ability to assign attributes or variables to build a process model. Besides many pre defined attributes, users can create their own. Includes the ability to define a statistical distribution and a build-in expression builder. Optima! is the high-end version of the Optima! family of products. Includes all the features of Optima! Express, as well as features specific to process simulation and analysis. A built-in simulation guide allows users to create scenarios and view the results of multiple simulations side by side. A trace view adds color-keyed process animation. An extensive reporting facility includes ability to produce attractive charts.

Process Charter (\$600)

Scitor Corporation, 333 Middlefield Road, Menlo Park, CA 94025. Phone: 415-462-4200; 1-800-549-9876.

This flow-diagramming tool is combined with analysis and simulation capabilities to provide a powerful discrete process modeling program. Once a process is defined with the flowcharting tools, resources are identified and assigned to the process steps. Then, a simulation can be run and the results can be presented in graphical and statistical

forms that can be incorporated in reports. Process charter uses a familiar spreadsheet metaphor for adding resources, viewing activities, assigning resources to activities, and generating reports. Extensive options and deep dialog boxes provide capabilities to create sophisticated simulation models, including in-depth cost and resource analyses for business applications.

STELLA (see ithink listing above, pricing is identical)

Vensim

Vensim Standard (\$495) Vensim DDS (\$1,995)

Vensim Professional (\$1,195) Vensim Runtime (\$495)

Vensim Personal Learning Edition (PLE) is free for academic use.

In support of education and basic research, Ventana provides educational discounts for other configurations.

Ventana Systems, Inc., 149 Waverley Street, Belmont, MA 02178. Phone: 617-489-5249

Vensim is an integrated simulation framework for conceptualizing, building, simulating, analyzing, optimizing, and deploying models of complex dynamic systems. It is available for PC and Macintosh. The standard version allows users to create, articulate and simulate models. The professional version adds advanced modeling capabilities and enables optimization of model performance. The DSS version increases model capacity and provides tools for building decision support systems and learning simulators. The PLE is free for academic use, and is designed for beginning systems dynamics models. In the PLE, all menus and dialogs have been simplified; most option settings have been removed; it has a fixed toolset; the number of model building tools has been reduced; and a limited number of functions are supported.



TM028074

## NOTICE

### REPRODUCTION BASIS

This document is covered by a signed "Reproduction Release (Blanket)" form (on file within the ERIC system), encompassing all or classes of documents from its source organization and, therefore, does not require a "Specific Document" Release form.

This document is Federally-funded, or carries its own permission to reproduce, or is otherwise in the public domain and, therefore, may be reproduced by ERIC without a signed Reproduction Release form (either "Specific Document" or "Blanket").