

DOCUMENT RESUME

ED 402 927

IR 056 224

AUTHOR Norvell, Donna, Ed.
 TITLE Knights Alive in '95. 1995 Summer Reading Program for Children.
 INSTITUTION Oklahoma State Dept. of Libraries, Oklahoma City.
 PUB DATE 95
 NOTE 266p.
 PUB TYPE Guides - Non-Classroom Use (055)

EDRS PRICE MF01/PC11 Plus Postage.
 DESCRIPTORS Budgets; Elementary Education; Learning Activities; *Library Extension; *Library Services; Planning; Program Design; Publicity; *Public Libraries; *Reading Programs; *Summer Programs; Young Children
 IDENTIFIERS Oklahoma

ABSTRACT

This manual presents a summer reading program for children. It was prepared to help Oklahoma public libraries plan activities that will enhance and enrich library services to all children. The ideas presented are designed to be flexible and can be expanded and adapted to suit library patrons' needs. The target audience for the Summer Reading Program is children ages 6 through 12. Programs provided are also adaptable for pre-schoolers and young adults. The manual is organized in six parts. Section 1 profiles the two artists who worked on the program. Section 2 focuses on planning, publicity and promotion. Highlights include: an introduction; promotional materials; basic guidelines; program decisions; planning checklist, budget, and supplies; budget planning; volunteers; "junk" that can be used in activities; goals and objectives; scheduling; program planner; the calendars; promotion in schools; public service announcements; press releases; sample news releases for the beginning and end of program; tips for parents; an suggestions for "Knightly News" an accompanying newspaper activity. Various sample forms are included throughout the second section. Section 3 lists individuals or groups in Oklahoma who are available for programming. Each listing includes address and phone number, a description of the presentation, fee (if applicable), length, and references. Section 4 contains the activities, as well as display and promotion ideas and section 5 provides clip art. (Contains 28 references.) (AEF)

 * Reproductions supplied by EDRS are the best that can be made *
 * from the original document. *

1995

Summer Reading Program for Children

Knights Alive in '95



Donna Norvell, Editor/Compiler
The Oklahoma Department of Libraries
 200 N.E. 18th Street
 Oklahoma City, Oklahoma 73105

TEL (405) 521-2502
 FAX (405) 525-7804

U.S. DEPARTMENT OF EDUCATION
 Office of Educational Research and Improvement
 EDUCATIONAL RESOURCES INFORMATION
 CENTER (ERIC)

- This document has been reproduced as received from the person or organization originating it.
- Minor changes have been made to improve reproduction quality.

• Points of view or opinions stated in this document do not necessarily represent official OERI position or policy.

"PERMISSION TO REPRODUCE THIS MATERIAL HAS BEEN GRANTED BY

B. Spriesterback

TO THE EDUCATIONAL RESOURCES INFORMATION CENTER (ERIC)."

056224

Knights Alive in '95 Summer Reading print materials have been issued by the Oklahoma Department of Libraries as authorized by 65 O.S. 1991 §3-110. Materials include 520,000 Medieval Character Coloring Bookmarks, 65,000 Castle Reading Logs, 65,000 Reading Certificates, 2,000 Promotional Posters and 225 Program Planning Manuals. Artwork, pre-press production and design, and printing were provided at a cost of \$22,272.50. Paid for with state and federal funds under the Library Services and Construction Act. 2/95.

ACKNOWLEDGEMENTS

Thanks to those who "Quested" before and were willing to share their manuals. This Manual is a blend of many of the ideas from other state manuals:

1981	Wisconsin	"Merlin's Mid-Summer Magic"
1981	Rhode Island	"Summer Knights"
1983	Arkansas	"Summer Enchantments"
1983	Iowa	"Dragon Summer"
1984	South Carolina	"Dragon Summer"
1984	Florida	"Book Quest: Search for the Dragon's Treasure"
1985	Virginia	"Summer Quest"
1987	Louisiana	"Castle Quest"
1990	Utah	"Knights and Dragontails"
1991	Alabama	"Sir Al and His Summer Knights"
1992	Montana	"Dragon Tales"

Thanks to Bill Young for his helpful suggestions and assistance with the printing and art work and to Bill Young and Donna Skvarla for "proofing" the manual. A special thanks to Wynema Ra for her endless days of typing and to Karen Currie whose word processing skills moved everything around and pulled it back together.

Bravo to Michael Wimmer, Oklahoma Artist for his art used to design the poster, the castle reading log, certificate, bookmark and clip art.

Thanks again to graphic artist Elizabeth Muller. Her talent once again adapted the wonderful Wimmer art to fit the needs of readers in Oklahoma.

Everyone's support, enthusiasm, dedication and hard work have been invaluable to the total development of "Knights Alive In '95".

TABLE OF CONTENTS

Section

1.

Artists

Meet Oklahoma Artist - Michael Wimmer	1
Meet Graphic Design Artist - Elizabeth Muller	4

Section

2.

Introduction, Planning, Publicity and Promotion

Introduction	5
The 1995 Promotional Materials	6
Basic Guidelines	7
Program Decisions - 1995	8
Planning Checklist/Budget/Supplies	9
Budget Planning	10
Using Volunteers	11
Volunteer Information Form	14
A Checklist of "Beautiful Junk"	15
Setting Goals and Objectives	17
Scheduling	18
Program Planner	19
The Calendar	23
Program Planning Calendars	24
Program Registration Forms	29
Promotion in Schools	37
Public Service Announcements for Radio	38
Public Service Announcements	39
Press Releases	40
Press Release Guidelines	41
Sample News Release (for beginning of program)	43
Sample News Release (for end of program)	44
Tips for Parents	45
Knightly News	47
5 Easy Steps for Newspapers	48
The Nightly News (blank sample forms)	49

Section

3.

Performers

Program Resources	55
Performance/Presenter Preparations	56
1995 Summer Program Presenters	57
Program Presenter Application Form 1996	67
1995 Performing Artist Evaluation Form	69

Section

4.

Programs	
Display and Promotion Ideas	71
Class Visits	72
Programming/Human Resources	73
Grand Finale Ideas	74
Castles	75
Royalty	93
Knights	123
Dragons	133
Unicorns	171
Sundry	185
Alchemists	187
Archery	188
Bookmaking	193
Calligraphy	195
Illumination	196
Chivalry	197
Costumes	198
Doodles	199
Games	200
Heraldry	207
Jester	211
Medieval Feast	214
Middle Ages	216
Mime	217
Minstrels and Ballads	219
Rubbings	225
Sewing, Stitchery and Tapestry	228
Stained Glass Windows	230
Tournament	233
Weaving	234
Wizards	235
Medieval Activities for Young Adults	239

Section

5.

Clip Art	
Clip Art	249

Section

6.

Resources	
Unusual Print and Non-Print Resources	273
Professional Bibliography	274
Evaluation Form, 1995 Okla. Summer Reading Program	277



Artists

**MEET THE ARTIST
MICHAEL (MIKE) WIMMER**



BACKGROUND:

Mike Wimmer is a resident of Norman, Oklahoma where he lives with his wife Carmelita and his children, Elijah, age 8 and Lauren, age 3. His studio, "I Do Art", is now located at the airport, but will soon be relocated in the new studio area being built at his home.

Mike was born in Muskogee, Oklahoma, where he grew up, like most boys, playing hard, fighting sleep, reading comic books and dreaming.

EDUCATION:

With no formal education or training, he naively set out for studies at the University of Oklahoma, where the opportunity to work with Don Ivan Punchatz at his famous "Sketch Pad Studio", in Arlington, Texas, availed itself. While working as an apprentice for two and one half years, Mike learned the business end of illustrating while also learning the painting techniques and working methods of many of the local Dallas illustrators. He has taught at both the University of Oklahoma and Oklahoma City Community College.

ILLUSTRATIONS AND PAINTINGS:

- ~ paints the pictures commercial artists use in advertising campaigns
- ~ illustrates magazine stories, and book covers used by publishing houses
- ~ covers for three Southwestern Bell telephone books (1989-90 OKC)
- ~ post-production work for Disney's "The Rescuers Down Under"; poster for the film "Mr. Destiny" and the cassette and CD covers for "The Lion King"
- ~ paints biblical figures and scenes for church organizations
- ~ paints images of perfect American families for Chevrolet and Pedigree dog food.
- ~ children's books

FAMILY:

In the beginning of 1987, Mike's life and work took a dramatic change with the birth of his first child, a son named Elijah. With fatherhood came responsibility, but also, and more important to the artist, a fresh focus of reliving childhood. Through Eli's, and later his daughter Lauren's eyes, he was able to capture the innocence and exuberance of childhood. "Thanks to my children, I am able to capture a youthfulness and zest for life that had unconsciously evaporated with time."

Every year for their birthdays, Mike paints a portrait, not only a portrait of what they look like but of who they are and their interest at that age.

"Dragonslayer, painted for Elijah's fourth birthday, was inspired by a visit of Elijah to my studio where he is free to paint on his little easel, watch cartoons, read from my collection of books, dress up in one of my many costumes, or play with one of the swords in my collection. I had given Eli a little wooden sword and he loved it. He would take it with him everywhere, he even slept with it. And on this day, he had it with him while we were both quietly painting and listening to Mozart playing in the background. While unknown to me, he discovered a cricket that had crawled into the studio. He ever so stealthily picked up his sword and...whack! Chopped the poor cricket to pieces. I wrote about this incident in the diary that my wife and I had kept since his birth, and with it drew a little cartoon of Eli fighting this giant cricket. And this event inspired the paintings of Eli defending his castle against the dreaded dragon, not a real dragon, but to a boy, an imaginary dragon can be just as real.

I truly hope that these paintings bring as much pleasure to you as they have brought to me. And through them, the child in each of us may continue to grow and flourish."

CHILDREN'S BOOKS ILLUSTRATED:

- 1987 - Seven Silly Circles. Pam Conrad. Harper. ISBN: 0-06-021333-7.
- 1988 - Staying Nine. Pam Conrad. Harper & Row. ISBN: 0-06-021319-1.
- 1990 - Train Song. Diane Siebert. Thomas Y. Crowell. ISBN: 0-690-04728-2.
*NCSS/CBS Notable Children's Trade Book in the field of social studies and Red Book Best Book, 1990.
*Scenes from the Norman Train Depot.
- 1991 - Flight: The Journey of Charles Lindberg. Robert Burleigh. Philomel. ISBN: 0-399-22272-3.
*Winner of the Orbis Picture Award for Outstanding Nonfiction for Children.
- 1991 - Bully for You Teddy Roosevelt. Jean Fritz. G.P. Putnam's, NY. ISBN: 0-399-21769-x.
- 1994 - All the Places to Love. Patricia MacLachlan. G.P. Putnam's, NY. ISBN: 0-06-021098-2.
*Children in the book are Eli and Lauren Wimmer.

MEET GRAPHIC DESIGN ARTIST ELIZABETH MULLER



Elizabeth Lewis Muller is a multifaceted artist with experience in an unusual span of endeavors. She brings to her graphic design the kinesthetic awareness of a modern dancer, the theatrical flair of a choreographer and lighting designer and the pizzazz of a pyrotechnician. (She's the one shooting off the fireworks at the Blazer's games!)

Elizabeth has a strong commitment to seeing the arts included in every facet of the community. She says, "I sincerely believe in the power of the arts to reach, to teach, to heal. Through dance, music, drama, literature and visual art, learning becomes a vital and real experience. The arts engender communication and understanding on levels which are too often ignored in our society. They are not an optional frill...they are essential."

A native of Mississippi Delta country, Elizabeth graduated cum laude from Mississippi State College for Women (now Mississippi University for Women) with a degree in Elementary and Special Education. After teaching in Tucson and Las Vegas, she moved to San Francisco and spent three years as a modern dancer before embarking on yet another career - motherhood. The Mullers moved to Oklahoma in 1977 courtesy of Kerr-McGee, and except for a 3 year stint in Gillette, Wyoming, have been here ever since.

In 1986, Elizabeth began taking classes at the University of Central Oklahoma, ostensibly to get a master's degree and return to teaching. Somehow she got sidetracked into the art department. (It has something to do with illustrating the children's stories she had been writing...) That diversion became a second undergraduate degree, this one in Visual Arts and Design, and a business which she calls **Eliza**en DESIGNS.

Elizabeth (still known by some as Betty) lives on an acreage north of Edmond with her husband, Toby, two teen-aged sons, Max and Ben, and a mini-menagerie. The loft of her horse barn has magically been transformed into a studio where she can be found at all hours of the day and night creating logos, brochures, newsletters, posters...and Summer Reading Programs.



Planning

INTRODUCTION

Welcome to the 1995 Oklahoma Summer Reading Program. Our theme "Knights Alive In '95" will take you and the children in your community on a medieval adventure.

Knowing that summer is the time when public libraries really shine, we have gone all out to offer you program ideas, activities and materials.

We have prepared this manual to help you in planning activities that will enhance and enrich library services to all children in your area.

Whether you are new to children's programming or an old pro, we hope you will use the manual as a scheduling guide and as a springboard for ideas of your own.

You know your community best, so you will know best which activities will work in your library. Likewise, you alone can measure the success of your summer program.

The ideas presented are designed to be flexible -- expand and adapt them to suit your patrons' needs.

The manual is organized in six parts:

- I. Meet the Artists
- II. Planning
- III. Performers
- IV. Programs
- V. Clip Art
- VI. Resources and Evaluation Form

The target audience for the Summer Reading Program is children ages six through twelve. Programs provided are adaptable for pre-schoolers and young adults.

Please feel free to use the forms provided in this manual to plan and evaluate your program, or design your own.

Let us know how your summer goes! We need to know what works and what doesn't, so that we can continue to improve our summer reading programs year after year!

Happy Questing,



Donna Norvell, Compiler and Editor
Children's Services Consultant
Oklahoma Department of Libraries

THE 1995 PROMOTIONAL MATERIALS

MANUAL - Ideas from the manual for all sorts of activities, displays and reading programs can be used to let our children know that very special things happen when they "get under the cover of a book."

POSTER - A poster is always a good way to catch the public's eye. Attach your library's specific information - dates, locations etc. at the bottom. Post in the library, schools, stores, etc. as early as possible to advertise the program. Posters also make good door prizes at the end-of-summer party.

BOOKMARK/CHARACTER CARDS - Eight medieval characters comprise eight different bookmarks. The Michael Wimmer-drawings of queen, king, knight, lady, jester, troubador, archer and alchemist feature young people in those roles. Each will have a short explanation of that person's function in the society of that era. The bookmarks will be black and white so the children can add their own colors.

CERTIFICATES - The reading certificate will be separate this year. It is in the form of a proclamation and will be printed on parchment like paper. It can be used either at the end of summer as an award for completion or given out after the first book is read (or any specified number of books are read) as a note of participation in the program.

CLIP ART - The clip art in the manual can be used to decorate flyers, handouts, posters, banners, and bookmarks, as well as letters to parents, teachers, schools, etc.

CASTLE READING LOG - The *Knights Alive in '95* reading log is in the shape of a castle. Furthermore, it will be die-cut and scored so that it can be punched out and folded creating a stand alone structure for imaginative play. Some of the Michael Wimmer-drawn characters which can be cut out and folded to stand will be included in each log. Lines for recording books read will fill the inside.

BASIC GUIDELINES

The "Knight's Alive in '95" manual is offered as a basic guide introducing you to new programs.

Let your imagination soar as you begin preparing for your summer program. Whether you plan, promote, and execute all facets of the program yourself, work with other library and system personnel, or rely heavily on volunteer assistance, the manual has something for you.

You need to organize carefully, paying attention to detail and making decisions about the overall effect of your program and how you will publicize it.

FLEXIBILITY

Flexibility - is your key to a summer reading program that is rewarding for the children of your community.

Keep rules simple to provide for greater participation by all children.

Provide programs that will bring youngsters into the library and encourage them to see it as an exciting place to visit again and again.

Allow the children to register at any time during the summer.

"Better late than never" is an appropriate maxim for our purposes; it is never too late for a child to discover the library.

There are no losers in the Summer Reading Program. All children who participate in the program should feel like winners.

Participation, not competition, is what counts.

PROGRAM DECISIONS

Summer programs can be structured in various ways; much depends on your community and your philosophy.

UNSTRUCTURED PROGRAMS

You may choose to provide loosely organized activities, with few restrictions, for children of all ages. This type of program usually has no reading contracts or official registration. Achievement certificates are awarded for a minimal number of books read or time spent reading. This approach can be less time-consuming for the understaffed library. Even more important, it can be more appealing to poor or hesitant readers and to children who are not entirely comfortable in the library setting. **Unstructured programs** provide a change from school-year patterns for all children. The success of this type of program can, however, be difficult to evaluate in any terms other than attendance.

FORMALLY STRUCTURED

More formally structured programs offer activities for specific age groups and require preregistration. Usually the librarian sets a minimum number of books to be read or a minimum time to be spent reading in order to get an achievement award or to be eligible for various prizes awarded as incentives. Children may have reading contracts with the librarian and be required to give a brief oral report on each book read. This approach allows the librarian to focus on particular age groups to be more involved with individual children, and to assess the progress of children who participate. Care must be taken, however, not to exclude certain children; for example, the poor reader, the noncompetitive child, the handicapped child, or the child who will be able to come for only part of the summer.

PRIMARY GOAL

Either type of program, or one designed somewhere between the two, can be successful. **A primary goal should be to allow enough flexibility so that all children who want to can participate.** Each child should read at his or her own pace and reading level. While you want to encourage children to read good books, each child should be free to choose books from a variety of levels.

PLANNING/CHECKLIST - 1995

Use this checklist as you plan your summer program!!

SCHEDULING

- ~ Determine what age group(s) you want to attract to summer activities.
- ~ Decide on the day of the week to hold programs, and determine the length of programs. Consider what day school ends and what other events in town may conflict with library programming.
- ~ Decide when official registration for the program will begin and end.
- ~ Find out the deadlines for community newspapers, church bulletins, other newsletters, and radio and television stations. Ask if the local paper will be willing to run the puzzle series provided in the program section of the manual.
- ~ Decide when you will visit schools and make necessary arrangements. Consider making a videotape to use in classrooms as an introduction to your "Knights Alive in '95" program if you will not be able to visit in person.
- ~ Decide when you will put up posters or flyers in the community.
- ~ Determine which days you will have special activities: speakers, performers, films, and so on. Book them early; cooperate with other libraries in your system.
- ~ Make sure everyone on your library's staff is aware of the summer program's schedule and special attractions.
- ~ Plan some special events (January/February/March/April/May) to raise funds to help support your summer program.
- ~ Plan a budget (see following page).

BUDGET PLANNING

BUDGET:

Check the budget. To supplement what you have, make a list of organizations and businesses that are good prospects for donating money, supplies, advertising space, printing and other services.

SUPPLIES:

Take inventory of your library's collection. Your children's collection may be small, but it's sure to contain many titles perfect for this year's Summer Reading Program. Remember there's always interlibrary loan or the possibility of borrowing from your local school library/media center.

Stock your supply closet. Decide what supplies the library will provide, and what supplies volunteers and others in the community will provide. Solicit "Beautiful Junk" from members of the community. This project promises at least two bonuses:

- (1) children will see the value of recycling usable materials; and,
- (2) by using recycled materials, the library will be able to have more, less expensive, programs of all kinds.

Volunteers and library staff will need to organize and store the "beautiful junk" collection periodically -- otherwise, the tasks will turn into a monumental chore! Organizing might include such tasks as stacking open egg cartons inside one another, fastening them together with string or rubber bands, and storing them in boxes or storage rooms.

Make all Kinds of Lists:

- ~ local video stores - films that would fit into your programs
- ~ special events
- ~ bulletin board and exhibit themes
- ~ supplies you'll need for various projects
- ~ people - all sorts of people you can call on for assistance

USING VOLUNTEERS

Volunteers are unpaid staff members. They give their time and energy to an organization or institution to conduct certain services or provide certain programs.

In addition to expanding the size of the staff, volunteers also bring a fresh approach, different experiences and perspectives, and a variety of talents. There is another major benefit of using volunteers: community relations is greatly enhanced by the personal involvement of people in the community.

Following are guidelines which will contribute to the success of your volunteer program.

1. Basic to the success of a volunteer program are prior planning and approval on the part of the staff and the governing body of the library.
2. All the principles and good practices that relate to sound personnel management, such as planning, training, evaluation and development, must be applied to volunteers. Training, in this case, should include discussion of characteristics, needs and abilities of children.
3. Planning for the use of library volunteers must include clarification of their status regarding such items as compensation for work-related injuries, insurance coverage when operating a library vehicle, and related benefits.
4. Library volunteers may have work-related expenses, which are to be paid or reimbursed by the library. The library's policies and procedures regarding such expenses should be established and made known to the volunteer before library service begins.
5. Volunteers should not supplant or displace established staff positions.

6. Recognition and appreciation of every volunteer and of all voluntary services are imperative. As volunteers receive no salary, other forms of appreciation and recognition are essential.
7. Volunteers should be assigned to meaningful work, which makes use of their talents, experience, training, and interests.
8. Volunteers should be assigned to those jobs that they feel competent to do and for which they have been trained.
9. Volunteer assignments should generally be for specific time periods to enable the library and volunteer to review, evaluate and reassign duties as may be needed.
10. There should be a staff coordinator of volunteers in medium or large libraries.
11. Continued orientation and training is essential for volunteers to keep them informed of procedures, policies, etc., just as is the continued training of paid staff members.
12. The staff should have training about the use of volunteers and should share responsibility for the success of the volunteer program.
13. Written, detailed job descriptions for volunteers are necessary to define the limits of their responsibilities and let them know just what is expected of them.
14. Realistic scheduling of volunteers is essential. This may mean some overlapping or duplication of the personnel schedule to cover emergencies and absences.
15. Programs and services must be planned bearing in mind the possible termination or unavailability of volunteer help.

EXAMPLES OF WORK WHICH VOLUNTEERS MIGHT DO FOR YOU AS PART OF YOUR SUMMER PROGRAM:

1. Make themselves available to read aloud to children on a one-to-one basis during certain hours each week.
2. Make themselves available to teach a special skill or discuss a special hobby on a one-to-one basis during certain hours each week.
3. Operate any equipment needed for programming, allowing the librarian/presenter to make smoother introductions and transitions to the program.
4. Make deliveries to home-bound children, thus including them in the "club".
5. Share skills, knowledge, or personal experiences with children in a special program.
6. Create publicity materials and/or distribute them in the community.
7. Work at the circulation desk while the librarian prepares for or conducts programs.
8. Set up exhibits.
9. Community experts in child development may be used as volunteers to train volunteers.

COMMUNITY INVOLVEMENT AND COOPERATION

As mentioned previously, volunteers are an excellent way of involving the community with your library. In addition to other tasks, there may be people in your community who have special talents or expertise which they would be willing to share with children through library programs. Musical programs or craft demonstrations are standard examples of this. No one knows the wonderful personal resources in your community better than you do. Be imaginative and bold in incorporating these resources in your "Knights Alive in '95" summer!

**"KNIGHTS ALIVE IN '95"
VOLUNTEER INFORMATION**

This summer, Oklahoma children will explore the Middle Ages during the statewide summer reading program. As they join the "Knights Alive in '95", they, and our library program, need your support.

We will welcome your assistance to make our summer program better than ever. Whether you can spin a yarn or help in another, behind-the-scenes way, we hope you'll support the library this summer!

Special skills and interests we're looking for this year are listed on the back of this sheet. However, if your expertise is in a field or subject not listed, that doesn't mean you're not needed. Let us hear from you anyway! So that we may call on you for the sort of assistance you feel best qualified to give, please complete the form below.

Name

Address

City

Zip

Telephone

Ways I can help with Summer Reading Club activities this summer:

Times I am available (days and hours): _____

I am unable to donate time, but will be happy to lend a hand by:

I can help by collecting "beautiful junk" (craft materials) for art activities.

A CHECKLIST OF "BEAUTIFUL JUNK"

Styrofoam materials

- ~ packing materials
- ~ trays from meat market (washed)
- ~ balls

Boxes, cans, other containers

- ~ egg cartons
- ~ shoe, oatmeal boxes
- ~ large facial tissue boxes
- ~ metal "band-aid" containers
- ~ coffee, cocoa cans with lids
- ~ margarine "tubs" with lids
- ~ plastic medicine containers, labels removed
- ~ plastic jugs

Old clothing

- ~ shoes
- ~ hats
- ~ scarves
- ~ evening dresses
- ~ sleeves from old sweaters and knitted shirts (great for making glove puppets)
- ~ handbags

Miscellaneous

- ~ jar lids
- ~ tops from spray cans
- ~ computer cards
- ~ scraps of leather
- ~ popsicle sticks
- ~ plastic or wooden spoons
- ~ scraps of tile, linoleum
- ~ pull tabs from soft drink cans
- ~ paper plates
- ~ shells
- ~ feathers
- ~ seeds, rice, beans, peas
- ~ kite string
- ~ tubes (paper towel, etc.)

SETTING GOALS AND OBJECTIVES

More and more of you are discovering that setting goals and objectives is a worthwhile exercise, even though the discipline is a difficult one. Knowing what you intend to do allows you to plan better. When the program is over, you can determine whether or not you did what you intended. This is a big help in the evaluation process.

A few examples of goals and objectives are suggested below. Identify those that are appropriate for your library, revise them or develop others which will reflect your community's needs. Note that GOALS are general statements of purpose and OBJECTIVES develop from a goal and are specific and measurable.

Examples:

The summer reading program will:

Goal 1: Encourage children to read during the summer and stimulate regular use of the library.

Objectives: A. Twenty-five (25) new borrowers will register for cards during the month of June.
B. The number of children meeting requirements for Certificates will increase by 5% over 1994.

Goal 2: Encourage children to read more widely from all areas of the library collection.

Objectives: A. Overall circulation of children's books will increase 5% over 1994.
B. Two subject bibliographies will be prepared and distributed.

Goal 3: Foster cooperation between community agencies and the library.

Objectives: A. Three community groups, including the schools, will publicize the program.
B. Two community agencies will co-sponsor group programs.
C. Two child-care facilities will bring children to the library regularly or will receive regular visits from library staff or volunteers.

SCHEDULING

- * Decide on the day(s) of the week and time(s) of the day when programs will be presented for the varying age groups which you plan to include in the "KNIGHTS ALIVE IN '95."

Sample program schedule:

Mondays
2:00 - 3:00 p.m.
program for
children of
school age

Tuesdays
10:00 - 10:40 a.m.
preschool storytime

Wednesdays
2:00 - 3:00
program for
children of
school age

- * Consider holidays (July 4th) and other events in town that may conflict with library programming.
- * Determine the dates that school ends in the spring and begins in the fall. On that basis, decide when your program's Registration and Finale should take place.
- * Establish dates you will visit schools to promote the program and make arrangements with school officials.
- * Determine when and where you will put posters in the schools and/or in the community.
- * Find out the print deadlines for local school newspapers, community newspapers, church bulletins, and newsletters. Determine deadlines at radio and/or TV stations for Public Service Announcements.
- * Decide on which of your regularly scheduled program days you will have special activities or presentations: performers, films, and so forth. Book them as early as possible.
- * Inform the rest of the library staff about the schedule for the "Knights Alive in '95".
- * You will want to keep a careful record of your program schedule and plans. A copy of a master calendar for this purpose is provided on the following page. Duplicate/then add months and dates.

PROGRAM PLANNER

1. Program: _____

Target Audience: _____ Preregistration: _____

Date: _____ Day: _____ Time: _____

Staff Organizer: _____

2. Speaker/Performer: _____ Cost: _____
(Name)

(Agency)

(Address)

Phone: _____ Confirmed: _____ Reminder Call: _____

Thank You/Payment Sent _____

3. Publicity:

Publicity Handouts (attach samples): _____

News Release

a)	before program	date	_____
b)	follow up article	date	_____

4. Library Materials Needed:

Films _____

Books _____

Records	_____	_____
	_____	_____
Kits	_____	_____
	_____	_____
Display Materials	_____	_____
	_____	_____
Other	_____	_____
	_____	_____

Craft Supplies Needed: (List) _____

Sample Made	# of samples	_____
	where stored	_____
Patterns Made	# of pieces	_____
	where stored	_____
Make Ahead		_____

5. Area Set Up: Equipment

1. _____

2. _____

Chairs _____

Other _____

6. Refreshments:

What? How Much? Pick Up Where? By? Funded By? Reimbursement? _____

7. Staffing:	Staff	_____	Assignments	_____
	Volunteers	_____	Assignments	_____
		_____		_____
		_____		_____

8. Emergency Program: _____

9. Other:

_____	_____
_____	_____
_____	_____
_____	_____

THE CALENDAR

Write these schedules and events on your calendar as soon as possible.

1. How many weeks will your summer reading program run?
2. What day will you clear school visits with the principal (and librarians) of each school?
3. When does school end?
4. What are the other events in town? (pool opens, camp begins, vacation bible school dates, little league play-offs - list all the special events that are attractive to your audience).
5. When will registration for the Summer Reading Program begin? End?
6. What are the print deadlines for local school newsletters? community newspapers? church bulletins? community or civic club newsletters?
7. When will you put up flyers in the schools? In the community?
8. What days will you have special activities? Book them early!!
9. Will there be a special opening event? Closing celebration?
10. What are the dates for the Summer Reading Program Workshops?

When you have developed your calendar and finalized as many of the summer reading program dates as possible, publicize them in your opening announcements. Be sure everyone knows about the events happening in the library so other activities won't be scheduled that will compete with the library. It's a good idea to include a list of activities in newspaper publicity throughout the summer to remind other program planners of your schedule.

PROGRAM PLANNING CALENDARS

**The next 4 pages are
blank calendar forms -
remove them and add
month/dates. Duplicate
as needed.**

30

Knights Alive In '95

Summer Reading Program ~ Oklahoma Department of Libraries

Saturday	Friday	Thursday	Wednesday	Tuesday	Monday	Sunday

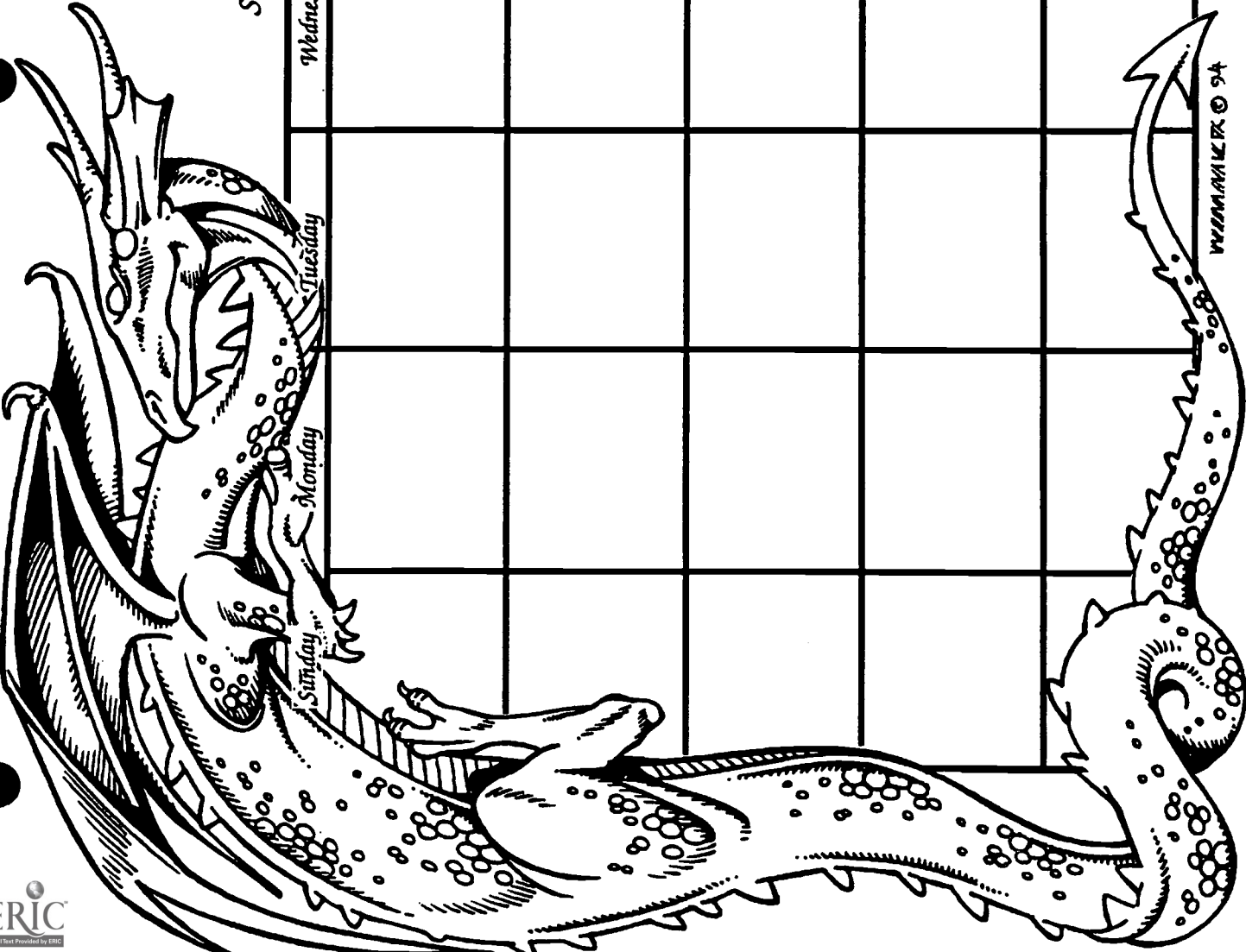

WILMAMARK © 94

Knights Alive In '95

Summer Reading Program ~ Oklahoma Department of Libraries

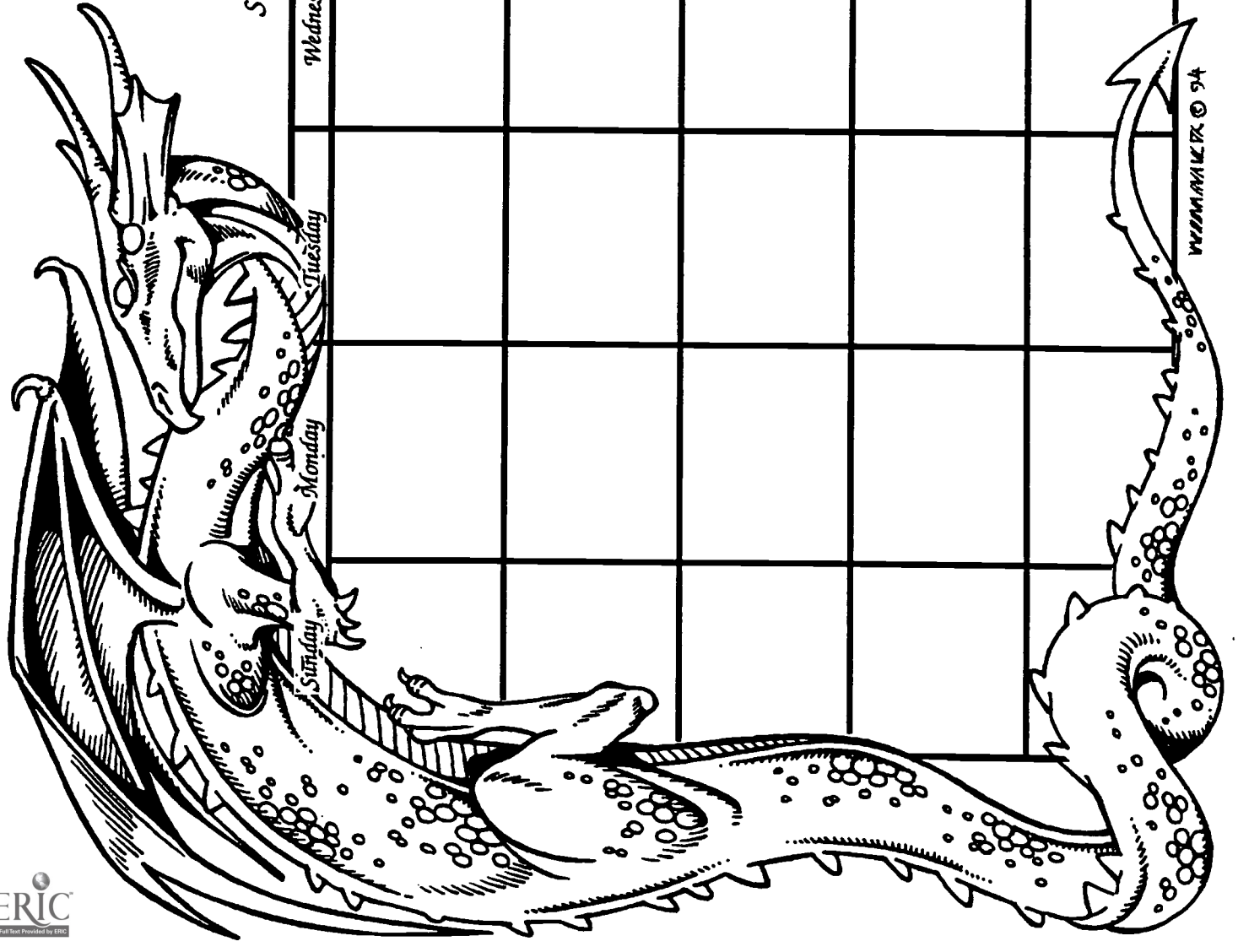

	Sunday	Monday	Tuesday	Wednesday	Thursday	Friday	Saturday

Knights Alive In '95

Summer Reading Program ~ Oklahoma Department of Libraries

Saturday	Friday	Thursday	Wednesday	Tuesday	Monday	Sunday

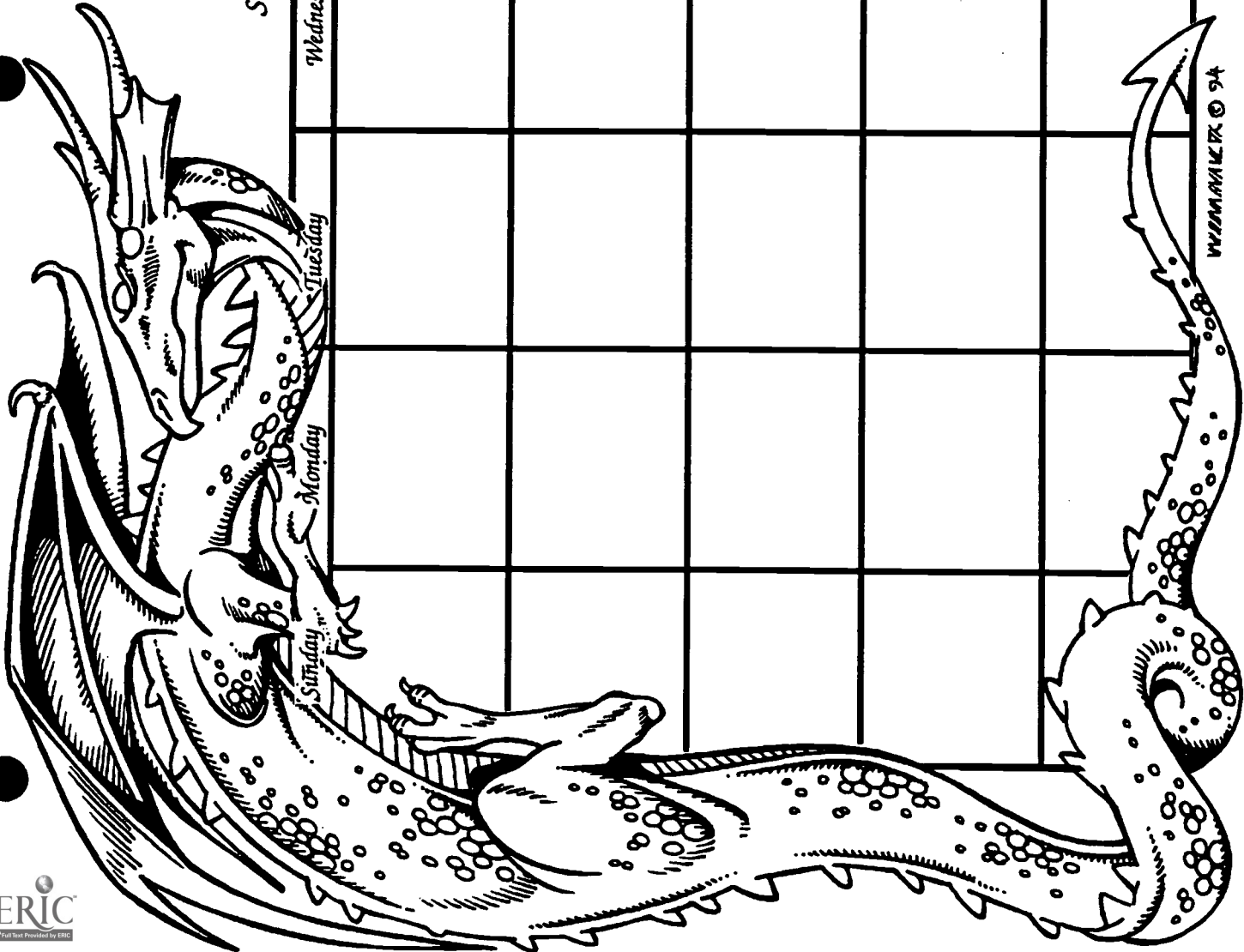

WIMMANKER © 94

Knights Alive In '95

Summer Reading Program ~ Oklahoma Department of Libraries

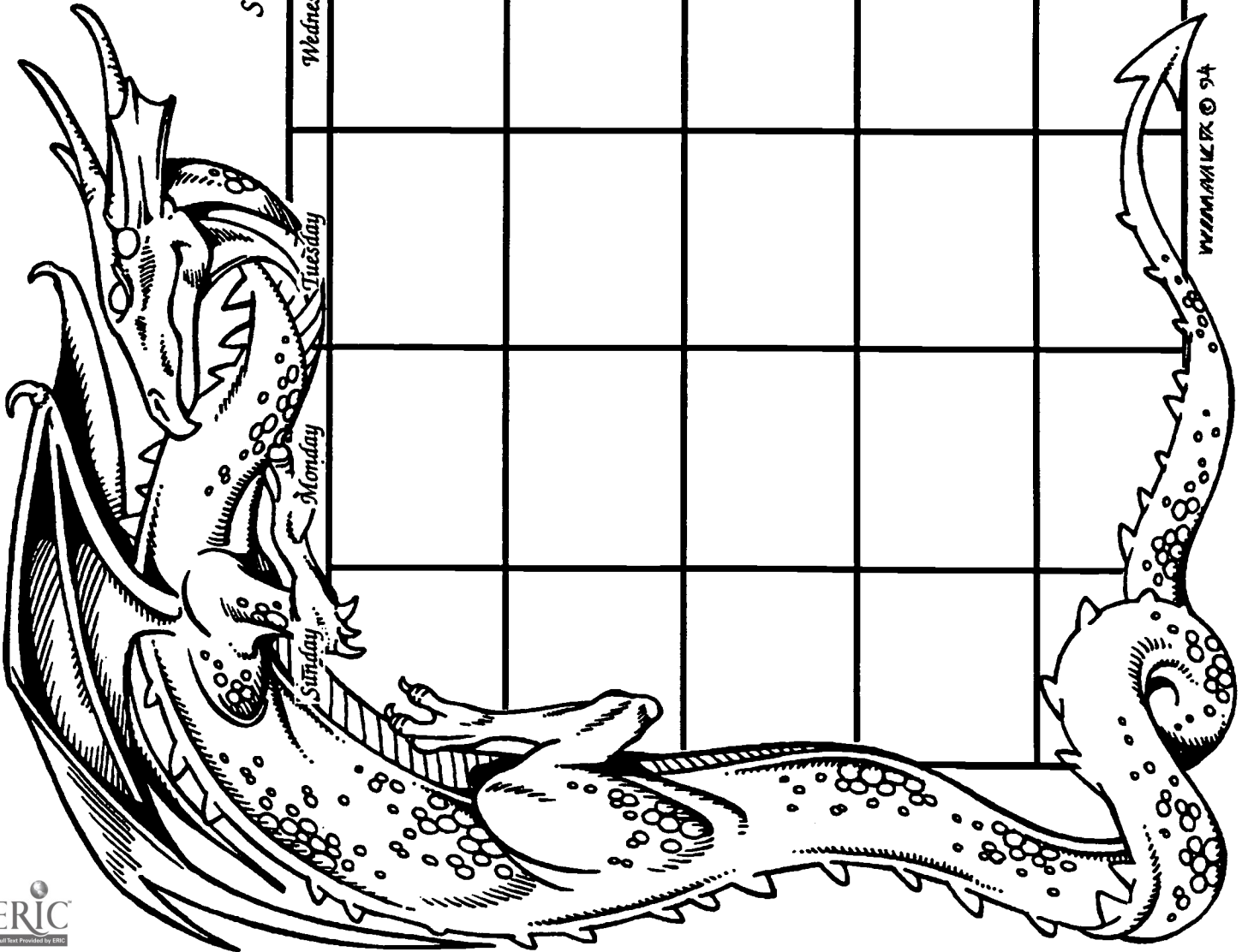

Saturday	Friday	Thursday	Wednesday	Tuesday	Monday	Sunday

WINTER © 94



PROGRAM REGISTRATION FORMS

**The next 5 pages are
blank program registration
forms. Remove them for use.
Duplicate more as needed.**

Knights Alive In '95

Program Registration

Date: _____

Time: _____

Place: _____



WANDA KIRK © 94

Child's Name	Parent's Name	Phone

Knights Alive In '95

Program Registration

Date: _____

Time: _____

Place: _____



VWJ/MH/VK © 94

Child's Name	Parent's Name	Phone

Knights Alive In '95

Program Registration

Date: _____

Time: _____

Place: _____



WIMMERS © 94

Child's Name	Parent's Name	Phone

Knights Alive In '95

Program Registration

Date: _____

Time: _____

Place: _____



WILLMARKE © 94

Child's Name	Parent's Name	Phone





REGISTRATION FORM

I would like to join the "Knights Alive in '95" by joining the 1995 Summer Reading Program.

NAME

ADDRESS

I will be in grade ____ in September, 1995.

REGISTRATION FORM

I would like to join the "Knights Alive in '95" by joining the 1995 Summer Reading Program.

NAME

ADDRESS

I will be in grade ____ in September, 1995.



PROMOTION IN SCHOOLS

School teachers and principals who want students to return in the fall with their reading skills intact or improved are natural allies in attracting children to the Summer Reading Program. Enlist their support with promotion in as many ways as possible.

One of the best ways to promote the program (and one which makes for good school/public library relations) is to arrange to visit all of the elementary schools in your service area. Contact the appropriate administrative offices and ask permission to promote the summer library program in each elementary school. Schedule visits during the last few weeks of classes -- but not so late as to conflict with end of school activities.

Various approaches have been used by libraries:

1. Arrange to visit each class in each elementary school.
2. Arrange to visit with all the combined classes at a school assembly.
3. Place promotional posters in prominent spots in the elementary schools and prepare an announcement to be read over the P.A. systems. Though school personnel may not always agree to your year-end visits, they may agree to distribute conveniently packaged bookmarks to the classrooms, or to send appropriate flyers home with the children.
4. Videotape your message for use in schools and/or public television channels.

Individual classroom visits are an ideal method of promoting your summer programs. In order to cover each class, your visit will need to be short (probably no longer than 5 minutes). Make the visit as interesting as possible. This is a good time to distribute your bookmarks and fliers.

Individual classroom visits are quite difficult in areas that cover a large number of schools. Many of these schools, however, hold regular assemblies of the entire student body. Check to see if it's possible for you to be scheduled to speak during an assembly. Some schools might be willing to give you enough time for something special, such as a short skit or a puppet show.

Another alternative is to video tape your message. Many school media centers have video equipment, and the media specialist may be willing to help you by taping your message and making it available to classes. When making a video, try to be "visually" interesting. If you only have time enough for a short message, be sure to wear a costume (wizard's hat, crown, etc.) and use props. If you're allowed more time, tell a story, do a puppet show, or perform a skit that would relate to the medieval theme. Many school systems use a public television channel (cable system) and can air a Summer Library Program promotional tape at regular intervals. This is another great way to reach the school children in your area!

PUBLIC SERVICE ANNOUNCEMENTS FOR RADIO

Public Service Announcements are generally 20, 30 or 60 seconds long. They are brief announcements of IMMEDIATE interest. Some stations will have a DJ read your written PSA onto a tape. However, many stations would rather use your voice. A quick call to the station manager will let you know which they want. If they want your voice and you have never recorded for radio, tell them. They will be glad to show you the ropes.

OTHER THINGS TO DO WITH YOUR PSAs

The public service announcements available as part of the summer reading materials can be used for a lot more than radio spots.

They make a great introduction for school visits to promote your summer reading program. Since they have definite styles, you could carry them over into your school visit.

Ask the school to play the PSA during the announcements the day before your school visit to promote summer reading. If circumstances don't permit you to visit each class, perhaps the PSA could be played over the loud speaker system followed by a brief announcement about your library's programs. Give your flyers or bookmarks to the teachers and ask that they be distributed at this time.

If you are going to meetings to ask for community or corporate support for your summer reading program, or just to make them aware of your library's special summer activities, take the PSA along and let it begin your presentation. This could also be effective when promoting children's services to the various boards involved in library planning and funding.

If there are any community events in the spring where the library has a booth, have the PSA ready to promote your summer reading program to passersby.

Remember, PSAs are great for radio promotion, but you can use them for much more.

PUBLIC SERVICE ANNOUNCEMENTS

Contact: Your name
Address
Phone

Date:

Ten Second Announcement

"Knights Alive In '95" is the theme hundreds of children will explore when they come to _____ Library this summer! Take part in all the exciting activities.

Call _____ or visit the library in person.

Twenty Second Announcement

"Knights Alive in '95" is the theme of _____ Library's summer program which will celebrate with medieval feasts, jousting knights and tournaments. Meet kings & queens and fight daring dragons. Contests, reading incentives, storytimes, and more super starred events will fill the summer. Children from _____ to _____ (ages or grades) are invited to register by calling the library at _____. Questions concerning this announcement may be directed to _____ (your name, name of library, phone number). Meet "Knights Alive in '95" at your library this summer.

PRESS RELEASES

Local papers are glad to receive information on your programs. Often the paper will reprint exactly what you submit. Other times they will rewrite your press release. Best of all, they may send a reporter or photographer to "cover" your event as news. No matter how you get into the paper, you need to provide the editor with the initial basic information.

If your library doesn't have a standard press release form, devise one. It will help your press contacts recognize the library news and will make it easier for you to remember to include all necessary information. Don't forget:

- * The 5 W's: WHO, WHAT, WHEN, WHERE, and WHY must come in the first paragraph.
- * Don't save the best for last! Put the most important information in the first paragraph. Newspapers cut to fit space by chopping from the bottom.
- * Below is a chart called the "inverted pyramid" that graphically portrays how your release should be organized.
- * Newspapers love to run expressive black and white photos that are of interest to the community. Include them with your release. They should be black and white only and 8" x 10" or 5" x 7". They should be clear, not too dark, and not too "busy."

WHO WHAT WHEN

WHERE WHY

**IMPORTANT
DETAILS**

**MISC.
INFO**

The Sperry and Hutchinson Company—1983 Quotations permitted if credited to PUBLICITY HANDBOOK, copyright by the Sperry and Hutchinson Company.

PRESS RELEASE GUIDELINES

1. Include the following crucial information at the top of the first page:

The full name of your library

Complete address including zip code

A contact name and phone number

Date article is to be released ("For release Oct. 22" or "Immediately")

Always be consistent about where you list this information. Releases will be easily recognizable, and the editor won't have to waste time looking for a name or phone number. With release dates, "Immediately" means the editor can use the information any time, which makes it very convenient. However, you can always specify exactly when the information you have provided is to be released.

2. Press releases should be typed double-spaced on 8 1/2" x 11" paper.
3. Leave a margin wide enough for the editor to make notes.
4. Use letterhead or stationery with your library logo.
5. If you include a headline, capitalize it. "SUMMER READING PROGRAM STARTS JUNE 16." A headline should always be capitalized to set it apart. Don't be surprised if the actual press release headline is not used. They seldom are.
6. If your release is more than one page, type "over" or "more" at the bottom of the first page and center a 2 at the top of the second page.
7. Releases should not exceed two pages in length. Anything over two pages is long enough to be a feature article. Features are completely different.
8. Finish each page with a complete paragraph. Do not split paragraphs. This makes it easier for an editor to lift a paragraph.
9. Always include the following closing tailored for your library:
_____ Public Library is located at _____. Library hours are _____
_____ Monday through Saturday and _____ on Sunday. For more
information, call the library at _____.
10. Press releases should be mailed to media 10 days to two weeks in advance of your activities.

11. Get to know someone on the staff of your local paper(s). Having a personal contact will make it more likely your information gets printed in a timely manner.
12. A good basic press release can provide information to other media besides your local paper. Also mail press releases to:
 - ~ Radio stations (send along with a couple of PSAs)
 - ~ TV Stations (send with or without PSAs)
 - ~ Church and Civic Bulletins
 - ~ Community Arts Center
 - ~ Shopper News
 - ~ Any other "Community Calendar" or "Events" listing

SAMPLE NEWS RELEASE (for beginning of program)

From: Library
Street
City, State, Zip

Date:
Contact Person:
Phone:

Release Date:

Join "KNIGHTS ALIVE IN '95" AT THE LIBRARY

FOR IMMEDIATE RELEASE

_____ Library announces the 1994 Summer Reading Program. Children will visit a medieval world of jousts, tournaments and dragons beginning _____ (starting date). The program runs until _____ (closing date) for children from _____ through _____ (age or grades). Activities this year include (provide a few specifics here such as contests, storytime series, guest entertainers).

Preregistration begins on _____ (or preregistration is not necessary). There is no charge for the program.

Summer hours will be _____. Questions concerning details should be directed to _____ (your name and telephone number).

Approximately 35,000 Oklahoma children participated last year in this annual statewide program which is sponsored by the Oklahoma Department of Libraries and (name of your library) to encourage year-round reading.

SAMPLE NEWS RELEASE (for ending of program)

(A selection of photographs of "Knights Alive In '95" activities would be appropriate here. Remember to acknowledge local contributors to the summer program too.)

From:	Library	Date:	Current Date
	Street	Contact:	Name
	City/State/Zip		Phone

Release Date:

MEDIEVAL THEME BRINGS KIDS TO LIBRARY

More than _____ children, ages ____ to ____, enjoyed a medieval world of knights, dragons and castles this summer. The _____ Library used books, puzzles, games, films, and performers to entertain, enlighten and inform those who attended its 1995 Summer Reading Program series.

"Knights Alive In '95" was the program theme. Brightly colored bookmarks and other giveaways were offered to attract children to programs aimed at keeping them reading over the summer. It worked; more than _____ children's books were borrowed from the library during June, July, and August.

Librarian _____ reports that children's programming will continue this fall with (indicate plans and dates).

TIPS FOR PARENTS



JOIN THE "KNIGHTS ALIVE IN '95" AND SHARE STORIES, READ EXCITING BOOKS AND HAVE EXCITING ADVENTURES

Your involvement with your child this summer can make all the difference in whether the library program is an exciting adventure or a frustrating experience. Here are some ideas to help you make this summer's library program all that it can and should be for your child.

- * **HELP YOUR CHILD SET A REALISTIC BOOK GOAL** for the summer. Try to encourage a goal that will challenge the child, but not one so ambitious that book enjoyment becomes a chore or successful participation too great a test.
- * **ESTABLISH A REGULAR TIME FOR READING** in your home for all members of the family.
- * **OFFER TO SHARE STORIES** at bedtime or as dinner conversation.
- * **ENCOURAGE YOUR CHILD TO SHARE FAVORITE STORIES** with you.
- * **SHOW GENUINE INTEREST** in the stories or programs your child discovers during the summer.
- * **APPRECIATE ALL BOOKS THE CHILD SELECTS**, even the ones that look "too easy." Summer is a time for fun, after all, and you can always guide your child to a more challenging book the next time you visit the library.
- * **READ TO YOUR CHILD.** Even if children are able to read themselves, they still enjoy hearing good stories read to them.
- * **READ YOURSELF!** And make sure your child knows you enjoy reading. There is nothing like a good role model.
- * **HELP YOUR CHILD ATTEND** special library programs. Many children appreciate going with friends. Your child might like to be able to invite a friend or two to attend also.

KNIGHTLY NEWS
A Summer Newspaper Program
Sponsored by the Oklahoma Newspaper Foundation



During the summer, a representative from the local newspaper (publisher, manager, editor, reporter, etc.) can be invited to make a 10-15 minute presentation about newspapers. (See "5 Easy Steps" on the following page.) After the talk, the children can make their own versions of the newspaper -- **KNIGHTLY NEWS**

The short talk before the exercise should include the following points:

- * The importance of reading includes newspaper stories also
- * Jobs at newspapers are fun for people who like to read and write
- * What goes in the paper and who decides
- * Advertising in the paper is paid by stores and businesses in town
- * Pictures in the paper are very important to tell the story

Now it's up to the children to make their own newspapers -- from stories, photos and ads they cut out of their local paper.

1. Give materials to the children at this point -- not before. Materials should include:
 - * Their community newspaper
 - * Blank Knightly News with printed masthead
 - * Scissors
 - * Tape or a glue stick
 - * Black pen
2. Tell the children to do the first step together:
Everyone is to write their own name after the word *editor* at the top of the newspaper.
3. Give the children 20 minutes to make their newspapers.
4. Show and tell.
5. Children take their newspapers home or you can display them at the library. Each newspaper can also include one book review written by the children that features one of the selections from your summer reading list.

*** 5 EASY STEPS FOR NEWSPAPERS ***

KNIGHTLY NEWS
A Summer Newspaper Program
Sponsored by the Oklahoma Newspaper Foundation

1. Get together with your local librarian.
2. Provide a special program for young readers on newspapers.
3. Publicize the program in your newspaper -- before and after.
4. Arrange for someone from your newspaper to make a 10-15 minute presentation and for a newspaper photographer to stop by.
5. Bring copies of your newspaper for the program.

That's all there is to it!

For additional information about this and other programs
contact:

The Oklahoma Newspaper Foundation
3601 N. Lincoln
Oklahoma City, Oklahoma 73105

*Librarians: Show this page to your local publisher or Newspaper in Education Manager at the paper.

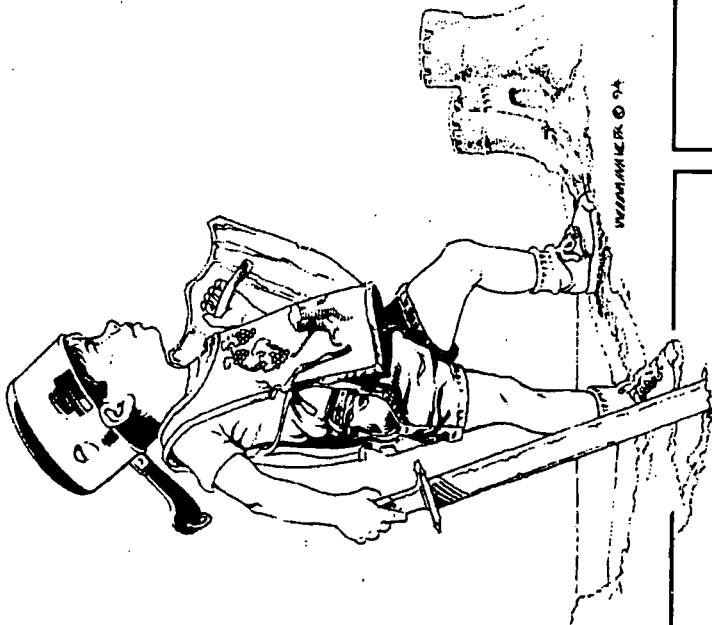

the Mightily News

1995 Oklahoma Summer Reading Program

Editor: _____

57

58

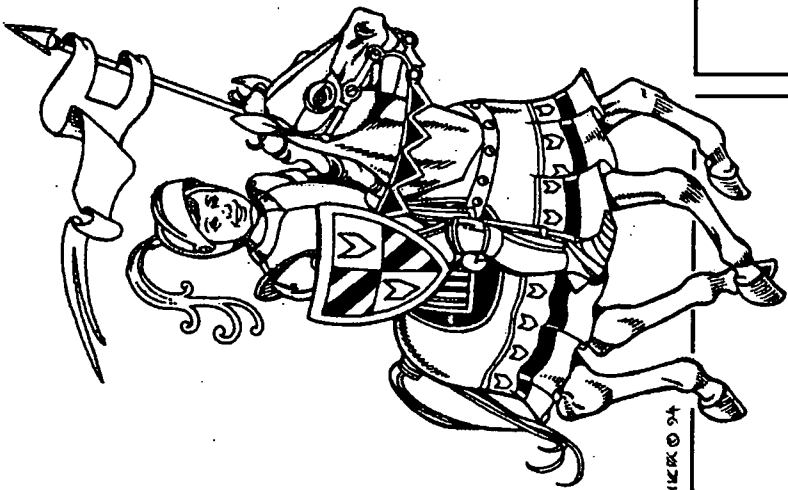

WIZARDK © 94

the Mighty News

1995 Oklahoma Summer Reading Program

Editor: _____

59

60

the Knightly News

1995 Oklahoma Summer Reading Program





Performers

PROGRAM RESOURCES

Many individuals and groups are available for programming. Included are those who charge a fee (ranging from minimal to quite expensive) and those who present at no cost to the library. This section lists individuals or groups who are available. All of these performers were contacted by letter and responded with the information included. You will note many of them have "keyed" their performance or presentation to our "medieval" theme.

In addition to providing actual programs in your library, this list may spur your thinking of other individuals and groups within your community who also may provide or contribute to your program.

If you have presenters at your library who would be interested in being included in the 1996 manual, please duplicate the form on page 67 for them.

Note: Please Fill out an evaluation form on each presenter and return it to Donna Norvell. Form on page 69.

NEWS FLASH

Mike Wimmer - Artist for the 1995 Summer Reading Program Promotional Materials will be available for program presentations.

**Fee: \$200.00 for a 1 hour presentation and book signings.
\$680.00 for full day.**

Call Mike to make arrangements. (405) 329-0478.

PERFORMANCE/PRESENTER PREPARATIONS

Performers and Presenters: Make arrangements early for any storytellers, puppeteers, or other performing artists you would like to have present a program. Inquire as to fees, arrangements for paying fees, and necessary physical arrangements. Get a commitment in writing. Others may present without a charge (see the Presenter's list beginning on the next page). These, too, need to be booked considerably in advance of the event. Send a reminder to your performer or presenter several days ahead of the performance date.

***Note:** Be sure and call to check references.

Physical Arrangements: Plan for rooms, parking lots, and other facilities which must be reserved. Obtain or locate speaking systems or other equipment which may be required in your programming. Check equipment to see that it is in good working order and that adequate bulbs, extension cords, etc., are available.

Staff: Review your staff schedule to determine that adequate staff will be available to accommodate the needs of your usual library patrons plus the needs presented by your programming schedule. Arrange for volunteers to provide additional staff, as needed.

Budget: For each program, assess the costs you will incur. Take into consideration the items listed below. Identify those materials or services that can be donated; confirm those donations. Then calculate the remaining costs for the entire summer.

Performer's fees	Overhead costs (space rental, etc.)
Rental of films, equipment	Additional paid staff, if required
Supplies	Miscellaneous

If no line item has been provided in your library's budget to cover expenses of the Summer Reading Program for Children, you may need to consider some fundraising efforts.

After carefully planning and budgeting your program, you may wish to request the funds or a portion thereof from local businesses or civic organizations. Those libraries which have a Friends of the Library group often find them to be a willing contributor. Funds for certain programs are available from the State Arts Council on a given schedule. You may want to study the "Directory of Oklahoma Foundations" for additional sources of possible funding. PLEASE NOTE: Most foundations and other funding organizations have a funding cycle, and it requires many months advance notice to be included in that cycle. It is very likely that present inquiries should address 1996 program needs.

1995 SUMMER PROGRAM PRESENTERS

DIXIE BELCHER

Program Title: **Sir Gawain and the GreenKnight: A Retelling in Oklahoma**

Route 4 Box 141 AA, Sapulpa, OK 74066; (918) 224-7844

Presentation: Hand and Rod puppets behind portable stage. Presents updated revision of the story of the good knight being tested on his honor by the King and Queen (a melodrama version). Sound effects and music add to the atmosphere of the Arthurian era. After performance children are invited to reenact the story through use of everyday items and additional costuming.

Fee: \$65.00 per performance. Could do 2 per day

Length: 45 minutes

Travel Range: 1st preference Creek County. Next Tulsa County or within 30 to 40 minute travel range.

References: Judy Mushrush, Children's Librarian, Sapulpa Public Library; (918) 224-5624; Julie Tattershall, Dir. Hellen Theater, Dept of Parks & Recreation, Tulsa; (918) 746-5065

ALBERT BOSTICK

Program Title: **Shakespeare's Heroes, Kings, Clowns and Villains**

2403 NW 39th Expressway Suite 200, Oklahoma City, OK 73112; (405) 521-8040

Presentation: Three of Shakespeare's most popular plays cut to one-act length: Hamlet, Macbeth, Romeo and Juliet.

Fee: \$1,500.00 per production

Length: 45-60 minutes

Travel Range: Greater Oklahoma City, out of Oklahoma proper requires mileage charge

References: Phyllis Willis, Northeastern State University, Tahlequah, OK; (918) 456-5511

LIZA CRUZ or DIANA FROST

Program Title: **Dancing and Jousting in the Troubadours' Castle**

910 Woodlake, 1710 Stonewood, Norman, OK 73071; (405) 360-4484 or (405) 360-0595;

Presentation: Our program is storytelling which combines the arts of dance and music with the spoken word. We present "The Story of Ferdinand" by Muro Leaf and "Amazing Grace" by Mary Hoffman as troubadours inside the story castle. Ferdinand confronts the question of jousting in his comical and fun loving way. Grace dances through the ages and is successful in her own challenges. We involve the audience in movement and discussion combining the body and mind in discovering the excitement of reading.

Fee: \$100 - \$200

Length: 45-60 minutes (one hour setup)

Travel Range: Within 100 miles of Norman

References: Basha Hartley, Pioneer Library System, 225 North Webster Avenue, Norman, OK 73069-7133; (405) 321-1481; Mary Strassner, Bethany Public Library, 3510 North Mueller, Bethany, OK 73008; (405) 789-8363 ext. 235

JIM DICKSON

Program Title: **Program 1 - Double Talk** **Optional Program: Knights of the Sea**

PO Box 5001, Waco, TX 76708-5001; (817) 753-2970

Presentation: Program 1 - Ventriloquism using humor, some material on statewide theme. An encouragement to use the library, and a section on drug and alcohol abuse.

Optional Program - Video with live narration. Video shows the under water environment with the reef, fish, dolphins and sharks! Videos taken on scuba dives Jim has made in Cozumel, Mexico and the Bahamas.

Fee: \$100.00 per presentation

Length: 40-45 minutes

Travel Range: South of I-40 and East of I-35

References: Doris Stevenson, Broken Bow, (405) 584-2815; Nita Ross, McAlester, (918) 426-0930

TYE DODDS

Program Title: **Kitchen Contraptions A Chef Uses**

PO Box 775, Perkins, OK 74059; (405) 547-2177

Presentation: Kitchen utensils a chef uses to prepare food for consumers delight.

Fee: \$50.00 plus mileage

Length: 1 hour

Travel Range: Doesn't matter

References: Helen Marler, Librarian, (405) 547-5185

JOSH DRAKE

Program Title: **Sixteen Addresses**

1201 Canterbury, Altus, OK 73521; (405) 482-8094

Presentation: True stories of WWII, sixteen different addresses.

Fee: \$100 per day plus expenses

Length: 1 hour

Travel Range: Anywhere in the US

References: Dr. Roy Snow, Anadarko Schools, (405) 247-6605; Tom McKay, Wynnewood Middle School, (405) 665-4105; Wayne Hall, Blanchard Elementary School, (405) 485-3394; Dr. Madeline Long, Bethany Elementary School, (405) 789-6623; Dr. James Caster, Oklahoma Boys State Program, (405) 946-4197

GERALD EDMUNDSON

Program Title: **Reading is Magic!**

PO Box 2657, Denton, TX 76202; 1-800-482-4863

Presentation: Programs of classic magic, sleight-of-hand, audience participation for kids and the whole family. Skills with magic and sleight-of-hand are used as a medium to show that reading opens the door to life's most exciting secrets.

Fee: \$150.00 for one location, \$75.00 for a second performance, same location, sameday and expenses

Length: 40-45 minutes

Travel Range: Unlimited, but must be arranged on tour schedule...inquire.

References: Logan W Ragsdale, Irving Public Library System, (214) 721-4441; Liza Arredonds, Nicholson Memorial Library, (214) 205-2585; Susan Allison, Richardson Public Library, (214) 238-4000

REBEKAH EDWARDS

Program Title: **Knights in Shining Armor**

1402 SW 59th, #5226, Oklahoma City, OK 73119; (405) 686-0858 or (405) 732-6965

Presentation: Bring the OU Medieval Fair to your library! The company that brought you the Joust and Living Chess Board are now available to perform for the libraries of Oklahoma. A full cast of well armored and well armed performers present an educational and entertaining picture of the Middle Ages. A wide range of Characters, costumes, weapons, armor, props and decorations transform your library into a Feasting Hall where singing, dancing, storytelling and swordplay bring the Medieval Age to life. Emphasis is placed on children's books covering this time period.

Fee: \$200.00 negotiable

Length: 30 minutes negotiable

Travel Range: Negotiable

References: Desiree Webber, Moore Public Library, (405) 793-5100; Wanda Searcy, Noble Public Library, (405) 872-5713; Linda Lynn, Director of OU Medieval Fair, (405) 321-7227.

REBEKAH EDWARDS

Program Title: **Fairy Tales**

1402 SW 59th, #5226, Oklahoma City, OK 73119; (405) 686-0858

Presentation: With Medieval props, costumes and decor a storyteller and Kindergarten teacher bring the days of the Middle Ages to life. Emphasis is placed on 398.2 - the address of Magic!

Fee: \$35.00

Length: 30 minutes

Travel Range: Negotiable

References: Desiree Webber, Moore Public Library, (405) 793-5100; Brenda Foster, Codidge Elementary School, (405) 685-2777

SIDNEY GREATHOUSE

Program Title: **Storyteller**

1500 W Wilshire Blvd., Oklahoma City, OK 73116; (405) 848-7729

Presentation: 30 minutes to 1 hour storytelling, no props needed.

Fee: volunteer

Length: 30 minutes ideal but can go 1 hour

Travel Range: Oklahoma City metro plus Shawnee

References: Glenda Pitts, Shawnee Public Library, (405) 275-6353; Lee Jenkins, El Reno Carnegie Library, (405) 262-2409; Shirle0 McNully, Midwest City Library, (405) 732-4828

SKEETER HALL

Program Title: **Skeeter and "Friends"**

6621 NW 130, Oklahoma City, OK 73142; (405) 721-3453

Presentation: Delightful year-round programming for children and adults of all ages. Her ventriloquial presentations include humor and music and are assisted by a minimum of 2 or more of her 11 puppet friends. The programs introduce values and good morals in an educational, yet whimsical manner. Skeeter has entertained throughout Oklahoma and in surrounding states to literally thousands of children and adults. She also brings safety programs to children, incorporating puppeteering, music, and group interaction, to

provide children with the information and confidence they need to protect themselves against child sexual abuse. She has spoken to more than 31,000 children, teens, and adults on this subject alone.

Fee: \$80.00 (Oklahoma City); \$90.00 (Remote to Oklahoma City)

Length: 45 minutes

Travel Range: State of Oklahoma

References: Maurine Wright or Ann Aliotta, Edmond Library, (405) 341-9282; Sharon Nolan, Capitol Hill Library, (405) 634-6308; Debra Engel or Ann Harris, Norman Public Library, (405) 321-1481; Kathleen Thomas, Newcastle Public Library, (405) 387-5076

MONTY HARPER

Program Title: **Singer/Songwriter, Monty Harper**

909 N. Bellis, Stillwater, OK 74075; (405) 624-3805

Presentation: Monty's program consists of original, imaginative songs performed with acoustic guitar and plenty of audience participation. An emphasis is placed on reading for fun, and at least one song will pertain to the "Knights Alive" theme. State Arts Council funding is available for performances scheduled after July 1, 1995

Fee: \$125.00 plus travel if further than 75 miles

Length: 45 minutes

Travel Range: unlimited

References: Ronna Davis, Edmond Public Library, 10 S. Blvd., Edmond, OK 73013, (405) 372-3633; Renita Ediger, Beaver County Library, Box 579, Beaver, OK 73932, (405) 625-3076; Sue Busch, Stillwater Public Library, 206 W 6th, Stillwater, OK, (405) 372-3633

MARIE HARRIS

Program Title: **Marie Harris, Storyteller**

3605 NW 72nd, Oklahoma City, OK 73116, (405) 842-4800 or (405) 721-4431

Presentation: Traditional stories of Oklahoma. Original stories of growing up for children as well as ghost or folk tales. Some Indian Folktales and many animal stories. Most stories are humorous with an audience age range from 5 to adult.

Fee: \$100.00 plus travel (negotiable)

Length: 30 minutes to 1 hour

Travel Range: Anywhere in state during summer months or on weekends

References: Peter Dolese, OKC Arts Council, Program Director, (405) 521-1426; Whit Edwards, Activities Director, Okla. Historical Society, (405) 521-2491; Amilia Turner, Programs Director, Kingfisher Library, (405) 375-3384

WINONA HENDERSON or KABITCHA FEKE SEGO (WILL HILL)

Program Title: **"Legends From Our Fathers"**

PO Box 921, Tulsa, OK 74101-0921; (918) 747-1044 or 1-800-536-1044

Presentation: Enter a time of days gone by in a Native American Campsite setting. Hear storytelling by a troupe of Native American Indian actors, dancers, and a drummer. Come join our circle as we share stories of monsters, dragons, heroes, villains and talking animals, as well as language, song and dance. (Actors and dancers from Muscogee, Apache, Comanche and Lakota Nations)

Fee: \$750.00 plus travel expenses

Length: 1 hour (this performance is suitable for assembly setting before a large group)

Travel Range: Oklahoma

References: Pat Whelan, State Arts Council of Oklahoma, (405) 521-2931; Donna Henderson, Hilldale School, Muskogee, (918) 683-1191; Beth Crabtree, Olive School, (918) 352-9569

WINONA HENDERSON or KABITCHA FEKE SEGO (WILL HILL)

Program Title: "Legends From Our Fathers"

PO Box 921, Tulsa, OK 74101-0921; (918) 747-1044 or 1-800-536-1044

Presentation: Learn Indian language, song and dance. Come hear a tale of high adventure, stories with monsters, dragons, heroes, villains and talking animals, told by a full-blood, traditional Native American Indian.

Fee: \$100.00 plus travel (will try to work with budget, if possible)

Length: 45 minutes

Travel Range: Oklahoma

References: Shawnee Public Library, (405) 275-6353; Ruth Wiens or Children's Summer Program Department, (918) 596-7977; Leslie Langley, Buckley Public Library; Georgia Williams or Kay Goss, Tulsa Arts & Humanities Council, (918) 584-3333

DAVID HOLDER

Program Title: "Merlin's Apprentice"

5624 NW 37th, Oklahoma City, OK 73122, (405) 787-7288 or (405) 521-6436

Presentation: A combination of magic and storytelling based on the legend of Merlin the Wizard. It will include chemical magic of the Alchemist and a magic castle.

Fee: \$75.00 plus mileage

Length: 30-45 minutes

Travel Range: up to 75 mi., will travel further if more than one performance can be scheduled

References: Linda Staley, Seminole Public Library, (405) 382-4221; Glenda Pitts, Shawnee Public Library, (405) 275-6353

PEGGY KANEY

Program Title: Days of Knights and Dragons

608 S Wilson, Tahlequah, OK 74464 (918) 458-0811

Presentation: This one-woman show presents "Tillie", the scullery maid, who is only too willing to take a break from her duties to share the tales of her beloved "Tillingsworth Castle." Through the use of puppets, masks, and costumes, we meet the royal inhabitants, brave knights, fair maidens, and even a dastardly dragon.

Fee: \$50.00 for single performance, discount for 2nd show in same locale: Mileage 0.25 per mile

Length: 45-60 minutes, depending on needs of host

Travel Range: Northeast Oklahoma

References: Robert Finch, Librarian, Tahlequah Public Library; (918) 456-2581

WILLIAM MCCUTCHEN

Program Title: Birth of a Clown

Route 2, Box 485-A, Crescent, OK 73028; (405) 969-2750 or (405) 329-0222

Presentation: I show how I change myself into "Sniffs the Clown" and then have fun with skates and jump rope.

Fee: \$50.00 plus mileage

Length: 30-45 minutes (I can make it fit your schedule)

Travel Range: anywhere in the state of Oklahoma

References: Jerri Menz, Hobart Library, (405) 726-2535; Ann Brown, Lawton Library, (405) 581-3450; Karen Wilson, Miami Library, (918) 542-3064; Lisa Wells, Purcell Library, (405) 527-5546

SONDRA MCMILLON

Program Title: **Prudence, A Knight To Remember**

3000 Pershing Blvd, Oklahoma City, OK 73107; (405) 951-0000

Presentation: A fifty minute to one hour play dealing with Prudence, a lady in waiting who wants to be a knight. Her only ally is the magician's assistant who is trying to work his way up to head magician. When Sir Stuff is sent to do away with the dragon, he turns out to be a terrible coward, and Prudence, with the help from her magician friend, comes in and saves the day.

Fee: \$850.00 a show: multiple shows negotiable

Length: 50 minutes to 1 hour

Travel Range: anywhere in the state of Oklahoma

References: Debra Engel, Assistant Director, Pioneer Library System, (405) 321-1481; John Clinton, Norman Public Schools, (405) 366-5870

CHRISTOPHER MAIER or ELIZABETH MULLER

Program Title: **The Pied Piper of Stories**

P.O. Box 33232, Austin, TX 78764-0232; (512) 443-9194; or Edmond, OK 73034; (405) 341-4066

Presentation: The Pied Piper brings his powers to fascinate from the Gothic world into the present. Rather than leading rats to death, he leads children to a greater aliveness, out of their video stupor and into the wonders of story making! Performed in costume and with tunes on the tin whistle, writer-actor-storyteller Christopher Maier thrills children with their own imaginative powers as well as his.

Fee: \$150.00 to \$250.00. Fee is negotiable based on multiple shows and block booking.

Length: Flexible. Version from 30 min. to 50 min.

Travel Range: Statewide though based on block booking.

References: Cindy Hoke-Blackburn, (405) 524-2923 (Very Special Arts Oklahoma); Annette Pate, (405) 340-2840 (Arts Coordinator, Edmond Public Schools).

EMILEA MORING

Program Title: **Her Majesty's Wizard**

707 W Madison, Purcell, OK 73080; (405) 527-5723

Presentation: A college student finds a poem, written in runes, on a parchment. He deciphers and recites it, and is magically transported to medieval times. He teams with a dragon, a werewolf, a reformed witch, and a magic ball and works magic by reciting poetry. They rescue the princess, restore her kingdom, and crown her queen.

Fee: \$35.00 plus \$.25 roundtrip mileage. Purcell, Lexington school/library free

Length: 30 minutes to 1 hour (your choice)

Travel Range: up to 100 miles

References: Lisa Wells, Purcell Library, (405) 527-5546; Church of Christ, Ninth and Pierce, Purcell OK, 73030, (405) 527-3176

LYNN MORONEY

Program Title: "A Medieval Feast of Stories"

1944 NW 20th, Oklahoma City, OK; (405) 524-2152

Presentation: A story concert. Tales of the Middle Ages: will include German (popular Grimm tales); Celtic (Finn McCool & Ancient Irish Tales) and other European Folktales of the Middle Ages. This program will be mostly Arthurian Tales. I will tell stories from your 398.2 collection. We will sing and tell some medieval ballads.

Fee: \$100.00 each performance plus travel expenses if location is outside of metro Oklahoma City

Length: Will vary (depending on age of group). Approximately 50 minutes to 1 hour, but will be shorter if audience is young

Travel Range: will travel statewide, but will increase fee if there is long travel time. If traveling to small town, would like to: A. include evening performances for adult community, or B. writing workshop for young people and adults

References: Linda Levy, Metroplitan Library System, (405) 231-8650; Peter Dolese, Arts Council of OKC, 236-1426

JOHN PANSZE

Program Title: Merlin's Magic in '95

725 Willow Run, Yukon, OK 73099; (405) 354-2453

Presentation: Comedy magic with a Merlin costume.

Fee: \$150.00

Length: 30-40 minutes

Travel Range: Greater Oklahoma City Area on Wed-Thurs-Fri-Sat between 9:00 AM and 2:00 PM

References: Carolyn Craine "Silver Production" (405) 843-1889; Gary Owen (405) 840-2100; Seymour Davis (405) 943-1951; Allen Todd "Entertainment Unlimited" (405) 728-7005

SKY SHIVERS

Program Title: The Hard Times of a Pioneer Woman

Box 224, NE Queenstown Ave., Bartlesville, OK 74006; (918) 335-2888

Presentation: Program consists of several early day devices. Four different washing machines - a butter churn - flat irons - dresses - bonnets - aprons - courting rituals - life expectancy - and old time remedies that she gave her children are examples of subjects we talk about as members of the audience demonstrate the props and model the clothes. Humor - theatrics - hands on learning are all used to illustrate the wonder of books and to show that books are the windows to the world past, present, and future.

Fee: \$150.00 for a 1 hour presentation plus 0.25 a mile

Length: 1 hour

Travel Range: anywhere in the NE-SE or central part of Oklahoma

References: Ann Hamilton, (800) 522-8116; Debora Garfinkle, President of Tulsey Town Yarn Spinners, (918) 492-3707

STEPHEN SMITH

Program Title: Stories of Armor and Magic

5604 Norman Road, Oklahoma City, OK 73122, 1-800-34T-upper or (405) 721-5042

Presentation: Armed with 80 pounds of working armor, a hammered broadsword, and a baby dragon, Stephen is ready for any audience. One participant wears part of the armour as the group learns about the Feudal System. Then they learn how to protect their Castle, and finally, with the help of the baby Dragon, they learn the truth about Medieval Magic.

Fee: \$150.00 for the Oklahoma City or Tulsa Area (Mileage or travel fees will be determined for other sites or tours at the time of booking)

Length: 1 hour

Travel Range: the state of Oklahoma and beyond

References: Sue Bush, Stillwater, (405) 372-3633; Ann Harris, Norman, (405) 321-1481; Glenda Pitts, Shawnee, (405) 275-6353; Leslie Langley, Poteau, (918) 647-3833

STEPHEN SMITH

Program Title: Tupper The Clown presents Medieval Fools

5604 Norman Road, Oklahoma City, OK 73122; 1-800-34T-upper or (405) 721-5042

Presentation: In the Middle Ages, Fools, Jesters, Jongleurs, Jugglers, and other Clowns abounded. Tupper uses his balloon skills, magic, juggling, and a dragon puppet to bring the stories of these Medieval Performers to life

Fee: \$150.00 for the Oklahoma City or Tulsa Area (Mileage or travel fees will be determined for other sites or tours at the time of booking)

Length: 1 hour

Travel Range: the state of Oklahoma and beyond

References: Sue Bush, Stillwater, OK (405) 372-3633; Ann Harris, Norman, OK (405) 321-1481; Glenda Pitts, Shawnee, OK (405) 275-6353; Leslie Langley, Poteau, OK (918) 647-3833

STEPHEN SMITH

Program Title: Ben Franklin: An Autobiography

5604 Norman Road, Oklahoma City, OK 73122, 1-800-34T-upper or (405) 721-5042

Presentation: Stephen Smith becomes Ben Franklin, the candle maker's son who loved books. Ben tells his story as he recorded it for his son, in his autobiography. An exciting story about growing up, loving to read, learning to make books, rising to greatness and even starting libraries. You will hear stories about early America, the Revolutionary War and about his experiments with electricity. You might even get to see a shocking experiment at the Library.

Fee: \$150.00 for the Oklahoma City or Tulsa Area (Mileage or travel fees will be determined for other sites or tours at the time of booking)

Length: 1 hour

Travel Range: the state of Oklahoma and beyond

References: Sue Bush, Stillwater, (405) 372-3633; Ann Harris, Norman, (405) 321-1481; Glenda Pitts, Shawnee, (405) 275-6353; Leslie Langley, Poteau, (918) 647-3833

DAVID TITUS

Program Title: **Knights & DAZE**

P.O. Box 419, Cache, OK 73527; (405) 429-3140

Presentation: My broad repertoire allows me to tailor my storytelling to your particular week. Usually, I can relate story, song and activity to your needs. I draw heavily from the vast body of world folklore.

Fee: \$150.00 plus travel from Cache, OK (near Lawton)

Length: 50 minutes

Travel Range: Earth

References: Sue Brown, Lawton Public Library, (405) 581-3450; Janet Lee, Ada Public Library, (405) 436-8122; Jerri Menz, Hobart Public Library, (405) 726-2535

JAN VANSCHUYVER

Program Title: **Jan VanSchuyver, Storyteller and Puppeteer**

12315 Woodlawn, Westfork, AR 72774; (501) 643-2208

Presentation: Jan's presentation combines two performing arts--puppetry and storytelling. Her show begins with storytelling, making words leap off the printed page and into our hearts and minds. The age-appropriate stories will be chosen to reflect the theme "Knights Alive in '95". The stories are followed by the featured puppet play. Available puppet plays include: The Three Wishes (an English folktale about a mischievous fairy and the lessons to be learned from three wishes), Lizard's Song (a delightful self-esteem booster based on the book by George Shannon), and Shadow Stories (multicultural folktales performed with shadow puppets). Jan's performances delight children through sixth grade and community audiences.

Fee: \$185.00 plus travel. Discounts are available for block bookings. Call Jan to discuss possibilities.

Length: 1 hour; Travel Range: Varies, depending on number of bookings available in an area. Call Jan to discuss possibilities.

References: Sue Ann Ghormley, Henderson Public Library, PO Box 580, Westville, 74965; (918) 723-5002; Anne Harris, Norman Public Library, 225 N Webster, Norman, 73069; (405) 321-1481 ext. 130

JAN VANSCHUYVER

Program Title: **Puppetry and Storytelling**

12315 Woodlawn, Westfork, AR 72774; (501) 643-2208

Presentation: Jan's storytelling and puppetry performances present age-appropriate multicultural folktales that capture the imagination of the audience and allow it to soar. Her 10 years as a children's librarian and 20 years as a performer and teacher combine to create lively literature-based programs for library audiences of all ages. Programs on Summer Reading and other themes are available. Jan is the author of *Storytelling Made Easy with Puppets*, (Oryx Press, 1993).

Fee: \$150.00 plus travel. Call to discuss discounts for multiple bookings. Travel fees will be substantially reduced if I'm touring in your area.

Length: 1 hour

Travel Range: flexible

References: Anne Harris, Norman Public Library, (405) 321-1481; Sue Ghormley, John F Henderson Public Library, Westville, (918) 723-5002; O.J. Grosclaude, Stanley Tubbs Memorial Library, Sallisaw, (918) 775-4481; Louise Turner, Ft. Smith Library, Arkansas, (501) 783-4481; Mary Alice Kline, Rogers-Hough Memorial Library, Arkansas; (501) 621-1152

GAIL WILLIAMS

Program Title: "The Magic In Reading"

2009 Mill Creek Rd., Edmond, OK 73003; (405) 348-3300

Presentation: Comedy magic and illusion show with audience participation; Also involves the use of a rabbit which the children really enjoy.

Fee: \$75.00 plus travel expenses

Length: 1 hour

Travel Range: unlimited

References: Judy Johnson, Ponca City Library, (405) 767-0345; Lisa Wells, Purcell Public Library, (405) 527-5546; Basha Hartley, Norman Public Library, (405) 321-1481

BEA WRIGHT

Program Title: When the World was a Jumper Place

4838 S 74th East Avenue, #7, Tulsa, OK 74145, (918) 627-0098 or (918) 665-8100

Presentation: Fairy tales. Core of program is "The Reluctant Dragon."

Fee: \$25.00 plus \$.28 a mile travel expenses

Length: 45 minutes to 1 hour, as requested

Travel Range: preferably no more than 50 miles out of Tulsa

References: Debra Garfinkle, (918) 492-3707; Helen Hellerich, (918) 627-8731

JAN WOLFE

Program Title: "Dragon Stew"

1022 Claremont, Sherwood, AR 72116; (501) 834-9167

Presentation: Stir up stories of dragons from around the world with Jan Wolfe, puppeteer. "Inchkin" from Japan tells the tale of a tiny samurai warrior who battles a gigantic dragon. Find out what dragons eat in the African-American story "The Wide-Mouthed Frog". Shows present different types of hand puppets and encourage audience participation. Stage sets up in a 6' x 4' area and Jan provides her own sound system. Member of the Arkansas Art Council's Touring Artist Roster and the Arts-in-Education Roster. Member of Puppeteers of America. As an educator and former children's librarian, Jan's main goal is to involve children in the magic of reading through puppetry.

Fee: \$150.00 plus travel

Length: 45 minutes

Travel Range: Central, Northeast and Northwest Oklahoma

References: Ned Metcalf, Arkansas Arts Council, 1500 Tower Building, 323 Center Street, Little Rock, AR 72201, (501) 324-9154; Georgia Williams, Tulsa Arts and Humanities Council, Harwelden, 2210 S. Main, Tulsa, OK, (918) 584-3333

PROGRAM PRESENTER APPLICATION FORM 1996

(Please type or print)

Title of Program: _____

Contact Person: _____

Group or Professional Name: _____

Address: _____

City, State, Zip Code: _____

Telephone: () _____

Description of Presentation: _____

(use reverse side, if necessary)

Fee: _____

Length of Performance: _____

Travel Range: _____

References (include phone numbers): _____

Return form to:

DONNA NORVELL
PUBLIC LIBRARY CONSULTANT FOR CHILDREN'S SERVICES
OKLAHOMA DEPARTMENT OF LIBRARIES
200 N.E. 18TH STREET
OKLAHOMA CITY, OKLAHOMA 73105
1-800-522-8116, EXT. 263
FAX 1-800-397-8116

**1995 OKLAHOMA STATEWIDE READING PROGRAM
ENTERTAINER EVALUATION**

NAME OF ENTERTAINER _____

Please rate each item on a scale of 1-10 with 10 representing excellent. Feel free to add narrative comments.

LEVEL OF PROFESSIONALISM	1	2	3	4	5	6	7	8	9	10
PROGRAM CONCEPT/CONTENT	1	2	3	4	5	6	7	8	9	10
STYLE/PRESENTATION	1	2	3	4	5	6	7	8	9	10
PERSONALITY/ENTHUSIASM	1	2	3	4	5	6	7	8	9	10
RELATES WELL TO CHILDREN	1	2	3	4	5	6	7	8	9	10
INVOLVES AUDIENCE	1	2	3	4	5	6	7	8	9	10
HOLDS ATTENTION	1	2	3	4	5	6	7	8	9	10
VOICE QUALITY/ CHARACTERIZATIONS	1	2	3	4	5	6	7	8	9	10

DATE OF PERFORMANCE _____

SITE _____

WE RATE OVERALL PERFORMANCE:

EXCELLENT

GOOD

UNSATISFACTORY

COMMENTS: (Please be specific - continue on back if needed)

SEND TO: Donna Norvell, Consultant for Children's Services
Oklahoma Department of Libraries
200 N.E. 18th Street
OKC, OK 73105-3298
FAX 1-800-397-8116



DISPLAY AND PROMOTION IDEAS

Promote your "Knights Alive in '95" program with color and pageantry.

- ~ **Display Poster for signup:**
dress a mannequin as King Arthur, Lady Guinevere, etc.
- ~ **Dress as Heralds with trumpets:** to announce the SRP to classrooms ---
use suitable music.
- ~ **Have a signed proclamation:** from King Arthur inviting all worthy young
people who aspire to a seat at the reading-round table to come to the library.
- ~ **Design: "Tapestries and Banners"**
(the halls of medieval castles were hung with shimmering tapestries woven
to fit particular spaces). Get a wide roll of craft or butcher paper and use an
opaque projector to enlarge figures from the "clip art" section and have the
children add colors.
- ~ **The Great Hall:** set up a space in the children's area as the great hall of
Camelot. Cover a round table with a cloth. Drape an armchair with a cloth
for King Authors throne. Drape a fabric or paper canopy over his chair and
down to the floor, with two dowels suspended from the ceiling.
- ~ **Create a doorway to the kingdom:**
If you have a separate children's area, create a frame for the entrance with
stacked cardboard boxes painted to look like stones or covered with stone
or brick patterned Contac Paper. Create banners on wooden dowel sticks
and place between the tops of the towers. Place a red carpet through the
entry. Or ask a carpet store for several of their large cardboard rolls and
create turrets on either side.
- ~ **Turn your children's area into a castle:**
hang banners made of felt or other inexpensive fabric or paper from the
ceiling. Design shields for the ends of bookshelves. Stuffed or inflatable
unicorns or dragons can add a nice magical touch. Doorways and desks
can be turned into fortress walls with painted cardboard. Cardboard tubes
make wonderful turrets! If you have enough space you might even want to
create a moat with blue plastic drop sheets on the floor and a paper,
cardboard, tile or plastic "bridge" laid over the top to provide entrance to the
kingdom. Many crafts stores have plastic chains that can be used to
heighten the effect.
- ~ **Create a library banner contest:**
Using the instructions above, invite participants to design a shield that
represents the library. Make a large version of cloth to hang in a highly
visible location in the library, a mall or city hall! Invite the press to meet the
winner and view the results.

CLASS VISITS

- ~ **Dress as a medieval page** and carry a "Proclamation" to every classroom. Shout "Hear Ye, Hear Ye". Use a long plastic or cardboard tube painted gold to be carried to enhance the page costume.
- ~ **"Magician"** - use a crystal ball to predict the fun children will have during the Summer Reading Program.
- ~ **Build a castle** brick by brick (or stones) with the names of books read by the children during the program. The "castle" could be a plain cardboard box to start with, and the children can paste on a "brick" each time they read a book.
- ~ **Put a "Merlin" figure on the wall** and tack a star near his wand for each book read.
- ~ **Have a "Jester's Joke Board"** - putting up new jokes each week.
- ~ **Have an "enchanted forest"** by designing a mural, and let the children add their own creatures to a scene.
- ~ **Design cardboard figures** of a king, queen, wizard, knight, dragon, etc., that a child could stand behind and stick his/her head through. Parents could be encouraged to come and take their children's picture.

PROGRAMMING/HUMAN RESOURCES

Involve local experts to speak about medieval topics.

An ARCHER to demonstrate (outdoors!) safe use of the bow and arrow.

A FALCONER to describe training and hunting with these great birds of prey.

A FENCING INSTRUCTOR to discuss and demonstrate the fine art of fencing.

A JUGGLER to perform and possibly offer instruction as well.

A MAGICIAN to demonstrate and maybe even teach a few tricks.

A MUSICIAN who is skilled in playing the lute or harp to perform.

A SINGER to perform some of the traditional songs of the era.

A BLACKSMITH to describe how this craft was and is performed.

A STAINED GLASS ARTIST to describe and demonstrate how it is done.

OTHER CRAFTS PEOPLE skilled in:

Calligraphy

Candle making

Embroidery

Leatherwork

Weaving

Woodworking

SOCIETY FOR CREATIVE ANACHRONISM. This group usually offers members who are willing to share their skills in all of the above areas. In addition, the group has been known to stage entire tournaments, jousts, festivals or dances in libraries.

GRAND FINALE IDEAS

- ~ **PLAN A MEDIEVAL FAIR!** Plan an outdoors festival in a park, playground or other appropriate space. Call on the resources of the Society for Creative Anachronism or use your own creativity and the resources to plan a Medieval Fair, complete with jugglers, games, a May pole, food and strolling musicians. Encourage children to come in costume.

- ~ **PLAN A GRAND TOURNAMENT!** Offer safe versions of traditional tournament games like jousting, archery and fencing. Of course it is important to remember that every traditional tournament began with a Grand Proclamation celebrating the Knights in attendance, and ended with food, drink and music!

- ~ **HAVE A CASTLE PARTY!** Make princess hats out of paper cones decorated with glitter and tinsel and knights helmets from one-gallon milk or bleach bottles covered with tin foil. Provide white paper place mats and crayons for children to create their own banners, then use the place mats to serve refreshments.

- ~ **PLAN A LIBRARY SLEEPOVER** with films, games, snacks and parent chaperons. Make sure to include storytelling from some of the classic fairy tales from the Middle Ages. Children bring their own blankets and pillows. Make sure you have parent names and telephone numbers in case of emergencies and an arranged time for children to be picked up in the morning.

- ~ **PLAN A VOLUNTEERS APPRECIATION PARTY** for the day after school starts with refreshments and recognition of special volunteer contributions. Provide some tips for continuing family book enjoyment throughout the year, either through a live presentation or a film or video.

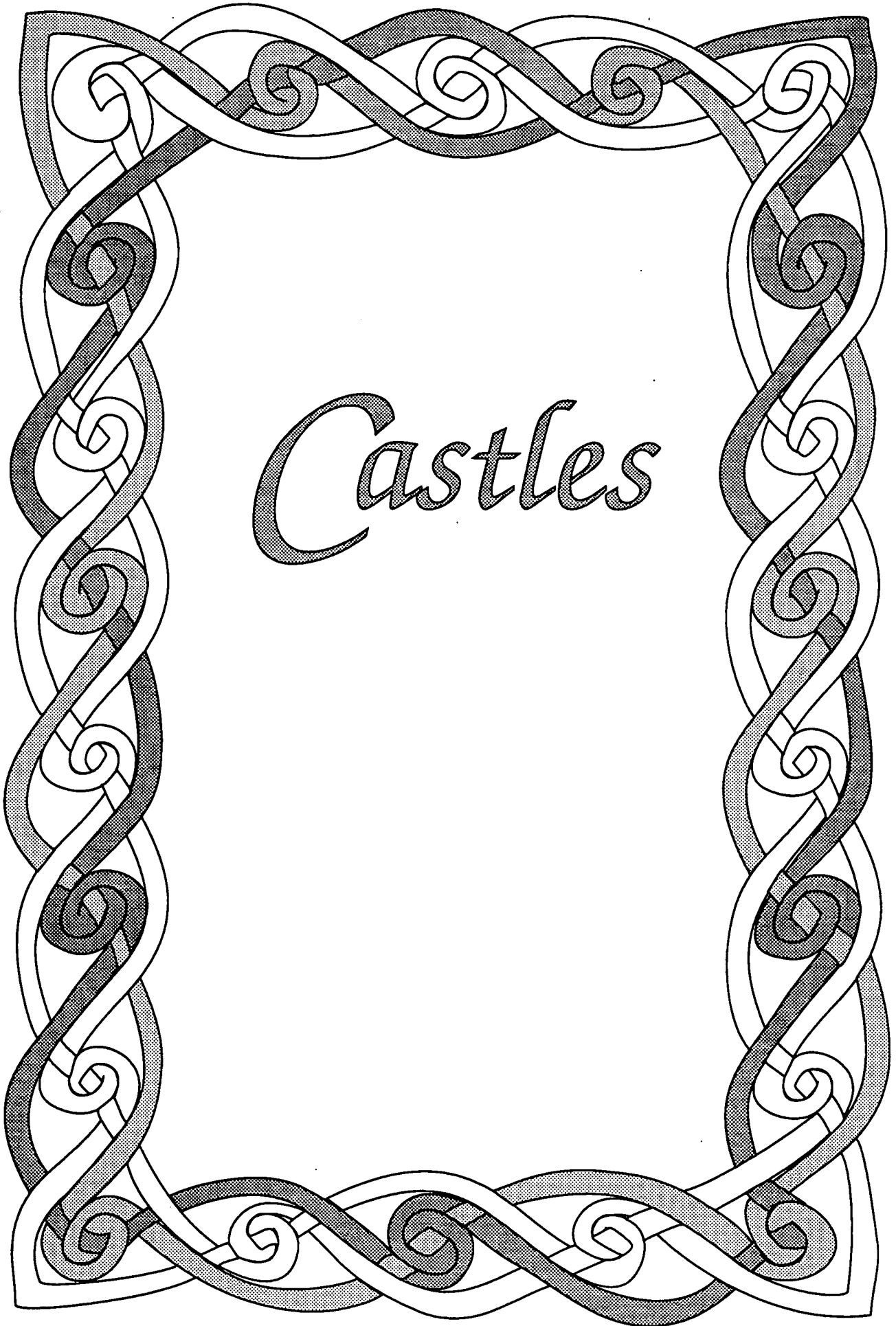

Castles

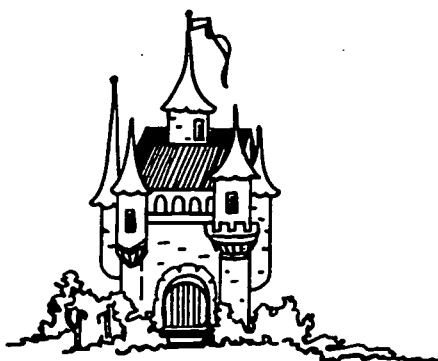

PROGRAM SKETCHES/CASTLES

Theme/Title: "My Home is my Castle"

Age Range: all ages (adapt to story shared)

Books/Stories: (See Castles Bibliography - page 91)

Share books about castles such as: The Truth About Castles by Gillian Clements or Castles by David Macaulay.

Activity:

Collect old jewels, clothing and fabric pieces for a Treasure Chest. (Keep an eye out at rummage sales for cheap costume jewelry and remnants of elegant fabrics such as brocade.) Talk to the children about the different people who lived in castles (royalty, knights, priests, blacksmiths, cooks, falconers, pages, artists, jugglers, musicians, etc.). Then let the children create their own costumes and decorations for their own medieval fashion show. (Also see various patterns in this manual.)

Media:

Show a video of David Macaulay's "Castle". The Public Broadcasting Service (PBS) program is available in two versions, the 58-minute original that combines colorful animation and live-action documentary sequences to tell the story of a 13th century Welsh castle, and a 29-minute shortened animated version.

(Note: This video is available from the Juvenile Review Collection, ODL.)

EXTENDERS: (Arts and Crafts)

- ~ Make a spool castle
- ~ Make a cookie jar castle
- ~ Make a sand castle
- ~ Make a drip castle
- ~ Make coal castles
- ~ Make a castle display
- ~ Make castle decorations (standards, etc.)

ACTIVITIES:

- ~ Castle fingerplays
- ~ Plan a castle party
- ~ Play castle games

HANDOUTS:

- ~ Castle puzzles
- ~ Castle Quest

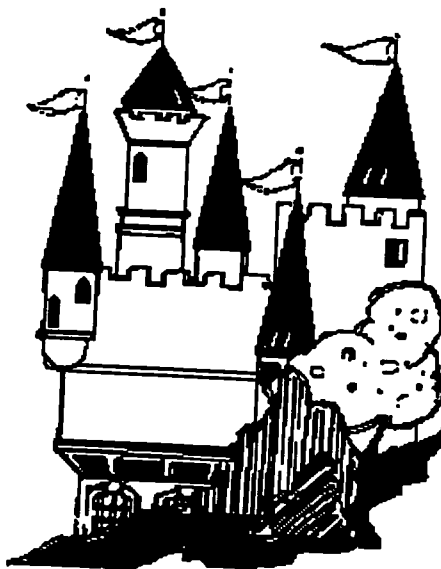

CASTLE/FINGER PLAYS

The Castle

This is the roof of the castle so tall	(Hold up hands, finger tips touching, hands spread apart at bottom)
These are the walls that are made of stone	(Extend hands parallel)
These are the windows that let in the light	(Make a square by extending index fingers up, thumbs out)
This is the door that shuts so tight	(Same as above)
What a good castle for us, one and all!	(Extend hands in front, parallel to each other)

CASTLE PARTY

Make princesses' hats by forming large cones out of 15 or 24 inch paper and decorating them with paint, glitter and tinsel. Make knights' helmets by using one-gallon milk or bleach bottles and covering them with tinfoil. Decorate the room with banners. Use a cardboard castle as a centerpiece. Have each child design a place mat in the form of a banner for use when refreshments are served.

CASTLE GAMES

Play "Bowl the Castle Over". Paint 6 one-quart milk cartons to look like castles. Set them up in bowling formation and use a rubber ball as a bowling ball. The person who bowls over the most castles wins.

Make a step-on playing board out of an old sheet by drawing a moat, drawbridge, passageways in a castle, dragon, etc., with felt tip markers or paint. The children can help to color it in. Make a spinner from a piece of cardboard and a plastic arrow to indicate how many moves the player may take and whether s/he moves forward or backward.

Play Cross the Moat. In a partially filled wading pool or tub, float toy fish or crocodiles. "Knights" must slay the creatures by scooping them up with a tropical fish net or slotted spoon.

Play Drawbridge. Players form two teams of Knights, separated by a line of masking tape on the floor. The Gatekeeper (adult supervisor) calls, "Drawbridge down!" One team then crosses the line to try and tag the other team. After 5 or 10 seconds the Gatekeeper calls, "Drawbridge up!" The attacking team must return to their side with all captured Knights. The game is repeated until all are captured. The teams then reverse roles.

CASTLE/ARTS AND CRAFTS

- ~ **MAKE A SAND CASTLE!** Brush off last summer's dish pans and spray bottles to make individual sand castles. Use various sizes of bottles and cups to make castle turrets, and use spoons to carve a moat around each castle. Resource: The Art and Industry of Sand Castles by Jan Adkins contains the history of sandcastles and architect's plans for their construction. Paper, \$9.95. ISBN 0-8027-7205-6.

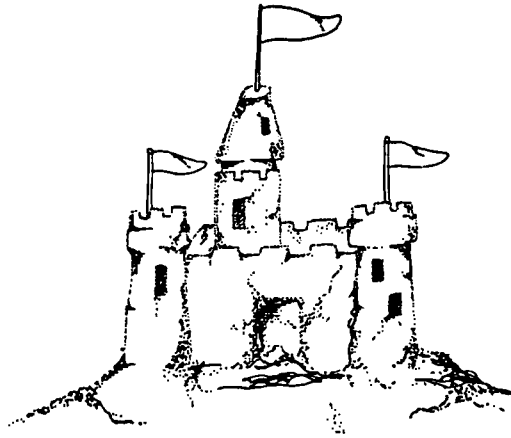

- ~ **MAKE DRIP CASTLES!** Younger children will enjoy this messy but fun variation. Scoop some sand into a bucket of water. Take a hand full of sand and water and let the sand drip off onto mounds of sand in each dish pan. Repeat until the desired effect is reached.
- ~ **MAKE COAL CASTLES!** These take time and are a bit messy, but lots of fun to watch! Give each child a shallow ceramic or glass dish. Provide pieces of coal, broken pieces of brick, porous rocks or sponges. (Warning! Do not use metal!) Instruct children to soak their coal in water, then arrange several in the dish. (Stacked pieces can make especially interesting shapes.) Stems of plastic flowers can also be added. Mix 4 tablespoons of water, 4 tablespoons of old-fashioned laundry bluing and 4 tablespoons of household ammonia in a glass cup. (The castle will not form properly unless you use OLD-FASHIONED bluing.) Pour the mixture over the wet rocks, making sure they are evenly dampened. Put a drop or two of various shades of food coloring and a drop or two of undiluted bluing at various spots for added color. Then sprinkle 4 tablespoons of salt over the chunks, sprinkling evenly. Within a matter of hours your castle will begin to grow. The entire process takes several days. After two days a fresh solution of 2 tablespoons of water and 2 tablespoons should be poured into the dish.

CASTLE/ARTS AND CRAFTS

Spool Castle

Paint wooden spools white or use white plastic ones. Arrange as desired and glue together. Fly bright paper flags from toothpick poles. Cut paper shapes that suggest windows and portals.

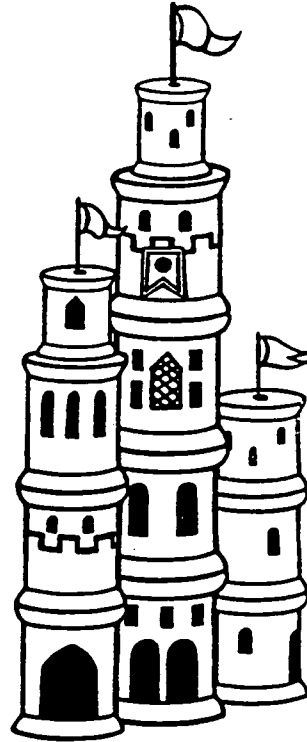

Cookie Jar Castle

Using an empty half-gallon milk carton, you can make an attractive holder for sweets. First, open the top of the carton completely; wash and dry it thoroughly. Use a 12 inch by 16 inch piece of heavy paper. Cut one 16 inch side to represent turrets at the top of the castle. Wrap the paper around the milk carton and tape it in place. With crayons or felt-tip markers, draw details. Fill your castle with cookies and other goodies.

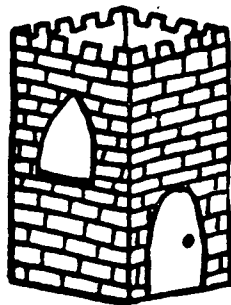

87

Reprinted from "Castle Quest", 1987 Louisiana.

CASTLE/DISPLAY

Child Size Castle

Materials Needed: Two refrigerator boxes and one range box.

Materials: Mat knife, pencil, yardstick, 6" x 24" piece of drawing paper (or wrapping paper or newspaper), scissors, quarter (25¢), table knife, sixteen 1½" paper fasteners, thumbtacks, string, glue, glue brush, four 8-foot lengths of rope or clothesline.

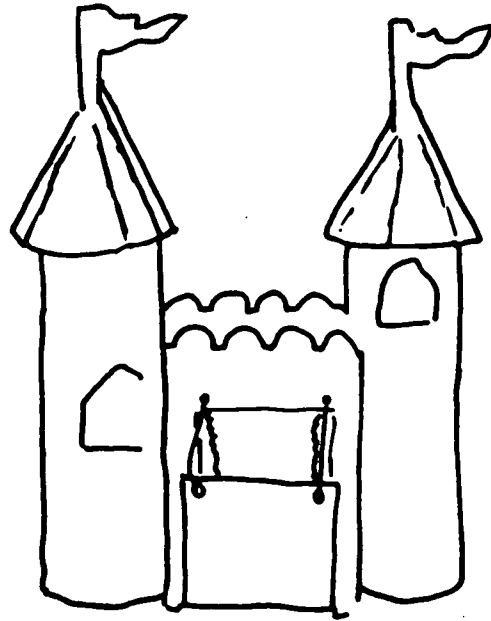

INSTRUCTIONS

1. To make the drawbridge section of the castle, cut the flaps from the top of the refrigerator boxes. Do not cut off the bottom flaps. Measure and draw a line as shown on all four sides of the box. Cut along the dotted line. Reserve the cut-away piece for pennants.
2. To make a pattern for the scallops at the top, fold the 6" by 24" piece of paper into thirds. On the folded paper, draw the shape as shown in the diagram. Cut along the dotted line. Unfold the pattern.
3. Hold or tape the pattern against the box as shown. Draw around the scallops. Use the pattern to draw scallops all the way around the box.

For the drawbridges, on each of two opposite sides of the box, draw a vertical center line. From this center line measure and draw a 24" x 36" rectangle. Using a quarter, draw small circles at the top corners of each drawbridge, and matching circles above, in the castle wall.

On each of the two other sides of the box, draw a 12" x 36" but coming to a point at the top 4" above the bottom edge of the box. Cut along all the dotted lines as shown.

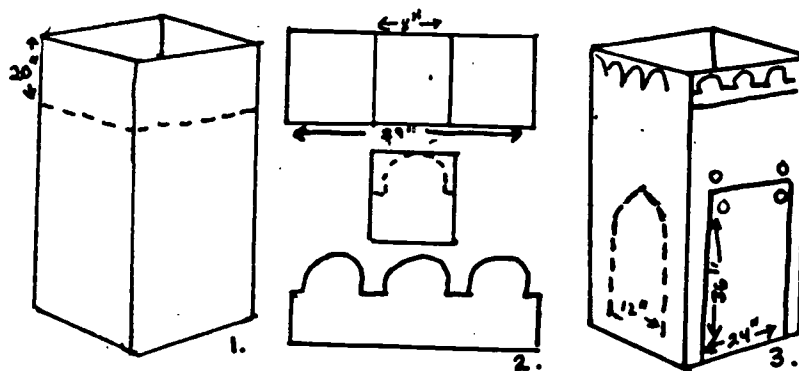

4. To make the bottom sections of the two towers, cut off the top and bottom flaps of the second refrigerator box. Cut the box in half along the dotted lines, as shown. Lay the two pieces out flat.
5. With a pencil and yardstick, divide each piece into equal vertical sections (approximately 6" wide) and draw lines as shown. Score and then fold along the lines. Bend the cardboard back and forth several times along the lines.
6. Measure and draw the door rectangle (12" x 36") in the center of each piece, 3" above the bottom edge as shown. Draw the large window rectangle (12" x 16") and the smaller window rectangle (10" x 12") as shown. Draw the curved lines. Cut along all the dotted lines.
7. Roll the two scored pieces into cylinders shapes. Overlap the edges 6" and punch three holes in the top, middle, and bottom of the overlap. Secure with the paper fasteners.
8. To make the two cone-shaped tower roofs, cut the range box in half along the dotted lines.
9. On each half draw a semicircle and flap. The radius of the semicircle should be approximately 29". Cut along the dotted lines and score and then fold along the solid lines.
10. Roll the two pieces into cone shapes. Punch holes in the overlapping flap and secure with paper fasteners. Cut a 3" slot in the top of the front of each one to hold the pennants.

11. To make the pennants, cut four 20" x 24" cardboard rectangles from the piece left over from the drawbridge box. Measure and draw four pennants as shown. Each square equals 4". Cut the pennants out and glue them together in twos for added strength.
12. To assemble the castle, punch holes in the sides of the drawbridge box and the two towers. Attach each of the towers to the drawbridge box with three paper fasteners. Put the cone roofs on the towers. (If you want to attach the roofs to the towers, punch holes in each side of the two cones and in the tower bottoms and thread with twine. Tie knots.) Insert the pennants in the roof slots. Thread the lengths of rope through the holes in the drawbridge section. Knot the ropes at both ends.

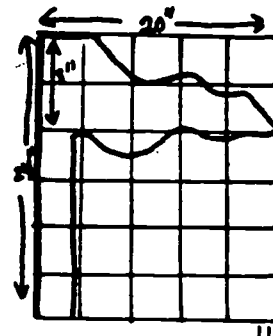
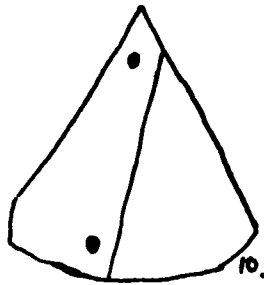
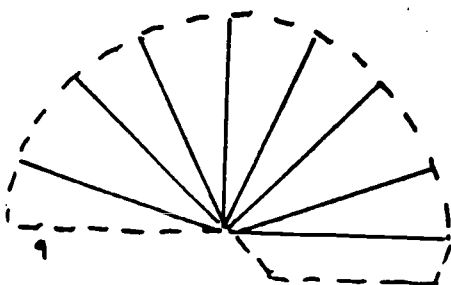
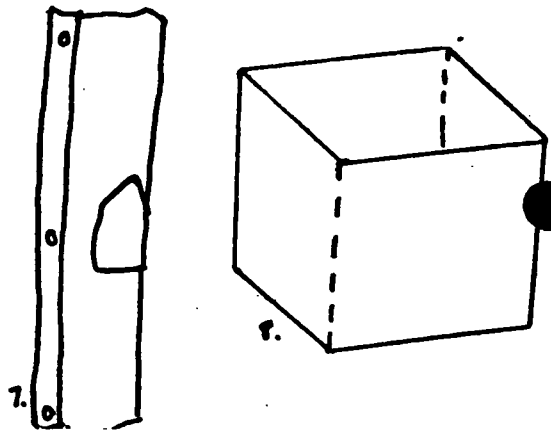
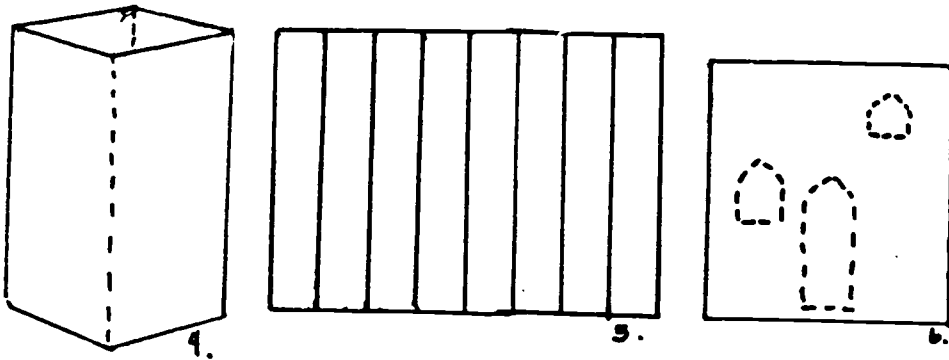

CASTLE/DISPLAY

3 Dimensional Castle for Bulletin Board

1. Collect paper towel tubes, oatmeal boxes, and string.
2. Split tubes and fold so they can be taped to bulletin board.
3. Cover each tube or lid in gray or white paper, staple or tape paper cover in place.
4. Draw on bricks or stones and windows with magic markers if desired.
5. Make turret roofs by rolling red or black pieces of paper into cones to fit. Fold backside flat for taping to bulletin board.
6. Make banners by gluing colored paper triangles to toothpicks. Push into tops of cones.
7. Make drawbridge with a rectangular piece of lightweight cardboard folded in the middle, punch holes and attach string.
8. Arrange on bulletin board with a blue construction paper moat and construction paper building extensions to fit size of board.

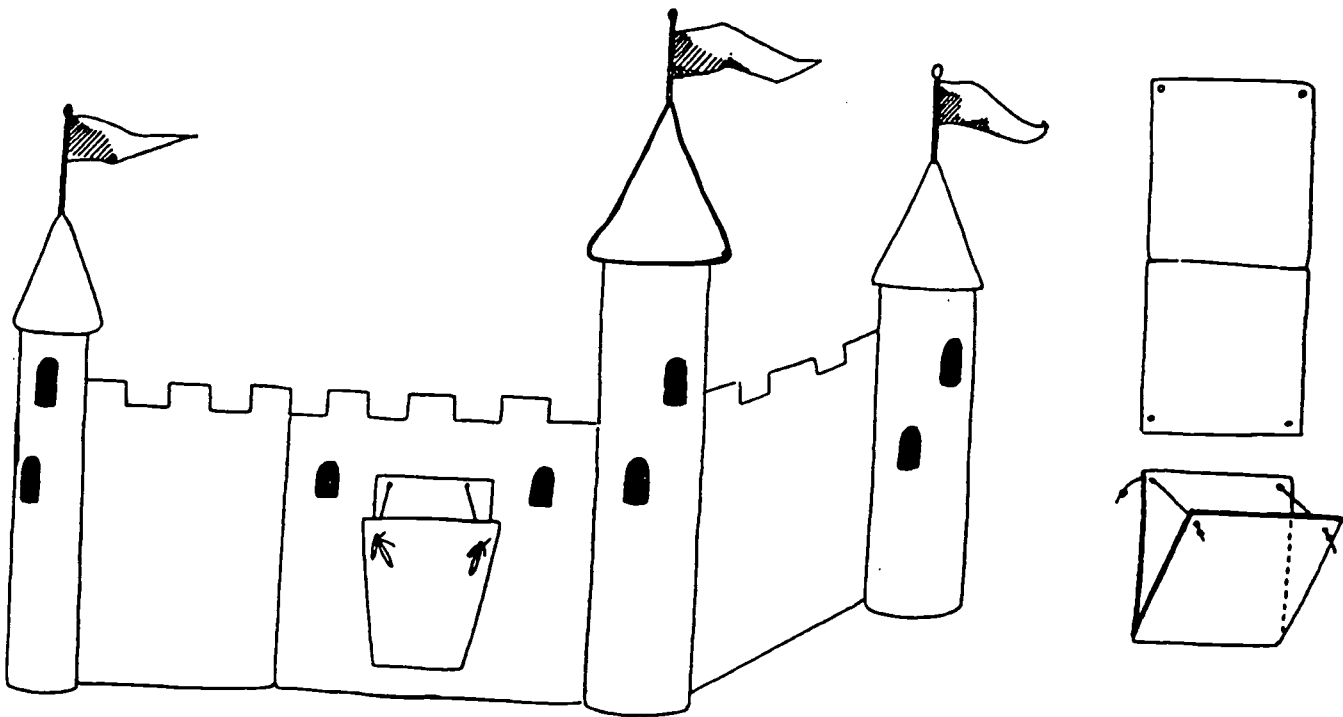

Reprinted from *Merlin's Magic: A Reading Activities Idea Book for Use With Children* edited by Carol H. Thomas. Published by the Oryx Press, (800) 278-8788. Used with Permission from the Oryx Press.

CASTLE/DISPLAY

Castle Bulletin Board

1. Remove bulletin board from wall.
2. Tape shoe box lid extensions to top of bulletin board.
3. Cover entire board with pale gray, white or light beige fabric or paper, tape and fold to fit.
4. Rehang board.
5. Insert paper or fabric banners on dowels in top or extensions.
6. It's ready to decorate with your schedules and usual bulletin board items.

CASTLES

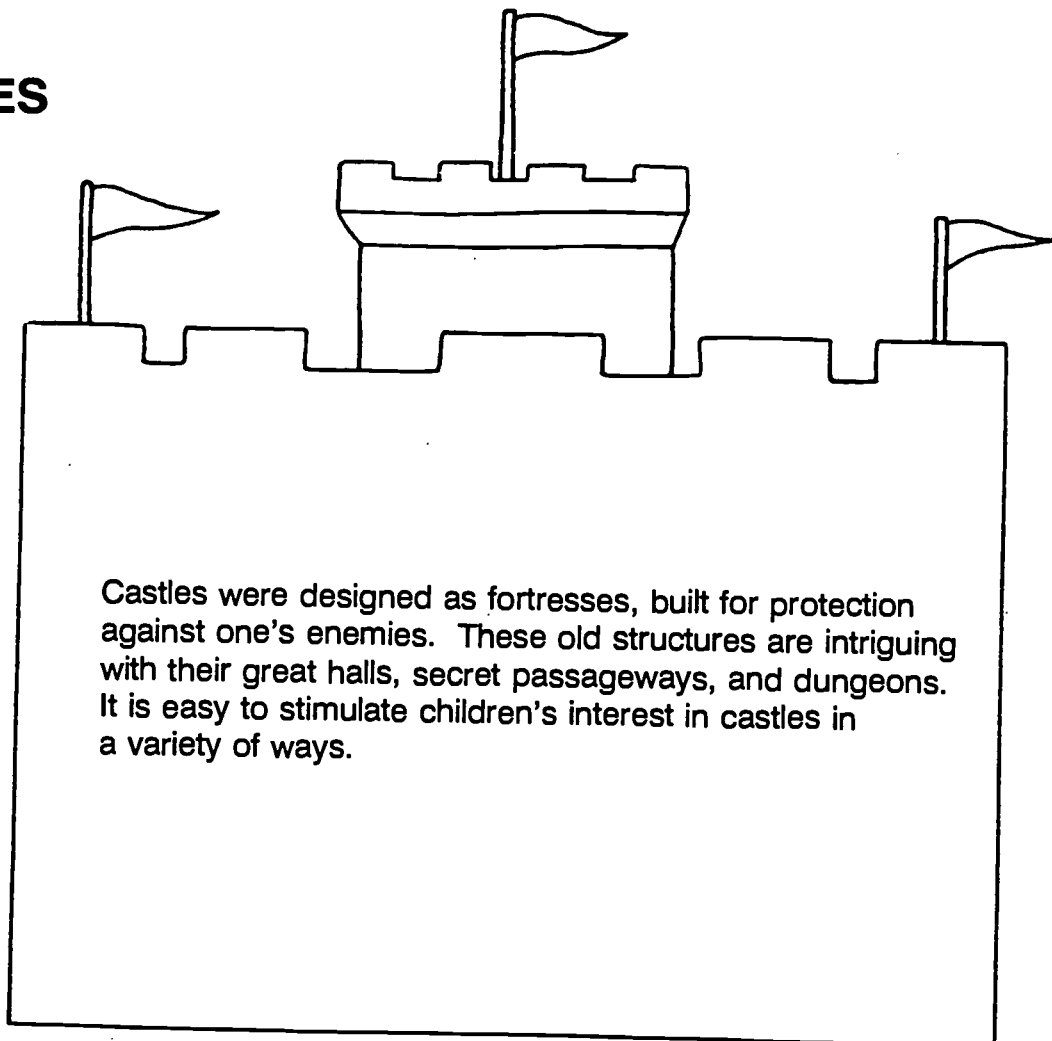

Reprinted from Merlin's Magic: A Reading Activities Idea Book for Use With Children edited by Carol H. Thomas. Published by the Oryx Press, (800) 278-8788. Used with Permission from the Oryx Press.

CASTLE/DECORATIONS

Standard - a long, narrow flag bearing the personal - rather than the family - devices of a medieval lord.

A good room decoration.

Materials:

Felt - for standard and another color for decoration.

Glue

Staples

A rod (dowel)

A pole

Thin nails

1. Cut felt in shape of drawing using measurements given. (Measurements are in centimeters.) Cut design to be used and glue onto the standard. Fold the upper edge of the standard back 3cm.
2. Cut out six strips of felt in design color 12cm long and 1.5cm wide. Fold them in half and staple onto the folded margin of the standard, placing them 6 to 7cm apart. When the strips have been attached, glue the margin down as shown in illustration.
3. Thread a 46cm rod through the loops. Nail a button across each end of the rod to stop the loops from sliding off. Fix the rod to the pole with a nail.

A shield with the same design might be constructed to complete the decoration.

Instructions from Castles by Victoria Prego de Oliver, Wayland, 1975.

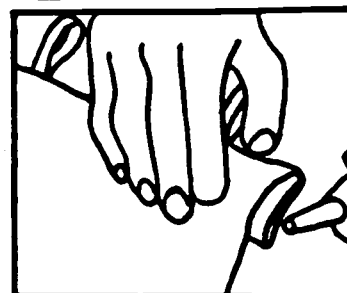
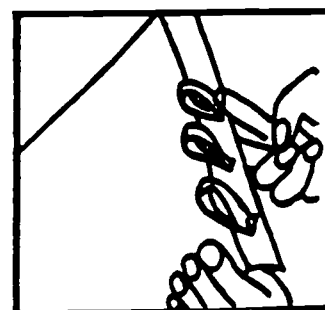
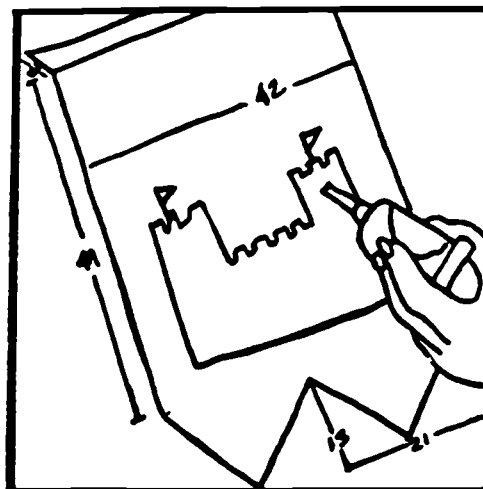
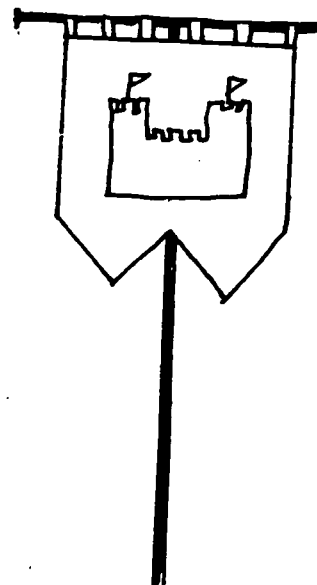

KEY - CASTLE QUEST PUZZLE

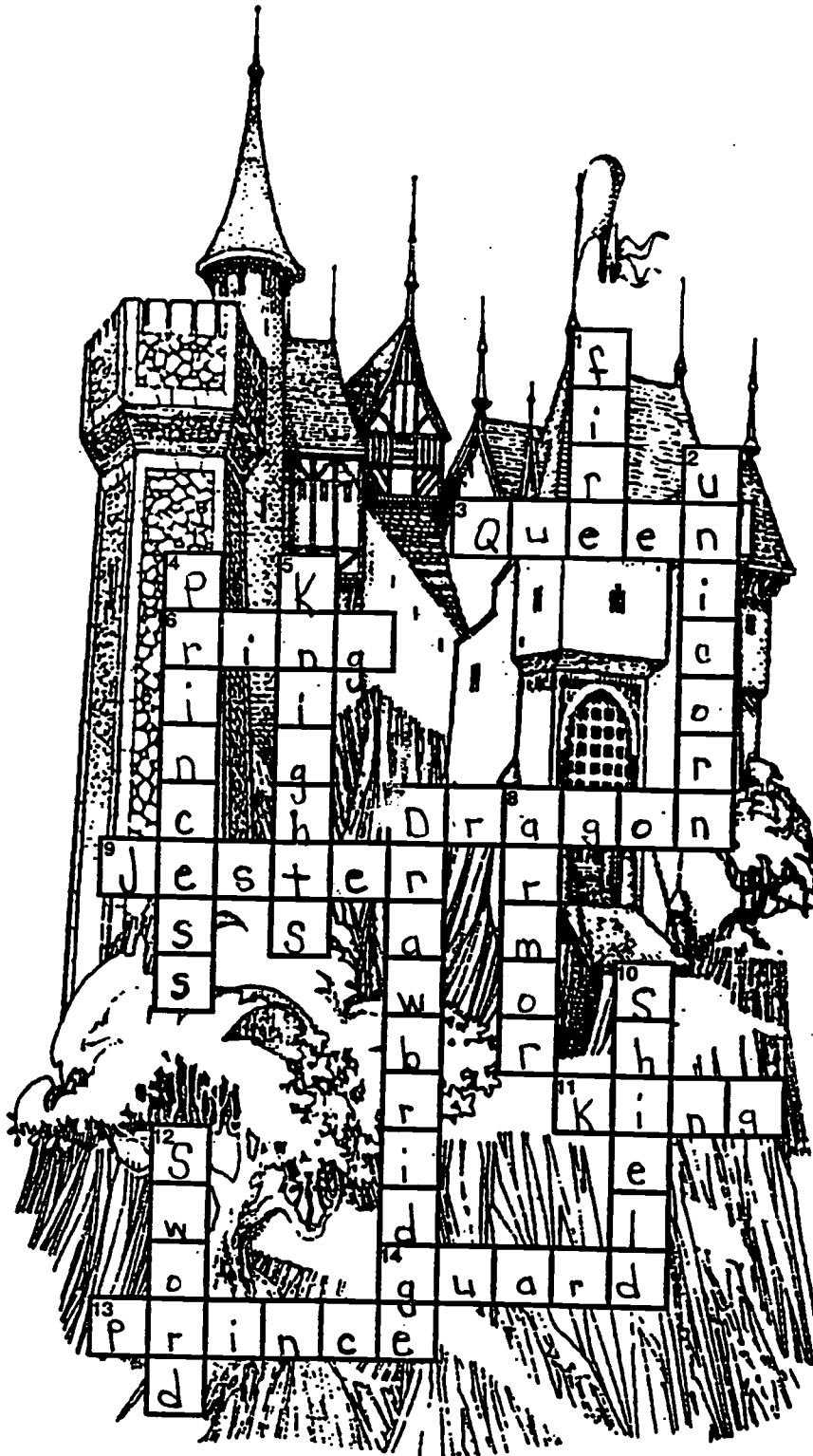

CASTLE QUEST

Down

1. What dragons breathe
2. A mythical horse with a horn in the middle of its forehead
4. The daughter of a king and queen
5. These men in shining armor served the monarchs in battle.
7. A bridge that can be raised or moved to one side
8. Covering worn to protect body against weapons
10. A piece of armor carried on the arm to ward off blows
12. A weapon with a long sharp blade and a handle at one end

Across

3. A female ruler
6. Jewelry worn on a finger
7. A make-believe monster who lives in caves and breathes fire
9. A clown hired by a ruler in the middle ages to do tricks and tell stories
11. A male ruler
13. A son of a royal family
14. The person hired to protect the castle and watch for the enemy

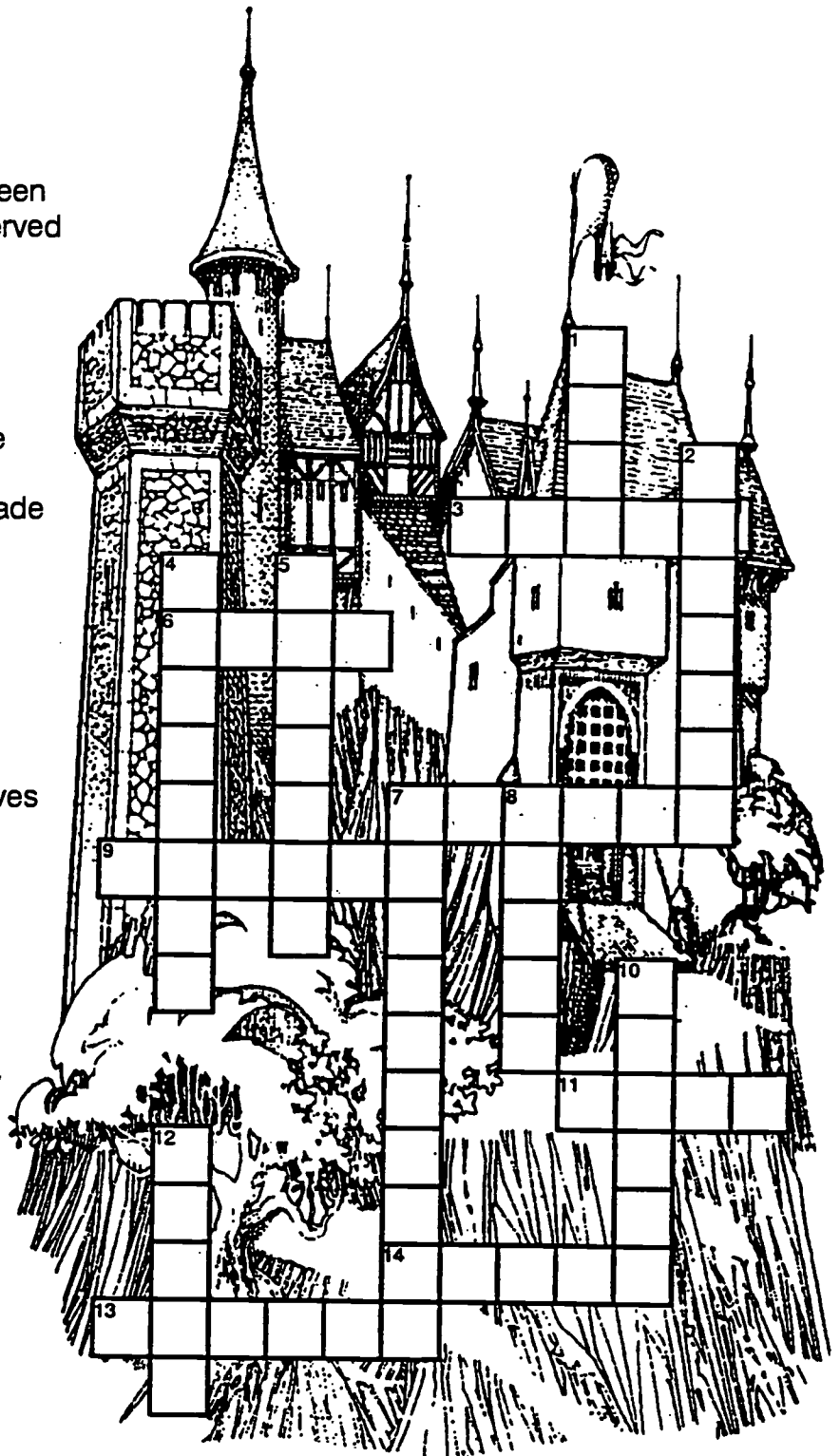

CASTLES/BIBLIOGRAPHY

The Battle For The Castle

By: Elizabeth Winthrop

Holiday House, 1993

ISBN: 0-8234-1010-2, \$14.95

Twelve-year-old William uses the magic token to return, through the toy castle in his attic, to the medieval land of Sir Simon, which is now menaced by a skeleton ship bearing a plague of evil.

Castle

By: David Macaulay

Houghton Mifflin Co., 1977

ISBN: 0-395-25784-0, \$14.95

Text and detailed drawings follow the planning and construction of a "typical" castle and adjoining town in thirteenth-century Wales.

The Castle In The Attic

By: Elizabeth Winthrop

Holiday House Books, 1985

ISBN: 0-8234-0579-6

A gift of a toy castle, complete with silver knight, introduces William to an adventure involving magic and a personal quest.

Castles: A 3-Dimensional Exploration

By: Gillian Osband

Orchard Books, 1991

ISBN: 0-531-05949-9, \$15.95

This book uses pop-up art to explore the life of a castle from the building to everyday life.

Castles: A First Discovery Book

By: Gallimard Jeunesse, Claude Delafosse and C. & D. Millet

Illustrated By: C. & D. Millet

Cartwheel Books, 1990

ISBN: 0-590-46377-2, \$10.95

In Castles, young children can cross over a drawbridge to a medieval castle, peek inside the home of a nobleman, and watch as knights defend the castle.

Castles: To Cut Out & Put Together

By: J.K. Anderson

Bellerophon Books, 1985

ISBN: 0-88388-088-1, \$3.50

Information on castles and keeps, black and white drawings of same, and cutouts you can put together.

The Cathedral Builders

By: Marie-Pierre Perdrizet

Illustrated By: Eddy Krahenbuhl

The Millbrook Press, 1992

ISBN: 1-56294-162-3

Describes the construction of Gothic cathedrals and the significance they had in the lives of those who built them.

Cross-Sections: Castle

By: Richard Platt

Illustrated By: Stephen Biesty

ISBN: 1-56458-467-4, \$16.95

The inhabitants of this medieval castle defend it against an enemy siege. The castle is sliced into 10 incredible cross-sections, each one teeming with life and detail.

The Enchanted Castle

By: E. Nesbit

Illustrated By: Paul O. Zelinsky

Books Of Wonder William Morrow & Co., 1992

ISBN: 0-688-05435-8, \$20.00

Four English children find a wonderful world of magic through an enchanted wishing ring.

I Wonder Why Castles Had Moats And Other Questions About Long Ago

By: Philip Steele

Illustrations By: Tony Kenyon, Nick Harris and Others

Kingfisher Books, 1994

ISBN: 1-85697-879-6, \$8.95

Answers to questions of long ago including: Why did castles have moats and why did knights wear armor?

King Cole's Castle

By: Colin and Moira Maclean

Kingfisher Books, 1991

ISBN: 1-85697-819-2, \$9.95

A lively new picture book adventure with a selection of your favorite nursery characters.

Life In A Medieval Castle And Village Coloring Book

By: John Green

Dover Publications, 1990

ISBN: 0-486-26542-0, \$2.95

This fascinating book combines the creative fun of coloring with an exciting sense of discovery as it realistically portrays many facets of life during the Middle Ages.

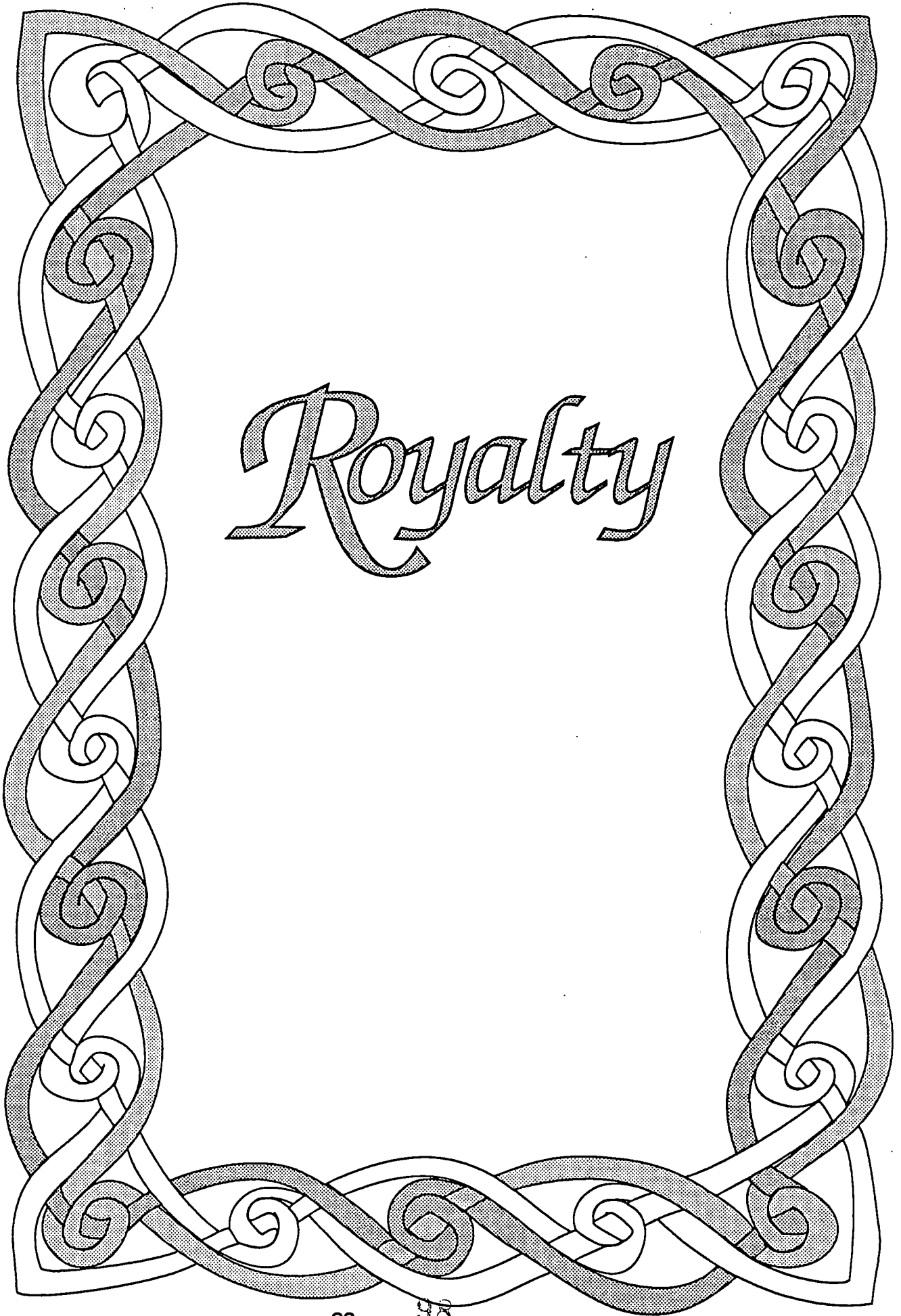

Royalty

PROGRAM SKETCHES/KINGS AND QUEENS

- Theme/Title:** "The King's in the Castle"
Age Range: Preschool - 2nd
Books/Stories: (see Kings and Queens Bibliography)

THE EMPEROR'S NEW CLOTHES KING MIDAS

or

other classic fairytales

KING BIDGOOD'S IN THE BATHTUB by Don and Audrey Wood

SING A SONG OF SIXPENCE by Pearson

Activities:

- ~ Fingerplays
- ~ Songs - "Did You Ever See A King?"
"The King Is On His Throne"
- ~ Play Simple Simon (letting everyone win)
- ~ Games: "Who Has the Gold", "Courtly Manners"
- ~ Rumpelstiltskin play

Extenders: (Arts and Crafts)

- ~ Make blackbird pies
- ~ Make Humpty Dumpty finger puppets
- ~ Make conical hats or crowns
- ~ King or Queen stick puppets
- ~ Royal jewels
- ~ King and Queen (construction paper)



KINGS AND QUEENS/FINGER PLAYS

THE FAMOUS KING OF FRANCE

The famous King of France
He led ten thousand men.
He marched them up the hill

(march, hands in air, one over the other, or may do standing and marching in place.)

And marched them down again. (march, hands down)
And when they were up they were up, up, up; (march, hands up)
And when they were down they were down, down, down; (march, hands down)

And when they were only half way up, (holds hands halfway up)
They were neither up nor down. (move hands up and then down very quickly)

MAD HATTERS PRESENTATION

Have all the children wear a hat to the program. Have a Mad Hatter's presentation of the 500 Hats of Bartholomew Cubbins by Dr. Seuss.

*Follow with a crown-making workshop.

KING AND QUEEN FOR A DAY PROGRAM

All the children who come can wear a crown or button proclaiming this is their day. Discuss how kings and queens treated their subjects in order to have a happy kingdom.

KINGS AND QUEENS/SONGS

DID YOU EVER SEE A KING?

(To the tune of "Did You Ever See a Lassie?")

Did you ever see a king
A king, a king
Did you ever see a king
Go this way and that?
Go this way and that way,
Go this way and that way,
Did you ever see a king
Go this way and that?

(Make crown with hands over head, fingers outstretched, swaying back and forth with the music as if the king is greeting his subjects.)

Add verses for:

A queen
(Wave regally)
A prince
(Bow from waist)
A princess
(Curtsey, hand under chin)
A knight
(Lunge forward with an imaginary sword.)
A dragon
(Grab out with hands curved into claws)

THE KING IS ON HIS THRONE

(To the tune of "The Farmer in the Dell")

(Have children in a circle, with the one chosen to be King in the middle. As the children sing and walk in a circle, the King - and subsequent characters - make their choices and pull the chosen people into the circle. For the last verse, have the child chosen as Dragon growl and run around the circle, chasing other players back into the outside ring. The Dragon is then in position to become the new King, for the next round.)

Verses: The king takes a queen
 The queen takes a knight
 The knight takes a dragon
 The dragon takes them all!!

OLD KING COLE



Jolly

Old King Cole was a mer-ry old soul, And a

mer-ry old soul was he. He

called for his pipe, and he called for his bowl,

And he called for his fid - dlers three.

The musical notation consists of four systems, each with a treble and bass staff. The key signature is one sharp (F#) and the time signature is 4/4. The melody is written in the treble clef, and the bass line is in the bass clef. The lyrics are placed between the staves.

KINGS AND QUEENS/ARTS AND CRAFTS

Blackbird Pie

PIE:

1. Cut two 12½ circles from light brown felt (or use paper plates). Cut one circle in half.
2. Cut several teardrop shapes from dark felt.
3. Sew the teardrops to both semicircles.
4. Sew the straight sides of semi-circles to a 12" zipper.
5. Sew the circles together.
6. For a pie that will hold a large flock of birds, use a 14½" or 16½" circle.

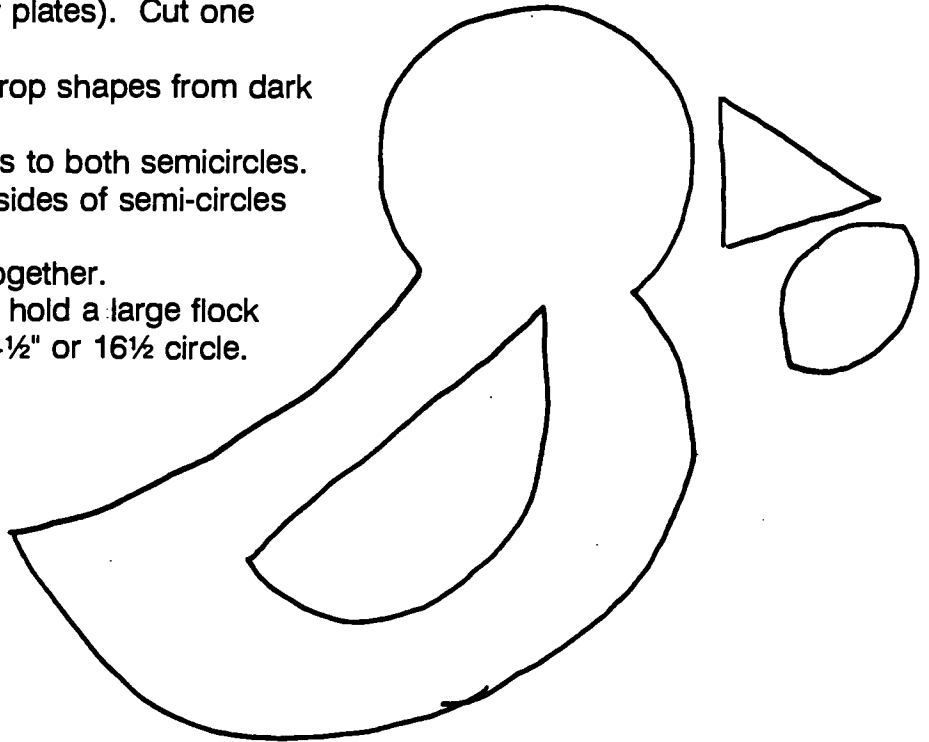

BIRDS:

1. Trace pattern and cut out of paper.
2. Cut 2 bird shapes from black felt and two wing shapes from gray felt. Cut out an orange beak and 2 white eyes.
3. Sew wing to one bird shape.
4. Sew or glue two eyes and beak to bird shape whose head will face forward. Sew an eye on each bird shape for a bird that will face sideways (beak will be sewn into seam later).
5. Place the 2 bird shapes together. Tuck the remaining wing and beak (if the bird faces sideways) between the shapes.
6. Sew the two shapes together with a bit of stuffing between them.
7. Make "four and twenty" birds, or as many as you wish.

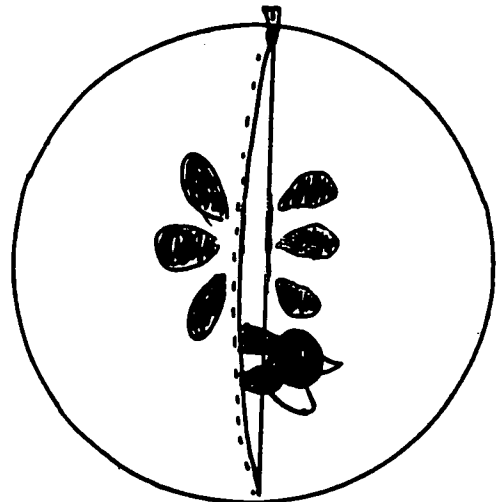

KINGS AND QUEENS/ARTS AND CRAFTS

Humpty Dumpty

Make a wall out of a cardboard box. While reciting the poem, set Humpty (paper pattern follows) on wall and let fall into lap. Then open him up to reveal the surprise yolk inside.

When making puppet, crayons are recommended so colors don't soak through. Color face and costume on one side and an egg yolk on the other. Cut out finger holes and insert fingers for legs.

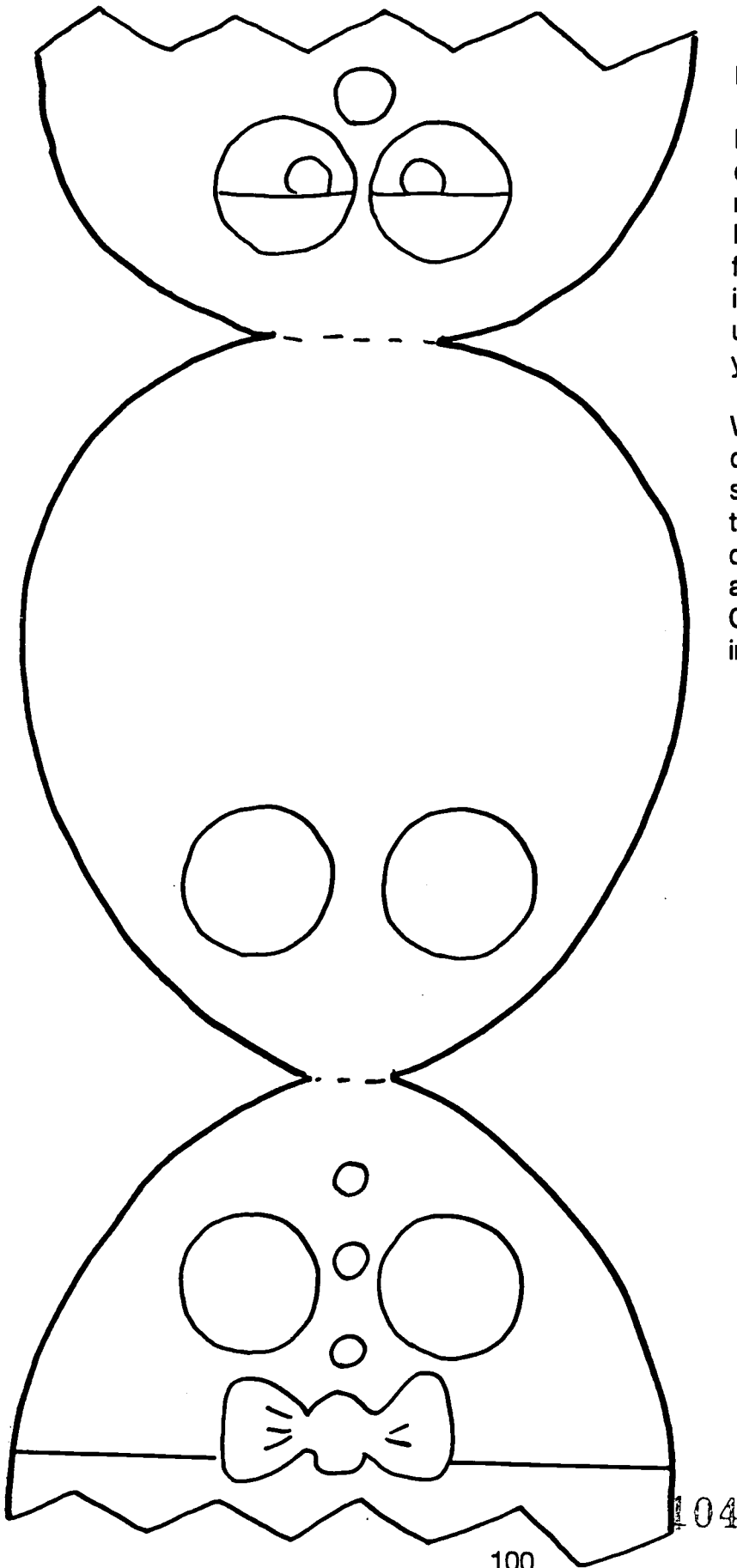

HATS ** CROWNS ** HATS

Make Conical Hats from cones of poster board. Cut a quarter circle with a 16" radius. Give children felt tip markers, glitter, glue, construction paper, scissors and crepe paper to decorate their own hats. Punch holes in the sides and attach string or yarn for safer wearing.

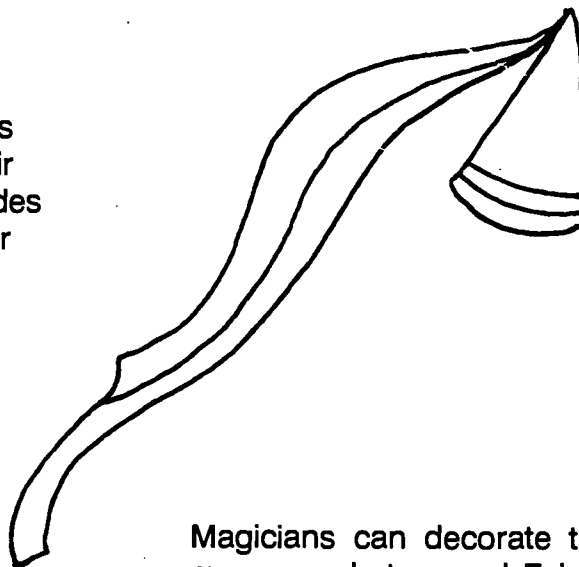

Magicians can decorate their hats with moons and stars and Fair Damsels with crepe paper scarves attached to the top.



Make Crowns, using this pattern (enlarged). Cut out of lightweight poster board or heavy construction paper. Provide children with glue, glitter, lace and ribbon scraps, foil stars, buttons, etc., for decoration. Fit each one to size and staple.

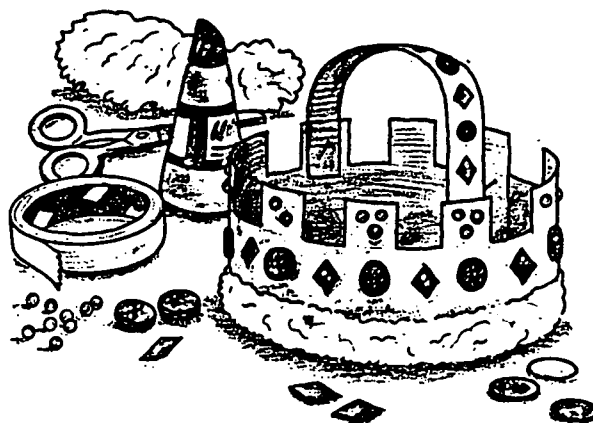

← Length of cardboard should fit around your head →



KINGS AND QUEENS/ARTS AND CRAFTS

King or Queen Stick Puppets

Have child trace around his/her hand and cut it out. Color and decorate and attach to a craft stick.

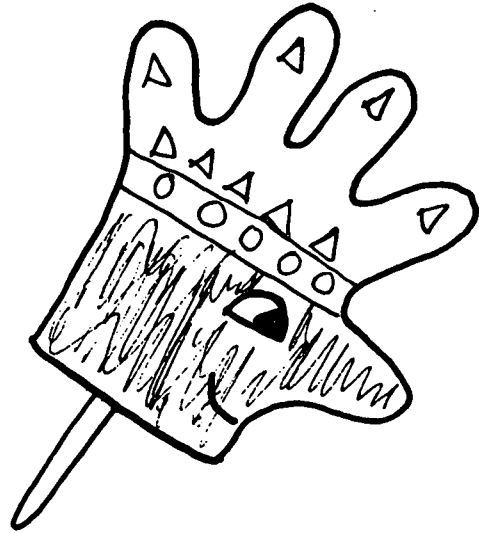

Royal Jewels

Materials needed: ~ a variety of macaroni with large holes;
~ straws cut into small pieces;
~ colored construction paper (optional);
~ string, yarn or a shoelace;
~ tape;
~ food coloring*

For color: Crayon or paint the macaroni or dye it the night before by dipping it into a small dish of food coloring mixed with water. Remove with tongs, gloves or a spoon. Dry on waxed paper.

To string: Make a tip on the yarn by wrapping a piece of tape tightly around one end. String the macaroni and straws one at a time, being careful to tie on the first and last bead. Leave some string at each end for tying.

*Note: macaroni can be purchased in different colors.

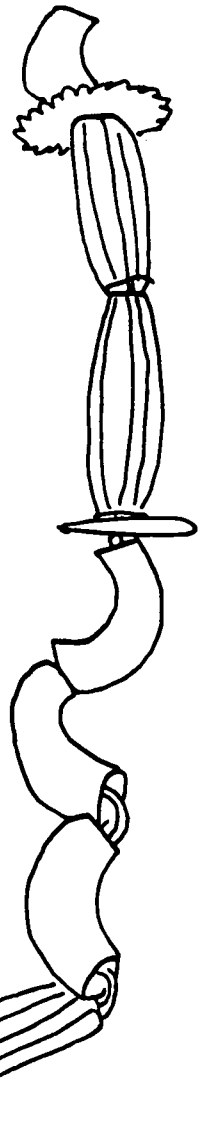

KINGS AND QUEENS/ARTS AND CRAFTS

Queen

Materials Needed:

Construction paper
A sheet of colorful wrapping paper
A sheet of silver or gold paper
Felt-tipped markers

How to Make It:

1. Draw a large circle on the sheet of wrapping paper. Cut it out and roll it up into a cone. Fasten with tape or staples. Cut off the tip of the cone, leaving a hole about 1 or 2 inches across.
2. Roll skin-colored paper into a cylinder tight enough to fit through the top of the cone. With the cone and the cylinder standing up on end, the cylinder should stick out about 2 inches at the top. Trim either or both parts to get the right proportions.
3. Glue on curled strips of paper to make the hair. Draw the face with felt-tipped markers.
4. To make the crown, cut a strip of silver or gold paper with a jagged row of points along the top. Roll it up around the top of the head and glue or staple it together.

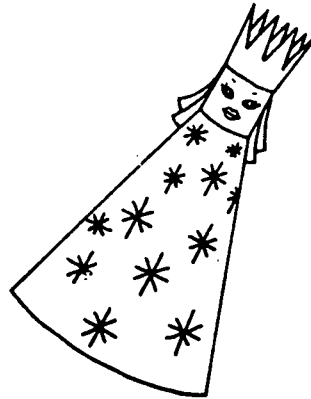

KING

Materials needed:

Construction paper

A sheet of patterned wrapping paper

A sheet of silver and gold paper

How to Make It:

1. Fold a piece of skin-colored construction paper in half and draw a pattern like the one in the diagram. Cut it out.
2. Unfold the body partway, so it can stand on its feet. Roll both ends of the strip for the head. Fasten it with glue.
3. Cut a rectangle of wrapping paper and put it around the king's shoulders to make a cloak. Staple the ends together.
4. Make the hair by gluing strips of paper to sides and back of head. Glue on curled strips to make the beard. Cut a moustache and two eyes out of construction paper. Glue them on.
5. Cut a wide strip of gold or silver paper long enough to fit around the top of the head. Cut out the points of the crown with scissors. Staple it in place, fastening it at the back, where the staple won't show.

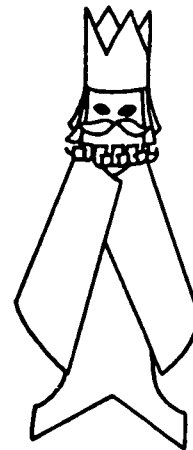

KINGS AND QUEENS/GAMES

WHO HAS THE GOLD? Cover a large button or circle of cardboard with gold foil or gift wrap. The children sit in a circle with the one chosen to be King or Queen in the middle. The king/queen closes her/his eyes while the children hide the "gold", then on the signal of "Eyes Open", must walk around the circle asking "Gold! Gold! Who has my gold?" in this variation of "Who Has the Button?"

PLAY COURTLY MANNERS. Invite children to try to imagine the most courteous way to deal with several situations, answering "What would you do if..." Give the players two pieces of paper each. On one piece have them write "What would you do if...". and on the other write "You should...". They then write down both a sticky situation and the solution. When everybody has written, players pass the question to the player on the right and the answer to the player on the left. Then everyone reads their questions and mismatched answers aloud, for hilarious results.

RUMPELSTILTSKIN

CHARACTERS:	Miller King Miller's Daughter Dwarf Messenger	PROPERTIES:	Spinning Wheel Chair, Straw Yellow Yarn Necklace, Ring A small bundle for the Queen's baby
-------------	---	-------------	---

SETTING: Before a drawn curtain, miller appears with his daughter, then the king. The king looks at the miller's daughter and turns around. He is about to leave when the miller detains him.

ACT I

MILLER: (bowing low) Good morning, your Majesty. Good morning. May I present my beautiful daughter? You may not believe it, but she can spin gold out of straw.

KING: (turns again, incredulous) Gold out of straw? No, I don't believe it. But we'll soon find out if what you say is true. I command you to send your daughter to my castle tomorrow morning and I'll put her to the test. (Exits)

MISTRESS MILLER: (very disturbed, almost frantic) But father, you know I can't spin gold out of straw. How can I possibly go to the castle?

MILLER: (apologetically) I was only trying to appear important in the eyes of the king.

MISTRESS MILLER: (frightened) What shall I do now?

MILLER: My dear, the king has commanded you to go to the castle. You have no choice now but to go.

MISTRESS MILLER: (crying) Oh dear! Oh dear! What will happen to me? What will happen to me? What will happen to me? (curtain closes)

ACT II (AT THE KING'S CASTLE) When the curtain rises, there is a spinning wheel in a corner, a chair and a small pile of straw on the floor. Hidden below is another small pile of yellow yarn.

KING: Well, Mistress Miller, I see you have come to spin all this straw into gold. Now sit yourself down and spin gold for me. If by tomorrow morning you have not done so, you shall die. (exits)

MISTRESS MILLER: (crying with her head in her hands) Oh dear me, I can't spin gold out of straw! What shall I do? What shall I do?

DWARF: (appears suddenly from under stage or through a window) Well, well, Mistress Miller. And why are you crying so?

MISTRESS MILLER: (lifting her head up) Ah me! Why shouldn't I cry? I have to spin gold out of this straw, and don't know how to do it.

DWARF: What will you give me if I do it for you?

MISTRESS MILLER: My necklace. (takes necklace off and gives it to the dwarf)

DWARF: (takes the necklace and puts it around his neck. He then sits down before the spinning wheel, takes straw from the floor, transfers it to spinning wheel, and makes it disappear below stage. Then he picks up yellow yarn from below stage and pretends to spin it out) Whee...whee...whee! Look at it turning to gold! (He does this until all the straw has disappeared below stage and the yellow yarn is piled up by his side) There, now, Mistress Miller, you have nothing to worry about. All the straw has been spun into gold. Good luck to you! (disappears below stage)

MISTRESS MILLER: (delighted) Thank you, thank you, little man.

KING: (appears and is astonished) My goodness! You can spin gold out of straw! My boots and saddle! I can hardly believe it! Now let's see what you can do this time. Come with me. (Curtain closes. When it reopens, the spinning wheel is in another part of the stage, to show another room, with lots more straw than before. King and Mistress Miller enter) So you see this straw?

MISTRESS MILLER: Yes, your majesty.

KING: Let me see what you can do this time, Mistress Miller. Sit yourself down and spin this straw into gold; and if you have not done so by tomorrow morning, you shall lose your life. (exits)

MISTRESS MILLER: (again, cries despairingly, with her head in her hands) Oh, me! What shall I do? What shall I do?

DWARF: (enters again) Well, well, in trouble again. What will you give me if I spin it once more?

MISTRESS MILLER: (relieved) Oh, little man. I will give you the ring off my finger. (Takes ring off and hands it to dwarf who takes it and puts it on his finger)

DWARF: (sits himself down before the spinning wheel and again makes the straw gradually disappear below stage while picking up and measuring out arm lengths of yellow yarn into a pile as before) Whee...whee...whee! Look at it turning to gold! (this goes on till all straw disappears) Now you need not cry any more, Mistress Miller. Good Luck! (disappears)

MISTRESS MILLER: (again appreciatively) Thank you! Thank you! Thank you! (fingers the yellow yarn)

KING: (appears, more surprised than before) My saddle and boots! You did it again! How marvelous! How wonderful! I'll tell you what I'll do. Spin it just once more. Come with me. (curtain closes and when it reopens, the spinning wheel has again been moved to a different position and there is lots more straw than before. King and Mistress Miller enter) Now, sit yourself down and once more spin all this straw into gold. If you do, I shall make you my queen. If not, you will forfeit your life. (exits)

MISTRESS MILLER: (crying) Oh me! Oh me! What shall I do now? What shall I do?

DWARF: (appears again) Again? What will you give me this time if I spin gold for you?

MISTRESS MILLER: (very sad) Alas! I have nothing more to give you.

DWARF: Will you promise to give me your first child after you become queen?

MISTRESS MILLER: Yes, yes, I promise!

DWARF: (sits down before spinning wheel and again spins gold by making straw disappear below stage and heaps yellow yarn in a pile) There now, it's all done. Remember your promise! (exits)

MISTRESS MILLER: (happily) Oh, thank you, thank you! Yes, I'll remember.

KING: (appears while Mistress Miller is fingering the gold) Well, well, well! I see you've done it again. I could not ask for a richer wife. Come, you shall become my queen. (King takes Mistress Miller by the hand and both exit. Draw curtain)

ACT III (IN THE QUEEN'S ROOM)

QUEEN: (cradles her baby in her arms and hums a lullaby) How happy I am. I not only am queen, but also mother of a beautiful child. My pretty little girl. (Suddenly she looks up)

DWARF: (appears suddenly before the queen with a gleeful voice) Ah! Now, my queen, I have come for what you promised me a year ago!

QUEEN: (tightens her hold on her child) Oh, no! No, I cannot give her to you. I'll give you all my jewels and you can become very rich.

DWARF: I have no need for your jewels. I would rather have something living than all the treasures in the world!

QUEEN: (cries frantically) Oh, please, please, don't take her from me! I beg you, I beg you not to!

DWARF: (feels sorry for the queen) Well--I will give you three days in which to guess my name. If within that time you do, you shall keep your child. (exits, curtain draws with queen crying)

QUEEN: (curtain reopens with queen alone) Ah, me, I couldn't sleep all night thinking of all the names I have ever heard. I even sent my messenger all over the country to inquire what other names there are. I hope I have the right name for the dwarf.

DWARF: (appears suddenly) And now, your Majesty, what's my name?

QUEEN: Is it Caspar?

DWARF: No! That's not my name!

QUEEN: Is it Melchior?

DWARF: Nope! That's not my name!

QUEEN: Is it Balzer?

DWARF: Nope! Not my name, not my name, not my name!

QUEEN: I'll try again tomorrow.

DWARF: (gleefully) You'll never guess my name! Never guess my name! (exits, jumping up and down. Curtain is drawn for a while, then reopens)

QUEEN: (very sleepy) I'm so tired. I was awake all night again thinking and inquiring of unusual and strange names. Oh, I hope I can guess the dwarf's name.

DWARF: (appears, suddenly and teasingly) Have you guessed my name? Have you?

QUEEN: (hopefully) Is it--Cowribs?

DWARF: Nope! Not my name!

QUEEN: Is it--Spindleshanks?

DWARF: Nope! Not my name!

QUEEN: Is it--Fancy Pants?

DWARF: (hopping around gleefully) Nope! Not my name, not my name, not my name. Never mind. You have one more day. Good luck for tomorrow! (exits, hopping and shouting) Not my name, not my name, not my name! (curtain closes with queen sobbing, with her head in her hands. After a while, curtain opens)

QUEEN: (very sadly) Here it is the third and last day. If I don't guess the dwarf's name today, I will lose my child. Oh, Dear, what shall I do, what shall I do?

MESSENGER: (enters and bows low) My queen.

QUEEN: (hopefully) My good messenger. Have you found any new names? Have you?

MESSENGER: No I haven't. But on my way home, as I turned the corner of a mountain, I saw a strange sight. In front of a cave at the foot of the mountain, there was a fire burning in the open. Around the fire, I saw a strange little man hopping first on one foot and then on the other. And as he hopped, he sang: Today I bake; tomorrow I brew my beer; the next day I will bring the queen's child here. Ah! Lucky 'tis that no one doth know Rumpelstiltskin is my name, ho! ho!

QUEEN: (delighted) Oh! My good messenger. If that is the right name, I shall reward you well. You may go now. (messenger exits)

QUEEN: (hopefully) Could it be Rumpelstiltskin?

DWARF: (appears suddenly) Now, your Majesty, what's my name?

QUEEN: (pretending to be anxious) Could it be--Kunz?

DWARF: No! That's not my name!

QUEEN: Is it--Heinz?

DWARF: Nope! Not my name!

QUEEN: Is it by chance--**RUMPELSTILTSKIN?**

DWARF: (shrieking) Arrrrrr! The devil told you that, the devil told you that! (He stamps and shrieks till he falls down below the stage)

QUEEN: Now I can live happily with my husband and child! (She bows to audience. Curtain closes)

King Arthur

There are many wonderful tales of a king named Arthur and of the brave Knights of the Round Table.

Who told the first story of King Arthur? No one knows. The tales are very old and have been told by many different storytellers in many different lands. Each told the stories in their own special way.

Was there a real King Arthur? People who study the past think there was. They know only a little about him.

- ~ He ruled in England about fifteen hundred years ago
- ~ He won many battles
- ~ He was a king no one could forget

Sir Thomas Malory gathered all the stories he could find about Arthur and wrote an exciting account of his life.

Howard Pyle so enjoyed reading Malory's stories about King Arthur that he wrote and illustrated his own story, "The Story of King Arthur and His Knights".

T.H. White wrote a story about Arthur as a boy. He called the young Arthur, "Wart". The Sword in the Stone ends where most stories about Arthur begin.

King Arthur

The Arthurian legends have been the basis for numerous tales, books, short stories, and poems that have been enjoyed by all age groups for many years.

Principal Characters

King Arthur
Queen Guinevere
Knights of the Round Table
Mysterious Magician Merlin

Bibliography/King Arthur

- Ashe, Geoffrey. King Arthur in Fact and Legend. Nashville, TN: Thomas Nelson, Inc., 1971. Out of print. Grades 7-12.
Traces the Arthur of fiction from the Middle Ages to the present; also tells the historical and archeological facts of all that is known about the king.
- Gross, Gwen. Adapter. Knights of the Round Table. Random House, 1993. Reading level 2-4.
Retells the exploits of King Arthur and his Knights of the Round Table.
- Haar, Jaap Ter. King Arthur. New York: Crane, Russak & Co., Inc., 1973. Out of print. Grades 4-8.
Shows a man of his time, struggling to create and hold a kingdom, and to bring light into the lives of his people.
- Hibbert, Christopher. The Search for King Arthur. New York: Harper & Row Publishers, Inc., 1970. Grades 7-9.
Skillfully weaves the fact and legend of King Arthur. The many illustrations reflect the history and the art of Arthurian romance through the years.
- Hodges, Margaret and Margery Everngen. Of Swords and Sorcerers: The Adventures of King Arthur and His Knights. Charles Scribner's Sons, 1993.
This version of King Arthur and his Knights of the Round Table have been written especially for young readers. It includes nine episodes in the Arthurian cycle, from the placing of the boy Arthur in Merlin's care to Arthur's departure for Avalon.
- Pyle, Howard. The Story of King Arthur and His Knights. New York: Charles Scribner's Sons, 1933. Grades 5-7.
Offers one of the many fine versions of the legend of King Arthur and a source for reading about Merlin's wizardry.
- Riordan, James. Tales of King Arthur. Chicago: Rand McNally & Co., 1982. Grades 5-9.
Retells the Arthur legend, beginning with the birth of young Arthur. It recounts the quests of Sir Gawain, Tristram, Lancelot, and Galahad and closes with the death barges taking the King to the Vale of Avalon. Booklist, February 1, 1983, p. 726.
- Sutcliff, Rosemary. Light Beyond the Forest: The Quest for the Holy Grail. New York: E.P. Dutton, 1980. Grades 4-7.
Describes the quest of Arthur and his knights for the Holy Grail, the cup used at the Last Supper. This is the second book of Sutcliff's Arthurain series. Bulletin of the Center for Children's Books, September 1980, p. 23.

_____. Road to Camlann: The Death of King Arthur. New York: E.P. Dutton, 1982. Grades 4-7.

Describes Arthur's last years in Camelot with Queen Guinevere, Lancelot, and Mordred. This is the third and concluding volume of Sutcliff's Arthurian series. Booklist, February 1, 1983, p. 727.

_____. The Sword and the Circle. New York: E.P. Dutton, 1981. Grades 4-7.

Follows the fortunes of Arthur from his conception to the summer of the Round Table. This is the first book in Sutcliff's Arthurian series. School Librarian, June 1981, p. 155.

White, T.H. The Sword in the Stone. New York: G.P. Putnam's Sons, 1939. Grades 6-8.

This story, based loosely on Malory's *Morte d'Arthur*, explains how King Arthur (Called Wart) is taught as a boy by Merlin the Magician and learns many fascinating lessons. King Pellinore, who is always on quest for the Beast Glatissant, is another character in the book. Elementary School Library Collection, 1979 (12th ed.), p. 521.

KING ARTHUR & THE KNIGHTS OF THE ROUND TABLE CROSSWORD PUZZLE

ACROSS

2. _____, a noble knight of the Round Table, was the son of Lancelot.
5. King Arthur's sword - the sword in the stone - was called _____.
8. Arthur grew up with Sir _____, his foster brother and the son of Arthur's guardian.
10. _____ was married to King Arthur.
12. Sir _____ was Arthur's guardian when he was growing up.
13. One of the bravest of Arthur's knights, Sir _____ was best known for his encounter with the Green Knight.
14. _____, Arthur's sister, was an evil sorceress.
15. One of King Arthur's nephews, _____ eventually caused the downfall of Camelot through his plotting against King Arthur's most noble knight.

DOWN

1. The _____ was a strange and wonderful creature for whom Sir Pellinore was always searching.
2. The Holy _____ was believed to be the cup used at the Last Supper. Many knights sought this precious object.
3. _____ was the famous magician, or wizard of King Arthur's court who lived backwards in time.
4. The nickname given to Arthur by his friend, a wizard, when he was just a young boy was _____.
6. Arthur's father was called _____.
7. Sir _____ was known as the noblest of King Arthur's knights. His love for the Queen eventually led to the destruction of Arthur's kingdom.
9. _____ was the name of the castle to which the Queen was taken to prevent her from being burned to death.
11. The name of the kingdom which King Arthur ruled was _____.

KING ARTHUR PUZZLE

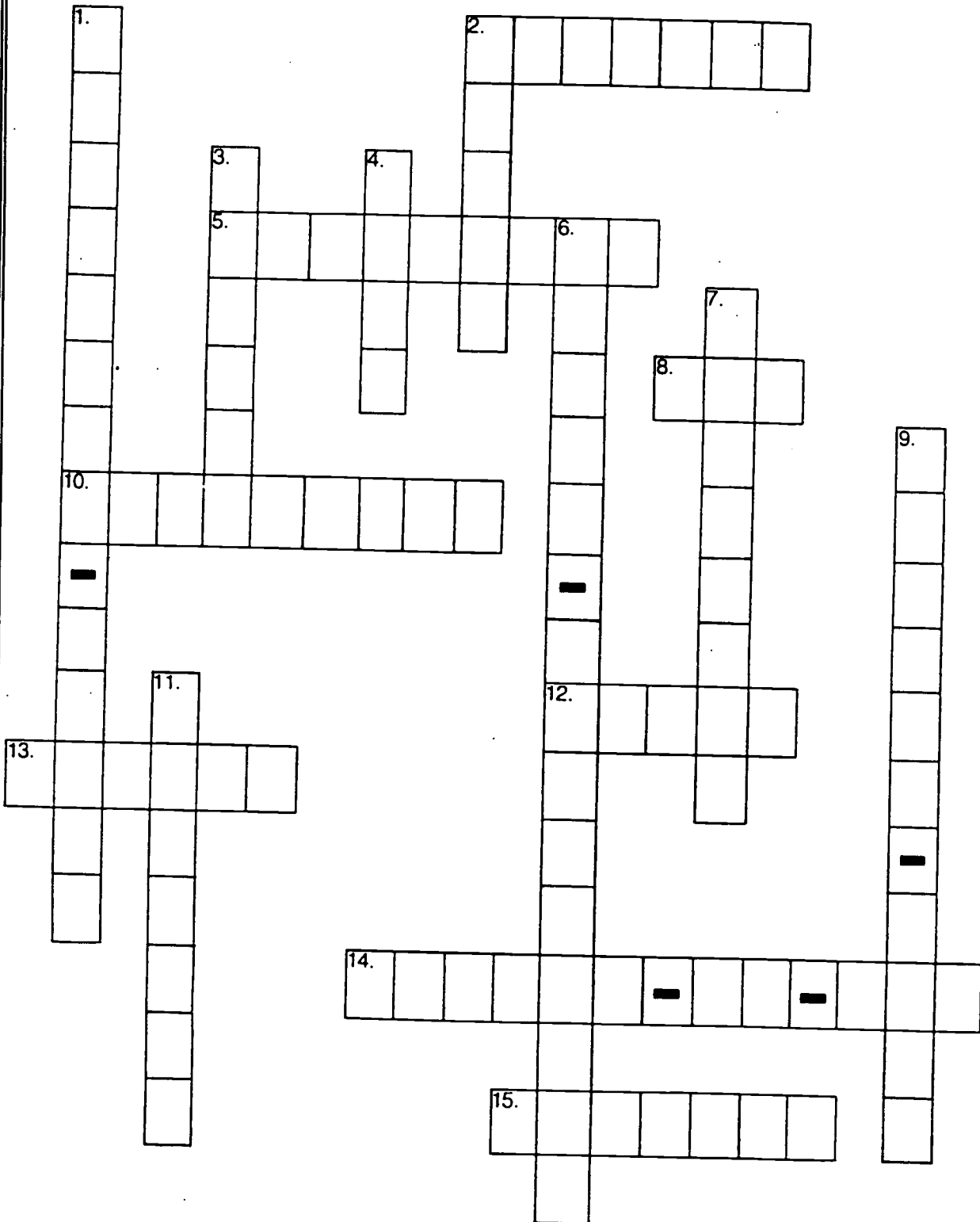

**ANSWER KEY: KING ARTHUR AND THE KNIGHTS OF THE ROUND TABLE
CROSSWORD PUZZLE**

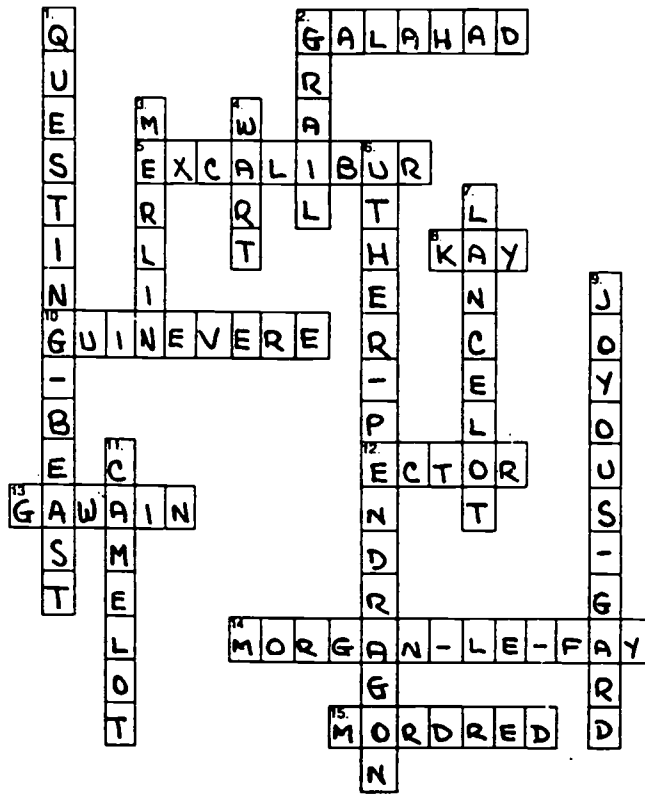

PROGRAM SKETCHES/PRINCES AND PRINCESSES

Theme/Title: "Princes and Princesses Week"

Age Range: Elementary Ages

Books/Stories:

Bub: or the Very Best Thing by Natalie Babbitt
(Michael di Capua Books, 1994) ISBN: 0-06-205045-1.

Silly King, Silly Queen, not to know what's the very best thing for the prince. Nobody else knows, either, except the prince himself, and the court Jester, too. Even though they're the only ones who aren't asked about it.

Activities:

- ~ Have a storytelling contest. Let older children pick a fairy tale (with a prince or princess) to tell to the group. They may wear a costume pertaining to the story if they wish. Everyone wins. Give each presenter a crown.
- ~ Guessing game: Bring the princess (prince a gift). A guessing game for older children. Guests must try to figure out the trick. Pick one child to be the princess or prince. Go around the room and have each person mention a gift the princess might like (a puppy, a necklace, some peaches, etc.). The princess accepts or rejects each gift. The trick is that the gift must start with the 1st letter of the royal person's name. Example - Betsy likes blouses, boats, bananas, etc. Keep playing until everyone has figured out the trick. The person who guesses the correct gift becomes the next royalty.
- ~ Have children act out the story of the "Princess and the Pea" with puppets.
- ~ Read the story "The Frog Prince" and then have an origami workshop to make frogs that hop.

Resources: (Fractured Fairy Tales)

Once upon A Golden Apple by Jean Little and Maggie DeVries, (Viking, 1991)

In this hilarious fractured fairy tale, everything seems to go wrong. A princess kisses a reluctant dragon...until all the mischief is sorted out and everyone lives happily ever after.

Princess Horrid by Erik Christian Haugaard, (Macmillan Publishing Co., 1990)

Princess Horrid wasn't born with the name, she earned it. She is transformed into a kitten and becomes the property of the lowliest kitchen maid in the castle. Can a mere scullery maid help a princess to become her true self?

Sleeping Ugly by Jane Yolen. (Coward-McCann., Inc. 1981)

When beautiful Princess Misereva, Plain Jane, and a fairy fall under a sleeping spell, a prince undoes the spell in a surprising way.

ORIGAMI FROG PATTERN

Your students should begin with colored rectangles of paper 5cm x 10cm. Then, they should study figures 1-5 and follow the written directions below. For very young elementary school children, you'll have to demonstrate as they fold and perhaps even modify this design. Lewis and Oppenheimer's book on making paper toys (1974) is a useful guide.

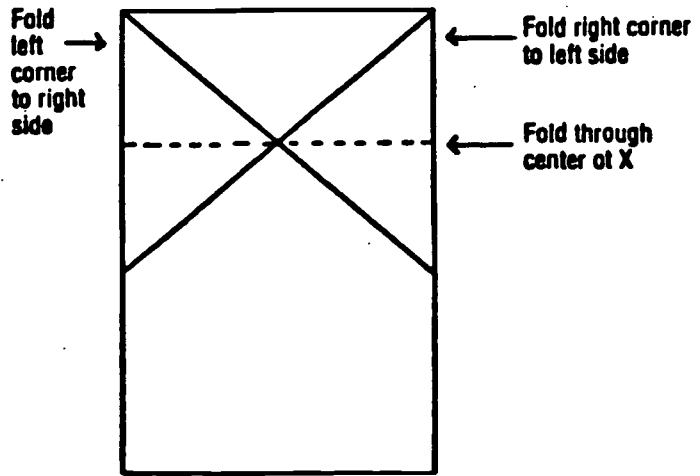

Figure 1

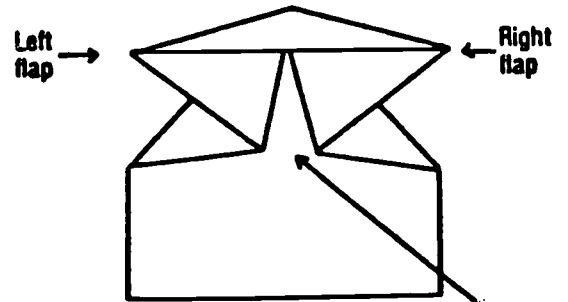

Figure 2

Side folds meet in center

Figure 3

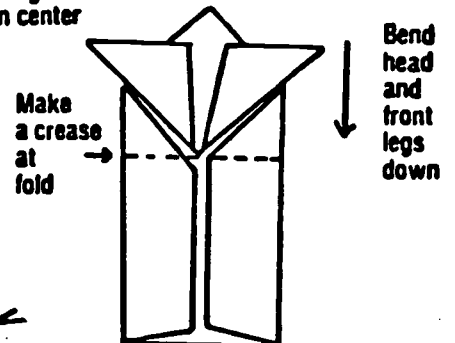
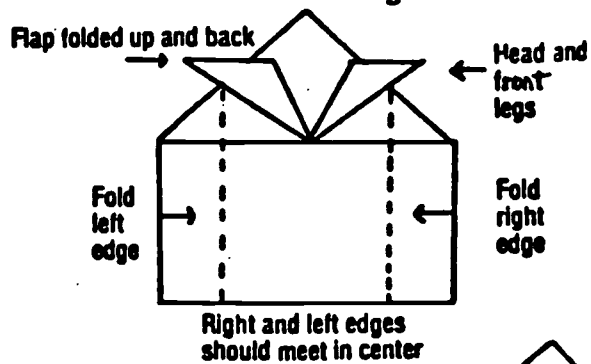

Figure 4

All set to jump

~ Figure 1. Fold the right corner over so it meets the left side of the rectangle, creasing the paper and then unfolding it. Then, reverse this process and repeat, left corner to right side. Next, fold the top edge down to form a crease through the center of the X formed by your first folds. Unfold the paper.

~ Figure 2. Push the top edge down. The two side folds will meet underneath the center.

~ Figure 3. Fold the right and left flaps back to that their edges meet at the top point and crease the folds. Then, divide each flap in half by folding it back on itself (away from the point), making the frog's head and front legs. Fold the right and left edges in to meet at the center, creasing the folds.

~ Figure 4. Bend the head and the front legs down and make a crease at the fold. Then, turn the frog over and fold the elongated section of paper so that the edge meets the fold.

~ Figure 5. Give your frog some eyes. Your finished leapfrog should look something like this.

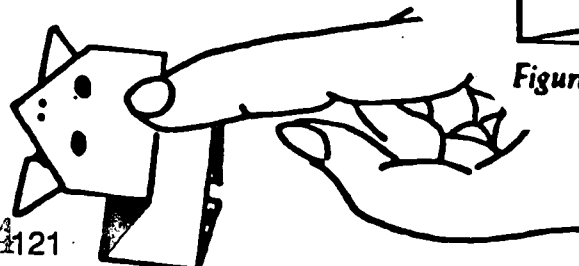

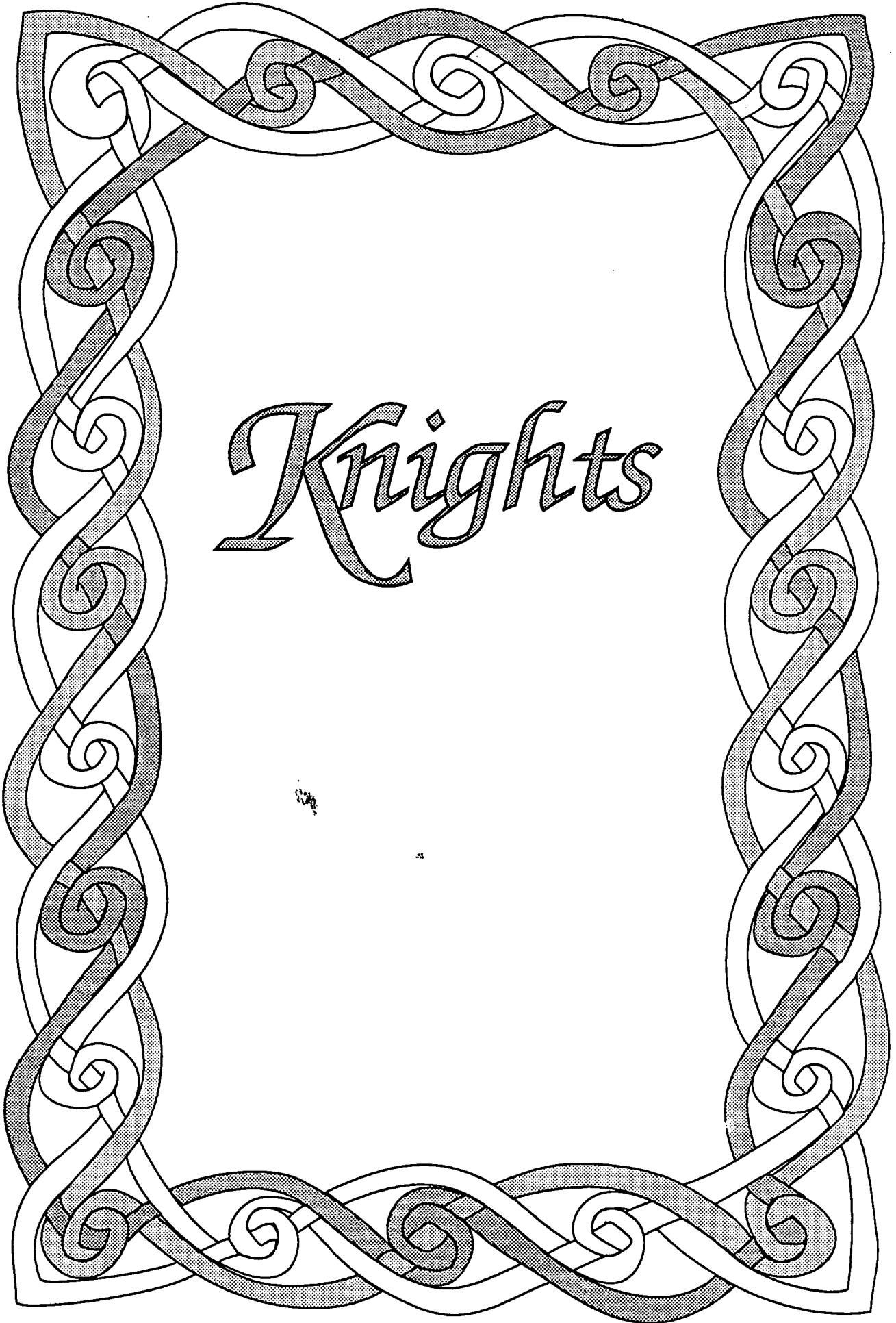

Knights

PROGRAM SKETCHES: KNIGHTS & LADIES

"Knights and Ladies Week"

- ~ Have a Renaissance Fair
- ~ Have demonstration activities (check your community resources for people to demonstrate their crafts)

DECORATE: a large space with banners and flags and create a castle-like entry way.

COSTUMES: Library staff and Volunteers can dress as royalty, craftspeople, troubadours, jesters, knights, ladies, etc.

Include such aspects from the courtly era as:

- ~ needlepoint & weaving
 - ~ clown jester makeup
 - ~ recorder playing
 - ~ juggling
 - ~ strolling singers
 - ~ manuscript illumination
 - ~ water-dunking machines
 - ~ jesters
 - ~ candle making
 - ~ stained glass
 - ~ leather working
 - ~ fencing
 - ~ calligraphy
 - ~ woodworking
 - ~ theatrical performers
 - ~ puppet shows
 - ~ games (blindman's bluff/chess/backgammon/top spinning/apple bobbing/egg tossing)
- ~ Set the demonstrations up as workshops, allowing the children to actually participate.
Example: needlepoint - simple designs could be drawn onto small squares of needlepoint canvas or on plastic mesh.
- ~ Invite a member of the Society for Creative Anachronism to speak to your group about the way of life of a medieval knight.
- ~ Introduce "Chivalry"



BECOMING A KNIGHT



A boy who wanted to be a knight earned the title through a long and hard training program. The boy began training when he was quite young and had to be a son of a nobleman. When a boy reached the age of seven he was sent away from home to be raised at the court of his father's lord or at the castle of a relative who was a famous knight.

PAGE

At first the young boy was a page. He was taught how to handle weapons and how to defend himself. As a page he learned the knight's way of life. He ran errands for the ladies and helped the knights with their horses and harnesses.

VALET

At the age of nine a boy became a valet. "Valet" means "little vassal" or "Little lord". He became a personal servant to the knight who was his master. He set the knight's table and stood behind his chair during mealtimes.

SQUIRE

When the young man became fifteen he became a squire. He accompanied the knight everywhere even into battle. As a squire he carried the knight's weapons, led his extra horse and helped the knight put on his armor. During a battle it was the squire's duty to rescue the knight when he was wounded or knocked off his horse.

The squire usually served the knight for five years. During that time he became very skilled in the use of weapons and horsemanship. When he had proven that he was a skillful warrior he was rewarded with knighthood.

KNIGHTING CEREMONY



A knighting ceremony was a very important event for the young man (squire) who was to be knighted and for the entire community. The young man was proud to be a warrior and the people were pleased to have another warrior to protect them from attack.

Knighting ceremonies were surrounded by religious rituals. The night before the ceremony the squire placed his weapons and armor on the altar of the church. During the night he confessed his sins, fasted, prayed and watched his armor. The next morning after a church service he bathed and dressed in his armor. During the knighting ceremony the squire knelt before the king or overlord. Drawing his sword, the king touched the young man lightly on the shoulder with his blade and proclaimed:

"In the name of God, Saint Michael and Saint George, I dub thee Knight."

This ceremony was called "dubbing". If a squire performed a brave deed in battle he could be knighted on the spot. It was a great honor to win a knight's spurs in this way. The new knight was addressed as "Sir." A squire was appointed to attend him and he was allowed to choose his own insignia, or coat of arms.

RULE: Any man who was a knight might "dub" another knight.

Knighting Ceremony for Summer Reading Program

[Blow horn or Kazoo] "Good and Gentle People of the library, may I have your attention please."

"[Child's name] has completed her/his summer reading challenge of [#] books. Please join me in congratulating her/him...."

"Good [child's name] kneel and receive your knighthood..."

[Take a play sword and tap on both shoulders while saying ...]

"I dub you champion of reading and Knight of King Arthur's Reading Round Table."

or

"I dub you a champion of reading and Knight of the Locust Grove Library Reading Round Table."

[Blow horn and/or clap]

Librarians can wear a ladies' pointed cap or crown while performing the knighting ceremony.

The horn can be constructed simply by attaching a kazoo to a light dowl rod with hot glue, and then attaching a felt banner to the rod. The banner could have a book logo or some other type of royal insignia.

Submitted by Desiree Webber, Moore Public Library

KNIGHTS/ARTS AND CRAFTS

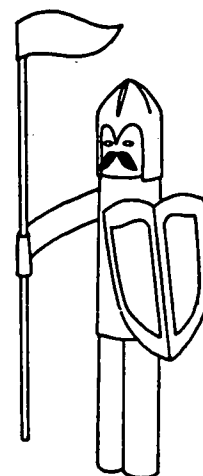

KNIGHT

Materials Needed:

Construction paper
A paper straw
A small, thin paint brush

How to Make It:

1. Make the knight's body by rolling up a cylinder of blue or gray paper. Fasten it with staples. Roll two tighter cylinders of paper of the same color. Insert the two tight cylinders into one end of the body. Hold the legs in place with glue.
2. Make the head by rolling a small cylinder of skin-colored paper and inserting it in the top of the body. Fasten it with staples or glue. Glue on eyes and a mustache cut from colored paper.
3. The arms are cut from a single long strip of paper of the same color as the body and legs. Glue the arms to the back of the figure. Curl them slightly so they bend around toward the front of the body.
4. Draw a helmet pattern like the one shown, big enough to fit around the head and overlap a little in back. Cut out the helmet. Fasten the ends together with glue. Bend the four points in toward the center and glue them together. Brush a little glue around the top of the head, then put the helmet on the head.
5. Cut a paper shield in some bright color. Decorate the shield with glued-on paper shapes. Bend the knight's left arm at the elbow. Glue the shield to the left arm, in front of the body. If the weight of the shield makes the knight fall over, just glue the edge of the shield to the knight's chest.
6. Wrap the knight's right hand around the paper straw. Fasten it with a little glue. Glue a paper flag to the top of the straw.

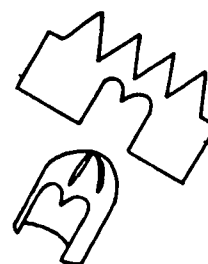
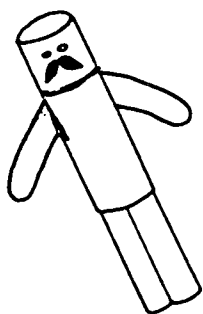

Reprinted from "Dragon Summer", 1983 Arkansas

KNIGHTS/CRAFTS

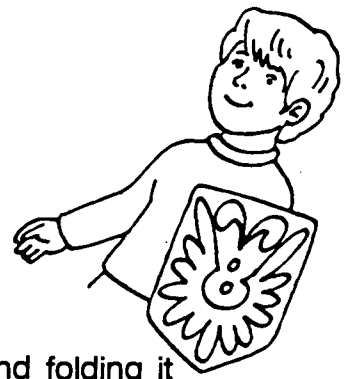

MAKE A SHIELD

1. Make a pattern for your shield by taking a piece of paper and folding it lengthwise as shown below. The size paper you use depends on how big a shield you wish to make. Cut off a rounded corner on the unfolded sides of the paper.
2. Trace your pattern on a piece of large, stiff cardboard and cut it out.
3. Using crayons or paint, decorate your shield with your own design or follow the examples shown.
4. Cut a strip of cardboard and glue it securely to the back of your shield for you to carry on your left arm.

1. Make a pattern

2. Trace pattern on a piece of cardboard

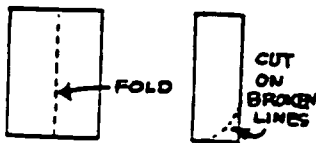

3. Create a design

4. Attach cardboard strip

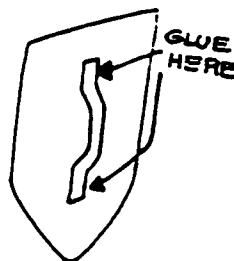
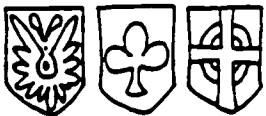

KNIGHTS/COSTUMES TUNIC

Try this pattern for an easy, anybody-can-make it tunic.

Material: 2 yards of fabric

- Directions:**
- Fold the 2 yards of fabric in half.
 - Cut a slit in the neck.
 - Seam bind around the edges or turn the edges under and stitch.
 - Sew the seams along the dotted lines.
 - Hem the bottom.

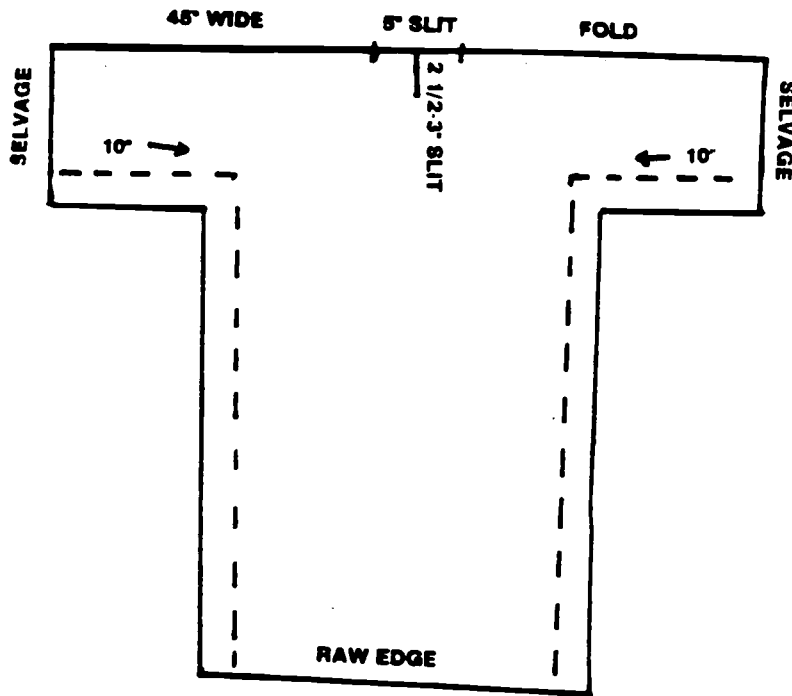

131

KNIGHTS/GAMES AND ACTIVITIES

JOUSTING.

For an easier, safer version of the traditional joust, try hanging ring-toss rings from a doorway or ceiling and letting Knights try their hand at tossing bean bags through the rings. Place a masking tape marker closer on the floor for younger participants and one further away for older, taller Knights. Signal each one to begin with a cry of "Charge!"

BANANA JOUST.

A messier but livelier version involves helping children make shields (see Crafts section), then conducting a joust with bananas or other soft objects such as dill pickles. Begin each event with the drop of a handkerchief. The victor is the one with the most banana intact, while the loser's has suffered greater damage. Involve other children as "squires" to rush in between rounds to clear the field of any excess bananas or peels.

FUN FENCING!

Pair up participants of approximately the same size and arm each with a soft sword. (You can find these in stores or make them yourself by cutting out long, narrow wedges from foam pieces. A less expensive but messier sword can be made from three or four sheets of newspaper, stacked and rolled diagonally. Twist one end back into a loop and tape in place for a handle. Swords should be at least 2 feet in length.) Appoint the previous two Fencers to serve as judges and, on the word "Go," Fencers try to touch each others' torsos with the tip of the sword. Touches to the arms, legs or head don't count. However each touch to the torso is a hit, and the first to score five hits is the winner. You can keep a log of winners and pair up winners until a Master Fencer is identified.

SPOON JOUSTING.

During the Middle Ages in Europe, soldiers were called knights. When life got dull, they played battle games. Each player has two table spoons or teaspoons or a small potato. The potato goes on one spoon. With the second spoon, try to knock the potato off the other players spoon. Match winners until there is a champion.



Dragons

HAVE A "DRAGON" DAY

1. Have children draw pictures of dragons.
2. Read dragon stories.
3. Sing "Puff the Magic Dragon" with the children.
4. Play "Dragon, May I?" (instead of "Mother, May I?")
5. Play "Pin the Tail on the Dragon".
6. Make dragon finger puppets.
7. Duplicate a drawing of a dragon and have the children write dragon poems on the dragon.
8. Make a dragon mask.
9. Go on a "Dragon Hunt".
10. Have a dragon picnic.

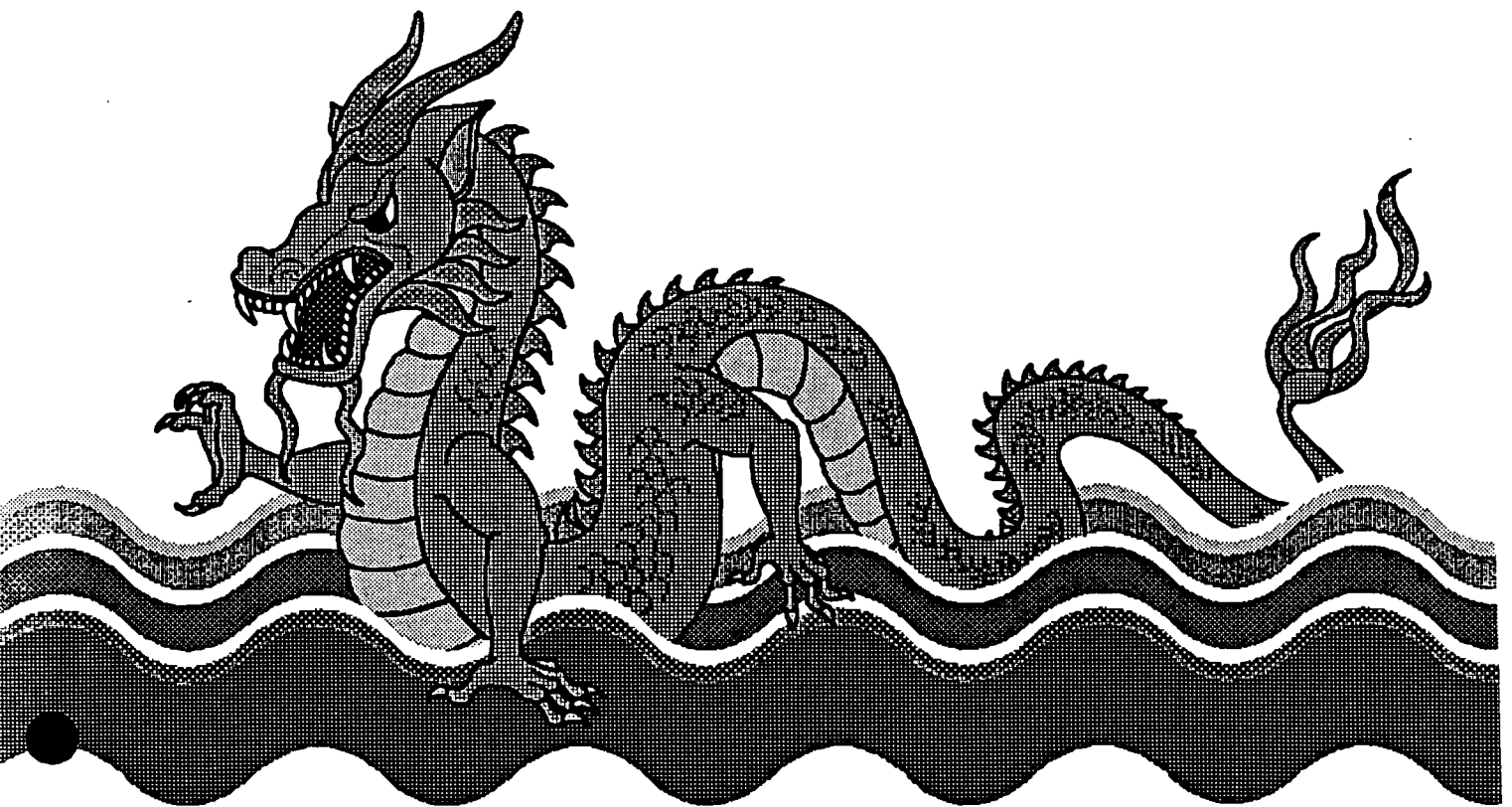



© Michael Wimmer

PROGRAM SKETCHES/DRAGONS

THEME TITLE: **POPCORN DRAGON**

AGE RANGE: Primary (5-7 year olds)

BOOKS/STORIES: Tell or read the story The Popcorn Dragon by Jane Thayer. (Morrow, 1953)
Dexter the dragon learns that others don't like it when he is a show-off. He channels his firebreathing ability into popping corn for everyone.

ACTIVITIES:

- ~ Make a popcorn dragon "popper" cover
- ~ Have a "dragon" popcorn party
- ~ Do dragon fingerplays
- ~ Share some red hots with the children and they will all have "dragon breath".

POPCORN DRAGON

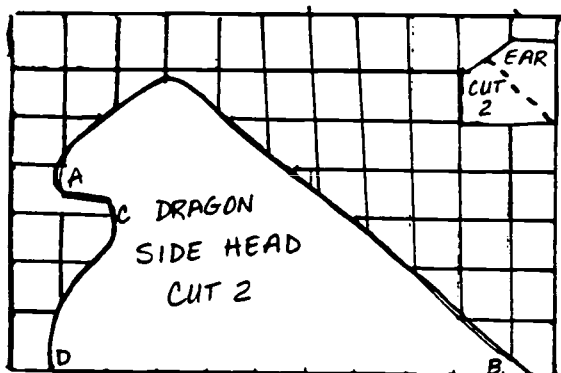

Enlarge grid to 2" squares.

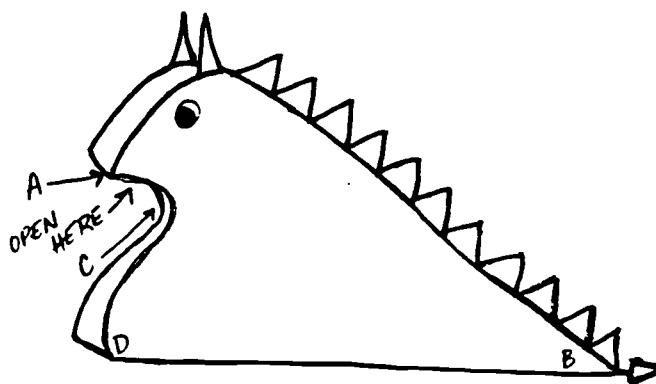

Pattern-fits over a hot-air popcorn popper.

Directions:

Cut pieces of the enlarged pattern

Cut strip 22" by 6" for back of neck and head of dragon

Cut strip 11" by 6" for throat of dragon

Cut eyes or use eyes purchased at craft store

In felt, sew with 1/8 inch seam allowance on outside

Pin "back" to side head from A to B

Repeat for other side

Ears are folded twice to help them stand up. Pin ears in place on seam. Stitch on machine.

Pin "throat" to side of head from D to C.

Repeat for other side. Stitch.

There should be open space for "mouth" for popcorn to come out.

Glue eyes in place.

Cover dragon's back with scales. You can glue any type of "scale" to the felt. Be creative.

PROGRAM SKETCHES/DRAGONS

THEME/TITLE: DRAGON POETRY

AGE RANGE: Upper Elementary (8-12 years olds)



BOOKS/STORIES:

Share your favorite poem from The Dragons Are Singing Tonight by Jack Prelutsky. (Greenwillow Books, 1993)
A collection of poems about dragons, including: "I'm an Amiable Dragon," and "If You Don't Believe in Dragons".

Put the poem on a transparency so the children can share the poem with you.
Have the children draw and color a dragon to take home with a copy of the poem.

or

The Tale of Custard Dragon by Ogden Nash.

The Gold-Tinted Dragon by Karla Kuskin.

A Modern Dragon by Rowena Bennett

The Toaster by William Jay Smith

Dragon Smoke by Lillian Moore

ACTIVITIES: Have a dragon poetry party. Have the children copy or write a dragon poem on the following pattern.

PATTERN:

"Dragon shape". Add and decorate a cover to produce their own Dragon Poetry Anthology. (pattern on the next page)

- ~ Have each child share his/her poem aloud
- ~ As a group - create a dragon "Cinquain" poem (see sample page -----)

DRAGON POETRY FORM

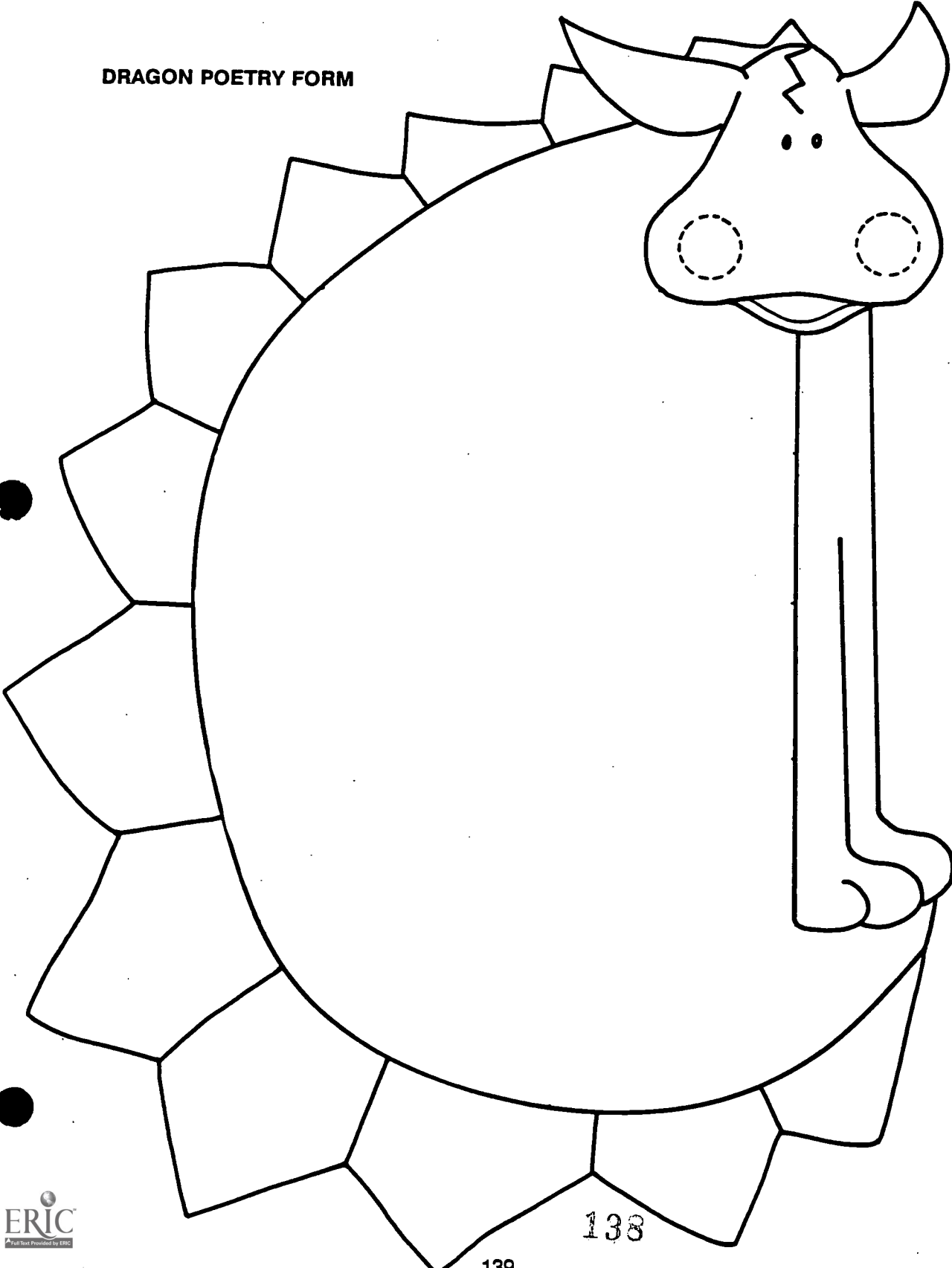

Dragon Poems:

Lost and Found

Lost:

A Wizard's loving pet.
Rather longish.
Somewhat scaly.
May be hungry or upset.
Please feed daily.

P.S. Reward

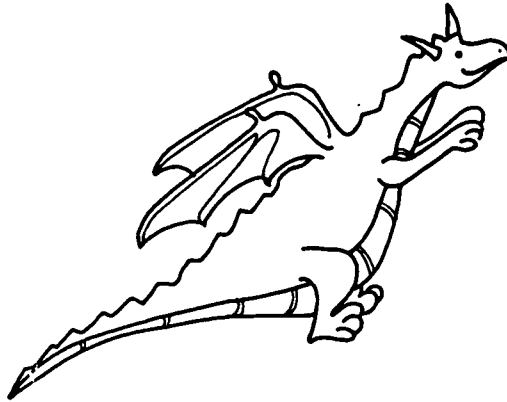

Found:

A dragon breathing fire.
Flails his scaly tail in ire.
Would eat twenty large meals daily
if we let him.

PLEASE

Come and get him.

P.S. No reward necessary.
Lillian Moore

The Gold-Tinted Dragon

What's the good of a wagon
Without any dragon
To pull you for mile after mile?
An elegant lean one
A gold-tinted green one
Wearing a dragonly smile.
You'll sweep down the valleys
You'll sail up the hills
Your dragon will shine in the sun
And as you rush by
The people will cry
"I wish that my wagon had one!"
Karla Kuskin

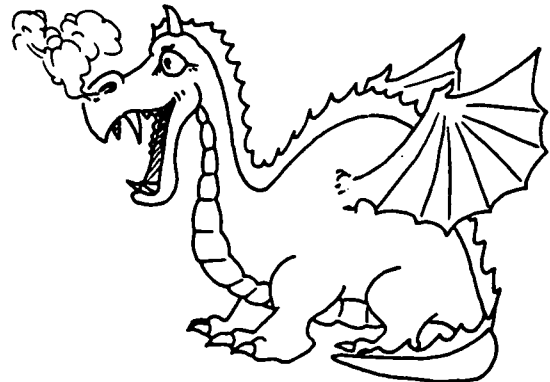

CREATE A DRAGON CINQUAIN POEM

Cinquain - five lines in this pattern:

- Line 1 - one word (title)
- Line 2 - two words (describe the title)
- Line 3 - three words (describe an action)
- Line 4 - four words (describe a feeling)
- Line 5 - one word (about the title)

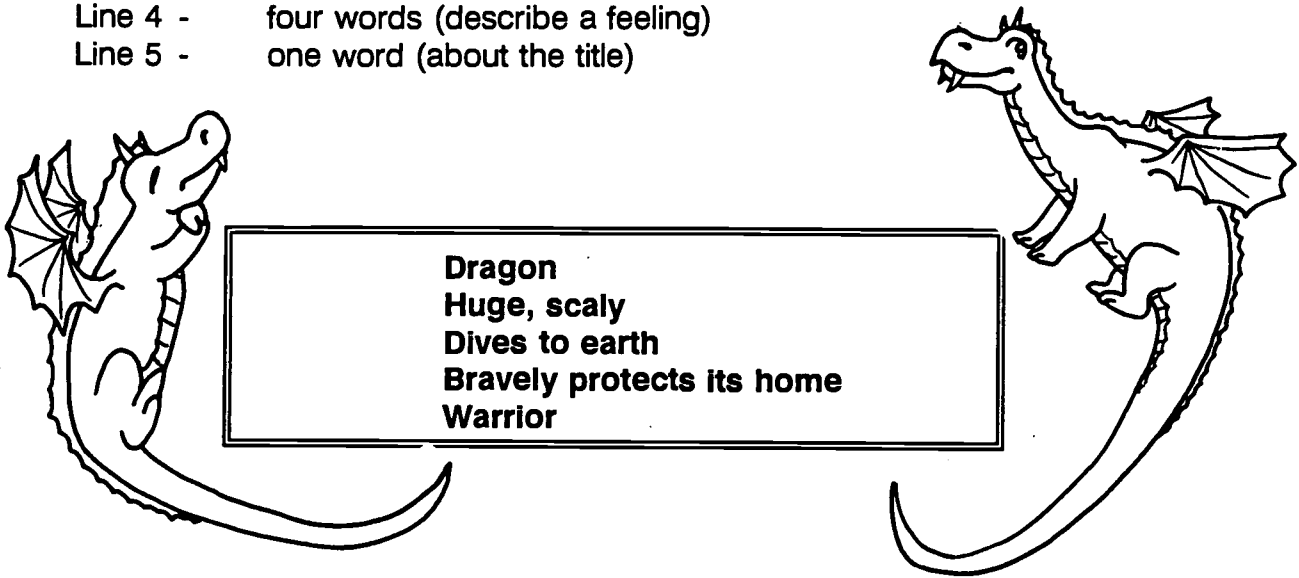

- Line 1 - Pick a one word title
Example - Dragon
- Line 2 - Think about two words that describe a dragon.
Example - huge, scaly OR flaming nostrils
- Line 3 - Think about three words that tell about an action a dragon might make.
Example - follows a knight OR dives to earth
- Line 4 - Think about four words that tell how the dragon might feel.
Example - bravely protects its home OR eager for its dinner.
- Line 5 - Think of words that tell about dragons.
Example - warrior OR hungry OR mythical.

DRAGON POEMS

Where Did They Go?

Dragons flew over castles.
Dragons flew over clouds.
Dragons gathered in flocks in the sky.
Dragons flew in graceful crowds.
I've searched the sky for hours.
I've searched the sky,
for a lifetime it seems.
I've looked for the wisp of a tail or scale.
I've searched my mind -
were they only in my dreams?
Where did they all fly off to?
Where did they decide to land?
Where on earth - or was it beyond?
Where did they go? I don't understand.

Leslie Tryon



Dragon

Mythical beast
Watches a passing knight
Silent death dropping from the sky
Battle

J.E. Moore

141

PROGRAM SKETCHES/DRAGONS

THEME/TITLE: "In Quest of Dragons"

AGE RANGE: Preschool - 2nd graders

BOOKS/STORIES:

Introduction - For fun before you begin, you could help children collectively describe a dragon on their own by asking leading questions: (1) Does it have scales? (2) What color is it? (3) Does it have claws? (4) How many on each foot? (5) Is it hungry? (6) What does it eat? and so on. Provide a verbal summary or "portrait" of their creation. At the end, tell them they all had good ideas, and then lead into a book by saying it is another person's idea about a dragon and its story.

or

Other dragon books from Dragon Tales Bibliography, page 167.

MEDIA:

Video: "Pete's Dragon"

Recording: "Puff the Magic Dragon"

ACTIVITIES:

- ~ Dragon Finger Puppets
- ~ Dragon Masks

EXTENDERS: (Arts and Crafts)

- ~ Invite the children to go on a "Dragon Hunt"
- ~ Snack - serve Dragon Punch (green punch) and Dragon's Teeth (lime jello cut into elongated triangles)
- ~ Dragon games

HANDOUTS:

- ~ Nap Time - Dragon picture search

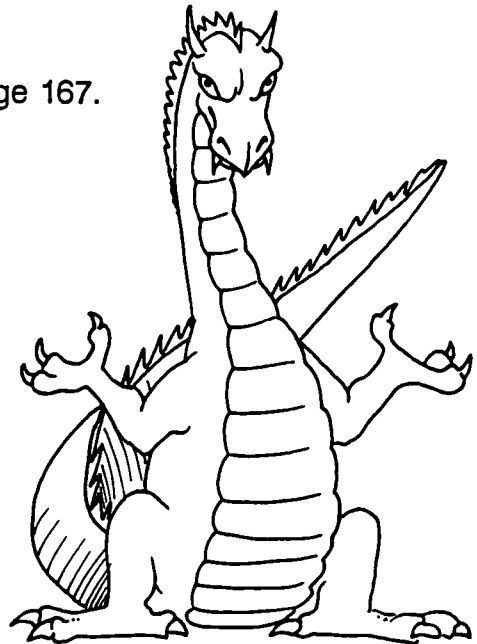

Dragon Finger Plays:

FIVE OLD WIZARDS FINGERPLAY

There were five old wizards
Sitting by the fire

(Hold up hand)

The first one said,
"What do I see?"

(Hold hand above eyes)

The second one said,
"I smell a dragon."

(Sniff around)

The third one said,
"Let's all run."

(Fingers run out)

The fourth one said,
"Let's hide in the shade."

(Put right hand under left arm)

The fifth one said,
"I'm not afraid"

(Put chest out)

"Boo" went the dragon
and away they all run

(Clap hands
Put hands behind you)

MISTER DRAGON

This is Mister Dragon

(Make fist -- hold out thumb)

He lives in a cave

(Interlock fingers, thumbs touching
at tips)

He likes his home very well

He roams the countryside on scaly feet.

(Walk fingers slowly up arm)

But, he always returns to his dark, dark cave.

(Walk fingers slowly down arm
and make cave as above)

Dragon Finger Plays:

DRAGON FRIENDS

Who's that knocking on the castle door?	(Mime knocking)
One dragon, 2 dragons, 3 dragons, 4!	(Hold up fingers successfully)
Who's that swinging on the castle gate?	(Rock back and forth)
Five dragons, 6 dragons, 7 dragons, 8!	(Hold up fingers successively)
Here come dragons 9 and 10.	(Hold up last two fingers)
Now let's do it all again!	(Clap hands)
(On the last verse, substitute for last line:)	
Say goodbye to dragon friends.	(Wave)

LITTLE HUEY DRAGON DRESSES UP RIGHT

Little Huey Dragon says, "It's time to go to town."	(hands on hips)
Little Huey Dragon dresses up to down	(touch head) (touch feet)
Little Huey Dragon puts on a hat;	(place palm on head)
Little Huey Dragon gives his tummy a pat.	(pat stomach)
Little Huey Dragon puts on his shirt;	(put on an invisible shirt)
Little Huey Dragon brushes off some dirt.	(brush sleeves, frowning)
Little Huey Dragon wears a tie.	(twiddle fingers at throat)
Little Huey Dragon rubs his eye.	(rub eyes)
Little Huey Dragon steps into his slacks.	(step into imaginary slacks)
Little Huey Dragon scratches his back.	(scratch back)
Little Huey Dragon puts on his shoes and socks	(do so)
Little Huey Dragon doesn't ride, he walks.	(walk in place)

LITTLE HUEY DRAGON

(An exercise)

Little Huey Dragon counts to three,
Little Huey Dragon bends one knee.
Little Huey Dragon whistles and sings. (la)
Little Huey Dragon touches his toes.
Little Huey Dragon touches his nose.
Little Huey Dragon makes a funny face.
Little Huey Dragon runs in place.
Little Huey Dragon lays on the floor.
Little Huey Dragon starts to snore.

Dragon Finger Plays:

THIS LITTLE DRAGON

This little dragon broke his toe.
This little dragon cried oh, oh, oh.
This little dragon laughed and was glad.
This little dragon cried and was sad.
But this little dragon did just as he should,
And ran to the doctor as fast as he could.

This little dragon eats grass.
This little dragon eats hay.
This little dragon drinks water.
This little dragon runs away.
This little dragon does nothing,
but sleep away the day.



THE DRAGON SONG

(Tune: When Irish Eyes Are Smiling)

When dragon eyes are glowing,
and you see those big red veins,
you know a dragon is near you.
He will make you turn and run.
When dragon nostrils are flaring,
and you see that flaming breath,
there is no time to hesitate,
for dragons do not play.

Dragon/Finger Puppet Plays:

FIVE LITTLE DRAGONS

Five little dragons trying to breathe fire.
One got scorched, then there were four.

Four little dragons trying to scare a knight.
The knight said Boo! And one ran from fright.

Three little dragons running through the woods.
One got lost, and then there was two.

Two little dragons running through the woods.
One got lost, and then there was one.

One little dragon sitting all alone.
There was nothing else to do, so he went home.

Pattern:

FINGER PUPPET

Directions:

Cut five out of construction paper.

Color and decorate with magic markers.

Use tape to affix to fingers.

Use with any or all of the dragon finger plays.

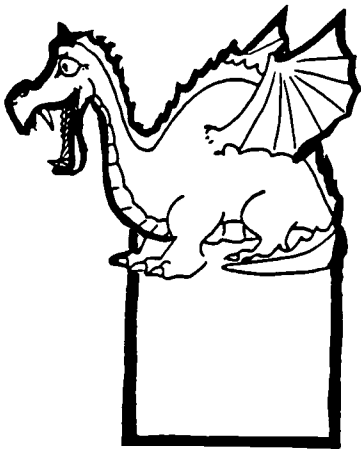

DRAGON, DRAGON ACTION RHYME

(Ask children to pretend that they are dragons. Then have them follow the rhyme.)

Dragon, dragon turn around.
Dragon, dragon now sit down.
Dragon, dragon wrinkle your nose.
Dragon, dragon wiggle your toes.
Dragon, dragon look up high.
Dragon, dragon wink you eye.
Dragon, dragon let your hands clap.
Dragon, dragon lay them in your lap.
Dragon, dragon look at me.
Dragon, dragon now quiet be.

Dragon Song: "Puff the Magic Dragon"

Puff the magic dragon
Lived by the sea
And frolicked in the autumn mist
In a land called Honah Lee.

Little Jackie Paper
Loved that rascal, Puff,
And brought him strings and sealing wax
And other fancy stuff.

Together they would travel
On a boat with billowed sail
Jackie kept a lookout
Perched on Puff's gigantic tail.

Noble Kings and Princes
Would bow whene'er they came,
Pirate ships would low'r their flag
When Puff roared out his name.

A dragon lives forever
But not so little boys,
Painted wings and giant rings
Make way for other toys.
One gray night it happened,
Jackie Paper came no more
And Puff that mighty dragon,
He ceased his fearless roar.

His head was bent in sorrow,
Green scales fell like rain,
Puff no longer went to play
Along the cherry Jane.
Without his life-long friend,
Puff could not be brave
So Puff that mighty dragon,
Sadly slipped into his cave.

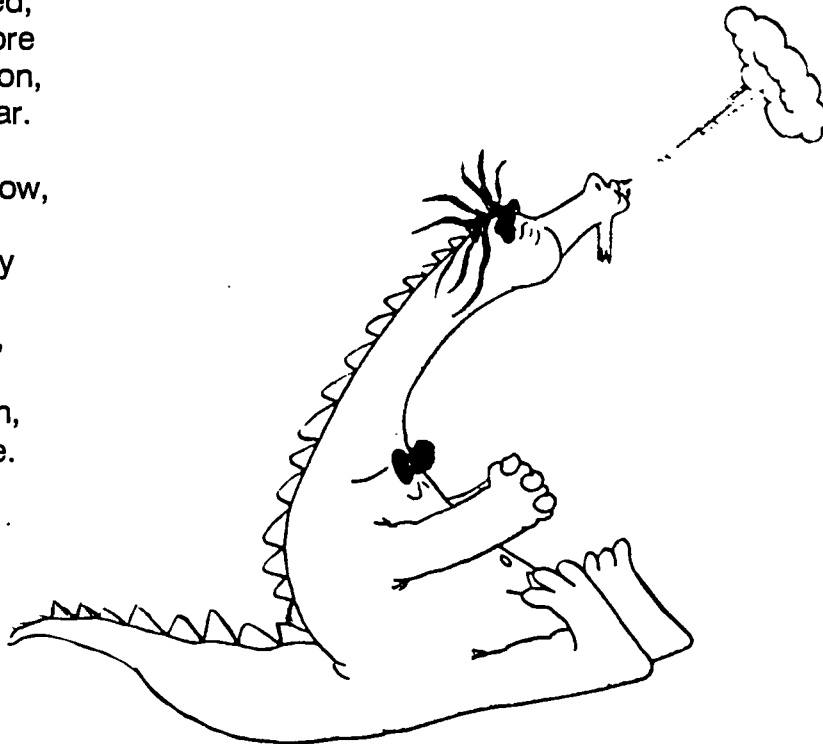

Dragon/Games:

Chase the dragon's tail: For this game, all of the players must line up behind the one who has been chosen to be the dragon's "head". Each child puts his/her hands on the shoulders of the person in front of him/her. The object of the game is for the "head" to catch the "tail", the last person in line. No one may let go of the shoulders of the person in front of him/her, but the line may maneuver to help the "tail" keep from getting caught. When the "tail" has been caught, that person is out of the game; the "head" becomes the new "tail" and the game continues until there are only 2 players left.

*Note: You may want to divide into groups of 10 to make this activity more manageable.

Dragon Hunt, played in masks. Before the program, hide one or more "dragons" (stuffed, plastic or paper) in the library. Have prizes available for those who find the dragons.

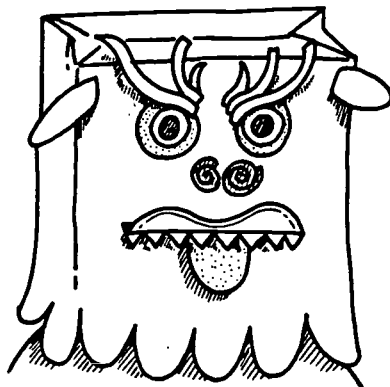

"Dragon Masks"

Create masks from brown paper bags, construction paper scraps, felt or materials scraps, etc.

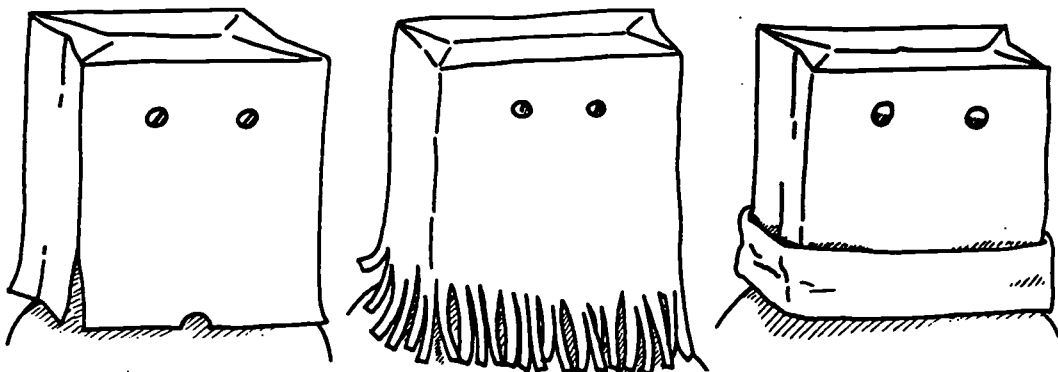

IMAGINE A DRAGON

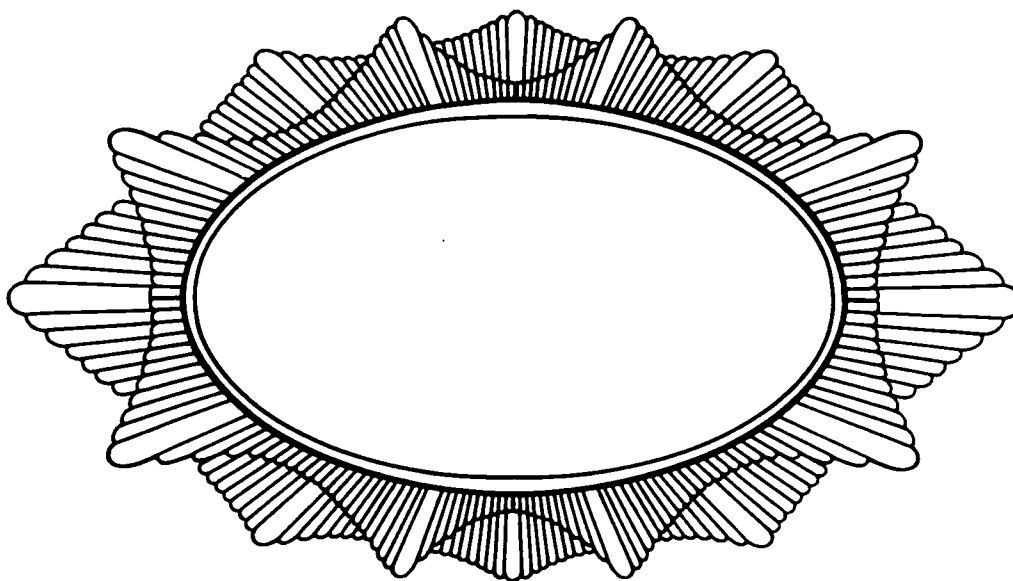

Does your dragon have...

scales? _____

wings? _____

claws? How many? _____

What is your dragon's name? _____

Describe your dragon:

length _____

weight _____

body covering _____

color _____

age _____

Write a paragraph describing the special talents and characteristics of your dragon.

A DRAGON INTERVIEW

Note: Have the children work in pairs. One portrays the dragon, the other conducts the interview. With younger children, select a dragon and have the rest of the children conduct the interview as you write down the answers.

What is your name? _____

Where were you born? _____

Where do you live now? _____

Tell about your childhood. _____

What makes you sad? _____

What makes you happy? _____

Other questions:

LET'S GO ON A DRAGON HUNT!!

Note: Have the children chant, repeating what you say.

Let's go on a dragon hunt. OK. Let's go. (hit knees with hands as if walking)
What's that up ahead? Looks like a Drawbridge.
Can't go round it.
Can't go under it.
Have to cross over it. (hit chest with fists)
Sure was a long Drawbridge.
Sure was. (resume hitting knees)
What's that up ahead? Looks like a moat.
Can't go over it.
Can't go under it.
Can't go round it.
Have to swim cross it. (make swimming motions)
Sure was a wet moat.
Sure was.
What's that up ahead? Looks like a tall tree.
Can't go under it.
Can't go over it.
Can't go through it.
Let's climb up it.
Maybe we'll see a dragon! (make climbing motions up, look around, climb down)

No dragons up here.
Nope.
What's that up ahead? Looks like a tall grass.
Can't go under it.
Can't go over it.
Have to go through it. (rub hands together to make swishing sound)

Sure was tall grass.
Sure was.
What's that up ahead? Looks like a cave.
Can't go over it.
Can't go under it.
Can't go round it.
Have to go into it. (hit knees very softly)
Sure is dark in here.
Sure is.
What's that up ahead?
Looks like two big red eyes.
IT'S A DRAGON! RUN!!! (hit knees quickly)
LET'S NOT GO ON A DRAGON HUNT! OK! (reverse all steps through to the end)

Dragon/Display:

Dragon Display

Construct a large dragon of cardboard, cloth, or other material. Use for display in the library or the children's room. When the children read a book, let them write their name and the title of the book on a scale and attach it to the dragon. Cut the scales in advance. Use glue, tape, or pins to fasten on the scales.



"Keys to the Castle" was the Wayne Oakland Library Federation's Summer Reading theme. At Milford (Michigan) Township Library, this medieval theme was picked up by Children's Librarian Sue Ellen Madere. Library page Michelle Colquitt drew this fire-breathing dragon, proudly displayed for the photographer by (l.to r.) Erik Knedgen and Suzanne and Kristine Lyndon. By summer's end, the dragon was covered with 2,259 green scales, each of which represented one book read

Dragon Feet/Display:

Some say he's romping through the dunes
at Jericho.

Others say they saw him slinking through
Monument Valley.

Still others think he's floating in the
Great Salt Lake.

But I say he's hiding, somewhere in your
own backyard!

So, if you happen to see footprints bigger
than these -
RUN QUICK!!

To Make Dragon Feet, you will need:

Five large supermarket bags (for two feet)
Newspaper
Crayons or felt-tip markers
Scissors and glue

Construction:

1. Stuff a bag loosely with crumpled newspaper.
2. With open ends facing one another, slip a second bag entirely over the stuffed bag, as shown and glue them together.
3. About three fourths of the way back cut a hole in the top of the bags that is large enough to put your foot through.
4. Cut out dragon toes from the extra bag and glue onto the front edge of your bag. Color toe nails whatever wild way you want.
5. Make a second foot so you will have a pair.
6. Slip your feet inside the holes in the bags, pressing down into the newspaper until they fit comfortably.

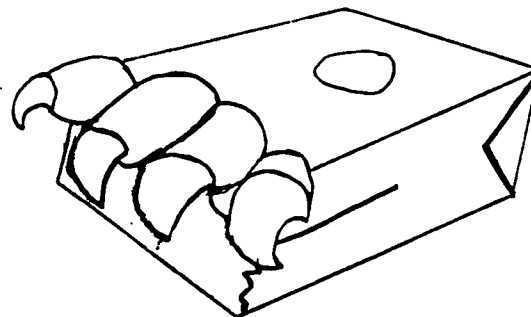
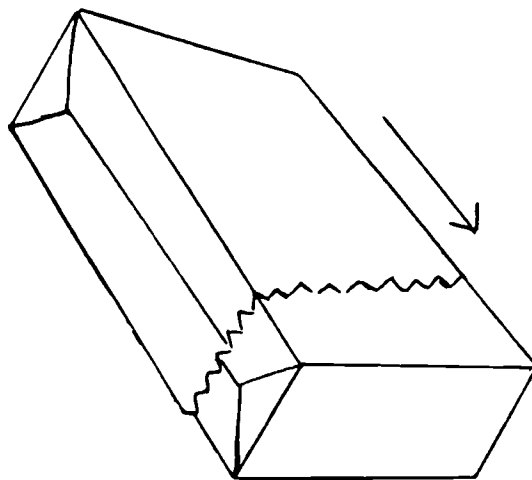

Now go scare someone!!

Dragon/Display:

DRAGONS AROUND THE LIBRARY: Make a dragon with five or six cardboard boxes painted green and loosely connected with rope. Make cutout cardboard eyes, nose and teeth for the "head" box and a tail for the last box. Cut small eyeholes for dancers to peep through. Children can carry the boxes over their heads and do crazy dance steps to whatever music you choose! This dancing dragon can appear at library programs as well as at community events.

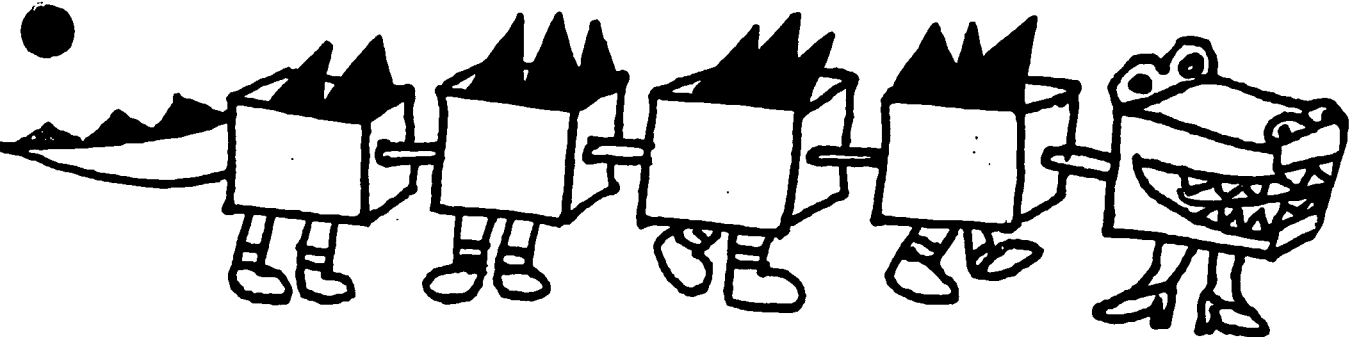

DRAGONS/ARTS AND CRAFTS

EGG CARTON DRAGON

Materials: 1 cone shaped pressed cardboard egg carton, glue, scissors, sharp knife, green acrylic paint, #5 brush, #7 eyes.

Construction:

1. Three cone shapes and end of center section will be used for the dragon body. Cut off each side of egg carton; then cut off 3 cones and end of center section. The other two cones will be head and feet of the dragon.

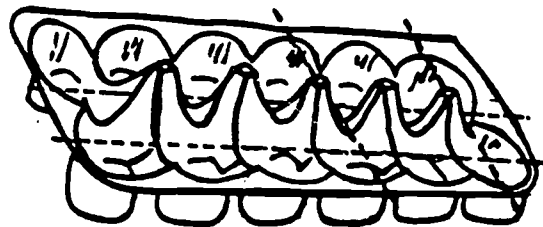

2. If the carton is not cone-shaped, you may cut a slit along the front edge of the first cone of the body. Form into triangular shape by overlapping the two sides and gluing them together. This will shape the neck.

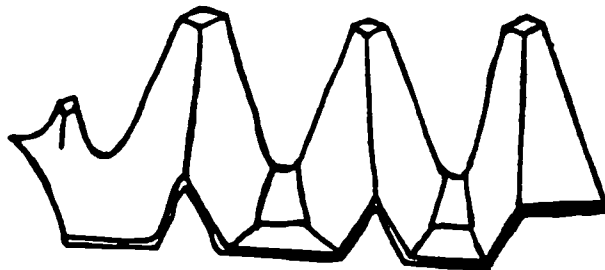

3. Cut off end part of the 2 cone section. Place in lower opening of the dragon's neck section. This will be the feet. Glue together.

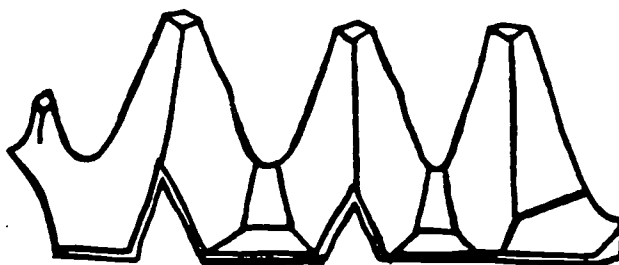

- Trim the remaining cone for the head and ears. Leave a triangular shape to form the ears.
- Glue the head on the top of the front cone. Allow enough time for this to dry. With sharp knife, carefully cut through center of carton. Do not make the opening any larger than necessary. Do not cut the section completely through. Make a slit in it across the top. Begin cutting, as indicated by broken lines. Also cut as indicated on head.

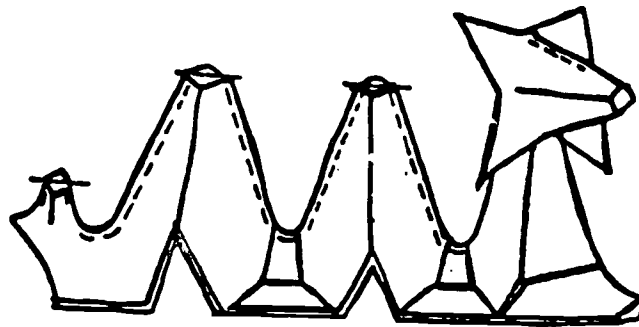

- Use the other portion of the egg carton for scales. Length for tail scales should be about 3 or 4 inches long; head scales should be about 2 to 3 inches long; body scales should measure $\frac{5}{8}$ inch wide by 1 inch. Cut tongue from red felt. Paint dragon; let dry.

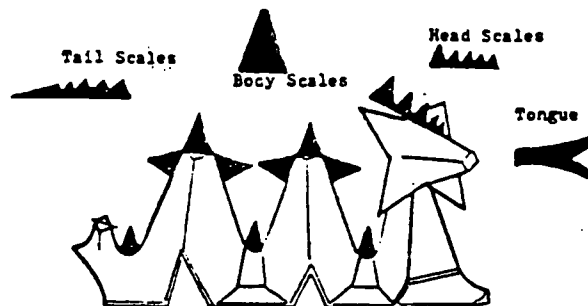

- Glue tongue and eyes in place. Fold ears forward. Your dragon is completed.

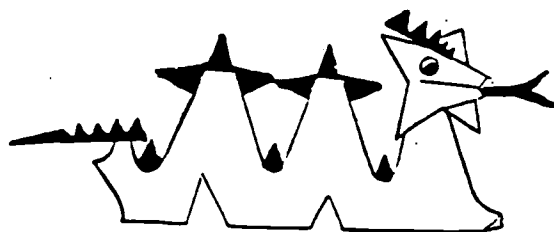

DRAGON/ARTS AND CRAFTS "Smoke Breathing Dragon"

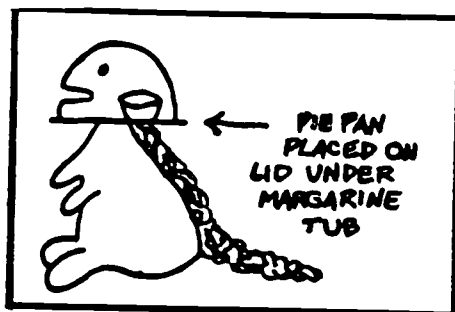

Feed this dragon dry ice chips with teaspoons of water and watch him smoke!

Materials needed: 1 gallon plastic milk bottle, 1-2 lb. margarine container with lid, 1 small (pot pie size) aluminum pie tin, 1 package of Dip and Drape materials, newspaper, masking tape, scissors and craft knife.

For body, cut off the handle of the milk bottle. Cut the handle in half for arms, and poke into sides of milk bottle. Tape in place.

For head, remove lid from margarine tub. Turn the tub upside down. Cut out a large mouth as shown. Cut two ears from left over scraps; insert in head.

Cut a hole in the lid to match the neck of bottle. Place the aluminum pie pan on the lid. Replace margarine tub on lid, tape head on bottle neck.

For tail, wad up newspapers and tape them to the back side of the milk container. Then use one wad of newspaper for each foot, and tape to body.

For skin, follow the directions on the Dip and Drape package. Cover head first. Cut around mouth opening, and tuck the rough edges inside mouth, shaping fangs as you do so. Cover the body next, then, use smaller pieces of Dip and Drape to cover feet, arms and ears. Be sure that dragon is completely covered.

For points down Dragon's back and tail, measure the back and tail of the dragon. Cut a piece of Dip and Drape material to measure five inches wide and three inches longer than the tail. Fold in half lengthwise. Cut on fold over 3" along the length of the strip.

Dampen Dip and Drape with a cloth. Position on top of back and tail. Fold down corners of Dip and Drape to make triangle shapes.

Allow to dry overnight. Paint with acrylics or latex paint.

Dragon/Arts and Crafts: "Paper Dragon"

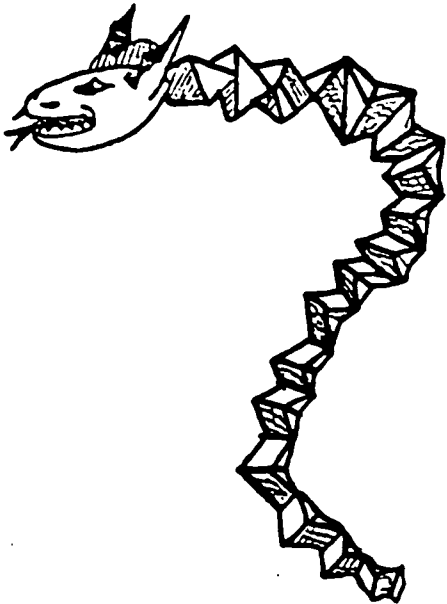

1. Take a long piece of wrapping paper and cut a double strip as shown in the picture. The two strips must get smaller at the ends.
2. Let the upper strip be y and the lower one be z. Lay strip y at a sharp angle over strip z so that they form a right angle.
3. Now lay strip y at a sharp angle over z to the left.
4. Overlap strip y upward over strip z. Then overlap strip z over y to the right. Continue with the overlapping until the strips are used up.
5. Paste the tips of the tail together so that they won't come apart. Fold the head part, which is still very broad, together lengthwise. Put the paste between these surfaces and press them firmly together. Form the mouth with your scissors. Add teeth, tongue, eyes, ears, and scales if you like. Be creative, it's your dragon.

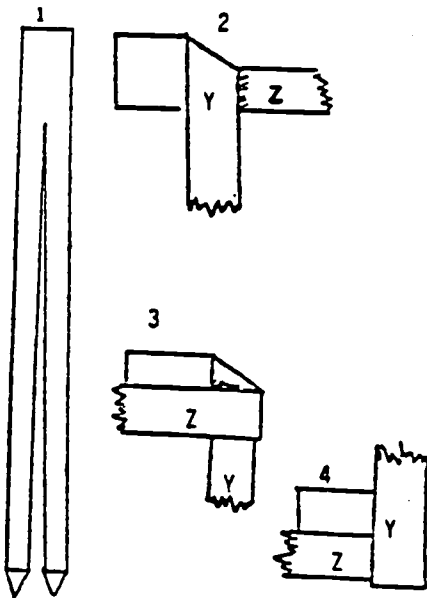

Dragon/Arts and Crafts: "Dragon Marionette"

Materials: Thin colored cardboard/construction paper or wallpaper sample sheets; string; short lengths of dowel or popsicle sticks; markers; scissors; ruler

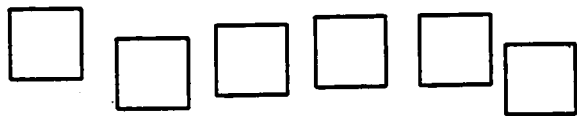

How to Do It:

1. Cut five or six 4" squares from the cardboard for each dragon. (Older children may cut for themselves. Younger children may need help or you might cut the squares ahead of time.)

2) Decorate five of the squares with scales and designs. Draw a profile face on the sixth square. Cut six 3" x 2" rectangles or connecting strips from the construction paper or wallpaper. Glue one connector to the back of each square so the connectors extend between the squares but allow each square to move independently.



3) Punch holes at the top of each square and tie a 5" length of string from each square. Tie the first three lengths of string to one popsicle stick or dowel. Tie the back three strings to the second popsicle stick.

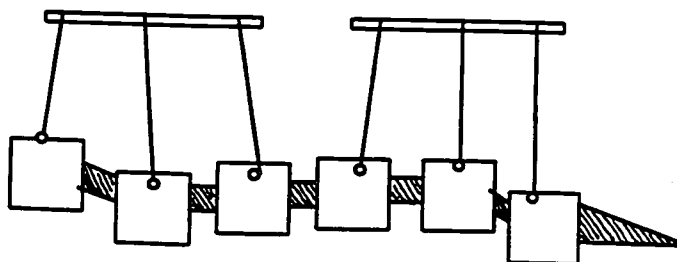

4) Fins, feet, wings and spikes may be cut from the wallpaper or construction paper and added to the dragon.

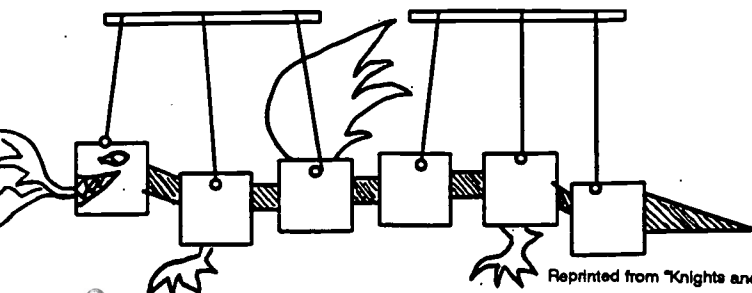

- 5) Children manipulate their marionette by holding one popsicle stick in each hand (and slanting) to move segments of the dragon.

Reprinted from "Knights and Dragonalls, 1990 Utah.

"Dragon Paper Bag Puppet"

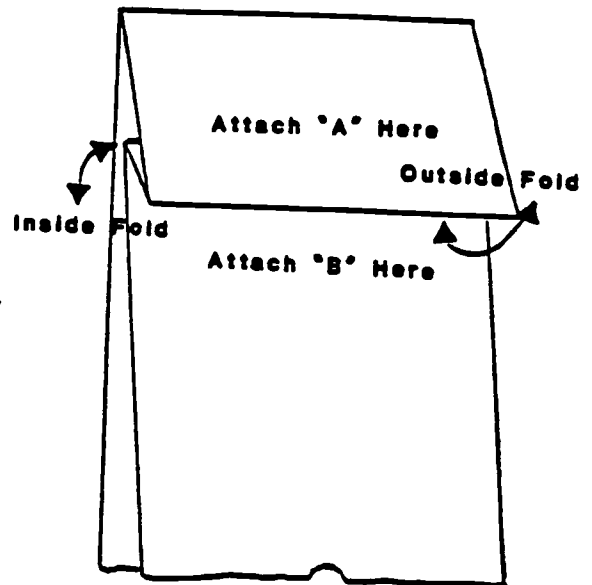
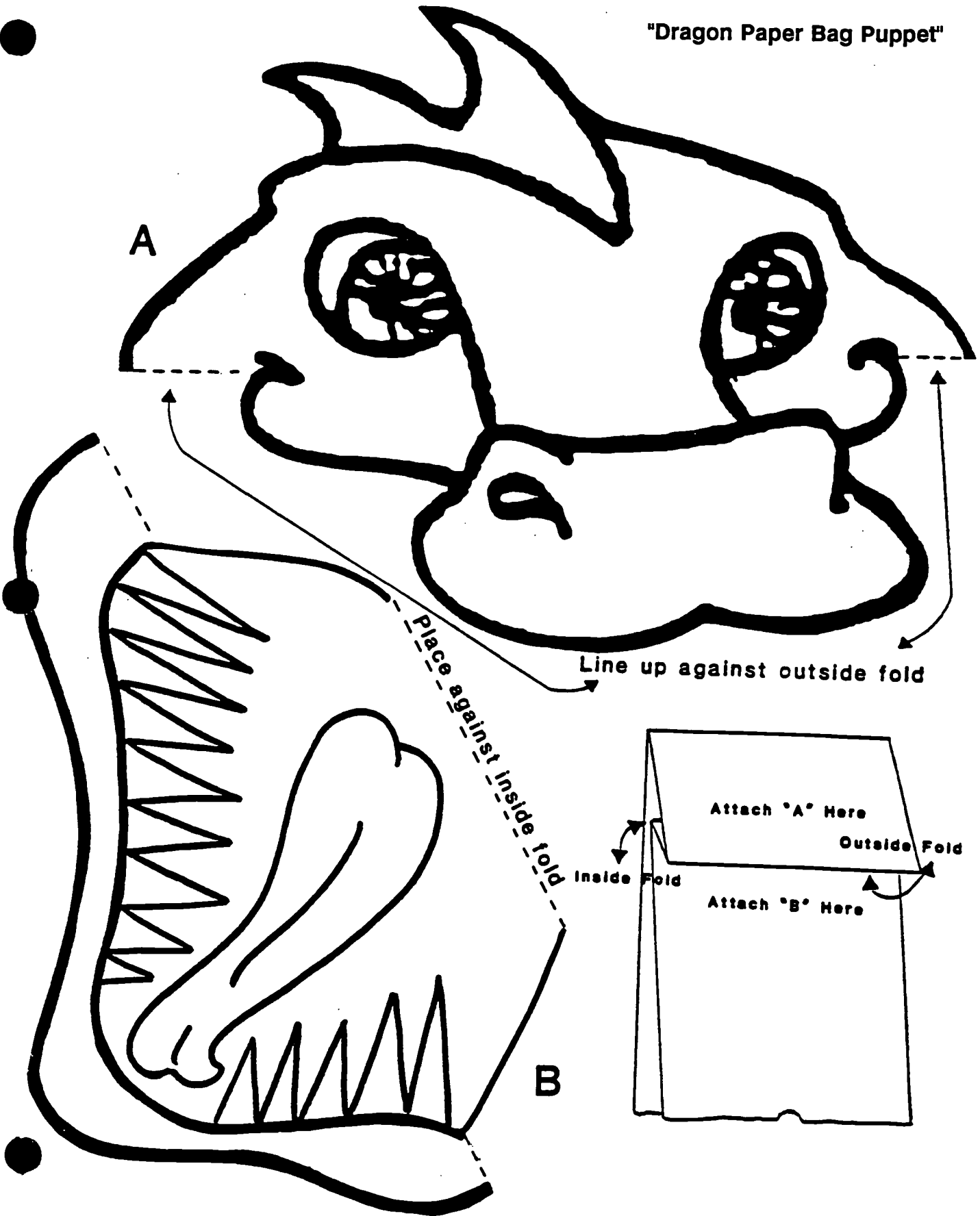

Dragon/Arts and Crafts: "Three-Fold Dragon"

Materials: green construction paper, 6" x 18" colored paper scraps, marking pens, scissors, paste.

1. Fold green 6" x 18" paper in thirds.

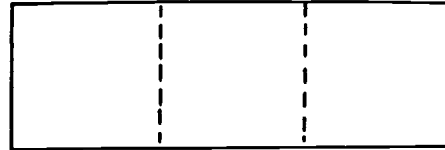

2. Round off top corners of Section 1. Zig-zag cut top edges of Sections 2 and 3.

3. Fold in Section 3; then fold in Section 1.

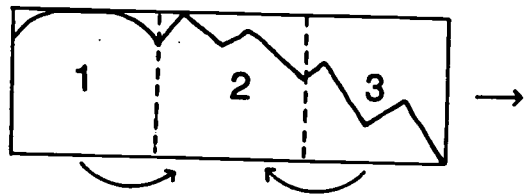

4. Let imaginations soar in creating a marvelous dragon face on Section 1. Write a message or poem on the middle section of the dragon.

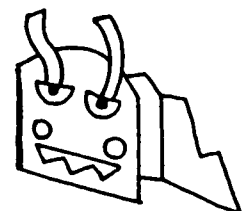
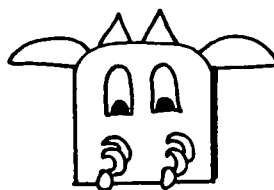
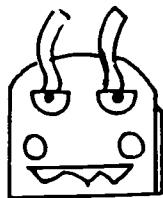
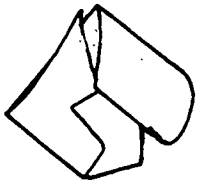

Dragon/Arts and Crafts: "Draw a Dragon"

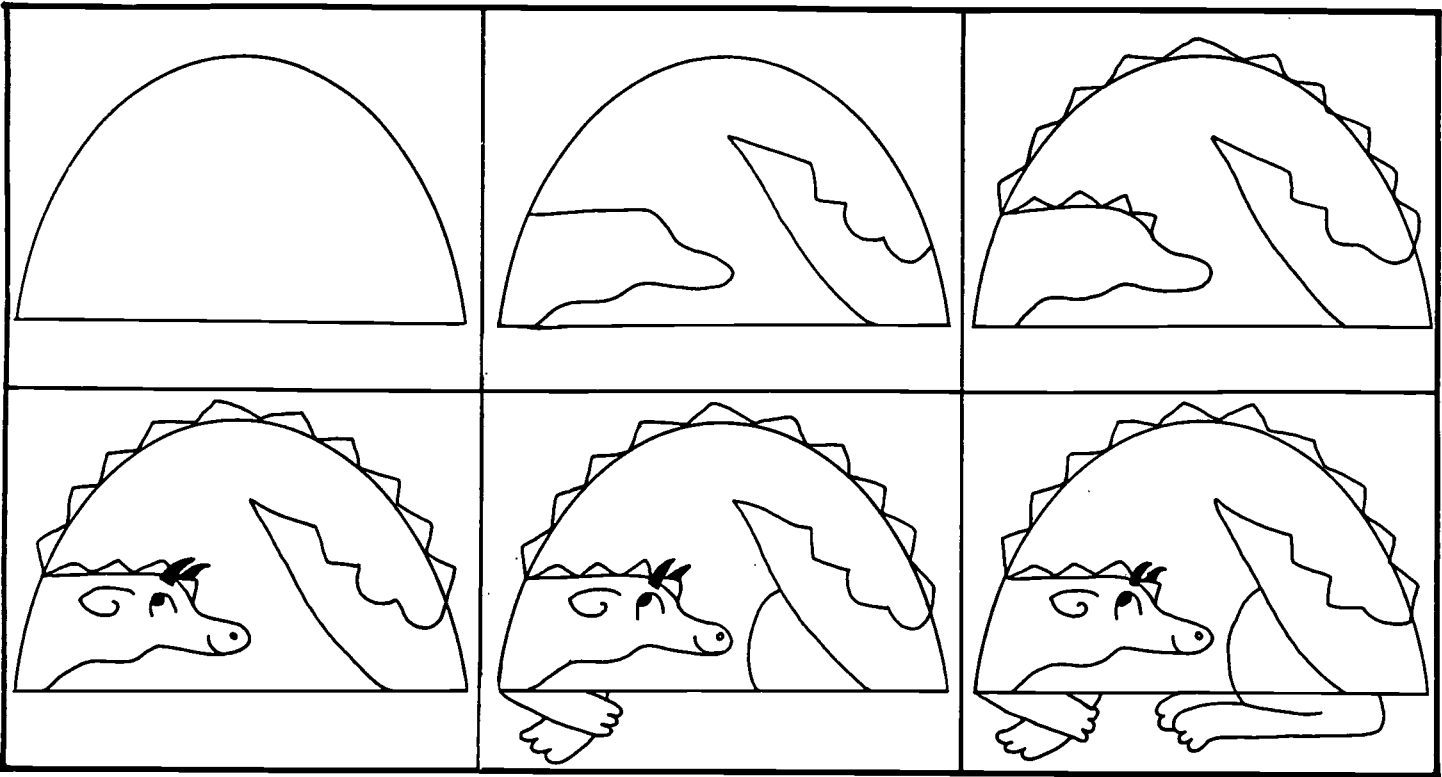

A Dragon Friend/Hand Puppet

A simple dragon can go home in each child's pocket! Have on hand 8½" by 11" medium green paper, small pieces of red and yellow paper, crayons and glue.

- Fold the green paper lengthwise into thirds as shown below.
- Fold the paper in half, then fold each end back toward the center fold as shown below.
- Reverse the center fold so that fingers and thumb can be inserted as shown.
- Use crayons to add scales, eyes, ears, nostrils, and teeth. Use red and yellow paper for tongue and "fire".

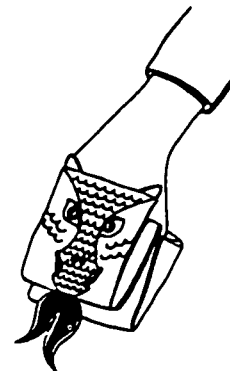
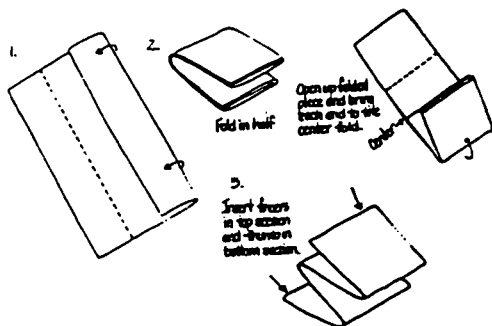

**DRAGON PICTURE
SEARCH**

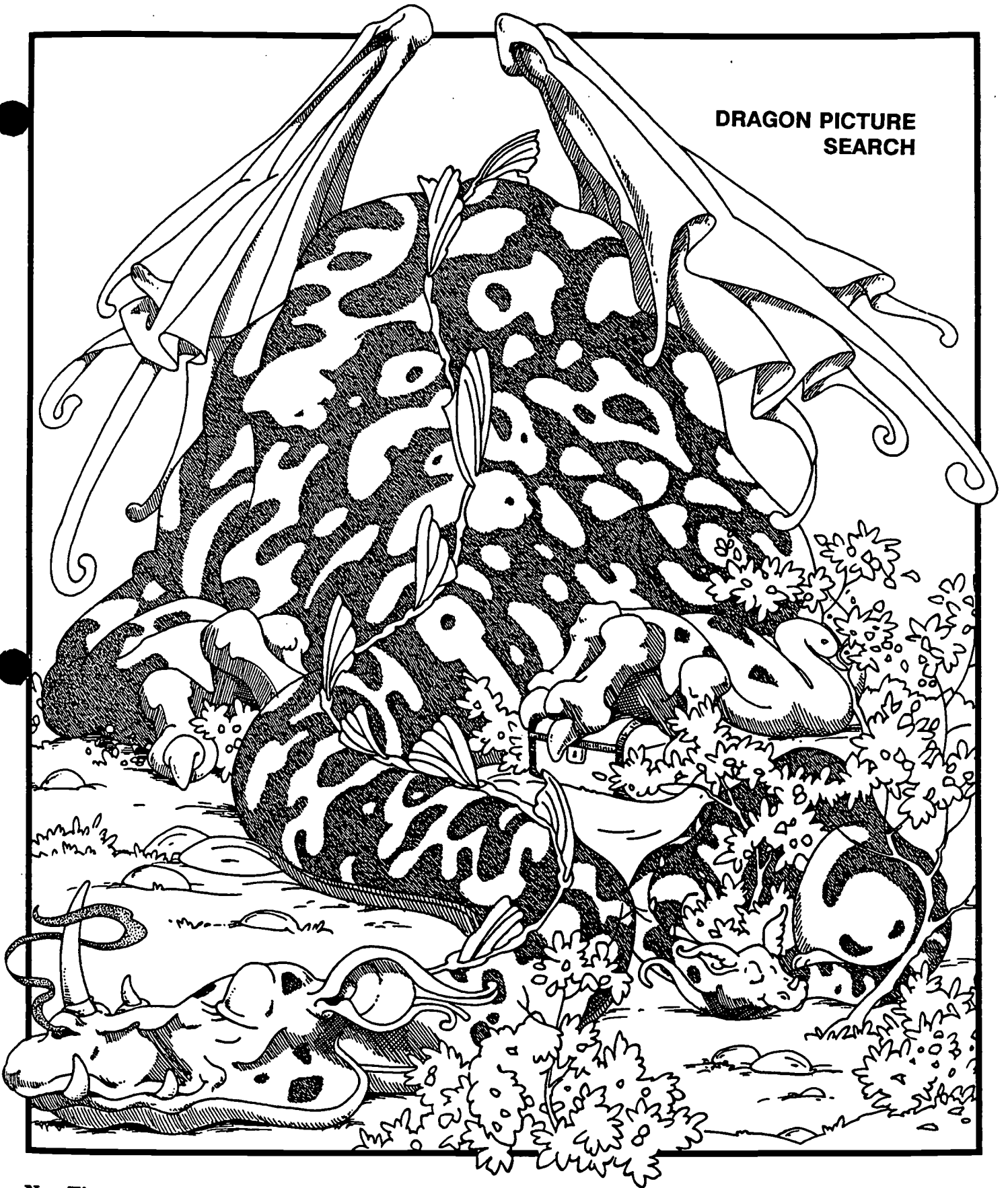

Nap Time

While Mom Dragon and her baby enjoy their afternoon nap, quietly search for a bell, closed umbrella, dog's head, vase, fish, musical note, tweezers, bird, rabbit's head, spoon, bone, mitten, three-leaf clover, butterfly, snake, swan, cat, key, and a beet.

Printed with permission of Highlights for Children, Inc., Columbus, OH. Copyright, 1995.

BEST COPY AVAILABLE

KEY - DRAGON PICTURE SEARCH



155: bell, closed umbrella, dog's head, vase, fish, musical note, tweezers, bird, rabbit's head, spoon, bone, mitten, three-leaf clover, butterfly, snake, swan, cat, key, beet

BIBLIOGRAPHY DRAGON TALES

A Friend For Dragon

By: Dav Pilkey

Orchard Books, 1991

ISBN: 0-531-07054-9, \$4.95, Ages 6-8

Dragon becomes such close friends with an apple that he deeply mourns its loss and is overjoyed when more grow to take its place.

Backyard Dragon

By: Betsy & Samuel Sterman

Harper Collins, 1993

ISBN: 0-06-020784-1, \$12.89

With the help of three friends, Owen and his grandfather help a 15th century Welsh Dragon (Wyrdryn) find his way home.

Beasties Coloring Book

By: Malcolm Whyte

Troubadour Press, 1970

ISBN: 0-8431-1719-2, \$3.95

This coloring book has 15 black and white drawings of creatures ranging from dragons to unicorns, with descriptions of all.

The Case Of The Dragon In Distress

By: E.W. Hildick

Macmillan Publishing Company, 1991

ISBN: 0-02-743931-3, \$12.95, Ages 8-12

The McGurk Organization members are transported back to the twelfth century where they encounter an evil princess who tries to hold them captive.

Dragon

By: Wayne Anderson

Green Tiger Press, 1992

ISBN: 0-671-78397-1, \$15.00, Ages 4-8

After hatching from an egg that fell into the sea, a creature that shares features with a fish, an insect, a bird, and a snake - but is not any of these - sets off to find its own kind and its mother.

Dragon Cauldron

By: Laurence Yep

Harper Trophy, 1991

ISBN: 0-06-440398-X, \$4.95, Ages 12-18

A dragon named Shimmer, a monkey wizard, a reformed witch, and two humans go on a quest to mend the magic cauldron needed to repair the dragon's home.

Dragon Poems

By: John Foster and Korky Paul

Oxford University Press, 1991

ISBN: 019-276096-3, \$12.95

A collection of poems about every kind of dragon you can think of.

The Dragons Are Singing Tonight

By: Jack Prelutsky

Pictures By: Peter Sis

Greenwillow Books, 1993

ISBN: 0-688-12511-5, \$14.95, Ages 4-8

A collection of poems about dragons, including "I'm An Amiable Dragon", "If You Don't Believe In Dragons", and "A Dragon Is In My Computer".

Dragons: Truth, Myth, and Legend

By: David Passes

Illustrations By: Wayne Anderson

Golden Books, 1993

ISBN: 0-307-17500-6, \$14.95

Presents various myths and legends about dragons and discusses dragon lore from around the world.

Dragon's Fat Cat

By: Dav Pilkey

Orchard Books, 1992

ISBN: 0-531-08582-1, \$12.99, Ages 6-8

Dragon finds a fat cat in the snow outside his house, brings it inside, and soon has a family.

Dragon's Merry Christmas

By: Dav Pilkey

Orchard Books, 1991

ISBN: 0-531-07055-7, \$4.95, Ages 6-8

Dragon has a merry time in the Christmas season, decorating a tree outdoors, making a chocolate candy wreath, and sharing his Christmas gifts with needy animals.

Emma's Dragon Hunt

By: Catherine Stock

Lothrop, Lee, & Shepard Books, 1984

ISBN: 0-688-02696-6

Emma's grandfather, newly arrived from China, introduces her to the power of dragons.

Everyone Knows What A Dragon Looks Like

By: Jay Williams

Four Winds Press, 1976

ISBN: 0-02-793090-4

Because of the road sweeper's belief in him, a dragon saves the city of WU from the Wild Horsemen of the North.

How Droofus The Dragon Lost His Head

By: Bill Peet

Houghton Mifflin Co., 1971

ISBN: 0-395-15085-X, \$13.95

Jeremy Thatcher, Dragon Hatcher

By: Bruce Coville

Illustrated By: Gary A. Lippincott

Jane Yolen Books, 1991

ISBN: 0-15-200748-2, \$15.95, Ages 8-12

Small for his age but artistically talented, twelve-year-old Jeremy Thatcher unknowingly buys a dragon's egg.

The Little Girl And The Dragon

By: Else Holmelund Minark

Pictures By: Martine Gourbault

Greenwillow Books, 1991

ISBN: 0-688-09914-9, \$13.95, Ages 3-6

The Magical Fellowship

By: Tom McGowen

Lodestar Books, 1991

ISBN: 0-525-67339-3, \$14.95

In 30,000 B.C., Lithim, an apprentice magician, and his father set out to unite the warring races of wizards, humans, little people, and dragons in an effort to save the earth from being destroyed by creatures from beyond the sky.

Matthew's Dragon

By: Susan Cooper

Illustrated By: Joseph A. Smith

Margaret K. McElderry Books, 1991

ISBN: 0-689-50512-4, \$13.95, Ages 4-8

The Dragon in Matthew's picture book comes to life and takes him for an amazing nocturnal ride.

One Day, Two Dragons

By: Lynne Bertrand

Illustrated By: Jane Street

Clarkson Potter, 1992

ISBN: 0-517-58413-1, \$14.00

A counting book that relates what happens when two dragons go to the doctor's office at Three Bug Street to get four vaccinations.

The Reluctant Dragon

By: Kenneth Grahame

Henry Holt and Co., 1983

ISBN: 0-8050-1112-9, \$14.95

A boy finds a dragon that is kindly and harmless and must convince the villagers and St. George there is no cause for concern.

Saint George And The Dragon

By: Margaret Hodges

Little, Brown and Co., 1984

ISBN: 0-316-36789-3, \$14.95

George, the Red Cross Knight, slays the dragon that has been terrorizing the countryside for years and brings peace and joy to the land.

There's A Dragon About

By: Richard and Roni Schotter

Illustrated By: R.W. Alley

Orchard Books, 1994

ISBN: 0-531-08708-5, \$14.99, Ages 4-7

Where Are You, Little Green Dragon?

By: Klaus Baumgart

Hyperion Books, 1993

ISBN: 1-56282-345-0, \$12.45, Ages 4-8

Whinnie The Lovesick Dragon

By: Mercer Mayer

MacMillan Publishing Co., 1986

ISBN: 0-02-765180-0

Whinnie the dragon falls in love with Alfred the knight, but she has trouble convincing him to accept her as a suitable romantic companion.

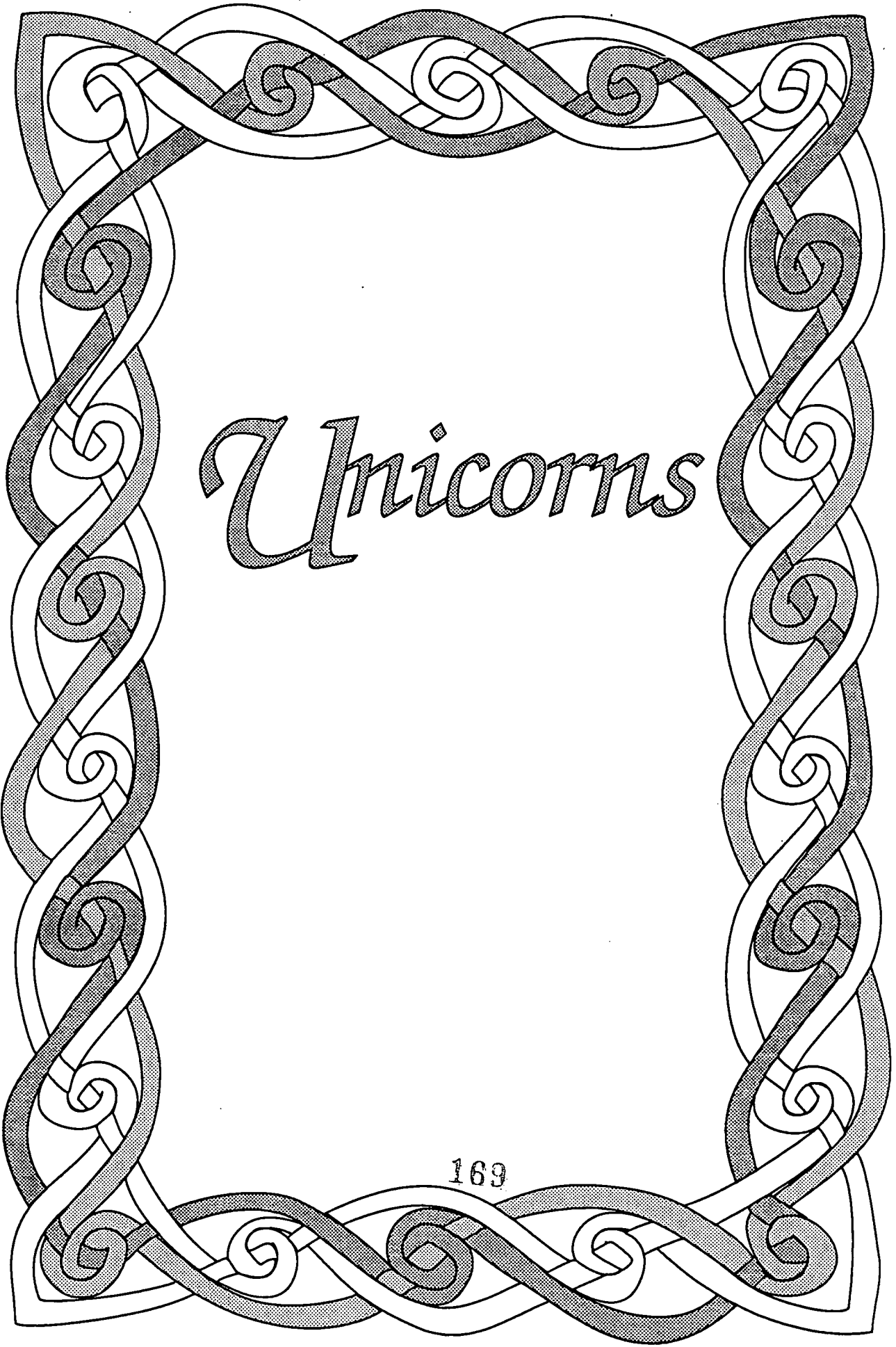

Unicorns

169

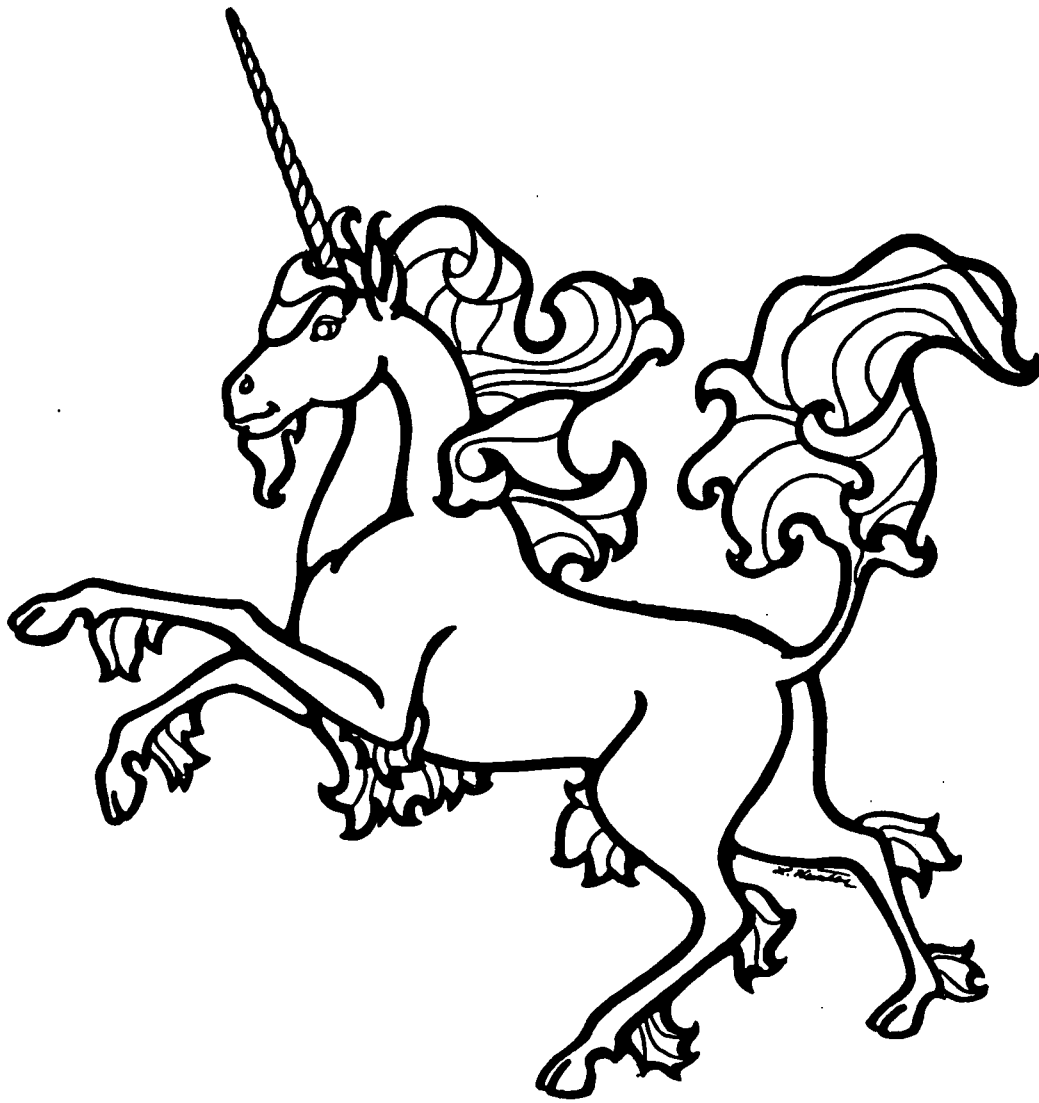

Unicorns

The unicorn was a legendary animal somewhat like a small horse with a silver mane, and a long horn in the middle of its forehead.

The word "unicorn" comes from the Latin word "unicornis" meaning "one-horned".

Unicorn Tapestries (seven tapestries) are known as "The Hunt of the Unicorn". They bring together all the wondrous qualities that medieval people associated with the unicorn, and give the world an image of the unicorn that would endure for centuries to come.

Seven Tapestries: (separate panels) each was originally 14' high and 12' wide. A band of hunters tracks and kills a handsome white unicorn and brings its dead body back to a castle. In the final tapestry, the unicorn miraculously returns to life.



Resource: The Unicorn Tapestries by Margaret B. Freeman, E.P. Dutton, 1976. *ODL - Regular collection

171

The Hunt of the Unicorn

UNICORNS

Resource: The Truth About Unicorns by James Cross Giblin
Harper Collins Grades 3-7 \$14.89
copyright 1991. ISBN 0-06-022478-9
ODL - Main Collection

Describes the origins of the unicorn legend, including the real-life animals that inspired it, and the various myths told about unicorns throughout the world.

DO YOU BELIEVE IN UNICORNS?

- ~ Today most believe they are a myth
- ~ Hundreds of years ago --- few people doubted their existence
- ~ Unicorn may have looked like...
horses, goats or a mixture of several animals
- ~ Common Element... a single horn growing from their heads
- ~ That "HORN" had magical powers
- ~ Unicorns are still a powerful presence in the world of imagination

PROGRAM SKETCHES/UNICORNS

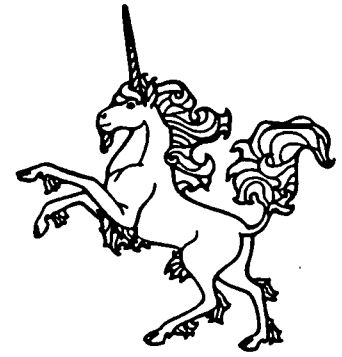

Theme/Title: "Do You Believe In Unicorns"

Age Range: Upper Elementary

Books/Stories:

Introduce the topic with the poem, "The Unicorn" by Shel Silverstein, page 76 from Where the Sidewalk Ends
(note: This poem is also available on cassette as a song)

Display: Check to see if someone in your community has a collection of unicorn objects that you can use in your display case. There have been many small unicorn items available in the last few years, and some people have been particularly attracted to anything with a unicorn on it. An exhibit of buttons, little figures, pictures, etc. in your display case would make a nice tie-in with the program.

Activities:

- ~ Pull and share books and illustrations you can find of unicorns. Ask the children to bring pictures of unicorns.
- ~ Play "Pin the Horn on the Unicorn". Have the children cut out a duplicated unicorn horn, write their names on it and add a piece of tape. Play like "Pin the Tail on the Donkey".
- ~ Share Unicorn Fingerplay (with younger children)

Extenders: (Arts and Crafts)

- ~ Make Flying Unicorns (pattern on following page)
- ~ Duplicate and let the children take a "Unicorn Word Search" puzzle home
- ~ Ask children to bring their unicorn items (mark clearly with child's name) to put in a display case. Caption: "Do You Believe in Unicorns?"
- ~ Unicorn Picture Search

Fingerplay:

This Little Unicorn

This little Unicorn eats grass

(Hold up one hand, finger erect, bend down one finger)

This little Unicorn eats hay

(Bend down another finger)

This little Unicorn drinks water

(Bend down another finger)

This little Unicorn runs away

(Bend down another finger)

This little Unicorn does nothing

(Bend down another finger)

But lie and sleep all day.

Flying Unicorns

Reproduce the pattern for each child. Provide scissors, crayons, drinking straws, and tape or glue. Give children these directions.

- ~ Color and decorate the unicorn and carefully cut it out around outside edges.
- ~ Fold along the dotted line and cut out the top section between mane and tail.
- ~ Glue and tape together the body, head, legs, and horn but not wings; fold the wings up.
- ~ Make holes where indicated in the mane and tail. Insert a 4-inch string through the hole in the tail and a 6-inch string through the hole in the mane and tie. Measure and cut strings of two different colors ahead of time to make things easier.
- ~ Make a slit in the end of a drinking straw, tie a knot in the free end of the long string, and insert through slit as shown. Tie short string around straw.

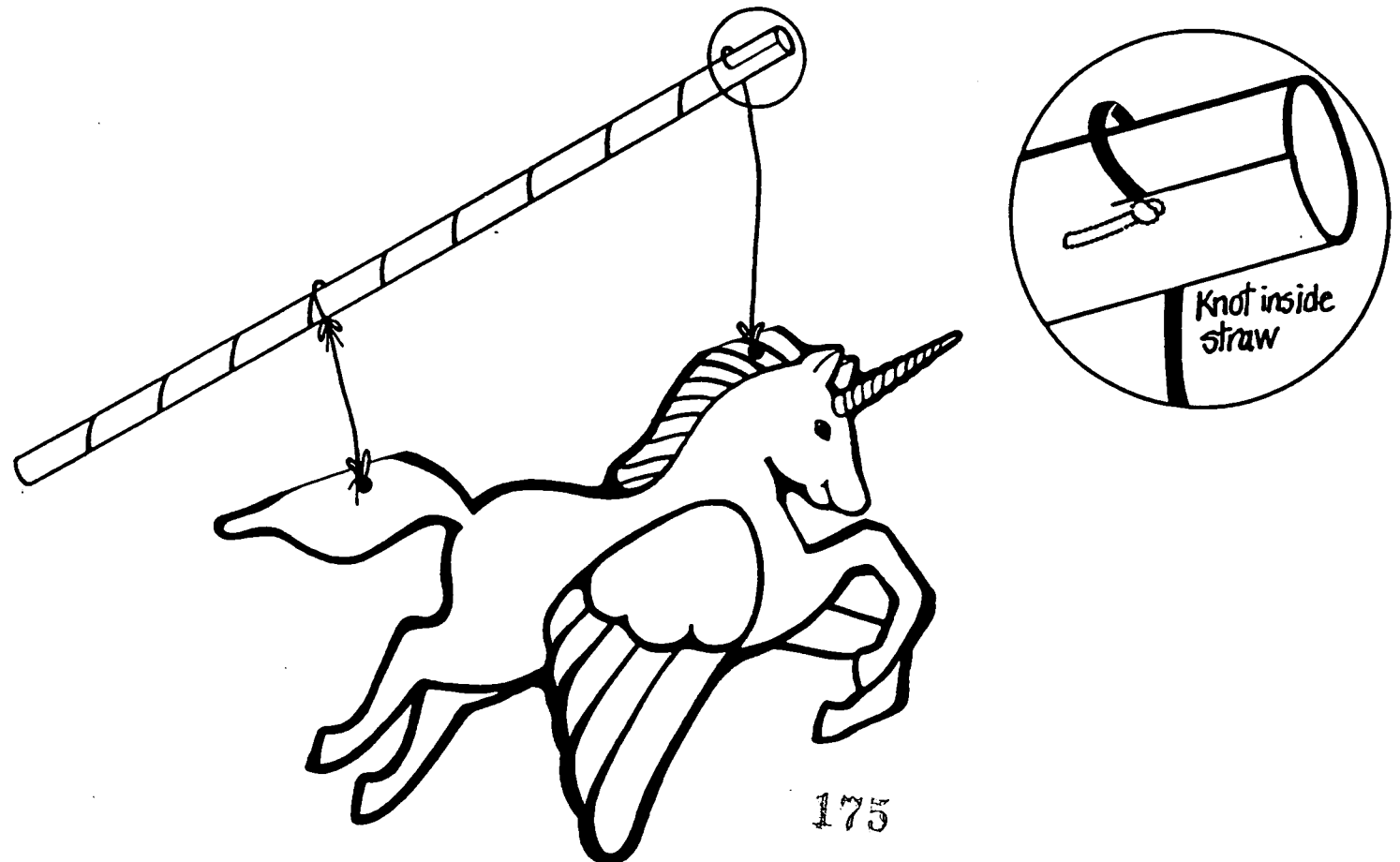

UNICORN PATTERN

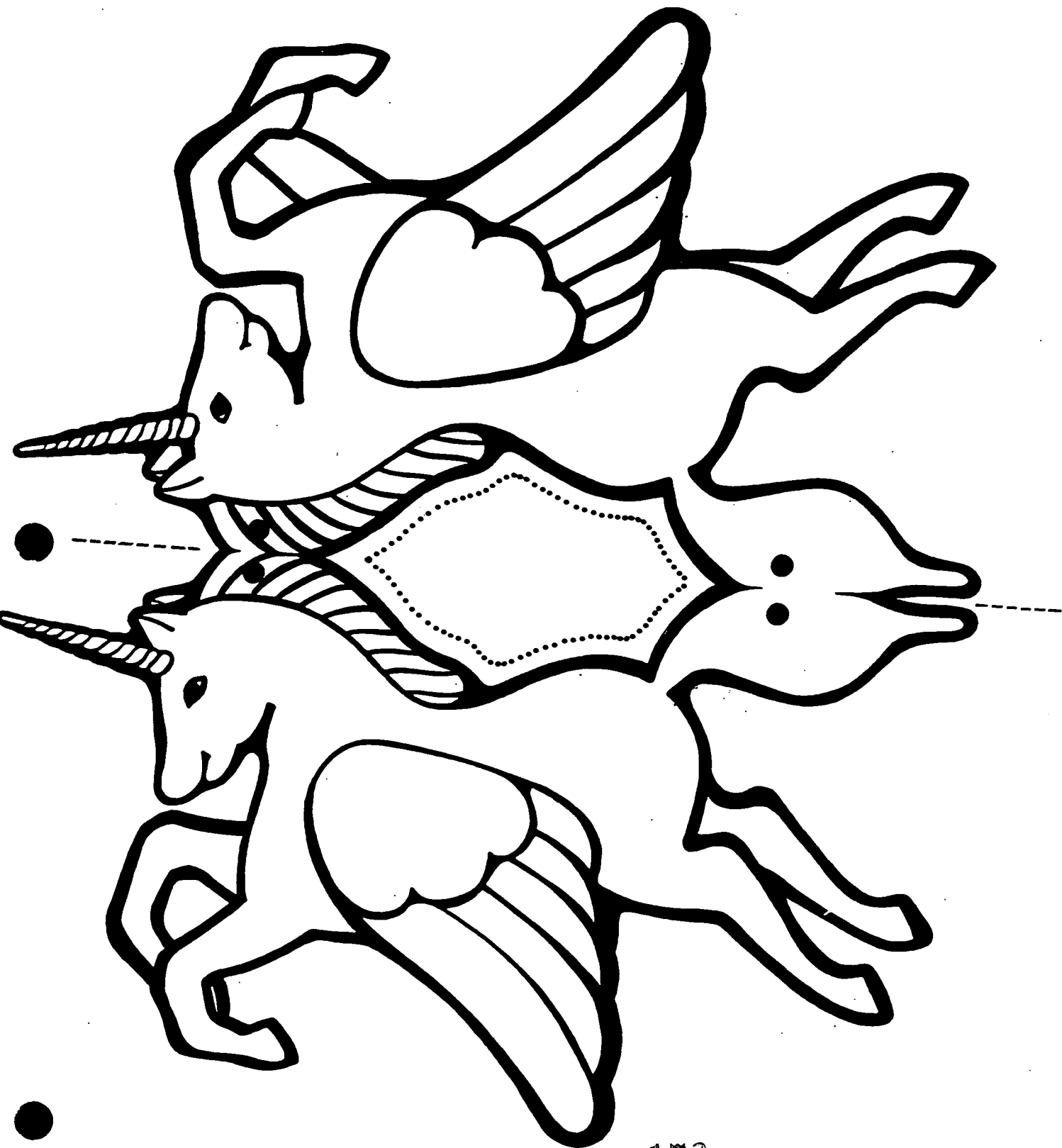

176

Reprinted from "Summer Quest", 1892 Wisconsin.

UNICORN WORD SEARCH



S	F	A	I	R	Y	Z	M	A	I	D	E	N	T
Z	L	C	H	X	T	O	W	Q	U	E	E	N	A
W	Y	Q	W	O	Z	Y	P	H	N	D	C	O	T
T	I	R	S	K	B	T	I	S	I	G	Z	Q	E
E	N	W	P	Z	G	B	X	P	C	K	X	M	Y
R	G	X	U	M	A	G	I	C	O	N	W	J	B
I	C	N	C	E	Y	F	E	T	R	I	M	E	M
B	A	M	E	R	M	A	I	D	N	G	E	S	X
D	R	O	W	L	E	N	U	R	W	H	V	T	X
Q	P	X	U	I	M	T	C	A	S	T	L	E	R
C	E	W	A	N	D	A	I	G	W	C	T	R	T
O	T	R	O	L	L	S	C	O	Z	U	R	E	N
A	S	I	W	R	E	Y	C	N	K	I	N	G	V

Locate vertically, horizontally, or diagonally, these words in the puzzle.

UNICORN
 DRAGON
 FANTASY
 JESTER
 KNIGHT
 MAIDEN

HOBBIT
 MAGIC
 MERLIN
 MERMAID
 PIXIE
 TROLLS

KING
 FAIRY
 QUEEN
 CASTLE
 WAND
 FLYING CARPETS

Reprinted from "Summer Quest", 1992 Wisconsin.

177

KEY

UNICORN WORD SEARCH

S	F	A	I	R	Y	Z	M	A	I	D	E	N	T
Z	L	C	H	X	T	O	W	Q	U	E	E	N	A
W	Y	Q	W	O	Z	Y	P	H	N	D	C	O	T
T	I	R	S	K	B	T	I	S	I	G	Z	Q	E
E	N	W	P	Z	G	B	X	P	C	K	X	M	Y
R	G	X	U	M	A	G	I	C	O	N	W	J	B
I	C	N	C	E	Y	F	E	T	R	I	M	E	M
B	A	M	E	R	M	A	I	D	N	G	E	S	X
D	R	O	W	L	E	N	U	R	W	H	V	T	X
Q	P	X	U	I	M	T	C	A	S	T	L	E	R
C	E	W	A	N	D	A	I	G	W	C	T	R	T
O	T	R	O	L	L	S	C	O	Z	U	R	E	N
A	S	I	W	R	E	Y	C	N	K	I	N	G	V

REACH THE UNICORN

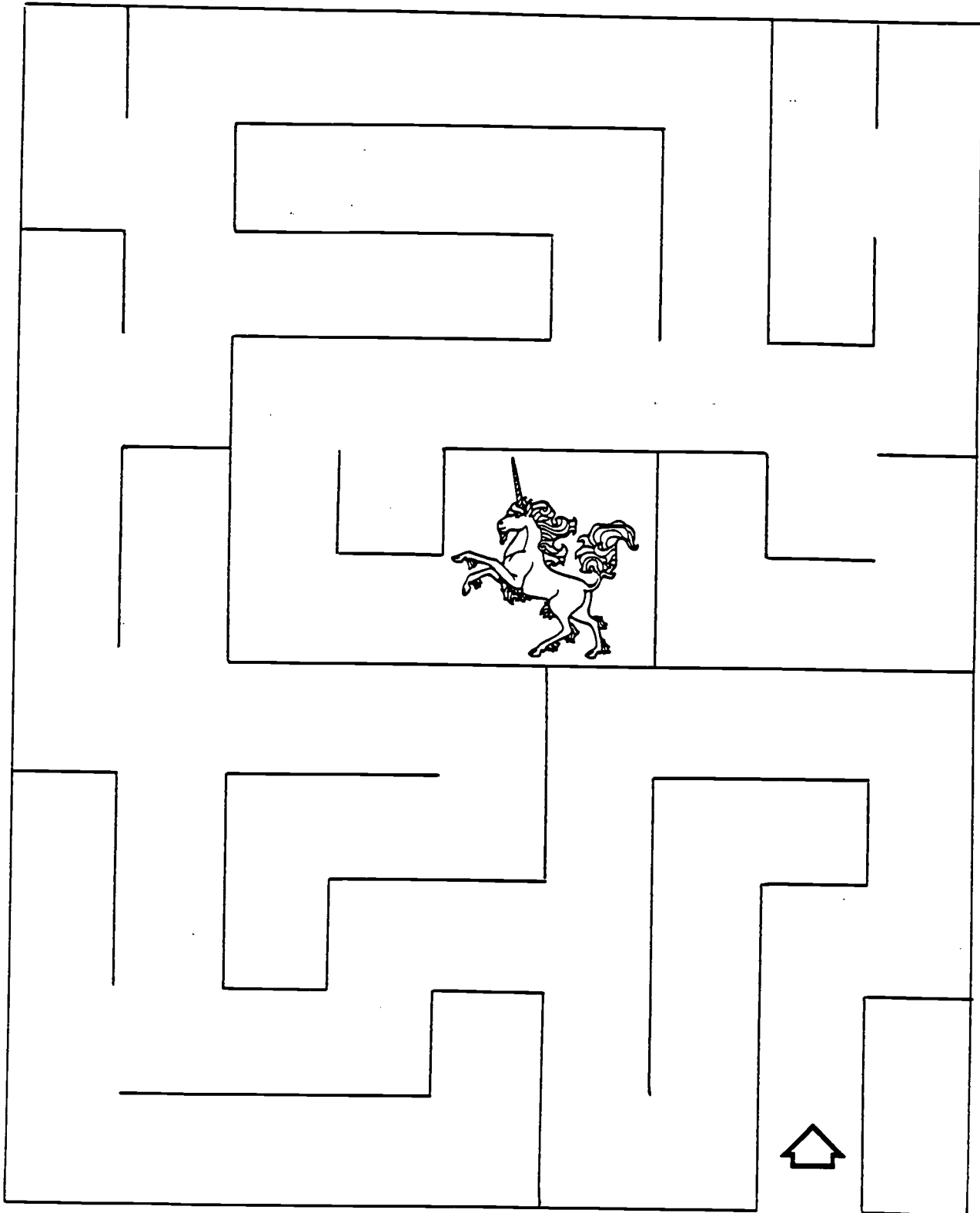

Reprinted from "Book Your Own Adventure", 1984 Arizona
img

UNICORN COUNTRY PICTURE SEARCH



The unicorns and the princess are about to cross the moat into the castle. Before they reach home, see if you can find a fish, bird, swan, hamster, sewing needle, feather, heart, screw, nail, pliers, and a witch's hat.

UNICORN/BIBLIOGRAPHY

Coville, Bruce. Sarah's Unicorn. Philadelphia, PA: J.B. Lippincott Co., 1979. Grades preschool-2.

This book tells how Sarah's secret friendship with a unicorn is threatened when her wicked aunt wants to steal his magic horn.

Coville, Bruce. Into the Land of the Unicorns. New York, Scholastic, Inc., 1994. ISBN: 0-590-45955-4.

First book in the Unicorn Chronicles. Having jumped into the fantasy land of Luster, Cara joins Lightfoot the unicorn in the search for Queen Arabella Skydancer.

dePaola, Tomi. The Unicorn and the Moon. Silver Burdett Press, 1995. ISBN: 0-382-24658-6.

When the moon gets stuck between two hills, the unicorn tries to free it with help from a giraffe and an alchemist.

Mayer, Marrianna. The Unicorn and the Lake. Dial, 1982.

A unicorn must battle an evil serpent to save a lake. Beautifully illustrated by Michael Hague.

Munthe, John Adam. I Believe in Unicorns. Chatto, 1979.

A unicorn saves the life of a little boy's mother. A story of faith and friendship.

KEY - UNICORN COUNTRY PICTURE SEARCH



67: fish, bird, swan, hamster,
sewing needle, feather, heart,
screw, nail, pliers, witch's hat

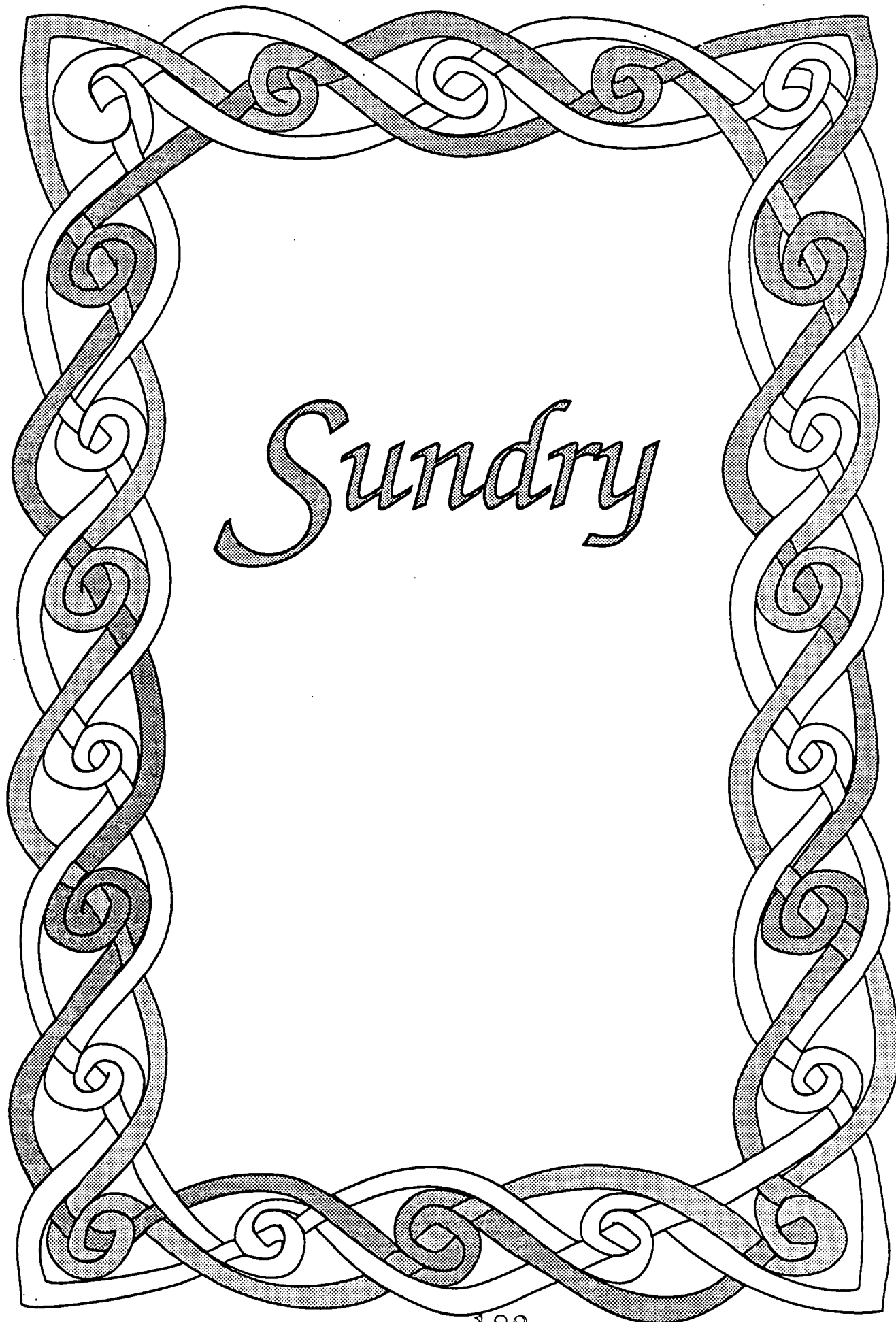

Sundry



Alchemists were interested in discovering the natural laws of the universe and in using them to benefit people. Most alchemists tried to find ways to turn other metals into gold, or tried to create a drink that would give immortality. Their experimentation established many of the basics of chemistry and created some useful medicines.



Set up a mini laboratory to conduct magic tests of the senses. Use experiments from More Science Experiments You Can Eat by Vicki Cobb (Philadelphia, PA, J.B. Lippincott, Co., 1957).

SOME EXPERIMENTS

1. Fill small jars (baby food) with pieces of cotton saturated with mystery smells (example: orange, peppermint, lemon, pickle, baby powder, cinnamon). Have the children guess what each jar contains.
2. Have several children who are blindfolded taste cola and lemon-lime soda with ice. Can they tell the difference? Try the same test with children who are blindfolded and wearing nose clips.



rchery

The bow and arrow were the chief weapons of warfare. King Henry VIII was an enthusiastic archer. He institutionalized archery as a sport and insured its success in England as a sport for wagering.

Resources:

The Story of Robin Hood Retold by Robert Leeson
(Larousse Kingfisher Chambers Inc., 1994) ISBN 1-85697-988-1
Robert Leeson recreates the original Prince of Thieves in a superb telling of the oldest and most authentic Robin Hood stories.

Activities:

- ~ dress in green tights, etc. and read or tell stories about Robin Hood or William Tell. "Listen, One and All, to my tales of Robin Hood..."

note:

Robin Hood is a folk tale in the form of an adventure romance. It began as a ballad in the Middle Ages. Robin Hood was the rightful Earl of Huntington, but because the times were so corrupt his family lost their lands and Robin was driven into the forest. The story demonstrates his method of protest, organizing a band of outlaws in Sherwood Forest and robbing the rich to support the poor until King Richard could return from the Crusades and right the wrongs committed by the tyrant Prince John. The Adventure tells of Robin Hood's courage, skill at archery, and daring deeds in support of the poor.

- ~ Play the William Tell Overture
- ~ Have an Archery Demonstration
- ~ View a movie version of "Robin Hood"
- ~ Draw a map (mural size) of Sherwood Forest
- ~ Dramatize one of Robin Hood's adventures
(The short chapters are ideal for short individual plays.)
- ~ Robin Hood Picture Search

Activities cont.:

- ~ Make another cinquain poem describing one of Robin Hood's adventures.

Bandit
Courageous, Free
Hiding, Fighting, Caring
He's Honorable and Just
Robin

- ~ Sing the "Robin Hood and Little John" Ballad

When Robin Hood was about twenty years old,
He happened to meet Little John.
A jolly brisk blade, just fit for the trade,
And he was a sturdy young man.

They happened to meet on Nottingham Bridge,
And neither of them would give way.
Till brave Robin Hood, in right merry mood-
"I'll show ye right Nottingham play."

Robin aid on so thick and so strong,
He made little John to admire;
And every knock, it made his bones smoke
As if he had been in a fire.

"Robin Hood and Little John"



"Robin Hood's Quiver"

Activity:

Materials needed:

Green paper, gray paper
An empty oatmeal box
Wooden dowels

(1) Cover an oatmeal box in green paper. (2) Punch holes near the top and bottom of the box, attach clothesline cord or heavy yarn, and knot inside container. (3) Make arrows by gluing gray construction paper triangles to dowels or by rolling paper tightly and marking on the point and feather with a magic marker.

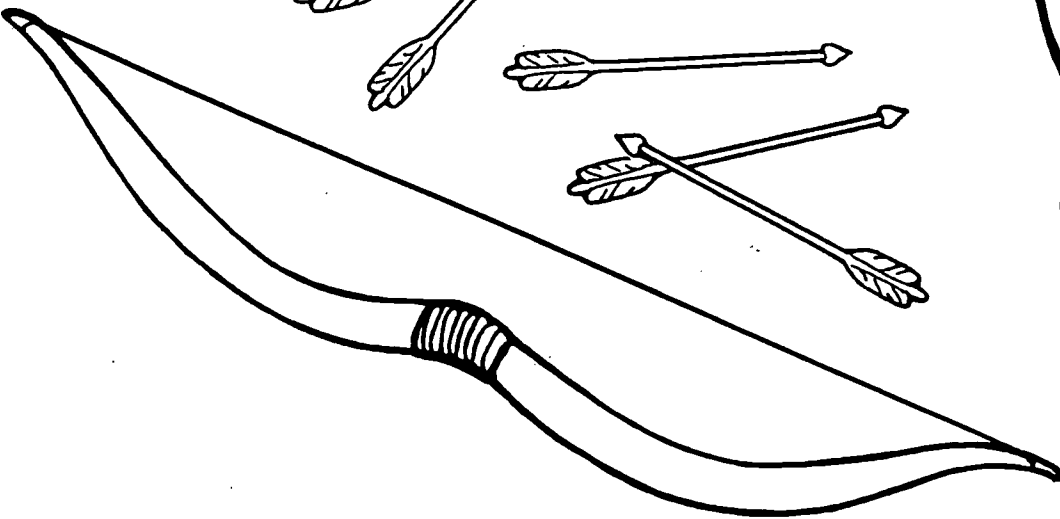
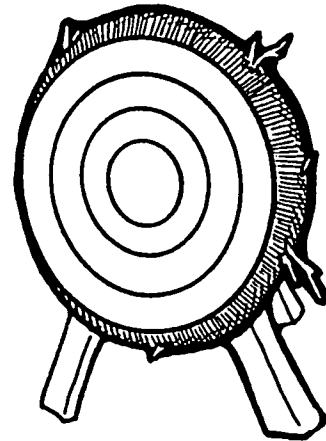
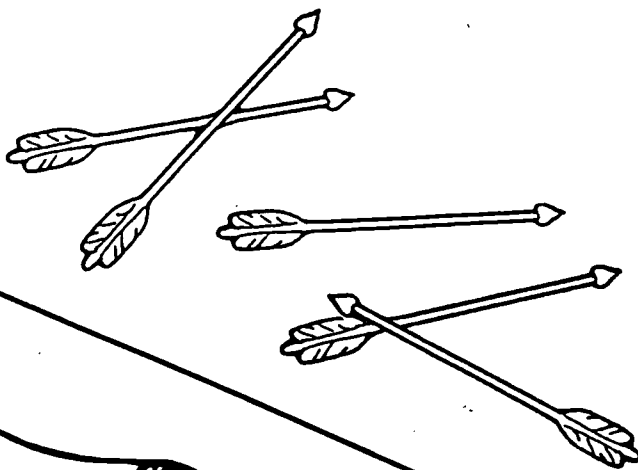
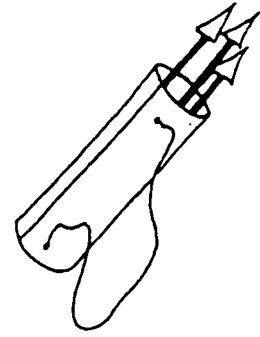

ROBIN HOOD
PICTURE SEARCH

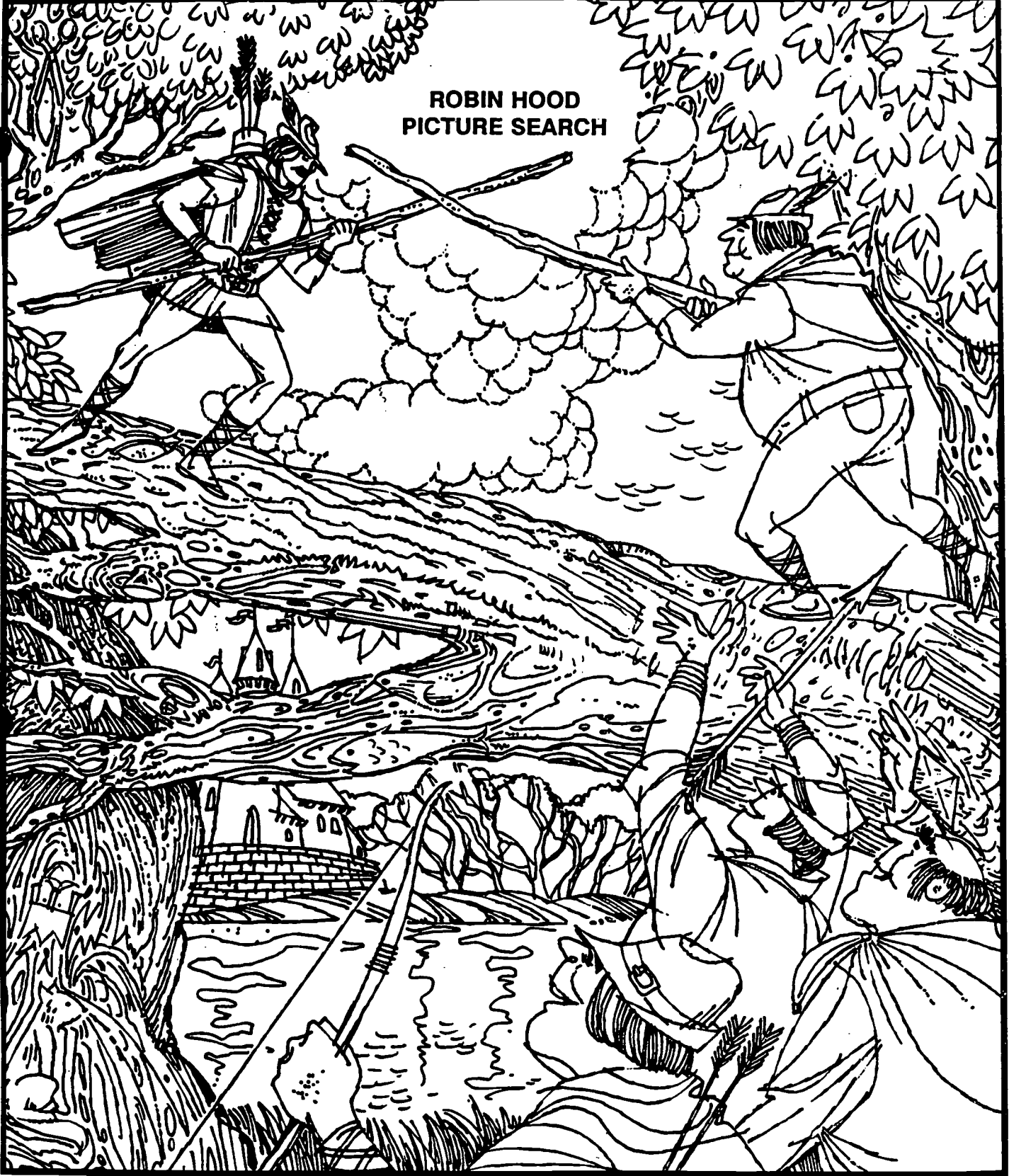

Robin Hood

What's hiding in Sherwood's Forest? Look for a teapot, horn, flashlight, kite, banana, fish, bird, pencil, toothbrush, spoon, ring, teacup, turtle, cat, king's head, scissors, and a duck.

Printed with permission of Highlights for Children, Inc., Columbus, OH, copyright 1995.

KEY - ROBIN HOOD PICTURE SEARCH



**134: teapot, horn, flashlight, kite,
banana, fish, bird, pencil, toothbrush,
spoon, ring, teacup, turtle, cat,
king's head, scissors, duck**



Bookmaking

Bookmaking was an art during the middle ages. Ask the children to guess how many books are in your library. (_____ estimated answer).

Tell them the following story:

"The Duke of Berry was a **bibliophile** (a person who loved books). When he died around 1415 A.D., he had an extremely large library for the time. How many books do you think he had? Answer: about 300 - this was considered a large collection because all books were written by hand. There were no computers or printing presses, and books could not be mass-produced.

Note: Creating a single book during the Middle Ages could cost as much as building a cathedral - and take almost as long. Each book was precious, and most precious of all were the illuminated manuscripts. A large number of books were produced during the Middle Ages and illuminated manuscripts are our best link to this long and fascinating period.

Resources:

Kehoe, Michael. A Book Takes Root: The Making of a Picture Book. Carolrhoda Books, 1993. ISBN: 0-87614-756-2.

This book traces the process of making a picture book, from idea to manuscript to final production. Green Beans by Elizabeth Thomas is the final product.

Stowell, Charlotte. Making Books: Step-by-Step. Kingfisher, 1994. ISBN: 1-85697-518-5.

Shows how to make all types of books including: peek-in-books, zigzag books and pop-up books.

Suhr, Mandy. Making a Book. Thomson Learning, 1994. ISBN: 1-56847-103-3.

This resource goes through the process from getting an idea, research, design, printing and binding.

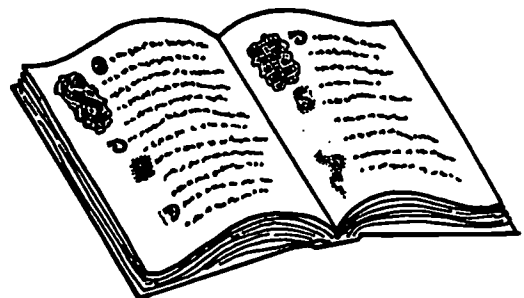

POP-UP BOOKS

Directions:

Mouth:

CUT a piece of cardboard the same size as a spread in your book.

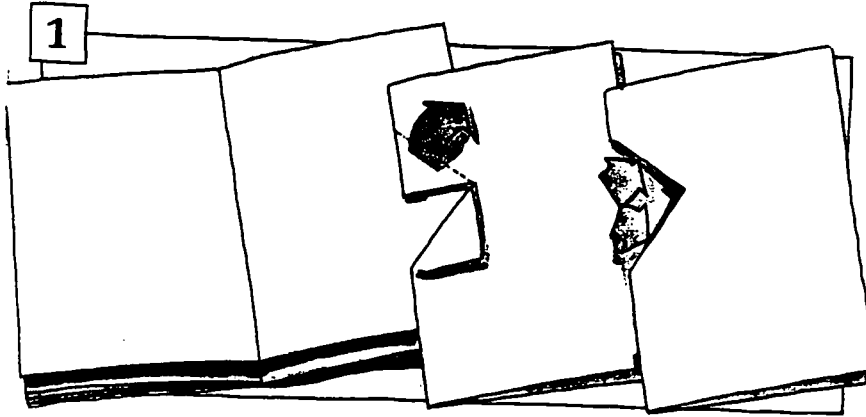

FOLD the paper and cut a slit near the middle. Fold back the flaps, and tuck in.

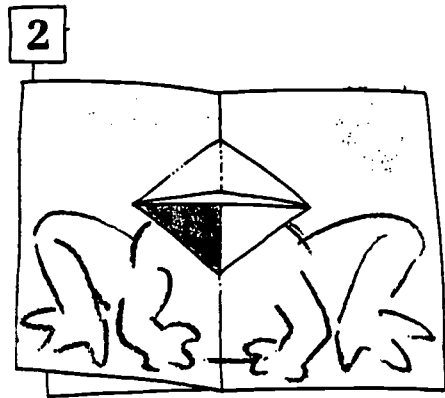

OPEN the page and the flaps will open like a mouth.

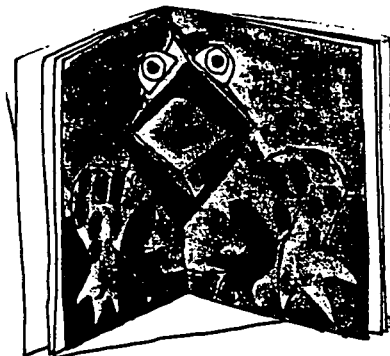

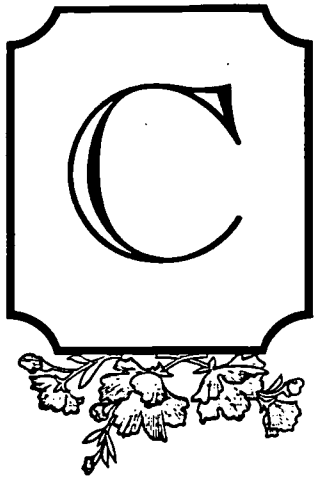

calligraphy

In the middle ages they didn't have books as we know them. Only the very rich could afford manuscripts hand printed by scribes on parchment and bound into book form.

Resources:

Calligraphy Projects for Pleasure and Profit by Margaret Shepard (Perigee)

Contains great sayings to put on bookplates and bookmarks. It also has instructions on how to make a book.

Human Resources: check your community for names of local calligraphers.

Activities:

- ~ Show older children how to make reed pens.
- ~ A calligrapher could teach older children the basics. They might use markers with wedge-shaped points to simplify the process.
- ~ You could have a spin-off competition (from the above activity) for a bookmark design.

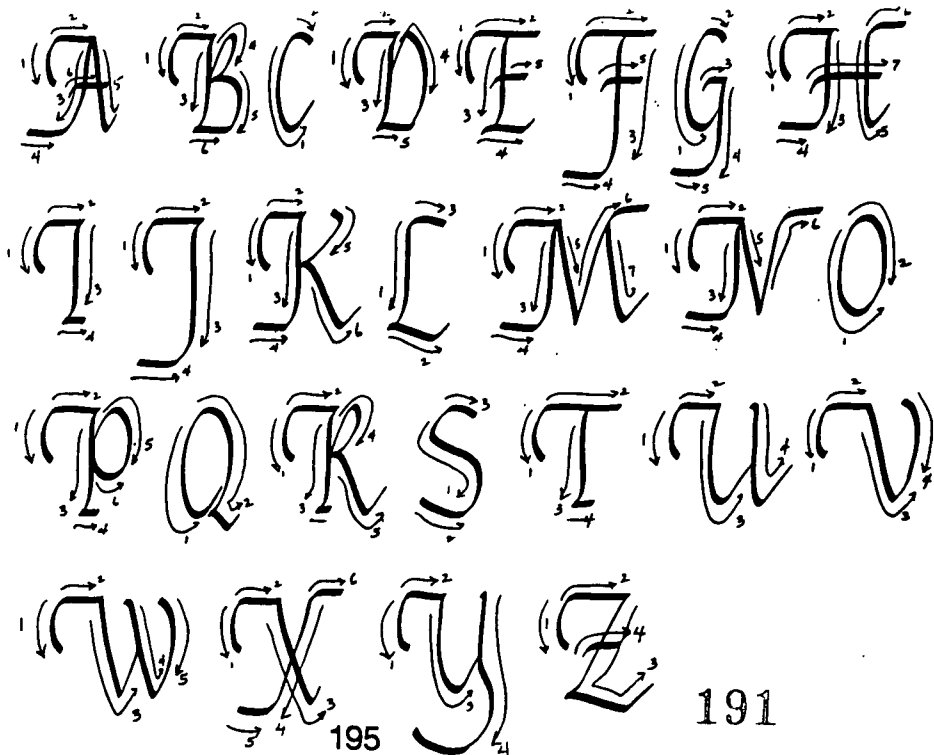

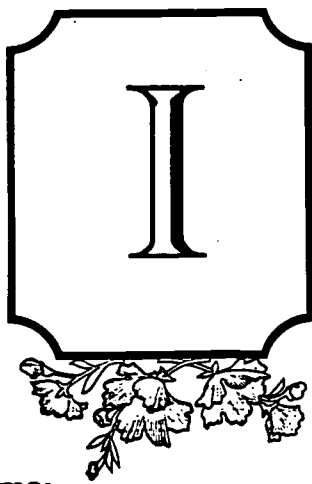

Illumination

Illumination - the art of using gold, silver, and paints to decorate a book. It was first developed as a way of glorifying the Holy Scriptures.

Terms:

Illuminations - painted decorations for a manuscript. They were often embellished with real gold or silver that reflected light.

Manuscript - hand-written books

Illuminators - artists who painted the books

Scribe - the person who writes out the text of a manuscript

Borders - decorations around the edge of the page

Vellum - pages were not made of paper but specially prepared animal skins called "vellum" or "parchment"

Resources:

Bibles and Bestiaries: A Guide To Illuminated Manuscripts by Elizabeth B. Wilson (Farrar, Straus & Giroux, 1994) ISBN 0-374-30685-0 (Bibles, etc.) *ODL Juvenile Collection

Activities:

- ~ Show samples of illuminated manuscripts
- ~ Most manuscripts started off with a large illuminated letter on each page. Younger children could make a fancy capital letter which would take up a whole page. It could be the beginning of the library's own alphabet book or give them a copy of a letter from A Medieval Alphabet to Illuminate. (Demco Catalog pg. 6, order # RH131-0124, price \$3.50.

Book: pg. 6, Illuminations by Jonathan Hunt. Order #RH-131-6594, price \$16.95.

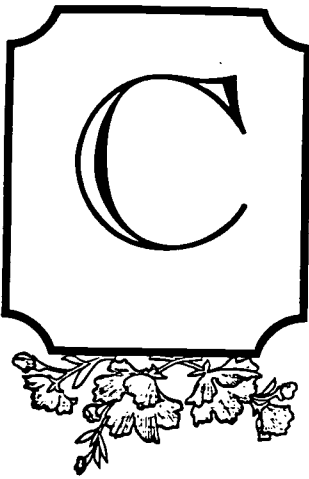

Chivalry

The fundamentals of chivalry were that the knight must defend not only the Christian faith and the king, but also the weak and oppressed. He was an embodiment of justice. From these duties arose personal qualities. To be an effective defender, the knight must be brave and practiced in arms. As a soldier of God, he must be pious and pure in heart. Defense of the weak meant he must be generous in his charity; it also came increasingly to mean fighting on behalf of a lady, and chivalry developed a strong romantic element.

Chivalrous behavior stressed loyalty and generosity as well as romance and valor.

The chivalric ideal of the thirteenth and fourteenth centuries was a powerful social code that has continued to shape our ideas about civilized behavior.

Resource: The Age of Chivalry: English Society 1200-1400 by Sylvia Wright. Warwick Press, 1988. *ODL regular collection.

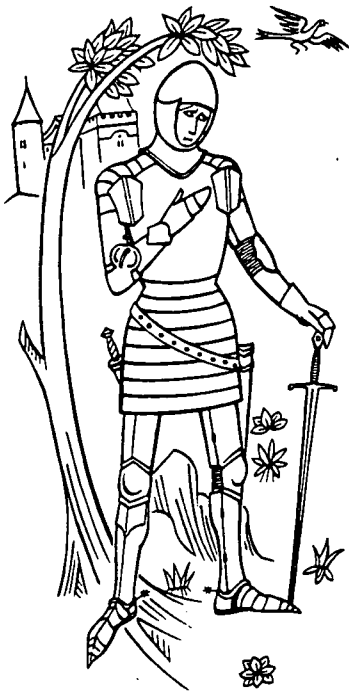

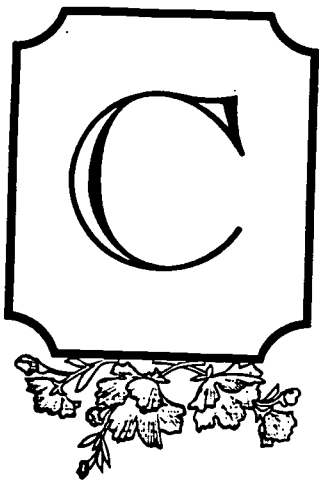

Costumes

A box of costumes and a mirror can allow the children to use their imaginations and create a royal atmosphere. They could also be used to act out stories.



Resource:

Easy Costumes You Don't Have to Sew by Goldie Taub Chernoff
(New York: Four Winds Press, 1975. Grades 3-5. * ODL Main Collection)

Directions are given for making a Knight's Costume, including a helmet constructed from cardboard milk cartons. A fiery dragon costume on page 30-31, a royal crow on page 37 and a jester's hat on page 37.





roodies

These picture riddles began in the Middle Ages in Italy and found new popularity in the United States in the 1950's.

Use these for bulletin boards and inspire children to create their own.

A flower in the spring

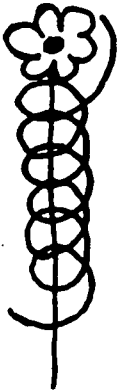

View from inside a pop can

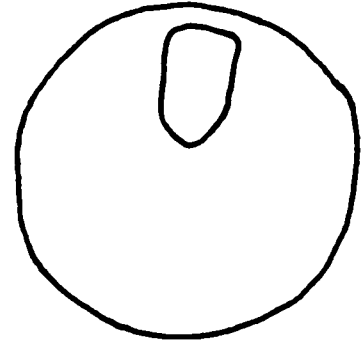

A comb with only one tooth left

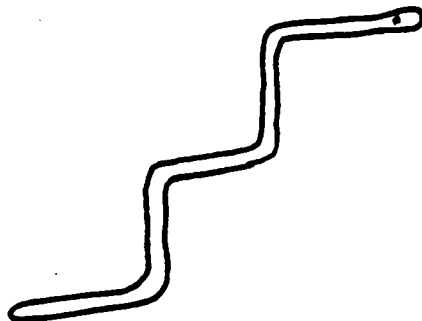

Snake climbing upstairs

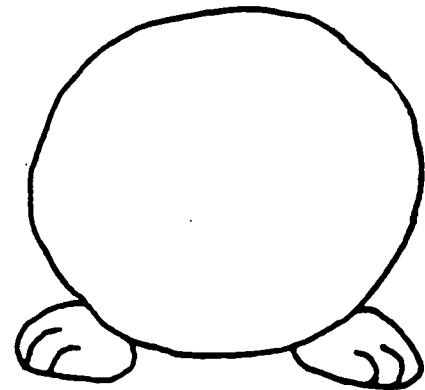

World bubble blowing champion

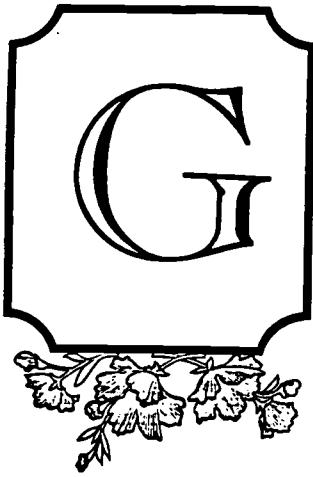

ames

Games were very popular in the Middle Ages. Enjoy a quiet, friendly game of chess? Not in the Middle Ages. Those days, instead of checkmate, the match was likely to end with a punch in the nose. Onlookers would yell, shout, and bet on which player would win. Prince John, future King of England, once tried to brain his opponent with the chessboard. Talk about a sore loser!

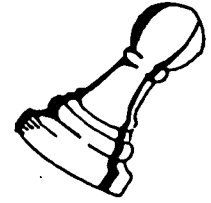

Chess, Checkers and Backgammon were also games that originated in the Middle Ages. Present these as games available for playing in the library at any time!

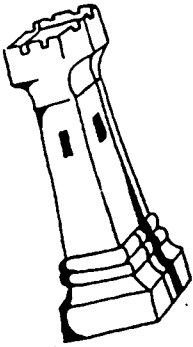

Note:

These might appeal more to older children. Set up a corner with the boards and pieces. Surround them with your books on board games. For a more organized program, a local chess buff could give beginning instructions. You could organize a chess club and hold occasional tournaments.

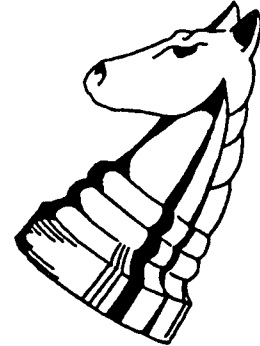

Resources:

Board and Table Games from Many Civilizations by R.C. Bell. (New York: Dover Publications, Inc., 1980). Grades 3-6

Resources to help children learn chess:

Byfield, Brian, and Orpin, Alan. Every Great Chess Player Was Once a Beginner. Secaucus, NJ: Stuart, Lyle, Inc., 1974. Grades 5-12.
This is a chess book that is fun to read and easy to understand.

Kidder, Harvey. Illustrated Chess for Children. Garden City, NJ: Doubleday & Co., Inc., 1970. Grades 4-6.

This book explains all of the basic elements of the game in colorful words and pictures, telling the story of the dramatic medieval battlefield that the chess board represents.

Lombardy, William. Chess for Children, Step by Step. Boston: Little, Brown & Co., 1977. Grades 4-6.

This book presents simple games that teach beginning players how to move each piece and what moves each piece can make in a game.

Pandolfini, Bruce. Let's Play Chess! A Step-by-Step Guide for Beginners. New York: Julian Messner, 1980. Grades 6-9.

This guide breaks down chess lessons into short, logical statements that are numbered in graded sequences for clarity. There are a number of diagrams. Chapters include general rules, principles, hints on technique, and an actual game. Booklist, October 1, 1980, p. 255.

Rosenberg, Arthur. Chess for Children and the Young at Heart. New York: Atheneum Publishers, 1977. Grades 4-8.

This book imparts a thorough understanding of how the game is played with a minimum of text and a maximum of pictures.

Sarnoff, Jane. The Chess Book. New York: Charles Scribner's Sons, 1973. Out of print. Grades 3-6.

This book presents the facts of chess in a logical and consistent fashion. A helpful portion on strategy is included as well as fun facts about chess history and background.

Board Games:

Play actual board games that were popular during the Middle Ages.

Several are described in R.C. Bell's Board and Table Games from Many Civilizations (New York: Dover Publications, Inc., 1980. Grades 3-6).

A program demonstrating the games and explaining the rules could lead to a season's worth of play. And there is always chess, one of the arts that knights were expected to perfect. A long tournament of a human chess game could spark a great deal of interest. If you have a local chess club, perhaps they would be willing to help arrange your own competition.

CARDS

Playing cards was one of the principal social and intellectual diversions during the Middle Ages. It was one of the only areas where women and men could compete equally.

Adding the pictures of royalty as the face cards originated in the Middle Ages as did using jesters for the jokers. (Playing cards came to America with Columbus.)

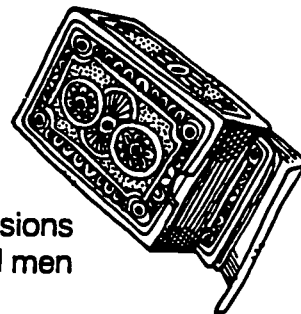

Activities:

- ~ Show samples of early card designs. Both the Smithsonian and Metropolitan Museums sell reproductions of early card designs for about \$10 a deck. There are illustrations of early decks in encyclopedias and some books in the 795.4 section.
- ~ Read selections from Alice in Wonderland illustrated by John Tenniel (William Morrow & Co., Inc., 1992) ISBN 0-688-11087-8. About the Queen of Hearts and her court.
- ~ Tarot Cards -- tarot decks preceded modern playing cards, are used mainly for fortune telling, and are still used to play games in Europe.
- ~ Have children design their own face cards.
- ~ Show children how to play simple card games: Slap Jack, War, Go Fish, Old Maid and Concentration.
- ~ Building with Cards - Show some of the basic building "blocks" and let them go.. "Houses" of cards are very precarious and could come down with a puff of wind or a jostle, so plenty of space and sturdy bases (the floor) are required. Steven Caney's Play Book (Workman, 1975). *ODL regular collection.

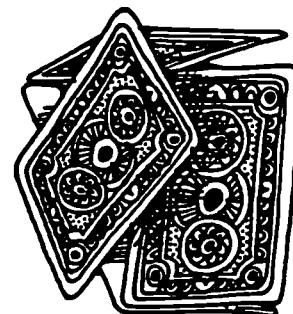
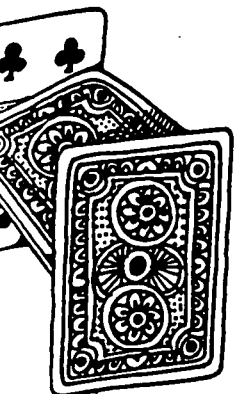

- Need one or more decks of cards
- Hardest part is starting the structure. Carpeted floor (not a smooth surface) is best so the cards won't slip.
- Delicately balance two or three cards against each other. (See pictures for 3 basic constructions.)
- Now, you can build out across the floor, or you can go up two, three or even four stories high.

Note: Building with cards is not to see how long a structure will stand, but how big and complicated you can make it before it collapses. Will "one more card" be one card too many?

DESIGN A CARD

K

X

199

DESIGN A CARD

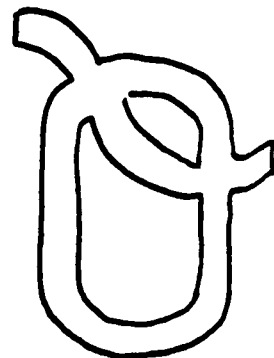
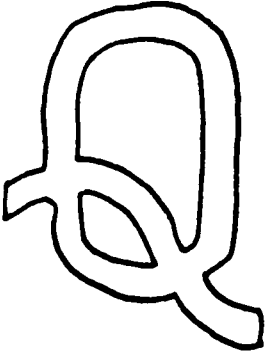

200

DESIGN A CARD

J

j

201

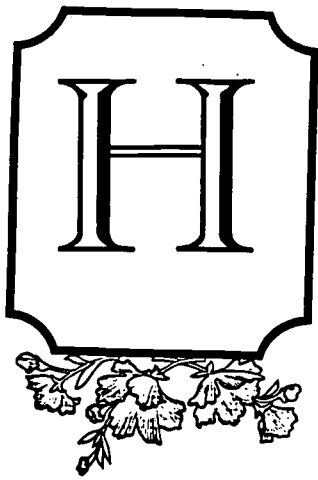

heraldry

In battle it was impossible to tell one soldier from another. During the Battle of Hastings in 1066, a lord saw a reason to distinguish his shield with markings. After that battle, he divided his shield down the middle to tell it from the others.

The practice caught on and shields got more intricate as sons added elements to their father's symbols. The symbols of the families were later organized and registered by the College of Heralds in England around 1483.

Activity:

Share Harold the Herald: A Book About Heraldry by Dana Fradon (Dutton 1990) to inspire program participants to create coats of arms to decorate the Library.

- ~ Show the children examples of shields from books on Knights and the Middle Ages.
- ~ Let the children design their own Coat of Arms. Encourage them to put something on the shield that they feel represents their family.
- ~ As a group project, design a shield representing your library, reading or books.
- ~ Simple designs could be made into crayon transfers for T-Shirts.

Resources:

Heraldry: The Story of Armorial Bearings by Walter Buehr G.P. Putnam's Sons, 1964.

Design Your Own Coat of Arms: A Introduction To Heraldry by Rosemary A. Chorzempa Dover Publications, 1987. ISBN 0-486-24993-X
(Available from the ODL Juvenile Collection.)

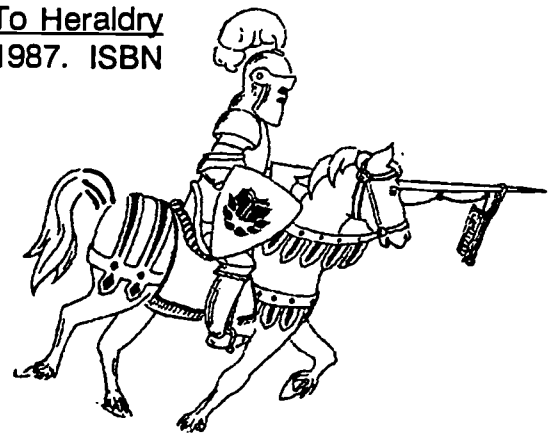
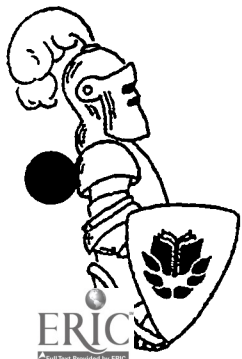

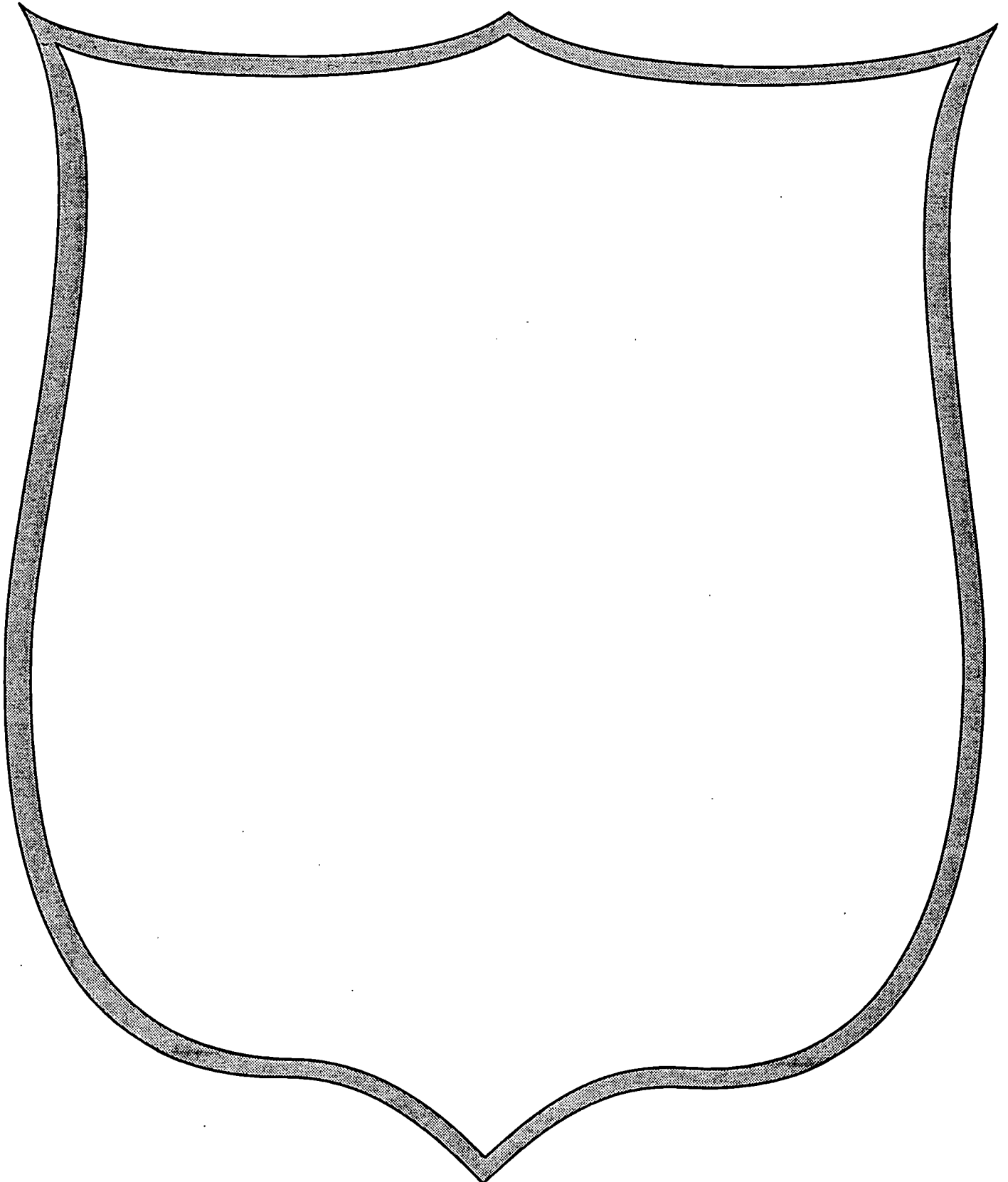

CREATE YOUR OWN CREST

Traditional heraldic devices feature simple colors (usually no more than three) and often referred to the knight's name. Some referred to a specific incident in the knight's life. After explaining this to participants, invite them to create their own devices. Younger children can choose and color one of the devices below, enlarged on a copy machine. Older children can devise their own, using the outlines below. For smaller groups, try making the pieces out of felt and glue. Then mount the results with a plastic straw glued or stapled to the top edge for handy mounting.

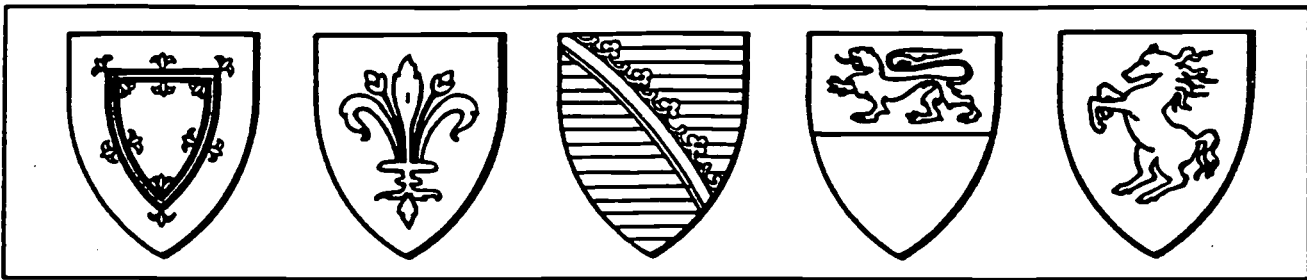

For a simpler version, have children fold 8 1/2" x 11" pieces of colored construction paper lengthwise, then cut off a triangle at the lower outside edges to form a shield shape.

Older children can make a "functional" shield by enlarging the shield shape onto an 11 x 14" piece of poster board, then stapling strips of poster board 2" x 18" at left and right of center on the back side for arm straps. Reinforce center seam with a thin wooden dowel stick taped or glued into place. Divide the shield face into four sections and ask the children to draw in each section pictures about themselves.

Design A Family Crest that tells something about you and your family.

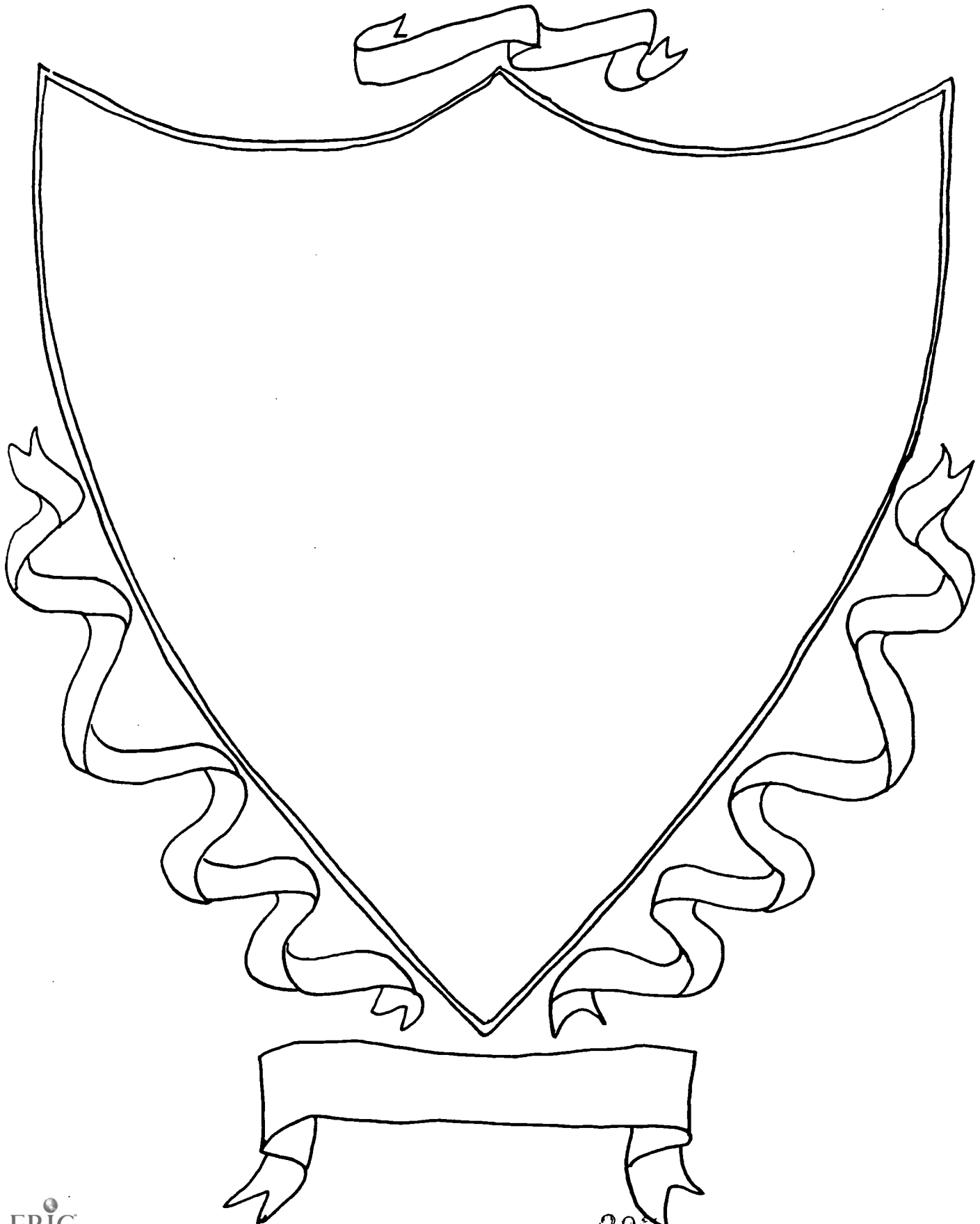

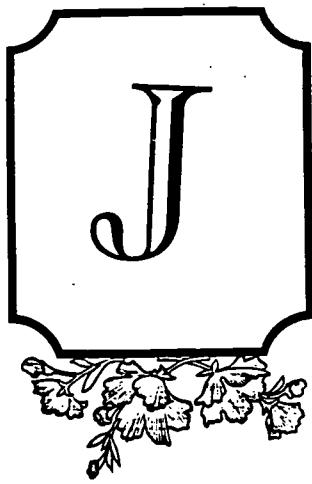

ester

Jesters, or fools, as they were also called, were a lot like today's clowns. They dressed funny and acted silly. They poked fun at the people around them. They used humor to entertain and make a point. A jester might work for hire or have regular employment in a royal court or a nobleman's house.

Resource: Hester the Jester by Ben Shecter. (Harper and Row, 1977)
This story is about Hester, who wants to be someone important, but has trouble deciding whether to be a jester, knight, or a king.

Activity:

- ~ Have A "Jesters, Jokes and Clowns Week"
- ~ Celebrate with a clown make-up contest
- ~ A juggling contest - use knotted socks (heavy cotton) for juggling balls. Give three to each child and let them experiment.
- ~ Make Jolly Jester stick puppets
- ~ Make jester hats
- ~ Jester's Gazette. Invite children to submit stories, jokes, riddles, and drawings for a weekly funny news publication. You can either produce the newspaper on your copy machine or turn a wall or bulletin board into the weekly product.

CREATE A JESTER'S JOKE BOARD using the riddles check call #793. Create a lively and colorful heading and a drawing of a jester. Then print the riddles on cards and attach to the board with strips of tape along the top so they can be lifted. Print the answers on the back. Change weekly.

JESTERS/ARTS AND CRAFTS

Jolly Jester

Materials needed:

Flat round suckers

Different colors of paper

Tiny pom poms (or bells)

Glue

Make a jester to amuse the royal family! Use a round, flat sucker on a sturdy stick and the patterns below. Cover the original wrapping with a circle of paper, draw face. Cut a hat shape out of bright felt or paper; glue tiny pompons to the ends; glue hat to head. Cut out several collars from bright felt or paper; glue to stick.

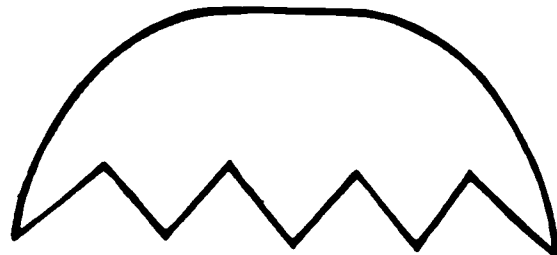
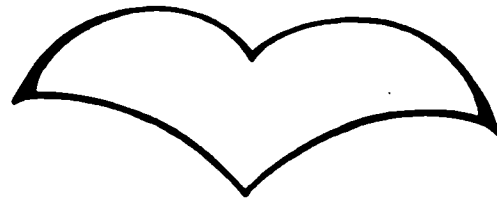
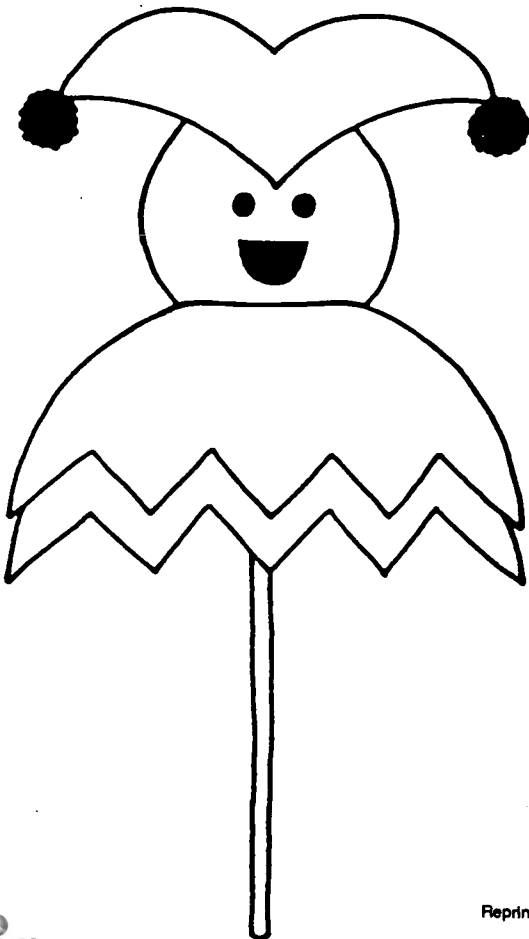

207

Reprinted from "Castle Quest", 1987 Louisiana

JESTERS/ARTS AND CRAFTS

Jester's Hat

~ MAKE JESTER'S HATS from brown lunchbag-sized paper bags. Cut the bottom out of the bag. Fold up the bottom to form a 2" hem. Cut petal shapes on upper bag. Glue cotton balls on the inside tips of petals. Decorate with magic markers, glitter and crayons. Adjust to size with a stapler if necessary.

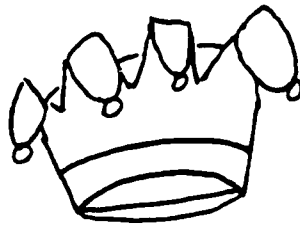



Medieval Feast

The noble folk of feudal castles were prodigious meat eaters and sat down to many dishes which would seem strange to us now. (Swans, peacocks, thrushes, blackbirds, storks, and cuckoos all went into the oven for special feasts... along with rabbits, venison, bear and wild boar.)

Medieval feasting was an art. Cooks not only prepared delicious food - they used their wild imaginations as well to:

- ~ mold pastry into castles
- ~ decorate elaborate scenes with food paints
- ~ have live jugglers jump out of puddings
- ~ bake birds in pies/sometimes hide live blackbirds in pies to fly out at astonished guests.

- ~ The food, although more colorful and varied than usual, was not the outstanding feature of a feast.
- ~ The crucial, distinctive aspect of any feast was entertainment, a show. A playlet, a silent mummings show, musicians, tumblers, to entertain the guests.

Food & Feasts in the Middle Ages by Imogene Dawson (New Discovery Books, 1994) ISBN 0-02-72634-X.

Describes the kinds of foods different people ate in their everyday lives and on special occasions. Shows how they cooked and served the meals. Include descriptions of the variety of foods that were produced, preserved, and prepared.

Resources:

Medieval Feast by Aliko. (Thomas A. Drowell, 1983) ISBN 0-690-04246-9.

Describes the preparation and celebration of a medieval feast held at an English manor house entertaining royal guests.

The Medieval Cookbook by Maggie Black. (Thomas and Hudson, 1992)

ISBN 0-500-01548-1. * Available from ODL Juvenile Collection

This mouth-watering selection of eight recipes has been drawn from Medieval manuscripts and adapted for the modern kitchen. Each section has an introduction which sets the historical and literary context and is then followed by recipes updated for the modern cook.

Living in A Castle by Rjunstead. (Addison-Wesley, 1971) ISBN 0-201-08495-3.

* OLD-Main Collection

Describes food and drink; the importance of spices and herbs; dinner at the castle; and table manners.

Activities:

- Plan a medieval feast at your library

Tasty Treats:

POOR KNIGHTS OF WINDSOR - Original name of strips of french toast.

SWORDS IN THE STONE - Insert small plastic cocktail swords into marshmallows, or plastic knives into muffins or baked potatoes.

FINGER FOODS - They didn't use knives and forks in the Middle Ages --- so serve finger foods such as cheese squares, fruit or chicken drumsticks.

SHIELD CAKE - Make or buy a 9 X 12" sheet cake. Cut off triangles at the bottom corners and frost in bright bands of Color.

NOTE: They use to eat off flat bread rather than plates. The rich then gave their "plates" to feed the poor.





Middle Ages

Activities:

Share books on the Middle Ages to give an overview of people, places, and events of the times.

The Middle Ages was a period of history in Europe that lasted for more than 1,000 years - from the end of the Roman Empire until about A.D. 1500.

Most people lived in the countryside, working the land under the feudal system. Lords and knights were given land, or manors, by the rulers. Poor people, or peasants lived on the land and had to work for their lord.

Resources:

Aliki. A Medieval Feast. New York: Harper Collins Children's Books, 1981.

Caselli, Giovanni. The Middle Ages. New York: Peter Bedrick Books, 1988.

Corbishley, Mike. Middle Ages. New York: Facts on File, 1990.

Corrick, James A. The Early Middle Ages. San Diego, CA., Lucent Books, 1994. ISBN: 1-56006-246-0.

Cosman, Madeleine Pelsner. Medieval Holidays and Festivals. New York: Scribner's, 1981.

Howarth, Sarah. Medieval People. Brookfield, Conn.: Millbrook Press, 1992.

_____. Medieval Places. Brookfield, Conn.: Millbrook Press, 1992.

Oakes, Catherine. The Middle Ages. San Diego: Harcourt Brace, 1989.

Ross, Cynthia. Medieval Times. Teacher Created Materials, Inc., 1992. ISBN: 55734-291-1.



Mime

Mime is not a silent art. It is the art of touching people. Mimes and clowns were favorite entertainers and Harlequin and Pierrot were two of the most famous. (Italy)

Mimicry is a basic form of language.

Mime entertained the masses throughout the Middle Ages. Performers portrayed the events of everyday life with the help of elaborate gestures.

Use Sing, Pierrot, Sing by Tomie de Paola, a story book that tells the story of the legendary rivalry (between Harlequin and Pierrot) in a wordless (mime) book. You could tell it as you show the pictures and then have the children act out the plot.

Characters:

The pantalooned Pierrot
His saucy sweetheart Columbine
Her lover Harlequin---full of good-natured drolleries and amusing tricks.

"The words, as in all mime, are in the eyes of the listener."

Resources:

Harlequin and the Gift of Many Colors by Remy Charlip, Parents Magazine (OP) 1973.

Sing, Pierrot, Sing: A Picture Book in Mime by Tomie de Paola (Harcourt, Brace, Jovanovich, 1983) ISBN: 0-15-274988-8

Marcel Marceau: Master of Mime by Ben Martin (Paddington Press LTD, 1977)

* ODL Main Collection

Human Resources:

- ~ Check your local community for performing mimes and clowns.
- ~ Check old movies - Chaplin and Keaton

Activities:

- ~ Charades is just a step or two from Mime. You could have children play charades with popular book titles (Wind in the Willows, The Mouse & the Motorcycle, etc.)
- ~ Have someone in your community that performs mime demonstrate his/her art.
- ~ You also might glean from books to show children a few of the basic movements, having everyone practice.
- ~ Face painting might be a fun activity!!
 - Resource: Five-Minute Faces: Fantastic Face-Painting Ideas
by Snazaroo (Random House, 1992) ISBN 0-679-82810-9
 - * ODL Juvenile Collection
 - See pg. 17, Pierrot - face painting, plus instructions for a Pierrot Hat.



Instrels & Ballads

The minstrels or troubadours of Western Europe were the first who really thought of love the way we do now, as a one-to-one relationship. They were the poets of their age.

Minstrels traveled and gave shows in villages, entertained at castles, and some even belonged to nobles and kings.

Minstrels sang the same ballads and folk tales over and over again helping to preserve them. When writing their ballads they chose themes of chivalry, courtly love, tenderness and sacrifice.

With the invention of the printing press in the 1400's, the minstrels lost their popularity.

Ballads are songs that tell stories in rhyming verse. Most have a four line stanza of short phrases.

A "The highway is the minstrel's home.
B He's working when he's playing
A He's never lost if far he roam.
B He wanders when he's staying."

*note: sample is from Adam of the Road by Elizabeth Janet Gray.

Resources:

Traditional Tunes of the Child Ballads by Bertrand H. Bronson. 4 Volumes. (Princeton University Press, 1962.)

A good source for standard ballads

*ODL Main Collection

~ Introduce and share some ballads with the children

Example: "Barbara Allen"

A version sung by Joan Baez is available on her album "Joan Baez, Vol. 2" (Vanguard, 1987)

~ Have older children make a minstrel's flute. For younger children, use the English Recorder.

Resource: The Recorder Book by Kenneth Wollitz

Singing Nursery Rhymes

"London Bridge" - was originally built from 1176 to 1200 and was used during the Middle Ages to get to London. The poem is a narrative ballad.

note: The original London Bridge is now at Lake Havasu, Arizona. Recent additions to "London Bridge" include stanzas that begin "London Bridge has now been sold", "Arizona's where it is".

The narrative ballad, "London Bridge", may have been a rhyme about the actual destruction of the bridge by King Olaf in the early part of the 11th century.

Check: Old Mother Goose books or editions for different versions.

~ Troubadors Search Puzzle

KEY TO TROUBADOR PICTURE SEARCH PUZZLE

160: bird, open book, swan, carrot,
banana, bell, pear, horse, dragonfly,
envelope, butterfly, crown, cake,
fork, dog



TROUBADOR PICTURE SEARCH



Imagine hearing the lovely medieval music as you search for a bird, open book, swan, carrot, banana, bell, pear, horse, dragonfly, envelope, butterfly, crown, cake, fork, and a dog.

Printed with the permission of Highlights for Children, Inc., Columbus, OH, 1965.

BARBARA ALLEN

In scarlet town, where I was born,
There was a fair maid dwelin',
Made every youth cry Well-a-way!
Her name was Barbara Allen.

All in the merry month of May
When green buds they were swellin',
Young Jemmy Grove on his death-bed lay,
For love of Barbara Allen.

He sent his man in to her then,
To the town where she was dwellin',
"O haste and come to my master dear,
If your name be Barbara Allen."

So slowly, slowly rase she up,
And slowly she came nigh him,
And when she drew the curtain by-
"Young man, I think you're dyin."

"O it's I'm sick and very very sick,
And it's all for Barbara Allen."
"O the better for me ye'se never be,
Tho' your heart's blood were a-spillin! "

"O dinna ye mind young man," says she,
"When the red wine ye were fillin,
That ye made the healths go round and
round,
And slighted Barbara Allen?"

He turn'd his face unto the wall,
And death was with him dealin':
"Adieu, adieu, my dear friends all,
And be kind to Barbara Allen!"

As she was walking o'er the fields,
She heard the dead-bell knelin';
And every jow the dead-bell gave
Cried "Woe to Barbara Allen."

"O mother, mother, make my bed,
O make it soft and narrow:
My love had died for me today,
I'll die for him to-morrow."

"Farewell," she said , "ye maidens all,
And shun the fault I fell in:
Henceforth take warning by the fall
Of cruel Barbara Allen."

Anonymous

LONDON BRIDGE

London Bridge is broken down,
Broken down, broken down,
London Bridge is broken down,
My fair lady.

Build it up with wood and clay,
Wood and clay, wood and clay,
Build it up with wood and clay,
My fair lady.

Wood and clay will wash away,
Wash away, wash away,
Wood and clay will wash away,
My fair lady.

Build it up with bricks and mortar,
Bricks and mortar, bricks and mortar,
Build it up with bricks and mortar,
My fair lady.

Bricks and mortar will not stay,
Will not stay, will not stay,
Bricks and mortar will not stay,
My fair lady.

Build it up with iron and steel,
Iron and steel, iron and steel,
Build it up with iron and steel,
My fair lady.

Iron and steel will bend and bow,
Bend and bow, bend and bow,
Iron and steel will bend and bow,
My fair lady.

Build it up with silver and gold,
Silver and gold, silver and gold,
Build it up with silver and gold,
My fair lady.

Silver and gold be stolen away,
Stolen away, stolen away,
Silver and gold be stolen away,
My fair lady.

Set a man to watch all night,
Watch all night, watch all night,
Set a man to watch all night,
My fair lady.

Suppose the man should fall asleep,
Fall asleep, fall asleep,
Suppose the man should fall asleep,
My fair lady.

Give him a pipe to smoke all night,
Smoke all night, smoke all night,
Give him a pipe to smoke all night,
My fair lady.

MINSTREL'S FLUTE

Materials: Bamboo section about 11 1/2" (29 cm) long by 1" (2.54 cm) in diameter; hand drill; 1/4" and 3/8" drill bits; newspaper to cover work surface; ruler; file; skills knife; a cork that fits in the top of the bamboo tube

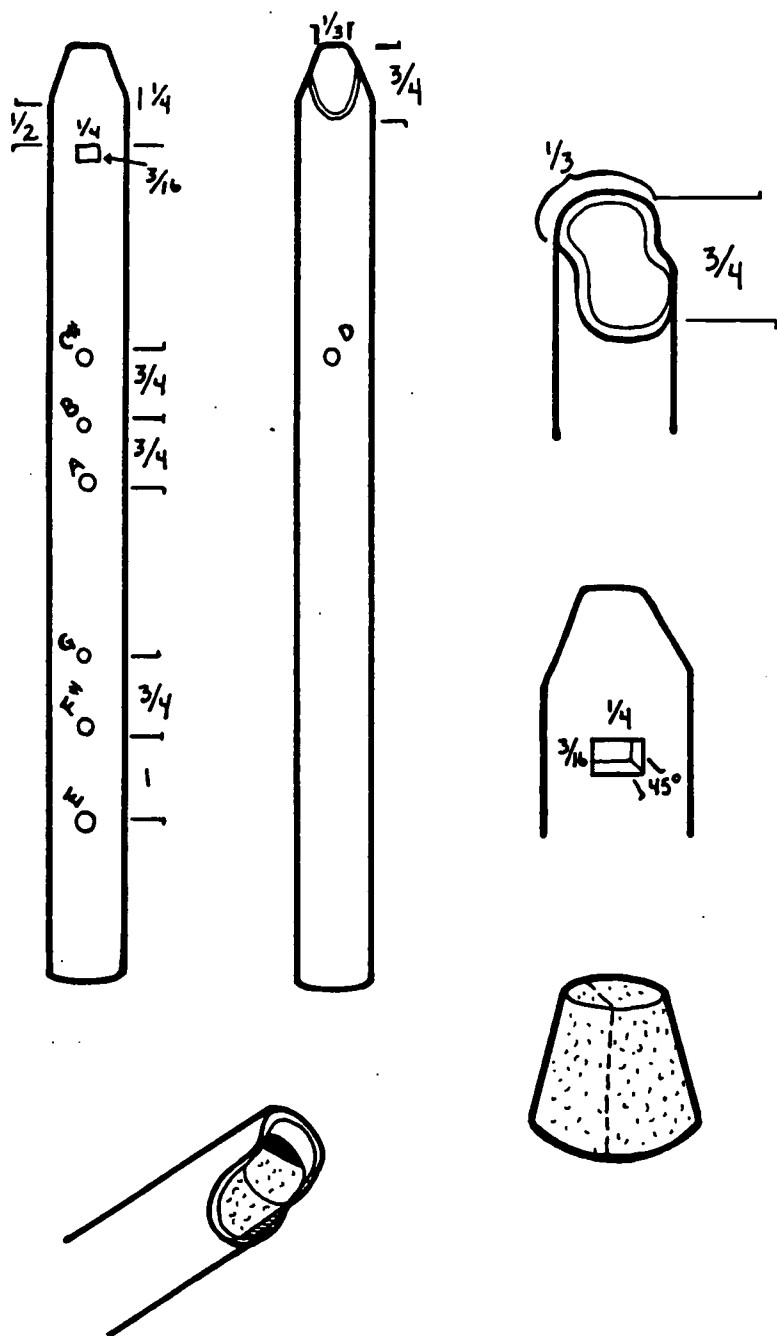

Your flute will have a window and six holes in front and one hole in the back. Measure 1 1/2" (4 cm) from the top opening and cut a small window 1/4" (.6 cm) across and 3/16" (.5 cm) down. Measure 2 1/4" (6 cm) below the window. Drill a 3/8" hole in front (C#) and a smaller hole (1/4") in the back, directly behind it (D). Make a 3/8" hole (B) by measuring 3/4" (1.8 cm) below C#. Drill a 3/8" hole (A) 3/4" below hole (B).

Starting from the bottom of the bamboo section, measure the distance to the window. Divide the result by 4 and drill a 3/8" hole (E) this distance from the bottom of the bamboo section. One inch above the E hole make the F# hole (gouge out a little larger than E). Drill the G hole 3/4" above the F# hole. This hole should be smaller than the E hole.

To make the blow hole, measure 1/3" around top front of bamboo section and cut at an angle toward the back so that you finish 3/4" below the top opening. Cut the cork on the side so that 1/3" (.8 cm) is sliced away. Use a file to create a channel on the inside of the bamboo shoot where the air will be blown.

Insert the cork to create a small passage for the air.

219



ubbings

Rubbing - is the lifting of a design from a pre-formed or carved surface. The technique of rubbing has been a tool of archaeologists since the Sung period in China. The most important European rubbings are those taken from monumental brasses (engraved figures.) Brasses are often the only accurate records of heraldry, design and military fashion. Monumental brasses represent the "types" of the medieval man and records of custom.

Resources:

How to Make Rubbings by Michael Kingsley Skinner (Van Nostrand Reinhold Company, 1972) ISBN 0-289-70190-2

Rubbings and Textures: A Graphic Technique by John J. Bodor (Reinhold Book Corp., 1968) LC-68-16026

* Available ODL Main Collection, call number 741.29 Bod

Activities:

- ~ How to Make Simple Rubbings: Place an object (example a coin) under a piece of paper. Then, with a pencil or crayon/or white wax crayon on black paper (resist method) "rub" the surface of the coin through the paper.
- ~ Other objects: Example: leaves - may be cut and arranged into a design.

Leaf Dragon:



Activities cont.:

- ~ commemorative plaques
- ~ cut out letters (example: your name), lay on smooth surface, place paper on top.
- ~ tombstones (a good field trip for YA's) Some have interesting crests, designs, or decorative writing and make very good rubbings. (Tape paper securely in place so it won't blow).

* Ask permission *

- ~ Fruits and Vegetables (surface textures - apples, pears, carrots, parsnips)
Inside Textures (cut in half or slice, make sure you produce a flat surface and leave them to dry)
Use tissue paper and soft wax crayons.

Check your local art store for:

- ~ non-smudge wax crayons in a variety of bright colors.

MONUMENTAL BRASS RUBBINGS



Monumental Brass:
Sir Roger de Trumpington
died 1287
A "Crusader"



Monumental Brass:
Eleanor of Bohun
Dutchess of Gloucester



Monumental Brass:
Sir Symon Felbrygge,
K.G.
Most Noble Order of
the Garter

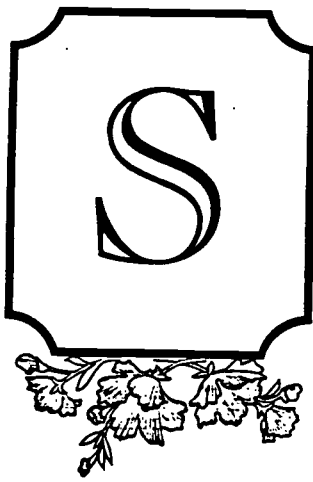

ewing & Stitchery & Tapestry

Sewing and embroidery were important activities during the Middle Ages. Sewing and embroidery took a lot of girls' and women's time.

Resources:

The Bayeux Tapestry by Norman Denny (New York: Atheneum Publishers, 1966. Grades 5-7) Shows clothing and tapestries made during the Middle Ages.

Stitch by Stitch by Carolyn Meyers (New York: Harcourt Brace Jovanovich, Inc., 1970. Grades 4-6) Has instructions for basic stitches.

Activities:

- ~ Make squares of burlap and have needles and yarn for children to do their own designs and embroidery. Then display their work.
- ~ Show pictures of clothing worn and tapestries.
- ~ Afternoon in the Garden Picture Search.

KEY: AFTERNOON IN THE GARDEN PICTURE SEARCH

spatula, crab, acorn, arrow,
spool of thread, cap, sailboat,
letter A, shoe, clam shell, parrot,
pliers, cat, bird, piece of pie,
ice-cream cone, tube of toothpaste



AFTERNOON IN THE GARDEN PICTURE SEARCH



seventeen objects hidden in this scene. Look for a spatula, crab, acorn, arrow, spool of thread, cap, sailboat, letter A, shoe, clam shell, parrot, pliers, cat, bird, piece of pie, ice-cream cone, and a tube of toothpaste.

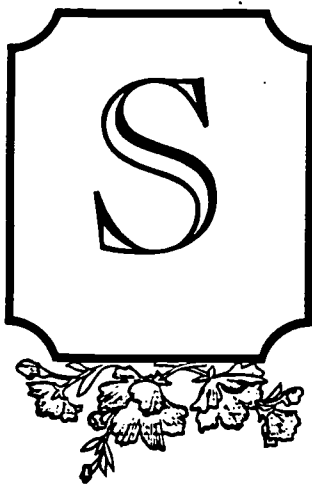

Stained Glass Windows

In castle times, most artists worked on cathedrals. Stained glass window making has been called painting with light.

Artists first drew a cartoon, or picture of the window, then made the colored glass. Next they made a large pattern for the window and cut the glass to fit the pattern. Then they outlined the glass pieces with lead and joined the lead pieces together and set the window into the building.

At first every part of the design was a different piece of glass; later, artists began painting on the glass for the fine details.

Resources:

Singing Windows by Mary Young.
Abingdon Press, 1962, LC #62-7869
*ODL Main Collection

Stained Glass Coloring Books:

Dover Children's Book Catalog
Dover Publications, Inc.
31 East 2nd Street
Mineola, NY 11501

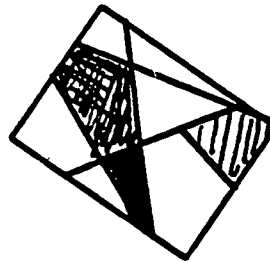

Zodiac Stained Glass Coloring Book, Order # 24350-9 Pa. \$3.95

Stained Glass Windows Coloring Book, Order # 22862-2 Pa. \$3.95

Cathedral Stained Glass Collection, Order # 24027-4 Pa. \$3.95

Art Nouveau Stained Glass Coloring Book, Order # 23399-5 Pa. \$3.95

Celtic Stained Glass Color Book, Order # 27456-X Pa. \$3.95 (mythical beasts)

Activities:

- ~ Make stained glass cookies, Medieval castles and stained glass cookies are described in Do A Zoom by Bernice Chester. (Boston: Little Brown & Co., 1975. Grades 2-4).
- ~ Make a stained glass window.

Note: There are many methods of making stained glass "windows" which will be suitable for many age levels.

STAINED GLASS WINDOW

Ages: Preschool to Kindergarten

Materials: White or manilla paper
Crayons
Black permanent marker
Salad oil
Brush (broad pastry brush works best)

How to Do It:

- Use the black permanent marker to draw criss cross lines on the paper.
- Color each black-outlined shape with a different crayon; color in heavily.
- Paint the picture with salad oil. After drying the picture will be translucent. Hang on window so light shines through.

(Don't let children take these home the day they make them. They take about a day to dry and will be greasy before then.)

STAINED GLASS WINDOW

Ages: Upper Elementary

You will need: White paper
Pencil
Crayons
Cotton balls
Vegetable oil

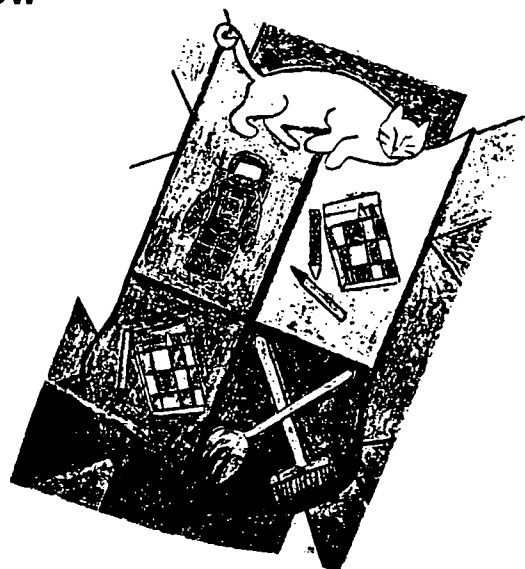

Design a coat of arms for you and your family. Your charges could show what your mom and dad do, or what your own hobbies are. Keep your design fairly simple as you need crayons for this project and they are not good for drawing tiny details.

1. Draw your design on a piece of white paper and then go over its outlines in black crayon. You'll need to press quite hard.
2. Color the spaces between the black lines. Make sure that the paper shows through only where you particularly want it to.
3. Pour a little vegetable oil onto a cotton ball and wipe it over the back of your design.
4. When the paper is dry, tape it on a windowpane. Your coat of arms will glow when the sun shines through it, just like a stained-glass window.

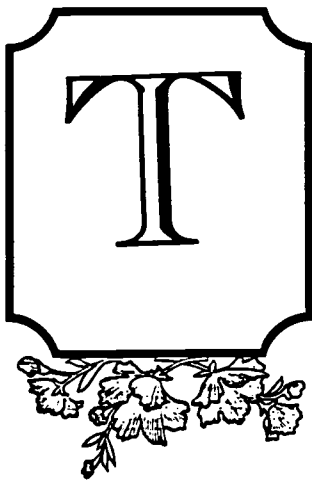

Tournament

Nobles were also knights, and were trained warriors. When they were not at war, knights practiced their skills in tournaments, or war games.

Tournaments were attended by the residents of the manor and visitors from neighboring castles.

Opening Day - noble contestants rode in a procession through the town and displayed their banners and coats-of-arms.

Tournament Day - a noble maiden was chosen as the tournaments' Queen of Love and Beauty and sat in the judge's stand.

Joust - two knights on horseback galloped toward each other from opposite ends of a field, each one trying to unseat the other rider with his lance. Knights wore full suits of armor for protection and carried a lance and a shield. If a knight were knocked off his horse, he lost his horse and armor and had to pay a ransom to get them back.

Three Kinds of Jousts:

1. Used sharpened points on the lances, which could cause death.
2. Used blunted lances which usually did not injure opponents.
3. Occurred with real weapons, but fighting could be stopped at any time.

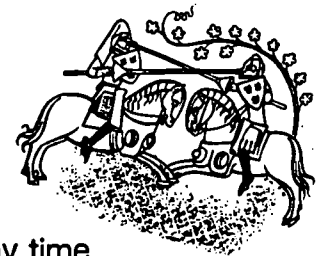

Tournaments not only provided practice for knights and entertainment for the people, but gave knights a chance to gain wealth and recognition.

Activities: Stage a mock tournament.

Sample Games:

GAMES OF SKILL Children still love to test their skill at such games as ring toss, beanbag toss, marbles, hoop rolling, longest-held musical note and best guess of the number of beans in a barrel. Believe it or not, all these favorites had their origins in the Middle Ages!

FOOT RACES Foot races were also popular during the Middle Ages. Try such versions as the egg-and-spoon race, the hopping race and the backward race.



weaving

Large tapestries were woven in the Middle Ages to decorate and to hang on the drafty castle walls to help insulate. It was the art form of many noblewomen. Some of the most famous tapestries told the legend of the unicorn.

POCKET PATCH using a styrofoam tray

Materials: Warp - bulky orlon yarn, 6 1/2 yards red
 Weft - bulky orlon yarn, 2 1/2 yards red, 24" pink
 Frame - styrofoam tray, 5-3/4" X 8"
 Cardboard shuttle

Frame: Cut one slit 1/2" from each corner of the short sides of the tray.

Warp: Anchor warp yarn in upper left corner. Wind the warp around the tray until you have 14 warp threads.

Shuttle: Fill with red yarn.

Weave: Begin at bottom and weave regularly for eight rows. Do not end yarn. Weave the pink yarn under 2, over 2, under 2, etc. for one row. Weave red next 2 rows. Repeat with pink as above. Continue pattern until five rows of pink. Finish to end of frame. Cut warp threads on back and knot to secure weave. Trim fringe to 3" at bottom and 1/2" on top. Pin or sew on a pocket. As you weave, use a comb to tighten rows.

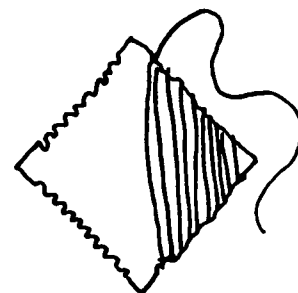
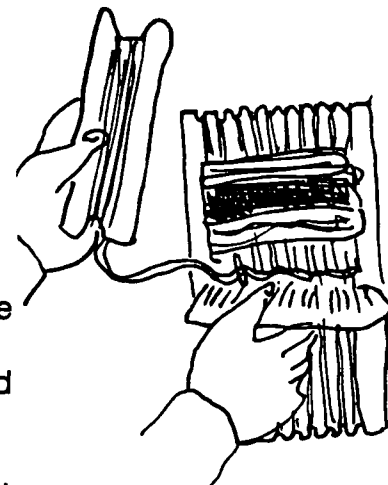

CARDBOARD WEAVING



Frame: Stiff cardboard, even a paper plate
 Mark notches 1/4" on two opposite sides and notch with hole punch, or scissors.

Warp: Beginning at one end string the warp.

Weft: Fill a shuttle with yarn or string.

Weaving: Begin by pushing the shuttle over and under the warp threads. After each row, pull the thread taut and use a pocket comb with big teeth to push the woven lines together.

Finishing: Either leave in the frame as part of a wall decoration or cut the warp threads on the back of the loom and tie them together in pairs at the end of the piece.

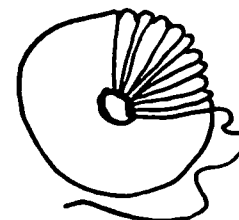

Human Resources: Check your community to see if you have people available to do a weaving demonstration.



izards

Merlin was King Arthur's chief adviser. He could cast spells and foresee the future. He foresaw that Arthur's father, King Uther Pendragon, would die when Arthur was a baby. So Merlin arranged for Arthur to be hidden and raised as the child of a simple knight.

Program:

Have a wizard, complete with a cone-shaped hat and crystal ball, conduct a program.

- ~ have the wizard read riddles
- ~ perform magic

Media:

"The Sorcerer's Apprentice" by Walt Disney

Craft:

"Wizard Hats"

Make Cone "Wizard Hats", decorate with moons & stars.

- (1) Cut a quarter circle with a 16-inch radius out of tagboard (black or dark blue)
- (2) Shape into a cone and tape or staple in place to size
- (3) Cut out star and half-moon shapes (yellow) and glue around the hat
- (4) Punch holes (if desired) near bottom at sides and attach strings (knot inside)

Activities:

- ~ Place the names of all the children attending in a decorated wizard's hat --- have a drawing and appoint that child "Wizard of the Day".
- ~ Create a "Merlin's Magic Fishing Pond" - write clues to good reading, books, etc. on cardboard fish (attach a small magnet to each fish). With a stick, string and magnetic sinker, let the children fish for clues to good reading.
- ~ Create "Merlin's Magic Crystal Garden"

MERLIN'S MAGIC CRYSTAL GARDEN

Supplies Needed:

- 1 baby food jar per child (label with each child's name)
- Measuring spoons
- Non-iodized salt
- Laundry bluing
- Water
- Magnifying glasses
- Food coloring
- Eye droppers
- Ammonia
- Porous material: lava, styrofoam, cork, clay pot, sponge

Crystal Garden solution: (makes 8 to 10 gardens)

- 1 cup non-iodized salt
 - 1 cup liquid bluing
 - 1 cup water
 - 4 tablespoon ammonia
- Mix well -- some salt will not dissolve.



Directions:

1. Mix crystal garden solution.
2. Add porous materials and fill the baby food jar 1/2 full.
3. Add 3 tablespoons crystal solution.
4. Add two drops of food coloring.
5. Watch your garden grow.

231

HIDDEN HOUNDS PICTURE SEARCH



The horse and rider are so intent on their mission that they have no idea there are twenty hounds coming along with them. Can you find all twenty hidden hounds?

KEY: HIDDEN HOUNDS PICTURE SEARCH



233

BEST COPY AVAILABLE

MEDIEVAL ACTIVITIES FOR YOUNG ADULTS

Young adults are most attracted to programs with hands-on activities and audience participation. Depending on your funds and local resource people, some possible program ideas are:

- ~ Acting or mime
- ~ Archery
- ~ Astrology
- ~ A 20th Century Medieval Feast
- ~ Book Talks
- ~ Calligraphy
- ~ Chess or Dungeons and Dragons Tournament
- ~ Fantasy Books Discussion
- ~ Fencing
- ~ Heraldry banners
- ~ Homemade herbal beauty aids
- ~ Juggling
- ~ Pottery
- ~ Stained glass
- ~ Trivia Quizzes - Example: "Knightly Trivia"
- ~ Weaving
- ~ Windowsill herb garden

Note: YA Program submitted by Brenda Johnson, Young Adult Librarian,
Moore Public Library

ASTROLOGY

Books: Anno's Medieval World by Mitsumasa Anno.

Rationale: During the Middle Ages, people believed that the stars and planets circled the Earth as set forth in Ptolemy's theory. Astrological theories plot the heavens revolving around each individual at the moment of his or her birth. It wasn't until 1543 that Copernicus set forth his theory that the Earth revolves around the Sun, which supplanted Ptolemy's theory.

CHESS OR DUNGEON AND DRAGONS TOURNAMENT

Sponsor a chess tournament or a Dungeons and Dragons tournament in the library. This would be a good activity for older children who frequently lose interest in using the library during the summer.

DUNGEONS AND DRAGONS!

1. Let your leader(s) begin by telling some basics about the game and why they like it. Then they can show some theme-related objects like maps, figures, etc. This part should probably last about 15 minutes.
2. After some general questions, other kids can show and tell the items they brought.
3. Break kids up into groups with one experienced player/dungeon master in each group. They begin to play. Be sure to talk with the leaders about the importance of getting started quickly and keeping the game moving. Allow 30-40 minutes for this section.
4. At the end, discuss possibilities for continuing the clubs. Decide ahead of time about the possibility of library space for this purpose.

PREPARATION:

1. Locate program leaders. Look for a game store owner, an existing club, high school or jr. high school experienced players (ask at the game, toy or hobby store, or just ask kids). You'll need one leader for every 6-7 participants.
2. Meet with the leaders to outline the program.
3. Advertise the program. Be sure to suggest that kids bring their dungeons and dragons theme-related items.

DISPLAYS:

1. Fantasy books and game objects (like maps, drawings and figures).

A 20TH CENTURY MEDIEVAL FEAST

The book Pleyn Delit: Medieval Cookery for Modern Cooks by Constance Hiatt provides many medieval recipes, but the stews, soups, and custards are not simple to prepare and require some lengthy cooking times.

Since medieval folk used forks for serving, not eating, an alternative could be having a group of young adults prepare an assortment of finger foods with a medieval theme and then serve the feast in the medieval fashion on a white tablecloth with candles.

As the participants enjoy their feast, they could listen to booktalks on books with medieval settings.

A sample menu:

CHESSBOARD SANDWICHES

Brown sandwiches:

1/2 cup peanut butter
1/4 cup shredded carrots
4 slices whole wheat bread

Mix peanut butter and carrots. Spread on 2 slices bread. Top with remaining bread. Trim crusts, cut in quarters.

White sandwiches:

1 can tuna
2 T. mayonnaise
2 T. pickle relish
4 slices white bread

Drain tuna, add mayonnaise and relish. Spread on 2 slices bread. Top with remaining slices. Trim crusts, cut in quarters.

Arrange sandwiches in chessboard pattern by alternating white and brown sandwich quarters.

TRENCHER OF DIP AND VEGGIES

6-10 inch round loaf of bread
1/2 cup plain yogurt
1/2 cup cottage cheese
1/4 Parmesan cheese

Slice off top inch of bread loaf and hollow remaining bottom portion as container for dip. Set aside. Cut bread removed from loaf into serving portions and set aside. Combine yogurt and cheeses and pour into bread "trencher". Serve with bread and assorted vegetable dippers.

TRENCHER OF DIP AND FRUIT

6-10 inch round loaf of bread
1/2 cup sour cream
1/2 cup plain yogurt
2 T. unsweetened, frozen juice
concentrate, thawed
Cinnamon

Slice off top inch of bread loaf and hollow remaining bottom portion as container for dip. Set aside. Cut bread removed from loaf into serving portions and set aside. Combine sour cream, yogurt, and juice concentrate. Pour into bread "trencher" and sprinkle cinnamon on top. Serve with bread and assorted fruit dippers, such as strawberries and apple, pear, melon, and pineapple slices.

CRUSADE DATES

Arabian Dates:

4 oz. cream cheese
1 T. wheat germ
1 T. honey
1 8 oz. package pitted dates

Mash cream cheese in small bowl with fork. Add wheat germ and honey. Mix thoroughly. Stuff dates with mixture. Chill.

Peanut Butter Dates:

1/2 cup peanut butter
1/4 cup crisp rice cereal
1 8 oz. package pitted dates

Mix peanut butter with rice cereal. Stuff dates with mixture. Chill.

INSTANT PUDDING

(Your favorite brand)

MULLED CIDER

2 qts. apple cider
1/4 c. brown sugar
2 sticks cinnamon
1/8 t. ground ginger
1 t. whole cloves
1 unpeeled orange, sliced

Combine all ingredients, except cloves and orange slices, in slow-cooking pot. Insert a few cloves in each orange slice and float on top of liquid. Cover and heat on high until hot.

FANTASY BOOK DISCUSSION FOR YOUNG ADULTS

Fantasy readers are passionate about their favorite genre while other young adults have never ventured into the realm. Try getting the two groups together in a discussion of the originators of the fantasy genre, classic folk or fairy tales.

There are many titles to choose from but a few of the tales with medieval backgrounds and origins are:

Beauty and the Beast (many authors)

The Castle of Ladies by Constance Heatt.

Erec and Enid by Barbara Schiller.

The Knight of the Cart by Constance Heatt.

The Kitchen Knight by Barbara Schiller.

Sir Gawain and the Green Knight by Constance Heatt.

St. George and the Dragon by Margaret Hodges.

Sleeping Beauty (many authors)

Taliesin and King Arthur by Ruth Robbins.

Tam Lin by Susan Cooper.

Water of Life by Barbara Rogasky.

Some possible questions for discussion are:

How would you update the tale for modern times?

How do the illustrations add or detract from the story?

How do the different versions of the story compare?

Why have these stories been passed down through the ages?

Does the story teach a lesson?

What did you like about this book?

What did you not like about this book?

How are folktale themes expressed in today's literature?

Can you retell the tale from the villain's point of view?

The group could also select scenes from the books to present as readers' theater and bring their favorite fantasy titles to recommend to the group.

TITLES TO BOOKTALK:

The Cats of Seroster by Robert Westall.

Dealing With Dragons by Patricia Wrede.

Dragon's Bait by Vivian Vande Velde.

Gleaming Bright by Josepha Sherman.

Kingdom of Summer by Gillian Bradshaw.

Knight's Wyrd by Debra Doyle.

Merlin Dreams by Peter Dickinson.

The Once and Future King by T.H. White.

The Princess Bride by William Golding.

The Sword and the Circle by Rosemary Sutcliff.

Windleaf by Josepha Sherman,

The Winter Prince by Elizabeth Wein.

The Woman Who Rides Like a Man by Tamora Pierce.

Trivia Quizzes

Have this or other quizzes available to young adults who drop by the library looking for something to do. The answers can be found in reference books, and a completed quiz could earn a food coupon or other small prize.

KNIGHTLY TRIVIA

1. King Arthur's sword was named a) Excalibur b) Camelot c) Galahad.
2. One of the knights in King Arthur's Court was a) Sir Lancelot b) Sir Merlin c) Sir Walter Raleigh.
3. Chivalry emphasized a) cleanliness b) bravery c) obesity.
4. The people who did the farming in the Middle Ages were the a) barons b) peasants c) artisans.
5. The main door of a castle was often protected by a wood and metal grating called a) a battlement b) a portcullis c) a belfry.
6. A medieval castle's toilet was called a) a keep b) a barbican c) a garderobe.
7. The surface of a knight's shield was called a) the charge b) the field c) the chevron.
8. After being a page, but before becoming a knight, a boy was a) a squire b) a bishop c) a pawn.
9. The medieval political system of giving land in exchange for services is called a) socialism b) democracy c) feudalism.
10. Which one of the knight's weapons is described as a "knobbed or spiked club"? a) hauberk b) trebuchet c) mace.

Answers: 1(a), 2(a), 3(b), 4(b), 5(b), 6(c), 7(b), 8(a), 9(c), 10(c).

YOUNG ADULT BIBLIOGRAPHY

Alexander, Lloyd. The Black Cauldron. New York: Holt, Rinehart and Winston, Inc., 1965. Grades 4-7.

This second book of the series sees Taran and his companions once again set forth to conquer the evil that threatens Prydain. Fierce armed battles and battles of the mind and heart ensue as Taran learns that true heroism depends on wisdom as well as courage.

_____. The Book of Three. New York: Holt, Rinehart and Winston, Inc., 1964. Grades 4-7.

The first book of the chronicles of Prydain details the adventures of young Taran, would-be hero and assistant pigkeeper, who, with some strangely assorted companions, pursues runaway Hen Hen, the oracular pig, and struggles to save Prydain from the forces of evil abroad in the land.

_____. The Castle of Llyr. New York: Holt, Rinehart and Winston, Inc., 1966. Grades 4-7.

In this third book of the chronicles of Prydain, Taran and his companions endeavor to rescue Princess Eilonwy from the wicked enchantress, Achren. It is Eilonwy's willingness to sacrifice her own magic powers that finally defeats Achren and saves Prydain from Achren's evil intent.

_____. The High King. New York: Holt, Rinehart and Winston, Inc., 1968. Grades 4-7.

In the conclusion of the Prydain series, Taran and Prince Gwydion lead an army of warriors in all-out war against Arawn, the Death-Lord, and his followers. Aided by Fair Folk and wild animals, the defeat of the evil Arawn marks the end of the era of evil enchantment and allows Taran to become mortal king of Prydain with Princess Eilonwy as his queen.

_____. Westmark. New York: E.P. Dutton, 1981. Grades 5-8.

In this book, a boy fleeing from criminal charges falls in with a charlatan, his dwarf attendant, and an urchin girl. He travels with them about the kingdom of Westmark and ultimately arrives at the palace where the king is grieving over the loss of his daughter.

Endless Quest Books:

Random House Juvenile and Merchandise Group

Andrews, Michael, Dungeon of Fear. ISBN: 156076-835-5

Make your choices and accept the consequences in this adventure based on the "Dragon Strike" game.

Baron, Nick. Castle of the Undead. ISBN: 1-56076-836-3.

You control the adventure set in the Ravenloft world.

For information on this series:

call 1-800-733-3000 or FAX 1-800-659-2436

(TRS) Dragon Lance Saga by Margaret Weis & Tracy Hickman

The Chronicles Trilogy:

Dragons of Autumn Twilight

ISBN: 0-88038-173-6

Dragons of Winter Night

ISBN: 0-33038-174-4

Dragons of Spring Dawning

ISBN: 0-88038-175-2

Dragon Lance: The Second Generation

ISBN: 1-56076-822

Dragon Lance: Tales of the Lance

ISBN: 1-56076-338-8

The perfect introduction to the Dragon Lance world of games for those who love books.

Dragon Strike Game

Boxed Set ISBN: 1-56076-635-2



WIMMER © 94

Clip Art

Summer Reading Program ~ Oklahoma Department of Libraries

Knights Alive in '95

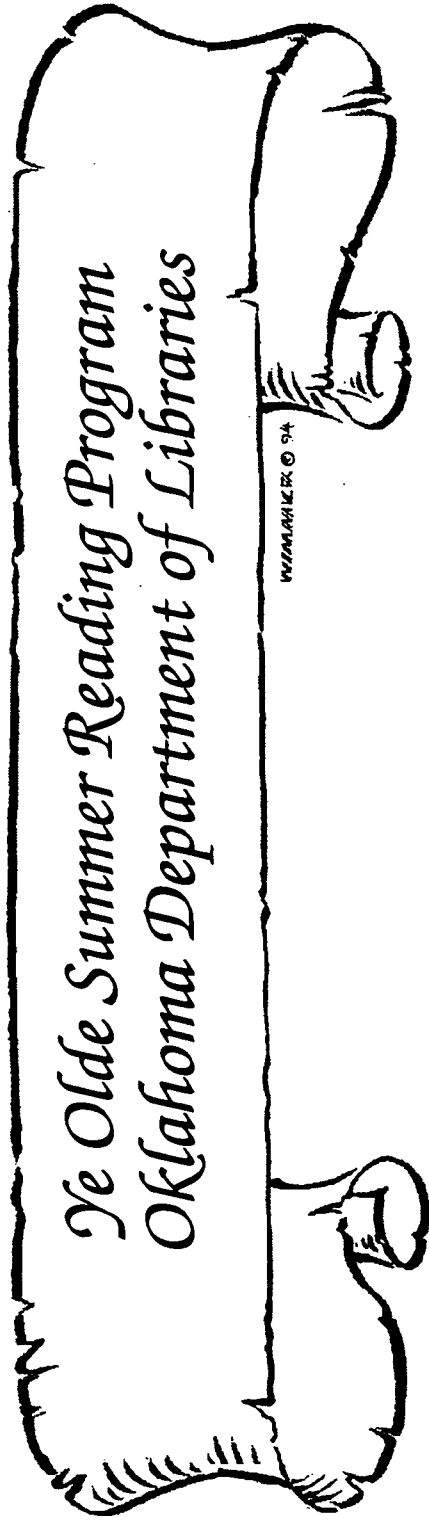

*Ye Olde Summer Reading Program
Oklahoma Department of Libraries*

W/MARKER © 94

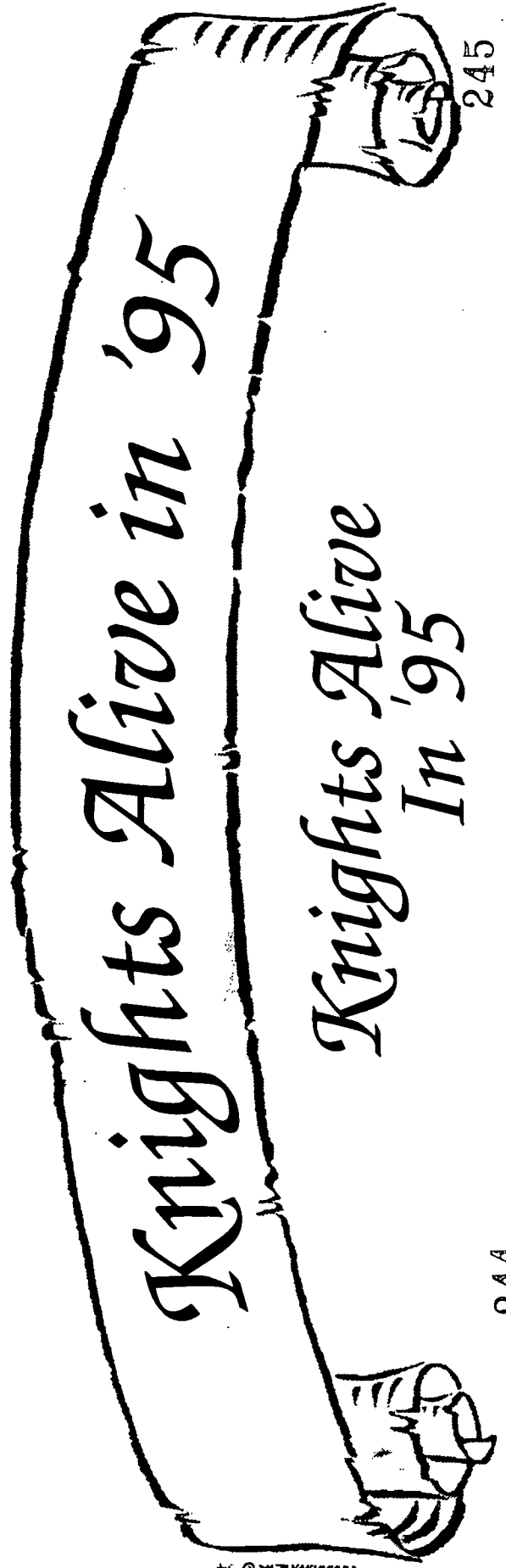

*Knights Alive
In '95*

W/MARKER © 94

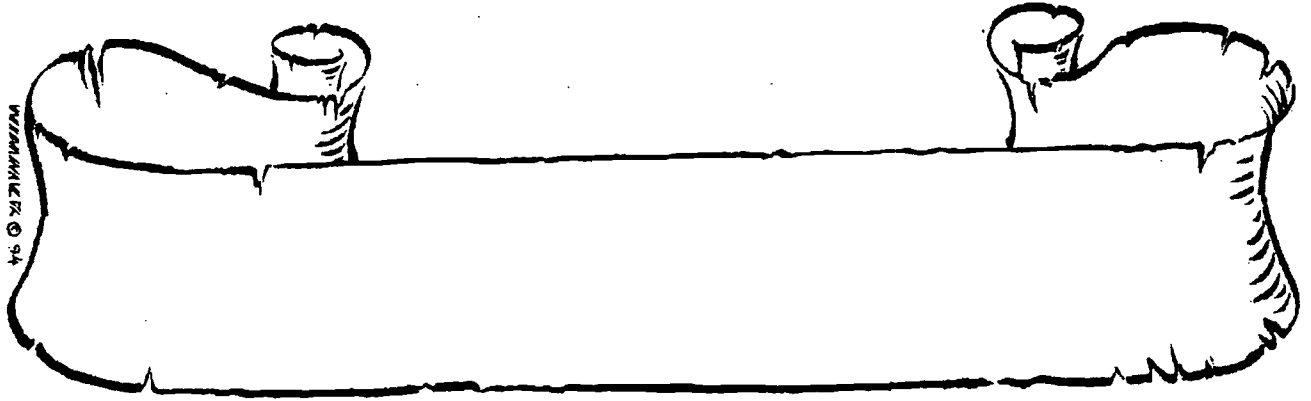

WIMMILK © 94

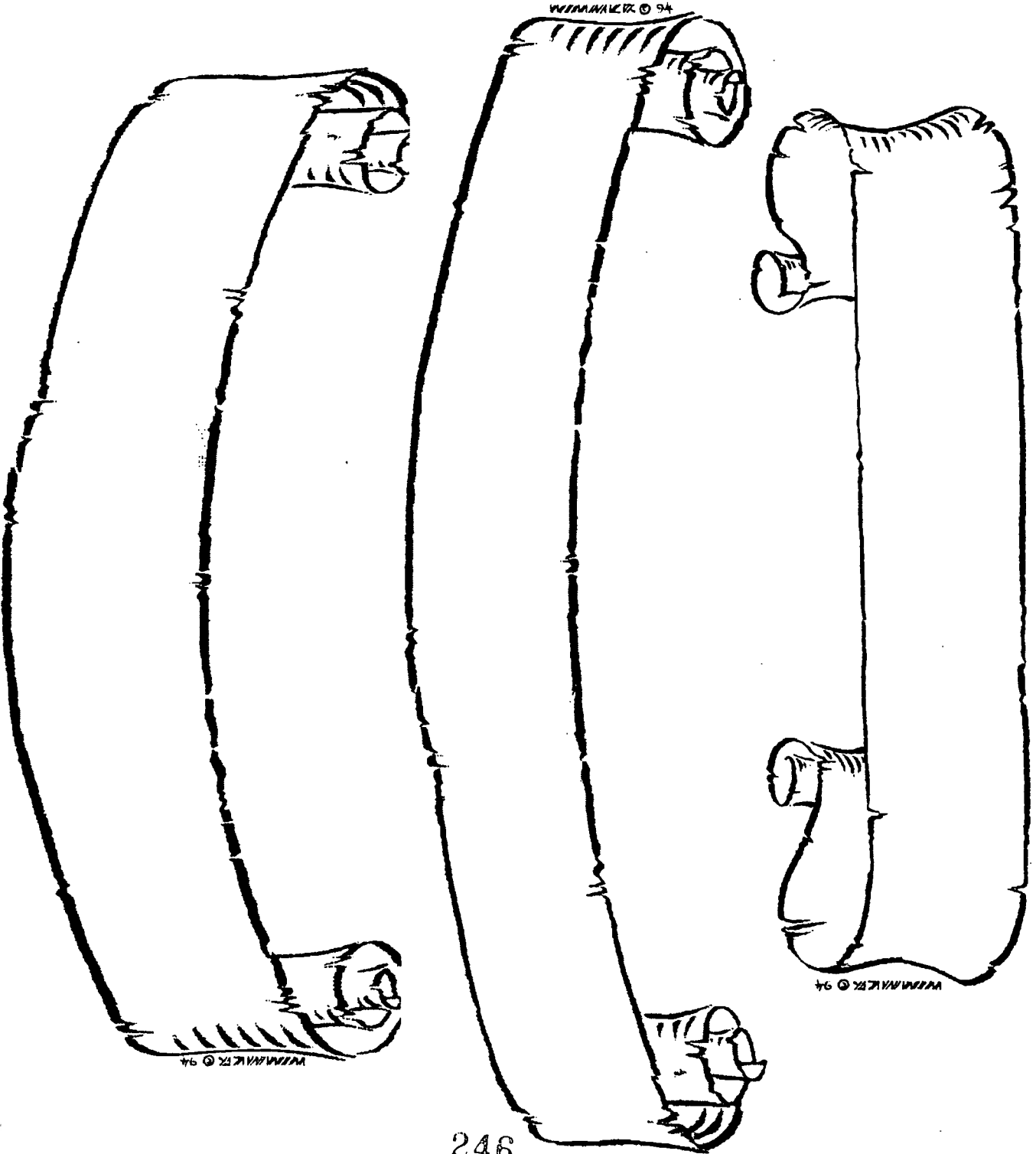

WIMMILK © 94

WIMMILK © 94

WIMMILK © 94

Conquer the Boredom Dragon... READ!

Conquer the Boredom Dragon

READ

King Arthur's Reading Roundtable

King Arthur's Reading Roundtable

the Knightly News

● ●
Become a Royal Reader

Become a Royal Reader

Castle Quest

Here Be Dragons! Here Be Draegons!

Here Be Dragons! Here Be Draegons!

Royally Good Books

Don't Let the Summer Drag On Without Reading a Good Book

Conquer the Boredom Dragon... READ!



WMM/NAK © 94

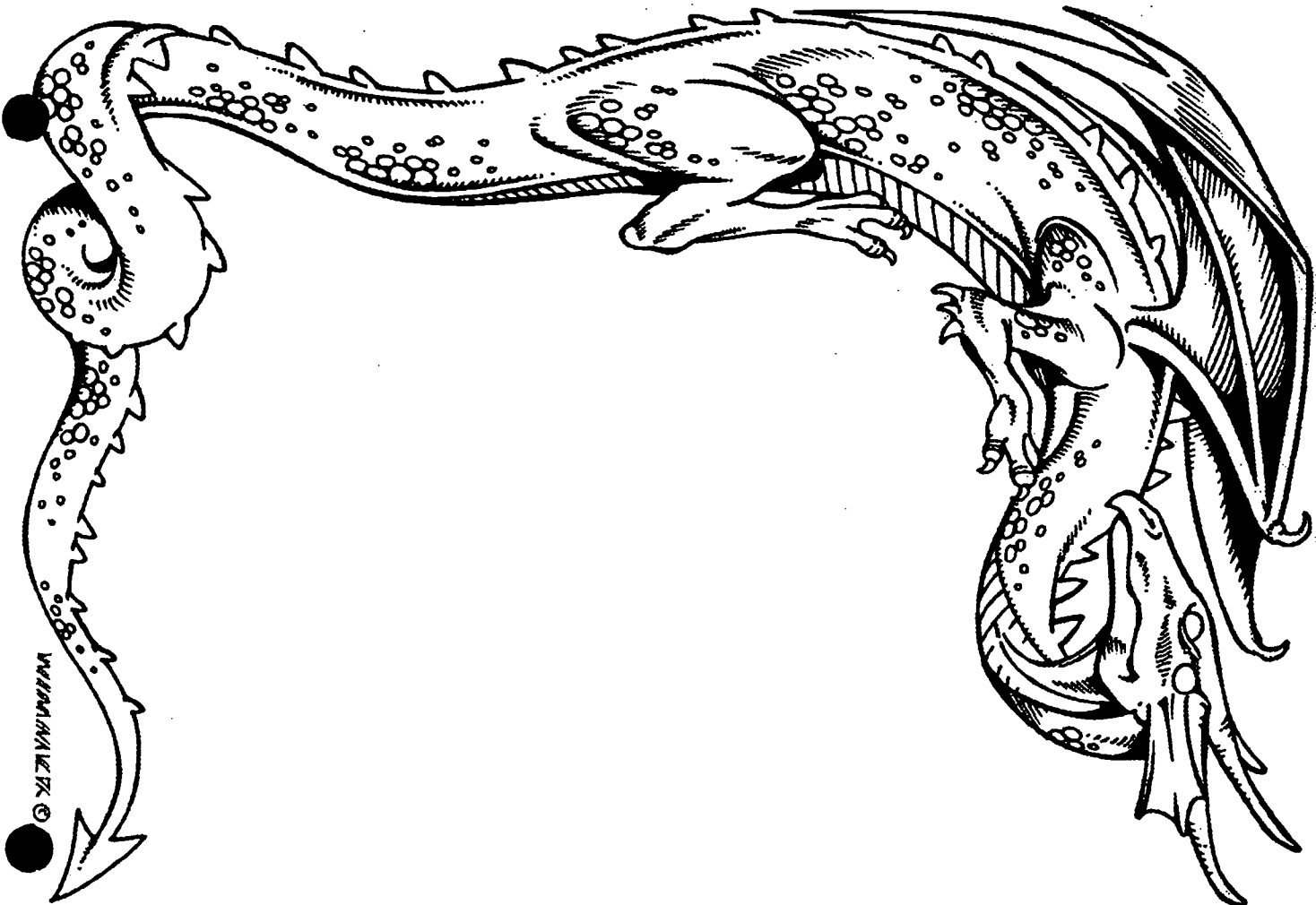

WIKIMANIA/ERIC ©



Summer Reading Program ~ Oklahoma Department of Libraries

Knights Alive In '95

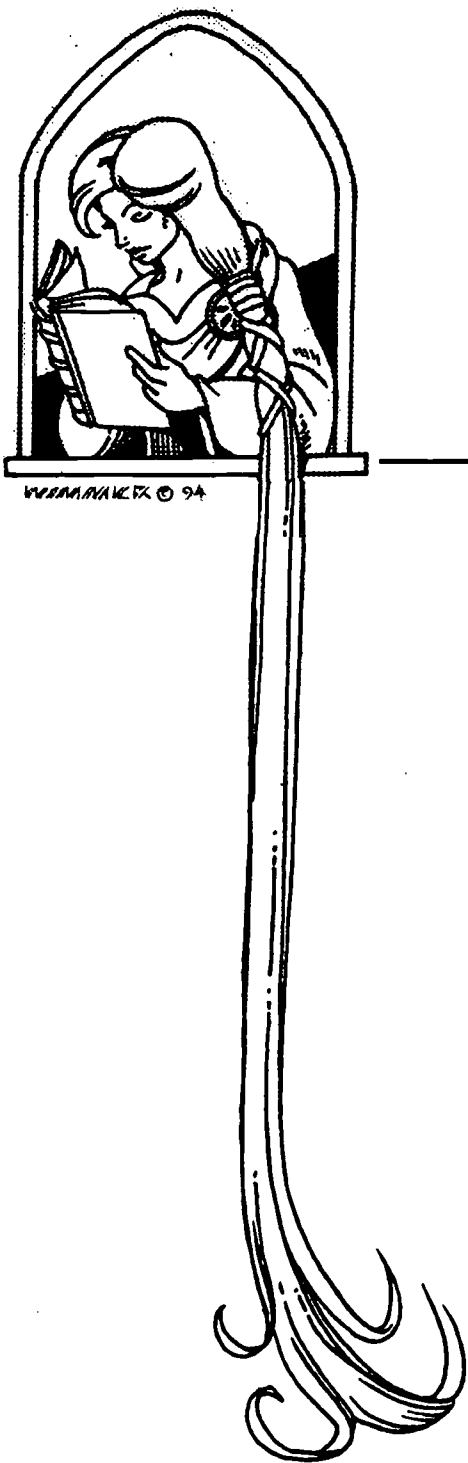

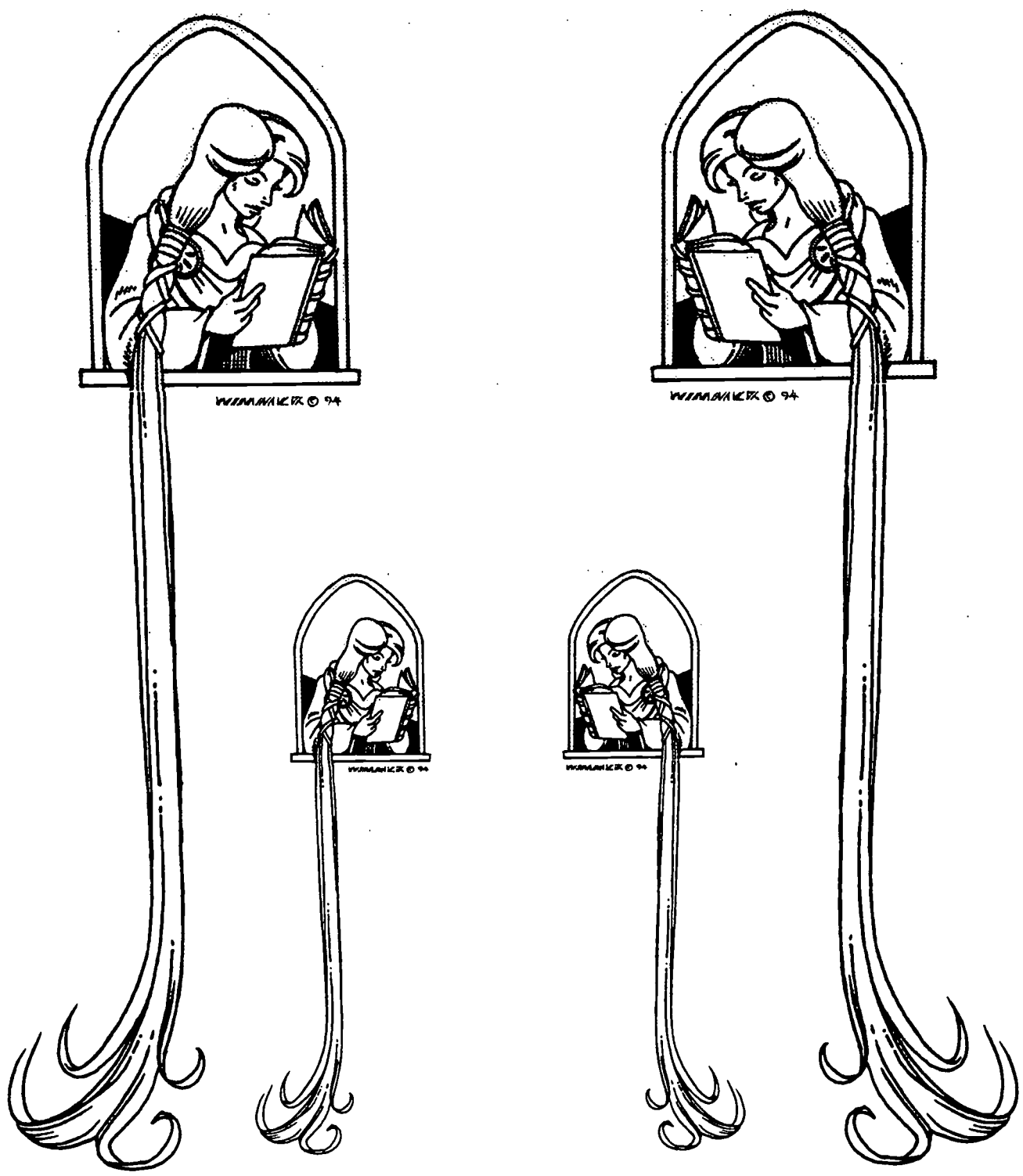









UNUSUAL PRINT AND NON-PRINT RESOURCES

Here are some out-of-the-ordinary sources for items beyond usual print and non-print materials libraries add to their collections. Try these places for book-related toys, promotional materials and programming supplies.

Acorn Products
c/o Burr Oak Press, Inc.
8717 Mocking bird Rd. S.
Platteville, WI 53818
Phone 608/348-8662

Sources for paper dolls,
puppets, book-
related cookie
cutters, stencils,
toys, and more

Book Mates
1-800-243-4504

Source for book-related
dolls, puppets,
stuffed animals

Childcraft
1-800-631-5657
20 Kilmer Road
Edison, NJ 08818

Educational toys, arts
and crafts

J.S. Latta's
1-800-772-2961
Box 128
Cedar Falls, Iowa 50613

School supplies, arts
and crafts,
games, toys,
equipment

Kidstamps
1-800-727-5437
P.O. Box 18699
Cleveland Hts., OH 44118

The greatest source of
book-related
stamps

Upstart
1-800-448-4887
32 E. Avenue
Hagerstown, MD 21740

Library-related promotional
items from
bookmarks &
posters to
t-shirts &
buttons

PROFESSIONAL BIBLIOGRAPHY

- Bauer, Caroline Feller. Handbook for Storytellers. ALA, 1977. Multi-media approach to sharing stories from puppetry to creative dramatics. Contains numerous annotated bibliographies.
- Bauer, Caroline Feller. Presenting Reader's Theater. Wilson, 1987. This much needed resource adapts popular children's books for reader's theater presentations. The selections are brief, appealing and immediately useable.
- Brown, Marc. Finger Rhymes. Dutton, 1970.
_____. Hand Rhymes. Dutton, 1985.
Two collections of traditional fingerplays with diagrams. Attractively illustrated.
- Champlin, Connie, and Renfro, Nancy. Storytelling with Puppets. ALA, 1985. Puppet construction and presentation methods for sharing dozens of stories.
- Elbert, Carol, and Currie, Robin. Rainbows and Ice Cream: Storytimes About Things Kids Like. Illustrated by Rene Lynch. Iowa Library Association, 1983. Storytime programs on popular themes are suggested along with appropriate books, a craft idea, and a fingerplay too. Sequel: Double Rainbows: More Storytimes About Things Kids Like. 1989.
- Freeman, Judy. Books Kids Will Sit Still For. Alleyside Press, 1984. Annotates over 1,000 books for K-6 with suggestions for literature-based activities.
- Fredricks, Mary, with Joy Segal. Creative Puppetry in the Classroom. New Plays, 1979. Covers puppet-making, manipulation and specific uses of them in the classroom and library. Will be useful for the novice and the experienced.
- Glazer, Tom. Eye Winker, Tom Tinker, Chin Chopper: Fifty Musical Fingerplays. Illustrated by Ron Himler. Doubleday, 1973. Popular fingerplays are included along with a description of the appropriate actions, piano music and guitar chords too! Companion title: Do Your Ears Hang Low?
- Heuer, Elain Engle. "I Want to Paint a Zebra But I Don't Know How." Small Business Press, 1987. Paperback teacher's guide to art appreciation describes step-by-step activities for cutting, gluing, working with clay, painting. Developmentally sound methods are described.

Irving, Jan. Fanfares: Programs for Classrooms and Libraries. Illustrated by Karen Myers. Teacher Ideas Press, 1990. Twelve chapters describe complete programs or units on twelve different topics from mummies to American tall tales and humor. Based on school age programming in a library setting, includes patterns for crafts and ideas for sharing books.

Irving, Jan, and Robin Currie. Full Speed Ahead: Stories and Activities for Children on Transportation. Teacher Ideas Press, 1988.

_____. Glad Rags: Stories and Activities Featuring Clothes for Children. Libraries Unlimited, 1987.

_____. Mudluscious: Stories and Activities Featuring Food for Preschool Children. Libraries Unlimited, 1986. Each title introduces complete text for 200 activities from fingerplays to flannelboard stories, crafts, games and more. Each book has a chapter of silly activities associated with the theme.

Kohl, Mary Ann F. Mudworks: Creative Clay, Dough, and Modeling Experiences. Bright Ring Publishing, 1989. Playdough, bread dough, edible dough and more! Available by writing to the press at Box 5768, Bellingham, WA 98227.

MacDonald, Margaret Read. Booksharing: 101 Programs to Use With Preschoolers. Library Professional Publications, 1988. Program planning guide with specific suggestions for books, songs, films and activities on topics that appeal to young children from an expert in the field.

McElmeel, Sharron L. An Author a Month (for Pennies). Libraries Unlimited, 1988. Nine complete units and three capsule units for sharing authors with children. Units on Bill Peet, Dr. Seuss and Steven Kellogg will be particularly good for this summer.

Nelson, Esther. The Silly Songbook. Sterling, 1981. This collection of traditional and original songs includes odd animal songs, silly songs and songs that won't end.

Nobleman, Roberta. Mime and Masks. Illustrated by Katherine McCabe. New Plays, 1979. Divided into three parts, the first describes use of mime, the second shows a variety of masks and the third provides scenes to use with both.

Polkingharn, Anne F. and Catherine Toohey. Creative Encounters: Activities to Expand Children's Responses to Literature. Libraries Unlimited, 1983. Annotates over 50 picture books and includes simple ideas for artistic and creative projects to inspire imaginative thinking.

- Price, Lowi, and Marilyn Wronsky. Concoctions. Dutton, 1976. Recipes for such silly concoctions as tooth paste putty and different doughs that use household ingredients.
- Raffi. The Raffi Singable Songbook. Crown, 1980.
- ____. The Second Raffi Songbook. Crown, 1986. Traditional songs and original ones by the popular song maker are included along with music and pictures. Many are humorous.
- Raines, Shirley C. and Robert J. Canady. Story S-t-r-e-t-c-h-e-r-s: Activities to Expand Children's Favorite Books. Gryphon House, 1989. Seventeen popular themes are presented with activities built around five books for each theme. The activities encourage learning centers and were developed for school settings, but the ideas are useful for libraries as well.
- Sattler, Helen Roney. Recipes for Art and Craft Materials. Lothrop, Lee & Shepard, 1987. This newly-revised edition contains dozens of recipes for glues, modeling compounds, paints, etc. to make from ordinary materials.
- Sitarz, Paula Gaj. Picture Book Story Hours: From Birthdays to Bears. Libraries Unlimited, 1987. Specific books and activities are outlined for a number of different themes that young children will enjoy.
- Sloyer, Shirlee. Readers Theater: Story Dramatization in the Classroom. NCTE, 1982. Suggestions for selecting and adapting materials include sample passages from poems and plays. Procedures for presenting and follow-up activities are given.
- Watson, Clyde, and Watson, Wendy. Father Fox's Feast of Songs. Philomel, 1983.

Evaluation Form
1995 Oklahoma Summer Reading Program
DUE SEPTEMBER 4, 1995

Name of Participating Library _____

Mailing Address _____

Name of Person in Charge of SRP _____

Did you set Goals and Objectives for your summer program this year? Yes ___
No ___

What was your primary goal? _____

Statistics:

Participants:

_____ Juvenile population in your service area

_____ Number of children **ENROLLED** in the program
(those who came to programs weekly or on a
regular basis)

Programs:

_____ Number of storytimes/special programs, etc.

_____ Total number of children **ATTENDING** all
programs

Materials:

Were the statewide materials useful? Yes ___ No ___

COMMENTS:

Was the manual helpful? Yes ___ No ___

Rate the materials in the "Knights Alive in '95" Program by checking the appropriate column.

	USEFUL	SOMEWHAT USEFUL	NOT USEFUL
Posters	___	___	___
Bookmarks	___	___	___
Reading Log	___	___	___
Certificate	___	___	___
Manual: Program Ideas	___	___	___
Activity Sheets	___	___	___
Publicity Ideas	___	___	___

Did you hear or see the Public Service Announcements in your area?

Yes ___ No ___ on Radio ___ TV ___

Did community members mention to you that they saw or heard the Public Service Announcements on radio or TV?

Yes ___ No ___ on Radio ___ TV ___

Do you think the Public Service Announcements mad more people aware of your Summer Reading Program? Yes ___ No ___ on Radio ___ TV ___

Did the children in your community participate in the Daily Oklahoman "Book Snackers" contest? Yes ___ No ___

List any themes you would like to have considered for a future summer reading program.

Additional Comments:

Return this form to:

Summer Reading Program
 Donna Norvell/Children's Services Consultant
 Oklahoma Department of Libraries
 200 N.E. 18th St.
 OKC, OK 73105-3298
 FAX: 800-397-8116



U.S. DEPARTMENT OF EDUCATION
Office of Educational Research and Improvement (OERI)
Educational Resources Information Center (ERIC)



NOTICE

REPRODUCTION BASIS



This document is covered by a signed "Reproduction Release (Blanket)" form (on file within the ERIC system), encompassing all or classes of documents from its source organization and, therefore, does not require a "Specific Document" Release form.



This document is Federally-funded, or carries its own permission to reproduce, or is otherwise in the public domain and, therefore, may be reproduced by ERIC without a signed Reproduction Release form (either "Specific Document" or "Blanket").