

DOCUMENT RESUME

ED 401 141

SE 059 213

AUTHOR Barker, Patricia L.; And Others  
 TITLE Learning Standards for Mathematics, Science, and  
 Technology. Revised Edition.  
 INSTITUTION New York State Education Dept., Albany.  
 PUB DATE Mar 96  
 NOTE 107p.  
 PUB TYPE Guides - Classroom Use - Teaching Guides (For  
 Teacher) (052) -- Guides - Non-Classroom Use (055)

EDRS PRICE MF01/PC05 Plus Postage.  
 DESCRIPTORS \*Academic Standards; \*Educational Assessment;  
 Elementary Secondary Education; Evaluation Criteria;  
 \*Mathematics Instruction; Performance; \*Portfolio  
 Assessment; Portfolios (Background Materials);  
 Science and Society; \*Science Instruction; State  
 Departments of Education; \*State Standards;  
 Technology Education  
 IDENTIFIERS \*New York

ABSTRACT

This document presents the framework of standards in New York state for mathematics, science, and technology at elementary, intermediate, and commencement levels. This revised edition incorporates changes to the content standards and performance indicators based on extensive review by the public. As educational practice improves, these standards will continually be revised. New in this edition are samples of student work, along with teachers' comments on the work. The examples are intended to provide some ideas of tasks that support attainment of the performance standards. The seven standards are related to the following: understanding mathematical analysis, scientific inquiry, and engineering design; utilization of information systems; competence in applying mathematics in real-world settings; understanding and applying scientific concepts that pertain to the physical setting and living environment; competence in applying technical knowledge and skills to satisfy human and environmental needs; understanding the interconnectedness of mathematics, science, and technology; and the ability to apply the knowledge and thinking skills of mathematics, science, and technology to address real-life problems by making informed decisions. Samples of student work are included in order to foster dialogue about defining performance standards. (DDR)

\*\*\*\*\*  
 \* Reproductions supplied by EDRS are the best that can be made \*  
 \* from the original document. \*  
 \*\*\*\*\*

PERMISSION TO REPRODUCE AND DISSEMINATE THIS MATERIAL HAS BEEN GRANTED BY

E. Classon

TO THE EDUCATIONAL RESOURCES INFORMATION CENTER (ERIC)

U.S. DEPARTMENT OF EDUCATION  
Office of Educational Research and Improvement  
EDUCATIONAL RESOURCES INFORMATION CENTER (ERIC)

This document has been reproduced as received from the person or organization originating it  
 Minor changes have been made to improve reproduction quality

• Points of view or opinions stated in this document do not necessarily represent official OERI position or policy

ED 401 141

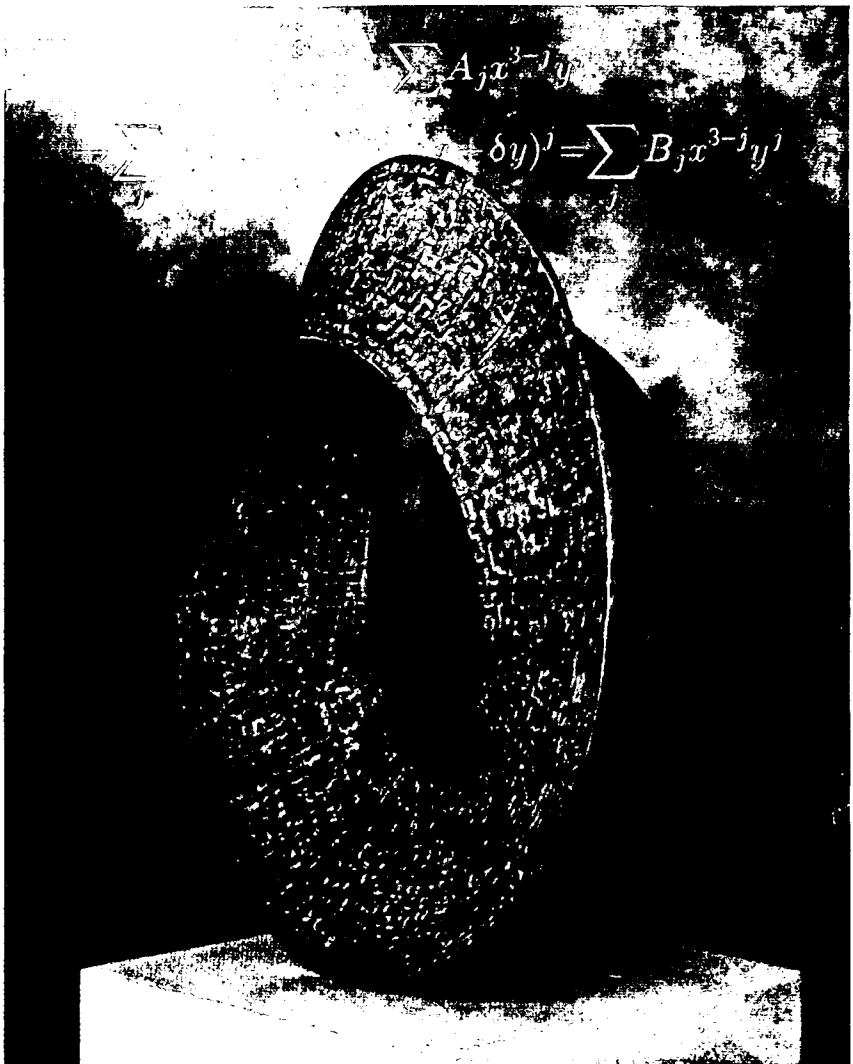

SE 059243

LEARNING STANDARDS FOR MATHEMATICS, SCIENCE, AND TECHNOLOGY



THE UNIVERSITY OF THE STATE OF NEW YORK  
THE STATE EDUCATION DEPARTMENT



## ABOUT THE COVER

Umbilic Torus NC is a captivating combination of Mathematics, Science, and Technology. The surface filling curve texture informs of theorems a century old, yet was cut with space age precision technology. The form itself integrates millennia-old plane geometry cycloid constructions with modern concepts of topology and matrix representations combined with lost wax bronze foundry technology. For more about this sculpture, the artist and scientist, see the book *HELANAN FERGUSON Mathematics in Stone and Bronze*, written by Claire Ferguson, and published by Meridian Creative Group, 5178 Station Road, Erie, PA 16510, phone (814) 898-2612.

**Learning Standards for  
Mathematics, Science, and Technology**

**Revised Edition  
March 1996**

**THE UNIVERSITY OF THE STATE OF NEW YORK**  
**Regents of The University**

<b>Carl T. Hayden, <i>Chancellor</i>, A.B., J.D.</b> .....	<b>Elmira</b>
<b>Louise P. Matteoni, <i>Vice Chancellor</i>, B.A., M.A., Ph.D.</b> .....	<b>Bayside</b>
<b>Emlyn I. Griffith, A.B., J.D.</b> .....	<b>Rome</b>
<b>Jorge L. Batista, B.A., J.D.</b> .....	<b>Bronx</b>
<b>J. Edward Meyer, B.A., LL.B.</b> .....	<b>Chappaqua</b>
<b>R. Carlos Carballada, <i>Chancellor Emeritus</i>, B.S.</b> .....	<b>Rochester</b>
<b>Mimi Levin Lieber, B.A., M.A.</b> .....	<b>New York</b>
<b>Norma Gluck, B.A., M.S.W.</b> .....	<b>New York</b>
<b>Adelaide L. Sanford, B.A., M.A., P.D.</b> .....	<b>Hollis</b>
<b>Walter Cooper, B.A., Ph.D.</b> .....	<b>Rochester</b>
<b>Diane O'Neill McGivern, B.S.N., M.A., Ph.D.</b> .....	<b>Staten Island</b>
<b>Saul B. Cohen, B.A., M.A., Ph. D.</b> .....	<b>New Rochelle</b>
<b>James C. Dawson, A.A., B.A., M.S., Ph.D.</b> .....	<b>Peru</b>
<b>Robert M. Bennett, B.A., M.S.</b> .....	<b>Tonawanda</b>
<b>Robert M. Johnson, B.S., J.D.</b> .....	<b>Lloyd Harbor</b>

**President of The University and Commissioner of Education**  
RICHARD P. MILLS

**Executive Deputy Commissioner of Education**  
THOMAS E. SHELDON

**Deputy Commissioner for Elementary, Middle, Secondary, and Continuing  
Education**  
JAMES A. KADAMUS

**Assistant Commissioner for Curriculum, Instruction, Assessment, and Innovation**  
EDWARD T. LALOR

**Coordinator of Curriculum and Instruction**  
ROSEANNE DEFABIO

The State Education Department does not discriminate on the basis of age, color, religion, creed, disability, marital status, veteran status, national origin, race, gender or sexual orientation in its educational programs, services and activities. Portions of this publication can be made available in a variety of formats, including braille, large print or audio tape, upon request. Inquiries concerning this policy of nondiscrimination should be directed to the Department's Office for Diversity, Ethics, and Access, Room 152, Education Building, Albany, NY 12234.

## CONTENTS

Acknowledgments vi

Introduction v

LEARNING STANDARDS FOR MATHEMATICS, SCIENCE, AND TECHNOLOGY AT THREE LEVELS 1

SAMPLES OF STUDENT WORK RELATED TO THE STANDARDS 67

# Acknowledgments

In addition to the people recognized in the *Preliminary Draft Framework for Mathematics, Science, and Technology*, we are grateful to the many writers whose work is reflected in this edition. Listed below are the names of those writers.

Patricia L. Barker, Newburgh Free Academy  
Betty McKnight, Consultant, Trumansburg, New York  
George E. DeBoer, Colgate University  
Marian Berke Sloane, New York City Schools  
John Weil, Fishers Island School  
Glen Botto, Arlington High School  
Nancy C. Bryan, North JHS, Newburgh  
Myron Rock, Sewenhaka High School  
Irene Jovell, Niskayuna High School  
Merri J. Earl, Chenango Forks Central Schools

Jeffrey J. Hering, Cortland JSHS  
Joan Dodway, Deposit JSHS  
Bruce Tulloch, Bethlehem CSD  
Dave Ferguson, SUNY Stony Brook  
Dorothy Rosenthal, Consultant, Indian Lake, New York  
William Peruzzi, NYSTEP  
Theodore Bredderman, SUNY Albany  
Tom Liao, SUNY Stony Brook  
James Tien, Rensselaer Polytechnic Institute  
Monique Havasy, Graduate Student, SUNY Albany

We are also grateful to the many teachers from throughout New York State who contributed performance tasks and samples of student work for possible inclusion in this revised edition. Listed below are the names of those educators whose materials appear in this document.

Helen Sultanik, Yeshiva of Flatbush  
Sandra LaTourelle, Ausable Valley CSD  
Glen Botto, Arlington High School  
Neal Swernofsky, Island Park UFSD  
Todd Kelly, Avon CSD  
David Propp, New Rochelle City SD  
Tom Venezia, North Colonie CSD

Shelley Shanok, Fort Hamilton High School, NYC  
James Luddington, Gananda Central School  
Rose Ambrosino, Smithtown Middle School  
Mary Ann Harasymowycz, Transit Middle School,  
Williamsville  
Richard Beeler, Niskayuna High School

## New York State Education Department Staff:

Major Capers  
Jan Christman  
Roseanne DeFabio  
Michael Hacker  
Virginia Hammer  
Barry Jameson  
Ed Lalor  
Benjamin Lindeman  
Toni Meyer  
Philip Pillsworth  
Lynn Richbart  
Elise Russo

## Project Editor:

Susan Siegel

This revised edition of the *Learning Standards for Mathematics, Science, and Technology* incorporates the content standards and performance indicators based on extensive review by the public. As practice improves, these standards will continually be revised.

New in this edition are samples of student work, along with teachers' comments on the work, intended to provide some ideas of tasks that support attainment of the performance standards. Levels of excellence. Rather, they vary in degree of achievement. Some are at the "acceptable" level, "more proficient" level. It is important to remember that these are just suggestions of ways to demonstrate progress toward achieving the standards.

The State Education Department will continue to collect and publish samples of student work to become more familiar with the standards and students become more proficient in meeting the performance standards and content standards will continue to rise.

Taken together, the content standards and the performance standards define the learning goals for students in mathematics, science, and technology.

The Board of Regents recognizes the diversity of students in New York State, including students with limited English proficiency, gifted students, and educationally disadvantaged students. The Board made a strong commitment to integrating the education of all students into the total school program. The standards in the framework apply to all students, regardless of their experiential background, cultural, mental and learning differences, interests, or ambitions. A classroom typically includes students of various abilities who may pursue multiple pathways to learn effectively, participate meaningfully, and attain the curricular standards. Students with diverse learning needs may need accommodations and instructional strategies and materials to enhance their learning and/or adjust for their learning.



# Learning Standards for Mathematics, Science, and Technology at Three Levels

- Standard 1:** Students will use mathematical analysis, scientific inquiry, and engineering design, to pose questions, seek answers, and develop solutions.
- Standard 2:** Students will access, generate, process, and transfer information using appropriate technology.
- Standard 3:** Students will understand mathematics and become mathematically confident by communicating mathematically, by reasoning mathematically, by applying mathematics in real-world settings, and by solving problems through the integrated study of number systems, geometry, algebra, data analysis, and trigonometry.
- Standard 4:** Students will understand and apply scientific concepts, principles, and theories in a physical setting and living environment and recognize the historical development of science.
- Standard 5:** Students will apply technological knowledge and skills to design, construct, use, and evaluate products and systems to satisfy human and environmental needs.
- Standard 6:** Students will understand the relationships and common themes that connect mathematics, science, and technology and apply the themes to these and other areas of learning.
- Standard 7:** Students will apply the knowledge and thinking skills of mathematics, science, and technology to address real-life problems and make informed decisions.

# Standard 1—Analysis, Inquiry, and Design

Elementary

## Mathematical Analysis

**1. Abstraction and symbolic representation are used to communicate mathematically.**

**Students:**

- use special mathematical notation and symbolism to communicate in mathematics and to compare and describe quantities, express relationships, and relate mathematics to their immediate environments.

*This is evident, for example, when students:*

- ▲ describe their ages as an inequality such as  $7 < \square < 10$ .

**2. Deductive and inductive reasoning are used to reach mathematical conclusions.**

**Students:**

- use simple logical reasoning to develop conclusions, recognizing that patterns and relationships present in the environment assist them in reaching these conclusions.

**3. Critical thinking skills are used in the solution of mathematical problems.**

**Students:**

- explore and solve problems generated from school, home, and community situations, using concrete objects or manipulative materials when possible.

## Scientific Inquiry

**1. The central purpose of scientific inquiry is to develop explanations of natural phenomena in a continuing, creative process.**

**Students:**

- ask “why” questions in attempts to seek greater understanding concerning objects and events they have observed and heard about.
- question the explanations they hear from others and read about, seeking clarification and comparing them with their own observations and understandings.
- develop relationships among observations to construct descriptions of objects and events and to form their own tentative explanations of what they have observed.

*This is evident, for example, when students:*

- ▲ observe a variety of objects that either sink or float when placed in a container of water.\* Working in groups, they propose an explanation of why objects sink or float. After sharing and discussing their proposed explanation, they refine it and submit it for assessment. The explanation is rated on clarity and plausibility.

**2. Beyond the use of reasoning and consensus, scientific inquiry involves the testing of proposed explanations involving the use of conventional techniques and procedures and usually requiring considerable ingenuity.**

**Students:**

- develop written plans for exploring phenomena or for evaluating explanations guided by questions or proposed explanations they have helped formulate.
- share their research plans with others and revise them based on their suggestions.
- carry out their plans for exploring phenomena through direct observation and through the use of simple instruments that permit measurements of quantities (e.g., length, mass, volume, temperature, and time).

*This is evident, for example, when students:*

- ▲ are asked to develop a way of testing their explanation of why objects sink or float when placed in a container of water.\* They tell what procedures and materials they will use and indicate what results will support their explanation. Their plan is critiqued by others, they revise it, and submit it for assessment. The plan is rated on clarity, soundness in addressing the issue, and feasibility. After the teacher suggests modifications, the plan is carried out.

Key ideas are identified by numbers (1).  
Performance indicators are identified by bullets (•).  
Sample tasks are identified by triangles (▲).

Students will use mathematical analysis, scientific inquiry, and engineering as appropriate, to pose questions, seek answers, and develop solutions.

## Engineering Design

3. The observations made while testing proposed explanations, when analyzed using conventional and invented methods, provide new insights into phenomena.

### Students:

- organize observations and measurements of objects and events through classification and the preparation of simple charts and tables.
- interpret organized observations and measurements, recognizing simple patterns, sequences, and relationships.
- share their findings with others and actively seek their interpretations and ideas.
- adjust their explanations and understandings of objects and events based on their findings and new ideas.

### *This is evident, for example, when students:*

- ▲ prepare tables or other representations of their observations and look for evidence which supports or refutes their explanation of *why objects sink or float when placed in a container of water.\** After sharing and discussing their results with other groups, they prepare a brief research report that includes methods, findings, and conclusions. The report is rated on its clarity, care in carrying out the plan, and presentation of evidence supporting the conclusions.

1. Engineering design is an iterative process of modeling and optimization finding the best solution within given constraints which is used to develop technological solutions to problems with constraints.

### Students engage in the following steps in a design process:

- describe objects, imaginary or real, that are modeled or made differently and suggest how the objects can be changed, fixed, or improved.
- investigate prior solutions and ideas from magazines, family, friends, neighbors, and community members.
- generate ideas for possible solutions, in whole or through group activity; apply age-appropriate mathematics and science skills; evaluate and determine the best solution; and explain choices.
- plan and build, under supervision, a model or solution using familiar materials, processes, and tools.
- discuss how best to test the solution; perform tests under teacher supervision; record and communicate results through numerical and graphic means; explain why things worked or didn't work; and present results in writing, suggesting ways to improve or better.

### *This is evident, for example, when students:*

- ▲ read a story called *Humpty's Big Day* where Humpty Dumpty had his accident and the place where Humpty Dumpty had his accident is asked to design and model a way to get to the top and down again safely.
- ▲ generate, draw, and model ideas for a space station that includes a pleasant living and working environment.
- ▲ design and model footwear that they could use on a sandy surface.

\* A variety of content-specific items can be substituted for the italicized text

# Standard 1—Analysis, Inquiry, and Design

Intermediate

## Mathematical Analysis

**1. Abstraction and symbolic representation are used to communicate mathematically.**

**Students:**

- extend mathematical notation and symbolism to include variables and algebraic expressions in order to describe and compare quantities and express mathematical relationships.

**2. Deductive and inductive reasoning are used to reach mathematical conclusions.**

**Students:**

- use inductive reasoning to construct, evaluate, and validate conjectures and arguments, recognizing that patterns and relationships can assist in explaining and extending mathematical phenomena.

*This is evident, for example, when students:*

- ▲ predict the next triangular number by examining the pattern 1, 3, 6, 10, □.

**3. Critical thinking skills are used in the solution of mathematical problems.**

**Students:**

- apply mathematical knowledge to solve real-world problems and problems that arise from the investigation of mathematical ideas, using representations such as pictures, charts, and tables.

Key ideas are identified by numbers (1).  
Performance indicators are identified by bullets (•).  
Sample tasks are identified by triangles (▲).

4

## Scientific Inquiry

**1. The central purpose of scientific inquiry is to develop explanations of natural phenomena in a continuing, creative process.**

**Students:**

- formulate questions independently with the aid of references appropriate for guiding the search for explanations of everyday observations.
- construct explanations independently for natural phenomena, especially by proposing preliminary visual models of phenomena.
- represent, present, and defend their proposed explanations of everyday observations so that they can be understood and assessed by others.
- seek to clarify, to assess critically, and to reconcile with their own thinking the ideas presented by others, including peers, teachers, authors, and scientists.

*This is evident, for example, when students:*

- ▲ After being shown the disparity between the amount of solid waste which is recycled and which could be recycled,\* students working in small groups are asked to explain why this disparity exists. They develop a set of possible explanations and to select one for intensive study. After their explanation is critiqued by other groups, it is refined and submitted for assessment. The explanation is rated on clarity, plausibility, and appropriateness for intensive study using research methods.

**2. Beyond the use of reasoning and consensus, scientific inquiry involves the testing of proposed explanations involving the use of conventional techniques and procedures and usually requiring considerable ingenuity.**

**Students:**

- use conventional techniques and those of their own design to make further observations and refine their explanations, guided by a need for more information.
- develop, present, and defend formal research proposals for testing their own explanations of common phenomena, including ways of obtaining needed observations and ways of conducting simple controlled experiments.
- carry out their research proposals, recording observations and measurements (e.g., lab notes, audio tape, computer disk, video tape) to help assess the explanation.

*This is evident, for example, when students:*

- ▲ develop a research plan for studying the accuracy of their explanation of the disparity between the amount of solid waste that is recycled and that could be recycled.\* After their tentative plan is critiqued, they refine it and submit it for assessment. The research proposal is rated on clarity, feasibility and soundness as a method of studying the explanations' accuracy. They carry out the plan, with teacher suggested modifications. This work is rated by the teacher while it is in progress.

12

Students will use mathematical analysis, scientific inquiry, and engineering as appropriate, to pose questions, seek answers, and develop solutions.

## Engineering Design

**3. The observations made while testing proposed explanations, when analyzed using conventional and invented methods, provide new insights into phenomena.**

### Students:

- design charts, tables, graphs and other representations of observations in conventional and creative ways to help them address their research question or hypothesis.
- interpret the organized data to answer the research question or hypothesis and to gain insight into the problem.
- modify their personal understanding of phenomena based on evaluation of their hypothesis.

### *This is evident, for example, when students:*

- ▲ carry out their plan making appropriate observations and measurements. They analyze the data, reach conclusions regarding their explanation of the *disparity between the amount of solid waste which is recycled and which could be recycled*\*, and prepare a tentative report which is critiqued by other groups, refined, and submitted for assessment. The report is rated on clarity, quality of presentation of data and analyses, and soundness of conclusions.

**1. Engineering design is an iterative process of modeling and optimization finding the best solution within given constraints which is used to develop technological solutions to problems with constraints.**

### Students engage in the following steps in a design process:

- identify needs and opportunities for technology from an investigation of situations of general interest.
- locate and utilize a range of printed, electronic, and human information resources to obtain information.
- consider constraints and generate several alternative solutions, using group and individual ideation techniques (group discussion, brainstorming, forced connections, role play); defer judgment until a number of ideas have been generated; evaluate ideas; and explain why the chosen solution is the best.
- develop plans, including drawings with dimensions and details of construction, and construct a prototype solution, exhibiting a degree of craftsmanship.
- in a group setting, test their solution against specifications, present and evaluate results, and discuss how the solution might have been modified for better results, and discuss tradeoffs that might be made.

### *This is evident, for example, when students:*

- ▲ reflect on the need for alternative growing systems and design and model a hydroponic system for growing vegetables without soil.
- ▲ brainstorm and evaluate alternative ideas for a device that will make life easier for a person with a disability, such as a device to pick up objects from the floor.
- ▲ design a model vehicle (with a safety belt restraint and crush zones to absorb impact) to carry a raw egg down a ramp and into a barrier without damage.
- ▲ assess the performance of a solution against specified criteria, enter the scores on a spreadsheet, and discuss how the solution might have affected total score.

\* A variety of content-specific items can be substituted for the italicized text

# Standard 1—Analysis, Inquiry, and Design

Commencement

## Mathematical Analysis

**1. Abstraction and symbolic representation are used to communicate mathematically.**

Students:

- use algebraic and geometric representations to describe and compare data.

**2. Deductive and inductive reasoning are used to reach mathematical conclusions.**

Students:

- use deductive reasoning to construct and evaluate conjectures and arguments, recognizing that patterns and relationships in mathematics assist them in arriving at these conjectures and arguments.

**3. Critical thinking skills are used in the solution of mathematical problems.**

Students:

- apply algebraic and geometric concepts and skills to the solution of problems.

Key ideas are identified by numbers (1).  
Performance indicators are identified by bullets (•).  
Sample tasks are identified by triangles (▲).

6

## Scientific Inquiry

**1. The central purpose of scientific inquiry is to develop explanations of natural phenomena in a continuing, creative process.**

Students:

- elaborate on basic scientific and personal explanations of natural phenomena, and develop extended visual models and mathematical formulations to represent their thinking.
- hone ideas through reasoning, library research, and discussion with others, including experts.
- work toward reconciling competing explanations; clarifying points of agreement and disagreement.
- coordinate explanations at different levels of scale, points of focus, and degrees of complexity and specificity and recognize the need for such alternative representations of the natural world.

*This is evident, for example, when students:*

- ▲ in small groups, are asked to explain *why a cactus plant requires much less water to survive than many other plants.*• They are asked to develop, through research, a set of explanations for the differences and to select at least one for study. After the proposed explanation is critiqued by others, they refine it by formulating a hypothesis which is rated on clarity, plausibility, and researchability.

**2. Beyond the use of reasoning and consensus, scientific inquiry involves the testing of proposed explanations involving the use of conventional techniques and procedures and usually requiring considerable ingenuity.**

Students:

- devise ways of making observations to test proposed explanations.
- refine their research ideas through library investigations, including electronic information retrieval and reviews of the literature, and through peer feedback obtained from review and discussion.
- develop and present proposals including formal hypotheses to test their explanations, i.e., they predict what should be observed under specified conditions if the explanation is true.
- carry out their research plan for testing explanations, including selecting and developing techniques, acquiring and building apparatus, and recording observations as necessary.

*This is evident, for example, when students:*

- ▲ develop, through research, a proposal to test their hypothesis of *why a cactus plant requires much less water to survive than many other plants.*• After their proposal is critiqued, it is refined and submitted for assessment by a panel of students. The proposal is rated on clarity, appropriateness, and feasibility. Upon approval, students complete the research. Progress is rated holistically by the teacher.

14

Students will use mathematical analysis, scientific inquiry, and engineering as appropriate, to pose questions, seek answers, and develop solutions.

## Engineering Design

3. The observations made while testing proposed explanations, when analyzed using conventional and invented methods, provide new insights into phenomena.

Students:

- use various means of representing and organizing observations (e.g., diagrams, tables, charts, graphs, equations, matrices) and insightfully interpret the organized data.
- apply statistical analysis techniques when appropriate to test if chance alone explains the result.
- assess correspondence between the predicted result contained in the hypothesis and the actual result and reach a conclusion as to whether or not the explanation on which the prediction was based is supported.
- based on the results of the test and through public discussion, they revise the explanation and contemplate additional research.
- develop a written report for public scrutiny that describes their proposed explanation, including a literature review, the research they carried out, its result, and suggestions for further research.

*This is evident, for example, when students:*

- ▲ carry out a research plan, including keeping a lab book, to test their hypothesis of *why a cactus plant requires much less water to survive than many other plants.*\* After completion, a paper is presented describing the research. Based on the class critique, the paper is rewritten and submitted with the lab book for separate assessment or as part of a portfolio of their science work. It is rated for clarity, thoroughness, soundness of conclusions, and quality of integration with existing literature.

1. Engineering design is an iterative process of modeling and optimization finding the best solution within given constraints which is used to develop technological solutions to problems with constraints.

Students engage in the following steps in a design process:

- initiate and carry out a thorough investigation of an unfamiliar situation and identify needs and opportunities for technological invention
- identify, locate, and use a wide range of human and material resources, and document through notes a how findings relate to the problem.
- generate creative solutions, break ideas into functional elements, and explore possible outcomes using mathematical and functional modeling techniques; choose the best solution to the problem, clearly document the solution against design criteria and constraints; a human factor, economics, ergonomics, and environmental considerations have influenced the solution.
- develop work schedules and working plans that include optimal use and cost of materials, time, and expertise; construct a model of the solution incorporating developmental modifications; working to a high degree of quality (craftsmanship)
- devise a test of the solution according to design criteria and perform the test; record, and logically evaluate performance test results using quantitative, graphic, and verbal means; use creative verbal and graphic techniques effectively to present conclusions, predict new problems, and suggest and pursue modifications.

*This is evident, for example, when students:*

- ▲ search the Internet for world wide web sites describing renewable energy and sustainable living and design a development and design of an energy efficient building
- ▲ develop plans, diagrams, and working drawings for the construction of a computer-controlled marble run that simulates how parts on an assembly line are moved.
- ▲ design and model a portable emergency shelter heated by a person's body to a life-sustaining temperature if the outside temperature is 20° F.

\* A variety of content-specific items can be substituted for the italicized text

# Standard 2—Information Systems

Elementary

## Information Systems

**1. Information technology is used to retrieve, process, and communicate information and as a tool to enhance learning.**

**Students:**

- use a variety of equipment and software packages to enter, process, display, and communicate information in different forms using text, tables, pictures, and sound.
- telecommunicate a message to a distant location with teacher help.
- access needed information from printed media, electronic data bases, and community resources.

*This is evident, for example, when students:*

- ▲ use the newspaper or magazine index in a library to find information on a particular topic.
- ▲ invite local experts to the school to share their expertise.

**2. Knowledge of the impacts and limitations of information systems is essential to its effective and ethical use.**

**Students:**

- describe the uses of information systems in homes, schools, and businesses.
- understand that computers are used to store personal information.
- demonstrate ability to evaluate information.

*This is evident, for example, when students:*

- ▲ look for differences among species of bugs collected on the school grounds, and classify them according to preferred habitat.

Key ideas are identified by numbers (1).  
Performance indicators are identified by bullets (•).  
Sample tasks are identified by triangles (▲).



Students will access, generate, process, and transfer information using a technologies.

**3. Information technology can have positive and negative impacts on society, depending upon how it is used.**

**Students:**

- describe the uses of information systems in homes and schools.
- demonstrate ability to evaluate information critically.

# Standard 2—Information Systems

Intermediate

## Information Systems

**1. Information technology is used to retrieve, process, and communicate information and as a tool to enhance learning.**

**Students:**

- use a range of equipment and software to integrate several forms of information in order to create good quality audio, video, graphic, and text-based presentations.
- use spreadsheets and data-base software to collect, process, display, and analyze information. Students access needed information from electronic data bases and on-line telecommunication services.
- systematically obtain accurate and relevant information pertaining to a particular topic from a range of sources, including local and national media, libraries, museums, governmental agencies, industries, and individuals.
- collect data from probes to measure events and phenomena.
- use simple modeling programs to make predictions.

*This is evident, for example, when students:*

- ▲ compose letters on a word processor and send them to representatives of industry, governmental agencies, museums, or laboratories seeking information pertaining to a student project.
- ▲ acquire data from weather stations.
- ▲ use a software package, such as Science Tool Kit, to monitor the acceleration of a model car traveling down a given distance on a ramp.
- ▲ use computer software to model how plants grow plants under different conditions.

**2. Knowledge of the impacts and limitations of information systems is essential to its effective and ethical use.**

**Students:**

- understand the need to question the accuracy of information displayed on a computer because the results produced by a computer may be affected by incorrect data entry.
- identify advantages and limitations of data-handling programs and graphics programs.
- understand why electronically stored personal information has greater potential for misuse than records kept in conventional form.

Key ideas are identified by numbers (1).  
Performance indicators are identified by bullets (•).  
Sample tasks are identified by triangles (▲).

**Students will access, generate, process, and transfer information using appropriate technologies.**

**3. Information technology can have positive and negative impacts on society, depending upon how it is used.**

**Students:**

- **use graphical, statistical, and presentation software to presents project to fellow classmates.**
- **describe applications of information technology in mathematics, science, and other technologies that address needs and solve problems in the community.**
- **explain the impact of the use and abuse of electronically generated information on individuals and families.**

# Standard 2—Information Systems

Commencement

## Information Systems

**1. Information technology is used to retrieve, process, and communicate information and as a tool to enhance learning.**

**Students:**

- understand and use the more advanced features of word processing, spreadsheets, and data-base software.
- prepare multimedia presentations demonstrating a clear sense of audience and purpose.
- access, select, collate, and analyze information obtained from a wide range of sources such as research data bases, foundations, organizations, national libraries, and electronic communication networks, including the Internet.
- students receive news reports from abroad and work in groups to produce newspapers reflecting the perspectives of different countries.
- utilize electronic networks to share information.
- model solutions to a range of problems in mathematics, science, and technology using computer simulation software.

*This is evident, for example, when students:*

- ▲ collect and amend quantitative and qualitative information for a particular purpose and enter it into a data-handling package for processing and analysis.
- ▲ visit businesses, laboratories, environmental areas, and universities to obtain on-site information
- ▲ receive news reports from abroad, and work in groups to produce newspapers reflecting the perspectives of different countries.
- ▲ join a list serve and send electronic mail to other persons sharing mutual concerns and interests.
- ▲ use computer software to simulate and graph the motion of an object.
- ▲ study a system in a dangerous setting (e.g., a nuclear power plant).

**2. Knowledge of the impacts and limitations of information systems is essential to its effective and ethical use.**

**Students:**

- explain the impact of the use and abuse of electronically generated information on individuals and families.
- evaluate software packages relative to their suitability to a particular application and their ease of use.
- discuss the ethical and social issues raised by the use and abuse of information systems.

*This is evident, for example, when students:*

- ▲ discuss how unauthorized people might gain access to information about their interests and way of life.

Key ideas are identified by numbers (1).  
Performance indicators are identified by bullets (•).  
Sample tasks are identified by triangles (▲).

Students will access, generate, process, and transfer information using appropriate technologies.

**3. Information technology can have positive and negative impacts on society, depending upon how it is used.**

**Students:**

- **work with a virtual community to conduct a project or solve a problem using the network.**
- **discuss how applications of information technology can address some major global problems and issues.**
- **discuss the environmental, ethical, moral, and social issues raised by the use and abuse of information technology.**

# Standard 3—Mathematics

Elementary

## Mathematical Reasoning

1. Students use mathematical reasoning to analyze mathematical situations, make conjectures, gather evidence, and construct an argument.

Students:

- use models, facts, and relationships to draw conclusions about mathematics and explain their thinking.
- use patterns and relationships to analyze mathematical situations.
- justify their answers and solution processes.
- use logical reasoning to reach simple conclusions.

This is evident, for example, when students:

- ▲ build geometric figures out of straws.
- ▲ find patterns in sequences of numbers, such as the triangular numbers 1, 3, 6, 10, . . .
- ▲ explore number relationships with a calculator (e.g.,  $12 + 6 = 18$ ,  $11 + 7 = 18$ , etc.) and draw conclusions.

## Number and Numeration

2. Students use number sense and numeration to develop an understanding of the multiple uses of numbers in the real world, the use of numbers to communicate mathematically, and the use of numbers in the development of mathematical ideas.

Students:

- use whole numbers and fractions to identify locations, quantify groups of objects, and measure distances.
- use concrete materials to model numbers and number relationships for whole numbers and common fractions, including decimal fractions.
- relate counting to grouping and to place-value.
- recognize the order of whole numbers and commonly used fractions and decimals.
- demonstrate the concept of percent through problems related to actual situations.

This is evident, for example, when students:

- ▲ count out 15 small cubes and exchange ten of the cubes for a rod ten cubes long.
- ▲ use the number line to show the position of  $1/4$ .
- ▲ figure the tax on \$4.00 knowing that taxes are 7 cents per \$1.00.

### Sample Problems

16. Mariene is designing a uniform for her soccer team. She can choose from 2 different shirts and 3 different pairs of shorts. How many different uniforms can she make if she uses all the shirts and all the shorts?

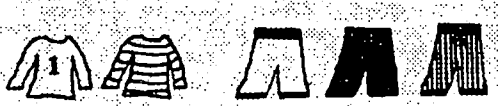

Answer \_\_\_\_\_

Explain how you got your answer with a picture or diagram.

Ms. Rivera's class must collect 180 soda cans to win the recycling contest. The chart below shows how the class is doing. How many cans must they collect in the fourth week to reach the goal of 180?

Week	Cans
1	42
2	74
3	18
4	
Goal	180

Answer \_\_\_\_\_

Key ideas are identified by numbers (1).  
Performance indicators are identified by bullets (•).  
Sample tasks are identified by triangles (▲).

Students will understand mathematics and become mathematically confident by communicating and reasoning mathematically, by applying mathematics in real-world settings, and by solving problems through the integrated study of number systems, geometry, algebra, data analysis, probability, and trigonometry.

## Operations

3. Students use mathematical operations and relationships among them to understand mathematics.

Students:

- add, subtract, multiply, and divide whole numbers.
- develop strategies for selecting the appropriate computational and operational method in problem-solving situations.
- know single digit addition, subtraction, multiplication, and division facts.
- understand the commutative and associative properties.

*This is evident, for example, when students:*

- ▲ use the fact that multiplication is commutative (e.g.,  $2 \times 7 = 7 \times 2$ ), to assist them with their memorizing of the basic facts.
- ▲ solve multiple-step problems that require at least two different operations.
- ▲ progress from base ten blocks to concrete models and then to paper and pencil algorithms.

## Modeling/Multiple Representation

4. Students use mathematical modeling/multiple representation to provide a means of presenting, interpreting, communicating, and connecting mathematical information and relationships.

Students:

- use concrete materials to model spatial relationships.
- construct tables, charts, and graphs to display and analyze real-world data.
- use multiple representations (simulations, manipulative materials, pictures, and diagrams) as tools to explain the operation of everyday procedures.
- use variables such as height, weight, and hand size to predict changes over time.
- use physical materials, pictures, and diagrams to explain mathematical ideas and processes and to demonstrate geometric concepts.

*This is evident, for example, when students:*

- ▲ build a  $3 \times 3 \times 3$  cube out of blocks.
- ▲ use square tiles to model various rectangles with an area of 24 square units.
- ▲ read a bar graph of population trends and write an explanation of the information it contains.

### Sample Problems

7. Shanelle earns \$3.50 per hour for babysitting. Each week she babysits for 4 hours.

A) How much money does she earn in 1 week?

Answer \_\_\_\_\_

B) How much money does she earn in 4 weeks?

Answer \_\_\_\_\_

11. Bobbie's family bought a pizza. Her mother and sister together ate  $\frac{1}{2}$  of the pizza. Bobbie ate  $\frac{1}{3}$  of what was left. Use the circle to draw a picture that shows how much of the pizza Bobbie ate.

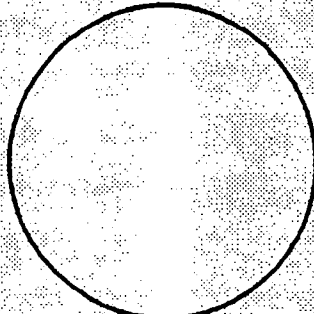

What fraction of the whole pizza did Bobbie eat?

Answer \_\_\_\_\_

# Standard 3—Mathematics

Elementary

## Measurement

5. Students use measurement in both metric and English measure to provide a major link between the abstractions of mathematics and the real world in order to describe and compare objects and data.

Students:

- understand that measurement is approximate, never exact.
- select appropriate standard and nonstandard measurement tools in measurement activities.
- understand the attributes of area, length, capacity, weight, volume, time, temperature, and angle.
- estimate and find measures such as length, perimeter, area, and volume using both nonstandard and standard units.
- collect and display data.
- use statistical methods such as graphs, tables, and charts to interpret data.

This is evident, for example, when students:

- ▲ measure with paper clips or finger width.
- ▲ estimate, then calculate, how much paint would be needed to cover one wall.
- ▲ create a chart to display the results of a survey conducted among the classes in the school, or graph the amounts of survey responses by grade level.

## Uncertainty

6. Students use ideas of uncertainty to illustrate that mathematics involves more than exactness when dealing with everyday situations.

Students:

- make estimates to compare to actual results of both formal and informal measurement.
- make estimates to compare to actual results of computations.
- recognize situations where only an estimate is required.
- develop a wide variety of estimation skills and strategies.
- determine the reasonableness of results.
- predict experimental probabilities.
- make predictions using unbiased random samples.
- determine probabilities of simple events.

This is evident, for example, when students:

- ▲ estimate the length of the room before measuring.
- ▲ predict the average number of red candies in a bag before opening a group of bags, counting the candies, and then averaging the number that were red.
- ▲ determine the probability of picking an even numbered slip from a hat containing slips of paper numbered 1, 2, 3, 4, 5, and 6.

### Sample Problems

It's Saturday and you're going to meet your friends for lunch and a movie. You have to leave your home at 11:30 AM. Your parents say you can't go until you finish your work. Your work includes your homework and your Saturday chores:

- 40 minutes of math homework.
- 30 minutes to clean your room.
- 15 minutes to fold the laundry
- 5 minutes to take out the garbage
- 60 minutes to eat and get ready to go

- A) At what time should you get started doing your work? Show all the math you did to figure this out.

Answer \_\_\_\_\_ AM

- B) Describe how you would use your time between when you wake up and when you leave at 11:30 AM to go to lunch and the movie.

Key ideas are identified by numbers (1).  
Performance indicators are identified by bullets (•).  
Sample tasks are identified by triangles (▲).

16

The spinner below was used by Jodie's class for the school fair:

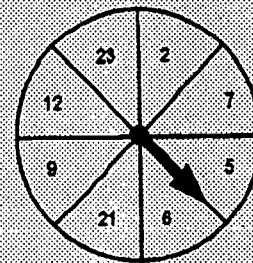

- A) If the spinner is spun once, what is the probability of the spinner landing on an even number?

Answer

- B) If the spinner is spun a second time, what is the probability of the spinner landing on a number that is divisible by 3?

Answer



Students will understand mathematics and become mathematically confident by communicating and reasoning mathematically, by applying mathematics in real-world settings, and by solving problems through the integrated study of number systems, geometry, algebra, data analysis, probability, and trigonometry.

## Patterns/Functions

7. Students use patterns and functions to develop mathematical power, appreciate the true beauty of mathematics, and construct generalizations that describe patterns simply and efficiently.

Students:

- recognize, describe, extend, and create a wide variety of patterns.
- represent and describe mathematical relationships.
- explore and express relationships using variables and open sentences.
- solve for an unknown using manipulative materials.
- use a variety of manipulative materials and technologies to explore patterns.
- interpret graphs.
- explore and develop relationships among two- and three-dimensional geometric shapes.
- discover patterns in nature, art, music, and literature.

*This is evident, for example, when students:*

- ▲ represent three more than a number is equal to nine as  $n + 3 = 9$ .
- ▲ draw leaves, simple wallpaper patterns, or write number sequences to illustrate recurring patterns.
- ▲ write generalizations or conclusions from display data in charts or graphs.

### Sample Problem

8 dots      12 dots      16 dots      20 dots

Draw the next figure in this pattern. How many dots are in the figure you drew?

Answer \_\_\_\_\_

Write one or two sentences to describe how the figure is changing.

---



---



---



---

# Standard 3—Mathematics

Intermediate

## Mathematical Reasoning

1. Students use mathematical reasoning to analyze mathematical situations, make conjectures, gather evidence, and construct an argument.

Students:

- apply a variety of reasoning strategies.
- make and evaluate conjectures and arguments using appropriate language.
- make conclusions based on inductive reasoning.
- justify conclusions involving simple and compound (i.e., and/or) statements.

*This is evident, for example, when students:*

- ▲ use trial and error and work backwards to solve a problem.
- ▲ identify patterns in a number sequence.
- ▲ are asked to find numbers that satisfy two conditions, such as  $n > -4$  and  $n \leq 6$ .

## Number and Numeration

2. Students use number sense and numeration to develop an understanding of the multiple uses of numbers in the real world, the use of numbers to communicate mathematically, and the use of numbers in the development of mathematical ideas.

Students:

- understand, represent, and use numbers in a variety of equivalent forms (integer, fraction, decimal, percent, exponential, expanded and scientific notation).
- understand and apply ratios, proportions, and percents through a wide variety of hands-on explorations.
- develop an understanding of number theory (primes, factors, and multiples).
- recognize order relations for decimals, integers, and rational numbers.

*This is evident, for example, when students:*

- ▲ use prime factors of a group of denominators to determine the least common denominator.
- ▲ select two pairs from a number of ratios and prove that they are in proportion.
- ▲ demonstrate the concept that a number can be symbolized by many different numerals as in:

$$\frac{1}{4} = \frac{3}{12} = \frac{25}{100} = 0.25 = 25\%$$

### Sample Problems

The table below shows the height of a plant during a period of 3 weeks. Initially the plant was 5 inches tall. The table indicates the growth rate of the plant for week 1 through week 3.

Weeks (W)	0	1	2	3
Height (H) (in inches)	5	8	11	14

A) Write an equation that expresses the height (H) of the plant in terms of the number of weeks (W).

Answer: \_\_\_\_\_

B) Use the table or your equation to predict the height of the plant after 10 weeks.

2. An inspector found 5 defective cassettes out of a random sample of 200 cassette tapes. If 4,000 cassette tapes are produced each day, how many tapes would you expect to be defective? Write a proportion that can be used to solve this problem and then solve the problem.

Answer: \_\_\_\_\_

Key ideas are identified by numbers (1).  
Performance indicators are identified by bullets (•).  
Sample tasks are identified by triangles (▲).

Students will understand mathematics and become mathematically confident by communicating and reasoning mathematically, by applying mathematics in real-world settings, and by solving problems through the integrated study of number systems, geometry, algebra, data analysis, probability, and trigonometry.

## Operations

3. Students use mathematical operations and relationships among them to understand mathematics.

Students:

- add, subtract, multiply, and divide fractions, decimals, and integers.
- explore and use the operations dealing with roots and powers.
- use grouping symbols (parentheses) to clarify the intended order of operations.
- apply the associative, commutative, distributive, inverse, and identity properties.
- demonstrate an understanding of operational algorithms (procedures for adding, subtracting, etc.).
- develop appropriate proficiency with facts and algorithms.
- apply concepts of ratio and proportion to solve problems.

This is evident, for example, when students:

- ▲ create area models to help in understanding fractions, decimals, and percents.
- ▲ find the missing number in a proportion in which three of the numbers are known, and letters are used as place holders.
- ▲ arrange a set of fractions in order, from the smallest to the largest:

$$\frac{3}{4}, \frac{1}{5}, \frac{2}{3}, \frac{1}{2}, \frac{1}{4}$$

- ▲ illustrate the distributive property for multiplication over addition, such as

$$2(a + 3) = 2a + 6.$$

## Modeling/Multiple Representation

4. Students use mathematical modeling/multiple representation to provide a means of presenting, interpreting, communicating, and connecting mathematical information and relationships.

Students:

- visualize, represent, and transform two- and three-dimensional shapes.
- use maps and scale drawings to represent real objects or places.
- use the coordinate plane to explore geometric ideas.
- represent numerical relationships in one- and two-dimensional graphs.
- use variables to represent relationships.
- use concrete materials and diagrams to describe the operation of real world processes and systems.
- develop and explore models that do and do not rely on chance.
- investigate both two- and three-dimensional transformations.
- use appropriate tools to construct and verify geometric relationships.
- develop procedures for basic geometric constructions.

This is evident, for example, when students:

- ▲ build a city skyline to demonstrate skill in linear measurements, scale drawing, ratio, fractions, angles, and geometric shapes.
- ▲ bisect an angle using a straight edge and compass.
- ▲ draw a complex of geometric figures to illustrate that the intersection of a plane and a sphere is a circle or point.

### Sample Problems

The graph below shows how Sue spent her allowance last week.

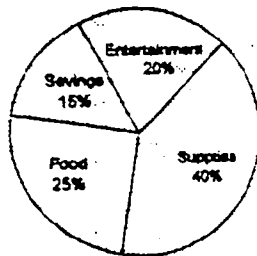

If Sue's allowance is \$6.00, how much of her allowance did she spend on entertainment last week?

#### TASK: SHARING

5. Six students were given four candy bars of equal size. Show how they could divide the candy bars so that each of them received the same amount of candy. Then use the numbers to express how much of a candy bar each student received.

# Standard 3—Mathematics

Intermediate

## Measurement

5. Students use measurement in both metric and English measure to provide a major link between the abstractions of mathematics and the real world in order to describe and compare objects and data.

Students:

- estimate, make, and use measurements in real-world situations.
- select appropriate standard and nonstandard measurement units and tools to measure to a desired degree of accuracy.
- develop measurement skills and informally derive and apply formulas in direct measurement activities.
- use statistical methods and measures of central tendencies to display, describe, and compare data.
- explore and produce graphic representations of data using calculators/computers.
- develop critical judgment for the reasonableness of measurement.

*This is evident, for example, when students:*

- ▲ use box plots or stem and leaf graphs to display a set of test scores.
- ▲ estimate and measure the surface areas of a set of gift boxes in order to determine how much wrapping paper will be required.
- ▲ explain when to use mean, median, or mode for a group of data.

## Uncertainty

6. Students use ideas of uncertainty to illustrate that mathematics involves more than exactness when dealing with everyday situations.

Students:

- use estimation to check the reasonableness of results obtained by computation, algorithms, or the use of technology.
- use estimation to solve problems for which exact answers are inappropriate.
- estimate the probability of events.
- use simulation techniques to estimate probabilities.
- determine probabilities of independent and mutually exclusive events.

*This is evident, for example, when students:*

- ▲ construct spinners to represent random choice of four possible selections.
- ▲ perform probability experiments with independent events (e.g., the probability that the head of a coin will turn up, or that a 6 will appear on a die toss).
- ▲ estimate the number of students who might choose to eat hot dogs at a picnic.

## Sample Problems

**TASK: Donato's Pizzeria**

1. Donato's is considering adding a 12" in diameter "large" pizza to its menu. One customer says that adding the large size pizza is unnecessary because it is the same amount of pizza as 2 of the 6" size pizzas. Use mathematics to determine if the customer is correct. Show your work and write a few sentences to explain your answer.

Answer: \_\_\_\_\_

\_\_\_\_\_

\_\_\_\_\_

\_\_\_\_\_

\_\_\_\_\_

**TASK: PAY PLANS**

You have just gotten an after school job at City Outfitters. This company offers two different payment plans to its sales employees.

Plan A Earnings:	\$110 per week plus 10% of sales
Plan B Earnings:	\$80 per week plus 15% of sales

You need to decide which plan to choose and explain why you made this choice.

28. To help you decide, you ask the sales manager what the average weekly sales are. She tells you sales vary a lot, but average around \$350 a week. How much would you expect to earn under each payment plan during an average week?

Answer: Plan A \_\_\_\_\_

Plan B \_\_\_\_\_

Students will understand mathematics and become mathematically confident by communicating and reasoning mathematically, by applying mathematics in real-world settings, and by solving problems through the integrated study of number systems, geometry, algebra, data analysis, probability, and trigonometry.

## Patterns/Functions

7. Students use patterns and functions to develop mathematical power, appreciate the true beauty of mathematics, and construct generalizations that describe patterns simply and efficiently.

Students:

- recognize, describe, and generalize a wide variety of patterns and functions.
- describe and represent patterns and functional relationships using tables, charts and graphs, algebraic expressions, rules, and verbal descriptions.
- develop methods to solve basic linear and quadratic equations.
- develop an understanding of functions and functional relationships: that a change in one quantity (variable) results in change in another.
- verify results of substituting variables.
- apply the concept of similarity in relevant situations.
- use properties of polygons to classify them.
- explore relationships involving points, lines, angles, and planes.
- develop and apply the Pythagorean principle in the solution of problems.
- explore and develop basic concepts of right triangle trigonometry.
- use patterns and functions to represent and solve problems.

This is evident, for example, when students:

- ▲ find the height of a building when a 20-foot ladder reaches the top of the building when its base is 12 feet away from the structure.
- ▲ investigate number patterns through palindromes (pick a 2-digit number, reverse it and add the two—repeat the process until a palindrome appears)

	42	86
	+24	+68
palindrome →	66	154
		+451
		605
		+506
palindrome →		1111

- ▲ solve linear equations, such as  $2(x + 3) = x + 5$  by several methods.

### Sample Problem

A painter leaned a ladder up against the wall of my kitchen. The ladder forms an angle of  $62^\circ$  with the floor. What is the measure of the angle formed between the top of the ladder and the wall?

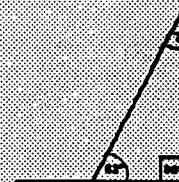

Answer: \_\_\_\_\_

# Standard 3—Mathematics

Commencement

## Mathematical Reasoning

1. Students use mathematical reasoning to analyze mathematical situations, make conjectures, gather evidence, and construct an argument.

Students:

- construct simple logical arguments.
- follow and judge the validity of logical arguments.
- use symbolic logic in the construction of valid arguments.
- construct proofs based on deductive reasoning.

This is evident, for example, when students:

- ▲ prove that an altitude of an isosceles triangle, drawn to the base, is perpendicular to that base.
- ▲ determine whether or not a given logical sentence is a tautology.
- ▲ show that the triangle having vertex coordinates of (0,6), (0,0), and (5,0) is a right triangle.

## Number and Numeration

2. Students use number sense and numeration to develop an understanding of the multiple uses of numbers in the real world, the use of numbers to communicate mathematically, and the use of numbers in the development of mathematical ideas.

Students:

- understand and use rational and irrational numbers.
- recognize the order of the real numbers.
- apply the properties of the real numbers to various subsets of numbers.

This is evident, for example, when students:

- ▲ determine from the discriminant of a quadratic equation whether the roots are rational or irrational.
- ▲ give rational approximations of irrational numbers to a specific degree of accuracy.
- ▲ determine for which value of  $x$  the expression  $\frac{2x+6}{x-7}$  is undefined.

### Sample Problems

33 Given the true statements:

$$\begin{aligned} & \sim a \vee \sim b \\ & b \\ & c \rightarrow a \end{aligned}$$

Which statement is also true?

- |              |              |
|--------------|--------------|
| (1) $c$      | (3) $\sim c$ |
| (2) $\sim b$ | (4) $a$      |

34 Which statement is logically equivalent to the statement: "If you are not part of the solution, then you are part of the problem?"

- (1) If you are part of the solution, then you are not part of the problem.
- (2) If you are not part of the problem, then you are part of the solution.
- (3) If you are part of the problem, then you are not part of the solution.
- (4) If you are not part of the problem, then you are not part of the solution.

Key ideas are identified by numbers (1).  
Performance indicators are identified by bullets (•).  
Sample tasks are identified by triangles (▲).

Students will understand mathematics and become mathematically confident by communicating and reasoning mathematically, by applying mathematics in real-world settings, and by solving problems through the integrated study of number systems, geometry, algebra, data analysis, probability, and trigonometry.

## Operations

3. Students use mathematical operations and relationships among them to understand mathematics.

Students:

- use addition, subtraction, multiplication, division, and exponentiation with real numbers and algebraic expressions.
- develop an understanding of and use the composition of functions and transformations.
- explore and use negative exponents on integers and algebraic expressions.
- use field properties to justify mathematical procedures.
- use transformations on figures and functions in the coordinate plane.

This is evident, for example, when students:

- ▲ determine the coordinates of triangle A(2,5), B(9,8), and C(3,6) after a translation  $(x,y) \rightarrow (x+3, y-1)$ .
- ▲ evaluate the binary operation defined as  $x * y = x^2 + (y+x)^2$  for  $3 * 4$ .
- ▲ identify the field properties used in solving the equation  $2(x-5) + 3 = x + 7$ .

## Modeling/Multiple Representation

4. Students use mathematical modeling/multiple representation to provide a means of presenting, interpreting, communicating, and connecting mathematical information and relationships.

Students:

- represent problem situations symbolically by using algebraic expressions, sequences, tree diagrams, geometric figures, and graphs.
- manipulate symbolic representations to explore concepts at an abstract level.
- choose appropriate representations to facilitate the solving of a problem.
- use learning technologies to make and verify geometric conjectures.
- justify the procedures for basic geometric constructions.
- investigate transformations in the coordinate plane.
- develop meaning for basic conic sections.
- develop and apply the concept of basic loci to compound loci.
- use graphing utilities to create and explore geometric and algebraic models.
- model real-world problems with systems of equations and inequalities.

This is evident, for example, when students:

- ▲ determine the locus of points equidistant from two parallel lines.
- ▲ explain why the basic construction of bisecting a line is valid.
- ▲ describe the various conics produced when the equation  $ax^2 + by^2 = c^2$  is graphed for various values of a, b, and c.

### Sample Problems

36 a On graph paper, draw the graph of the equation  $y = x^2 - 4x + 3$ , including all values of  $x$  in the interval  $-1 \leq x \leq 5$ . [4]

b On the same set of axes, draw the graph of the image of the graph drawn in part a after the translation which moves  $(x,y)$  to  $(x+3, y+2)$ , and label this graph b. [3]

c On the same set of axes, draw the graph of the image of the graph drawn in part b after a reflection in the  $x$ -axis, and label this graph c. [3]

### Semicircles

The figure below is made of three small semicircles, all of the same size, and one large circle.

The diameters of the semicircles are the same length as the radius of the large circle.

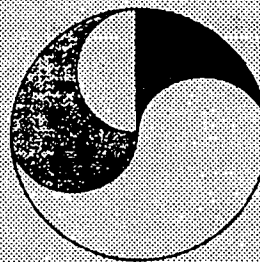

Assume that the radius of the large circle is 4 cm long. What is the area of the gray region?

Describe your method: how did you figure it out?

Used with the permission of  
New Standards, copyright 1995.

23

# Standard 3—Mathematics

Commencement

## Measurement

5. Students use measurement in both metric and English measure to provide a major link between the abstractions of mathematics and the real world in order to describe and compare objects and data.

Students:

- derive and apply formulas to find measures such as length, area, volume, weight, time, and angle in real-world contexts.
- choose the appropriate tools for measurement.
- use dimensional analysis techniques.
- use statistical methods including measures of central tendency to describe and compare data.
- use trigonometry as a method to measure indirectly.
- apply proportions to scale drawings, computer-assisted design blueprints, and direct variation in order to compute indirect measurements.
- relate absolute value, distance between two points, and the slope of a line to the coordinate plane.
- understand error in measurement and its consequence on subsequent calculations.
- use geometric relationships in relevant measurement problems involving geometric concepts.

This is evident, for example, when students:

- ▲ change mph to ft/sec.
- ▲ use the tangent ratio to determine the height of a tree.
- ▲ determine the distance between two points in the coordinate plane.

### Sample Problems

39 As shown in the accompanying diagram, a ship is headed directly toward a coastline formed by a vertical cliff  $\overline{BC}$ , 70 meters high. At point A, the angle of elevation from the ship to B, the top of the cliff, is  $23^\circ$ . A few minutes later at point D, the angle of elevation increased to  $30^\circ$ .

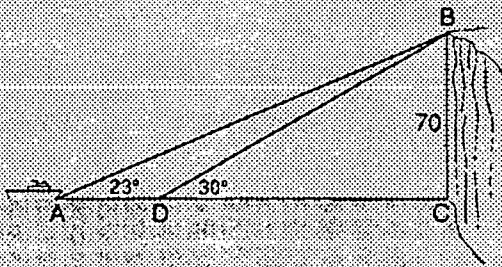

a To the nearest meter, find:

- (1)  $DC$  [1]
- (2)  $AC$  [2]
- (3)  $AB$  [3]

b To the nearest meter, what is the distance between the ship's position at the two sightings?

## Uncertainty

6. Students use ideas of uncertainty to illustrate that mathematics involves more than exactness when dealing with everyday situations.

Students:

- judge the reasonableness of results obtained from applications in algebra, geometry, trigonometry, probability, and statistics.
- judge the reasonableness of a graph produced by a calculator or computer.
- use experimental or theoretical probability to represent and solve problems involving uncertainty.
- use the concept of random variable in computing probabilities.
- determine probabilities using permutations and combinations.

This is evident, for example, when students:

- ▲ construct a tree diagram or sample space for a compound event.
- ▲ calculate the probability of winning the New York State Lottery.
- ▲ develop simulations for probability problems for which they do not have theoretical solutions.

Every morning Walker Bryce walks 1.7 miles to school.

He leaves his house at 8:05 and walks 1.2 miles, then he waits for Bobby and Denise.

When they show up, all three of them start walking to school together. They arrive minutes later at 8:55.

Draw a graph that could show Walker's journey to school.

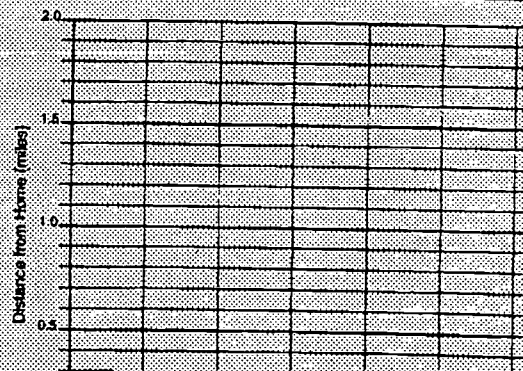

Used with the permission of *New Standards*, copyright 1995.

Key ideas are identified by numbers (1).  
Performance indicators are identified by bullets (•).  
Sample tasks are identified by triangles (▲).



Students will understand mathematics and become mathematically confident by communicating and reasoning mathematically, by applying mathematics in real-world settings, and by solving problems through the integrated study of number systems, geometry, algebra, data analysis, probability, and trigonometry.

## Patterns/Functions

7. Students use patterns and functions to develop mathematical power, appreciate the true beauty of mathematics, and construct generalizations that describe patterns simply and efficiently.

Students:

- use function vocabulary and notation.
- represent and analyze functions using verbal descriptions, tables, equations, and graphs.
- translate among the verbal descriptions, tables, equations and graphic forms of functions.
- analyze the effect of parametric changes on the graphs of functions.
- apply linear, exponential, and quadratic functions in the solution of problems.
- apply and interpret transformations to functions.
- model real-world situations with the appropriate function.
- apply axiomatic structure to algebra and geometry.
- use computers and graphing calculators to analyze mathematical phenomena.

This is evident, for example, when students:

- ▲ determine, in more than one way, whether or not a specific relation is a function.
- ▲ explain the relationship between the roots of a quadratic equation and the intercepts of its corresponding graph.
- ▲ use transformations to determine the inverse of a function.

### Sample Problem

#### Fibonacci Pattern

This is the Fibonacci sequence:

1, 1, 2, 3, 5, 8, 13, 21, ...

Each number (starting with the "2") is the sum of the previous two. For example,

$$1 + 1 = 2 \text{ and } 2 + 3 = 5.$$

The number that comes after 21, in the above sequence, is 34 because:

$$13 + 21 = 34.$$

Now look at the pattern of odd and even numbers in this sequence. If we replace each odd number with "O" and each even with "E," we get:

O, O, E, O, O, E, O, O, ...

Only one of the following statements is correct.

Decide which one you think is correct and explain in detail your choice.

A. The pattern, O, O, E, does NOT repeat forever.

B. The pattern, O, O, E, repeats forever.

Used with the permission of  
New Standards, copyright 1995.

25

BEST COPY AVAILABLE

33

# Standard 3—Mathematics

Four-year sequence in mathematics

## Mathematical Reasoning

**1. Students use mathematical reasoning to analyze mathematical situations, make conjectures, gather evidence, and construct an argument.**

**Students:**

- **construct indirect proofs or proofs using mathematical induction.**
- **investigate and compare the axiomatic structures of various geometries.**

*This is evident, for example, when students:*

- ▲ **prove indirectly that: if  $n^2$  is even,  $n$  is even.**
- ▲ **prove using mathematical induction that:  
 $1 + 3 + 5 + \dots + (2n - 1) = n^2$ .**
- ▲ **explain the axiomatic differences between plane and spherical geometries.**

## Number and Numeration

**2. Students use number sense and numeration to develop an understanding of the multiple uses of numbers in the real world, the use of numbers to communicate mathematically, and the use of numbers in the development of mathematical ideas.**

**Students:**

- **understand the concept of infinity.**
- **recognize the hierarchy of the complex number system.**
- **model the structure of the complex number system.**
- **recognize when to use and how to apply the field properties.**

*This is evident, for example, when students:*

- ▲ **relate the concept of infinity when graphing the tangent function.**
- ▲ **show that the set of complex numbers form a field under the operations of addition and multiplication.**
- ▲ **show that the set of complex numbers forms a field under the operations of addition and multiplication.**
- ▲ **represent a complex number in polar form.**

Key ideas are identified by numbers (1).  
Performance indicators are identified by bullets (•).  
Sample tasks are identified by triangles (▲).

Students will understand mathematics and become mathematically confident by communicating and reasoning mathematically, by applying mathematics in real-world settings, and by solving problems through the integrated study of number systems, geometry, algebra, data analysis, probability, and trigonometry.

## Operations

**3. Students use mathematical operations and relationships among them to understand mathematics.**

**Students:**

- use appropriate techniques, including graphing utilities, to perform basic operations on matrices.
- use rational exponents on real numbers and all operations on complex numbers.
- combine functions using the basic operations and the composition of two functions.

*This is evident, for example, when students:*

- ▲ relate specific matrices to certain types of transformations of points on the coordinate plane.
- ▲ evaluate expressions with fractional exponents, such as  $8^{2/3} 4^{-1/2}$ .
- ▲ determine the value of compound functions such as  $(f \circ g)(x)$ .

## Modeling/Multiple Representation

**4. Students use mathematical modeling/multiple representation to provide a means of presenting, interpreting, communicating, and connecting mathematical information and relationships.**

**Students:**

- model vector quantities both algebraically and geometrically.
- represent graphically the sum and difference of two complex numbers.
- model and solve problems that involve absolute value, vectors, and matrices.
- model quadratic inequalities both algebraically and graphically.
- model the composition of transformations.
- determine the effects of changing parameters of the graphs of functions.
- use polynomial, rational, trigonometric, and exponential functions to model real-world relationships.
- use algebraic relationships to analyze the conic sections.
- use circular functions to study and model periodic real-world phenomena.
- illustrate spatial relationships using perspective, projections, and maps.
- represent problem situations using discrete structures such as finite graphs, matrices, sequences, and recurrence relations.
- analyze spatial relationships using the Cartesian coordinate system in three dimensions.

*This is evident, for example, when students:*

- ▲ determine coordinates which lie in the solution of the quadratic inequality, such as  $y < x^2 + 4x + 2$ .
- ▲ find the distance between two points in a three-dimension coordinate system.
- ▲ describe what happens to the graph when  $b$  increases in the function  $y = x^2 + bx + c$ .

# Standard 3—Mathematics

Four-year sequence in mathematics

## Measurement

**5. Students use measurement in both metric and English measure to provide a major link between the abstractions of mathematics and the real world in order to describe and compare objects and data.**

**Students:**

- derive and apply formulas relating angle measure and arc degree measure in a circle.
- prove and apply theorems related to lengths of segments in a circle.
- define the trigonometric functions in terms of the unit circle.
- relate trigonometric relationships to the area of a triangle and to the general solutions of triangles.
- apply the normal curve and its properties to familiar contexts.
- design a statistical experiment to study a problem and communicate the outcomes, including dispersion.
- use statistical methods, including scatter plots and lines of best fit, to make predictions.
- apply the conceptual foundation of limits, infinite sequences and series, the area under a curve, rate of change, inverse variation, and the slope of a tangent line to authentic problems in mathematics and other disciplines.
- determine optimization points on a graph.
- use derivatives to find maximum, minimum, and inflection points of a function.

*This is evident, for example, when students:*

- ▲ use a chi-square test to determine if one cola really tastes better than another cola.
- ▲ can illustrate the various line segments which represent the sine, cosine, and tangent of a given angle on the unit circle.
- ▲ calculate the first derivative of a function using the limit definition.

## Uncertainty

**6. Students use ideas of uncertainty to illustrate that mathematics involves more than exactness when dealing with everyday situations.**

**Students:**

- interpret probabilities in real-world situations.
- use a Bernoulli experiment to determine probabilities for experiments with exactly two outcomes.
- use curve fitting to predict from data.
- apply the concept of random variable to generate and interpret probability distributions.
- create and interpret applications of discrete and continuous probability distributions.
- make predictions based on interpolations and extrapolations from data.
- obtain confidence intervals and test hypotheses using appropriate statistical methods.
- approximate the roots of polynomial equations.

*This is evident, for example, when students:*

- ▲ verify the probabilities listed for the state lottery for second, third, and fourth prize.
- ▲ use graphing calculators to generate a curve of best fit for an array of data using linear regression.
- ▲ determine the probability of getting at least 3 heads on 6 flips of a fair coin.

Key ideas are identified by numbers (1).  
Performance indicators are identified by bullets (•).  
Sample tasks are identified by triangles (▲).

Students will understand mathematics and become mathematically confident by communicating and reasoning mathematically, by applying mathematics in real-world settings, and by solving problems through the integrated study of number systems, geometry, algebra, data analysis, probability, and trigonometry.

## Patterns/Functions

**7. Students use patterns and functions to develop mathematical power, appreciate the true beauty of mathematics, and construct generalizations that describe patterns simply and efficiently.**

Students:

- solve equations with complex roots using a variety of algebraic and graphical methods with appropriate tools.
- understand and apply the relationship between the rectangular form and the polar form of a complex number.
- evaluate and form the composition of functions.
- use the definition of a derivative to examine the properties of a function.
- solve equations involving fractions, absolute values, and radicals.
- use basic transformations to demonstrate similarity and congruence of figures.
- identify and differentiate between direct and indirect isometries.
- analyze inverse functions using transformations.
- apply the ideas of symmetries in sketching and analyzing graphs of functions.
- use the normal curve to answer questions about data.
- develop methods to solve trigonometric equations and verify trigonometric functions.
- describe patterns produced by processes of geometric change, formally connecting iteration, approximations, limits, and fractals.
- extend patterns and compute the  $n$ th term in numerical and geometric sequences.
- use the limiting process to analyze infinite sequences and series.
- use algebraic and geometric iteration to explore patterns and solve problems.
- solve optimization problems.
- use linear programming and difference equations in the solution of problems.

*This is evident, for example, when students:*

- ▲ transform polar coordinates into rectangular forms.
- ▲ find the maximum height of an object projects upward with a given initial velocity.
- ▲ find the limit of expressions like  $\frac{n-2}{3n+5}$  as  $n$  goes to infinity.

# Standard 4—Science

Elementary

## Physical Setting

**1. The Earth and celestial phenomena can be described by principles of relative motion and perspective.**

**Students:**

- describe patterns of daily, monthly, and seasonal changes in their environment.

*This is evident, for example, when students:*

- ▲ conduct a long-term weather investigation, such as running a weather station or collecting weather data.
- ▲ keep a journal of the phases of the moon over a one-month period. This information is collected for several different one-month periods and compared.

**2. Many of the phenomena that we observe on Earth involve interactions among components of air, water, and land.**

**Students:**

- describe the relationships among air, water, and land on Earth.

*This is evident, for example, when students:*

- ▲ observe a puddle of water outdoors after a rainstorm. On a return visit after the puddle has disappeared, students describe where the water came from and possible locations for it now.
- ▲ assemble rock and mineral collections based on characteristics such as erosional features or crystal size features.

**3. Matter is made up of particles whose properties determine the observable characteristics of matter and its reactivity.**

**Students:**

- observe and describe properties of materials using appropriate tools.
- describe chemical and physical changes, including changes in states of matter.

*This is evident, for example, when students:*

- ▲ compare the appearance of materials when seen with and without the aid of a magnifying glass.
- ▲ investigate simple physical and chemical reactions and the chemistry of household products, e.g., freezing, melting, and evaporating; a comparison of new and rusty nails; the role of baking soda in cooking.

**4. Energy exists in many forms, and when these forms change energy is conserved.**

**Students:**

- describe a variety of forms of energy (e.g., heat, chemical, light) and the changes that occur in objects when they interact with those forms of energy.
- observe the way one form of energy can be transformed into another form of energy present in common situations (e.g., mechanical to heat energy, mechanical to electrical energy, chemical to heat energy).

*This is evident, for example, when students:*

- ▲ investigate the interactions of liquids and powders that result in chemical reactions (e.g., vinegar and baking soda) compared to interactions that do not (e.g., water and sugar).
- ▲ in order to demonstrate the transformation of chemical to electrical energy, construct electrical cells from objects, such as lemons or potatoes, using pennies and aluminum foil inserted in slits at each end of fruits or vegetables; the penny and aluminum are attached by wires to a milliammeter. Students can compare the success of a variety of these electrical cells.

**5. Energy and matter interact through forces that result in changes in motion.**

**Students:**

- describe the effects of common forces (pushes and pulls) on objects, such as those caused by gravity, magnetism, and mechanical forces.
- describe how forces can operate across distances.

*This is evident, for example, when students:*

- ▲ investigate simple machines and use them to perform tasks.

Key ideas are identified by numbers (1).  
Performance indicators are identified by bullets (•).  
Sample tasks are identified by triangles (▲).

Students will understand and apply scientific concepts, principles, and theories pertaining to the physical setting and living environment and recognize the historical development of ideas in science.

## The Living Environment

**1. Living things are both similar to and different from each other and nonliving things.**

**Students:**

- describe the characteristics of and variations between living and nonliving things.
- describe the life processes common to all living things.

*This is evident, for example, when students:*

- ▲ grow a plant or observe a pet, investigating what it requires to stay alive, including evaluating the relative importance and necessity of each item.
- ▲ investigate differences in personal body characteristics, such as temperature, pulse, heart rate, blood pressure, and reaction time.

**2. Organisms inherit genetic information in a variety of ways that result in continuity of structure and function between parents and offspring.**

**Students:**

- recognize that traits of living things are both inherited and acquired or learned.
- recognize that for humans and other living things there is genetic continuity between generations.

*This is evident, for example, when students:*

- ▲ interact with a classroom pet, observe its behaviors, and record what they are able to teach the animal, such as navigation of a maze or performance of tricks, compared to that which remains constant, such as eye color, or number of digits on an appendage.
- ▲ use breeding records and photographs of racing horses or pedigreed animals to recognize that variations exist from generation to generation but "like begets like."

**3. Individual organisms and species change over time.**

**Students:**

- describe how the structures of plants and animals complement the environment of the plant or animal.
- observe that differences within a species may give individuals an advantage in surviving and reproducing.

*This is evident, for example, when students:*

- ▲ relate physical characteristics of organisms to habitat characteristics (e.g., long hair and fur color change for mammals living in cold climates).
- ▲ visit a farm or a zoo and make a written or pictorial comparison of members of a litter and identify characteristics that may provide an advantage.

**4. The continuity of life is sustained through reproduction and development.**

**Students:**

- describe the major stages in the life cycles of selected plants and animals.
- describe evidence of growth, repair, and maintenance, such as nails, hair, and bone, and the healing of cuts and bruises.

*This is evident, for example, when students:*

- ▲ grow bean plants or butterflies; record and describe stages of development.

**5. Organisms maintain a dynamic equilibrium that sustains life.**

**Students:**

- describe basic life functions of common living specimens (guppy, mealworm, gerbil).
- describe some survival behaviors of common living specimens.
- describe the factors that help promote good health and growth in humans.

*This is evident, for example, when students:*

- ▲ observe a single organism over a period of weeks and describe such life functions as moving, eating, resting, and eliminating.
- ▲ observe and demonstrate reflexes such as pupil dilation and contraction and relate such reflexes to improved survival.
- ▲ analyze the extent to which diet and exercise habits meet cardiovascular, energy, and nutrient requirements.

**6. Plants and animals depend on each other and their physical environment.**

**Students:**

- describe how plants and animals, including humans, depend upon each other and the nonliving environment.
- describe the relationship of the sun as an energy source for living and nonliving cycles.

*This is evident, for example, when students:*

- ▲ investigate how humans depend on their environment (neighborhood), by observing, recording, and discussing the interactions that occur in carrying out their everyday lives.
- ▲ observe the effects of sunlight on growth for a garden vegetable.

**7. Human decisions and activities have had a profound impact on the physical and living environment.**

**Students:**

- identify ways in which humans have changed their environment and the effects of those changes.

*This is evident, for example, when students:*

- ▲ give examples of how inventions and innovations have changed the environment; describe benefits and burdens of those changes.

# Standard 4—Science

Intermediate

## Physical Setting

**1. The Earth and celestial phenomena can be described by principles of relative motion and perspective.**

**Students:**

- explain daily, monthly, and seasonal changes on earth.

*This is evident, for example, when students:*

- ▲ create models, drawings, or demonstrations describing the arrangement, interaction, and movement of the Earth, moon, and sun.
- ▲ plan and conduct an investigation of the night sky to describe the arrangement, interaction, and movement of celestial bodies.

**2. Many of the phenomena that we observe on Earth involve interactions among components of air, water, and land.**

**Students:**

- explain how the atmosphere (air), hydrosphere (water), and lithosphere (land) interact, evolve, and change.
- describe volcano and earthquake patterns, the rock cycle, and weather and climate changes.

*This is evident, for example, when students:*

- ▲ add heat to and subtract heat from water and graph the temperature changes, including the resulting phase changes.
- ▲ make a record of reported earthquakes and volcanoes and interpret the patterns formed worldwide.

**3. Matter is made up of particles whose properties determine the observable characteristics of matter and its reactivity.**

**Students:**

- observe and describe properties of materials, such as density, conductivity, and solubility.
- distinguish between chemical and physical changes.
- develop their own mental models to explain common chemical reactions and changes in states of matter.

*This is evident, for example, when students:*

- ▲ test and compare the properties (hardness, shape, color, etc.) of an array of materials.
- ▲ observe an ice cube as it begins to melt at temperature and construct an explanation for what happens, including sketches and written descriptions of their ideas.

**4. Energy exists in many forms, and when these forms change energy is conserved.**

**Students:**

- describe the sources and identify the transformations of energy observed in everyday life.
- observe and describe heating and cooling events.
- observe and describe energy changes as related to chemical reactions.
- observe and describe the properties of sound, light, magnetism, and electricity.
- describe situations that support the principle of conservation of energy.

*This is evident, for example, when students:*

- ▲ design and construct devices to transform/transfer energy.
- ▲ conduct supervised explorations of chemical reactions (not including ammonia and bleach products) for selected household products, such as hot and cold packs used to treat sport injuries.
- ▲ build an electromagnet and investigate the effects of using different types of core materials, varying thicknesses of wire, and different circuit types.

**5. Energy and matter interact through forces that result in changes in motion.**

**Students:**

- describe different patterns of motion of objects.
- observe, describe, and compare effects of forces (gravity, electric current, and magnetism) on the motion of objects.

*This is evident, for example, when students:*

- ▲ investigate physics in everyday life, such as at an amusement park or a playground.
- ▲ use simple machines made of pulleys and levers to lift objects and describe how each machine transforms the force applied to it.
- ▲ build "Rube Goldberg" type devices and describe the energy transformations evident in them.

Key ideas are identified by numbers (1).  
Performance indicators are identified by bullets (•).  
Sample tasks are identified by triangles (▲).



Students will understand and apply scientific concepts, principles, and theories pertaining to the physical setting and living environment and recognize the historical development of ideas in science.

## The Living Environment

**1. Living things are both similar to and different from each other and nonliving things.**

**Students:**

- compare and contrast the parts of plants, animals, and one-celled organisms.
- explain the functioning of the major human organ systems and their interactions.

*This is evident, for example, when students:*

- ▲ conduct a survey of the school grounds and develop appropriate classification keys to group plants and animals by shared characteristics.
- ▲ use spring-type clothespins to investigate muscle fatigue or rulers to determine the effect of amount of sleep on hand-eye coordination.

**2. Organisms inherit genetic information in a variety of ways that result in continuity of structure and function between parents and offspring.**

**Students:**

- describe sexual and asexual mechanisms for passing genetic materials from generation to generation.
- describe simple mechanisms related to the inheritance of some physical traits in offspring.

*This is evident, for example, when students:*

- ▲ contrast dominance and blending as models for explaining inheritance of traits.
- ▲ trace patterns of inheritance for selected human traits.

**3. Individual organisms and species change over time.**

**Students:**

- describe sources of variation in organisms and their structures and relate the variations to survival.
- describe factors responsible for competition within species and the significance of that competition.

*This is evident, for example, when students:*

- ▲ conduct a long-term investigation of plant or animal communities.
- ▲ investigate the acquired effects of industrialization on tree trunk color and those effects on different insect species.

**4. The continuity of life is sustained through reproduction and development.**

**Students:**

- observe and describe the variations in reproductive patterns of organisms, including asexual and sexual reproduction.
- explain the role of sperm and egg cells in sexual reproduction.
- observe and describe developmental patterns in selected plants and animals (e.g., insects, frogs, humans, seed-bearing plants).
- observe and describe cell division at the microscopic level and its macroscopic effects.

*This is evident, for example, when students:*

- ▲ apply a model of the genetic code as an analogue for the role of the genetic code in human populations.

**5. Organisms maintain a dynamic equilibrium that sustains life.**

**Students:**

- compare the way a variety of living specimens carry out basic life functions and maintain dynamic equilibrium.
- describe the importance of major nutrients, vitamins, and minerals in maintaining health and promoting growth and explain the need for a constant input of energy for living organisms.

*This is evident, for example, when students:*

- ▲ record and compare the behaviors of animals in their natural habitats and relate how these behaviors are important to the animals.
- ▲ design and conduct a survey of personal nutrition and exercise habits, and analyze and critique the results of that survey.

**6. Plants and animals depend on each other and their physical environment.**

**Students:**

- describe the flow of energy and matter through food chains and food webs.
- provide evidence that green plants make food and explain the significance of this process to other organisms.

*This is evident, for example, when students:*

- ▲ construct a food web for a community of organisms and explore how elimination of a particular part of a chain affects the rest of the chain and web.

**7. Human decisions and activities have had a profound impact on the physical and living environment.**

**Students:**

- describe how living things, including humans, depend upon the living and nonliving environment for their survival.
- describe the effects of environmental changes on humans and other populations.

*This is evident, for example, when students:*

- ▲ conduct an extended investigation of a local environment affected by human actions, (e.g., a pond, stream, forest, empty lot).

# Standard 4—Science

Commencement

## Physical Setting

**1. The Earth and celestial phenomena can be described by principles of relative motion and perspective.**

**Students:**

- explain complex phenomena, such as tides, variations in day length, solar insolation, apparent motion of the planets, and annual traverse of the constellations.
- describe current theories about the origin of the universe and solar system.

*This is evident, for example, when students:*

- ▲ create models, drawings, or demonstrations to explain changes in day length, solar insolation, and the apparent motion of planets.

**2. Many of the phenomena that we observe on Earth involve interactions among components of air, water, and land.**

**Students:**

- use the concepts of density and heat energy to explain observations of weather patterns, seasonal changes, and the movements of the Earth's plates.
- explain how incoming solar radiations, ocean currents, and land masses affect weather and climate.

*This is evident, for example, when students:*

- ▲ use diagrams of ocean currents at different latitudes to develop explanations for the patterns present.

**3. Matter is made up of particles whose properties determine the observable characteristics of matter and its reactivity.**

**Students:**

- explain the properties of materials in terms of the arrangement and properties of the atoms that compose them.
- use atomic and molecular models to explain common chemical reactions.
- apply the principle of conservation of mass to chemical reactions.
- use kinetic molecular theory to explain rates of reactions and the relationships among temperature, pressure, and volume of a substance.

*This is evident, for example, when students:*

- ▲ use the atomic theory of elements to justify their choice of an element for use as a lighter than air gas for a launch vehicle.
- ▲ represent common chemical reactions using three-dimensional models of the molecules involved.
- ▲ discuss and explain a variety of everyday phenomena involving rates of chemical reactions, in terms of the kinetic molecular theory (e.g., use of refrigeration to keep food from spoiling, ripening of fruit in a bowl, use of kindling wood to start a fire, different types of flames that come from a Bunsen burner).

**4. Energy exists in many forms, and when these forms change energy is conserved.**

**Students:**

- observe and describe transmission of various forms of energy.
- explain heat in terms of kinetic molecular theory.
- explain variations in wavelength and frequency in terms of the source of the vibrations that produce them, e.g., molecules, electrons, and nuclear particles.
- explain the uses and hazards of radioactivity.

*This is evident, for example, when students:*

- ▲ demonstrate through drawings, models, and diagrams how the potential energy that exists in the chemical bonds of fossil fuels can be converted to electrical energy in a power plant (potential energy  $\Rightarrow$  heat energy  $\Rightarrow$  mechanical energy  $\Rightarrow$  electrical energy).
- ▲ investigate the sources of radioactive emissions in their environment and the dangers and benefits they pose for humans.

**5. Energy and matter interact through forces that result in changes in motion.**

**Students:**

- explain and predict different patterns of motion of objects (e.g., linear and angular motion, velocity and acceleration, momentum and inertia).
- explain chemical bonding in terms of the motion of electrons.
- compare energy relationships within an atom's nucleus to those outside the nucleus.

*This is evident, for example, when students:*

- ▲ construct drawings, models, and diagrams representing several different types of chemical bonds to demonstrate the basis of the bond, the strength of the bond, and the type of electrical attraction that exists.

Key ideas are identified by numbers (1).  
Performance indicators are identified by bullets (•).  
Sample tasks are identified by triangles (▲).

Students will understand and apply scientific concepts, principles, and theories pertaining to the physical setting and living environment and recognize the historical development of ideas in science.

## The Living Environment

**1. Living things are both similar to and different from each other and nonliving things.**

**Students:**

- explain how diversity of populations within ecosystems relates to the stability of ecosystems.
- describe and explain the structures and functions of the human body at different organizational levels (e.g., systems, tissues, cells, organelles).
- explain how a one-celled organism is able to function despite lacking the levels of organization present in more complex organisms.

**2. Organisms inherit genetic information in a variety of ways that result in continuity of structure and function between parents and offspring.**

**Students:**

- explain how the structure and replication of genetic material result in offspring that resemble their parents.
- explain how the technology of genetic engineering allows humans to alter the genetic makeup of organisms.

*This is evident, for example, when students:*

- ▲ record outward characteristics of fruit flies and then breed them to determine patterns of inheritance.

**3. Individual organisms and species change over time.**

**Students:**

- explain the mechanisms and patterns of evolution.

*This is evident, for example, when students:*

- ▲ determine characteristics of the environment that affect a hypothetical organism and explore how different characteristics of the species give it a selective advantage.

**4. The continuity of life is sustained through reproduction and development.**

**Students:**

- explain how organisms, including humans, reproduce their own kind.

*This is evident, for example, when students:*

- ▲ observe the development of fruit flies or rapidly maturing plants, from fertilized egg to mature adult, relating embryological development and structural adaptations to the propagation of the species.

**5. Organisms maintain a dynamic equilibrium that sustains life.**

**Students:**

- explain the basic biochemical processes in living organisms and their importance in maintaining dynamic equilibrium.
- explain disease as a failure of homeostasis.
- relate processes at the system level to the cellular level in order to explain dynamic equilibrium in multicelled organisms.

*This is evident, for example, when students:*

- ▲ investigate the biochemical processes of the immune system, and its relationship to maintaining mental and physical health.

**6. Plants and animals depend on each other and their physical environment.**

**Students:**

- explain factors that limit growth of individuals and populations.
- explain the importance of preserving diversity of species and habitats.
- explain how the living and nonliving environments change over time and respond to disturbances.

*This is evident, for example, when students:*

- ▲ conduct a long-term investigation of a local ecosystem.

**7. Human decisions and activities have had a profound impact on the physical and living environment.**

**Students:**

- describe the range of interrelationships of humans with the living and nonliving environment.
- explain the impact of technological development and growth in the human population on the living and nonliving environment.
- explain how individual choices and societal actions can contribute to improving the environment.

*This is evident, for example, when students:*

- ▲ compile a case study of a technological development that has had a significant impact on the environment.

# Standard 5—Technology

Elementary

## Engineering Design

**1. Engineering design is an iterative process involving modeling and optimization used to develop technological solutions to problems within given constraints.**

**Students:**

- describe objects, imaginary or real, that might be modeled or made differently and suggest ways in which the objects can be changed, fixed, or improved.
- investigate prior solutions and ideas from books, magazines, family, friends, neighbors, and community members.
- generate ideas for possible solutions, individually and through group activity; apply age-appropriate mathematics and science skills; evaluate the ideas and determine the best solution; and explain reasons for the choices.
- plan and build, under supervision, a model of the solution using familiar materials, processes, and hand tools.
- discuss how best to test the solution; perform the test under teacher supervision; record and portray results through numerical and graphic means; discuss orally why things worked or didn't work; and summarize results in writing, suggesting ways to make the solution better.

*This is evident, for example, when students:*

- ▲ read a story called *Humpty's Big Day* wherein the readers visit the place where Humpty Dumpty had his accident, and are asked to design and model a way to get to the top of the wall and down again safely.
- ▲ generate and draw ideas for a space station that includes a pleasant living and working environment.
- ▲ design and model footwear that they could use to walk on a cold, sandy surface.

## Tools, Resources, and Technological Processes

**2. Technological tools, materials, and other resources should be selected on the basis of safety, cost, availability, appropriateness, and environmental impact; technological processes change energy, information, and material resources into more useful forms.**

**Students:**

- explore, use, and process a variety of materials and energy sources to design and construct things.
- understand the importance of safety, cost, ease of use, and availability in selecting tools and resources for a specific purpose.
- develop basic skill in the use of hand tools.
- use simple manufacturing processes (e.g., assembly, multiple stages of production, quality control) to produce a product.
- use appropriate graphic and electronic tools and techniques to process information.

*This is evident, for example, when students:*

- ▲ explore and use materials, joining them with the use of adhesives and mechanical fasteners to make a cardboard marionette with moving parts.
- ▲ explore materials and use forming processes to heat and bend plastic into a shape that can hold napkins.
- ▲ explore energy sources by making a simple motor that uses electrical energy to produce continuous mechanical motion.
- ▲ develop skill with a variety of hand tools and use them to make or fix things.
- ▲ process information electronically such as using a video system to advertise a product or service.
- ▲ process information graphically such as taking photos and developing and printing the pictures.

Key ideas are identified by numbers (1).  
Performance indicators are identified by bullets (•).  
Sample tasks are identified by triangles (▲).

Students will apply technological knowledge and skills to design, construct, use, and evaluate products and systems to satisfy human and environmental needs.

## Computer Technology

3. Computers, as tools for design, modeling, information processing, communication, and system control, have greatly increased human productivity and knowledge.

### Students:

- identify and describe the function of the major components of a computer system.
- use the computer as a tool for generating and drawing ideas.
- control computerized devices and systems through programming.
- model and simulate the design of a complex environment by giving direct commands.

### *This is evident, for example, when students:*

- ▲ control the operation of a toy or household appliance by programming it to perform a task.
- ▲ execute a computer program, such as SimCity, Theme Park, or The Factory to model and simulate an environment.
- ▲ model and simulate a system using construction modeling software, such as The Incredible Machine.

## Technological Systems

4. Technological systems are designed to achieve specific results and produce outputs, such as products, structures, services, energy, or other systems.

### Students:

- identify familiar examples of technological systems that are used to satisfy human needs and wants, and select them on the basis of safety, cost, and function.
- assemble and operate simple technological systems, including those with interconnecting mechanisms to achieve different kinds of movement.
- understand that larger systems are made up of smaller component subsystems.

### *This is evident, for example, when students:*

- ▲ assemble and operate a system made up from a battery, switch, and doorbell connected in a series circuit.
- ▲ assemble a system with interconnecting mechanisms, such as a jack-in-the-box that pops up from a box with a hinged lid.
- ▲ model a community-based transportation system which includes subsystems such as roadways, rails, vehicles, and traffic controls.

### Sample Problem/Activity

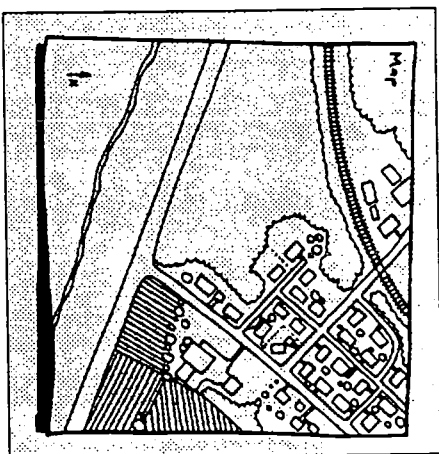

Computer design for model community

# Standard 5—Technology

Elementary

## History and Evolution of Technology      Impacts of Technology

**5. Technology has been the driving force in the evolution of society from an agricultural to an industrial to an information base.**

**Students:**

- identify technological developments that have significantly accelerated human progress.

*This is evident, for example, when students:*

- ▲ construct a model of an historical or future-oriented technological device or system and describe how it has contributed or might contribute to human progress.
- ▲ make a technological timeline in the form of a hanging mobile of technological devices.
- ▲ model a variety of timekeeping devices that reflect historical and modern methods of keeping time.
- ▲ make a display contrasting early devices or tools with their modern counterparts.

**6. Technology can have positive and negative impacts on individuals, society, and the environment and humans have the capability and responsibility to constrain or promote technological development.**

**Students:**

- describe how technology can have positive and negative effects on the environment and on the way people live and work.

*This is evident, for example, when students:*

- ▲ handmake an item and then participate in a line production experience where a quantity of the item is mass produced; compare the benefits and disadvantages of mass production and craft production.
- ▲ describe through example, how familiar technologies (including computers) can have positive and negative impacts on the environment and on the way people live and work.
- ▲ identify the pros and cons of several possible packaging materials for a student-made product.

### Sample Problem/Activity

#### CAN WE REDUCE SOLID WASTE BY REDUCING PACKAGING?



##### 1.8 DEVELOPMENT

- measuring: Students are able to measure the amount of packaging waste generated in their homes during a given period of time.
- graphing: Students are able to graph their data and meaningfully combine it with others' data to form a class set.

Key ideas are identified by numbers (1).  
Performance indicators are identified by bullets (•).  
Sample tasks are identified by triangles (▲).

Students will apply technological knowledge and skills to design, construct, use, and evaluate products and systems to satisfy human and environmental needs.

## Management of Technology

7. Project management is essential to ensuring that technological endeavors are profitable and that products and systems are of high quality and built safely, on schedule, and within budget.

Students:

- participate in small group projects and in structured group tasks requiring planning, financing, production, quality control, and follow-up.
- speculate on and model possible technological solutions that can improve the safety and quality of the school or community environment.

*This is evident, for example, when students:*

- ▲ help a group to plan and implement a school project or activity, such as a school picnic or a fund-raising event.
- ▲ plan as a group, division of tasks and construction steps needed to build a simple model of a structure or vehicle.
- ▲ redesign the work area in their classroom with an eye toward improving safety.

### Sample Problem/Activity

#### HOW CAN WE REDUCE SOLID WASTE IN OUR SCHOOL?

##### Evaluation

Students will be able to develop and implement useful solid waste reduction strategies within their school based upon their investigations of the current solid waste stream.

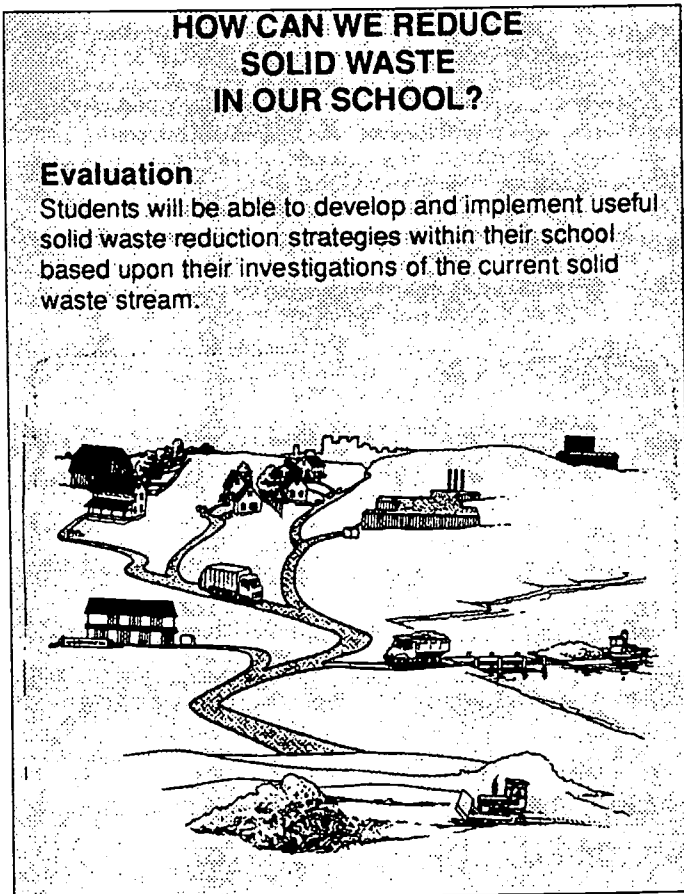

# Standard 5—Technology

Intermediate

## Engineering Design

**1. Engineering design is an iterative process involving modeling and optimization used to develop technological solutions to problems within given constraints.**

Students engage in the following steps in a design process:

- identify needs and opportunities for technical solutions from an investigation of situations of general or social interest.
- locate and utilize a range of printed, electronic, and human information resources to obtain ideas.
- consider constraints and generate several ideas for alternative solutions, using group and individual ideation techniques (group discussion, brainstorming, forced connections, role play); defer judgment until a number of ideas have been generated; evaluate (critique) ideas; and explain why the chosen solution is optimal.
- develop plans, including drawings with measurements and details of construction, and construct a model of the solution, exhibiting a degree of craftsmanship.
- in a group setting, test their solution against design specifications, present and evaluate results, describe how the solution might have been modified for different or better results, and discuss tradeoffs that might have to be made.

*This is evident, for example, when students:*

- ▲ reflect on the need for alternative growing systems in desert environments and design and model a hydroponic greenhouse for growing vegetables without soil.
- ▲ brainstorm and evaluate alternative ideas for an adaptive device that will make life easier for a person with a disability, such as a device to pick up objects from the floor.
- ▲ design a model vehicle (with a safety belt restraint system and crush zones to absorb impact) to carry a raw egg as a passenger down a ramp and into a barrier without damage to the egg.
- ▲ assess the performance of a solution against various design criteria, enter the scores on a spreadsheet, and see how varying the solution might have affected total score.

## Tools, Resources, and Technological Processes

**2. Technological tools, materials, and other resources should be selected on the basis of safety, cost, availability, appropriateness, and environmental impact; technological processes change energy, information, and material resources into more useful forms.**

Students:

- choose and use resources for a particular purpose based upon an analysis and understanding of their properties, costs, availability, and environmental impact.
- use a variety of hand tools and machines to change materials into new forms through forming, separating, and combining processes, and processes which cause internal change to occur.
- combine manufacturing processes with other technological processes to produce, market, and distribute a product.
- process energy into other forms and information into more meaningful information.

*This is evident, for example, when students:*

- ▲ choose and use resources to make a model of a building and explain their choice of materials based upon physical properties such as tensile and compressive strength, hardness, and brittleness.
- ▲ choose materials based upon their acoustic properties to make a set of wind chimes.
- ▲ use a torch to heat a steel rod to a cherry red color and cool it slowly to demonstrate how the process of annealing changes the internal structure of the steel and removes its brittleness.
- ▲ change materials into new forms using separate processes such as drilling and sawing.
- ▲ process energy into other forms such as assembling a solar cooker using a parabolic reflector to convert light energy to heat energy.
- ▲ process information into more meaningful information such as adding a music track or sound effects to an audio tape.

Key ideas are identified by numbers (1).  
Performance indicators are identified by bullets (•).  
Sample tasks are identified by triangles (▲).



Students will apply technological knowledge and skills to design, construct, use, and evaluate products and systems to satisfy human and environmental needs.

## Computer Technology

3. Computers, as tools for design, modeling, information processing, communication, and system control, have greatly increased human productivity and knowledge.

**Students:**

- assemble a computer system including keyboard, central processing unit and disc drives, mouse, modem, printer, and monitor.
- use a computer system to connect to and access needed information from various Internet sites.
- use computer hardware and software to draw and dimension prototypical designs.
- use a computer as a modeling tool.
- use a computer system to monitor and control external events and/or systems.

*This is evident, for example, when students:*

- ▲ use computer hardware and a basic computer-aided design package to draw and dimension plans for a simple project.
- ▲ use a computer program, such as Car Builder, to model a vehicle to desired specifications.
- ▲ use temperature sensors to monitor and control the temperature of a model greenhouse.
- ▲ model a computer-controlled system, such as traffic lights, a merry-go-round, or a vehicle using Lego or other modeling hardware interfaced to a computer.

## Technological Systems

4. Technological systems are designed to achieve specific results and produce outputs, such as products, structures, services, energy, or other systems.

**Students:**

- select appropriate technological systems on the basis of safety, function, cost, ease of operation, and quality of post-purchase support.
- assemble, operate, and explain the operation of simple open- and closed-loop electrical, electronic, mechanical, and pneumatic systems.
- describe how subsystems and system elements (inputs, processes, outputs) interact within systems.
- describe how system control requires sensing information, processing it, and making changes.

*This is evident, for example, when students:*

- ▲ assemble an electronic kit that includes sensors and signaling devices and functions as an alarm system.
- ▲ use several open loop systems (without feedback control) such as a spray can, bubble gum machine, or wind-up toys, and compare them to closed-loop systems (with feedback control) such as an electric oven with a thermostat, or a line tracker robot.
- ▲ use a systems diagram to model a technological system, such as a model rocket, with the command inputs, resource inputs, processes, monitoring and control mechanisms, and system outputs labeled.
- ▲ provide examples of modern machines where microprocessors receive information from sensors and serve as controllers.

### Sample Problem/Activity

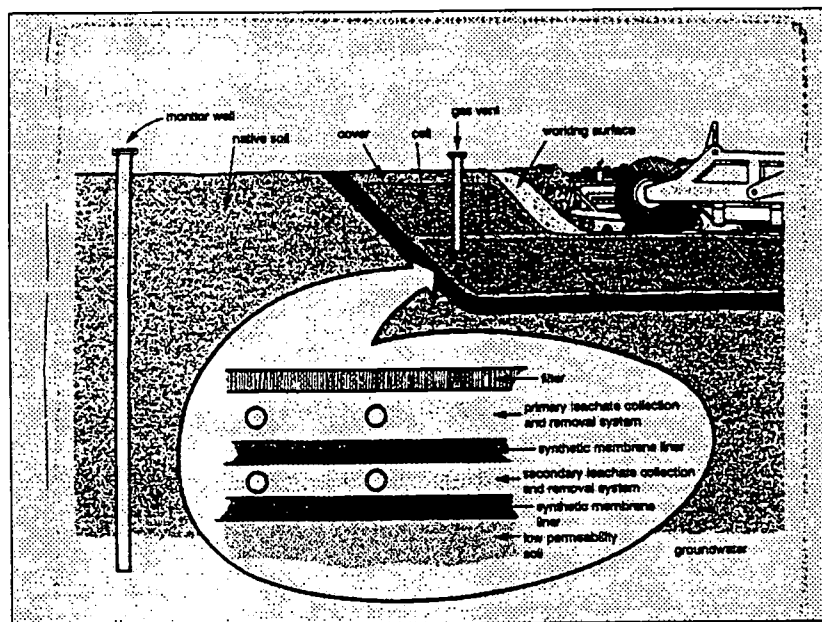

Systems diagram for a filter system

# Standard 5—Technology

Intermediate

## History and Evolution of Technology      Impacts of Technology

**5. Technology has been the driving force in the evolution of society from an agricultural to an industrial to an information base.**

**Students:**

- describe how the evolution of technology led to the shift in society from an agricultural base to an industrial base to an information base.
- understand the contributions of people of different genders, races, and ethnic groups to technological development.
- describe how new technologies have evolved as a result of combining existing technologies (e.g., photography combined optics and chemistry; the airplane combined kite and glider technology with a lightweight gasoline engine).

*This is evident, for example, when students:*

- ▲ construct models of technological devices (e.g., the plow, the printing press, the digital computer) that have significantly affected human progress and that illustrate how the evolution of technology has shifted the economic base of the country.
- ▲ develop a display of pictures or models of technological devices invented by people from various cultural backgrounds, along with photographs and short biographies of the inventors.
- ▲ make a poster with drawings and photographs showing how an existing technology is the result of combining various technologies.

**6. Technology can have positive and negative impacts on individuals, society, and the environment and humans have the capability and responsibility to constrain or promote technological development.**

**Students:**

- describe how outputs of a technological system can be desired, undesired, expected, or unexpected.
- describe through examples how modern technology reduces manufacturing and construction costs and produces more uniform products.

*This is evident, for example, when students:*

- ▲ use the automobile, for example, to explain desired (easier travel), undesired (pollution), expected (new jobs created), unexpected (crowded highways and the growth of suburbs) impacts.
- ▲ provide an example of an assembly line that produces products with interchangeable parts.
- ▲ compare the costs involved in producing a prototype of a product to the per product cost of a batch of 100.

### Sample Problem/Activity

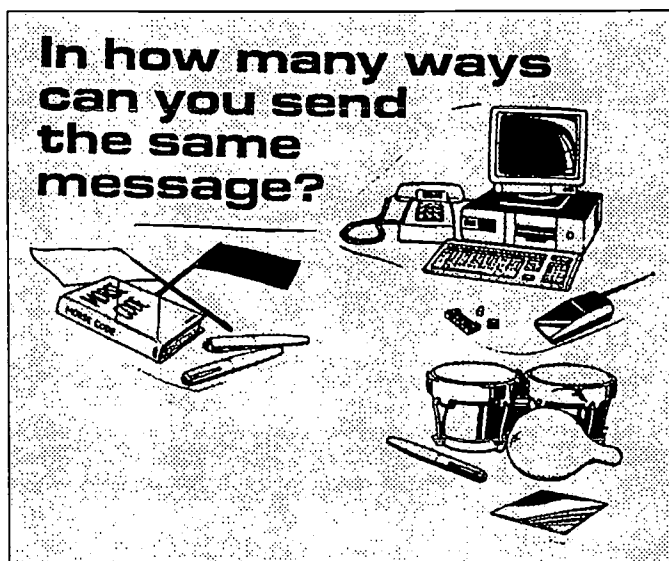

42

Key ideas are identified by numbers (1).  
Performance indicators are identified by bullets (•).  
Sample tasks are identified by triangles (▲).

50

Students will apply technological knowledge and skills to design, construct, use, and evaluate products and systems to satisfy human and environmental needs.

## Management of Technology

**7. Project management is essential to ensuring that technological endeavors are profitable and that products and systems are of high quality and built safely, on schedule, and within budget.**

**Students:**

- **manage time and financial resources in a technological project.**
- **provide examples of products that are well (and poorly) designed and made, describe their positive and negative attributes, and suggest measures that can be implemented to monitor quality during production.**
- **assume leadership responsibilities within a structured group activity.**

*This is evident, for example, when students:*

- ▲ **make up and follow a project work plan, time schedule, budget, and a bill of materials.**
- ▲ **analyze a child's toy and describe how it might have been better made at a lower cost.**
- ▲ **assume leadership on a team to play an audio or video communication system, and use it for an intended purpose (e.g., to inform, educate, persuade, entertain).**

### Sample Problem/Activity

## Can we build a working speaker?

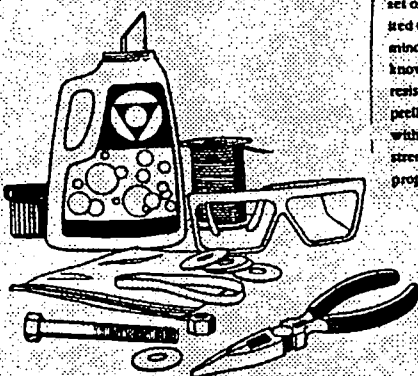

**Classroom Activity**

1. Divide the class into groups consisting of four students each. Challenge each group to design a plan for the construction of a homemade radio speaker for the eight-ohm speaker or jack on an inexpensive transistor radio or cassette recorder. Provide each group with a set of materials, and inform students that they are limited to the use of these materials in their designs. Remind students to draw upon the information and knowledge they possess about electromagnets, current, resistors, and circuits. After each group has generated a preliminary plan, hold a class discussion. Work out with students a class consensus plan that combines the strengths and minimizes the weaknesses of their group proposed plans (see Procedural Notes section).

# Standard 5—Technology

Commencement

## Engineering Design

**1. Engineering design is an iterative process involving modeling and optimization used to develop technological solutions to problems within given constraints.**

Students engage in the following steps in a design process:

- initiate and carry out a thorough investigation of an unfamiliar situation and identify needs and opportunities for technological invention or innovation.
- identify, locate, and use a wide range of information resources including subject experts, library references, magazines, videotapes, films, electronic data bases and on-line services, and discuss and document through notes and sketches how findings relate to the problem.
- generate creative solution ideas, break ideas into the significant functional elements, and explore possible refinements; predict possible outcomes using mathematical and functional modeling techniques; choose the optimal solution to the problem, clearly documenting ideas against design criteria and constraints; and explain how human values, economics, ergonomics, and environmental considerations have influenced the solution.
- develop work schedules and plans which include optimal use and cost of materials, processes, time, and expertise; construct a model of the solution, incorporating developmental modifications while working to a high degree of quality (craftsmanship).
- in a group setting, devise a test of the solution relative to the design criteria and perform the test; record, portray, and logically evaluate performance test results through quantitative, graphic, and verbal means; and use a variety of creative verbal and graphic techniques effectively and persuasively to present conclusions, predict impacts and new problems, and suggest and pursue modifications.

*This is evident, for example, when students:*

- ▲ search the Internet for world wide web sites dealing with renewable energy and sustainable living and research the development and design of an energy efficient home.
- ▲ develop plans, diagrams, and working drawings for the construction of a computer-controlled marble sorting system that simulates how parts on an assembly line are sorted by color.
- ▲ design and model a portable emergency shelter for a homeless person that could be carried by one person and be heated by the body heat of that person to a life-sustaining temperature when the outside temperature is 20° F.

Key ideas are identified by numbers (1).  
Performance indicators are identified by bullets (•).  
Sample tasks are identified by triangles (▲).

## Tools, Resources, and Technological Processes

**2. Technological tools, materials, and other resources should be selected on the basis of safety, cost, availability, appropriateness, and environmental impact; technological processes change energy, information, and material resources into more useful forms.**

Students:

- test, use, and describe the attributes of a range of material (including synthetic and composite materials), information, and energy resources.
- select appropriate tools, instruments, and equipment and use them correctly to process materials, energy, and information.
- explain tradeoffs made in selecting alternative resources in terms of safety, cost, properties, availability, ease of processing, and disposability.
- describe and model methods (including computer-based methods) to control system processes and monitor system outputs.

*This is evident, for example, when students:*

- ▲ use a range of high- tech composite or synthetic materials to make a model of a product, (e.g., ski, an airplane, earthquake-resistant building) and explain their choice of material.
- ▲ design a procedure to test the properties of synthetic and composite materials.
- ▲ select appropriate tools, materials, and processes to manufacture a product (chosen on the basis of market research) that appeals to high school students.
- ▲ select the appropriate instrument and use it to test voltage and continuity when repairing a household appliance.
- ▲ construct two forms of packaging (one from biodegradable materials, the other from any other materials), for a children's toy and explain the tradeoffs made when choosing one or the other.
- ▲ describe and model a method to design and evaluate a system that dispenses candy and counts the number dispensed using, for example, Fischertechnik, Capsela, or Lego.
- ▲ describe how the flow, processing, and monitoring of materials is controlled in a manufacturing plant and how information processing systems provide inventory, tracking, and quality control data.

Students will apply technological knowledge and skills to design, construct, use, and evaluate products and systems to satisfy human and environmental needs.

## Computer Technology

3. Computers, as tools for design, modeling, information processing, communication, and system control, have greatly increased human productivity and knowledge.

Students:

- understand basic computer architecture and describe the function of computer subsystems and peripheral devices.
- select a computer system that meets personal needs.
- attach a modem to a computer system and telephone line, set up and use communications software, connect to various on-line networks, including the Internet, and access needed information using e-mail, telnet, gopher, ftp, and web searches.
- use computer-aided drawing and design (CADD) software to model realistic solutions to design problems.
- develop an understanding of computer programming and attain some facility in writing computer programs.

*This is evident, for example, when students:*

- ▲ choose a state-of-the-art computer system from computer magazines, price the system, and justify the choice of CPU, CD-ROM and floppy drives, amount of RAM, video and sound cards, modem, printer, and monitor; explain the cost-benefit tradeoffs they have made.
- ▲ use a computer-aided drawing and design package to design and draw a model of their own room.
- ▲ write a computer program that works in conjunction with a bar code reader and an optical sensor to distinguish between light and dark areas of the bar code.

## Technological Systems

4. Technological systems are designed to achieve specific results and produce outputs, such as products, structures, services, energy, or other systems.

Students:

- explain why making tradeoffs among characteristics, such as safety, function, cost, ease of operation, quality of post-purchase support, and environmental impact, is necessary when selecting systems for specific purposes.
- model, explain, and analyze the performance of a feedback control system.
- explain how complex technological systems involve the confluence of numerous other systems.

*This is evident, for example, when students:*

- ▲ model, explain, and analyze how the float mechanism of a toilet tank senses water level, compares the actual level to the desired level, and controls the flow of water into the tank.
- ▲ draw a labeled system diagram which explains the performance of a system, and include several subsystems and multiple feedback loops.
- ▲ explain how the space shuttle involves communication, transportation, biotechnical, and manufacturing systems.

### Sample Problem/Activity

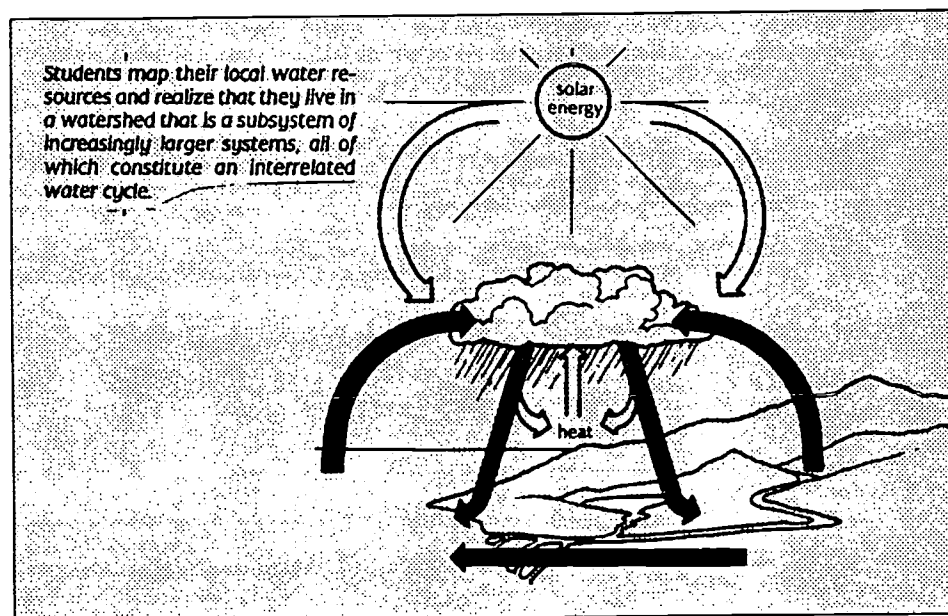

# Standard 5—Technology

Commencement

## History and Evolution of Technology    Impacts of Technology

5. Technology has been the driving force in the evolution of society from an agricultural to an industrial to an information base.

Students:

- explain how technological inventions and innovations have caused global growth and interdependence, stimulated economic competitiveness, created new jobs, and made other jobs obsolete.

*This is evident, for example, when students:*

- ▲ compare qualitatively and quantitatively the performance of a contemporary manufactured product, such as a household appliance, to the comparable device or system 50-100 years ago, and present results graphically, orally, and in writing.
- ▲ describe the process that an inventor must follow to obtain a patent for an invention.
- ▲ explain through examples how some inventions are not translated into products and services with market place demand, and therefore do not become commercial successes.

6. Technology can have positive and negative impacts on individuals, society, and the environment and humans have the capability and responsibility to constrain or promote technological development.

Students:

- explain that although technological effects are complex and difficult to predict accurately, humans can control the development and implementation of technology.
- explain how computers and automation have changed the nature of work.
- explain how national security is dependent upon both military and nonmilitary applications of technology.

*This is evident, for example, when students:*

- ▲ develop and implement a technological device that might be used to assist a disabled person perform a task.
- ▲ identify a technology which impacts negatively on the environment and design and model a technological fix.
- ▲ identify new or emerging technologies and use a futuring technique (e.g., futures wheel, cross impact matrix, Delphi survey) to predict what might be the second and third order impacts.

### Sample Problem/Activity

#### How Has The Use Of Electric Appliances Changed Over Time?

Have each student make a list of the electric appliances in her/his household, including everything from light bulbs to refrigerators. Instruct students to ask a parent (or other adult of approximately the same age) to record how many of each kind of appliance was in her/his household when (s)he was a child. Develop with the class a set of common procedures that can be used to collect the information.

► What specific procedures should we follow to ensure that everyone's data is comparable?

► How will we account for missing data in our survey, due to forgetfulness of some participants or other factors?

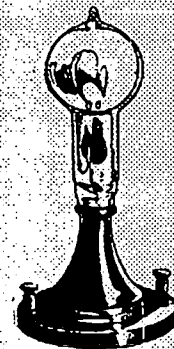

Key ideas are identified by numbers (1).  
Performance indicators are identified by bullets (•).  
Sample tasks are identified by triangles (▲).

Students will apply technological knowledge and skills to design, construct, use, and evaluate products and systems to satisfy human and environmental needs.

## Management of Technology

**7. Project management is essential to ensuring that technological endeavors are profitable and that products and systems are of high quality and built safely, on schedule, and within budget.**

**Students:**

- **develop and use computer-based scheduling and project tracking tools, such as flow charts and graphs.**
- **explain how statistical process control helps to assure high quality output.**
- **discuss the role technology has played in the operation of successful U.S. businesses and under what circumstances they are competitive with other countries.**
- **explain how technological inventions and innovations stimulate economic competitiveness and how, in order for an innovation to lead to commercial success, it must be translated into products and services with marketplace demand.**
- **describe new management techniques (e.g., computer-aided engineering, computer-integrated manufacturing, total quality management, just-in-time manufacturing), incorporate some of these in a technological endeavor, and explain how they have reduced the length of design-to-manufacture cycles, resulted in more flexible factories, and improved quality and customer satisfaction.**
- **help to manage a group engaged in planning, designing, implementation, and evaluation of a project to gain understanding of the management dynamics.**

*This is evident, for example, when students:*

- ▲ **design and carry out a plan to create a computer-based information system that could be used to help manage a manufacturing system (e.g., monitoring inventory, measurement of production rate, development of a safety signal).**
- ▲ **identify several successful companies and explain the reasons for their commercial success.**
- ▲ **organize and implement an innovative project, based on market research, that involves design, production, testing, marketing, and sales of a product or a service.**

# Standard 6—Interconnectedness: Common Themes Elementary

## Systems Thinking

1. Through systems thinking, people can recognize the commonalities that exist among all systems and how parts of a system interrelate and combine to perform specific functions.

Students:

- observe and describe interactions among components of simple systems.
- identify common things that can be considered to be systems (e.g., a plant population, a subway system, human beings).

## Models

2. Models are simplified representations of objects, structures, or systems used in analysis, explanation, interpretation, or design.

Students:

- analyze, construct, and operate models in order to discover attributes of the real thing.
- discover that a model of something is different from the real thing but can be used to study the real thing.
- use different types of models, such as graphs, sketches, diagrams, maps, to represent various aspects of the real world.

*This is evident, for example, when students:*

- ▲ compare toy cars with real automobiles in terms of size and function.
- ▲ model structures with building blocks.
- ▲ design and construct a working model of the human circulatory system to explore how varying pumping pressure might affect blood flow.
- ▲ describe the limitations of model cars, planes, or houses.
- ▲ use model vehicles or structures to illustrate how the real object functions.
- ▲ use a road map to determine distances between towns and cities.

### Sample Problem/Activity

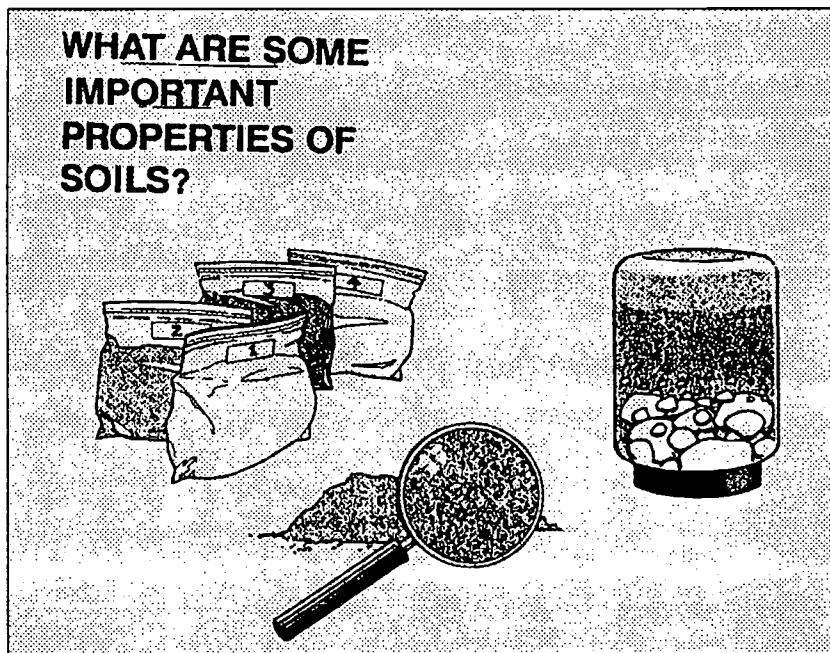

Key ideas are identified by numbers (1).  
Performance indicators are identified by bullets (•).  
Sample tasks are identified by triangles (▲).



Students will understand the relationships and common themes that connect mathematics, science, and technology and apply the themes to these and other areas of learning.

## Magnitude and Scale

3. The grouping of magnitudes of size, time, frequency, and pressures or other units of measurement into a series of relative order provides a useful way to deal with the immense range and the changes in scale that affect the behavior and design of systems.

Students:

- provide examples of natural and manufactured things that belong to the same category yet have very different sizes, weights, ages, speeds, and other measurements.
- identify the biggest and the smallest values as well as the average value of a system when given information about its characteristics and behavior.

*This is evident, for example, when students:*

- ▲ compare the weight of small and large animals.
- ▲ compare the speed of bicycles, cars, and planes.
- ▲ compare the life spans of insects and trees.
- ▲ collect and analyze data related to the height of the students in their class, identifying the tallest, the shortest, and the average height.
- ▲ compare the annual temperature range of their locality.

## Equilibrium and Stability

4. Equilibrium is a state of stability due either to a lack of changes (static equilibrium) or a balance between opposing forces (dynamic equilibrium).

Students:

- cite examples of systems in which some features stay the same while other features change.
- distinguish between reasons for stability—from lack of changes to changes that counterbalance one another to changes within cycles.

*This is evident, for example, when students:*

- ▲ record their body temperatures in different weather conditions and observe that the temperature of a healthy human being stays almost constant even though the external temperature changes.
- ▲ identify the reasons for the changing amount of fresh water in a reservoir and determine how a constant supply is maintained.

### Sample Problem/Activity

## What can I learn about my body?

- > How do your results compare to your classmates' results?
- > What factors do you think could account for the differences?
- > Who would benefit from the information you gathered and how?
- > What other information do you think would complete your knowledge of your body?
- > Are there some data on your form that you would rather keep confidential? Which data?
- > Who should and should not have access to this information? Give reasons for your answers.

CONTENT UNDERSTANDINGS  
 ■ Soil consists of weathered rock fragments that contain organic material

MEASURING ME	
Name:	_____
Grade/Period:	_____
Pulse Rate:	_____
Temperature:	_____
Body Length:	_____
Body Mass:	_____
Hand Span:	_____
Hand Grip:	_____
Hand Strength:	_____
Hand Size:	_____

# Standard 6—Interconnectedness: Common Themes Elementary

## Patterns of Change

5. Identifying patterns of change is necessary for making predictions about future behavior and conditions.

Students:

- use simple instruments to measure such quantities as distance, size, and weight and look for patterns in the data.
- analyze data by making tables and graphs and looking for patterns of change.

*This is evident, for example, when students:*

- ▲ compare shoe size with the height of people to determine if there is a trend.
- ▲ collect data on the speed of balls rolling down ramps of different slopes and determine the relationship between speed and steepness of the ramp.
- ▲ take data they have collected and generate tables and graphs to begin the search for patterns of change.

## Optimization

6. In order to arrive at the best solution that meets criteria within constraints, it is often necessary to make trade-offs.

Students:

- determine the criteria and constraints of a simple decision making problem.
- use simple quantitative methods, such as ratios, to compare costs to benefits of a decision problem.

*This is evident, for example, when students:*

- ▲ describe the criteria (e.g., size, color, model) and constraints (e.g., budget) used to select the best bicycle to buy.
- ▲ compare the cost of cereal to number of servings to figure out the best buy.

### Sample Problem/Activity

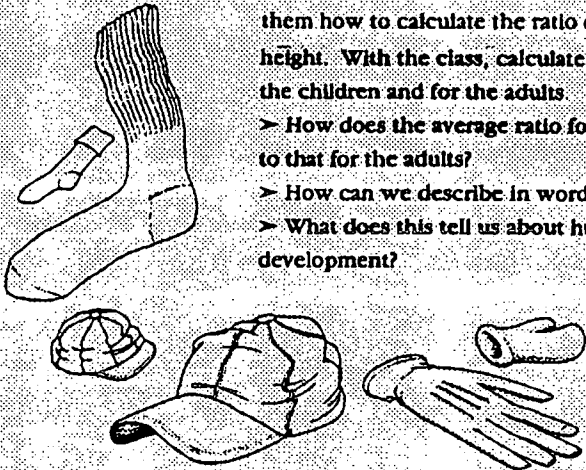

Ask each student to measure the length of the head and the height of three adults and three children (two years old or younger) as an outside assignment. Show them how to calculate the ratio of head length to height. With the class, calculate the average ratio for the children and for the adults.

- > How does the average ratio for the children compare to that for the adults?
- > How can we describe in words the change in ratios?
- > What does this tell us about human growth and development?

Key ideas are identified by numbers (1).  
Performance indicators are identified by bullets (•).  
Sample tasks are identified by triangles (▲).

Students will understand the relationships and common themes that connect mathematics, science, and technology and apply the themes to these and other areas of learning.

Sample Problem/Activity

# Why would I need an owner's manual?

Students will be able to describe similarities and differences between a manual they create for a device and a personal manual they will create throughout the course of this module and perhaps beyond.

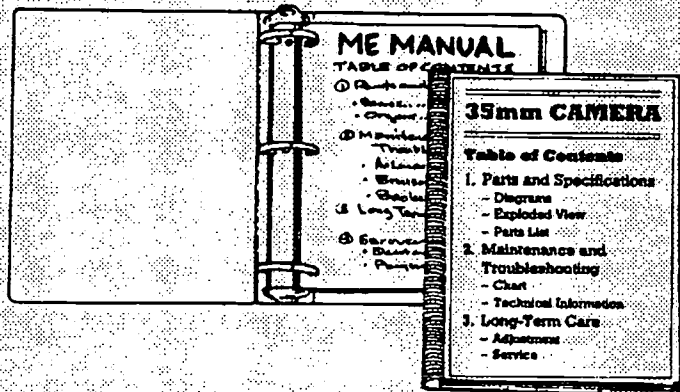

## Interdisciplinary Connections

These activities focus on devices as technologies:

- **Technology:** Compare electronics information about several types of devices, and account for their similarities and differences.
- **Social Studies:** Talk to a lawyer, paralegal, or representative of the Better Business Bureau about written and implied warranties.
- **Language Arts:** Develop a second version of your manual that contains a limited number of technical words. Consult your language arts teacher, a children's writer, or a technical writer for assistance in using this kind of controlled approach to manual writing.

- **Mathematics:** Locate and read selected magazine articles to determine the nature and extent of the market in various devices. Prepare graphs and charts that show relative percentages of kinds of goods sold and other pertinent information.
- **Health:** Interview a nurse, audiologist, pediatrician, or other health specialist regarding hearing losses associated with one or more entertainment devices.
- **Home and Career Skills:** Conduct a survey of the electronic devices in your home, including entertainment and nonentertainment devices. Compare your results with an

- informal survey of one or more older persons regarding electronic devices used in a typical home in the early sixties.
- **Foreign Languages and Cultures:** Look through a number of owners' manuals at home or at a car dealership or electronics store. Note whether these manuals are written only in English or in other languages as well. Try to explain why the manufacturer chose certain languages.

# Standard 6—Interconnectedness: Common Themes Intermediate

## Systems Thinking

1. Through systems thinking, people can recognize the commonalities that exist among all systems and how parts of a system interrelate and combine to perform specific functions.

**Students:**

- describe the differences between dynamic systems and organizational systems.
- describe the differences and similarities between engineering systems, natural systems, and social systems.
- describe the differences between open- and closed-loop systems.
- describe how the output from one part of a system (which can include material, energy, or information) can become the input to other parts.

*This is evident, for example, when students:*

- ▲ compare systems with internal control (e.g., homeostasis in organisms or an ecological system) to systems of related components without internal control (e.g., the Dewey decimal, solar system).

## Models

2. Models are simplified representations of objects, structures, or systems used in analysis, explanation, interpretation, or design.

**Students:**

- select an appropriate model to begin the search for answers or solutions to a question or problem.
- use models to study processes that cannot be studied directly (e.g., when the real process is too slow, too fast, or too dangerous for direct observation).
- demonstrate the effectiveness of different models to represent the same thing and the same model to represent different things.

*This is evident, for example, when students:*

- ▲ choose a mathematical model to predict the distance a car will travel at a given speed in a given time.
- ▲ use a computer simulation to observe the process of growing vegetables or to test the performance of cars.
- ▲ compare the relative merits of using a flat map or a globe to model where places are situated on Earth.
- ▲ use blueprints or scale models to represent room plans.

### Sample Problem/Activity

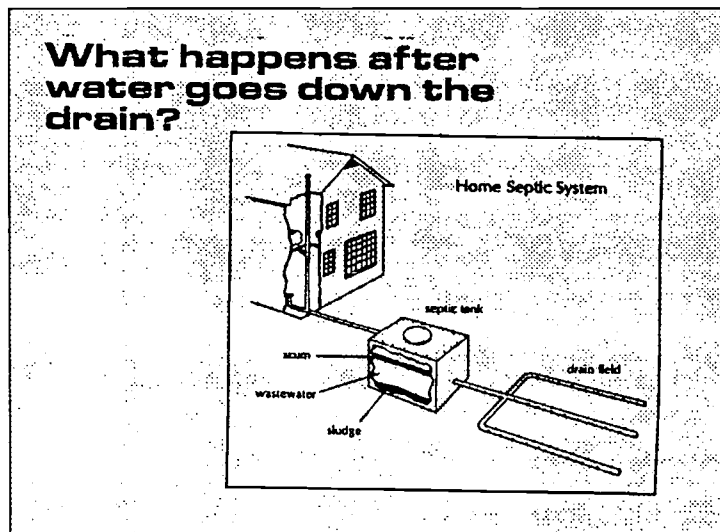

Key ideas are identified by numbers (1).  
Performance indicators are identified by bullets (•).  
Sample tasks are identified by triangles (▲).

Students will understand the relationships and common themes that connect mathematics, science, and technology and apply the themes to these and other areas of learning.

## Magnitude and Scale

3. The grouping of magnitudes of size, time, frequency, and pressures or other units of measurement into a series of relative order provides a useful way to deal with the immense range and the changes in scale that affect the behavior and design of systems.

Students:

- cite examples of how different aspects of natural and designed systems change at different rates with changes in scale.
- use powers of ten notation to represent very small and very large numbers.

*This is evident, for example, when students:*

- ▲ demonstrate that a large container of hot water (more volume) cools off more slowly than a small container (less volume).
- ▲ compare the very low frequencies (60 Hertz AC or  $6 \times 10$  Hertz) to the mid-range frequencies (10 Hertz-FM radio) to the higher frequencies ( $10^{15}$  Hertz) of the electromagnetic spectrum.

## Equilibrium and Stability

4. Equilibrium is a state of stability due either to a lack of changes (static equilibrium) or a balance between opposing forces (dynamic equilibrium).

Students:

- describe how feedback mechanisms are used in both designed and natural systems to keep changes within desired limits.
- describe changes within equilibrium cycles in terms of frequency or cycle length and determine the highest and lowest values and when they occur.

*This is evident, for example, when students:*

- ▲ compare the feedback mechanisms used to keep a house at a constant temperature to those used by the human body to maintain a constant temperature.
- ▲ analyze the data for the number of hours of sunlight from the shortest day to the longest day of the year.

### Sample Problem/Activity

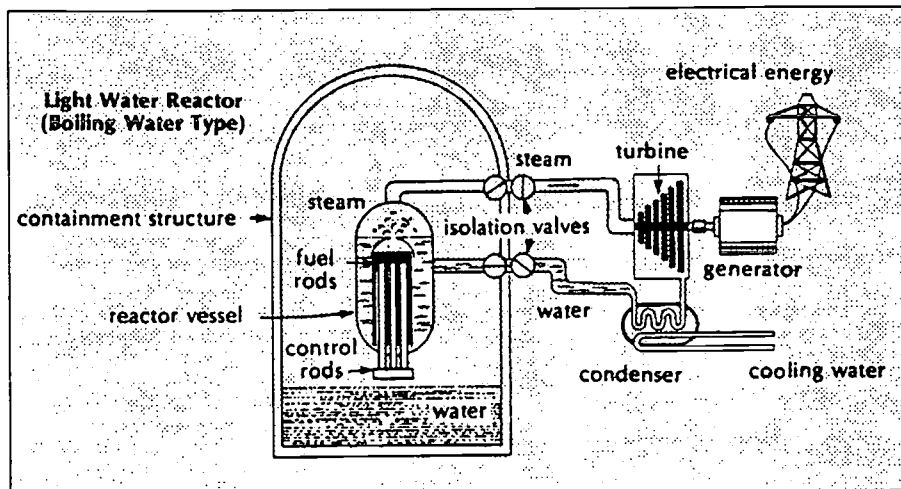

# Standard 6—Interconnectedness: Common Themes Intermediate

## Patterns of Change

5. Identifying patterns of change is necessary for making predictions about future behavior and conditions.

**Students:**

- use simple linear equations to represent how a parameter changes with time.
- observe patterns of change in trends or cycles and make predictions on what might happen in the future.

*This is evident, for example, when students:*

- ▲ study how distance changes with time for a car traveling at a constant speed.
- ▲ use a graph of a population over time to predict future population levels.

## Optimization

6. In order to arrive at the best solution that meets criteria within constraints, it is often necessary to make trade-offs.

**Students:**

- determine the criteria and constraints and make trade-offs to determine the best decision.
- use graphs of information for a decision making problem to determine the optimum solution.

*This is evident, for example, when students:*

- ▲ choose components for a home stereo system.
- ▲ determine the best dimensions for fencing in the maximum area.

### Sample Problem/Activity

#### HOW MANY IS ENOUGH?

■ Students will be able to use a simple model to illustrate resource depletion and will be able to suggest variations to the model which would allow management of population size for a wildlife species.

#### Classroom Activity

1. Form student groups of four or five. Display a container more than half full of paper clips. Tell students that each clip represents an individual of one kind of bird and that all the clips in this container represent a wild bird population (i.e., all are of the same species).

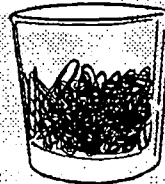

The container represents the habitat for the population. Also display a similar container less than half full of the same size, but a different color, of paper clip. Explain that each of the clips in this container represents one individual of another population (i.e., a different species) of wild birds. Finish introducing the bird game (see Procedural Notes section) and have students play the game.

#### Evaluation

Students are able to identify factors that influence population size, and they suggest reasons why unlimited killing of wild creatures by humans has more of a long-term effect on some species than on others.

Key ideas are identified by numbers (1).  
Performance indicators are identified by bullets (•).  
Sample tasks are identified by triangles (▲).

Students will understand the relationships and common themes that connect mathematics, science, and technology and apply the themes to these and other areas of learning.

### Sample Problem/Activity

## What is a resistor and how can it be used?

In Series



In Parallel

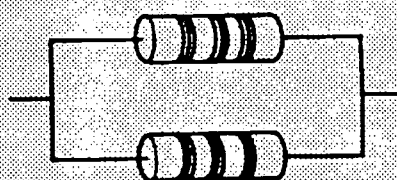

These activities focus on resistors:

► **Technology:** Carefully open one or more unplugged electronic devices around your house, and list the various types of resistors employed in the different devices. (You may use schematics to describe the types of resistors instead of naming the types.) Calculate an average value of a typical resistor in a domestic appliance.

► **Social Studies:** Research the invention of the resistor and ways in which its use has expanded over time. / Explore patent law as it would relate to the discovery of a new type of resistor.

► **Language Arts:** Write a play which chronicles the life history of a resistor from the creation of its original constituent materials to the end of its useful life.

► **Mathematics:** Create a computer program that will calculate the overall resistance for a particular circuit when different types of resistors are employed. / Calculate the resistance of one of the circuits used in this activity if several different values of resistors are utilized within the circuit.

► **Health:** Write to Underwriters Laboratories to find out about their work testing electrical devices in the interest of consumer safety.

► **Home and Career Skills:** Conduct a mini-family workshop in which you explain to members of your household the use of resistors. / Investigate careers in electronics.

► **Arts:** Produce a small flip-chart presentation of the movement of electrons within a circuit in which two resistors reside, so that when the booklet is flipped with the fingers, the electrons appear to move through the circuit. Alternatively, create a set of overhead transparencies that your teacher can use to demonstrate this phenomenon.

► **Foreign Languages and Cultures:** Research periodical literature to find out which nations are the leading producers of resistors.

# Standard 6—Interconnectedness: Common Themes Commencement

## Systems Thinking

1. Through systems thinking, people can recognize the commonalities that exist among all systems and how parts of a system interrelate and combine to perform specific functions.

### Students:

- explain how positive feedback and negative feedback have opposite effects on system outputs.
- use an input-process-output-feedback diagram to model and compare the behavior of natural and engineered systems.
- define boundary conditions when doing systems analysis to determine what influences a system and how it behaves.

*This is evident, for example, when students:*

- ▲ describe how negative feedback is used to control loudness automatically in a stereo system and how positive feedback from loudspeaker to microphone results in louder and louder squeals.

## Models

2. Models are simplified representations of objects, structures, or systems used in analysis, explanation, interpretation, or design.

### Students:

- revise a model to create a more complete or improved representation of the system.
- collect information about the behavior of a system and use modeling tools to represent the operation of the system.
- find and use mathematical models that behave in the same manner as the processes under investigation.
- compare predictions to actual observations using test models.

*This is evident, for example, when students:*

- ▲ add new parameters to an existing spreadsheet model.
- ▲ incorporate new design features in a CAD drawing.
- ▲ use computer simulation software to create a model of a system under stress, such as a city or an ecosystem.
- ▲ design and construct a prototype to test the performance of a temperature control system.
- ▲ use mathematical models for scientific laws, such as Hooke's Law or Newton's Laws, and relate them to the function of technological systems, such as an automotive suspension system.
- ▲ use sinusoidal functions to study systems that exhibit periodic behavior.
- ▲ compare actual populations of animals to the numbers predicted by predator/ prey computer simulations.



Students will understand the relationships and common themes that connect mathematics, science, and technology and apply the themes to these and other areas of learning.

## Magnitude and Scale

3. The grouping of magnitudes of size, time, frequency, and pressures or other units of measurement into a series of relative order provides a useful way to deal with the immense range and the changes in scale that affect the behavior and design of systems.

Students:

- describe the effects of changes in scale on the functioning of physical, biological, or designed systems.
- extend their use of powers of ten notation to understanding the exponential function and performing operations with exponential factors.

This is evident, for example, when students:

- ▲ explain that an increase in the size of an animal or a structure requires larger supports (legs or columns) because of the greater volume or weight.
- ▲ use the relationship that  $v = f \lambda$  to determine wave length when given the frequency of an FM radio wave, such as 100.0 megahertz ( $1.1 \times 10^8$  Hertz), and velocity of light or EM waves as  $3 \times 10^8 \text{ m/sec}$  can.

## Equilibrium and Stability

4. Equilibrium is a state of stability due either to a lack of changes (static equilibrium) or a balance between opposing forces (dynamic equilibrium).

Students:

- describe specific instances of how disturbances might affect a system's equilibrium, from small disturbances that do not upset the equilibrium to larger disturbances (threshold level) that cause the system to become unstable.
- cite specific examples of how dynamic equilibrium is achieved by equality of change in opposing directions.

This is evident, for example, when students:

- ▲ use mathematical models to predict under what conditions the spread of a disease will become epidemic.
- ▲ document the range of external temperatures in which warm-blooded animals can maintain a relatively constant internal temperature and identify the extremes of cold or heat that will cause death.
- ▲ experiment with chemical or biological processes when the flow of materials in one way direction is counter-balanced by the flow of materials in the opposite direction.

### Sample Problem/Activity

**Observing the Greenhouse Effect**

**Directions:** Follow the steps below and complete the experiment. Place all information that you gather on the data table on Worksheet C. Then graph your results and answer the questions.

- Place soil to a depth of 2 cm in each of the shoeboxes. Thoroughly moisten the soil with water, but not so much that water sits on top of the soil.
- Cut out a piece of cardboard so that when it is inserted into one of the clear plastic shoeboxes it will divide the box in half and will be only about three-fourths the height of the box (Diagram 1). Construct a similar cardboard divider for the other box.
- Insert a cardboard divider into each shoebox.
- Lean a thermometer (with the bulb end up) against each divider (Diagram 2).
- Set the boxes side by side and about 2 cm apart under the flood lamp. Adjust the flood lamp so that it is about 25 cm above and equally distant from each box (Diagram 3). Place a clear plastic cover on one box.
- When the temperatures of the thermometers stop changing, record them in the appropriate spaces of the "0 minutes" row of the data table on Worksheet C.
- Turn on the light. Record in the data table the temperature of each thermometer every 30 seconds for 13 minutes. Then turn off the light.

**Caution:** Do not touch the flood lamp since it may become very hot. Do not look directly at the lamp. Do not leave the lamp unattended.

Diagram 3

Diagram 1

Diagram 2

**Caution:** Locate your set-up away from direct sunlight or drafts from windows and heating or cooling systems. These may produce convection currents that could interfere with the activity.

# Standard 6—Interconnectedness: Common Themes

Commencement

## Patterns of Change

5. Identifying patterns of change is necessary for making predictions about future behavior and conditions.

Students:

- use sophisticated mathematical models, such as graphs and equations of various algebraic or trigonometric functions.
- search for multiple trends when analyzing data for patterns, and identify data that do not fit the trends.

*This is evident, for example, when students:*

- ▲ use a sine pattern to model the property of a sound or electromagnetic wave.
- ▲ use graphs or equations to model exponential growth of money or populations.
- ▲ explore historical data to determine whether the growth of a parameter is linear or exponential or both.

## Optimization

6. In order to arrive at the best solution that meets criteria within constraints, it is often necessary to make trade-offs.

Students:

- use optimization techniques, such as linear programming, to determine optimum solutions to problems that can be solved using quantitative methods.
- analyze subjective decision making problems to explain the trade-offs that can be made to arrive at the best solution.

*This is evident, for example, when students:*

- ▲ use linear programming to figure the optimum diet for farm animals.
- ▲ evaluate alternative proposals for providing people with more access to mass transportation systems.

### Sample Problem/Activity

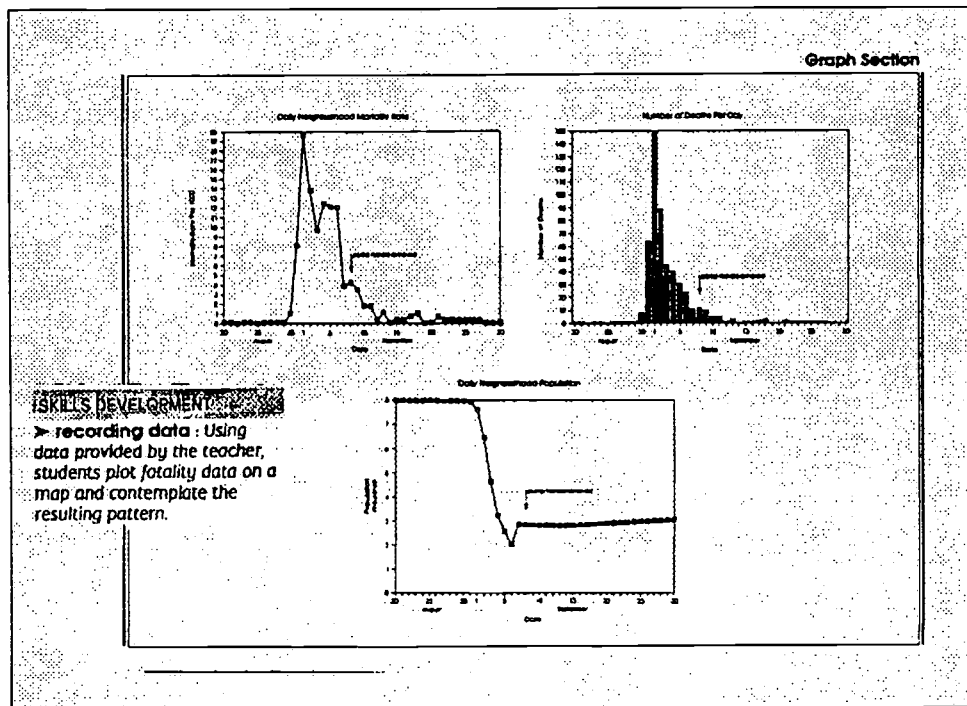

Key ideas are identified by numbers (1).  
Performance indicators are identified by bullets (•).  
Sample tasks are identified by triangles (▲).

Students will understand the relationships and common themes that connect mathematics, science, and technology and apply the themes to these and other areas of learning.

### Sample Problem/Activity

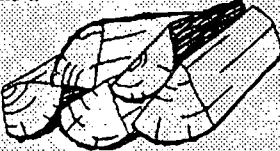
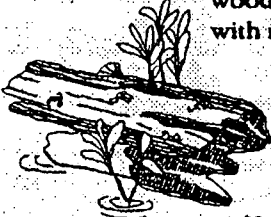

#### Classroom Activity

1. Ask students to describe to one another in small groups what the word "composting" means. See if each group can develop a definition acceptable to all members of the group. Share these definitions with the entire class.
  - Does anyone's family, relatives, or neighbors compost?
  - What are the advantages and disadvantages of composting?
  - What actually goes on within material to cause it to turn to compost? How do you know?
  - Could the items in the bags used in Activity 1.2 become compost? Why or why not?
  - Does composting occur in nature without human intervention? How can we verify this?
2. Help students plan a natural decomposition field investigation such as a comparison of two logs in a local woodland—one decomposing and the other with no visible signs of decomposition. Students should develop a common observation sheet to use in their investigations, as well as a systematic set of procedures to obtain samples from different locations for further study.
3. Take students to a local woodland or wet area. Have them take notes on evidence of active decomposition within the area. They should remove for study small samples of various materials (both decomposing and nondecomposed), using the procedures they developed.

# Standard 7—Interdisciplinary Problem Solving

Elementary

## Connections

1. The knowledge and skills of mathematics, science, and technology are used together to make informed decisions and solve problems, especially those relating to issues of science/technology/society, consumer decision making, design, and inquiry into phenomena.

### Students:

- analyze science/technology/society problems and issues that affect their home, school, or community, and carry out a remedial course of action.
- make informed consumer decisions by applying knowledge about the attributes of particular products and making cost/benefit tradeoffs to arrive at an optimal choice.
- design solutions to problems involving a familiar and real context, investigate related science concepts to inform the solution, and use mathematics to model, quantify, measure, and compute.
- observe phenomena and evaluate them scientifically and mathematically by conducting a fair test of the effect of variables and using mathematical knowledge and technological tools to collect, analyze, and present data and conclusions.

*This is evident, for example, when students:*

- ▲ develop and implement a plan to reduce water or energy consumption in their home.
- ▲ choose paper towels based on tests of absorption quality, strength, and cost per sheet.
- ▲ design a wheeled vehicle, sketch and develop plans, test different wheel and axle designs to reduce friction, chart results, and produce a working model with correct measurements.
- ▲ collect leaves of similar size from different varieties of trees, and compare the ratios of length to width in order to determine whether the ratios are the same for all species.

## Strategies

2. Solving interdisciplinary problems involves a variety of skills and strategies, including effective work habits; gathering and processing information; generating and analyzing ideas; realizing ideas; making connections among the common themes of mathematics, science, and technology; and presenting results.

Students participate in an extended, culminating mathematics, science, and technology project. The project would require students to:

- work effectively
- gather and process information
- generate and analyze ideas
- observe common themes
- realize ideas
- present results

*This is evident, for example, when students, addressing the issue of solid waste at the school in an interdisciplinary science / technology / society project:*

- ▲ use the newspaper index to find out about how solid waste is handled in their community, and interview the custodial staff to collect data about how much solid waste is generated in the school, and they make and use tables and graphs to look for patterns of change. Students work together to reach consensus on the need for recycling and on choosing a material to recycle—in this case, paper.
- ▲ investigate the types of paper that could be recycled, measure the amount (weight, volume) of this type of paper in their school during a one-week period, and calculate the cost. Students investigate the processes involved in changing used paper into a useable product and how and why those changes work as they do.
- ▲ using simple mixers, wire screens, and lint, leaves, rags, etc., students recycle used paper into useable sheets and evaluate the quality of the product. They present their results using charts, graphs, illustrations, and photographs to the principal and custodial staff.

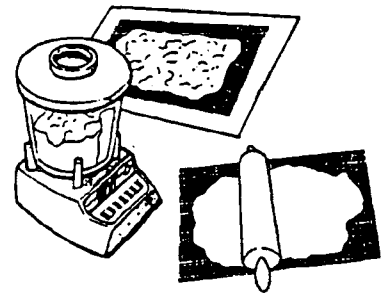

Key ideas are identified by numbers (1).  
Performance indicators are identified by bullets (•).  
Sample tasks are identified by triangles (▲).

Students will apply the knowledge and thinking skills of mathematics, science, and technology to address real-life problems and make informed decisions.

## Skills and Strategies for Interdisciplinary Problem Solving

**Working Effectively:** Contributing to the work of a brainstorming group, laboratory partnership, cooperative learning group, or project team; planning procedures; identify and managing responsibilities of team members; and staying on task, whether working alone or as part of a group.

**Gathering and Processing Information:** Accessing information from printed media, electronic data bases, and community resources and using the information to develop a definition of the problem and to research possible solutions.

**Generating and Analyzing Ideas:** Developing ideas for proposed solutions, investigating ideas, collecting data, and showing relationships and patterns in the data.

**Common Themes:** Observing examples of common unifying themes, applying them to the problem, and using them to better understand the dimensions of the problem.

**Realizing Ideas:** Constructing components or models, arriving at a solution, and evaluating the result.

**Presenting Results:** Using a variety of media to present the solution and to communicate the results.

### Sample Problem/Activity

## How much of Earth's water is readily available for human consumption?

### Student Worksheet

Category	Percentage of Total Water in the World	Freshwater/Salt Water
freshwater lakes	0.0090	freshwater
saltwater lakes	0.0080	salt water
rivers	0.0001	
groundwater	0.6250	
sea ice and glaciers	2.1500	
atmospheric water vapor	0.0010	
oceans	97.2000	

1. As you conduct your library research, complete the chart above by filling in the Freshwater/Salt Water column with either the term "freshwater" or the term "salt water."
2. Represent the information in the first two columns by constructing either a two- or three-dimensional model.

Comments:

# Standard 7—Interdisciplinary Problem Solving

Intermediate

## Connections

1. The knowledge and skills of mathematics, science, and technology are used together to make informed decisions and solve problems, especially those relating to issues of science/technology/society, consumer decision making, design, and inquiry into phenomena.

### Students:

- analyze science/technology/society problems and issues at the local level and plan and carry out a remedial course of action.
- make informed consumer decisions by seeking answers to appropriate questions about products, services, and systems; determining the cost/benefit and risk/benefit tradeoffs; and applying this knowledge to a potential purchase.
- design solutions to real-world problems of general social interest related to home, school, or community using scientific experimentation to inform the solution and applying mathematical concepts and reasoning to assist in developing a solution.
- describe and explain phenomena by designing and conducting investigations involving systematic observations, accurate measurements, and the identification and control of variables; by inquiring into relevant mathematical ideas; and by using mathematical and technological tools and procedures to assist in the investigation.

### *This is evident, for example, when students:*

- ▲ improve a habitat for birds at a park or on school property.
- ▲ choose a telescope for home use based on diameter of the telescope, magnification, quality of optics and equatorial mount, cost, and ease of use.
- ▲ design and construct a working model of an air filtration device that filters out particles above a particular size.
- ▲ simulate population change using a simple model (e.g., different colors of paper clips to represent different species of birds).  
Timed removals of clips from plastic cups represents the action of predators and varying the percentage of the return of clips to cups represent differences in reproductive rates. Students apply mathematical modeling techniques to graph population growth changes and make interpretations related to resource depletion.

## Strategies

2. Solving interdisciplinary problems involves a variety of skills and strategies, including effective work habits; gathering and processing information; generating and analyzing ideas; realizing ideas; making connections among the common themes of mathematics, science, and technology; and presenting results.

Students participate in an extended, culminating mathematics, science, and technology project. The project would require students to:

- work effectively
- gather and process information
- generate and analyze ideas
- observe common themes
- realize ideas
- present results

*This is evident, for example, when students, addressing the issue of auto safety in an interdisciplinary science/technology/society project:*

- ▲ use an electronic data base to obtain information on the causes of auto accidents and use e-mail to collect information from government agencies and auto safety organizations. Students gather, analyze, and chart information on the number and causes of auto accidents in their county and look for trends.
- ▲ design and construct a model vehicle with a restraint system to hold a raw egg as the passenger and evaluate the effectiveness of the restraint system by rolling the vehicle down a ramp and into a barrier; the vehicle is designed with crush zones to absorb the impact. Students analyze forces and compute acceleration using  $F=ma$  calculations. They present their results, including a videotaped segment, to a driver education class.

Key ideas are identified by numbers (1).  
Performance indicators are identified by bullets (•).  
Sample tasks are identified by triangles (▲).

Students will apply the knowledge and thinking skills of mathematics, science, and technology to address real-life problems and make informed decisions.

## Skills and Strategies for Interdisciplinary Problem Solving

**Working Effectively:** Contributing to the work of a brainstorming group, laboratory partnership, cooperative learning group, or project team; planning procedures; identify and managing responsibilities of team members; and staying on task, whether working alone or as part of a group.

**Gathering and Processing Information:** Accessing information from printed media, electronic data bases, and community resources and using the information to develop a definition of the problem and to research possible solutions.

**Generating and Analyzing Ideas:** Developing ideas for proposed solutions, investigating ideas, collecting data, and showing relationships and patterns in the data.

**Common Themes:** Observing examples of common unifying themes, applying them to the problem, and using them to better understand the dimensions of the problem.

**Realizing Ideas:** Constructing components or models, arriving at a solution, and evaluating the result.

**Presenting Results:** Using a variety of media to present the solution and to communicate the results.

### Sample Problem/Activity

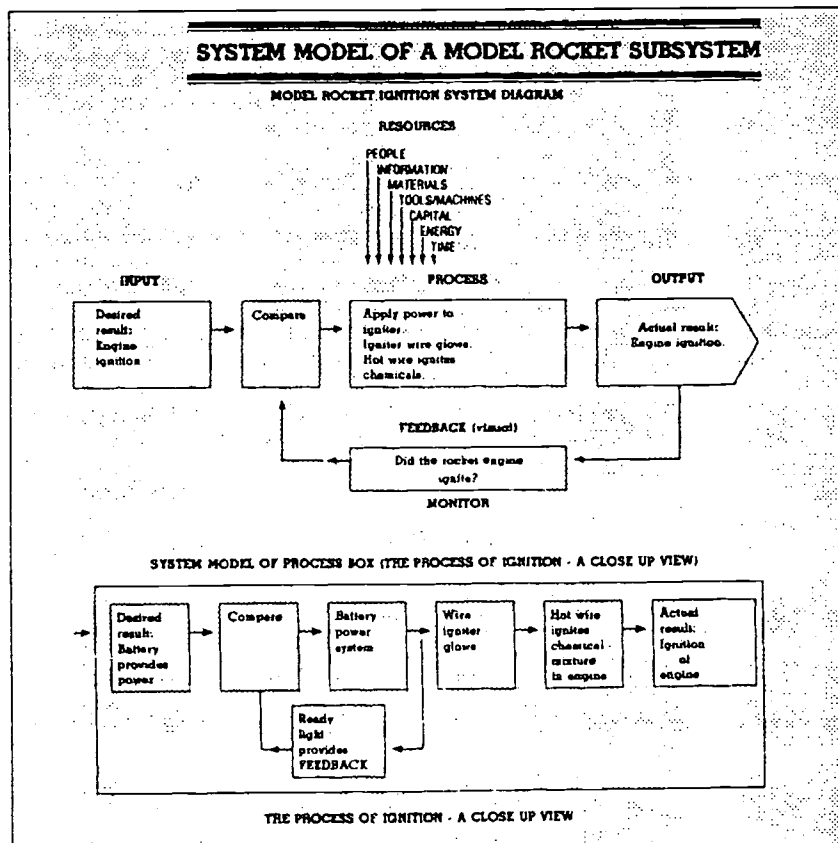

# Standard 7—Interdisciplinary Problem Solving

Commencement

## Connections

1. The knowledge and skills of mathematics, science, and technology are used together to make informed decisions and solve problems, especially those relating to issues of science/technology/society, consumer decision making, design, and inquiry into phenomena.

### Students:

- analyze science/technology/society problems and issues on a community, national, or global scale and plan and carry out a remedial course of action.
- analyze and quantify consumer product data, understand environmental and economic impacts, develop a method for judging the value and efficacy of competing products, and discuss cost/benefit and risk/benefit tradeoffs made in arriving at the optimal choice.
- design solutions to real-world problems on a community, national, or global scale using a technological design process that integrates scientific investigation and rigorous mathematical analysis of the problem and of the solution.
- explain and evaluate phenomena mathematically and scientifically by formulating a testable hypothesis, demonstrating the logical connections between the scientific concepts guiding the hypothesis and the design of an experiment, applying and inquiring into the mathematical ideas relating to investigation of phenomena, and using (and if needed, designing) technological tools and procedures to assist in the investigation and in the communication of results.

### *This is evident, for example, when students:*

- ▲ analyze the issues related to local energy needs and develop a viable energy generation plan for the community.
- ▲ choose whether it is better to purchase a conventional or high definition television after analyzing the differences from quantitative and qualitative points of view, considering such particulars as the number of scanning lines, bandwidth requirements and impact on the frequency spectrum, costs, and existence of international standards.
- ▲ design and produce a prototypical device using an electronic voltage divider that can be used to power a portable cassette tape or CD player in a car by reducing the standard automotive accessory power source of approximately 14.8 volts to a lower voltage.
- ▲ investigate two similar fossils to determine if they represent a developmental change over time.

## Strategies

2. Solving interdisciplinary problems involves a variety of skills and strategies, including effective work habits; gathering and processing information; generating and analyzing ideas; realizing ideas; making connections among the common themes of mathematics, science, and technology; and presenting results.

Students participate in an extended, culminating mathematics, science, and technology project. The project would require students to:

- work effectively
- gather and process information
- generate and analyze ideas
- observe common themes
- realize ideas
- present results

*This is evident, for example, when students, addressing the issue of emergency preparedness in an interdisciplinary science/technology/society project:*

- ▲ are given a scenario—survivors from a disaster are stranded on a mountaintop in the high peaks of the Adirondacks—they are challenged to design a portable shelter that could be heated by the body heat of five survivors to a life sustaining temperature, given an outside temperature of 20°F. Since the shelter would be dropped to survivors by an aircraft, it must be capable of withstanding the impact. Students determine the kinds of data to be collected, for example, snowfall during certain months, average wind velocity, R value of insulating materials, etc. To conduct their research, students gather and analyze information from research data bases, national libraries, and electronic communication networks, including the Internet.
- ▲ design and construct scale models or full-sized shelters based on engineering design criteria including wind load, snow load, and insulating properties of materials. Heat flow calculations are done to determine how body heat could be used to heat the shelter. Students evaluate the trade-offs that they make to arrive at the best solution; for example, in order to keep the temperature at 20 degrees F., the shelter may have to be small, and survivors would be very uncomfortable. Another component of the project is assembly instructions—designed so that speakers of any language could quickly install the structure on site.
- ▲ prepare a multimedia presentation about their project and present it to the school's ski club.

Key ideas are identified by numbers (1).

Performance indicators are identified by bullets (•).

Sample tasks are identified by triangles (▲).

BEST COPY AVAILABLE



Students will apply the knowledge and thinking skills of mathematics, science, and technology to address real-life problems and make informed decisions.

## Skills and Strategies for Interdisciplinary Problem Solving

**Working Effectively:** Contributing to the work of a brainstorming group, laboratory partnership, cooperative learning group, or project team; planning procedures; identify and managing responsibilities of team members; and staying on task, whether working alone or as part of a group.

**Gathering and Processing Information:** Accessing information from printed media, electronic data bases, and community resources and using the information to develop a definition of the problem and to research possible solutions.

**Generating and Analyzing Ideas:** Developing ideas for proposed solutions, investigating ideas, collecting data, and showing relationships and patterns in the data.

**Common Themes:** Observing examples of common unifying themes, applying them to the problem, and using them to better understand the dimensions of the problem.

**Realizing Ideas:** Constructing components or models, arriving at a solution, and evaluating the result.

**Presenting Results:** Using a variety of media to present the solution and to communicate the results.

### Sample Problem/Activity

## Where Does Electricity Come From?

Students will be able to explain how electricity is generated and how the rate at which electricity is generated is related to the appliance being operated.

### Interdisciplinary Connections

These activities focus on the ways in which electricity is generated:

► **Technology:** Technology is used not only to generate electricity but also to transmit it to where it is used. Find out what technologies are important in the transmission of electricity; of particular interest is the importance of electric transformers and electric insulation.

► **Social Studies:** Learn about the early history of the generation of electricity in the United States. In particular, you will want to learn about the role of Thomas Alva Edison, whose Pearl Street Station generated the first commercial electricity, and also about the roles of George Westinghouse and Nikola Tesla.

► **Language Arts:** When electricity was discovered, new words were developed to describe it. Make a list of all the words you can find that were developed specifically to describe electricity, and indicate which were "borrowed" and which were coined at that time.

► **Mathematics:** The electricity generated at power plants today is known as "alternating current," because it flows alternately in one direction and then in another (or is alternately positive and negative). A graph of alternating current in relation to time is known as a "sine curve." Find out more about the sine curve and its many other uses in mathematics, science, and technology.

► **Health:** Because life-sustaining equipment in hospitals is so reliant on the generation of electricity, hospitals have their own backup source of electric power to be used in case commercial gen-

eration of electricity is interrupted. Inquire about your local hospital's emergency generating system, including the amount of power it can generate and its duration.

► **Home and Career Skills:** Trace the transmission of power to your household from the power plant that generates it, or from a nearby major transmission substation. (In the event of a power failure, you will know that something went wrong along the line you have traced.)

► **Arts:** The alternating current generated in the United States has a frequency of 60 Hertz (Hz). This means that the direction of the current reverses from positive to negative and back to positive 60 times every second. Find out which aspects of the performing arts are dependent upon this frequency.

► **Foreign Languages and Cultures:** Choose another nation in the world. Find out how the voltage and frequency of alternating current generated in that nation differs from that in the United States.

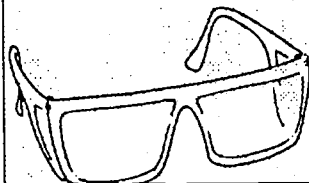

# Samples of Student Work

The samples of student work included in this section are intended to begin the process of articulating the performance standards at each level of achievement. This collection is not yet adequate for that purpose in either numbers or scope of examples. As New York State continues to collect work samples from the schools for inclusion in the document, we expect a much clearer understanding of the performance standards to be evident.

Neither are these samples presented as models of excellence. They vary in degree of achievement. Some are "acceptable;" others "more proficient." All are meant to provide examples of the kind of work students might produce to demonstrate progress toward the standard.

# Standard 1—Analysis, Inquiry, and Design

Elementary

Mathematical  
Analysis

Student  
Work  
Sample

## Context

Math 4/5 Pilot test Spring 1995

## Performance Indicators

Students can:

... explore and solve problems generated from school, home, and community situations using concrete objects or manipulative materials when possible.

## Task

I have 6 coins worth 42 cents. What coins could I possibly have? Draw a picture of the 6 coins which total 42 cents.

## Commentary

The Sample:

- The symbolic equation clearly illustrates the thinking of the student as he/she arrives at a solution using an addition method.
- Using a subtraction method the student arrives at a second solution.
- Student shows two different solutions to the 42 cent sum, but only the 2nd way meets both conditions of the problem.

A) Show 2 ways to solve this problem.

1st Way  $2p + 1n = 7d + 1d = 1.7d + 1q = 42c$

2nd Way

$$\begin{array}{r} 42 \\ - 2 \\ \hline 40 \end{array}$$

$$\begin{array}{r} 30 \\ 40 \\ - 25 \\ \hline 15 \end{array}$$

$$\begin{array}{r} 15 \\ 10 \\ \hline 5 \end{array}$$

$$\begin{array}{r} 5 \\ 5 \\ \hline 0 \end{array}$$

$$\begin{array}{r} 17 \\ + 25 \\ \hline 42 \end{array}$$

B) List the coins you have chosen:

1st Way 1q, 1d, 1n, 2p

2nd Way 1q, 3n, 2p

# Standard 1—Analysis, Inquiry, and Design

Commencement

Mathematical Analysis

Student Work Sample

## Context

Course I Regents Examination,  
June 1995.

## Performance Indicators

Students can:

... apply algebraic and geometric concepts and skills to the solution of problems.

## Task

A landscaper has two gardens: one is a square and the other is a rectangle. The width of the rectangular garden is 5 yards less than a side of the square one, and the length of the rectangular garden is 5 yards less than a side of the square one, and the length of the rectangular garden is 3 yards more than a side of the square garden. If the sum of the areas of both gardens is 165 square yards, find the measure of a side of the square garden. Show or explain the procedure used to obtain your answer.

## Commentary

The Sample:

- Student accurately illustrates, labels, and represents information and relationships in the problem.
- Student prepares and labels chart to test trial and error hypotheses.
- Student makes, evaluates, and adjusts conjectures against conditions of the problem.
- Student recognizes and accepts proper solution.

Student Response

side of  $\square$  garden = 10

TRIAL	$x-5$	$x+3$	$(x-5)(x+3)$	$x^2$	$(x-5)(x+3)+x^2$	$= 165$
$x=6$	1	9	9	36	45	no
$x=12$	7	15	105	144	249	no
$x=11$	6	14	84	121	205	no
$x=10$	5	13	65	100	165	yes

TRIAL & ERROR

# Standard 1—Analysis, Inquiry, and Design

Elementary

Scientific  
Inquiry

Student  
Work  
Sample

## Context

In this fourth-grade activity students were designing a slide to be used in a proposed playground for kindergarten children. Student designers were to take into account safety features, cost factors, design of the playground, and fun for the children who would ultimately use the slide.

## Performance Indicators

Students can:

- ... develop written plans for exploring a phenomena. . . .
- ... carry out their plans through direct observation and through . . . measurements of quantities.
- ... organize observations and measurements . . . .
- ... interpret observations and measurements, recognizing simple . . . relationships.

## Commentary

The Sample:

- Shows that students raised a relevant question (Which material will make the sliding faster?).
- Shows that students designed and performed a simple experiment (compared the sliding time on a plastic and metal model).
- Shows that students collected data (time in seconds).
- Shows that students arrived at an appropriate conclusion (to be fast, the slide should be covered with metal).
- Shows advanced progress toward understanding the use of scientific inquiry, though the work can be improved by repeating the experiment and averaging measurements, calculating speed, and presenting results in a chart form.

## Scoring Guide

### Scientific inquiry

- Student explored task-related science concepts and principles through appropriate experimentation.
- Student collected and analyzed data, and presented clear and accurate results.

Day 4

Today we make our slide. our teacher gave us wood that was 3 ft long. I told my group that have to have safety, they thought of it too. Then we made our slide with plastic on the platform. We timed how fast our man slides down the slide, it was about 5 to 6 seconds. Pedro said "I think metal goes faster than plastic." We said "why don't we try that." We took out the plastic and put aluminum foil on the top of our slide. We timed the slide and it was much faster it slid down in 2 seconds. We thought it should be made out of metal. We designed everything for the last time.

# Standard 1—Analysis, Inquiry, and Design

Intermediate

## Scientific Inquiry

## Student Work Sample

### Context

An eighth grade student saw that there were a number of leaky water faucets in his school. Worried about pollution and wasting natural resources, he measured the water loss over a two-minute period, did the calculations, and found that over the year, 453,600 gallons of water would be wasted. He decided to do a study of 10 faucets in 7 neighborhood schools to determine the magnitude of the waste.

### Performance Indicators

*Students can:*

- ... use conventional techniques and those of their own design to make further observations guided by a need for more information.
- ... Carry out their research proposals, recording observations and measurements.
- ... design charts, tables, graphs, and other representations of observations in conventional and creative ways to help them address their research questions or hypothesis.
- ... modify their personal understanding of the phenomena based on evaluation of their hypothesis.

My hypothesis was inconclusive. Only four out of the seven schools that I tested leaked over two hundred milliliters per minute. If I were to repeat this project I would test more schools and more faucets in each school.

I also observed that screw top faucets leaked much more than the push button. In the future I would test whether there really is a difference between the screw top and push button faucets. This project is a very important project, because by knowing this we can find a way to fix the faucets and be able too conserve water.

### Commentary

The Sample:

- Indicates collection and manipulation of quantitative data.
- Shows a graphic display of results.
- Elaborates on other variables which may become important during further study.
- Indicates the ability to apply information generated by the study.

The graph indicates that school A leaks 219.4 ml. per minute more than the nearest school, school B. School A leaked 631.7 ml. per minute, and school B leaked 412.3 ml. per minute. School C leaked 229.4 ml per minute. School D leaked 221.9 ml per minute. School E leaked 105 ml per minute. School F leaked 53 ml per minute. School G didn't leak at all. School A-D and School G are private parochial schools. Schools E and F are public schools. Schools G and F were both high schools, and the rest of the school were elementary schools.

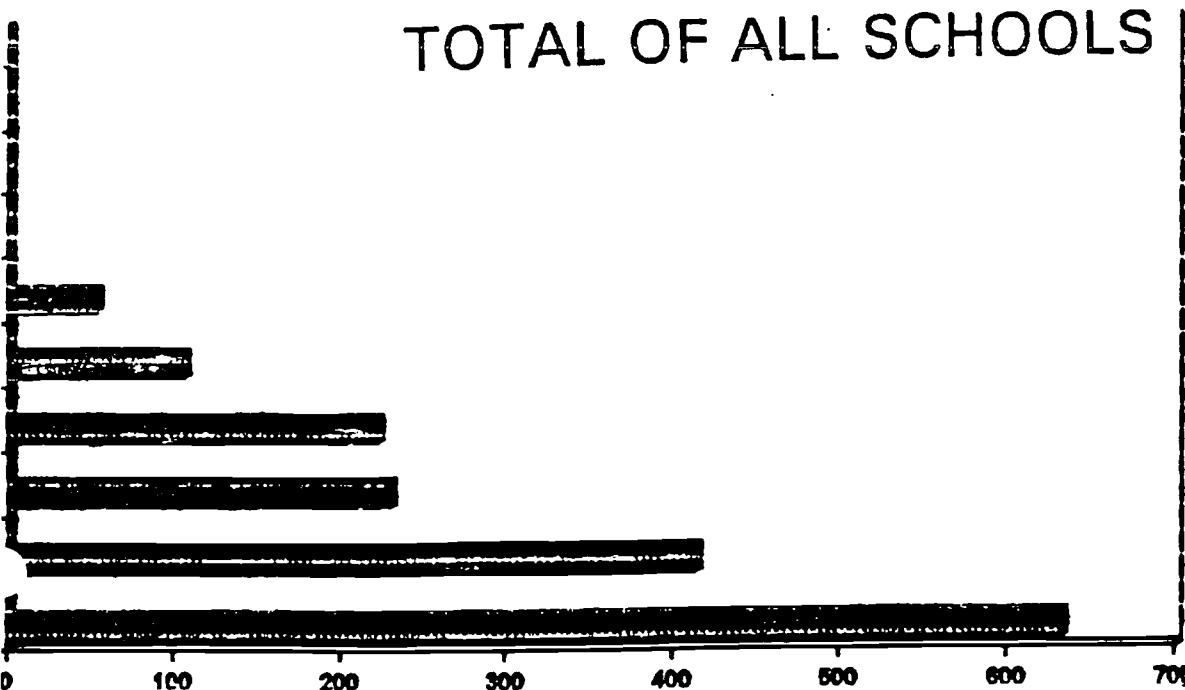
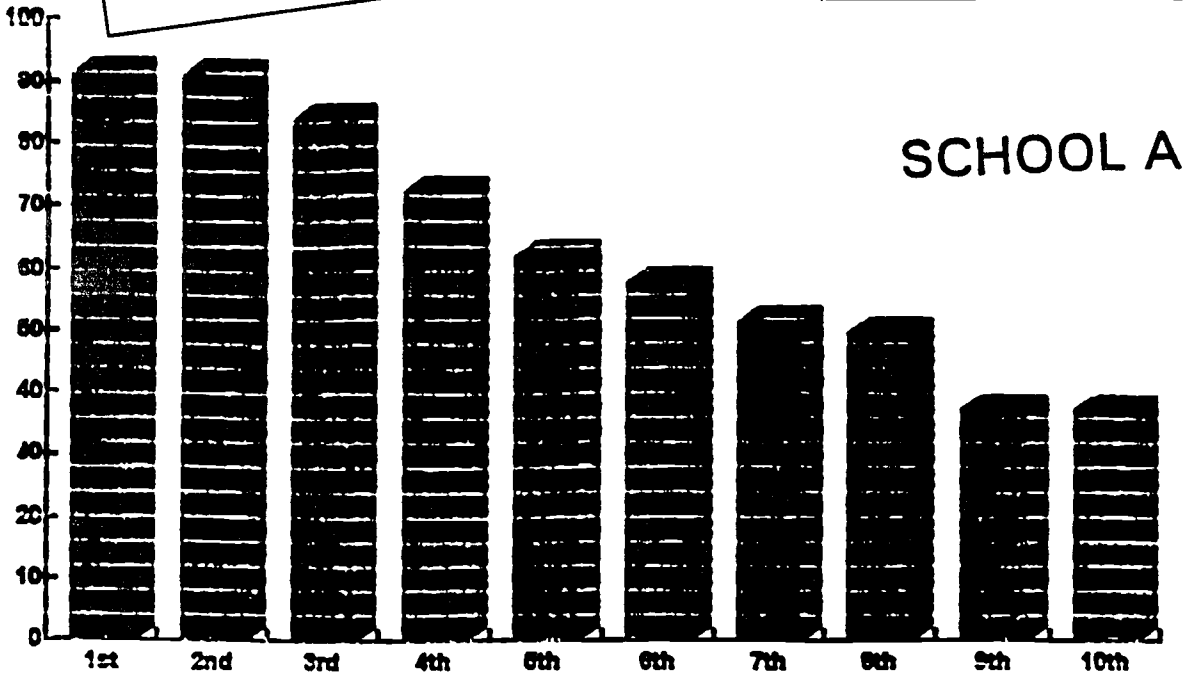



# Standard 1—Analysis, Inquiry, and Design

Commencement

Technological Design

Student Work Sample

## Context

This example reflects an auto safety problem posed to a 12th grade technology education Principles of Engineering class. The engineering design challenge was to design a passenger protection system for a vehicle that would carry two eggs, roll down a ramp, and crash into a barrier. An indicator was to be incorporated into the design to determine the amount of impact distance so that the crash zone could be measured accurately.

## Performance Indicators and Commentary

*Students initiate and carry out a thorough investigation of an unfamiliar situation and identify needs and opportunities for technological invention or innovation.*

- Students investigated forces on real cars. They found initial and final velocities, deceleration, and g-forces acting on their model car after it hits the abutment.

*Students identify, locate, and use a wide range of information resources including subject experts, library references, magazines, videotapes, films, electronic databases and on-line services, and discuss and document through notes and sketches how findings relate to the problem.*

- Students did a great deal of mathematical modeling to obtain data which influenced their design.

*Students generate a number of creative solution ideas, explore possible refinements of significant functional elements, and use mathematical and functional modeling techniques to predict possible outcomes; choose the optimal solution to the problem, assessing ideas against design criteria and constraints; explain how economics, ergonomics, and environmental considerations have influenced the solution.*

- Many variations were attempted. Students sketched subsystems of the vehicle and analyzed the pros and cons of individual functional elements. They used a computer aided design package to draw components of their model. A great deal of sophisticated mathematical modeling was incorporated to both predict how the design would work, and to analyze its operation.

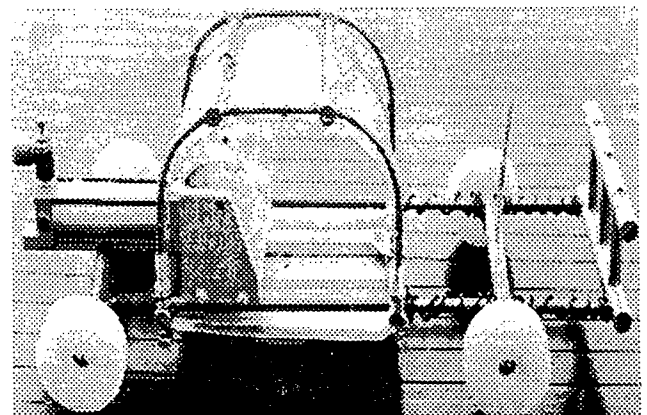
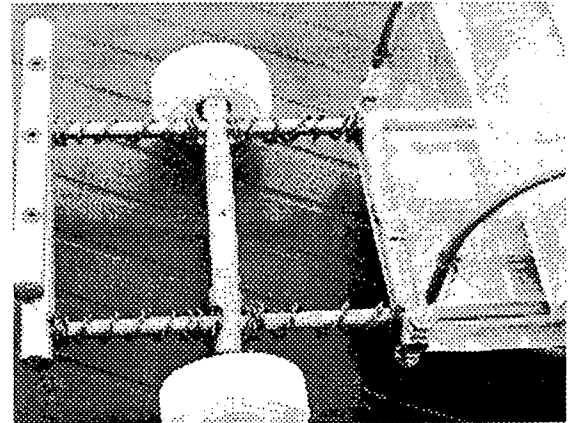

Concern: The egg is exposed to damage in the event of a roll-over or a flip.

Solution: implement a roll bar that is higher than the egg, and will support the weight of the car.

Sketch:

This line represents the floor

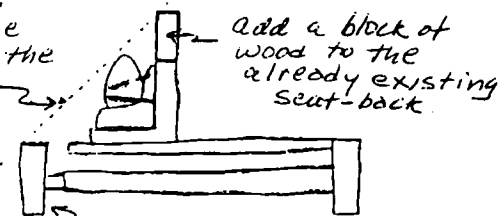

Students develop work schedules and working plans which include optimal use and cost of materials, processes, time, and expertise; accurately construct a model of the solution, incorporating developmental modifications while working to a high degree of quality craftsmanship).

- A beautifully crafted working model of the vehicle was built. Testing along the way provided data which influenced design changes.

Students devise a test of the solution relative to the design criteria, and perform the test; record, portray, and evaluate performance test results through quantitative, graphic, and verbal means; use verbal and graphic techniques to effectively and persuasively present conclusions, predict impacts and new problems, and suggest and pursue modifications.

- Testing procedures were well documented and communicated graphically and orally. The degree to which the tests were successful were quantified and recorded.

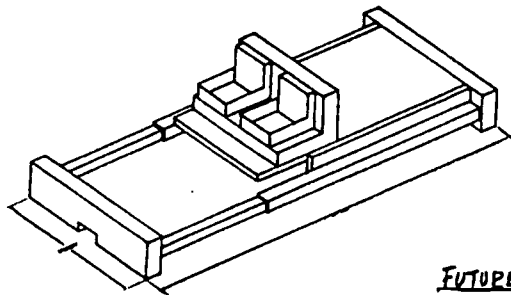
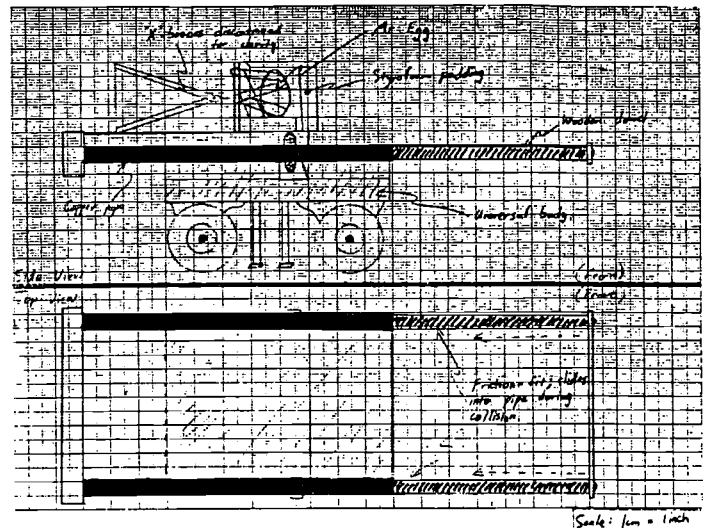

1989 GMC Pickup

Dimensions: length: 242" (20' 2")  
width: 72" (6')

Weight: 5,500 lbs

$$p = \frac{m}{V}$$

$$V_c = 128 \times 32 \times 72 = 294,912 \text{ in}^3$$

$$V_m = 18 \times 72 = 252 \text{ in}^3$$

$$\frac{V_m}{V_c} [M_c] = M_m$$

$$\frac{252}{294,912} [5500] = 4.7 \text{ lbs}$$

= minimum value for realistic mass.

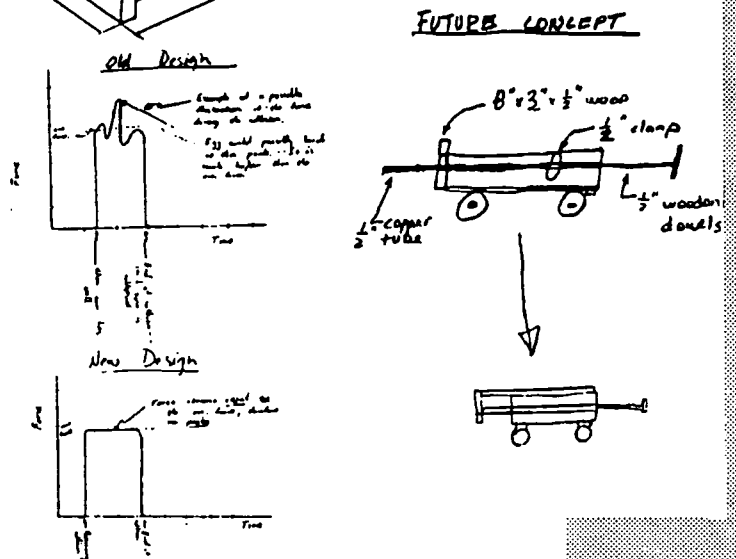

Concern: The current design of the friction-fit dowels inside the copper pipe will not provide a smooth deceleration, causing the instantaneous force at any given time to fluctuate above and below the average force. To solve this problem, we changed how the car is slowed by friction.

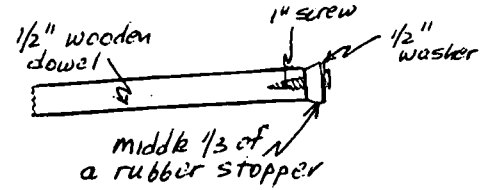

# Standard 1—Analysis, Inquiry, and Design

## Context

Commencement  
Technological  
Design

11th grade technology education students were asked to design an emergency shelter that could be air dropped to survivors of an airplane crash in a cold, snow covered environment. The shelter must be carried by one person, withstand a parachute drop, and be heated by the body heat of four survivors to 50° F when the outside temperature is 20° F. The shelter would be accompanied by pictorial assembly instructions as the survivors might not be English-speaking.

Student  
Work  
Sample

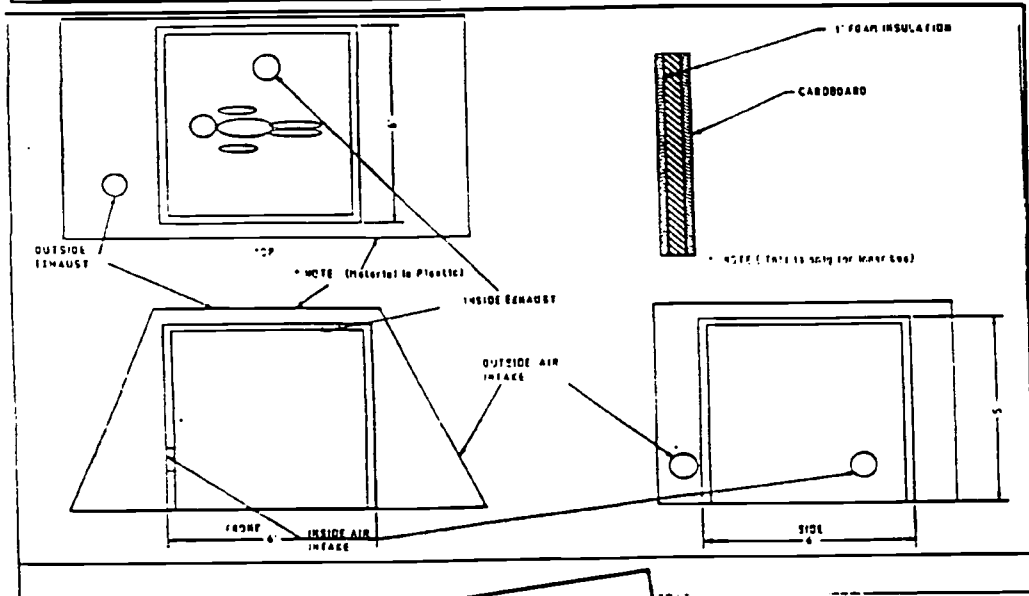

The first thing we had to take into account was the location of the plane crash that we were designing the shelter for. The surveillance plane had reported that four people were injured and exposed to the harsh conditions of the Cabinet Mountains. Since the Cabinet Mountains are known for their harsh, cold, and extremely dangerous weather conditions, our plans had to provide an environment warm enough to protect the four inhabitants from acquiring hypothermia, a dangerous condition occurring when the normal homeostasis of the human body is upset, and the body temperature drops, which slows down the body's functions. This, if left untreated, causes eminent death, or at least, even if treated, causes after just a few hours of it's first signs, causes shock or amputation if the blood's circulation is upset.

Throughout different procedures, we experimented with various designs. Some of the designs we used included basic squares, rectangles, and pyramids. We took into account different shapes for runoff for snow and ice, as well as rain, and any other forms of precipitation. Because the structure has to be made with energy efficient materials also, we fused them into the shelter's plans. We experimented with some of the more complicated plans we had, and also with some of the more fundamental ones, because sometimes the most efficient, safest designs, are the simplest ones. Also, plans for food storage and suitable bedding were added.

## TEST RESULTS

Time (am.)	Outside Temp(F)	Inside Temp(F)
9:25	34.00	42.00
9:35	34.00	54.00
9:45	35.00	59.00
10:05	35.00	64.00
10:20	38.00	69.00
10:45	38.00	69.00
10:55	35.00	68.00
11:07	34.00	68.00
11:13	34.00	72.00
11:15(end)	34.00	70.00

## Performance Indicators and Commentary

Students initiate and carry out a thorough investigation of an unfamiliar situation and identify needs and opportunities for technological invention or innovation.

• Students investigated the situation and clarified the problem. A stronger response would have been a more detailed analysis of weather conditions, including quantitative data relative to average wind speed and snow fall.

Students generate a number of creative solution ideas, explore possible refinements of significant functional elements, and use mathematical and functional modeling techniques to predict possible outcomes; choose the optimal solution to the problem, assessing ideas against design criteria and constraints; explain how economics, ergonomics, and

## Heat Loss Calculations

The heat made by four inactive people is 600 BTU's.  
Considering the cold/hot air exchange, we had to figure for  
a heat loss of 1250 or 1300 BTU's by the materials themselves.

### R-Values Used

1" foam with aluminum facing = 7.2  
2 layers cardboard = .368

### Equations Used

$$\text{Heat Loss} = \text{Surface Area} \times u \times \Delta t$$

$$u = \frac{1}{R}$$

$$SA = (4 \times \text{Area of each side}) + (2 \times \text{Area of ceiling or floor - same size})$$

$$SA = 4(5 \times 6) + 2(6 \times 6)$$

$$SA = 120 + 72$$

$$SA = 192 \text{ ft}^2$$

$$u = \frac{1}{R}$$

$$u = 7.568$$

$$u = .132$$

$\Delta t$  is given as 60°

$$HL = (192)(.132)(60)$$

$$HL = 1520 \text{ BTU's}$$

You might look upon that number and think, these people are going to freeze! We figured that along with the plastic, thick, pool cover covering this enclosure, that will hold a lot of heat in, as plastic is known to do. We were going to go with 1 1/2" of foam insulation, but because of a combination of expense and increased difficulty with construction, plus the fact that we figured the tarp will keep us warm enough, we decided against getting extra 1/2" sheets of insulation. The tarp will protect against wind, rain, and also keep the heat in very well. Also, since we made our air exchange so that it will not be entirely cold air into the box, that would allow us a little more leeway.

environmental considerations have influenced the solution.

- Various geometric shapes were considered and evaluated against design criteria. Students considered energy efficiency, ergonomics, and cost/benefit tradeoffs. No evidence was shown that relative ranking of alternatives occurred. Heat loss calculations show evidence of mathematical modeling and understanding of heat transfer principles. However, when the analysis showed that heat loss exceeded heat gain, students simply assumed that certain revised design elements (e.g., plastic covering) would suffice, and never modeled or tested the revision.

Students develop work schedules and working plans which include optimal use and cost of materials, processes, time, and expertise; accurately construct a model of the solution, incorporating developmental modifications while working to a high degree of quality (craftsmanship).

- The drawings lack detail but annotations show that students considered material usage and construction details such as how air exchange occurs. Assembly directions indicate understanding of spatial relationships and technical assembly methods and the ability to communicate a complex process in a concise format. Pictograms were not included, thus the assembly

instructions did not completely satisfy the design criteria.

Students in a group setting, devise a test of the solution relative to the design criteria, and perform the test; record, portray, and evaluate performance test results through quantitative, graphic, and verbal means; use verbal and graphic techniques to effectively and persuasively present conclusions, predict impacts and new problems, and suggest and pursue modifications.

- Data collected during testing of the structure compares outside to inside temperature. The data indicates that the structure was effective in providing a warmer interior; however the students did not address the fact that the outside temperature during the testing (32° F), was higher than the specified design temperature (20° F). The display of results could have been enhanced by graphs, and by a discussion of what source heated the structure under test.

# Standard 3—Mathematics

## Intermediate Task

### Mathematics

### Student Work Sample

You have been asked to design a phone chain that will contact your classmates in case of emergency. (Assume a class of 30.)

You will be expected to:

- determine how long it would take to call everyone on the chain if you used a two, three, four, or five-person chain. (Explain the method you used in the summary.)
- consider advantages and/or disadvantages of using a certain numbered chain. (Explain your reasoning in the summary.)
- present your solution in an organized way that will convince classmates that your plan is the best choice.

Record your work as you attempt to solve the problem. Record any thoughts or questions you have as you proceed. Write a summary of your solution.

### Student Response

In order to determine the time it would take to complete a two, three, four, or five person chain, I drew up a chart for each chain. In each chain I picked 4:00 a.m. to start the calls. I estimated that each call took one minute to complete. I assigned each person a number and wrote down when they had been contacted. According to my work a two person chain that is started at 4:00 a.m. will be completed at 4:07. My work also shows that a three person chain started at 4:00 a.m. will end also at 4:07. A four person chain started at 4:00 a.m. will end at 4:08 and a five person chain started at 4:00 a.m. will end at 4:09. Overall, the two person chain is the best because each person has to call fewer people which saves, each person calling, money. It also is the fastest time you can get out of all the chains.

Start 4:00 a.m. Call: = 1 minute: \* c = classmate

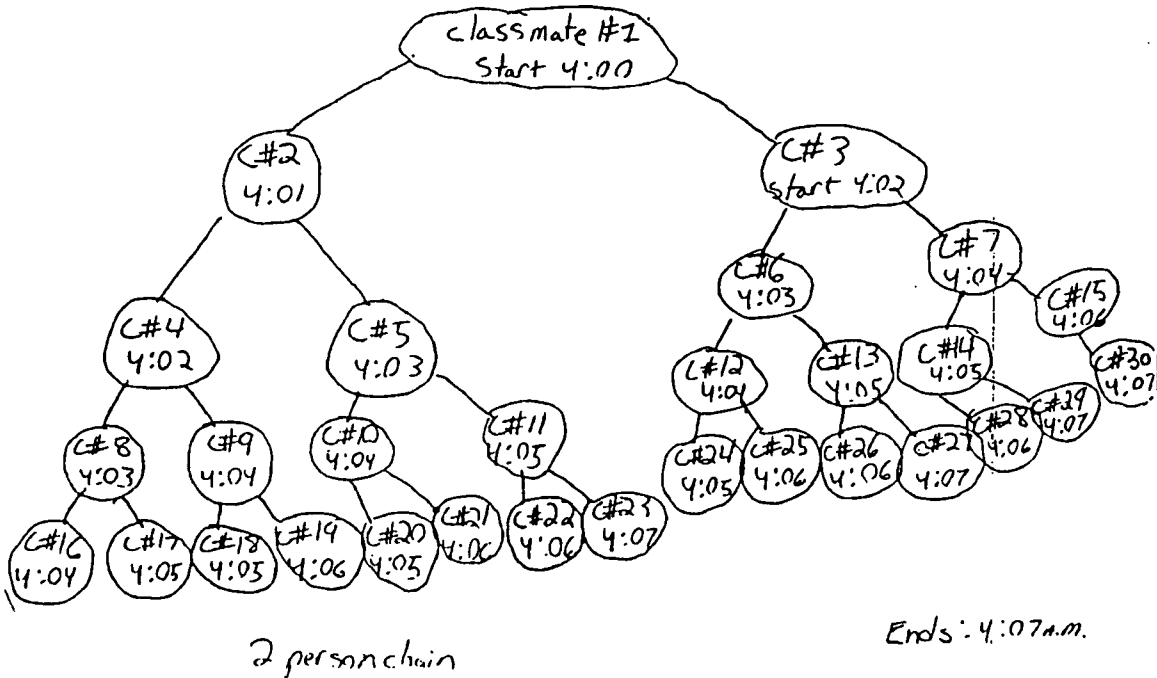

## Performance Indicators

### OPERATIONS

- Make and evaluate conjectures and arguments using appropriate language
- explore and produce graphic representations of data . . . .

### MODELING

- use concrete materials and diagrams to describe the operation of real-world processes and systems.

### MEASUREMENT

- estimate, make, and use measurements in real-world situations.
- select appropriate measurement units to measure to a desired accuracy.

### UNCERTAINTY

- use estimation to solve problems for which exact answers are inappropriate.

## Commentary

The Sample:

- Uses a tree diagram to illustrate the phone chain.
- Shows times are well sequenced.
- Explains the procedure for the completing the phone chain.
- Clearly expressed the conclusion regarding the relationship between the number of persons and time needed.

# Standard 3—Mathematics

Intermediate  
Mathematics

Student  
Work  
Sample

## Task

### Percents

Create an illustration to represent a real-life situation involving the mathematics you've studied in this unit. Use your imagination!!

## Performance Indicators

Students can:

... understand and apply ratios, proportions, and percents through a wide variety of hands-on explorations.

## Commentary

The Sample:

- Illustrates a real-life application of the use of percent.
- Correctly computes and rounds sales tax.
- Estimates total cost to nearest dollar.
- Shows dialogue that is realistic and imaginative.

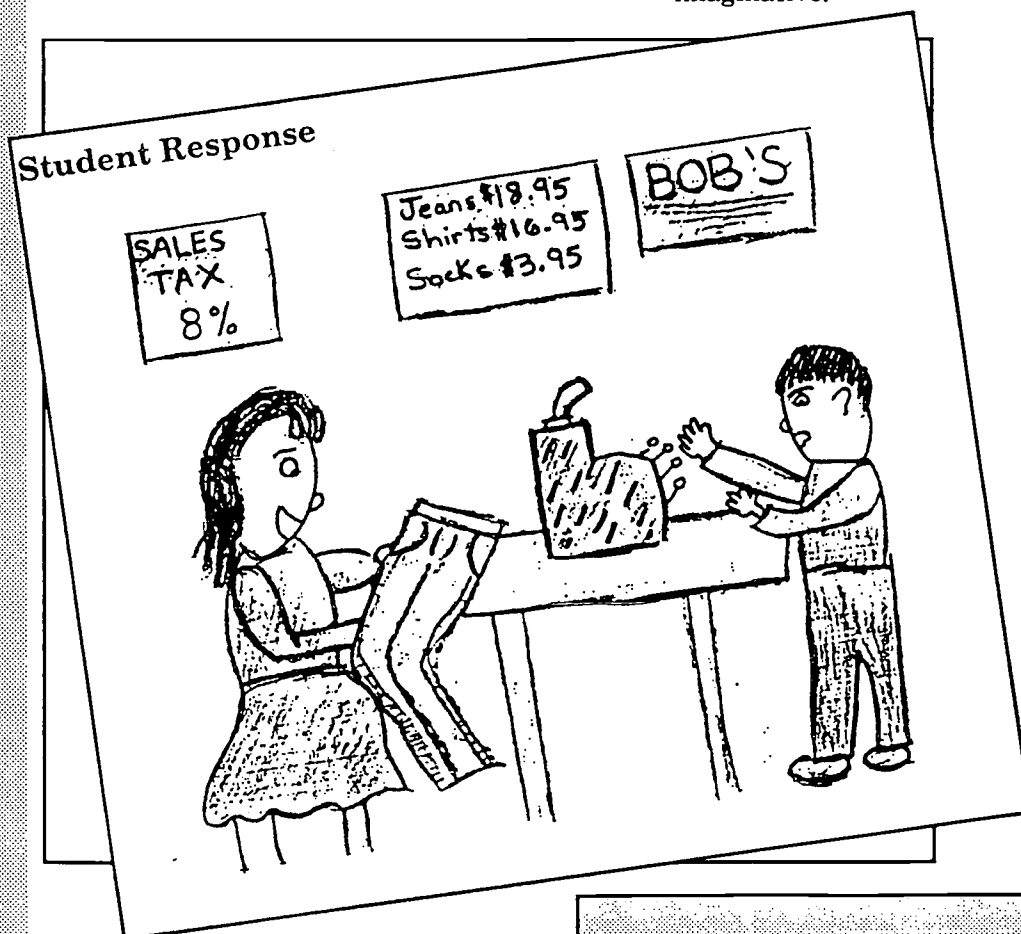

Write a caption describing your illustration:  
Girl: The jeans are \$18.95, so  $\$18.95 \times 8\%$  tax equals \$1.52.  
Man at counter: Tax is \$1.52.  
Girl:  $\$18.95 + \$1.52$  equals about \$20.  
Man: That will be \$20.47 total.  
Girl: I was pretty close! Thank you.

BEST COPY AVAILABLE

# Standard 3—Mathematics

Commencement

Mathematics

Student Work Sample

## Task

**Directions for Creating a Concept Map for Parabolas**  
 Working in pairs or individually you are to design a complete and clear mind map of everything we discussed and shared about parabolas. You will be given one 80-minute class period to research and create a draft of your concept map.

Along with the map, you are to create equations of a minimum of two examples of parabolas that display as much of the information in your map as possible. Clear and detailed graphs as well as explanations of your work must be included.

All concept maps and examples will be displayed in the classroom. As you know, I am expecting your best work. **BE CREATIVE AND HAVE FUN!**

Your grade will be based on the following rubric and equivalent to one test grade.

## Performance Indicators

Students can:  
 . . . develop meaning for basic conic sections.

## Commentary

The Sample:

- The concept map illustrates many properties of the parabola, including the effect of "a," "c," and the axis of symmetry.
- Student shows understanding of a concept map.
- There are several arithmetic errors in the table of values, one of which affects the subsequent graph.
- The concept map contains some misconceptions regarding the effect of the coefficient "b."

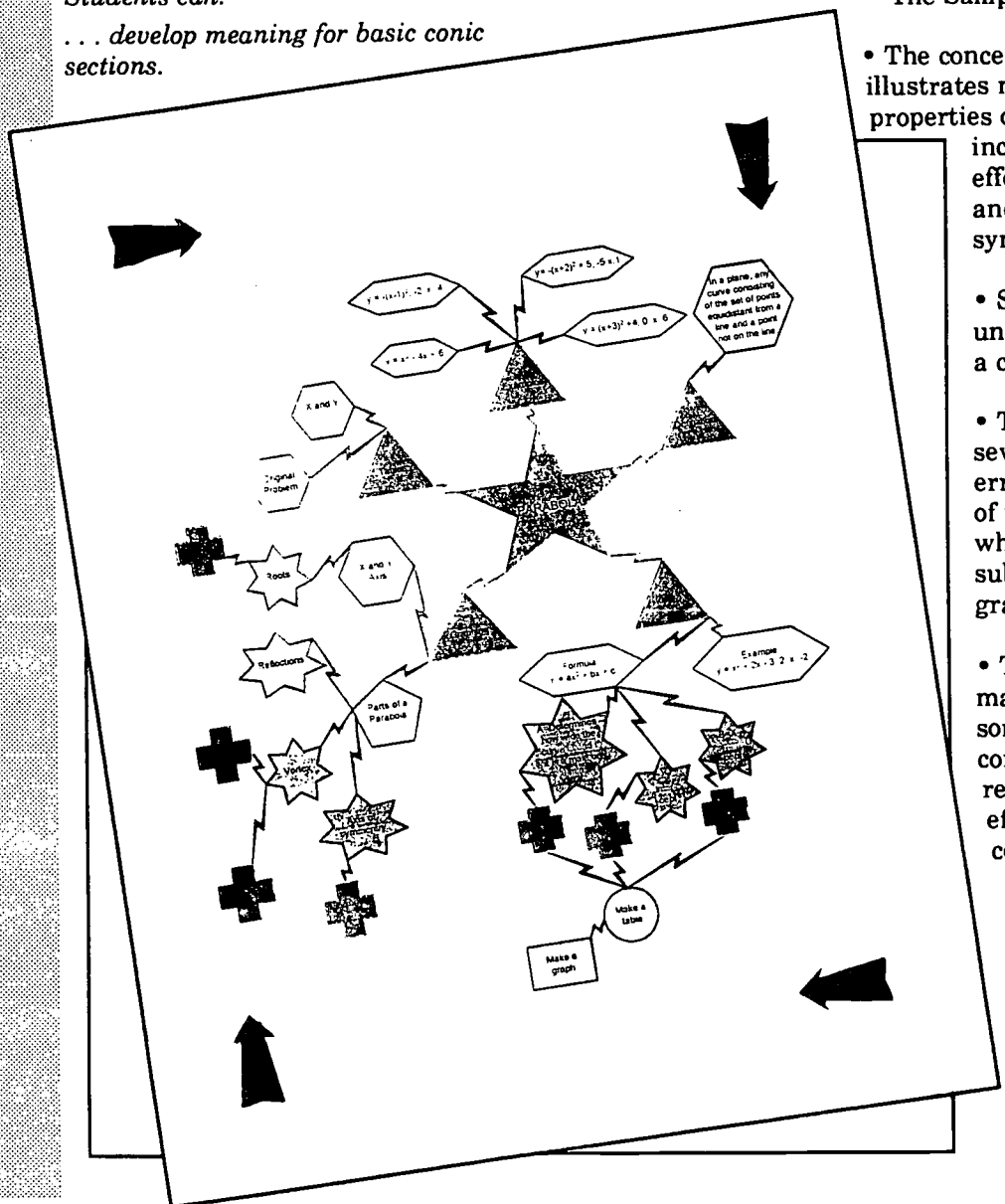



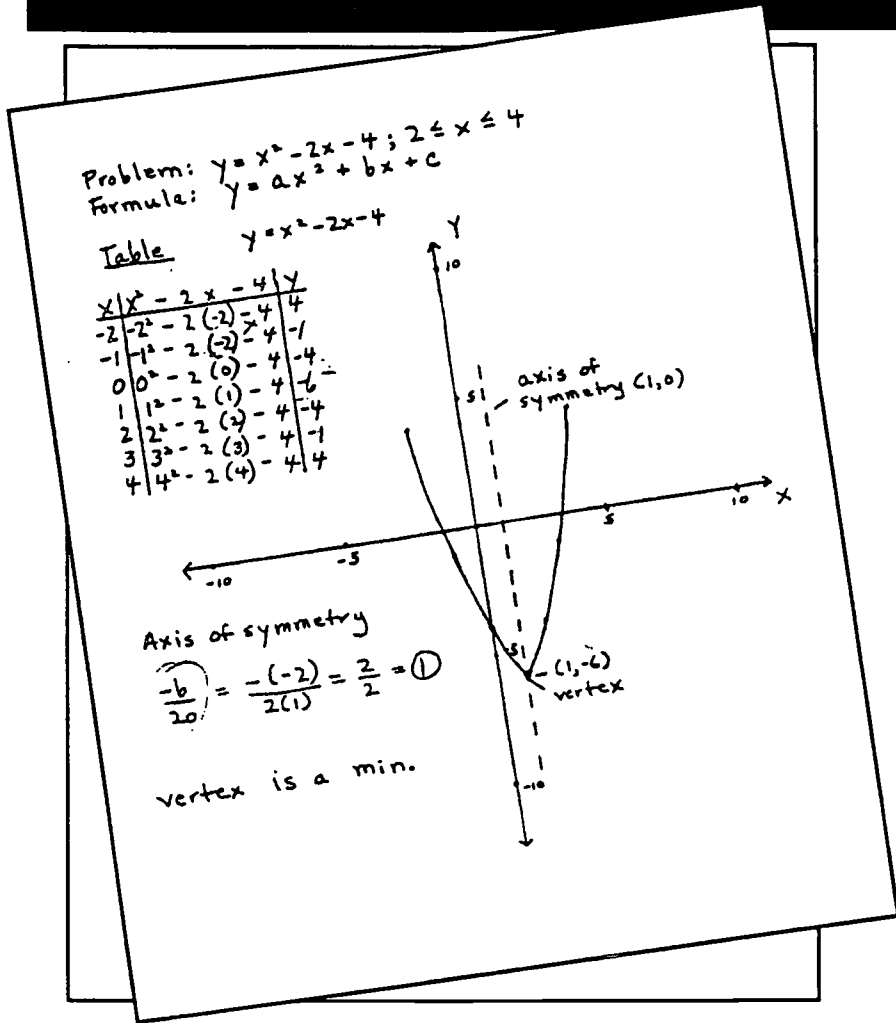

**SCORING GUIDE:**  
 Creating Concept Maps  
 "Content" Rubric

- Superior (5 pts.)** The written and visual presentation of the concept map is free of any math errors. The description of the math examples is logical and thorough. The complexity of the concept being described exceeds the level to which they have been taught in school. Student work is over and above the quality standards set by the class.
- Proficient (4 pts.)** Mathematical errors are inconsequential. The descriptions are logical and thorough enough to be understandable to an expert. The complexity of the examples are no more than one year below grade level. The quality of work meets the standards set by the class.
- Acceptable (3 pts.)** Some major mathematical errors may be present but are corrected upon questioning. The descriptions of the concept map and examples are incomplete or illogical enough to be confusing to experts, but are corrected upon questioning. The complexity of the examples is not challenging. One or two of the standards on quality are missing.
- Not Yet** Major math flaws or errors exist. The descriptions are incomplete or illogical and not corrected upon questioning. Does not go beyond common knowledge. Student work does not meet several of the quality standards.

# Standard 3—Mathematics

Commencement Task

Mathematics

Student Work Sample

As a concerned friend you have decided to help a student in your class learn major math concepts that were taught to the class while he/she was absent. Since you love to write notes in class anyway, it will be a great way to "teach" your friend what was missed. Your note should include your own "creative" examples supporting your descriptions of how to apply the major concepts of Right Triangle Trigonometry identified in class. Clear and accurate diagrams, detailed steps leading to solutions of your examples, and descriptions of the work in complete sentences should be included in your note. After you describe each example, please include a follow up activity for your friend to check for his/her understanding.

(Copyright 1994-1995 Peak Learning Systems, Inc. (303) 654-2236)

## Student Response

Dear friend,  
I thought you might want to know about what we learned while you were gone so that our teacher doesn't have a fit. We learned about how to apply Trigonometry to things that could really happen. We used that "SohCahTba" formula for right triangles that we used before. That's where the Sine of an angle is equal to the measure of the Opposite side over the Hypotenuse, Cosine is the Adjacent side over the Hypotenuse and Tangent is equal to the Opposite side over the Adjacent side. Using this formula you can find missing sides or angles by putting numbers into it for either the sine, cosine or tangent parts, and solving by using a calculator or a Trigonometry Table.

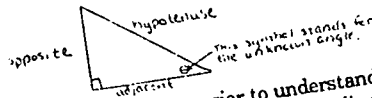

This whole concept is probably easier to understand if you look at a problem:  
You are at the top of a tree and you are holding a string that is 54 ft. long stretching from the ground to the top of the tree. The angle of depression from your eye level to the string is  $14^\circ$ . How tall is the tree?

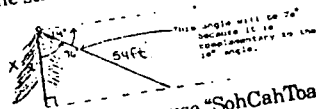

For this problem, you have to use "SohCahTba" to find the missing side (the height of the tree). You use the information that you have which is 54 ft. and  $76^\circ$ . "x" is the height of the tree because that is what we don't know. The 54 ft. is the hypotenuse of the triangle and "x" is adjacent to the angle that we already know. Referring back to "SohCahTba" we find that we need to use the cosine function  $\cos = \frac{\text{Adj.}}{\text{hyp}}$ . Then using this you should have that the cosine of 76 is equal to x over 54. or  $\cos 76^\circ = \frac{x}{54 \text{ ft.}}$  Then using the

calculator you find out that the cosine of  $76^\circ$  is .2419. Then you can solve for x by multiplying that number by 54. Then you will find that the tree is 13 ft. tall.

Now here is a problem that you can try on your own:  
A dog that was wearing a 127 ft. leash fell down to the bottom of an empty pool. The angle from the wall of the pool to the leash is  $29^\circ$ . How deep is the pool?



I have the answer if you would like to know what it is.

Your friend,

## Performance Indicators

Students can:

... use trigonometry as a method to measure indirectly.

## Commentary

### The Sample:

- Accuracy, thoroughness, and clarity are superb.
- The activity for the reader matched the examples presented in the letter.
- Explanation of the concepts was very clear.
- The illustrations were well done.

## SCORING GUIDE:

### Expert

Meets and exceeds the criteria and standards for proficient.

### Proficient

Right angle trigonometry and its application(s) are accurately and clearly described in a logical order for both the skill and the reader. Clear and relevant examples are provided for clarification both before and during the description. Effective checks are provided for the reader to check for his/her ability to perform the skill and its application(s). More than one approach is used to provide for the reader's needs. The reader reports he/she had little or no difficulty working through your descriptions until he/she could do what was being described.

### Competent

The reader is able to work through the descriptions and examples and within three attempts is able to do what is being described. The reader reports that the descriptions and examples tended to be unclear or confusing, but they ultimately worked. Checks are provided for the reader to check for his/her ability to perform the skill and its applications(s).

### Novice

The reader is confused by the note. There are not adequate examples and/or the procedures described are not described clearly enough, or the procedures described will not generally work.

Expert: A+  
Proficient: A  
Competent: B  
Novice: Work in Progress

# Standard 3—Mathematics

Four-year  
sequence

Mathematics

Student  
Work  
Sample

## Task

Students were asked to formulate a simple research question and then carry out an experiment to help answer their question. They could also devise a survey to answer their question. They were then asked to use one of three statistical tests to analyze their results—a Chi Square, a Pearson's  $r$ , or a matched  $t$ -test. Finally, the students were asked to write a research paper.

## Performance Indicators

Students can ;

... obtain confidence intervals and test hypotheses using appropriate statistical methods.

## Commentary

The sample:

- Student made a proper use of the  $t$ -test.
- Student chose an interesting experiment and followed standard statistical procedures.
- Although the student did find the difference between the results of the two tests, it was not statistically significant and does not warrant the conclusion drawn.
- References were appropriate, but should have been at the end of the paper.

## Student Response

### Introduction:

The purpose of this paper is to determine the effects of listening to various types of music on performing a task. If this experiment provides satisfactory results, then all the students in this world can listen to the music that will aid them to perform better on exams. The researchers believe that listening to Mozart's and Pachelbel's music will affect the teenagers in doing better on exams because we think Mozart's music is calm and serene for the brain to enable them to concentrate. We feel that other varieties are too nerve-wracking and distracting for the brain while studying for an exam.

### Literature Review:

The fact that many universities have picked Mozart's music as a variable for testing the theory of his music as significantly improving student's performance on intelligence tests greatly implies that his music is considered complex and highly structured. Researchers from the University of California at Irvine have found that exposure to Mozart's Sonata for Two Pianos in D Major results in considerably improved student's aspect in intelligence tests taken immediately afterward (4). The students IQ scores rose by nine points after listening to ten minutes of Mozart's music. They have shown that listening to Mozart's music also assists in the solution of spatial puzzles involving folded cutout shapes, while undergraduates listening to Philip Glass's Music in Changing Parts' did not perform as well. (4) Studies have also found that surgeons who listen to classical music while performing an operation improved their performance. They had faster speed and better accuracy when listening to Pachelbel's Canon in D. (2)

Researchers have done studies as to why people who listen to music have improved short-term memory and they have found that as blood flow increases in the temporal lobe, it all produces changes in the temporal lobe and enables the brain to have improved short-term memory. (1)

**References:**

1. Bower, B. "Brain Images Reveal Cerebral Side of Music," *Science News*, 145:260.
2. Choo, Viven. "Music for Surgeons," *Lancet*, 344:947, 1994.
3. *The New York Times Company*, (Nature) "Mozart makes the brain hum, a study finds," October 14, 1993, p. 9, sec:B.
4. *The New York Times Company*, "Classical View; listening to Prozac . . . er, Mozart," August 28, 1994, p.23, sec:2.

**Measures:**

Test results were measured according to the matched T-test. The T-test showed that students listening to Mozart's music while administering the test received better results.

**Findings:**

We found that students did better on the second test while listening to Mozart's music. Nearly 70% of the students improved their test scores while listening to Mozart.

**Total Scores:**

No music 234

With music 250

(paper included list of data and formula for t-test ( $t = 1.146$ ))

**Method:**

Our sample consisted of all the students taking the Invest Tech course...between the ages of 12 and 15 ( $N = 26$ ; there were 9 boys and 17 girls). First, an arithmetic test was administered without music. Next the same group was given a similar test while listening to Mozart's Piano Concerto No. 19 in F Major (k.459) and Piano Concerto No. 20 in D Minor (k.466).

First, we handed out Test A and tested the students without music. Then we handed out Test B and tested the students with Mozart's music. Each test was conducted in 12 minutes. Raw scores on both tests were calculated.

**Discussion:**

The major finding of this study was that there was a difference in the students when taking the test while listening to Mozart's music. For example, they would tap their feet and move their heads in time to the music . . . But we do know that our study proved that Mozart's music does aid people to do better on tests.

Intermediate

Physical  
Setting

Student  
Work  
Sample

## Context

Eighth grade students investigated the phenomena of three-dimensional photography. They researched the stereoscope then attempted to duplicate the method of producing 3-D photos. Subsequently, they surveyed a group to determine which photos appeared the most three-dimensional.

## Performance Indicators

Students can:

... describe the sources and identify the transformations of energy observed in every-day life.

... observe and describe the properties of sound, light, magnetism, and electricity.

1. We took ten pictures of the same object. The camera was 1 meter from the end of the object. Five pictures were taken on the right and five pictures were taken from the left, from the center of the object. Each picture was moved over five centimeters. Every time the camera was moved over, it created a new angle.

2. We slid the pictures into a box. The box had two lenses on the front at the same length away as two eyes. The pictures were nine inches away from the lenses. In between the lenses was a cardboard board dividing the two pictures.

3. We surveyed sixty people. We asked each person to rate the images they saw one through five from those that appeared least three dimensional to those that appeared most three dimensional.

### Analysis

By studying the graphs many patterns can be found. 60% of the people surveyed said that the most three dimensional picture was picture 5. This is 20% more people than the total number of people who said that pictures 1, 2, 3, and 4 were the most three dimensional.

45% of the people surveyed said that the second most three dimensional picture was picture 4. This is only 10% less than the total number of people who said that pictures 1, 2, 3, and 5 were the second most three dimensional.

45% of the people surveyed said that picture 3 was the third most three dimensional. This is only 10% less than the total number of people who said that pictures 1, 2, 4, and 5 were the third most three dimensional. This is the same percent of people who said that picture 4 was the second most three dimensional.

44% of the people surveyed said that the fourth most three dimensional picture was picture 2. This is only 12% less than the total number of people who said that pictures 1, 3, 4, and 5 were the fourth most three dimensional.

67% of the people surveyed said that the least three dimensional picture was picture 1. This is 34% more than the total number of people who said that pictures 2, 3, 4, and 5 were the least three dimensional.

The pattern is that there is a definite trend presented by the survey. This means that most people said that the most three dimensional picture is picture 5 and the least three dimensional picture was picture 1.

Our hypothesis was proven correct. We tested to find out if an increase in angle would affect the three dimensional image of the pictures. We found out that as the angle of the picture increased the three dimensional image increased.

If we were to repeat this experiment we would improve it by moving the camera further and further until we found the limit of the three dimensional image.

As an outgrowth of this investigation we would test other factors that may affect three dimensional images. We would test the distance of the camera from the object. We could also test the positioning of the lenses in our stereoscope.

## Commentary

The Sample:

- Illustrates the use of devices which transform light energy.
- Demonstrates the manipulation of variables to verify or refute a hypothesis.
- Uses numbers and graphics to describe phenomena.
- Identifies patterns.
- Suggests further experimentation and analysis.

3-O Magic

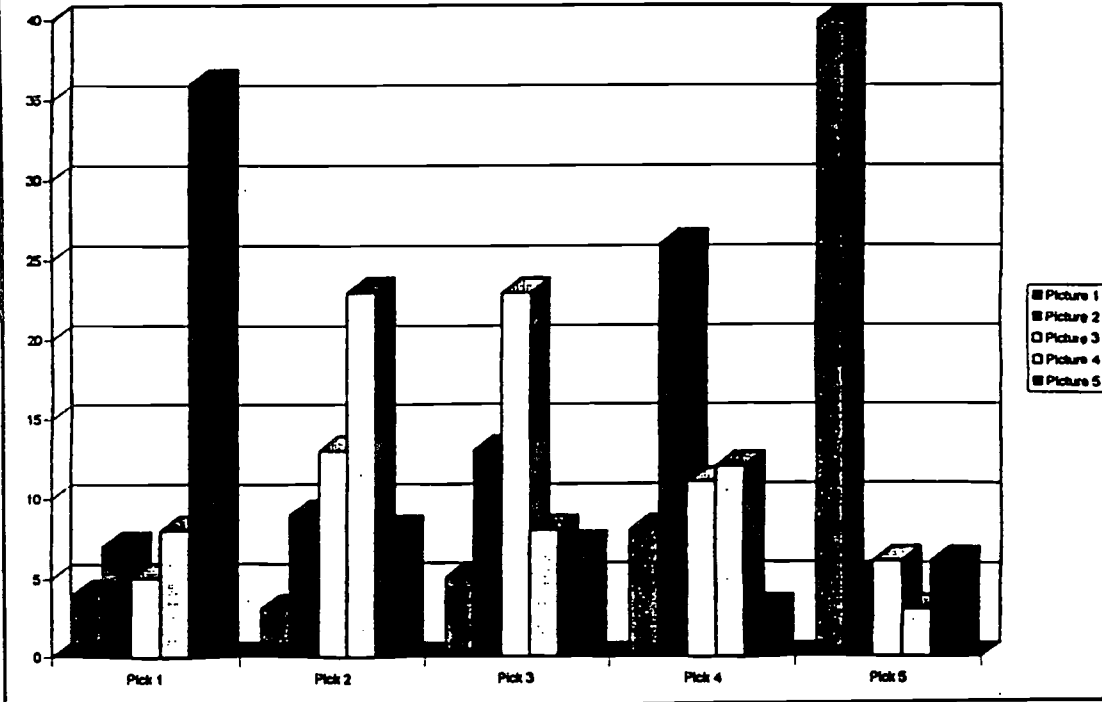

# Standard 4—Science

Commencement

Physical  
Setting

Student  
Work  
Sample

## Context

High school students become involved in problem solving in this physics lab. By throwing a frisbee they are able to make and verify predictions about momentum, air friction, gravity and lift as related to distance traveled by the toy.

## Performance Indicators

Students can:

... observe, describe, and compare the effects of forces, such as gravity . . . on the motion of objects.

... explain and predict different patterns of motion of objects.

## Commentary

The Sample:

- Demonstrates an understanding that moving objects behave according to certain general principles.
- Describes the effect of gravity, wind, and air friction on the path of an object, in this case, a frisbee.
- Predicts the effect of lack of gravity, wind, and air friction.
- Uses drawings to illustrate phenomena.

### Physics Frisbee Lab

- 1.a. Gravity  
b. Gravity pulls the frisbee toward the center of the earth.  
c. The frisbee would stay suspended in air if gravity didn't act upon it.  
d. If you throw it off a second story building, it won't resist gravity, but it will fly further.
2. a. Wind  
b. Wind makes the path of the frisbee curve.  
c. If there was no wind, the frisbee would go straight.  
d. Of you throw the frisbee on a windless day, the path it makes will be straight.
3. a. Air friction  
b. Air friction slows the frisbee down.  
c. If there was a lack of air friction, the frisbee would continue flying until another force acts upon it.  
d. The only way to stop air friction is to put th frisbee in a vacuum.



Key, Causes

### Diagrams for lab

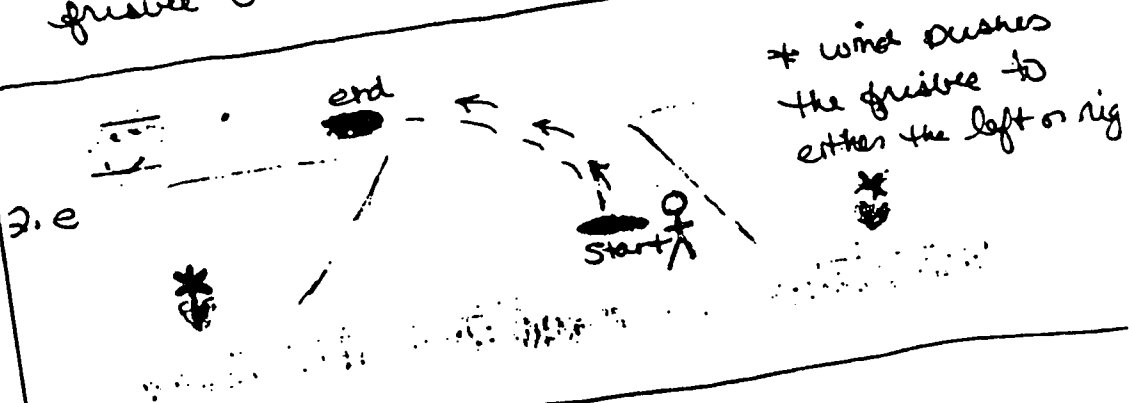
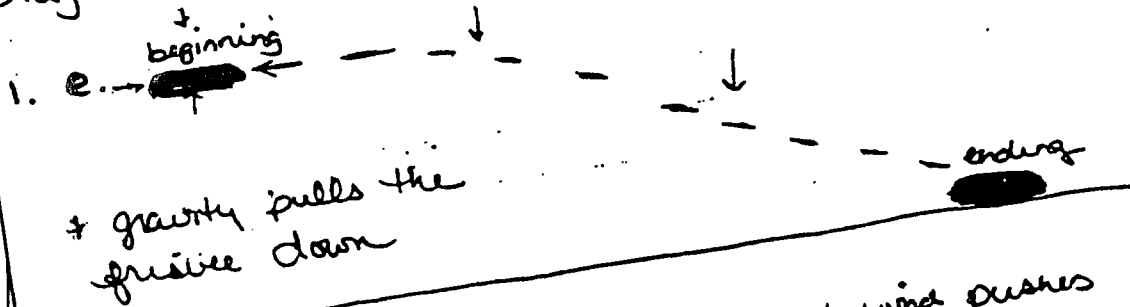

\* If gravity existed also, the frisbee would fall to the ground.

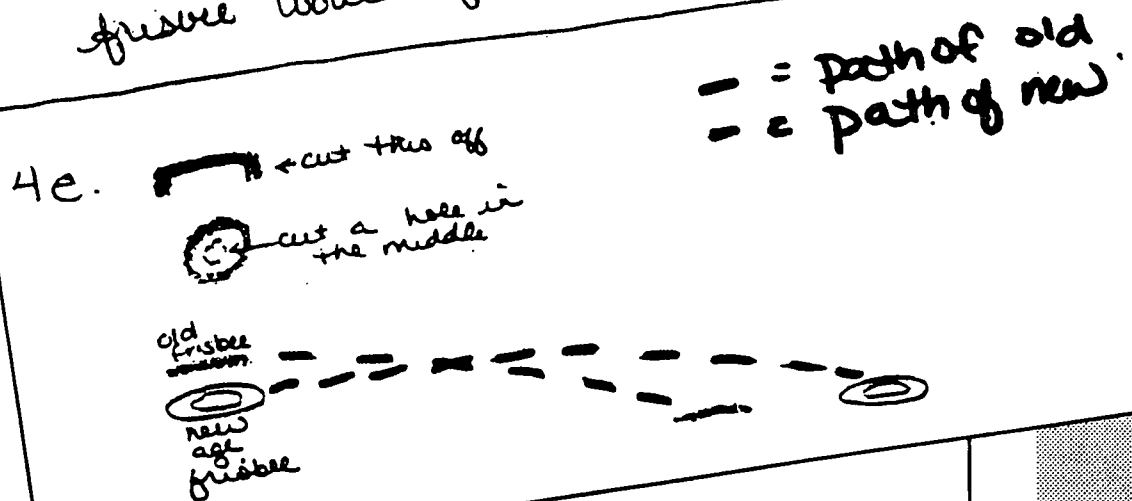

# Standard 4—Science

Elementary

## The Living Environment

### Student Work Sample

#### Context

Fifth-grade students studied the characteristics of spiders and insects, noting their similarities and differences. They constructed imaginary spiders and used a variety of methods to simulate spiders in an effort to better understand what spiders' lives are like. The students learned how to spin their own webs and taught the second graders to do the same. By making a classroom sized web of clothesline and string, the students discovered that they needed to plan their construction and work together with their classmates. Ultimately, the students constructed models of insect prey and "ate" like a spider.

#### Performance Indicators

Students can:

... describe basic life functions of common living specimens.

... describe some of the survival behaviors of common living specimens.

#### Commentary

The Sample:

- Demonstrates an understanding of the characteristics unique to spiders.
- Shows a graphic representation of the spider.
- Shows respect and appreciation for the organism.

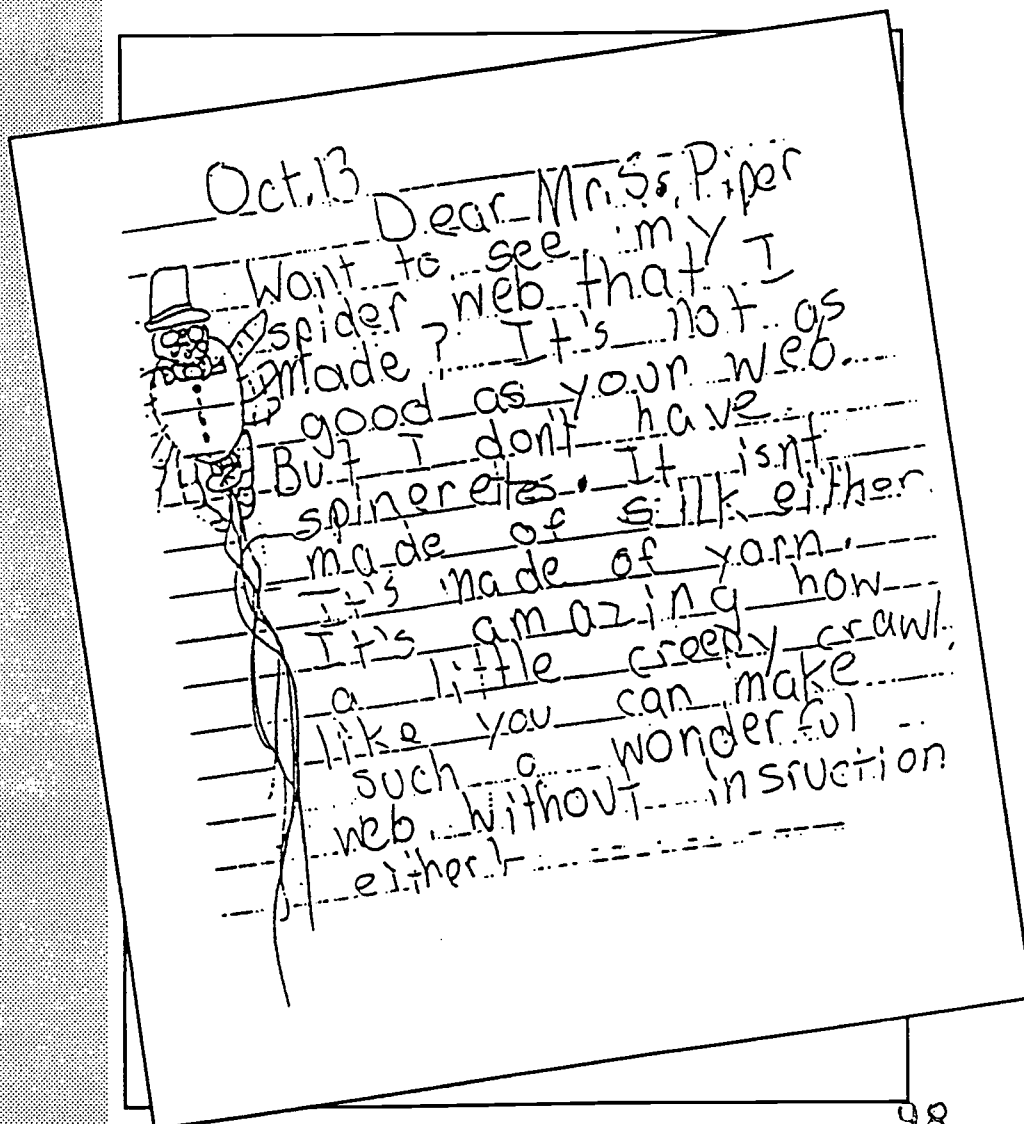

# Standard 4—Science

Intermediate

## The Living Environment

### Student Work Sample

#### Context

This middle school science project was conducted to test the hypothesis that, "... irradiation will increase the rate of germination and increase the height of the plants ...".

#### Performance Indicators

Students can:

... recognize that traits of living things are both inherited and acquired . . . .

... describe sources of variation in organisms and their structures and relate the variations to survival.

In order to test our hypothesis, we ordered ordinary radish seeds as the control and, as the variable, seeds irradiated with four different measurements: 4,000,000r, 500,000r, 150,000r, 50,000r. We planted five pots of each kind, with ten seeds in each pot. They were watered every other day with ninety milliliters of water and covered with saran wrap. Each day, we recorded the number of seeds germinated, then graphed the results. The heights were measured six days after they were planted.

Our hypothesis was proven incorrect. Irradiation worsened the growth of the plants. This experiment disproves the theory that the reason for the incredible growth of the seeds in "Jack and the Beanstalk" was that they were irradiated. Irradiation could not have increased the height of the beanstalk. The hypothesis to test next would be that ordinary radish seeds would germinate quicker than irradiated seeds and the ordinary plants would grow taller and healthier than those irradiated. In order to improve upon this experiment, we would plant the seeds in larger pots so as to give the plants more room to grow. In addition, we could observe the plants over a longer period of time. Future investigations we could do as an outgrowth of this one, are testing the effect of irradiation on different types of seeds and testing irradiation's effect on the fruit of the seeds.

#### Commentary

The Sample:

- States the hypothesis.
- Describes the preparation of seeds to encourage germination including the irradiated ones.
- Identifies manipulated and held constant variables.
- Describes experimental procedure.
- Represents plant growth and germination using computer generated graphics.
- Concludes that the hypothesis was flawed as evidenced by the charted data.
- Could be improved by presenting an explanation for the results, or plans to seek explanatory information.
- Identifies areas for further research.

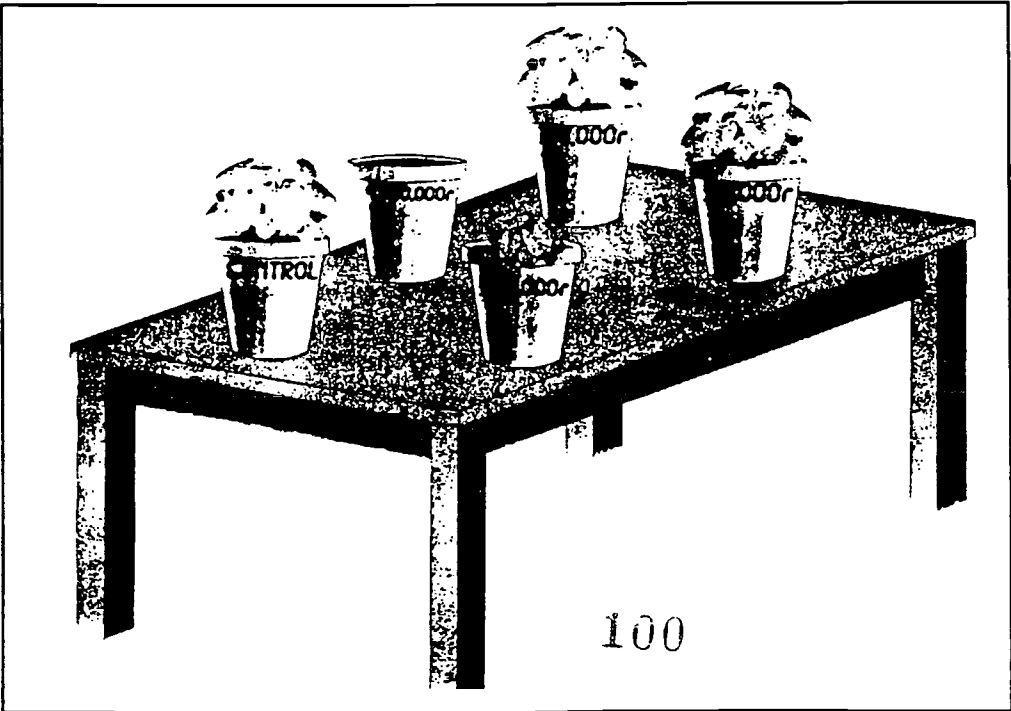
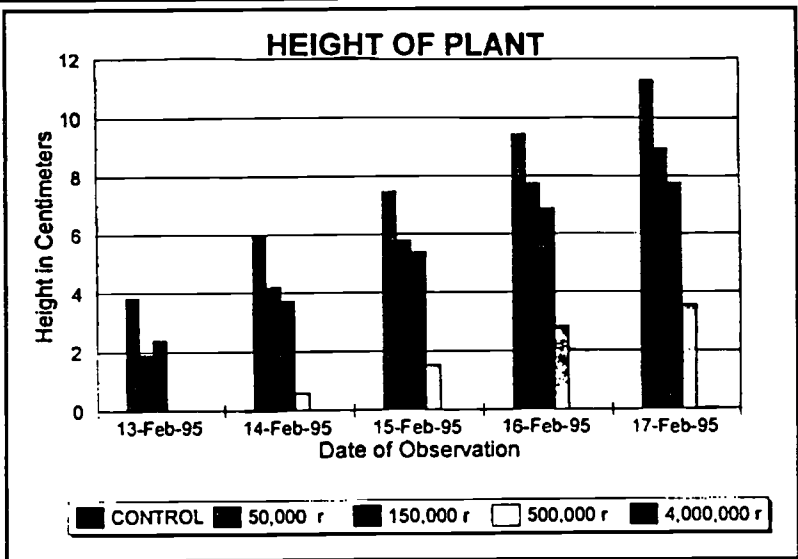
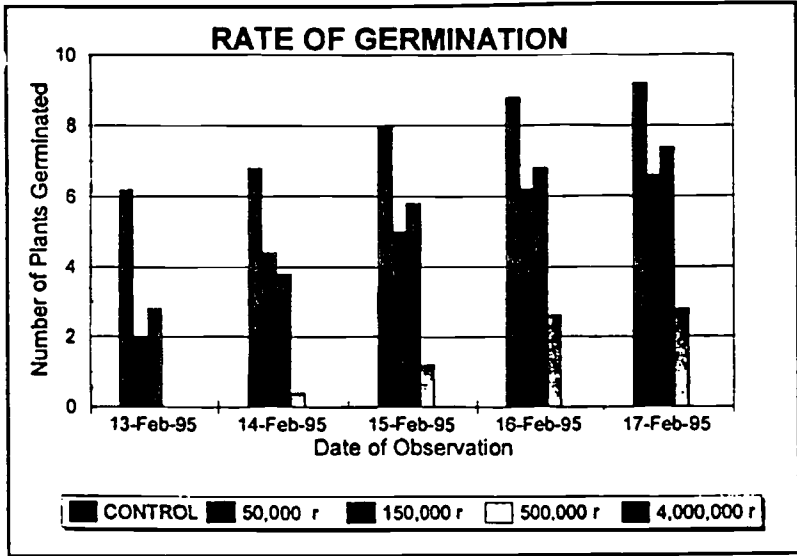

100

# Standard 5—Technology

## Elementary Technology

### Student Work Sample

#### Context

This is 5th grade work where the students in teams, were asked to design a model of a multi-functional freestanding playground structure for kindergarten children to use.

Today we made our zipline. This by far was the hardest thing so far. First we couldn't cut the wire. But our teacher cut it off. Second of all the poles were cut unevenly. Then the wood was splintery and we had no sandpaper. But the wire was the hardest. Since the wire is so thin it was hard to glue it down on the pole. With the glue gun. Since the glue gun's glue is hot you couldn't press the wire down because your finger is wider than the wire. Than finally after we got the wires finally on I realized that I forgot to put the paper clip on. Because of this I had to repeat the whole method over again. This was HARD!

Our construction period was long and tough. We had a serious problem with supplies. But we got just enough to build our design. Most of the wood we worked with was from scraps of other cut wood. I thought the first part of building was the funnest, because the second part was extremely hard cause of the monkey bars.

Then probably the hardest one of them all, the blueprints. They had to be drawings in exact scale. It was torture to measure almost every possible thing to measure on our playground, but I had to do it, and I did. Plus, since my dad's an architect, I had the perfect program to do it with. So I also drew it in 3-D. In an isometric view. And I'm proud of what I did. And I'm glad it's over with because it was such a hard task to complete. In my final presentation, I had two elevations, a plan view, and two isometric views. The program I did it in was called MiniCad. CAD stands for computer assisted design. It's a program for architects. But I used it for my needs.

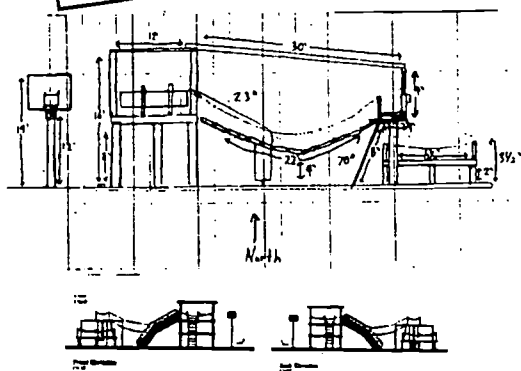

Lets start with the Bill of Materials. It was sort of like a bill. You had to determine what certain parts of your project would be, like if you had a long pole, you might make that out of 2x4s, and we have this catalog from Pergament that would tell you how much 2x4s cost. You also had to pay for labor. If you were going to do it on the computer, you would use a spreadsheet. Our Bill of Materials also included some graph information for some extra good grades.

Today we are starting a mini-project, on technology. Technology means an advancement in scientific creation. Just as a guess, the club, might be one of the first advancements in technology. The wheel was also, perhaps. So technology is really something to make things easier in everyone's lives. It takes something like a stick, and turns it into a thicker thing like a club. "Necessity is the mother of inventions". The idea is when you have a need, people will start inventing. Such as the telephone. Usually people think about inventing something after a problem has happened.

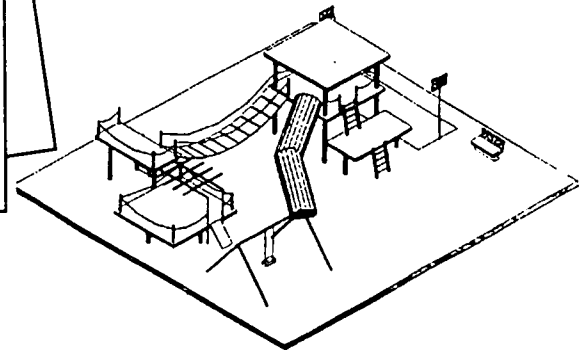
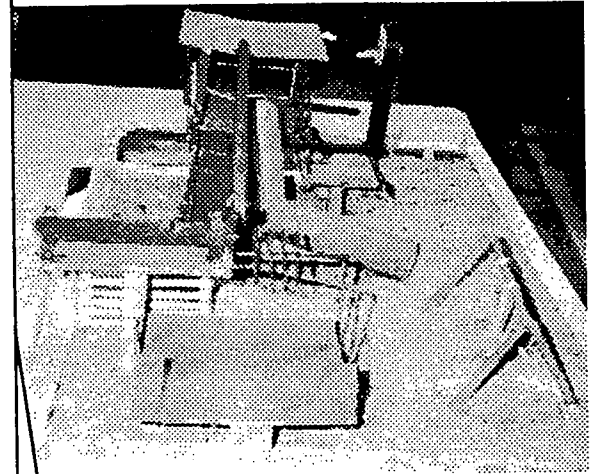

Bill of Materials			
Material	Number of Items	Cost Per Item	Total Cost
75 inch x 100 foot 2x4 wood	24	5.00 dollars	120.00
4x4 wood beams	2	6.99	13.98
6 inch chain	200 feet	6.00 dollars	1200.00
steel poles 3/4 inch diameter	2	4.00 dollars	8.00
plastic tubes 2 1/2 inch in diameter	25 yards	20.00 dollars	500.00
sand	1000 lbs	1.50 dollars	1500.00
labor	5 hours @ 20 dollars	100.00	500.00
architects fee	1 hour @ 20 dollars	20.00	20.00
<b>Total</b>			<b>1745.98</b>

Material	Number of Items	Cost Per Item	Total Cost
75 inch x 100 foot 2x4 wood	24	5.00 dollars	120.00
4x4 wood beams	2	6.99	13.98
6 inch chain	200 feet	6.00 dollars	1200.00
steel poles 3/4 inch diameter	2	4.00 dollars	8.00
plastic tubes 2 1/2 inch in diameter	25 yards	20.00 dollars	500.00
sand	1000 lbs	1.50 dollars	1500.00
labor	5 hours @ 20 dollars	100.00	500.00
architects fee	1 hour @ 20 dollars	20.00	20.00
<b>Total Cost</b>			<b>1745.98</b>

## Performance Indicators and Commentary

Students explore, use, and process a variety of materials and energy sources to design and construct things.

- The playground model is well constructed and colorfully painted. Common materials (cardboard, wire, balsa wood, plywood, sand, and paint) were used. Students tested joint strength, however, erroneously reported breaking point in pounds, rather than grams.

Students develop basic skill in the use of hand tools.

- Hand tools such as glue guns and paint brushes were used, however, there is no evidence students used a range of tools in this endeavor. One is led to believe materials were pre-cut for them. Availability of additional hand tools might have enabled students to be more creative and adept in construction.

Students use simple manufacturing processes (e.g., assembly, multiple stages of production, quality control, etc.) to produce a product.

- Students primarily used gluing techniques to assemble the model. References were made (in the bill) to materials beyond those used, but no indication was given as to how students would have assembled the real playground equipment which included 3" diameter steel poles, and 2.5" diameter plastic tubes.

Students use the computer as a tool for generating and drawing ideas.

- A CAD program was used to draw orthographic and isometric views of the playground. Drawings were well done and clearly descriptive of the various types of equipment, but would have been enhanced by dimensions, particularly in the orthographic drawing. This omission was recognized by a team member in the final evaluation.

Students identify technological developments that have significantly accelerated human progress.

- A discussion of technological invention evidenced a basic understanding of the impact of technology on human capability; a stronger response would have recognized that early technology occurred long before science and was more than "an advancement in scientific creation."

Students participate in small group projects and in structured group tasks requiring planning, financing, production, quality control, and follow up.

- The students worked in a group and delegated certain tasks (e.g., drawing, financing, testing of joints) to subgroups, or individuals.

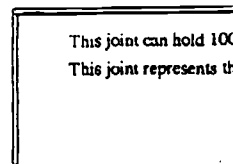
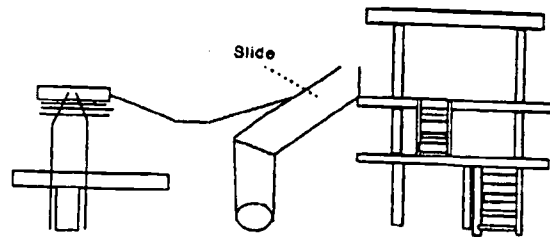

This joint can hold 1000 lbs. before snapping.  
This joint represents the joint for the monkey bars

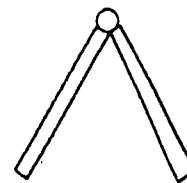

This joint represents the joint on the monkey bars.

This joint can hold 4000 lbs. before snapping.

The final piece had four platforms, two high ones, and two low ones. They were all made of plywood except for the lowest one on the left, which was made from balsa wood. The slide was made from cardboard. Each platform could hold around 6000 lbs. The slide could hold 2000 lbs. And the bridge that was also made from balsa could hold 1000 lbs. per block. The playground met the safety code and building code perfectly. And so far I have noticed it is the only one that fits the safety code. There are some other playgrounds that would kill a child a day.

Looking back on our project, we think that it's okay. It is not perfect since it's somewhat off scale and the paint job was bad. It is still sturdy and strong, has safety in its design and I'm his made a great 3-D blue-print from his computer. Many people think that ours is one of the best, but I personally think it's a little above satisfactory.

The first thing I saw that was bad was the scale of the project. Some of the columns were too big and the wood had little drops of paint on it from people who tried to play with our project. That forced us to paint the project. Another big problem which I pointed out in an earlier entry, was our indecisiveness. We could never decide what or where we should put something.

I think that our team deserves a 3 on our sketches because we did all the angles, dimensions and views possible but our sketches did not resemble the final product. [NAME] was not in our group then but he made the final real sketches which turned out great except there were no dimensions.

I think that we got a 4 on our blueprints because Mr. [Name] said so and because we had every dimension and view needed. [Name] really overdid it because he did a 3-D computer blueprint on a Mini Cad program on his computer.

I think our model construction is a 3 because the paint job is horrible although it is very strong. Everything is level and okay. Nothing is absurdly crooked or anything. Our slide is 73" and every platform is neat.

I think that we rushed a little with the painting because we missed a few spots. I think we made up for it when we made our blueprints and bill of materials.

If I could make the project over, I'd make it more simple and neat. I would not paint it and I would listen to my groups opinion more.

# Standard 5—Technology

Intermediate  
Technology

Student  
Work  
Sample

## Context

This is an example of work from middle school technology students who decided to produce an item for sale to classmates as a class project. The chosen product was a clock with a quartz movement which was mass produced in the technology lab.

## Performance Indicators and Commentary

Students choose and use resources for a particular purpose based upon an analysis and understanding of their properties, costs, availability, and environmental impact.

- Students chose a variety of woods, assessed their costs, and determined which combinations of wood would be best liked. No evidence was provided that students considered other materials, nor was there any explanation as to why the particular wood types were chosen.

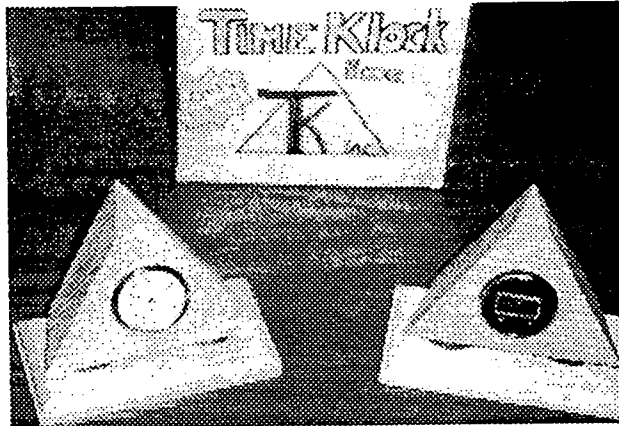

Figure 1: Finished Clocks.

Students use a variety of hand tools and machines to change materials into new forms through forming, separating, and combining processes, and processes which cause internal change to occur.

- A layout of the technology lab illustrates the wide range of tools and machines used. These include drawing tools, sawing and drilling machines, soldering tools, shaping tools, and sanders. A high level of mechanical knowledge was evidenced in construction of the clamping device and other sub-assemblies of the sanding jig.

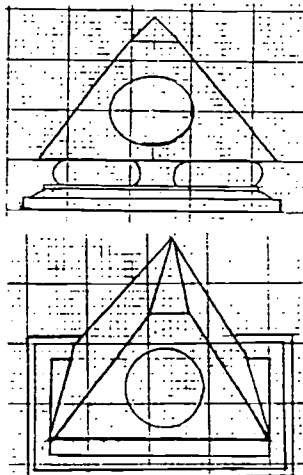

Figure 2: Orthographic and 3-Dimensional Drawings of Clock.

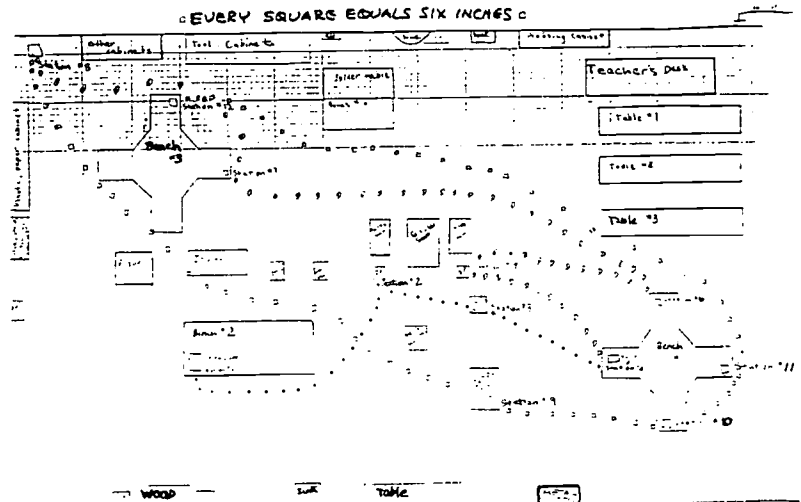

Figure 3: Layout of Technology Laboratory Depicting Production Flow.

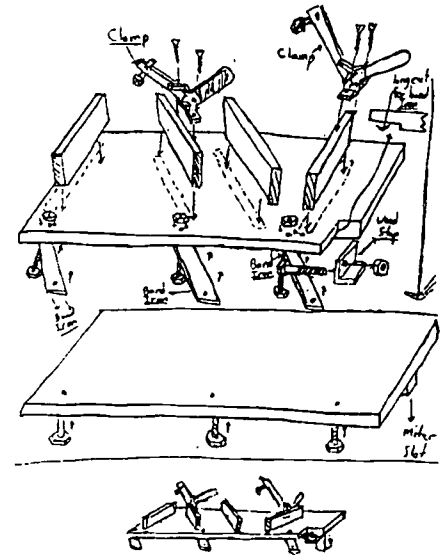

Figure 4: Sketches of Sanding Jig.

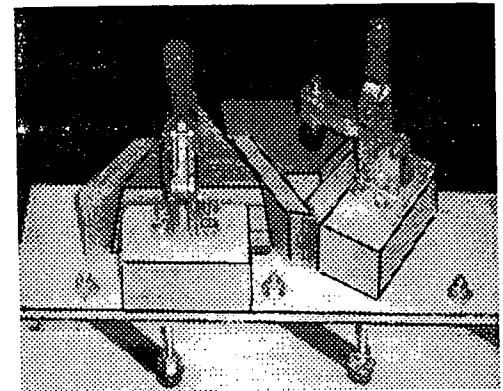

Figure 5: Finished Sanding Jig With Clock Pieces Clamped in Place.

FINANCE DEPARTMENT

Cost of Materials (\$3.18 per clock)

COST PER BF

Black Cherry	Base	25	3.71
Black Walnut	Base	25	4.13
Red Oak	Base	25	3.09
Hard "Rock" Maple	Base	25	3.28
Butternut	Base	25	3.99
Black Cherry	Triangle	25	9.17
Black Walnut	Triangle	25	10.22
Red Oak	Triangle	25	7.64
Hard "Rock" Maple	Triangle	25	8.11
Butternut	Triangle	25	9.87
Black Cherry	Triangle	25	1.56
Black Walnut	Donuts	50	1.74
Red Oak	Donuts	50	1.3
Hard "Rock" Maple	Donuts	50	1.38
Butternut	Donuts	50	1.68
	clocks	25	\$40.00
Sandpaper (belt)		1	7.95
Sandpaper (palm)		10	
Stain (Danish Oil)	1 qt. clear		5.89
Stain (Danish Oil)	1 qt. black		5.89
Fasteners		50	\$1.35
adhesive disk		1	\$5.20

## Student Survey Questions

1. Do you think people of your age would buy this clock?
2. When would be a good time to sell these clocks?
3. What colors do you like these clocks in?
4. How much should they be sold for?
5. Would you like to see digital faces or the kind with hands?
6. Would you buy this clock for yourself or for someone else? Who?

Figure 6: Survey Results

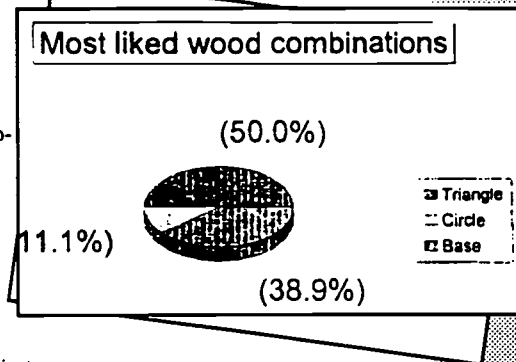

## Performance Indicators and Commentary

Students combine manufacturing processes with other technological processes to produce, market and distribute a product.

- The laboratory diagram shows how students determined the sequence of operations and plotted the production flow for each component of the clock. Drawing, computer-based information processing, and graphic design processes were integrated into this project.

Students process energy into other forms and information into more meaningful information.

- Information processing is evident in computer-generated charts and tables, technical drawings, and the advertisements.

Students manage time and financial resources in a technological project.

- Students developed a price list for materials, and kept a daily log of accomplishments.

Students assume leadership responsibilities within a structured group activity.

- Students organized into project work teams (marketing, production, administration, and finance). They kept track of each others progress and provided critical feedback.

Students identify needs and opportunities for technical solutions from an investigation of situations of general or social interest. (From Standard One)

- Students determined, through a marketing survey, that a clock would sell well to classmates, and that both a digital face, and one with hands would be saleable.

Students develop plans, including drawings with measurements and details of construction, and accurately construct a model of the solution, exhibiting a degree of craftsmanship. (From Standard One)

- Drawings were developed, but did not include construction details or dimensions. Finished products were functional, attractive, and of commercial quality. A jig was designed and built to hold the housing for the clock face while it was being sanded. This triangular part with beveled edges required complex conceptualization and superior drawing and construction skills to implement.

Figure 7: Advertising Ideas

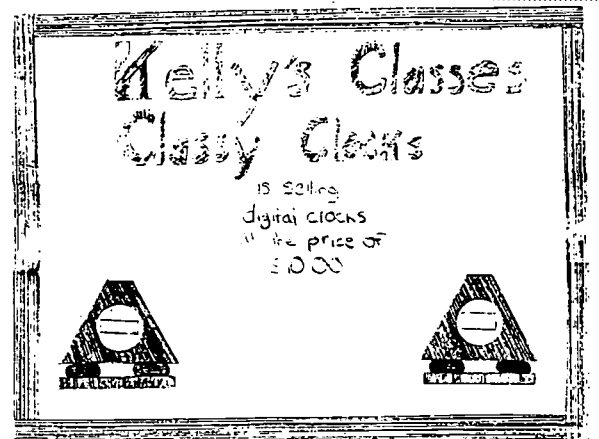
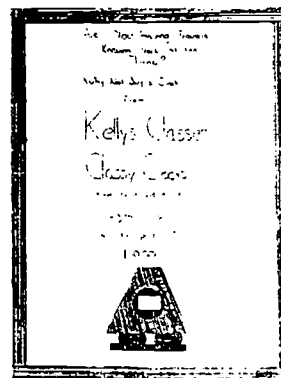

Marketing Dept.—

Your group has a problem with cooperation, I believe. If I'm wrong, let me know I need to know everything that is going on in your group. Your log was fine, but I need to have it handed in with the paper in the folder. I need your leader, Nora, to come & talk to me about your group. Thank you.



# Standard 5—Technology

Commencement

## Context

This is an example of work from students in a 12th grade Principles of Engineering class who were challenged to design and model a system to evaluate the size of packages, and load two trucks so that optimal use is made of truck space.

## Technology

## Student Work Sample

This has surely been fun. I never had so much work in my life. Coming into this project, I thought it would be breeze; just a regular walk in the park for a great trier-and-true programmer such as myself. Well, guess what-I didn't realize that I'd have to contend with inferior and convoluted mechanical designs such as the sorry one my team put out. The sensor didn't work half the time, the kidBar would stop the 4 cm block half the time, and no one knows how the reset sensor didn't work at all until I spent about 1 1/2 hours fixing it!

After hooking the project up to my computer and discovering in a rather painful way that the project did not run under OS2, I spent the next hour trying to get DOS to run BC++ without crashing. Kudos to DOS. Now do you know why I switched to OS2 in the first place?

Anyway, I then worked in a rather sparse text mode interface to get the project to detect the block correctly. After building four different grim reapers following my readjusting the conveyor slightly, I finally got the project to detect the 3 and 4 cm blocks with 100% accuracy. The 2 cm blocks work correctly about 80% of the time, and the 1 cm blocks...well, let's just say they work when the wolf bays at the moon.

The first problem was a tendency for the 1 cm block impulse on the godBar to cause it to bypass the 1 cm photo sensor gap completely, registering the block as 2 cm. Well, to repair this problem, I simple added a timing element to the program, making it so that a block that ran through the godBar in a short enough interval, would always be registered as a 1 cm block.

The second problem was that the 2 cm blocks kept being registered as 3 cm or more, since the 2 cm photo sensor gap on the godBar would sometimes be positioned right at the spot where the 2 cm block would advance the godBar to. Thus, the photo sensor would register 3, 4, 7, 18, however many light level changes there were, and thus make the block 18 cm. Try fitting that in one of our trucks. I repaired this problem by moving the 2 cm gap back slightly. This increased the accuracy of the system tenfold.

I will attempt to describe the benefits and failures of our mechanical design. We could also have used more sensors; specifically, ones to determine how far to retract the kidBar, so it would be retracted to the same point after every use. As it is, the kidBar may retract slightly less or slightly farther every time; far is good, but not enough makes the 4 cm blocks run into it and jam the machine. And that gets messy. ("Sir, our radar's been JAMMED!")

Our mechanical design was also far too fragile to make it useful in large-scale production. Every time you set up the project, you'd have to fiddle with the superstructure to get the conveyor to the correct height. Bad Boys design, while similar in the way it detected the blocks was also significantly more well built. Their robot is prettier and more reliable. Their programming could be better, but the mechanics were nearly flawless.

Our project in spite of all its flaws and all my insults, was actually a great success. If I consider how well our project works compared to some of the other teams, I am happy that ours works as well as it does. Thus, I can justify the grades that we are giving our team members. Our detection method, while perhaps not as reliable as it could have been, did actually detect the blocks correctly about 97% of the time. And the mechanics, while not the prettiest, did get the blocks where they were going. And the programming, well...how can you improve on omnipotence? Thanks to XXX for getting the mechanics done, to XXX for doing the wiring and finally getting the reset sensor to work nominally, and to XXX for setting up the project every day. We are a good team.

## Daedalus Robotics Block Sorting Flow Diagram

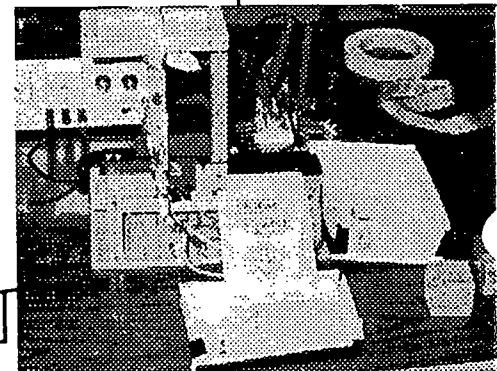
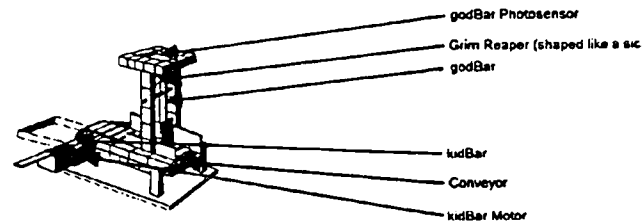
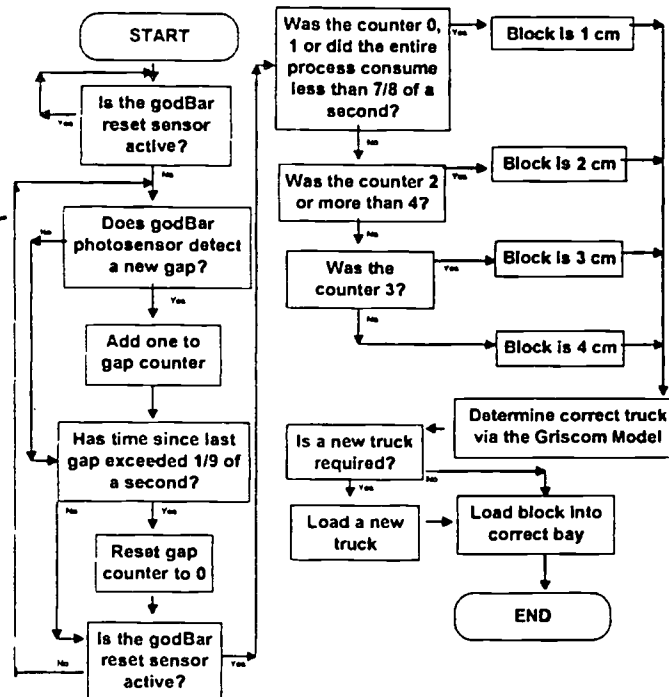

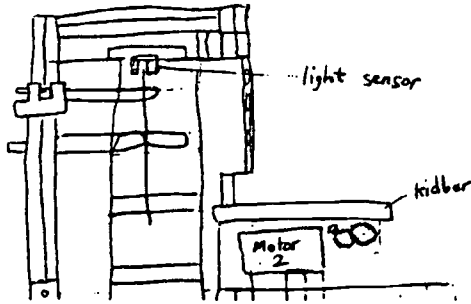

### Performance Indicators and Commentary

Students describe and model methods (including computer-based methods) to control system processes and monitor system outputs.

- The model was computer controlled, using an interface with 10 inputs and 5 outputs. Operation of the photo sensor was clearly understood as a feedback control mechanism, and was used to monitor the size of the passing blocks.

Students develop and use computer-based scheduling and project tracking tools, such as flow charts and graphs.

- A flow chart was designed and used as a management tool to monitor system performance.

Students develop work schedules and working plans which include optimal use and cost of materials, processes, time, and expertise; accurately construct a model of the solution, incorporating developmental modifications while working to a high degree of quality (craftsmanship). (From *Standard One, Engineering Design*)

- Critical analysis has been made of each design; individual improvements were suggested, tried, revised, and tested. The solution evolved through many developmental modifications. The working model was well built and the students demonstrated great tenacity while working on this complicated multi-faceted problem.

Students understand basic computer architecture and describe the function of computer subsystems and peripheral devices.

- References to various operating systems, wiring the interface, and the connection to the computer and to sensors and mechanical devices makes clear that students have developed a high level of computer system expertise.

Students develop an understanding of computer programming and attain some facility in writing computer programs.

- Programming was extensive. Students wrote pages of code to control and monitor the system's operation.

### Programming Code

```
int project::incl()
// Main Control Loop
// Actually determines the block size and controls to which bin the b
// goes; keeps track of which tracks have which blocks and which track
// is each bay */
// Stack variables of
int done = 0; // Main control loop done (quit prog)
blockplaced; // Block was placed already?
setcount0; // Set open counter to 0?
blockdone; // Determines whether block is there;
count; // Number of open in sensor
tsum; // Temporary sum
smallestavail; // Smallest available space
long lasttimer; // Saved timer information
startblocktimer; // Block start time information
unsigned char tctr; // Track counter
// Bay counter
bayctr;
tbody; // Block eventually placed in bay?
*caplin; // Track capacity line
blockctr; // Block size counter
unsigned capacitytrick[4]; // Capacity of a particular track
char tempstr[50]; // Temporary string
// A modification was added here which would spare to TRACKING EX1
// neglected to bring the latest copy of the source code here to p
```

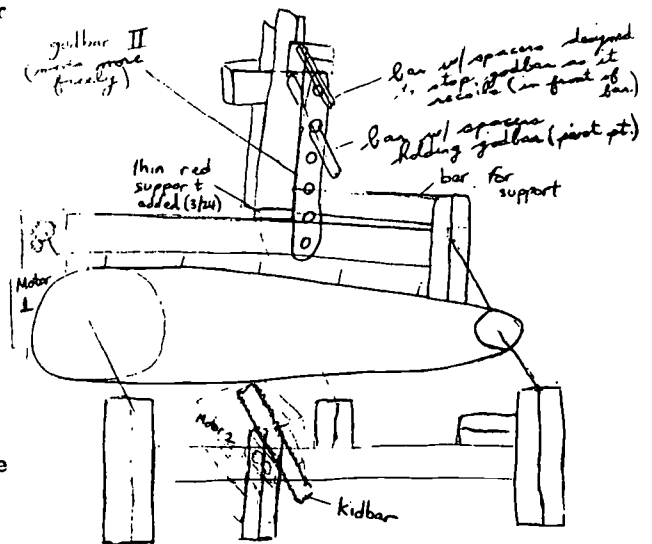
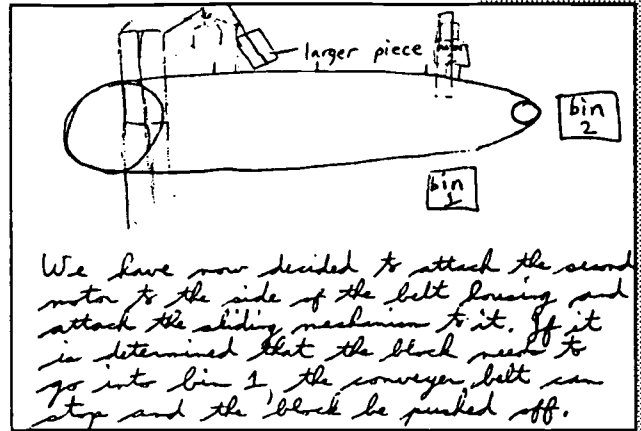

Wiring Diagram for Interface Inputs/Outputs

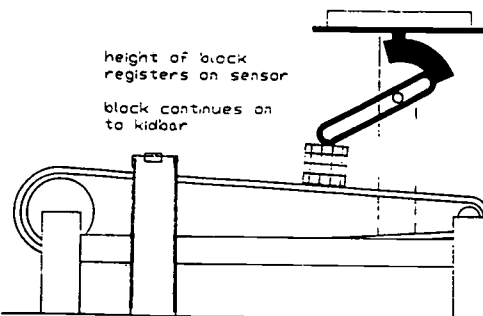
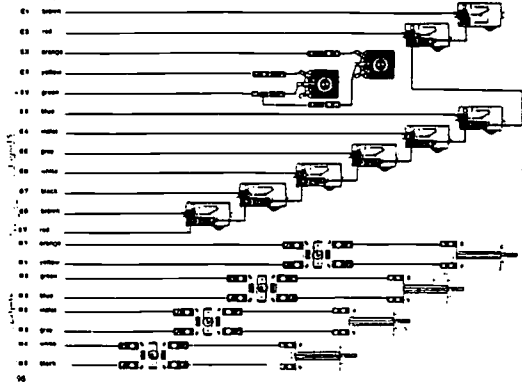

NEW YORK STATE EDUCATION DEPARTMENT  
ALBANY, NEW YORK 12234

NON-PROFIT ORG.  
U.S. POSTAGE  
PAID  
Albany, NY  
Permit No. 293

BEST COPY AVAILABLE



**U.S. DEPARTMENT OF EDUCATION**  
*Office of Educational Research and Improvement (OERI)*  
*Educational Resources Information Center (ERIC)*



## NOTICE

### REPRODUCTION BASIS

This document is covered by a signed "Reproduction Release (Blanket)" form (on file within the ERIC system), encompassing all or classes of documents from its source organization and, therefore, does not require a "Specific Document" Release form.

This document is Federally-funded, or carries its own permission to reproduce, or is otherwise in the public domain and, therefore, may be reproduced by ERIC without a signed Reproduction Release form (either "Specific Document" or "Blanket").