

ED 398 683

EC 304 975

AUTHOR Swan, William W., Ed.; Brown, Carvin L., Ed.  
 TITLE The Georgia Psychoeducational Network (GPN) Research Report, 1992.  
 INSTITUTION Georgia Psychoeducational Network.; Georgia State Dept. of Education, Atlanta.; Georgia Univ., Athens.  
 PUB DATE 92  
 NOTE 55p.; Published annually. For other reports in this series, see EC 304 971-976.  
 AVAILABLE FROM Alpine Psychoeducational Program, P.O. Box 2459, Gainesville, GA 30501 (\$5).  
 PUB TYPE Reports - Research/Technical (143) -- Collected Works - Serials (022)  
 JOURNAL CIT GPN Research Report; n5 1992  
 EDRS PRICE MF01/PC03 Plus Postage.  
 DESCRIPTORS Academic Achievement; \*Autism; Behavior Development; \*Behavior Disorders; \*Computer Oriented Programs; Developmental Stages; Disability Identification; Elementary Secondary Education; \*Emotional Disturbances; Followup Studies; Interpersonal Competence; Leadership Qualities; \*Leadership Responsibility; \*Locus of Control; Longitudinal Studies; Preschool Education; Program Costs; Reinforcement; Self Concept; Services; Student Characteristics; Student Development  
 IDENTIFIERS Georgia; \*Georgia Psychoeducational Network

## ABSTRACT

This research report includes articles on students, leadership, and technology related to the Georgia Psychoeducational Network (GPN), which serves students with severe emotional disturbances or behavior disorders. "The Relationship of Locus of Control of Reinforcement to Indicators of Student Growth in Academic, Behavioral, and Social Areas" (Patricia Hinely and Stephen Nowicki, Jr.) reports on a study examining the relationship between locus of control orientation, ego status, achievement, and developmental levels of 108 children in GPN programs. "Descriptive Examination of Students with Autism and the Services Available in the Georgia Psychoeducational Network, 1989-1990" (Robert A. Gordon and others) describes characteristics of 375 students with autism and the services provided to them. "Longitudinal Cost Study of Preschool Children with Severe Emotional Disabilities" (Barbara Ann Brown Geter) reports on a follow-up study of the cost of providing services over 11 years to 15 children with severe emotional disabilities identified as preschoolers. "Why Can't We Stay the Same? Or The Shift is On!: Paradigm Shifts and Proactive Leadership Strategies" (William W. Swan and Carvin L. Brown) discusses 10 proactive educational leadership strategies. "Enhancing Communication Through Computers in the Southwest Psychoeducational Program" (Richard Swenson) examines development of a computer system in a rural Georgia area. In "Converting from Pen and Paper to Computerized Records and Communication--A Challenging Task," Wayne Moffett describes hardware and software, training, and implementation of a regional computer system. (Most papers contain references.) (CR)

ED 398 683

# GPN RESEARCH REPORT

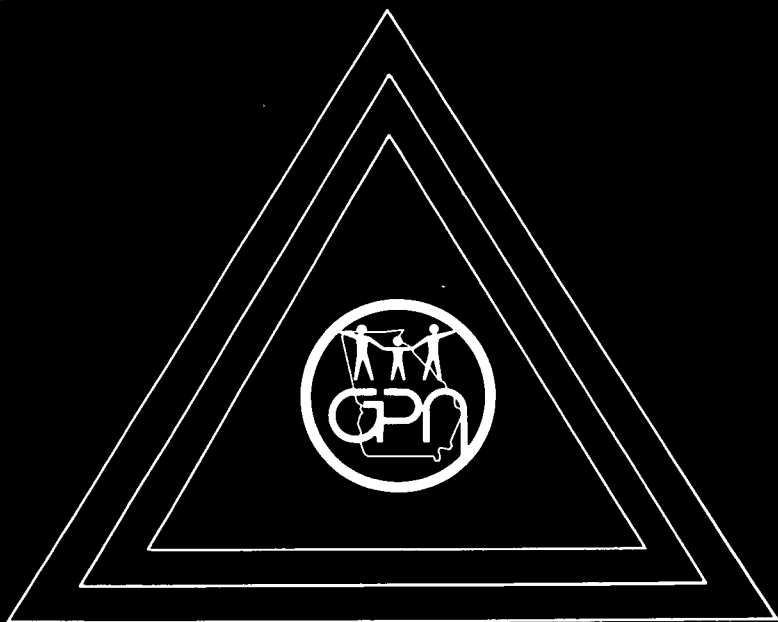

**BEST COPY AVAILABLE**

GPN Research Report  
5, 1992



PERMISSION TO REPRODUCE AND  
DISSEMINATE THIS MATERIAL  
HAS BEEN GRANTED BY

*W. Swann*

TO THE EDUCATIONAL RESOURCES  
INFORMATION CENTER (ERIC)

*Editors*

William W. Swan, University of Georgia  
Carvin L. Brown, University of Georgia

*Associate Editors*

Joan A. Jordan, Georgia Department of Education  
Phillip H. Pickens, Georgia Department of Education  
Mary M. Wood, University of Georgia

*Assistant Editors*

C. Thomas Holmes, University of Georgia  
M. Carolyn Combs, Rutland Center

*Network Program Effectiveness Committee*

Wayne Moffett (Chair), David Craddock, Patricia Hinely, Robert T. Jacob, Elizabeth Bell  
LeClair, Glenda Molton, Juanda Ponsell, Richard Swenson

*Directors, Georgia Psychoeducational Network Programs*

George Andros, Child Development, Dalton  
Jim Bachrach, Oak Tree, Albany  
Brenda Bedford, Oconee Area, Milledgeville  
David Craddock, Burwell, Carrollton  
David Fallin, Flint Area, Cordele  
Harry Goodwin, Sand Hills, Augusta  
Robert Gordon, South Metro, Atlanta  
Harry Hamm, Comprehensive Psychoeducational Program, Valdosta  
Patricia Hinely, Chatham-Effingham, Savannah  
Molly Howard, Ogeechee Area, Midville  
Robert T. Jacob, Rutland, Athens  
Judy Kelley, Cedarwood, Collins  
Elizabeth Bell LeClair, Middle Georgia, Macon  
Al Manning, Heart of Georgia, Dublin  
Glenda Molton, DeKalb-Rockdale, Scottdale  
Wayne Moffett, Alpine, Gainesville  
Martha Patton, Northwest, Rome  
Juanda Ponsell, Crossroads, Griffin  
Michael Powell, Cobb-Douglas  
William H. Rivenbark, Jr., Harrell, Waycross  
Richard Swenson, Southwest Georgia, Ochlocknee  
Kenneth Wallin, Golden Isles, Brunswick  
Larry Weiner, North Metro Atlanta  
Homer Wells, Woodall, Columbus

The GPN RESEARCH REPORT is published by a consortium of the Georgia Psychoeducational Network, the Georgia Department of Education, and The University of Georgia to serve the needs of those who educate severely emotionally disturbed and severely behaviorally disordered students in Georgia. The emphasis is on both quantitative and qualitative research in all areas of operation of the Programs.

**ORDERING INFORMATION:** Individuals who wish to receive the GPN RESEARCH REPORT should contact: Dr. Wayne Moffett, Director, Alpine Psychoeducational Program, P.O. Box 2459, Gainesville, Georgia, 30501. Copies of the GPN RESEARCH REPORT are \$3.00 each. Checks should be made payable to Pioneer RESA.

Funding for the development and production of this document was provided through a project under P.L. 102-119 (Part B) of The Individuals with Disabilities Education Act (IDEA) as amended by P.L. 102-119, The Individuals with Disabilities Education Act Amendments of 1991, signed October 7, 1991.

However, the contents do not necessarily represent the policy of the U.S. Department of Education and no endorsement by the Federal Government should be inferred.



RESA does not discriminate on the basis of race, color, religion, national origin, sex, age, or handicap.

# GPN Research Report, 5, 1990-1991

## The Georgia Psychoeducational Network (GPN) Research Report

### Table of Contents

#### Students:

The Relationship of Locus of Control of Reinforcement to Indicators of Student Growth in Academic, Behavioral, and Social Areas <i>Patricia Hinely and Stephen Nowicki, Jr.</i>	1
Descriptive Examination of Students with Autism and the Services Available in the Georgia Psychoeducational Network, 1989-1990 <i>Robert A. Gordon, Carolyn Riley Baker, Elaine K. Brown, Annette Chambers, Gloria Duncan-Boyer, Anna Elizabeth Farrell, Beverly Gratigny Gray, and Joann M. Middlebrooks</i>	9
Longitudinal Cost Study of Preschool Children with Severe Emotional Disabilities <i>Barbara Ann Brown Geter</i>	17
<b>Leadership:</b>	
Why Can't We Stay the Same? or The Shift is On!: Paradigm Shifts and Proactive Leadership Strategies <i>William W. Swan and Carvin L. Brown</i>	31
<b>Technology:</b>	
Enhancing Communication Through Computers in the Southwest Psychoeducational Program <i>Richard Swenson</i>	39
Converting from Pen and Paper to Computerized Records and Communication--A Challenging Task <i>Wayne Moffett</i>	47

# Dedication

This fifth volume of the GPN Research Report is dedicated to James C. Flanagan, M.D. Jim served as the consulting child psychiatrist to many of the programs in the Georgia Psychoeducational Network from the inception of the Network in 1971 until his death on May 14, 1991.

Jim was an outstanding child psychiatrist, a teacher, a leader in the mental health field, an advocate for quality mental health services in Georgia, a mentor to many staff members in the Network, and above all a friend to many people who serve children — physicians, psychologists, teachers, and parents.

Jim's impact was significant — he began the child psychiatry program at Emory University, was influential in getting school psychology programs in Georgia, opened the Children's Unit at the Georgia Mental Health Institute, was the consulting psychiatrist at Rutland Center from its beginning in the late 1960's, and served many of the psychoeducational programs in Georgia.

His vision of comprehensive services to children and adolescents in Georgia, his commitment to the mission of creating or stimulating these services regardless of perceived barriers, and his passion for children and life serve as a model to each of us as we continue to pursue his most vibrant mission.

Jim will be missed by many — his vision will guide us for years to come.

# The Relationship of Locus of Control of Reinforcement to Indicators of Student Growth in Academic, Behavioral, and Social Areas

Patricia Hinely  
*Chatham-Effingham Psychoeducational Program*

Stephen Nowicki, Jr.  
*Emory University*

*The purpose of the study was to determine the relationship among assessed locus of control orientation and ego status, achievement, and developmental levels of students in psychoeducational treatment programs. Children between the ages of 6 and 17 years of age completed locus of control scales in the fall of 1988, the spring of 1989, and the fall of 1989. Ratings of ego status, stage within Wood's developmental framework and level within adolescents' level system, and Peabody academic achievement scores were obtained from records. It was predicted and found that higher internal control expectancies were related to higher ego status, higher stage and level rankings, and higher academic achievement. Implications for program planning and intervention are discussed.*

Directors of psychoeducational programs have reported that their greatest need is to provide instructionally effective programs and services that promote student growth in three areas — academic, behavioral, and social (Swan, et al., 1989). The search for ways to promote improvement in these three areas has become even more important as both the number of children and adolescents served by the psychoeducational programs and the severity of their disturbance continue to increase.

The search should include the examination of constructs from education, psychology, psychiatry, and medicine that might help to organize, guide, and evaluate treatment interventions. To be eligible for consideration a construct ought to reflect the *major goals* of the psychoeducational approach such as helping children gain appropriate control over their behavior, achieve up to their abilities, and develop supportive friendships. It would be an added bonus if the construct is part of a larger theoretical system, because then it also might help to generate additional ways of assessing, treating, and evaluating the severely disabled children and adolescents who are served through the psychoeducational network.

The locus of control of reinforcement (LOC) is one such potentially helpful construct that may help reflect selected psychoeducational goals. It has been defined by Rotter (1966) in his social learning theory as: "When a reinforcement is perceived by the subject as following some reaction of his own but not being entirely contingent upon his action then, in our culture, it is typically perceived as the result of luck, chance, fate, as under the control of powerful others, or as unpredictable because of the great complexity of the forces surrounding him. When the event is interpreted in this way by an individual, we have labelled this a belief in external

control. If the person perceives that the event is contingent upon his own relatively permanent characteristics, we have termed this a belief in internal control (p. 1)."

The construct of locus of control has been the source of nearly four thousand studies whose results attest to its importance across many fields of human behavior, but especially in education and psychology (Lefcourt, 1976, 1981, 1983, 1984). Generally, what researchers have found is an impressive constellation of positive characteristics in the achievement, behavior, and social areas that are associated with internal control expectancies and an equally impressive constellation of negative characteristics and behaviors related to external control expectancies. These findings are summarized by Crandall and Crandall (1983): "Although there are clearly some exceptions in particular studies, perceptions of internal control, compared to perceptions of external control, are generally found to facilitate (a) more active search of the environment for information relevant to salient goals, superior cognitive processing and recall of that information, and more incidental as well as intentional learning; (b) more spontaneous engagement in achievement activities, selection of more challenging tasks, and better ability to delay gratification and to persist under difficulty; (c) higher levels of academic and vocational performance and more positive achievement-related attitudes; (d) more attempts to prevent and remediate health problems; (e) better interpersonal relationships, more assertiveness toward others, and more liking and respect from others, despite greater resistance to their influence; and (f) better emotional adjustment (higher self esteem, better sense of humor, less anxiety, less depression, less severe psychiatric diagnoses, etc.) and greater reported life satisfaction and contentment."

Consistent with these findings, Thomas (1973), using the Nowicki-Strickland locus of control scale, found that external control expectancies characterized the nearly 7,000 children he surveyed from mental health settings in Georgia. Further, research reported by others suggests strongly that the more severe the forms of psychopathology the greater the tendency toward external control expectancies (e.g., Carlton, 1979; Duke & Mullens, 1973; Nelson, Finch, Montgomery, & Bristow, 1975).

To establish the usefulness of the locus of control construct in psychoeducation, its relationship to three important indicators of performance and status within psychoeducational programs (behavior levels placement, ego status, and academic achievement) must be determined. First, behavioral levels systems that are used in most psychoeducational programs appear to provide a framework for reflecting the growth of independence and responsibility (or in Bauer and Shea's (1988) terms, expectation and privilege) in children and adolescents. Most behavioral levels systems include three or four levels (Mastropieri, Jenne, & Scruggs, 1988) that reflect an ever increasing amount of independence and responsibility and a disciplinary level reserved for children and adolescents who are given little or no freedom. (This level has been called the "D" for disciplinary level or "S" for safety level depending on the program's perspective about the function of this level.) Hopefully, although it is not stated explicitly in most levels systems, the levels placement is assumed to reflect changes that are taking place within the children and adolescents (Bauer et al., 1986; Doyle & Carter, 1984) and not just changes in behavior that will hold while they are in the supportive structure of a psychoeducational program. It is our belief that if internal changes do not take place and become more stabilized, then when children and adolescents leave the structure of the psychoeducational program they will soon revert back to the old disordered patterns of thinking and behaving.

Based on the definition of the construct of locus of control and the set of findings associated with it, we suggest that the psychoeducational stages developed by Wood (Wood, Combs, Gunn, & Weller, 1986) and the numerous levels systems presently in use within the psychoeducational network can be viewed as ways to assess and to track changes in control expectancies from inappropriate external control expectancies to more appropriate internal ones.

In addition to levels placement, if locus of control is to be seen as a useful construct within psychoeducational programs then internal control expectancies also should be related to cognitive functioning as measured by ego status and academic achievement. Ego status (Hinely, 1988) reflects the degree to which children use reality based coping mechanisms to deal with environmental problems as opposed to reflexive, impulsive, and defensive operations. As described, higher ego status should be related to internal control expectancies and external control expectancies should be related to more reflexive attempts to react.

Lastly, on a more specific cognitive level, internal control expectancies also should be related to greater academic achievement. This has been found by previous researchers (e.g., Nowicki & Duke, 1983) and should be reflected by progress through the levels systems as well.

To summarize then, in the present study, we evaluated the usefulness of locus of control of reinforcement for evaluating the status of students with serious emotional disabilities in psychoeducational settings by predicting the following relationships:

(1) If locus of control is to be a useful construct for educators working within the psychoeducational network, it should be related to important indicators of children's and adolescents' progress in the program, such as behavioral levels placement, ego status, and academic achievement. We predict that internal control expectancies will be related to higher measured ego status, higher levels placement, and greater academic achievement.

(2) Locus of control should reflect progress in the psychoeducational treatment program. Therefore, it is predicted that subjects' perception of control expectancies will become more internal during their time in the program.

(3) In addition, when subjects are no longer part of the psychoeducational program in which they are being helped to develop internal control expectancies, such as over summer vacation, and are placed in environments that do not facilitate the growth of internal control expectancies, they will develop greater external control expectancies. Therefore it is predicted that from fall to spring subjects will show an increase in internal control expectancies and between spring and fall, they will show a decrease in internal expectancies.

## Method

### *Subjects*

The subjects were 108 students served in the Chatham-Effingham Psychoeducational Program. They ranged from 6 to 17 years of age (children and adolescents) with a mean age of 12.78 years. There were 79 boys (47 white and 32 black) and 29 girls (16 white and 13 black). All students were served in the program during the period of time from the fall of 1988 to the fall of 1989.



## Measures

**Locus of Control of Reinforcement.** Locus of control was assessed by the Nowicki-Strickland Internal-External control scale (Nowicki & Strickland, 1973) Nowicki & Duke, 1983; Nowicki, 1989). Items ( $n = 40$ ) are answered "yes" or "no". Reading level is set at third grade. Construct validity is provided for the scale by the nearly 600 studies that have used it.

**Levels Standing.** For adolescents, the placement at one of four behavioral levels was taken at the end of the school year and used as the measure for levels standing for this study. The Chatham-Effingham behavioral levels system, like most of those used elsewhere (e.g., Doyle & Carter, 1984) reflects responsibilities and privileges associated with each level from "S" or safety level where students who exhibit extremely irresponsible behavior are placed to "3" where students are eligible to work on personal goals related to mainstreaming in a less restrictive environment. For children, placement in Stage I, Stage II, or Stage III was made on the basis of Wood's (1986) definition of abilities in the areas of behavior, communication, socialization, and academic skills. This is a system that is used throughout the psychoeducational network; higher stage placement reflects the ability of children to perform better cognitively and relate in a cooperative way.

**Ego Status.** This construct is based on the theory of ego development. The ego is defined as the main planning, perceiving, and reasoning part of the personality. Based on the assumption that the external environment impacts on the development of the individual, it is assumed that a negative or positive growth enhancing environment would produce different kinds of ego development. In evaluating the "ego status" of individuals the developmental history is important. Social histories provide information of the critical developmental period ranging from the first through the third years. Traumas and disruptions can retard ego status growth resulting in difficulties in logical thinking, delay of gratification, and impulsivity.

Clinical-educational evaluations were the source of information used to assess ego status. Nine areas of information were used to rate where the subject fell along a continuum of ego status anchored at one end by ego strength (good ego) and at the other by ego weakness (poor ego):

- (1) The ability to express feelings;
- (2) the ability to interpret external stimuli;
- (3) the ability to anticipate consequences of behavior;
- (4) the ability to delay gratification and control impulses;
- (5) the ability to be reflective;
- (6) the adequacy of cognitive coping mechanisms;
- (7) responsiveness to stress;
- (8) the ability to plan and solve problems;
- (9) the ability to adjust to different environments.

For the present study, the rating of ego status was made after raters ( $n = 3$ ) examined clinical case information. When raters disagreed on a rating for a particular subject, discussion was used to resolve the discrepancy. Raters had no knowledge of subjects' locus of control orientation.

**Academic Achievement.** The Peabody Individual Achievement Test-Revised (PIAT-R, 1987) was used to assess the reading and math academic achievement of children and adolescents. Standardizations and norms are extensive and representative. For the present study, scores from the Reading Recognition, Math, and Reading Comprehension subtests were used. These tests have shown adequate internal consistency and test-retest reliability and

extensive evidence of construct validation involving developmental changes, correlations with other tests, and factor analyses.

### Procedure

Levels placement and stages as well as PIAT-R scores were obtained for each student from school records. Locus of control items were read aloud to students either individually or in small groups to obtain these data from each subject.

## Results

Table 1 presents the correlations between locus of control scores and indices of behavioral, academic, and social standing in the psychoeducational program for three different time periods--fall 1988, spring 1989, and fall 1989. It can be seen that there is support at all three time periods for the first prediction that internal locus of control is related to higher ego status (ranging from  $r = .36$  to  $r = .41$ ), higher levels rating (ranging from  $r = -.32$  to  $r = -.48$ ), and higher academic achievement ( $r = -.24$  to  $r = -.58$ ). Twenty-eight of the thirty correlations are significant at the .05 level.

The mean locus of control scores for children and adolescents who were part of the psychoeducational program and completed scales in the fall of 1988, the spring of 1989, and the following fall of 1989 were subjected to a one-way analysis of variance. The results of this one way analysis of variance provided support for the second prediction ( $F(2,58) = 5.44, p < .05$ ). Paired comparisons indicated that locus of control scores became significantly more internal when fall and spring testing were compared (mean for fall = 19.78; mean for spring

**Table 1**

**Correlations Between Locus of Control Scores of Students Served at the Chatham-Effingham Psychoeducational Program and Ego Status (ES), Ranking of Level of Development (LOD), and Peabody Achievement Test Scores in Reading Recognition (PIAT, RR), Reading Comprehension (PIAT-RC), and Math (PIAT-M)**

Indicators	LOC-88, Fall	LOC-89, Spring	LOC-89, Fall
ES	.37	.41	.36
LOD-Fall, 1988	-.32	-.39	-.47
LOD-Spring, 1989	-.32	-.40	-.36
LOD-Fall, 1989	-.49	-.42	-.48
PIAT-RR-Fall, 1988	-.33	-.32	-.36
PIAT-RC-Fall, 1988	-.24 <sup>a</sup>	-.35	-.29 <sup>a</sup>
PIAT-M-Fall, 1988	-.45	-.46	-.58
PIAT-RR-Fall, 1989	-.45	-.31	-.31
PIAT-RC-Fall, 1989	-.43	-.33	-.27
PIAT-M-Fall, 1989	-.49	-.47	-.48

<sup>a</sup>Significant at the  $p < .10$  level. All other correlations significant at the  $p < .05$  level.

= 15.67). Further, as was predicted, students were more external in the following fall (mean = 17.89) as compared to the preceding spring (mean = 15.67) testing. Students were able to maintain an overall change toward internality when the differences between fall of 1988 (mean = 19.78) and fall of 1989 (mean = 17.89) were examined.

## Discussion

The results of the present study support the possible usefulness of the construct of locus of control of reinforcement to reflect the functioning of students within psychoeducational programs. Internally controlled students were more likely to have higher ego status, higher levels placement, and higher academic achievement scores. These prime indicators of positive progress in the psychoeducation system are consistent with the promotion of student growth in the behavior, achievement, and social areas advocated by the directors of the psychoeducational programs (Swan, et al., 1989). The association between locus of control scores and indicators of positive progress in psychoeducational programs suggests that changing locus of control expectancies might impact on important areas of student growth, or that locus of control might be able to function as a summary indicator of progress toward achievement, behavior, and/or social goals.

It is especially noteworthy that progress toward greater internal control expectancies also was associated with time spent in the psychoeducational programs and conversely that movement toward greater external control expectancies was associated with time away from treatment programs. This suggests that locus of control is malleable and vulnerable to both positive and negative environmental influences. It would be interesting to see if longer time spent in the program makes shifts toward internality more resistant to change. Moreover, it would be important as well to see what, if any, activities over the summer would help children and adolescents to maintain their internal control expectancies and further what activities would help facilitate their recoupment of internal control expectancies when they return to the psychoeducational program in the fall.

Finally, it appears that the ego status measure is assessing an important source of variance in children and adolescents' behavior. Conceptually it is assumed to be more fixed than is locus of control orientation and the use of both may give educators in the psychoeducational network a firmer grasp on the potential for change in the children and adolescents with severe emotional disabilities.

## References

- Bauer, A.M., & Shea, T.M. (1988). Structuring classrooms through levels systems. *Focus on Exceptional Children*, 21(3), 1-12.
- Bauer, A.M., Shea, T.M., & Keppler, R. (1986). Levels systems: A framework for the individualization of behavior management. *Behavioral Disorders*, 11, 28-35.
- Carlton, R.J. (1979). A comparative study of locus of control between regular class students and emotionally handicapped students within self-contained classes in elementary, middle, and high school. *Dissertation Abstracts International*, 40, 1353A.
- Crandall, V.C., & Crandall, B.W. (1983). Maternal and childhood behaviors as antecedents of internal-external control perceptions in young adulthood. In H. Lefcourt (Ed.), *Research with the locus of control construct*, Volume 2. New York: Academic Press.

- Doyle, W., & Carter, K. (1984). Academic tasks in classrooms. *Curriculum Inquiry, 14*, 129-149.
- Duke, M.P., & Mullens, C. (1973). Interpersonal distance as a function of locus of control in hospitalized schizophrenics and nonschizophrenics. *Journal of Consulting and Clinical Psychology, 41*, 230-234.
- Hinely, P. (1988, August). The concept of ego strength in the treatment of severely emotionally disturbed children. Twelfth Annual Meeting of the Georgia Psychoeducational Network, St. Simons, GA.
- Lefcourt, H.M. (1984). *Research with the locus of control construct*, Volume 3. New York: Academic Press.
- Lefcourt, H.M. (1983). *Research with the locus of control construct*, Volume 2. New York: Academic Press.
- Lefcourt, H.M. (1981). *Research with the locus of control construct*, Volume 1. New York: Academic Press.
- Lefcourt, H.M. (1976). *Locus of control: Current trends in theory and research*. Hillsdale, NJ: Erlbaum.
- Mastropieri, M.A., Jenne, T., & Scruggs, T.E. (1988). A level system for managing problem behaviors in a high school resource program. *Behavioral Disorders, 13*, 202-208.
- Nelson, W.W., III, Finch, A.J., Montgomery, L.E., & Bristow, A. (1975). Locus of control and locus of conflict in emotionally disturbed and normal children. *Psychology, 12*, 27-31.
- Nowicki, S. (1989). *The manual for the children's internal-external control scale*. Atlanta: Department of Psychology, Emory University.
- Nowicki, S., & Duke, M.P. (1983). The Nowicki-Strickland life-span locus of control scale: Construct validation. In H. Lefcourt (Ed.), *Research with the locus of control construct*, Volume 2: New York: Academic Press.
- Nowicki, S., & Strickland, B.R. (1973). A locus of control scale for children. *Journal of Consulting and Clinical Psychology, 40*, 148-154.
- Rotter, J.R. (1966). Generalized expectancies for internal versus external control of reinforcement. *Psychological Monographs, 80* (1, No. 609).
- Swan, W.W., Brown, C.L., Combs, C., Pickens, P.H., Ponsell, J., & Weiner, L. R. (1989). Leaders views of effective leadership in GPN programs. *GPN Research Report, 4*, 35-45.
- Thomas, G.A. (1973). A baseline evaluation of child-caring institutions in Georgia. Athens, GA: Regional Institute for Social Welfare Research, School of Social Work.
- Wood, M.M., Combs, C., Gunn, A., & Weller, D. (1986). *Developmental therapy in the classroom* (2nd Edition). Austin, TX: Pro-Ed.

# **Descriptive Examination of Students with Autism and the Services Available in the Georgia Psychoeducational Network, 1989-1990**

**Robert A. Gordon**  
*Mercer University*

**Carolyn Riley Baker**  
**Elaine K. Brown**  
**Annette Chambers**  
**Gloria Duncan-Boyer**  
**Anna Elizabeth Farrell**  
**Beverly Gratigny Gray**  
**Joann M. Middlebrooks**

*South Metro Psychoeducational Program\**

*The 24 programs which comprise the Georgia Psychoeducational Network (GPN) responded to questionnaires related to students with a DSM III-R diagnosis of 299.00 or 299.80 who received services in GPN therapeutic classes and/or community programs during 1989-1990. The information requested included diagnosis, key behaviors at onset, placement services provided, age range, and prescribed medications. Information obtained on the 375 students in the sample for this study was compared to other research in the field. The descriptive information expands the current data base on severely impaired students with autism currently being served by the GPN.*

Previous literature and program planning and refinement efforts indicate there is a need for continued examination of programs for students with autism (Gordon, Busbee, Cook, Heninger, & Kennedy, 1989). The purpose of this study was to further review the types of students who are severely impaired with autism in the Georgia Psychoeducational Network (GPN) and those services available to them in Georgia for 1989-1990. The results were compared with other research including the prior work in Georgia by Gordon, et al. (1989).

---

\*This study was completed as part of a course offered at Mercer University for these students.

## Method

### Questionnaire

Statistical information was obtained from questionnaires completed by the 24 GPN programs. The response rate was 100%. The questionnaires focused on students with a DSM III-R diagnosis of 299.90 or 299.80 who received services in GPN therapeutic classes and/or community programs in fiscal year 1989-1990. The data included diagnosis, key behaviors at onset, placement information, age range, and prescribed medications.

### Sample

The sample for this study included 375 students (ages birth through 21 years) with the specified DSM-III-R diagnoses who were served in GPN programs and/or in the community. This age range is used consistent with the requirements of the Individuals with Disabilities Education Act (IDEA, 1990) and the Quality Basic Education Act (1985 as amended) for serving students with disabilities.

## Results

As Table 1 indicates, GPN programs served a total of 375 students who are severely impaired with autism during 1989-1990. Considering age ranges, a total of 58 preschool (birth-5 years 11 months), 255 school age (6 years 0 months-14 years 11 months), and 62 adolescent (15 years 0 months-18 years 11 months) students who are severely impaired with autism were served. Comparing these data to those from a prior study (Gordon, et al., 1989) revealed that the number of students who are severely impaired with autism who were served had increased 35% with the greatest increase occurring in the school age category. This increase may be attributed partially to preschool students progressing from home-based programs to specialized classrooms during the year. Additional investigation of reasons for this increase should be conducted. This is supported by an increase of 21 classrooms for students who are severely impaired with autism in the network since 1988-1989.

Estimates for the number of individuals with autism vary. Zahner and Pauls (1987) used diagnostic criteria in defining autistic cases and reported that classic forms occur at a rate of 2.0 per 10,000 individuals. They also found that cases with broader features of autism occurred

**Table 1**  
**Age Comparisons of Autistic Students Served in the GPN in 1988-1989 and 1989-1990**

Age Group	1988-1989	1989-1990
Preschool (Birth-5,11)	38	58
School Age (6,0-14,11)	158	255
Adolescent (15,0-18,11)	46	62
Total	242	375

at a rate of from 4.0 to 5.0 per 10,000 individuals. Regarding individuals exhibiting characteristics of autism who can be classified as severely impaired, Rimland (1980) provided a more conservative estimate of from .2 to .5 per 10,000.

Considering that the total preschool through adolescent population (3 years 0 months through 21 years 11 months) is 1,331,593 (Georgia Department of Labor, 1990), the GPN programs served between 56% (the more liberal estimate—5.0/10,000) and 141% (more conservative estimate—2.0/10,000) of the number of students who might need services in Georgia.

### *Behaviors Signifying Onset of Problems*

Twenty-two of the GPN programs provided information concerning those student behaviors which resulted in their being referred for services. Seven behaviors which were most commonly associated with a diagnosis of autism based on the DSM III-R and work by Shreibman (1988) were selected:

1. Abnormalities in development of cognitive skills
2. Abnormalities of posture/motor behavior such as stereotypes (e.g., arm flapping, jumping, grimacing)
3. Odd responses to sensory input (e.g., ignoring some sensations, communication problems)
4. Abnormalities in eating, drinking, or sleeping
5. Abnormalities of mood (e.g., labile mood, giggling or weeping for no apparent reason, absence of emotional reactions, lack of fear of real danger)

**Table 2**  
**Ranking of Key Behaviors Signifying Onset of Problems (n = 22 Programs)**

Key Behaviors	Rank						
	(1)	(2)	(3)	(4)	(5)	(6)	(7)
Abnormalities in development of cognitive skills	9	6	3	4	0	0	0
Abnormalities of posture/motor behavior	8	4	4	3	2	1	0
Odd responses to sensory input	3	6	4	5	2	1	1
Abnormalities in eating, drinking, or sleeping	0	2	0	4	6	7	3
Abnormalities of mood	0	4	8	5	3	1	1
Self-injurious behavior	1	0	3	0	6	10	2
Mental depression	1	0	0	1	3	2	15

6. Self-injurious behavior (e.g., head banging, finger or wrist/hand biting)
7. Mental depression.

Each of these seven problems was ranked on a seven point scale — 1 = most common; 7 = least common. Table 2 contains the summary rankings of key behaviors resulting in referral of these students for services. Abnormalities in development of cognitive skills, abnormalities of posture/motor behavior, and unusual responses to sensory input and abnormalities of mood were ranked as the top three most common problematic behaviors. The least common behavior was mental depression which is a behavior frequently observed in pre-pubescent adolescents with autism (Paul, 1987), but is not commonly seen in the literature on autistic children. Very few of these students exhibited all of these behaviors.

### Placements

*Factors Influencing Placement.* The placement for each student was determined by the IEP Placement Committee based on student needs and strengths. Each placement was individualized for each child and emphasized placement in the least restrictive environment. The responses to the questionnaires indicated that the top two factors influencing placement for these students were the severity of the student's disability and the student's level of functioning. Schopler (1988) recommended that placements should be in the least restrictive environment with sufficient structure to maintain the attention span of students who are severely impaired with autism and to foster developmental growth. Schopler did not describe placements by the same influencing factors as the questionnaires. Factors cited by Schopler (1988) that had little or no influence on the placements of these students included the presence of splinter skills, toilet training, and language deficits.

*Placement by Age Groups.* Placements of these students by age group are displayed in Table 3. Preschool, school age, and adolescent students were served in three delivery modes — half day classes (2 to 3 hours per day); full day classes (6 hours per day); and other direct service alternatives (e.g., school-based programs with regular classes, behavior disorders resource or self contained classes, or moderately mentally handicapped classes; community based programs; home based programs), all of which were assisted by GPN personnel.

Approximately one-half ( $n = 30$ ) of the preschool students were placed in half-day programs with the other half ( $n = 28$ ) being served through home based programs and other

**Table 3**  
**Placement by Age Groups in 1989-1990 ( $n=375$  Students)**

Placement Type	Preschool	School Age	Adolescents
Half Day	30	106	0
Full Day	0	149	62
Other*	28	0	0
Totals	58	255	62

\*Direct services and home programs



direct services. About 40% (n = 106) of the school age students were served in a half day program which consisted of a minimum of two hours of specialized classroom instruction. The remaining four hours of instruction were provided in regular classrooms supported by GPN staff emphasizing more normalized settings with peer models, assistance in accessing materials, or developing materials, and teacher training concerning techniques and activities.

The remaining school age students (n = 149) received full day GPN services. All of the adolescents (n = 62) were served in full day GPN programs. According to Schopler (1988), students with autism need small, specially structured classrooms, with teachers trained not only in behavior modification but in teaching vocalization, communication, and socialization skills. These students are served in classrooms characterized by these descriptors.

*Alternative Placements/Services.* For 71 students, the 24 GPN programs reported using several alternative placements/services in addition to the therapeutic classes they provided. As indicated in Table 4, 15 students received respite care; 21 received joint public school placements; 5 were placed in residential programs; 11 were provided home training; 13 received home training for parents and/or family members; 6 were provided camp or other leisure services.

While regular classes were used as placements for several of these students, the majority of programs reporting the use of this placement indicated that these students were usually served in classes for the moderately mentally handicapped based most often on functional level. Three times as many of these students were jointly placed in public school classes and GPN program classes in rural areas as in urban areas. This may be due to location of GPN classes in rural areas, cultural factors, transportation factors, and other unique factors.

It was found that the use of other alternative placements and services appeared to be based on unique local resources. For example, services from the Department of Human Resources appeared to be available in some areas but not in others. Seven GPN programs reported using respite care services, five linked families with mental health services, and four reported referring families to DHR facilities for some form of family counseling. These services were not used on a systematic basis throughout the state however.

**Table 4**  
**Alternative Placements for Autistic Students in 1989-1990 (n = 71 Students)**

Placement	Urban	Rural
Respite care	6	9
Public school classes	5	16
Residential programs	2	3
Home training (students)	5	6
Home training (families)	6	7
Other	3	3
Totals	27	44

*Duration of Services.* The average length of GPN services for the 375 students who are severely impaired with autism at the end of the 1989-1990 school year was 7 years, 4 months. The projected length of placement in GPN programs for these students ranged from four years (reported by seven programs) to 16 years (reported by four programs). Twelve of the 24 GPN programs report that they project services to these students throughout their enrollment in public schools. There is very little literature on length of placement for students such as these with which to compare these results. Part of the reason may be that comprehensive services have not been universally available and, many of these students were historically placed in programs for mentally retarded students in order to find special public school placements (Schopler, 1988).

### *Prescribed Medications*

Of the 375 students who are severely impaired with autism served by the GPN programs, 74% received medications prescribed by physicians to help control problematic behavior. The data indicated that more students enrolled in rural GPN programs received Ritalin and Tegretol than those enrolled in urban programs. The other most often cited medications were distributed evenly across both urban and rural programs.

Table 5 portrays the number of citations by program for the drug categories most often indicated—tranquilizers, Ritalin, antidepressants, neuroleptics, antiserotonergics, and anticonvulsants. Table 6 indicates that the prescribed medications for these students were monitored by physicians, psychiatrists, mental health workers, and families with no specification of monitors in several cases. The majority of medications were monitored by either physicians (other than psychiatrists) or psychiatrists.

### *Graduation*

Seven of these students graduated in 1989-1990 (Georgia Department of Education, 1990). Five of the students were subsequently placed in DHR training center day programs, one student was enrolled in respite day care (private), and one student was reported to be unemployed and at home. None of the seven graduates were residing outside their homes. Two of the seven graduates were working in sheltered settings on a part time basis.

**Table 5**  
**Medication Profile for Students with Autism (n = 24 Programs)**

Categories of Medication	Number of Programs Reporting
Tranquilizer	22
Ritalin	15
Anticonvulsant	9
Antidepressant	8
Neuroleptic	8
Antiserotenergic	4

**Table 6**  
**Reported Primary Monitors of Prescribed Medications for Autistic Students**  
**Served in GPN in 1989-1990\***

Monitor	GPN Programs Reported	% Per Category**
Physician	12	37%
Psychiatrist	6	18%
Mental Health	6	18%
Family	5	15%
Not Specified	4	12%

\*Greater than 24 Programs because of multiple citations

\*\*Percent rounded

## Conclusions and Recommendations

These results indicate that the GPN programs serve from 56% (the liberal estimate of incidence) to 141% (the conservative estimate) of the projected number of severely impaired students with autism. The key behaviors signifying onset of problems include abnormalities in development of cognitive skills, abnormalities of posture and motor behavior, and unusual responses to sensory input. These results are consistent with other results in the literature. Placements vary depending on individual needs but GPN programs provide the majority of services to these students with other services provided in collaborative arrangements with the schools and other agencies. The array of services in a given locale depends on the unique strengths and resources available in that locale. The majority of these students who are placed in public school programs are placed in classes for the moderately mentally handicapped based in large part on the student's functioning level. The duration of services averages over 7 years as of 1989-1990 for these students. Twelve of the 24 GPN programs project to provide services to these students until their 22nd birthday.

The large majority of these students (74%) of these students are receiving prescribed medications. The majority of the monitoring of these prescribed medications is completed by physicians (other than psychiatrists) and psychiatrists.

While this study has responded to several questions from the Gordon et al., (1989) study, future examinations of students who are severely impaired with autism should include the following:

- Where are the students with autism not identified in this study being served? How many of them are there?
- Which agency (ies) at the state and/or local levels could most effectively provide respite care, group or therapeutic foster homes or alternative care for these students?
- Are there additional services offered to similar students and their families in other states which are not being offered in Georgia? If so, what are they and how could Georgia offer them?

## References

- Georgia Department of Education (1990, November). Interview with Georgia Department of Education Personnel.
- Georgia Department of Labor (1990, October). Interview with Georgia Department of Labor Personnel.
- Gordon, R., Busbee, T., Cook, J., Heninger, K., & Kennedy, A. (1989). An initial study to describe autistic children in the Georgia Psychoeducational Network. *GPN Research Report, 4*, 29-33.
- Individuals with Disabilities Education Act of 1990, P.L. 101-476 (The 1990 Education of the Handicapped Act Amendments). October 30, 1990.
- Paul, R. (1987). Natural history. *Handbook of Autism and Pervasive Developmental Disorders, 7*, 121-130.
- Quality Basic Education Act (1985). Georgia Department of Education, Atlanta.
- Rimland, B. (1980). Autism. *The World Book Encyclopedia, 1*, 913-914.
- Schopler, E. (1988). New developments in the definition and diagnosis of autism. *Advances in Clinical Child Psychology, 6*, 93-107.
- Schreibman, L. (1988). Autism. In *Developmental clinical psychology and psychiatry*. New Berry Park, NY: Saga Publications.
- Zahner, G., & Pauls, D. (1987). Epidemiological surveys of infantile autism. *Handbook of Autism and Pervasive Developmental Disorders, 12*, 199-207.

# Longitudinal Cost Study of Preschool Children with Severe Emotional Disabilities

Barbara Ann Brown Geter  
*Rutland Psychoeducational Services*

*This study used an ex post facto design in 1985-1986 to follow-up 37 children who in 1974-1975 were served as severely emotionally disturbed (SED) preschoolers 15 students were located. During this ten year period, from 3 to 8 students (38% to 63%) were served in special education each year. Fifty percent of those receiving special education services were classified as mild with 40% being classified as severe and 10% moderate. The most frequent disabilities were behavior disorders, behavior disorders/learning disabilities, and learning disabilities. There were a total of 15 instances of retention and 3 students were placed in residential settings. While there are constraints in the cost comparisons because of varying funding methods (APEG vs. QBE), the mean program weight (using QBE weights) for these 15 students was 1.907 which was significantly higher than the program weights for cohorts (comparison students) but less than the overall national estimated weight of 2.17 for all disabled students and less than the Category I (special education) weight under QBE. The results are discussed.*

The positive effects of early intervention with preschool children with disabilities are well documented in the literature (e.g., Bloom, 1976; Garwood, 1979; Hochleiter, 1977; Karnes, 1973; Karnes, Zehrbach, & Teska, 1974; Macy & Carter, 1980; Skeels, 1966). Recognizing the implementation of the mandates of P.L. 99-457, a growing number of preschool youngsters with disabilities and their families will receive specialized educational services in the coming years. While studies have demonstrated the impact of early intervention in terms of student outcomes and some studies have documented the costs of these programs, very few studies have investigated both placements and costs with students who are severely emotionally disabled (SED) over extended periods of time.

Several studies have tracked students with severe emotional disabilities. Kaufman, Paget, and Wood (1981) investigated parentally perceived problems of children with SED as measured by responses on a problem checklist. Significant decrements in perceived problem behavior were sustained for two years following intervention. Strain (1982) followed-up 40 youngsters with SED previously served at the Regional Intervention Program in Nashville, Tennessee. These students had received no special services for the preceding three to nine years at follow-up. He found no differences between the former students with SED and their "normal" peers with respect to appropriate/inappropriate social behavior. Ponsell, Jacob, LeClair, Moore, and Pickens (1987) followed-up students served as preschoolers with SED. Five years subsequent to preschool services, they found that 36% were placed in general education classes, 8% were served in resource classes, 25% were served in self-contained special education classes, 5% were in Georgia Psychoeducational Network classes, 3% were at home in day care, 1% were in other placements, and 16% could not be located. None of the studies examined costs of their services.

The fact that special education is costly is indisputable. Kakalik, Furry, Thomas, and Carney (1981) determined that special education is 2.17 times as costly as regular education across the nation, e.g., the total annual per pupil with disabilities expenditure was estimated to be \$4698 as compared to \$2636 per typical pupil for that year. Program funding weights for Georgia in 1985 for students with disabilities ranged from 2.139 (students with mild disabilities in resource classes) to 3.987 (students with severe disabilities in self-contained classes (Quality Basic Education Act, 1985). Revised program funding weights for Georgia for the 1991-1992 school year range from 2.27 to 5.32 depending on the nature of the disability and the setting in which the student is served.

Recognizing the expense of early intervention and anticipating positive impact of early intervention, Schweinhart and Weikert (1981) followed-up 123 subjects from the Perry Preschool when they were 15 years old and found that they required 50% less special help in school than their control peers. They reported a cost effectiveness index of 248%—a return on the original preschool investment resulting in decreased education costs based on reduced special education service provision, corresponding increases in projected subjects' earnings, and value of parental release time during their youngsters' preschool program attendance. Wood (1981) conducted an intensive investigation of costs for special education emphasizing the impact of preschool services. She found an overall cost reduction/saving of \$16,000 per student with disabilities when intervention occurred during the preschool years. None of these studies focused specifically on students with SED.

The length of time between service provision and follow-up for longitudinal studies is a critical variable in accurately assessing the impact of preschool interventions. For example, McKey, Condell, Ganson, Barret, McConkey, and Plantz (1985) conducted a ten-year follow-up study of Head Start participants. Their findings included positive enhancement of participants' chances for a three year period but found that after that time, the students were indistinguishable from their disadvantaged non Head Start peers. This suggests that longitudinal studies should use a time period of at least three years.

Considering the need to provide additional information on the longitudinal impact of preschool services for youngsters with SED both in terms of subsequent special education services and relative costs, this study was designed to follow-up one group of youngsters originally served as SED ten years after they were served as preschoolers. Two questions were addressed:

1. To what extent were early intervention programs for the preschoolers with SED followed by special education services in subsequent school years?
2. What were the relative costs of educating these students with SED compared to their non-disabled peers.

## Method

### Subjects

Subjects were selected based on their participation as preschoolers with SED served by the Rutland Psychoeducational Services (RPS) during 1974-1975. Of the 37 subjects originally served, 15 (41%) were located in the school system based on computer generated lists. Table 1 provides a description of the 15 students in the sample in 1985-1986. Of these 15 students,

**Table 1**  
**Subject Characteristics in 1985-1986 (n = 15)**

Sex/Race	Black	White	Total
Male	7	6	13
Female	2	0	2
Total	9	6	15
Age in Months			
Range	147-201	182-201	147-201
Mean	174.7	193.2	182.1
S.D.	18.0	8.5	1.5
Grade Placement			
Range	6-7	7-11	6-11
Mean	7.2	9.0	8.3
S.D.	1.3	1.5	1.5

the majority were male, black, designated as indigent (Hollingshead & Redlick, 1958), and enrolled in one of two local public high schools.

### *Preschool Intervention Treatment*

The intervention/treatment approach used by Rutland Psychoeducational Services is comprised of three service delivery components: (a) Direct intervention with the child daily using Developmental Therapy (Wood, 1986, 1975); (b) intervention in the child's home to provide ongoing help for families in coping with their child and to foster skill development toward effective child management and supportive, therapeutic input with the child; and (c) intervention into the child's school to establish and maintain cooperative efforts on behalf of the child. Thus, the program is designed to provide coordinated involvement and input in the different settings in which the child functions throughout the child's life space.

The intervention curriculum was Developmental Therapy (Wood, 1986) which is designed to teach mastery of hierarchically-ordered milestones in the areas of behavior, communication, socialization, and (pre) academics. Developmental Therapy is eclectic in nature, drawing on developmental theorists such as Erikson (1963), Kohlberg (1983), Loevinger (1976), Montessori (1976), Piaget (1977), Selman (1981), and others. Broadly, this curriculum can be described as diagnostic prescriptive in that the initial program step is to assess the child's level of developmentally-determined functioning in the four curriculum areas of Behavior, Communication, Socialization, and (pre) Academics. The prescription is the fostering of the child's social, emotional, behavioral, and cognitive growth and development by simulating real life experiences in a supportive, small group setting. Developmental Therapy is valid in terms of

viability, effectiveness, and transportability (Davis & Wood, 1990; Kaufman, Paget, & Wood, 1981; Swan, Beardsley, & Wood, 1975; Wood & Combs, 1981).

## Procedures

### *Review of Files*

A preliminary review of cumulative files of the students in the sample of 15 students was conducted. Recognizing the complexity of ten years of data for each student, a qualitative procedure for generating additional research questions based on the available data was used (Bogdan & Biklen, 1982; Bogdan & Taylor, 1975). This procedure expanded the original questions within both the special education services received and the relative costs of these services. These additional questions were incorporated under the original two research questions.

### *Cost Analysis*

The funding for special education programs for 1973-1985 was a unit funding under the Adequate Program for Education in Georgia (1973). The funding in 1985-1986 was a program weight funding formula under the Quality Basic Education Act (1985). The two types of funding (unit funding and program weights) are not directly comparable; however, because the QBE weights provided more specificity for particular program services, the QBE weights were projected back to 1974-1975 to provide the basis for comparison. This was judged to be a reasonable and acceptable procedure by a panel of experts in the area of educational finance.

Regarding the cost analysis, each subject was paired with a typical peer (nondisabled peer) to form a dyad. Cost weights were established using the weights specified in Georgia's Quality Basic Education Act (1985). The typical QBE standard (cohort) in each instance was a derived entity, reflecting the same educational starting point and progressing through the general education grades for the same number of years as the paired subject. Hence, subject and cohort may not have attained the same grade level placement at follow-up, but each would have spent the same time in the educational milieu. Each cost weight was determined by the number of segments per day a student spent in a given educational setting and the nature of the learning environment which reflect the area and the severity of the disabling condition. At the middle school level, cost weights for subjects were computed on the basis of seven rather than six segments per day, since there were seven periods per day at this level. Thus, weights contained in this study accurately reflect subjects' school days as they experienced them and the relative concomitant cost weights. Annual cost weights for each student were calculated for the actual educational programs provided using these QBE weights. A total mean program weight for the entire 10 year period was then projected for each subject and the corresponding, derived QBE standard cohort from general education. These annual individual mean program weights were then used for group comparisons to calculate the t-statistic (Pearson & Hartley, 1954).

Subjects receiving services in RPS were assigned the heaviest weight for the time spent in that setting (i.e., 3.897) since their eligibility for the "severe" program classification had already been established by service provision. Two adaptations from the Quality Basic Education Act's determination of Full Time Equivalency are represented in this study--the division of the school day into seven rather than six segments at the middle school level and the factoring in



one segment for each day for vocational and nonvocational labs to compute an average of three program weights applicable to high school (1.094).

Each subject's costs were calculated based on a per segment annual basis consistent with the placement required under the subject's individualized education program (IEP). Thus, if a student was in two segments per day of Behavior Disorders (BD) class setting and in four segments of a regular education program, the calculations would be weighted appropriately for that combination.

## Analyses/Results

The results are presented in two sections based on the original research questions. The first section focuses on placement and special education services and the second on cost.

### *Placement and Special Education Services*

A descriptive analysis was conducted for chronological age and grade placement for each of the ten years of follow-up. These results are contained in Table 2. The increasing sample size in the first four years of the study reflects that not all children were of sufficient age to enter kindergarten at the beginning of the study period. The chronological age range during the fourth and subsequent years was about 4 years. From the third year of the study and subsequent years, the range of grades was about 5 grades. Combining the results for chronological age and grade suggests that many of these students were retained in grade or entered kindergarten or first grade at a higher than normal age. These data also indicate that students did progress through the system in a graded structure in this school system.

**Table 2**  
**Chronological Age and Grade Placement of Enrolled Subjects for Each Year of Follow-up (n = 15)**

School Term	n*	Age		Grade Placement	
		Range	Mean	Range	Mean
1976-1977	7	5.8-6.8	6.5	1-2	1.3
1977-1978	8	6.2-7.8	7.3	1-3	2.0
1978-1979	12	4.9-8.8	7.5	K-4	2.2
1979-1980	13	5.9-9.8	8.4	1-5	2.6
1980-1981	15	6.3-10.8	9.2	1-6	3.1
1981-1982	15	7.3-11.8	10.2	2-7	4.0
1982-1983	15	8.3-12.8	11.2	3-8	4.9
1983-1984	15	9.3-13.8	12.2	4-9	5.7
1984-1985	15	10.3-14.8	13.2	5-10	6.7
1985-1986	15	11.3-15.8	14.2	5-11	7.6

\*Sample size includes students enrolled in grades K and higher

### *Disability Severity/Special Education Placement*

An examination of the placements for these 15 students was conducted based on disability and severity. The determination of level of severity was made based on two factors — number of segments spent in special education (mild, moderate, and severe) and specific disability.

During the first three years of the study, the number of students in special education settings ranged from 3 to 7 students or 38%-47% of the sample; in the remaining seven years, the number of students in special education settings ranged from 8 to 10 or 50% to 63% of the sample. While there were students in all three categories of severity, the largest proportion (approximately 50%) of the students in placements were categorized as mild, about 40% were classified as severe, and about 10% were classified as moderate. These proportions were more varied in the first four years and more distinct in the last six years of the study.

Regarding special education services provided in the ten years following special education intervention as preschoolers, the most frequent services were Behavior Disorders (BD) followed by BD/Learning Disabilities (LD) and LD. The students were classified in 11 different combinations of exceptionalities used over the ten year period including BD, LD, mildly mentally handicapped (MIMH), moderately mentally handicapped (MOMH), and SED. Between six and eight different services were provided to the 15 students annually.

**Retention Rates.** A total of 15 grade retentions was observed from the data — 3 students were retained at grade one, 5 at grade three, 3 at grade four, 2 at grade five, and 1 each at grades six and eight. No pattern for retention emerged from the data. Even when the change of classification to a “milder” category was examined, no pattern was identified as four of the seven youngsters whose disability was so changed were retained. These data suggest that factors other than disability or level of severity alone affected grade retention decisions. These results may have significant implications for predicting school dropouts in coming years.

**Residential Placement.** Three of the 15 students in the sample required residential placement. One student was placed in residential services for the last five years of the study, one for the last two years of the study, and one for the last year of the study.

### *Costs*

The costs for all educational services over the ten year period were based on the application of the QBE weights (1985) for all years of services. While APEG units were used prior to the use of QBE program weights, this procedure was judged to be reasonable and acceptable for the purposes of this study.

Figures 1-4 provide four examples of the subject-cohort program/cost weight compared with the cohort always participating in regular education classes for the same time period as the subject. Figure 1 portrays Student 7601 who was in self-contained classes for five years while the cohort was in regular education classes for that same period. In Figure 2, Subject 7602 was in regular classes for years 2-3 and 6-10 but received some type of special education resource help in years 4 and 5. In Figure 3, subject 7606 was in special education resource classes for the ten year period. And in Figure 4, Subject 7620 was in regular education classes for all years of participation in the study.

A review of the placements for all 15 students indicated the following:

- 4 of the 15 students spent 90% or more of their school year placements in self-contained placements;

# Subject-Cohort Cost Weight Comparison

## Subject Number 7601

### Group 1

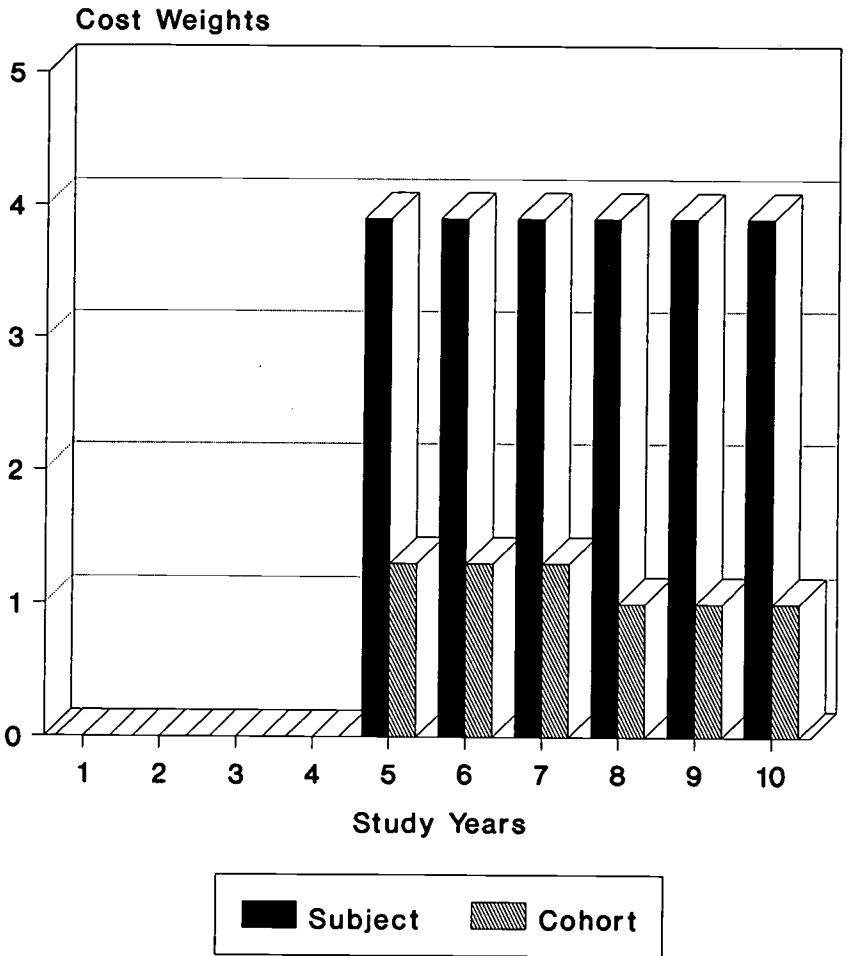

Figure 1

## Subject-Cohort Cost Weight Comparison Subject Number 7602 Group 1

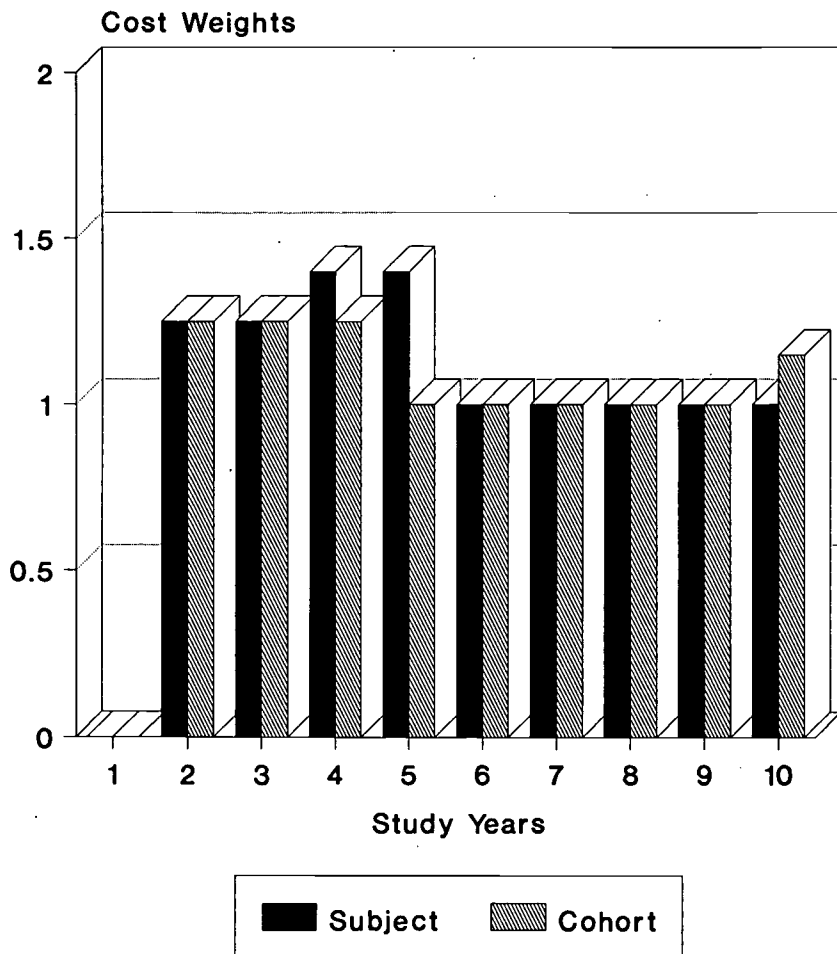

Figure 2

## Subject-Cohort Cost Weight Comparison

Subject Number 7606  
Group 1

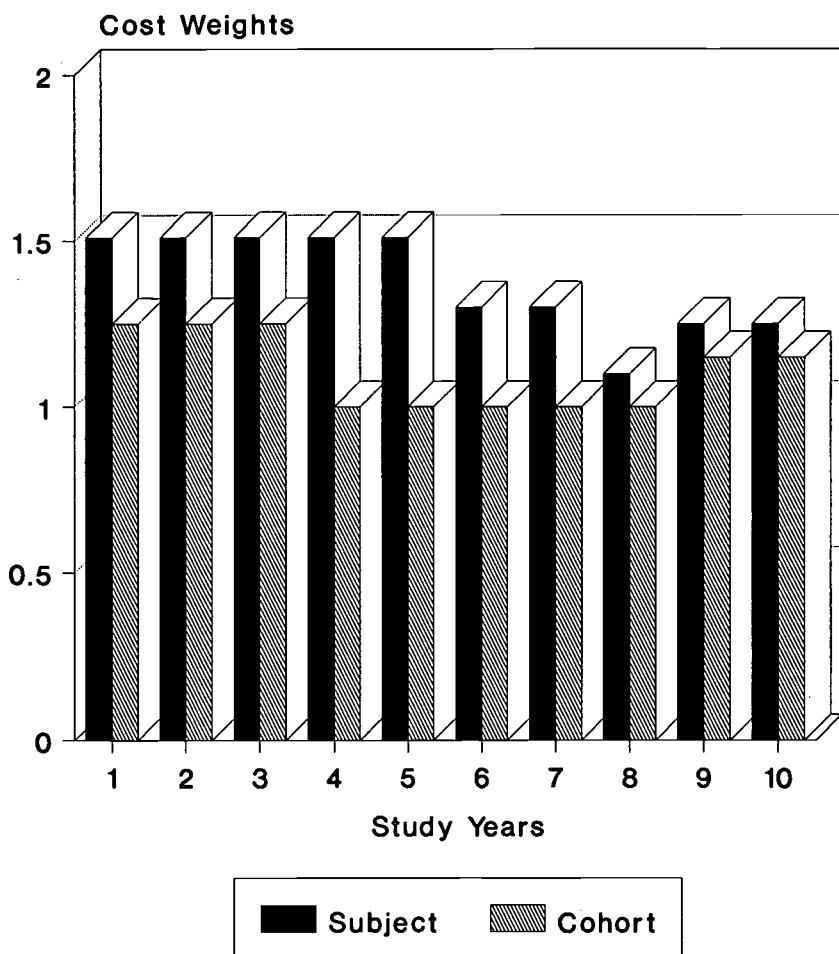

Figure 3

## Subject-Cohort Cost Weight Comparison Subject Number 7620 Group 1

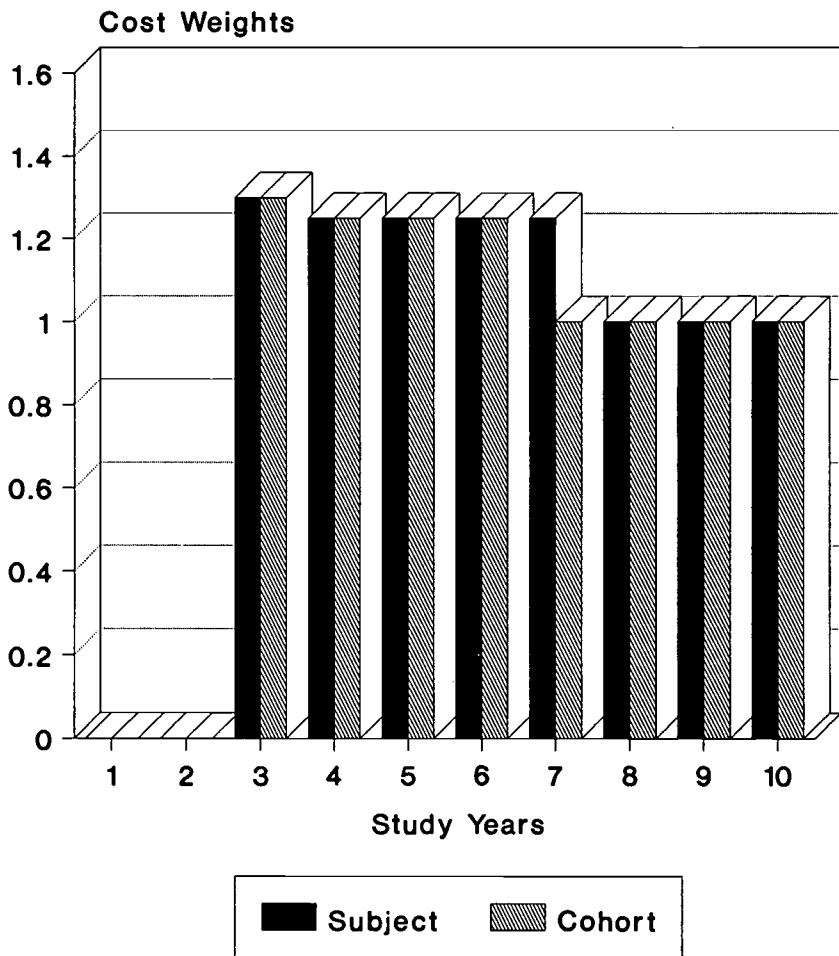

Figure 4

- 5 of the 15 students spent 30% or less of their school years without special education intervention;
- 10 of the 15 students changed placements during the study period reflecting educational responses to individual student needs.

Table 3 summarizes the program weight cost data for the 15 students and their cohorts. As expected, the t-value of 2.99 was significant at the  $p < .01$  level indicating that the costs for the subjects were significantly higher than the costs for their cohorts.

**Table 3**  
**Comparison of Mean Educational Cost Weights for Students with Disabilities and Typical Cohorts (n = 15)**  
**Individual Subject/Cohort Ten Year Mean Cost Weights**

Subject Number	Subject Weight	Cohort Weight
#7601	3.8970	1.2370
#7602	1.1387	1.0894
#7603	1.2452	1.0899
#7606	1.4179	1.0899
#7610	1.2359	1.0899
#7614	1.2463	1.1185
#7615	3.5896	1.0899
#7618	1.1286	1.0756
#7619	3.1622	1.0899
#7619.5	3.8970	1.0899
#7620	1.1596	1.1300
#7622	2.8893	1.1016
#7623	1.0351	1.0756
#7624	1.1596	1.1300
#7625	1.1596	1.1300

**t-Test Analysis Using Mean Weights as Dependent Variable**

Weights	Subjects With SED		Typical Cohorts
	Mean	S.D.	
	1.97	1.12	1.11
			.04

Computed  $t = 2.99, p < .01$

## Discussion

The placement data reflect the constantly changing nature of programming to meet each student's multi-dimension needs — changes in placement, changes in level of disability, retentions, use of the residential placement option—which reflects the continuing development of an annual IEP for each student with a disability. That from 40% to 60% of the students received special education services during any one of the 10 years and is perhaps consistent with the severity of the disability identified in the preschool years. However, it is also important to note that five of the students needed no subsequent special education services which suggests that some severe disabilities may be ameliorated if identified early in the student's life.

While the relative mean program weight of educating these 15 students is 1.97 over the ten year period, this relative mean weight is less than the overall national special education average weight of 2.17 reported by Kakalik et al. (1981) and less than the Category I weight under QBE. The results suggest that preschool intervention (with its multiple components including family intervention) may have been a significant factor in reducing the amount of special education services needed in subsequent years to the preschool intervention thus keeping the cost for those students with severe disabilities in this sample below the national estimate for all disabled students. These results are consistent with those of Schweinhart and Weikert (1981) and Wood (1981) and support the cost-effectiveness of early intervention.

## Limitations/Constraints

This study has several limitations/constraints including the following: Concerns about consistent assessment of academic performance because of varying grade levels and disabilities, the inability to obtain consistent family information or social histories, the variation in treatment approaches during the school years, the lack of a control group to provide comparisons for a true experimental design, and the small sample size. The results of this study should be interpreted and generalized considering these limitations/constraints.

## Summary

Longitudinal cost studies are very difficult to conduct because of constantly changing variables, funding approaches, programming, and environmental changes. While these ex post facto data support the cost-effectiveness of preschool intervention in terms of both less restrictive placements and reduced special education services for some students, additional research is needed to determine the post school placement of these students. Additional research is also needed to assess the relationships between early academic performance, communication skills, and later academic performance at selected grade levels.

## References

- Adequate Program for Education in Georgia (1973). Atlanta: Georgia Department of Education, Office of the Superintendent.
- Bloom, B. (1976). *Human characteristics and school learning*. New York: McGraw-Hill
- Bogdan, R., & Biklen, S. (1982). *Qualitative research for education: An introduction to theory and methods*. Boston: Allyn & Bacon, Inc.



- Bogdan, R., & Taylor, S. (1975). *Introduction to qualitative methodology*. New York: John Wiley & Sons.
- Davis, K., & Wood, M.M. (1990). *A developmental curriculum for social and emotional competence*. Report of Office of Special Education Programs, U.S. Department of Education, Washington.
- Erikson, E. (1963). *Childhood and society*. New York: W.W. Norton & Company.
- Quality Basic Education Act (1985). Atlanta: Georgia Department of Education, Office of the Superintendent.
- Hochleiter, M. (1977). Berdgleichende Untersuchung Von Kindern mit Zerebraler Bewegungsstoring mit Und Ohne Neurojophysiologischer Frutherapie. *Ost Arzteztg*, 321.
- Hollingshead, A.B., & Redlich, F.C. (1958) *Social class and mental illness: A community study*. New York: The Wiley Company.
- Kakalik, J.S., Furry, W.S., Thomas, M.A., & Carney, M.F. (1981). *The cost of special education: Summary of study findings*. Santa Monica: CA: Rand Corporation. Under contract to the Office of Special Education Programs, U.S. Department of Education.
- Karnes, M.B. (1973). Evaluation and implications of research with young handicapped and low income children. In G.C. Stanley (Ed.), *Compensatory education for children, ages 2 to 8*. Baltimore, MD: The Johns Hopkins University Press.
- Karnes, M.B., Zehrbach, R.R., & Teska, G.A. (1974). Preschool programs: Rationale, curricular offerings, and follow-up data. In S. Ryan (Ed.), *A report on longitudinal evaluations of preschool programs*, 1. Washington, D.C.: Department of Health, Education, and Welfare, Office of Child Development, Children's Bureau (DHEW Publication No OHD 74-24).
- Kaufman, A.S., Paget, K.D., & Wood, M.M. (1981). *Effectiveness of Developmental Therapy for severely emotionally disturbed children. Perspectives for a New Decade*. ERIC. Minneapolis.
- Kohlberg, L. (1983). *Essays on moral development*, 2. San Francisco, CA: Harper & Row.
- Loevinger, J. (1976). *Ego development*. San Francisco, CA: Jossey-Bass.
- Macy, D.G., & Carter, G.L. (1980) *Triple T infant consortium follow-up study*. Dallas: Macy Research Associates.
- McKey, R.H., Condell, L., Ganson, H., Barrett, B., McConkey, C., & Pantz, M. (1985). *The impact of Head Start on children, families, and communities*. Final Report of the Head Start Evaluation, Synthesis and Utilization Project. Washington, DC: CSR, Inc.
- Montessori, M. (1976). *The absorbent mind*. New York: Holt, Rinehart, & Winston.
- Piaget, J. (1977). *The development of thought*. New York: Viking Press.
- Ponsell, J., Jacob, R.T., LeClair, E.B., Moore, G.C., & Pickens, P.H. (1987). Five year longitudinal follow-up study of severely emotionally disturbed/severely behaviorally disordered preschool students. *GPN Research Report*, 2, 1-8.
- Schweinhart, L.J., & Weikart, D.P. (1981). Effects of the Perry Preschool Program on youth through age 15. *Journal of the Division of Early Childhood*, 4, 29-39.
- Selman, R. (1981). *The growth of interpersonal understanding*. New York: Holt, Rinehart, & Winston.
- Skels, H.M. (1966). Adult status of children from contrasting early experiences: A follow-up study. *Monograph of the Society for Research and Child Development*, 31, 1-57.

- Strain, P.S., Steele, P., Ellis, T., & Timm, M. (1982). Long term effects of oppositional child treatment with mothers as therapists and therapist trainers. *Journal of Applied Behavioral Analysis, 15*(1), 151-157.
- Swan, W.W., Beardsley, A., & Wood, M.M. (1975). The Rutland Center Developmental Therapy Model for treating emotionally disturbed children. Joint Dissemination Review Panel Submission 75-63, Approved. Washington, DC: Bureau of Education for the Handicapped, U.S. Department of Health, Education, and Welfare.
- Wood, M.M. (1981). Costs of intervention. In C. Garland, et al., (Eds.). *Early intervention for children with special needs and their families*. Seattle: Western States Technical Assistance Resource, University of Washington.
- Wood, M.M. (1986). *Developmental Therapy in the classroom*. Austin, TX: PRO-ED.
- Wood M.M. (1975). *Developmental Therapy*. Baltimore: University Park Press.
- Wood, M.M., & Combs, M.C. (1981). Inservice training in Developmental Therapy. Joint Dissemination Review Plan Submission 81-19, Approved. Washington, DC: Office of Special Education Programs, U.S. Department of Education.

# Why Can't We Stay the Same? or The Shift is On!

## Paradigm Shifts and Proactive Leadership Strategies

William W. Swan  
Carvin L. Brown  
*The University of Georgia*

*The roles of educational leaders continue to change, sometimes in dramatic ways. Paradigms are defined and applications to educational leadership are discussed. Ten proactive leadership strategies which can be used by effective leaders to maximize the positive impact of shifting paradigms in education are stated and discussed.*

Educational leaders are constantly challenged to improve the effectiveness of their schools. As an integral part of change, leaders need ways to examine current operations and develop new approaches to solving current problems. One way of approaching leadership and change is by using paradigms. Barker and Christensen (1989) define a paradigm as a set of rules and regulations that prescribe boundaries and filters incoming information enabling one to take action. Paradigms influence leaders' decision-making by influencing their perceptions. Paradigms help solve problems and direct focus to information which is relevant. Barker (1991) defines success as the ability to solve problems and suggests three core skills which are needed for success in the 21st Century. First, effective leaders must have extremely high standards of excellence which they are able to share with their followers/colleagues. These standards of excellence are integral to all their efforts individually and organizationally. Second, effective leaders are innovative. They have a willingness to compete, to be on the cutting edge of new developments, to take risks and explore new ideas, and to be creative. Third, effective leaders anticipate change by being in the right place at the right time with the right idea. Effective leaders need to be sensitive to new paradigms and position themselves to benefit from the shifting paradigms. Barker indicates that effective leaders need not create a new paradigm to be successful; effective leaders who have the ability to change and adapt by incorporating new paradigms early in the paradigm's development and implementation can benefit as much or more than the creator of the new paradigm. Barker and Christensen (1989) emphasize that each of us can choose to change our paradigms, that if we are to be successful, we must continue to adapt and change as our world adapts and changes.

Barker (1991) and Barker and Christensen (1989) provide several ideas about leaders' use of paradigms. First, if a leader's paradigm fails to adapt or shift based on new information, the leader can suffer "paradigm paralysis" and become unable to act effectively in changing situations. Unless these leaders emerge from their "paralysis", they will be unsuccessful and will lose their opportunity to lead. Second, leaders of the old paradigm who want to join the new paradigm in its early stages must be courageous. Often, they must act in defiance of the evidence produced by prior problem-solving and prior experience with which they are most comfortable. Ineffective leaders often view paradigm shifts as threats rather than opportunities. Third, when there is a significant paradigm shift, the "going back to zero rule" applies. Prior success under the old paradigm guarantees no success in the new paradigm. Under this "rule", everyone begins at the same place and competition begins anew. If one cannot incorporate or adapt to the new paradigm, "paradigm paralysis" will almost surely be a fatal leadership disease.

## **Educational Application**

Human service providers, especially those involved with interagency collaboration, such as psychoeducational program directors, need skills that enables them to manage the process of change (McNulty, 1989, 147-151). McNulty states that the classic pyramidal, bureaucratic model characterizing most governmental organizations contributes significantly to the difficulty in adapting to change. A significant paradigm shift is suggested in which multiple diverse perceptions and realities are integrated into organizations which become more responsive to multiple clients' needs. Several examples of significant paradigm shifts are evident which impact education in Georgia. At the federal level, PL 99-457 redefined the roles and functions of organizations as they provide services to preschool children with disabilities and their families. The shift stressed the collaborative responsibilities of all community agencies (Peterson, 1991; Thiele & Hamilton, 1991) using a combination of federal, state, and local funds and programs to meet the needs. At the state level, the fiscal constraints in 1991-1992 and subsequent years, the continuing trend to streamline and improve the efficiency of education (e.g., the Williams Commission), and the Governor's Georgia 2000 have stimulated consideration of all regional services, including the Georgia Psychoeducational Network. These examples and other factors suggest that significant paradigm shifts are occurring and more are on the horizon for educational leaders in Georgia.

## **Leadership Style Change**

The traditional bureaucratic paradigm of leadership is shifting to emphasize participatory management (Hoy & Miskel, 1991, p. 326-328), shared decision-making (Hoy & Miskel, 1991, p. 328-340), restructuring (e.g., Lamotey & Swanson, 1989), shared governance (e.g., Glickman, 1990), and backward mapping for policy development (Dokecki & Heflinger, 1989). Three common characteristics appear in this new paradigm:

- Each person is treated as an individual of worth
- Individuals trust each other and the organization
- The process focuses on results.

The traditional leadership paradigm in special education is also shifting. The critical success factors for effective special education leaders (Burrello & Zadnik, 1986; Burrello & Johnson, 1986) are being refined to include more emphasis on educational leadership for all children rather than maintaining the unnecessary distinct isolation of special education and regular education. Recognizing these paradigm shifts, Burrello, Schrup, and Barnett (1989) have suggested a new paradigm for building level leaders and for special education leaders which emphasizes the common leadership elements based on a leadership paradigm for regular education (Dyer, Lee, Barnett, Filby, Rowan, & Kojimoto, 1985).

These characteristics and shifts suggest that effective leaders will need to use a general set of principles across educational programs to maintain their effectiveness in educational programs for all students. However, leaders must individualize these principles to their unique set of program strengths and weaknesses to achieve their maximum effectiveness in paradigm shifts.

## Proactive Leadership Strategies

Considering the need to shift our paradigms and being cognizant of the variety of ways in which such shifts can occur, ten proactive leadership strategies have been articulated from the literature and practical experiences of the authors. These ten strategies are stated in perceived hierarchical order and have been designed to emphasize concrete actions (see Table 1).

### 1. *Communicate*

Especially in times of significant change, it is critical to nurture and expand existing trust as well as build more trust among individuals and groups by extensive communication. Leaders must inform those around them so surprises and information gaps are absolutely minimized

**Table 1**  
**Proactive Leadership Strategies**

1. Communicate
2. Predict the Future
3. Reach Out Internally and Externally
  - a. Identify Your Clients
  - b. Identify New Sources or Creativity and Organized Strength
4. Remove Barriers/Cure Dysfunctions
5. Expand Definitions
6. Increase Flexibility
7. Broaden Contacts
8. Empower Followers
9. Model Enthusiasm for the Mission and the Work
10. Maintain Vigilance of the Professional Environment, Demographics, and the Governance Structures

and everyone is up-to-date. Leaders should focus on saying words which revive and rejuvenate followers and colleagues. Ideally, the leader and the followers/colleagues should reflect together on recent information or perceptions and revise their plans of action accordingly. Leaders also need to choose the right time to communicate the right idea to be effective in times of significant change. A sure way to eliminate leadership effectiveness is to cease effectively communicating with ones colleagues and followers.

## *2. Predict the Future*

Effective leaders must envision the future. This is not always a pleasurable experience because significant change is difficult for most people. However, realistic expectations and changes in the systems in which leaders work must be anticipated. A real perspective of real change enables one to establish a mission statement based on that vision of the future. Based on that mission statement, leaders and leadership teams can develop methods to enable the school to achieve its goals, objectives, and activities.

## *3. Reach Out Internally and Externally*

Effective leaders must identify their clients/constituents. During times of significant change, clients may shift their perceptions/paradigms and/or the target clients may change. It is critical that effective leaders court their clients, visit them in their locations, invite them to one's meetings, and get invited to their meetings. When invited to client meetings, effective leaders attend, listen, and respond appropriately to the tasks at hand. As a strategy, focusing on what is working effectively often builds bridges when other strategies do not work. Effective leaders must build bridges to span the changes as they occur in order to remain effective.

As effective leaders reach out, they must identify new sources of creativity and organized strength. This requires a shift in paradigms from the old power structures to considering new alternatives such as teachers, students, support staff, parents, and supporting school systems. Effective leaders find ways to individualize their proactive behavior to maximize positive impact with each of these groups based on the individual and group needs within each structure.

## *4. Remove Barriers/Cure Dysfunctions*

Effective leaders are able to remove barriers to actively support new ideas and develop new wide-open ways to approach problems. Effective leaders encourage followers and colleagues to generate and express new ideas and then provide support to make these new ideas possible. The emphasis is on acting quickly and effectively in removing existing barriers to make creative ideas come true. Effective leaders must be willing to take risks with potentially useful ideas, to remove limits which have been perceived to exist, to remove limits which have been established without adequate reason, to request variances or exceptions for attempting new pilot programs, to create an atmosphere of opportunity and excitement. For example, if socially maladjusted students cannot be served as students with severe emotional disabilities, effective leaders explore new ways to serve these students in other ways. Most barriers have been established as reasonable limits at some point in time. Effective leaders perceive when no longer effective or necessary barriers need to be removed.

Effective leaders also identify dysfunctions and cure them. If a leader knows of a dysfunctional activity or person and fails to take action, the leader loses power and can no longer be

the role model so essential to demonstrating effective practice. Taking reasonable and timely actions significantly enhances a leader's formal and informal respect and power.

### *5. Expand Definitions*

Effective leaders expand their definitions to be more inclusive and less restrictive, especially during times of significant change. A critical definition which needs to be expanded is leadership. The old, limiting version of leader and followers needs to be transformed to statements such as the following: Leaders are followers, teachers are experts, clients have significant investment and meaningful input, clients can serve you as you can serve clients, leaders and followers share. Unless one is open to expanding definitions, the system remains closed, the leader suffers from paradigm paralysis, and effective leadership is transformed to at best administrative continuation of programs rather than survival, rejuvenation, and growth.

### *6. Increase Flexibility*

Effective leaders identify those things they are unwilling or unable to do and seek additional training or expand their flexibility to work with others in a collaborative fashion to get these things done. Periodically, leaders must test their own limits and learn new knowledge and skills to be more effective. When a leader stops growing, a leader becomes at best an administrator and maintains rather than creates. Administrators often perform poorly in times of significant change because they cannot adapt or shift their paradigms sufficiently to operate under new conditions. Administrators who are unable to work effectively with conflict will be unable to deal effectively with change. Sometimes, training in conflict resolution skills can enable a person to become an effective leader once again. Leaders are able to change and grow. They can only do this by being flexible.

### *7. Broaden Contacts*

Important aspects of leader effectiveness are formal and informal social systems. During times of change, the movers and shakers change — the old sources of power are often discarded for new sources of power, not necessarily better sources of power but new sources of power. Effective leaders broaden their social systems to incorporate these new leaders in addition to maintaining contacts with the existing sources. Target clients for broadening both formal and informal contacts include community leaders, school system leaders, college and university leaders, business leaders, and civic association/club leaders. Effective leaders are always looking for ways to broaden contacts.

One potential perceived constraint in broadening contacts is that by establishing new contacts, the old contacts lose status. Effective leaders are able to maintain the old contacts while establishing new ones. Often times, unpredictable changes occur which places the prior "old contacts" in new leadership roles.

### *8. Empower Followers*

Effective leaders have transitioned from the old "top-down" management to more collegial leadership philosophies. Empowering followers allows effective leaders to benefit from the thinking of all the expertise available, to build ownership of ideas, to solve problems with less difficulty, to redirect time and effort to critical problems, to expand the leadership respon-

sibility for all, to consider new paradigms and new directions which could not have even been imagined before.

### **9. Model Enthusiasm for the Mission and Work**

Effective leaders are role models for enthusiastic support for the organization's mission and work. Effective leaders are congenial, motivated, pleasant, interested, interactive and communicative, and praise-oriented. Effective leaders individualize reinforcement strategies for each person to build bridges for the enthusiasm to flow from the leaders to the followers and from the followers to the leaders.

### **10. Maintain Vigilance of the Professional Environment, Demographics, and Governance Structures**

Effective leaders identify scholars and experts in their own environments as well as external environments. They establish study groups and encourage discussion for predicting change. They are on the cutting edge of change. They focus all possible expertise and power sources on problem resolution and solution implementation, give credit to all for success, and assess paradigm effectiveness for one's self and with others on a continuing and consistent basis.

## **Summary**

The paradigms for educational leadership in Georgia are shifting for many reasons. These ten proactive leadership strategies provide a foundation for leaders to respond to these paradigm shifts. Effective leaders will individualize the use of these strategies to meet the needs in each leadership situation.

## **References**

- Barker, J.A., & Christensen, R.J. (1989). *The business of paradigms: Discovering the future*. Burnsville, MN: Charthouse Learning Corporation.
- Barker, J.A. (1991, September). *Paradigms the rest of the story*. Tampa, FL.
- Burrello, L.C., & Johnson, V.L. (1986). Critical success factors, rural and urban, for special education administration. *Journal of Special Services in the Schools*, 4(1-2), 1-16.
- Burrello, L.C., & Zadnik, D.J. (1986). Critical success factors of special education administrators. *The Journal of Special Education*, 20, 367-377.
- Burrello, L.C., Schrup, M.G., & Barnett, B.G. (1992). The principal as the special education instructional leader. *Special Education Leadership Review*, 1.
- Dokecki, P.R., & Heflinger, C.A. (1989). Strengthening families of young children with handicapping conditions: Mapping backward from the "street level". In J.J. Gallagher, P.L. Trohanis, & R.M. Clifford (Eds.), *Policy implementation and PL 99-457*. Baltimore: Paul H. Brookes Publishing Company.
- Dyer, D.C., Lee, G.V., Barnett, B.G., Filby, N.N., Rowan, B., & Kojimoto, C. (1985). *Understanding the principal's contribution to instruction: Seven principals, seven stories*. San Francisco, CA: Far West Laboratory for Educational Research and Development.
- Glickman, C.D. (1990). *Supervision of instruction: A developmental approach*. (Second Edition). Boston: Allyn and Bacon.



- Hersey, P., & Blanchard, K.H. (1988). *Management of organizational behavior*. (5th Edition). Englewood Cliffs, NJ: Prentice-Hall, Inc.
- Hoy, W.K., & Miskel, C.G. (1991). *Educational administration: Theory, research, practice*. (Fourth Edition). New York: McGraw-Hill, Inc.
- Individuals with Disabilities Education Act of 1990, P.L. 101-476. (The 1990 Education of the Handicapped Act Amendments). October 30, 1990.
- Lamotey, K., & Swanson, A. (1989). Restructuring school governance: Learning from the experiences of urban and rural schools. In S.L. Jacobson & J.A. Conway (Eds.), *Educational leadership in the age of reform*. White Plains, NY: Longman.
- McNulty, B.A. (1989). Leadership and policy strategies for interagency planning: Meeting the early childhood mandate. In J.J. Gallagher, P.L. Trohanis, & R.M. Clifford (Eds.), *Policy implementation and PL 99-457*. Baltimore, Paul H. Brookes Publishing Company.
- Peterson, N.L. (1991). Interagency collaboration under Part H: The key to comprehensive multidisciplinary, coordinated infant/toddler intervention services. *Journal of Early Intervention*, 15(1), 89-105.
- Public Law 99-457. (1986). The Education of the Handicapped Act Amendments of 1986. October 8, 1986. 100 STAT 1145-1177.
- Quality Basic Education Act (1985). Georgia Department of Education, Atlanta.
- Thiele, J.E., & Hamilton, J.L. (1991). Implementing the early childhood formula: Programs under PL 99-457. *Journal of Early Intervention*, 15(1), 5-12.

# Enhancing Communication Through Computers in the Southwest Georgia Psychoeducational Program

Richard Swenson

*Southwest Georgia Psychoeducational Program*

*The development and implementation of a computer system to enhance communication in the Southwest Georgia Psychoeducational Program is described. The characteristics of the service delivery area, primarily rural, and the needs of the program provide the parameters for development. Goals, participants, hardware, and software are discussed. Planning, implementation procedures—including pilot testing, and initial and follow-up training are reviewed. Refinement of the program, maintenance procedures, and training new people are described. Strengths of the system and planned improvements are specified.*

## Context and Need

The Southwest Georgia Psychoeducational Program, one of the 24 programs in the Georgia Psychoeducational Network, provides special education and related services to children and youth with severe emotional disabilities in eight school systems in a six county regional area. Based on the nature of the population distribution, ranging from metropolitan to very rural, the program delivery models vary across the school systems.

The main program location is in Thomasville where six classes are conducted, each staffed by a teacher and a support teacher. The support personnel at this location include three social workers, a psychologist (three days per week), and a program coordinator. The administrative staff include a program director, two secretaries, and a program evaluator. There are three satellite programs—one each in Moultrie, Cairo, and Donalsonville. Each satellite program is staffed with a program coordinator, at least one social worker, and instructional staff (teachers and support teachers) based on the number of children and adolescents served in each location.

With a distance of up to ninety miles between the program sites and sixty miles from the main program to the most distant outpost, unique communication and coordination problems exist. Extensive use of the phone system with all calls being long distance has been required. Record keeping was a challenging burden. There was significant duplication of student records to make necessary information available to the main program to develop required reports and to monitor the paperwork completed at each site. It was important to have current information throughout all sites.

Other network programs have encountered similar communication, coordination, reporting, record management, and monitoring problems. To resolve some of these problems, the network developed a student information computer program which generated required state reports, allowed for inter-site communication and enhanced coordination. Some network programs have a primary computer at the main site along with terminals at satellites.

The rural nature of our program created a need to which the network computer system was unable to respond. By modifying the existing computer system — both hardware and software — we resolved many of our communication, coordination, reporting, record management, and monitoring problems, enhanced the administrative process at the program, and focused more leadership time and attention to improve services to the students and their families.

## Goals

The initial goals were as follows:

1. To establish a communication network that eliminated the need for duplicated paperwork.
2. To establish a student information system that was readily available to all staff members who needed immediate access to the information.
3. To establish an efficient communication system that did not rely on people being at their desks or in a satellite at any given time.
4. To maximize the capabilities of the computer throughout the entire program in the most cost effective way.
5. To update computer information that would give all staff immediate access to current data.
6. To replace most of the phone calls within the program with electronic mail messages.
7. To use hardware and software that could be easily updated by any local vendor through competitive bidding.

## Participants — Characteristics, Computer Skills

Participants included the program director, four site coordinators, seven social workers, the psychologist, the program evaluator, and three secretaries. The computer experience at the beginning of the project focused on the student data base used to develop required local and state reports. The program director, evaluator, and two of the secretaries operated and entered data into a four user system over a three year period. While some of the participants had limited exposure to computers, over 75% of the staff had minimal to no computer experience or skills.

## Hardware

The hardware for this system was extensive and job specific. It included the following:

1. One computer was located in the main program. This computer has an 80386-25Mhs main processor with 32Kb cache Memory. There is 18MB of main memory with 320Mb/16ms Hard Disk. It also has a 150Mb Tape backup drive. There are 16 intelligent RS232 ports and 2 nonintelligent RS232 ports. The main console has a vega monochrome console and a 101 keyboard. The computer uses a Unix 286/ix operating system.
2. Each user has a Wyse 60 Terminal resulting in a total of 17 work stations.
3. There are five laser printers located at critical points within a few feet of the work stations.

4. There are three dedicated phone lines running from the main program to the program's satellite locations. These lines are open 24 hours a day and are for data transmission only. The main program has one phone line dedicated to fax and external modem use.

5. There are three modems at the main program and one at each satellite program. These are designed to run at 9600 speed.

6. A four-user multiplexer was placed in Moultrie and Thomasville to allow four users to use the computer simultaneously on one telephone line.

This configuration allows 18 people to use the computer simultaneously (see Figure 1).

## Software

Multiple software applications have been made in accomplishing the project goals. To establish a simple communication system and give all participating staff members access to the tools they might want to use on the computer, Uniplex Office Automation System was purchased. This computer program allows eight people to utilize the system simultaneously with the following applications: Word Processing Spreadsheet; Data Base; Sketchpad; Formal; Report Writer; Mail; Time Manager; Personal Organizer; and Card Index. This program cost approximately \$1700. A student information program was already available and in use.

The software which enables the use of this variety of applications is the Unix multi-user system which cost approximately \$1000. The Unix and Uniplex software, when fully integrated, provide significant power and ease of use. Commands for all of the Uniplex applications are similar and require little effort to go from one package to another. For example, one can combine information from one's data base and a spreadsheet and then incorporate the two into a word processing document.

## Procedures

The procedures for implementing the system were as follows:

1. The program director sought advice about the mechanics of establishing the computer application to accomplish the stated goals. A computer specialist who was knowledgeable about multiuser systems and who understood both the hardware and the software was found.

2. Based on this information and the guidance from the specialist, a plan was formulated on how to configure and implement the system.

3. A list of necessary hardware and other equipment was developed.

4. Bids and state contract price lists were examined for each piece of hardware and equipment.

5. Because Southern Bell's equipment played such an integral part in this plan, numerous meetings were conducted with their marketing and engineering staff to confirm the details of and the feasibility of this system.

6. Approval of the project and the budget was obtained from the Board of Control for the program.

7. Equipment was purchased at the lowest price available.

8. An agreement was reached with a computer vendor on the installation and coordination of the system with an established contract price.

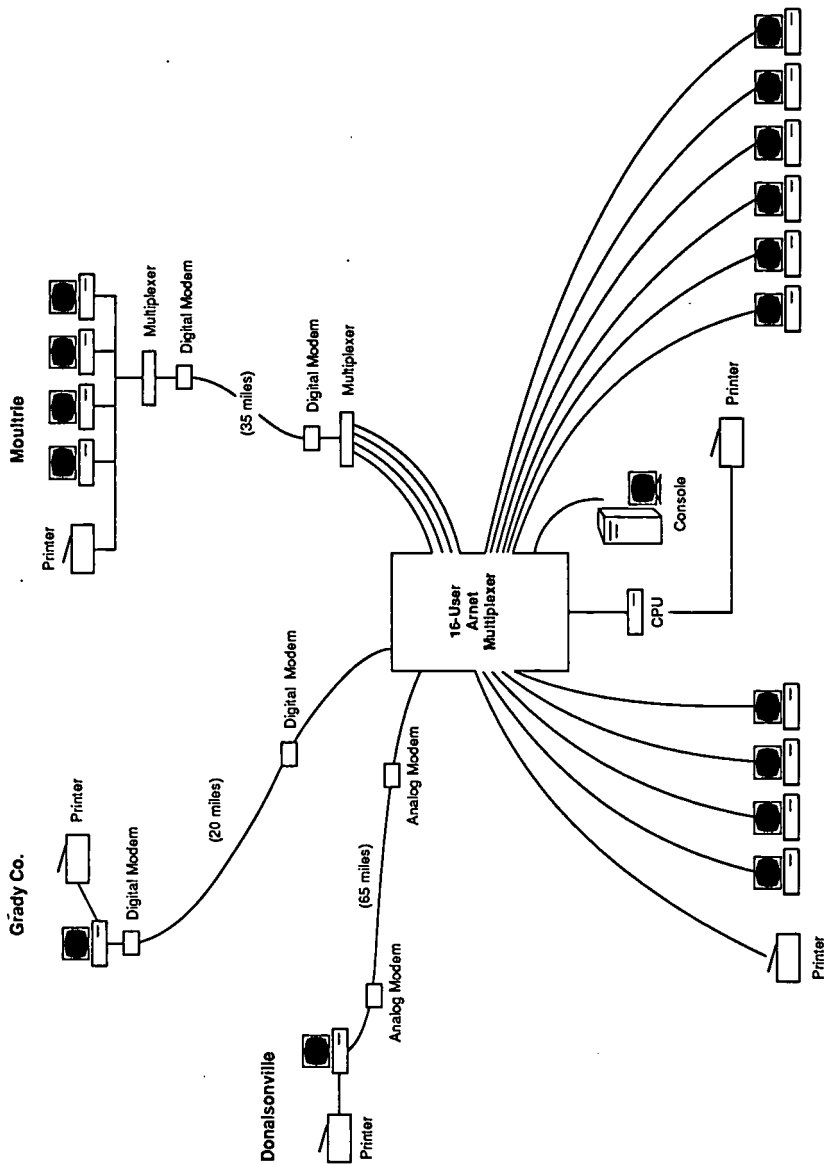

Southwest Georgia Psychoeeducational Services at Dunlap Center

Figure 1: Overview of Computer System

BEST COPY AVAILABLE

## Implementation

### *Pilot Testing*

This project involved a three phase introduction of the system. The first phase included the purchase of the main computer and four terminals. During this phase, the initial multi-user system was established and the director, program evaluator, and two administrative secretaries learned how to use the basic equipment and Office Automation software. The basic hardware and Unix operating system were tested for possible problems. The testing period lasted for approximately three months.

The second phase involved contracting with Southern Bell to install the phone lines necessary to establish communication between the main program and the satellite programs. This was accomplished with two digital leased data circuits and one leased analog circuit. These lines remain open 24 hours per day. The cost for these circuits is figured at a monthly rate with unlimited usage. This process required approximately two months and in the case of the main program required completely rewiring the phone system and running new phone lines to the building.

The third phase was implemented without pilot testing. During this phase, the hardware required in all of the satellite locations and the remaining work stations in the main program office were installed. Over a five day period, the necessary equipment was installed and the communication system was established among all computer terminals and the main CPU.

### *Training*

Training in using this system was key to staff receptivity to this project. This has been the most difficult and challenging aspect of the project. The initial training on the part of the director, evaluator, and two secretaries was facilitated by the prior experience of these individuals working with computers and some knowledge of the way a multi-user system worked. The Office Automation software was new to everyone including the vendor who provided it. Our training on this was limited to a trial and error approach after reading the manuals that accompanied the software. Fortunately the manuals were very easy to read and with a few exceptions we were and are able to do everything we want by just following the manuals. Each satellite was given a set of manuals for the Uniplex operating system. An operating manual is currently being produced for the student information system.

Since the remainder of the staff had little or no computer experience, the primary concern was to anticipate little production until they had received sufficient training. Training sessions were organized by the director to explore different aspects of the system and staff members were instructed not to attempt certain applications before receiving training.

We also realized that many of the applications available to all staff would not be of immediate interest to them. Since the communication capabilities of the software were crucial to the success of the project, it was decided that this would be the first area addressed. All social workers and coordinators were brought to the main office and given an introduction to the communications and electronic mail application. The group received a one hour demonstration on mail and then each person went to a terminal with a partner to practice sending mail to each other. The director and other main program staff assisted the trainees when they encountered problems. There was no real attempt to explain how the system worked or to explain the nature of the multi-user system. We focused on how to enter the computer

and then how to access and use the mail. The staff responded very positively to the training and within a very few days everyone was using the inter-office MAIL on a regular basis.

Subsequent training activities have focused on two directions. Enthusiasm grew with the success in MAIL, so many individuals requested more information almost immediately. Questionnaires were developed to determine their common interests and small workshops were developed to meet the small group needs. The program also developed an agenda for training based on the needs of the program staff. In these areas, the director trained the coordinators so that they could support the staff in their satellite locations. Following this training, the director inserviced the entire group and established a direction for further program development.

It is important to realize that the program is in the very early stages of training. The available software is so large that it may require as much as two years to train all staff in all applications. However, this is not the intent of the program. New training sessions will be established as staff master the applications which have already been initiated.

### *Refinement*

The director and administrative staff have constantly sought and received information on the effectiveness of the system. Each application is evaluated separately and in relation to the system as a whole. Informal discussions and formal feedback through questionnaires have generated both positive and negative concerns about the system regarding the project goals. Procedures for processing data are now being developed in conjunction with the end user. Meetings have been conducted to establish the most effective means of gathering data and coordinating input into the computer so that the end product meets the needs of the user and the program.

## **Maintenance**

There are two basic types of maintenance required in this project. These include problems dealing with hardware and software. Both are extremely important to the efficient and effective use of the system and to avoid user frustration which might result in staff avoiding use of the computer. The major issue in maintenance is to determine where the failure occurred and why. Frequently, it is difficult to determine if the problem is the result of the hardware or the software or inadvertently created by user error. We have dealt with this problem by having the service provider log into the machine at his location and trouble-shoot the problem before responding to initial descriptions of difficulty.

Hardware maintenance has been accomplished through a service contract with a computer vendor. Problems are solved in several ways. Once a problem is identified the vendor may then repair or replace equipment problems on site. If the problem cannot be resolved at our location, the equipment is taken to a repair location. During these times it is advisable that the program have backup equipment for the less expensive or critical components. Equipment failure contributes directly to user frustration.

Software maintenance problems are generally resolved by first identifying the problem, reporting this problem to the program developer, and having software corrections written into your system. This is usually accomplished by placing the correction on a disk and then entering this disk into the system. Many software problems occur simply as the result of not under-

standing how to use the package correctly. To solve this problem, we have a toll-free line to our vendor who will answer questions when problems occur.

## **Training New People**

All new staff members are given access to the system following an initial orientation. The procedure for training this person will be similar to that used as the project began. New staff members will have access to a complete set of manuals and the help of staff members who are already trained. The pace of the training depends on the individual's inclination to learn how to use the system and the needs of the program.

## **Updating and Refining the System**

With the many goals of this project, there is a constant process of updating the software to meet the needs of the state network and this program. Weekly contact and improvements are being added to the system with the assistance of software programmers and the hardware vendor. This is a continuous process rather than a process with ending points. Once the current programming is refined to a smoothly working, user friendly status, additional programming will be developed to meet newly emerging needs.

## **Strengths of the System**

There are six significant strengths of this system directly related to the goals originally established for this project:

1. Many people have access to important current data used in the program in a simple, quick, accurate manner.
2. Communication in the program between individuals at different sites and at the same location has improved significantly and has saved significant time in communication.
3. Software is very user friendly and encourages continued use.
4. The system is sufficiently flexible to add additional users without further cost
5. Hardware is easily maintained by individuals locally and replacement parts or upgrades of the hardware are possible at very competitive pricing.
6. There is flexibility in the system and through assistance of a programmer to continue development of this system as we direct.

## **Planned Areas of Improvement**

Current plans for improving the system do not call for major changes. Improvements will be made in the student database and we will add to our reporting system. However, our primary goals this year and the next are to expand the users' ability to use the current system and expand the use of available applications yet to be explored.

---

Note: Those readers interested in more detailed information on this system should contact Mr. Richard Swenson, Director; Southwest Georgia Psychoeducational Program; 915 B Lester St.; Thomasville, GA 31792 (FAX: 912-226-2988; Phone: 912-226-4133)



# Converting from Pen and Paper to Computerized Records and Communication — A Challenging Task

Wayne Moffett, Director  
*Alpine Psychoeducational Program*

*The change from pen and paper to computerized records and communication at the Alpine Psychoeducational Program is reviewed. The system is defined in terms of hardware and software which are used in the main program and seven satellite locations in northeast Georgia. The training/implementation process is described including the three stage process for training on a continuing basis. The multi-user aspects of the computer system are discussed including the combination of use of internal and external expertise for the computer programming. Strengths of the current computer system as well as future directions in terms of IEP development and electronic scanning of documents are explored.*

Converting the administration of a psychoeducational program from pen and paper (or typewriter and paper) records to computerized records is a slow and arduous process. Although the conversion may be superficially and quickly accomplished by simply purchasing a computer and generic office automation software, we have determined that generic software is inappropriate and often unusable for a psychoeducational program's specialized needs. This method does not produce the desired result with our personnel, specifically, transferable computer skills and general computer literacy. At Alpine, we have created a long-range plan for total computerization which includes the selection of appropriate computer(s) and peripheral equipment, the development and through time, modification of task-oriented software, and careful training and testing of personnel in the use of hardware and software.

## Description of System

Because of the many staff members who use the computer and share data and programs, the Alpine Psychoeducational Program has selected a multi-user supermicro computer with a terminal for each user. The computer currently accommodates 12 terminals and may be expanded for as many as 28 terminals. It is also designed to support a LAN (Local Area Network) of personal computers.

The deciding factor in the choice of computer, however, was the operating system, UNIX, which contains a large number and variety of utility programs, allowing users at varying levels of training and computer sophistication to perform operations. Such operations included sending and receiving electronic mail, creating and manipulating data and text files, and even writing simple programs with relative ease. In addition, UNIX contains built-in system security, providing the system administrator with the ability to limit or restrict the accessibility of data and text files, programs, and the computer itself. For example, the security on a data file may be adjusted so that only certain staff members may alter the data but a larger group of

authorized users may examine it. This facility decreases the likelihood of unauthorized entry and eliminates the need for clumsy program passwords and other not-so-elegant computer security measures to protect sensitive data and ensure confidentiality.

In addition to the computer and terminals (Tandy 6000's), Alpine's computer system includes printers and modems—three non-impact laser printers with near typeset quality output, which are available to all users, and a modem which is used in sending and receiving electronic mail throughout the Georgia Psychoeducational Network. Alpine has seven satellite locations, some located over fifty miles from the main program site. For each satellite, a terminal, small dot-matrix printer, and modem have been installed. This hardware has allowed Alpine to establish its own electronic communication network. Figure 1 shows the array of hardware both in the main program location and in each of the satellites.

## Training/Implementation

The next step toward installing the computer system was training the Program's administrative and clerical personnel in the operation of the hardware and in the use of UNIX utility programs and other software. Optimally, the training should proceed at a gradual but constant pace and should maintain a consistent level of competence throughout the staff. Realistically, however, learning rates of individual staff members vary widely as do their attitudes toward the computer. Their attitudes range from anxiety to apathy to enthusiasm. It is neither necessary nor advisable or even possible to make every staff member a computer/software expert. It is much preferable to individualize the instruction program, insisting on competence from each person only in basic computer skills and in those programs which will make the person's job faster and easier. More advanced topics should be offered only to interested personnel who will learn faster during training and continue to learn and experiment with what they have learned long after formal training has been completed.

At Alpine, training is provided in three stages. First, new topics are introduced and rudimentary instruction is offered to appropriate personnel at a group meeting by either the program director or some other staff member who is competent in the use of the computer and all necessary software. For topics or questions on which no staff member has expertise, consultants are hired at a daily or hourly rate to provide group and/or individual instruction. This gives depth to our training and demonstrates that it is not necessary to have a computer/UNIX expert on staff.

Second, each person is issued one or more manuals which provide detailed instruction in the use of the required programs, utilities, and/or hardware and is given time to learn the new skills either individually or in small groups. Finally, after an adequate amount of time, each staff member is tested privately on the required new skills. If necessary, personal individualized instruction is provided and additional practice is suggested on any skill at which the person does not demonstrate at least minimal competence.

The order in which most topics are introduced during training is generally left to the discretion of the instructor; however, there are two specific areas which must be covered first—operation and care of the computer/terminal and gaining access to the computer (logging on). At the beginning of the software training, no pre-packaged or custom software is introduced. Instead, the use of UNIX utilities to develop basic skills is emphasized, e.g., sending and receiving electronic mail with *mail* or *xmail*, creating text and data files with the

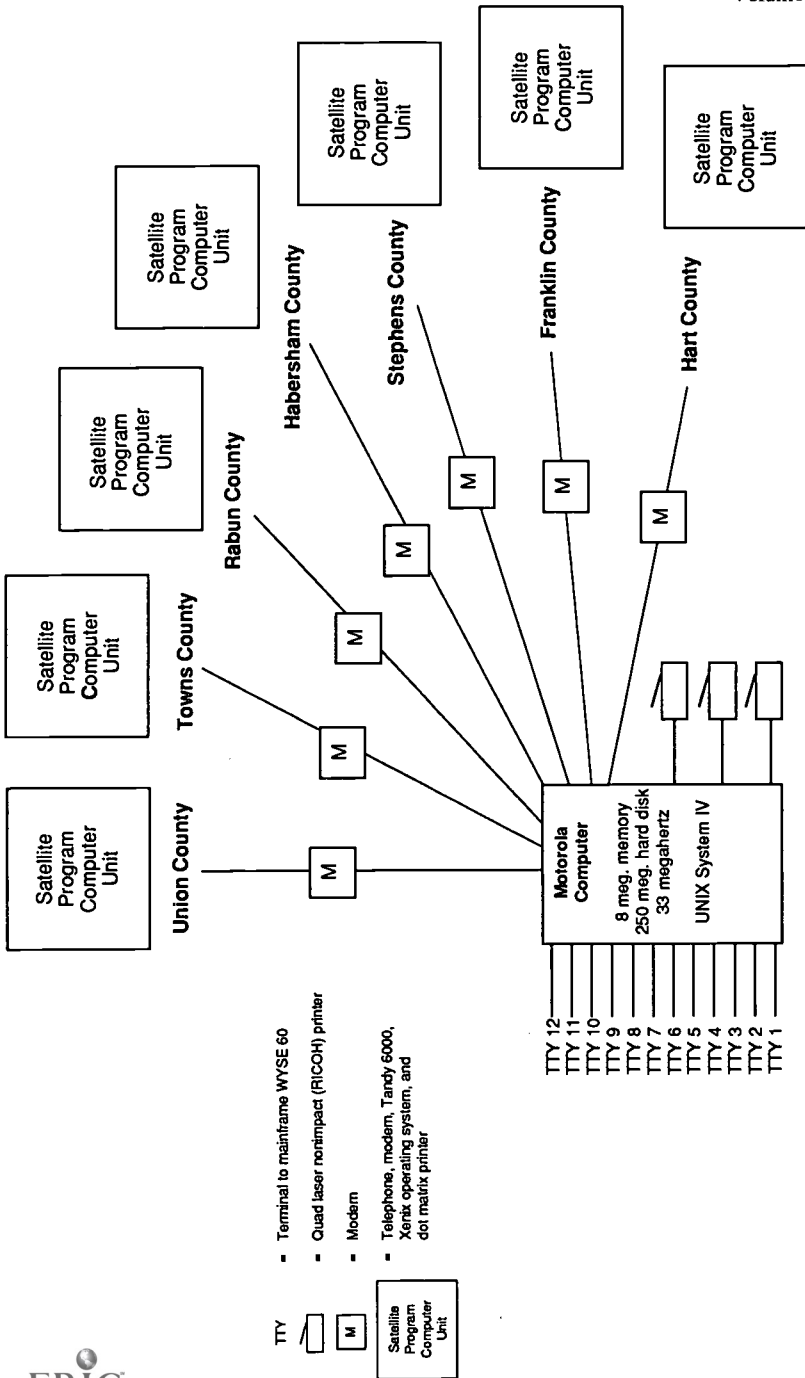

Main Program  
(Gainsville)

Figure 1: Overview of Computer System for Alpine Psychoeducational Program



*vi* screen editor, and manipulating directories and files with *mkdir*, *ll*, *l*, *mv*, *cp*, and *cat*, among others.

The most important and useful of these skills for every staff members is proficiency with the UNIX screen editor *vi* which allows the user to create letters, memos, forms, and other text files as well as simple data lists. Skill with *vi* is also the basis for the use of the UNIX typesetter program *troff* and its related programs *tbl* (for creating tabular output), *eqn* (for formatting mathematics), and *pic* (for creating simple line drawings). A relatively unsophisticated user can use these programs to create simple documents (letters, office forms, etc.) which will appear to be typeset when printed on a laser printer.

The computer needs to be useful if it is to be used effectively by staff. The use of the UNIX utility programs, particularly *vi* and *troff*, allows staff members to produce professional-looking output, save time, and establish a strong link to use the computer in more situations.

After becoming confident and competent with UNIX utilities, each staff member is trained in the same way to operate any generic or custom software, such as a word processor, spreadsheet, database, etc., which is useful to the staff member. After the initial training period, formal training may be resumed whenever a need arises, e.g., new employees, new software.

Once each staff member has achieved a minimal level of skill with the basic UNIX utility programs, particularly *vi* and *troff*, the staff member will naturally begin to create memos, data lists, letters, forms, etc., which are essential to the staff member's job. Although these *vi* applications are not programs in the formal sense of the computer term, they become the software because they fulfill an administrative need and are reusable, significantly shortening the time required to complete these jobs. Once the original file is typed and saved on the computer, it is easy and quick to copy it and make any necessary minor revisions through *vi*.

The first real, although simple, programs were written in-house using UNIX programming tools, *awk* and *sed*, which are simple programming languages with similarities to BASIC and the UNIX shell (*sh*) which is a powerful command interpreter. Although the time consumed in constructing *awk* or *sed* programs and shell scripts is considerable, the functioning programs may decrease the time spent on these tasks by as much as 90%.

A complex shell script is used to create a file to store information derived from a student's scores on the Kaufman Test of Educational Achievement as well as observations and recommendations of the test administrator. The resulting file is used to produce an educational report.

The *awk* language is also used to create a series of simple budgeting programs which provide assistance with a complex administrative task. Each *awk* budget program requires input from one or more simple data files containing budget figures, account numbers, and in some cases, purchase order numbers. With the data file input, each program produces a formatted report which may range in type from budget development (including funding source and allocation) to comparisons of real spending with the projected budget (including purchase order tracking). Because the data file input may be modified quickly and easily and the report is generated by the program itself, typing time is significantly reduced.

## Multi-User Application

Creating programs for multi-user operation is a considerably more difficult task than programming single-user applications. Besides providing accessibility of the program to all relevant users, the programmer must ensure that users do not interfere with each other while

using the same program. For example, a multi-user database program must be sufficiently sophisticated to allow two or more users to edit data records simultaneously yet prevent them from editing the same record at the same time. The level of programming skill and the amount of time required for creating this type of program under UNIX are in general far beyond what is available in most psychoeducational programs; thus for large or extremely complex programs outside consultants are employed.

Our first need for an external programmer arose when we considered the software necessary to create the monthly and quarterly reports consistent with requirements from the Georgia Department of Education. Since an accurate report detailing the psychoeducational program's services is one of our important outputs and the production of this report by hand is extremely time-consuming, the generation of this report was the first major external programming task attempted. Initially, we combined text files and *awk* scripts and succeeded in gathering some of the required information. This was helpful and reduced the amount of time slightly. However, because of the complexity of the calculations (e.g., unduplicated counts) and the large amount of data, the generation of the reports was beyond in-house programming skills. Therefore, we contracted with a software firm to produce custom-written software which would store the necessary data and create accurate monthly, quarterly, and annual reports. The ultimate goal, software which would produce uniformity of data-gathering and reporting techniques throughout the network, was realized with the release of the School Information System (SI) which is based on an intertwined system of custom-defined databases.

In addition to the generation of required reports, SI provides help with several other administrative tasks. Among these are maintenance of personnel and student files with associated demographic reports. These are summaries of information from the student and testing databases sorted by age, gender, and/or other factors.

Included with the SI software is another group of utility programs for UNIX including a relational database package (*r* database) which is composed of a collection of programs (*rvi*, *rsort*, *rotal*, *rittle*, etc.) which allow a user to define a simple database and create customized reports. Using these programs, Alpine has developed databases for inventory of equipment and supplies with related reports.

After the successful implementation of SI throughout most of the network, it was clear there was a need for the development of similar software concerning budgeting, inventory control, materials and supplies, staff development, and other administrative applications network-wide. These programs are now available.

## Strengths

Several strengths characterize Alpine's computer operations:

- staff perception that computer applications have made their jobs easier — subsequent to a feeling of being overwhelmed when beginning to learn the system;
- almost instance accessibility to data and information for staff;
- accurate data/information updated daily for staff use;
- minimal staff time needed to generate a variety of statistical reports;
- electronic transmission of required service reports to funding agency;
- continuing accurate chronology of due process events;
- continuing accurate chronology of progress reports;

- instant access to all student records for past five years regardless of status of service;
- effective monitoring of personnel assigned to specific student activities on a dated basis – daily, weekly, monthly, or quarterly.

## Future Directions

Two major computer program developments are projected. The first is creating an individualized education program (IEP) for those students enrolled in a psychoeducational program. This program will be developed using *Si* and the addition of a new database consisting of Quality Core Curriculum and it will allow staff to interactively produce the IEP. The second is the use of a scanner to scan documents, e.g., psychologicals, psychiatrics, social histories, educational, other typed documents, into a separate database and to cross-reference them to existing student data bases. This second development will utilize the existing computer (expanding the hard disk to 1 gigabyte), Ethernet, and Apple MacIntoshes plus custom software. Both are significant challenges as the system continues to become more useful.

---

Note: Those readers interested in more detailed information on this system should contact Dr. Wayne Moffett, Director; Alpine Psychoeducational Program; P.O. Box 2459; Gainesville, GA 30501 (FAX: 404-532-6386; Phone: 404-532-9981).

## GUIDELINES FOR AUTHORS

The GPN RESEARCH REPORT invites manuscripts concerned with any research aspect of Program operations for severely emotionally disturbed or behaviorally disordered students in Georgia. In order to be considered for publication, manuscripts must report or interpret some aspect of data-based scientific finding or practical experience that leads to improved understanding of SED/SBD students or educational programs for these students.

*AGREEMENTS: To be considered for review, a manuscript must meet the following prerequisites:*

1. It is not being considered concurrently by another publisher.
2. The author assumes responsibility for publication clearance in the event that the manuscript was presented at a professional meeting of another organization or was developed by a project funded by an external funding agency.
3. The manuscript has not been published in substantial part in another journal or published work.

*REQUIREMENTS: In preparing manuscripts for publication, authors must use the following guidelines:*

1. Manuscripts should be well organized and concise. Historical data common to dissertations should be limited. The readers of the GPN RESEARCH REPORT use the studies and therefore research findings should be specific, concrete, and gleaned from the method and procedures. Implications for the practitioner should be discussed in light of the findings.
2. Manuscript length may vary according to the subject. However, those most adaptable to space available are between 8 and 15 doubled spaced pages.
3. A brief abstract of 80-125 words should accompany the manuscript. It should be a clear and succinct statement of the treatment, method, and conclusion.
4. Complete author information should be given on a cover sheet: full name, title or position, institution, city, state, and address with zip code. Grant numbers and funding information should be included when appropriate. The author's name should appear nowhere on the manuscript.
5. Avoid footnotes.
6. All material must be double spaced, including quotations and references. Wide margins should be left for editorial work.
7. References are to follow the style described in the Publication Manual of the American Psychological Association (APA, 1200 17th Street, N.W., Washington, D.C. 20036).
8. Submit a master copy of the manuscript plus 4 additional copies to William W. Swan/Carvin L. Brown, Editors, GPN RESEARCH REPORT, G-10 Aderhold Hall, The University of Georgia, Athens, GA 30602.
9. Authors are responsible for the factual accuracy of their contributions. Manuscripts will be acknowledged upon receipt. Following preliminary examination by the editors, the manuscripts will be sent to associate editors for review. Within approximately 3 months, the author(s) will be notified concerning disposition of the manuscript.

EC304975

U.S. DEPARTMENT OF EDUCATION  
EDUCATIONAL RESOURCES INFORMATION CENTER  
(ERIC)

REPRODUCTION RELEASE

I. DOCUMENT IDENTIFICATION

Title: GPN Research Report, Volume #5  
Author(s): (6 Articles)  
Date: July 8, 1996

II. REPRODUCTION RELEASE

In order to disseminate as widely as possible timely and significant materials of interest to the educational community, documents announced in the monthly abstract journal of the ERIC system, *Resources in Education* (RIE), are usually made available to users in microfiche, reproduced paper copy, or electronic/optical media, and are sold through the ERIC Document Reproduction Service (EDRS) or other ERIC vendors. Credit is given to the source of each document. If reproduction release is granted, one of the following notices is affixed to the document.

"PERMISSION TO REPRODUCE THIS MATERIAL HAS BEEN GRANTED BY  
William W. Swan  
The University of Georgia  
TO THE EDUCATIONAL RESOURCES INFORMATION CENTER (ERIC)"

"PERMISSION TO REPRODUCE THIS MATERIAL IN OTHER THAN PAPER COPY HAS BEEN GRANTED BY  
  
TO THE EDUCATIONAL RESOURCES INFORMATION CENTER (ERIC)"

If permission is granted to reproduce the identified document, please CHECK ONE of the options below and sign the release on the other side.

- Permitting microfiche (4" x 6" film) paper copy, electronic, and optical media reproduction (Level 1) OR  Permitting reproduction in other than paper copy (Level 2)

Documents will be processed as indicated, provided quality permits. If permission to reproduce is granted, but neither box is checked, documents will be processed at Level 1.

OVER

Signature Required

"I hereby grant to the Educational Resources Information Center (ERIC) nonexclusive permission to reproduce this document as indicated on the other side. Reproduction from the ERIC microfiche or electronic/optical media by persons other than ERIC employees and its system contractors requires permission from the copyright holder. Exception is made for non-profit reproduction by libraries and other service agencies to satisfy information needs of educators in response to discrete inquiries."

Signature: [Signature]  
Printed Name: William W. Swan  
Organization: The University of Georgia  
Position: Associate Professor and Editor  
Address: G-10 Aderhold Hall  
Athens, GA  
Tel. No: 706 542-4074 Zip Code: 30602-7171

III. DOCUMENT AVAILABILITY INFORMATION

(Non-ERIC Source)

If permission to reproduce is not granted to ERIC, or, if you wish ERIC to cite the availability of the document from another source, please provide the following information regarding the availability of the document. (ERIC will not announce a document unless it is publicly available, and a dependable source can be specified. Contributors should also be aware that ERIC selection criteria are significantly more stringent for documents which cannot be made available through EDRS).

Publisher/Distributor: Alpine Psychoeducational Program  
Address: P O Box 2459, Gainesville, GA 30501  
Price Per Copy: \$5.00  
Quantity Price: Negotiable

IV. REFERRAL TO COPYRIGHT/ REPRODUCTION RIGHTS HOLDER

If the right to grant reproduction release is held by someone other than the addressee, please provide the appropriate name and address:

\_\_\_\_\_  
\_\_\_\_\_  
\_\_\_\_\_

Detach and complete this form and submit with your document. This form may be copied as needed.

