

DOCUMENT RESUME

ED 396 114

CE 071 791

AUTHOR Kleifgen, Jo Anne; Frenz-Belken, Patricia
 TITLE Problem-Solving at a Circuit-Board Assembly Machine: A Microanalysis.
 INSTITUTION National Center for Research in Vocational Education, Berkeley, CA.
 SPONS AGENCY Office of Vocational and Adult Education (ED), Washington, DC.
 PUB DATE Jun 96
 CONTRACT V051A30003-96A; V051A30004-96A
 NOTE 55p.
 AVAILABLE FROM NCRVE, Materials Distribution Service, 46 Horrabin Hall, Western Illinois University, Macomb, IL 61455 (order no. MDS-1043: \$5.50).
 PUB TYPE Reports - Research/Technical (143)

EDRS PRICE MF01/PC03 Plus Postage.
 DESCRIPTORS Adults; Creative Thinking; *Error Correction; *Manufacturing; Manufacturing Industry; Perception; *Problem Solving; Repair; Teamwork; *Troubleshooting; Vocational Education

ABSTRACT

A study described machine operators' problem-solving actions at a computerized circuit-board assembly machine in a small manufacturing plant located on the West Coast. Participants were a machine operator and his supervisor, both from Vietnam, who were building large prototype boards for a major computer corporation. Over a 6.5 minute interval, the workers confronted two problems with the assembly. First, the robotic arm was unable to pick a component from the feeder; and, second, the component was larger than the place assigned to it on the board. The workers solved the first problem by adapting machine parts so that the arm would place the component correctly and the second by recommending a change in the customer's design plans. For each problem they followed this procedure: notice the problem, hypothesize the source, test the hypothesis, and look for an optimal solution. Fine-grained analysis of the workers' actions on the machine showed they applied perceptual and representational competence during the problem-solving process. This second level of analysis of the workers' collaborative actions on the machine showed that they drew on well-honed perceptions--auditory, visual, and kinesthetic--to discover the trouble and find its source. Throughout the troubleshooting, the workers referred to various kinds of inscriptions; work with numerical inscriptions pervaded the activity. Worker perceptions and representations mutually elaborated on one another. (Contains 30 references.) (YLB)

 * Reproductions supplied by EDRS are the best that can be made *
 * from the original document. *



National Center for Research in Vocational Education

University of California, Berkeley

PROBLEM-SOLVING AT A CIRCUIT -BOARD ASSEMBLY MACHINE: A MICROANALYSIS

U.S. DEPARTMENT OF EDUCATION Office of Vocational Research and Improvement EDUCATIONAL RESOURCES INFORMATION CENTER (ERIC)

- This document has been reproduced as received from the person or organization originating it. Minor changes have been made to improve reproduction quality.

Points of view or opinions stated in this document do not necessarily represent official OERI position or policy.

BEST COPY AVAILABLE

Supported by the Office of Vocational and Adult Education, U.S. Department of Education

CE 071 791

This publication is available from the:

National Center for Research in Vocational Education
Materials Distribution Service
Western Illinois University
46 Horrabin Hall
Macomb, IL 61455

800-637-7652 (Toll Free)

**PROBLEM-SOLVING
AT A CIRCUIT-BOARD
ASSEMBLY MACHINE:
A MICROANALYSIS**

**Jo Anne Kleifgen
Patricia Frenz-Belken**

Teachers College, Columbia University

**National Center for Research in Vocational Education
Graduate School of Education
University of California at Berkeley
2150 Shattuck Avenue, Suite 1250
Berkeley, CA 94720-1674**

Supported by
The Office of Vocational and Adult Education,
U.S. Department of Education

June, 1996

MDS-1043

FUNDING INFORMATION

Project Title: National Center for Research in Vocational Education

Grant Number: V051A30003-96A/V051A30004-96A

Act under which Funds Administered: Carl D. Perkins Vocational Education Act
P.L. 98-524

Source of Grant: Office of Vocational and Adult Education
U.S. Department of Education
Washington, DC 20202

Grantee: The Regents of the University of California
c/o National Center for Research in Vocational Education
2150 Shattuck Avenue, Suite 1250
Berkeley, CA 94720-1674

Director: David Stern

Percent of Total Grant Financed by Federal Money: 100%

Dollar Amount of Federal Funds for Grant: \$6,000,000

Disclaimer: This publication was prepared pursuant to a grant with the Office of Vocational and Adult Education, U.S. Department of Education. Grantees undertaking such projects under government sponsorship are encouraged to express freely their judgement in professional and technical matters. Points of view or opinions do not, therefore, necessarily represent official U.S. Department of Education position or policy.

Discrimination: Title VI of the Civil Rights Act of 1964 states: "No person in the United States shall, on the ground of race, color, or national origin, be excluded from participation in, be denied the benefits of, or be subjected to discrimination under any program or activity receiving federal financial assistance." Title IX of the Education Amendments of 1972 states: "No person in the United States shall, on the basis of sex, be excluded from participation in, be denied the benefits of, or be subjected to discrimination under any education program or activity receiving federal financial assistance." Therefore, the National Center for Research in Vocational Education project, like every program or activity receiving financial assistance from the U.S. Department of Education, must be operated in compliance with these laws.

PREFACE

This research was supported in part by a grant from the National Center for Research in Vocational Education, "Skills Employers Want, Skills Employers Need" (Agreement #SA1059-32364Z). Data was collected while the first author was on sabbatical at the Institute for Research on Learning in Palo Alto, California.

Heartfelt gratitude is extended to Shelley Goldman, Jim Greeno, Brigitte Jordan, Ted Kahn, Charlotte Linde, and the staff at IRL for their generous support and stimulating ideas. We thank Tom Bailey, David Belkin, Charles Goodwin, Clifford Hill, Franklin Horowitz, Eric Larson, and Hervé Varenne for helpful comments on earlier versions of the paper.

We are deeply indebted to Ted Kahn of IRL for introducing us to the circuit-board manufacturing company and most especially to the employees and management for opening their doors to this research and for teaching us about their work.

Finally, we thank Professor Suu Nguyen and Mr. Hung Le, who not only provided the Vietnamese transcriptions and translations, but also helped clarify meanings for us.

EXECUTIVE SUMMARY

One way to help educators understand the skill demands for today's pre-baccalaureate workforce is to study work in its context from the perspective of people who actually perform various tasks in the course of their day (Stasz, 1994). The aim of this study was to describe workers' activities in a company that uses high-tech machines. In addition, we wanted to observe such work in a small business setting, since it represents the work situation for great numbers of people employed in this country. The firm selected was a small circuit-board manufacturing plant located on the West Coast. What did workers in this firm need to know in order to operate new technologies, and just how did they perform this kind of work? This report focuses on machine operators' problem-solving actions at a computerized circuit-board assembly machine.

Background

Beliefs about the effect of technology on people's work lives have shifted over time. In the post-World War II era, the increasing automation of the workplace was enthusiastically received; it was hoped that workers would be freed from monotonous tasks and that automation would result in a reduction of work hours. This positive outlook came under attack in the late 1960s and 1970s, however, when studies showed that automation of the workplace was leading to a degeneration of work skills (e.g., Braverman, 1974; Noble, 1979; Zimbalist, 1979). In recent years, this second notion has been challenged. Bailey (1989) points out that new technologies have forced industries to give up a de-skilling approach. Firms that attempted to transfer all skills to machines soon realized that a skilled worker cannot easily be replaced by a machine (Levine, 1995). In the current view of work around new technologies, skill demands have shifted from mechanical competence to an abstract understanding of how computerized machines function (Adler & Borys, 1989).

A growing body of research in the ethnomethodological tradition is focusing on the way people interact with one another and with the material artifacts surrounding them in the workplace. An example of a detailed examination of work in a technologically saturated environment is a study by Goodwin (1992), who closely analyzes the interaction of employees in an airlines operations room. Goodwin shows how workers' talk-in-action is

combined with their perceptions of what is on TV monitors in such a way that what they see on the screen is co-constructed. By carrying out research at this level of detail in high-tech work settings, it becomes possible to increase our understanding of what kind of skills employees should have.

Setting and Method

The analysis presented in this report is part of a larger ethnographic study of work in a small circuit-board manufacturing plant which assembles circuit boards "to order." One important characteristic of this company is that it is in a highly competitive market. To survive, the company must have leading-edge equipment, be able to do a fast turnaround of a job, and provide excellent quality control. A second feature of this company is the ethnolinguistic diversity of its employees. The teams generally organize themselves by ethnolinguistic background, an arrangement that is supported by the management because it perceives that these groups work well among themselves. These arrangements do not have tight boundaries, however, and individuals move across teams, when necessary, to make last minute changes requested by the customer, meet deadlines, or troubleshoot the machines. Because circuit-board technology is changing more rapidly than the machines that assemble them, workers frequently confront problems with the assembly.

Over a three-month period, workers were observed and videotaped as they performed their tasks on the manufacturing floor. These observations were supplemented with more formal and extended interviews, providing information on the company's history and structure, the participants' background and education, the kinds of tasks performed, and the functions of the different machines. The larger research project provided overarching contextual information for the present microanalysis.

Our microanalytical method is drawn largely from the work of conversational analysis, which provides a theoretical foundation for understanding how talk-in-interaction is organized (c.f., Goodwin & Heritage, 1990). Through the study of ordinary conversation, analysts demonstrate how human activity is coordinated and how meaning and mutual understanding are achieved. Recently, researchers in this tradition have turned to the analysis of task activities in institutional settings such as courtrooms (Atkinson & Drew, 1984), classrooms (McHoul, 1990), and doctors' offices (Heath, 1992; see Drew &

Heritage, 1992, for an excellent collection). In the present research, a microanalysis of workplace interaction was designed to throw light on the kinds of skills workers actually employ in the midst of collaborative activities. Two machine operators' troubleshooting activities were observed. The workers' interactions with machine parts, measuring tools, computerized data, and with one another were subjected to various levels of analysis.

Analysis of the Task Activity

The participants in the interaction were a machine operator and his supervisor, both from Vietnam, who were working under tremendous time pressure with a machine programmed on this particular day to build large prototype boards for a major computer corporation. The first board moved on a conveyor belt through the machine which comes equipped with a robotic arm. The arm was taking components from feeders and placing them at assigned locations on the circuit board. Over a six-and-a-half-minute interval, the workers confronted two problems with the assembly. First, the robotic arm was unable to pick a component from the feeder; and second, the component was larger than the place assigned to it on the board. The workers solved the first problem by adapting machine parts so that the arm would place the component correctly; and the second by recommending a change in the customer's design plans. For each problem, they followed a procedure which can be summarized as follows: notice the problem, hypothesize the source, test the hypothesis, and look for an optimal solution.

Working with Perceptions and Representations

Fine-grained analysis of the workers' actions on the machine showed that they applied perceptual and representational competence during the problem-solving process. This second level of analysis of the workers' collaborative actions on the machine showed that they drew on well-honed perceptions—auditory, visual, and kinesthetic—to discover the trouble and find its source. For example, a sudden shift in the sound of the robotic arm's rhythmic movements directed the workers' visual attention to problems with the way the components were being fed onto the machine. Based on their auditory and visual perceptions, the workers formed a hypothesis as to the source of the problem. They confirmed their hypothesis by measuring components on the feeder. They contested one another's suggestions for adapting a machine part and came to agree on an optimal solution. Then the measurements were checked against the numbers on the machine's

computer screen. Finally, by means of gestures, one worker displayed to his colleague his assessment of the robotic arm's placement of components on the board. Tracing his finger across the board's landscape in large and small loops, he showed errors in the relationships between the components already placed and those yet to be placed. This visual assessment led them to alter a series of numbers in the computer program.

Throughout the troubleshooting, the workers referred to various kinds of inscriptions such as a blueprint of the board, the customer's bill of materials, and the computer program data; they also made their own inscriptions by measuring objects and modifying numbers in the program. Work with numerical inscriptions pervaded the activity. The workers recognized these numbers as representations of the task to be accomplished by the machine, numbers which require careful assessment by comparing them against other inscriptions, and, in particular, against their own perceptions. Contrary to widely held assumptions that workers place greater emphasis on representational knowledge—numbers given in a computer program—than in their perceptual intuitions, this study shows that their assessments moved in both directions during their conjoint problem solving. Worker perceptions and representations mutually elaborated on one another.

Discussion and Educational Implications

Although modern technology places new skill demands on workers, workers still retain many of the skills that were required in traditional work settings. Machine operators still rely on their hands, eyes, and ears when they are setting up a machine for a specific task or when troubleshooting is required. They interpret and manipulate the data in the computer program that runs the machine. They recognize these numbers as representations of the task to be accomplished by the machine and, consequently, as numbers that require careful assessment, comparing them against other inscriptions they make and, in particular, against their own perceptions. The findings of this study challenge claims that workers who use high-tech equipment act primarily as monitors who have abstract knowledge of the machinery and have little use for their perceptual skills.

Workers, moreover, detect and solve problems as problems arise. Because of the rapid changes in machine technology and products, workers have to constantly readjust to

more advanced equipment and adapt the machine to the requirements of a specific job. Since they typically work under a tremendous time pressure, they carry out much of the problem-solving on the fly. Lévi-Strauss (1966) formulated the notion of *bricoleur* to describe a person who uses tools in creative ways, including ways that go beyond the original purposes for which the tools are designed. This research has shown that workers' *bricolage* skills have not been lost with the advent of computerized technologies. They are contemporary *bricoleurs*, adapting even the digital tools to ever-changing circumstances.

This study also demonstrates how effective teamwork actually proceeds. Workers are able to contest one another's suggested solutions and assemble, as it were, the knowledge that is distributed between them and across material inscriptions surrounding them, and eventually come upon optimal solutions. This trend of working in teams has broader implications about learning on the job. No single person is expected to hold all the knowledge about assembling circuit boards. Workers combine their knowledge with different coworkers, in different situations, and use different cognitive artifacts. Assembling knowledge resides, not in the machine, nor in an individual, but in the dynamics of the conjoint problem-solving situation.

Assuming that this workplace is typical of what work settings will be like in the 21st century, then work-based learning will be a major aspect of a person's educational life. If this is the case, what is the role of educational institutions in preparing workers for their future jobs? Based on case studies of production workers and professionals, Stasz, Ramsey, Eden, Melamid, and Kaganoff (1995) identified work-related attitudes and "new" generic skill areas—problem-solving, communication, and teamwork. Schools can give learners practice in these new skills through authentic learning situations such as project-based work. Projects present learners with everyday problem-solving situations, require them to come to decisions collaboratively, and compel them to communicate and share knowledge effectively. The present study supports the practical value of such authentic learning practices. Our findings further suggest that more emphasis be placed on the integration of cognitive abilities with perceptual and manual skills into learning practices.

Finally, though employees' ethnolinguistic diversity was not the primary focus of this research, we observed this firm's attitudes toward its ethnolinguistically diverse workers. The management created a climate that encouraged workers to use their indigenous ways of interacting in order to assemble high-quality products. Given the

continued demographic shifts in this country, we argue that such attitudes should be fostered through on-the-job training and through high-quality instruction in diversity both at school and in the workplace.

TABLE OF CONTENTS

Preface	i
Executive Summary	iii
Introduction	1
Background	2
Context of the Study	4
Setting	4
Participants	5
The Circuit Boards	6
The Machines	7
Analysis of the Task Activity	8
The Pick Problem	9
The Placement Problem	16
Working with Perceptions	19
Working with Representations	24
Discussion and Educational Implications	29
References	33
Appendix A	37
Appendix B	43

INTRODUCTION

Imagine a day in the life of workers on a certain manufacturing floor. There is a flurry of activity amidst a deafening sound of machines. The tasks are constantly changing. As soon as the workers get used to making one product, a new kind has to be made. The product they are working on now is not the same as the one that was made the day before; in fact, three quite different products will have to be built before the day is through. Moreover, the machines that the workers have been using to build similar products have just been replaced by newer, more sophisticated ones. Workers have begun this day performing assigned tasks in their usual teams, but a customer's needs could easily require a sudden shift to other teams and tasks, and the workers will probably be asked to do overtime in order to meet the deadline.

This high-pressure, fast-paced scene is not fiction; it is typical in many work sites today. Circuit-board manufacturing is a case in point: As with many firms involved in emerging digital technologies, change seems to be the only constant. In this study, we examine how workers in a small company which manufactures circuit boards accomplish their tasks in highly fluid circumstances. We pay particular attention to the interactions of workers, who are operating computerized machines for assembling components on the circuit boards. We analyze workers' concerted actions supported by these machines and other objects in the work environment. The environment is teeming with material objects and inscriptions—words, numbers, and images¹—all of which are contributing elements to the workers' activities. As will be seen, the tasks are accomplished when people make skillful use of these elements in their work.

Stasz (1994), in a review of research dealing with skill demands in the modern workforce, affirms that skills of workers have to be studied in context, from the perspective of people who actually perform various tasks in the course of their day. The present microanalytical study is part of a larger research project which employed an ethnographic approach—extensive videotaped observations and interviews—which provided overarching contextual information. The microanalytical method used here is drawn largely from the work of conversation analysis, which presents a theoretical

¹ Following Derrida (1977), we apply the notion of *inscription*, which is also used by Latour and Woolgar (1986) and Goodwin (1994) to refer to all marks—writing, graphs, numbers, blueprints, and images—that organize and represent material phenomena.

foundation for understanding how talk-in-interaction is organized (c.f., Goodwin & Heritage, 1990). Through the study of ordinary conversation, analysts demonstrate how human activity is coordinated and how meaning and mutual understanding are achieved. Recently, researchers in this tradition have turned to the analysis of task activities in institutional settings such as controlrooms (Atkinson & Drew, 1984), classrooms (McHoul, 1990), and doctors' offices (Heath, 1992; see also Drew & Heritage, 1992, for an excellent collection). In our view, the close study of workplace interaction, especially during troubleshooting moments, can throw light on the kinds of skills workers actually employ in the midst of collaborative activities.

BACKGROUND

Beliefs about the effect of technology on people's work lives have shifted over time. The increasing automation of the workplace in the post-war era was enthusiastically received by employers and researchers alike; it was hoped that workers would be freed from monotonous tasks and that automation would result in a reduction of work hours, giving workers more free time to pursue their own interests. This positive outlook came under attack in the late 1960s and 1970s, when studies claimed that automation of the workplace was leading to a degeneration of work skills. According to critics like Braverman (1974) and Zimbalist (1979), workers who operate computerized machinery need fewer skills than workers who use traditional machines because the modern machine presumably performs most of the tasks that were formerly carried out by a skilled worker. In their view, the worker was becoming an "unthinking" adjunct to a "thinking" machine.

Noble (1979) noted that a traditional machine operator used to "transmit his skills and purpose to the machine by means of cranks, levers, and handles. Feedback is achieved through hands, ears, and eyes" (p. 21). In contrast, a worker operating a computerized machine has little more to do than push a button. Because of the complexity of modern machinery, Noble claimed, workers in automated work settings have little knowledge about the workings of the machines; rather, such knowledge is concentrated in the minds of engineers and programmers. This de-skilling view became widespread, especially among those who were not themselves machine operators.

In recent years, this notion has been challenged. Bailey (1989) points out that although some industries pursued a de-skilling strategy in the 1970s, new technologies have forced them to give up that approach. Firms that attempted to transfer all skills to machines soon realized that a skilled worker cannot easily be replaced by a machine. Taking a similar perspective, Levine (1995) cites an article in the *Economist*, which describes the fiasco in a General Motors plant where robots were to take over most of the tasks previously carried out by humans. These robots turned out to be highly unreliable in that they started to dismember one another, smash cars, spray paint everywhere, and fit the wrong equipment. The company had to give up its plans for full automation and return to the approach of hiring skilled workers to operate high-tech machinery.

What do workers need to know in order to operate these digital technologies, and just how do they perform this kind of work? Insightful studies have taken into account the situated actions of workers in various contexts (e.g., Hutchins, 1993 (navigation); Jordan, 1989 (midwifery); Scribner & Sachs, 1990 (stockroom work); Suchman, 1987 (human-machine interaction). A detailed examination of activity in the workplace was done by Goodwin (1994), who closely analyzes the interactions of people in different professions as they use the tools of their trade. For example, he describes the work of an archaeologist and her student assistant. The archaeologist corrects the student's way of observing an excavated dirt wall; the student learns how to see with an archaeologist's eye. Their work entails the integration of "talk, writing, tools, and distributed cognition as two parties collaborate to inscribe events they see in the earth onto paper" (p. 612). In another study, Goodwin (1992) describes the multi-activity responsibilities of employees in an airline's operations room. Their job is to coordinate the ground operations for the airline—baggage transfer, contact with arriving and departing planes, and management of statistics. Personnel in the operations room work with a variety of electronic tools such as computers, radios, and monitors connected to TV cameras outside the gates. In his analysis, Goodwin shows how workers' talk-in-action and their perceptions of what is on the monitors mutually inform one another. The workers' vision is "something that is artfully crafted within an endogenous community of competent practitioners" (p. 16).

BEST COPY AVAILABLE

CONTEXT OF THE STUDY

Setting

We were interested in observing a small business rather than a large corporation. Such a setting represents the kind of workplace in which employees will find themselves in the 21st century, due in part to the downsizing of large corporations and the growth of smaller firms. We looked, in particular, for a sector of industry that requires the use of advanced technology, which is increasingly becoming more common in the workplace. In addition, because more than 75% of today's workers have completed between 12 and 15 years of schooling (U.S. Department of Labor, 1994, pp. 160-161), we wanted to focus on a firm in which the majority of employees have a prebaccalaureate background.

A site that met all these requirements was a circuit-board manufacturing plant, which we will call Company X, located in the Silicon Valley of California. Company X assembles circuit boards to order. Its customers are electronics companies from aerospace, computer, or medical industries, who outsource their manufacturing in order that they themselves may focus on engineering and product development. Outsourcing is a growing industry today. One important characteristic of this company is that it is in a highly competitive market. To survive, the company must have leading-edge equipment, be able to do a fast turnaround on a job, and provide excellent quality control. Employees have a large stake in the success of this firm. The quality of the product determines whether or not the company will win more contracts or simply fold.

The first author spent three months on the manufacturing floor observing and videotaping the workers. Although they were asked questions during actual tasks in order to clarify what was happening, every effort was made not to interfere with the pace of the work. These observations were supplemented with more formal and extended interviews with six of the workers, two supervisors, the manufacturing manager, and the company president. The interviews, which were audiotaped, provided information on the company's history and structure, the participants' background and education, the kinds of tasks performed, and the functions of the different machines. A total of 15 hours of videotaped task activities and 20 hours of audiotaped interviews were transcribed. (For a list of Transcription Conventions and the Full Transcription, see Appendix A. Communication in Vietnamese was also transcribed and translated.)

Participants

Company X is composed of approximately 120 employees, 80 of whom work on the manufacturing floor. Jobs range from unskilled and semiskilled, such as preparing parts or hand-placing them on the board, to skilled labor, such as operating computerized machines, soldering, or testing the completed circuit boards. Workers can have a career path within this company. Some of the workers in Company X have been promoted from unskilled to skilled jobs and even to supervisory positions. Almost all jobs have multi-task functions, and some tasks require programming skills. The work is carried out by teams of workers at stations.

A feature of this company is the ethnolinguistic diversity of its employees—people of Chinese, Latino, Middle Eastern, and Vietnamese background, along with African Americans and European Americans. Some workers are recent immigrants with green cards, most of whom come from Mexico and Vietnam. The teams generally organize themselves by ethnolinguistic background, an arrangement that is supported by the management because it perceives that these groups work well together. These arrangements do not have tight boundaries, however, as other members on a given team may include native speakers of other languages. Moreover, individuals move across teams when they are needed for troubleshooting, making last minute changes requested by the customer, or meeting deadlines. As they work, the groups play their music of choice, forming a cacophony of ethnic sounds, which mingle with the blare of the machines.

Within this setting, workers frequently take part in troubleshooting activities. We isolated one incident for analysis because of its typicality: a team of workers engaged in complex problem-solving at a high-tech machine. The focal participants in the interaction analyzed here are two Vietnamese workers: Tran², a 32-year-old machine operator, and Du, his supervisor. These two men form part of a team of six who work in one of the circuit-board assembly departments. Five workers are from Vietnam, and one is from the United States. Tran came to this country as a refugee at the age of 14; he completed high school here and eventually earned an associate's degree in computer science from a community college. Du, who is now reaching the age of retirement, also arrived as a refugee from Vietnam, where he had completed secondary school. In this country, Du studied briefly at a technical institute in order to become an electrician. An opportunity

² The participants' names are pseudonymous.

came for him to take a job in manufacturing, however—work that he has continued doing for more than 15 years. Both men are experienced in their respective jobs, and both have received occasional on-the-job training at Company X. Just prior to this study, they were trained to operate new high-tech machines recently acquired for their department. Before examining Tran and Du's interactions, it is necessary to describe the circuit boards they assemble and the equipment that they use to accomplish the task.

The Circuit Boards

Today, circuit boards are ubiquitous. Not only are they used in PCs, but they can also be found in other machines used for homemaking, work, transportation, and leisure. Circuit boards come in different sizes and contain a variety of interconnected components, which themselves vary in size. Specific examples of components include integrated circuits, resistors, capacitors, magnetics, crystals, and sockets. Some components are secured to the board with through-hole punching. Others are attached to the surface of a board that has been covered with a thin layer of solder paste. One component, the socket, bears some description because it figures importantly in the interaction described below. Sockets are relatively large receptacles for components that have a big turnover. Because these other components are plugged into sockets rather than soldered to the board directly, they can be replaced easily by newer versions. Thus, using sockets can be economically advantageous for end users, as well as designers, since the latter can upgrade existing boards rather than having to manufacture new ones.

The Machines

In general, components that are assembled on circuit boards have become much smaller over time. Because circuit-board technology is undergoing this rapid miniaturization, manufacturing technology must keep pace. This means that the machines designed to assemble the boards can have a life cycle of only six months to a year. Company X uses both older-generation machines—for through-hole assembly—and newer ones, which have surface mount technology (SMT). Often, a customer requires boards that contain a combination of through-hole and SMT assembly.

Both types of machine must be programmed to place components on boards at assigned points on an x/y axis. The machine programmer uses a customer's bill of materials, a blueprint, and sometimes a sample board as a basis for data entry. In a small office just off the floor, the programmer enters the information into a database, then converts the program to SMT-based software and takes the disk to the machine operator. The machine in Figure 1 is equipped with a robotic arm and a vision system designed for accurate placement of components. The operator can input and modify data using the operator panel and Cathode Ray Tube (CRT) display on the machine. The components are fed from feeders arranged in slots along the front and back of the machine. Reels of tape containing these components are placed on the feeders.³ Each time the robotic arm "picks" a component from the reel, the feeder moves another component into place for the next pick. The first board in a series, having been prepared with a film of solder paste, moves on a conveyor belt through each machine, where the arm picks components from feeders and places them at designated points. During the trial run, the operator has the option of moving the arm in slow motion. Once the first board is assembled accurately, the other boards are run at high speed. A single job for a customer can range from assembling just a few boards to several thousand boards, using from one to three SMT machines.

³ Other feeders may hold sticks or trays of components. For the purposes of this paper, we will focus on the reels as illustrated in Figure 2. All diagrams of the SMT machine and its parts are from the manufacturer's instruction manual and are reproduced with permission from Zevatech, Inc.

Figure 1
SMT Machine

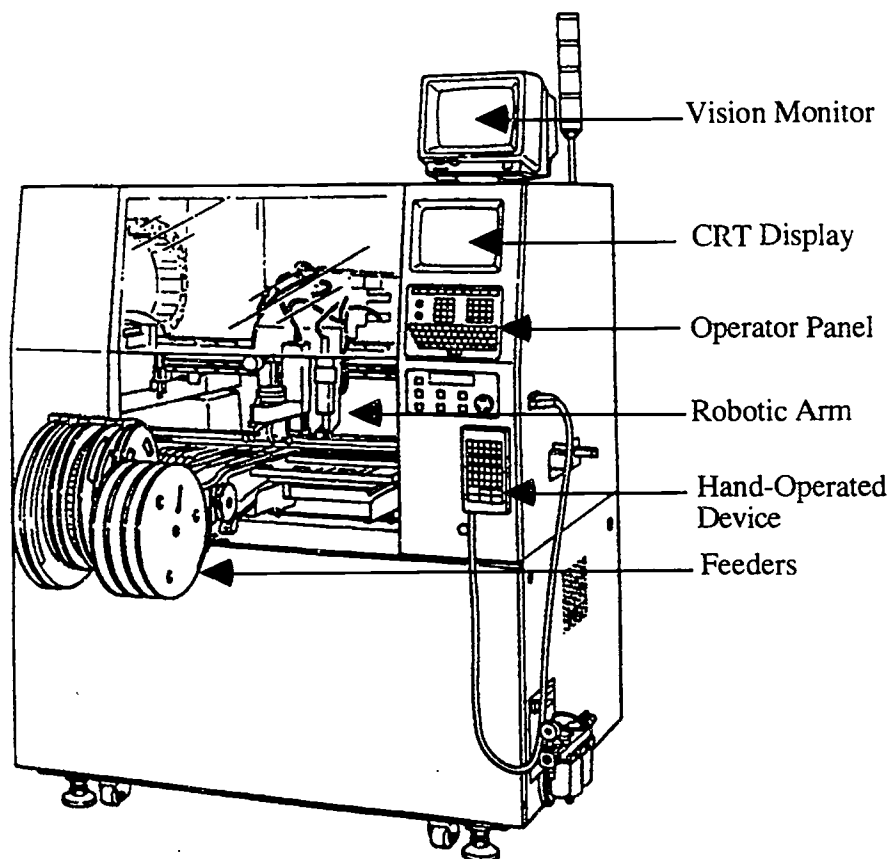

ANALYSIS OF THE TASK ACTIVITY

Our analysis takes place while Tran and Du are working with two of the higher-end SMT machines that have been programmed on this day to build large prototype boards for a major computer corporation. Earlier in the morning, before the activity examined here, Tran set up the machines for the job, a task which took nearly five hours. (For a complete list of tasks performed by machine operators and assistants, see Appendix B.) The set-up entailed offsetting the board,⁴ which required mathematical calculations by hand, since the machine was not designed to offset boards of this size; checking that the feeders were

⁴ Offsetting is a complex procedure in which the computerized machine must be programmed to "read" the size of the board and calculate the grid for placement of the components along an x/y axis.

located in the right slots; observing the location of the robotic arm over each pick point (on the feeders) and place point (on the board); and adjusting the computer data where necessary by using either the operating panel or the handheld device connected to the machine.

Having completed this preliminary work, Tran is ready to run the first board. He sets the robotic arm to slow motion in order to observe the accuracy of every pick and placement. He has at his disposal the vision display, the CRT display recording the ongoing placement, a printout of the data entry, and a blueprint of the board. Du is working with him because the boards are slated to be completed and shipped to the customer this same afternoon. After some troubleshooting, the men succeed in getting the board through the first machine, which has loaded about half of the components. Presently, the partially loaded board moves along the conveyer belt to the second machine. Here, over a six-and-a-half minute interval, the two men confront new problems with the assembly. These problems have consequences regarding how the boards will be completed. We isolate this troubleshooting process for close analysis.

The Pick Problem

Tran sets the robotic arm to resume high-speed placement. In fractions of a second, it places ten components before moving to a feeder with a large reel containing sockets. The machine has been programmed to pick and place four such sockets on this board. After the first socket placement, however, the arm tries and fails twice to pick the second one. The second socket is finally placed on the third try. This rapid trial-and-failure sequence (two misses before one successful pick) happens again for the third socket. Du calls attention loudly to the problem as soon as the arm fails the first time:

10:17:16 Du: MISS PICK—

10:18:16 Tran: Oo: : : h.

There are several possible sources for this problem. For example, the data entry could have an incorrect z-axis value, which is the vertical path of the robotic arm for picking and placing. Or, as the workers soon hypothesize to be the case here, there could be an incorrect feed pitch (which is explained below). Tran stops the machine, peers inside, and counts on his fingers the number of sockets that have been picked so far:

10:25:23 Tran: °One, two, three.

He observes for a few seconds and starts the machine again as shown in Figure 2.

Figure 2
Tran Examining Problem

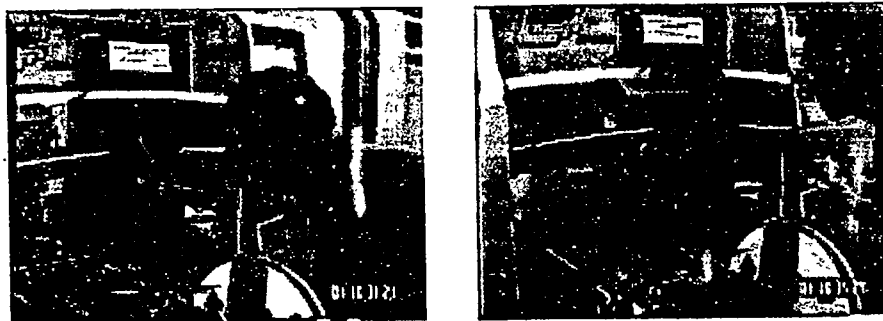

In rapid succession, the arm places the third socket and swings back to pick up the fourth. At this point, Tran sets the machine to slow motion and observes the arm's attempts to pick:

10:39:22 Tran: °Hai cai.
'Two (picks).'⁵

°Ba cai.
'Three (picks).'

10:41:00 (directs gaze at pick point)

As the arm, now grasping the fourth socket, begins to move slowly over the board, Tran presses stop. The arm holds the socket suspended over its placement point. The two men agree that they will have to adjust a part on the feeder, which they think to be the source of the problem:

10:45:15 Du: Có phải chỉnh con ốc ở dưới không?
'Is it necessary to fix the screw underneath?'

10:47:28 Tran: U.
'Yeah.'

⁵ Whenever Vietnamese transcription appears, it is followed by an English translation.

Du, kneeling down at the base of the machine, takes the end of the feeder tape in one hand and uses a ruler to measure the distance from the midpoint of one component to the midpoint of the next. This distance is the feed pitch: The tape is fed forward as soon as a component is picked, so that the next component is ready for the robotic arm. Tran leans over to watch Du measure the tape and begins calculating:

- 11:12:23 Tran: 'Kỳ ta.'
'Strange.'
- 11:15:10 Tran: Hai.
'Two.'
- 11:16:10 Du: [(xxxx)
Tran: [Hai, ba rưỡi.
'Two, three and a half.'
- 11:19:06 Hai mười va hai mươi lăm.
'Twenty and twenty-five.'

Tran announces the measure as Du holds the ruler with one hand and with the other traces the distance between the midpoints of two components on the tape. Together, they determine that the pitch is 24mm, and Tran acknowledges an error in setting up the feeder:

- 11:25:14 Tran: Hai mươi bốn.
'Twenty-four.'
- 11:27:22 Du: Từ cái mỏ này tới cái mỏ này.
'From this point to this point.'
- 11:30:20 Tran: U.
'Yeah.'
- 11:31:05 Hai mươi bốn.
'Twenty-four.'
- 11:32:15 Hai mươi bốn la mười hai.
'Twenty-four, then [it's] twelve.'

At this point, the workers test their hypothesis that the feeder pitch is set incorrectly. Tran removes the feeder from the machine and holds it up for them to examine more closely (see Figure 3).

Figure 3
The Feeder



Examining the Feeder

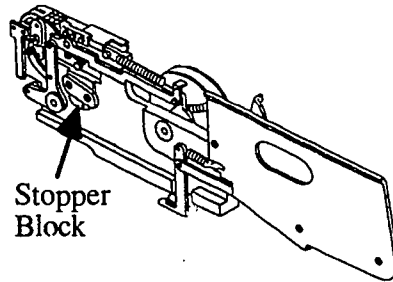

Diagram of a Feeder

They both look at the stopper block, an adjustable part resembling a sprocket, which determines the pitch this feeder will apply. Feeders for this SMT machine are designed to hold stopper blocks having anywhere from two to four teeth, or pitch points. Du notes that the stopper block on this feeder has four points (an example of a stopper block with three pitch points is in Figure 4). He signals each of the points on the block as he itemizes the four pitch choices to Tran:

11:44:05 Du: Có mấy?
'How many?'

11:44:30 Bốn sáu tám mười. (pointing to each point)
'Four, six, eight, ten.'

Tran places the feeder on a nearby chair. Du goes to get the digital calipers, which measure more precisely. He returns with it and measures the feeder tape again while Tran looks on. The 24mm measure is confirmed. Du observes that the stopper block is set to a 10mm pitch:

12:44:15 Du: Yeah?
12:45:01 Twen'-four.

12:45:25 This one only, uh, ten? (looking at stopper block)
 12:49:27 Twenty-four: : r.

The two men are now in a quandary in terms of an optimal solution. This SMT machine is not designed to place components with a 24mm pitch. The workers must make adjustments to compensate for this shortcoming. Tran suggests looking for a different stopper block, one with a 12mm pitch point, whereas Du suggests setting the current stopper block to an 8mm pitch point. If they take up the former suggestion, the robotic arm would pick the component on the second try; if they decide on the latter, it would pick the component on the third try. In terms of efficiency, the 12mm pitch is a better choice because the machine action would absorb less time:

12:51:01 Tran: Phải cần đến mười hai.
 '[We] must set it to twelve.'

12:51:15 Let's see if I can find twelve. (walks some distance away)

13:00:03 Du: Twenty-four=
 =so you have to
 put this one to EIGHT. (looking back at Tran; using
 a heightened tone of voice)

13:03:00 NUMBER EIGHT.

13:04:00 So this HIT NEXT THREE TIMES.

13:06:05 Tran: °No.

In spite of Du's recommendation, Tran returns with another feeder. The stopper block on this second feeder has three pitch points, one of which is 12mm, as shown in Figure 4.

Figure 4
Stopper Block with Three Pitch Points

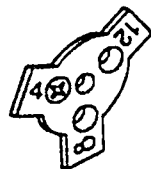

Looking at the second feeder, the two men continue to negotiate what action to take. Tran urges trying another stopper block, while Du favors using the one they already have. Eventually, Du concedes, telling Tran to place the second feeder beside the first on the chair with the two stopper blocks in view:

- 13:08:05 Tran: Let's see if we can put this.
- 13:14:00 Du: *No cái đó không có đúng.* (gaze directed at second feeder)
'No, that's not the right one.'
- 13:14:xx Tran: (xxxx) (pointing to pitch point)
- 13:27:10 Du: *Bây giờ ở đây nè.*
'This time it's here.'
(xxxx)
- 13:29:27 *Tám bốn.*
'Eight, four.'
- 13:32:25 Tran: *Mười hai.*
'Twelve.'
- 13:37:10 Du: *Thấy cái đó đây.* (pointing to chair)
'Put this (feeder) here.'

They unscrew the stopper blocks and try to exchange them, but they find that the second stopper block does not fit on the first feeder. So, they are left with the original stopper block and must choose between two pitch options that are factors of twenty-four—four and eight:

- 14:34:00 Tran: No.
Too (xxxx).
- 14:44:12 Du: *Tám bốn no cho có hai cái ha.*
'Eight, four, it allows two only.'

Next, Du directs Tran to check the component ID in the computer database. They both move to the machine and examine the CRT display. They are looking for the pitch value that was assigned for the socket. Tran finds that the customer programmed a 12mm pitch. Du tells him to correct the pitch information to 24mm in the database. He also affirms that they will have to set the feeder at 8mm, which means that the machine will pick the component successfully only on the third try:

- 14:51:00 Du: Tran, Tran coi cái *component ID*.
'Tran, Tran, look at the component ID.'
- 14:51:00 Coi coi ở trong đó.
'Look, look in there.'
- 14:53:00 Tran: (moves to display on machine)
- 14:59:00 Du: Coi coi bao nhiêu. (getting up, pointing to screen)
'See, see how much.'
- 15:04:00 Bỏ cái đó cho nó chạy lại. (standing next to Tran at machine)
'Let it run through it again.'
- 15:20:19 Tran: Mười hai.
'Twelve.'
- 15:25:19 Du: Mười hai.
'Twelve.'
- 15:27:55 Chút nữa phải cho nó hai mươi bốn.
'After this [we] must give it twenty-four.'
- 15:29:27 Hai mươi bốn chẻ số tám chẻ làm ba cái.
'Twenty-four divided by number eight is three.'
- 15:39:00 Yeah nó sẽ chẻ ba cái.
'Yeah, it divides into three.'

This work just accomplished has its consequences for the continued assembly. One consequence is the added time required to finish the task. Aside from down time during

troubleshooting, time will now be lost in missed picks. Secondly, the solution is a local one; it solves the pick problem for the components on one feeder. Yet picking, however successful, is only part of the process. Accurate placement is another concern. When a component is placed, it joins a constellation of other parts sharing limited space on a board. The men have noted a discrepancy between the numbers in the computer program and the actual pitch for this socket. Number mismatches like these put them on alert for related problems. Tran has been directed to correct the numbers in the program, but before doing so, he examines the sockets in their context—on the board itself.

The Placement Problem

At this point, Tran pulls the board out of the conveyor belt and looks at it. He notices that the three sockets just placed are larger than the spaces assigned to them. These sockets are taking up some of the adjacent spaces, which have been designated for other components:

15:59:29 Tran: °Oo: : :h thôi không được rồi.
'Oo: : :h no, it doesn't work.'

16:02:26 (xxxx) *socket*.

He calls Du over to observe the problem. Du draws near to examine the board with him. Tran signals each of the three sockets with his little finger and traces over empty spaces on the board surrounding them. His pointing displays to Du how the sockets are encroaching into areas where other components are to be placed. He tells Du that 11 other components will be affected.

16:05:66 Đâu có lắp *socket* được.
'[It's] impossible to install the socket.'

16:09:00 Thế này đâu có lắp *socket* được. (pointing to spaces
'Like this [it's] impossible to install the socket.' around the 3 sockets)

16:09:23 Du: Cái?
'Which?'

- 16:11:20 Tran: Quên.
'Forgot.'
- 16:13:09 Cái gì *wrong*.
'Something is wrong.'
- 16:16:05 Du: Ba con hay là mấy.
'Three [of them], or how many?'
- 16:17:07 Tran: Tôi mười một con.
'Up to eleven [of them].'

Now the magnitude of the placement error emerges. Tran and Du discover that the customer's circuit-board designers had not, in fact, programmed the sockets at all. Instead, they erroneously calculated only enough space on the board for the components that go inside the four sockets:

- 16:19:03 Du: Nó không có đưa cho mình.
'It doesn't give it to us.'
- 16:19:50 Nó đâu có đưa cho mình con nào đâu.
'It didn't give us anything.'
- 16:25:27 Tran: Nó đưa mình bốn năm còn gì đó.
'It gives us four, five or so.'

Once again, the workers have to make a choice. If they leave these sockets on the board, the surrounding components will not fit. If they remove the sockets, the components which were to be held by them will have to be fixed directly on the board. Their decision, like the pitch choice made earlier, must be based on efficiency and accuracy. Given the number of other components affected, Du makes the decision that the sockets must be removed:

- 16:27:18 Tran: Mà chưa có *program*=không có bỏ vô.
'There's no program: it wasn't put in.'
- 16:31:10 Du Bỏ mẹ cái này bỏ luôn cái này.
'Get rid of this one and the other one also.'

Using pincers, Tran removes the sockets, which had come from the feeder that they had worked so hard to troubleshoot. Together, they make the decision to write a command in the program to skip the placement of these sockets altogether.

16:54:00 Tran: Skip?

16:55:12 Du: Skip.

16:56:13 Skip it.

Tran goes to the computer to do so. They will inform the customer of their solution and suggest that the components that were originally going into the sockets will have to be placed directly on the board. This decision is the best one for the customer, too. For, in order to preserve the convenience of having sockets, the customer would have to redesign the entire board to make them fit. Given the design error, the most practical decision is probably to discard them and place the three components directly on the board.

In a six and a half minute interval, we have seen the workers repair breakdowns in the assembly of a circuit board. For each problem, they have followed a procedure which can be summarized as notice the problem, hypothesize the source of the problem, test the hypothesis, and look for an optimal solution (see Figure 5).

Figure 5
Troubleshooting Procedures

	<i>Notice Problem</i>	<i>Hypothesize Source</i>	<i>Test Hypothesis</i>	<i>Find Optimal Solution</i>
<i>Pick Problem</i>	missed pick	wrong feeder pitch	check stopper block	change pitch to 8mm
<i>Placement Problem</i>	oversized socket	board design error	check computer program	skip socket placement

This chart is not meant to make claims about patterns in troubleshooting; rather, it is meant to demonstrate the workers' speed and efficiency in pinpointing and solving problems during this six-and-a-half-minute interval. Tran and Du have moved through these procedures with few words, most of which are a series of numbers that would appear quite literally indecipherable to an outside observer. In fact, the workers' language-in-action,

taken alone, can be characterized as markedly sparse.⁶ Certainly, their prior troubleshooting experiences and shared understandings may partially explain why there has been little call for extended discussions about which actions to take. The level of machine noise and pressure of customer deadlines may also have been contributing factors to this reduced speech. In the following sections, we deal with how the two men accomplished this kind of problem-solving so quickly and with minimal use of language. We pay particular attention to their skilled use of perceptions and representations. The analysis begins where they notice each problem and continues as they detect the source of the problem and search for an optimal solution.

Working with Perceptions

The workers draw on well-honed perceptions—auditory, visual, and kinesthetic—to notice the trouble and to find its source. These skills are especially evident during the first 44 seconds of the pick problem, during which they do the noticing and form a hypothesis. When set to high-speed, the SMT machine has an audible click-click—swish—click-clack rhythm from pick to placement. The arm can be seen to dance, as it were, to these sounds as it shifts from the feeder to the board and back again. In the following excerpt, we see that the rhythmic sound and movement, maintained up to the placement of the first socket, are broken when the arm tries and fails to pick the second socket. The pick sound is repeated (click-click, click-click) as the arm attempts twice to pick the socket. The men put one another on verbal notice just after the break in the rhythm:

10:15:14	Robotic Arm:	(first pick try: click-click sound)
10:17:03		(second pick try: click-click sound)
10:17:16	Du:	MISS PICK—
10:18:11	Robotic Arm:	(successful pick: click-click sound)
10:18:16	Tran:	Oo: :h.
10:18:27	Robotic Arm:	(socket placed: swish—click-clack)

As the arm swings back for the third socket, Tran combines kinesic and visual action to stop and start the machine at key moments in the pick-placement sequence and to observe

⁶ For a detailed analysis of how the two workers make parsimonious use of Vietnamese and English in this setting, see Kleifgen (1995).

the movement of the robotic arm over the pick and place points. The broken rhythm continues—two miss picks before a successful one. As the arm begins to carry the third socket to its placement point, Tran presses “stop,” counts the number of sockets already taken from the feeder, and observes for several seconds the position of the arm over the third place:

10:19:22	Robotic Arm:	(first pick try: click-click sound)
10:21:05		(second pick try: click-click sound)
10:22:13		(successful pick: click-click —swish sound)
10:22:17	Tran:	(presses “stop”)
10:25:23	°One, two, three.	(counting on fingers; gaze turned toward board)
10:29:19-30		(leans inside machine toward robotic arm poised over the board)

Then Tran presses “start.” He observes the arm rapidly place the third socket and swing back to the feeder (click-clack—swish). As soon as it reaches the pick point again, he presses a button on the SMT operator panel, and the arm begins to pick in slow motion. Tran is able to see the downward movement of the arm (z-axis) together with the forward movement of the feeder (pitch). With slow motion, it is possible to see that the feeder pitches the tape forward three times before the socket is within the reach of the arm:

10:33:12	Tran:	(straightens up, hand on button, looks at screen)
10:35:04		(presses “start”)
	Robotic Arm:	(placement: click-clack—swish)
	Tran:	(leans in to watch placement and arm’s return to feeder)
10:35:21	Robotic Arm:	(first pick try: click-click sound)
10:35:25	Tran:	(presses button for slow motion)
10:36:18		(lifts plastic screen as arm goes down in slow motion to pick socket)
10:37:23- 10:42:27	Robotic Arm:	(second pick try: click-click sound in slow motion)

10:39:22 Tran: °Hai cái.
 'Two (picks).'

°Ba cái.
 'Three (picks).'

10:41:00 (directs gaze at pick point)

Du has been observing, too. He suggests adjusting the stopper block, and Tran agrees. This is the moment in which they are displaying to one another their hypothesis—the source of the problem may be an incorrect pitch point on the stopper block:

10:45:15 Du: Có phải chỉnh con ốc ở dưới không?
 'Is it necessary to fix the screw underneath?'

10:47:28 Tran: U.
 'Yeah.'

The second problem—the placement problem—is also detected perceptually. Tran has just changed the pitch value in the computer program from 12 to 24, twice the amount originally assigned to the socket. Before restarting the machine to finish the assembly, Tran takes the board from the conveyor belt, holds it in both hands, and looks down closely at the sockets placed on it. With this close look, he notices that something is wrong:

15:59:29 Tran: °Oo: :h thoi khong được rồi.
 'Oo: :h, no, it doesn't work.'

16:02:26 (xxxx) *socket*.

01:16:05:66 Đâu có lắp *socket* được.
 '[It's] impossible to install the socket.'

Then, still holding the board, he calls Du over to look. Tran displays the problem to Du by tracing a series of spatial boundaries over the board with his finger (see Figure 6).

Figure 6
Signaling Spaces on the Circuit Board

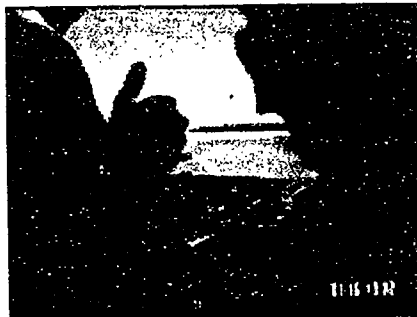

He gestures toward the problem's effect on the entire board. His finger first swings from one socket to another in a large sweep, then marks spaces around the sockets in small loops, and finally traces another large sweep between the two sockets.

- | | | | |
|-----------------------|-------|--|--|
| 16:09:00 | Tran: | Thế này đâu có lắp <i>socket</i> được.
'Like this [it's] impossible to install the socket.' | (pointing to spaces
around the 3 sockets) |
| 16:09:23 | Du: | Cái?
'Which?' | |
| 16:11:02
-16:11:20 | Tran: | | (sweeps finger right to left,
socket to socket) |
| 16:11:20 | | Quên.
'Forgot.' | |
| 16:11:21
-16:13:08 | | | (makes small loops with finger
around socket) |
| 16:13:09 | | Cái gì <i>wrong</i> .
'Something is wrong.' | |
| 16:13:09
-16:16:29 | | | (makes small loops with finger
around socket) |

16:16:05 Du: Ba con hay là mấy.
'Three [of them], or how many?'

16:17:07 Tran: Tôi mười một con.
'Up to eleven [of them].'

16:17:04 (sweeps finger left to right,
-16:17:14 socket to socket)

Tran makes smaller, bouncing loops with his finger which coincide with and surround his verbal notification that a problem exists. That is, the fact that a problem exists is signaled, not identified verbally. The line above the utterances represents the time between the onset and completion of Tran's gestures. Tran's words are in boldface:

[————— Small loops with finger around socket —————]
16:11:21 **16:13:09** 16:16:05 16:16:29
"Something is wrong." "Three, or how many?"

Also coinciding with these gestures is Du's question (in boldface) about the number of surrounding components:

[————— Small loops with finger around socket —————]
16:11:21 16:13:09 **16:16:05** 16:16:29
"Something is wrong." **"Three, or how many?"**

Du's query, along with Tran's response ("eleven"), are evidence that they are both associating the gestures with the affected smaller components. It has already been noted that Tran's shorter gestures are further enclosed by the larger sweeps of his finger from socket to socket. With these distinguishing gestures, the two workers shift their concerted attention back and forth between three sockets and the 11 other components affected by their presence. That is, the layout of the sockets on the board's landscape provides more insight into the program error. The numerical information provided by the customer and programmed for the machine corresponded, not to the sockets, but to the smaller components that were to be plugged into them. In sum, these gestural practices serve conjoint problem-solving, enabling the workers to establish the scope of the placement problem and to hypothesize its source as a customer design error ("There's no program, it was not put in.").

Working with Representations

In this activity, the workers' sharing of perceptions is embedded in their work with a computerized machine. Thus, they both compare and convert the perceptual boundaries they have shaped to abstract representations of them. For comparison purposes, they may refer to ready-made inscriptions such as a blueprint of the board, the customer's bill of materials, data in the software, or the machine's instruction manual. Alternatively, they may create their own inscriptions by writing down calculations on scraps of paper or by measuring objects and modifying information in the program. Because number use pervades this activity, our analysis focuses on Du and Tran's work with numerical inscriptions, including computerized numerical controls.

The workers convert perceptions about distances (between components on the tape) and bounded spaces (on the board's landscape) to numerical values by taking various measurements. To test their hypothesis about the miss-pick trouble source, they use a metric ruler and digital calipers to verify their perceptual impressions. While they continue to draw on perceptual structures, these are given new representations with the help of the tools. They first determine the pitch value. Du places a ruler on the tape, while Tran looks on. At the moment the ruler and tape are aligned, Tran assesses what he sees:

11:12:23 Tran: °Kỳ ta.
 'Strange.'

His utterance makes it clear that the measured pitch length is going to be unusual. Then Du adjusts the ruler so that one end is placed directly at the center point of one component as shown in Figure 7.

Figure 7
Aligning the Ruler with the Components



Together, they calculate the distance between the two components. The centimeter markings on the ruler must be converted to the equivalent measure in millimeters. Tran calculates aloud and comes up with a 24mm pitch:

- 11:15:10 Tran: Hai.
 'Two.'
- 11:16:10 Du: [(xxxx)
 Tran: [Hai, ba ruỗi.
 'Two, three and a half.'
- 11:19:06 Hai mười va hai mười lăm.
 'Twenty and twenty-five.'
- 11:25:14 Hai mười bốn.
 'Twenty-four.'

It's tempting to say that the workers turn to numerical inscriptions as hard evidence for their perceptual intuitions. Yet the verifications move in both directions during their conjoint problem-solving. Tracing the distance with his little finger, Du shifts from Tran's mathematical representation of distance back to a perceptual one as shown in Figure 8.

Figure 8
Tracing the Pitch Size

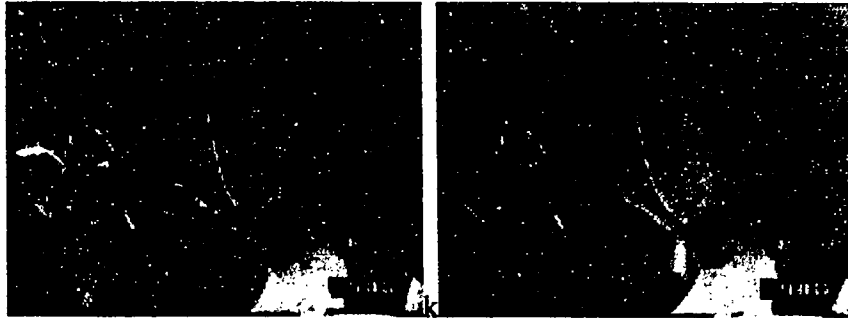

His marking of the start- and end-points to be measured permits Tran and Du to focus on the same bounded space. Tran acknowledges these boundaries and reiterates the numerical

representation. Worker perceptions and representations, to apply Goodwin's terms, are "mutually elaborating each other":

11:27:05- Du: (traces little finger of right hand
-11:27:29 from midpoint of one component
up to midpoint of other component)

11:27:22 Từ cái mỏ này tới cái mỏ này.
'From this point to this point.'

Tran: U.
'Yeah.'

11:31:05 Hai mươi bốn.
'Twenty-four.'

The workers' skilled actions taken on machine parts and components have been pinpointed, along with their work with numerical representations of them. We gain a fuller understanding of the complexity of their actions by examining the workers' displays of understandings about how the SMT machine itself works. Their local actions on machine parts and corresponding numbers have global consequences at the level of the computerized machine. For example, having converted their perceptual assessments to numerical representations of them, they check the computerized database. The two men make sure that the information in the computer program conforms to component sizes and the movements of mechanical parts. In this case, the stopper blocks on the feeders have to be set at a pitch point that accommodates the large sockets on the reel, and the information displayed on the screen must correspond to the actual pitch for that reel. Recall that, when the men finish working with the stopper block, Du asks Tran to look for information about the component in the computer program:

14:51:00 Du: Tran, Tran coi cái *component ID*.
'Tran, Tran, look at the component ID.'

14:51:00 Coi coi ở trong đó.
'Look, look, in there.'

14:53:00 Tran: (moves to display on machine)

- 14:59:00 Du: Coi coi bao nhiêu. (getting up, pointing to screen)
'See, see how much.'
- 15:04:00 Bỏ cái đó cho nó chạy lại. (standing next to Tran at machine)
'Let it run through it again.'

To find information on the screen, Tran must be familiar with the screen organization, ways to select a menu, functions of the dialog boxes, setup commands, data entry, and data editing procedures, along with the functions of the keys and switches on the operator panel keyboard. In short, he must know all the basic operating procedures of the machine. At this point in the task, he uses a search command to find information about the socket in question, as seen in Figure 9. The component data appears on the screen, and the two men turn their attention to these numbers. They have now shifted their focus from machine parts and their own calculations to the on-screen data representing these elements; in doing so, they signal their understanding of the interdependence between the mechanical and computerized features of the machine.

Figure 9
Checking Data on CRT Display

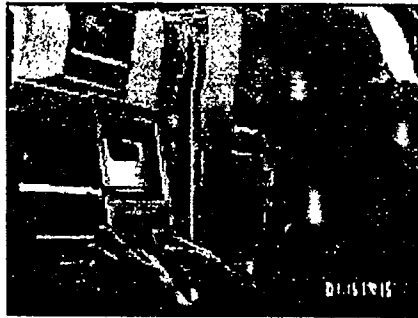

To show one another that they are converging on the same unit of data—the feeder pitch value—, which is nestled among dozens of numbers on the screen in arrays of five to six columns, Tran reads the number from the screen, which Du repeats, signaling their alignment with the same information.⁷ Because the on-screen numbers (representing

⁷ This use of repetition in interaction is congruent with studies of groups learning together at a computer, in which users signal to one another that they are focusing on the same on-screen referent either by pointing to areas on the screen or repeating aloud the information (Kleifgen, 1992; Pujol-Ferrán, 1993).

computerized controls) do not conform to their own perceptions and calculations, the numbers must be corrected. Du directs Tran to change the pitch data to 24mm:

15:20:19 Tran: Mười hai.
'Twelve.'

Du: Mười hai.
'Twelve.'

15:27:55 Chút nữa phải cho nó hai mươi bốn.
'After this [we] must give it twenty-four.'

Hai mươi bốn chẻ số tám chẻ làm ba cái.
'Twenty-four divided by the number eight is three.'

In summary, numerical inscriptions have to be made so that the digital technology can function. Workers make sure that the information displayed on the screen conforms to the components' assigned place on the board. The x and y axis values are numerical controls directing the arm to place the component at a precise point; the z-axis value directs the arm to reach down the distance needed to pick and place a component having a given thickness. But this analysis has shown that their work is more than a straightforward matching function. As we have seen, these inscription-action relationships often do not hold. Newer components and boards may be outside the range of sizes for which the machine was designed. The workers have to know how to adapt the machine to these changes. In one worker's words, "You sometimes have to 'fool' the machine" by entering numerical controls that do not actually correspond to board or component sizes.

To summarize the analysis, circuit-board assemblage is all about goodness of fit. The robotic arm has to be in harmony with the components it picks and places; components have to be in harmony with one another on the board. Workers are, literally, sensitive to these connections and spaces, as eyes, ears, and hands detect relationships. The eye observes the relationships among the forward pitch of the feeder, the height of the component, and the downward movement of the robotic arm to pick and place it. The ear detects the rhythmic movements of the robotic arm amidst a cacophony of sounds. The eye observes and the hand signals the relationship between a given space on the board and the components assigned to that and surrounding spaces. The hand stops and starts the

machine at precise moments. Workers also recognize and represent numerical versions of what they perceive. They assess perceptual structures with the use of other tools and inscriptions by measuring distances with precision instruments and converting them to numerical values and by matching spatial relations to numerical representations programmed in the software. This assessment is bidirectional; the use of numerical representations is inextricably tied to objects and actions in a work setting. Numbers uttered and entered are not disembodied entities; their meaning is co-constructed in the physical and social context in which they are embedded. In order to be accepted as valid by the workers, the representations must receive the final *imprimatur* of the workers' eyes, ears, and hands.

DISCUSSION AND EDUCATIONAL IMPLICATIONS

Modern technology places new skill demands on workers while still retaining many of the skills that were required in traditional work settings. Machine operators, for example, still rely on their hands, eyes, and ears when they are setting up a machine for a specific task or when troubleshooting is required. Even with fully computerized machines, certain alignments are still carried out manually. During trial runs, machine operators watch the machine's movements closely, often running it in slow motion to detect potential trouble sources. Machine operators not only adjust machine parts, they also interpret and manipulate the data in the computer program that runs the machine. They recognize these digital inscriptions as representations of the computerized commands to be executed by the machine, and, consequently, as numbers that require careful assessment by comparing them against other inscriptions they make and, in particular, against their own deft perceptions.

Workers' skilled use of perceptions and representations are particularly manifested during troubleshooting moments at the machine. Machines have been shown to be idiosyncratic in their behavior. Orr (1991a, 1991b) notes that as machines age, workers have to deal with their quirks. This study has found that, because of rapid changes in the machine technology and products, workers have to constantly readjust to different circuit-board jobs and to more advanced equipment. Given the protean nature of applications technology, workers are often faced with the task of having to adapt the machine to the requirements of a specific job. Since they typically work under tremendous time pressure,

BEST COPY AVAILABLE

29
42

they carry out much of the problem solving on the fly. The workers in this study used their perceptual skills in adapting machine parts creatively to accommodate special component sizes, adapt software data so that the machine would be able to offset boards of unusual size, and even suggest way to adapt a faulty assembly design. Lévi-Strauss (1966) formulated the notion of *bricoleur* to describe the person who uses tools in creative ways, including ways that go beyond the original purposes for which the tools are designed. Some (e.g., Harper, 1987) have argued that the traditional workers' skills at *bricolage* have been lost with the advent of computerized technologies. Adler and Boris (1989) point out that operators of computer-controlled machines need an abstract knowledge of the machinery in order to detect and solve problems. They claim that tasks have shifted from machining to monitoring and, therefore, workers place less emphasis on perceptual processes. In contrast, this research argues that workers can be contemporary *bricoleurs*, adapting even the digital tools to ever-changing circumstances.

Work in Company X is accomplished in teams, a concept that is receiving wide acceptance across diverse work settings. One successful team endeavor has been the New United Motor Manufacturing, Inc., a joint venture between General Motors and Toyota, which Wilms, Hardcastle, and Zell (1994) describe as the creation of a "hybrid" organizational culture. One clear feature of this re-organization is that the workers' skills are valued; workers are looked upon as responsible participants who solve problems together and who have a stake in the quality of the product. The management and employees at Company X clearly have a sense of teamwork. The management supports the practice of workers organizing their own groups (known in some corporations as natural teams). Workers are trusted to use their shared language and cultural understandings for the good of the company. This research shows that the employer's trust in workers' good will is well-founded. The workers have "a sense of responsibility for the integrity of the whole process" (Adler & Borys, 1989, p. 393). They consider outcomes beyond their own immediate circumstances and take into account larger issues such as providing alternatives for customer design errors. They are free to contest one another's suggested solutions and assemble, as it were, the knowledge that is distributed between them and across material inscriptions surrounding them and, eventually, come upon optimal solutions.

This ability to work together has broader implications about learning on the job. No single person is expected to hold all the knowledge about assembling circuit boards.

Workers combine their knowledge with different co-workers, in different situations, and by using different artifacts. Nevertheless, the whole of this knowledge is greater than the sum of its distributed parts: problem-solving moments are moments of ignorance⁸ in which workers construct new knowledge together. Opportunities for learning occur with relative frequency in Company X, where market demands require that workers be flexible enough to shift occasionally to different teams and assignments. Because tools, products, and tasks change rapidly, workers are challenged daily by new situations with their attendant problems that need solving and with new domains about which to learn. Tran's comment in one interview, "I learn something new every day," embodies what most employees who spoke to us claimed and what we actually observed in their concerted work.

Assuming that this workplace is typical of what work settings will be like in the 21st century, then work-based learning will become a major aspect of a person's educational life. If this is the case, what is the role of educational institutions in preparing workers for their future jobs? Schools cannot replicate the pressure under which most workplace activities happen. Nor can they afford up-to-date high-tech equipment in classrooms and labs. We would argue, however, that schools *can* provide a valuable foundation for the development of skills that support this kind of work-based learning.

Based on case studies of production workers and professionals, Stasz, Ramsey, Eden, Melamid, and Kaganoff (1995) identified work-related attitudes and "new" generic skill areas—problem-solving, communication, and teamwork. Schools can give learners practice in these new skills by providing authentic learning situations such as project-based work. Projects present learners with everyday problem-solving situations, require them to come to decisions collaboratively, and compel them to communicate and share knowledge effectively. The present study supports the practical value of such authentic learning practices. Our findings further suggest that more emphasis be placed on the integration of cognitive abilities with perceptual and manual skills into learning practices.

Finally, we offer a brief note on workplace attitudes. Though employees' ethnolinguistic diversity was not the primary focus of this research, we observed how a firm behaved toward its ethnolinguistically diverse workers. The management created a climate that encouraged workers to use their indigenous ways of interacting in order to

⁸ We thank Hervé Varenne for highlighting this point.

assemble high-quality products. We suspect that management and worker attitudes toward diversity at this site may not be typical of other work sites. Given the continued demographic shifts in this country, we argue that such attitudes should be fostered through on-the-job training and through high-quality instruction in diversity both at school and in the workplace.

REFERENCES

- Adler, P. S., & Borys, B. (1989). Automation and skill: Three generations of research on the NC case. *Politics & Society*, 17(3), 377-402.
- Atkinson, J., & Drew, P. (1984). *Order in court: The organization of verbal interaction in judicial settings*. London: Macmillan.
- Bailey, T. (1989). *Changes in the nature and structure of work: Implications for skill requirements and skill formation*. (Technical Paper No. 9). New York: National Center on Education and Employment.
- Braverman, H. (1974). *Labor and monopoly capital: The degradation of work in the twentieth century*. New York: Monthly Review Press.
- Derrida, J. (1977). *Of grammatology*. Baltimore: Johns Hopkins University Press.
- Drew, P., & Heritage, J. (Eds.). (1992). *Talk at work*. Cambridge, England: Cambridge University Press.
- Goodwin, C. (1992, May 1). *Transparent vision*. Paper presented at the Workshop on Interaction and Grammar, Department of Applied Linguistics, UCLA.
- Goodwin, C. (1994). Professional vision. *American Anthropologist*, 96(3), 606-633.
- Goodwin, C., & Heritage, J. (1990). Conversation analysis. *Annual Review of Anthropology*, 19, 283-307.
- Harper, D. A. (1987). *Working knowledge: Skill and community in a small shop*. Chicago: University of Chicago Press.
- Heath, C. (1992). The delivery and reception of diagnosis in the general-practice consultation. In P. Drew & J. Heritage (Eds.), *Talk at work* (pp. 235-267). Cambridge, England: Cambridge University Press.

- Hutchins, E. (1993). Learning to navigate. In S. Chaiklin & J. Lave (Eds.), *Understanding practice* (pp. 35-63). Cambridge, England: Cambridge University Press.
- Jordan, B. (1989). Cosmopolitical obstetrics: Some insights from the training of traditional midwives. *Social Science and Medicine*, 28(9), 925-944.
- Kleifgen, J. (1992). *Social interaction at the computer: The merging of talk and text* (Literacy Center, Technical Report 92-1). New York: Teachers College, Columbia University.
- Kleifgen, J. (1995). *Assembling talk* (Manuscript). New York: Teachers College, Columbia University.
- Latour, B., & Woolgar, S. (1986). *Laboratory life: The construction of scientific facts* (2nd ed.). Princeton, NJ: Princeton University Press.
- Lévi-Strauss, C. (1966). *The savage mind*. Chicago: The University of Chicago Press.
- Levine, D. L. (1995). *Reinventing the workplace: How business and employees can both win*. Washington, DC: The Brookings Institution.
- McHoul, A. W. (1990). The organization of repair in classroom talk. *Language in Society*, 19, 349-377.
- Noble, D. F. (1979). Social choice in machine design: The case of automatically controlled machine tools. In A. Zimbalist (Ed.), *Case studies on the labor process* (pp. 18-50). London: Monthly Review Press.
- Orr, J. E. (1991a). *Contested knowledge* (PARC Technical Report SSL-91-116 [P91-00053]). Palo Alto, CA: Xerox PARC.
- Orr, J. E. (1991b). *Talking about machines. An ethnography of a modern job* (PARC Technical Report SSL-91-07 [P91-00132]). Palo Alto, CA: Xerox PARC.

- Pujòl-Ferrán, M. (1993). *The design and evaluation of a hypercard application: ESL through the communicative approach*. Unpublished Doctoral Dissertation, Teachers College, Columbia University.
- Scribner, S., & Sachs, P. (1990). *A study of on-the-job training* (Technical Paper No. 13). New York: National Center on Education and Employment, Teachers College, Columbia University.
- Stasz, C. (1994). *Skill and attitude requirements in the workplace* (Manuscript). Santa Monica, CA: RAND.
- Stasz, C., Ramsey, K., Eden, R. A., Melamid, E., & Kaganoff, T. (1995). *Generic skills and attitudes in the workplace: Case studies of technical work* (DRU-1180-NCRVE/UCB). Santa Monica, CA: RAND.
- Suchman, L. (1987). *Plans and situated actions*. Cambridge, England: Cambridge University Press.
- U.S. Department of Labor. (1994). *Report on the American workforce*. Washington, DC: U.S. Government Printing Office.
- Wilms, W. W., Hardcastle, A. J., & Zell, D. M. (1994). A cultural transformation: New United Motor Manufacturing, Inc. In *The Sloan Management Review*. Cambridge: Sloan School of Management, Massachusetts Institute of Technology.
- Zimbalist, A. (1979). Technology and the labor process in the printing industry. In A. Zimbalist (Ed.), *Case studies on the labor process* (pp. 103-126). London: Monthly Review Press.

APPENDIX A

Transcription Conventions

°	Soft voice
CAPS	Loud voice
:	Elongation of sound
[Overlapping utterances
]	
=	Contiguous utterances
.	Downward intonation contour
?	Upward intonation contour
!	Animated voice tone
(xxxx)	Unclear speech
'single quotation marks'	Translation of Vietnamese talk into English
<i>italics</i>	English words embedded in Vietnamese talk

Full Transcription

10:15:14	Robotic Arm:	(first pick try: click-click sound)
10:17:03		(second pick try: click-click sound)
10:17:16	Du: MISS PICK—	
10:18:11	Robotic Arm:	(successful pick: click-click sound)
10:18:16	Tran: Oo: : : h.	
10:18:27	Robotic Arm:	(socket placed: swish—click-clack)
10:19:22	Robotic Arm:	(first pick try: click-click sound)
10:21:05		(second pick try: click-click sound)
10:22:13		(successful pick: click-click—swish sound)
10:22:17	Tran:	(presses stop)
10:25:23	°One two three.	(counting on fingers; gaze turned toward board)
10:29:19		(leans inside machine toward robotic arm poised over the board)
-30		

10:33:12		(straightens up, hand on button, looks at screen)
10:35:04		(presses start)
	Robotic Arm:	(placement: click-clack—swish)
	Tran:	(leans in to watch placement and arm's return to feeder)
10:35:21	Robotic Arm:	(first pick try: click-click sound)
10:35:25	Tran:	(presses button for slow motion)
10:36:18		(lifts plastic screen as arm goes down in slow motion to pick socket)
10:37:23-	Robotic Arm:	(second pick try: click-click sound—
10:42:27		slow motion)
10:39:22	Tran:	°Hai cai. 'Two [picks].' °Ba cai. 'Three [picks].'
10:41:00		(directs gaze at pick point)
10:45:15	Du:	Có phải chỉnh con ốc ở dưới không? 'Is it necessary to fix the screw underneath?'
10:47:28	Tran:	U. 'Yeah.'
11:12:23	Tran:	°Kỳ ta. 'Strange.'
11:15:10		Hai. 'Two.'
11:16:10	Du:	[(xxxx)]
	Tran:	[Hai, ba rưỡi. 'Two, three and a half.'
11:19:06		Hai mươi và hai mươi lăm. 'Twenty and twenty-five.' Hai mươi bốn. 'Twenty-four.'
11:27:22	Du:	Từ cái mỏ này tới cái mỏ này. 'From this point to this point.'

- 11:30:20 Tran: U.
'Yeah.'
- 11:31:05 Hai mươi bốn.
'Twenty-four.'
- 11:32:15 Hai mươi bốn la mười hai.
'Twenty-four, then [it's] twelve.'
- 11:44:05 Du: Có mấy?
'How many?'
- 11:44:30 Bốn sáu tám mười. (pointing to pitch points)
'Four, six, eight, ten.'
- 12:44:15 Du: Yeah?
- 12:45:01 Twen'-four.
- 12:45:25 This one only, uh, ten? (looking at stopper block)
- 12:49:27 Twenty-four: : r.
- 12:51:01 Tran: Phải cần đến mười hai.
'[We] must set it to twelve.'
- 12:51:15 Let's see if I can find twelve. (walks some distance away)
- 13:00:03 Du: Twenty-four=
=so you have to (looking back at Tran; using
put this one to EIGHT. a heightened tone of voice)
- 13:03:00 NUMBER EIGHT.
- 13:04:00 So this HIT NEXT THREE TIMES.=
- 13:06:05 Tran: ='No.
- 13:08:05 Let's see if we can put this.
- 13:14:00 Du: No cái đó không có đúng. (gaze directed at second
feeder)
'No, that's not the right one.'
- Tran: (xxxx) (pointing to pitch point)
- 13:27:10 Du: Bây giờ ở đây nè.
'This time it's here.'
(xxxx)
- 13:29:27 Tám bốn.
'Eight, four.'
- 13:32:25 Tran: Mười hai.
'Twelve.'

- 13:37:10 Du: Thấy cái đó đây. (pointing to chair)
'Put this [feeder] here.'
- 14:34:00 Tran: No?
Too (xxxx).
- 14:44:12 Du: Tám bốn no cho có hai cái ha.
'Eight, four, it allows two only.'
- 14:51:00 Du: Tran, Tran coi cái *component ID*.
'Tran, Tran, look at the component ID.'
Coi coi ở trong đó.
'Look, look in there.'
- 14:53:00 Tran: (moves to display on machine)
- 14:59:00 Du: Coi coi bao nhiêu. (getting up, pointing to screen)
'See, see how much.'
- 15:04:00 Bỏ cái đó cho nó chạy lại. (standing next to Tran at machine)
'Let it run through it again.'
- 15:20:19 Tran: Mười hai.
'Twelve.'
- 15:25:19 Du: Mười hai.
'Twelve.'
- 15:27:55 Chút nữa phải cho nó hai mươi bốn.
'After this, [we] must give it twenty-four.'
- 15:29:27 Hai mươi bốn chẻ số tám chẻ làm ba cái.
'Twenty-four divided by number eight is three.'
- 15:39:00 Yeah nó sẽ chẻ ba cái.
'Yeah, it divides into three.'
- 15:59:29 Tran: °Oo: : h thôi không được rồi.
'Oo: : h no, it doesn't work.'
- 16:02:26 (xxxx) *socket*.
- 16:05:66 Đâu có lắp *socket* được.
'[It's] impossible to install the socket.'
- 16:09:00 Thế này đâu có lắp *socket* được. (pointing to spaces
'Like this [it's] impossible around the 3 sockets)
to install the socket.'

16:09:23 Du: Cái?
'Which?'

16:11:02 Tran: (sweeps finger right to left,
-16:11:20 socket to socket)

16:11:20 Quên.
'Forgot.'

16:11:21 (makes small loops with finger
-16:13:08 around socket)

16:13:09 Cái gì *wrong*.
'Something is wrong.'

16:13:09 (makes small loops with finger
-16:16:29 around socket)

16:16:05 Du: Ba con hay là mấy.
'Three [of them], or how many?'

16:17:07 Tran: Tôi mười một con.
'Up to eleven [of them].'

16:17:04 (sweeps finger left to right,
-16:17:14 socket to socket)

16:19:03 Du: Nó không có đưa cho mình.
'It doesn't give it to us.'

16:19:50 Nó đâu có đưa cho mình con nào đâu.
'It didn't give us anything.'

16:25:27 Tran: Nó đưa mình bốn năm còn gì đó.
'It gives us four, five, or so.'

16:27:18 Mà chưa có *program*=không có bỏ vô.
'There's no program; it wasn't put in.'

16:31:10 Du Bỏ mẹ cái này bỏ luôn cái này.
'Get rid of this one and the other one also.'

16:54:00 Tran: Skip?

16:55:12 Du: Skip.

16:56:13 Skip it.

APPENDIX B**Surface Mount Machine Operator
Sequence of Tasks for Operating Machines**

- A. Set-Up at SMT Machines
1. Adjust conveyor belt to fit board—either pin or shape holders.
 2. Begin adjustment of offset data from computer keypad on SMT machine (easier to work from machine to make adjustments in order to look at board, heads, camera, and data at once).
 3. Adjust pick points (movement of robotic arm to pick up components from feeders) and tray holders.
 4. Adjust placement points (the last step in programming):
 - Click on one x/y coordinate to see if head will place the component on the exact location on the board.
 - Align the head to the x/y point on the board where each component is to be placed, using either a camera or a laser beam to center the nozzle onto each point; if necessary, adjust the x/y coordinate points on the computer
 - Check rotation of component; if necessary, change rotation
 - Use computer program to skip places in the placement data section of the software, and indicate yes or no under USE in the component data.
- B. Screen Print
5. Set up stencil and plate by aligning stencil and making sure there is no gap.
 6. Adjust the stop position and pressure of squeegee.
 7. Add solder paste (check quality of paste) and run machine.
 8. Inspect board for correct amount and alignment of solder.
- C. Run Job
9. Run one board first and have inspector examine it carefully. If trial board passes inspection, then the whole job can be run (may take up to 8 hours to set up the whole SMT line to run properly).
 10. Run the whole job, placing boards on the conveyor and replenishing feeders and trays.

Note: The following tasks are done by the machine operator's assistants:

- A. Load components on machine:
 - 1. sticks and tapes on feeders
 - 2. trays in matrix tray holder
- B. Move feeders into slots which will optimize worker view and machine efficiency.
- C. Check all the feeders to be sure that they are placed correctly and that the numbers in the program correspond to the slot number for each feeder; check the tapes and tubes for jamming in each feeder; note which spaces are skipped by the program.