

DOCUMENT RESUME

ED 395 840

SO 025 481

AUTHOR Skapski, George J.
 TITLE Tract on Panot. Part 1: Text. (In Form of a Dialogue between Master PAN and Student NOT). Part 2: Examples. (Music Examples in Both Traditional and PANOTation). Part 3: Appendices and Supplements. (Reference Materials in Both Traditional and PANOTation).
 INSTITUTION California State Univ., Northridge.
 PUB DATE 92
 NOTE 429p.
 PUB TYPE Reports - Descriptive (141) -- Books (010)
 EDRS PRICE MF01/PC18 Plus Postage.
 DESCRIPTORS Comparative Analysis; Descriptive Writing; Higher Education; *Musical Composition; Music Education; *Music Reading; *Music Techniques; Reference Materials
 IDENTIFIERS *Music Notation

ABSTRACT

This document proposes and presents a new concept in music notation. Consisting of three separately-bound parts, the first part presents the rationale for the new musical notation in the form of a dialogue between two people who discuss what the ideal musical notation would be: the subject of unmeasured durations and articulations, the representation of the temporal parameter, the domain of pitch and intervals, symbols for dynamics and timbre, and some observations on analytical insights. The second part provides numerous examples of each of the areas discussed in the dialogue. The final part presents the 50 appendices and supplemental materials concerning PANOTation along with traditional notation. (JAG)

 * Reproductions supplied by EDRS are the best that can be made *
 * from the original document. *

✓

George J. Skapski

TRACT ON PANOT

PART I : TEXT

BEST COPY AVAILABLE

50 025 481

U.S. DEPARTMENT OF EDUCATION
Office of Educational Research and Improvement
EDUCATIONAL RESOURCES INFORMATION
CENTER (ERIC)

C.S.U.N.

PERMISSION TO REPRODUCE THIS
MATERIAL HAS BEEN GRANTED BY

This document has been reproduced as
received from the person or organization
originating it.

Minor changes have been made to improve
reproduction quality.

GEORGE J. SKAPSKI

• Points of view or opinions stated in this docu-
ment do not necessarily represent official
OERI position or policy.

TO THE EDUCATIONAL RESOURCES
INFORMATION CENTER (ERIC)

TRACT ON PANOT

PART I : TEXT

(In Form of a Dialogue between Master PAN and Student NOT)

by

George J. Skapski

*

This monograph is a follow-up to the experimental research performed in part pursuant to an Academic Program Improvement Grant for 1989-90 funded by the California State University Office of the Chancellor

The California State University, Northridge, 1992

© 1992 by the Trustees of the California State University

This tract is referring to 3 monographs: *PANOT: An Experiment with a New Music Notation System, Sound Taxonomy, and PANUM*. Those monographs were developed with the support of an Academic Program Improvement Grant for 1989-90 funded by the California State University Office of the Chancellor. No part of this work may be reproduced, stored in a retrieval system, or transcribed, in any form or by any means, electronic, mechanical, photocopying, recording, or otherwise, without the prior written permission of The Trustees of the California State University. Project Director: Dr. George J. Skapski, California State University, Northridge.

The author wishes to express his gratitude to William Toutant for his kind assistance in editing of the preliminary draft of this monograph. Dr. Toutant is my friend and colleague on the music faculty of the California State University at Northridge. He is presently serving the University as the Associate Dean of the School of the Arts.

***** To the memory of Guido of Arezzo,
the pioneering music pedagogue,
on the millenary anniversary of his birth

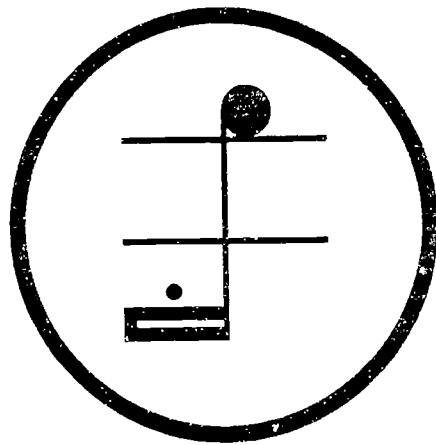

TABLE OF CONTENTS

DAY		PAGE
	INTRODUCTION	ix
FIRST:	THE IDEAL NOTATION	1
SECOND:	THE UNMETERED DURATIONS AND ARTICULATIONS	12
THIRD:	THE REPRESENTATION OF THE TEMPORAL PARAMETER	25
FOURTH:	THE DOMAIN OF PITCH AND INTERVALS	67
FIFTH:	NEW SYMBOLS FOR DYNAMICS AND TIMBRE	104
SIXTH:	ANALYTICAL INSIGHTS	131
	INDEX	167

INTRODUCTION

There is no lack of proposals for the reform of the present music notation. In fact, interested writers have difficulty in accounting for all proposals conceived through the years. In this regard, contributions of Gardner Read are the most significant and valuable in recent years. The inevitable criticism of new proposals usually ranks them between two opposites: either too simplistic or too complex. The "allergic reaction" to anything new does not help in arriving at an objective value judgment. Seldom do critics raise the question of the relative advantages of a new system over the standard notation. It is an important consideration which should be favorably decided whenever the advantages are perceived as outweighing the disadvantages. The ultimate decision should depend on whether or not an individual is persuaded about the superiority of the proposed solution. The fear of undue complexity should not prevent experimenters from trying new procedures, provided they have carefully examined the worth of new proposals in comparison with the solutions offered by conventional notation.

If musicians feel comfortable with the present notation, they should leave it as it is. If they are convinced that either a partial or comprehensive reform is necessary, they should do something about it. The present proposal asks for nothing more than a "*sine ira et studio*" examination of all the possible advantages arising from the new system. While trying to make up our mind, let us not worry nostalgically about a possible loss of favorite symbols and familiar terminology. Changes often demand parting with familiar icons; this should not be a traumatic experience. After all, time has been known to heal the deepest wounds inflicted by the seemingly outrageous human ideas and actions.

George J. Skapski

Northridge, California;
December 15th, 1992

THE FIRST DAY

THE IDEAL MUSIC NOTATION

Master PAN: Now, we will be concerned with music notation. Could you define for me music notation?

Student NOT: Music notation, as we know it, is a system of symbols used for permanent recording of sounds.

PAN: Generally, it seems to be a reasonable and sufficient definition. However, especially in our times, some additional qualifications are needed. The need for a brief qualification becomes clearer when you will ask the question: what purpose does music notation serve?

NOT: Obviously, the purpose of music notation is to enable anybody reading it to re-create the progression of sounds composed by another human being.

PAN: Certainly, this is an acceptable answer. Notation, thus defined, helps the performer. Therefore, all those graphs and diagrams created after music has been produced, do not deserve the name of music notation?

NOT: I do not think so.

PAN: Why?

NOT: Because, they only account for what has been already produced. They may be of some value for the mechanical encoding or for analytical purposes. However, they hardly could guide a performer in music making.

PAN: You have pointed the obvious difficulties encountered when trying to make music from "ex-post" symbolical graphs or from accumulation of some statistical

data. Imagine trying to convert rectangular bars to sounds of different duration. The eye can distinguish perhaps double- or half-durations. Maybe, the triple proportions can be perceived in relation to the referential unit. Surely, this type of proportions is only an infinitely small portion of the rich variety of durational proportions found in music. How about guessing the relationship of two bars which stand for the proportion expressed in traditional notation as double-dotted quarter note followed by a sixteenth note?

NOT: As a rule, performers could not rely on bars for accuracy in judging different durations. I cannot think of a pianist required to play from such notation.

PAN: Unless he would be equipped with a ruler to compare different durations with each other. Joke aside, a similar situation could arise in the realm of pitch. How would you react to a prospect of producing just two different sounds of the following specifications: One designated at the frequency of 273 cycles per second, and the other to be following at the level of 405 cycles per second?

NOT: Impossible! Even when I think of those singers endowed with a so-called "perfect absolute pitch," none of them could reproduce accurately a longer succession of sounds so encoded.

PAN: Do we need to go on with more examples?

NOT: Actually, I realize that I should have added to my definition the purpose of music notation. All those "ex-post" notations, as you called them, are incapable of serving the performing musician. Couldn't they be used, however, to feed the machines which produce music by electronic means?

PAN: Well, if the composer uses a machine to program his music, and the print-outs represent the data used in this process, the reverse process should produce the same music as originally intended. Who knows if that may be the only process to create music in the future.

NOT: Does this obliterate the need for music notation in the future?

PAN: Time only will tell. Right now, I am concerned with music notation which by-passes the machine, and which establishes the direct communication between human beings. Actually, music composed at a synthesizer needs procedures which will permit the encoding of sounds electronically. Those procedures are not designed for the human eyes to see them. They would not help vocalists or performers on acoustic instruments.

NOT: So, in my first definition of music notation, should I have included the human being as its addressee?

PAN: In your "amended" version of the definition of music notation, you have already added the direct communication among humans as its purpose. One can, of course, regard all those visual charts and graphs as a sort of music notation. They may even be intended for performers' consumption though, usually, they account for music which was already performed. Computer programs could be also considered music notation, especially those involving MIDI, although their purpose is not to address a singer or an instrumental performer.

NOT: Are all those types of music notations the result of technological advances in our century?

PAN: Technology has opened new possibilities. At the same time, new compositional concepts have also contributed to new experiments and new solutions. Music notation has a long history, and it demonstrates an incredible ingenuity. It has progressed from primitive beginnings to an imposingly sophisticated system. It has attempted to reach the seemingly unattainable goal of perfection. It has been criticized in our day for its alleged ambiguity, redundancy, and confusing complexity. Hence, it seems rather natural to ask the question: what kind of characteristics should be the indispensable attributes of an ideal music notation.

NOT: I like this approach supported by the examination of the quest for perfection. Perhaps much more can be gained from considering the ideal picture of future notation rather than criticizing its past inadequacies.

PAN: Let us then examine those characteristics one by one, and discuss their implications.

NOT: This approach may highlight some practical and desirable changes in the way music is notated.

PAN: If our discussion highlights the shortcomings of conventional notation, so much the better for our quest. After all, the ability to conjure a vision of an idealized condition is at the core of what we consider the true criticism. It is by thinking of an ideal music notation that we say what the music notation should be.

NOT: I am convinced. Please do not hold me any longer in suspense. Which one is the first of the characteristics which an ideal music notation should display?

PAN: I do not necessarily list them in order of decreasing or increasing importance. Establishing of their priority is not necessary here. Let us start with the quality known as **universality**. Think what this would imply, will you?

NOT: A notation which could serve in the global sense all the people from different civilizations, different language families, and, possibly, different educational backgrounds...?

PAN: Not only this, but also a notation which could provide uniform bases for the practice of writing, reading, performing, teaching, analyzing, and referring to music. Sort of an *Esperanto* for music communication. Is this an impossible dream? Is its potential for success as limited as *Esperanto's* seems to be? Is it too optimistic to expect the universal language of music to adopt a truly universal notation? All right, do not answer those questions. I see you are perplexed and slightly incredulous.

NOT: It would be nice, but rather difficult, if not impossible, to achieve.

PAN: How about generality as the second characteristic? What should the quality of generality facilitate? First, it should supply a new language of description and analysis applicable to all styles of music and all media of performance, including electro-acoustic music. Secondly, it should enable anyone to transcribe accurately all music literature of the past without resorting to the traditional symbols or compromising its integrity. Thirdly, it should provide modern composers with a grammar and signals reflecting new structural predilections and the nature of sound materials they use.

NOT: A notation which could serve all media and all manifestations of music regardless of style! This, certainly, would appeal to me. Does this mean, however, that all tablature types of notation would have to disappear?

PAN: It is unavoidable that certain styles and media will develop special notations serving their idiosyncratic needs. The point is to make the general notation capable of symbolizing all of them, as well.

NOT: I understand that would be similar to transcribing lute tablatures into conventional notation. Whatever type of general notation is adopted, would not Gregorian chant, for example, lose something in such a transcription?

PAN: That is precisely why it is important for the ideal notation to be general enough to provide for a system which permits as faithful a transcription as possible. Nevertheless, learning to read chant neumes would be probably a much better option than singing them from any transcription. You seem to be interested in idiosyncratic notations of the past. Please, do not forget that I have hinted already on the responsibility of an ideal notation to be general enough to provide also new grammar and signals to contemporary composers. At this point, you may start wondering whether or not this particular quality of notation is attainable, at all...

NOT: Yes, I admit all this sounds a little bit utopian to me. I wonder what is the third characteristic which we should consider now?

PAN: Neutrality. Do you suspect what this would possibly mean in relation to music notation?

NOT: I must confess I do not have a green idea.

PAN: I thought so. Permit me to reach for some examples, in order to explain this most desirable characteristic. Think, for instance, of an interval of pitch formed between the two bottom lines of the traditional five-line staff. What is this interval?

NOT: A third,... a minor third.

PAN: You must be thinking in treble clef. Would this still be a minor third in bass clef?

NOT: No. That would be a major third. It would remain also a major third in alto clef but not in the tenor clef.

PAN: Didn't you notice that equidistant staff-lines do not always produce equidistant intervals? Now, let us consider intervals of time. The elementary rules of traditional theory establish durations as being based on the squares of number 2. If it happens that 3 divisions are needed to a unit they are called "triplets" meaning their values are incompatible with the meter in use. If the unit is represented by a quarter-note, then those triplets are written as 3 eighth-notes. Doesn't this strain your sense of logic that 3 third-notes are written as 3 eighth-notes?

NOT: I have never noticed any incompatibility in those examples. I have just accepted those values as normal. Any other examples, please?...

PAN: Just think of intervalic measurements. All those perfect fourths, major seconds, or minor tenths; are they not based on a heptatonic scale? Every student learns a major or minor scale as a ladder of uneven steps. Which scales present equidistant rungs of a ladder?

NOT: A chromatic scale, of course. Also a whole-tone scale.

PAN: For neutral measurement, do you think tailors would agree on using a tape measure like the major scale in music?

NOT: Do you suggest that a semitonal scale would supply a better base of pitch measurement because every tool of measurement should have uniform units?

PAN: Now you begin to understand what I meant by neutrality. Standards of measurement should be impartial. The implications of this characteristic are so far reaching that you would probably be startled by such names as a fourth for a major third, or a seventh for a perfect fifth. Guess what a major seventh would be called, in such case?

NOT: An eleventh?

PAN: Of course! Are you ready to make such a drastic switch in accounting for intervals? I am afraid this is the price we would have to pay for embracing the principle of neutrality. The next characteristic, the fourth one, deals with pragmatic concerns. It brings to mind the ideal of **directness** in representing the chief parameters of pitch and duration. This means that the picture of notation should come as close as possible to the real dimensions on the coordinates of time and space. What the inner ear hears should be facilitated for the eye in an analogous immediacy. Such an arrangement may permit also a relatively easy extraction of any statistical data for analytic purposes. One can only fondly hope that such direct notation could also serve as a sort of a data-bank for computer application. Imagine how much time and effort could be saved by feeding this type of notation directly into the computer without the need for first "translating" the conventional notation into computer codes.

NOT: I hope we will have time to discuss those implications more in detail later. Right now, my head starts swimming.

PAN: Let us go on with considering a new quality which suggests the importance of **uniformity**. Later, we will have time, I hope, to develop the implementation of those characteristics in every dimension. The importance of uniformity may be felt much more convincingly in the field of pedagogy than in the practice of notation itself. You have had, probably, enough experience in this regard to know how many different ways exist to refer to metric articulation in music. What kinds of syllables are used to articulate different points of metric hierarchy?

NOT: I heard so many of them that I do not know what is the best way to call them; should they be "ta" or "te" or "and" or just numbers, if appropriate.

PAN: What about pitch? Do you remember the phrygian mode in solmization?

NOT: I suppose you want the so-called "movable do." Let me think: "do, ra, me, fa, sol, le, te, do." Perhaps, those syllables should read: "mi, fa, sol, la, ti, do, re, mi?"

PAN: Those are just isolated examples of uncertainty which could be remedied by adopting a system of reference which is underlying all parameters with the same logic in the formation of codes and icons. Be it pitch, interval, articulation or duration (just to start with the modular parameters), every one of them deals with values which can be expressed in numbers. Every Roman vowel may be assigned to a certain parameter. Bear with me for just one brief example to illustrate the possibilities. Accept for the sake of a specific example the consonant "r" as substituting for number 4. Now agree with the Roman vowel "a" as representing the number of beats, and the vowel "e" as representing the beat division. Accordingly, "ra" would mean 4 beats, and "re" would substitute for the fourth part of the beat. Let us suppose we would select the Roman vowel "o" to stand for pitch, and the Roman vowel "i" to represent intervals. It follows that a "ro" would suggest the pitch of "e" (starting with the pitch of "c" as number 0), and a "ri" would mean the interval of a fourth (and not a major third, as in traditional nomenclature). Do you have difficulty following, so far?

NOT: Yes! We are going so far afield.

PAN: This is my fault. I always have great difficulty with pleading the case of a uniform notation without going into details. I believe uniformity could improve the methods of referring to sounds. It is so tempting to suggest new ways rather than to point to the shortcomings of the traditional notation. I apologize.

NOT: I cannot wait until we will have time to discuss all the ramifications of new ideas.

PAN: Before we move to another characteristic. I want to add that numbers also can be symbolized with arbitrarily assigned consonants. They can also be expressed by arbitrary, but logical, visual signs. If those signs are built according to logical principle, they could be easily recognized as multi-purpose icons. All this I am mentioning to you as the possibilities facilitating the reference to sounds by "voice," by visual icon, and by numerical code. Imagine how desirable this would be just for the purpose of teaching the elements of the world of sounds! Whatever the benefits, this is one of the ways of applying the principle of uniformity to the notation.

NOT: Could you scan the remaining characteristics with one sweep, if possible? I already have so much material to digest before we meet tomorrow.

PAN: Certainly. The next quality, namely that of **comprehensiveness**, is so closely related to that of uniformity, that there is no need to elaborate. The thrust of comprehensiveness is directed toward ensuring that all provisions necessary for tonal reference apply to all manifestations of single and multiple sounds.

NOT: I think that comprehensiveness is a desirable trait in every sort of classification, not only in the notation of sounds.

PAN: You will see that this is true also of the other characteristics. Take, for instance, the ideal of clarity. Isn't this quality most desirable in every human pursuit?

NOT: I think so. I even can think of some examples where our present notation could be improved with regard to clarity.

PAN: Some attempts have been made to restore clarity to music notation. However, not all of them were successful. Especially in proposals suggesting notation based on tablature principle, the small gain in "touch" notation was rather offset by a total loss of polyphonic identification. Think also of big scores from the beginning of our century. The combination of different instrumental transpositions and different clefs is far from being a model of clarity. Furthermore, key-signatures placed at the head of a staff system to be ignored or contradicted by many accidentals do not contribute to a clear picture of pitch movements. Again, I am losing myself in details. Let us move to the quality of economy which seems to be such a positive quality in so many human endeavors. Do you know of any shortcomings of our notation with regard to economy?

NOT: I cannot recall anything specific but I suspect some examples could be found.

PAN: Indeed, speaking generally of economy of means, our notation is almost exemplary. Nevertheless, you may wonder why is it necessary to denote one single string harmonic with as many as three symbols.

NOT: I can readily accept economy as one of the most welcome qualities in an ideal music notation. Please, go on.

PAN: Now, we can consider for a moment flexibility as an important element of ideal notation. On the surface, flexibility may appear as an unnecessary introduction of the element of redundancy. In retrospect, however, flexibility may provide the saving grace of simplicity wherever an option exists. The rigors of uniform symbolization may be ignored under certain circumstances. Just one thing comes to mind to illustrate such a case. Suppose, for example's sake, some new notational symbols call for extremely complex icons. Wouldn't it be much simpler to have a provision which would permit to substitute plain Arabic numerals for those otherwise correct and logical icons?

NOT: You have lost me completely. Apparently, you reach for an example from an esoteric type of ideal notation with which I am not familiar.

PAN: I was thinking of a hypothetical situation which calls, for instance, for the representation of an eleventh division of a pulse. Surely, the ideal notation may provide for a system of flags and other signs to represent an "eleventh-note" in form of a rather complex icon. Thanks to the provision of flexibility, the same could be simply expressed as a single flag with number 11 above it. I think keeping optional solutions in reserve would only enhance and further simplify the notational process.

NOT: Originally, I thought of an ideal notation as a strictly structured one with no chance for any redundancy. I recognize, however, that options do not necessarily introduce confusion. Actually, they should be chosen if the result is simplification.

PAN: There is only one quality left to be discussed briefly, and that is the very pragmatic notion of efficiency. This is also a very utilitarian aspect of music notation. No matter how logical, how general, or how specific music notation pretends to be, it remains unsatisfactory unless it can be used effortlessly and with the utmost economy of means. It must provide an efficient way of communicating one's intentions. The ancient theorists used to ask a question which suggests a similar concern: "*Quod valet subtilitas ubi perit utilitas?*" Subtlety is fine as long as the utilitarian aspect does not disappear.

NOT: Isn't this a shame that subtlety, which is one of the glories of our art, must be subject to the utilitarian aspect?

PAN: Please, do not misunderstand. Certainly, subtlety will always remain one of the important attributes of every art. Remember, however, that we are concerned here with notation. Notation should, ideally, be able to record subtleties of tonal language, but notation by itself is more science than art. As a tool of communication, it appeals largely to the left brain hemisphere with its penchant for categorization. Even Debussy had to learn the conventional notation to communicate efficiently his sound concepts. He frequently used verbal descriptions to take care of those subtle feelings which could not be communicated by symbol alone.

NOT: Amazing! How scientific a notation should be in order to express the innermost feelings of the soul! I have a feeling that the goal of a perfect, ideal notation could never be reached.

PAN: That does not mean that we should not strive to achieve this goal. Particularly, in our time when so many elements of our notation became rather obsolete, and so many new ones proliferate as private notations.

NOT: I begin to feel that part of the responsibility for this state of affairs is on my shoulders. You did not state so explicitly, but did you really want to convey that impression?

PAN: I will leave it to you to find your own answer. Before we end our meeting, I would like to present you with still another aspect of efficiency. I will digress again to make my point. Put yourself in the role of a conductor in front of an ensemble. Suddenly, you hear a wrong sound coming from the horn section. You stop the ensemble because you feel responsible for the accuracy of performance. You look at your score and start explaining: "Second horn, please, look at the third dotted sixteenth-note in that group of four on the second beat of measure twenty-six. This should be a 'g-sharp' and not a 'g-natural' as I heard it. I mean the concert 'c-sharp' in the one-lined octave. Do you agree?" So far, for the conductor's comment. Now, I have written down that explanation for you to see how many lines it takes in writing.

NOT: Over three lines, I guess... You mean to point to the rather unwieldy verbosity?

PAN: Precisely! Is there a way, perhaps, to shorten the references to wrong sounds during a rehearsal, in the interest of efficiency? After all, the reference to certain pitches or durations can become even more complex in contemporary scores. On one hand, efficiency may be viewed as the need for as few strokes of pen as possible. On the other hand, efficiency may be related to the nomenclature of sounds. That would add a new task to what is normally expected of a music notation. Notation would be no longer just a graphic presentation of sounds in time and space. Would you agree that some streamlining of referential descriptions of sounds should be an important ingredient of a truly efficient music notation?

NOT: You are talking emphatically about the practicality of new ideas. How do you suppose this streamlining can be achieved? Probably, nothing short of designating terse, unique terms for every parameter of sound would be necessary in this reform.

PAN: A formidable task, indeed. Can you anticipate the benefits to the pedagogy of music theory? Can you see how much time and effort could be saved for students of music from the early grades to post-graduate analysis? Actually, very little is needed to expand the traditional functions of music notation in this direction. We are concerned here with translating the visual code into a spoken code. Once we agree on assigning certain vowels and consonants to tonal orders, we may come up with a type of artificial language which could pinpoint certain pitches or durations with an unprecedented accuracy and economy at the same time. Further distinctions could be made also between those syllabic references, depending on their purpose. One way of referring to sounds could entirely forego the staff notation. The relation of such writing to musical notation would be similar to the relation between longhand writing and shorthand. Unlike shorthand, however, such syllabic writing could be uttered "viva voce," that is it could be dictated for direct transcription to another person. Furthermore -- particularly in this age of "apersonal" communication -- the substitution of numerical values for some aspects of tonal orders could result in a type of "alphameric" notation, a

mixture of letters and numbers. You can guess how easily this type of code could be fed into a computer storage for quick recall.

NOT: This goes far beyond what we usually consider as music notation. This type of speculation aims at exploring the ways in which we should refer to sounds. Since we are considering the ideal aspects of music notation, we may, as well, search for an optimal nomenclature, and ideal ways of referring to sounds. Speculation itself will not suffice. I am sure we will need to consider some specific proposals. Only then one can compare various ideas and evaluate them in light of the criteria which you have suggested as guidelines conditioning the goal of perfection.

PAN: Now we are ready, finally, to discuss one of such wild proposals. I will expect from you an uncompromising critical attitude, and a cheerful capacity for infinite patience. New things are usually irritating, and sometimes infuriating. I would not want you to have any prejudicial notions "a priori." This would be rather counterproductive. After the whole system is explored, you will have plenty of opportunity to voice your disagreements, frustrations, and possibly disgust. Watching your facial expressions for the past few minutes, I have noticed already a shade of frustration. This is, probably, due to the fact that facing so many unexpected concerns you must have reached the point of saturation. I will leave you for now, hoping that you will mull over in your head everything we have touched upon. Review those ten characteristics again, and consider their ramifications. If you wish to review them in an abbreviated form on a single page, please look at the very first appendix to this tract (Appendix 1). Above all, start generating some creative juices of your own. Can you think of any other qualities which you could add to those I have mentioned to you? Can you point to some shortcomings of the conventional notation which you would like to see improved? Do not stop there! Remember that in this endeavor of improving music notation, criticism is only the beginning. You may be dissatisfied with present conditions, to be sure. Cursing the darkness brings about only the identification of the problem. Showing the light of a tentative solution is infinitely better than suffering darkness. I will see you tomorrow.

NOT: Thank you, master Pan, and good-bye.

*

THE SECOND DAY

THE UNMETERED DURATIONS AND ARTICULATIONS

PAN: Thank you, Mr. Not for being punctual this morning.

NOT: Good morning! I sort of expected that you would be anxious to start early today. This is why I came even slightly ahead of time.

PAN: Well, we have such an immense amount of material before us that we had better start right away. Become a composer for a moment, and tell me what kind of the most primitive distinction would you make for the duration of sounds?

NOT: Short sounds and long sounds, I suppose...

PAN: Yes, this seems to be a most primitive distinction among durations. Notice, that we are accepting here an unmetered situation. This means that longer durations do not have to be exactly twice as long as the short ones. As a matter of fact, the short durations do not have to be uniformly short. In this way, we may notate a virtually non-pulsative music. The first example I borrowed from a popular medieval song (see Ex. 2.1 a) p.E1) represents mostly short durations interspersed with a few longer ones. However, you do not see here the original notation but a transcription into the traditional notation which implies strict meter and neatly divides the strophe into ten measures. The metric character of this song is probably predicated on the regular accentual pattern of the Latin text. The prevalent succession of alternating accentuated syllables lends itself to be locked here in a quadruple simple meter, although a simple duple meter could also be used. An alternative of a simple triple meter could also be suggested. Now, the accentuated syllables will become twice as long as the unaccentuated short syllables. This interpretation of rhythm is perfectly justified by the well-known practice of giving the quantitative value to the accents. The present transcription into the quadruple simple meter suggests giving rather the qualitative value to the accents. Most syllable patterns represent a trochaic rhythm. The trochaic rhythm is represented by even durational values in qualitative interpretation of accents. The quantitative interpretation changes the duple (or quadruple) metric units into the triple ones because the accented syllable receives a double emphasis in duration. Incidentally, this was known as the first rhythmic mode in

medieval theory long before the duple units were recognized as legitimate divisions of time units.

NOT: I appreciate the historical background for all those rhythmical distinctions but, for all the practical purposes, I see here only the short and the long notes. Could not two different durational symbols take care of this music?

PAN: I see you are ready to accept some arbitrary symbols for two different types of duration in this example. Let us start with the stem as a symbol of articulation. Now, draw a short line touching the top of the stem at a 45° angle to the right of the stem. Then connect it with the short horizontal bar toward the imaginary prolongation of the stem. If you are lost, just look at the first series of signals in Example 2.1 b) p.E1 to see the shape we will use for short notes in unmeasured music. While you are looking at this example, notice that the signal for long notes will be derived from the short-note signal by taking it figuratively by the stem and twirling in your fingers by 180° in either direction. The syllables in italics are the actual names of those notes. A "*fa*" will stand for a short note, and a "*sa*" will signify a long note. The ending note of each strophe is a considerably longer than that one found ending the two-measure phrases. Therefore, you can amend it by adding a vertical stroke to the horizontal bar, and calling it "*saf*." Anticipating your dismay at all those arbitrary symbols, let me assure you that there are reasons for the choice of those symbols. They will become an integral part of a system which will develop gradually as we progress toward more advanced examples.

NOT: Do I have to accept those new signals with the attending new names on faith?

PAN: I beg your forbearance. We must start somewhere. Those fancy signals and names will make sense eventually in a larger context of all the durational distinctions. Right now, let us continue with the simplest distinctions. The next example, featuring a popular English carol "God rest you merry gentlemen," does not go beyond short-long distinction, at least in its opening phrase (Ex. 2.2 a) p.E2. Of course, we know it and sing it in a strictly metered way. The regularity of its rhythmic shape is due again to the alternating accents of the text syllables. However, the impression is that of an iambic rhythm rather than that of a trochaic rhythm in the first example. The anacrusis (or "up-beat") with which it begins produces a rhythmic construction which was recognized as the second rhythmic mode and which is actually the reverse of the first medieval mode. Interpreting the textual accents quantitatively, would make this carol swing in a triple meter or, conceivably, in a lilting duple compound meter, particularly when responding to the "alla breve" meter of the traditional version. Would this not make a nice variation of the original rhythm? Whatever you decide, the short and long durational values are all that is needed for this phrase. You can see it again in part b) of Example 2.2 p.E2. You may be bothered by the triple value (strictly speaking) of the dotted half-note at the end of the phrase. In this case, simply add a vertical stroke across the bar of "*sa*" and make it a "*saf*".

Thus, the note becomes one of sustained duration. Leaving it a "sa" at the end may as well be preferable because you will have to take breath somewhere at the presumably lively tempo of this phrase.

NOT: I do not find anything bothering me, so far. I wonder, however, how many examples can you find for music relying only on those fundamental distinctions. After all, even this carol uses two eighth-notes to the word "comfort" in the refrain of the piece. This would require something like a half duration of the note which you call "fa".

PAN: Certainly, the literature restricted to the primitive distinction between long and short notes is itself restricted and not readily available. The two syllables of the word "comfort" you have mentioned are articulated within one quarter-note and are perfectly compatible with the meter. Ours is, however, the investigation of unmeasured music, for the time being. The interpretation of a long note as consisting of precisely two short notes leads inevitably to the metric concept. You may remember the time in history when, after a long experimentation, the "longa" consisted of two "brevis" notes, and the "brevis," in turn, of two "minim" notes. Further subdivisions, e.g.: "semiminim," "fusa," were predicated on exact integer proportions. The non-pulsative music is not based on an isochronous pulse governing the rhythm. We are ready, now, to enter a huge body of music literature which is usually interpreted as "free-rhythmed" rather than subject to metric strictures.

NOT: Let me anticipate your examples. This, if for nothing else, is just to prove to you that I am not as ignorant as you may think. I am sure you want to take your examples from Gregorian Chant. Is not that so?

PAN: I am glad you are thinking and anticipating. Soon you will be able to judge for yourself how beneficial the streamlining of the conventional notation may become in transcribing the unmeasured music of plain chants. Let us examine the opening strophe of the famous hymn for the feast of Pentecost: "Veni Creator Spiritus." Just think how inspiring is the invocation to the creative spirit requesting it to visit the minds of all people. In a sense, it should be the motto of our whole notational enterprise.

NOT: I am not particularly religious but I realize that nothing short of supernatural help would be welcome in learning the new system.

PAN: In looking at the Gregorian notation, (Ex. 2.3 a) p.E3 you realize that it needs some sort of transcription for people not familiar with ancient neumes, clefs, and staff. The Benedictine monks of Solesmes have taught us that this music should be regarded as free of any metric implications. At the same time, they have suggested an interpretative device which should govern the rhythmic life of chant. They call it an "ictus." I am sorry but I could not find any definition of what this term precisely means. It is not supposed to be an accent in our sense of the word. It is supposed, however, to help

organizing the rhythm in groups of two or three tones. Wherever the number "one" falls, this is the place of the "ictus." Thus, a string of tones interlacing freely binary or ternary groups gives some sense of order to the chant.

NOT: Who does actually determine where the "ictus" falls?

PAN: There are a few simple rules in Solesmes editions for placement of the "ictus." When in doubt, the "ictus" is marked by the editors in form of a vertical stroke which is called a "vertical episema," to distinguish it from a "horizontal episema" which marks notes to be slightly lengthened. I am mentioning this now because you can find a few "ictus" marks in the (a) portion of this example, and the entire ictus pattern in the (b) portion of the same example. Later on, in the next example (Ex. 2.4) p.E4 you will find also a few "horizontal episemas."

NOT: Does it mean that the use of "horizontal episemas" necessitates the introduction of special signs for notes slightly lengthened, besides the short and long ones?

PAN: You have met the problem already with the last note of the "Song of the Ass," our very first example. We will discuss the solutions when we arrive at the next example. You are quite right that the notation will call now for a few more durational distinctions. The sensitive performance of chants may call for some subtle distinctions far more sophisticated than the music of our first two examples. The universal notation should be able to represent them as accurately as possible. Let us not get ahead of our concerns, however, and return to the problems posed by the reality of "ictus" patterns. I said "reality" because it seems to be a paradox that an "ictus" should be only mentally conceived. No dynamic or agogic attention should be paid to the "ictus" in performance, and yet it should become the "rhythmic step" or "alighting point" giving life and order to a chant melody.

NOT: All this sounds rather mystical or, perhaps, poetical. I fail to see what import the "ictus" may have on durations, since it is not supposed to have anything to do with duration.

PAN: It certainly appears to be so, but those subtleties have some impact on the picture of notation, after all. Before you look at the transcription in portion (b) of our example, let us review the common practice of beaming two or more notes of the same duration to one syllable of the text. Since chants are vocal music and their origin is logogenic, the preservation of this practice seems worthy of continuing. Notice how many short notes are beamed together when they are sung to one syllable. In the code transcription they become "famfa" for two notes, and "famfamfa" for three notes to one syllable. The letter "m" stands here for the beam connecting two or three short notes. Now, look at the strange configuration beginning second line starting with the syllable

"Im" of the word "Im-ple." The short stem indicates a rest or an absence of sound. The letter "x" attached to the durational symbol, in this case a "*fam*" makes the code name change to a "*famx*." With the articulation of the syllable "Im" of the text the stem regains its normal length, and the code "*fa*" is representative of the already familiar short duration.

NOT: The normal question I suppose, would be why do you suggest a rest at this point? There is nothing in the Gregorian notation which suggest introduction of a rest.

PAN: So you would think, but you must have noticed a bar similar to our conventional measure-bars at the end of the first line separating it from the second line. Again, I must remind you of the fact that bar lines in chant are merely signs pertaining to the divisions of phrasing. They come in different lengths, and they do not have anything in common with the concept of meter. The "full" bar line separating both lines of text here is a rather important division. The "double" bar line which you see at the end does not end the selection but separates the first strophe from the next ones. It is used also very frequently as a sign of change of choirs in antiphonal singing. The lesser division is called a "half" bar. You see two of them in this example cutting through the inside staff lines only. The "quarter" bar line (or an "incise") is also possible. You will see two of them in the next example (Ex. 2.4 a) p.E4. This lecture on Gregorian bar lines was not meant to annoy you. You will soon discover the relevance of those bar lines to the actual performance practice. The phrase divisions may suggest the most convenient places for replenishing the breath. If not necessarily at the "quarter" bars, very definitely at the "full" bar line, as is the case in our example at the end of the first line.

NOT: Pardon my interjection but why not simply use a separate rest after the word "visita" and then a separate short note for the syllable "Im?"

PAN: Probably because the transcription of this place in the b) portion makes the "ictus" pattern clearer. There is no doubt that the syllable "ple" starts with an "ictus" because one of the rules says that the beginning of a neum takes precedence over the single note with regard to the placement of an "ictus." Since the syllable "ta" at the end of the first line is endowed with two counts of the "ictus" pattern as a long note, the rest symbol could be regarded as the third count. This would leave the "Im" at the beginning of the second line unassigned because count number four is out of question, and count number one is also impossible because the next note is an "ictus" note, and pattern numbers one are never following each other in succession.

NOT: If the time of breath taking is assigned to a short note duration, this may make sense. Is the regard for the clarity of "ictus" pattern such an important issue in Gregorian rhythm?

PAN: It may become important under certain circumstances, assuming you agree with the Solesmes interpretation. I am rather reluctant to jump ahead to the following example but I will make an exception and ask you to look at the second line of the formal version in the transcription portion of Example 2.4 p.E4. There are no more text syllables underlying the music, after the word "Alleluia." The singer continues with a melismatic string of notes to the sound of the ultimate vowel "a." This is the typical chant "jubilus." Compare it, please, with the neumatic nature of "Veni Creator." There are no larger groups of notes than three attached to one text syllable. In case of "Alleluia," the extended second part of this music could be written as a string of as many as six or even twelve short notes interpolated with a few long notes. They all would appear under a very long beam. In order to reveal the "ictus" pattern, you may prefer to "beam" together groups of two or three notes. You can see that this usage of beams does more than just connect notes of the same duration and sung to the same vowel. You can see that I used the beams as means of separating the groups of a free rhythmic pattern. The itemization of groups seems also to be helpful in reading or dictating the code notation. Pardon, once again, my anticipatory digression. Is there anything else you would like to know about the interpretation of "Veni Creator," our preceding example?

NOT: I will attempt to get acquainted with this chant, and then I may have to ask you additional questions. Somehow, I feel learning to read the square notation would prepare me to sing this chant fluently with all the necessary inflections.

PAN: No doubt about this. On the other hand, remember that we are trying to discover such a comprehensive way of notating sounds which would permit covering every type of music with the same system of symbols. No matter which system you use, the ultimate goal is a performance which reflects all the real and even implied notational symbols. I strongly urge you to make all the examples into living music. Studying theoretical concepts, we frequently neglect the music itself. There is nothing in these examples which should prevent any willing musician (not necessarily a singer) to bring them to life. I realize that these are the first examples using Gregorian notation. You could sing easily the "Song of the Ass" and "God rest you merry gentlemen" from the traditional notation. If "Veni Creator" and "Alleluia" seem forbidding pitch-wise, at least try the rhythms in a quasi-parlando manner. Unfortunately, such are the inconveniences of planning the survey of temporal aspects before reaching the pitch aspects. In a few days, you will find some of the same examples used to illustrate pitch movement. By then, the most fundamental parameters of sound will be joined together.

NOT: I will try to do so but there are some of the new signs and even a few code names in the "Alleluia" transcription (Ex. 2.4 b) p.E4) which you have not explained as yet. I am particularly puzzled by the musical representation of the very first syllable of the word "Alleluia." The "famfa" is familiar but why are those code syllables followed by hyphens? Is this just incidental? What is the meaning of "faex" and "fäf" just underneath the other code syllables?

PAN: The code names with an "ae" belong actually to matters of tempo. Think of a longer note as a momentary suspension of the prevalent tempo. If the tempo for this particular note is slightly slower, the note will be also slightly longer in duration. The hyphen after "fam" should be followed by "faex" in reading of the code. Lack of space, and crowding the following syllable underneath the first one, make the reading rather awkward. The meaning is that the first of two short notes connected by a beam is supposed to be slightly longer in duration. This will make the name of the first note a "fam-faex." The signal is changed by addition of a short diagonal line to the left of the stem. Look up Appendix 3 to get better acquainted with new signals and codes. Similarly, the code for the second of the "beamed" short notes should read: "fa-fäf." The second syllable of this code needs a longer explanation. The vowel "ä" is reserved for all matters pertaining to the quality or the timbre of a sound. If you look through a magnifying glass at the first group of four notes opening this "Alleluia," you will notice that the second note is slightly slanted and wears a tiny three-pronged crown. This shape is known by the name of a "quilisma." It is supposed to differ from the other surrounding notes by a certain "liquidity" or rather by the transient and rarified qualities of sound. Most textbooks warn against lengthening or shortening of its duration. Therefore, its unusual quality is marked by one of the timbre codes, and one of the corresponding timbre signals. A diagonal line extends to the left underneath the filled diamond (the symbol of quality of sound) and then turns up. You will have an opportunity to come to know the signs and codes representing the timbre differentiations but not until the end of our discussions. I have used this symbol here because "quilisma" has some relevance to the durational parameter, after all. The general practice recommends slight lengthening of the note directly preceding the "quilisma." Therefore, you can see the reason for a slightly sustained character of the first note. Although there is no sign indicating the prolongation of the first note, the performance practice of extending the note preceding the "quilisma" is strongly implied here. The normal signs for slight extension of the duration take the shape of a horizontal "episema." You will remember the vertical "episema" as the sign of an "ictus." The horizontal "episema" usually extends over two or three notes and could be again interpreted as a momentary slackening of the tempo. Find three more code syllables of "faex" in the transcriptions (Ex. 2.4 b) p.E4, and see how they correspond to horizontal "episemas" in the Gregorian notation (Ex. 2.4 a) on the same page.

NOT: Now I can see those "episemas" in the original Gregorian notation. They are so tiny that they are hardly noticeable.

PAN: Sometimes, the horizontal "episemas" extend over a longer group of notes. In such a case, a gradual lengthening is suggested, similar to a "ritenuto" rather than to abrupt slowing down of the tempo. Do not worry about transcription of long "episemas" because you will not see them in our examples. The last practice I should explain, before moving to the next example, is the utilization of one of the most ancient and useful devices in music notation. You see it used in the informal section of the

transcription. It is the tie which frequently simplifies the notational practice. You may declare all those signals above the stem unnecessary, provided you make it known that all stems indicate the articulation of short values only. When long values are needed, you simply may tie together two short articulations to double their single value. The consonant "s" added at the end of code syllables identifying the given duration functions as a code symbol for a tie. A good illustration of this point is provided by the short duration succeeding the long one for the syllable "le" of the word "Alleluia." In the formal version the "sa" precedes the "fa." In the informal version you see three "beamed" notes, the first two of which are tied. The alpha-code reads here: "famsfamfa." Much space and time may be saved by such a streamlined approach.

NOT: So there is room for alternatives in representing the same music. I like seeing some degree of flexibility in the system which seems so austere at first as not to admit any other options. I can also see the utility of alpha-codes for referring to all notes. Otherwise, I would call those short and long durations eighth- or quarter-notes. This would hardly be representative of their true nature in unmeasured music. The very appearance of beams and ties makes it tempting though to call them by their traditional names.

PAN: There is also something functionally consistent in the selection of consonants for the alpha-code. You may have noticed already the use of an "x" as the symbol for a rest when appended to the durational value. Furthermore, the letter "m," suggesting "multiplicity," was used in reference to the beams connecting multiple articulations of the same value. The consonant "s" preceding the vowel "a" served as a code name for long durations. As a matter of fact, the letter "s" is most frequently used in this system with reference to something larger, longer, louder, higher, etc. When you see it ending a code syllable standing for certain duration, you may as well expect it to suggest something larger or longer. This is exactly what happens when you tie two or more articulations. The result is always a longer duration because you suppress the following articulations.

NOT: From the perspective of those two excerpts from the world of chant, I remember short and long durations, and also those which you called slightly lengthened. Practically speaking, they must lie somewhere between the short and long ones. I wonder if there are any situations in chant where the tempo may actually increase making the short durations even shorter?

PAN: Wonderful! What kind of justice would it be to recognize slightly lengthened durations, and exclude even the possibility of slightly shortened ones. Two last examples from the chant literature (Ex. 2.5 and 2.6), on pages E5 and E6, respectively, will present such opportunities. The first of them presents two brief portions of the phrase which dwell on repeated pitches. In such places, it is quite permissible to speed up slightly what appears to be a recitation. Under such circumstances, the music follows the rhythm

of verbal recitation as in any vocal recitative. In no other place is the unmetred nature of the chant more evident than in such phrases as you see in both of those examples. The transcription of such examples offers also two solutions. The full version of the Example 2.5 b) p.E5 differs from the abbreviated version in one fundamental aspect. The full version itemizes signals and codes for every articulation. The abbreviated version plants just the initial signal at the beginning of recitation, and uses a new signal meaning "ditto" articulation until change. The signal for the slightly increased tempo appears similar to the one you have seen used for slightly slower tempo. This time, however, the diagonal line extends to the right of the stem, and the code name is: "saef" instead of "faef," as you have seen used before. For the abbreviated version, the new signal (under the initial syllable of the text) consists of a diagonal line extending to the left from the top of the stem at a 45° angle and then bent downward. The code name for this signal is "fu" and it should be used in front of the durational value. The meaning of those new symbols is simply to repeat the same articulation a few times. Later on, you will see what kind of a signal and a code to use to specify the precise number of repeats. This time, it may suffice just to follow the syllabified text. No strain is demanded from the performer in synchronizing text with music because both recitation passages use the repetition of the same pitch.

NOT: I have seen only recitatives which use metered notation, although I remember composers' admonitions to adapt their rhythm to the rhythm of the spoken words. Such instructions as, for instance, "colla voce" must keep the accompanists alert, unless they have only a few perfunctory chords to interject.

PAN: This is not a particular problem in chant because the vocal line is supposed to be unaccompanied, at least theoretically. Nevertheless, you can see the incompatibility of free-rhythmic recitation locked into the strictures of a metrical notation. There exists a whole branch of chant interpretation which follows the rules of so-called psalmody. The antiphonal performance of double psalmodic strophes is based on a traditional pattern repeating itself with every new strophe but permitting a flexible underlay of different texts. Glance at this pattern as outlined in simple form in the first strophe of Example 2.6 b) p.E7. Look also at the extended pattern underlying the fourth strophe. Except for the few melodic formulas, such as occur at the very beginning of the first strophe, or in the middle and at the end of both strophes, the chant consists of recitation on the same pitch. You are given here the professional names for the parts of a psalmodic formula. The first recitation (sometimes called: tenor or tuba) of the fourth strophe is interrupted by a momentary pause called: "flex." The use of a "flex" is optional, and is recommended whenever the text line is so long that it necessitates a brief pause for breath.

NOT: I understand why a "flex" is used in the fourth strophe. There are twice as many text syllables in the first recitation of the fourth strophe as in the first recitation of the first strophe. We are not supposed to touch the pitch movement in those

examples but I could not help noticing in Example 2.6 a) on page E6 that melodically "flex" is almost a metaphor for exhaustion. It says it is time for a new breath.

PAN: Not all of them are like this one but I agree that they are psychologically appropriate for the situation. There are two new signals and corresponding codes in Example 2.6 b) p.E7 which need explanation. First, there is still a different signal for reiteration of the same duration. It looks like a long extension of the stem upwards crossed by a short bar. You see it, for the first time, supplementing the signal for the slightly shorter duration (code: "fasaef") above the text syllable "te" of the first word "Confitebor." The code syllable "mu" is added to the duration ("fasaef") making the entire code: "fasaefmu." The meaning is almost the same as in the reiteration signal and code "fusaef" which you have seen in Example 2.5 b) p.E5. Whereas the "fusaef" meant: reiterate a few times, the "fasaefmu" means: reiterate extensively the same or approximate duration (particularly appropriate in liturgical recitatives) until change. The need for the second signal is typical in strophic settings where the same music serves different texts. Example 2.6 a) p.E6 presents the entire psalm with its twelve different text strophes. Only the initial strophe is set to the music of a psalmodic formula. The remainder is expected to be sung to the same formula. However, you see that the articulation in the mediant cadence (preceding the asterisk) and in the final cadence (the termination) will have to be adjusted. This will depend on whether one or two syllables follow the last word accent. The Gregorian notation inserts an empty square for an additional articulation, in case there are two more syllables needed. In transcription, (Example 2.6 b) p.E7 you see a signal which is a combination of the signal for short duration (code: "fa") with the signal for few reiterations (code: "fu") mirrored with the same icon on the right side at the top of the stem (again code: "fu") This symbol stands for an optional articulation and is expressed by the code: "fujafu." I know you are frustrated again. Let me explain in clearer terms. The letter "j" will stand always for any quantity you wish to substitute for it in code names. Therefore, the code name for the penultimate text syllable in both mediant and final cadence is "fufafu." Do you see both places which are marked with a (p.) in the text line?

NOT: You are talking about the transcription, are you not? Yes, now I do see those places. I am almost ready to accept the new signal for optional articulation. Does it have to be so elaborate?

PAN: Actually, the signal on the right side of the stem means something else when used by itself. I did not mention this because there is no need to use it in unmetred music. This signal, however, (code: "jafu" or "jasu") is very useful in metrical music when it deals with determined amount of reiterations. The code name becomes now: "jaqu" and it determines how many articulations are needed within a chosen duration. All this is far ahead of our material but, nevertheless, I would like you to notice still another consonant, namely a "q" in code names. This letter will stand always for a determined amount which could be expressed in numbers. It is not so wide-reaching as

the letter "j" which represents any quantities, including the descriptive ones. Since at the present time we are concerned only with descriptive quantities, try to remember that the combination of both signals spells an optional articulation. Separately, though, a "ja" preceded by a "fu" would mean to repeat a few times your chosen duration, and a "ja" followed by a "fu" would mean to articulate a few times within a chosen duration.

NOT: I must confess I feel like a sailor lost at sea. The further we go the more I am worried about the pronunciation of those strange code syllables. This is becoming more of a problem for me than anything else. I suspect you follow some esoteric rules of pronunciation which make those words sound in your mouth quite unlike I would enunciate them.

PAN: I regret very much that I found it impossible to base the pronunciation of code names solely on English standards. This is why those words sound so strange to your ears. The universal acceptance of the new musical nomenclature seems to suggest some kind of compromise between the major languages of this world. Among many choices are either adopting the pronunciations of some artificial languages or imitating the way the consonants and vowels are pronounced in such basic languages as Latin or Greek. Probably, no universal agreement will ever be reached in this matter. An arbitrary guide for pronunciation of codes has been concocted for the use of students like yourself. Please, consult this guide and see whether or not the difficulties could be conquered. This table appears as Appendix 2, under the title: "Pronunciation of Codes.". You may remember that during the first day we have discussed the problem of an ideal music notation. I touched briefly on the necessity of formulating something more than just symbols of music notation. I suggested the invention of a uniform referential system by which we could call "viva voce" the names of notes while dictating or analyzing music. This could be accomplished if we agree first on some common nomenclature, and then adopt a common way of reading those new names. The musical terms and their pronunciation are not usually regarded as belonging to the essential concerns of musical notation. Nevertheless, global acceptance of simple names for the elements of musical notation would facilitate communication among musicians. The effectiveness of this communication, in turn, would be greatly increased by agreement on the general standards of pronunciation. Think how beneficial this may prove in schools or in any situation where people try to refer to the elements of musical notation.

NOT: It is all so overwhelming! You seem to suggest not only the reform of conventional notation but also a new system of notational terminology and, on the top of all this, what amounts to the adaptation of new and quite arbitrary linguistic standards.

PAN: My only defense is to ask you to evaluate everything carefully and to see (at least theoretically) whether or not the effort is worth trying. The initial difficulties should not intimidate you. One cannot evaluate the benefits of the new system until one has a perspective on the whole. Only then you can decide whether or not the perceived

benefits outweigh the suspected disadvantages. Unfortunately, the process of learning does not provide such comfortable vistas in the initial stages. If you are not convinced of the obsolescence of the traditional notation, the road toward progress may be rather arduous and challenging. A small dose of intuition is sometimes helpful as an antidote for grim determination.

NOT: I grant you that we have not examined yet completely one single parameter. I expect you to move any time now to the metrical durations. Perhaps the examination of this music will be easier because, after all, we are more familiar with the concept of the meter. However, I would not take it for granted. There is already so much material to remember. Most of it is so unexpected and unprecedented that one cannot anticipate new concepts, new ways of identifying them, and new terminology.

PAN: Before we move to the representation of metrical durations and articulations, I would like you to see how easily you could transcribe the unmetred music composed a few years ago by Bruce Saylor. You have learned to transcribe the music of the past. Lest you have an impression that non-pulsative music (or rather music deprived of a steady, isochronous pulse) belongs only to the dim ages, let us look at a modern example. With one exception, you are already equipped to represent the temporal aspect of this phrase in universal terms. Observe what kind of notes the composer uses in Example 2.7 a) p.E8. Read also his performance directions. This excerpt omits the accompanying flute part which is strictly metrical for the most part. Try your hand at making this transcription yourself. Then look at the b) portion of this example and compare it with your work. You should have come up with something similar. You could not account yet for the mark of "rit." which appears above the text of "lest I sleep." The signal for gradual slowing down consists of a long diagonal line descending to the left from the top of the stem. The code name for this is "*faej*." Incidentally, the gradual speeding up ("accelerando") is represented by what is actually the slowing down signal flipped vertically to the right side of the stem. Predictably, the code name changes to "*saej*."

NOT: It seems we have almost exhausted all the possibilities of free-rhythmed expression.

PAN: Not quite. Learning the rest of the signals and codes will be more suitable in connection with the metrical durations. For the purpose of a quick review, you may be interested in seeing some of the symbols we have discussed during the second day. They are gathered in a single table entitled: "Preliminary Signals and Codes for the Non-quantitative Temporal Values." This table constitutes Appendix 3. Much lies ahead of us. After all, it is the measured music which remains in the mainstream of western developments for a millenium. Accordingly, we should spend much more time projecting possible improvements in light of its traditional symbology and conventional terminology. At this point, nonetheless, you should be able to appreciate one of the most important attributes of any notation which pretends to claim universality. Consequently,

it becomes imperative that one of the most important functions of a responsive notation should be its capacity to offer the composer a variety of logically designed signals for expressing any conceivable wish or any desirable whim of compositional fancy.

*

THE THIRD DAY

THE REPRESENTATION OF THE TEMPORAL PARAMETER

PAN: We will continue today with the temporal aspect of notation. This time, however, we will try to examine the problems which arise in connection with the representation of metric music. I do not know whether or not we will be able to accomplish this in just one day. As you well know, the field of music written in the straight jacket of meter occupies much more space historically, and also poses many more notational problems than free-rhythmed music which we have surveyed heretofore.

NOT: Could we return to the very first example which you have shown on the second day? I believe, it was the "Song of the Ass," and it was locked into the common meter of four quarters.

PAN: I thought of this already. the "Song of the Ass," as transcribed into the conventional notation, may serve us again for a far ranging exploration of metric options. Actually, we do not need the entire period of ten bars as represented in Example 2.1 a) p.E1. The initial phrase locked in four bars will be sufficient for our purposes. So, now, let us sing it together from Example 3.1 a) p.E9. Did you notice how smoothly everything flows, and how the textual accents reinforce the regular quadruple division of four larger units?

NOT: Obviously, the rhythm fits the words like a glove. I could not imagine singing this phrase in triple meter.

PAN: Do not arrive at hasty conclusions, please. Do you remember when we discussed the difference between the qualitative and quantitative interpretation, the other day? In this text the accent falls gracefully on every other syllable. What happens when you adopt longer values to the naturally stressed syllables? Obviously, the rhythm changes from uniform rhythm of duple or quadruple metric implications to one of uneven values. Then, this phrase could be easily translated into the triple meter provided you regard it as a phrase of eight triple instead of four quadruple measures. This interpretation would result in a rhythm characterized by alternating longer and shorter durations, and not in uniform rhythms of a quadruple (or for that matter also duple) version. A similar effect could be

obtained in four measures of a conventional compound duple meter. Let us not get ahead of ourselves, however. Every examination of temporal aspects of a metric phrase will involve the answer to two fundamental questions: how many units within a measure, and how fast they are supposed to move in time? The answer to our first question, in this example, is four units to a measure. We may call those units tacts (or TAKs, later on.) In duration code (DUR-KOD) the syllable "ta" will stand for a univalent duration. The same univalent duration as a duration signal (DUR-SIG) will resemble a capital letter "T." You may see those symbols as the very first examples in Appendix 10, which bears the title "Quantitative Durations." Incidentally, you will find it helpful to refer to this Appendix more often than once because it features the fundamental codes and signals for pulsative and absolute durations.

NOT: I am already looking at the bottom portion of Example 3.1, which is labeled as Example 3.1 b) p.E9. You seem to suggest that a new time signature be adopted which contains not only two but, actually, three designations for tempo, pulse, and meter. Why do you single out the pulse as such an important component of the time signature?

PAN: Because, even though the, more or less, precise tempo is expressed conventionally in form of a separate metronome sign, it's data are an integral and important part of the temporal aspect of music notation. The rate of speed is attached to either the so-called "beat" of the measure or to the whole measure or even to a part of the "beat." So, for instance, in a duple measure of two quarter-notes the metronome mark assigning the number of 120 to a quarter-note will result in the entire measure lasting but one second. If, however, the same number is assigned to a half-note (representing the full measure) then the entire measure is only half-a-second long. On the other hand, the same metronomic number attached to an eighth-note will lengthen the measure to two seconds. Kindly notice that each time the pulse count is attached to different metric values. Obviously, the pulse is not always identified with the traditional "beat" of the measure. Therefore, it seems advisable to separate the concept of pulse (PUL) from that of tact (TAK) which is the univalent and referential duration within a measure. Some pulses may be identical with tacts but some may be identified with other metrical values also. There is still another reason to separate pulses from tacts. Think, for a moment, of a pulse as a gesture. Try to conduct any music you know, even if it is not written for an ensemble. Soon you will find a comfortable speed at which your hand, your head or your foot will move in tempo. You may also discover that those gestures will not necessarily coincide with the "beats" of the measure. Purely pragmatic reasons will eliminate gestures which are simply too fast for effective conducting or too slow for assisting in recognition of the flow of the tempo. Something will emerge, probably, within the range of gestures from one-second long to pulsations recurring every half of a second or even at shorter frequency, if necessary. All those temporal attributes may be expressed in one time signature. Before you examine Example 3.1 b) p.E9, we should look first at Appendix 15, which illustrates the signals and codes used for matters pertaining to tempi and pulses under the title "Tempo References." Please disregard, for the time being, both options for

codes and signals at the bottom of the tempo signature. They refer to the "Table of Tempi" in Appendix 17 which deals with arbitrarily established gradational tempi, the type of tempi designation which we have not touched yet. Other than that, try to assimilate the codes and signals listed in Appendix 15.

NOT: I can follow the way in which the signals for tempo signature in part (1), and for pulse signature in part (2) of Appendix 15 are constructed but I am completely lost at deciphering the verbal symbols in the code column. What is the meaning of all those strange syllabic terms?

PAN: Now, you are touching on the main obstacle to the understanding of the language of codes. At the core of this problem lies the arbitrary selection of some consonants to substitute for numerals, and of some vowels to symbolize different sound parameters. This occasion is as good as any to interrupt any further discussions of temporal aspects, and to delve into the symbolic arcana of the proposed notation. Appendix 4 surveys selected vowels and consonants as they may be used in the temporal parameter. Appendix 5 may be skipped temporarily because its application is not essential in early stages of learning the new system. However, Appendix 7 is essential for understanding alphameric conversions between numbers and consonants. The value of Appendix 8 lies more in helping to convert pitch classes to the face of the clock than in memorizing the values of temporal codes. Appendix 9, again, is essential for learning the signals of parametric valence, and the way those signals are constructed. Once you learn them now, they will serve you also for all the other parameters of sound. It is not easy to memorize all this information in one day, so start by using those appendices first as a constant reference. Later on, every time you will refer to those tables you will find them easier to remember. Above all, try to absorb Appendices 7, 8, and 9. Gradually, you will supplement the rest of the new symbols from other appendices, according to need.

NOT: I doubt I will ever become proficient in using this veritable maze of symbols and icons. Does the price of progress have to be always so high? I will try my best but I must admit I am beset with doubts about the viability of this system.

PAN: The only thing I can offer you as a sort of consolation is that after conquering this initial hurdle, all the other problems will become less formidable, and, eventually, will disappear. The sooner you will learn new formulations -- the sooner you will be comfortable in handling of foreign ciphers. At the end of this arduous road, nothing will stand in your way because the problems of memory will become the habits of mind.

NOT: As a student, I am used to take the validity of many new things purely on faith. Nevertheless, I cannot help wondering whether or not the results will be commensurate to the efforts...

PAN: Thank you for being candid with me. Now, after this rather dismal digression, it is high time for us to return to the consideration of Example 3.1 b) p.E9. Look at the tempo signature, which is the first of those three signatures listed within the big square brackets in the middle of the page. The triangular scaffolding serves here as a recognizable icon to which time values will be attached. The numeral "1", above the top line, stands for "one second", whereas the code term "*tutam*" not only confirms "one second" but also refers to its position at the top of the signature triangle, which means "one second" for "one tact." If you are already confused, please examine the second illustration in Appendix 15. It appears there as section (1)(b). The consonant "*q*" is replaced by the consonant "*t*" because this consonant translates to number "one" according to the Table of Alphameric Consonants in Appendix 7. You should be acquainted with the code syllable "*ta*" which you have seen as the first position in Appendix 10. It means "one tact" and the terminal consonant "*m*" qualifies it as part of the tempo signature. All together, this tempo signature reads simply: "every tact lasts one second." The remainder of section (1) in Appendix 15 shows you two other possible positions for numerals to the left or to the right of the top line but, actually, outside the triangle. Those positions (marked by an oval) indicate the length of time an entire measure or a tact reciprocal will take. Naturally, the second parts of codes for such tempo signatures will change to "*mam*" or "*quem*", respectively. If you are mystified by the parenthetical "*fea*," do not despair. It is like the abbreviation "sec." and stands for the second as a unit of time. The other codes for such time units as minutes and hours are found under number 4 of section (1) in Appendix 4. The very last illustration of section (1) under (d) gives you all possible positions for marking the amount of time assigned to the metrical units. At the same time, this example shows you an option for tempo signature whenever the exact amount of time is not known or is not desirable. Before the invention of metronome, and often after its introduction to musical scores, composers were satisfied with verbal tempo descriptions, such as "*Andante*" or "*Allegretto*." Although it did not matter to establish absolute values for the rate of speed at which music moved, those terms were carefully arranged on a scale from extremely slow to extremely fast tempi. You will find such a table of gradational tempi in Appendix 17. They are arbitrarily divided into six slow tempi, and six fast tempi. Flipping back to Appendix 9 will remind you of the way the signals in the last column of Appendix 17 were constructed. It will also remind you of the interchange between numbers and consonants necessary for reading of the codes. Just compare the rows prefaced by the names NUM and KON. Although there is no new consonant in the code column of Appendix 17, you may be surprised by the use of a double vowel "*ae*" which is reserved exclusively for general tempo codes.

In case you want to dispense entirely with the formal tempo signature, you may attach those signals for gradational tempi (as listed in Appendix 17) to the note stems. You may also prefer to use somewhat nebulous terms such as "slow" or "fast" or even "extremely slow" and "extremely fast." This choice calls still for another set of signals. The quick survey of both signals and codes for those two types of tempi appears in Appendix 14. They are classified there as "quantified" (1) and "descriptive" (2), and are a

part of the table named "Tempo Signals." As I mentioned earlier, you do not need to attach those tempo signals to the tempo signature. You may do so, however, in a way which is best illustrated at the end of section (1) of Appendix 15, under position (d), as an option following the absolute values. What you see there is the place for all those signals of either gradational or descriptive tempi hanging from the bottom tip of the signature triangle. The slower tempi are to be placed to the left, and the faster tempi to the right of center. The code qualifiers "fu" or "su" could be used to distinguish the group of slower tempi from the faster ones, but are not essential. In descriptive tempi, however, the qualifier "su" is used as an intensifier of either slow or fast designation, as shown in illustration (d) and (f) of section (2) in Appendix 14.

Before leaving the realm of tempo signatures, it may be advisable to consider for a moment the preeminence of the second as the unit of time in tempo measurements. The calculations necessary to deduce the desired tempo from metronomic figures are familiar to all musicians. The comparison of metronome numbers with what they mean as a time unit is compressed into one-page table named appropriately "Tempi Conversion Table" and appearing in Appendix 19. It does not strain the mind too much to figure out if there are 120 quarter-notes in a minute then every quarter-note must last for only half of a second. Arithmetically this is so because 60 (in a minute) to 120 (in a minute) makes for a one to two proportion which is one half of a second. However, you may hesitate before finding the duration of a quarter-note if the metronome sign equates it with the number 80. The conversion table tells you that the quarter-note would be precisely three-quarters of a second long. You could figure it out for yourself by reducing the proportion of 60 (in a minute) to 80 (in a minute.) The end result is a three-quarters proportion. For the metronomic number of 90 you realize that your note is two-thirds of a second long. In this case, the proportion is 6 to 9 or, by reduction, 2 to 3.

NOT: It is still too abstruse for me to know that this note is three-quarters of a second long unless I pull out my stopwatch. How tangible could you make the results of this conversion?

PAN: All right! Count aloud with me: "one po-ta-to, one po-ta-to, one po-ta-to," etc. Now put the main stress on "one," and move vigorously your hand as if marking the down "beat" in conducting. Try to make "one" coincide with what you estimate to be every second of time. Watch for regularity and precision of your syllabic count. Now, cut off the last syllable "to" of the word "potato," while maintaining the same rate of speed as before. The result should sound like "one po-ta. one po-ta, one po-ta," etc. Your accent on "one" and your arm's down-motion should occur now every three-quarters of a second.

NOT: Could you suggest another rhythmic jingle for figuring out those "one" accents to occur every two-thirds of a second?

PAN: Surely! Scan with me "one pea-nut, one pea-nut, one peanut, one peanut," etc. Enough? Now do it again making sure that every "one" agrees with your concept of ticking seconds, and that you distribute the rest of syllables as evenly as possible. Fine! You are ready to forget the "nut" of the "peanut," and scan only "one pea, one pea," etc. at the same tempo as you articulated the "peanut" syllables the first time. Now, you are ticking off two-thirds of a second with every "one" and every "down-beat." In the conversion table, this would correspond to the metronome number of 90, and the pulse number of 0.67", which is approximately two-thirds of a second. Metronome ticks or some modern computerized devices will not substitute for the sense of time unit which we should carry in ourselves. In the past musicians often referred to the pulse of blood as a basis for regulating the tempo. In our times, we may as well learn to develop the sense of a second of time as referential unit for all other calculations. The fractions of a second need not be expressed in decimal numbers past the decimal point. They may be grasped much more effectively as simple fractions. It is the purpose of Appendix 18 to present a few of the handy fractions of a second, in relation to the metronomic numbers. They may assist in establishing proximate time values which lie between them. Machines and electronic devices can always be used to confirm human sense, especially when precision is required.

The second triangle in Example 3.1 b) p.E9 features the numeral "1" below the top line. This place is reserved for numerals denoting the amount of pulses. They may appear also to the left or to the right of the triangle though always beneath the level of the top line. Those situations, which constitute the pulse signature, are presented in section (2) of Appendix 12 ("Tempo References.") The oval-shaped enclosures identify the spaces reserved for the amount of pulses encountered in a measure, or a tact, or a tact-reciprocal. The codes reflect those three options. This is similar to the tempo signature, except that the number of pulses is now following the "*mam*," "*tam*," and "*qem*," instead of preceding them as in tempo signatures. You should be able, now, to read the specific pulse signature in Example 3.1 b) p.E9. The numeral "1" inside the triangle, hence below the top line, signifies by its position one pulse per tact. The code "*tamtu*" confirms what the signal shows graphically.. It is a very simple and usual occurrence where the tact is identified with the pulse.

To the right of this example, one more component of the time signature is presented within the big square brackets. This is the meter signature substituting for the conventional signs with the signs resembling flags attached to the left and the right sides of the signature triangle. The left signal stands for number "4." The right signal stands for number "2." At the base of the triangle you see the top of a tact signal (without the usual stem.) Put together all the elements, and you will decipher the meter signature which reads: there are four tacts in a measure, and each one of them is divisible by two. The code, underneath the signal, reads: "*rutabu*" which means the same, namely four tacts divisible by two within a measure. You can see the icon for the meter signature at the bottom of Appendix 12. This appendix is also very helpful to understand the rationale which led to the formulation of meter signatures. You know already that meter signatures

guarantee the regular recurrence of so-called "beats" in measures of traditionally notated music. They are placed at the beginning of a rhythm, and consist usually of two figures arranged in form of a fraction. The numerator of the fraction indicates the number of "beats" in simple meters or "beat" divisions in compound meters. The denominator of the fraction indicates the relative duration of every single "beat" in simple meters or every "beat" division in compound meters. The new system places the number of "beats" or rather tacts to the left of the center, and the number of their divisions to the right of center. The center here is the place to which all the durational and articulative signals are attached. Formally, it is called the "time hub," (TEM-NUX) or "*jamux*" in code language. It was introduced already in Appendix 3, in the middle of section (a.) The purpose of those little black squares in the signal column is just to orient the reader, only initially, as to the topographic position of the "time hub" or attachment center for temporal values. At the head of Appendix 12 you will find signals and codes for a concept of articulation which distinguishes the reiteration of a given durational value from the reiteration within a given durational value. The first procedure suggests the number of recurrences of the same note; the second one suggests the amount of articulations within this note. To put it differently, the first repetition occurs between the notes themselves (or "*inter*" notes,) whereas the second repetition occurs within a note (or "*intra*" note.) The concept of two types of recurrences is underlying the proposed signal for the meter signature. Just attach both signals, the one for "*inter*" iteration to the left, and the one for "*intra*" iteration to the right of the time-nut. Since the measure consists of repeated tacts, let us put this structure on the top of the tact signal (which you remember resembling the capital letter "T.") We can dispense with the stem, and use only the cross-bar of the tact signal. Now, look at the bottom of the page, and try to comprehend that the icon for the meter signature says precisely what we want every meter signature to say: how many tacts in the measure, and what type of tact division is in use. All the conventional simple meters will feature a signal for double division on the right side. The compound meters will feature, of course, a signal for the triple division on the same side.

Returning again to our first Example 3.1 b) p.E9, and looking to the left of square brackets, you will see the entire time signature (TEM-SIT) being a composite of a tempo signature (TEP-SIT,) a pulse signature (PUL-SIT,) and a meter signature (TEM-SIT.) It is a new expression of what would be a conventional meter signature of four quarter-notes (possibly four half-notes, or perhaps four eighth-notes.) It could also feature a capital "C," actually, a half-circle, or even a slashed circle, suggesting the so-called "common time," and "*alla breve*," respectively. The old metronomic sign would have to propose the quarter-note equaling the figure of 60. You can see already what an excruciatingly slow tempo would result from making every quarter-note last a whole second of time. Yet, this is precisely how we are going to perform this song:: one second to every tact.

NOT: I have never learned how to sustain breath support for a longer time. I will try to replenish breath after the comma in text.

PAN: We are about to practice articulations so it does not matter very much. Ready? Start beating with me the preliminary measure: one - two - three - sing! "O - ri - n - tis - par - ti - bus - - Ad - ven - ta - vit - a - si - nus - - ."

Let me explain that array of signals and codes which clutter the bottom part of Example 3.1 b) p.E9. The first row of empty wedges represents the seconds of time. The parenthetical explanation describes this type of track as an upper one, implying that inverted empty wedges below the score could be also used as a lower seconds track. The appearance of a seconds track here is quite redundant but it may be helpful later on, not to mention its special use where it may substitute for the meter. The four arrow-heads in the second row actually substitute for the conventional bar-lines. Just imagine those arrow-heads positioned at the bottom of the score, but inverted. Could you draw an imaginary line connecting them together? If you cannot do so, connect them with a real line, solid or dashed, and you will have restored the traditional bar-line. The third row presents a metric code (MEM-KOD) which simply identifies the first, second, third, and fourth measures. There is something new here which we did not have time yet to discuss. I beg your indulgence for another digression which I trust will not tax your patience.

We should start with the necessity to distinguish between cardinal and ordinal numbers. In Appendix 7, you have met already with this problem, further complicated by distinctions between the decimal and the duodecimal (or *modulo* 12) systems. You have learned already that certain arbitrarily chosen consonants are identified with numbers. When they precede any of the few vowels used for the temporal parameter, they denote a cardinal value. For example: the code syllable "ta" means: one tact, whereas the code "tat" means: the first tact. Similarly, the code "ma" signifies one measure but the code "mat" would signify the first measure. The note referring to the asterisk in the table of Appendix 8 tells you that there is a significant exception for codes using the vowel "u." The ordinal numbers are formed by just attaching the consonant "t" to the vowel "u." Thus, the cardinal number "one" is coded as "tu" but the ordinal number "first" is coded as "tut." The cardinal number "six" is recorded as "gu" but its cardinal version is recorded as "t." Try to apply this newly won knowledge to the terms "mat," "mab," etc. just under the arrow-heads, when you go back to Example 3.1 b) p.E9. They, obviously, are the code counterparts of the arrow-head signals for the beginning of each measure. It is not accidental that metric points of reference are expressed in ordinal values. In the same Example 3.1 b) p.E9, observe, please, the way a metric code is formed for the tacts (MET-D.) The terms "tat," "tab," "tal," and "tar" are nothing else but code expressions for the first, second, third, and fourth tact in the measure. It is too early to explain the importance of establishing distinct signals and codes for the metric points of reference. Their usefulness will become apparent when you will try to pinpoint precisely a note anywhere in the middle of the music texture. You may anticipate the need for them by referring to Appendix 13 (Metric and Absolute References) where you will find some of the signals and codes which we have just discussed. You will see that the empty wedges and arrow-heads may be easily expanded by adding to them specific numbers. You will

realize also that points of metric reference (MET-PUN) may be extended to include points of selection reference (SEL-PUN.) All those referential tools become very handy when, for instance, in rehearsal you want to communicate the need to change a note which occurs as a second sixteenth-note on the third beat of the ninth measure in the fourth movement. I will leave it to you to figure out the signal for such communication, but I will suggest the following code: "*mer-man-tal-reb*" in the context of traditional "beats" being quarter-notes. Check for accuracy using Appendices 13 and 7, if you do not mind.

NOT: You must be overestimating my capacity to learn new things. I will try but I would prefer to consider this as a home assignment.

PAN: Certainly. Please, consider everything we covered so far as a home assignment. This should prove the best way to digest new concepts, and to reinforce the memory of codes and signals. We have very little left to complete the first transcription in Example 3.1 b) p.E9. Right above the text syllables, there is a row of duration signals (DUR-SIG.) They are all symbols for one tact, except for the two phrase endings where the symbols used are those for a "*ba*" or the value of two tacts. They correspond, of course, to the two half-notes in traditional notation. If you have trouble with remembering basic signals, please, review the Appendices 8 and 9. The duration code (DUR-KOD,) underneath the text syllables, in the Example 3.1 b) p.E9, is using, predictably, the codes of "*ta*" and "*ba*." The first of the last two rows at the bottom of the page supplies a set of signals for different types of pulses, called here PUL-INF because they happen to be placed below the music, and the filled wedges point upwards. The last row lists the appropriate pulse codes (PUL-KOD) for the different points in the metric hierarchy. Appendix 15 lists all the pulse signals at its bottom as section (3.) As you see, the signals for those different pulses do not differ very much from each other. They all include black wedges, as their distinguishing mark. Only in case of the main pulse, they resemble black arrows because a stemmed wedge looks like an arrow. You may wonder why so much fuss about the differentiation of pulses. In reality, you have much latitude to employ any type or combination of pulse signs. The syllable "*tu*" may be quite sufficient to identify the pulse by gesture or by vocal articulation. The syllable "*mu*," identifying the first pulse in a measure, is added here for optional clarification only. In the next example, (3.1 c) p.E10 you will see syllables of "*te*" employed additionally to provide an optional articulation for any of the tact's reciprocals. Therefore, the differentiation of different pulse syllables offers a sort of a complement to pitch syllables used in solmization. This vocal or gestural articulation in real time may prove helpful in reading or reproducing complex rhythms. A lot of improvisation can be used here. The verbal patterns familiar from rhythmic drills or rhythmic dictation, as used in conventional instruction, may be combined with the new syllables. The consonant "*x*" may be appended to the vowels to distinguish rests from notes. It is often helpful to articulate even the "silent" pulses, though such a phenomenon may sound like an oxymoron. Students of music allergic to any type of complication in performance of rhythms may prefer to skip entirely the suggestions to use the variety of different codes and signals for the pulses. After all, the use of the durational

codes, such as "ta" may be as effective as vocalizing "tu." What can be easily overlooked, however, is the fact that syllables utilizing such vowels as "a" or "e" are symbols of duration and not of articulation. It is important to recognize the dual nature of temporal relationships consisting of articulation and duration, both of them permeated with the implications of tempo. This helps in developing tolerance toward any effective means to learn, perform, and label the rhythms. How often have you seen the haphazard handling of rhythmical problems, or futile verbal explanations of rhythmic intricacies? Rhythm does not thrive only on durational proportions but also on where, when or how those durations are articulated.

NOT: I cannot deny the importance of some terms or signals by which we could communicate and record rhythmic shapes in a better way than it is done today. I appreciate also the various options which can be taken in matters of terminology. I can see the application of the principle of flexibility in something which at first appeared to be permeated with rigor and austere dogmatism.

PAN: So far, the examination of examples and appendices has been rather slow and laborious because we have had to establish references at every step of learning something new. Now, we will attempt to look at many more examples of different rhythmic notations, hoping that you will be able to bank on your past experiences.

NOT: I have already looked at Example 3.1 c) p.E10 which you have mentioned the other day. I think I understand the procedures but do not take it for granted. Try to explain as you would to anyone who starts anew.

PAN: To somebody completely new to the subject of our study, Example 3.1 c) p.E10 will present a set of ciphers without any redeeming grace. I am confident that you can benefit from these few days of instruction. You can relate already to past formulations with the knowledge of new codes and signals. You would hardly expect that level of understanding from a student who sees this page for the first time. I will try, however, to show you how you can relate to things you have learned in our previous sessions.

NOT: Is the first section (1) of Example 3.1 c) p.E10 supposed to show you that you can increase the amount of pulses in the same situation as we had before in Example 3.1 b) p.E9?

PAN: Very good! The meter has not changed; there are still four tacts in a measure, each divisible by two. The tempo has not changed; each tact is still one-second long. The pulse pattern, however, has changed. Notice that, this time, there are supposed to be two pulses to a tact. The code for the pulse signature has changed, accordingly, from "tutamtu" to "tutambu." The articulation pattern lists additional syllables "te," besides "mu" and "tu." You may opt not to use them, at all. You may even disregard the codes for "mu." You may limit your pattern just to the repetition of syllables "tu," provided

you beat regularly two pulses to a tact. The tact is one second long but your pulse recurs at the rate of one-half of a second. Compare this version with the previous one, if you please. Which one of those may prove more reliable for performers? You realize that stretches of one second between "beats" are rather long. Subdividing the stretch by two may appeal to some performers as more comfortable to secure precise articulation. Orchestral musicians would probably also prefer the subdivided "beat" rather than exceedingly long stretches between conductor's motions. Whatever the preference, remember that your pulse does not have to be identical with the tact. As a conductor of this song, you would owe it to your singers to explain, beforehand, what kind of pulse will you use. This all sounds so theoretical that we may fail to see the practical application. Would you mind singing again, and I will conduct beating even seconds as indicated in the first version based on Example 3.1 b) p.E9 ? Thank you. Now, I will follow the first version in Example 3.1 c.) p.E10. Notice that you do not have to make identical motions for every pulse. Actually, it would be better to make all "te" gestures much smaller than those used for all "tu." Doing so, you are going to reinforce the significance of "tu" pulses which coincide with the articulation of the notes themselves. Thus, singers are assisted in precise articulation, and in general feeling for the flow of the tempo.

NOT: Apparently, there are some limits to the frequency of "beating" pulses. Do you wish to establish some specific limits to this frequency?

PAN: Not at all. All that matters is how effective is the frequency of pulses in relation to music. The frequency which is even slower than one second to a pulse may be appropriate for certain types of lethargic music. On the fast side, the frequency which is even faster than half-a-second to a pulse may be quite desirable to convey effervescent music. Whatever frequency performers or conductors elect will depend on how they feel the tempo of underlying pulses. If the speed of pulses seems too frantic in relation to music, they will choose to attach the pulse to longer metric units. If, on the other hand, the speed of pulses seems too slow to reflect the character of music, they will choose to attach the pulse to shorter metric units. In a way, this is similar to what is supposed to happen inside an atom, if you ever studied atomic physics. The electrons orbiting around the nucleus jump from one orbit to another of a greater or lesser speed. The different orbits attract electrons as different metric values attract pulses. I do not know whether or not the electrons do it because they are more comfortable in certain orbits. I know, however, that pulses may feel more comfortable if gauged by the type of music.

NOT: I did not study atomic physics but I understand what you mean. I remember when we sang the Christmas carol "Silent night," as a very large group of people outdoors. Our conductor elected to indicate triple meter, "beating" slow and protracted pulses (three pulses for the first word, and three pulses for the second word) to keep us together. At another occasion, I sang the same selection in a chamber choir where the conductor gave us just one pulse for each word.

PAN: I suspect you sang the carol at a faster tempo on the second occasion. The composer locked this song originally in a duple compound meter of six eighths. The second conductor gave you only two dotted quarter-notes, as pulses to guide your singing. The first conductor, however, intended to give you six eighth-notes, as guiding pulses. What came out was probably a triple meter of three eighth-notes for every word. The slower tempo would be perfectly justified for a large group of people. However, if the conductor made every word a new triple measure, the original metric hierarchy would be distorted. In duple compound meters the middle point of the measure is not supposed to be felt as strongly as the first one. This is probably the reason why the composer chose this meter for the song. Otherwise, the strength of the metrical hierarchy would be felt equally strong at the second word as the first one.

NOT: I have never experienced such a subtlety in the interpretation of tempi and meters. They seem to interact quite often. I wonder sometimes why composers prefer one compound duple measure over two triple measures. Are the effects of tempo, meter, and the flow of pulses possible reasons for the choice?

PAN: Possibly so. Frankly, we are getting ahead of ourselves, again. I did not intend to generate this discussion before I let you see the remainder of illustrations in Example 3.1 c) p.E10. Since we have touched already on the interaction of meter and tempo, let me forward your attention to the two last illustrations of Example 3.1 d) on the next page (E11). The first one (2) adjusts the "Song of the Ass" to the conventional simple triple meter, and the second one (3) presents the same song in a traditional duple compound meter. In the triple measure, the tact is supposed to last for about a third of a second, hence the entire measure is one second long. The pulse could occur for every first tact in the measure, as the code "*mu*" indicates. It could be articulated for every tact, as the code "*tu*" indicates, this time without corresponding signals. Clearly, this is an optional solution left to the conductor and performers. The code "*dux*" in the time signature substitutes for the decimal point. Appendices 5 and 6 list some verbal and computational marks translated into the code language. There you will find such terms as the already mentioned "*dux*." If you are interested, you can find there also the code substitutes for such familiar marks as comma and period. Among computational marks, particularly in Appendix 6, you will encounter the verbal terms for the basic arithmetical functions, besides many other which may be helpful for some later, mostly statistical accounts. I wish to clarify right away that the knowledge of those marks and codes is not essential to the notation itself. You had better not study them now but rather keep their place in your memory as a kind of reference in case of need. Their purpose is solely to supply means of communication to people who yearn for an universal language besides their native one. For the time being, using an English word "comma" is as good as memorizing "*flux*." Occasionally, you may even come across a code word such as the one used for a mark of addition "*sum*" which is not very far from its English counterpart. The big difference, though, would be in the correct pronunciation which would make it sound like "soom."

The situation changes in the second illustration (3). Although the entire measure lasts also one second, the tempo feels quite differently, because there are two distinct pulses corresponding to two tacts each divisible by three. Accordingly, one-half of a second (0.5") is assigned to the tact in the time signature. and the code "*duxcutam*" means precisely this. Since two pulses are suggested to a measure they will be separated by half of a second. The code confirms this by listing "*mambu*" in the time signature. Notice that as easily one could expect the assignment of one pulse to the tact, in which case number "1" would be inside the triangle, and the code for the whole signature would be changed to read: "*duxcutamtu*." To demonstrate the interaction of tempi and meters, between a simple triple measure and compound duple measure, let us try to sing both versions marked (2) and (3), respectively. I hope you realize that, in this respect, there is nothing new in the proportions of music itself, except for a new manner of notating its temporal structure.

NOT: I will have to digest the new manner of notating the rhythmic proportions. Although this manner seems to be logical and consistent with the nature of integers and reciprocals, the time signature baffles me, especially, when you mention other options possible.

PAN: This is quite understandable. Once you digest strict initial rules, the options will emerge as a welcome opportunity to apply some creative flexibility. Lest we forget where we left off, let us return to Example 3.1 c) p.E10 and compare the version marked (2) with the version marked (3.) Both are in the same meter of four tacts divisible by two. Both assign half-a second to a tact. The difference is in assigned pulses. In the first version the suggested pulse will coincide with every syllable of the text. In the second version the pulse will be felt or indicated on every other syllable of the text. Although the absolute tempo is the same, the choir will be following four hand or baton motions to the measure in the first version, but only two motions per measure in the other version. Hum both versions to yourself with hand motions to guide the tempo. Do you perceive any other difference?

NOT: Yes! The second version seems to be more sedate, in comparison with the more alert first version. Yet, the rate of speed is the same.

PAN: We should leave it to the psychologists to elaborate on this phenomenon. Still a slightly different effect would be suggested if the second version were in duple rather than quadruple meter. Let us suppose you would want to sing the song syllables at the same rate of speed as either of the versions. You would also expect the conductor to indicate again two pulses, as in the second version. The fact that choristers faced this music written in a traditional meter of two quarter-notes rather than four quarter-notes, would cause some differences in metric spellings. Actually, you can see those differences for yourself in the very first version (1) of the following Example 3.1 d) p.E11. This time, the syllables of the text coincide with tact reciprocals, in this case half-

tacts (or half-notes, in new parlance.) They are coded almost throughout as "be." The time signature records the changed situation, in relation with what you have seen in the second version (3) of Example 3.1 c) p.E10. The tact is one second long, and two pulses are advised for every measure. The code for the tempo is: "*tutam-mambu*." The meter is the simplest possible: two tacts divisible by two. The code expression, following the tempo prescription, is also a symmetrical "*butabu*." Besides all those codes, there are also some other rows of codes listed in this version. Do you have any inkling what they represent?

NOT: I can only guess. They must have something to do with the duration because the familiar syllables "*ma*," "*ta*," and "*be*" return.

PAN: Did you notice how each vowel is followed by a progressively changing consonant? This very appearance makes them not so much code expressions for duration but rather codes for...?

NOT: Articulation?

PAN: Obviously! You have just seen illustrations of metric codes in Example 3.1.b) p.E9, in the middle of today's discussions. The row of "*mat, mab, mal, mar*" is nothing else but the time points for the first, second, third, and fourth measures, in the first version of Example 3.1 d.) p.E11 Underneath the code for durations of text syllables, you see another code substituting for the ordinal numbers of tact reciprocals. The first duration of "*be*" is labeled as "*tat-bet*" which means this is the first tact reciprocal (or half-note) in the first tact. The next duration, being also a "*be*" is labeled as "*tat-beb*" which means this is the second tact reciprocal (or half-note) still in the first tact. The rest of the code follows the same pattern for the second tact of the measure. The advantage of this type of codes for every metric division is obvious in situations where a precise pinpointing of articulation is desired. Take, for instance, the note assigned to the last syllable "vit" of the word "adventavit" in the song's text. The code of "*mal, tab-beb*" is sufficient to identify this note's precise point of articulation.

Believe it or not, Mr. Not, but we are approaching the end of our discourse on tempo and meter. Two last versions, taken from the sections (4) and (5) of Example 3.1 c) p.E10 offer a case where both tempo and pulse are attached to the measure rather than to a tact. In version (4) the whole measure is to last but one second, and there is to be only one pulse to the measure. The code for the time signature expresses this type of articulation as "*tumamtu*" and finishes it with "*rutabu*" which represents our familiar quadruple measure divisible by two. In version (5) the measure is to last only half of a second, whereas the pulse frequency remains the same as in the former version, that is one pulse per measure. You can already anticipate the products of this interaction between meter and tempo. Again, let us sing both versions! I will establish the pulse for two introductory bars, and then we will sing together version (4.) first. Before we sing version (5), look at the time signature. The change occurs in the amount of time allotted to the measure. It is

only half a second (0.5") for a measure. The pulse is supporting every measure, hence it is also recurring every half-a-second. Now, brace yourself for a tempo unlike any tempo we have sung thus far. Let us put two pulses for two blank measures, in front of version (5). I doubt this song was ever performed so fast. The point is only how radically one can change music through tempo-meter notation. Furthermore, it is not our concern to judge composer's or performer's choices. It is not our problem to discover what makes composers prefer duple meters over quadruple meters, in a given selection, or *vice-versa*. However, it is our concern to offer them any possible alternative to express even most subtle rhythmic intricacies in a viable notation.

NOT: I have never thought it possible to spend so much time on matters of tempo, meter, and, previously, unmetred music. Matters of pitch notation and intervals appear to be more important to some people. Are we very far from considering the realm of pitch and intervals?

PAN: Not very far. We will examine, now, a few examples of various rhythms. So far, we have dwelled on the rather primitive example of medieval rhythm, as exemplified by the "Song of the Ass." The first of a new group of examples moves you from medieval ages to the eighteenth century, and the music of Mozart. Again, I have to apologize for such an abrupt leap in history. It would be marvellous to have time to delve into the intricacies of the late fourteenth-century rhythms of French and Italian mannerists. The handling of rhythms in the Renaissance, and later in the Baroque era may intrigue you, some day, to transcribe them into PANOT. The music of Monteverdi and Schütz offers splendid examples of how ingeniously they used the notation of their day to represent refreshingly innovative interactions of rhythms and tempi. Our purpose, however, is not to follow the historical survey of music notation. After all, the ability of new notation to transcribe faithfully the music of the past is only a part of its *raison d'être*.

The "Menuetto" from one of the most celebrated symphonies (K. 550) by Mozart bears a tempo inscription of "*Allegretto*," and a meter signature of three quarters, as you can see this in Example 3.2 a) p.E12. If you look at the transcription of the same music (Example 3.2 b), on the same page, the time signature incorporates the code of "*pae*" (see Appendix 17 for the table of gradational tempi) meaning it is the seventh grade on an arbitrary scale of twelve tempi. The new way of indicating the meter includes the code of "*lutabu*." The signal for the tempo is denoting number seven, and the signals for the meter denote number three for the amount of tacts, and number two for the number of tact subdivisions. The duration code is combined with metric references codes, and their signals, to indicate not only the relative duration of notes but also the beginning of every measure. In this respect, those are the terms and signals with which you became acquainted previously. The metric references include the upper and lower bar sign, unlike previous examples. In addition, the upper bar signs include the specific measure number inside a small rectangle. All those signals are featured in the first section (1) of Appendix 13. You should have no trouble figuring out what those parenthetical expressions (like

"majfstu") mean as code extensions. Compare, please, with the "mat," "mab," etc., listed already in Example 3.1 b) p.E9, and you will realize that those later code expressions are just another way of signaling or coding the consecutive measures. There is also something else new here which needs special explanation. The last note in the first measure is tied to the first note in the second measure. The form of a tie is the same as in traditional notation. It ties also the heads of notes, as it is conventionally done. The code expression adds an "s" to the duration vowel, making this "ta" a "tas." The second measure features also four notes which are beamed together. Notice that in the original version, two pairs of eighth-notes are beamed together. The practice of separating "beats" by not beaming them together has, of course, a long tradition. One must respect it, when it helps clarify the rhythmic construction. The rule of not beaming across the middle of a quadruple measure, or across the tacts of a compound measure, is particularly important in traditional, as well as in proposed method. In simpler situations, however, the tacts of a transcription may sometimes be combined by beams. The triple meter of this minuet lends itself rather well to such an optional treatment. The codes for beamed notes change from just reiterating the durational values to codes which add an "m" at the end of every syllable. This is why you see "bem-bem-bem-be," instead of "be, be, be, be." Remember that you do not need to add an "m" at the end of last syllable, because the sign of "two" (or the flag, as you know it) to the right of the stem is part of the value of the note (in this case a "half-note" or "be") in new system. Theoretically, the new beams are signs connecting only separate notes, and they do not extend from stem to stem. Since they connect mostly tact reciprocals, the flags merge with beams into one segment of a thick line. Therefore, the distinction between flags and beams is practically impossible, though theoretically quite instructive.

NOT: I have noticed that, in the codes, you separate also the articulation of single notes by commas but you use hyphens to separate beamed notes. Is this going to be a consistent way of separating code syllables?

PAN: Not necessarily so. For the time being, you may separate code syllables this way. Perhaps, a better way of separating some exceedingly long codes, when used even for a single articulation, can be found. The usage of other punctuation marks, such as colons and semicolons, comes to mind as a possibility. When you intend to use codes for dictation, there must be a distinction between single notes, tied notes, and beamed notes. For instance, a verbal command of "be" simply means a single articulation of a simple tact reciprocal ("half-note".) The code "bes" signifies that this "half-note" will be tied to anything following it, making the articulation of that following note unnecessary. On the other hand, the code syllable "bem" makes that note only visually connected to the following single or more "half-notes," not affecting at all their separate articulations. In short, you can tie a note to any value you wish, but you can beam a note only to the note of the same durational value or denomination. Ties cancel the articulation of the note following it, and beams do not affect articulation, at all. See, how traditional are those rules and conventions, except, for the terminology of signals and codes.

NOT: Things start falling in their places rather slowly. Which Appendices will help me in reviewing all those matters?

PAN: You will find the relevant codes and signals already in Appendix 3 which referred to non-quantitative values, as you remember from our discussions the day before yesterday. Section (4) of Appendix 12 also reminds you of the recurring patterns of articulation effected by beaming notes of the same value.

NOT: I am looking at those places, right now. The consonant "j" must be used here to be substituted by any temporal value, quantitative or non-quantitative, is not this so?

PAN: Yes, of course. The tying and beaming can be applied to both unmetered and metered durations. In metrical rhythms, a tie on a weaker part of metrical hierarchy produces an effect known as syncopation. One can only speculate why Mozart places such an emphasis on what is the third "beat" of the measure. Is this to suggest the movement of feet for the dancers? Is this, perhaps, to respond to the custom of placing left and right feet in an initial duple pattern, against the triple meter of the dance? At any rate, if you have seen some authentic ancient dances, the minuet is not danced like a waltz, regardless of the meter signature they have in common. You must have heard of the pattern called hemiola, where, for instance, two bars of triple articulation run against or alternate with one big triple bar consisting of double durational value of the first bar. Examine, please, the second section (2) of Example 3.2 b) p.E12. Notice that the meter signature does not refer to the tact but to two tacts. This means that the new tact is worth now two previous tacts. You can regard the new construction as being still the triple measure with the former "ba" equaling the new "ta." Accordingly, you may code the new progression: "ta, ba, ba, bem-bem-bem-be, tam-ta." as recorded in the elongated rectangle. Also, the bar-line marked "(majfsbu)" at the beginning of the second measure, would have to be shifted to where the third bar started in the original version. Otherwise, you could consider the new meter as sextuple (simple) rather than triple. Another adjustment must be made in order to correspond, at least approximately, to the original tempo. Surprisingly, the original "Allegretto" becomes something closer to an "Adagio." Kindly notice also that the rhythm has not changed because the temporal relationship of durations remains the same. Actually, the tempo has not changed either, in spite of the signature which suggests the relaxed "Adagio." The actual meter, however, has changed significantly. It doubles the length of the original tacts by changing its reference from tact to double tact. A brief explanation may preface the new metrical situation. It could be presented in form of an equation: "ba" = "ta." The signal for the old "ba" would be equated with the new "ta." Try to conduct the original version giving one pulse to one tact, and giving due attention to the feeling of the syncopation. Immediately after this exercise, switch to one pulse to the new tact, and notice the difference in interpretation. Still better, stand up and try to alternate your footsteps, according to the second version.

Start with the left foot for the first tact, continue with the right foot on the second tact, and so on. Ask yourself: Is this the real, stately way the dancers moved their feet, with possible changes of direction of the steps and other rhythmic compensations? Amazingly, you deal with the same music, except for its metrical reference, and the overall effect seems so different.

NOT: I am trying to dance and conduct, at the same time. How much, actually depends on the manner of notation? I wonder what determines the choice of meters, tempi, pulsations, and metric reference?

PAN: In the interaction of all those elements lies the secret of the rhythmic omnivalence of music. No single element seems to determine the overall effect. Deep contemplation of those problems brings us closer to the realization of how important the knowledge of music notation is to both creative and re-creative artists. The third (3) section on the same page (Example 3.2 b) p.E12 illustrates still a different metric concept of the same music. Everything remains the same as in the second version, except that there are now two long tacts, and not three, in the measure. In relation to the original version, the metric code reads: "*bubabu*," which translates to: two tacts in a measure, each derived from a double original tact, and divisible normally by two. It sounds uncanny, as if the dance became, temporarily at least, something reminiscent of a gavotte rather than a minuet. Naturally, when you examine the entire minuet, the choice of the meter and tempo is quite natural. I have used its initial trimeter to depart from the original version for the purpose of focusing on possible implications. No doubt, those are only speculations, but they underscore the subtlety caused by different metric references and choice of pulsation.

NOT: You have not mentioned the relationship of tacts to pulses. I understand the implications of Mozart example as a good illustration how independent the tacts should be considered from pulses. I would always opt to conduct the original version with an energetic pulse for every tact. Particularly at the beginning, it seems necessary to indicate the anacrusis with a vigorous gesture inviting all players to start unanimously.

PAN: You remember well. I thought you would arrive at this conclusion, in light of our previous discussions on the need of distinction between tacts and pulses. I am sure, you will be delighted with the next example which again may be regarded as presenting different metric references. It is taken from the beginning of the last movement of Beethoven's first symphony (see Example 3.3 a.) p.E13 At the first glance, you see that the rhythmic picture is much more differentiated than that of Mozart. Besides that there is a drastic change of tempo toward the end of the excerpt. The first transcription (Example 3.3 b) p.E13 translates literally the original notation. We will start with the first set of signals and codes included in the rectangular frame, to the left of the elongated rectangle containing the title description. I will ask you to look at Appendix 13,

particularly at the illustrations (e), (f), and (g) of the first (1) section, and at the entire second (2) section. Those signals and codes determine precisely where the quoted musical excerpt starts. The so-called metric point (MET-PUN) indicates by its signals and the code "tab-beb" that the the quoted music starts on the second subdivision of the second tact. In case you wonder, the last movement starts, actually, with a massive pitch-class of "g" in the entire orchestra, and then the first section of violins follows with what you see in Example 3.3 a) p.E13. This is the reason why the measure number of what appears as an incomplete measure is "1" and not "0." The lower portion of the set framed by a rectangle is concerned with the identification of the measure and larger units of a composition such as movements. This selection point (SEL-PUN) shows by its signals and the code "mer-mat" that this music begins with the first measure of the fourth movement. The metric points take care of the intra-measure places, whereas the selection points indicate the inter-measure placement. Thus within a few strokes of the appropriate signals, and with a few letters of the alphameric codes, the precise temporal place is readily identified.

NOT: For the statistical reasons, or for pinpointing a metrical place, this method of identification seems to have an advantage over verbose descriptions. Did you not talk already about this , the other day?

PAN: Yes, I did at an occasion of showing you metric codes and measure codes for the medieval "Song of the Ass." Let us look, now, at the time signature. The meter is transcribed from the original as two tacts to a measure, divisible by two. The general tempo of "Adagio" is represented by a signal corresponding to the third level on the scale of twelve tempi, as illustration (d) in the first section (1) of Appendix 17 indicates. The code is, accordingly, the syllable of "lae." The metronome sign in the traditional edition lists 63 eighth-notes to a minute, which makes every eighth-note slightly shorter than a second in duration. By using the tempi conversion table in Appendix 19, the duration of every "half-note" in the transcription should be set at 0.95 of a second. Hence, the note representing half of a tact remains a second long, for all the practical purposes. This durational value may also serve as a convenient pulse. One pulse, spaced every second, is assigned to every half of the tact, or the new "half-note." You see those data in the signals of the tempo signature. The code says the same in the syllabic language: "duxnucu-bem-tu."

NOT: Would this not be much simpler to read this music in a simple quadruple meter? Let us say, everything in four eighths, instead in two quarters? After all, a slower pulse than every second is not very effective, as you have pointed out earlier.

PAN: It is not our purpose to second-guess Beethoven's intentions. Part of the answer may lie in the fact that this is only a brief introduction, and the remainder of the movement is locked in a perky "Allegro," quite compatible with a duple measure. Nonetheless, nothing should impede our choice of the most convenient pulse. The circumstances will often prove, time and again, the advantages stemming from separation

of pulses from tacts. Among the different versions of this music, I have included also such a transcription in quadruple meter, as the last section (Example 3.3 d) p.E15 exemplifying Beethoven's example. You may satisfy your curiosity by finding this version, but I would rather return to our first transcription. Nothing would make you more intimately acquainted with the nature of this music, than to set up a an opportunity for taking a dictation. I will play the excerpt a few times on the piano, and you will try to put down the rhythms on a piece of paper. First, attempt to reproduce the notes in the traditional way. Later, you may try your hand at a PANOT transcription.

NOT: Mercy! I did not expect any testing so soon.

PAN: I will assist you whenever necessary. We will start with conventional counting of the "beats": one, and, two, and -- for the whole prefatory measure. Although you have seen already the original version, please refrain from looking at this example, while writing. Do not hurry to scribble, after the first hearing. Try to memorize the melody, and this will help you to associate the rhythmic shapes with the profile of the melody. Remember that you are not taking a melodic dictation. Notes on a single line will be sufficient for the rhythmic picture. Be sure to intersect this line with bar-lines, wherever they occur. Are you ready?

NOT: May I help myself with: loud counting, or some other gestures?

PAN: No problem. Actually, you may want to march around the room, while humming the tune to yourself. Begin with the left foot on the first "beat" of the measure. The count assigned to "and" will then synchronize with the right foot. Next, the left foot will mark the second "beat," and the right foot will complete the measure with an "and." You have danced the minuet so gracefully, just a moment ago, so that marching should not present any difficulty. Now, here is the prefatory measure in counting. Change yourself into ears, watch your auxiliary steps, and try to see the rhythms with your third eye.

NOT: (after dictation) This is the best I could come up with.

PAN: Not bad, at all. Some minor inaccuracies in the second measure. In music which features long stretches of silence, it is difficult sometimes to assign an exact duration to the note which precedes the pause. Of course, you were completely lost when the tempo switches to fast movemer. There are eight measures in this excerpt, not incomplete seven, as you recorded. I will not ask you now to transcribe this music into PANOT, because you are not familiar with the handling of dotted rhythms. Use your dictation paper to sketch or copy the appearance of those rhythms in Example 3.3 b) p.E13. The very first signal for the anacrusis, or up-beat to the second measure may puzzle you. You can find the reference materials which will assist you in Appendix 9, and mostly in Appendix 10 and Appendix 14. The rhythmic figure in the first measure consists of a

dotted sixteenth-note beamed to a thirty-second note, in traditional terms. Its durational contents represent the last eighth-note in the bar. In PANOT terms, this durational content becomes worth half of the tact, hence it is a "half-note" placed at the end of the measure. The first traditional value of a dotted sixteenth-note is actually three thirty-second notes, as you know already. The same three thirty-second notes are expressed in PANOT terms as three eighth-notes. This happens so because thirty-second notes are a traditional eighth-note divided by four, whereas eighth-notes are a "half-note" divided by four in PANOT. The conversion is easy when you remember that a conventional eighth-note with one flag, or one beam, corresponds to a proposed "half-note" with a flag to the right of the stem. Similarly, a traditional sixteenth-note with a double flag corresponds to a "quarter-note" in PANOT with a double flag or beam to the right of the stem. A traditional thirty-second with a triple flag or beam compares with a proposed "eighth-note" with a triple flag or beam to the right of the stem. The traditional durational value becomes a new value by dividing it by the number four. Therefore, the durational content of this group of four thirty-second notes in the first measure becomes a group of four "eighth-notes" in PANOT. Appendix 9 explains how the compound signal elements are constructed. Illustrations (e) and (f) of Appendix 10 show the signals and codes for multiple durations. The vertical signals, or flags, if you will, are erected above the time hub (see section (a) of Appendix 3) as a sort of extension of the stem. Their value depends, of course, on what number the signal indicates. The code consonants "q" are to be substituted with the alphameric consonants which stand for numbers expressing quantitative durations. In our case, the value of the very first "eighth-note" of the group is supposed to be multiplied by the number three. Why? Because the signal of a line, or flag with a dot expresses number three. Consult, again, Appendix 9 for peace of mind. The code reflects this situation by labeling the first note a "*lumvem*." This means that a triple "eighth-note" is beamed to another note, which in our example is a single "eighth-note," labeled as "*ve*" in the code. This last note completes the value of four "eighth-notes" which occupy the last "half-note" of the first measure. Noticing your perplexed look, I advise you to consult both of those appendices (Appendix 9, and Appendix 10).

NOT: It looks like I will have to spend the whole night reviewing these complicated matters. Perhaps, I should study first the signals, and then the codes.

PAN: Not necessarily. Reviewing pictures and names together not only saves time but also helps correlating them in memory. Some signals and codes are rather secondary in importance. A good example of those is offered right here in the same rhythmic group. The wedge-like triangles suspended from the time hub are marks corresponding to the dots underneath the notes, in the first measure. Obviously, some sort of separation of those notes is suggested by those marks. On the piano keyboard, they would be played "*staccato*," which means quite detached. On the violin, the degree of detachment would be probably much less reminding rather of a "*portato*." Although the disassociative manner of playing seems to be a matter of style rather than of strict duration, nevertheless, it should be considered within the realm of temporal parameters. You can

find more of those disassociative, as well as associative signals with their codes in Appendix 21. For the time being, accept the codes of "sufa" as expressions of such truncated durations.

The notation of rhythms within the second measure will be easier to understand, after you have conquered the initial hurdle. The first tact consists of one "half-note" being articulated, and to be followed by another being silent. The difference is seen in the length of their stems. The first one normal in length, the second one truncated to the half of normal length. Both the note and the rest are beamed together. The code labeling, after the second measure identification "(majsbu)" spells: "bem-bex," which stands for a "half-note" beamed to a "half-note rest." The second tact starts with a pause worth three "eighth-notes" followed by an articulation of a single "eighth-note," followed again by an articulation worth of three "eighth-notes," to be completed with an articulation of a single "eighth-note." The entire group is connected with a triple beam characterizing the "eighth-note" value. This rhythm reads in code language: "lumvemx-ve-m-lumvem-ve." The third measure involves the use of fractional durations. It begins the same way as the first tact of the preceding measure with a "be" articulation beamed to a "be" rest. The rhythmic group, on the second tact of this measure, starts with a "re" ("quarter-note") rest but the next two values, although they are triple-beamed as "ve" values, have something unusual in their appearance, and also in their code labeling. We need to go back to Appendix 10 again, before this construction is clarified. The illustrations (c) and (d) of the second section (2) present a special way of expressing divisions of durations longer than the tact, or shorter than tact reciprocals. Let us concentrate on this special way, because it is germane to our example. The duration of "re" can be expressed by simply using the double flag or beam for its identity. The first rest of the second tact is marked this way, as we have seen already. Under special circumstances, the same duration may use a symbol of a "half-note" or a "be" represented by a single flag or beam to the right of the stem combined with another flag or beam to the left of the stem, and in a position one notch lower than the first flag or beam. Such a fractional duration reads "bemba" in the code language, and means that a "be," on the right side of the stem, has been divided by a "ba," on the right side of the stem, one notch lower. If you divide one-half ("be") by two ("ba") the result is one-fourth ("re.") Obviously, this is the same as you would put the double flag or beam to the right of the stem. The illustration (d) of section (2) in Appendix 10 depicts the simplest imaginable fractional duration: "bemba," half-tact divided by two, resulting in a quarter-tact. Keep in mind that this is simply an available option. The same value of a quarter-tact could be notated by using double flags or beams to the right of the stem.

The fractional durations may be used in situations like the present one, in the second half of the third measure. This time the group of double-beamed notes (all of them, apparently, of "re," or "quarter-note" value) is modified for the first two notes appearing right after the "quarter-note" rest. The modification shows those two notes appear to be two "ba" notes beamed together. Those notes, however, are not really "ba"

notes, or notes representing double-tact values. By the virtue of their position, being placed one notch lower than the existing beams, they are merely the divisors of the tact reciprocal, which happens to be here a "re" value. Now, if you divide the "re" value by the "ba" value -- the result is the "ve" value. Mathematically speaking: the dividend of one-fourth divided by the divisor of two equals one-eighth. Therefore, the value of each of those two notes is a "ve," or an "eighth-note." The proper coding of those notes demands the following labeling: "rembam.," not just a "ve." You will recall that verbal codes serve the purpose of enabling us to reconstruct precisely the appearance of signals. The first code "rembam" indicates a note which carries two beams to the right of the stem, and one beam to the left, beneath the right beams. The second code "ve," or rather "vem," in this case, would indicate a note with all the three beams to the right of the stem. Glance at the same rhythmic figure in Example 3.3 c), on the next page (p.E14). Here, those two notes are written and labeled correctly as being two "vem" notes. In contradistinction, Example 3.3 b) p.E13 shows you the same notes written and labeled also correctly as being two "rembam" notes.

NOT: So, if I understand them correctly, fractional durations are just alternatives to a normal method of placing flags or beams to one side of the stem. Do you see any advantages in being partial to their employment, instead of using the normal way? In other words, what will make you prefer one over another?

PAN: No particularly strong reasons for one or the other way. However, I would like you to see some situations in which the use of both sides of the stem is unavoidable. Please turn to Appendix 11, which presents a few samples of fractional rhythms. Look at the first position in the second row of the table. The signal shows one flag to the left, worth a two-tacts value ("ba.") The flag to the right stands for one-third of the tacts value ("le.") The resultant value of this note would be two-thirds of a tact ("bamle.") You must have noticed that we multiply the left value by the right value in fractional integers. You know already that in fractional reciprocals the opposite happens: right values are divided by left (lower) values. The two shaded rows in the table demonstrate this principle of computation. Two simple operations have to be remembered: you multiply going from left to right; you divide moving from right to left. In the third column of the second row, you see two beamed notes, each worth two-thirds of a tact ("bu[bamle].") Together, the group occupies four-thirds of a tact, what means it exceeds the limits of a single tact by one third ("ramle.") The fourth column presents the predictable, and ultimate, result of grouping three beamed notes, each worth the same two-thirds of a tact ("lu[bamle].) The group fills in completely the two-tacts space ("ba,") the durational value with which we started trying to divide it in three portions.

NOT: Let me sum it up, briefly, at this point. The upper portion of the table shows the use of flags and beams on both sides as an inevitability. The lower portion shows again the use of both sides but, this time, it is an option, not an inevitability. Did I get it right?

PAN: Brilliant observations, Mr. NOT! There is one tiny notational sign which is new in the third measure, and which I would like you to notice, before we progress to the next measure. It is a mini-slur over those two "eighth-notes." The slurs do not change their meaning nor shape in PANOT. You can find a variety of signals and code syllables for their diversified occurrences in the second section (2) of Appendix 22. The code used here for this very short slur is: *'tusjefs,*" because it is an upper slur beginning and ending shortly. The next measure features the same kind of a slur, occurring almost at the same metric place. It is marked there also with the same signal and code. The other two slurs in our excerpt are somewhat longer. The slur in measure 5 is considerably longer, and therefore it is coded separately for its beginning (*"tusjef"*) and ending (*"tusjes."*) The same happens to the second one occurring in the last measure.

Since you have asked the question about the reasons for choice, if available, let me continue with the rhythmic group which you see in the second part of the fourth measure, in Example 3.3 b) p.E13. The fractional duration is applied here for a special purpose to show that the two "half-notes," or half-tacts are divided into three portions. This corresponds, of course, to the triplets in the original version. Every note of the triplet passage may be expressed as a division of "be" by a "la," hence a "bemla." Therefore, you see six beamed stems, each worth a "bemla," because the beamed flags to the right represent the "be" values, and the beamed flags to the left, with a dot, represent the "la" values. The non-fractional value of each of the stems is a sixth of a tact, or "ge," in code language. You can see the signals for this version in the corresponding place (second half of the fourth bar) in Example 3.3 c) p.E14. The flags, expressing the value of one-sixth of a tact ("ge") are beamed together within the second tact of the measure. You may have noticed that such representation does not reflect exactly what is happening in the original score. The six sixths may suggest a grouping of three times two, as well as a pattern of two times three. It is the latter pattern which is desired here by the composer: every half of the tact to be subdivided into three portions. The other solution is neutral in its implications, but it could, as well, be recorded as three thirds of a tact divided by two. The curious ambivalence of a group of six articulations was appreciated by the early theorists. The rich literature on the implications of the so-called "senario" attests to that fact. If you return, for a moment to Appendix 11, and particularly to those asterisked positions in the first column of the lower portion, you will see how little those two rows differ from each other.

NOT: Why do you include slurs in the discussion of rhythmic matters? Do they really affect the duration of notes, the metric order, or tempo, for that matter?

PAN: The slurs have been the integral part of so much music that they cannot be ignored. Where would you place them for consideration? Together with the matters of pitch and intervals? Perhaps as a part of deliberations on dynamics or timbre? One thing is sure: they are carefully observed by all artists, and they are the subject of

serious concern for those who study performance practice. The articulations placed under a slur become subject of special integration. The manifestations of this integration will vary, of course, depending on the medium of performance, and on general stylistic considerations. Sometimes, slurs will mean a "legato" way of playing the piano on other occasions they will indicate the bowing, or notes played on one breath, as well as sung to one syllable of text. The art of phrasing depends so much on slurs, that occasionally musicians supply them even if they are not printed.

NOT: I did not mean to underestimate the importance of slurs in music. On the second thought, I realize that they have more in common with the temporal matters than with other parameters, with possible exception of dynamics. I even see that those fashionable dotted slurs may be employed in PANOT without resorting to special modifications in signals or codes. Looking now at the slur used by Beethoven in the fifth measure, I see how the smoothness of the scale is achieved by playing it under one bow. Incidentally, are those "eighth-notes" under the slur examples of fractional reciprocals?

PAN: Yes, they are. This is why most of them are recorded as "*rembam*," notes and not as "*vem*" notes as in Example 3.3 c) p.E14. By the way, do you have any idea what is the meaning of this tiny diagonal sign attached to the first note of measure 6?

NOT: I must confess, I do not remember ever seeing this sign.

PAN: Really? Let us turn to Example 2.4 b) p.E4, way back to our second day. There are four of them, in either version, all coded with "*faex*." Their purpose was to make the notes slightly longer, as if making the tempo suddenly slower, or even momentarily arrested. Appendix 3 listed this sign, among others, as applications for non-quantitative temporal values. Appendix 16 lists this sign, again, as the first symbol in its first (1) section featuring signals and codes abruptly modifying the tempo. What a perfect opportunity to use this sign, again, to transcribe Beethoven's fermata sign. Do you see this?

NOT: I am ashamed to admit my ignorance. How can one remember things which were subject of our discussions full two days ago?

PAN: Yes, in learning new things, this is a long time, indeed. Forget it! I know this is not the last time it will happen. Keep reviewing diligently all the terms and symbols, and you will minimize unavoidable slips of memory. Now, let us contemplate the big tempo change toward the end of the sixth measure. Can you tell me what you see in the transcription?

NOT: Yes, I can see that the meter does not change at all; it remains the simplest imaginable, that is simple duple. The tempo changes generally from "*lae*," which stood for Adagio, to "*lae*," which stands for Allegro. Specifically, it is suggested that a

pulse worth approximately two thirds of a second should govern every measure. Let me read the code, and decipher it slowly: apparently, "*duxguvu-mam*" stands for the tempo of 0.68 of a second to a measure, and "*mam-tu*" refers to one pulse per measure.

PAN: Your translation is excellent. You have all the elements necessary to conduct the music in your hand. Practice conducting this excerpt by reading the rhythms from the transcription, and by humming the melody from memory. Consider any effective gestures you may use to coax your imaginary violinists to make the tempo shift as elegant as possible. You should get interested also in the quadruple-meter version, as presented in Example 3.3 d) p.E15. Notice, at this occasion, how much leaner is the texture of the signals. In this version, which corresponds to the original locked in a four eighth meter, you would expect that you reduce by half the amount of metric divisions. The initial rhythmic figure, for instance, is represented by a double beam only, instead of a triple beam, as in the duple-meter version. The triplets in measure 4 are real "triplets" because they divide each tact into three parts, each worth a "*le*" durational value. You may take the suggestion to give two pulses to the fast measures, instead of just one. You will be "beating" every half of the measure, at the rate of speed approximating one third of a second rather than every measure at the speed of two thirds of a second. Decide for yourself which pattern of pulsation is more appropriate for the fast tempo. Could it be that the latter pattern would help musicians to start the new tempo, whereas the first pattern should be used for the remainder of the movement? Would you do so just to save your arm, or for other reasons?

NOT: I am not experienced enough to make those choices but I am very excited at the prospect of conducting this music. I will also try to play it on the piano with my right hand, while "beating" the pulse with the left hand. May I listen to some recordings of this symphony?

PAN: Of course, all those modes of responding to the rhythm of music are equally acceptable. Listening to recordings will open your ears to the extent of variances some conductors take with this brief introduction and the remainder of the last movement. Sometimes, those nuances are barely noticeable; sometimes, they are quite pronounced.

NOT: I have one last question before we quit Beethoven's example. This funny sign above the rectangle enclosing measure number 8; it looks like a cap with a feather... I will swear I have not seen it before.

PAN: You are right that you have not seen it before, but from its position you may deduce its purpose.

NOT: Does it have something to do with the double bar and repeat sign in the original?

PAN: You have guessed it right. Open the book to find Appendix 23, and you will find it there as the first example (a) of the first (1) section. The entire appendix deals with mandatory and optional signals regulating the repeatable limits of a composition. Although we will not find much use for those signals in our examples, get acquainted with them and with their codes, at some later date.

NOT: I suppose you are anxious to proceed with our material for today, so I will turn again into ears, and anticipate other examples with curiosity. How much more can I learn, after this veritable avalanche of codes and signals?

PAN: Do not ever doubt your capacity for learning. I promised that, after covering the basic materials, you will feel much more comfortable. Before we make a chronological leap of a whole century to the music of Stravinski, let me call your attention to an example of music by Chopin. You will find it in Example 3.31 a) p.E16. First notice how the composer uses ametrical "tuplets" in measures 2, 3, 11, 14 and 73. Then look at the same measures in transnotation as found in Example 3.31 b) on the same page. The formal transcription calls for an expanded number of beams, particularly with tact divisions reaching the number of eleven or twenty. Underneath these measures you see (in big parentheses) an optional way of notating those unusually small tact divisions. If you are perplexed, find, please, a special provision for this option in Appendix 10 under position (j) of the second (2) section. You can avoid dense beam structure by simply placing the number of tact divisions above the "be" flag. Appendix 51 provides a good opportunity for you to see how simple numbers compare with PANOT icons. This number system is part of PANUM (universal numbering system) which I have developed before completing the proposed music notation. Going back to Appendix 7 will also be helpful at this point to review numbers and codes used for parametrical values. Now excuse me for leaping again by many years in my choice of examples. Historically this is inexcusable but, at least, the chronology is preserved, so far. Stravinski's excerpt in Example 3.4 a) p.E17 offers a good example of the so-called multimeters. It will be good for you to see how the frequent changes of meter are handled in transcription. First, read the identifier of the excerpt enclosed in a frame to the left of the title for Example 3.4 b) p.E17.

NOT: "*tab-beb*" is a metric point indicating the beginning of music at the second half-tact of the second tact. "*meb-map*" is the selection point indicating the seventh measure from the second movement.

PAN: Actually from the second part rather than the second movement. The trombone part which you see here is extracted from the "Soldier's March" which you can find in the second part of the suite entitled: "*L'histoire du soldat.*" Now, read the code for the initial meter signature, will you?

NOT: It is "*butabu*" again. The simplest meter possible, as in the Beethoven's example.

PAN: Not only this, but also the music starts at the same metric place. The codes for the tempo and pulse are skipped here, but you can see from the signals that 0.54 of a second is assigned to every tact, and that one pulse per tact is considered optimal in this situation. This is the same what the Stravinski's score suggests in the metronome sign. Practically, the rate of speed is half-a-second per tact. After the interpolation of measure 10 in triple meter, you return to the initial meter in measure 11. The meter changes briefly but this does not affect the tempo, because you still keep assigning the same value of half-a-second to every tact. With measure 12 the triple meter takes over again. This time, previous half-tacts play the role of tacts for two measures. You see this change in the time signature. Since the previously established pulse would be incompatible with those measures, one should look for a pragmatic solution. The code pattern which you see running under the rhythms, suggests a still different way of counting from what you have seen before. The code syllables: "*tu*," "*bu*," and "*lu*" guide the first, second, and third tacts, respectively. The syllables: "*te*" help in articulating the half-tacts. All you have to do in the twelfth and thirteenth measures is to add one more "*te*" , at the same rate of speed. The "*tu*" will occur only at the beginning of the measure, and two "*te*" will follow, instead of one only. The meter signature reflects this change by making the meter temporarily triple with reference to the half of the previous tact. The tempo signature shows 0.81 of a second for the entire measure. This is the result of a brief calculation which adds one-half of 0.54" (approximately 0.27") to 0.54" which results in 0.81." The pulse reference is also to the entire measure. The number 0.81 should be regarded as auxiliary only. The general tempo does not change, because half-tacts run at the same rate of speed. The main pulse, however, is arrested briefly for those two exceptional measures, and also for the penultimate measure of our example. The overall temporal picture abounds in syncopations: in its lively rhythm. Fundamentally, however, the flow of its integrative tempo glides effortlessly over the frequent metric changes.

NOT: I will try my hand at conducting this excerpt. It appears to me more complicated than what you make of it. What did you call this process of constantly changing meters?

PAN: Multimeters, or many meters following each other. This term should be distinguished from polymeters, which occur when different meters are combined simultaneously.

NOT: I am sure you have included an example of polymeters for my edification. Is my assumption correct?

PAN: Of course, I could not have missed such an opportunity. As a matter of fact, the next example will illustrate an ingenious application of the principle of

polymeters. It is taken from the writings of Charles Ives, and it packs in two brief measures as many as five different metric aspects sounding at the same time. Open, please, the book to Examples 3.5 a) and b) (pages E18 and E19, respectively). From the entire score, only those parts have been extracted which represent the singular metric aspect. The trumpet part (at the top) quotes the familiar tune known as "British Grenadiers," and you should familiarize yourself with its rhythmic features, to be able to keep it in mind as a constant reference to other metric patterns. For simplicity's sake, the tempo signatures and pulse signs are ignored. The bar signs, however, are shown to facilitate the metric correlation. I do not see any new signals or codes which could cause any difficulty. Is there anything which troubles you in the transcription of the trumpet part in Example 3.5 b) p.E19?

NOT: I am reading it right now. All those "*sufa*" codes, I suppose, are pertaining to the "*staccato*" marks in the original version. Otherwise, the signals and codes are straight forward. I understand also the quadruple meter, as indicated in the meter signature.

PAN: Fine. Let us proceed now with an examination of the clarinet part. What kind of changes do you perceive here?

NOT: The changes are minimal. You would expect them in comparing any simple meters with their compound counterparts. In simple meters tacts have a duple subdivision, whereas in compound meters tacts have a triple subdivision. In code terms, the first type operates mainly with "*be*" syllables, the latter one with "*le*" syllables. This is what I see here. Tacts and bar signs coincide in both versions.

PAN: Is the metric situation different in the transcription of the bass drum part?

NOT: Quite different here, because the measures do not coincide. They cannot do so, where a a triple measure is pitted against a quadruple measure, while the duration of tacts remains the same.

PAN: How about the snare drum part? Do you understand its metric derivation, and all those complex signals with rather lengthy codes?

NOT: Frankly, I do not. The conjectural meter signature is also puzzling to me. Even the original version of this part is strange. You explain in the brackets that the actual meter of two quarter-notes is derived from three eighth-notes of the trumpet part. Is this why Ives writes quadruplets instead of using just plain eighth-notes?

PAN: If you look at the meter signature in the transcription, you will notice that this simple duple meter does not refer to the tact but to three "quarter-notes" of the

tact in our main reference in the trumpet part. The code confirms this relationship by placing parenthetically: "*lumre*" for the normally expected: "*ta*." In the space of a new tact you have to place two articulations of the original quadruplets, knowing that the entire new measure consists of four articulations in a duple measure. Therefore, the value of each of those new articulations must correspond to three "eighth-notes." Four such values in a measure add up to twelve "eighth-notes," which can be reduced to three "half-notes," which, in turn, is the transcribed duration of the trumpet part, from which the new measure in the snare drum was generated. The three "eighth-notes" of every articulation are written here as fractional reciprocals, dividing the double beam (signifying one "fourth-note," or "*re*" of the metric reference in the signature) by another beam to the left of the stem (signifying the "half-note, or "*ba*,"") This identifies every note as a "*lumremba*" or, in non-fractional terms, a "*lumve*" for every articulation. The codes record the fractional duration, and add the signs of separation for every but the first articulation in the measure. You do not see any "*staccato*" dots or separation marks in the original quadruplets, because I have simplified somewhat the original notation. In the original, the articulations of every quadruplet but the first are separated by sixteenth-note rests, and the quadruplet notes themselves are recorded as sixteenth-notes in duration. This notation, although characteristically idiomatic for the percussion instrument, is slightly different from my quotation but it does not have any effect on the metric structure of the passage.

NOT: Your mathematics have overwhelmed me. I do not want to sound like those of your students who make apologies to you for their difficulty in understanding mathematics. I will try to review all those computations in this example, tonight.

PAN: It is not mathematics but simple arithmetic. Without its knowledge, you may experience difficulties in understanding complex rhythms. I understand however your complaint. Whenever you are frustrated, consider for a moment how lucky we are that we do not live in those very ancient times when music was not much more than numbers. When you go back to Example 3.5 b) p.E19, you will see still another meter derived from the trumpet's reference meter. It is the music played by the violins and many wind instruments with the piano. The meter signature indicates a triple meter whose tacts are equivalent to half-tacts of the trumpet part. The duration of the artificially created new measures will agree with those of the snare drum. Every other imaginary bar sign will also coincide with the big triple measure for the bass drum. If you look again at the entire page of Example 3.5 b) p.E19, you can separate the two top parts from the three lower parts, because only in the lower parts new conjectural meters have been introduced. In Ives original composition, the bar lines starting with bar 135 go across the entire score, and the measure duration does not change. In the transcription, the imaginary bar signs for the three lower parts do not coincide with the two top parts. The transcription as the so-called actual meters must be understood as a pure conjecture. The original is locked in a single quadruple meter from the top to the bottom of the score. Yet, due to the rhythmic sequences, different meters are implied, and even heard as grating against each other.

NOT: How can two ears take so many different meter implications? I must hear this excerpt in the orchestral recording. I do not believe anybody could do justice to it on the piano. Faintly, I begin to see the point of a transcription which permits one to clarify the actuality of different meters and rhythms coexisting within the same time span.

PAN: The actual experience of listening to this music is a little simpler than you anticipate with such anxiety. It is the metric clash between the first and last parts which is most audible in our example. The jaggy trumpet part is accompanied by bassoon, violoncello, and contrabass, all bearing a similar metric aspect. The part for violins sweeps waltz-like against the square trumpet tones, and is strongly supported by the the similar rhythms in parts for flute, oboe, horn, trombone, tuba, and piano.

NOT: Ives seems to subject those implied meters to one overriding meter. Does such music exist in which the real different meters are used by composers at the same time?

PAN: One can find some in the Baroque era but, perhaps, the most celebrated example is that of Mozart in "*Don Giovanni*." Try your hand at transcribing that moment in the score where one pair of characters (Donna Anna with Don Ottavio) dances the stately minuet, the other pair (Zerlina with Don Giovanni) is hopping to the lively rhythms of a contradance, and the third pair (Massetto with Leporello) whirls to the music of a German dance ("*la teitscha*."). The minuet is written naturally in three quarters. The contradance uses the duple meter signature of two quarters. The German dance uses again a triple meter signature but different from the minuet. Every "beat" of this meter is only one-half "beat" of the minuet so, it is using three eighths as its meter signature. You can see already that the bar lines of the German dance will coincide with every other bar of the minuet. The bar lines of the contradance, though, conflict with the bar lines of the other two dances. It is rather hard to notice this conflict by listening to recordings, but the score shows clearly Mozart's intentions. In the theater, you have a better chance to perceive this "*imbroglio*." Separate bands, visual observations, stage directions, they all may enhance the understanding, and reinforce the impact of the composer's fantastic imagination.

Do you see what time it is? It is so easy to get off on a tangent while discussing music. We must hurry to examine two more examples, today. They will illustrate similar processes which we have examined with regard to the meter. They apply to the tempo, on this occasion. The first example will present a concept analogous to multimeter which, for the lack of a better term, we may call multitempo. The second example will demonstrate polytempo, a neologism to be sure, but quite reminiscent of the polymeters. Both examples are borrowed from the works of the American contemporary composer Elliott Carter. One can hardly think of a better and more succinct demonstration of those two concepts, than in the works of this pioneering composer. On one page each (E20 and E21), you will be able to see the original and transcription. Code identifications are missing in

the interest of greater clarity. Now, let us get acquainted with the Example 3.6 b) p.E21 and its meter signature. Duple compound meter with one pulse suggested for each of its two facts, and with the frequency of two thirds of a second (0.67") for each fact and pulse. Do you notice those tiny little hooks attached to the middle of note-stems? The ones turned down, as at the start of the second or third measures, or the ones turned up, as inside the fourth measure, are signals for weaker or stronger accents, respectively. Although accents belong formally to the parameter of dynamics, we cannot simply ignore them here, because they play a very important role in transitions from one tempo to another. Moreover, accents are inseparable parts of temporal aspects of music, frequently identifying the metrical construction, or separating identical rhythms from each other.

Since the place of dynamics is in the middle of the stem, this is why you find accents here. The subtleties of other marks in the original, like "*staccato*" dots, encircled letters for special performance effects, etc., have not been considered in transcription for the fear they would detract from our main purpose of dealing with temporal aspects. Everything is regular in metrical sense until the second fact of the third measure, where an irregular group of four "*re*," or actually "*bemba*," notes appears. This group is incompatible with the meter in use, because it substitutes the quadruple division for the triple division of the fact, as indicated by the meter signature. Notice that Carter opts for making each of those notes a dotted sixteenth-note rather than bracketing them with a number 4 above. If you remember our exercise with scanning the syllables of "peanuts" and "potatoes," try to scan repeatedly and evenly: "one pea - nut," and then: "one po - ta - to," in the same time it took you to scan the "peanut," that is, making sure that your "one" syllable is uttered at the same rate of speed. Doing this, you learn the speed of articulation for quadruplet notes, forgetting their spelling as dotted sixteenth-notes. There is a strong syncopated disturbance of the regular meter in the fifth measure but, otherwise, the duple subdivision does not return until measure 7 with four dotted eighth-notes filling the entire measure in the original. The transcription simply uses four "*be*" notes for this measure. What follows in measure 8 contributes further to the loss of that triple subdivision so characteristic of compound meters. Now, watch carefully for what happens in measure 9, and for one measure beyond. Despite the fact that quadruple divisions dominate, the sense of "tripleness" returns. Do you see why?

NOT: Is this due to those strong accent marks given every third of the dotted sixteenth-notes, or attached to every third "*re*" value in transcription?

PAN: Apparently so. The purpose of this "metric modulation" as many call it, is obvious here. The "one - po - ta - to," formal quadruplet at the end of measure 8, gives in to a series of four "one - pea - nut" scannings (keep the same tempo for every articulation, while scanning). This helps to accentuate the triple division of the fact. Measure 10 is necessary for a smooth transition to measure 11. It acts here similarly to a pivot in harmonic modulation. It looks back to the old "peanuts" formed from truncated "potatoes" (formally spelled in the original meter) and anticipates the new "peanuts"

divisions of the compound duple meter but at a faster tempo, precisely one-fourth faster than the beginning.

NOT: Incredible! What a metamorphosis! In the original music, above this measure, there is a small-size, dotted sixteenth-note equaling an eighth-note. A meter signature for one-tact measure only must be sort of an anomaly. In transcription, you have used a signal for three-times reiterated "third-note" or "le," framed in a vertically elongated rectangle. To the right, you have suggested a stricter and more formal version, resembling more of a normal meter signature. Do I read those signs correctly?

PAN: Correct observations, Mr. NOT. If you look past that measure, in transcription, you will also see a literal translation of those small-size notes which you have found above the original bar. The "*bemba*" or "*re*" note value, at the top of the stem, shows the identity with a "*le*" note, at the bottom of the same stem. The whole conversion is enclosed in an elongated oval shape. Maybe, this designation should be enough to indicate the pivotal conversion.

NOT: Actually, there is no change in meter signature in measure 10. The three eighths in the original signature merely seem to indicate one half of the preceding measures. When I look at your transcription, I wonder whether or not this single dot, in place of the flag for the amount of tacts, means just that? A measure consisting of a single tact?

PAN: Surely, this is the meaning of the dot which, as you know, represents the number one, regardless of whether it stands alone or is used in combination with flags. Next, compare the meter signature prefacing measure 11 with that at the beginning of the rhythm in measure 1. Both are the same, except that the metronome changes to 120 tacts per minute, in the original version, and to half-a-second only per tact, in the transcription. Obviously, everything will be moving at a faster rate of speed than before. You know even precisely how much faster the tempo will be. Since four articulations of the new "peanuts" have to be squeezed in the time-space of three articulations of the old "peanuts," it stands to reason that the new tempo will be four thirds faster than the old one.

NOT: You have lost me completely. Why not one fourth faster?

PAN: Let us calculate this again, in the conventional terms of metronome signs for the original version. Ask yourself the question: how much larger is number 120 (at measure 11) than number 90 (at measure 1)? The answer is 30 (for every large "beat" of the compound duple meter.) There are only three "thirties" in number 90. There are, however, four such "thirties" in number 120. Obviously then, number 120 contains three "thirties" plus one. The end result is four "thirties." Since the "thirties" are third parts of number 90, the new tempo is faster by four thirds, in comparison with the old tempo. Graphically, I tried to show the relationship by drawing indented vertical lines

corresponding to every bar sign, for the initial ten measures of the transcription. I have also turned the stems upside-down by attaching the temporal signals at their bottom, to provide better contrast between the original tempo and changes which follow. After many more "metric modulations," the original tempo returns with measure 25 to the original graphical appearance. By following the vertical auxiliary bar-lines you can readily see that starting with measure 12 bar signs do not correspond to bar signs for measures 2 and 3, until measure 15 where, again, there is an agreement with bar sign for measure 5. I hope it is not too difficult for you to see that it takes full four bars in the new tempo to fill the space of full three bars in the old tempo. The bar signs for measure 16 and 17 do not agree, again with the initial bar signs. This happens not because the tempo has changed but because the meter has been truncated by one third of the tact. Instead of three bars of a duple compound meter (containing six thirds of a tact) we see three bars containing only five thirds of a tact. You know that at this fast pace you either have to be conscious of three thirds plus two thirds subdivision of the measure, or accept the new tempo for the entire measure. Such options are depicted in those rectangles above the rhythms. The first solution is probably more practical. It shows in the asymmetrical grouping of stems, corresponding to the same type of grouping in the original. The other approach necessitates temporary conversion of what have been the thirds of a tact to the fifths of a measure. Incidentally, 0.83 in the tempo signature is computed by adding 0.5" to 0.33", for those who would like to know the precise duration of the five-fifths measure.

NOT: At the end of this passage, I see again the durational pivot in the elongated oval. It must be there to direct our attention to the fact that a third of the tact will be converted to a half of a tact, in the new triple measures 18 - 20. In the conventional notation, measures 18 and 19 stand under the meter signature of three quarters. The actual meter for measure 19 appears to be rather nine eighths than three quarters, due to the triplet subdivisions of the "beat," a triple compound rather than triple simple meter. Measure 20 features only three eighth-notes which are supposed to be equal in duration to the former "beat" of a quarter-note. At least, this is what I read from the small-size notes above the key signature of three eighths.

PAN: This is true but you missed one set of small-size notes, right above the new meter signature of three quarters, in measure 18. This explains why there is a new tempo signature necessary besides new meter designation. A quarter-note equals 180 in the metronome sign. The reason for this change lies in the conversion of the former metronome sign with 120 to a dotted quarter-note to a new metronome sign indicating that two eighth-notes, and not a dotted quarter-note, will be the new metric reference. The number 180 divided by 120 leaves you with a three-halves proportion. This proportion is right, because it will take now three new eighth-notes (halves of the quarter-note "beat") to match the same amount of time as it took three old eighth-notes. In PANOT transcription, just compare the beginning of measure 15 with measure 18. In the former measure, the first tact is subdivided into three third-notes, but in the latter the tacts are subdivided into two only. The tact subdivisions are spaced similarly in both measures. If

you do not believe it, take out a ruler and check on the distance between stems, in both cases. It should be clear that it takes three half-notes, in the new tempo, to correspond to the time-space of three third-notes, in the previous tempo. Therefore, also, the new tempo signature lists: 0.35" for the new tact.

NOT: What I do not understand is why there is a tempo change between measures starting with bar 11, and those after bar 18. The articulation of either those third-notes or of the succeeding half-notes occurs at the same time intervals. So, it seems to me the rate of speed is the same, in both cases.

PAN: You are right that a tempo change should manifest itself in a change of rate of speed. What matters here is to what metric value this tempo is referenced. In the first case, its reference is the double-tacted measure, whereas in the second case, its reference is the triple-tacted measure. Surely, the ear does not notice any change in tempo, but the reference has changed in measure 18. You will recall that in a harmonic modulation, a similar thing happens. The ear cannot notice a modulation took place, when the pivot chord sounds. It is only after the pivot that we realize we are in the new tonal reference system. By analogy, the pivotal rhythms at the end of measure 16, and at the beginning of measure 17, prepare us for the new metric reference. Those two groups, each consisting of two accented third notes, sound the same as three groups of similarly accented half-notes, in measure 18. Soon, we realize the meter has changed, as a pertinent reference. Perhaps, from this point of view, the name: "metric modulation" is better justified than "tempo modulation."

NOT: I can see already that the same happens soon after bar 20. This bar is again acting here as a single tact entity. Since a similar thing happened before in bar 10, could this bar be interpreted as a metric pivot?

PAN: Of course it may be regarded as a pivot. Its appearance is prepared by the triplets of measure 19. Are you looking at the original score?

NOT: Yes, I am. Let me try to interpret this modulation. Correct me if I am wrong. From the metronomic number 270 over measure 21, and comparing it with the still prevailing number 180, I deduce that the same proportion of three to two will result, because 270 over 180 can be reduced to three halves.

PAN: Good beginning. In reality, is this what is happening?

NOT: Well, three pairs of eighth-notes in bar 21 are taken from the first two eighth-notes of the preceding bar. Therefore, it would take three of the new eighth-notes to occupy the duration of measure 20. They will be no different in articulation time from those in previous bars, but their reference will be to the new triple meter, shorter by one third. I can surmise that the metronome signs corroborate this conclusion.

PAN: Good observations and a good conclusion. Please, look at the same passage in transcription. The elongated oval, at the end of measure 20, confirms the metric conversion from third-notes to half-notes. The triple meter, in measures 21 - 24, is subject to the fastest tempo we have heard so far. The tempo signature registers 0.22", which is even less than a quarter of a second per tact. There is a constructed slow-down from the uniform rhythm of half-notes in measure 21 to the full tacts, in measure 22 and, finally, to full measures, in measures 23 and 24. Then, by converting the last triple-tacted measure down to one tact of a duple compound measure, as marked in the last elongated oval, following measure 24, we find ourselves (oh, small wonder!) back in the rhythms and tempo of the beginning of the piece. You do not need to be an enthusiast of kettledrum music to appreciate the charming concept of modulating through three distinct tempi only to return to the home base.

NOT: We have spent so much time on this example. Is there something else besides its novel temporal construction, which you had in mind?

PAN: I am glad you have asked this question. One objective, which you may have suspected already, is to demonstrate that even complex temporal constructions can be transcribed into PANOT. Another one, is to ask ourselves the question what is honestly gained by doing so. The small advantages do not appear on the surface. The objectivity of comparing the graphic picture of the transcription with the original notation may be adversely affected by the sheer novelty and strangeness of new symbols. The terminology may sound forced and artificial. However, I would urge you to compare the traditional description of the initial rhythmic figure with the code language used in transcription. First the conventional method: "a dotted eighth-note rest followed by a sixteenth-note and an eighth-note, all beamed together as a group worth the big "beat" in the duple compound measure with a meter signature of six eighth-notes, and a tempo suggesting 90 "beats" to a minute." Then, the PANOT code: "*duxgupu-tam-tu; butalu. lumlembamx, lembam, le.*" I want you to forget, for a moment, the obvious brevity of the code, in comparison with the traditional description. Think rather of what "a dotted eighth-note rest" really means, in the context of a duple compound meter. Why does the big "beat" have to be a dotted quarter-note? Why do the "beatlets" have to be "eighth-notes"? Rebellious questions? Is it so, perhaps, because not all things taught in schools are right?

NOT: Master PAN! Please, do not contribute to the delinquency of a minor. The collective conventional wisdom has adopted and continued the traditional symbols with the theory and terminology of the traditional notation. I feel the least competent person to question this order. I will abide by your system, however, and try to explore the new aspects of temporal notes and their codes.

PAN: Thank you, thank you very much. I will bank on the capital of good will you have just declared. If time permits, you may consider a double-headed home

assignment for tomorrow. Write, in long-hand, the codes for all those twenty-eight bars. You are already equipped with most of the necessary syllables, with the exception of a few details. If you want to verbalize the accent marks occurring here, utilize "fy" for the weak ones, and "sy" for the strong ones. After you have completed coding, close the book, and try to reconstruct the signals of the transcription. Only after finishing this exercise, open the book again, and compare carefully your version with Exercise 3.6 b) p.E21. You do not need to split the music into different levels of tempi, as you see in my transcription. You may leave out even some optional time signatures, but make sure to identify measure numbers for quick reference. I will appreciate your cooperation, because this is the only way I can learn of the inadequacies of the system.

NOT: I knew the written home assignments were coming sooner or later. Be assured that I will do my best.

PAN: Do you recall, when I promised you to present a brief example of "polytempi" as I called them? As with "multitempi," which you have just examined, it is rather difficult to find succinct and brief examples of "polytempi." Two measures from Carter's Third String Quartet must suffice for our purposes. As you see from Example 3.7 a) p.E22, "Duo I" is supposed to play simultaneously with "Duo II," featuring different meter and tempo. The six major "beats" of the upper duet ("Duo II") are subdivided into three "beatlets" simultaneously with a subdivision into five "beatlets." The four major "beats" of the lower duet ("Duo I") are subdivided mostly into three "beatlets," making it sort of a quadruple compound meter. The signature reflects this condition with the fraction: twelve eighths-notes. The upper meter signature registers six quarter-notes, without implying the duple compound meter, although the middle points of two measures meet vertically. That makes the fourth "beat" of the upper duet coincide with the third "beat" of the lower duet. Besides this, the first "beats" of both measures coincide also at the same time point. Reduced to fundamental conflicts, two durational units of one duet are pitted against three units of the other duet. The tempi differ not only in metronomic figures but also in character, the upper one "*maestoso*," and the lower one "*furioso*." The upper one suggests 105 quarter-notes (major "beats") to a minute. The lower one lists 70 dotted quarter-notes (major "beats, in this meter) to a minute. It is also important for the players to remember that the upper tempo insists on strict values ("*giusto sempre*,") whereas the lower tempo permits some articulative freedom ("*quasi rubato sempre*."") The correlation of different tempi is not easy, and the artists have been known to rely on a track of pulse clicks by wearing earphones. Probably for a better unanimity, one duet is separated from the other. The notation of rhythms is complex due to a variety of subdivisions, and syncopated groupings.

NOT: This music is so frightfully complex that I wonder if the machine could not secure a more precise performance. Could MIDI be instrumental in making it an effortless sound generation?

PAN: We are here not to criticize the processes of composition or suggest performance practice. We should look at the method of notating this music. We should examine its temporal aspects, and not some aesthetic premises. Example 3.7 b) p.E23 presents the transcription of this music in PANOT. Every articulation is aligned vertically with the precision of a diagram. The first and last rows, as well as the median strip, present the tacts with their encircled numbers for the two different types of meters. In the middle of the upper duet, between tacts 5 and 6 of the first measure, and tacts 1 and 2 of the next measure, there appears an alternative interpretation of this rhythm, not unlike an "ossia" passage. Two separate sets of pulse signals are provided for each duet, to offset them better from each other. Both meter signatures refrain from showing the differing tact subdivisions. The tempi signatures are as carefully adjusted as in the original version. After all, the first tacts of the second measure are supposed to coincide with each other. 0.57" to each of six tacts of the upper duet produces almost the same total as 0.86" to each of the four tacts of the lower duet. This is so because 6 times 0.57 equals approximately 4 times 0.86. There are plenty of different fractional divisions, both, reciprocal and integral in the rhythmic texture. You should have no difficulty in deciphering the durational signals, after some practice of the previous selection. This texture should provide you also with a good exercise in figuring out the codes for both duets. Whatever difficulty you encounter, let me know the next day. I am sure both of us together will find the viable solution to the use of right symbols and codes.

NOT: The articulations look so neat on this page, because they are aligned to the metric grid. I wonder what happens when somebody writes the signals, for those four instruments, from the code dictation in longhand?

PAN: The alignment of parts may cause some problems when writing from code dictation. Otherwise, the alignment of rhythmically independent parts will always demand attention and patience. I had a chance to look at the manuscript facsimile of this piece, and I was impressed with the composer's neat distribution of temporal values. Your question brings up also the problem of the compromise between the analog and purely symbolic notations. It really does not matter whether or not you put down on paper the signals for "Song of the Ass" with geometric precision. Everybody will understand the tact signals and their meaning, even if they are not spaced evenly. The moment you deal with multiple parts, you must be more careful in aligning, at least, the bar signals. The strict alignment of tacts and tact subdivisions is necessary with parts like those in this quartet. You owe it to the performers and to the analysts to make your articulations clear and properly conforming to whatever time grid you impose on your music. If the contents of measures vary so widely that one measure taken vertically across the score, is packed with subdivisions, and the other almost empty, I would not hesitate to shrink the latter considerably. In such cases, you allow the symbolic principle to take precedence over the time-analog principle, in the interest of economy of space.

NOT: I am interested in the sound of such temporal complexity. Will I be able to hear separate tempi? I notice that the quartet is divided into one duet of second violin with the viola, and the other combining first violin with a violoncello. Does this division help guiding the ear to recognize the metric and tempo conflicts?

PAN: The receptivity of a human ear, in matters temporal, as well in other parameters, depends on experience, and varies with the individual. As readily as you can recognize multiple strains of polyphony, in the realm of pitch, you can also become aware of simultaneously flowing rhythms, be they locked in compatible meters and tempi or not at all. Let me emphasize, again, all what matters is that even rhythmically refined music can be transcribed into a new system which may offer some advantages in the consistency and logic of its signals and codes. Without particular effort, the first figures in the second violin part can be identified as third-notes. Their phrasing, however, makes them sound rather as traditional "duolets." The diagram omits the slurs and dynamic accents which are, of course, very important in the character of rhythms. The viola part presents traditional "quintuplets," simply fifth-notes in new terms, but as divisions of two tacts, calling for the use of integral fractional signals. The phrasing and dynamics, again, make them difficult to recognize as a group of five notes. Adding all those secondary attributes to the multidimensional spatial concept, makes this music different from an engineering model. It is live, effervescent music making unusual demands on our powers of perception.

We have arrived again at the end of our fourth day. I hope you realize that the task of illustrating different temporal concepts is an unending one. There are so many writings on the problems we have touched upon, that the field seems inexhaustible. In a rapid survey, we traveled from the simplicity of early examples to the sophistication of later examples. We have seen the transcriptions of simple and compound meters, grappled with the concepts of tacts and pulses, tested the relative advantages of transcribing multimeters with polymeters, and even examined the process of transcribing multitempi and polytempi. The style of present-time music is still more demanding on the notational resources. Unfortunately, the very moment you quote an example from the recent literature, it becomes obsolete, in a sense. I am certain you could find many new compositions which you could subject to the transcription process of PANOT. Only then you will be able to judge for yourself whether or not this process is viable and advantageous. The demands of the future are hard to predict. Nevertheless, any proposals for a new musical script must cope with this problem. Nobody will adopt new notation unless it has a potential for expansion, and the flexibility to adapt itself to future demands.

NOT: This appears to be such an immense undertaking, not to mention the responsibility inherent in all new proposals. I have heard so many times that a new notation cannot be invented; it can only evolve. What is your frame of mind on this dilemma? Are you more optimistic than what this opinion seems to imply?

PAN: No doubt, the history of music notation proves this point, to a certain degree. However, the history of notation is also full of inventions which served as catalysts for change, if not prompt adoption. Think only of the augmentation dot, or the tie. Somebody at some time, had to propose their usage.

NOT: It seems to me that you propose a complete overhaul, not just a few additions here and there. Does such an approach have any chance of acceptance?

PAN: I am not a prophet. I leave this question for you to ponder. My beliefs, whether tending to fatalistic attitude or to missionary zeal, will not matter much. PANOT will have to defend itself without my help.

NOT: What will be our next concern, in matters notational, master PAN?

PAN: The huge realm of pitch and intervals will be topics of our next discussions, for a few days. Before we leave the temporal aspects, let me remind you that we have not exhausted them, by any means. A glance at the untouched sections of our appendices will reveal to you many new signals and codes. As early as in Appendix 3 you have seen symbols mostly applicable to non-quantitative temporal values. You are already acquainted with the symbols listed in section (b) but you did not suspect that they can be used also as modifications of quantitative temporal values. For example, you may desire to make a tact slightly shorter in duration than its normal duration in a given tempo. You can put the hook-like signal (the one appearing as first in the section entitled "Applications,") over the tact signal. The code for this modification will read: "*tafa*." You can modify any other pulsative duration in the similar way. The other way to modify slightly the given duration is to use signals and codes which signify a slight and brief modification of the tempo. You have seen them already in chant examples. Now look at Appendix 16, which lists signals and codes for either lengthening durations by momentarily arresting the tempo, or for shortening durations by briefly forwarding the tempo. The same appendix illustrates also the symbols necessary to change the tempo in a smooth, gradual way. You see them in the second section of the appendix. They correspond, of course, to the familiar marks: "*rallentando*" or "*ritenuto*," and "*accelerando*" or "*stringendo*." While discussing tempi I did not have an opportunity to provide examples of slight delays or anticipations, known most often as "*rubato*," in conventional parlance. The last section (3) of Appendix 14 presents all the symbols you will need to indicate the variations in the incidence of an articulation. Do not forget also a very useful symbol for reiteration of notes until change occurs. You have seen it already at the end of Appendix 3, and in the recitation passages of Example 2.6 b) p.E7 as well as Example 2.7 b) p.E8. It is listed also in section (3) of Appendix 12, because it can be applied to any single or multiple articulation. There is also something to learn from Appendix 18. The transcription of the "*staccato*" dots was about the only reason why we looked into this appendix. The first two sections (1) and (2) expand the notion of associative and disassociative relationships.

NOT: Pardon my interruption but what are those two positions (b) and (c) about, in the first (1) section? I simply cannot figure out the "subtractive" and "protractive" relationships.

PAN: Imagine holding a chord on the piano, and lifting the fingers one after another, from the bottom up or, for that matter, from top to the bottom. Do you understand now the subtractive relationship? Now, play the same chord by adding one tone after another, until you hold the entire chord. Do you see an example of protractive relationship?

NOT: Why, this is simply like playing an "*arpeggio!*" A strange way, though. Normally, you just play "*arpeggios*" either "*legato*" or "*staccato*." How about the direction of playing? Do you have any symbols for that?

PAN: You would not forgive me such an oversight, so I included them at the bottom of the same Appendix 21. Those few signals (with their codes) take care of every directional configuration. This includes any clusters or vertical aggregates first up, then down, or first down, and then up, or simply first and last down, or first and last up. Combine those options with the signals for protractive and subtractive relationship, and you have quite a variety of performance modes at your disposal.

NOT: I never thought of playing "*arpeggios*" as a matter belonging to the temporal relations. I am almost convinced. I know what to do when I encounter a wavy line to the left of a chord, with possible directional arrows.

PAN: It is perfectly normal to be attached to the time-honored symbols, and to the familiar ways of doing things. Do you think it possible, however, to find enough conventional symbols to notate the variety of different modes of performance, as we have examined them previously?

NOT: I remember that your intention is to satisfy every possible whim of the composer. In this regard, I grant you that a plethora of specific desires will require an adequate number of new symbols.

PAN: I cannot resist sending you to appendices for even more symbols I neglected mentioning in our discussions. Take time to familiarize yourself also with Appenidces 22 and 23 which are concerned with illustrations of signals and codes for larger temporal entities. With the exception of slurs, which occupy section (2) of Appendix 22, you are not yet familiar with the assortment of different brackets and frames which group and separate the temporal contents. The time frames which appear as the last positions of the first (1) section are, perhaps, the most important of those marks. They have been used for some time to present multiple articulations to be sounded within one larger duration.

Can you imagine how useful they could be when used with the reiteration signs for repeat of the same until change? Some modern styles of composition require much of protracted temporal reiteration. The parts, if not scores, of such music could profit from resorting to symbols outlined in those appendices. Do not overlook also the possibility of ignoring the metric grid in favor of absolute values measured by minutes, seconds, and second-fractions. The absolute values are found at the bottom of Appendix 13, and they can be used in combination with the separation lines, like the one at the bottom of Appendix 22. Music for films is not the only field of application for those symbols. I will attempt to demonstrate the use of symbols found in Appendix 23 at an occasion of quoting a longer excerpt from a composition, probably in the pitch division of our discussions. Otherwise, it is rather difficult to demonstrate all the "*da capo*," "*d'al segno al fine*," and "*prima volta*." Finally, Appendix 24 is a review of all the temporal signals with codes appearing in appropriate places. Use this diagram when in doubt or to refresh your memory. All signals are centered around the time hub ("*jamux*,") because temporal signals cannot appear as a rule, at any other place. The exceptions are signals regulating larger entities, all codes, and also time signatures, bar signs, second signs, pulse signals, measure numbers, etc. The oval-enclosed thicker flags do not necessarily identify the value of number 2. They mean that any other flag value may be substituted for the single flag. Appendix 9 offers an explanation for such substitution in the section entitled "Signal Elements." It is assumed that the stem extends downwards, as shown here in Appendix 24. However, since pitch discs can be attached either at the bottom or at the top of the stem, so also the temporal signals can be attached either at the top (as illustrated) or at the bottom of the stem. The principle of a vertical flip is to be observed when inverting stems direction. If in doubt, compare with Example 3.6 b) p.E21 or 3.7 b) p.E23. I am sorry for rushing, but it is highest time for us to go home. Reflect, please, on everything you have heard and seen today. Later on, we may have time to review all the names, signals, and codes, in a systematic presentation by sound parameters. Good-bye, for now.

NOT: Good-bye, master PAN. I will be here tomorrow.

*

THE FOURTH DAY

THE DOMAIN OF PITCH AND INTERVALS

PAN: Did you have time to digest the signals and codes of the temporal parameter?

NOT: Not as thoroughly as I wished to do so. In spite of all the complexities, I start seeing light at the end of the tunnel.

PAN: This is good news, indeed. We are about to start investigating all the possibilities for an entirely new look at the spatial parameter. I hope to present it as concisely as I can. We will consider some tangential issues only with your indulgence, and only when time permits.

NOT: I believe you expect to convert me to PANOT. Am I a worthy candidate for such a conversion?

PAN: I have never doubted your capacity for learning new things. However, if you want to compare me to a zealous missionary, I must correct this impression. The amount of faith I expect from you is rather limited. All I want from you is a little patience, for the time being, while we are discovering new things. The process of learning the different systems of music notation is worthwhile and promising for the future. Beyond that I would not insist on your conversion to the new methods. However, without this limited and temporary amount of initial faith, it is hard to generate enough perseverance, if not curiosity.

NOT: Why is it so?

PAN: Because we always like to invest our time and interest in things which promise us certain benefits. The adoption of a new notation is definitely not among those advantages which are guaranteed, after you have learned the new system. Yet, nothing new can be even considered for adoption until it has been learned. Therein lies the dilemma of every notational reform.

NOT: I am ready to sacrifice my time to learn the principles of a different music notation. I realize that I cannot anticipate whether or not all my efforts will be commensurate with future benefits. I am willing to try even if future benefits may prove disappointing.

PAN: Thank you, Mr. NOT. After you have seen the basic concepts and applications of PANOT, you will decide for yourself what chances, if any, the new system has. Even if the results of our discussions prove disappointing, the process of learning may give you some arguments for possible future alternatives to the anachronistic features of the conventional music notation. Let us start with another look at the "Song of the Ass" which must be familiar to you after so many demonstrations before. I am talking about Example 4.1 a) p.E24, which presents a transcription of pitch movement for the first time. Naturally, you must be startled by the distribution of notes around a "digram" (or "bigram") of two staff lines, instead the familiar pentagram of five staff lines. Therefore, we must get acquainted first with the topography of the new staff and with the disk placement. Appendix 25 illustrates the basic pitch references, and Appendix 26 explains the meaning of the pitch depending on the disk's position on the staff. Appendix 30 presents a table of codes and signals for the quantitative and descriptive pitches. The signals may seem superfluous to you in the presence of disk notation. However, they are necessary whenever the pitch movement is expressed without resorting to the staff notation. The resulting shorthand notation may prove quite serviceable as a substitute for staff notation demanding more space. The two-lined staff is best understood as an arbitrary grid of a series of two equidistant and horizontal lines. The two staff lines are separated by an equidistant but not always visible auxiliary line. Portions of this auxiliary line are made visible whenever they are necessary to clarify the pitch of notes placed between the two-lined staff. The analogy with the familiar ledger line seems appropriate here. Just consider for a moment the placement of the traditional "middle c" either below the treble-clef sign or above the bass-clef sign in traditional notation. Notice, please, that the short ledger line is always reserved for the pitch-class of "c" in new notation. Appendix 25 further illustrates the use of a long ledger line. It is, simply, an option for drawing the complete staff of two lines when the pitch only briefly touches on the lower or upper range of the neighboring staff. Look at the highest pitch of the phrase in Example 4.1 b) p.E24, for an optional application of the long ledger line to clarify the position of high "d". A similar use of the long ledger line occurs in the next Example 4.2 b) p.E25. The entire system of staff digrams (two-lines staves) spans the entire range of audible pitch. Appendix 27 surveys the staff lines in relation to the standard keyboard. Appendix 28 offers a conversion table between the new and old notation. You must be a keen observer to notice that the new staff lines (in the middle of the table) are truly equidistant, whereas the traditional staff lines (to the left of the table) are intentionally not equidistant. The interval of a major third between the pitches of "g" and "b" in the treble clef staff is a greater distance than the minor thirds what the other lines contain. Two pairs of outside intervals in the bass clef staff are major thirds, whereas two pairs of inside intervals are minor thirds.

NOT: Now I remember you mentioning this discrepancy between equidistant staff lines and anything but equidistant intervals during our first meeting. What was the occasion to bring it up at that time?

PAN: We were discussing the third characteristic of an ideal music notation which is neutrality. The wishful thinking was about the standards of measurement to be free of any partiality. The traditional staff was found to be partial to the diatonic system. The impartial grid would have to conform to the chromatic scale. There is more, however, to the PANOT staff in its difference from the traditional staff. The disk placement of twelve pitches of the chromatic spectrum on the two-lined staff is outlined in a schematic way in Appendix 26. You will notice that the space between staff lines serves three distinct pitch levels. The difference between the traditional way of restricting this interspace to one pitch level and the new way of expanding this space to three positions lies at the core of the new spatial system. Right here you can see the advantage of getting rid of the necessity for "sharps" and "flats." This advantage must be balanced against a certain loss of compaction in space. Obviously, taller scores will become inevitable as the result of abandoning accidentals. You will have to decide for yourself, again, whether or not this relative advantage of sacrificing the need for chromatic signs is worth abandoning the compaction of the traditional pentagram.

NOT: I can see the inevitability of taller scores, as you put it, when every tone deserves a separate ring, so to say, on the ladder of a chromatic spectrum. I am not ready, however, to assess the relative advantages over the conventional pitch placement. Is there not a way to compromise somehow with the traditional staff in order to eliminate the need for accidentals, and, at the same time, to retain the graphic compaction?

PAN: I do not know of any, except when you want to increase the number of staff lines per octave or, perhaps, consider the differentiation of pitch by the shape of the note head.

NOT: Could you find something in the history of staff notation?

PAN: When the staffless neumes of the plain chant needed more differentiation as to their pitch level, a single horizontal line was introduced. Thus, the freely floating neumes above the text (*in campo aperto*, as they called it) became more distinguishable as to their height. Additional lines added more precision to the pitch placement, although they may have been first regarded as equivalents of the strings of a kithara or a lute. By the time the now familiar Gregorian tetragram was introduced, both lines and spaces between them served the purpose of pitch placement. Later pentagrams continued to use the same principle of line and space utilization. The expansion of space to accommodate three space positions instead of just one could be regarded as a further attempt to adapt the traditional staff to modern approach. Note heads sitting on the line

are different from note heads floating between the lines, and they are different also from note heads hanging below the staff line.. Naturally, the space between the lines should be larger than that one between the lines of the conventional staff. Otherwise, it may be difficult to distinguish between the places occupied by the note heads.

NOT: Is not this contributing to the overall increase in length of the score?

PAN: Of course, this is the uncomfortable concomitant of the exclusion of accidentals from the pitch picture. If this becomes too worrisome to you, remember how much is gained by the reduction of staff to two lines. At one time in history, notes had to be read from a staff of eleven, thirteen, and even more staff lines. Do you think it was easy to determine the pitch placed, for example, on the eighth line from the bottom?

NOT: They probably did not have sight-reading proficiency examinations in those days. I consider myself lucky to put up with the conventional staff lines but I am not comfortable with the constant change of the meaning of those lines, depending on the clef they carry at the beginning.

PAN: Start counting your blessings. The new staff does not need any other clefs than the signs of octave region. The region clef is always attached to the top staff line, as illustrated at the bottom of Appendix 25. The octave regions are counted from the bottom of the pitch range with a pitch-class of "c" ("za") at its beginning. Since the region below the last ("organ") "c" is represented by the fraction of an octave, it is designated as a "0" ("zero" or "zok") region. The successive regions above it are marked 1, 2, 3, etc. until 8 which is the upper limit of the keyboard range. It is easy to lose sight of a remarkable advantage of this staff which permanently fixes each chromatic tone in one and only one position. This is why you do not have to be conscious of the type of clef while you read the music from the new staff. The traditional clef is replaced by the sign of the octave region. Look again at the Appendices 27 and 28 to review the new spatial features of the entire pitch range. Example 4.1 b) p.E24 shows you the use of a clef which by its signal identifies the region as number four. Region No.4 starts with the familiar "middle c", in common parlance. Its new code name is therefore "rok." The code name of the first pitch is "rokco," translating from the traditional "f one-lined." The clef used in the next Example 4.2 b) p.E25 is a "lok" which suggests the third octave (the one starting with a "small" or "tenor" "c"). This is a literal translation of the tessitura profile moving mostly below the "c" clef of Gregorian Chant. You must bear in mind, however, that Gregorian clefs do not designate necessarily the absolute pitch with their stylized letters "C" or "F." Their use is predicated on the range of the melody which must be accommodated on four staff lines with one ledger line permitted only above or below the staff.

NOT: What a relief for sight-singers! Even in piano scores notes could be placed on the sixth ledger line below the bass-clef staff, or on the ninth line above the

treble-clef staff. Mercifully, the "8va" or "15ma" sign with an extended dotted line makes the reading easier.

PAN: You may think of the modern region clefs as fulfilling the same purpose as *ottava* signs. Actually, you will see, in the future, a possibility of using just a single two-lined staff with changing region clefs to accommodate even the widest jumps of the melodic profile. So, for instance, a pitch movement one octave up may use the same pitch placement on the staff with a higher region clef in front of it. Such a handling of pitch movement may disappoint a reader expecting a graphically true melodic profile. On the other hand, it may save space in huge orchestral scores.

NOT: While you mention the economy of space, I remember the use of a special durational symbol for articulation of the same duration until change. You have demonstrated this effort-saving device with regard to an ancient psalm.

PAN: Yes, we did look at such examples during our second day. Actually, two next examples (Example 4.3 b) p.E27, and Example 4.4 b) p.E28) use this technique as applied to plainsong music of a psalmodic formula, and to the modern psalm by a contemporary composer. In both cases, the space must be reserved for the text which goes on with different words. The music, however, does not change and is expressed by one symbol for pitch and articulation. In the first example (Example 4.3 b) p.E27, you find two open disks instead of normally filled black note heads. They correspond to the open squares of Gregorian notation in the mediant and terminal cadences. Their purpose is to provide a pitch option for three syllables from the ultimate accent in a psalmodic formula. There is no need for this option in the first strophe. The situation is different in the fourth strophe where both cadences are dactylic and require the pitch identification for the middle, unstressed syllable.

NOT: I understand the use of open disks, in this case. Could they be used also for the *ossia* passages found in some romantic piano music? I noticed that word used at the top of Appendix 25.

PAN: Certainly, they can be used whenever an optional solution is suggested. Perhaps, those small-print note heads, as found frequently in the piano works of Liszt, could be so written. Think also of some ornaments. Possibly, some normal note heads could be embellished by open disks.

NOT: What did you mean by enclosing the ultimate note of Example 4.4 b) p.E28 in brackets?

PAN: This is simply another way of writing the final pitch of traditional "e-flat two-lined" (a "*coklo*", in our terms) instead of hanging from the longer upper ledger line in the "*rok*" clef -- as hanging from the bottom staff line in the clef changed to "*cok*."

We have discussed this possibility just a moment ago. The only justification I can think of for this usage is to economize the vertical space.

NOT: While we are at this example of music by Saylor, I would like to ask you for an explanation concerning the use of a short ledger line in this, as well as in the earlier examples. I understand when the short ledger line crosses a note head that means always a "zo" note. Just why are those ledger lines used in conjunction with "bo" notes, at the beginning of this example? Is not their floating (but not hanging) position under the first staff line identifying them sufficiently?

PAN: I am glad you have asked this question. Of course, it appears redundant to add short ledger lines underneath "bo" notes. Their floating position should be sufficient to identify them correctly. Nevertheless, I decided to add them, at least in these early examples, lest their pitches appear vague or be confused with "lo" positions. A similar situation arises with the use of notes pitched on "do" level. Look at the note corresponding to the text syllable "-swer" of the word "an-swer." A short ledger line is added above the note head, although it is, actually, superfluous. After you get used to some intentional "overkill" in notational matters, you will probably better tolerate the lean version. Pitch calibration is not the only manifestation of this sort of flexibility.

NOT: I did not expect flexibility to go so far but I will accept redundancy any time it helps clarify the notation in order to avoid a potential misreading. This reminds me of those redundant accidentals within a measure. They are not necessary but they are certainly helpful to those with a short memory span.

PAN: Although space estimation is slightly different from memory retention, your point is well taken. Now, let us move away from minutiae, and consider still another aspect of pitch representation. The staff notation is not the only mode of pitch notation. In the second (2) section of Appendix 26, you see, underneath the disk notation (DYS-NOT) and pitch code (KOD), the signal notation (SIG), which does not need any staff lines to represent different pitches. At times, it may be advantageous to avail yourself of plain Arabic numerals (in base twelve) for designating or identifying chromatic scale degrees. Numerical (NUM) notation, as seen at the bottom of this Appendix, may lead directly towards computer applications of different pitch values. I would like you to continue now with Example 4.5 b) p.E29, which presents a few bars of Mozart's music which you have already examined for its temporal aspects in Example 3.2 b) p.E12. The staff notation is used at the top, the syllabic code in the middle, and the signal notation at the bottom. Before you read the signal notation, make sure to go back to Appendices 26, 29, and 30, for assistance in recognizing the value of symbols. Although those icons may look forbidding, at first, they are recording the pitch movement with the same precision as the staff notation. Moreover, they will occupy less space than the wildest skips of the melody. A combination of pitch signals with those of duration presents a sort of a shorthand for recording staffless pitch movement together with temporal values. The pitch movement

implies direction, besides pinpointing the place of every note in the vertical dimension. It is very helpful to know the direction in which to find the pitch level of the next note. This becomes rather important when trying to record or to read the pitch movement from dictation by using the syllabic code. If pitches follow each other in a catenary fashion, you may add the vowel "u" to whatever pitch degree is used ("qo") and close the code with either the consonant "f" or "s", depending on the direction in which the next pitch is to be found. If pitches are grouped in a synchronous fashion, you should add the consonant "m" before closing the code with the final, directional consonants. All this sounds very complicated but a brief look at the relevant codes and signals should dispel any apprehensions. First, examine the second (2) section of Appendix 31 entitled "Pitch Sequels and Others." Then, turn to Example 4.5 b) p.E30 for an illustration of the syllabic codes (KOD-SYL) and parametric signals (SIG-PAR) in relation to the initial trimeter of Mozart's minuet. This brief excerpt of a melody is not exactly the best proof for the convenience of using the pitch sequel symbols. You could simply account for it in dictation as a "(rok)bo" followed by a "po", "do", "no", etc., because all those pitches occur in the same octave region ("rok"). Thus, you will abide by the tacit agreement about refraining from repeating the code for the octave region until it changes. However, with frequent changes of octave regions, the use of pitch sequels may prove convenient in dictation.

NOT: Do I understand you to say that the use of some features of the new system depends mostly on circumstances?

PAN: The circumstances should be foremost in your mind. Use whatever seems to be the simplest and most economic way. Options which compromise the clarity of intention in a given instance should simply not be chosen. The realm of pitch is intrinsically connected with the concept of pitch interval. The relationship between pitch and interval could be compared with that of articulation and duration in time realm. Pitch and intervals are articulated and measured on a vertical scale of space in a similar way durations are articulated and measured on a horizontal scale of meter.

NOT: So, in a sense, pitch is calibrated on the vertical coordinate according to an universal consensus. The size of interval depends on the units of calibration. The duration of a note depends on the choice of tempo for the metrical unit. The meter is then an instrument of time calibration. Are those analogies too risky?

PAN: Not entirely. It is good, nevertheless, to indulge in those comparisons between the temporal and spatial elements. They help clarify the uniqueness of each sound attribute on a scale of Cartesian coordinates. You must be interested now in intervals, since we have already touched upon this spatial attribute. As Appendix 30 illustrates the quantitative and descriptive pitches, Appendix 32 does the same for quantitative and descriptive intervals. After you get acquainted with the new signals and codes, look at Example 4.5 c) p.E30. The second (2) section of this example lists the

appropriate code syllables, parametric signals, and even the numerical code for the intervals formed by Mozart's melody. Notice that the vowel "i" is reserved for interval or step formations, and the signals look like mirrors of the pitch signals, this time above the space hub. The numerals are modified by short dashes above or below, depending on the direction of the interval. Double dashes (not illustrated here) would probably serve best for simultaneous intervals. The measurement of progressive or synchronous intervals is simple enough when it follows the concatenation principle. Concatenation means that the next size is measured from the end of the preceding interval. The intervals can also be measured by referring always to either the upper or the lower anchor of the initial interval. This type of measuring intervals is regressive because it looks back to the first interval as its reference. Both procedures are outlined in Appendix 33 with addition of codes and signals for departure and arrival points. The third (3) section of Example 4.5 c) p.E30 demonstrates the regressive measurement in relation to the same music as in previous sections. The departure and arrival points happen to be the same here: "d one-lined" or "(rok)bo", in new notation.

NOT: Besides revealing the range of the melody in intervalic terms, there is, probably, little benefit from this type of measurement.

PAN: Although there are some benefits accruing from the regressive measurement of successive intervals, most of the benefits become obvious when you subject simultaneous intervals to this procedure. The resulting summary of all intervals used in the formation of such a chord or cluster defines its characteristics. Such a concise version of the pitch contents supports the identification of similar harmonic structures in analysis and performance. An example of regressive assemblage of synchronous intervals is provided in Example 4.5 d) p.E31. Please, do not overlook the fact that there is only one arrival point ("xi(rok)do"), at the top of the composite interval, but there are four consecutive anchors for counting the intervals from the bottom up: "zi(rok)bo, ti(rok)go, bi(rok)po," and "li(rok)no." The intervals summary, at the bottom of the page, shows that the pitch contents of five separate pitches generates ten different intervals. They are: two "ti" intervals, one "bi" interval, two "li" intervals, three "ri" intervals, two "ci" intervals, and none in the class of "gi" intervals. Do not be surprised if we do not recognize any higher interval classes. There could be, of course, an actual "pi" interval. You can spot one, as the third one from left, in the first (1) section of this example. As an interval class "pi" counts the same as "ci." This is the result of subtracting "pi" (or seven) from "ki" (or twelve even intervals in an octave) which yields "ci" (or five.) This is why you see two "ci" intervals in the table the first one is the second from left in section one (1) recorded there as "cims-fioz," and the second one is the third from left, which I mentioned already before, and which is recorded as "pims-fioz." This last interval of "pims" converts to "cims" as belonging to the same interval class. Therefore, you find the numeral 2 underneath the numeral 5 in the table, indicating the amount of two intervals within the interval class of 5.

NOT: The complexity overwhelms me again. I cannot absorb all this information without going first over all the appendices pertaining to intervals.

PAN: This must be my fault, again. Now I notice that I have completely overlooked Appendix 29 which presents a diagram of tempered intervals within an octave. I should have shown this diagram to you before I sent you to Appendices 32 and 33. My apologies for this oversight, and I do hope that reviewing the materials in the correct order will help you assimilating so many new codes and signals..

NOT: I will do so tonight but, in the meantime, please, go ahead with next examples.

PAN: I am concerned because I know how difficult it is to expect understanding of advanced symbols and concepts with a shaky foundation of basic materials. Unfortunately, that happens often with limited time at our disposal. Just imagine what a luxury this would be if we had six weeks instead of six days to cover the material! It is my hope that you will be interested enough to continue studying all those examples and appendices on your own.

NOT: I do realize they provide a departure point for future work.

PAN: Let me move along then with a few more examples from music literature which will illustrate some further aspects of the pitch picture. First, we will deal with the music of Beethoven, the same music which you have already examined in our third day. This time, you will see both the temporal and spatial parameters combined together. Example 4.6 b) p.E32 spreads the pitch range over two staves, and adds the pitch code underneath. Here you have a perfect opportunity to try your voice by imitating the sound of the violin. You may use code syllables to help you enunciate the pitch and articulate the rhythm. It will be not easy to read the transcription while maintaining all the disciplines involved here. At all times, you will have the traditional model in front of you for reference. The sooner you conquer the unfamiliar notation the taller you will grow in experience. There is no substitute for it. The purpose of Example 4.6 c) p.E33 which is opposite Example 4.6 b) p.E32 is not to provide you with a sight-singing exercise. The objective is to present two non-staff modes of notation of pitch and duration. The upper section marked "SIG" features both parameters with pitch also encoded in staff-less signals. The lower section marked "KOD" utilizes the syllables as you would read them in dictation. The pitch codes are separated from duration codes by a slash. You realize, I am sure, that those two modes of notation would be not used for live performance Yet, they provide another option where staff notation would be not so desirable. Notice how the rests are accounted for. In case of a frequent eighth-note rest, the "bex," signifying the rest value corresponding to the conventional eighth-note, is followed by an "ox," a verbal symbol for absence of sound.

NOT: For the first time I see the unity of signals and codes between the temporal and spatial parameters. The same consonants serve both pitch and duration regarding their values in codes. The same configuration of signals does the same with regard to the values of spatial and temporal parameters.

PAN: I am glad you feel this way. One of the greatest economizers in the new system is its reliance on the principle of uniformity. I remember spending some time with you in underscoring the importance of this characteristic of an ideal notation. The moment you realize that all parameters share the same logic and visual appearance in formation of their icons and codes, the task of learning them becomes much easier. That is why I have stressed the relevance of the material contained in early Appendices 8 and 9. Both appendices are indispensable for unlocking the value of signals and codes. The alpha-clock contains the essential data for alphameric conversion between letters and numbers. The choice of consonants is arbitrary, and they must be memorized for all future references. We are not interested in what the long hand of the clock indicates. Five minutes between hour positions were a good analogy for the traditional circle of fifths. The short clock hand and the hour positions are relevant for our purposes. Try to associate in your memory their numerical values with the arbitrary consonants in their place. The diagrams of Appendix 9 will equip you with an ability to recognize instantly the value of icons whenever they are used as signals in different parameters. In this way, very much is gained with a relatively small effort.

NOT: When you talk about the verbal codes, this actually means that the entire new terminology for all parameters is built on the same principles. Do you really mean that such a neologism as, for instance, "be" will replace the good old "eighth-note" (at least in the Beethoven example)? Do you expect the term "vo" to take place of the traditional designations of "g-sharp" or "a-flat"?

PAN: I realize I am hoping against the hope. Perhaps, all those concerns will vanish with computers crunching better symbols for music of the future. When such time comes, you will be prepared to form new concepts and their applications. At any rate, now is the time to move to a next example which presents the familiar excerpt from the works of Charles Ives. You have already examined its temporal intricacies. The added pitch parameter in Example 4.7 b) p.E35 will make this excerpt more palatable. Again, you will have the opportunity to try your musicianship in diatonic and chromatic orders. In similarity with the traditional model, on the opposite page, one staff system is sufficient to accommodate the melodic instruments. The syllabic code may help in singing, like in previous examples. Actually, there is no need for a single staff line and no note heads are needed here for percussion instruments. Consult position (e) in the second (2) section of Appendix 31 for the proper signal for indistinct calibration. The indefinite pitch is correctly coded here as a series of "xo" syllables.

NOT: Strictly speaking, the purpose of note heads and the medium of a bass or snare drum are mutually exclusive.

PAN: Of course. Now, the complex music of Carter's Third String Quartet, appears before your eyes quite differently from the old example featuring only its rhythms. Example 4.8 b) p.E37 vividly depicts the wide range of the score. It is in scores like this one that you realize the extent of the vertical dimension necessary to represent all pitches. The widespread multiple stops of the string instruments preclude any possibility of manipulating the region clefs to lessen the length of the score. Notice that it takes three staff systems (with the exception of the viola part) to accommodate all parts. The same pitch range is locked into one traditional staff only, for every instrument. There are plenty of accidentals and multiple ledger lines to put up with. Toward the end of the cello part, there is even a clef change from bass to tenor. The new look dispenses, of course, with accidentals, utilizes at most one short and one long ledger line, and keeps a single "rok" region clef for reference.

NOT: When I compare the third beat of the second measure in the transcribed viola part with the same place in the earlier Example 3.7 b) p.E23, I notice some discrepancy. In the present example, you have split the part into two portions, and that seems to be missing in the earlier example. Why is it so?

PAN: The reason for this can be explained very simply. In the earlier example, such splitting would be irrelevant because it would not affect the actual rhythm. In the present example, concerning pitch besides rhythm, you see the transcription which corresponds faithfully to the composer's writing. When you look at the opposite page containing the original (Example 4.8 a) p.E36) you see the composer putting a dotted quarter-note rest separating the bottom portion from a tied double stop of dotted quarter-notes above it. Later, the bottom portion maintains its independence from the top portion by featuring a double stop of eighth-notes to be followed by an eighth-note rest. It would be rather frustrating to recognize that, in reality, we should not be talking about either quarter-notes or eighth-notes. This passage – beats three through four – is filled with a quintuplet of eighth-notes carved out of two beats which are represented here by quarter-notes. Hence, those beatlets should not be eighth-notes but rather fifth-notes taken out of a half-note (representing the value of two beats.) Does it mean, perhaps, that those eighth-notes are each a "two/fifth" note? In the new system, there is no doubt that this passage should be represented by a rest for three-times "two/fifth" duration, followed by a double stop with a single "two/fifth" note value, and finished with a rest for a single "two/fifth" duration. Three "two-/fifths" plus one "two/fifth" plus one "two/fifths" add up to five "two/fifths." This is what you see in this split passage. The upper portion carries slightly different values and, therefore, should be separated in accordance with the composer's wishes.

NOT: Crazy arithmetic is what bothers me. I must admit that it makes better sense to call those eighth-notes in the viola part "two/fifths" notes. "Two/fifths" sounds funny but it is true. "Eighth-note" is more palatable but patently untrue, in this situation.

PAN: A similar situation occurs in the cello part where in the first measure there are two instances of a split part with stems in opposite directions. The reason is again a slight difference in durations between the upper and lower portions. Do you see how this split is transcribed in Example 4.8 b) p.E37?

NOT: Let me see if I can point to those two spots in a formal PANOT way. The first is found at "*mat,tab*," meaning the first measure, second beat. The second spot is found at "*mat,tar-beb*" meaning the first measure, fourth beat, second half or second beatlet, if I may borrow your term.

PAN: You are so proficient that I will ask you to identify now the metrical position of the spot in the viola part which we have discussed previously. Could you also code the pitch parameter?

NOT: Let me try. It starts at "*mab,tal*." with a "*lumbamcemx*," follows with a "*cem/(lok)touspo*," and ends with a "*bamcex*." Correct?

PAN: Almost! Reporting on the double stop, I would add the consonant "*m*" between "*tou-*" and "*-spo*" of your pitch code. This is necessary to acknowledge that the two pitches of the double stop are supposed to sound simultaneously. In all cases like this one, follow the form of the code or signal as listed in position (d) of the second (2) section of Appendix 31. Therefore, the correct version of the first pitch account would be: "*cem/(lok)toumspo*." We went slightly off on a tangent but it was delightful to see you gaining confidence with all those strange terms and icons. Before we move to microtones, I would like to dwell for a while on the so-called descriptive pitches and intervals. We should give composers an opportunity to notate pitch levels and interval sizes which are intentionally lacking in precision. Such terms as "high" or "extremely low," and "extremely small" or "large" could be sufficient to satisfy the desires of some composers and performers. You may want to get acquainted with the pertinent codes and signals. They are listed in the second (2) sections of Appendices 30 and 32. The same signals you will find there, if attached to other spatial signals modify their levels or sizes. You could do so with the descriptive temporal signals to make durations slightly longer or shorter, if you remember our previous discussions. When you attach the descriptive spatial signals to other spatial signals, you modify them slightly or considerably, depending on which degree of intensity you will choose. The field of microtones, which we will enter now, is very large and plagued with many uncertainties. There is very little agreement on the use of symbols, and the terminology is also subject to many interpretations.

NOT: This must be a reflection of the general confusion about octave divisions, and different modes of tuning.

PAN: The growing interest in symmetrical, as well as asymmetrical, divisions led to adoption of many scales and tunings which often conflict with each other. The insistence on infinitesimal divisions sometimes caused considerable strain on the powers of the ear's perception, and also a complete disregard for the practical outcome. For the new system of accounting for micro-divisions, please turn again to the middle portions of Appendices 30 and 32. Positions (d) through (g) in the first (1) section of Appendix 30 suggest an open-ended system for upper or lower micro-degrees. You can choose any division of the tone (traditionally, a half-tone) you desire, including even multiple values. If your fancy dictates a micro-degree two-sevenths lower than a tempered "bo," you just choose the appropriate signal to hang underneath the "bo" note, and code it "bobumpömf." Modification of intervals with micro-inflections follows the same principle, and uses similar signals. You find them in positions (e) and (f) in the first (1) section of Appendix 32. Wishing to enlarge slightly an interval of "ri" (a conventional major third), you may choose to enlarge this interval by one-fourth of a tone (a conventional one-eighth of a step.) The signal is easy to construct after the model given in positions (e) and (f.) The code should read: "rirü." In case you want to shrink the size of a "ni" (conventional major sixth) by a "lü" (conventional one-sixth of a step), first you should choose a "vi" (conventional minor sixth) and add a "bumlü" (conventional four-sixth of a step.)

NOT: I cannot imagine composers demanding such fine distinctions as two-seventh of a tone which translates into one-seventh of a conventional full step. What is the point of providing them with such subtle distinctions?

PAN: You must remember me reiterating, at more than one occasion, the need for a notation which is characterized by a possibly limitless capacity to satisfy any wish of a composer. This is also a part of the responsiveness of a modern notation to any conceivable configuration of parametric values. The PANOT system of microtonal notation offers the possibilities. The price of the extremely complex distinctions will be always an increasingly complex notation. The point is that the signs and codes are available, regardless whether or not such fine distinctions can be purposefully produced by a human voice or acoustic instruments. Do not discount the capabilities of electronic instruments which could be programmed according to the most exacting specifications.

NOT: It seems to me that electronic instruments will not be programmed by notations devised for direct human consumption. I recognize, however, the potential of the new system to provide tools which could be converted to computer use.

PAN: This is quite true. Do you remember when we tried to define music notation in our first day, you agreed that our chief concern should be a music notation for

live performance? Let me show you, at this time, a few appendices which illustrate the traditionally recorded microtones being converted to the new system. Appendix 36 presents a 24-tone scale. This means that every new level is a quarter-step apart, in traditional terms. This scale is transnotated in disk notation, code syllables, and "shorthand" signals. Now, you recognize a 24-tone scale consisting of 24 half-steps (not traditional quarter-steps.) Above the disk notation, you see also a numerical code in an elongated oval. The number sequence follows a "base 12" system. Compare it with the conventional numerical sequence which appears in an elongated rectangle, above the traditional notation. If you want to refresh your memory concerning the comparison of those two numbering systems, Appendix 7 may be helpful. The use of "base 12" system is not mandatory in the durational parameter but it is very helpful in the spatial parameter. Do you see why?

NOT: The main reason must be the time-honored division of an octave in twelve parts. Why do you favor also the division of time elements in twelve?

PAN: One of the reasons is the avoidance of two digits up to number twelve. This will become important for computer encodings. Since most temporal units fall into divisions of twelve, for instance: 2, 4, and 6 (do you remember the *senario* from history?) they seem to be more convenient to handle than decimal divisions. Although there is no octave of time, most metrical values follow the power of number 2. Nevertheless, any other temporal division must be made equally available.

NOT: I begin to see now the system's integrating principles which are embodied in the alpha-clock (Appendix 8) and in signals of parametric valence (Appendix 9.) I do not want to anticipate but I looked already at the opposite page of Appendix 26. What did you want to convey in this complex table of Appendix 27?

PAN: It is a very delimited example of what kind of simple microtonal possibilities exist between the tone of "d one-lined" and "e one-lined." In our terms this is the space of two tones between "*rokbo*" and "*rokro*." You know enough of the new system to be able to decipher most of the data. The third column from left lists data with which you may be not familiar. The measurement of interval sizes in so-called cents has been in use for some time. The traditional tempered half-step interval is said to contain 100 cents. Consequently, the entire octave contains 1200 cents. Here, in the table, I assume that we start from point zero identical with the pitch degree of 0 (or "*zo*"). The space from "*bo*" to "*ro*" is thus represented as stretching from 200 cents to 400 cents for a distance of 200 cents. The rest of the columns and their entries should prove self-explanatory. The following Appendices 38 and 39 provide further examples of microtonal scales. The second (2) section of Appendix 38 presents a 36-tone scale which divides every step (or every half-step in traditional terms) into three mini-steps. This is why you see the first pitch of this scale ("*rokzo*") followed by the pitch one-third tone higher: "*zo-lös*." The next pitch is two-thirds higher and it is coded accordingly: "*zo-bum-lös*." The coding and signals of the

remainder of this scale follow the same pattern. The situation is quite different in the first (1) section of this appendix. The division of six whole-steps into three portions produces an 18-tone scale. This means that every two steps of the new system are divided by three. That necessitates an adjustment insofar as the second pitch level becomes one-third out of two steps higher. This is reflected in the code: "zo(bi)-lös" to be followed by "zo(bi)bum-lös," meaning the third pitch level being two-thirds out of two steps higher than the second one. As in the 36-tone scale, the symbols for the remainder of the 18-tone scale follow the same principle. You may have heard of Ferruccio Busoni who at the beginning of this century suggested division of whole steps into six parts. Busoni's sixth-tones are actually third-steps of the new system.

NOT: Looking at the picture of those scales on the new staff, I see that you opt sometimes to invert the direction of note stems. The microtonal signals become inverted also. I suppose you are guided by the same concern as in traditional notation: to balance the stems' appearance neatly on the staff. Should I follow any particular rule with this regard?

PAN: The elegant graphic appearance is certainly one of the chief objectives for this practice. The most economical distribution of available space has also something to do with it. In polyphonic music up- and down-directed stems become a must, particularly when parts are crowded on one staff system. Incidentally, consult Appendix 25 for still other ways to distinguish separate parts by changing the precise place of stem attachment to the disk. The best rule to keep in mind when reversing the direction of stems is the rule of a vertical flip. All signals attached to note heads in disk notation, and all temporal signals become inverted on a horizontal axis but their left or right directions remain the same. Check how this works in practice in this appendix. The pitch level of "g₀" (or traditional "f-sharp") may have the stems attached in either direction because this is the central position of the new staff system. All levels below it should point their stems up, and all levels above it should point their stems down. Do not worry too much about this prescription. The circumstances will permit many exceptions in practice.

NOT: There is still something I do not understand in Appendix 38. What is the meaning of those acronymic terms: INT-SIT and SEG-SIT with the appended codes which appear close to the left margin?

PAN: The explanation of those terms will take longer than usual. Brace yourself for listening first to discussion of unusual concepts. The understanding of these concepts is a prerequisite for understanding new notational symbols. It is a good occasion to examine them, while we are considering the notation of symmetrical microtonal scales. The construction of these scales is characterized by repetition of the same intervals found between their pitch degrees. This is not an exclusive characteristic of the microtonal scales. The chromatic and whole-tone scales are well-known examples of symmetrical but not microtonal scales. Due to the extraordinary spatial density, the symmetrical microtonal

scales lend themselves rather well to the demonstration of interjacent intervals. You may take an octave as a peripheral interval encompassing either 12, or 18, or 24, or even 36 interjacent intervals. All you will need is to select modified signals and codes for the interjacent intervals to be used with unchanged symbols for peripheral intervals. The absolute values of interjacent intervals are placed on elongated flags, the same ones which support normal intervals. When encountering such compound symbols, you will have to remember that interjacent intervals are found above the normal, or, in this case, peripheral intervals. The entire system of placing the signals for interjacent and peripheral intervals is demonstrated in Appendix 35. There you find also the special way the consonant "w" is added to code syllables to distinguish the codes for interjacent intervals from those for peripheral ones.

NOT: I see a lot of signals and codes on this page. Can you tell me which ones would apply to the 18-tone scale which we have just examined.

PAN: I know you must be impatient with an avalanche on new symbols. Let us look then again at Appendix 38, in which you find this scale. You have asked about the symbols found underneath the term INT-SIT. The little dot hanging from the left flag of the intervalic signal refers to one octave, for a dot represents an absolute value of "one." On the right side, you see an extended flag bearing absolute values of an interjacent multiple-step reciprocal interval. You can compare this signal with position (f) of the first (1) section in Appendix 35. Read the code also: "*qum(qü)w*" and compare it with the applied code in Appendix 38. Is the code for this scale: "*tik-bumlüw*" truthful to the situation you find in this scale?

NOT: Yes, it is. The initial "*tik*" represents one single octave, as the dot indicates it on the left side of the interval signal. The code is complemented with a "*bumlüw*" which translates into "two-thirds, interjacent." This is the same as saying for the whole construction: a third-microstep (or step reciprocal), out of two full steps, serving here as an interjacent component of the peripheral octave. So far so good but the mystery still remains with the term SEG-SIT.

PAN: The numbers you see within the ovals are just absolute values which may substitute for either the signal or the code. Number 18 stands for the amount of interjacent segments, and number 66.6 stands for the approximate value of every segment in cents. Positions (g) and (h) in the first (1) section of Appendix 35 provide the codes, signals, and the same explanation I just gave you.

NOT: Why those names: INT-SIT or SEG-SIT? Does it have something to do with signatures? We called time signatures by the name TEM-SIT, way back while exploring the temporal parameter.

PAN: It may seem preposterous to you to consider such a thing like space signatures but, particularly with frequent use of microtonal dimensions, they may prove helpful. If you are interested, you can find them outlined in Appendix 40. You are familiar already with the first two. The use of the third one is rather limited to those who wish to pinpoint precisely the pitch level by using the "Hertz" or "cycles per second" units. The generally accepted standard of tuning being 440 c.p.s. for "a one-lined" (or our "*rokno*,"") would read "*rokno-440 feo*." The last space signature is, simply, a catch-all of the preceding ones, in the same way as time signature was for the separate tempo, pulse, and meter signatures. Incidentally, another analogy of spatial symbols with the temporal ones comes readily to mind. Consider for a moment the duration of a tact modified with a signal for twelve articulations, in accordance with the symbols for intra-iterative type of reiteration given in Appendix 12. Apply those symbols appearing in position (b) of the first (1) section to the tact, and you get a signal corresponding to the code: "*taku*." The result will be one tact's duration divided by twelve articulations. The duration of each articulation will be a "*ke*" which means a twelfth note. Compare now the tact, an interval of a temporal unit, so to say, with the octave, an interval of a spatial unit. Divide this spatial interval by twelve, and receive twelve component intervals, each worth one step. The chromatic scale will be the obvious result. The peripheral interval of an octave will yield twelve interjacent steps (traditionally half-steps.)

NOT: Reversing your line of thought, in this specific case, a tact is a peripheral unit of time consisting of twelve interjacent articulations. What makes this comparison so relevant is that in both cases, temporal as well as spatial, there are notational symbols available to effect an immediate application. Returning to the other example in Appendix 38 presenting a 36-tone scale, are circumstances different here?

PAN: Insofar as we deal here with three divisions of a step (traditional half-tone) and not three divisions of two steps (traditional full tone) they are different. Your signal and code reflects the new situation accordingly. The code for the interval signature "*tik-lüw*" indicates a single octave as a peripheral interval divided into interjacent intervals each one worth one-third of a step (traditionally one-third of a half-tone.) The segment signature confirms that division by pointing to 36 divisions, and 33.3 cents as an approximate size of each interjacent interval. Similar notation can be applied to symbolize asymmetrical microtonal scales. In view of a worse confusion regarding the traditional ways of notating those scales, the new system copes rather efficiently and consistently with the substitutes for a whole array of mini-sharps and mini-flats used in the present notational system. Our last example of microtonal scales presents a rarely applied 31-tone scale in Appendix 39. The segment signature (SEG-SIT) shows 31 octave-segments with every segment measuring almost 40 cents (approximately 39 cents.) You can calculate for yourself that an even amount of 40 cents would indicate every mini-step being one-fifth out of two steps (traditionally out of a whole step.) Only then five divisions for every of the twelve steps in an octave would add up to 30 tones in an octave. The trouble is that there are supposed to be 31 tones in every octave.

NOT: Why is this particular number of divisions so favored for the construction of a 31-tone scale?

PAN: This tuning system has a most colorful history for which we will not have time here. Certain acoustic conditions arising from superimposing intervals in the mean-tone temperament, and the formation of a so-called *diesis*, all are responsible for the resulting 32 tones (or 31, if starting from zero.) You will notice, I am sure, that I have patched up this asymmetric condition by dividing the last interval into two-tenths. It is a highly arbitrary solution for the notation of this scale. We may as well wait for somebody to come up with a better solution.

NOT: Is this what those funny looking signals mean in the lower portion of the interval signature? The code syllables are positively forbidding, either for writing or speaking. Must this be the price of complexity?

PAN: Unavoidable, I am afraid, in this complex system of relationships. Nonetheless, let me explain the logic behind this interval signature. First the code "*tik-bumcüw*" translates to: one peripheral octave consisting of interjacent intervals, each worth two-fifths of a step (traditionally of a half-tone.) The signal represents graphically the same what the code does verbally. Check now, please, how this is confirmed by the disk notation. The first micro-degree reached after "*(rok)zo*" is "*zo(bi)cös*," meaning the level of "*zo*" plus one-fifth degree higher out of an interval of two steps (traditionally out of a whole step.) So far we could explain the 30-tone scale but not the 31-tone scale. This is why a supplemental signal and code is added to account for the last segment. The code syllable "*gük*" standing in place of the usual peripheral octave may cause some confusion. Looking back at position (b) of the second (2) section in Appendix 35 may help clarify the signals and codes. The lower oval and the last syllable of the code represent the peripheral octave reciprocal. In our case, the code "*gük*" signifies one-sixth portion of an octave. As you know, the sixth portion of an octave is nothing else but two steps (or traditionally a whole-tone). The next syllable "*cü*" refers to the other peripheral interval reciprocal of one-fifth out of the "*gük*" which in itself is already an sixth reciprocal of an octave. The final portion of the code: "*bumdüw*" indicates that within a "*cü*" out of a "*gük*" you will find interjacent intervals worth each two-tenth microtones out of a double step (or, traditionally, a whole-tone.) The signal is as complex as the code because the circumstances of an asymmetrical scale call for it.

NOT: I do not intend to write any music in the 31-tone system because the notation intimidates me. When I look at the traditional notation on the same page, I see those traditional accidentals are not of much help either. They must have been decided upon also by some arbitrary reasoning.

PAN: There are many notations developed for this scale. Many of them use also special signs besides modified chromatic signs. I think it is time for us to leave this scale and move to other intriguing aspects of peripheral and interjacent intervals. Appendix 35, to which I referred a while ago, suggests that there are also other interjacent intervals which can be used as effectively as microtones. Take, for example, a huge interval of seven octaves, from the lowest to the highest "c" on the keyboard, as the peripheral interval and divide it by a series of such interjacent intervals as half-octaves. You will be playing consecutively a series of ascending or descending tritones. Those octave reciprocals will be the traditional "f-sharps" or "go" pitches in the new system. Try to fashion a notation for those intervals by using the symbols listed in Appendix 35. I will give you a clue by this code: "(pik)bükw." In the meantime, I will give you another example. Imagine playing diminished-seventh arpeggios throughout three octaves. Instead of notating every single tone, simply designate three octaves as the peripheral interval ("lik"), and three steps ("liw") as interjacent intervals (minor thirds to ancient people.)

NOT: Could the same be done with major thirds, whole tones, or even the traditional half-steps, as interjacent intervals?

PAN: Of course you could do this because they all are equidistant intervals dividing the octave into three, six, or twelve even portions, respectively. Using the multiple functions, you can also divide a peripheral interval of two octaves into three interjacent intervals valued each at a double third of an octave reciprocal. The code would read then: "(bik)bum(lük)w," and you should be able to construct a signal corresponding to this code.

NOT: Now, I am beginning to understand the whole realm of peripheral and interjacent intervals as offering the benefit of a stenographic notation for repeated intervals. One does not need to write out every single pitch degree for the reiterated pattern of intervals. What happens when not all interjacent intervals are identical?

PAN: You have just seen an interesting case of 31 tones to an octave. Seldom can you patch up uneven intervals within a larger peripheral interval. An instructive example of a special handling is the notation reserved for keyboard glissandos. Although the intervals are uneven, you can use the symbols listed in position (b) of the first (1) section of this indispensable table of reference in Appendix 35. An addition of "f" for white, and "s" for black keys clarifies the intent sufficiently. If you are interested in transnotating a sophisticated example from literature, try just two bars (69 and 70) from the second movement of Bartok's *Sonata for Two Pianos and Percussion*. The part for the first piano features a series of roller-coaster scales for white keys only, combined with scales for black keys only, all this in simultaneity and a half-step apart. In the next measure, similar scales are reinforced by glissandos of alternating scales, descending for black keys, and rising for white keys, both formed of intervals separated by one black or white key,

respectively. Examine the glissandos in the first piano part in measure 70 and following measures. Notice how the composer utilizes a sort of a short cut by writing out only the beginning and concluding intervals, and filling the interspace with a pair of oblique lines. I am certain this type of notation will not only remind you of peripheral and interjacent intervals but will assist you in transcribing it into our system.

NOT: So far, you have talked about interjacent intervals in succession. How about a chromatic 12-tone scale sounding synchronously within the peripheral interval of an octave?

PAN: It is sufficient to mark the peripheral interval as a simultaneous one. In your example the code "timk" should be enough to suggest that all the interjacent intervals are supposed to sound together. For emphasis, you may mark the component intervals: "timw," and attach either of the symbols under positions (c) or (d) of the first (1) section in Appendix 33 to the signals. Actually, you can use both of them. In simultaneous intervals the direction matters only when referring to the method of their measurement. The chords or, to be more general, the extended vertical aggregates are difficult to perform on a keyboard, unless you use your forearms or a ruler. In ensemble music, however, many different voices or instruments may contribute to a formidable cluster consisting of uniform steps or their reciprocals. Modern electronic instruments and synthesizers are capable of sustaining many tones in their simultaneity. Unless those component intervals are uniform in size, there is very little use for the notation of peripheral and interjacent intervals.

NOT: Could you show me an example from music literature for clusters consisting of uniform intervals?

PAN: There are many of them in contemporary literature. One which comes to mind as particularly revealing is found at the very end of Penderecki's *Threnody for the Victims of Hiroshima*. In a brief time of less than a minute, several microtonal clusters are heard first in separate string instruments and then as a total group of 52 string instruments. In an unusual notation for his time, the composer used elongated black rectangles placed on the staff to define peripheral intervals. Separate notes for each of the interjacent microtones were placed underneath the rectangles on conventional short staves. You see this score in Example 4.9 a) p.E38 which is facing the transnotated score on the opposite page E39 of Example 4.9 b). The instrumental parts in the original are arranged in a traditional way from first violins down to the string basses. This type of arrangement never guarantees that lower placed instruments will always have the lowest notes of the score, and vice versa. The true pitch level is further obscured by different clefs and *ottava* signs. The transcription spreads the peripheral intervals across six octave regions in their spatially precise position. 24 violins are divided into two groups of 12, in this score. Let us look at the second group extending from 13 to 24 violins, near the top of the score in measure 67. From the linear arrangement, you see the true transcription of

what are the quarter tones in original but become half steps in PANOT. If you have any doubts about the correct notation, compare those little hooks attached to every other note head with position (f) in the first (1) section of Appendix 30. The linear arrangement of those half-steps (traditionally, quarter tones) starts with a "gokro" (traditionally, an "e three-lined) and ends with a "goknobös" (traditionally, an "a plus a quarter degree, three-lined.") In synchronous terms, this interval stretching from "gokro" to "goknobös" presents a "cibüm" or, traditionally, a fourth with a quarter tone. Never mind the terminology, look how this peripheral interval appears now on the big staff in vertical form at the beginning of measure 67. The long-flagged "büw," attached at the top head of this peripheral interval, tells you that the interjacent intervals are half steps (traditionally, quarter tones.)

NOT: I will examine the rest of those peripheral and interjacent intervals tonight, at home. They seem to follow the same principles so it should not be difficult to discover what they imply. I assume that all those scales on short staves in right upper corner are just the linear statements of the big cluster found at the beginning of measure 70.

PAN: Yes, they are just transcriptions of what you find at the bottom of the original score. The big cluster, as you called it, is the transcription of that extended black rectangle filling the whole of the last measure. The normally expected durational flags have not been added in transcription because they are also missing in the original. Instead, the absolute time values as recorded in the seconds track of the original have been faithfully transcribed, in accordance with the provisions of position (d) in the third (3) section of Appendix 13. When you examine at home the total effect of the transnotation of the original notation, please, try to assess its relative advantages. Have a critical look at what is gained and what is possibly lost in this type of operation. Apply the criteria of ten characteristics of an ideal notation, if necessary. Above all, try to arrive at a definitive answer as to which system of notation represents the spatiotemporal elements in a more convincing way. I have used the term "transnotation" advisedly because it describes the process of converting one notation to another more precisely than the term "transcription," which is much broader in meaning. Transcriptions may depart significantly from the original, particularly when transferring music from one medium to another. Therefore, with your indulgence, I will use this neologism more often from now on.

NOT: It will take some time before I become comfortable with so many new terms and symbols. Frankly, I did not anticipate that intervalic notation may offer so many simplifications which can be directly applied.

PAN: We have missed some features of intervalic notation which may find application completely outside the common practice. One of those features concerns transient intervals, that is intervals which can gradually change their size. A gradual change can occur only in the temporal realm. Hence, we are concerned here with linear

intervals occurring only in succession. Appendix 34 lists codes and signals needed for such gradual expansions or contractions. The second (2) section on interval anchors provides symbols for further detailing of the process of change. Remember that you may leave the arrival point either undetermined or specifically designated by the symbol of the following interval. Transient intervals are best exemplified if produced by human voices and instruments which are capable of continuous pitch manipulation. They are all but ineffective with instruments operated by keyboards.

NOT: Does not the staff system preclude any smooth and continuous movement of pitch?

PAN: It is in the very nature of every staff to provide ladder rungs for diastematic pitch placement. Therefore, it is helpful to have available modifying symbols which cancel the impression of angularity of pitch movement, whenever desirable. In this regard, the symbols for transient pitches may prove to be even more often applicable than those for transient intervals. You can peruse them in the first (1) section of Appendix 31. I presume you are already familiar with the second (2) section dealing with pitch sequels. The gradually rising or falling pitch, emancipated from its reputation as a jocular device, became quite a serious resource in contemporary music. I doubt that any invented signal will ever come close to record or prescribe the subtle vocal or instrumental pitch inflections at artist's disposal. Nevertheless, the notation should provide for some symbols facilitating the expression of transient pitch levels. The realm of continuous pitch movement is too vital a force in musical expression to be sacrificed in favor of the artificially calibrated pitch spectrum.

NOT: I remember seeing some fluid lines trying to depict the continuous motion of subtly changing pitch levels. Does this practice belong to the category of graphs rather than to music notation?

PAN: If those lines do not have any anchors in diastematic pitch levels, they may as well suggest an atmospheric motion, of little help to the performer. That is why the symbols for transient pitches should be followed by pitch levels of arrival points. Following such procedure, in conjunction with precise durational symbols, will help eliminate possible misinterpretations.

NOT: Have we not exhausted all possibilities in the spatial parameter? It seems to me one cannot go any further.

PAN: There is always something we tend to forget. Do you realize, for instance, how important is the concept of transposition of pitch levels? You know that in the temporal parameter the transpositions may apply to shifting rhythms within a meter from one metrical position to another. The result may change the implied accents of the metrical hierarchy, and consequently change also the outlook of the rhythm. In spatial

parameter, transposition means the shifting of the same pitch event within the pitch calibration from one level to another. The result is also a change in the character of the pitch event, though the profile itself remains unchanged. Again, recall, please, that the profile of a rhythm does not change, as such, when you drag it across the real or implied bar lines. Yet, its character undergoes changes depending on how it is positioned within the meter. The new question is how notation can facilitate the recording and the recognition of a pitch transposition. You know already that it is inherent in the PANOT staff that it always depicts intervals true to their actual size. A transposed interval will never change its size on the staff. A transposed melodic profile will never change the pitch proportion between its members. If by some magic you move the staff lines up or down, and keep everything else intact, you will discover that you have actually transposed the music down or up, respectively. I have prepared a series of transpositions based on this principle to show you the practical application. They all feature the melody of the opening flute solo from the Prelude to *The Afternoon of a Faun* by Debussy, as it appears in Example 4.10 a) p.E40, and on the following two pages. In Example 4.10 b) p.E40 the transnotation is exact with regard to the absolute pitch level. You may pause for a moment and review all the signals used in addition to the disk notation. For the time being, disregard, please, those tiny signals attached to the middle of the stems. They indicate the dynamic levels and dynamic changes, in order to make the transcription complete with reference to the original. Check, however, the durational symbols for accuracy. The rhythm is complex and uses many fractional values. A review of Appendices 10 and 11 will not hurt, at this point. You would greatly benefit also from trying to write the two missing modes of the new notation: the staffless signals, and, particularly, the code syllables.

NOT: It will take me ages to construct the signals and to supply the codes. Should I use the same form you have shown in the previous examples? I mean should I write codes in vertical columns underneath the corresponding note heads?

PAN: If your handwriting is small, that would be best for the sake of immediate comparison. You can also stretch the codes in a straight line, starting every measure from a new line, for better clarity. Do not attempt, however, to draw the staffless signals too close to each other. They fail to communicate when they are crowded on the page. If you are not bent on saving paper, the combination of well-separated staffless signals with the code syllables underneath provides a readable account of music independent from the staff.

NOT: I do not see any changes in the same music on page E41, except for the absolute pitch of every note. Is this an example of a transposition by moving the staff lines?

PAN: You have guessed it correctly. Appendix 4.11 c) p.E41 shows the transposition by one degree up. The music starts with a "d two-lined" instead of starting

with a "c-sharp two-lined." In our terms, music is lifted from a "cokto" beginning to a "cokbo." It looks like you had to write anew every single note on the staff to effect this change. Save the labor by simply knocking down the staff system one notch down. Do not forget to adjust the ledger lines also; they will have to be moved but occasionally you will find them unnecessary. Can you expect the same results when moving the conventional five-lined staff up or down? Consider something else, while looking at the original score. Four sharps in the key signature suggest either the major tonality of "E-major" or the relative minor key of "c-sharp." You will be mistaken accepting "c-sharp minor" as the key of the opening phrase, only because it starts with this tone. The ending is also hardly indicative of any special key. However, the penultimate third measure is strongly suggestive of "E-major" tonality. How does it help you to conclude which key and which key signature would be used in the transposed version?

NOT: The key of "F-major" with one flat in its signature, if for no other reason than that "f" is a half tone above "e."

PAN: Now, how would you move the new staff system in order to transpose the music to the primitive key of "C-major"?

NOT: Let me think for a moment. The starting pitch is "c-sharp" the sixth degree in the original key of E-major. In the key of "C-major" the starting pitch would have to be its sixth degree which is the pitch of "a." The pitch of "a" lies four half tones below the pitch of "c-sharp" so I would have to move the new staff system four degrees up.

PAN: Example 4.13 e) p.E43 is the reward for your laudable solution. What a different picture of note heads in relation to the staff lines! At the same time, you recognize that you are dealing with the same music because its graphic profile did not change at all. One more transposition, marked as Example 4.13 f) on the same page, could be effected by either lifting or dropping staff lines by six notches. Since the interval of six traditional half-steps marks exactly one half of an octave, the transpositional direction is immaterial here. "B-flat" as the key and two "flats" in the key signature would be correct in this hypothetical situation. As much as the grid of staff lines is indispensable to determine the pitch levels, the melodic profile is so characteristic that it is perceptible in all its details even without the staff lines. You know already that it will always stay the same because all of its different intervals are frozen graphically into a fixed size. Example 4.12 d) p.E42 gives you an opportunity to see this profile naked without staff lines. Anytime you decide to superimpose the staff grid, you will not need to adjust this profile to the demands of different clefs in conventional notation.

NOT: The second (2) section of Example 4.12 d p.E42 is puzzling. I guess you wanted to see how the same melodic profile behaves under strictures of a different meter.

PAN: This is what I had in mind. The difference in meters is obvious. The first is compound triple, and the second one is simple triple. That is why you see a new measure for each one of the three compound beats of the original meter. Are you reminded of some familiar rhythm in the second (2) section?

NOT: Should I know this rhythm from previous examples?

PAN: I think so. Perhaps you can detect it by trying to play all the notes of Debussy's profile on the piano in new rhythm. Let it remain an enigmatic rhythm, for the time being. Let me know as soon as you discover its source. I do not want to bring up the whole baggage of history for you but a review of isomelic and isorhythmic procedures throughout the fourteenth and fifteenth centuries would provide you with most cogent examples. I will add only one comment regarding the melodic profiles in different rhythms. The eye and the ear may experience difficulty in recognizing familiar melodies in any but their original rhythm. Familiar rhythms in any but the originally assigned melodies may produce the same frustrating effect. In both cases, the notation should be a help and not a hindrance. If the human faculties fail, the signals, codes, and disk positions should identify the rhythm, melody or aggregates, if properly encoded in the computer memory. The new system provides already a notation which may be applied directly in computer programming.

NOT: I can think of an immediate benefit in recognition of canons. In traditional notation they are always subject to different shapes imposed by staff lines which do not always guarantee equidistant intervals. Are there any other benefits in the field of canonic recognition?

PAN: Of course, think only of dodecaphonic music which relies on the principle of recurring sets in every direction -- temporal, as well as spatial. In this sense, the whole body of this literature is "canonized" music. The new system is much kinder to recognition of the same sets in the score than the conventional notation. Ever since the pitch was divorced from duration in canons, the recognition of identical shapes was not an easy task.

NOT: I did not have enough of courses in analysis to fully appreciate the quality of directness in the message of new notation. It would also be nice to have machines check for you any inverted retrograde canons you may have missed either by the eye or the ear. Coming back to your demonstration of facile transpositions, I am greatly comforted that I can compose everything in the key of "C" and then move the staff two notches down to transpose everything automatically to the key of "D." The reverse of this process would be like writing in the key of "D" for a B-flat clarinet, and expecting everything to sound in the key of "C".

PAN: Do not worry about transposing instruments because in the new system everything appears in concert pitch. Talking about transpositions, I noticed that you like to use familiar terms. I am certain you will have no difficulty in forgetting eventually the "pre-diluvian" terms and exchanging such pitch levels as "c" or "c-sharp" for "zo" or "to," respectively.

NOT: This would not be difficult but I have one small problem with the new terminology. How are we to distinguish whether or not a "to" is actually an old "c-sharp" or a "d-flat"?

PAN: An excellent question. After all, every time you transcribe pitch levels into new notation you lose irretrievably all accidentals. A reader cannot tell if the pitch of "vo" was originally a "g-sharp" or an "a-flat." You assume, of course, that such information is crucial to understanding and analysis of old tonal systems with all their transpositions and modulations. There is a special provision for such need, in the new system. Find it, please, in Appendix 32 under positions (g) and (i) of its first (1) section. I may have mentioned already that those symbols can be used primarily for minute raising or lowering of pitch levels by a few cents. The numbers placed in ovals are microtonal modifiers of whatever pitch levels they affect. At the same time, they can be appended to any pitch level which is not a "natural" originally, for the purpose of clarification of its original pitch. For example: an original "g-natural" should be transnotated as a "po" but the original "f-double sharp" should use the hand appended on its right side (crossed hand to distinguish it from a single "sharp") and the code: "po-seüs." This handling informs the reader that the pitch "po" is a product of an originally "double sharped" pitch. Insisting on amending every non-"natural" pitch with those special signals may erase all the benefits of an accidental-free notation. Perhaps we should leave alone all those pieces written in key signatures with a high number of chromatic signs to be performed from originals? I do not see, however, how much would be lost if you tried to play Bach's Eighth Prelude and Fugue from the first book of the Well-Tempered Clavier from the PANOT transnotation. You may remember that the venerable composer left the Prelude in the key of "d-sharp minor" with six sharps in the key signature, and the Fugue in the key of "e-flat minor" with six flats in the key signature. Add all the necessary amendments for the accidentals, and imagine how crowded the new score would look. The best compromise may be to copy the old key signature in modern terms on the new staff. The first sharp being a "f-sharp" would be represented by a "go" head with an appended hand on the right side, and the rest of them would be transcribed similarly. The same method could be applied to the flats of the original key signature. Ponder this problem and see whether or not you can come up with better solutions.

NOT: Yes, indeed this is a vexing problem. Is there any truth to what I was told that actually a "c-sharp" is closer to "d" than "d-flat"? If so, perhaps we should recognize the division of a whole tone into three portions?

PAN: When you look at one of the traditional spellings of a 18-tone scale in Appendix 38 you will see that a "c-natural" is followed first by a "d-flat" and then by a "c-sharp." The preference given such a sequence is understandable. You have heard that chromatic tones tend to resolve in the direction of its chromatic inflection. If "d-flat" hugs "c" and "c-sharp" hugs "d," then such a succession is justified. You understand, of course, that such deliberations concerning the keyboard instruments are at best a moot point.

NOT: Would abandoning the 12-tone scale in favor of the 18-tone scale improve the chances of a more sensitive division of a whole tone?

PAN: There are many musicians who think so. There exist also compelling reasons for regarding third-tones as acoustically more justified than the compromised half tones. Before you go any further, let me assure you that embracing any other than 12-tone scale is unnecessary, except in special situations. Look once again at Appendix 38, and at the DYS-NOT of the first (1) section. Notice how the little hooks modifying the first three notes are sufficient to identify the three-partite division of a whole tone. This is not to say this is the only way to notate those pitches. Instead of marking the second note as "zo(bi)-lös" you can mark it as "bo(bi)-bum-löf." That means that you do not regard the second note as lifted one-third of a whole tone up from "zo" but as lowered two-thirds of a whole tone from "bo" (the fourth note). You will have to change the position of microtonal hooks to the left side, in this case. So much for the three divisions of the first whole note. Supposedly the next whole tone does not call for this type of division but for two plain half-steps. You know by now that the next half-step up from "bo" will be "lo" which is just a step in modern system and does not need any microtonal modifications. The next whole step from "ro" to "go" may suddenly require five divisions. You do have notational resources at your disposal because most of the 31-tone scale is based on such divisions. I hope you understand by now that an *a priori* determination of the microtonal scale is not necessary. You can notate any microtonal divisions according to need at any time in the score. The designation of a special scale may be helpful, however, if the entire piece or a particular instrument use this tuning. Remember also, please, the space signatures listed in Appendix 40 for use in protracted music of a specific symmetrical tuning. The exotic tunings of the past or our own times are relatively easily effected on keyboard or fretted instruments (acoustic or electronic.) Other instruments can profit from a special notation which approximates the desired pitch levels. The proliferation of special symbols for the asymmetrical tuning systems is overwhelming. It is doubtful that musicians will ever master the intricate signals invented for scales having 53 tones to an octave. The notation relying on cents or ratios may be the answer to such and similar scales. The practicality of such notations for live performances is another matter.

NOT: Aside from those exotic notations, how do you want to implement your notation? When is the best time to introduce PANOT for practical use? You said that transnotations from the traditional systems may suffer from excess of modifications if

you desire, for instance, to preserve the identity of old chromatic signs. Do you favor then a clean cut with the past notations?

PAN: We may have to continue with reading the old literature from originals, and hope that new literature will be written in a modern system. That presupposes generations of musicians who would have to become a sort of "bilingual" experts in matters of music notation. The clean cut is an impossibility. The gradual change is much more likely in the future. The changes in music notation are possible when new generations of musicians will not yet have pledged their exclusive allegiance to the outdated script.

NOT: Are the future composers the ones who are the most likely catalysts for change?

PAN: Most assuredly, the composers preference for a method of notating sounds will play an important role in conversion to any new system. Performers will follow if they feel the investment of their time for learning the new system is important for their future career. The key to change will be probably in the hands of music publishers. Their willingness to pioneer in the dissemination of new notation would give an enormous incentive to composers and performers. I am afraid that to think of any notational reform succeeding without a well-endowed and committed publishing house is a dream of a cut-off head.

NOT: We are rapidly approaching the end of the day, and I will quit asking questions calling for prognostication. I appreciate very much your giving me some views on the potential of success for any notational reform. I will soon retire to my pad trying to review the entire material concerning spatial relationships and their representation. How do you want me to go about it? Reviewing the pertinent appendices and examples, starting from the beginning? Consulting my notes?

PAN: All those approaches are legitimate. My concern is not so much about the theory but about building up your ability to write music in new system. Try to reinforce whatever you learn with an immediate practical application. There are plenty of opportunities for transnotation, particularly in examples where certain portions were intentionally left incomplete for such purposes. Mastering the new system is more a matter of practical application than of abstract logic. Before you start detailed reviewing take a good look at Appendix 41 which presents a collection of spatial signals together with most of the corresponding codes. Diagrams of this sort tend to have an intimidating effect on onlookers. They are the most condensed source of information to be filtered with an eye for specific application. The complexity is due to the fact that all signals, from the most frequently used to the most rarely applied, are coming together under one roof. The signals radiate from the central space hub in a fashion similar to temporal signals which you have seen already radiating from the time hub in Appendix 24. Unlike the case with

temporal signals, the disk notation makes some signals redundant. An explanation is in order. You remember that to record a pitch of "rokto" (traditionally, a "c-sharp one-lined") all you need is to place the disk above the short ledger line underneath the staff system provided with a "rok" or fourth region clef. In order to express the same in a staffless fashion you will need signals suspended to the left and right from the space hub and marked "qok" and "qo", respectively. The signal flag on the left arm will change to a double bar representing the value "four" or "r" in modern terms. The signal flag on the right arm will change to a single dot representing the value of "one" or "t" in modern terms. Keep in mind that you will need this array of signals only when you elect to abandon the staff notation.

NOT: So, the complexity of such a diagram is unavoidable when three modes of notation are involved: staff notation, signal notation, and code notation.

PAN: Precisely so, because disregarding the signal notation would leave the diagram much less dense. Now consider the recording of an interval of four octaves and a half-step up from the so-called "middle c." Let us suppose we deal with a simultaneous interval, and are ready to record it on the staff, that is as a disk notation (DYS-NOT). Placing the disk on the short ledger line at the bottom of the fourth region, you fix the pitch level of "rokzo" as a lower anchor. The upper limit of the interval is to reach four octaves and a half-step so you have to place the upper disk above the short ledger line in the eighth octave region. The account of this interval in terms of signal notation will call for the left and right side of signals erected above the space hub. They are identified by the code names of "qik" and "qi," respectively. You will have to substitute "q" with "r" again to conform with the value of four octaves, on the left flag. Furthermore, you will have to substitute "q" with "t" to conform with the traditional value of one half-step, on the right flag. This array will read: "riktims" in modern notation. Your code for the same interval in a linear form will read "riktis" and you will need to shift your disk to the right from a vertical alignment on the staff. Not all signals can be substituted by staff notation. Octave reciprocals with step reciprocals (microtones) will use signals in addition to the disk notation, particularly when peripheral and interjacent intervals are involved. This is why you see such a dense superstructure in the upper part of the diagram. A similar situation is depicted in the diagram collecting all the temporal signals in Appendix 24. The time or space signatures occupy much space in both cases. The time signature is extracted from the collection of temporal signals and appears separately in Appendix 20. The space signature is also extracted from the collection of spatial signals and appears separately in Appendix 40. Erase those signatures, figuratively speaking, and you will be surprised how transparent the remainder of the diagram becomes, in both cases.

NOT: The diagram is full of those modifying flags utilizing the consonants "f" and "s" for their codes. I am confused as to tracing the flag arms to which they are attached.

PAN: Yes, this presents a problem on a condensed diagram like this one. Go back to Appendices 30 and 32, for a moment. Find the second (2) sections in both appendices and try to retrace the direction of the diagonal arms in their signals to the diagram in Appendix 41. Compare the signal corresponding to the code "fo" to the signal corresponding to the code "fi," and transport them mentally to the collective diagram. Similar comparisons made between single signals in appendices and their places on the diagram will help clarifying their construction.

NOT: There seems to be some parallelism between signals pertaining to either pitch or intervals. I have notice it looking at your last example. Did you have any particular plan in constructing the signals?

PAN: The distribution of signals follows an organization dictated both by logic and convenience. You see that most of the signals identifying pitch are grouped in the lower part, whereas the signals connected with interval identification are placed in the upper part. It is not always possible to adhere to this rule, because other considerations may interfere. The collection of temporal signals is also organized according to the principle of keeping articulation, duration, and tempo signals together. There are also some other principles which make both the temporal and spatial collection alike. You may have noticed that signals featuring absolute values differ from descriptive values. It is not only the thickness of the flag itself which denotes an absolute value. The purely descriptive values are thinner in graphic appearance. An important part of distinguishing absolute from descriptive values is the angle their flags form with the arm which carries them. The flags with absolute values form a right angle with their arms. In contradistinction, most of the descriptive flags form any but the right angle with their arms.

NOT: Let me find quickly an example, while looking at Appendix 41. The signal identified with the code "qu" in the upper part of the diagram has a thick flag attached under the right angle to the arm radiating diagonally from the hub. This signifies a definite value of a step-reciprocal or a microtone. You need only to substitute "q" with a consonant from the alpha-clock to define its numerical value. On the other hand, when I look at the thin flag extending from the same place of attachment vertically up, I realize that this must be a modifier.

PAN: It is a modifier of any interval, as the beginning syllable of the code: "ji" indicates. It is to be used with an up-directed interval, as the consonant "s" indicates. It may incorporate the consonant "m," in case the interval is supposed to be simultaneous. Did you notice that its flag is at 135° angle to the arm growing from the hub?

NOT: This is not the only angle formed between the non-absolute values and their carrying arms. Right?

PAN: A 45° angle is very common with its mirror 315°, also 225° as a complementary angle to 135°. A 180° angle is an exception due to its protracting nature, and it carries either absolute or descriptive values, depending on circumstances. The orderly assignment of angles should help in recalling the shape of signals whenever they are needed.

NOT: In your arrangement of the diagrams, you have placed the temporal signals at the top of the stem, and the spatial signals at its bottom. I understood from previous descriptions that this orientation can change diametrically.

PAN: You can have the signals of the temporal parameter at the bottom of the stem, and the signals of the spatial parameter at the top. On the staff, you change the stem direction all the time. Even in the staffless signal notation, there is hardly any problem with confusing the location of parametric signals. The spatial signals are quite distinct from the temporal signals. Take a look at Beethoven's music in signal notation as it appears in Example 4.6 c) p.E33. In addition, look also at Mozart's music in signal notation in Example 4.5 b) p.E29. Could you possibly mistake spatial for temporal signals in those examples?

NOT: Since there is no need to invert the stems' direction in this type of notation anyhow, could one expect this orientation to be typical and remain as a model?

PAN: No objection to this orientation, of course, but it is comfortable to know that you always can substitute alternatives. The other mode of notation also offers frequent alternatives. I mean the code notation with all its options for separating syllables by commas, semicolons, hyphens, slashes, parentheses, or brackets.

NOT: I still do not fully appreciate the code notation. Is its purpose to facilitate the dictation?

PAN: Its potential importance cannot be overestimated. First of all, it provides terminology for the most important sound phenomena. This terminology is based on consistent principles unifying all parameters. Not too long ago, you were examining the use of selected vowels and consonants in basic codes of the temporal parameter in Appendix 4. More tables dealing with selected marks for use in codes followed in Appendices 5 and 6. Finally, Appendix 7 suggested the mutual exchange between numbers and consonants for the decimal, as well as for the duodecimal numbering systems. You can extend now the knowledge gained from those early appendices to the spatial parameter. Appendix 41 will assist you again in surveying the elements of code language. There is hardly any change in use of consonants. Their alphameric character is the same as in the temporal domain. The change is reserved to new vowels which are used exclusively for the spatial parameter. The most often used vowel "o" is connected with symbolizing pitch levels and octave regions. The less used

vowel is "ö" which is reserved for microtonal levels of pitch. You can see their usage in connection with consonants in Appendices 30 and 31. The frequently used vowel "i" is always associated with intervals. The less frequently used vowel "ü" serves all interval reciprocals including, of course, all step-reciprocals which are microtones.

NOT: Pronouncing the vowels of the temporal values was less of a problem than it is with these vowels. I suppose people speaking German should not have any difficulty with those *Umlaut* sounds.

PAN: No matter what one does to create a language of universal acceptance, pronunciation will always be a stumbling block. I must apologize that I could not do anything better than to establish a few arbitrary rules. A limited table within one page, as outlined in Appendix 2, is hardly satisfactory. Expanding on it would only increase complications and discourage even those people who are favorably disposed toward learning the new system. Authenticity of a correct pronunciation is not an objective here. Approximation will do probably for the sake of understanding each other. The sound of "ü" is not too difficult to achieve if you attempt to pronounce "u" (which in itself is pronounced as "oo" in "moon") through the mouth filter of "i" (pronounced by itself as "i" in "police.) In the same way, you could approximate the sound of "ö" by attempting to filter the sound of "o" through the vowel "e" (pronounced as "e" in "ten".) For uniformity's sake, there are also some surprising consonant sounds. If you look at the table in Appendix 2, notice the recommended spellings and pronunciations of consonants listed as the following current numbers: 17, 18, 20, 23, 25, 31, and 34. Remember that according to our first characteristic of an ideal notation, as listed in Appendix 1, we should aim at developing symbols and terms for adoption by people from different civilizations, language families, and educational backgrounds. This is the reason for the tortuous rules of pronunciation and arbitrary spellings.

NOT: I cannot any longer call a quarter-note a "quarter-note," nor a g-sharp a "g-sharp." The syllabic code directs me to call them a "re" and a "vo," respectively. Do you mean that the syllabic code completely replaces the old nomenclature?

PAN: First of all, you do not call a quarter-note a "re" if you transcribe from a conventional measure of four quarters. They each become a "ta" or a tact unit. A "re" would be justified as the fourth division of a tact. If the original uses sixteenth notes, each of them would be a "re" deserving a double flag or beam, the same way as they appear traditionally. Secondly, the syllabic code provides a uniform basis for the practice of referring to sounds. This is consonant with the fifth characteristic which suggests a notation which applies the same formative principles in its terminology, and which is consistent in generation of graphic icons.

NOT: The collections of spatial and temporal signals have convinced me that the generation of signals is consistent not only in their separate parameters but also across

them. I must admit that the same consistency and uniformity underlies the syllabic codes which constitute the new terminology.

PAN: Look at all this from still another point of view: a "ba" is always two facts, a "be" is always a half-note, a "bumbe" is a double half-note which equals a tact, a "bube" is a twice reiterated half-note, a "bebu" is two reiterations within a half-note. Furthermore, a "bok" is the second octave region, a "bo" is the second degree of a 12-tone scale, a "bö" is the half-degree or microtone, a "bi" is a two-step interval, a "bü" is the half-step microtone. Notice how consistently number 2 plays a role in association with all those different vowels. Do you regard this system as providing a high degree of uniformity and consistency?

NOT: Undoubtedly the system links all the different manifestations of sound elements into one reference pool. It still remains to be learned before I can use it with a reasonable degree of confidence.

PAN: The other advantages of using syllabic codes could be tied with their potential for computer use. It is rather hard to predict which of the three modes of notation lends itself best to computer programming: the staff notation, the graphic signals, or the syllabic codes. The first two modes which rely on graphic images may prove more direct and less time consuming in generating non-live performances. On the other hand, syllabic codes may feed the information directly from the typewriter keyboard to the computer for a printable monitor image of the staff notation. Only future can tell which of those notational modes will be found most viable for computer application.

NOT: What else should I learn about the symbols of the spatial parameter? As a matter of fact, I just noticed a strange signal extending downwards from the space hub, and labeled: "qosoq" as the syllabic code. I am still looking at the collection of spatial signals in Appendix 41.

PAN: The signal and its appertaining code are listed in the last position (k) of the first (1) section of Appendix 30. As you know from your own experience, the notation of harmonics (or partials) has been for a long time subject of animated controversies and various options. The new system appends a simple armless flag at the bottom of a disk in staff notation standing for the ordinal number of a partial involved. I had better stress the word: *ordinal* because it is an exception for this flag symbol to indicate any other than cardinal value. In this case, the ordinal count of partials is accepted as the basis for their values. Therefore, the first partial, which is in our count the fundamental of the tone, is symbolized by a single dot underneath the hub (or disk.) You see this specific application in position (i) just above the position (k) which pertains to all the upper partials. Would you be surprised, if you would see dots under the disks of a soprano part?

NOT: I rule out *staccato* dots as you find them in piano music. Otherwise, how can sopranos produce fundamental pitches only? You must be kidding. Besides, how would this notation affect the text?

PAN: I did not say that sopranos had a given text to sing. Hypothetically, they may have an annotation: "*bocca chiusa*" to their part. Do you know what tone you can produce when you close your mouth? Can you make a connection now? Humming produces a fundamental tone as a rule, and you can prove it to yourself by watching the sine wave unencumbered by overtones on the oscilloscope. Therefore, dotted notes may, as well, denote humming in vocal parts.

NOT: Can you give me an example of the notation for a harmonic in an instrumental part?

PAN: Gladly I will do so. Take a viola part, for example. Let us suppose you want to generate the fourth partial (the third harmonic) above the lowermost tone of the viola which is "*lokzo*" (traditionally, "small c" on the open first string). The fourth partial will be two octaves higher which results in the pitch of "*cokzo*" ("c two-lined, in familiar terms.) Make use of the partials flag valued at four, and append it underneath the hub or disk for "*cokzo*." The proper code for this partial should read: "*cokzosor*," according to what is listed in position (k) of the first (1) section of Appendix 30. There may be some other ways of writing harmonics which are better suited to the nature of specific instruments. This system does not recognize the method of overtone production but the resulting pitch only. This, alone, is a simplification of traditional methods which tolerate sometimes as many as three symbols to denote one single harmonic.

NOT: The symbols-collection seems to grow endlessly. I really do not see anything I may have missed in Appendix 41, except for those codes which stand alone in oval enclosures without any flags. I understand them as substitutes for the numerical values of interjacent segments ("*qu-sei*,") or cents for every segment ("*qu-fei*,") as appearing in the upper portion of the diagram. The corresponding ovals in the lower portion of the diagram are occupied by a number referring to the pitch level in Herz or cycles per second ("*qu-seo*,") on the left side, or by a number referring to the standard of tuning in Herz or cycles per second ("*qu-feo*,") on the right side. The two vertical ovals at the bottom of the diagram signify the modification of an interval by a few cents up or down. They may also supplement a given pitch degree with information on their original chromatic inflection in traditional notation. The two codes are: ("*qu-seü*") and ("*qu--feü*,") in case of number of cents modifying intervals, and ("*qu-seü(f)(s)*") and ("*qu-feü(f)(s)*,") in case of original accidentals.

PAN: Let me add that the first option ("*f*") stands for single "sharps" or "flats," whereas the second option ("*s*") is reserved for double "sharps" or "flats." The inside of ovals is supposed to remain empty but the diagonal arms should be crossed with

a central episema for double accidentals. Although the complexity of those signals and codes is considerable, their usefulness is rather limited to exceptional situations. Nevertheless, transnotations preserving the original chromatic signs are possible in case of need. I have just mentioned central episemas, and I remember now having left them out in our previous discussions. Both central and terminal episemas are listed at the bottom of Appendix 9. Their role is important in modifying many signals in temporal and spatial signals. They are left out in Appendix 41 for the reason of avoiding cluttering the diagram with details.

NOT: This must be the end of surveying all those spatial symbols from this seemingly inexhaustible collection in Appendix 41. What else does one need to account for the movements of pitch and intervals?

PAN: There are still certain signals implied in this collection which are not apparent in the diagram of Appendix 41. It is important to set aside symbols leaving the choice of pitch levels or interval sizes to the performer. Although those symbols are integrated in the collection, you can see them better at the bottom of Appendices 30 and 32. They both permit a free choice of either the optional zone (for descriptive pitches) or the optional compass (for the descriptive intervals.) Similar options are offered for transient pitches and intervals, as listed at the end of the first (1) sections of Appendices 31 and 34. Their signals are easy to recognize by their symmetrical shapes, and their code-vowels are always prefaced by "fs" consonants.

NOT: The transient pitches and intervals must be in themselves a rather esoteric concept. The *glissandos* are probably the only practical application on a keyboard instrument or on the harp. The gradually changing pitch movements are quite effectual in the human voice, and melodic instruments; even kettledrums can demonstrate them by manipulating the tension of membranes, I do not see how transient intervals can be anything else but linear intervals. Is the arrival point for transient pitches and intervals always determined by the following note?

PAN: The arrival points may be left to the discretion of the performer. Imagine a situation where a long note or interval marked with transient signals are separated from the following note by a series of rests. Obviously, the choice where to finish the gradual transformation is up to the performer (this includes the conductor.) It is only when the affected duration touches directly on the next pitch event that it is mandatory to complete the gradual transformation with the next pitch level or interval size. Your concerns about transient pitch movements are quite understandable. Most of the traditional pitch movements occur diastematically from level to level leaving the fine gradations to be controlled by the demands of style and performance practice. In some situations vocal scoops are not only permissible but even desirable. There is no specific notation reserved for gradual pitch changes. The conventional notation of pitch movement resembles a stair-case profile rather than the movement of a snake. The wavy

line from note to note is being increasingly used in contemporary scores. I would not have anything against the use of undulatory lines, provided their pitch anchors are visible from time to time for reference.

NOT: Your attitude toward the frequently used modern devices is not only that of tolerance but also of approval, if compatible with the new system. Does the same go for symbols designed to embody aleatoric principles?

PAN: Start regarding the new system as a scaffolding of consistent pillars and logical beams; a system which permits compatible modern variables to be used alongside. Take also in consideration that idiomatic notations will continue to be developed for any conceivable media generating sounds. The notation for an organ will differ from the notation for a cello. Each one of them will rely on a set of idiosyncratic symbols which are particularly effective in its medium. It is rather uncertain what kind of advantages would be gained by transnotating a lute tablature. The tablatures are apparently the highly idiomatic touch notations which address the performer directly without any pretense for graphic analogues. A lute player well versed in all kinds of tablatures faced with a transnotation in our system would probably still opt for the tablature. The complexities of an unfamiliar new system would not be the only reason for this preference. Most likely, the transcription into the traditional notation would be also rejected in favor of the original tablature. Although it is possible to transnotate the notations of the past into the new system, it remains an open question when music should be performed from the original notation.

NOT: Is then a compromise possible featuring new coordinates and still preserving the salient points of an idiomatic notation?

PAN: PANOT provides a general notation which should profit from every advance in modern concepts. It should aim at incorporating those new elements, after filtering them through the principles of unity and consistency. It should also examine the idiosyncratic elements to prevent possible conflicts with already existing signals or to eliminate redundant symbols. It is very difficult to avoid editorializing when transcribing. Here lies the problem every time somebody attempts to lift music from the original script or print to a different notation. Nowhere is this problem more acutely felt than in trying to transcribe old ornaments. Of course, you can transport them without any change into the new system. This method presupposes some kind of an additional glossary which suggests the performance of those symbols. You can also use open disks for note heads when you want to emphasize the optional character of those ornaments. That means you are leaving to the performer whether or not to use them at all. Would you, then, use open disks for Handelian appoggiaturas or some recitativic cadences though their time-honored tradition of performance is different from what they look like in the original score? If you want to incorporate the small-note embellishments, or some other symbols standing outside the meter, into the metrical fabric, you cannot help editorializing. You realize, I

hope, what kind of metrical monstrosities can arise from such treatment. Just imagine the simple trill written out in 128th-notes for the duration of whole note, in conventional notation. The whole reason to avoid such complexities was in deciding on a "tr" symbol with a wavy line following it. Do you have to invent new symbols for such ornaments when you are ready to transnotate? Do you opt for putting all ornaments written out in the metrical straight jacket? Bear in mind that the moment you transcribe an appoggiatura as consisting of two long notes, you interpret it and eliminate other options for performance. Furthermore, once you decide on the trill starting from the upper note, you may find out that just the reverse was meant by the composer. Give some thought to such questions and concerns. Still better, see for yourself how different editors treated Bach's ornaments in the *Aria of Goldberg Variations*. The new system provides for very simple transnotations of some ancient embellishments. It is already within your capacity to figure out the best ways to notate them in the new system. Let me remind you that you can go as far back as to Appendices 3, 12, 14, 16, and even 21 to review the temporal options for transnotating old ornaments into the new system.

NOT: If I am not ready reviewing the previous appendices by tomorrow, I will try to cover them during the weekend.

PAN: Thank you very much for your declaration of intention. There are so many things which come to mind, and which I wanted to let you know, but the hour is growing rather late. I will expect you tomorrow for another day of deliberations on a parameter which is quite different from the domain of time and space.

*

THE FIFTH DAY

NEW SYMBOLS FOR DYNAMICS AND TIMBRE

PAN: Hello Mr. NOT! Did you try to identify the enigmatic rhythm to which Debussy's melody was subjected?

NOT: Last night, I looked over all the examples we have examined yesterday. It could be not any other but the rhythm of the Mozart minuet underlying the melody by Debussy.

PAN: What is the point of such an anachronistic impudence?

NOT: I suppose it is to prove that the identity of any familiar melody may be obscured with the change of its rhythm. We take for granted that melody and its rhythm are inseparable. We lose the identity of the melody or the "tune," in popular terms, as soon as its profile is anchored with durations other than the original ones.

PAN: Both the rhythmic and the melodic attributes are necessary to recognize the identity of "tunes," as you called them. The notation which fixes precisely the melodic profile makes its recognition easier. Mozart's rhythm from Example 3.2 b) p.E12 and Debussy's melodic profile from the first section (1) of Example 4.12 b) p.E42 are fused together in the second (2) section of the last example. It takes three isorhythmic patterns of the minuet to fit the flute solo. The composers of the fourteenth and fifteenth centuries must have delighted in such rhythmic ostinatos. It took some time to discover such a compositional technique. Today we call the repeated rhythmic pattern a *talea*. The first *talea* extends in the minuet from the *anacrusis* to the first measure, throughout the trimeter, up to the *anacrusis* to the fourth measure, exclusive. Then it is repeated up to the last "beat" preceding the seventh measure, and once again (though not exactly) up to the ninth measure. Incidentally, the flute solo of Debussy features the same rhythm in the second measure as in the first one. Imagine extending the same rhythm for the third time to the remaining notes in the third and fourth measures. Obviously the first two measures share the same rhythm and melody. The third measure would continue with the same rhythm but not the same melodic profile. The device of repeating the first motive and diverging from it on the third time is found very often in music.

NOT: Are we more conscious of the independence of melody and rhythm attributes today than in the past?

PAN: Much of contemporary music depends on separation of those parameters, if for nothing else than for purely structural reasons. We are expected to perceive them as independent entities and not always as inseparable Siamese twins. The modern notation should be assisting in graphic perception of musical gestures which may retain only one of the former twins.

NOT: What faculties should be trained in aural perception besides the graphic recognition?

PAN: You can simply begin by playing the flute solo by Debussy at the keyboard. Then, after you get acquainted with its sinuous melody, try to play the same melody in the rhythm of the minuet outlined in the second (2) section of Example 4.12 d) p.E42. I do not recommend singing it first because I have still to find a student who could sight-read this chromaticized melody with a modicum of success. You may also try to play the third and fourth measure of the Debussy example in the same rhythm of the first two measures.

NOT: I recognize the benefits flowing from such exercises. I can only hope that my general musicianship will profit accordingly.

PAN: Did you notice how I went on a tangent right from the beginning of our meeting? I could not resist talking about those matters which have only a tangential relationship with notation. Our main purpose of today's meeting is to examine the new symbols for dynamics. You know already that this parameter of musical sounds is quite different from the parameters of time and space. First of all, it is non-modular in character. Its structural elements are unlike the metrical and durational modules. It does not share well-defined units of measurement with pitch and interval. The customary way of indicating the dynamic levels by abbreviated letters from the Italian language is dealing with relative and not absolute values. The relativism is further complicated by the lack of agreement whether or not the dynamic markings refer to the individual voice or instrument. Is a trombone's *piano* comparable to the harp's *mezzo forte*? Does the pianist have to tone down his *fortissimo's* on a concert grand piano in a small room? Do we need any dynamic markings for the music for a clavichord? Such and similar questions arise when considering the meaning of dynamic signs. Modern practice shows some attempts at fixing the absolute dynamic levels in decibels. As commendable as this usage of numerals may be, it still depends on variable acoustics for performance. Some composers and performers object to this practice by preferring the dynamic levels to be left rather vague.

NOT: Are not those controversies only confirming the fact that music notation for live performance can at best indicate the approximate values? At least, it seems to be so, particularly with regard to the dynamic parameter.

PAN: The modular parameters of time and space can afford better precision in relation to their elements. However, you must have noticed that we have met already with the problem of relative values and establishment of arbitrary levels in trying to determine the different levels of tempi. Similarly, a table of dynamic levels is possible to construct arranging them in arbitrary twelve levels, as you can see them in Appendix 44. The grouping in softer and louder levels reminds you of the slower and faster grades in the Table of Tempi in Appendix 17. You will notice, also, that signals and codes operate on the same principles as established before. The vowel "y" (pronounced as "i" in "dim") becomes the chief identifier for dynamics code notation. The configurations of the signals correspond to the same conversions between numbers and icons as seen before in time and space parameters.

NOT: The placement of signals, however, is different from the one I have seen in the table of tempi. In the last case, they dangled at the bottom of the stem, and now they protrude to the left from the center of the stem.

PAN: You will see soon that the illustration of signals in this table is incomplete because it represents only the initial levels of dynamics. You need to turn now to Appendix 42 for the broader treatment of the specific placement of dynamic signals. The dynamic hub is placed as a rule in the middle of the stem; see position (a) of this appendix. In practice, it may be placed anywhere between the upper time-hub and the lower space hub. Caution must be exercised that the signals emanating from the dynamic hub be not confused with signals belonging to those two other parameters. Please, remember that the directions of all the following dynamic signals are adjusted to this fundamental position where the time signals are above and the space signals (or disks) are below. In case of inverting the stem direction for the note, everything else is inverted according to the rule of the vertical flip. In position (b) of Appendix 42 you see the placement of signals for the weaker dynamic levels. Let us suppose you write a note on the staff with the disk above the time signals. You have actually inverted the stem direction. Consequently, your dynamic signals for weaker levels will look like the one illustrated at position (c). That last signal indicates the strong dynamic levels only when the space signal (or disk) is underneath the time signals.

NOT: This whole stem inversion problem may cause a lot of confusion. Is there a way to avoid potential misunderstandings?

PAN: Well, some sort of a rule must be established and adhered to. In case of flags in the traditional music, they also invert according to similar principles. There are some inaccuracies, but the right hand flags still remain on the right side when inverted.

Every time you invert the direction of the stem, all diagonal signals which rise from left to right will drop from left to right. Vice versa, those which drop from left to right will rise from left to right in inverted position. Example 3.6 b) p.E21 is the best page to see how the signal marks for dynamic accents look when stems' direction is inverted.

NOT: I am surprised that you have transnotated the accent marks so early in our study. Did we not discuss them while examining the tempo modulation?

PAN: You remember well. The transnotation of an excerpt from Elliott Carter's *Canaries* used the inversion of stems' direction to juxtapose a few sections differing in meter and tempo. The accents seem to be such an integral part of this music that I have included them in new version. Very often accents are considered to be part of the articulation. Articulation, in itself, involves also the temporal aspects of sound. Judiciously placed accents may change the way music is articulated. When we discussed this example on our third day, I have mentioned to you the crucial role the accents play in measure 9. They are responsible for the way those quadruplets of sixteenth-notes are articulated, and ultimately for the speeding up of tempo.

NOT: So, there are no hard and fast rules for considering accents as parts of either the temporal or the dynamic category. Is this what you are trying to emphasize?

PAN: There are some types of accents, for instance the agogic accents, which are definitely part of the temporal articulation. Dynamic accents, although part of the dynamic parameter, may support or contradict the metric hierarchy thus having also articulative powers. There are two types of weak accents and two types of strong accents. Their codes and signals are listed under positions (g) through (j) of Appendix 42. There is also a provision for an optional accent under position (k).

NOT: The remainder of Appendix 42, as represented by positions (l) through (r), looks like a cryptogram to me. What are those "intra" and "terminal" levels, and what is their application?

PAN: First, I would rather have you turn to the next Appendix 43 which presents a table of fluctuating dynamics. It will be easier to understand those other dynamic levels in Appendix 42, after you see all the different ways in which dynamics can fluctuate. Let us take up the different modes of gradual decrease, as outlined in the first (1) section. The first three positions (a) through (c) show the codes and signals to be used for the beginning of decrease (or traditional *diminuendo*) for more than one articulation. The term "inter" means simply that gradual decrease of a dynamic level will occur throughout more than one articulation or between articulations, if you will. The three codes and signals differentiate between the different speeds at which the decrease occurs. If a slow decrease is desired, then symbols of position (a) should be used. The low point of decrease will be reached toward the very end of this process. The opposite will occur if

symbols of position (c) are desired. The low point will be reached much sooner than in the first case. The middle position (b) will indicate the ordinary decrease, and will be best for transcribing most of the terms such as *diminuendo* or the customary hairpins open at the left side. All codes and signals of the next group of positions (d) through (i) refer to the "intra" concept which means the fluctuation occurring within one single articulation. In the first (1) section we are concerned with the gradual decrease. Look at positions (e) and (h) which illustrate the ordinary decreases for the beginning of the sustained note, and for the ending of that note, respectively. The other positions merely regulate the speed of gradual fluctuation. By combining the signal corresponding to the code "fufyj" with the signal corresponding to the code "sufyj" you should see a long diagonal line starting at the top, left, and ending at the bottom, right, after having intersected the stem in the middle at the dynamics hub. This would be a sound picture of a sustained tone gradually decreasing in its strength throughout its duration. You may, of course, use either "fufyj" or "sufyj" separately thus suggesting that either the first half of the duration decreases only, or that the second half of the total duration decreases only, respectively.

NOT: Obviously, those "intra" signals have no meaning to a pianist, since they refer to instruments which can sustain and control their dynamic levels.

PAN: Do not forget the human voice which lends itself eminently to gradual control of dynamics. You may have heard of the term "*messa di voce*" which was used in *bel canto* style of singing and which was transferred to the baroque style of playing certain instruments.

NOT: I have heard the term but I do not recall its exact meaning. Was it a practice of slightly swelling and receding from a sustained tone?

PAN: The performance practice of Baroque compositions permits and even encourages this manner of performance of single notes. Today, we hardly could use this prescription for contemporary music, unless explicitly marked for this effect. Do you know what signals you would use to achieve the gradual increase at the beginning, and gradual decrease at the end of a single sustained note?

NOT: Let me look at the second (2) section of Appendix 43 to find the symbols for the gradual, ordinary increase within one articulation. Under position (e) I find the symbols pertaining to the beginning of an ordinary increase within a sustained note. The code notation lists "fusyj" as the proper code notation. Am I right so far?

PAN: Yes, you are. Go on, please, with the second half.

NOT: The other position for the ordinary decrease during the second half of the same articulation should be found in the first (1) section. Here it is under position (h) and the code coordinate of "sufyj." The result of the combination of "fusyj" with "sufyj"

should represent the gradual increase to be followed by the gradual decrease within the same articulation.

PAN: In signal notation this would look like a rectangular wedge pointing upwards. The tip of the wedge should be located on or close to the dynamics hub on the stem. Graphically, this would remind you also of a rising and falling shape of the "inside" (or "intra") *crescendo* and *diminuendo*. Be careful not to extend this analogy too far because with inverted stem positions the rectangular wedge would point downwards.

NOT: To summarize, I understand the "intra" symbols as a separate family of signs to depict what can transpire inside a single sustained articulation with regard to the fluctuating dynamics. Do you really expect composers to be so fastidious in using all those notational opportunities?

PAN: Remember our original objective to give composers signs for every intention or, at least, close to every intention? The "intra" signs do not come close to precision, even with their varieties of the speed of fluctuation. Fixing the levels of arrival within the proposed twelve dynamic levels may be the next step to gain exactness. Two distinct levels of arrival may be distinguished, in this regard. The first one would refer to the arrival point within the single articulation. The second one would refer to the final arrival at the end of fluctuating dynamics for a series of articulations. Now we will return to Appendix 42 to examine the codes and signals listed under positions (l) and (m) as the symbols pertaining to the first alternative. You can use either of those signals corresponding to "(fu)qyw" or "(su)qyw" for the placement of quasi-modular twelve dynamic levels. A different set of symbols is used for the marking of terminal arrival levels after a series of articulations. You find them under positions (o) and (p) which correspond to "(fu)qym" or "(su)qym." You should notice that the signals are facing outward in opposite direction to the flags of "intra" levels.

NOT: I am trying to review the concepts of the initial level, the "intra" arrival, and the terminal arrival. Could you help me summarize these three functions and their applications?

PAN: I will do so gladly. Undoubtedly, the marking of the initial level will be most frequently used. Fixing a certain level initially means it remains valid until change. This is tantamount to the conventional placing of an "f" and expecting it to last until it is cancelled by a "p" or any other dynamic mark. The icons corresponding to sections (b) and (c) in Appendix 42 are supposed to be attached to the stem of an affected note somewhere between the time and space hubs. Consider also a possibility of using those icons attached to the stem alone lacking any temporal or spatial value. This option may prove a great time saver in marking extensive scores which feature whole sections to be performed at one dynamic level. As you recall the terrace dynamics of any Baroque *concerto grosso*, you could expect an entire contrasting section to be performed at a single

level. Very often the dynamics of *ripieno* and *concertino* sections were implied and brought about by contrasts in the density of instrumentation. The familiar echo effects of the Baroque era belong in this category. Editing such scores for today's performance could use a few wholesale dynamic marks, if any at all. At any rate, a single dynamic mark at the bottom, in the middle, or near the top of a score would be sufficient. However, the extracted parts from such score would have to carry dynamic marks for each one of them, similar to the customary practice. Dynamic signals standing alone in the open field are considered to be always in fundamental position. This means they are non-invertible. It stands to reason to regard them as such because with no temporal or spatial signals attached to the stem the inversion becomes invalidated. Look for the open field option and the appertaining codes at position (d) of Appendix 42.

NOT: So, there is a great amount of latitude in placement of dynamic marks. I am afraid there is much less freedom in dealing with "intra" dynamics.

PAN: That depends on the texture of a musical composition. Most compositions have a highly diversified texture. In case of sustained orchestral chords requiring fluctuating dynamics, however, the option of a single arrival icon, either above or below the chord, is possible. Otherwise, you will have to attach one of those signals listed under positions (l) and (m) of Appendix 42 directly to the stem carrying a note or a series of notes. Please, notice that the usefulness of those icons is rather limited. Their application is possible only in the context of fluctuating dynamics, and when specifying a relative level of dynamics is desirable within a single articulation. The function of a terminal arrival is two-fold. It may mark the relative level at the end of a long increase or decrease of volume throughout many articulations. It may serve also as the terminal level reached by a momentary increase or decrease of volume within one single articulation. In both cases, the signals listed under positions (o) and (p) should be used.

NOT: The gist of all those options is then that initial levels may be applied to both "inter" and "intra" dynamics. Arrival levels inside a single articulation are reserved for "intra" dynamics only. The terminal levels may be used again for both "inter" and "intra" dynamics. All options apply only when fixing a certain relative level from the twelve listed in the table of Appendix 44 is desirable. What happens when dynamic fluctuation ends without any indication of the level reached? In traditional music, the end of the dynamic hairpin signals the end of the fluctuation. In the new system, there are signals for the beginning of *diminuendo* and *crescendo*, as you listed them in the "inter" dynamics of Appendix 43, but how do we know how long they last?

PAN: The first position (a) of the third (3) section in Appendix 43 answers your question. The signal looks like a right-angled wedge pointing to the right and attached with its tip to the middle of the stem. It is actually a combination of two signals used for the beginning of the fluctuation for "intra" dynamics. The code reads: "fsyjx" where "fsyj" suggests any type of fluctuating dynamics, and "x" is appended to signify

completion. This signal is to be used whenever the termination of gradual volume fluctuation is reached without a specific level designated. The use of a signal designating a specific level reached at the end of a fluctuation effectively makes void the nondescript "fsyjx" and the equivalent signal.

NOT: I cannot see anything more exact than attaching the arrival and exit levels to the established relative values on a dynamic scale of twelve. In previous parameters you have always provided symbols for absolute values of seconds or cycles per second. The intervals could use the precise measurement of cents. Is there a comparable absolute measure of dynamic levels?

PAN: Of course, there is always a possibility of measuring dynamics by the amount of decibels. Go forward to Appendix 44, which we have seen at the beginning of our session. The column titled "Decibels" lists the very approximate levels of intensity as they relate to the twelve arbitrary and relative levels of dynamics. I doubt that we ever arrive at the point where the numeral 72 will be accepted as meaning: slightly louder than loud. In a parameter where everything seems to be relative, the employment of numerical values may prove an exercise in futility. Add to this the questions arising from where the measurements should take place: at the sound generator or in the middle of the concert hall. The final outcome of such deliberations would cause presumably precise decibels revert to the vagueness of relative values. Nevertheless, the composer has a perfect right to use the absolute values. Therefore, you will find symbols available: the familiar empty ovals to be filled with desired numerals. The codes "qu-sey," "qu-seyw" and "qu-seym" can be found in Appendix 42, positions (e), (n) and (q) for initial, "inside" and terminal levels, respectively.

NOT: In a sense, the situation reminds me of the numerals used for the tempo and pulse signatures. Even the traditional metronome formulas operate according to the principle how many given notes are to be found in a minute.

PAN: I do not deny the probability of much more frequent use of decibel levels in the future. After all, the trend toward much more precision is well observable in modern compositions. I believe that limiting absolute levels to initial, "inside" and terminal situations is sufficient. Take into account that every, even the slightest change of the dynamic level may be recorded in absolute numerals under those three provisions as a new "initial" level until next change. Therefore, your analogy to the changes in tempo and pulse is well taken because every time such changes occur absolute numbers confirm or anticipate them. Certainly one can assign numbers to every single articulation. Fractions of seconds for durations, cycles for pitch, cents for intervals, or decibels for dynamics would create a notation decipherable perhaps by machines but hardly by humans for live performance.

NOT: I think I understand the purpose of all those symbols in Appendix 42, except for the two positions marked (f) and (r). I do not believe you have explained them yet. Both of them refer to the beginning and ending of a comparative level. Does it mean the same as relative levels?

PAN: The comparative levels are established on certain dynamic levels of intensity in relation to the other musical parts which sound with them. They are more than just relative values attached to the dynamic scale. It is rather a matter of context in which those specific parts find themselves. Let us look at Example 4.8 a) p.E36, specifically at the end of the first measure in Duo I. Do you see the bold, right angles encompassing the violin and cello motives?

NOT: Yes, they also continue throughout the second measure. Is this a way to let the players know they are playing important tones which should be emphasized?

PAN: Apparently so but I am not sure. In spite of increased dynamic levels, composers like occasionally to emphasize certain phrases or motives, or even single tones. Schönberg was fond of using the capital letter "H" with an extended short line at the top, right side of the letter. This was the abbreviation of the German word "*Hauptstimme*" meaning the principal voice or principal part. You will see the use of this mark in Example 5.3 a) p.E47, but for now let us return to those two positions (f) and (r) in Appendix 42. The first one, "fyq" in code notation, permits not only the designation of a more important part but also the degree of its importance in context of other parts. The consonant "q" at the end of the code can be substituted by any value from number one to twelve. You know by its position at the end of the syllable that ordinal numbers are placed here not the cardinal ones. Hence, this is an exception to the rule that bold flags under right angle to the hand express only the cardinal values. It is very unlikely that more than a few comparative levels will be ever employed in the contextual mode of comparison. However, again, the symbols are available, in case of need. Transcribing the Schönbergian "H" to the new notation you can use the flag value of "2" (code: "fyb") because later in the score you find the designation "N" suggesting a "*Nebenstimme*" or a less important part. The natural thing to do would be to assign number "1" (code: "fyt") to this comparative level of intensity. You will need to differentiate those two levels of comparative intensity for a faithful transnotation because the very first measure of the first variation in this composition juxtaposes the "N" level with the "H" level. Since you have heard so much already about this composition, let us look at a brief excerpt juxtaposing the original notation with its transnotation in PANOT. Example 5.3 b) p.E47 shows you not only the disk notation but also the account of all three parameters in code notation. As you read the code syllables, check them against the disk notation for accuracy and applicability. In case you forgot, the code syllables enclosed in parentheses result from conversion of measure numbers to the language of code notation. Try to discover the meaning of the first dynamic marks attached to the first pitch articulation.

NOT: The code tells me it is a "ry, fyb" hence the initial volume is "ry" which corresponds to the *piano* of the original. Furthermore, the code for "fyb" indicates that this is the beginning of a cello part which is more important than others. The next articulation has a "syj" attached to it meaning that this is the beginning of a *crescendo* marked by a dynamic hairpin in the original. This brief *crescendo* gives way to a *diminuendo* (marked again by a reversed dynamic hairpin) starting from the long "ba" note in measure 35. A similar situation of a brief swell and following decrease occurs in measure 36. The positioning of a pair of dynamic hairpins in measure 37 is probably suggesting the momentary swell for this particular articulation.

PAN: I agree with your interpretation and this is why you see the pair of "fusyj-sufyj" in the concordant code notation. It is possible also that a slight dynamic accent was meant here because you hardly can start increasing the volume on a rest! The dynamic hairpin in the last measure could also be interpreted as a slight emphasis. It seems to remind us that one should start with a stronger tone than the end of the reversed hairpin in the previous measure would indicate. Other elements, such as the metric position of the tone on the strongest part of the metric hierarchy, and also the beginning of a slur, invite an *appoggiatura* type rendition of two last articulations.

NOT: Why there is no ending signal for the comparative intensity in sight?

PAN: It is missing because the solo cello part continues to dominate the orchestral texture for another twelve measures.

NOT: I do not find it difficult to follow the new dynamic indications at all. I realize also that dynamic markings are not an exact science, and no amount of precise directions will replace the need for the intuition and the sense of style.

PAN: Neither is new notation for other parameters an exemplification of exact science. There is no way to lock the elusive language of music in such precise terms that they will be understood by everybody. Perhaps it is the greatest wonder of our art that it can be renewed every time performers bring it to life. Would you be interested even to listen if all you could hear were clones of the same performance? Thank goodness, there are so many choices of canned music available today. What a dull and intolerable situation would arise if we could not have different live or canned interpretations! It seems paradoxical but think how much we owe to inexact music notation.

NOT: Nonetheless, I have heard you say time and again that we must strive to offer a new notation which can satisfy the most fussy demands of present and future composers.

PAN: It is not only the characteristic of our age but also the eternal and ever growing desire for more precision which demand changes. The complexity of today's

music requires a system of symbols by which the creator's or the editor's intentions can be communicated to the performer with the least amount of uncertainty. I am glad that you feel comfortable with the new dynamic marks. Now, brace yourself for the transnotation which uses the inverted stems. Do not fear the upside-down world of dynamics. Time will eventually mellow your frustrations. The piano reduction of orchestral music by Berlioz shows an important role the dynamics play in this music, as shown in Example 5.2 b) p.E46. Although this excerpt consists of two measures, it may be regarded as a single measure containing seven traditional "beats." The dynamic roller-coaster ostinato in low strings contributes splendidly to the atmosphere of this scene in the oratorio. The upper stems in the right hand, and the lower stems in the left hand are used here for convenience. Keeping all stems in one direction, though possible, would necessitate the differentiation in disks' attachment to the stems if separation of parts became advisable. The score would look crowded and definitely less elegant than the picture you see now. All the dynamic signals in the bottom (left hand) part are inverted from the models you have seen in Appendix 42 and 43. The initial dynamic level is marked at the same level as in Schönberg's example. It is a "ry" and it uses a signal in the normal position attached to the first articulation in the right hand. The same signal in the left hand is inverted because the direction of the stem is also inverted. In addition, the first articulation in the left hand carries a signal for gradual increase of volume which looks confusingly like the signal for gradual decrease in the normal position of the stem. The fifth articulation (or "tab" in our terms) reverses the signal "syj" to "fyj" and adds a normally strong accent mark "sy." Find its icon under position (i) of Appendix 42. Do not be surprised that you see its shape inverted in the left hand due to inverted stems. Its meaning is still: a normally strong accent. It coincides with the *sforzato* mark in the original. There is no indication of the relative dynamic level reached at the place marked *sforzato*. Therefore there is no need to speculate and attach any other signal than that of an accent in transnotation.

NOT: In comparison with a variety of different accent marks in traditional notation, the choice of new accent marks seems rather limited to those four types listed in positions (g) through (k) of Appendix 42.

PAN: The amount of traditional accent marks appears to be large because some of them fuse articulative values such as *staccato* or *tenuto* with purely dynamic ones. Schönberg used even the mark for a sort of a negative accent. A small wiggle over the note (or the bar line) was supposed to cancel the normally expected emphasis on the first "beat" of the measure. There is no special provision for a negative accent in our system but using the signal for "fyf" or extremely weak accent as listed under position (h) of the same appendix would do under circumstances. Using signals for either of the first three softer levels (see Appendix 44) could also prevent the unwanted emphasis. With regard to the positive accents, you must remember that to accentuate one or two notes the marks for *forte* were simply added long before the variety of accent marks became generally accepted.

The overture to the *Magic Flute* by Mozart offers an instructive example for such notational treatment of accents.

NOT: Anyhow, the use of signals for relative dynamic levels must be more precise than relying on those few accent marks. Although the arbitrary dynamic levels are also relative, they denote the accentual strength more accurately.

PAN: The last example, taken from Chopin's music, creates an impression of strong accents while refraining from the use of actual accent marks. As you see it in Example 5.1 a) p.E44, the first delicate and ethereal tetrameter is contrasting strongly with the explosive second (extended) one. The initial dynamic level is transnotated as an open-field "ly" in the PANOT section, although the dynamic suggestion merely says: *sotto voce* in the original. There is little doubt that the composer wants a subdued performance of the first fleeting motive. In fact, when this motive returns in following measures it is marked explicitly "pp." The choice of level "ly" in transnotation is justified by the fact that this level corresponds to the traditional *pianissimo* level, according to the table of dynamics in Appendix 44. The *fortissimo* level of the sharp and detached stroke at measure 5 is translated into an open-field signal equivalent to the code "vy." After a big leap, a chord is struck presumably with the same force as before. In transnotation, the normal position is in the left hand. The right hand has an inverted stem for the obvious reason of saving space. This is why the dynamic signals (attached to the stems, this time) for a combination of "fufyj-sufyj" appear to be contradictory. Now what is the meaning of this *diminuendo* inside (or "intra") the chord?

NOT: It does not make much sense from the pianistic point of view. Two identical chords are tied through measures 6 and 7 as one single articulation. What purpose does the reversed hairpin serve? Everybody knows that after you strike this chord you cannot affect its decrease in volume; it will take care of itself by the gradual devitalization of vibrating strings.

PAN: It is hard to speculate but could this mark of decrease suggest that the following chords in measure 8 and 9 are to be played with less intensity than measures 5 and 6? Could it also suggest that the chord in measure 6 is to be played with no slackening of volume from the fortissimo of measure 5? The resulting effect would be that one of a strong accent. Was this what Chopin would expect by placing the reversed hairpin starting with the chord of measure 6? By the way, do not overlook the role of the damper pedal which permits overtones to reinforce each other and thus affect the dynamic balance.

NOT: I have seen so many dynamic marks appearing in places where they cannot possibly affect the intended outcome. I will pay more attention to those marks particularly in the medium of piano or plucked strings. I see that they may suggest many interpretations which are rather hard to find by looking merely on the surface.

PAN: I am sure you will find this kind of examination fascinating. Now I would like to call your attention to Example 5.1 c) which you find on the next page: E45. Here you see the same excerpt of Chopin's music transnotated into two other modes of new notation. The signal (SIGNOT) notation and the following code (KODNOT) notation may look complicated to you, at first. The durational symbols are essentially the same as in the previous Example 5.1 b) p.E44 but the disks (DYSNOT) have been replaced here by pitch signals.

NOT: Would you mind reviewing for me, once again, the purpose of both signal and code notations?

PAN: You have seen them already applied to the music of Beethoven in Example 4.6 c) p.E33. This time the symbols for dynamics have been added. The signal notation presents notes regardless of their graphic time and space dimensions. That means the durational signals are attached to stems which follow each other in uniform distances. Similarly, the spatial signals are attached to stems regardless of their relative position in pitch space. You can hardly perform music from signal notation but you can sketch notes in a sort of shorthand notes. Likewise, you cannot perform music from code notation but you can dictate notes to another human being for reconstructing either signal or staff notation. Furthermore, both modes of notation may be fed directly into computers. Signal notation could be easily recorded by picture reading scanners, and code notation could be typed on computer keyboards. The computers could then translate either of the modes into staff notation or even produce sounds from a bank of stored-in notes. I suppose the reverse process could be also made possible in the future. Paradoxically, the sound of music could create its own notation, although not the type of spectral photographs or oscilloscopic vibrations, but the result of conversion of sounds into a symbolic notation readable by a performer.

NOT: Let me see: heard music is converted by a computer into symbolic notation so that it can be recreated again by human beings. I know that the musical instruments digital interface (MIDI) produces music by reading its notation. How, possibly, the sound of music can produce its symbols needed for performance?

PAN: Although computer-generated sounds are not our concern here, we cannot afford refraining from marvellous ways a computer could facilitate the computer-generated notation. Therefore, I think we should emulate every attempt at creating special music notation software which is not based on our antiquated notation. Think also of a hypothetical situation where all the scores of a madrigal have completely disappeared in a cataclysm. One performance on the tape miraculously survived. Would not be it nice to be able to restore the madrigal's notation from the tape?

NOT: I would be satisfied with computer-generated notation like those produced by the proliferating software programs. I guess you would prefer those programs to use the symbols and fonts for the new notation.

PAN: I find it indefensible to feed today's computers with the incompatible symbols of the past. Lest we become mired in speculative thinking, let me return to the proposed signal and code notation as useful tools of reference. Although the use of signals is limited to comparative analysis and statistics, the code notation offers a viable substitute for traditional terminology.

NOT: Do you mean that verbal codes are shorter and thus a more efficient way of referring to sounds?

PAN: Just compare such description as: "an eighth-note d-sharp in one-lined octave on the the third beat of the seventh measure of the second movement, in the flute part sounding fortissimo" with "FLAU/be-mebmaptal/roklo/vy." We assume, of course, that a quarter-note is here the tact's value.

NOT: The code is definitely a more economical way of accounting for the various sound attributes. The question is: will people ever get used' to such a laconic way of communicating?

PAN: That is the question I cannot answer because i do not know. Look again at Chopin's music in the "dehydrated" form of signals and codes. Admittedly, those symbols seem incompatible with the disk notation, and yet you can recreate the disk notation from codes alone. Moreover, you can pronounce those syllables. Do you see how they can substitute for traditional terms?

NOT: They also have characteristics of a neutral international language which may have a chance of wider acceptance than separate terminologies for each language.

PAN: Try to read the code notation from Example 5.1 c) p.E45 and reconstruct the score without looking first at Example 5.1 b) p.E44. Do the same with signal notation and you will have acquired a valuable first-hand experience. While looking at the signal notation in Example 5.1 c) p.E45, you will notice that signals have been separated into two layers corresponding to the left hand and right hand parts in traditional layout. It is not necessary for signal notation to conform to the layout of the original notation. Signals can be assembled on one stem for all the simultaneous sounds. Except for the preferable arrangement from the bottom to the top sounds, their placement does not have to correspond to real pitch distances. They serve statistical and analytical purposes rather than those desirable in analog representation. Nevertheless, it is helpful to see them arranged in an analogous way to the composition's layout. Such an arrangement permits

quick identification in reference to the texture of sounds. The vertical orientation of signals is of little help in recognition of polyphonic ideas or, for that matter, in tracing of a melodic line. The particular layout chosen here for Chopin's music is actually a compromise between the strict and pitch-oriented listings of signals. This deployment is also reflected in the code notation for the same music.

NOT: Obviously, the signal and code notations are not notations in the sense of blueprints for performance. They could implement the notation or serve as stenographic devices. I appreciate their potential as analytical tools, computer applications, and a source of new terminology.

PAN: Actually they are auxiliary notations which refer to sounds through special icons or arbitrary syllables of an artificial language which could be spoken or written depending on need. Do not abrogate too hastily the functionality of signal notation for performance. After all, musicians used to perform even polyphonic pieces from either lute or keyboard tablatures. The obvious difference is that graphic icons are substituted here for letters and numbers. In addition, signal notation is not exactly meant to be touch notation. Be careful, however, not to underestimate the capacity of performers to decipher even most complex cryptograms. It is time for us to turn now to a new parameter: the realm of timbre or quality of sound. In a way it is one of the most difficult parameters to account for by signs. It is rather time-consuming to try to represent its vast vocabulary in adequate and well-ordered symbols. Therefore, we will examine its intricacies in an accelerated survey. Many of the necessary symbols will have to wait for the future to define their shapes, properties and functions.

NOT: Indeed, there are so many special expression marks, text expressions, and abbreviations for every major instrument, not to mention the human voice.

PAN: The vastness of idiosyncratic textual expressions is even further increased by different languages used by nationally conscious composers. There was a time when everybody used and learned Italian terms. Today's musician has to learn the meaning of foreign terms, in order to be independent in preparing performances.

NOT: How well I remember learning the foreign names of instruments in my orchestration class! After suffering through such an unspeakable exertion, I am glad that some terms as, for example, *pizzicato* are still universally used and understood.

PAN: The Italian term *pizzicato* is reserved for bowed string instruments. It is useless for brass instruments. By the same token, the French term *bouché* indicates a "stopped" tone on the horn but is meaningless on the violin. Everybody knows of all those special effects used exclusively for a single instrument or for instrumental families. The question arises whether or not a general notation should provide uniform terms for

every special effect known so far. Perhaps, we should acknowledge the existence of so many idiomatic expressions, and leave them alone.

NOT: Do you mean that all the text expressions of the past and of the future should be appended to music notation in the language the composer wishes to use?

PAN: Translations and explanations can be always gathered in a prefatory note. Special signs and symbols must be also explained before the score begins. Naturally, those procedures are hardly satisfactory. Using explanatory notes in excess may lead to a ridiculous situation where the prefatory notes outweigh the composition itself.

NOT: Why is it impossible to invent a whole new dictionary of terms and symbols for every conceivable musical term? Something similar to codes and signals you have used thus far.

PAN: It is possible but rather impractical. This would amount to substituting an equivalent of *Esperanto* language for common expressions. Remember that the quality of sound is a non-modular parameter. Some experiments in determining timbre intervals notwithstanding, this parameter does not lend itself very well to quantification. The assignment of codes and signals to the modular quantities and directions of temporal and space parameters can be easier justified than suggesting an entirely new world of arbitrary terminology and symbolism for the tone color. The immensity of the task of supplying satisfactory uniform designation for every known textual expression alone is seldom recognized until you consider any of those expressions specifically. Since you have mentioned how comfortable you felt with the term *pizzicato*, let me explore the implications of this term a little further. The nineteenth-century meaning of this term does not pose any problems. Its use in the twentieth-century music literature is subject to certain distinctions. The Bartokian "bow and arrow" *pizzicato* produces a different quality from the usual quality, and it is differently marked. Similarly, plucking the string with the finger nail gives the sound an additional, sharper quality. The sound color of a mandolin played with a pick is still different from the modes I mentioned earlier.

NOT: I remember learning in my ethno-musicology classes that some civilizations, other than ours, have developed much more sensitive ears for the sound quality. Is this due to our emphasis on structural pitch and duration at the expense of timbral subtleties?

PAN: Undoubtedly this is one of the causes of our neglect. However, with the modern advances it becomes clear that our own century tries to make up for the regrettable neglect of this little known realm of musical sound. The fact remains that it is rather difficult to account notationally for everything this sort of sensibility requires. If you are interested in how the Chinese have handled the problem of timbral notation, consider several ways of playing the Chinese lute. There are many sources which give you

a glimpse into the performance practice on this instrument. It really matters how the string is pulled, which finger of which hand plucks it, besides considering some other details of highly complex actions. All this is coded in form of a tablature featuring those graphically charming Chinese icons. Therein lies the problem. It is a tablature, a touch notation for the specific instrument. The general notation is replaced by instructions how to produce certain tones on a given instrument.

NOT: I think it is inevitable that specific instruments will require specific instructions on producing special effects. You seem to be interested rather in general notation which leaves special vocal and instrumental groups to their own devices. Is that right?

PAN: There are enough problems with modernizing the conventional notation for general use before we turn our attention to idiosyncratic solutions. The only suggestion I would make is that the extent of text expressions be regulated with regard to which notes they affect. Consider for a moment the question what constitutes the "normal" way of singing or playing an instrument. Bowing is normal for a violin as plucking is normal for a harp. We assume correctly that the normal way of playing a predecessor of a guitar, the Spanish *vihuela*, was plucking the strings with fingers. The full name of the instrument: *vihuela de mano* confirms this practice. When it was required to rub the strings with a bow the name of the instrument changed to *vihuela de arco*. A separate qualification for a separate purpose. Plucking the strings with fingers was normal for the *vihuela de mano* but bowing strings was normal for the *vihuela de arco*. Today we expect manifold timbral distinctions from a single instrument. It is good to remember, however, that in the past it was not always so. When Monteverdi rehearsed his *Combattimento* in Venice, the violin players reportedly refused to pluck the strings with their fingers. Apparently they thought it undignified to play violins in this manner. All what the composer wanted was to imitate the sound of clashing swords in the middle of a battle. A few years later his student Farina fared much better in Dresden. He not only expected his performers to play *pizzicato*, but also instructed them to play *col legno* and *sul ponticello*. In addition, he also introduced *glissando* and what we know today as *vibrato*; all those novel techniques in one, single piece entitled: *Capriccio stravagante*.

NOT: That sounds almost like contempt for the "normal" way of playing an instrument. Any reasons for such an intense display of "abnormal" techniques?

PAN: The piece was highly programmatic and illustrated everything from the barking dogs to the meowing cats. Eventually, those effects became "normalized, and lost their initial association with programmatic meanings. Observing the modern practice, we know that frequent use of special effects necessitates some indications when to return to the normal way of playing. This is shown by such terms as *modo ordinario*, *jeu normal*, or *gewöhnlich*, depending on the composer's language preference. When two or more special effects are used confusion may arise as to which one is being terminated.

Therefore, let me suggest special signals of delimitation. They are to be put in front of the mark or text expression for the beginning of special effect. The reverse of those signals is to be put behind the mark or text expression for the termination of the intended effect. Whenever the special effect is reserved just for one specific articulation there is no need for beginning and ending signals. Those possibilities are outlined in the fourth (4) section of Appendix 47. The delimitation signals look like broken parentheses, and the ones for the beginning and termination of a particular text expression end with the consonants "z" and "x", respectively. One could use the same signals drawn with dashed lines in case of page-breaks or other staff transfers.

NOT: Is not the normal way of using an instrument already an indication of a specific sound quality? After all, we do associate the sound of a trombone with the general timbre of this instrument. Composers assigning their sound ideas to the trombone, must have the timbre of this instrument in their inner ears.

PAN: Certainly this is the case also with score readers. The name of an instrument evokes immediate expectations as to its general sound color. There is a lot to learn trying to memorize the names of instruments in different languages, as you have experienced yourself. In this regard, it may prove helpful to reduce their names to four-letter words, for easier reference. Accordingly, I have included a selection of abridged names for voice and acoustic instruments in Appendices 48 and 49. Whatever this list lacks in comprehensiveness and proper classification, it may gain in practicality and usefulness. Do not forget that those truncated name-substitutes should be pronounced according to the rules listed in Appendix 2.

NOT: I have noticed that you have used already those abbreviations in place of conventional names in transnotated music examples for dynamics, and even before. I did not ask you then for explanation of those strange terms because I knew that their justification would be forthcoming shortly.

PAN: Now you see the entire list, at last. I will urge you to add to this list any other acoustic instruments you think should be included, preferably in abbreviated form. Now, let us move to another factor which influences the timbre. There is a difference between the sound emanating from a solo singer and from the choir, as you well know. Similarly, there is a difference between the sound of a single violin and the entire section playing together. The difference is partly caused by the interaction of various overtones stemming from imprecise intonation of fundamentals. The result is even more noticeable when reinforced by group dynamics. Composers have often used timbral contrasts by requiring various reductions or reinforcements of voices or instruments. Some were satisfied with the *divisi* mark, some others reduced the number of performers to one-half or any other fraction. The amount of performers assigned to a part could range from precision to indeterminacy. A survey of such possibilities is given in Appendix 46. A word of explanation is needed with regard to the first (1) section involving quantified

assignments. The code and signal for position (b) denote either the total amount of performers or the amount of performers assigned to a particular part. In the last case, it is the same as customary qualification added in front of the part. The traditional inscription: "a 2" requires two performers to a part. When the performers are supposed to read different music on the same staff, numbers: "1." and "2." are added to clarify which performer takes the upper or lower portion. Number "1." in such cases means that the second performer is silent. For vocalists and instrumentalists unassigned to a portion of a composition the text expression: "tacet" is used. This practice may be continued in the new system as well. For the ordinal assignments, however, the code and signal for position (c) may substitute for the customary use of ordinal numbers. The second (2) section of the same Appendix gives an alternative to composers satisfied with the approximate description of the optimal amount of performers. The third (3) section specifies quantitatively the proportion of performers needed for a portion of the composition or one of its vocal or instrumental parts. The signals, as listed under positions (i) and (j) can be used for either integer multiples or integer fractions of a given number of performers. Indefinite increases or reductions of a number of performers can be expressed by the codes and signals appearing under positions (k) through (n), with position (o) reserved for approximate amounts to the ones announced at the beginning of the composition or one of its parts.

NOT: Since the number of performers has such an influence on the general sound quality, I believe regulating their number is as important as balancing of dynamics or deciding on the use of mutes or other special effects.

PAN: The contrasts between a group of soloists and a larger group of performers owe much more to timbral than to dynamic contrasts. This can be observed in a juxtaposition of a concertino to concerto grosso, as well as in chamber music arranged for an orchestra. The use of mutes which you mentioned in your comment is independent of the influence of the number of performers on sound quality. Contrary to the popular belief, the muted sound is not only softer in volume but also, even more importantly, different in tone color. The complexity of all the factors which contribute to a specific timbre is subject of increasingly proliferating studies. From the point of view of notation it is virtually impossible to suggest symbols for the infinite variety of possible timbres. Just in case anybody wishes to suggest the number of partials present in a tone, position (a) of the first (1) section of Appendix 47 answers this need. Position (b) could be used for signaling which particular partial is desired. It must be remembered that this type of notational signals may be not enough to produce the desired effect. The outcome will depend anyhow on the built-in characteristics of a sound generator and the spatial ambience. The presence of particular overtones, their relative volume and interaction, are important factors contributing to the total timbral effect. However, all efforts to lock those elements into a quantitative language are of little value for notation. Perhaps they should be best left to modern technology to offer sensible differentiation. In the meantime, the best we can achieve in symbolization of tone quality is to suggest such descriptive terms as,

for instance: sparse versus rich, or simple versus complex. In this way we vaguely refer to the graphic profile of a sound wave. The second (2) section of Appendix 47 suggests a few codes with their signals for descriptive harmonics. The sound of a *molto vibrato* playing the violin *sul g* must correspond to the "säs" code of position (f). On the other hand, a suggestion to produce a so-called "white" sound for a Renaissance madrigal may be marked for a singer with the "fä" code of position (c). By doing so you do not necessarily advocate the "white" sound as most authentic sound quality for this particular performance. Perhaps a "sä" mark and its corresponding signal under position (e) should be used here. After all, there are some reasons to believe that the Renaissance ideal was a nasal, pinched quality of the vocal sound. While we are discussing the quality of vocal sound, do you remember when I mentioned briefly the allotment of a special sign to the second note of the Gregorian Alleluia in Example 2.4, p.E4?

NOT: I must confess I forgot the circumstances, It was so long ago...

PAN: Let me refresh your memory. Please, open your book to Example 4 and notice the tiny hook suspended from a diamond and coded with the syllable "fäf." Now you recognize the diamond as the timbre hub (see the very first position in Appendix 46) and the "fäf" signal as the one corresponding to position (d) in Appendix 47. The reason for choosing this signal is the "quilisma" demanding a light, fluid performance characteristic of "liquescent" neumes.

NOT: There are so many varieties of vocal intonations that I do not see how those few choices in the second (2) section of Appendix 47 can do justice to all the shadings and nuances of a singer.

PAN: They are meant only as very general substitutes for what textual expressions can do much more effectively. Any attempt to suggest signals governing sound quality, particularly for the human voice, is frustrating at best, and futile at worst. Can you think of a signal substitute calling for overtones of sadness?

NOT: Neither for overtones of joy, for that matter. The gamut of human feelings is far too sensitive to be bent to the rigors of a signs dictionary.

PAN: Large amount and intensity of harmonics result in a complex sound wave. There are additional factors which further influence this initial complexity caused by the tone generator. Particular conditions for resonance or for the formant favoring certain regions are also important in shaping the resulting tone color. The flexibility of the human voice to adjust momentarily the resonating cavities permits the incredible variety of tone colors and nuances. You know that whistling or humming cannot compare with the richness of sustained vowels. Consonants add to the color in a different way because they are usually initial or terminal noises. Noises are generated by non-periodic vibrations. The presence and intensity of noises can also significantly alter the timbre of

sounds generated by instruments. Be it the "flutter tongue" of a flute or a *cuivré* of a horn, those special effects add another dimension to the overall tone quality. As we have seen in the case of harmonics, the inharmonics are also impossible to indicate notationally other than by very vague, descriptive terms. The choice of possible codes and signals is listed in the third (3) section of Appendix 47. Again, let me emphasize my belief that textual expressions and tablature-like instructions are far more practical than the available codes and signals.

NOT: Are not the noises constant concomitants of so many sounds, anyhow? I think the instrumental identification is made easy by paying attention to the very beginning of sound articulation.

PAN: Certainly, the so-called sound envelope gives away the identity of an instrument in question. The sustained portion is not so easy to identify as its beginning. Of course, all those considerations rarely find their application in general notation. However, we must be ready with something better than just vague descriptions for those who compose not only music but also single sounds. Hopefully, technology will permit offering more precise recipes for symbolizing sound envelopes, determining the amount and intensity of partials, and the extent of noise "contamination."

NOT: I wonder why it would not be possible to add real color to help us in symbolizing the sound colors. It seems an agreement on attaching certain colors to timbral distinctions could be reached rather easily.

PAN: It seems like a great idea, Mr. NOT! You may be not the first to suggest such a solution. Besides the risk of offending all the daltonists, this is easier to contemplate than to apply in practice. The analogy between the real color and the sound color is frequently made. Not much is gained from it in reality. You know anyhow what kind of a general sound quality to expect from a given instrument. Supposedly you designate the color of orange as most appropriate for the sound of a trumpet. Would the brown color be the happiest choice for a muted trumpet? Perhaps the orange hue should be made darker to express the same effect?

NOT: Would not this result in the same "dirty" orange or brown?

PAN: Well, strictly speaking brown results from intensified, or rather saturated orange. "Dirty" orange, as you put it, is the result of increasing the darkness on a gray scale. Every hue (the one lying on the surface of a color solid) is subject to saturation (reaching into the inside of the solid) and brightness (extending from black at the bottom to white at the top, and different degrees of gray in between.) What principle should we follow to represent the flutter-tongue on a flute? If, for instance, flute is a pale yellow in hue, should the flutter-tongue be marked in brilliant and vivid yellow or in dark and dull

yellow? Furthermore, what should be marked in those colors? The staff assigned to the flute or, perhaps, the note heads only?

NOT: I am so glad now that there is no dilemma with the color of piano sounds. The note-heads are black, as a rule, and white or "open" on rare occasions.

PAN: Although a piano is considered a monochromatic instrument, do not overlook the possibilities of adding sound color due to the key activation and employment of different pedals. Incidentally, any attempts to equate the rising pitch with the color hue are of little value because of fundamental differences in the linear nature of pitch order and the circular nature of the color hue. Besides, what help would it be to paint the keyboard from deepest to the lightest colors? Slide-boards have a better chance at application of color because they would operate on the principle of a pitch continuum, and not diastematic pitch slices. In harpsichords and organs, the different stops and registers are selected by their function, and any color designation would have rather negligible effect in notation.

NOT: I thought color would enhance the designation of various timbres but I am reconciled to the fact that its use would provide identifications which are probably as vague as arbitrary signals. Although I know that we are restricted here to acoustic instruments, I cannot help noticing that name identification is also sufficient with the digital interface in computer applications and in MIDI hooked-up keyboards. What examples have you prepared for me to see how to transnotate timbre indications in music literature?

PAN: First let us look again at Example 4.9 a), p.E38, the music with which you are already familiar. On the opposite page (E39) you see the transnotation of its temporal and spatial aspects. This time let us move a little further and examine its timbral intricacies. The first black bar at the top of p. E38 starting with m.67 does not seem to have any timbral qualification for the sound of twelve violins (1-12). Yet, the sound quality is very far here from the normal bowing. You do not see any indication of this because this part begins on the preceding page with two of the composer's specific annotations. The first is a special sign resembling a long-hand letter "z" and signifying a very rapid non rhythmized tremolo, according to the composer's prefatory explanations. It is the same sign which is visible right above the part for 10 violas, down the printed page. Moreover, the composer instructs the group of the first twelve violinists to play this part *col legno* by using the abbreviation: c.l. in m.66 which precedes m.67 with which the example starts. In summary, this passage is to be played not only with a rapid non rhythmized tremolo but also with the wood of the bow. Therefore, in transnotation of m.67 one could put both the "z" sign and the c.l. abbreviation in parentheses as a reminder of what the real tone quality is here after the page break. However, you may opt rather for the opening and dashed broken parenthesis of position (o) in the fourth (4) section of Appendix 47. It all depends on whether you consider this sound band a single or a multiple articulation. It seems to be

a single articulation for each of the instruments involved. On the other hand, it could be regarded as an example of multiple articulation, considering the multiple bowings. Shortly before m.69 the composer instructs the cessation of tremolo by the text expression: *senza trem.* but substitutes it with a wavy, widely undulating line which is supposed to indicate here a very slow vibrato with an one-quarter tone frequency difference produced by sliding the finger. Instead of using the text expression *senza trem.* in transnotation you can use the "z" sign (which referred to the *tremolo* in original) with the closing broken parenthesis such as pictured in position (p) of the fourth (4) section of Appendix 47. You do not need to extend the wavy, widely undulating line throughout the entire m.69. It is enough in transnotation to start a few waves preceded by an opening broken parenthesis such as shown in position ((n) in the fourth (4) section of Appendix 47. Remember that you could also treat this pitch band as a single articulation. In this case, you would not need to list *senza trem.* but simply draw a few wavy lines above the staff.

NOT: Do you have any preference regarding those two options of treating the sound bands as either single or multiple articulation?

PAN: I am not partial to any one of those two ways. It is really not too important to agonize about the choice. Either one of them provides adequate identification of the intended effect, and this is all what matters. When we examine the last massive pitch band in a few moments, you will see some additional factors which will help in arriving at the best practical solution. Let me review quickly the remaining marks affecting the sound quality in this score. The second group of twelve violins (13-24), right below the first one, features also a wavy line but one which is much more tightly undulating. This means here: *molto vibrato* which expects the performers to play with a very intense vibrato. What you do not see on this page, is the beginning of this part on the preceding page marked with an abbreviation: s.p. This stands for *sul ponticello*, and instructs the performers to bow close to the bridge. The *molto vibrato* of m.67 gives way to the non-vibrato in m.68 but is followed by the slow vibrato similar to the one shown right above it in the first group of the first violins (1-12). The very rapid tremolo is the mark above the part for violas; this is to be substituted with very slow vibrato and close to bridge playing in m.69. The part for violoncellos starts on the preceding page and is marked with *con sord.* which indicates the use of mutes. Otherwise, the part follows the same pattern of *molto vibrato* to slow vibrato as in the part for the second group of violins (13-24). The part for string bass starts on the preceding page with a very rapid tremolo and wood of the bow indication. The sudden change of dynamics from *forte* to *piano* and cessation of tremolo characterize m.67. Throughout measures 68 and 69, the back-of-the-bow indication is exchanged for *arco* or the customary bowing but close to the bridge, and also expecting the fingering of strings with a very slow vibrato. The ultimate measure (70) presents a block of all strings exploding in a triple *forte* and using several irregular changes of bow, as the prefatory note explains the placement of both customary down-bow and up-bow signs close together. The abbreviations: s.p., ord., and s.t. instruct the players to start *sul ponticello*, that is close to the bridge, to move to the ordinary way of bowing (except for

irregular changes) and to finish *sul tasto*, that is bowing over the fingerboard. All this happening throughout 30 seconds in a gradual decrease of volume down to a quadruple *piano*. Now, with a special instruction for irregular bowing this band looks like a pitch mass of multiple articulations. It would be simpler to treat it as a single articulation. By doing so you could avoid cluttering the space with all the parentheses by listing those abbreviations just as they appear in the original. In a sense you would utilize the same principle as with marking the fluctuating dynamics "intra" that is within one single articulation. When you look at the entire excerpt, you realize that the primary interest is centered around sound masses or sound bands where every instrument is separated by a traditional quarter-tone (or half-tone in new system). The overall effect is similar to "white noise," and it is evident that massing of such pitch aggregates creates a unique timbral texture.

NOT: In a sense the sum is greater than its parts. Single pitches by themselves are rich in unusual timbral effects but when combined with each other they produce sound quality which could not be anticipated by merely hearing them as component parts. I remember when I heard this coda to the *Threnody* for the first time. I vividly recall the timbral texture, and the powerful impression it makes on the listener.

PAN: When you look at all those signs and abbreviations, you may agree with me that there is no point in changing them into something new. The introduction of new, arbitrary signs, no matter how brief and how logical, would hardly improve things from the point of view of economy. Therefore, you could either transcribe them verbatim or use customary abbreviations, all this under the condition that you add the signals of delimitations wherever appropriate. For a different type of music but similarly dependent for its effect on timbral values, let us examine an excerpt from *Le marteau sans maître* by Boulez. Example 5.4 a), p.E48 constitutes a transcription of the original score in a slightly different format but still in traditional notation. Examples 5.4 b) p.E49, and 5.4 c) p.E50, offer PANOT transnotations, the first faithful to the original, and the second arranging this music in two types of condensed scores.

NOT: I notice French textual expressions mixed with the Italian ones. Those are probably the ones which you would transfer without change into the transnotation.

PAN: I would not bother with translation but I recognize the right of an editor to do so for whatever reasons. It will be interesting for you to scrutinize all text expressions and see why some are provided with broken parentheses, and some of them are completely excluded from transnotation. Actually, only two of them are provided with the opening broken parenthesis. The first is the tempo inscription above the score which is valid for the entire section, and the second is: *quasi parlando* which qualifies the vocal part and does not cease affecting it with the sixth measure. All the rest of them are deprived of broken parentheses which means that they are valid for one articulation only. Look, for example, at the guitar part and notice that the expression *vers le chevalet* (which

is equivalent to the Italian *sul ponticello*) is not followed by *jeu normal* in the third measure. This is in accordance with the rule that text expressions standing alone are valid only for that particular articulation, and everything what follows reverts automatically to the ordinary way of playing. Hence, to print *jeu normal* would be redundant in this context. The term: *arco* in the transnotation of the viola part at the third measure is missing for the same reason.

NOT: Almost the entire vocal part is transnotated with note-heads adorned with a pair of prongs which look like devil's horns.

PAN: Now do not let your imagination carry you too far. Position (e) of the second (2) section of Appendix 31 will remind you of a signal with which you are already familiar. You have seen this signal applied to the percussion of Example 4.7 b), p.E35. It is combined here with the note-head for a determinate pitch in order to suggest half-speech half-song approach. In the original you see tiny crosses applied to the note stems, and also the warning: *quasi parlando* to suggest the need for a compromise between the determinate and indeterminate pitch intonation. In the middle of fourth measure, observe how the singer utters an impassioned cry on a pitchless note gliding downwards to another pitchless sound. The transnotation respects the text expression: *quasi crié* but replaces the descending snake with a symbol of glissando conforming with the signal illustrated in position (b) of the first (1) section of Appendix 31. Lest you misunderstand the French practice of articulating mute last vowels in singing, notice that the terminal vowels for the following words: *J'écoute*, *jambes*, *morte*, and *tête*, have all a very short note marked appropriately according to examples in Appendix 3. Those short notes exist outside of the meter. Similar very short notes occur simply as grace notes in measures 2 and 7 of the xyloimba part, in measures 4, 5, and 6, of the guitar part.

NOT: The tempo markings have disappeared entirely with the exception of the inscription at the beginning which suggests a free rhythm similar to that of a recitative. Please, explain the reason why you have eliminated them in Example 5.4 b) p.E49.

PAN: There is no need to transcribe those two *libre* expressions following the metronome marks. The signals for a "free" tempo, borrowed from the bottom of Appendix 14, can replace them very well. Likewise, the new signals for the gradual slowing down of the tempo, as listed in Appendix 16, can replace the French terms which appear at the top of two last measures of the example. There is also no need to transcribe the *pour 4* in measures 4 and 5. Those text expressions remind the reader that there are five sixteenth-notes in place of usual four. You know already that durations of such ametric figures are expressed by durational signals. The same happens with triplets, and the numbers attached to triplets or quintuplets would be completely redundant in the new system. I hope you will have time to examine also the transnotation of meter signatures which the composer changes with mercurial abandon for every measure, except the initial ones.

NOT: This reminds me of the changing meters in an example taken from Stravinski's *L'histoire du soldat*. Is there anything else I am missing?

PAN: There is something else in the metric situation which I ought to explain to you at this juncture. You may not notice anything unusual in the penultimate measure 7. Its meter demands three quarter-notes in the original version. It is correctly transnotated as a triple simple meter of three tacts. Nonetheless, the space given this measure is half of what it deserves to have. The real space is the same as that of the preceding measure bearing the three eighth-notes or three half-tacts in transnotation. This has been done purely for reasons of economizing the space. I could not possibly accommodate this excerpt on one page without severely reducing it in size. It is not wrong to do so, especially when music activity is not too busy in a particular measure. The publishers have done so from times immemorial. Nevertheless, it is an expedient compromise here, particularly in view of the fact that all the rest of measures are precisely proportioned to the initial ones.

NOT: It is comforting to know that the contents of measures do not have to be necessarily analogous to the real time. Something else caught my attention. It is apparent in this score that the timbral marks are wedded with meticulously marked dynamic signs. They seem to reinforce each other for the total effect.

PAN: You are right about the impact of dynamics on the sound quality. The timbre would be quite different with different dynamic marks. Everybody should realize how important it is for any transnotation to reflect precisely but not necessarily redundantly the timbral intentions of the composer.

NOT: Earlier you have mentioned that the c) portion of Example 5.4, p.50, presents the same transnotation but in condensed form. I see there two sections framed separately. The differences in arrangement are quite considerable. I am still unsure what is the purpose of these arrangements.

PAN: They both are condensed scores in which the dynamics and text expressions have been deleted for the sake of greater clarity in representation of pitch and rhythm movements. Such an arrangement permits an overview of temporal and spatial relationships at a glance. It is also a help in surveying the modular parameters for analytical purposes. The note-heads for the vocal part have been "opened" so they would stand out in contrast to the usual black heads. In the second arrangement (section 2) all separate rhythms of individual parts have been reduced to the common denominator of a single rhythm. You need to watch the durational signals only at the bottom of the score. This procedure further simplifies the total picture and facilitates the performance of the score at the keyboard. I doubt very much you could perform this music from the original disposition of the score in traditional notation. Condensing the original score using

similar reductive procedures would still present a formidable task to the performer. With the reduction appearing in the second section of Example 5.4 c) p. E50, there is a chance, at least, that a conductor or an analyst could perform this music at the keyboard, no matter how haltingly or tentatively. In case of far reaching intervals, an octave adjustment can always be made for the ease of performance. The new system facilitates such an adjustment because you know that pitch positions are always the same on the staff regardless of the octave region.

NOT: I will take this music home and will try out condensed scores in practice. I cannot guarantee the results but I will try, nonetheless.

PAN: Make sure that you do it gradually. First, learn the vocal part helping yourself at the piano. Then start looking at those instrumental pitches which significantly interact with the voice. Finally, explore the simultaneous sonorities. Only after those preparatory steps try to play notes in the discipline of their rhythm. If you do not succeed at first, lay the project aside, and try again on another occasion. Above all, do not allow your frustrations to cause a lack of self-confidence. You are too new to this notation to expect a flawless performance of condensed scores. However, you should have a first hand acquaintance with the potential of PANOT for condensing even complex scores. Such familiarization with the total sound fabric through performance may prove impossible otherwise.

NOT: Thank you, master PAN! Do we meet tomorrow for our last session?

PAN: Yes, of course. I will be expecting you at the normal time. Thank you for your patience, again.

*

THE SIXTH DAY

ANALYTICAL INSIGHTS

NOT: Good morning! It does not feel like we are at the end of our daily sessions. Time certainly flies fast. Will you have time to complete everything you have planned to do?

PAN: I will try. So far we have covered the new system's ways of representing the major parameters of musical sound. Today, we will consider the ways how the new system can facilitate the analysis of music. I hope that certain advantages of the new system over the traditional notation will become clear to you. Before we move into this topic, however, let me ask you first which features of the new notation promise to be most helpful, in this regard?

NOT: I think the representation of the pitch space must be the most prominent advantage. Each tone having its own place on the staff is readily accountable, unlike the traditional system where the placement of tones may be further qualified by chromatic accidentals.

PAN: Your observation extends further to include the integrity of intervals which, in the new system, always represent true dimensions. In every way the movement of pitch appears to be easier to survey than in traditional notation. You may have seen some diagrams and graphs used by analysts to explain the movement of pitch. The usual purpose of those graphs is to simplify relations and to clarify proportions. In the new system there is no need for translating pitch movement into simplified forms. The pitch movement, as represented on the bigram of the new staff is in itself a diagram. More importantly, the proportions of intervals never change. Thus, the new system offers visual advantages of easier scanning and comparison in a most direct way. In that sense, the new notation constitutes a graph or diagram which obviates the need for further simplification or other adjustments.

NOT: You have not included this point in your list of desirable characteristics for an ideal music notation. Is not simplicity an ideal toward which all notation reformers should strive?

PAN: Simplicity is a relative term as are also many other desirable characteristics on my list. After all, what is simple to me may prove complex to you. Although I did not include specifically simplicity, you may find it implied in such listed characteristics as: directness, clarity, and efficiency. What matters here is which notation facilitates analytical insights in a more effective way: the traditional one or the proposed one?

NOT: Could I look at some examples from music literature, before I make up my mind? I am certain you have prepared some illustrations to support your point.

PAN: Let us start with an example based on the celebrated third piece of a work by Schönberg entitled: *Five Pieces for Orchestra*, op. 16. There is no space here to present this movement in its entirety. Please, consult the traditional score or its arrangement for two pianos. In Example 6.1 p.E51, which uses the PANOT system, you see the chord of five tones (called here: the immutable pentad) preserving its shape almost without exception throughout the piece. To emphasize its immutable quality, I have moved the staff lines to fit this chord's several transpositions. It happens that the pitch of "c" (or our *zo*) is at the bottom of the first chord. Hence, we can regard it as being in "root" position or in "zero" transposition. Consequently, the next chord which you find assembled in measure 9 is in "eleventh" (or our *hu*) transposition because it is based on the pitch of "b" (or our *ho*). The same chord (or aggregate) does not emerge again until measure 15. Here it is based on the pitch of "d" (or our *bo*). Therefore it is in the *bu* transposition which is marked numerically as transposition number two: [2]. Later on, the same chord undergoes additional transpositions based on the pitch of: "c-sharp," "e," and "e-flat." This translates to: *tu*, *ru*, and *lu* or [1], [4], and [3] transpositions, respectively. When you will look at the original score, you will see that those pentads do not appear always as isolated harmonic pillars. As a matter of fact, they are not easily identifiable because they are arrived at different transpositions by a very elaborate progression. Take, for instance, the progression between the initial pentad and the next one in measure 9. Each of the partaking five parts of the pentad is not moving directly by half-step (or our step) down to the next transposition. Instead, the composer moves first each part a half-step up to be followed by a whole-step down. This ultimately results in a half-step down. In our terms, a step up, and two steps down result in a step down. Again be careful not to assume those five parts move simultaneously up and down. Actually, they move very gradually from the beginning to the first transposition in a canonic fashion. This is what is meant as the classification: "(a) canonic" in the illustration. The next move from transposition [h] to transposition [2] does not follow the canonic route. It arrives at the [2] transposition by simply moving the entire pentad three half-steps up from the [h] transposition. In our terms, this means, of course, three steps up. In our example, this type of transposition falls into the category: "direct" marked by an interval (3) up.

NOT: I am still trying to follow those procedures in the traditional score. I must confess I cannot follow all those compositional ideas. I am sure I will be able to make some sense of it, tonight or tomorrow. I do not see, however, how I could possibly concoct such a diagram as yours in order to better understand this score.

PAN: The problem is caused by the notation which is heavily cluttered with accidentals, beside the other hurdles in form of various clefs and transposing instruments. Imagine how much more transparent the pitch parameters could be represented in the new system. Then, it would take you much less time to survey compositional procedures.

NOT: I have noticed your different classifications of intervals in this piece, at the right margin of the example. Is this a sort of summary which flows from the diagram and enhances the understanding of the piece?

PAN: Those summaries are the by-product of an analytical diagram such as the one presented here. They permit you to account for all the intervals involved in the pentad. You see the type of progressive and regressive sequels in the table entitled: "Actual Intervals." Compare those findings with similar accounts in Example 4.5 a), p.E31, when we have discussed Mozart's minuet. The table marked: "Interval Classes" in the present example reduces the actual intervals to their six classes, and generates, in turn, the table "Interval Content." Since you did not have time yet to look back at the Mozart's example, let me call your attention to the table: "Intervals Summary" at the bottom of Mozart's diagram (p.E31). The bottom row shows you how many intervals of the same type occur in the simultaneity, or in linear profile condensed to simultaneity. So, for example, you read that there are two intervals of the type one (or *ti*) and only one of the type two (or *bi*), and so on. The complete bottom row reads: 212320. Now move up to our present example (p.E31). Does not it strike you that the Schönbergian pentad shares the same interval structure with the opening phrase of the Mozart's minuet?

NOT: It is precisely the same number: 212320 so the intervals involved must have the same structure. I would never guess that those two aggregates have something in common.

PAN: Do not let your imagination run wild, however. Such coincidences may occur between widely disparate styles and compositional intentions. After all, the Mozart chord has been artificially assembled from the initial melodic profile of the minuet purely for pedagogical purposes. Nevertheless, analytical pursuits should not overlook factual data. There is another advantage stemming from comparing different aggregates which seemingly do not have anything in common. The reduction of an aggregate to its "normal" form, as practiced in modern analysis, permits the instantaneous comparison of two or more aggregates in question. One does not need to consider statistical data from aggregates to compare their interval content. In the second (2) section of the present example, please notice how with the aid of the new system you can identify the graphic

profile of the "normal" form of the Schönbergian pentad. The third (3) section of the same example presents still another graphical form of the same pentad. This time it is its symmetrical form which is highlighted by such an arrangement.

NOT: I find it a definite advantage to be able to compare chords spelled out in traditional notation by arranging them in "normal" form. I see also further advantage of transnotating them into the new system, and seeing them in graphical form preserving all the true proportions.

PAN: I am glad that such visual impressions make you feel comfortable. If they contribute to better understanding of musical structure, so much better for those attempting to analyze complex relationships. A brief sampling from the music of Charles Ives will also illustrate how the traditional notation compares with the new system's notation. A curious imitative juxtaposition of diatonic and chromatic orders in various rhythmic configurations is the subject of this music, as quoted in Example 6.2 a), p.E52. Notice how differently the diatonic and chromatic profiles look in the new system, (Example 6.2 b), p.E53) compared to the profiles in conventional notation. It takes time, of course, to get used to the true profile of each of these orders. Once the distances are visually absorbed, they become a sort of pattern by which all other pitch orders may be visually recognized. A far more complex situation is presented in Example 6.3 a), p.E54, and the following transnotations in Example 6.3 b), p.E55, and Example 6.3 c), p.E56. The music excerpt here consists of five bars closing the familiar symphonic poem by Richard Strauss *Till Eulenspiegels lustige Streiche*. Let us delimit our analytical interest here to the identification of harmonic functions in those cadential chords. First of all, let us transnote the traditional score to PANOT. This, in itself, will require conquering the initial notational hurdles. Correct identification of pitch levels will be among the most important tasks. A large orchestra consists of 35 instruments, in addition to the usual contingent of strings. Besides the usage of four different clefs (treble, bass, alto, and tenor), there are twelve staff pentagrams utilizing various transposing instruments. In comparison, there are only ten pentagrams where the real, concert pitch is identical with the notated one. To be exact, there is one notated pitch sounding an octave up, and two staves of notated pitch sounding an octave down. There is one staff of notated pitch sounding a perfect fourth up, and three staves sounding a perfect fifth down. In addition, you will find two staves of notated pitch sounding a major second up, and two staves of notated pitch sounding a major second down, with one staff transposing by an octave plus a major second down. If this is not enough for you, there is one staff pentagram transposing its notes by a minor seventh down.

NOT: It must be very hard for a conductor to scan such a score, and be aware of all the true pitches involved. What if there is a wrong note played? Will he be able to detect its source and identify the note? To me it is a welcome relief that such complexity can be transnotated into a score where clefs are replaced by region symbols, and transposing

instruments are transcribed into a "C" score. That means all of them will produce "concert" pitch.

PAN: The transnotation of such a score can be accomplished consistently but rather laboriously, and you see the result of it in Example 6.3 b), p.E55. I apologize for crowding those five bars into a limited space. Actually, the score would benefit from expanding it slightly beyond the space of one page. One can gain clarity but not without paying the price of acquiring additional space. At first, the transnotation may strike you as undecipherable. After a while, certain recurring patterns of pitch and rhythm become identifiable. Closer examination reveals a frequent occurrence of the traditional F-major triad in "root" position, inversions, or melodic fragments. There is also evidence of some similar chords resolving to this major triad. A condensed score eliminating pitch duplication is a very useful method to provide analytical insights. The result of such process is illustrated in Example 6.3 c), p.E56.

NOT: Is this really all what is involved in pitch movement?

PAN: Yes! Those are the essential pitches only. All the rest is duplication. Take the trouble to identify all the pitch levels, and attempt to play them at the keyboard. Even if you cannot perform them at the prescribed rhythm, try to savor, at least, the sonority of all the simultaneities. Pay particular attention to the chords directly preceding the resolution to an F-major triad.

NOT: I see them isolated again in the second (2) section of your example. Right underneath the second section, they are further simplified, as seen in positions (a), (b), and (c) of the third (3) section.

PAN: In the second (2) section the brief melodic ejaculations along the F-major triad have been marked in open notes as not necessarily belonging to the main function of the chords. In the third (3) section the chords are further condensed and adjusted to lend themselves to analytical comparisons. Brief explanations which follow are not the only ways to interpret their harmonic functions in traditional terms. You could try to find different explanations, and, perhaps, come to different conclusions.

NOT: I remember this music from recordings, and I know that the identity of those sonorities could be hardly distinguished because they occur at such a fast tempo.

PAN: That is quite true. The chords containing augmented sixths sound here almost like forceful appoggiaturas to the tonic triad. There is very little difference among them, and yet they add subtly different flavor to every pair. You may look upon them also as double leading-tone chords, not in the sense of doubled leading tones which is forbidden in the classic harmony, but as chords containing tones leading directly to the dominant from both directions: below and above. In this case, you can forget about their

subdominant or supertonic derivations. What matters is that they resolve the augmented sixth to the octave. Traditionally, the octave of resolution is the dominant of the key in question. In this example by Strauss, the octave of resolution of the first two chord pairs is not the dominant of the key but the third of the tonic triad. The third pair uses the German-sixth chord, derived from the subdominant, and the traditionally "correct" resolution to the dominant octave. This octave is a part of the tonic triad in its second inversion rather than part of the root-position dominant chord.

NOT: Whatever are the analytical conclusions, the very fact that such analysis is facilitated by transnotating the entire texture to the new system makes the task less arduous and time-consuming. I like particularly the ease of condensing the score to its most essential parts and breaking it down to its significant components. However, with all your stress on resolutions of the augmented sixth, I do not understand how one knows the direction of resolution when a "b-flat" is a "do" and "g-sharp" is a "vo"?

PAN: This is a problem which we have discussed already at the end of our fourth day. In Appendix 32 positions (g) and (i) of the first (1) section give you an option to attach small "hands" to the note head, thus revealing its original chromatic inflection. Since tension intervals tend to resolve into the direction of their chromatic inflection, you can easily reconstruct the original intention. Otherwise, the interval from "do" to "vo" could be regarded as the interval from "b-flat" to "a-flat." The resulting relationship of a minor seventh would call naturally for a different resolution. Any time you want to avoid ambiguities, you may use those simple signs attached to note heads. In our example a "b-flat" would become a "do-feü" and a "g-sharp" would change to "vo-seü." Now, look again at the third (3) section of Example 56, and see how those signs attached to tones demanding resolution clarify their original chromatic character. Under position (c) the chord has been slightly rearranged to present the tension tones at a distance of an augmented sixth. As you see from the second (2) section above, the real interval is here that of a diminished third, a complementary by inversion to the augmented sixth. A "ho" from below meets a "to-feü" from above at the pitch of "zo."

NOT: I suppose one could guess from the direction of pitch movement what are the chromatic attributes of the tones involved. Do you think this is a safe procedure?

PAN: Not at all. Think only of chromatic textures which do not resolve their tension tones. Then consider also possible misspellings by composers of tones designed to move in the direction of their chromatic inflection. There is little else you can do to correctly assign harmonic functions to a traditional score. Remember that our chief concern here is only with transnotation of conventional scores for analytical purposes.

NOT: I realize that in the process of transnotation certain things are lost. One of those is the erasing of chromatic inflections as signals of proper resolution in traditional music. The other one is more space demanded by the bigram staff for uncluttered

presentation. Nevertheless, the transnotation of this music by Strauss is helpful to me for many reasons. It permits me to sit down at the piano and play the excerpts from the score. I do not need even your condensed scores to do so. Picking up the parts of the first four horns in Example 6.3 b), p.E57, gives me enough of a sampling for the essential sound of this passage. Furthermore, it permits me to trace the compositional logic with much more clarity than by following the conventional score. There is also no doubt about the tonality of this music. Everywhere I can easily recognize either the isolated elements or the characteristic shape of an entire major triad based on "F" as its root.

PAN: Of course, this is easy to see in so-called "tonal" music. The new system facilitates also the recognition of other characteristic shapes which are not as simple as a major triad. I am thinking of potential gains stemming from reduction of compound intervals in case of a widespread pitch spectrum. One example comes to mind, in this regard. Look at the next Example 6.4, p.E57, which extracts the component pitches from the opening and the ending chords of a brief song accompanied by the full orchestra. The third song from Berg's *Altenberg Lieder* is here the subject of such an abbreviated treatment. Be sure to get acquainted first with the score of this music. Only then will you better appreciate the benefits of the transnotation of even such a narrow focus as the two instrumental chords framing the song.

NOT: I do not remember having seen the score yet. The left and the right columns of the diagram already give me an idea how widespread the instruments are. The contra bassoon reaches into the bottom of the second octave region, in the wind column. The violins, in the strings column, reach the last available pitch in the seventh region. This is a span of almost six octaves. I suppose you have reduced all pitches to their closest proximity in the middle of the diagram.

PAN: That is right. Both chords are condensed to pitches available within an octave. The first chord utilizes the usual opaque disks, and the second one the open disks just for better contrast. Both of them have been arbitrarily arranged starting with a "zo" at the bottom for better comparison. The result is clearly a chromatic spectrum which does not duplicate or omit any of its pitch classes.

NOT: Does it mean that the interval content of such a cluster is twelve members in every class?

PAN: Yes, perhaps with the exception of the tritone (number six in our table of interval content) which actually exhibits only half of this amount. There is also no "normal" position because wherever you start it, this pitch aggregate exhibits the same interval distribution. Many instruments have a little sign behind its name. Do you remember the meaning of those symbols?

NOT: I think they are signs for the personal distribution of instruments in each part. When they extend to the right of the timbre diamond, they tell us which one of the consecutively numbered instruments is to perform the specific part. However, I do not see here any flags extending to the left of the timbre diamond. There must be a reason for it...

PAN: Although Berg uses a large orchestra, the wind instruments are employed here on the soloistic principle as in chamber music. Therefore there is no need to use any of those signs, except when the composer specifies which one of the instruments assigned to a section of the staff is to be used. Thus when you see the first of the clarinets from above, it is followed by a symbol for number three, on the ordinal side of the timbre diamond. This means that this is the music for the the third clarinet in this group of instruments assigned to this section of the score. Apparently there is no need for the first two clarinets of this kind in this song. After playing the opening phrase the performer is instructed to change to clarinet in B-flat.

NOT: I do not understand. Was this not the music for a B-flat clarinet from the beginning?

PAN: No, it was not. The syllable "lo" placed parenthetically behind the signal identifies this instrument as a clarinet in E-flat. I suppose to be precise the code: "lo-feü" should be used here to prevent interpreting a "lo" as a possible "d-sharp." Since I do not know of any clarinets in D-sharp, this is rather a moot point. However, there exist clarinets in D; the best proof is its use in the score for *Till Eulenspiegels lustige Streiche*, as seen in the preceding Example 6.3 b), p.E55. Even so, clarinets in E-flat usually perform the part of the almost extinct clarinets in D.

NOT: I am trying to figure out what note was used in the original score for the "cokho" which appears in transnotation. Since the clarinet in E-flat transposes a minor third upwards, it must have been a two-lined "g-sharp," in traditional terms.

PAN: Your guess is right. It is a "g-sharp." Now, the clarinet placed right below the E-flat clarinet is the B-flat clarinet. This is why you see the syllable "do" behind its diamond sign. The sign itself means the "first" clarinet, suggesting again that in other parts of the score there are may be other B-flat clarinets assigned to the same staff section. If all this sounds too complicated to you, remember that you can always use the traditional instrumental nomenclature. If you want to keep everything consistently new, you have some options demonstrated here. Suggesting a change implies a change for the future; it does not mean necessarily a conversion of everything in the past to new standards.

NOT: It will take me some time to get used to new terms and signs. I recognize also the fact that the new system is not designed to merely transnotate the

traditional notation. Perhaps the conventional notation should serve the performance of music which has been originally recorded in the old system.

PAN: I am sorry that I could not include the two pages of the traditional version of Berg's song. There are so many interesting things the composer does in this score. The first chord evaporates gradually after eight measures from the beginning. The last chord is reassembled also gradually in staggered entrances of "divisi" strings silver-lined with the tinkling of a celesta. In both cases, everything happens at very low dynamic levels, in the moderate tempo, and in the meter of three quarters to a measure.

NOT: I notice from Example 6.4, p.E57, that strings are divided methodically in four groups of three staff bigrams. This is probably as symmetrical a division into twelve parts as any. Is the rest of the song also dodecaphonic?

PAN: The rest of the song treats its music rather freely. Though, the fifth and last song in this cycle contains a dodecaphonic phrase.

NOT: You would expect this from a student of Schönberg. Was this one of Berg's first experiments with twelve tones?

PAN: It was a first for Berg but do not take for granted that it was composed after the examples of twelve tones by Schönberg. Actually, this cycle of songs by Berg antedates the earliest twelve-tone pieces by his mentor. It is a rather risky business to claim the "first" of anything in history. Just think of the traces of twelve-tone construction discovered in the works of Richard Strauss, Liszt, and even earlier. Coming back to our original objective, one of the advantages of this transnotation is that it permits us to gain analytical insights in a more direct way than is possible with conventional notation.

NOT: I see already that the next Example 6.5 a), p.E58, is from the piano music by Debussy. No more transposing instruments but plenty of sharps both as a key-signature and as accidentals. What analytical insights can be gained from transnotation of such music into the new system?

PAN: The trouble lies in the inordinate amount of accidentals in the original. It is difficult to see the forest through the trees of sharps. Especially for the inexperienced pianist, it takes time to realize that those chords in the right hand are nothing else but a series of four-part major triads. Moreover, the roots of those chords are outlining all four ingredients of a full diminished-seventh chord. This is the first advantage of the transnotation as you can glean it from Example 6.5 b), p.E59. It has been said that Debussy's intention was to conform with the exigencies of an octatonic scale in notation of this passage. If it is so, then the symmetries of an octatonic scale are even better represented in the new system of notation. The transnotation clearly shows that every other tone of an octatonic scale forms a diminished chord. Even in the left hand the

symmetrical formation is made obvious except for the presence of a "g-sharp." This "g-sharp" can be explained as a dominant in a larger context which is not seen in this brief excerpt. The tonal feeling revolves around "c-sharp" as a tonic. The reiterated pitch of "g-sharp" in the lowest range changes eventually to the subdominant. You can see it in the last measure of this example.

NOT: Is there any particular order in those melodic fragments on the middle staff?

PAN: Yes, it is also permeated with the characteristic octatonic progressions of a whole-step followed by a half-step or vice versa. Notice that the transnotation is using one three-staff system separated from the lower four-staff system. The separation of music for the right hand from that for the left hand may be regarded as an improvement over the original notation. However, this arrangement has also its shortcomings. First of all, it stretches the field of pitch to considerable heights. Then, it demands much attention to the region clefs. The bottom of the upper staff system has the same region clef as the uppermost part of the lower staff system. Both of them indicate the same fourth octave region. Now, it may become a bit uncomfortable for the pianist to realize that the thumb of the left hand is only a whole-step (two steps in PANOT) distant from the thumb of the right hand at the beginning of this excerpt. Hence, with the advantage of clearer perception of intervals and pitch movement comes the necessity for reorienting the absolute pitch placement when two neighboring staff bigrams cover the same octave region.

NOT: You must have chosen the repetition of the fourth octave region right below it for the reason of transparency. Actually, you could put the music of the top staff for the left hand on the same staff as the bottom staff of the right hand. There seems to be enough space to locate the note heads without the risk of conflict.

PAN: This is true, but it would be difficult to find space for the note stems for the melodic fragments in the middle of the score. The chords from above and from below come very close to each other leaving very little space for the independent melody played mostly with the thumb of the left hand. Otherwise, it would be much better to have an arrangement where every staff bigram from the top to the bottom represents the uninterrupted sequence of consecutive octave regions. Think of a possibility to separate the middle portion in the ways similar to the original notation. Would that be desirable regardless of the increased difficulty in scanning the score stretched even further along the vertical coordinate?

NOT: I would have to write out this music in this way, and try playing it for comparison with the original and with your version. I really do not know what would be a more practical solution. Regardless of the layout of the page, I think the process of reading the transnotation is made simpler because of the absence of accidentals.

PAN: I am glad that you are interested so much in problems of performance. We should never lose sight of the pragmatic side of any proposals for new music notation. Nevertheless, our chief concern with this example is to ascertain what, if any, advantages are gained from the analytical point of view. Let us combine the concern for performance ease with the concern for analytical insights. I propose that you hold under the fingers of your left hand all the four keys of a full diminished seventh chord, starting with an "a" of the tenor octave under your little finger. The depressed keys will be the same as the four roots of major triads you see in the right-hand part of the very first measure of our Example 6.5 b), p.E59. Then, with your right hand over the left hand try to find the four keys belonging to another full diminished chord, starting with a "b-flat" under your thumb, closest to the key of "a" already held by the left hand. It will be a little uncomfortable to crowd both hands to play the keys in such a close proximity. This time, the depressed keys should be the same as the ones in the first chord seen in the left-hand part of this example. For the time being, disregard the key of "g-sharp" at the bottom of the chord. Now, what you hold under your fingers are two diminished seventh chords, one at a distance of a half-step from another. If you can manage to strike alternately all keys, starting with the left-hand "a", following with a "b-flat" under the thumb of the right hand, continuing with the left-hand "c", and so on -- you will play an octatonic scale underlying this passage. Do you remember my assertion that the tone of "g-sharp", which lies outside this octatonic scale, acts as a dominant?

NOT: Yes, I do. You said something to the effect of "g-sharp" fulfilling a dominant function in the the fuller context of the entire prelude.

PAN: Then, it seems that the whole excerpt is nonatonic rather than octatonic, with the pitch classes of "b", "d", and "f" missing entirely. Of course, you would have to look at the entire piece to see whether or not this is a valid conclusion. This observation proves to be wrong because the pitch classes missing here are freely used in other sections of the prelude. Moreover, the piece, whose key-signature suggests "c-sharp minor," ends on an exquisitely delicate Picardy third.

NOT: I am so fascinated that I will try to transnotate this prelude and play it afterwards at the piano.

PAN: You will be amply rewarded, I am sure. Let us move now to an example which will illustrate how far you can go in obtaining analytically relevant data from a transnotation. The music is taken from the ending of a section entitled "Querimonia" in Stravinski's *Threni*. Get acquainted with this excerpt, please, by turning to Example 6.6 a), p.E60. After examining the traditional notation in its modern layout, move to Example 6.6 b), p.E61. You are experienced enough to be able to check every detail of the transnotation for correctness. Compare the interval sets inside the highlighted and elongated bars, and see which ones are similar and which are different. Before you try to

make some sense from the pitch sets, turn the page to Example 6.6 c), p.E62, and read all the explanations underneath the magical square. The magical square, or prosaically: set matrix, is a device which permits you to see at a glance what changes a set can undergo in retrograde direction, in inversion, and in all eleven transpositions. The fundamental set in this case is a dodecuple set which appears first in the score of this modern oratorio. It is not the "original" set first employed by the composer before he added a few introductory instrumental measures in front of the previously composed duet. You can find this fundamental or prototype set as the first row at the top of the square. It starts with pitch classes: 6, 5, 0, and so on.

NOT: Pardon the interruption, master PAN. I did not have enough time to assimilate the matrix symbols. What would you call the second row starting with 7, 6, 1, etc.?

PAN: When you compare it with the top one, you will notice that it represents the same order but shifted one-half step (one full step, in our terms) upward. Therefore you can call it the first transposition of the prototype set. The transpositional numbers can be found in the shaded column marked "PT" for "prime transposition." They are read always upward from the given pitch level. For instance, the transpositional number of the one before the last row (starting with 4, 3, d, etc.) is "d" because number 4 is a "d" distant upward from 6, the starting pitch of the prototype. It is a much closer distance from 6 downward to 4, and yet to avoid confusion use the number "d" instead of: 2 downward. Similar computations can be applied to the inverted image of the prime set. The inversion (called later: "inver") at a zero transposition is the very first column of the square, starting with 6, 7, 0, and reading the rest of the column downward. The shaded row marked "IT" for "inversion transposition," confirms the zero transposition of the first column. On the other hand, the last column, the one starting with 3, 4, 9, etc., is at a ninth transposition, because 3 is "9" distant (of course, upward) from 6, the starting pitch of inversion at a zero transposition. One more thing for you to remember is that all retrogrades (of the prime, as well as of the inversion sets) carry the same transpositional numbers as "straight" primes and inversions.

NOT: Please, give me an example because I still do not understand.

PAN: Take, for instance, the last row, starting as a prime with 9, 8, 3, etc. It is the third transposition of the prototype because 9 is "3" above 6, in the left, upper corner of the square. The retrograde version (or: "rever" for short) of the same set would start with 6, h, d, etc. It still is the same third transposition, although strictly speaking a set starting with a "6" could be regarded as a zero transposition of the retrograde. This is done for simplicity's sake, and also for uniformity's sake to avoid possible referential confusions. The same applies to the retrograde inversion (called here "niversion" and later "niver" (just to shorten the unwieldy appellation: retrograde inversion.) Let us agree then that transpositions are read always from the head, and not from the tail of the set.

NOT: What purpose does the identification of pitch sets serve? Just to trace their conformity with the permutations of the prototype set?

PAN: It is helpful to see what compositional choices are made, and how the unity of the composition is preserved. The interaction of different versions of the same set is relevant to the overall form of the piece. Depending on the style the composer adopts, the tracing may become difficult at times. Stravinski's serial compositions occasionally exhibit irregularities in combining certain embedded hexachords, and in extended repetitions within a set. The simultaneities, like the ones exhibited here for the chorus of voices or trombones, often admit of more than one interpretation. I am sure you would not have any difficulty in tracing the pitch movement of the first tenor from the transnotation on p.E61. If you are in doubt, you can always look up solutions at the bottom of p.E62. Tracing pitch sets is only a very elementary analysis. Far more important, for our purposes, is to follow and discover the handling of intervals. After all, the master himself considered serial music, first of all, as "music of intervals." You can automatically deduce the prime set of intervals from the prime prototype by filling in the spaces between pitch integers with interval integers, and by adding directional signs. Next, you can easily subject this interval set to inversion and to concomitant retrogrades. The result of those processes is shown in a diagram at the top of p.E63. The structure of this music excerpt is not fully revealed until you have identified all the interval sets throughout all media of performance. You will find the identification of interval sets in another diagram, at the bottom of p.E63. Compare this diagram with the elongated and shaded bars in Example 6.6 b), p.E61, and see for yourself how those strings of intervals can be interpreted.

NOT: As I look at them, their use makes sense. It reveals how skillfully the composer has juxtaposed portions of different versions of the set with each other.

PAN: Those portions of the set you talk about are sometimes called hexachords for they constitute exactly the half of the dodecuple series. You see them separated by interspaced lines on the pitch-set matrix, on p.E62. You see also their terminal intervals enclosed in interspaced enclosures on the interval diagrams at the following page, E63.

NOT: From what I see here, it would take me longer to recognize the compositional workmanship if I had worked from the original notation. The transnotation, on p.E61, provides a basis from which all those matrices and diagrams can be methodically generated.

PAN: It is important to evaluate objectively the relative advantages the new system provides. Serial sets, and their recognition, are only the tools of preliminary analysis. They could be also constructed by examining the conventional score. What matters here, however, is not only the question of speed at which one can discover the

serial logic in traditionally notated music. It is rather the fact that the results of tracing serial orders have to be converted anyhow to a collection of data similar to set matrices illustrated on pages E62 and E63. Thus, the transnotation leads directly to the account of analytical insights.

NOT: I noticed also that every set member has an assigned number. Is this also an arrangement which you consider indispensable to analysis?

PAN: It is useful if you want to point to a specific pitch or interval, and identify its place. How, otherwise, could you compare two intervals from different set versions, or refer to a pitch class that both set versions share in common?

NOT: When referring to set analysis, you use traditional terminology. Would you not expect the employment of the new terminology in analysis too?

PAN: Yes, I would but I do not believe I could communicate both the new approach to analysis, and the new codes and signals at the same time. I hope that by now you can start expressing everything in PANOT terminology and proper pronunciation.

NOT: Let me try to express the interval set for the first tenor, as it appears in the diagram at the bottom of page E63. I will read slowly, and please correct whatever is wrong. NOT reads: "Pee, one to h," or rather: "Pee, *to to ho*."

PAN: Good try, Mr. NOT, but there are several things wrong with your reading. First of all review the early appendices, particularly A2, A4, and A5. Then, let us agree that capital letters will be distinguished from the lower case by appending the consonant "k" at the end of their phonetic spelling. Consequently, I would read: "pek." It may sound like a linguistic monstrosity but such is the price of hoping for an internationally uniform pronunciation. Furthermore, set members should be treated as numbers and use the vowel "u" for their spelling and pronunciation. Therefore, their range from one to "h" should be spelled: "tu" through "hu" and pronounced by English speaking people as: "too" through "hoo." Now, try to encode the interval sets for the second tenor.

NOT: I will attempt only to spell them correctly. I must postpone their pronunciation to a later date. I will write in my note-book, and show that to you after I am finished. NOT writes the following: "*ik, pu* through *ku*, and *tu* through *cu*."

PAN: Wonderful! If you want to avoid mixing the code notation with such English words as "through", you may use the code words for opening and closing parenthesis, as well as those for hyphens. You can find them in Appendix 5. A very formal appearance of the interval sets for the second tenor would be then in writing: "*ik - muf pu fuj ku mus, muf tu fuj cu mus*." As an approximate phonetic guide, I would

recommend to you: "eek moof poo fooy koo moos, moof too fooy tsoo moos." Have you had enough of this nonsense?

NOT: You must be aiming at an ideal situation where everybody agrees on what becomes in reality a new artificial language. Do you really have any hope for adoption of such codes and, particularly, their pronunciation?

PAN: I told you before that I realize I am hoping against hope. I had to verbalize those ideas as a consequence of stubborn consistency. Do not forget that you can still pronounce those terms any way you want. At any time, you can substitute also the native terms for the neologisms. However, I could not resist buttoning up whatever I have suggested earlier. We are accustomed to use the language of description when referring to musical sounds. In dealing with analysis the language of description often becomes inadequate and rather unwieldy. You may always point to the third member of a retrograde inversion at the eleventh transposition, and be understood. You can also accomplish the same with scribbling: "Nh(3)" or saying "*enkhu--muf-lu-mus.*" It may be regarded as unfortunate by many, that the language of musical analysis relies so often on statistical data. Those data can be expressed in terms or symbols reduced to essentials, rather than in long-winded descriptions. You are already familiar with codes which can be used in reference to pitch, duration, dynamics, or timbre. They substitute effectively for descriptive terms which are usually much longer. Do you remember, for example, how would you express the following note in a code: a dotted thirty-second-note on the second half of the third "beat" in a meter of four quarters?

NOT: The meter would be: "*rutabu,*" and the note would read: "*lumve-taibeb.*" I hope I am right.

PAN: Yes, you are. One more example, if you please. Find one code for the following verbal expressions: 1) the pitch on the ledger line below the treble-clef staff, 2) the pitch on the ledger line above the bass-clef staff, 3) the pitch of "one-lined do", 4) the pitch of the "middle c."

NOT: It will take me some time but I will try, anyhow. Could it be that two syllables would be sufficient to identify this pitch: "*rokzo*"?

PAN: Right again. You see that communication in code syllables is not that abstruse, provided you overcome the initial shock. I hope you remember also the signals for duration and pitch placement as well as you remembered the codes. Now, returning to the example of music by Stravinski, I will give you the complete reading for one, single note which you will find in the traditional score on page E60. Toward the end of the part for the second bass, find the note over the text syllable "de" of the Latin word "i-de-o". It is an "e-flat" in the third space of the bass-clef staff, and it is depicted as a "half-note" being the second note of a triplet extending for the metrically normal two "half-notes" in the

meter of three "half-notes" for a measure. The tempo indicated at the beginning of the section, long before this excerpt, approximates one second to the tact. Being a part of pitch series, this pitch happens to be member number nine of the prime set in the eighth transposition, as you can check it for yourself in the set matrix, on page E62. The full information for this single note, to be found in the penultimate measure of the part for the second bass, can be summed up in the following code: *"tutamtu-bamle, loklo, pekvu, muf-nu-mus."*

NOT: It is an "e-flat" in the third octave, and yet you identify it only as "loklo." I understood that you are supposed to append a "feü" to "lo" to make sure nobody mistakes it for a "d-sharp" or possibly for a "f-double flat."

PAN: You would be right about that only in textures where progressions in the direction of resolution really matter. Serial music, recognizing the equivalence of all twelve tones of the chromatic spectrum, effectively cancels the validity of enharmonic spellings. Have a close look at this "e-flat" again. It progresses to a "f-flat" which is the next member of the set. The composer probably preferred a "f-flat" to the plain "e" because of the context of "flats" preceding and following this pitch. Apparently, "e-flat" was not chosen because of its tendency to resolve downward. After all, chromatic inflections do not "resolve" in serial sets. Were it so, a "d-sharp" would be more appropriate because the next pitch is an "e." So, you may always write: *"lo-feü"* to indicate the original spelling of the pitch. In serial context, however, this is not necessary. The only reason for doing so may be that it helps the singer in psychological perception of the pitch level.

NOT: Do you suppose, then, that a blind person who knows a little about music can learn the system and use codes for dictation?

PAN: Certainly. Your question brings up something else. You know already from history how people communicated their ideas through script. Be it Chinese brush ideograms, or Hammurabi's cuneiform codes chiseled in stone, or ancient Greek documents using styli on papyrus, the human hand was directly involved in communication. Quills, pens, brushes, and lead pencils on parchment or paper have been used from times immemorial for art, lettering, graphs, and music notation. It is only after Gutenberg's movable type that the human hand is not directly involved in printing. The typewriter machine further removed the hand from written communication, and handwriting became slowly a rarity in important documents.

NOT: I remember seeing some music typewriters which produced very neat characters used in music notation. Today, however, nothing can compare with the ease a special computer software can produce pages of music notation in relatively short time.

PAN: This leads me very close to my original point. One cannot ignore the more recent developments which offer a composer or arranger a bewildering variety of

software programs. Notice that decisions are still implemented by the human hand on the keyboard or a slide board. Can you try to reach with me into the future, and anticipate the situation where humans will communicate by completely bypassing the hand?

NOT: Do you mean speaking directly into the computer microphone, and receiving the printout of what you said?

PAN: The time is probably not too distant when this will be not only possible but generally used. Could you foresee the role of our codes being fed into the computer, and music notation unfolding before our eyes? Should we not be prepared for such opportunity where the eye does not guide the hand but where the tongue indirectly affects the eye? Do you see now the potential which the code notation represents?

NOT: I never indulged myself before in speculations which can reach so far into the future. I can see, however, how the codes could be applied to something more than just facilitating for blind persons the writing of music notation by dictation.

PAN: Do not forget also that a software programmer can enter the entire signal notation whether in staffless form or disk notation for staff placement. Tool palettes and menu bars could be used as in other programs to point and click with your mouse.

NOT: Do you think that handwriting of music notation is doomed?

PAN: I did not say that. I just wanted to demonstrate to you that the new system of notation lends itself equally well to handwriting as to computer application. Actually, entrusting the new system to the computer may help streamline the redundancies and distortions of the conventional notation. I cannot restrain myself from going into tangents. Let us complete our preoccupation with this excerpt from the music by Stravinski with one more example. How would you write the pitch sets characterizing the part of the first bass. You will find the symbols for this part at the bottom of page E62.

NOT writes the following: "*ikzu,muf-gu-fuj-hu-mus, muf-zu-fuj-cu- mus,*" and then asks: Is this right?

PAN: Excellent! Notice that pitch sets will be distinguished from interval sets by having always a transposition number immediately following the symbol for set version. That is why placing of the code word: "*muf*" for the opening parenthesis is important to differentiate pitch sets from interval sets.

NOT: One thing more, please. What is important about the small diagram accounting for the interval content, on page E63?

PAN: The diagram permits you to see that the set is characterized by absence of major seconds and tritones. In our language, the missing intervals are "bi" and "gi." By the way, do you know how to read the content of sets of pitch classes and intervals?

NOT: Not exactly. Read for me the prototype pitch set from the magic square, will you?

PAN reads: "go, co, zo, ro, ho, bo, no, to, do, po, vo, lo." I would like to read to you also the prime set for the intervals, as it appears at the top of the diagram, on page E63. PAN reads again: "tif, cif, ris, cif, lis, cif, ris, lif, lif, tis, cif, and eventually lis, if needed. This should be enough for the examination of music by Stravinski. We must move to the next examples in order to finish our discussions today.

NOT: I have so much to review and to become familiar with new analytical tools. The writing and pronunciation of codes are the major stumbling block for me. I do not know when, if ever, I will acquire adequate proficiency.

PAN: Do not worry exceedingly. Things take time. Above all, refrain from communicating with other musicians, at least for the time being. Hearing you using the code language they may suspect that you either speak in tongues, or that you have lost your marbles.

NOT: Thank you for words of reassurance and of caution. I am ready to examine the next example.

PAN: It will be a complete novelty for you because we will discuss the relevance of so-called BAR-NOT to the analysis of a piece of music. The music is taken from the last movement of the second cantata by Anton Webern. What you see in Example 6.7 a), p.E64, is not the entire score although it is the entire movement ending the cantata. We can dispense with instrumental parts accompanying the chorus, because they duplicate the vocal parts, and do not change the pitch picture, except for contributing their unique timbre. The metric picture may appear strange to you. The reason is the composer's throwback to the art of Netherlanders where the "tactus" mattered and not the meter. The result is several barlines which do not coincide with each other. That is also the reason for lack of measure numbers. Five sections of the piece are marked by the initial capital letters of the alphabet. It is difficult to find the precise temporal place in such a score. Pointing to the vocal part, and to the text syllable underlying the specific note becomes a viable option for identification. It is an effective way to find your place in vocal music, particularly in syllabic textures, as evidenced here. However, for ease in this search, tentative measure numbers have been introduced in transnotation, as you can see them in Example 6.7 b), p.E65. Those measures correspond only to barlines in the uppermost part for sopranos. Keep it in mind when we refer in our discussions to other vocal parts.

NOT: I see that you are using color for the first time. It looks like pitch movement is more important in this transnotation than the rhythm.

PAN: This transnotation is actually a condensed score which records only the pitch and articulations of the notes. The parts are not arranged separately, as in the original score. They are put together on one canvas of pitch space rising from the second to the fifth octave region. This is the reason why they are differentiated by different colors. The use of colors in this and in the following examples is purely for symbolic reasons. There is no attempt here to appeal to your aesthetic sense. The rhythmic picture is rather simple. It is dominated by the amphibrachic metrical feet. Their characteristic rhythm is not felt strongly throughout the movement, except for the beginning and the ending, and a few places in the middle. This happens because the individual part rhythms are dispersed polyphonically and do not occur simultaneously. Later on, we will discuss in detail the intricate canonic construction of this movement. Right now, notice that in the condensed score you see individual rhythms melted into one resultant rhythm. The durational beam at the bottom of the transnotated score represents a huge extension of a single "tactus." All note stems either carry an articulation or a rest worth one single tact.

NOT: I have never seen such a treatment of rhythm. Can you sit down at the piano, and play from such a score?

PAN: Of course, you can. I think you can do so probably with less distractions than if you would attempt the same from a condensed conventional score. I have prepared for you the same condensed score but in a different form than you see here on page E65. It is mounted on a continuous roll of paper. The end of the score is glued to its beginning to form a circle. This big sleeve is put over the piano rack, as you see here. I am glad we have the grand piano in this room because this would not work very well with most upright pianos. Now, sit down near me, grab the score-sleeve with your hand, and help me forwarding the score as I will play from it. I probably could do it myself but stand by, please, just in case I start fumbling. (PAN plays at the piano.)

NOT: Now I understand what you are doing. You have played the piece three times. There are no repeat signs in the original score but I see there are three different verses for each vocal part. Obviously, the music of the movement is to be repeated three times.

PAN: Let us suppose you are assisting at a rehearsal of this piece without the instruments. You are anxious to support the conductor, or, perhaps, you are yourself the vocal coach. Imagine some intonational difficulties arising in the middle of the movement. Could you promptly check the total sound by flipping pages of a conventional score back and forth?

NOT: You want me to notice the advantages of the new system over the traditional one. I see the role condensed scores can play in rehearsals and analysis. It seems to me that even a plain, uncompressed score would be helpful. You could transnotate every vocal part with the appertaining three verses of text. Would it not be helpful too?

PAN: Yes, especially when coaching separate vocal parts. You realize, however, that such a score would be stretched far wider from bottom to top than the score you see on page E64. Adding separate parts for instruments would even demand more space. My purpose in showing you the sound abstract on page E65 is to prepare you for the conversion of this score to the bar notation. Example 6.7 d), p.E67, is nothing else but substitution of disks you see on page E65 with bars whose length corresponds to the duration of the note. First, you will be bewildered by shapes which sometimes make sense and at other times do not make any sense at all. This is where analysis is necessary in order to make sense of everything transpiring here. I hope you will notice again how the new system facilitates understanding.

NOT: I recognize the magic square, on the opposite page. Please, explain the relevance of set matrices to the bar notation on the following page.

PAN: There is no secret that pitch movements for this excerpt are governed by a single dodecuple set which also underlies the entire cantata. You know already that you can find the prototype set in the first row at the top of the matrix. The fact that it starts with a "zo" makes it very convenient to read the transposition levels of inversions. Just follow the shaded bar (marked "IT") and see that any number in it signifies the transposition of the column which extends from there downward. Similarly, the first column is in zero transposition. Read any number enclosed in this column (marked "PT") and you will discover the transposition level of the row extending to the right. It is a coincidence, but transpositions are always recognized very easily when the first column (from the left) and the first row (from the top) are in a zero transposition. Spot a zero in the left, upper corner of any pitch matrix, and you know that conditions for identification of transpositional level will be the same.

NOT: All colored rows and columns consist of a pair of contrasting colors. For example the first inversion, the one which you would call I0, is shared both by the soprano, and by the bass. Does it mean that the same order is found in both parts or, perhaps, the set members alternate?

PAN: What is meant here is that one part (soprano) follows the set I0, but the other part (bass) follows the retrograde of this set, that is N0. Let us find where those sets start and where they end. It cannot be the beginning of the soprano part shortly before measure 4.

NOT: Why not? It could mark the beginning of N0 because it starts with a "go."

PAN: That is true but do you see that the part follows with a "no"? What do you expect as the next pitch after a "go" in N0?

NOT: It should be a "po."

PAN: Well, let us look now at what happens in the bass part just one tact before measure 10. Do you not recognize a "go" followed by a "po"?

NOT: Yes, I do. Moreover, the succeeding pitches are: "vo," "ro," and "co," which confirms the fact that the bass part starts the retrograde inversion at the zero transposition with a "go," one tact before measure 10.

PAN: Trace the rest of the members of this set, and pinpoint the end of the set, will you?

NOT: It ends with a "zo" at one tact before measure 17. This must be right because the set N0 should end with the pitch class "zo."

PAN: You have found the end of N0 correctly. So now we know that the bass part carries the untransposed retrograde of inversion from one tact before measure 10 to one tact before measure 17. Let us go back to the untransposed inversion, and find its appearance in the soprano part, on page E67. We have found out already that it cannot be the first entrance of sopranos at one tact before measure 4. You are looking for a set continuity which starts with the pitch classes: "zo," "lo," "ho," etc.

NOT: I think I found it. It starts at measure 10 and ends at one tact before measure 17.

PAN: Do you see how the untransposed inversion and its reverse cover almost an identical space of time in the middle of the movement? They can be found in the parts for sopranos and basses. This is the reason why the first inversion column on the matrix, on page E66, is highlighted by a pair of colors corresponding to the colors associated with those two vocal parts.

NOT: Please, clarify for me one more pair of colors symbolizing the tenor and alto parts, such as found combined for the prime and retrograde at the fourth transposition (P4, or R4, as you would call them.)

PAN: I assume we are looking at the same thing; it is the bottommost horizontal row on the matrix exhibiting the colors of tenors and altos. You are searching

for pitch numbers 4, 1, and 5, for the beginning, and for numbers 8, 9, and d. for the ending of the set. You will find that this is the alto part which starts with those pitches at measure 9, and ends with them at one tact before measure 16. The reverse of this series appears in the tenor part. It starts with number d (or "do") at one tact before measure 7, and ends with number 4 (or "ro") in measure 14. We could go on with the identification of other set transposition but it is time to leave you to your own devices, and consider a faster and more musical way to discover the secrets of a serial composition. After you examine the interval diagram found below the pitch matrix, on page E66, it should not escape your notice that the prototype set starts with 3 down, 4 up, 1 up, etc. (in our code language: "lis, rif, tis," etc.) This set ends with: 4 down, 1 up, 1 up (in our code language: "rif, tis, tis.") This is equally valid for inversions, except for reversed directions. In retrogrades everything is reversed, the order of progression, as well as the direction of intervals. It is very helpful to look for those strategic intervals, when trying to find the set used in a serial composition. Simply remember: "lis, rif, tis," and "rif, tis, tis," not only as a mute recollective device, but as a live sound, humming those intervals to yourself. Tracing different sets becomes less of a drudgery, and you do not need to juggle in memory the different pitch class successions possible for all the rows and columns of a pitch matrix. The interval approach also saves time. As you look at the bar notation on page E67, please tell me what relationship do you see between the tenor and soprano parts at the onset of this movement?

NOT: From the bar placement for both parts, I conclude that they must have similar intervals. Since the tenor part starts from a "bo" with "lis, rif," this must be "ikbu," or the inversion at the second transposition. The soprano exhibits the same intervals but it starts with a "go," so it must be "ikgu," or the inversion at the sixth transposition.

PAN: You see, then, that their interval structure is not only similar but, actually, identical. You can also anticipate that tenors and sopranos will complete the remainder of their I2, and I6, respectively. You still have not answered my question. How could you characterize the relationship of those two parts, in traditional terms?

NOT: Those two parts stand in canonic relationship with each other.

PAN: Does it surprise you?

NOT: Do you mean that you can expect from serial music that everything found in it stands in canonic relationship?

PAN: Go back to the history of canons with their primordial beginnings in *Stimmtausch* and, later, with the dazzling examples of complex relationships. Not all canons need to be serial, but serial music based on the same set becomes canonic. Even relationships between primes and retrogrades are actually canonic. The change in direction of successive set members does not change the fact that they are identical in

content. Therefore, when you look back at our two pairs of retrogrades between soprano and bass, and between tenor and bass, they both are serial canons. They are manifestations of the essence of every canon in the sense of temporal and spatial displacement of the sameness. The sameness, however, may extend to include various octave transpositions. Hence, serial pitch canons are rather pitch class canons than canons of absolute pitch. You see an interesting example of this principle when you compare the alto part with the bass part, at their very first entrances. At first, they do not seem related but closer examination reveals their identical shape. You need only to transpose the "do" in altos one octave down to recognize that the bass part has the same shape. The initial intervals in both parts are "lif, ris," the unmistakable characteristics of prime sets. The first pitches of both parts determine their transposition levels, so you could label those sets Pd in alto, and P2 in bass. The entire canonic exposition can be summed up as I2, Pd, I6, and P2, in order of vocal entrances.

NOT: I am intrigued by the concept of octave transpositions. If those are pitch class canons, any canonic relationship can be easily concealed by wide skips in either direction.

PAN: This happens here very often. However, compound intervals can always be reduced to simple intervals within an octave's range. A further reduction to just six interval classes is also an effective process permitting relevant comparisons. Those procedures are made very simple on the PANOT staff because the pitches always retain the same position on the staff, regardless of octave regions. The compression to six interval classes subjects all intervals wider than a tritone (six steps in our system) to an inversion, and provides them with an opposite direction sign. This is also a kind of octave transposition. It is aimed at compressing larger intervals to their smaller complements within an octave, rather than reducing compound intervals.

NOT: I cannot see how such adjustments could be possible in a conventional score. Octave transpositions result in change of position on conventional pentagrams, and accidentals conceal the true size of intervals.

PAN: Before you see the real advantage of bar notation for analytical purposes, spend a little time getting familiar with what transpires in two next examples. The first one, on page E68, presents octave transpositions in soprano, alto, and tenor. The second one, on page E69, does the same with the parts for alto, tenor, and bass. The checkered bars indicate the original pitch placements. They are replaced now by solid bars through the process of octave transposition. Changes were introduced only where they served the objective of ensuring an effective comparison. These two pages do not purport to explain everything. We must postpone the full analytical explanation to the time when you will be ready to look at the next pair of pages, E70, and E71.

NOT: Something strikes me as very relevant to analysis in those pages. The characteristic motives of the beginnings and ends of sets begin to emerge from the textural maze I have seen on the previous page. Now, the canons between tenor and soprano can be traced rather easily, except for the middle portion. I also can trace the bass part following canonically the alto part, on the next page. As in the tenor-soprano comparison before, the structure of the middle part escapes me again. Is there a way to justify analytically those middle portions?

PAN: Rest assured that there is a way to explain graphically the role those portions play in the context of the movement. I will go back, again, to your own discoveries that the middle portions consist of an untransposed inversion running almost parallel to the untransposed inversion retrograde in soprano and bass parts. You know already that the tenor and alto parts run almost simultaneously with the other parts, and juxtapose prime with retrograde in the fourth transposition. Imagine reversing the direction of retrogrades in the score. What would you see as the result of such an analytical impudence?

NOT: Both parts, the prime set and the former retrograde, should be the same. I do not know if they would feature the same pitches at the same time. That will depend on whether or not pitch retrogrades are also rhythmic retrogrades.

PAN: They are not, so do not expect that you will see perfect alignment of durations. They still would be easy to trace by comparing their pitches. What is your observation regarding the pairs of prime and inverted sets: are they also the rhythmic canons?

NOT: Definitely so. They consist of pitch motives which are also rhythmic motives. Their spatial and temporal correspondence can be traced with little difficulty, after adjusting them to each other by octave transpositions. Therefore, I think that analytical insights are significantly enhanced by those two pages, E68, and E69. You are using very thin lines to connect bars of the same color. Sometimes they are vertical, and sometimes they are slanted. Do the slanted lines represent rests?

PAN: Yes, they do. Any time you see a slanted line, it means that those durations are separated by silence. The checkered bars, representing original pitches, are not connected with any lines because they are extraneous to our objectives. With the last pair of examples, E70, and E71, the absolute pitch no longer matters. That is why region clefs disappear. The temporal displacement of canons is also reduced to zero. This means canons are no longer represented in staggered entrances. Space does not permit entering the entire texture on one page. The graphic layout for both pages is similar to the previous pair of pages. Page E70 outlines the relationships between the three upper vocal parts. Page E71 does the same with the three lower vocal parts. The outside portions of the movement are correlating the pairs of parts as strict canons. The middle portions are seen

as canons by retrograde because one part of the pair of vocal parts has been adjusted to the other by reversing the direction of pitch members. Except for a few discrepancies in durations, the correspondence of those parts is visually verifiable.

NOT: I am amazed at the strict implementation of pitch canons. The unchangeable pitch distance of a major third between them must have been the result of the composer's choice of set transpositions.

PAN: Of course, you can glean this from the bar notation on page E70, or even from the set matrix. Take, for instance, the pair of sopranos and tenors. In the first portion of the movement they follow inversions at the second, and sixth transpositions. Notice that the transpositions are separated by four half-steps (in our system by four steps, or by a "ri".) In the final portion they follow retrogrades at the second and "d" transpositions. They are separated again by the same interval of a major third (or "ri," in our system.) The same happens in the pair of altos and basses, as seen in bar notation on page E71. In the first portion, they follow primes at the second and "d" transpositions, separated again by "ri." In the final portion, they follow retrograde inversions at the second and sixth transpositions, hence maintaining the same interval of separation (major third or "ri.")

NOT: What kind of separation exists in the middle portion?

PAN: None whatsoever. By reversing the order of succession of pitch members you just duplicate the same. Zero separation is the best term here even if there is an octave distance between parts. An octave is always reducible to an unison for such analytical purposes. You must remember, however, that reversing of set orders is employed here only to demonstrate visually the canonic relationship. In reality, this relationship is not easy to discover, unless you spot the same transpositions of prime and its retrograde by analysis.

NOT: Are there any irregularities in this movement?

PAN: You may consider some departures from the durational pattern in retrogrades as irregularities but they are negligible. Even in some places where identical pitches follow each other in close succession, (suggesting repetition) they belong to different sets. Contrary to some opinions, serial compositions are not necessarily engineering models or wall-paper music. Precision is relieved here especially by free octave transpositions. The adjusted bar notation clearly shows that the movement is tripartite in construction. Choice and distribution of set transpositions has much to do with it. Do not overlook also that sets are overlapping by either one or three set members. Check the continuation of I2 with R4 at the beginning of the tenor part. Do you see that the last three set members of I2 overlap with the first three members of R4?

NOT: Yes, I see it now. Is this always so?

PAN: I have just told you that sets can overlap also by one member. The soprano part, for example, starts with I6 and continues with I0. You can see it in the set matrix that the first set is hinged to the second one by the same pitch class. The inversion at the sixth transposition (I6) ends with the pitch class "zo," and this is also the starting pitch class for the untransposed inversion (I0.) Without getting involved in some other details, I think it is time for us to conclude the examination of this remarkable piece. Try to review all the advantages of the new system in general, and of the bar notation, in particular, for gaining analytical insights. Consider whether or not such things as, for instance, octave transpositions, reductions of intervallic patterns and temporal displacements would be equally effective in traditional notation. Think over how serial analysis is facilitated by special tools of analysis, and how helpful it is to have the notational system compatible with those tools. I am sure you will have no difficulty in assessing the relevance of bar notation to our next, and last example. The music excerpt is taken from piano variations by the same composer, Anton Webern. The traditional version in Example 6.8 a), p.E72 is transnotated in Example 6.8 b), p.E73. Whereas bar notation serves the purposes of analysis, this last example is again in disk notation, and it is meant for performance. I cannot think of a better exercise for you than to try to play those nine measures, first from the conventional notation, and then from transnotation into PANOT. All the dynamic and phrasing aspects of the original have been omitted in this version in order to concentrate only on temporal and pitch aspects. Is there anything in the transnotation what you did not notice in the conventional notation?

NOT: Perhaps an overall symmetry which is hard to glean from the original. There are so many clef changes, and also so many accidentals to observe. The only thing which confuses me in transnotation is how am I supposed to divide this music between the right and left hands.

PAN: I would appreciate your advice on how to solve this problem. Do you remember when we first encountered the problem of hands division in the piano prelude by Debussy?

NOT: Yes, I do, and I am still uncertain about what is the best solution. I do not think marking each note with a "R" for the right hand, and with a "L" for the left one, is a good idea.

PAN: I do not think so either. If you had to do so, you may prefer letters "D" for the right (dextera) and "S" for the left (sinistra) hand, similar to the terms "MANDEX" AND "MANSIN" as used in Debussy (Example 6.5 b), p.E59.) Another way is to depend on the stem direction for hands assignment. Still a different way is to attach stems to the right side of the disk, for the right hand, and to the left side of the disk for the left hand. This is the distinction used in our present Example 6.8 b), p.E73. You have to try it on the

keyboard, and tell me what problems you have with sight-reading. Let me give you a hint for the fingering of the very first figure in measure 19. Put the thumb and the fifth fingers of your right hand on "bokho," and "lokdo," respectively. This fingering can be also marked briefly as D1, and D5. Then, put the fifth finger of the left hand on "lokro," underneath the right hand. Thus, you will be ready to play the "rokvo" with the left hand, and the "cokbo" with the right hand, the keys starting next figures.

NOT: I cannot read this score fluently, because I am still fighting with perceiving the distinction between the two sides of stems' attachment. I will try to transnotate this music with stems up for the right hand, and stems down for the left hand.

PAN: That is very commendable. You will see that the first figure in measure 19, as well as similar figures later on, will necessitate separate beams in transcription. The picture of the remainder of the score will not be changed significantly. Could you try alternating between the traditional score and the transnotation, in your readings? This way you will be able to compare the two versions in a very practical way. What is more comfortable: watching for frequent changes of clefs or for frequent changes of stem attachments? What is more reassuring: lower staff for the left hand, and upper staff for the right hand, or unchangeable octave regions on a constant grid of pitch space?

NOT: I will continue playing this excerpt, until I am ready to answer your questions. I suppose playing up to tempo is important here. Why did you add an optional tempo to the one given in print?

PAN: Just to make it little easier on pianists. The optional tempo is slightly slower than the printed one. There is reason to believe that the composer himself suggested a slower tempo for performance of these variations. Beside, it is easier here to refer to the tact rather than to the entire measure for proper tempo realization.

NOT: Right above the top staff bigram, I see a row of signals. I forgot their meaning; could you refresh my memory now?

PAN: You can find them in the second (2) section of Appendix 16. The roof-shaped ones mean "a tempo," and the ones with one arm only signify "ritenuto." Their observance is very important to the proper interpretation of this music. The dynamic signs and slurs in the original score have not been transnotated, though they are no less important than the signs for fluctuating tempi. In our preoccupation with performance problems, we tend to forget that we should concentrate on discovering analytical advantages of the transnotation. The limitation to temporal and spatial aspects only, is sufficient to perceive what you called an overall symmetry, a while ago. The conversion of this transnotation to bar notation brings out even more forcefully symmetrical relationships. Since both pitch and rhythm are subject to serialization in this excerpt, the picture reveals section limits and axes of symmetry which are not so clear in disk notation.

There are two full sections, and the beginning of the third one, demonstrated in Example 6.8. d), p.E75. The first section follows the inversion and its reverse at the seventh transposition. The second section exhibits the prime and its reverse at the sixth transposition. The partial third section starts with the untransposed inversion and its reverse. The long bars under the staff bigrams summarize the pitch sets with their beginnings and endings related to the pitch bars in the score. You should not take those identifications on faith. You can verify them on the opposite page with the help of set matrices, on page E74. Check the inversion at the seventh transposition (your last column on the pitch matrix), set member by set member, with the score bars on page E75. Then, do the same with the prime at the sixth transposition (the fourth row from the bottom on the pitch matrix.) Since those pairs are used almost simultaneously with their reverses, you can conclude that the entire set is spent by the time the axis of symmetry is reached. Both axes of symmetry are marked with double lines, and numbers 1 and 2, placed inside long wedges above the staff bigrams. A set bending on itself from the middle may remind you of an analogous occurrence in handling of words. Undoubtedly, you have heard of palindromes.

NOT: Yes, I know of the "Madam, I'm Adam" types of construction. So, these sections are perfect counterparts of palindromes in music. Is this an isolated occurrence?

PAN: No, the entire first movement illustrates this principle as applied to music. Bar notation helps reveal this as a series of palindromes of amazing variety, all based on the same pitch set. You can find the set prototype as the first topmost row on the magic square. Incidentally, it is difficult to ascertain what constitutes the prototype set because of the fact that the movement containing this excerpt starts with simultaneities and palindromes right from the beginning. The close canons of the second movement are not much help either. However, the first linear (consecutive set members) statement of the set in the third movement of these variations, permits establishing the prototype by reverse apportioning back to the second, and the first movements.

NOT: The diagrams which you present below the magic square, on page E74, strike me as something new. I understand that the bars diagram represents the untransposed prototype with its inversion, and with their retrogrades to be read backwards. In the numerical diagram, underneath, you have compressed the size of intervals just to one row. In the set matrix for intervals, serving the cantata example by the same composer, on page E66, you have listed four rows of intervals, each for the P, R, I, and N, versions. The intervals set for our last Stravinski example has also the same arrangement. Why is the interval matrix different, this time?

PAN: It is to show you that interval matrices can be reduced to the prototype row, and interval directions can be indicated above and below this line. Get acquainted,

please, with explanations of symbols, on the right side of the page. Now, start reading with me the prime set from the table at the bottom of the page:

NOT: 1, 4, 2, 3, 2, 6, ...

PAN: Now, begin reading the corresponding interval directions in the row marked "DR":

NOT: s, f, s, f, s, sf, ...

PAN: Fine. Could you combine the beginnings of those two lines, and read for me the intervals of the prototype in a code?

NOT: *tis, rif, bis, lif, bis, gisf, ...*

PAN: Use the table again, if you will, and read the retrograde of contra direction. Start with the same interval where you left off: number 6.

NOT: I suppose I should use the same row above the numbers. Since I am reading backwards, I will be following the mark for "RK." The result is: *gisf, bis, lif, bis, rif, tis*. Why, this is the same as I read for the prototype but backwards! The intervallic directions have not changed at all.

PAN: This is always so. Check, for a moment, the interval diagram on p. E66, please. Do you see that intervallic directions for the "P" and for the "N" are identical, and only the order of succession of set members is reversed?

NOT: I see this and I keep wondering how much further you can go reducing the statistical data to the barest minimum.

PAN: Is this not our ideal, to eliminate redundancy, particularly in analytical tools? If you prefer such diagram for intervals as shown for the cantata, or for *Threni*, by all means, use it. The present form is illustrated here as an option, at a time when you will get tired of the four-row diagrams with all those dashes above and below the numbers.

NOT: You offer some further assistance in pronunciation of codes and abbreviations, on the last two pages of our examples. Do you believe this knowledge is an indispensable part of the new system of notation?

PAN: From the beginning, our aim was not only to create a new graphic representation of music but also to establish a referential language by which we can communicate musical terminology. The major part of this language can be learned gradually while establishing symbols, signals, and codes for every parameter of sound.

You went through this process from temporal to spatial parameters, in addition to dynamics and timbre. We went far beyond the "do, re, mi" crutches of the conventional system. Yet, you must have noticed that all those neologisms are imbued with the same logic in their construction. Always the same consonants for the same numbers are combined with the same vowels for specific parameters. During our last meeting, you have discovered new tools of analysis facilitating the recognition of diverse orders possible in music. It seems only consistent with everything we have done so far, to establish such codes and pronunciations also for analytical tools.

NOT: Then I see PANOT as not only the reform of the notational system but also as a reform of the entire referential system. I sense that you believe that this synthetic language has a chance of adoption as the second language reserved strictly for composers, performers, theorists, and music educators.

PAN: There is something else hidden in the system which uses the clock's face for alphameric conversions. You have seen it already emerge from numerical accounts in analytical procedures. The vowel "u" was reserved for the consonants to signify only numbers and not parameters of sound. Thus when you looked for the prototype set, you have learned that the symbol "P0" pronounced "*pekzu*," could replace the word "prototype." The syllable "zu" by itself means "zero." So, the syllable "du" by itself means "ten," in the duodecimal system. Since we use the decimal system most frequently for counting, the expression "*tuzu*" could stand for "ten," in the decimal system. You do not suspect, I suppose, that you are already equipped to count loudly up to any amount you wish.

NOT: I am really curious. Give me a sample of a simple arithmetical operation, if you please.

PAN: You say: six plus eight equals fourteen. Then you write: $6 + 8 = 14$. The same can be expressed as: "*gu sum vu jum turu*." However, in base twelve system you say: six plus eight equals one dozen and two. Then you should write this as: $6 + 8 = 12$. The same in number words is expressed thus: "*guk sum vuk jum tukbu*."

NOT: Do you believe people would ever accept such an artificial language?

PAN: The proper question to ask, Mr. NOT, is not whether or not people will ever accept such a language, but do you wish they would. How does: "eight, or *octo*, or *acht*, or *huit*, or *otto*, or *ocho*, or *osiem*, compare for brevity with a "*vu*"? In spite of the notorious lack of acceptance of any artificial language, perhaps the time has come to universalize at least the way number words are written and spoken. If you are interested, you always can get acquainted with a seven-pages long pamphlet entitled: PANUM which is a spin-off product of the same research which led to PANOT. It may be worthwhile for

you to look also into Appendices 5 through 8 which are already in your hands. They contain some codes and marks which are used for computation.

NOT: I have never expected that study of new notation may equip me with number words, and lead me to a new way of counting. No matter how useful this will prove to me in the future, I will consider this knowledge definitely one of my fringe benefits.

PAN: As long as we feel that "do-re-mi" sounds more elegant than "zo-bo-ro," there is little chance that even the language of elementary reference will find acceptance. This comparison brings to my mind the potential of the new system for instruction of children. Although it is hard to expect from publishers any investment in such risky enterprise as a new notation, instructional materials for children can be easily produced in these days of desktop publishing. The instructional materials should be produced in such a way that notational symbols are not crowded on a page as you have seen them in most of my examples and appendices.

NOT: I realize that nothing is more frustrating than trying to decipher the position of pin-sized note-heads on a narrow staff. Placing notes in close proximity also makes reading difficult. Printing scores which are bigger in size than the traditional ones seems to be the only solution.

PAN: No doubt about this. I have tried to compare large scores in traditional notation with their transnotation in the new system. The comparison yields many instructive hints for handling of such scores in transnotation. A special Supplement, which you can locate behind the Appendices, contains some of these examples. The first one of interest here is an excerpt from the opening of Bach's *St. Matthew Passion*. The first choir and orchestra appear on pages S10(a) and S11(a) in conventional notation, whereas the second choir and orchestra appear on pages S10(b) and S11(b) also in conventional notation. In a similar layout, the first choirs appear on pages S12(a) and S13(a) in transnotation, whereas the second choirs appear on pages S12(b) and S13(b) in transnotation. Now I will point to a few interesting ways of treating the new notation when space is at premium. Right at the beginning, in measure 30 of S12(a), you see the parts for the first and second flute which play the same music. Of course, one could simply reserve one staff for this music labeling it FLAU (1, 2). However, the two flutes do not necessarily play the same music throughout the rest of this movement. Therefore it seems reasonable to treat them separately. In the same measure you see also an example of clef transposition. Instead of adding another staff at the top of the existing ones, the clefs are changed from "gok" to "cok" region. In the next measure (31) a high "e" (or our "ro") in the sixth region ("gok") is reached on the fourth "beat" of the measure. For this pitch, the first flute momentarily borrows the staff reserved for the boys' part in the fourth region ("rok"). Similarly the second flute momentarily borrows the staff reserved for the first flute part in the fifth region ("cok"). Both the boys' fourth region and the first flute's fifth

region denote the sixth region for this isolated pitch. The change of clef is not necessary because the continuity of the melodic line in both flutes indicates the regions reached.

NOT: So, actually, the space saving is achieved by a sort of condensation effected here by clef transposition and by parts freely crossing the neighboring pitch regions.

PAN: Otherwise we would have to increase the number of staves. This would increase the size of the score considerably. This situation is even more obvious in the second part of this score, as it appears in measures 34-38 of S13(a). The flute parts reach the sixth region very often, although the formal change of clef does not occur until the very last note in measure 38. Unlike with the wide-ranging flute parts, it is sufficient to accommodate the first oboe part and the second oboe part easily within the fifth and fourth regions, respectively. Music for violins, which is similar to that for oboes, also uses only two staves. When you look at the choral parts, you see how they are supported by oboes, violins, violas, and the bass of the continuo.

NOT: I have noticed that you are trying to squeeze the text in every place it is possible. When I look at the first measure (30) in the first part of the Supplement S12(a), I see that the sopranos and altos share the same text. Since the beginning of measure 31 the situation changes, because the sopranos sustain the syllable "kla-" while the altos have a different word rhythm.

PAN: The traditional text underlying may undergo some modifications. The words may be fitted wherever they do not collide with note-heads or note-stems. The beams also occupy much space, so this leaves a very restricted space for text syllables. Remember, however, that in vocal music beams should be used only for notes to be sung on the same syllable. Otherwise, the use of flags alone should leave enough space between the stems to fit the text comfortably. There is no problem with text underlay when choral parts are extracted from the context of the full score. You see such an arrangement in Supplements S14(a)(b) and S15(a)(b). The parts for sopranos, tenors, (and basses in measures 34-38 only) of the first choir demand two staves each, for depicting an uncluttered and true pitch profile. Single staves are all that is necessary to depict the interjections of the second choir, as seen at the bottom of Supplement S15(a)(b). These two pages may serve singers, as well as coaches and accompanists in the similar way as reduced and conventional vocal scores serve choristers and keyboard players. You can see a completely condensed and textless score in Supplement S16. It is not an arrangement for the keyboard, though its major portion can be negotiated on the keyboard, particularly when you occasionally omit some high-placed flute notes.

NOT: I must try it on the piano. It should prove exhilarating to bring such a huge score to life just for hearing the pitch and rhythm movements.

PAN: There are further possibilities such as extracting orchestral parts only or the extreme parts only. It must be remembered, however, that by extracting orchestral parts only, one cannot avoid outlining the choral music because most of the instruments just double the vocal parts. Before we leave the Bach example, let me call your attention to the fact that this transnotation is less formal than many you have seen previously. The informality manifests itself in the way the full "beats" or tacts are printed. Normally, you would expect to see short flags extending on both sides of the stem. One can circumvent this formal method by leaving the note representing a tact with the stem alone. You can best see these notes in the part for boys choir. The reason for doing this is to simplify the process of writing. After all, the short flags protruding on both sides of the stem just mean two divided by two, hence a single tact. This method should not be extended to the treatment of rests. The full tact rest ought to look like the capital letter "T," because single stems without flags are less visible in a crowded score, and they may be confused with some other signs.

NOT: In Supplement S12(b) I notice also this veritable swarm of rests for a whole measure. Is there, perhaps, a less formal way to represent a complete void of music in these parts?

PAN: Yes, you could simply skip all those signs for rests and leave the staves empty. You could even go further and skip all the empty staves, in the way modern scores are printed. In our case, you would only retain the staff for the organ part supporting the boys choir. Whatever improvements you may devise, you should not lose the sight of a fundamental simplification possible in the new system. This makes reading and understanding the transnotation much easier than trying to cope with the traditional score containing four different clefs and plenty of ledger lines in flute parts. As a matter of fact, in some editions you will find boys-choir and soprano parts in the ancient soprano clefs, further complicating the overall picture.

NOT: I see a Chopin etude directly following the Bach example. Did you want to include a complete piece for the piano in your Supplement?

PAN: I wish I had more space to illustrate transnotations of complete compositions. I have chosen a brief etude by Chopin mostly to demonstrate the informal transcription of a few dynamic, tempo, and expression marks. When we discussed dynamics, I suggested the attachment of dynamic marks to the middle of note stems. You could go back to examples illustrated on pages E46 through E49 to see this method of marking dynamic levels, as well as fluctuating dynamics. However, on page E44, which precedes these examples, the symbols for two dynamic levels of "very soft" and "very loud" are attached to isolated stems in open field. The same method is utilized in Supplement S18 not only for dynamics but also for tempo levels and fluctuations. The three pages of conventional notation in Supplement S17 correspond to three pages of

transnotation in Supplement S18. You can easily compare both Supplements (S17 and S18) in the same way you could find corresponding places in Bach's excerpt.

NOT: It is interesting that both Example E44 and Supplement S17 through S19 use the music of Chopin. Is there any hidden motive for your choice of this music?

PAN: It is purely coincidental that both illustrations feature Chopin's music. The same method could be demonstrated in any other music with some dynamic and tempo marks. This informal method does not differ very much from the traditional method of placing these signs usually underneath the notes. Passing over the relative advantages of formal or informal methods, I am still unhappy about the look of some of these music examples. The desire to illustrate complete compositions in the small format of these pages results in some disappointments.

NOT: What do you mean?

PAN: I think playing this music from either the standard or new notation demands too much effort from the performer. It was necessary to scale down the content of these pages to the size which is too small for comfortable reading.

NOT: I admit that providing more space between staff lines would permit better recognition of notes placed on the lines, "floating" between the lines or "hugging" the lines.

PAN: It becomes imperative that new scores are printed with ample space between staff lines, lest the pitch identification become obscured. Increasing the size of measures would also improve the chances for effortless reading. The following Supplement S19 is in itself an experiment in something what you probably never heard before. The fairly successful new notation invented more than sixty years ago by Cornelius Pot in Holland, and generally known as *Klavarskribo* proposes to write and read music from left to right as it is played at the keyboard. In a gesture of respect for this keyboard orientation, I tried to demonstrate that the PANOT system can also be written and read in this orientation. The same Chopin etude is rearranged in Supplement S19, permitting reading of consecutive measures downward rather than to the right. This orientation places lower tones to the left and higher tones to the right. Naturally, there are many fundamental differences between the two systems. Among those PANOT does not recognize are the *Klavarskribo* staff, whose lines correspond to the black keys of the keyboard, and its use of white and black notes as durational symbols. Nevertheless, it is possible to present our system in vertical orientation for the use of keyboard players for whom the vertical orientation seems more natural than the customary horizontal one. A miniature toccata for the piano by Dolly Kessner concludes the Supplement division as S20(a) in traditional notation. Supplement S20(b) shows the same toccata in our new system, and Supplement S20(c) presents the same music in vertical orientation.

Supplement S20(d) is added to illustrate still a different version. Notice that only one staff is sufficient to transnotate this tiny piece. Different stem directions help separate the right from the left hand. Sometimes I think the rests can be dispensed with, thereby simplifying the reading of this piece to the utmost. Perhaps the "beamed" version S20(d) is easier to read. Try to perform the toccata from the three versions of the new system, and, later, compare them with the traditional notation. Before I forget, let me add that the first nine supplements (S1 - S9) present nine different variants of the staff including two variants for the vertical orientation called KLAVAR 1 and KLAVAR 2, the names being abbreviations derived from the type of the keyboard ("clavis") variant. All of the variants, with exception of the last (S9), span the entire serviceable pitch spectrum with seven staves. You may choose from the variety of lighter or darker shading offsetting either the middle region ("rok") or the space between two staff lines.

NOT: Thank you so much for the advice and the explanation of those interesting examples in the Supplement. Since I realize the time has arrived to conclude my meetings with you, let me, at last, ask you this question: What, in your opinion, will prompt any changes in music notation, and when do you expect them to take place?

PAN: Such a thing is very hard to predict. I can only tell you what circumstances may bring about some changes. A strong conviction about the relative advantages of one system outweighing the relative advantages of another system (including the traditional one) may be instrumental in a change of attitude. Many proposals in past years have aimed at improving certain aspects of the existing notation. These partial changes tend to complicate the picture even further. Adding improvements to an illogical system does not make it logical. The system itself must be changed, first. A broader perspective is necessary to make a comprehensive assessment of contemporary needs and to effect reforms of the entire referential system.

NOT: On whose shoulders would you place the responsibility for the future of music notation?

PAN: It must be a cooperative effort of all music professionals, be they composers, performers, theorists, musicologists, ethno-musicologists, music educators, or music editors. Music organizations, music publishers, music journals, software programmers, school administrators, and grant institutions, should also be aware of the importance of changes in music notation. In the pursuit of an ideal notation, the needs of amateurs and young students should not be neglected. I recall a friend of mine, professor of physics, who was so much in love with Wagnerian operas that he bought himself vocal scores. Being a reasonably experienced pianist, he attempted to play from those scores. Soon he became very frustrated, and complained bitterly: "why am I denied the joy of savoring those luscious harmonies under my fingers?" Why do the same keys constantly change their names depending on sharps or flats?" I think it is regrettable when intelligent people find music notation an obstacle to their desire to get acquainted with the

joys of music. Look also at legions of children who are repeatedly turned off by music notation. Of course, other factors such as short span of attention, and lack of internal discipline play an important role here. Nevertheless, I suspect notation to be also a culprit, particularly regarding the aspiring pianists. Why are so many bright singers condemned to singing by rote? Why are so many gifted practitioners of the popular art functional illiterates in music? It is our professional responsibility to present the amateurs and novices with a music notation which offers reasonable chances of being mastered still within their life time.

NOT: Do you see any potential for further developments of your own system?

PAN: Yes. I do, particularly in the area of idiomatic notations for specific vocal, instrumental, or even electronic media. I trust that string players dissatisfied with the way special effects are treated in the general PANOT notation, will contribute better, and more numerous solutions. Perhaps, there is a simpler way to indicate harmonics, beside the general suggestions. All similar efforts should be most welcome. The general, traditional notation is being kept alive by many new devices fitting a particular medium or the entire group of similar media. In conclusion, it is best that we all accept the fact that PANOT is not an epochal solution. It has plenty of patience to wait, and eventually surrender to any better way of accounting for sounds. The future may select only certain aspects of our new system for implementation, but overlook and forget the others. Historical evidence indicates that PANOT will not be the last word in the chronology of reform proposals. If it succeeds only in shaking up apathetic music educators, it may become an important catalyst in the process of re-orienting our thinking. The name PANOT suggests that it is a notation which, I hope, will merit universal application. For the lack of stricter definition, PANOT can be described as a new system of music notation which attempts to combine the experiences of the past with the exigencies of the present, and the foreseeable demands of the future.

NOT: I know it will take me some time before I will be able to assess fully the relative advantages of the new system. In the meantime, I promise to experiment with new notations, and to keep thinking.

PAN: Thank you, once again, Mr. NOT, for your cooperation, forbearance, and cheerful attitude. If you have any further questions, I will be happy to see you any time, preferably before the end of this century.

* *
*

I N D E X

- 18-tone scale, 82
- 24-tone scale, 79
- 31-tone scale, 83
- 36-tone scale, 83
- acoustic instruments, 121
- "Alleluia", 17, 123
- alphameric conversion, 27, 76, 160
- Bach, 161
- BAR-NOT, 148
- Bartok, 85
- "beatlets", 60, 61, 77
- "beats", 7, 26, 31, 33, 40, 44, 60, 61, 77, 90, 114, 163
- Beethoven, 42, 75
- Berg, 137
- Berlioz, 114
- "bigram", 68
- Boulez, 127
- canonic relationship, 152
- cardinal and ordinal numbers, 32
- Carter, 55, 76, 106
- Chopin, 51, 115, 163
- clarity, 8
- code notation, 17, 95, 97, 106, 108, 112, 116, 117, 144, 147
- compound meter, 13, 31, 36, 53, 60, 61
- comprehensiveness, 7

computer-generated notation, 116
 condensed scores, 129
 "Confitebor tibi", 19
 "Consider and answer me", 23
 Debussy, 89, 104, 139, 156
 "digram", 68
 directness, 6
 disk notation, 95
 dodecuple set, 142
 dynamic markings, 105
 economy, 8
 efficiency, 9
 Farina, 120
 fermata, 49
 flex, 20
 flexibility, 8
 fluctuating dynamics, 107
 fractional duration, 46
 generality, 4
 "God rest you merry gentlemen", 13
 Gregorian notation, 14, 71
 harmonics (or partials), 99
 "Hauptstimme", 112
 horizontal episema, 15
 ictus, 14 - 18
 idiomatic notations, 102, 166
 informal transcription, 163
 interval classes, 133
 interval content, 133
 interval set, 143
 "inter" and "intra" dynamics, 110
 inversion, 142
 Ives, 53, 76, 134
 Kessner, 164
 KLAVAR, 165
 Klavarskribo, 164
 ledger lines, 72
 magical square, 142
 meter signature, 30, 31
 metric modulation, 56, 59

microtonal notation, 79
 MIDI, 3, 61, 116, 125
 modification of the tempo, 64
 Monteverdi, 39, 120
 Mozart, 39, 55, 104, 115, 133
 multimeters, 51, 52
 multitempo, 55, 61
 "Nebenstimme", 112
 neutrality, 5
 "normal" form, 133
 octatonic scale, 139
 octave regions, 70
 octave transposition, 153
 old ornaments, 102
 palindromes, 158
 PANOT, 166
 PANUM, 51, 160
 Penderecki, 86
 peripheral and interjacent intervals, 84
 pitch interval, 73
 pitch notation, 72
 polymeters, 52
 polytempo, 55, 61
 Pronunciation of Codes, 22
 prototype set, 142
 protractive relationship, 65
 psalmodic formula, 20, 71
 pulse (PUL), 26
 pulse signature, 30, 31
 "quilisma", 123
 repeat sign, 50
 retrograde, 142
 retrograde inversion, 142
 rhythmic jingle, 29
 rules of pronunciation, 98
 Saylor, 23, 71, 72
 Schönberg, 112, 132
 Schütz, 39
 serial sets, 143
 set matrix, 142

signal notation, 72, 95, 97, 108, 116, 117, 118, 147
 simple meter, 12, 31, 53
 slurs, 48
 solmization, 6, 33
 "Song of the Ass", 15, 25, 36, 39, 43, 68
 sound envelope, 124
 space signature, 95
 staff, 68
 stem inversion, 106
 Strauss, 134
 Stravinski, 51, 141, 158
 subtractive relationship, 65
 tablature, 4, 8, 102, 120, 124
 tact (TAK), 26
 tempo modulation, 59
 tempo signature, 28, 31
 timbre or quality of sound, 118
 time signature, 31
 transient intervals, 87
 transient pitches and intervals, 101
 transnotation, 87
 transposition, 88, 142
 triplets, 50
 "tuplets", 51
 uniformity, 6
 universality, 3
 "Veni Creator Spiritus", 14
 vertical episema, 15
 Webern, 148, 156

George J. Skapski

TRACT ON PANOT

PART II : EXAMPLES

C.S.U.N.

TRACT ON PANOT

PART II: EXAMPLES

(Music Examples in both Traditional and PANOTation)

by

George J. Skapski

*

This monograph is a follow-up to the experimental research performed in part pursuant to an Academic Program Improvement Grant for 1989-90 funded by the California State University Office of the Chancellor

The California State University, Northridge, 1992

© 1992 by the Trustees of the California State University

This tract is referring to 3 monographs: *PANOT: An Experiment with a New Music Notation System, Sound Taxonomy, and PANUM*. Those monographs were developed with the support of an Academic Program Improvement Grant for 1989-90 funded by the California State University Office of the Chancellor. No part of this work may be reproduced, stored in a retrieval system, or transcribed, in any form or by any means, electronic, mechanical, photocopying, recording, or otherwise, without the prior written permission of The Trustees of the California State University. Project Director: Dr. George J. Skapski, California State University, Northridge.

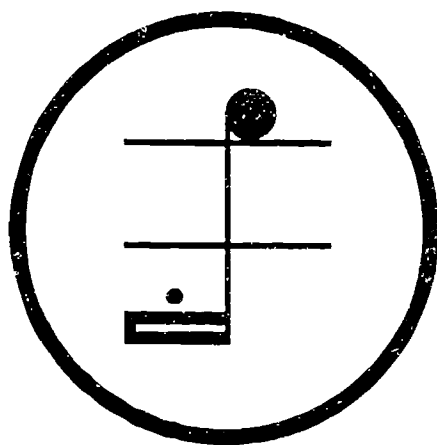

TABLE OF CONTENTS

TRANOT = Traditional Notation
 GRENOT = Gregorian Notation
 PANOT = Universal Notation

EXAMPLE	PAGE
THE SECOND DAY: THE UNMETERED DURATIONS AND ARTICULATION	
2. 1 a) <i>Orientis partibus ...</i> , (Song of the Ass) Transcription of the opening of this monophonic conductus in TRANOT .	E1
2. 1 b) <i>Orientis partibus ...</i> , (Song of the Ass) The temporal aspect of the transcription of the opening of this monophonic conductus in PANOT .	E1
2. 2 a) <i>God rest you merry gentlemen ...</i> , (Traditional Carol) The opening phrase in TRANOT .	E2
2. 2 b) <i>God rest you merry gentlemen ...</i> , (Traditional Carol) The temporal aspect of the opening phrase in PANOT .	E2
2. 3 a) <i>Veni Creator ...</i> , (Hymn for the Feast of Pentecost), the opening strophe in GRENOT .	E3
2. 3 b) <i>Veni Creator ...</i> , (Hymn for the Feast of Pentecost), the temporal aspect of the opening strophe in PANOT .	E3
2. 4 a) Second Alleluia (<i>cum júbilo</i>) for the Second Sunday after Easter in GRENOT .	E4
2. 4 b) Second Alleluia (<i>cum júbilo</i>) for the Second Sunday after Easter. The temporal aspect in PANOT .	E4

- 2.5 a) *Fiat misericordia ...*, the penultimate strophe from *Te Deum* (Thanksgiving Hymn in Simple Tone) in **GRENOT**. E5
- 2.5 b) *Fiat misericordia ...*, the penultimate strophe from *Te Deum* (Thanksgiving Hymn in Simple Tone).The temporal aspect in **PANOT**. E5
- 2.6 a) *Confitebor tibi ...*, (Psalm 110 in the Second Mode), Psalmodic Formula in **GRENOT**. E6
- 2.6 b) *Confitebor tibi ...* and *Memoriam fecit ...*, The temporal aspects of the first and the fourth strophe of Psalm 110 (*Confitebor tibi ...*) in **PANOT**. E7
- 2.7 a) *Consider and answer me ...*, an excerpt from the vocal part (m. 34 - 37) of *Psalm 13* in *Four Psalm Settings* by Bruce Saylor, (c. 1978) in **TRANOT**. E8
- 2.7 b) *Consider and answer me ...*, an excerpt from the vocal part (m. 34 - 37) of *Psalm 13* in *Four Psalm Settings* by Bruce Saylor, (c. 1978). The temporal aspect in **PANOT**. E8

THE THIRD DAY: THE REPRESENTATION OF THE TEMPORAL PARAMETER

- .1a) *Orientis partibus ...* (Song of the Ass) Transcription of the first phrase of this monophonic conductus in **TRANOT**. E9
- .1b) *Orientis partibus ...* (Song of the Ass) The metered aspect of the transcription of the first phrase of this monophonic conductus in **PANOT**. E9
- .1c) *Orientis partibus ...* (Song of the Ass) The pulse aspect of the transcription of the first phrase of this monophonic conductus in **PANOT**. E10
- .1d) *Orientis partibus ...* (Song of the Ass) Sampling of different metrical aspects of the first phrase of this monophonic conductus in **PANOT**. E11
- .2a) The initial trimeter from the third movement of Mozart's *Symphony in g-minor*, K. 550 in **TRANOT**. E12

3. 2b) The temporal aspects of the initial trimeter from the third movement of Mozart's *Symphony in g-minor*, K. 550 in PANOT. E12
3. 3a) The introductory measures from the violin part of the fourth movement of Beethoven's *Symphony in C-major*, No.1 in TRANOT. E13
3. 3b) The introductory measures from the violin part of the fourth movement of Beethoven's *Symphony in C-major*, No.1 in PANOT. E13
3. 3a) The introductory measures from the violin part of the fourth movement of Beethoven's *Symphony in C-major*, No.1 in TRANOT. E14
3. 3c) The temporary aspect of the introductory measures from the violin part of the fourth movement of Beethoven's *Symphony in C-major*, No.1 in the optional tact divisions of PANOT. E14
3. 3a) The introductory measures from the violin part of the fourth movement of Beethoven's *Symphony in C-major*, No.1 in TRANOT. E15
3. 3d) The introductory measures from the violin part of the fourth movement of Beethoven's *Symphony in C-major*, No.1 in the optional meter of PANOT. E15
- 3.31a) Four excerpts (mm. 0-4, 14, 11 and 73) from *Nocturne op. 9, no. 1*, by Chopin in TRANOT. E16
- 3.31b) The temporal aspect of four excerpts (mm. 0-4, 14, 11 and 73) from *Nocturne op. 9, no. 1*, by Chopin in PANOT. E16
3. 4a) An excerpt from the trombone part of Stravinski's *L'histoire du soldat* (Part II: The Soldier's March, mm 7-17) in TRANOT. E17
3. 4b) The temporal aspect of an excerpt from the trombone part of Stravinski's *L'histoire du soldat* (Part II: The Soldier's March, mm 7-17) in PANOT. E17
3. 5a) An excerpt from the score of Ives' *Three Places in New England* (Part II: General Putnam's Camp, mm 134-135) in TRANOT. E18
3. 5b) The temporal aspect of an excerpt from the score of Ives' *Three Places in New England* (Part II: General Putnam's Camp, mm 134-135) in PANOT. E19

- .6a) The beginning of *Canaries* from *Eight Pieces for Four Timpani* by Elliott Carter in **TRANOT**. E20
- .6b) The temporal aspect of the beginning of *Canaries* from *Eight Pieces for Four Timpani* by Elliott Carter in **PANOT**. E21
- .7a) The initial two measures opening the *String Quartet No.3* by Elliott Carter in **TRANOT**. E22
- .7b) The temporal aspect of the initial two measures opening the *String Quartet No.3* by Elliott Carter in **PANOT**. E23

THE FOURTH DAY: THE DOMAIN OF PITCH AND INTERVALS

- .1a) *Orientis partibus ...* (Song of the Ass) Transcription of the opening of this monophonic conductus in **TRANOT**. E24
- .1b) *Orientis partibus ...* (Song of the Ass) The spatial aspects of the transcription of the opening of this monophonic conductus in **PANOT**. E24
- .2a) *Veni Creator ...* (Hymn for the Feast of Pentecost) The opening strophe in **GRENOT**. E25
- .2b) *Veni Creator ...* (Hymn for the Feast of Pentecost) The spatial aspect of the opening strophe in **PANOT**. E25
- .3a) *Confitebor tibi ...* (Psalm 110 in the Second Mode) Psalmodic Formula in **GRENOT**. E26
- .3b) *Confitebor tibi ...* and *Memoriam fecit ...* The spatial aspects of the first and the fourth strophes of Psalm 110 (*Confitebor tibi ...*) in **PANOT**. E27
- .4a) *Consider and answer me ...*, an excerpt from the vocal part (m.34-37) of *Psalm 13* in *Four Psalm Settings* by Bruce Saylor, (c.1978) in **TRANOT**. E28
- .4b) *Consider and answer me ...*, an excerpt from the vocal part (m.34-37) of *Psalm 13* in *Four Psalm Settings* by Bruce Saylor, (c.1978). The spatial aspect in **PANOT**. E28
- .5a) The initial trimeter from the third movement of Mozart's *Symphony in g-minor*, K.550 in **TRANOT**. E29

4. 5b) The spatial aspects of the initial trimeter from the third movement of Mozart's *Symphony in g-minor*, K.550 in TRANOT. E29
4. 5a) The initial trimeter from the third movement of Mozart's *Symphony in g-minor*, K.550 in TRANOT. E30
4. 5c) The spatial aspects of the initial trimeter from the third movement of Mozart's *Symphony in g-minor*, K.550 in PANOT. E30
4. 5a) The initial trimeter from the third movement of Mozart's *Symphony in g-minor*, K.550 in TRANOT. E31
4. 5d) The spatial aspects of the initial trimeter from the third movement of Mozart's *Symphony in g-minor*, K.550 in PANOT. E31
4. 6a) The introductory measures from the violin part of the fourth movement of Beethoven's *Symphony in C-major*, No.1 in TRANOT. E32
4. 6b) The introductory measures from the violin part of the fourth movement of Beethoven's *Symphony in C-major*, No.1 in PANOT. E32
4. 6a) The introductory measures from the violin part of the fourth movement of Beethoven's *Symphony in C-major*, No.1 in TRANOT. E33
4. 6c) The introductory measures from the violin part of the fourth movement of Beethoven's *Symphony in C-major*, No.1 in PANOT. E33
4. 7a) An excerpt from the score of Ives' *Three Places in New England* (Part II: General Putnam's Camp, mm. 134-135) in TRANOT. E34
4. 7b) The spatial aspect of an excerpt from the score of Ives' *Three Places in New England* (Part II: General Putnam's Camp, mm. 134-135) in PANOT. E35
4. 8a) The initial two measures opening the *String Quartet No.3* by Elliott Carter in TRANOT. E36
4. 8b) The spatial aspect of the initial two measures opening the *String Quartet No.3* by Elliott Carter in PANOT. E37
4. 9a) The spatial aspect of the ending of Penderecki's *Threnody for the Victims of Hiroshima* (mm. 67-70) in TRANOT. E38
4. 9b) The spatial aspect of the ending of Penderecki's *Threnody for the Victims of Hiroshima* (mm. 67-70) in PANOT. E39

- . 10a) The opening flute solo from the Prelude to
The Afternoon of a Faun by Debussy in TRANOT. E40
- . 10b) The opening flute solo from the Prelude to
The Afternoon of a Faun by Debussy in PANOT. E40
- . 11a) The opening flute solo from the Prelude to
The Afternoon of a Faun by Debussy in TRANOT. E41
- . 11c) The opening flute solo from the Prelude to
The Afternoon of a Faun by Debussy in PANOT
transposed 1 degree up by moving staff lines down E41
- . 12a) The opening flute solo from the Prelude to
The Afternoon of a Faun by Debussy in TRANOT. E42
- . 12d) The opening flute solo from the Prelude to
The Afternoon of a Faun by Debussy in PANOT.
Staffless pitch profiles in two different rhythms E42
- . 13e) The opening flute solo from the Prelude to
The Afternoon of a Faun by Debussy in PANOT
transposed 4 degrees down by moving staff lines up E43
- . 13f) The opening flute solo from the Prelude to
The Afternoon of a Faun by Debussy in PANOT
transposed 6 degrees up by moving staff lines down E43

THE FIFTH DAY: NEW SYMBOLS FOR DYNAMICS AND TIMBRE

- 1a) The opening of Chopin's second *Scherzo* in TRANOT E44
- 1b) The opening of Chopin's second *Scherzo* in PANOT E44
- 1c) The opening of Chopin's second *Scherzo* in SIGNOT and KODNOT E45
- 2a) Piano reduction of the first heptameter of the cabalistic
dance of Magicians from the first part of *L'Enfance du Christ*
by Berlioz in TRANOT E46
- 2b) Piano reduction of the first heptameter of the cabalistic
dance of Magicians from the first part of *L'Enfance du Christ*
by Berlioz in PANOT E46

5. 3a) The opening pentameter of the cello part from the *THEMA of Variationen für Orchester* by Schönberg in TRANOT E47
5. 3b) The opening pentameter of the cello part from the *THEMA of Variationen für Orchester* by Schönberg in PANOT E47
5. 4a) The opening of part IX (mm. 1 - 8) from *Le marteau sans maître* by Pierre Boulez in TRANOT E48
5. 4b) The opening of part IX (mm. 1 - 8) from *Le marteau sans maître* by Pierre Boulez in PANOT E49
5. 4c) The opening of part IX (mm. 1 - 8) from *Le marteau sans maître* by Pierre Boulez in PANOT condensed scores E50

THE SIXTH DAY: ANALYTICAL INSIGHTS

6. 1 Transpositions of the initial chord from the third movement of *Five Pieces for Orchestra* (op.16) by Schönberg in diagrammatic form in PANOT E51
6. 2a) The Interlude from *Scherzo* by Charles Ives in TRANOT E52
6. 2b) The Interlude from *Scherzo* by Charles Ives in PANOT E53
6. 3a) The closing five bars from Richard Strauss' *Till Eulenspiegels lustige Streiche* in TRANOT E54
6. 3b) The closing five bars from Richard Strauss' *Till Eulenspiegels lustige Streiche* in PANOT E55
6. 3c) The closing five bars from Richard Strauss' *Till Eulenspiegels lustige Streiche* in PANOT condensed scores for analysis E56
6. 4 The spatial juxtaposition of accompanying instruments in the first and last measures from the third song of *Altenberg Lieder* (op.4) by Alban Berg in PANOT E57
6. 5a) An excerpt (mm. 25 - 31) from the second prelude of the second book of *Préludes* for the piano by Debussy in TRANOT E58

- 5. 5b) An excerpt (mm. 25 - 31) from the second prelude of the second book of *Préludes* for the piano by Debussy in PANOT E59
- 5. 6a) The conclusion of "Querimonia" (mm. 192 - 193) from *Threni* by Igor Stravinski in TRANOT E60
- 5. 6b) The conclusion of "Querimonia" (mm. 192 - 193) from *Threni* by Igor Stravinski in PANOT E61
- 5. 6c) Set matrix and set identification for the dodecuple pitch content at the conclusion of "Querimonia" from *Threni* by Igor Stravinski E62
- 5. 6d) Set diagram and set identification for the interval content to the conclusion of "Querimonia" from *Threni* by Igor Stravinski E63
- 5. 7a) The choral parts from the sixth movement of the second cantata (op. 31) by Anton Webern in TRANOT E64
- 5. 7b) The articulative and pitch patterns in the textless, choral parts from the sixth movement of the second cantata (op. 31) by Anton Webern in PANOT E65
- 5. 7c) Set matrices for the pitch and interval content to the second cantata (op. 31) by Anton Webern E66
- 6. 7d) The choral, textless parts from the sixth movement of the second cantata (op. 31) by Anton Webern in PANOT (In BARNOT form) E67
- 6. 7e) The choral, textless parts from the sixth movement of the second cantata (op. 31) by Anton Webern in PANOT (Reduction of pitch profiles of soprano, alto, and tenor parts by octave transposition in BARNOT form) E68
- 6. 7f) The choral, textless parts from the sixth movement of the second cantata (op. 31) by Anton Webern in PANOT (Reduction of pitch profiles of alto, tenor, and bass parts by octave transposition in BARNOT form) E69
- 6. 7g) The choral, textless parts from the sixth movement of the second cantata (op. 31) by Anton Webern in PANOT (Reduction of intervallic pattern and temporal displacement in soprano, alto, and tenor parts in BARNOT form) E70

6. 7h) The choral, textless parts from the sixth movement of the second cantata (op. 31) by Anton Webern in PANOT (Reduction of intervallic pattern and temporal displacement in alto, tenor, and bass parts in BARNOT form) E71
6. 8a) An excerpt (m. 19 - 27) from *Variationen für Klavier* op. 27 by Anton Webern in TRANOT E72
6. 8b) An excerpt (m. 19 - 27) from *Variationen für Klavier* op. 27 by Anton Webern in PANOT (Temporal and spatial aspects only) E73
6. 8c) Matrices for pitch and interval sets to *Variationen für Klavier* op. 27 by Anton Webern E74
6. 8d) An excerpt (m. 19 - 27) from *Variationen für Klavier* op. 27 by Anton Webern in PANOT (In BARNOT form) E75
-

EXAMPLE 2.1 a)

Orientis partibus ... (Song of the Ass)
Transcription of the opening of this
monophonic conductus in TRANOT.

O - ri - en - tis par - ti - bus, Ad - ven - ta - vit a - si - nus, Pulcher et for - tis - si - mus,
Sar - ci - nis ap - tis - si - mus, Hez, Sir As - ne, hez.

EXAMPLE 2.1 b)

Orientis partibus ... (Song of the Ass)
The temporal aspect of the transcription of the opening
of this monophonic conductus in PANOT.

fa fa fa fa fa sa fa fa fa sa fa fa fa sa
O - ri - en - tis par - ti - bus Ad - ven - ta - vit a - si - nus Pul - cher et for - tis - si - mus
fa fa fa fa fa sa fa fa fa sa
Sar - ci - nis ap - tis - si - mus Hez, Sir As - ne, hez.

EXAMPLE 2.2 a)

God rest you merry gentlemen ... (Traditional Carol)
The opening phrase in TRANOT.

God rest you mer - ry gen - tle - men, let noth - ing you dis - may,

EXAMPLE 2.2 b)

God rest you merry gentlemen ... (Traditional Carol)
The temporal aspect of the opening phrase in PANOT.

fa fa fa fa fa fa fa fa fa fa fa fa sa
God rest you mer - ry gen - tle - men, let noth - ing you dis - may,

EXAMPLE 2.3 a)

Veni Creator ... (Hymn for the Feast of Pentecost)
The opening strophe in GRENOT

Hymn.
8.

Veni Cre-á-tor Spi-ri-tus, Méntes tu-órum ví-si-ta :
Imple su-pérna grá-ti-a Quae tu cre-ásti péc-to-ra.

Source: Liber Usualis, Benedictines of Solesmes, eds., (Tournai, Belgium: Desclée & Co., 1938), p. 885.

EXAMPLE 2.3 b)

Veni Creator ... (Hymn for the Feast of Pentecost)
The temporal aspect of the opening strophe in PANOT

ictus pattern:

fa fa famfa fa fa sa Spi - ri - tus Men - tes tu - o - rum vi - si - ta :
Ve - ni Cre - a - tor

Im - ple su - per - na gra - ti - a Quae tu cre - a - sti pe - cto - ra .



EXAMPLE 2.4 a)

Second Alleluia (*cum júbilo*) for the Second Sunday after Easter in GRENOT.

1. 

Source: *Liber Usualis*, Benedictines of Solesmes, eds., (Tournai, Belgium: Desclée & Co., 1938), p. 818.

EXAMPLE 2.4 b)

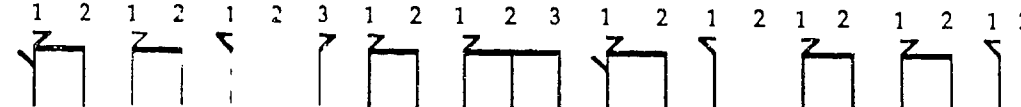

Second Alleluia (*cum júbilo*) for the Second Sunday after Easter. The temporal aspect in PANOT.

1) Formal

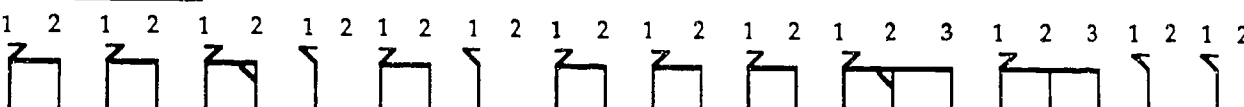
ictus pattern:	1 2 1 2 1 2 3 1 2 1 2 3 1 2 1 2 1 2 1 2 1 2
durations & articulations:	
alpha-code:	fam- fa- famfa sa fa famfa famfamfa fam-fa sa famfa famfa sa
text syllables:	Al - le - lu - ia (a) -

1 2 1 2 1 2 1 2 1 2 1 2 1 2 1 2 3 1 2 3 1 2 1 2

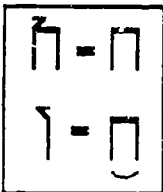
famfa famfa famfa- sa famfa sa famfa famfa famfa famfam-fa famfamfa sa sa
faex faex

2) Informal

	
	fam- fa- famfa famsfamfa famfa famfamfa fam-fa famsfa famfa famfa famsfa
	faex fäf faex
	Al - le - lu - ia (a) -

famfa famfa famfa- famsfa famfa famsfa famfa famfa famfa famfam-fa famfamfa famsfa famsfa
faex faex

EXAMPLE 2.5 a)

Fiat misericordia..., the penultimate strophe from *Te Deum*
(Thanksgiving Hymn in Simple Tone), in GRENOT.



Fí-at mi-se-ri-cór-di-a tú-a Dómine super nos, quemádmodum spe-rávimus in te.

Source: *Liber Usualis, Benedictines of Solesmes, eds.*, (Tournai, Belgium: Desclée & Co., 1938), p. 1837.

EXAMPLE 2.5 b)

Fiat misericordia..., the penultimate strophe from *Te Deum*
(Thanksgiving Hymn in Simple Tone). The temporal aspect in PANOT.

1) Full

fa	sa	sa	sa	sa	sa	sa	sa	sa	sa	sa	sa	sa	sa	sa	sa	sa	sa	sa	sa	sa																				
fa	fa	fa	fa	fa	fa	fa	fa	fa	fa	fa	fa	fa	fa	fa	fa	fa	fa	fa	fa	fa																				
fa	sa	sa	sa	sa	sa	sa	sa	sa	sa	sa	sa	sa	sa	sa	sa	sa	sa	sa	sa	sa																				
Fi	at	mi	-	se	-	ri	-	cor	-	di	-	a	tu	-	a	Do	-	mi	-	ne	su	-	per	nos,	quem	-	ad	-	mo	-	dum	spe	-	ra	-	vi	-	mus	in	te.

1) Abbreviated

fufasaex	sa	sa	sa	sa	sa	sa	sa	sa	sa	sa	sa	sa	sa	sa	sa	sa	sa	sa	sa	sa																				
fa	fa	fa	fa	fa	fa	fa	fa	fa	fa	fa	fa	fa	fa	fa	fa	fa	fa	fa	fa	fa																				
fufasaex	sa	sa	sa	sa	sa	sa	sa	sa	sa	sa	sa	sa	sa	sa	sa	sa	sa	sa	sa	sa																				
Fi	at	mi	-	se	-	ri	-	cor	-	di	-	a	tu	-	a	Do	-	mi	-	ne	su	-	per	nos,	quem	-	ad	-	mo	-	dum	spe	-	ra	-	vi	-	mus	in	te.

EXAMPLE 2.6 a)

Confitebor tibi ... (Psalm 110 in the Second Mode)
Psalmodic Formula in GRENOT.

Tone 2. D.

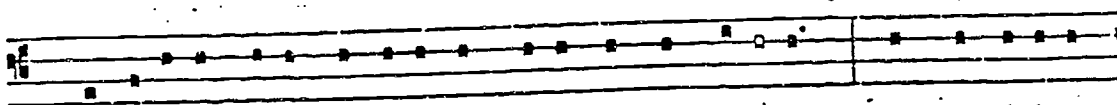
Mediant of τ accent.Ending of τ accent with τ preparatory syllable.

1. Confi-tébor tibi Dómine in tóto córde mé- o : * in consi-li-o

D



justórum et congregáti- ó- ne. Flex : su-órum, †

2. Magna ópera Dómini : * exquisita in ómnes voluntátes éjus.

3. Conféssio et magnificéntia ópus éjus : * et justitia éjus mánet in saéculum saéculi.

4. Memóriam fécit mirabílium suórum, † miséricors et miserátor Dóminus : * éscam dédit timéntibus se.

5. Mémor érit in saéculum testaménti súi : * virtútem óperum suórum annuntiábit pópulo súo :

6. Ut det illis haereditátem géntium : * ópera mánuum éjus véritas et iudiciúm.

7. Fidélia ómnia mandáta éjus : † confirmáta in saéculum saéculi : * fácta in veritáte et aequitáte.

8. Redemptiónem misit pópulo súo : * mandávit in aetérnum testaméntum súum.

9. Sánctum et terribile nómen éjus : * initium sapiéntiae timor Dómini.

10. Intellectus bónus ómnibus faciéntibus eum : * laudátio éjus mánet in saéculum saéculi.

11. Glória Pátri, et Filio, * et Spirítui Sáncto.



12. Sicut érat in princípío, et nunc, et sémper, * et in saécula saeculórum. Amen.



Source: *Liber Usualis*, Benedictines of Solesmes, eds., (Tournai, Belgium: Desclée & Co., 1938), p. 134.

EXAMPLE 2.6 b)



Confitebor tibi ... and Memoriam fecit ... The temporal aspects of the first and the fourth strophes of Psalm 110 (*Confitebor tibi ...*) in PANOT.



FIRST STROPHE

INITIUM	FIRST RECITATION	MEDIANT
 <i>fa fa fasaexmu</i> Con - fi - te - bor	ti - bi Do - mi - ne in to - to cor - de	 <i>fa fufafu sa</i> me - (p.) - o :

SECOND RECITATION	TERMINATION
 <i>fasaexmu</i> in con - si - li - o	 <i>fa fa fufafu sa</i> ju - sto - rum et con - gre - ga - ti - o - (p.) - ne .

FOURTH STROPHE

FIRST RECITATION	FLEX
 <i>fasaexmu</i> Me - mo - ri - am	 <i>sa</i> fe - cit mi - ra - bi - li - um su - o - rum ,

FIRST RECITATION RESUMED	MEDIANT
 <i>fasaexmu</i> mi - se - ri - cors et mi - se - ra - tor	 <i>fa fa sa</i> Do - mi - nus :

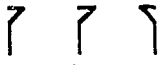
SECOND RECITATION	TERMINATION
 <i>fasaexmu</i> es - cam	 <i>fa fa sa</i> de - dit ti - men - ti - bus se .

EXAMPLE 2.7 a)

Consider and answer me ..., an excerpt from the vocal part (m. 34 - 37) of Psalm 13 in *Four Psalm Settings* by Bruce Saylor, (© 1978) in TRANOT.

sub. mp, p, mf, rit., pp

Con - sid - er and an - swer me, O Lord my God; lighten my eyes, lest I sleep the sleep of death;

Vocal Symbols (according to the composer's performance directions):

- sustained tone;
- short tone;
- Ⓟ reciting tone: Sing the text crisply and rapidly in the rhythm of speech.

Copyright 1978 by Bruce Saylor. Used by permission.

Psalm 13 can be found in the *Anthology for Musical Analysis*, edited by Charles Burkhardt, starting with the Third Edition by Holt, Rinehart and Winston, 1978.

EXAMPLE 2.7 b)

Consider and answer me ..., an excerpt from the vocal part (m. 34 - 37) of Psalm 13 in *Four Psalm Settings* by Bruce Saylor, (c. 1978). The temporal aspect in PANOT.

fa fa fa fa fa fa fa fa fa fa fa fa sa sa fa sa

Con - sid - er and an - swer me, O Lord my God; lighten my eyes, lest I sleep the sleep of death;

EXAMPLE 3.1 a)

Orientis partibus ... (Song of the Ass)
 Transcription of the first phrase of this monophonic conductus in TRANOT.

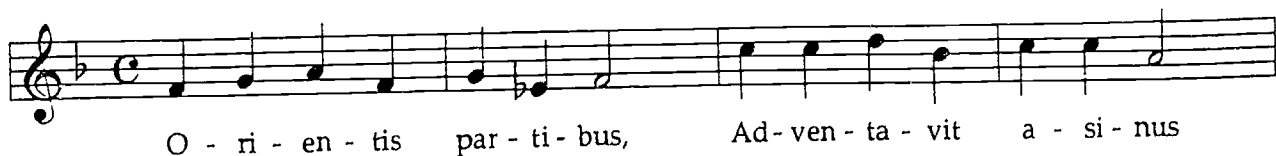

EXAMPLE 3.1 b)

Orientis partibus ... (Song of the Ass)
 The metered aspect of the transcription of the first phrase of this monophonic conductus in PANOT.

TEM-SIT (time signature):		TEP-SIT (tempo signature)	PUL-SIT (pulse signature)	MET-SIT (meter signature)
SEK-SUP (upper seconds track):	▼ ▼ ▼ ▼ ▼ ▼ ▼ ▼ ▼ ▼ ▼ ▼ ▼ ▼			
MES-SUP (upper bar sign):	▼	▼	▼	▼
MEM-KOD (<i>maq</i>) (metric code for measures):	mat	mab	mal	mar
DUR-SIG (duration signal):	T T T T T T T	T T T T T T T		
TEXT SYLLABLES:	O - ri - en - tis par - ti - bus, Ad - ven - ta - vit a - si - nus			
DUR-KOD (duration code):	ta ta ta ta ta ta ba		ta ta ta ta ta ta ba	
MET-KOD (<i>taq</i>) (metric code for tacts):	tat tab tal tar tat tab tal		tat tab tal tar tat tab tal	
PUL-INF (lower pulse sign):	▲ ▲ ▲ ▲ ▲ ▲ ▲		▲ ▲ ▲ ▲ ▲ ▲ ▲	
PUL-KOD (pulse code):	mu tu tu tu mu tu tu		mu tu tu tu mu tu tu	

EXAMPLE 3.1 c)

Orientis partibus ... (Song of the Ass)
 The pulse aspect of the transcription of the first phrase of this monophonic conductus in PANOT.

(1)

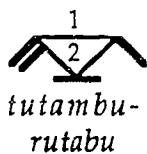

▽	▽	▽	▽	▽	▽	▽	▽	▽	▽	▽	▽	▽	▽	▽
▽				▽				▽				▽		
O - ri - en - tis par - ti - bus, Ad - ven - ta - vit a - si - nus														
▲	▲	▲	▲	▲	▲	▲	▲	▲	▲	▲	▲	▲	▲	▲
▲	▲	▲	▲	▲	▲	▲	▲	▲	▲	▲	▲	▲	▲	▲
mu	tu	tu	tu	mu	tu	tu	tu	mu	tu	tu	tu	mu	tu	tu
te	te	te	te	te	te	te	te	te	te	te	te	te	te	te

(2)

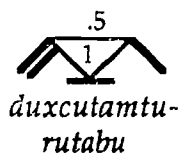

▽				▽				▽				▽		
▽				▽				▽				▽		
▲	▲	▲	▲	▲	▲	▲	▲	▲	▲	▲	▲	▲	▲	▲
mu	tu	tu	tu	mu	tu	tu	tu	mu	tu	tu	tu	mu	tu	tu

(3)

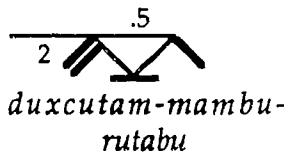

▽				▽				▽				▽		
▽				▽				▽				▽		
▲				▲				▲				▲		
mu				tu				mu				tu		

(4)

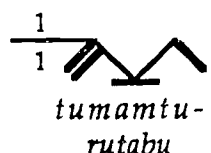

▽				▽				▽				▽		
▽				▽				▽				▽		
▲				▲				▲				▲		
mu				mu				mu				mu		

(5)

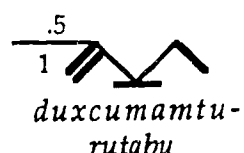

▽				▽				▽				▽		
▽				▽				▽				▽		
▲				▲				▲				▲		
mu				mu				mu				mu		

EXAMPLE 3.1 d)

Orientis partibus ... (Song of the Ass)
 Sampling of different metrical aspects of the first phrase of this monophonic conductus in PANOT.

(1)

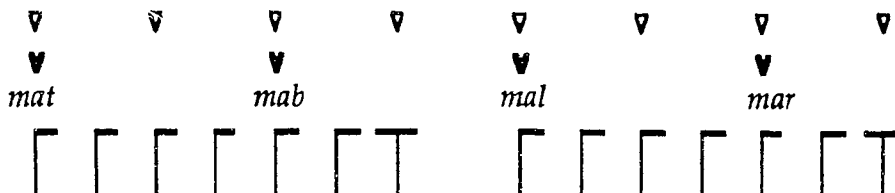
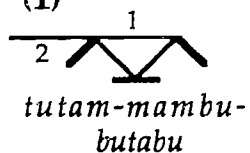

O - ri - en - tis par - ti - bus, Ad - ven - ta - vit a - si - nus

be be be be be be ta be be be be be be ta

tat- tab- tat- tab- tat- tab- tat- tab-
bet beb bet beb bet beb bet beb bet beb



(2)

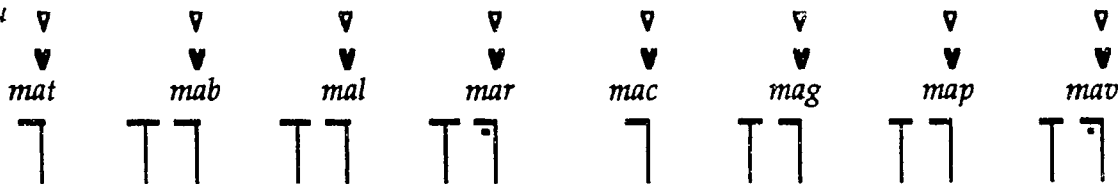
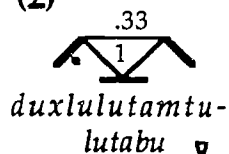

O - ri - en - tis par - ti - bus, Ad - ven - ta - vit a - si - nus

ba ta ba ta ba ta la ba ta ba ta ba ta la



(3)

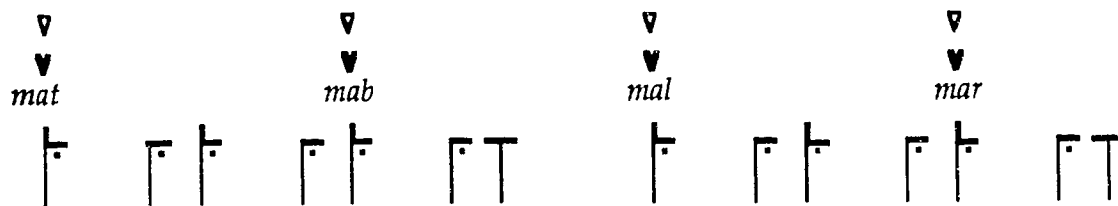
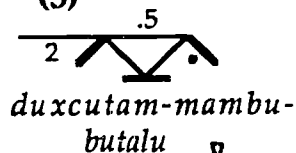

O - ri - en - tis par - ti - bus, Ad - ven - ta - vit a - si - nus

bumle le bumle le bumle le ta bumle le bumle le bumle le ta



EXAMPLE 3.2 a)

The initial trimeter from the third movement of Mozart's *Symphony in g-minor*, K. 550 in **TRANOT**

Allegretto

(Violino I)

EXAMPLE 3.2 b)

The temporal aspects of the initial trimeter from the third movement of Mozart's *Symphony in g-minor*, K. 550 in **PANOT**

(1)

lutabu-
pae

ta, (majfstu) ba, tas (majfsbu) ta, bem - bem - bem - be, (majfslu) ta, ta.

(2)

ba = ta
lu(ba)bu-
lae

ta, (majfstu) ba, ba, bem - bem - bem - be, (majfsbu) tam-ta.

(3)

ba = ta
bu(ba)bu-
lae

ta, (majfstu) ba, ba, (majfsbu) bem - bem - bem - be, tam - ta.

EXAMPLE 3.3 a)

The introductory measures from the violin part of the fourth movement of Beethoven's *Symphony in C-major*, No. 1 in TRANOT

Adagio (♩ = 63)



Allegro molto e vivace (♩ = 88)

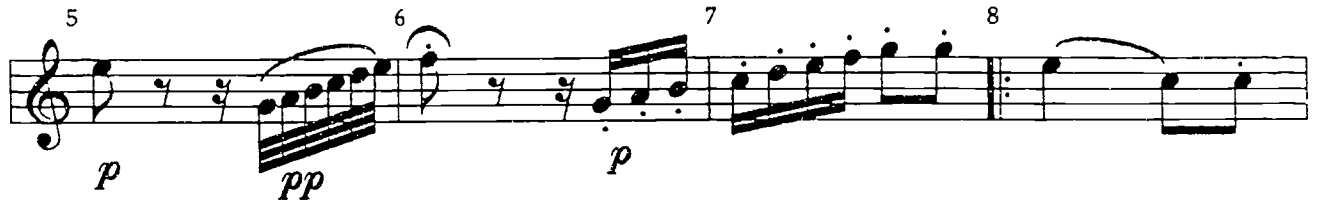

EXAMPLE 3.3 b)

The introductory measures from the violin part of the fourth movement of Beethoven's *Symphony in C-major*, No. 1 in PANOT

duxnucu-bem-tu-butabu - lae

1 ^{.95}

2

3

4

5

6

7

8

duxguvu-mam-tu-(butabu) - nae

1 ^{.68}

2

3

4

5

6

7

8

tab-beb
mer-mat

sufa; lumvem-
sufa; ve,
(majsbu)bem-
bex,

lumvemx-
sufa; vem-
lumvem-
sufa; ve,
(majstu)bem-
bex,

remx
tusjefs;
rembam-
rembam-
sufa; rem-
sufa; re,
(majstru)bem-
bex,

bemlamx-
bemlam-
bemlam-
sufa; bemlam-
sufa; bemlam-
sufa; bemla,

(majscu)bem-
bex,

remx-
tusjefs;
rembam-
rembam-
rembam-
rembam-
remba,
(majsgu)
faex;bem-
bex,

remx-
sufa; rem-
sufa; rem-
sufa; re,
sufa; (majspu)rem-
sufa; rem-
sufa; rem-
sufa; re,
sufa; bem-
sufa be,

(majsvu)tusjefs
ta,jut;

tusjefs bem-
sufa be,

EXAMPLE 3.3 a)

The introductory measures from the violin part of the fourth movement of Beethoven's *Symphony in C-major*, No. 1 in **TRANOT**

Adagio (♩ = 63)



Allegro molto e vivace (♩ = 88)



EXAMPLE 3.3 c)

The temporary aspect of the introductory measures from the violin part of the fourth movement of Beethoven's *Symphony in C-major*, No. 1 in the optional tact divisions of **PANOT**

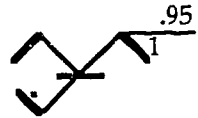
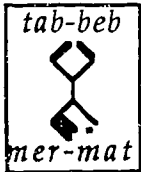

duxnucu-bem-tu-
butabu - lae

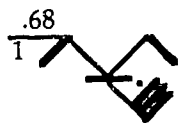
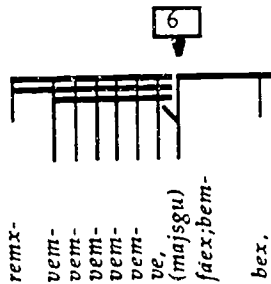
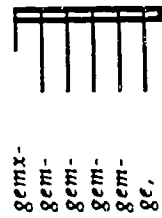
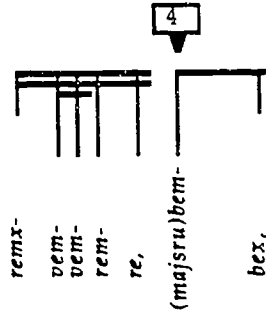
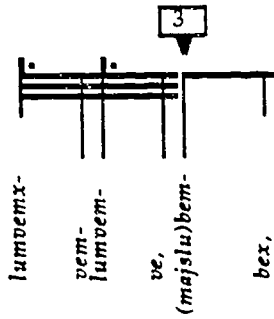
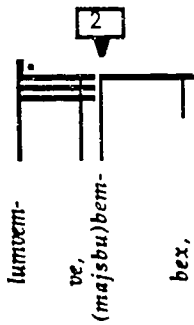

duxguvu-mam-tu-
(butabu) - nae

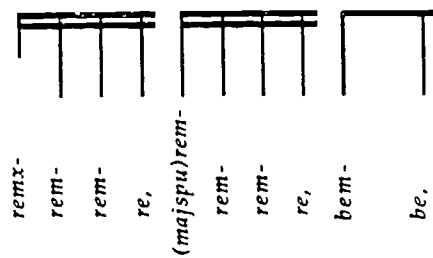

EXAMPLE 3.3 a)

The introductory measures from the violin part of the fourth movement of Beethoven's *Symphony in C-major*, No. 1 in TRANOT

Adagio (♩ = 63)



Allegro molto e vivace (♩ = 88)

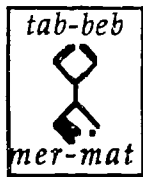
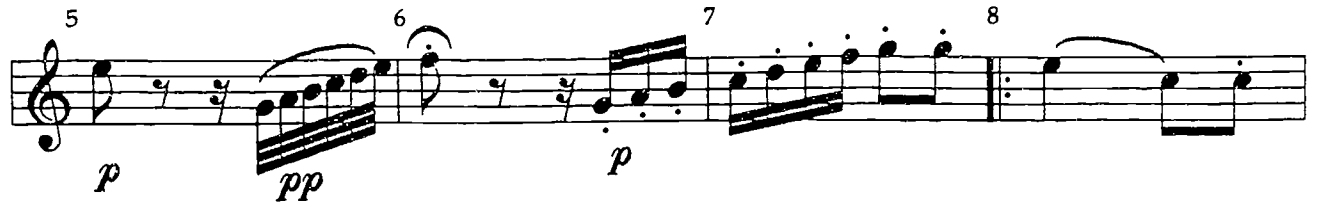

EXAMPLE 3.3 d)

The introductory measures from the violin part of the fourth movement of Beethoven's *Symphony in C-major*, No. 1 in the optional meter of PANOT

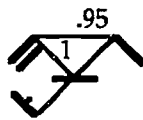

dumnucu-tam-tu-
rutabu - lae

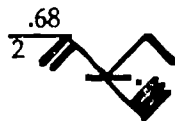
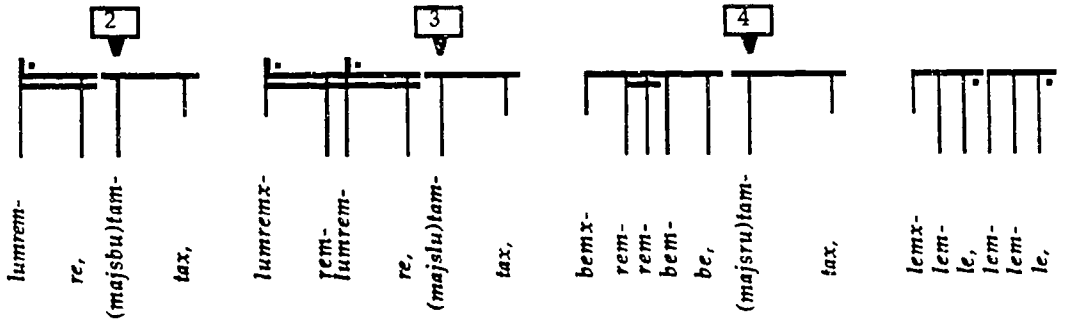

duxguvu-mam-bu-
(rutabu) - nae

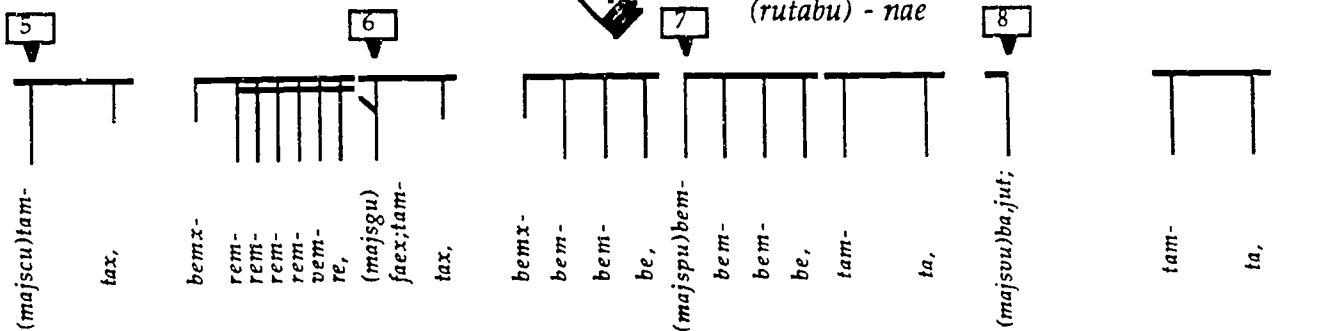

Four excerpts (mm. 0-4, 14, 11 and 73) from *Nocturne* op. 9, no. 1, by Chopin in **TRANOT**.

Musical score for Chopin's *Nocturne* op. 9, no. 1. The score is in G-flat major and 3/4 time, marked "Larghetto". It consists of two staves: a piano part (treble clef) and a bass part (bass clef). The piano part features a melodic line with various ornaments and dynamics. The bass part provides harmonic support with chords and a steady rhythm. Excerpts are marked with numbers and brackets: 0, 1, 2, 3, 11, 14, 20, 22, 73, and 84.

EXAMPLE 3. 31 b)

The temporal aspect of four excerpts (mm. 0-4, 14, 11 and 73) from *Nocturne* op. 9, no. 1, by Chopin in **PANOT**.

Temporal representation of the four excerpts from the Nocturne. Each excerpt is shown as a rhythmic pattern on a staff, with a corresponding measure number in a box above it. The patterns are labeled with their respective measure numbers: 0, 1, 2, 3, 11, 14, 20, 22, 73, and 84. Dynamic markings like "(emhu)" are included below the patterns. The patterns show the rhythmic structure of the excerpts, including rests and note values.

EXAMPLE 3.4 a)

An excerpt from the trombone part of Stravinski's *L'histoire du soldat*
(Part II: The Soldier's March, mm 7-17) in TRANOT

M.M. $\text{♩} = 112$

7 Trombone

8 9 10 11 12 13 14 15 16 17

Copyright © 1924 by J. & W. Chester. Used with permission of Hansen House.

tab-beb
meb-map

EXAMPLE 3.4 b)

The temporal aspect of an excerpt from the trombone part of Stravinski's
L'histoire du soldat (Part II: The Soldier's March, mm 7-17) in PANOT

.54 luxcuru-tam-tu .54
butabu lutabu

7 8 9 10

.54 (.81) (.27) .54
butabu lu(be)bu (be = ta) butabu

11 12 13 14

(.81) (.27) .54
lu(be)bu (be = ta) lutabu

15 16 17

EXAMPLE 3.5 a)

An excerpt from the score of Ives' *Three Places in New England*
(Part II: General Putnam's Camp, mm 134-135) in TRANOT

Trumpet (similar metrically: Bassoon, Violoncello and Contrabass parts)
[REFERENCE METER: C or 4/4]

marcato ----- *sempre* ----- *marcato*

Clarinet (similar metrically: Viola) [ACTUAL METER: 12/8 (triplets)]









Bass Drum [ACTUAL METER: 3/4]

Snare Drum (approximate rhythm) [ACTUAL METER: 2/4 or 4/8 (quadruplets) out
of 3/8 in the Trumpet's part 4/4]

Violin (similar metrically: Flute, Oboe, Horn, Trombone, Tuba and Piano)
[ACTUAL METER: 3/8 out of 3/8 in Trumpet's 4/4]

EXAMPLE 3.5 b)

The temporal aspect of an excerpt from the score of Ives' *Three Places in New England* (Part II: General Putnam's Camp, mm 134-135) in PANOT

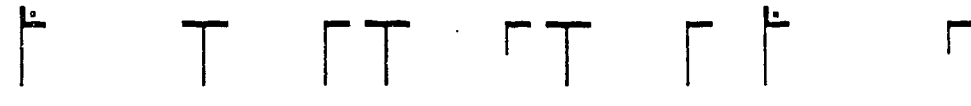
	134		135	
<div style="border: 1px solid black; padding: 2px; display: inline-block;">Trumpet</div>  <i>rutabu</i> (Simple Quadruple) REFERENCE METER	 be sufa;bem sufa;be sufa;be sufa;be ta sufa;be sufa;rem sufa;re bem be sufa;rem sufa;rem sufa;rem sufa;re ia bex			
<div style="border: 1px solid black; padding: 2px; display: inline-block;">Clarinet</div>  <i>rutalu</i> (Compound Quadruple)	 lem lem le lem lem le lem lem le lem lem le lem lem le lem lem le lem lem le			
<div style="border: 1px solid black; padding: 2px; display: inline-block;">Bass Drum</div>  <i>lutabu</i> (Simple Maxi-Triple)	 ta be bex be bex ta be bex be bex ta be bex			
<div style="border: 1px solid black; padding: 2px; display: inline-block;">Snare Drum</div>  <i>bu(lumre)bu</i> (Simple Mini-Duple)	 lumrembam sufa;lumremba sufa;lumrembam sufa;lumremba lumrembam sufa;lumrembam sufa;lumrembam sufa;lumremba lumrembam sufa;lumrembam sufa;lumrembam sufa;lumremba lumrembam sufa;lumrembam sufa;lumrembam sufa;lumremba lumrembam sufa;lumrembam sufa;lumrembam sufa;lumremba lumrembam sufa;lumrembam sufa;lumrembam			
<div style="border: 1px solid black; padding: 2px; display: inline-block;">Violin</div>  <i>lu(be)bu</i> (Simple Mini-Triple)	 lumbe ta be ta bex ta be lumbe bex			
	134		135	

EXAMPLE 3.6 a)

The beginning of *Canaries* from
Eight Pieces for Four Timpani by Elliott Carter in TRANOT

The musical score consists of five systems of music for timpani, written in bass clef with a key signature of one flat (Bb). The systems are numbered 1, 5, 11, 17, and 23.

- System 1:** Tempo $\text{♩} = 90$. Dynamics: *mf*. Articulations: (>), (v), (v). Includes circled 'C' and circled 'N' markings.
- System 5:** Dynamics: *p*, *f*. Articulations: (>), (v). Includes circled 'R', circled 'N', and circled 'C' markings. A bracketed section of four notes is shown.
- System 11:** Tempo $\text{♩} = 120$. Dynamics: *marc.*, *meno f*, *f*, *meno f*. Articulations: (>), (v). Includes circled 'C' and circled 'N' markings.
- System 17:** Dynamics: *f*, *meno f*, *f*, *più marc.*. Articulations: (>), (v), (>), (>), (>), (>). Includes circled 'C' and circled 'N' markings. Tempo markings: $\text{♩} = 180$ and $\text{♩} = 270$.
- System 23:** Tempo $\text{♩} = 90$. Dynamics: *pp*. Articulations: (>), (v). Includes circled 'N' and circled 'R' markings.

Copyright © 1968 by Associated Music Publishers, Inc.
 Reproduced with permission of G. Schirmer, Music Sales Corporation

EXAMPLE 3.6 b)

The temporal aspect of the beginning of *Canaries* from *Eight Pieces for Four Timpani* by Elliott Carter in PANOT

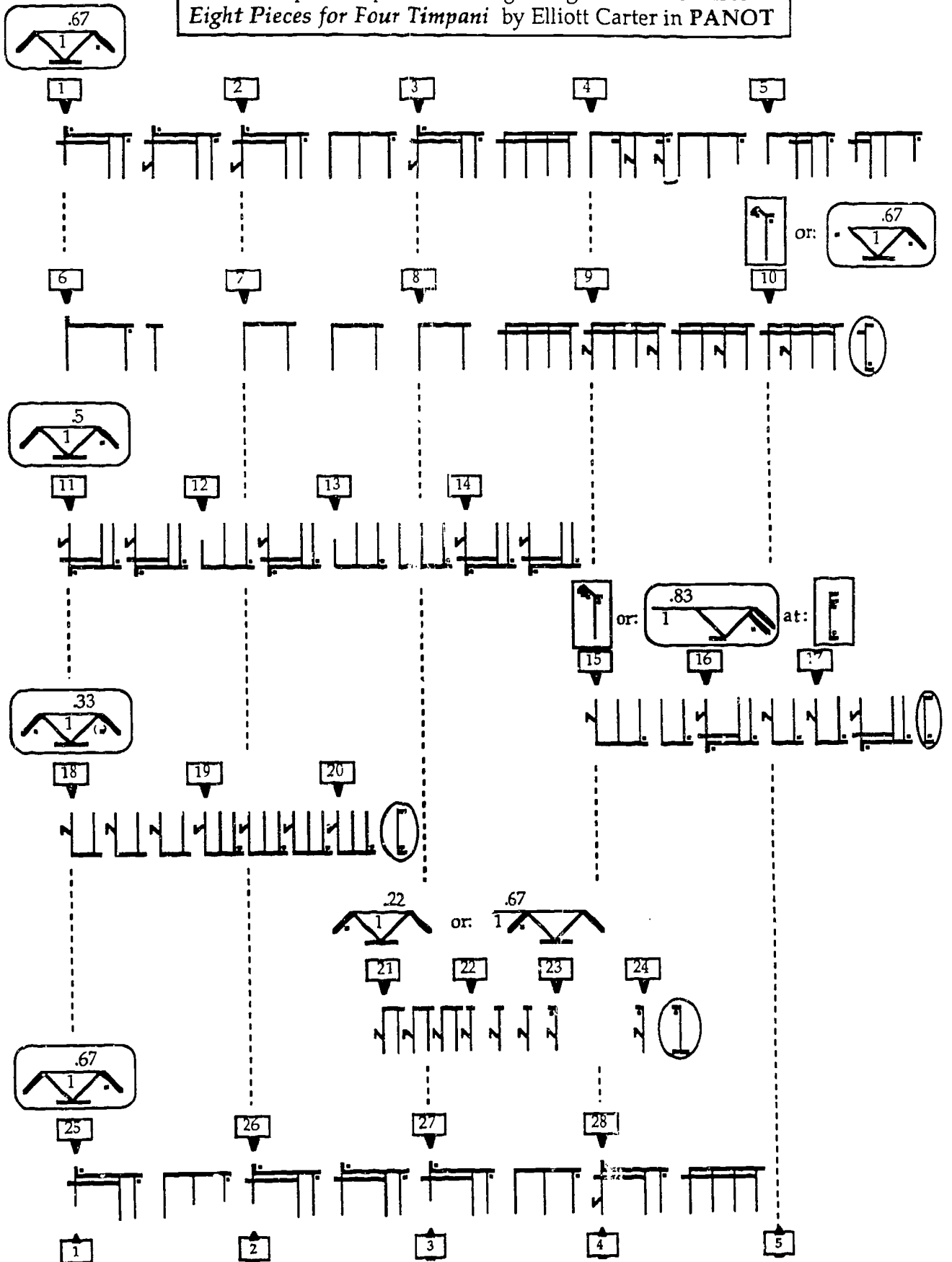

EXAMPLE 3.7 a)

The initial two measures opening the
String Quartet No.3 by Elliott Carter in *TRANOT*

Maestoso (giusto sempre)
 ♩ = 105

Duo II

Violin (II)

Viola

Furioso (quasi rubato sempre)
 ♩ = 70

Duo I

Violin (I)

Cello

EXAMPLE 3.7 b)

The temporal aspect of the initial two measures opening the *String Quartet No.3* by Elliott Carter in PANOT

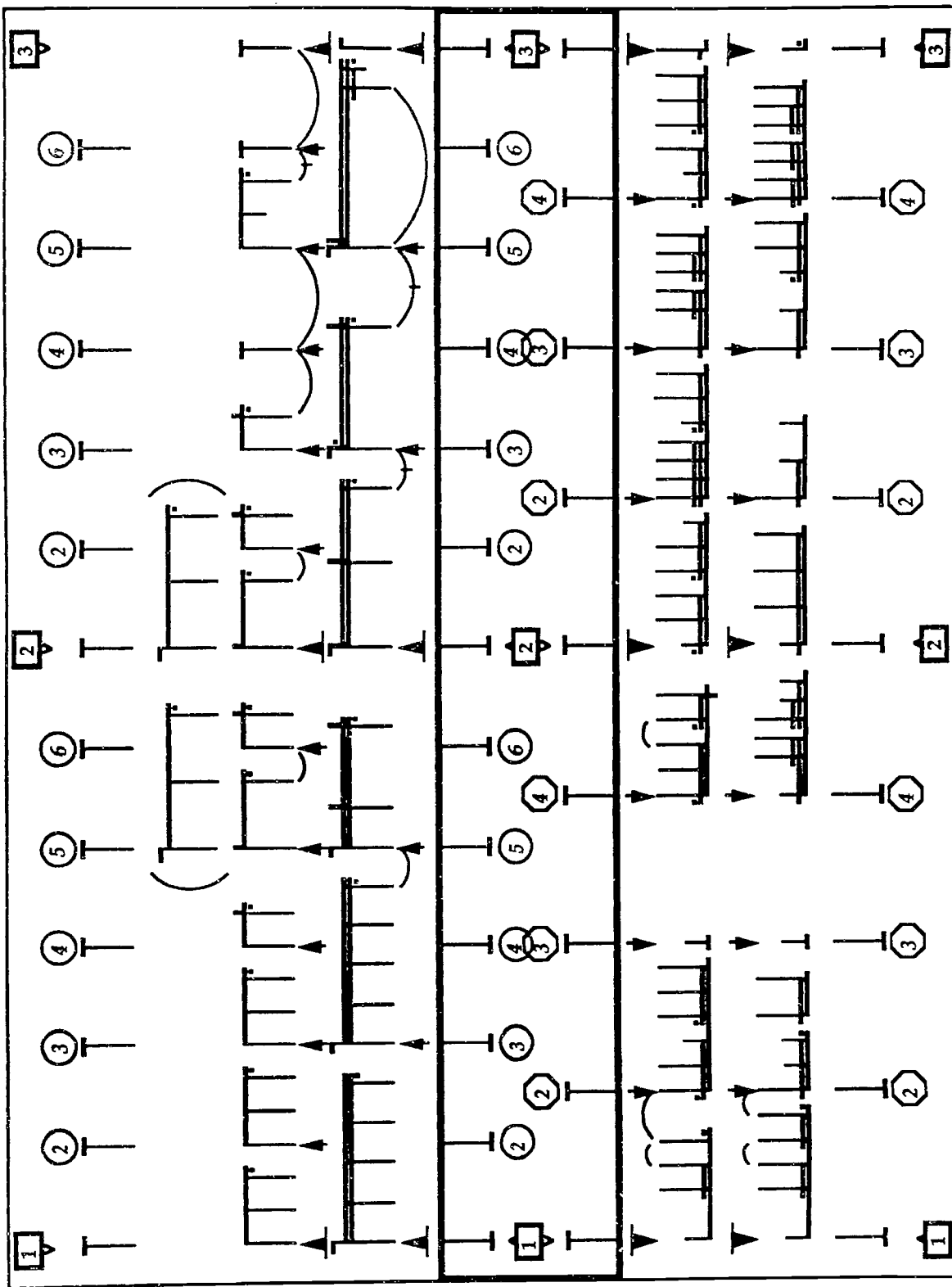

Maestoso
(giusto sempre)

.57



H	VINO 2
DUO	VILA

(.57" x 6 = 3.42')

Furioso (quasi
rubato sempre)

.86



I	VINO 1
DUO	VILO

(.86" x 4 = 3.44')

EXAMPLE 4.1 a)

Orientis partibus ... (Song of the Ass)
 Transcription of the opening of this
 monophonic conductus in TRANOT.

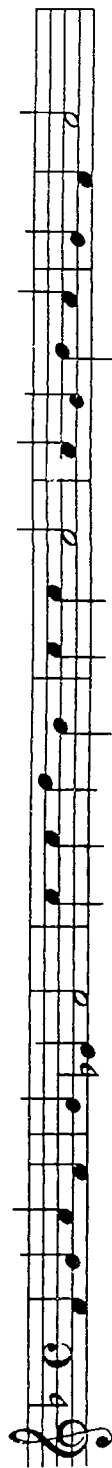

O - ri - en - tis par - ti - bus, Ad - ven - ta - vit a - si - nus, Pul - cher et for - tis - si - mus,

EXAMPLE 4.1 b)

Orientis partibus ... (Song of the Ass)
 The spatial aspects of the transcription of the opening
 of this monophonic conductus in PANOT.

(1) KAL-KOD rokco, po, no, co cokzo, zo, bo, rokdo,cokzo, zo, rokno, no, po, do, no, po, co, no,
 TEXT O - ri - en - tis par - ti - bus, Ad - ven - ta - vit a - si - nus, Pul - cher et for - tis - si - mus,

(2) KAL-KOD rokco, po, no, co cokzo, zo, bo, rokdo,cokzo, zo, rokno, no, po, do, no, po, co, no,
 TEXT O - ri - en - tis par - ti - bus, Ad - ven - ta - vit a - si - nus, Pul - cher et for - tis - si - mus,

(3) KAL-KOD rokco, po, no, co cokzo, zo, bo, rokdo,cokzo, zo, rokno, no, po, do, no, po, co, no,
 TEXT O - ri - en - tis par - ti - bus, Ad - ven - ta - vit a - si - nus, Pul - cher et for - tis - si - mus,

EXAMPLE 4.2 a)

Veni Creator ... (Hymn for the Feast of Pentecost)
The opening strophe in GRENOT

Hymn.
8.

V

Veni Cre-á-tor Spi-ri-tus, Méntes tu-órum ví-si-ta :
Imple su-pérna grá-ti-a Quae tu cre-ásti péc-to-ra.

Source: *Liber Usualis*, Benedictines of Solesmes, eds., (Tournai, Belgium: Desclée & Co., 1938), p. 885.

EXAMPLE 4.2 b)

Veni Creator ... (Hymn for the Feast of Pentecost)
The spatial aspect of the opening strophe in PANOT

(l)ok)po, no, po, co, po, no, po, (rok)zo, bo, zo, (lok)po, no, (rok)zo, bo, zo, bo, ro, bo,
Ve - ni Cre - a - tor Spi - ri - tus Men - tes tu - o - rum vi - si - ta :

ox, zo, bo, ro, (rok)zo, no, po, (rok)zo, bo, (lok)po, no, (rok)zo, (lok)no, po, co, no, ho, no, po, co, po,
Im - ple su - per - na gra - ti - a Quae tu cre - a - sti pe - cto - ra.



EXAMPLE 4.3 a)

Confitebor tibi ... (Psalm 110 in the Second Mode)
Psalmodic Formula in GRENOT.

Tone 2. D.

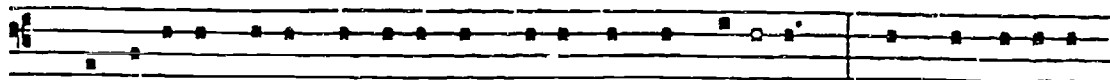
Mediant of τ accent.Ending of τ accent with τ preparatory syllable.

1. Confi-tébor tibi Dómine in tóto córde mé- o : * in consi-li-o

D

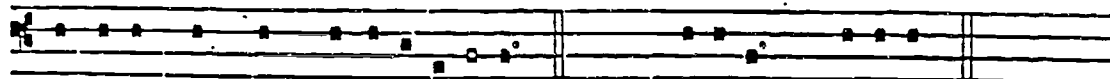

justórum et congregáti- ó- ne. Flex : su-órum, †

2. Mágna ópera Dómini : * exquisita in ómnes voluntátes éjus.

3. Conféssio et magnificéntia ópus éjus : * et justítia éjus mánet in saéculum saéculi.

4. Memóriam fécit mirabilium suórum, † miséricors et miserátor Dóminus : * éscam dédit timéntibus se.

5. Mémor érit in saéculum testaménti súi : * virtútem óperum suórum annuntiábit pópulo súo :

6. Ut det illis haereditátem géntium : * ópera mánuum éjus véritas et iudicium.

7. Fidélia ómnia mandáta éjus : † confirmáta in saéculum saéculi : * fácta in veritáte et aequitáte.

8. Redemptiónem misit pópulo súo : * mandávit in aetérnum testaméntum súum.

9. Sánctum et terríbile nómen éjus : * initium sapiéntiae tímor Dómini.

10. Intelléctus bónus ómnibus faciéntibus eum : * laudátio éjus mánet in saéculum saéculi.

11. Glória Pátri, et Fílio, * et Spirítui Sáncto.

12. Sicut érat in princípío, et nunc, et sémper, * et in saécula saeculórum. Amen.

EXAMPLE 4.3 b)

Confitebor tibi ... and Memoriam fecit ... The spatial aspects of the first and the fourth strophes of Psalm 110 (*Confitebor tibi ...*) in PANOT.

FIRST STROPHE

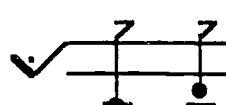
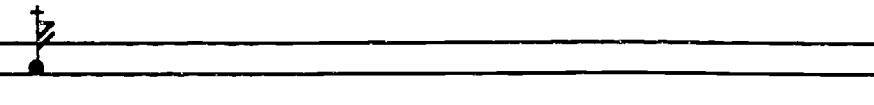
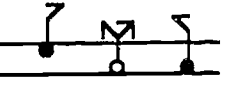
INITIUM	FIRST RECITATION	MEDIANT
		
(lok)zo, bo, ω,		po, (co) co,
Con - fi - te - bor	ti - bi Do - mi - ne in to - to cor - de	me - (p.) - o :

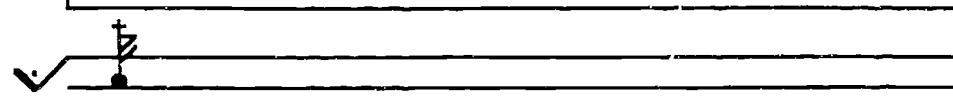
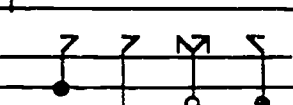
SECOND RECITATION	TERMINATION
	
ω,	ro, zo, (bo) bo,
in con - si - li - o	ju - sto - rum et con - gre - ga - ti - o - (p.) - ne .

FOURTH STROPHE

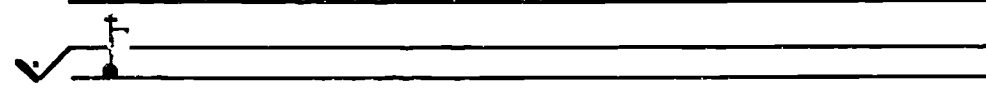
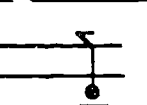
FIRST RECITATION	FLEX
	
ω,	bo,
Me - mo - ri - am	fe - cit mi - ra - bi - li - um su - o - rum ,

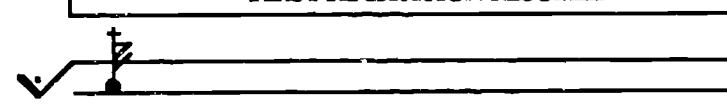
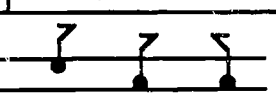
FIRST RECITATION RESUMED	MEDIANT
	
ω,	po, co, ω,
mi - se - ri - cors	et mi - se - ra - tor Do - mi - nus :

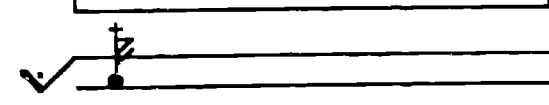
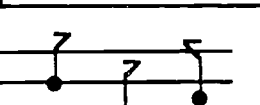
SECOND RECITATION	TERMINATION
	
ω,	ro, zo, bo.
es - cam	de - dit ti - men - ti - bus se .

EXAMPLE 4.4 a)

Consider and answer me ..., an excerpt from the vocal part (m. 34 - 37) of Psalm 13 in *Four Psalm Settings* by Bruce Saylor, (© 1978) in **TRANOT**.

sub. mp ; sub. p rit. pp
Con - sid - er and an - swer me, O Lord my God; lighten my eyes, lest I sleep the sleep of death;

Vocal Symbols (according to the composer's performance directions):

- sustained tone;
- short tone;
- ∩ reciting tone: Sing the text crisply and rapidly in the rhythm of speech.

Psalm 13 can be found in the *Anthology for Musical Analysis*, edited by Charles Burkhardt, starting with the Third Edition by Holt, Rinehart and Winston, 1978.

EXAMPLE 4.4 b)

Consider and answer me ..., an excerpt from the vocal part (m. 34 - 37) of *Psalm 13* in *Four Psalm Settings* by Bruce Saylor, (c. 1978). The spatial aspect in **PANOT**.

(ok)ho,(rok)co, ho, ho, vo, do, ho, zo, go, no, po, lo, co, go, ro, (cok)lo, (cok)lo.

Con - sid - er and an - swer me, O Lord my God; lighten my eyes, lest I sleep the sleep of death; Ideath;]

EXAMPLE 4.5 a)

The initial trimeter from the third movement of Mozart's *Symphony in g-minor*, K. 550 in TRANOT

Allegretto

(Violino I) *f*

EXAMPLE 4.5 b)

The spatial aspects of the initial trimeter from the third movement of Mozart's *Symphony in g-minor*, K. 550 in PANOT

(1)

lutabu-
pae

KOD: (rok)bo, po, do, no, po, go, no, po, bo,

SIG:

(2)

ba = ta
lutabu-
lae

KOD: (rok)bo, po, do, no, po, go, no, po, bo,

SIG:

(3)

(ba = ta)
butabu-
lae

KOD: (rok)bo, po, do, no, po, go, no, po, bo,

SIG:

EXAMPLE 4.5 a)

The initial trimer from the third movement of Mozart's *Symphony in g-minor*, K. 550 in TRANOT

Allegretto

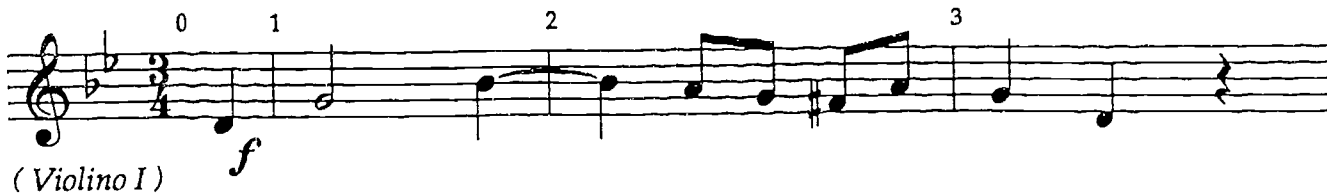

EXAMPLE 4.5 c)

The spatial aspects of the initial trimer from the third movement of Mozart's *Symphony in g-minor*, K. 550 in PANOT

(1)

DYS-NOT
(disk notation)

KOD-SYL
(syllabic code)

SIG-PAR (parametric signal)

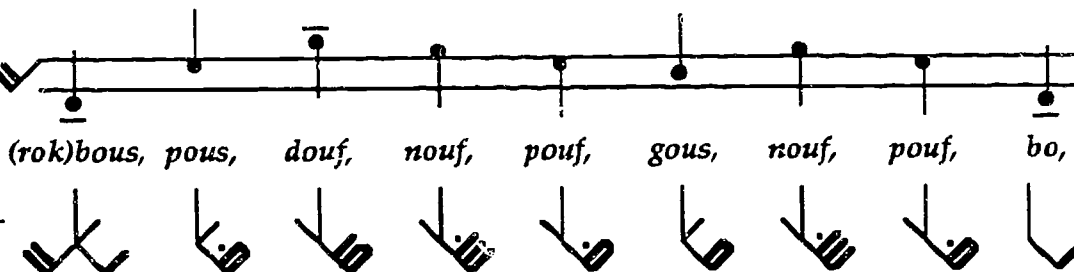

(2)

KOD-SYL
(syllabic code)

SIG-PAR
(parametric signal)

KOD-NUM
(numerical code)

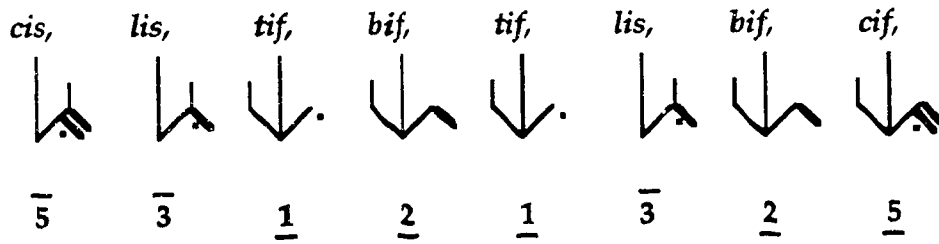

(3)

DYS-NOT
(disk notation)

KOD-SYL
(syllabic code)

SIG-PAR
(parametric signal)

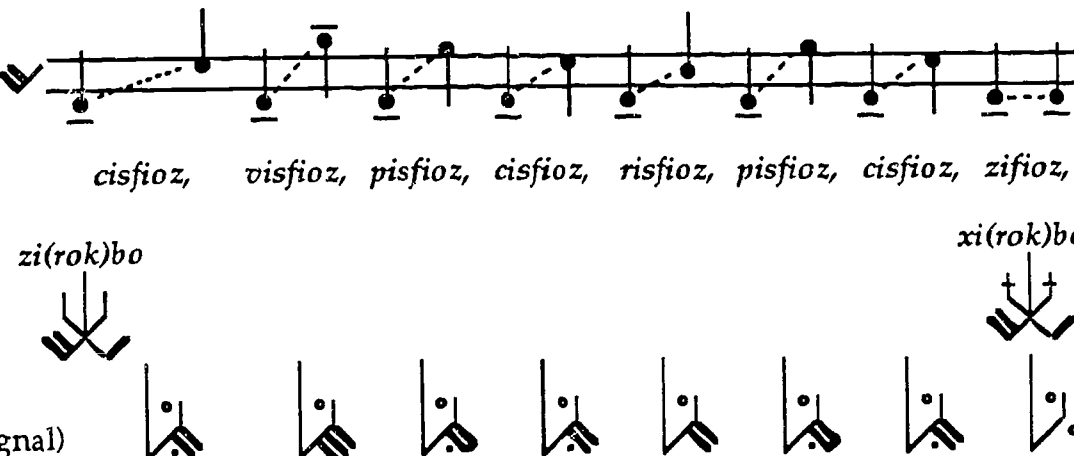

EXAMPLE 4.5 a)

The initial trimeter from the third movement of Mozart's *Symphony in g-minor*, K. 550 in TRANOT

Allegretto

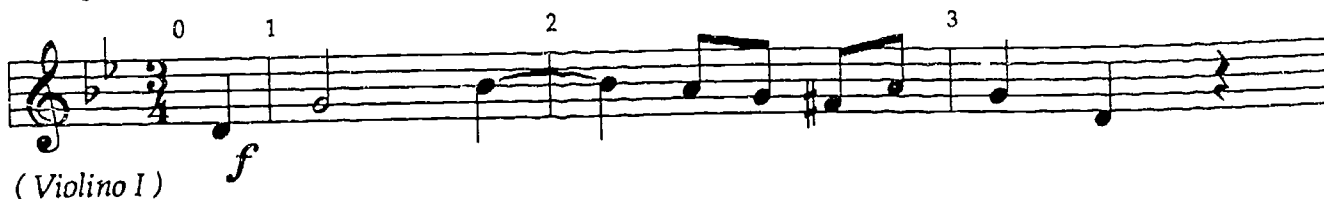

EXAMPLE 4.5 d)

The spatial aspects of the initial trimeter from the third movement of Mozart's *Symphony in g-minor*, K. 550 in PANOT

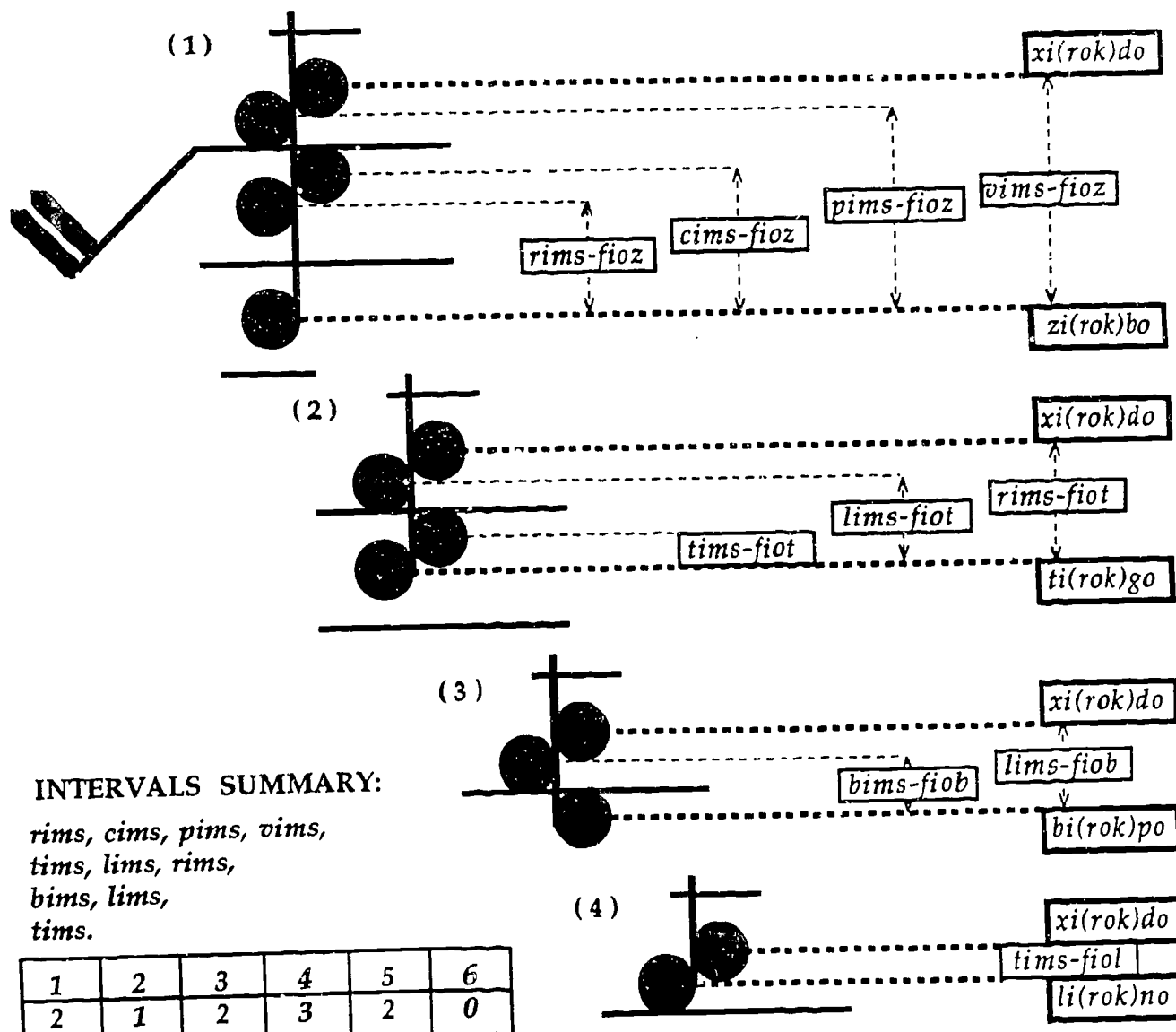

INTERVALS SUMMARY:

rims, cims, pims, vims,
tims, lims, rims,
bims, lims,
tims.

1	2	3	4	5	6
2	1	2	3	2	0

EXAMPLE 4.6 a)

The introductory measures from the violin part of the fourth movement of Beethoven's *Symphony in C-major*, No. 1 in **TRANOT**

Adagio (♩ = 63)

Musical notation for measures 1-4 of Example 4.6 a). The music is in 2/4 time, Adagio (♩ = 63). Measure 1 starts with a piano (*p*) dynamic. Measures 2, 3, and 4 contain triplets of eighth notes.

Allegro molto e vivace (♩ = 88)

Musical notation for measures 5-8 of Example 4.6 a). The music is in 2/4 time, Allegro molto e vivace (♩ = 88). Measure 5 starts with a piano (*p*) dynamic. Measure 6 has a pianissimo (*pp*) dynamic. Measures 7 and 8 return to a piano (*p*) dynamic.

EXAMPLE 4.6 b)

The introductory measures from the violin part of the fourth movement of Beethoven's *Symphony in C-major*, No. 1 in **PANOT**

Musical notation for Example 4.6 b) with phonetic transcriptions. The notation is in 2/4 time. Measure 1 is marked with a tempo of .95. Measure 7 is marked with a tempo of .68. The phonetic transcriptions are as follows:

- Measure 1: (rok)po, no, ho, ox, ox, po, no, ho, (cok)zo, ox, ox, (rok)po, no, ho, bo, ox, ox, (rok)po, no, ho, (cok)zo, bo.
- Measure 2: (rok)po, no, ho, ox, ox, po, no, ho, (cok)zo, ox, ox, (rok)po, no, ho, bo, ox, ox, (rok)po, no, ho, (cok)zo, bo.
- Measure 3: (rok)po, no, ho, ox, ox, po, no, ho, (cok)zo, ox, ox, (rok)po, no, ho, bo, ox, ox, (rok)po, no, ho, (cok)zo, bo.
- Measure 4: (rok)po, no, ho, ox, ox, po, no, ho, (cok)zo, ox, ox, (rok)po, no, ho, bo, ox, ox, (rok)po, no, ho, (cok)zo, bo.
- Measure 5: ro, ox, ox, (rok)po, no, ho, (cok)zo, bo, ro, co, po, po, ro, zo, zo.
- Measure 6: (rok)po, no, ho, (cok)zo, bo, ro, co, po, po, ro, zo, zo.
- Measure 7: (rok)po, no, ho, (cok)zo, bo, ro, co, po, po, ro, zo, zo.
- Measure 8: (rok)po, no, ho, (cok)zo, bo, ro, co, po, po, ro, zo, zo.

EXAMPLE 4.6 a)

The introductory measures from the violin part of the fourth movement of Beethoven's *Symphony in C-major, No. 1* in **TRANOT**

Adagio (♩ = 63)



Allegro molto e vivace (♩ = 88)



EXAMPLE 4.6 c)

The introductory measures from the violin part of the fourth movement of Beethoven's *Symphony in C-major, No. 1* in **PANOT**



.95

1 duxnucu-bem-tu-
2 butabu - lae
3
4

SIG

KOD

sufa; lumvem- / (rok)po, sufa; ve./no, (majsbu)bem- / ho, bex./ox, lumvemx- / ox, sufa: vem- / po, lumvem- / no, sufa; ve./ho, (majstu)bem- / (cok)zo, bex./ox, remx- / ox, tusjefs; rembam- / (rok)po, rembam- / no, sufa; rem- / ho, sufa; re./ (cok)zo, (majstru)bem- / bo, bex./ox, bemlamx- / ox, tusjefs; bemlam- / (rok)ro, bemlam- / o, sufa; bemlam- / ho, sufa; bemlam- / (cok)zo, sufa; bemla./bo,

.68

1 duxguvu-mam-tu-
2 (butabu) - nae
3
4
5
6
7
8

SIG

KOD

(majscu)bem- / ro, bex./ox, remx- / ox, tusjefs; rembam- / (rok)po, rembam- / no, rembam- / ho, rembam- / (cok)zo, rembam- / bo, tusjes; remba./ro, (majsgu) faex;bem- / co, bex./ox, remx- / ox, sufa; rem- / (-ok)po, sufa; rein- / no, sufa; re./ho, sufa; (majspu)rem- / (cok)zo, sufa; rem- / bo, sufa; rem- / ro, sufa; re./co, sufa; bem- / po, sufa; be./po, (majsvu)tusjefs; jut;ta./ro, tusjes; bem- / zo, sufa; be./zo,

EXAMPLE 4.7 a)

An excerpt from the score of Ives' *Three Places in New England*
(Part II: General Putnam's Camp, mm 134-135) in TRANOT

Trumpet (similar metrically: Bassoon, Violoncello and Contrabass parts)
[REFERENCE METER: C or 4/4]

marcato ----- *sempre* ----- *marcato*



Clarinet (similar metrically: Viola) [ACTUAL METER: 12/8 (triplets)]

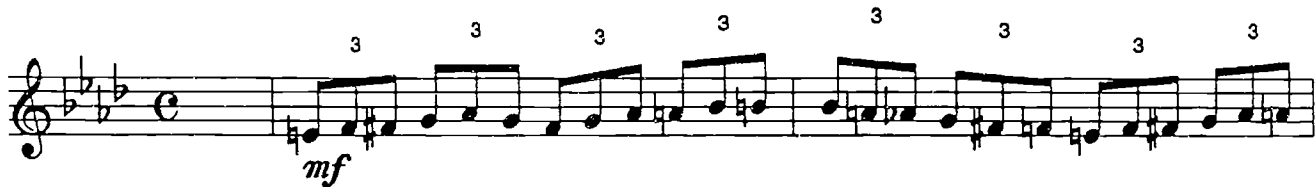

Bass Drum [ACTUAL METER: 3/4]

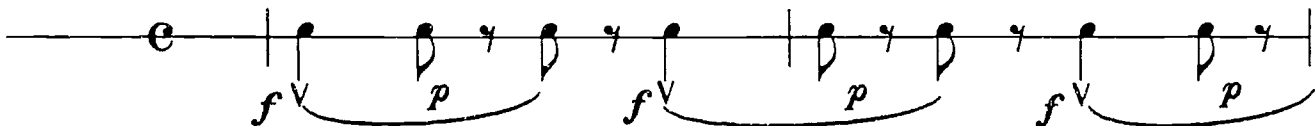

Snare Drum (approximate rhythm) [ACTUAL METER: 2/4 or 4/8 (quadruplets) out
of 3/8 in the Trumpet's part 4/4]

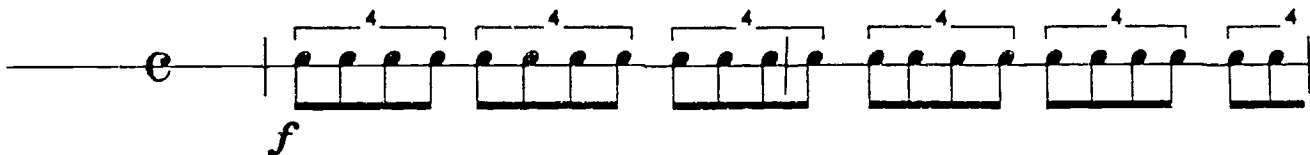

Violin (similar metrically: Flute, Oboe, Horn, Trombone, Tuba and Piano)
[ACTUAL METER: 3/8 out of 3/8 in Trumpet's 4/4]



EXAMPLE 4.7 b)

The spatial aspect of an excerpt from the score of Ives' *Three Places in New England* (Part II: General Putnam's Camp, mm 134-135) in PANOT

Trumpet
rutabu
(rok)lo, vo, lo, vo, do, (cok)zo, (rok)do, (cok)zo, to, lo, (rok)vo, (cok)zo, (rok)do, vo, po, vo, ox,

Clarinet
rutalu
(rok)ro, co, go, po, vo, po, go, po, vo, no, do, ho, do, no, ve, po, go, co, ro, co, go, po, vo, no,

Bass Drum
lutabu
xo, xo, ox, xo, ox, xo, xo, ox, xo, ox, xo, ox, xo, ox, xo, ox,

Snare Drum
bu(lumre)bu
xo, xo,

Violin
lu(be)bu
(cok)zo, zo, (rok)ho, (cok)zo, ox, (cok)zo, (rok)do, vo, ox,

134 135



EXAMPLE 4.8 a)

The initial two measures opening the
String Quartet No.3 by Elliott Carter in TRANOT

Maestoso (giusto sempre)
♩ = 105

Duo II
Violin (II)
Viola

Furioso (quasi rubato sempre)
♩ = 70

Duo I
Violin (I)
Cello

Violin (II) *ff* *f* *ff* *f* [hold all 3 notes]

Viola *ff* *f* *ff* *f* [hold all 3 notes]

Violin (I) *ff* *ff* *ff* *ff*

Cello *ff* *ff* *ff* *ff*

2 *mf* *ff* *f-mf* *f-mf*

mf *f* *ff* *f* *ff* *ff*

Copyright © 1973 by Associated Music Publishers, Inc.
Reproduced with permission of G. Schirmer, Music Sales Corporation



EXAMPLE 4.8 b)

The spatial aspect of the initial two measures opening
the *String Quartet No.3* by Elliott Carter in PANOT

Maestoso
(giusto sempre)

VINO 2

DUO II

VILA

1 2 3 4 5 6 2 3 4 5 6

*Furioso (quasi
rubato sempre)*

VINO 1

DUO I

VILO

1 2 3 4 2 3 4

1 2 3 4 2 3 4

EXAMPLE 4.9 a)

The spatial aspect of the ending from the score of Penderecki's *Threnody for the Victims of Hiroshima* (mm. 67-70) in **TRANOT**

12Vn I-12 (67) (68) (69)

12Vn 13-24

10Vl I-10

10Vc I-10

8Cb I-8

6'' 8'' 10''

tutti archi (70)

24Vn I-24

10Vl I-10

10Vc I-10

8Cb I-8

30''

EXAMPLE 4.9 b)

The spatial aspect of the ending from the score of Penderecki's *Threnody for the Victims of Hiroshima* (mm. 67-70) in PANOT

The musical score displays four parts: VINO, VILA, VILO, and VIBA. Measure markers 67, 68, 69, and 70 are indicated at the top. Circled labels indicate instrument counts for each part at specific measures:

- Measure 67: 12 VINO (2) 13-24, 10 VILA 1-10, 12 VINO (1) 1-12, 8 VIBA 1-8, 10 VILO 1-10, 10 VILA 1-10, 10 VINO (1) 1-10, 8 VIBA 1-8.
- Measure 68: 12 VINO (1) 1-12, 8 VIBA 1-8, 10 VILO 1-10, 10 VILA 1-10.
- Measure 69: 10 VINO 1-10, 10 VILA 1-10, 8 VIBA 1-8, 10 VILO 1-10, 10 VILA 1-10.
- Measure 70: 24 VINO 1-24, 10 VILA 1-10, 8 VIBA 1-8, 10 VILO 1-10, 8 VIBA 1-8.

Each instrument part includes a musical staff with notes and a list of fingerings (e.g., VINO: 1, 2, 3, 4, 5, 6, 7, 8, 9, 10, 11, 12).

EXAMPLE 4.10 a)

The opening flute solo from the Prelude to *The Afternoon of a Faun* by Debussy in TRANOT

Très modéré (M.M. $\text{♩} = 44$)
FLUTE SOLO

p doux et expressif

EXAMPLE 4.10 b)

The opening flute solo from the Prelude to *The Afternoon of a Faun* by Debussy in PANOT

p doux et expressif

1.36
1
or:
.45
1

FLAU SOLO

242 243

EXAMPLE 4.11 a)

The opening flute solo from the Prelude to
The Afternoon of a Faun by Debussy in TRANOT

Très modéré (M.M. ♩ = 44)
 FLUTE SOLO

p doux et expressif

EXAMPLE 4.11 c)

The opening flute solo from the Prelude to
The Afternoon of a Faun by Debussy in PANOT
 transposed 1 degree up by moving staff lines down

FLAU SOLO

p doux et expressif

EXAMPLE 4.12 a)

The opening flute solo from the Prelude to *The Afternoon of a Faun* by Debussy in TRANOT

Très modéré (M.M. $\text{♩} = 44$)
FLUTE SOLO

p doux et expressif

EXAMPLE 4.12 d)

The opening flute solo from the Prelude to *The Afternoon of a Faun* by Debussy in PANOT. Staffless pitch profiles in two different rhythms

(1) 1.36 or: .45

(2)

EXAMPLE 4.13 e)

The opening flute solo from the Prelude to *The Afternoon of a Faun* by Debussy in PANOT transposed 4 degrees down by moving staff lines up

1.36 or: .45
1. .1

1 2 3 4 5

FLAU SOLO

doux et expressif

Detailed description: This musical score shows a flute solo on a single staff. It begins with a 'FLAU SOLO' marking and a dynamic marking of 'doux et expressif'. The first measure contains a quarter note with a fingering of '1' and a breath mark. Above this measure are two alternative fingering diagrams: one for a half note with fingerings '1.36' and '1. .1', and another for a quarter note with fingerings '.45' and '.1'. The melody continues with eighth and sixteenth notes, marked with fingerings '2', '3', '4', and '5' in boxes. A large slur covers the final four measures of the solo.

EXAMPLE 4.13 f)

The opening flute solo from the Prelude to *The Afternoon of a Faun* by Debussy in PANOT transposed 6 degrees up by moving staff lines down

1.36 or: .45
1. .1

1 2 3 4 5

FLAU SOLO

doux et expressif

Detailed description: This musical score shows the same flute solo as in Example 4.13 e), but transposed 6 degrees up. It includes the same 'FLAU SOLO' and 'doux et expressif' markings. The fingering diagrams at the beginning are identical to those in Example 4.13 e). The notes on the staff are shifted up by six degrees compared to the original score. The fingerings '1', '2', '3', '4', and '5' are marked in boxes throughout the piece, and a large slur covers the final four measures.

EXAMPLE 5.1 a)
The opening of Chopin's second Scherzo in TRANOT

Presto

soffo voce

ff

8^{va}

1 2 3 4 5 6 7 8 9

(Piano solo)

EXAMPLE 5.1 b)
The opening of Chopin's second Scherzo in PANOT

PIANO SOLO

1 2 3 4 5 6 7 8 9

250

251

EXAMPLE 5.1 c)

The opening of Chopin's second Scherzo in SIGNOT and KODNOT

	<p>(majstu) ba / bokao, tusjef // ly / (majstu) ba / lokao, tusjef; lem / bokno / lem / lokno; lem / bokao / lem / lokao; le / lokto / le / rokto; (majsbu) ta / lokco, tusjes / (majsbu) ta / rokco, tusjes;</p>
	<p>tax / (ox) / tax / (ox) / tax / (ox) / tax / (ox) / lem / bokno, tusjef / lem / lokno, tusjef; lem / bokao / lem / lokao; le / lokto / le / rokto; (majstu) ta / lokco, tusjes / (majstu) ta / rokco, tusjes;</p>
	<p>tax / (ox) / tax / (ox) / tax / (ox) / tax / (ox) / (majstru) lax / (ox) / (majstru) lax / (ox); (majscu) ta, susa / tokdo, bokdo // RESPEF // vy / (majscu) ta, susa / lokdo;</p>
	<p>(majsgu) las / bokao-lokzo-lo-go-do / fufyj, sufjy / (majsgu) las / cokao-gokgo-do / fufyj, sufjy; (majspu) la / bokao-lokzo-lo-go-do / (majspu) la / cokao-gokgo-do; (majsun) lumbem / bokao-lokzo-lo-go-do / (majsun) lumbem / coklo-gokzo-lo- be / bokao-lokzo-lo-go-do / ta / bokao-lokzo-lo-go-do // RESPEF / ta / cokgo-gokzo-go;</p>
	<p>(majsun) ta, susa / bokao-lokto-co-do / (majsun) ta, susa / cokco-gokto-co- E45</p>

SIGNOT

KODNOT

EXAMPLE 5.2 a)

Piano reduction of the first heptameter of the cabalistic dance of Magicians from the first part of *L'Enfance du Christ* by Berlioz in TRANOT

Piano (reduction)
 Allegretto. M.M. ♩ = 152

EXAMPLE 5.2 b)

Piano reduction of the first heptameter of the cabalistic dance of Magicians from the first part of *L'Enfance du Christ* by Berlioz in PANOT

Optional Meter:

EXAMPLE 5.3 a)

The opening pentameter of the cello part from the **THEMA** of *Variationen für Orchester*, op.31, by Schönberg in **TRANOT**

Molto moderato (♩ = 88)

Vcl. *p* *zart*

USED BY PERMISSION OF BELMONT MUSIC PUBLISHERS, PACIFIC PALISADES, CA 90272

EXAMPLE 5.3 b)

The opening pentameter of the cello part from the **THEMA** of *Variationen für Orchester*, op.31, by Schönberg in **PANOT**

VILO SOLO

zart

7
duxpu-tam-tu
lutabu-gae

ba / rokouf, tusjes / ry, fyb
lumhem / rous / syj
be / gouf
(majslu) bax / lous / fyi
ta / cous, tusjes
(majslu) bex / (ox)
bem / nouf, tusjes
lumrem / bouf / syj
re / tous
ta / pous, tusjes / fyi
(majslu) ta / (ox)
lumhem / vouf, tusjes / fusi-sufyi
be / lokho, tusjes
(majslu) ta / hous, tusjes / fyi
ba / rokzo, tusjes



EXAMPLE 5.4 a)

The opening of part IX (mm. 1 - 8) from *Le marteau sans maître* by Pierre Boulez in TRANOT

Tempo libre de récit
 J = 63 // libre
 Xylorimba

ppp

Vibraphone

ppp

Percussion
Maracas
mf
 (Maracas)

Guitars

mf
mf
mp
pp
 feu normal

Voix
quasi parlante
p

Jécou
 te mar - cher dans mes jambes la mer mor - te
 va ques par dessus le

Alto

pizz.
arco
mf
pp
ppp
 pos. nat.
mp

Ralenti
mf
Encore plus ralenti

© Copyright 1954 by Universal Edition (London) Ltd., London. Final Version: © Copyright 1957 by Universal Edition (London) Ltd., London.
 © Copyright Renewed. Poems de René Char © Copyright 1964 by Jose Corti Editeur, Paris. All Rights Reserved. Used by permission of
 European American Music Distributors Corporation, sole U.S. and Canadian agent for Universal Edition London.

EXAMPLE 5.4 b)

The opening of part IX (mm. 1 - 8) from *Le marteau sans maître* by Pierre Boulez in PANOT

< Tempo libre de récit

MARA

vers le chevalet

laissez vibrer

quasi parlando

quasi crié

J'é cou... mar... cher dans mes jambes la mer mor-te va-gues par dessus têt

pizz. m. 8.

XYRI

VIFO

PERK

GUIT

VOXM

VILA

EXAMPLE 5.4 c)

The opening of part IX (mm. 1 - 8) from *Le marteau sans maître* by Pierre Boulez in PANOT condensed scores

Tempo libre de récit

(1)

(2)

EXAMPLE 6.2 a)

The Interlude from *Scherzo* by Charles Ives in TRANOT

Slow (about 66 = \downarrow)

The musical score is presented in three systems, each with four staves. The first system includes a tempo marking 'Slow (about 66 = \downarrow)' and a dynamic marking 'mf'. The second system features a dynamic marking 'f'. The score consists of a single melodic line in the upper staff of each system, with accompaniment in the lower three staves. The notation includes various rhythmic values, slurs, and dynamic markings.

© Copyright 1958 by Peer International Corporation. All rights reserved. Used by Permission.

EXAMPLE 6.2 b)
The Interlude from *Scherzo* by Charles Ives in PANOT



1 2 3 4 5 6 7

VINO (1)

VINO (2)

VILA

VILO

EXAMPLE 6.3 a)

The closing five bars from Richard Strauss'
Till Eulenspiegels lustige Streiche in TRANOT

kl. Fl.

12.3. gr. Fl.

1.2.3. Ob.

Englh.

Kl. (D)

1.2. Kl. (B)

B.-Kl. (B)

1.2.3. Fag.

K.-Fag.

1.3. H. (F)

2.4. H. (F)

5.6.7.8. H. (D)

1.2.3. Trp. (F)

4.5.6. Trp. (D)

1.2. Pos.

3. Pos. Tb.

Pk.

1. Vl.

2. Vl.

Br.

Vlc.

Kb.

zu 3

zu 3

zu 2

zu 3

ad lib. 5.6.

5.7.

7.8.

6.6.

ad lib.

zu 2

zu 2

Used by permission of C. F. Peters Corporation.

EXAMPLE 6.3 b)

E55

The closing five bars from Richard Strauss' *Till Eulenspiegels lustige Streiche* in PANOT

FLAU (1,2,3)
OBOE (1,2,3)
KORI
KLAR (bb)
KLAR (do)(1,2)
KLAB
FAGO (1,2,3)
KORFA
KORN (1,3)
KORN (2,4)
KORN (5,6,7,8)
TROM
TROM (bb)(4,5,8)(oo)(1,2,2)
TRON (1,2)
TUBA/TRON (3)
TIMP
VINO (1)
VINO (2)
VILA
VILO
VIBA

PIKO

1 2 3 4 5

EXAMPLE 6.3 c)

The closing five bars from Richard Strauss' *Till Eulenspiegels lustige Streiche* in PANOT condensed scores for analysis

(1)

(2)

(3)

Harmonic Functions

(a)

Half-diminished chord (actually a dominant function in B, b) resolving its augmented sixth to the third of F-major (tonic) triad

(b)

French-sixth chord (strictly, in the keys of D, d or A-flat, a-flat) resolving its augmented sixth to the third of F-major (tonic) triad

(c)

German-sixth chord (properly in F) resolving its augmented sixth directly to the fifth of F-major (tonic) triad, and bypassing the dominant sonority

EXAMPLE 6.4

The spatial juxtaposition of accompanying instruments in the first and last measures from the third song of *Altenberg Lieder* (op.4) by Alban Berg in PANOT

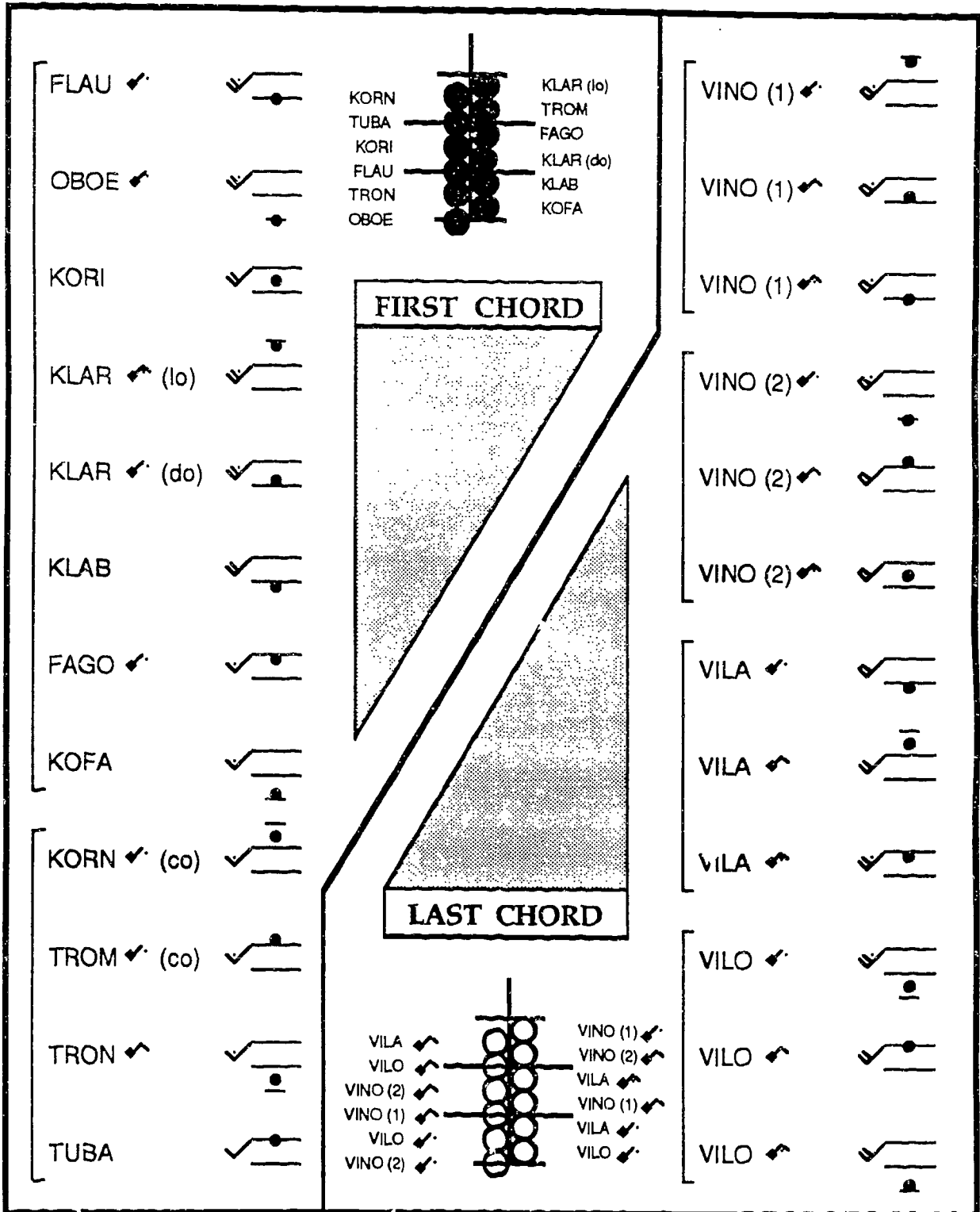

EXAMPLE 6.5 a)

An excerpt (mm. 25 - 31) from the second prelude of the second book of *Préludes* for the piano by Debussy in **TRANOT**

The musical score consists of two systems. The first system contains measures 25, 26, 27, and 28. The second system contains measures 29, 30, and 31. The key signature is one sharp (F#), and the time signature is 3/4. The score is written for piano, with a treble and bass clef. The right hand plays a melodic line with a 'un peu en dehors' (slightly out of tune) effect, indicated by a wavy line under the notes. The left hand provides a harmonic accompaniment. Dynamics include *ppp* (pianissimo) at the beginning, *p* (piano) for the accompaniment, and *pp* (pianissimo) for the final chord in measure 31. The tempo is marked **TRANOT**.

Used by permission of Dover Publications, Inc.

EXAMPLE 6.5 b)

E59

An excerpt (mm. 25 - 31) from the second prelude of the second book of *Préludes* for the piano by Debussy in PANOT

Musical score for MANDIX and MANSIN, measures 25-28. The score is written on two systems of staves. The upper system is labeled MANDIX and the lower system is labeled MANSIN. Measures 25, 26, 27, and 28 are indicated by boxed numbers above the staves. The MANDIX part features a series of chords with a wide intervallic structure, often spanning an octave or more. The MANSIN part provides a harmonic and rhythmic accompaniment, including a melodic line with a slur and the instruction "un peu en dehors" (a little out of phase) in measure 25. Vertical dashed lines separate the measures.

Musical score for MANDIX and MANSIN, measures 29-32. The score continues from the previous system. Measures 29, 30, 31, and 32 are indicated by boxed numbers above the staves. The MANDIX part continues with its characteristic wide intervallic chords. The MANSIN part includes a melodic line with a slur and the instruction "marqué" (marked) in measure 30. In measure 31, there is a tempo change instruction "Plus lent" (Slower) with an arrow pointing to the right. The score concludes in measure 32 with a final chord in both parts. Vertical dashed lines separate the measures.

EXAMPLE 6.6 a)

The conclusion of "Querimonia" (mm. 192-193)
from *Threni* by Igor Stravinski in TRANOT

Ten. I
 Haec..... re - col - lens in cor -

Ten. II
 Haec re - col - lens in..... ec. - de me - o,

SOLI
 Haec re - col - lens in..... cor - de me - o, i - de -

Basso I
 Haec..... re - col - lens

Basso II
 Haec..... re - col - lens

CORO
 ZA - IN.....

Trb. I
p

Trb. II
p

Ten. I
 - de me - o, i - de - o spe - ra - bo.....

Ten. II
 i - de - o spe - ra - bo.

SOLI
 - o spe - ra - bo.

Basso I
 in cor - de me - o, i - de - o spe - ra - bo.....

Basso II
 in cor - de me - o, i - de - o spe - ra - bo.....

EXAMPLE 6.6 b)

The conclusion of "Querimonia" (mm. 192-193)
from *Threni* by Igor Stravinski in PANOT

← T = T →

re - col - lens in cor - de me - o, i - de - o spe - ra - bo.

Haec
Haec re - col - lens in cor - de me - o, i - de - o spe - ra - bo.

Haec re - col - lens in cor - de me - o, i - de - o spe - ra - bo.

Haec re - col - lens in cor - de me - o, i - de - o spe - ra - bo.

re - col - lens in cor - de me - o, i - de - o spe - ra - bo.

MULV KORO

TRON

275





276



EXAMPLE 6.6 c)

Set matrix and set identification for the dodecuple pitch content at the conclusion of "Querimonia" (mm. 192 - 193) from *Threni* by Igor Stravinski

		← FIRST HEXACHORD →					← SECOND HEXACHORD →							
SET MEMBER		0	1	2	3	4	5	6	7	8	9	d	h	
SET MEMBER	0													
	1	6	5	0	4	h	2	9	1	d	7	8	3	
	2	7	6	1	5	0	3	d	2	h	8	9	4	
	3	IT	0	h	6	d	5	8	3	7	4	1	2	9
	4	8	7	2	6	1	4	h	3	0	9	d	5	
	5	1	0	7	h	6	9	4	8	5	2	3	d	
	6	d	9	4	8	3	6	1	5	2	h	0	7	
	7	3	2	9	1	8	h	6	d	7	4	5	0	
	8	h	d	5	9	4	7	2	6	3	0	1	8	
	9	2	1	8	0	7	d	5	9	6	3	4	h	
	d	5	4	h	3	d	1	8	0	9	6	7	2	
	h	4	3	d	2	9	0	7	h	8	5	6	1	
		9	8	3	7	2	5	0	4	1	d	h	6	

MATRIX SYMBOLS

 _____ prototype (prime) set
 or  _____ retrograde set
 _____ inversion set
 _____ niversion (retrograde inversion) set

 _____ column of the matrix identifying the transpositions of the prime sets
 _____ row of the matrix identifying the transpositions of the inversion sets

N.B.: Transposition numbers for retrograde and niversion (retrograde inversion) orders are the same as for prototype (prime) and inversion orders, respectively.

IDENTIFICATION OF PITCH SETS

(MULV)

KORO: P0(2-5) or N1(7-4) [prime set at the zero transposition; set members two through five]
 [niversion (retrograde inversion) set at the first transposition; set members seven through four]

TRON: N6(4-0) [niversion (retrograde inversion) set at the sixth transposition; set members four through zero]

TENO SOLO (1): P9(0-h) [prime set at the ninth transposition; set members zero through h]
 TENO SOLO (2): I6(6-h)(0-5) [inversion at the sixth transposition; second and first hexachord]
 BASO SOLO (1): I0(6-h)(0-5) [inversion at the zero transposition, second and first hexachord]
 BASO SOLO (2): P8(0-h) [prime set at the eighth transposition; set members zero through h]

EXAMPLE 6.6 d)

E63

Set diagram and set identification for the interval content to the conclusion of "Querimonia" (mm. 192 - 193) from *Threni* by Igor Stravinski

SET MEMBER	1	2	3	4	5	6	7	8	9	d	h	k*
P	<u>1</u>	<u>5</u>	<u>4</u>	<u>5</u>	<u>3</u>	<u>5</u>	<u>4</u>	<u>3</u>	<u>3</u>	<u>1</u>	<u>5</u>	<u>3</u>
R	<u>5</u>	<u>1</u>	<u>3</u>	<u>3</u>	<u>4</u>	<u>5</u>	<u>3</u>	<u>5</u>	<u>4</u>	<u>5</u>	<u>1</u>	<u>3</u>
I	<u>1</u>	<u>5</u>	<u>4</u>	<u>5</u>	<u>3</u>	<u>5</u>	<u>4</u>	<u>3</u>	<u>3</u>	<u>1</u>	<u>5</u>	<u>3</u>
N	<u>5</u>	<u>1</u>	<u>3</u>	<u>3</u>	<u>4</u>	<u>5</u>	<u>3</u>	<u>5</u>	<u>4</u>	<u>5</u>	<u>1</u>	<u>3</u>

*) k - interval between the last and the first member of the pitch set

INTERVAL CONTENT

1	2	3	4	5	6
2	0	4	2	4	0

IDENTIFICATION OF INTERVAL SETS

MEDIUM	SET	INTERVALS
(MULV) KORO:	N(5-7) P(3-5)	<u>4</u> <u>5</u> <u>3</u>
TRON:	N(h-8)	<u>1</u> <u>5</u> <u>4</u> <u>5</u>
TENO SOLO (1):	P(1-h)	<u>1</u> <u>5</u> <u>4</u> <u>5</u> <u>3</u> <u>5</u> <u>4</u> <u>3</u> <u>3</u> <u>1</u> <u>5</u>
TENO SOLO (2):	I(7-k) (1-5)	<u>4</u> <u>3</u> <u>3</u> <u>1</u> <u>5</u> <u>3</u> <u>1</u> <u>5</u> <u>4</u> <u>5</u> <u>3</u>
BASO SOLO (1):	I(7-k) (1-5)	<u>4</u> <u>3</u> <u>3</u> <u>1</u> <u>5</u> <u>3</u> <u>1</u> <u>5</u> <u>4</u> <u>5</u> <u>3</u>
BASO SOLO (2):	P(1-h)	<u>1</u> <u>5</u> <u>4</u> <u>5</u> <u>3</u> <u>5</u> <u>4</u> <u>3</u> <u>3</u> <u>1</u> <u>5</u>

EXAMPLE 6.7 a)
The choral parts from the sixth movement of the second cantata (op. 31) by Anton Webern in TRANOT

Sehr langsam 3/4

First system of musical notation for the choral parts, featuring multiple vocal staves with notes and rests. The tempo is marked 'Sehr langsam' and the time signature is 3/4. A box labeled 'A' is positioned above the first few staves.

Second system of musical notation for the choral parts, continuing the vocal staves with notes and rests. A box labeled 'B' is positioned above the first few staves.

Words by Hildegard Jone. English version by Eric Smith. © Copyright 1956 by Universal Edition A. G., Wien. © Copyright Renewed. All Rights Reserved. Used by permission of European American Music Distributors Corporation, sole U.S. and Canadian agent for Universal Edition Vienna.



EXAMPLE 6.7 b)

The articulative and pitch patterns in the textless, choral parts from the sixth movement of the second cantata (op. 31) by Anton Webern in PANOT

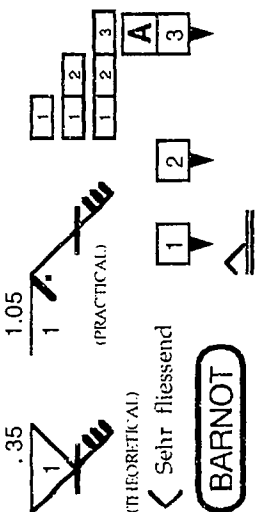

BARNOT

PIAN REDU

SOPO
ALTO
TENOR
BASO

C 13 **D** 18 **E** 22

EXAMPLE 6.7 c)

Set matrices for the pitch and interval content to the second cantata (op.31) by Anton Webern

SET MEMBER	0	1	2	3	4	5	6	7	8	9	d	h
0	0	9	1	2	d	3	h	7	8	4	5	6
1	3	0	4	5	1	6	2	d	h	7	8	9
2	h	8	0	1	9	2	d	6	7	3	4	5
3	h	7	h	0	8	1	9	3	4	2	5	6
4	2	h	3	4	0	5	1	9	d	6	7	8
5	9	6	d	h	7	0	8	4	5	1	2	3
6	1	d	2	3	h	4	0	8	9	5	6	7
7	5	2	6	7	3	8	4	0	1	9	d	h
8	4	1	5	6	2	7	3	h	0	9	d	h
9	8	5	9	d	6	h	7	3	4	0	1	2
d	7	4	8	9	5	d	6	2	3	h	0	1
h	6	3	7	8	4	9	5	1	2	d	h	0

N.B.: For explanation of set symbols see Example 6.6 c) p. E62

TENO

ALTO

SOPO

BASO

SET MEMBER	1	2	3	4	5	6	7	8	9	d	h	k*
P	<u>3</u>	<u>4</u>	<u>1</u>	<u>4</u>	<u>5</u>	<u>4</u>	<u>4</u>	<u>1</u>	<u>4</u>	<u>1</u>	<u>1</u>	<u>6</u>
R	<u>1</u>	<u>1</u>	<u>4</u>	<u>1</u>	<u>4</u>	<u>4</u>	<u>5</u>	<u>4</u>	<u>1</u>	<u>4</u>	<u>3</u>	<u>6</u>
I	<u>3</u>	<u>4</u>	<u>1</u>	<u>4</u>	<u>5</u>	<u>4</u>	<u>4</u>	<u>1</u>	<u>4</u>	<u>1</u>	<u>1</u>	<u>6</u>
N	<u>1</u>	<u>1</u>	<u>4</u>	<u>1</u>	<u>4</u>	<u>4</u>	<u>5</u>	<u>4</u>	<u>1</u>	<u>4</u>	<u>3</u>	<u>6</u>

*) k - interval between the last and the first member of the pitch set

INTERVAL CONTENT

1	2	3	4	5	6
4	0	1	5	1	1

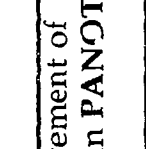
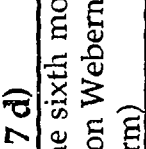
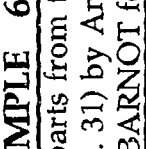
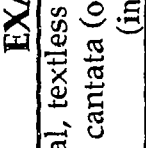
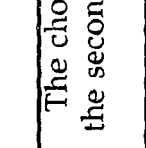
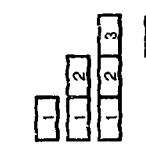
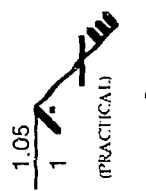
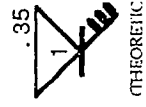

< Sehr flüssend

BARNOT

EXAMPLE 6.7 d)

The choral, textless parts from the sixth movement of the second cantata (op. 31) by Anton Webern in **PANOT** (in **BARNOT** form)



SOPO
ALTO
TENOR
BASO

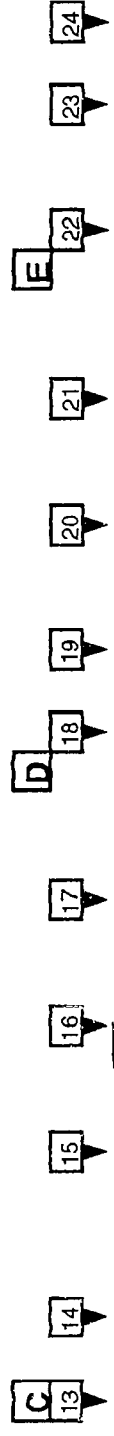

EXAMPLE 6.7 e)
 The choral, textless parts from the sixth movement of the second cantata (op. 31) by Anton Webern in **PANOT** (Reduction of pitch profiles of soprano, alto, and tenor parts by octave transposition in **BARNOT** form)

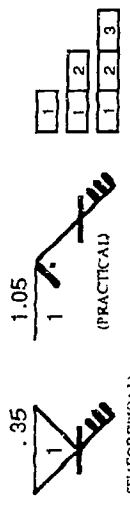

REAL (UNTRANSPOSED)
 PITCH POSITION WHENEVER
 IT DIFFERS FROM ADJUSTED
 BARS OF SOLID COLOR



BARNOT

SOPO
 ALTO
 TENO

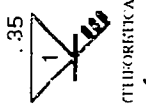

< Sehr flüchtig

BARNOT

EXAMPLE 6.7 f)

The choral, textless parts from the sixth movement of the second cantata (op. 31) by Anton Webern in **PANOT** (Reduction of pitch profiles of alto, tenor, and bass parts by octave transposition in **BARNOT** form)



R.B.A.L. (UNTRANSPPOSED)
PITCH POSITION WHENEVER
IT DIFFERS FROM ADJUSTED
BARS OF SOLID COLOR

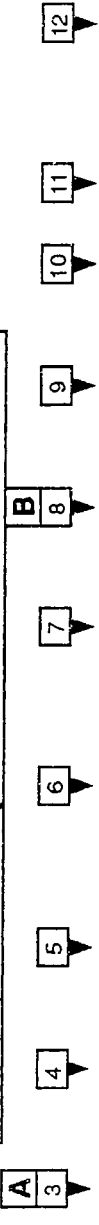

ALTO
TENOR
BASSO

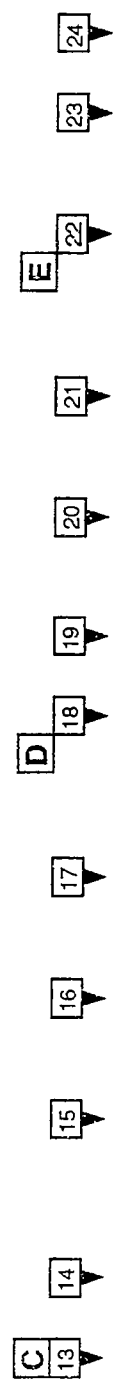

EXAMPLE 6.7 g)

The choral, textless parts from the sixth movement of the second cantata (op. 31) by Anton Webern in PANOT (Reduction of intervallic pattern and temporal displacement in soprano, alto, and tenor parts in BARNOT form)

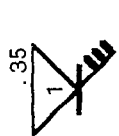

< Sehr flüchtig

BARNOT

SOPO
ALTO
TENOR

P4 reversed to.

set inversions in a canon by *ri* (major third) with no temporal displacement

prime set in alto part reversed to match the retrograde in tenor part

set retrogrades in a canon by *ri* (major third) with no temporal displacement

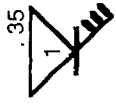

< Sc'r fliessend
(THEORETICAL)

BARNOT

- ALTO
- ◀ TENO
- BASO

EXAMPLE 6.7 h)

The choral, textless parts from the sixth movement of the second cantata (op. 31) by Anton Webern in **PANOT** (Reduction of intervallic pattern and temporal displacement in alto, tenor, and bass parts in **BARNOT** form.

retrograde in tenor reversed to match the prime in alto

EXAMPLE 6.8 a)

An excerpt (m. 19-27) from *Variationen für Klavier* op. 27 by Anton Webern in TRANOT

tempo

rit. - - - tempo

rit. - - -

rit. - - - tempo

rit. - - - tempo

rit. - - - tempo

rit. - - -

Copyright 1937 by Universal Edition. Copyright Renewed. Used by permission of European American Music Distributors Corporation, sole U.S. and Canadian agent for Universal Edition.



EXAMPLE 6.8 b)

An excerpt (m. 19-27) from *Variationen für Klavier*
op. 27 by Anton Webern in PANOT
(Temporal and spatial aspects only)

((Sehr mässig))



(As given in print)

(Possible option)

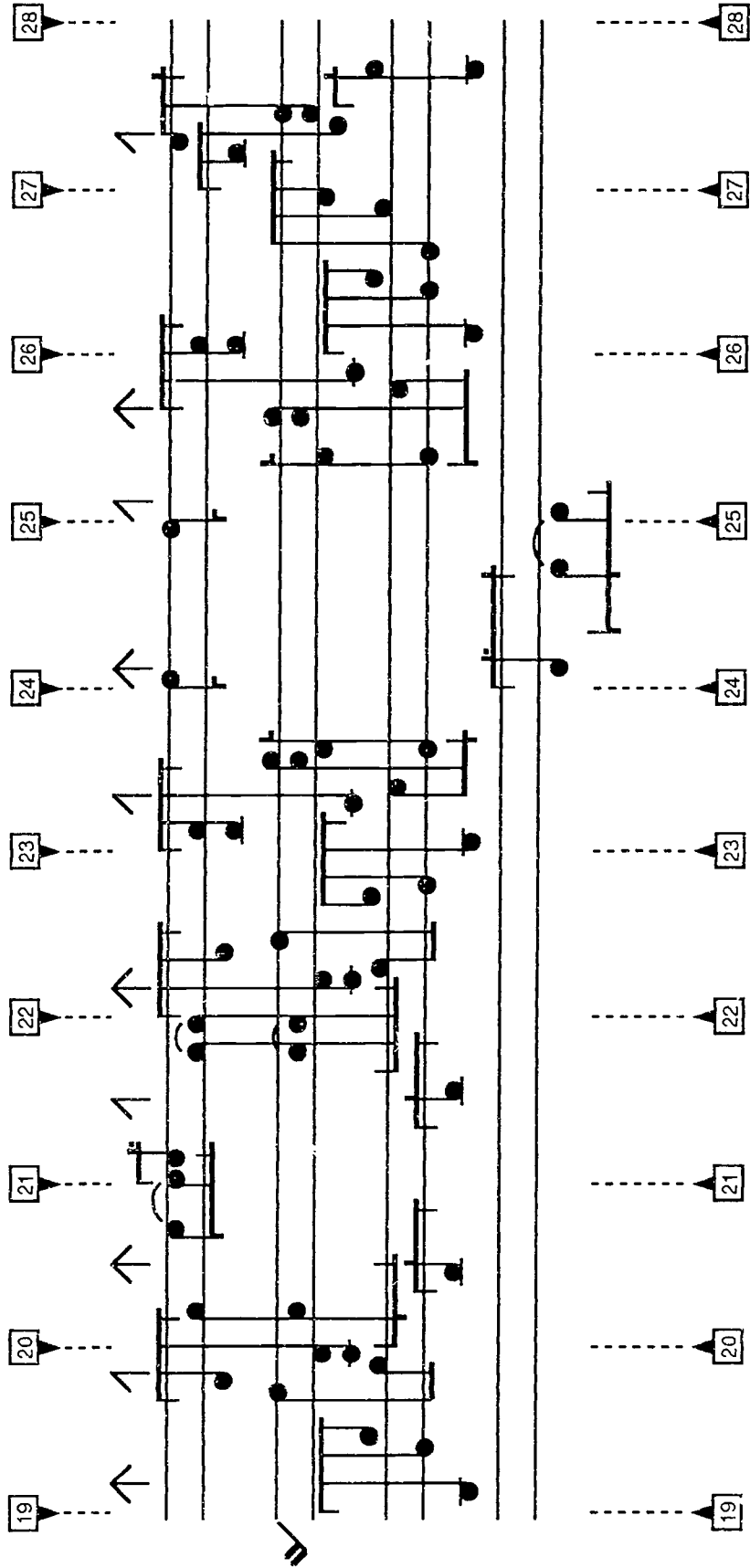

The musical score consists of two staves, likely representing the right and left hands. The top staff contains the primary melodic line, while the bottom staff contains accompaniment. Measures 19 through 28 are marked with arrows and numbers. The notation includes various rhythmic values, rests, and articulation marks. The piece is in a minor key, as indicated by the key signature (one flat).

EXAMPLE 6.8 c)

Matrices for pitch and interval sets to
Variationen für Klavier op. 27 by Anton Webern

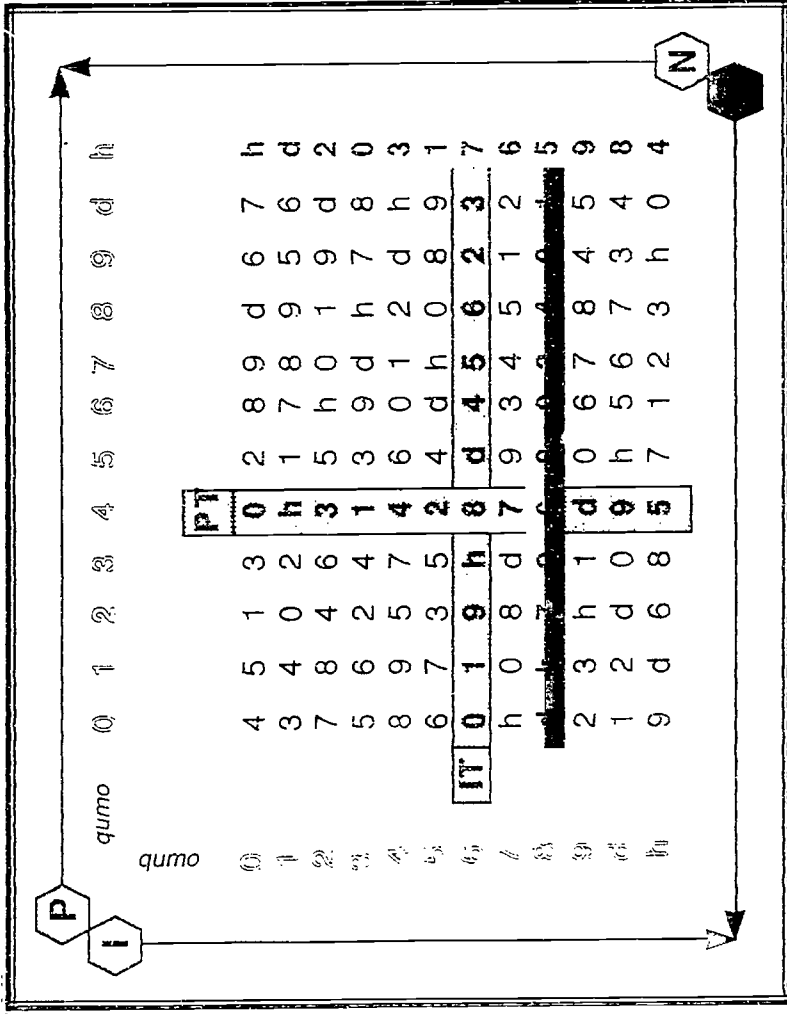

PITCH SET

P [pek] PRIME (prototype)

R (or: R) [erk] REVER (retrograde)

I [ik] INVER (inversion)

N [enk] NIVER (inversion) (retrograde inversion)

qumo [kvu-mo] pitch set member

N.B.(1): For explanation of set symbols see Example 6.6 c) p.E62

P0, R0, I0, N0
[pek-zu, erk-zu, ik-zu, enk-zu]
(untransposed pitch sets
or: zero transposition)

SET OF (REDUCED)
INTE 'VALS
IN DIAGRAM, TIC FORM

(REDUCED)
INTERVAL SET

QI [kvek-ik] interval size

DR [dek-erk] direct

KR [kek-erk] contra (direction)

RD [erk-dek] retrograde (direction)

RK [erk-kek] retrograde of contra

qumi [kvu-mi] (reduced) interval set member

N.B.(2): Pronunciation for abbreviations is placed in square brackets; otherwise, consult Appendix 2, (A2)

INTERVAL CCNT

1	2	3	4	5	6
4	2	1	3	1	1

INTERVAL DIRECTION

(qi)s	up
(qi)f	down
(qi)sf	up (or down)
(qi)fs	down (or up)

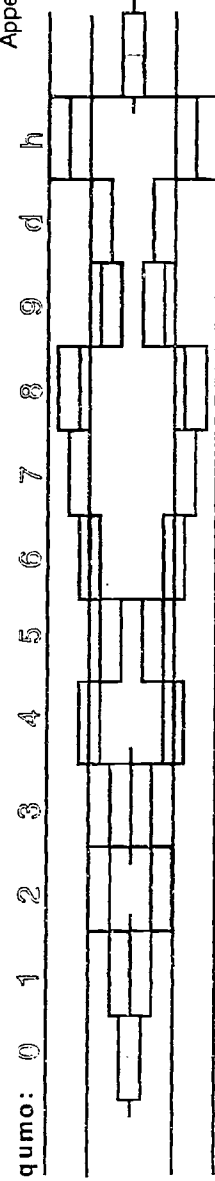

(< Sehr mässig)

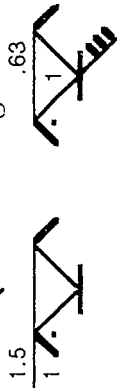

EXAMPLE 6.8 d)

An excerpt (m. 19-27) from *Variationen für Klavier*
op. 27 by Anton Webern in PANOT
(in R.ARNOT form)

SET LIMITS

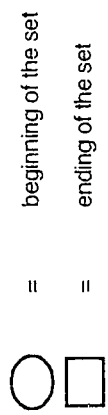

(As given in print) (Possible option)

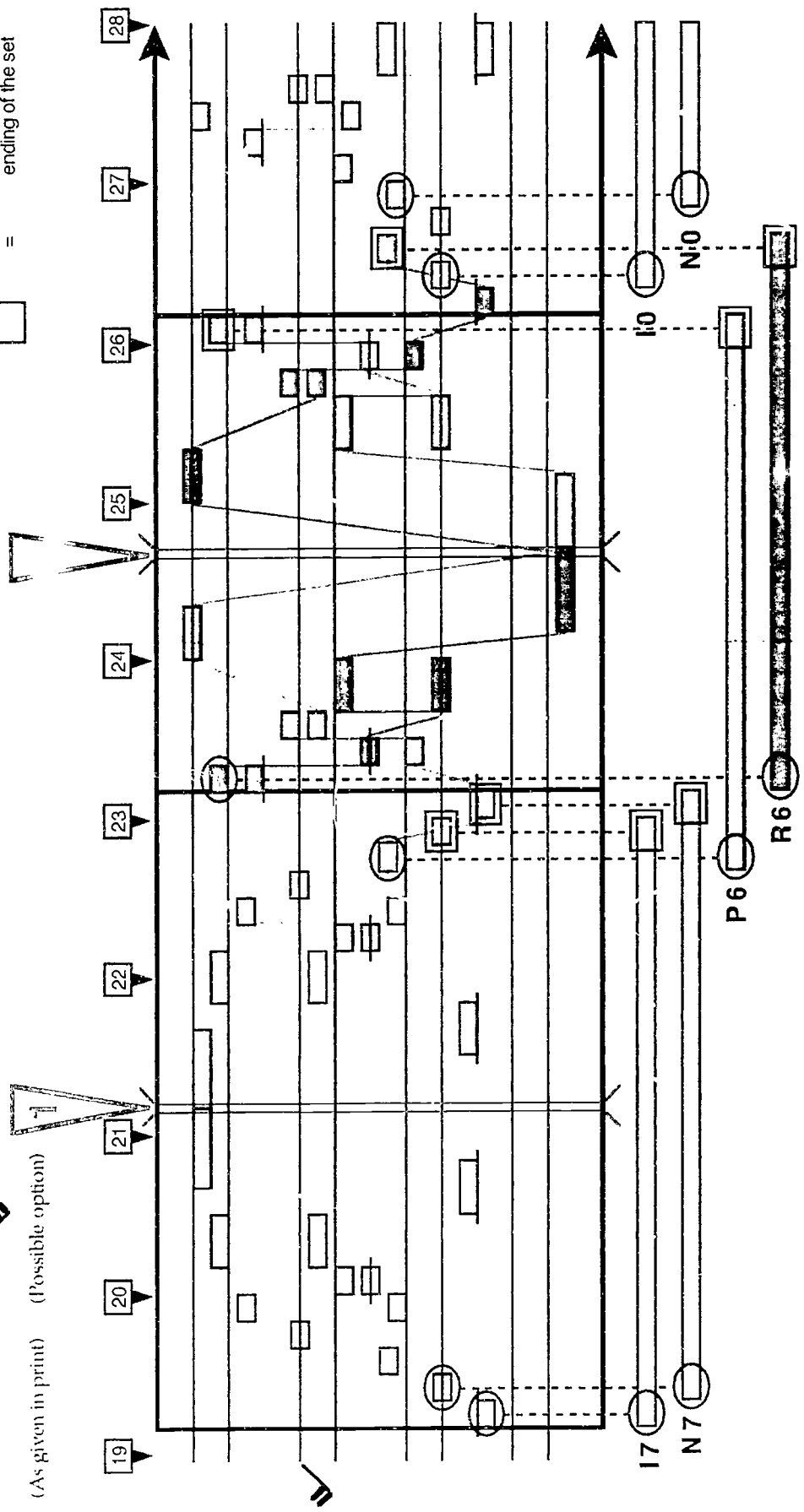

KODNOT

17(0-h) [ik-pu (zumo-humo)]	P6(0-h) [pek-gu (zumo-humo)]	I0(0-4) [ik-zu (zumo-rumo)]
N7(h-o) [enk-pu (humo-zumo)]	R5(h-0) [erk-gu (humo-zumo)]	N0(h-7) [enk-zu (humo-pumo)]

George J. Skapski

TRACT ON PANOT

PART III : APPENDICES
AND SUPPLEMENTS

C.S.U.N.

TRACT ON PANOT

PART III: APPENDICES AND SUPPLEMENTS

(Reference Materials in both Traditional and PANOTation)

by

George J. Skapski

*

This monograph is a follow-up to the experimental research performed in part pursuant to an Academic Program Improvement Grant for 1989-90 funded by the California State University Office of the Chancellor

The California State University, Northridge, 1992

© 1992 by the Trustees of the California State University

This tract is referring to 3 monographs: *PANOT: An Experiment with a New Music Notation System, Sound Taxonomy, and PANUM*. Those monographs were developed with the support of an Academic Program Improvement Grant for 1989-90 funded by the California State University Office of the Chancellor. No part of this work may be reproduced, stored in a retrieval system, or transcribed, in any form or by any means, electronic, mechanical, photocopying, recording, or otherwise, without the prior written permission of The Trustees of the California State University. Project Director: Dr. George J. Skapski, California State University, Northridge.

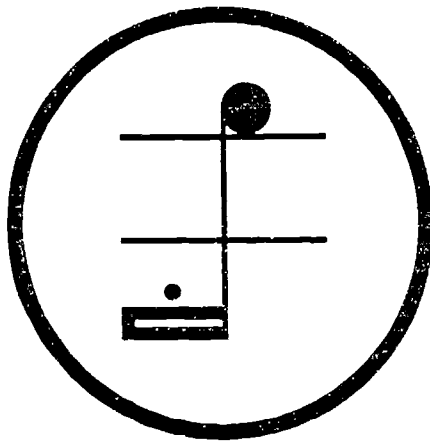

APPENDICES
TABLE OF CONTENTS

APPENDIX	PAGE	
1	The Decalogue of Desirable Characteristics for an Ideal Music Notation	A1
2	Pronunciation of Codes (KOD)	A2
3	Preliminary Signals and Codes for the Non-quantitative Temporal Values	A3
4	Selected Letters in Basic Codes of the Temporal Parameter	A4
5	Selected Marks (MAR) for Use in Codes (KOD)	A5
6	Selected Computation Marks (MAR) for Use in Codes (KOD)	A6
7	Table of Alphameric Consonants (KON)	A7
8	alpha-clock	A8
9	Signals of Parametric Valence	A9
10	Quantitative Durations	A10
11	Samples of Fractional Rhythms	A11
12	Recurring Patterns of Articulation	A12
13	Metric and Absolute References	A13
14	Tempo Signals	A14
15	Tempo References	A15

16	Fluctuating Tempi	A16
17	Table of Tempi	A17
18	Selected Tempi as Fractions of a Second	A18
19	Tempi Conversion Table	A19
20	Time Signatures	A20
21	Relationships and Priorities	A21
22	Contents Grouping and Separation	A22
23	Progressive Contents	A23
24	Collection of Temporal Signals	A24
25	Basic Pitch References	A25
26	Disk Placement	A26
27	Standard Keyboard in DYSNOT	A27
28	Pitch Conversion Table	A28
29	Tempered Intervals within an Octave	A29
30	Quantitative and Descriptive Pitches	A30
31	Modifications and Sequels of Pitch	A31
32	Quantitative and Descriptive Intervals	A32
33	Directions and Sequels of Intervals	A33
34	Modifications and Anchors of Intervals	A34
35	Peripheral and Interjacent Intervals	A35
36	Conversion of a 24-Tone Scale	A36
37	A Sample of Microtonal Topography	A37

38	18- and 36-Tone Scales	A38
39	Representation of a 31-Tone Scale	A39
40	Space Signatures	A40
41	Collection of Spatial Signals	A41
42	Placement of Dynamic Levels	A42
43	Fluctuating Dynamics	A43
44	Table of Dynamics	A44
45	Collection of Dynamic Signals	A45
46	Personnel Assignments	A46
47	Spectra Distinction and Symbols Delimitation	A47
48	Media, Voice and Selected Acoustic Instruments (Section A)	A48
49	Media, Voice and Selected Acoustic Instruments (Section B)	A49
50	Collection of Timbre Signals	A50
51	Table of PANUM / PANOT Number Systems	A51

SUPPLEMENTS
TABLE OF CONTENTS

SUPPLEMENT	PAGE
1 STAVAR 1 Staff Variant One	S1
2 STAVAR 2 Staff Variant Two	S2
3 STAVAR 3 Staff Variant Three	S3
4 STAVAR 4 Staff Variant Four	S4
5 STAVAR 5 Staff Variant Five	S5
6 STAVAR 6 Staff Variant Six	S6
7 KLAVAR 1 Variant One in <i>Klavarskribo</i> vertical orientation	S7
8 KLAVAR 2 Variant Two in <i>Klavarskribo</i> vertical orientation	S8
9 (STAVAR 9) (Staff Variant Nine)	S9
10(a) An excerpt from the opening of St. Matthew Passion (mm. 30-38) by J. S. Bach in TRANOT (Coro I, mm. 30-33 only)	S10a
10(b) An excerpt from the opening of St. Matthew Passion (mm. 30-38) by J. S. Bach in TRANOT (Coro II, mm. 30-33 only)	S10b
11(a) An excerpt from the opening of St. Matthew Passion (mm. 30-38) by J. S. Bach in TRANOT (Coro I, mm. 34-38 only)	S11a
11(b) An excerpt from the opening of St. Matthew Passion (mm. 30-38) by J. S. Bach in TRANOT (Coro II, mm. 34-38 only)	S11b

12(a)	An excerpt from the opening of St. Matthew Passion (mm. 30-38) by J. S. Bach in PANOT (Coro I, mm. 30-33 only)	S12a
12(b)	An excerpt from the opening of St. Matthew Passion (mm. 30-38) by J. S. Bach in PANOT (Coro II, mm. 30-33 only)	S12b
13(a)	An excerpt from the opening of St. Matthew Passion (mm. 30-38) by J. S. Bach in PANOT (Coro I, mm. 34-38 only)	S13a
13(b)	An excerpt from the opening of St. Matthew Passion (mm. 30-38) by J. S. Bach in PANOT (Coro II, mm. 34-38 only)	S13b
14(ab)	An excerpt from the opening of St. Matthew Passion (mm. 30-38) by J. S. Bach in PANOT (Choral Parts, mm. 30-33 only)	S14ab
15(ab)	An excerpt from the opening of St. Matthew Passion (mm. 30-38) by J. S. Bach in PANOT (Choral Parts, mm. 34-38 only)	S15ab
16	An excerpt from the opening of St. Matthew Passion (mm. 30-38) by J. S. Bach in PANOT (Condensed Score)	S16
17	An Etude for Piano in f-minor (Op. 25, No. 2) by Chopin in TRANOT	S17
17.1	An Etude for Piano in f-minor (Op. 25, No. 2) by Chopin in TRANOT (p. 1)	S17.1
17.2	An Etude for Piano in f-minor (Op. 25, No. 2) by Chopin in TRANOT (p. 2)	S17.2
17.3	An Etude for Piano in f-minor (Op. 25, No. 2) by Chopin in TRANOT (p. 3)	S17.3
18	An Etude for Piano in f-minor (Op. 25, No. 2) by Chopin in PANOT	S18
18.1	An Etude for Piano in f-minor (Op. 25, No. 2) by Chopin in PANOT (p. 1)	S18.1
18.2	An Etude for Piano in f-minor (Op. 25, No. 2) by Chopin in PANOT (p. 2)	S18.2
18.3	An Etude for Piano in f-minor (Op. 25, No. 2) by Chopin in PANOT (p. 3)	S18.3

19	An Etude for Piano in f-minor (Op. 25, No. 2) by Chopin in PANOT (KLAVAR orientation)	S19
19.1	An Etude for Piano in f-minor (Op. 25, No. 2) by Chopin in PANOT (KLAVAR orientation, p.1)	S19.1
19.2	An Etude for Piano in f-minor (Op. 25, No. 2) by Chopin in PANOT (KLAVAR orientation, p.2)	S19.2
19.3	An Etude for Piano in f-minor (Op. 25, No. 2) by Chopin in PANOT (KLAVAR orientation, p.3)	S19.3
20(a)	Toccata by Dolly E. Kessner in TRANOT	S20a
20(b)	Toccata by Dolly E. Kessner in PANOT	S20b
20(c)	Toccata by Dolly E. Kessner in PANOT (KLAVAR orientation)	S20c
20(d)	Toccata by Dolly E. Kessner in PANOT ("beamed" version)	S20d

A P P E N D I C E S

APPENDIX 1

The Decalogue of Desirable Characteristics for an Ideal Music Notation

1) UNIVERSALITY

A notation which serves all the people from different civilizations, language families, and educational backgrounds, and which establishes a global terminology.

2) GENERALITY

A notation which serves all media of performance, and all manifestations of music regardless of style, for the purpose of identifying, transcribing, and analysis.

3) NEUTRALITY

A notation which in all its applications provides logically sound and consistently impartial standards of measurement for all parameters of sound.

4) DIRECTNESS

A notation which, besides its symbols, facilitates the perception of sounds as close as possible to the real dimensions on the coordinates of time and space.

5) UNIFORMITY

A notation which applies the same formative principles when referring to the terminology, and which is consistent in generation of graphic icons.

6) COMPREHENSIVENESS

A notation which ensures the capacity for recording any imaginable single and multiple sounds, and which offers a name of reference for each such event.

7) CLARITY

A notation which avoids ambiguity, represents faithfully spatio-temporal proportions, and facilitates the perception of compositional textures.

8) ECONOMY

A notation which saves space and effort, and which avoids redundancy in the usage of its visual symbols and its nomenclature.

9) FLEXIBILITY

A notation which offers optional modes of aural and written reference, and which allows for substitution of different choices in the interest of simplicity.

10) EFFICIENCY

A notation which is not only practical in performance, but which also provides a speedy communication when referring to sounds in pedagogy and analysis.

APPENDIX 2

Pronunciation of Codes (KOD)

	No.	Symbol	IPA	Model	In English	(or other languages)	Pron.
VOWELS (KODVOK)	1)	a	[a]	a	car		a
	2)	aj		i	life		aj
	3)	ä	[e]	a	mate		ä
	4)	ë	[ɛ]	e	ten		ë
	5)	ej		ay	day		ej
	6)	i	[i]	ee	meet		i
	7)	ij		ill		fille (French)	ij
	8)	o	[o]	o	pony		o
	9)	oj		oy	toy		oj
	10)	ö	[ø]	oe		Oel (German)	ö
	11)	u	[u]	oo	tool		u
	12)	uj		ull		ulla (Spanish)	uj
	13)	ü	[y]	ue		gruen (German)	ü
	14)	y	[j]	i	djm		y
	15)	yj		ыя		HOBYя (Russian)	yj
CONSONANTS (KODKON)	16)	b	[b]	b	bed		be
	17)	c	[ts]	ts	hats		ce
	18)	ç	[tʃ]	ch	chin		çe
	19)	d	[d]	d	desk		de
	20)	d'	[dʒ]	j	jet		d'e
	21)	f	[f]	f	fat		ef
	22)	g	[g]	g	gamble		ge
	23)	g'	[ʒ]	g	genre		g'e
	24)	h	[h]	h	hen		he
	25)	i	[i]	y	yes		je
	26)	k	[k]	k	keg		ke
	27)	l	[l]	l	let		el
	28)	m	[m]	m	met		em
	29)	n	[n]	n	net		en
	30)	p	[p]	p	pet		pe
	31)	q	[kw]	qu	quest		qve
	32)	r	[r]	r	red		er
	33)	s	[s]	s	sad		es
	34)	s'	[ʃ]	sh	shed		eʃ
	35)	t	[t]	t	test		te
	36)	v	[v]	v	verse		ve
	37)	w	[w]	w	west		ue
	38)	x	[ks]	x	expert		eks
	39)	z	[z]	z	zoo		ze

NOTE: In multisyllabic codes (KOD) the accents lie on the last syllable (vowel or diphthong) and on every other syllable, counting backwards.

NB Capital letters should have the consonant "k" appended at the end of their phonetical transcription and pronunciation, in order to distinguish them from lower case letters.

APPENDIX 3

Preliminary Signals and Codes for the Non-quantitative Temporal Values

	NAME	USE	SIG(nal)	KOD (code)
(a) SYSTEM				
Principal Stem	FOR	for sound (event) articulation		za
Auxiliary Stem	FORX	for silence (rest) articulation		zax
Time Hub	TEMNUX	for placement of durations and articulative signs	■	jamux
Beam	KOM	for combining same durations	┌	jam(ju)
Tie	FUS	for prolongation of durations by canceling next articulation	└	jas
(b) APPLICATIONS				
		for short durations	└	fa
		for very short durations	└	faf
		for long durations	└	sa
		for very long durations	└	saf
		for optional durations, values outside of time, fermatas	▽	fasa
		for slightly shorter duration (slightly faster tempo)	└	saex
		for slightly longer duration (slightly slower tempo)	└	faex
		for beginning the gradual speeding up of the tempo	└	faej
		for beginning the gradual slowing down of the tempo	└	saej
		for reiterating the durational value a few times	└	fuja
		for reiterating the durational value many times	└	suja
		for reiterating a few times within a given duration	└	jafu
		for reiterating many times within a given duration	└	jasu
		for optional articulation	└	fujafu
		for articulation of the same duration until change	└	jamu
(c) SUMMARY OF ALL LISTED SIGNALS				



APPENDIX 4

Selected Letters in Basic Codes of the Temporal Parameter

Selected Vowels (VOK) in Basic Codes (KOD) of the Temporal Parameter

No.	VOK	Application
1)	<i>a</i>	integral duration
2)	<i>e</i>	reciprocal duration, pulse reciprocal, movement
3)	<i>ae</i>	tempo
4)	<i>ea</i>	absolute duration (hea - hours, sea - minutes, fea - seconds)
5)	<i>u</i>	number, articulation, multiplication, modifier
6)	<i>au</i>	set member of integral duration
7)	<i>eu</i>	set member of reciprocal duration
8)	<i>ua</i>	durational set
9)	<i>ue</i>	articulative set

Selected Consonants (KON) in Basic Codes (KOD) of the Temporal Parameter

S u f f i x

P r e f i x

Application	KON	Application
simultaneity, entity, beamed	- m -	multiplicity, temporal values, set
absence, single articulation, last ordinal value	- x -	indefinite value, indistinct
transient, conjunction, modifier	- q -	cardinal value
first priority, few, modifier	- j -	optional, any value
second priority, many, modifier	- f -	first priority, few, modifier
interjacent, marginal, interdurations	- s -	second priority, many, modifier
	- w -	division, contraction, bracket

APPENDIX 5

Selected Marks (MAR) for Use in Codes (KOD)

NUM	NOM	KOD	MAR
-----	-----	-----	-----

(1) Punctuation, Modification

1)	comma, separator	<i>fox</i>	,
2)	period	<i>sux (dux)</i>	.
3)	colon	<i>mux</i>	:
4)	semicolon	<i>wux</i>	;
5)	decimal point, ordinal point	<i>dux (sux)</i>	.
6)	duodecimal point	<i>kux</i>	..
7)	over - point (all except last digits modulo 12)	<i>jus</i>	q̇
8)	under - point (single digit modulo 12)	<i>juf</i>	q̣
9)	over dash (intervals up)	<i>fus</i>	q̄
10)	under dash (intervals down)	<i>fuf</i>	q̅

(2) Conjunction, Separation, Repeat

1)	hyphen	<i>fuj</i>	-
2)	dash	<i>suj</i>	—
3)	(up-right) slash	<i>muj</i>	/
4)	(up-left) slash	<i>wuj</i>	\
5)	opening parenthesis	<i>muf</i>	(
6)	closing parenthesis	<i>mus</i>)
7)	opening bracket	<i>wuf</i>	[
8)	closing bracket	<i>wus</i>]
9)	ditto (repeat)	<i>fsuj</i>	~
10)	space	<i>zuj</i>	□

Selected Computation Marks (MAR) for Use in Codes (KOD)

NUM	NOM	KOD	MAR
1)	addition	<i>sum</i>	+
2)	subtraction	<i>fum (fuj)</i>	-
3)	multiplication	<i>mum</i>	×
4)	division	<i>wum (mux)</i>	:
5)	equality	<i>jum</i>	=
6)	inequality	<i>xum</i>	≠
7)	approximation	<i>fsum</i>	~
8)	infinity	<i>zum</i>	∞
9)	lesser than	<i>fufum</i>	<
10)	greater than	<i>susum</i>	>
11)	lesser or equal	<i>fujum</i>	≤
12)	greater or equal	<i>sujum</i>	≥
13)	(square) (cube) root	<i>quw</i>	√
14)	fraction (line)	<i>suw</i>	—
15)	factorial	<i>mumum</i>	!
16)	percent	<i>mus</i>	%
17)	subscript (base)	<i>qf</i>	q_q
18)	superscript (power)	<i>qus</i>	q^q

APPENDIX 7

Table of Alphameric Consonants (KON)

DECIMAL (DUM)					DUODECIMAL (KUM) (modulo 12)				
Prefix for Ordinal Numbers (ORD)			Suffix for Cardinal Numbers (KAR)		Prefix for Ordinal Numbers (ORD)			Suffix for Cardinal Numbers (KAR)	
NUM	KOD	KON	NUM	KOD	NUM	KOD	KON	NUM	KOD
0.	-z	-z-	0	z-	0.	(k)-z	-z-	0	z-(k)
*) 1.	-t	-t-	1	t-	1.	(k)-t	-t-	1	t-(k)
2.	-b	-b-	2	b-	2.	(k)-b	-b-	2	b-(k)
3.	-l	-l-	3	l-	3.	(k)-l	-l-	3	l-(k)
4.	-r	-r-	4	r-	4.	(k)-r	-r-	4	r-(k)
5.	-c	-c-	5	c-	5.	(k)-c	-c-	5	c-(k)
6.	-g	-g-	6	g-	6.	(k)-g	-g-	6	g-(k)
7.	-p	-p-	7	p-	7.	(k)-p	-p-	7	p-(k)
8.	-v	-v-	8	v-	8.	(k)-v	-v-	8	v-(k)
9.	-n	-n-	9	n-	9.	(k)-n	-n-	9	n-(k)
10.	-t-z (d-z)	-t-z-	10	t-z- (d-)	10.	(k)-d	-d-	10	d-(k)
11.	-t-t (d-t)	-t-t-	11	t-t- (d-t-)	11.	(k)-h	-h-	11	h-(k)
12.	-t-b (d-b)	-t-b-	12	t-b- (d-b-)	12.	-t-kz (k-z)	-t-z-	12	t-kz- (k-)
13.	-t-l (d-l)	-t-l-	13	t-l- (d-l-)	13.	-t-kt (k-t)	-t-t-	13	t-kt- (k-t-)
14. etc.	-t-r (d-r)	-t-r-	14	t-r- (d-r-)	14.	-t-kb (k-b)	-t-b-	14	t-kb- (k-b-)

*) Every ordinal number using code-vowel "u" ends on the consonant "t."
N.B. Hyphens to be substituted by an appropriate code-vowel or syllable.

APPENDIX 8

alpha - clock

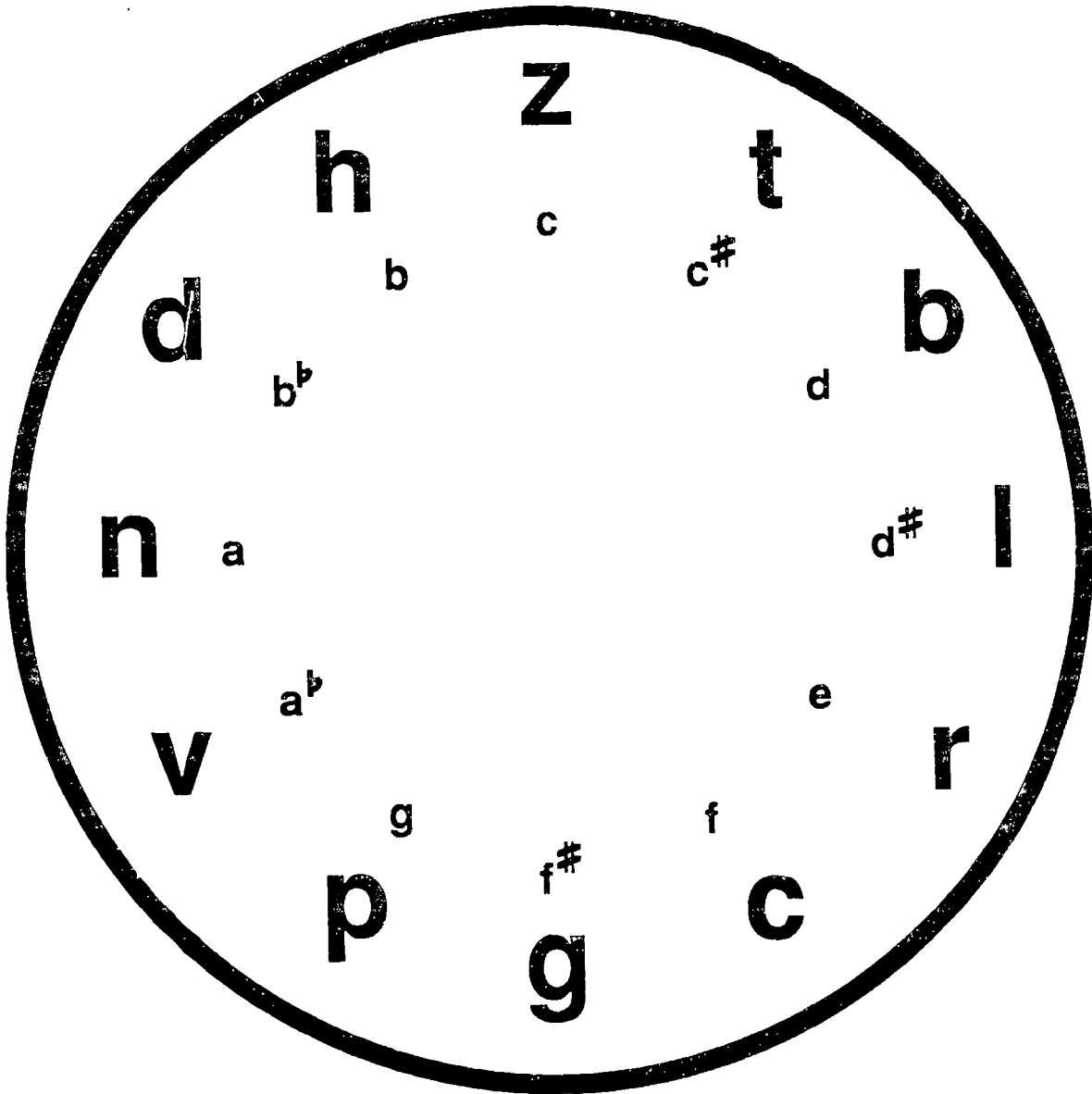

for alphameric conversion of parametric valences

APPENDIX 9















Signals of Parametric Valence

NUM (integers mod 12)	0	1	2	3	4	5	6	7	8	9	d	h	10
VAL (valence)	o	•	—	•	—	•	—	•	—	•	—	•	—
KON (consonants)	z-	t-	b-	l-	r-	c-	g-	p-	v-	n-	d-	h-	k-
						(ts-)							

SIGNAL ELEMENTS

	NOM	(SYS) KOD	SIG	VAL
Ring		<i>nul</i>	•	0
Dot		<i>pun</i>	•	1
Flag: a) descriptive b) absolute c) substitute (an oval enclosing the absolute flag makes it subject to optional values)		<i>dem</i>	—	$2^1 (2^2) (2^3)$ etc. substitute flag with any value
		<i>sem</i>	—	
		<i>fem</i>	⊖	
Bridge		<i>pon</i>	or: [---]	2 - more special any
Hand		<i>man</i>	or: /	
Episema: a) central b) terminal		<i>cen</i>	or: -+-	
Number		<i>ter</i>	or: [---]	
		<i>num</i>	or: ○	

Quantitative Durations

NOM	KOD	SIG
<u>(1) PULSATIVE UNIVALENT</u>		
(a) UNI-TAK (tact unit)	<i>ta</i>	
(b) UNI-MAS (measure unit)	<i>ma</i>	
(c) UNI-MOT (movement unit)	<i>me</i>	
<u>(2) PULSATIVE POLYVALENT</u>		
(a) FUN-INT (fundamental integral)	<i>qa</i>	
(b) FUN-REC (fundamental reciprocal)	<i>qe</i>	
(c) FRA-INT (fractional integral)	<i>qamqe</i>	
(d) FRA-REC (fractional reciprocal)	<i>qemqa</i>	
(e) FUM-INT (multiple integral)	<i>qumqa</i>	
(f) FUM-REC (multiple reciprocal)	<i>qumqe</i>	
(g) FRU-INT (multiple fractional integral)	<i>qum qamqe</i>	
(h) FRU-REC (multiple fractional reciprocal)	<i>qum qemqa</i>	
(i) NUM-INT (numerical integral)	<i>aqu</i>	
(j) NUM-REC (numerical reciprocal)	<i>equ</i>	
<u>(3) ABSOLUTE</u>		
(a) ABS-MIN (minutes)	<i>qu sea</i>	
(b) ABS-SEK (seconds)	<i>qu fea</i>	

Samples of Fractional Rhythms

qa = durational integer;

qe = durational reciprocal (qe = $\frac{1}{qa}$)

qa — qe	qa × qe	2 × (qa × qe)	3 × (qa × qe)	4 × (qa × qe)	5 × (qa × qe)	6 × (qa × qe)
2 $\frac{1}{2}$	$2 \times \frac{1}{2} = \frac{2}{2}$ bambe	$2 \times \frac{2}{2} = 2$ bu(bambe)=ba				
2 $\frac{1}{3}$	$2 \times \frac{1}{3} = \frac{2}{3}$ bamle	$2 \times \frac{2}{3} = \frac{4}{3}$ bu(bamle)=ramle	$3 \times \frac{2}{3} = 2$ lu(bamle)=ba			
2 $\frac{1}{4}$	$2 \times \frac{1}{4} = \frac{2}{4}$ bamre	$2 \times \frac{2}{4} = 1$ bu(bamre)=ta	$3 \times \frac{2}{4} = \frac{3}{2}$ lu(bamre)=lambe	$4 \times \frac{2}{4} = 2$ ru(bamre)=ba		
2 $\frac{1}{5}$	$2 \times \frac{1}{5} = \frac{2}{5}$ bamce	$2 \times \frac{2}{5} = \frac{4}{5}$ bu(bamce)=ramce	$3 \times \frac{2}{5} = \frac{6}{5}$ lu(bamce)=gamce	$4 \times \frac{2}{5} = \frac{8}{5}$ ru(bamce)=vamce	$5 \times \frac{2}{5} = 2$ cu(bamce)=ba	
2 $\frac{1}{6}$	$2 \times \frac{1}{6} = \frac{2}{6}$ bame	$2 \times \frac{2}{6} = \frac{2}{3}$ bu(bame)=bamle	$3 \times \frac{2}{6} = 1$ lu(bame)=ta	$4 \times \frac{2}{6} = \frac{4}{3}$ ru(bame)=ramle	$5 \times \frac{2}{6} = \frac{5}{3}$ cu(bame)=camle	$6 \times \frac{2}{6} = 2$ gu(bame)=ba
3 $\frac{1}{2}$	$3 \times \frac{1}{2} = \frac{3}{2}$ lambe	$2 \times \frac{3}{2} = 3$ bu(lambe)=la				
3 $\frac{1}{3}$	$3 \times \frac{1}{3} = \frac{3}{3}$ lamle	$2 \times \frac{3}{3} = 2$ bu(lamle)=ba	$3 \times \frac{3}{3} = 3$ lu(lamle)=la			
3 $\frac{1}{4}$	$3 \times \frac{1}{4} = \frac{3}{4}$ lamre	$2 \times \frac{3}{4} = \frac{3}{2}$ bu(lamre)=lambe	$3 \times \frac{3}{4} = \frac{9}{4}$ lu(lamre)=namre	$4 \times \frac{3}{4} = 3$ ru(lamre)=la		
3 $\frac{1}{5}$	$3 \times \frac{1}{5} = \frac{3}{5}$ lamce	$2 \times \frac{3}{5} = \frac{6}{5}$ bu(lamce)=gamce	$3 \times \frac{3}{5} = \frac{9}{5}$ lu(lamce)=namce	$4 \times \frac{3}{5} = \frac{12}{5}$ ru(lamce)=lamce	$5 \times \frac{3}{5} = 3$ cu(lamce)=la	
3 $\frac{1}{6}$	$3 \times \frac{1}{6} = \frac{3}{6}$ lamge	$2 \times \frac{3}{6} = 1$ bu(lamge)=ta	$3 \times \frac{3}{6} = \frac{3}{2}$ lu(lamge)=lambe	$4 \times \frac{3}{6} = 2$ ru(lamge)=ba	$5 \times \frac{3}{6} = \frac{5}{2}$ cu(lamge)=cambe	$6 \times \frac{3}{6} = 3$ gu(lamge)=la
qa — qe	qa + qe	2 × (qa + qe)	3 × (qa + qe)	4 × (qa + qe)	5 × (qa + qe)	6 × (qa + qe)
2 $\frac{1}{2}$	$\frac{1}{2} + \frac{1}{2} = \frac{1}{1}$ bemba	$2 \times \frac{1}{1} = \frac{2}{1}$ bu(bemba)=be	$3 \times \frac{1}{1} = \frac{3}{1}$ lu(bemba)=lamre	$4 \times \frac{1}{1} = 4$ ru(bemba)=ta	$5 \times \frac{1}{1} = \frac{5}{1}$ cu(bemba)=camre	$6 \times \frac{1}{1} = \frac{6}{1}$ gu(bemba)=lambe
3 $\frac{1}{2}$	$\frac{1}{2} + \frac{1}{3} = \frac{1}{6}$ bemla	$2 \times \frac{1}{6} = \frac{1}{3}$ bu(bemla)=le	$3 \times \frac{1}{6} = \frac{1}{2}$ lu(bemla)=be	$4 \times \frac{1}{6} = \frac{2}{3}$ ru(bemla)=bamle	$5 \times \frac{1}{6} = \frac{5}{6}$ cu(bemla)=camge	$6 \times \frac{1}{6} = 1$ gu(bemla)=ta
4 $\frac{1}{2}$	$\frac{1}{2} + \frac{1}{4} = \frac{1}{4}$ bemra	$2 \times \frac{1}{4} = \frac{1}{2}$ bu(bemra)=re	$3 \times \frac{1}{4} = \frac{3}{4}$ lu(bemra)=lamre	$4 \times \frac{1}{4} = 1$ ru(bemra)=be	$5 \times \frac{1}{4} = \frac{5}{4}$ cu(bemra)=camre	$6 \times \frac{1}{4} = \frac{3}{2}$ gu(bemra)=lamre
5 $\frac{1}{2}$	$\frac{1}{2} + \frac{1}{5} = \frac{1}{10}$ bemca	$2 \times \frac{1}{10} = \frac{1}{5}$ bu(bemca)=ce	$3 \times \frac{1}{10} = \frac{3}{10}$ lu(bemca)=lamce	$4 \times \frac{1}{10} = \frac{2}{5}$ ru(bemca)=damce	$5 \times \frac{1}{10} = \frac{1}{2}$ cu(bemca)=be	$6 \times \frac{1}{10} = \frac{3}{5}$ gu(bemca)=lamce
6 $\frac{1}{2}$	$\frac{1}{2} + \frac{1}{6} = \frac{1}{3}$ bemga	$2 \times \frac{1}{3} = \frac{2}{3}$ bu(bemga)=ge	$3 \times \frac{1}{3} = 1$ lu(bemga)=re	$4 \times \frac{1}{3} = \frac{4}{3}$ ru(bemga)=le	$5 \times \frac{1}{3} = \frac{5}{3}$ cu(bemga)=camge	$6 \times \frac{1}{3} = 2$ gu(bemga)=be
2 $\frac{1}{3}$	$\frac{1}{3} + \frac{1}{3} = \frac{1}{1.5}$ lemba	$2 \times \frac{1}{1.5} = \frac{2}{1.5}$ bu(lemba)=le	$3 \times \frac{1}{1.5} = 2$ lu(lemba)=be	$4 \times \frac{1}{1.5} = \frac{8}{3}$ ru(lemba)=bamle	$5 \times \frac{1}{1.5} = \frac{10}{3}$ cu(lemba)=camge	$6 \times \frac{1}{1.5} = 4$ gu(lemba)=ta
3 $\frac{1}{3}$	$\frac{1}{3} + \frac{1}{3} = \frac{1}{1.5}$ lemle	$2 \times \frac{1}{1.5} = \frac{2}{1.5}$ bu(lemle)=lamle	$3 \times \frac{1}{1.5} = 2$ lu(lemle)=le	$4 \times \frac{1}{1.5} = \frac{8}{3}$ ru(lemle)=ramle	$5 \times \frac{1}{1.5} = \frac{10}{3}$ cu(lemle)=camle	$6 \times \frac{1}{1.5} = 4$ gu(lemle)=bamle
4 $\frac{1}{3}$	$\frac{1}{3} + \frac{1}{4} = \frac{1}{12}$ lemra	$2 \times \frac{1}{12} = \frac{1}{6}$ bu(lemra)=ge	$3 \times \frac{1}{12} = \frac{1}{4}$ lu(lemra)=re	$4 \times \frac{1}{12} = \frac{1}{3}$ ru(lemra)=le	$5 \times \frac{1}{12} = \frac{5}{12}$ cu(lemra)=camge	$6 \times \frac{1}{12} = \frac{1}{2}$ gu(lemra)=be
5 $\frac{1}{3}$	$\frac{1}{3} + \frac{1}{5} = \frac{1}{15}$ lemca	$2 \times \frac{1}{15} = \frac{2}{15}$ bu(lemca)=gamte	$3 \times \frac{1}{15} = \frac{1}{5}$ lu(lemca)=ce	$4 \times \frac{1}{15} = \frac{4}{15}$ ru(lemca)=ramte	$5 \times \frac{1}{15} = \frac{1}{3}$ cu(lemca)=le	$6 \times \frac{1}{15} = \frac{2}{5}$ gu(lemca)=gamte
6 $\frac{1}{3}$	$\frac{1}{3} + \frac{1}{6} = \frac{1}{2}$ lemga	$2 \times \frac{1}{2} = 1$ bu(lemga)=ne	$3 \times \frac{1}{2} = \frac{3}{2}$ lu(lemga)=ge	$4 \times \frac{1}{2} = 2$ ru(lemga)=bamle	$5 \times \frac{1}{2} = \frac{5}{2}$ cu(lemga)=camte	$6 \times \frac{1}{2} = 3$ gu(lemga)=le

Recurring Patterns of Articulation













NOM	KOD	SIG
(1) <u>DETERMINED REITERATION</u>		
(a) HOK-TER (<i>ad-hoc</i> inter-iterative)	<i>quja</i>	
(b) HOK-TRA (<i>ad-hoc</i> intra-iterative)	<i>jaqu</i>	
(2) <u>OPTIONAL REITERATION</u>		
OPT-TER (optional inter-iterative)		
(a) TER-PAU (few times)	<i>fuja</i>	
(b) TER-MUL (many times)	<i>suja</i>	
OPT-TRA (optional intra-iterative)		
(c) TRA-PAU (few times)	<i>jafu</i>	
(d) TRA-MUL many times)	<i>jasu</i>	
(3) <u>DETERMINED CONTINUING</u>		
DET-KON (reiterated until change)	<i>jamu</i>	
(4) <u>MULTIPLE STEMS COMBINED</u>		
MUS-KOM (reiterating the same value by beaming)	<i>jam (ju)</i>	
(5) <u>METRICAL ORDER</u>		
MET-SIT (meter signature)	<i>qutaqu</i>	

Metric and Absolute References

NOM	(SYS) KOD	SIG
(1) <u>INTRA - MEASURE</u>		
(a) MES-SUP (upper bar sign)	<i>majs</i>	▼
(b) MES-INF (lower bar sign)	<i>majf</i>	▲
(c) MEN-SUP (upper measure number)	<i>majsq</i>	◻▼
(d) MEN-INF (lower measure number)	<i>majfq</i>	▲◻
(e) MET-PUN (metric point)	<i>taqqeq</i>	◊
(f) PUN-TAK (tact unit)	<i>taq</i>	↙
(g) PUN-SUB (tact subunit)	<i>qeq</i>	↘
(2) <u>INTER - MEASURES</u>		
(a) SEL-SUP (selection upper double-bar sign)	<i>mejs</i>	▼
(b) SEL-INF (selection lower double-bar sign)	<i>mejf</i>	▲
(c) SEL-PUN (selection point)	<i>meqmaq</i>	◊
(d) PUN-MOT (movement unit)	<i>meq</i>	↙
(e) PUN-MAS (measure unit)	<i>maq</i>	↘
(3) <u>ABSOLUTE</u>		
(a) SEK-SUP (upper second unit)	<i>feajs</i>	▼
(b) SEK-INF (lower second unit)	<i>feajf</i>	▲
(c) TEM-SUP (upper duration segment in min/sec)	<i>su qu-(s) (f) ea</i>	◻▼
(d) TEM-INF (lower duration segment in min/sec)	<i>fu qu-(s) (f) ea</i>	▲◻











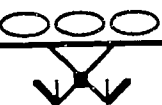

APPENDIX 14

Tempo Signals

NOM	KOD	SIG
(1) <u>QUANTIFIED</u>		
(a) GRA-LEN (gradational slow) c.f. Table of Tempi	<i>(fu) qae</i>	
(b) GRA-VEL (gradational fast) c.f. Table of Tempi	<i>(su) qae</i>	
(2) <u>DESCRIPTIVE</u>		
(a) LEN-NOR (slow normal)	<i>fae</i>	
(b) LEN-EXT (slow extreme)	<i>su fae</i>	
(c) VEL-NOR (fast normal)	<i>sae</i>	
(d) VEL-EXT (fast extreme)	<i>su sae</i>	
(e) DES-MOD (moderate)	<i>fsae</i>	
(3) <u>INCIDENCE</u>		
(a) ANT-MIN (slightly anticipatory)	<i>mu fae</i>	
(b) ANT-MAX (considerably anticipatory)	<i>musu fae</i>	
(c) TAR-MIN (slightly delayed)	<i>mu sae</i>	
(d) TAR-MAX (considerably delayed)	<i>musu sae</i>	
(e) INC-LIB (free) (<i>tempo rubato</i>)	<i>mu fsae</i>	













APPENDIX 15

Tempo References

NOM	KOD	SIG
<u>(1) SECONDS PER METRICAL UNITS</u>		
(a) SEK-MAS (seconds per measure)	<i>qu (fea) mam</i>	
(b) SEK-TAK (seconds per tact)	<i>qu (fea) tam</i>	
(c) SEK-TAR (seconds per tact reciprocal)	<i>qu (fea) qem</i>	
(d) TEP-SIT (tempo signature)	<i>qu (fea) (mam) (tam) (qem)</i> or: <i>(fu) (su) qae</i> or: <i>(su) (fae) (sae)</i>	
<u>(2) PULSES PER METRICAL UNITS</u>		
(a) PUL-MAS (pulse per measure)	<i>mamqu</i>	
(b) PUL-TAK (pulse per tact)	<i>tamqu</i>	
(c) PUL-TAR (pulse per tact reciprocal)	<i>qemqu</i>	
(d) PUL-SIT (pulse signature)	<i>(mam) (tam) (qem) qu (fs)</i>	
<u>(3) PULSE SIGNALS (for gestures)</u>		
(a) MUL-SUP (upper, first pulse in a measure)	<i>mus</i>	
(b) MUL-INF (lower, first pulse in a measure)	<i>muf</i>	
(c) PUL-SUP (upper, any other pulse)	<i>tus</i>	
(d) PUL-INF (lower, any other pulse)	<i>tuf</i>	
(e) RUL-SUP (upper, any pulse reciprocal)	<i>tes</i>	
(f) RUL-INF (lower, any pulse reciprocal)	<i>tef</i>	

APPENDIX 16

Fluctuating Tempi

NOM	KOD	SIG
(1) <u>ABRUPT</u>		
(a) LEN-MIN (slightly slower)	<i>faex</i>	
(b) LEN-MAX (considerably slower)	<i>su faex</i>	
(c) VEL-MIN (slightly faster)	<i>saex</i>	
(d) VEL-MAX (considerably faster)	<i>su saex</i>	
(e) REF-ANT (original tempo) (<i>tempo primo</i>)	<i>fsaex</i>	
(2) <u>TRANSIENT</u>		
(a) TAR-LEN (slow retardation)	<i>faejf</i>	
(b) TAR-NOR (normal retardation)	<i>faej</i>	
(c) TAR-VEL (rapid retardation)	<i>faejs</i>	
(d) CEL-LEN (slow acceleration)	<i>saejf</i>	
(e) CEL-NOR (normal acceleration)	<i>saej</i>	
(f) CEL-VEL (rapid acceleration)	<i>saejs</i>	
(g) FOR-ANT (previous tempo) (<i>a tempo</i>)	<i>fsaejf</i>	

APPENDIX 17

Table of Tempi

NOM	PUL	KOD	SIG
(1) GRA-LEN (GRADATIONAL, SLOWER)	(approx.)		
(a) <u>Grave</u> (extremely slow)	1.50"	zae	
(b) <u>Largo</u> (very slow)	1.33"	tae	
(c) <u>Lento</u> (slow)	1.16"	bae	
(d) <u>Adagio</u> (dragging)	1.00"	lae	
(e) <u>Andante</u> (reposeful)	0.86"	rae	
(f) <u>Andantino</u> (leisurely)	0.75"	cae	
(2) GRA-VEL (GRADATIONAL, FASTER)			
(a) <u>Moderato</u> (moderate)	0.67"	gae	
(b) <u>Allegretto</u> (apace)	0.63"	pae	
(c) <u>Allegro</u> (lively)	0.50"	vae	
(d) <u>Vivace</u> (fast)	0.57"	nae	
(e) <u>Presto</u> (very fast)	0.50"	dae	
(f) <u>Prestissimo</u> (extremely fast)	0.33"	hae	

APPENDIX 18

Selected Tempi as Fractions of a Second *)

No.	M.M. *	PUL **	$\frac{\text{sec}}{2}$	$\frac{\text{sec}}{3}$	$\frac{\text{sec}}{4}$	$\frac{\text{sec}}{5}$
1)	30	2"	$\frac{4''}{2}$	$\frac{6''}{3}$	$\frac{8''}{4}$	$\frac{10''}{5}$
2)	34	1.74"			$\frac{7''}{4}$	
3)	36	1.67"		$\frac{5''}{3}$		
4)	40	1.5"	$\frac{3''}{2}$		$\frac{6''}{4}$	
5)	43	1.4"				$\frac{7''}{5}$
6)	45	1.33"		$\frac{4''}{3}$		
7)	48	1.25"			$\frac{5''}{4}$	
8)	50	1.2"				$\frac{6''}{5}$
9)	60	1"	$\frac{2''}{2}$	$\frac{3''}{3}$	$\frac{4''}{4}$	$\frac{5''}{5}$
10)	75	0.8"				$\frac{4''}{5}$
11)	80	0.75"			$\frac{3''}{4}$	
12)	90	0.67"		$\frac{2''}{3}$		
13)	100	0.6"				$\frac{3''}{5}$
14)	120	0.5"	$\frac{1''}{2}$		$\frac{2''}{4}$	
15)	150	0.4"				$\frac{2''}{5}$
16)	180	0.33"		$\frac{1''}{3}$		
17)	240	0.25"			$\frac{1''}{4}$	
18)	300	0.2"				$\frac{1''}{5}$

) approximate values; M.M. = metronome numbers; PUL** = pulse in seconds.

APPENDIX 19

Tempi Conversion Table

A19

M.M.*	PUL*	M.M.*	PUL*	M.M.*	PUL*	M.M.*	PUL*	M.M.*	PUL*
10	6								
11	5.45	61	0.98	111	0.54	161	0.37	211	0.28
12	5	62	0.97	112		162		212	
13	4.62	63	0.95	113	0.53	163		213	
14	4.29	64	0.94	114		164		214	
15	4	65	0.92	115	0.52	165	0.36	215	
16	3.75	66	0.91	116		166		216	
17	3.53	67	0.9	117	0.51	167		217	
18	3.33	68	0.88	118		168		218	
19	3.16	69	0.87	119	0.5	169		219	0.27
20	3	70	0.86	120	0.5	170	0.35	220	
21	2.86	71	0.85	121	0.5	171		221	
22	2.73	72	0.83	122	0.49	172		222	
23	2.61	73	0.82	123		173		223	
24	2.5	74	0.81	124	0.48	174		224	
25	2.4	75	0.8	125		175	0.34	225	
26	2.31	76	0.79	126		176		226	
27	2.22	77	0.78	127	0.47	177		227	0.26
28	2.14	78	0.77	128		178		228	
29	2.07	79	0.76	129		179		229	
30	2	80	0.75	130	0.46	180	0.33	230	
31	1.94	81	0.74	131		181		231	
32	1.88	82	0.73	132		182		232	
33	1.82	83	0.72	133	0.45	183		233	
34	1.77	84	0.71	134		184		234	
35	1.71	85	0.71	135	0.44	185	0.32	235	
36	1.67	86	0.7	136		186		236	0.25
37	1.62	87	0.69	137		187		237	
38	1.58	88	0.68	138		188		238	
39	1.54	89	0.67	139	0.43	189		239	
40	1.5	90	0.67	140		190		240	0.25
41	1.46	91	0.66	141		191	0.31	241	
42	1.43	92	0.65	142	0.42	192		242	
43	1.4	93		143		193		243	
44	1.36	94	0.64	144		194		244	
45	1.33	95	0.63	1	0.41	195		245	
46	1.31	96		146		196		246	0.24
47	1.28	97	0.62	147		197	0.3	247	
48	1.25	98	0.61	148		198		248	
49	1.22	99		149	0.4	199		249	
50	1.2	100	0.6	150		200		250	
51	1.18	101	0.59	151		201			
52	1.15	102		152		202		260	0.23
53	1.13	103	0.58	153	0.39	203		270	0.22
54	1.11	104		154		204	0.29	280	0.21
55	1.09	105	0.57	155		205		290	
56	1.07	106		156		206		300	0.2
57	1.05	107	0.56	157	0.38	207			
58	1.03	108		158		208		400	0.15
59	1.02	109	0.55	159		209		500	0.12
60	1	110		160		210		600	0.1

*) M.M. = metronome numbers;

*) PUL = pulse in seconds

APPENDIX 20

Time Signatures

(TEM - SIT)

TEP-SIT
(tempo signature)

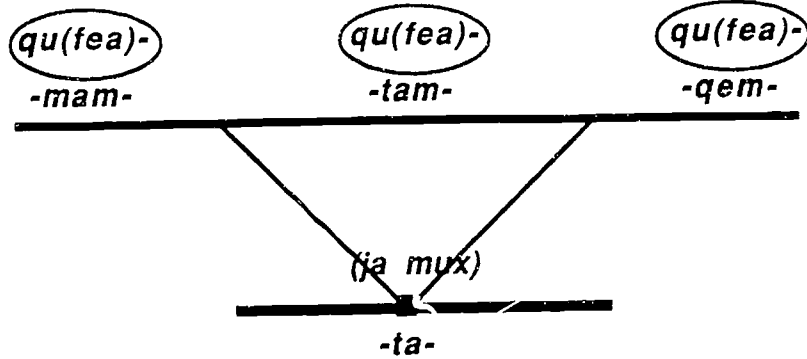

PUL-SIT
(pulse signature)

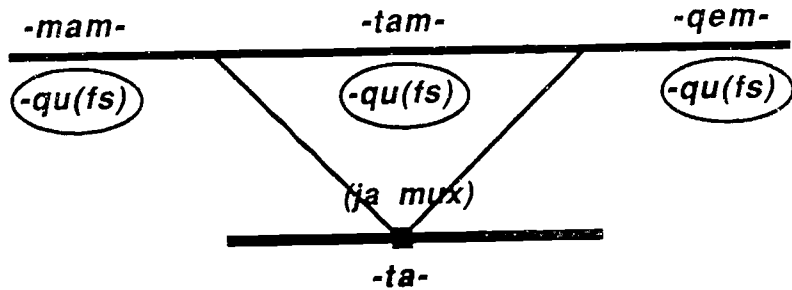

MET-SIT
(meter signature)

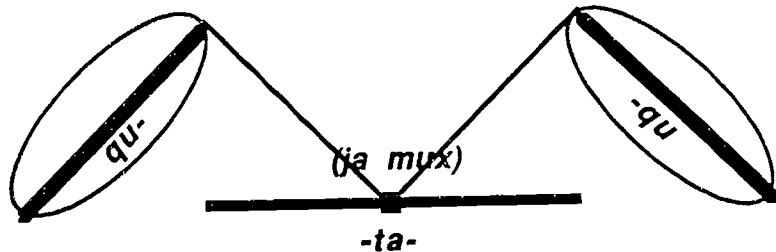

TEM-SIT
(time signature)

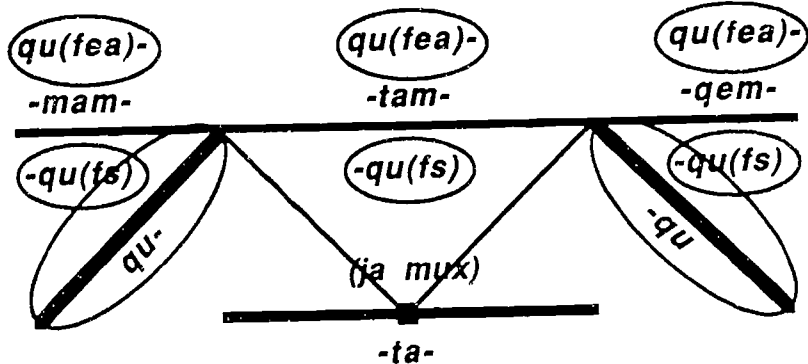

APPENDIX 21

Relationships and Priorities









NOM	KOD	SIG
<u>(1) ASSOCIATIVE RELATIONSHIPS</u>		
(a) ASO-TEN (held) (<i>tenuto</i>)	<i>fusa</i>	
(b) TEN-SUB (subtractive)	<i>fusaf</i>	
(c) TEN-PRO (protractive)	<i>fusas</i>	
(d) ASO-LEG (connected) (<i>legato</i>)	<i>fufsa</i>	
<u>(2) DISASSOCIATIVE RELATIONSHIPS</u>		
(a) DIS-POR (separated) (<i>portato</i>)	<i>sufa</i>	
(b) DIS-STA (detached) (<i>staccato</i>)	<i>susa</i>	
<u>(3) ARTICULATIVE PRIORITY</u>		
(a) PRI-PRI (first)	<i>fu</i>	
(b) PRI-INF (down)	<i>fuf</i>	
(c) PRI-SUP (up)	<i>fus</i>	
(d) PRI-ULT (last)	<i>su</i>	
(e) ULT-INF (down)	<i>suf</i>	
(f) ULT-SUP (up)	<i>sus</i>	
(g) PRI-OPT (optional)	<i>fsufs</i>	

Contents Grouping and Separation

NOM	(SYS) KOD	SIG
<u>(1) TIME FORMATION</u>		
(a) TEM-SUP (upper time bracket)	<i>sukus</i>	
(b) TEM-INF (lower time bracket)	<i>fukus</i>	
(c) MAS-SUP (upper measures bracket)	<i>sukum</i>	
(d) MAS-INF (lower measures bracket)	<i>fukum</i>	
(e) RAM-MAN (time frame, mandatory order)	<i>futus</i>	
(f) RAM-OPT (time frame, optional order)	<i>futuf</i>	
<u>(2) CONSECUTIVE INTEGRATION</u>		
(a) ARK-SUP (upper slur)	<i>tusje</i>	
(b) SUP-KOM (upper slur beginning)	<i>tusjef</i>	
(c) SUP-FIN (upper slur ending)	<i>tusjes</i>	
(d) ARK-INF (lower slur)	<i>tufje</i>	
(e) INF-KOM (lower slur beginning)	<i>tufjef</i>	
(f) INF-FIN (lower slur ending)	<i>tufjes</i>	
<u>(3) SPACE FORMATION</u>		
(a) BRA-APE (opening simultaneity bracket)	<i>wuf</i>	
(b) BRA-KLA (closing simultaneity bracket)	<i>wus</i>	
(c) SIM-RAM (simultaneity frame)	<i>sutu</i>	
<u>(4) SPACE SEPARATION</u>		
(a) SEP-KOM (space comma, breathing comma)	<i>tux</i>	
(b) SEP-LIN (separation line)	<i>tuj</i>	

APPENDIX 23

Progressive Contents

NOM	KOD	SIG
(1) <u>REPEATABLE LIMITS</u>		
(a) LIM-KAP (opening repeat sign, <i>capo, segno</i>)	<i>jut</i>	
(b) QAN-MAN (mandatory)	<i>juqu</i>	
(c) QAN-OPT (optional)	<i>juquj</i>	
(d) KAP-ORD (repeat order)	<i>juqujq</i>	
(e) LIM-KAU (closing repeat sign, tail, <i>fine</i>)	<i>jux</i>	
(2) <u>REPEATABLE REFERRAL</u>		
(a) REF-MAN (mandatory referral)	<i>jusuq</i>	
(b) REF-OPT (optional referral)	<i>jusuj</i>	
(3) <u>NON-REPEATABLE CONTENTS</u>		
(a) NON-MAN (mandatory close, <i>volta</i>)	<i>jufuq</i>	
(b) NON-OPT (optional close, <i>volta</i>)	<i>jufuj</i>	

Collection of Temporal Signals

(TEM - KOL)

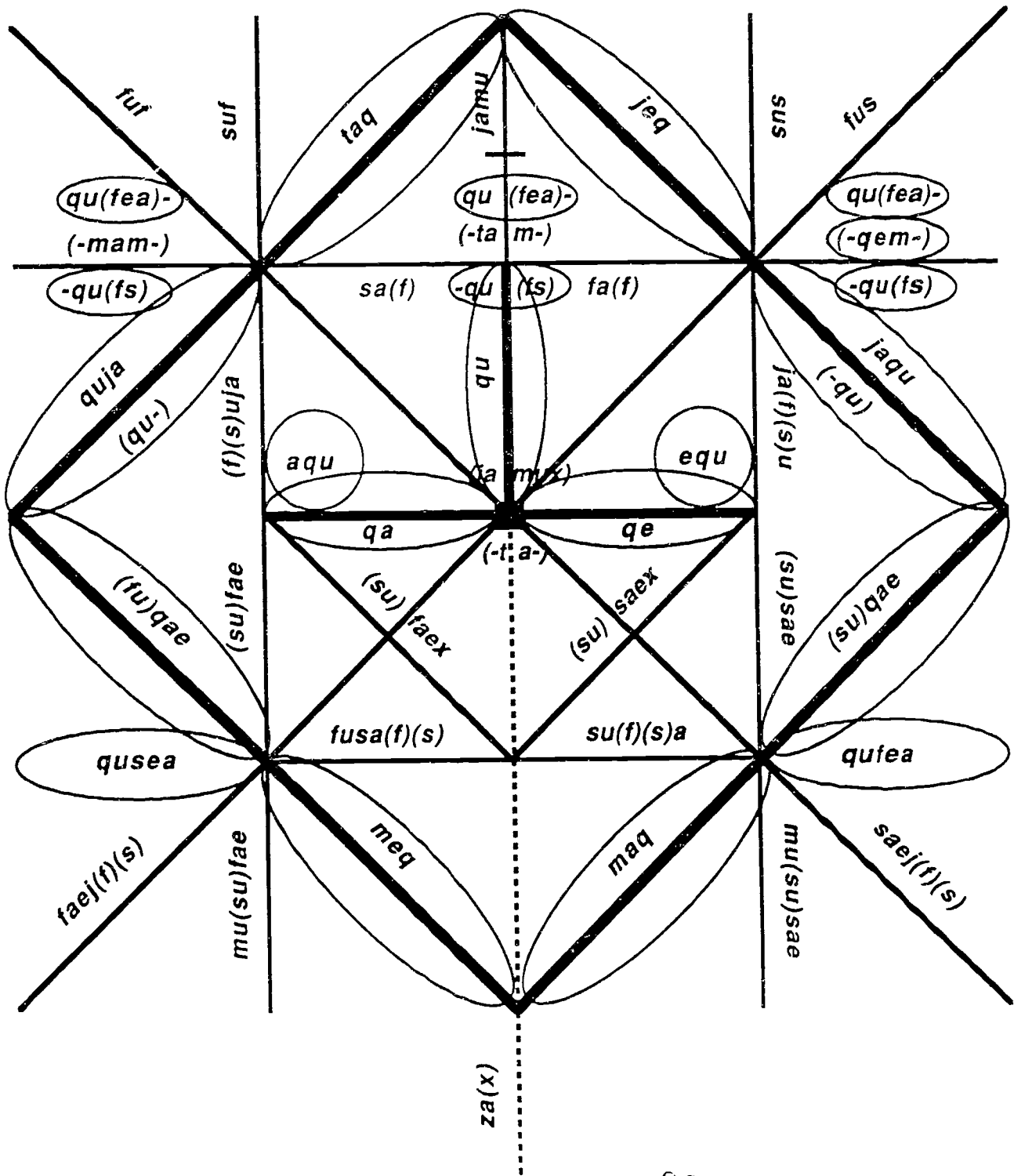

APPENDIX 25

Basic Pitch References

NOM	SIG
(1) <u>DISK TYPES (DYS-TYP)</u>	
(a) TYP-DEF (definite; filled)	●
(b) TYP-OPT (optional; empty, <i>ossia</i>)	○
(2) <u>STEM ATTACHMENT (DYS-STE)</u>	
(a) SIN-INF (left-lower)	
(b) SIN-SUP (left-upper)	
(c) CEN-INF (center-lower)	
(d) CEN-SUP (center-upper)	
(e) DEX-INF (right-lower)	
(f) DEX-SUP (right-upper)	
(3) <u>STAFF TOPOGRAPHY LINES</u>	
(a) LED-BRE (short ledger lines; between staff lines)	
(b) LED-LON (long ledger lines; substituting for either the top or the bottom staff line)	
(c) GEM-PRI (first, bottom staff line)	
(d) GEM-SEK (second, top staff line)	
(e) REG-KLE (region clef; attached to the top staff line)	

APPENDIX 26

Disk Placement

(1) TRANOT

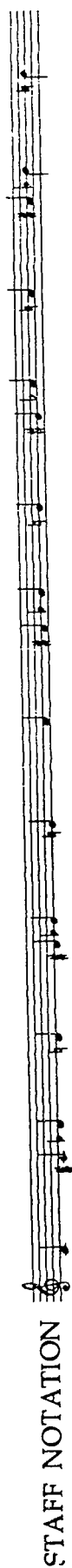
STAFF NOTATION 

LETTER NAMES c c[#]/d^b d[#] d^b/e^b e[#] f f[#]/g^b g[#] g^b a[#] a^b b[#]

SOLMIZATION do di/ra re ri/me mi fa fi/se so si/le la li/te ti

(2) PANOT

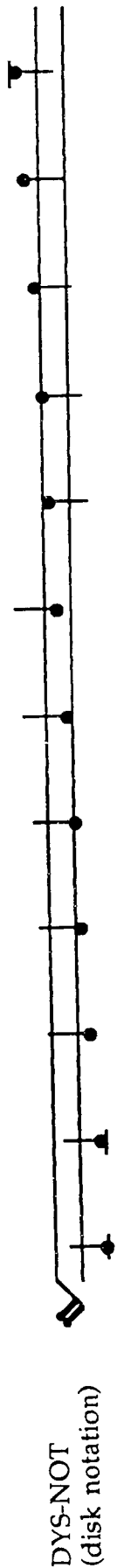
DYS-NOT (disk notation) 

KOD (code) zo to bo lo ro co (fso) go po vo do ho

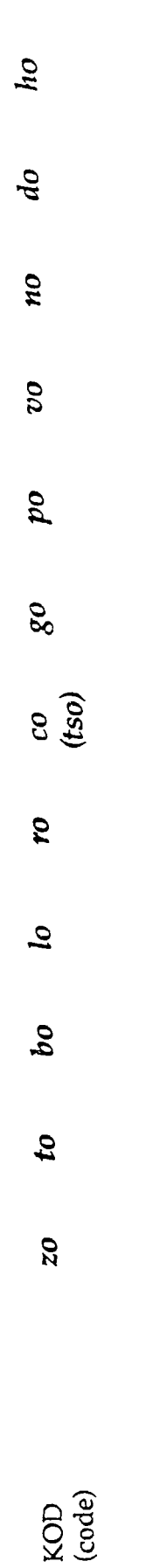
SIG (signal) 

NUM (integer mod 12) 0 1 2 3 4 5 6 7 8 9 h

REGION 8

REGION 7

REGION 6

REGION 5

REGION 4

REGION 3

REGION 2

REGION 1

REGION 0

APPENDIX 27

Standard Keyboard in DYSNOT

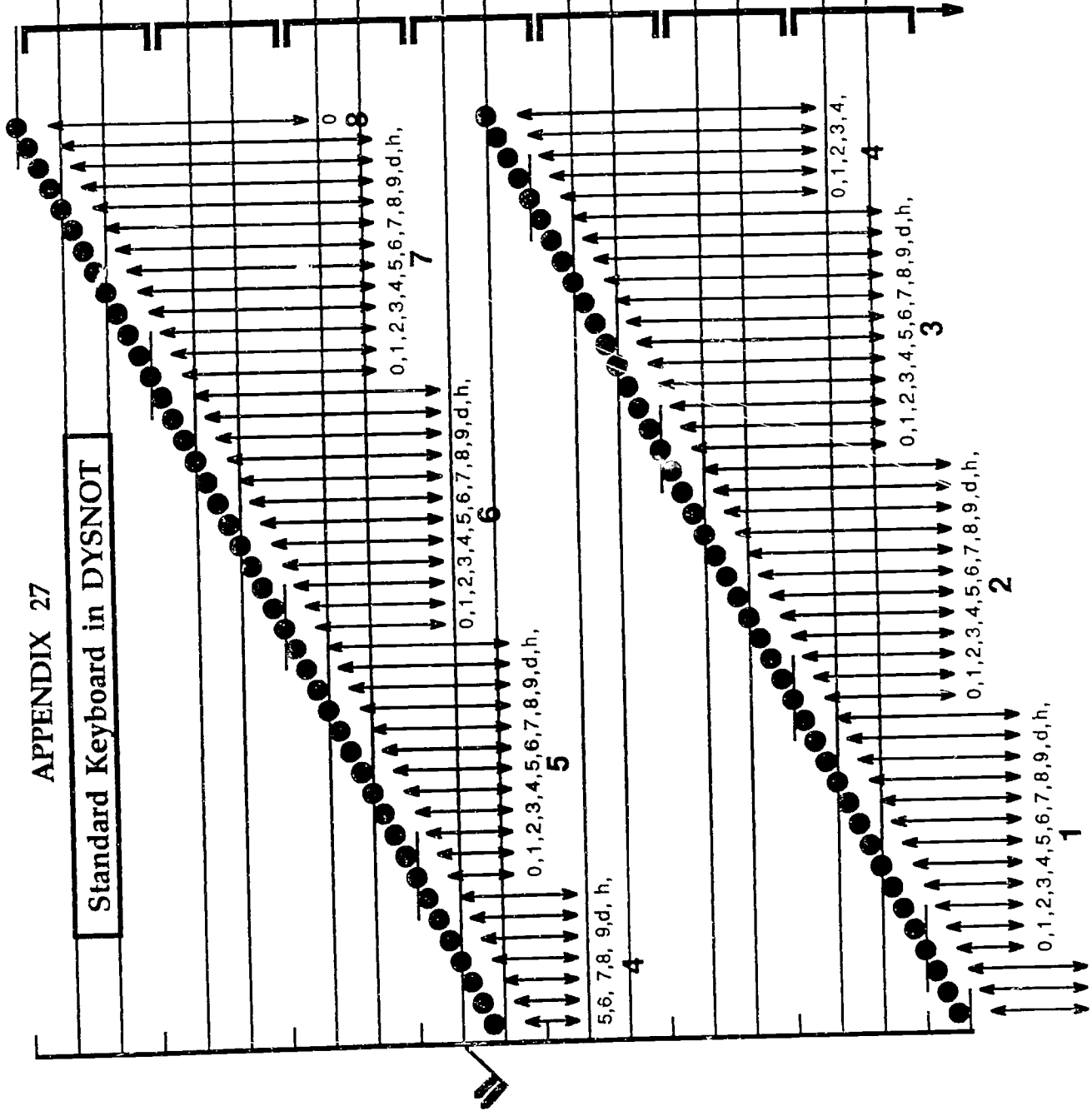

APPENDIX 28

Pitch Conversion Table

STAFF

KEYBOARD

POK

STAFF

KEYBOARD

TOK

STAFF

KEYBOARD

ZOK

STAFF

KEYBOARD

COK

STAFF

KEYBOARD

ROK

STAFF

KEYBOARD

LOK

STAFF

KEYBOARD

BOK

STAFF

KEYBOARD

TOK

STAFF

KEYBOARD

ZOK

APPENDIX 29

Tempered Intervals within an Octave

(1) TRANOT

STAFF NOTATION		
SYMBOLS	0 M2 m2 M3 m3 M4 P4 M3 P4 A4 P5 m6 M6 m7 M7 P8	(L2) (+2) (-2) (+3) (-3) (+4) (L4) (L5) (-6) (+6) (-7) (+7) (L8)
NAMES	unison	major second, minor second, major third, minor third, augmented fourth, perfect fifth, minor sixth, major sixth, minor seventh, major seventh, perfect octave

(2) PANOT

DYS-NOT (disk notation)		
KOD (code)	zim [ix]	tim bim rim cim gim pim vim nim dim him tikzim [kim]
SIG (signal)		
NUM (integer mod 12)	0 1 2 3 4 5 6 7 8 9 10	















APPENDIX 30

Quantitative and Descriptive Pitches

NOM	KOD	SIG
<u>(1) QUANTITATIVE PITCHES</u>		
(a) SPA-NUX (space hub)	<i>jomux</i>	
(b) TEM-REG (tempered octave region)	<i>qok</i>	
(c) TEM-DEG (tempered octave degree)	<i>qo</i>	
(d) REC-INF (reciprocal, lower micro-degree)	<i>qöf</i>	
(e) MUR-INF (multiple reciprocal, lower micro-degree)	<i>qum (qöf)</i>	
(f) REC-SUP (reciprocal, upper micro-degree)	<i>qös</i>	
(g) MUR-SUP (multiple reciprocal, upper micro-degree)	<i>qum (qös)</i>	
(h) DEG-HER (any degree in Herz, c.p.s.)	<i>qu seo</i>	
(i) STA-HER (standard of tuning in Herz, c.p.s.)	<i>qu feo</i>	
(j) PAR-FUN (partials fundamental)	<i>qosot</i>	
(k) PAR-SUP (upper partial)	<i>qosoq</i>	
<u>(2) DESCRIPTIVE PITCHES</u>		
(a) INF-NOR (normally low)	<i>fo</i>	
(b) INF-EXT (extremely low)	<i>fof</i>	
(c) SUF-NOR (normally high)	<i>so</i>	
(d) SUP-EXT (extremely high)	<i>sof</i>	
(e) ZON-OPT (optional zone)	<i>fso</i>	

APPENDIX 31

Modificatons and Sequels of Pitch









NOM	KOD	SIG
(1) <u>TRANSIENT PITCHES</u>		
(a) INF-LEN (falling, slowly)	<i>fojf</i>	
(b) INF-NOR (falling, ordinarily)	<i>foj</i>	
(c) INF-VEL (falling, rapidly)	<i>fojs</i>	
(d) SUR-LEN (rising, slowly)	<i>sojf</i>	
(e) SUR-NOR (rising, ordinarily)	<i>soj</i>	
(f) SUR-VEL (rising, rapidly)	<i>sojs</i>	
(g) TRA-OPT (transient, optional)	<i>fsoj</i>	
(2) <u>PITCH SEQUELS and OTHERS</u>		
(a) KAT-INF (catenary, next lower)	<i>qouf</i>	
(b) KAT-SUP (catenary, next higher)	<i>qous</i>	
(c) SYN-INF (synchronous, lower neighbor)	<i>qoumf</i>	
(d) SYN-SUP (synchronous, upper neighbor)	<i>qoums</i>	
(e) KAL-IND (indistinct calibration, indefinite pitch)	<i>xo</i>	
(f) KAL-ABS (absence of sound event, rest)	<i>ox</i>	

Quantitative and Descriptive Intervals
--

NOM	KOD	SIG
(1) <u>QUANTITATIVE INTERVALS</u>		
(Univalent)		
(a) UNI-SEG (univalent segment)	<i>tik</i>	
(b) UNI-GRA (univalent step)	<i>ti</i>	
(Polyvalent)		
(a) OKT-SEG (octave segment)	<i>qik</i>	
(b) OKT-REC (octave reciprocal)	<i>qüik</i>	
(c) MUO-REC (multiple octave reciprocal)	<i>qum (qüik)</i>	
(d) GRA-INT (integral step)	<i>qi</i>	
(e) GRA-REC (step reciprocal, microstep)	<i>qüi</i>	
(f) MUG-REC (multiple step reciprocal)	<i>qum (qüi)</i>	
(g) AKC-INF (flats & double flats)	<i>qo-feü(s)</i>	
(h) CEN-INF (microstep cents below)	<i>qu-feü</i>	
(i) AKC-SUP (sharps & double sharps)	<i>qo-seü(s)</i>	
(j) CEN-SUP (microstep cents above)	<i>qu-seü</i>	
(2) <u>DESCRIPTIVE INTERVALS</u>		
(a) PAR-NOR (normally small)	<i>fi</i>	
(b) PAR-EXT (extremely small)	<i>fif</i>	
(c) MAG-NOR (normally large)	<i>si</i>	
(d) MAG-EXT (extremely large)	<i>sif</i>	
(e) KOM-OPT (optional compass)	<i>fsi</i>	

APPENDIX 33













Directions and Sequels of Intervals

NOM	KOD	SIG
(1) <u>DIRECTIONS</u>		
(a) KON-INF (consecutive, down)	<i>jif</i>	
(b) KON-SUP (consecutive, up)	<i>jis</i>	
(c) SYN-INF (synchronous, down)	<i>jimf</i>	
(d) SYN-SUP (synchronous, up)	<i>jims</i>	
(2) <u>REGRESSIVE SEQUELS</u>		
(a) REF-EGR (departure reference)	<i>qi qokqo</i>	
(b) REF-ADV (arrival point)	<i>xi qokqo</i>	
(c) ANK-INF (anchors from bottom)	<i>fioq</i>	
(d) ANK-SUP (anchors from top)	<i>sioq</i>	
(3) <u>ABSENCE</u>		
(a) INT-ABS (interval absence, unison)	<i>ix (zi)</i>	

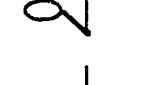
Modificatons and Anchors of Intervals

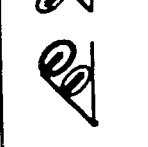
NOM	KOD	SIG
(1) <u>TRANSIENT INTERVALS</u>		
(a) KON-LEN (slow contraction)	<i>fijf</i>	
(b) KON-NOR (normal contraction)	<i>fij</i>	
(c) KON-VEL (rapid contraction)	<i>fijs</i>	
(d) EXP-LEN (slow expansion)	<i>sijf</i>	
(e) EXP-NOR (normal expansion)	<i>sij</i>	
(f) EXP-VEL (rapid expansion)	<i>sijf</i>	
(g) AMP-OPT (optional amplitude)	<i>fsij</i>	
(2) <u>INTERVAL ANCHORS</u>		
(a) INA-INF (lower anchor, down)	<i>fiof</i>	
(b) INA-SUP (lower anchor, up)	<i>fios</i>	
(c) SUA-INF (upper anchor, down)	<i>siof</i>	
(d) SUA-SUP (upper anchor, up)	<i>sios</i>	

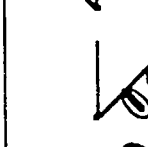
Peripheral and Interjacent Intervals

NOM	KOD	SIG
<u>(1) INTERJACENT INTERVALS</u>		
(a) INO-SEG (interjacent octave segment)	<i>qikw</i>	
(b) INO-REC (interjacent octave reciprocal) (for keyboard glissandos: <i>f</i> - for white keys, <i>s</i> - for black keys)	<i>qükw</i> <i>fükw</i> <i>sükw</i>	
(c) IMO-REC (interjacent multiple octave reciprocal)	<i>qum(qük)w</i>	
(d) ING-INT (interjacent integral step)	<i>qiw</i>	
(e) ING-REC (interjacent step reciprocal, interjacent microstep)	<i>qüw</i>	
(f) IMG-REC (interjacent multiple step reciprocal)	<i>qum(qü)w</i>	
(g) ABS-SEG (number of interjacent segments)	<i>qu -sei</i>	
(h) ABS-CEN (number of cents for every segment)	<i>qu -fei</i>	
<u>(2) INTERJACENT INTERVALS WITH PERIPHERAL INTERVALS</u>		
(a) PIO-SEG (peripheral & interjacent octave segment)	<i>(qik) qikw</i>	
(b) PIO-REC (peripheral & interjacent octave reciprocal)	<i>(qük) qükw</i>	
(c) IMO-REC (peripheral & interjacent multiple octave reciprocal)	<i>(qük)</i> <i>qum(qük)w</i>	
(d) PIG-INT (peripheral & interjacent integral step)	<i>(qi) qiw</i>	
(e) PIG-REC (peripheral & interjacent step reciprocal, peripheral & interjacent microstep)	<i>(qü) qüw</i>	
(f) PIM-REC (peripheral & interjacent multiple step reciprocal)	<i>(qü)</i> <i>qum(qü)w</i>	

APPENDIX 36

Conversion of a 24-Tone Scale

(1) TRANOT

STAFF NOTATION

NAMES

- c natural
- c quarter-sharp
- c sharp
- d quarter-flat
- d natural
- d quarter-sharp
- d sharp
- e quarter-flat
- e natural
- e quarter-sharp
- f natural
- f quarter-sharp
- f sharp
- g quarter-flat
- g natural
- g quarter-sharp
- g sharp
- a quarter-flat
- a natural
- a quarter-sharp
- a sharp
- b quarter-flat
- b natural
- b quarter-sharp
- c natural

(2) PANOT

DYS-NOT (disk notation)

KOD (code)

- zo
- zo-bös
- to
- bo-böf
- bo
- bö-bös
- lo
- ro-böf
- ro
- ro-bös
- co
- co-bös
- go
- po-böf
- po
- po-bös
- vo
- no-böf
- no
- no-bös
- do
- ho-böf
- ho
- ho-bös
- zo

SIG (signal)

APPENDIX 37

A Sample of Microtonal Topography

		M I C R O T O N E S									
TRANOT	PANOT	CENTS	STEPS	TRANOT 1/x L (up)	PANOT representing 1/x degree (up)	TRANOT 1/x L (dn)	PANOT representing 1/x degree (dn)	TRANOT 1/x L (up)	PANOT representing 1/x degree (up)	TRANOT 1/x L (dn)	PANOT representing 1/x degree (dn)
	DYSNOT		DEGREES	DYSNOT	KODNOT	DYSNOT	KODNOT	DYSNOT	KODNOT	DYSNOT	KODNOT
		400		(whole tone up)	ro		ro		ro		ro
		375		3/4 tone up	lohumiös (2/3° up)		roröf (1/4° dn)		roröf (1/4° dn)		rolöf (1/3° dn)
		366+			lobös (1/2° up)		roböf (1/2° dn)		roböf (1/2° dn)		robumiöf (2/3° dn)
		350			lorös (1/4° up)		rolumröf (3/4° dn)		rolumröf (3/4° dn)		rolöf (1/3° dn)
		333+			lo		loröf (1/4° dn)		loröf (1/4° dn)		lo
		325			lobumiös (2/3° up)		loböf (1/2° dn)		loböf (1/2° dn)		lobumiöf (2/3° dn)
		300		1/2 tone up	lo		lobumröf (3/4° dn)		lobumröf (3/4° dn)		loböf (1/2° dn)
		275		1/4 tone up	bolös (1/3° up)		loböf (1/2° dn)		loböf (1/2° dn)		loböf (1/2° dn)
		266+			borös (1/4° up)		loböf (1/2° dn)		loböf (1/2° dn)		loböf (1/2° dn)
		250			bo		loböf (1/2° dn)		loböf (1/2° dn)		loböf (1/2° dn)
		233+			bo		loböf (1/2° dn)		loböf (1/2° dn)		loböf (1/2° dn)
		225			bo		loböf (1/2° dn)		loböf (1/2° dn)		loböf (1/2° dn)
		200			bo		loböf (1/2° dn)		loböf (1/2° dn)		loböf (1/2° dn)



APPENDIX 38

18- and 36-Tone Scales

(1) 18 - Tone Scale

T R A N O T

INT-SIT



tik-bumlüw

or:

SEG-SIT



-- (rok) zo --
 -- zo (bi) -lös --
 -- zo (bi) bum-lös --
 -- (rok) bo --
 -- bo (bi) -lös --
 -- bo (bi) bum-lös --
 -- (rok) ro --
 -- ro (bi) -lös --
 -- ro (bi) bum-lös --
 -- (rok) go --
 -- go (bi) -lös --
 -- go (bi) bum-lös --
 -- (rok) vo --
 -- vo (bi) -lös --
 -- vo (bi) bum-lös --
 -- (rok) do --
 -- do (bi) -lös --
 -- do (bi) bum-lös --
 -- (cok) do --

(2) 36 - Tone Scale

P A N U M

INT-SIT



tik-lüw

or:

SEG-SIT



-- (rok) zo --
 -- zo - lös --
 -- zo - bum-lös --
 -- (rok) to --
 -- to - lös --
 -- to - bum-lös --
 -- (rok) bo --
 -- bo - lös --
 -- bo - bum-lös --
 -- (rok) lo --
 -- lo - lös --
 -- lo - bum-lös --
 -- (rok) ro --
 -- ro - lös --
 -- ro - bum-lös --
 -- (rok) co --
 -- co - lös --
 -- co - bum-lös --
 -- (rok) go --
 -- go - lös --
 -- go - bum-lös --
 -- (rok) po --
 -- po - lös --
 -- po - bum-lös --
 -- (rok) vo --
 -- vo - lös --
 -- vo - bum-lös --
 -- (rok) no --
 -- no - lös --
 -- no - bum-lös --
 -- (rok) do --
 -- do - lös --
 -- do - bum-lös --
 -- (rok) ho --
 -- ho - lös --
 -- ho - bum-lös --
 -- (cok) zo --



APPENDIX 39

Representation of a 31-Tone Scale

0, 1, 2, 3, 4, 5, 6, 7, 8, 9, 10, 11, 12, 13, 14, 15, 16, 17, 18, 19, 20, 21, 22, 23, 24, 25, 26, 27, 28, 29, 30, 31.



0, 1, 2, 3, 4, 5, 6, 7, 8, 9, d, h, 10, 11, 12, 13, 14, 15, 16, 17, 18, 19, id, ih, 20, 21, 22, 23, 24, 25, 26, 27.

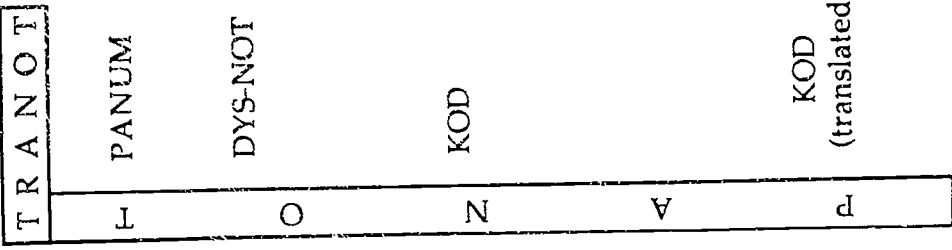
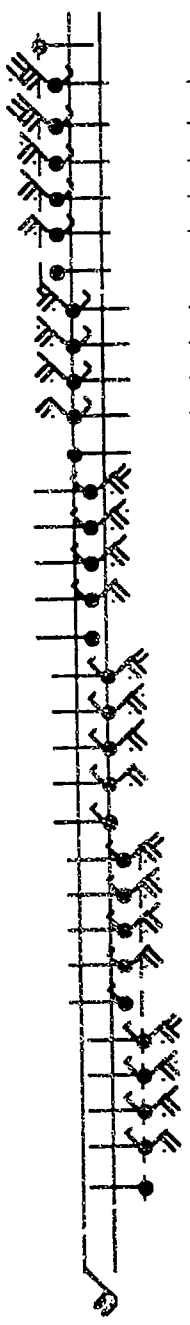

INT-SIT



tik-bumcüw

and:



gük-cüü-bumdiüw

(for the last segment)

or:

SEG-SIT



31 octave-segments; approximate size of each octave segment: 39 cents.

-- 0° (fourth region)	-- (rok) zo	--
0° + 1/5° (of 2 steps) up	-- zo (bi) cös	--
0° + 2/5° (of 2 steps) up	-- zo (bi) bum-cös	--
0° + 3/5° (of 2 steps) up	-- zo (bi) lum-cös	--
0° + 4/5° (of 2 steps) up	-- zo (bi) rum-cös	--
-- 2° (fourth region)	-- (rok) bo	--
2° + 1/5° (of 2 steps) up	-- bo (bi) cös	--
2° + 2/5° (of 2 steps) up	-- bo (bi) bum-cös	--
2° + 3/5° (of 2 steps) up	-- bo (bi) lum-cös	--
2° + 4/5° (of 2 steps) up	-- bo (bi) rum-cös	--
-- 4° (fourth region)	-- (rok) ro	--
4° + 1/5° (of 2 steps) up	-- ro (bi) cös	--
4° + 2/5° (of 2 steps) up	-- ro (bi) bum-cös	--
4° + 3/5° (of 2 steps) up	-- ro (bi) lum-cös	--
4° + 4/5° (of 2 steps) up	-- ro (bi) rum-cös	--
-- 6° (fourth region)	-- (rok) go	--
6° + 1/5° (of 2 steps) up	-- go (bi) cös	--
6° + 2/5° (of 2 steps) up	-- go (bi) bum-cös	--
6° + 3/5° (of 2 steps) up	-- go (bi) lum-cös	--
6° + 4/5° (of 2 steps) up	-- go (bi) rum-cös	--
-- 8° (fourth region)	-- (rok) vo	--
8° + 1/5° (of 2 steps) up	-- vo (bi) cös	--
8° + 2/5° (of 2 steps) up	-- vo (bi) bum-cös	--
8° + 3/5° (of 2 steps) up	-- vo (bi) lum-cös	--
8° + 4/5° (of 2 steps) up	-- vo (bi) rum-cös	--
-- d° (fourth region)	-- (rok) dc	--
d° + 1/5° (of 2 steps) up	-- do (bi) cös	--
d° + 2/5° (of 2 steps) up	-- do (bi) bum-cös	--
d° + 3/5° (of 2 steps) up	-- do (bi) lum-cös	--
d° + 4/5° (of 2 steps) up	-- do (bi) rum-cös	--
-- 0° (fifth region)	-- (cok) zo	--



APPENDIX 40

Space Signatures

(SPA - SIT)

INT-SIT
(interval signature)

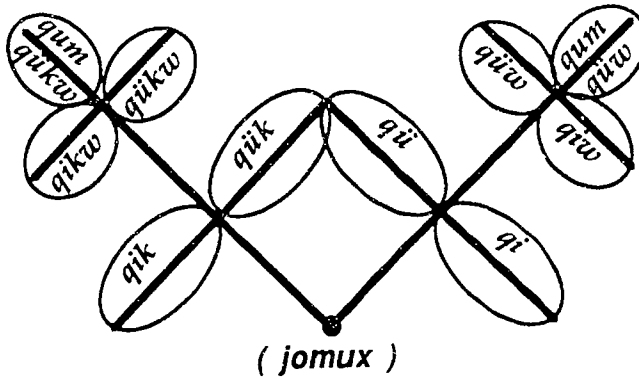

SEG-SIT
(segment signature)

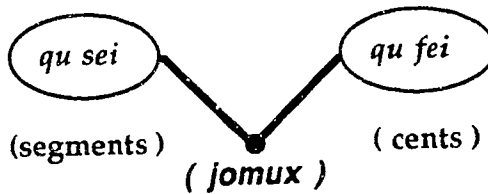

KAL-SIT
(calibration or pitch signature)

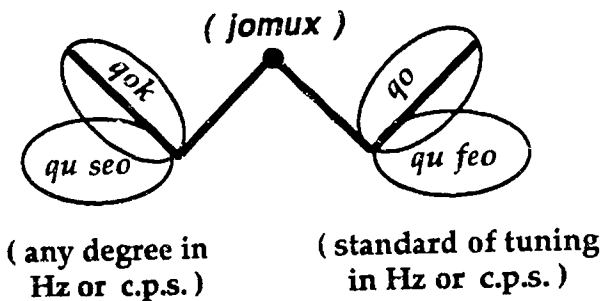

SPA-SIT
(space signature)

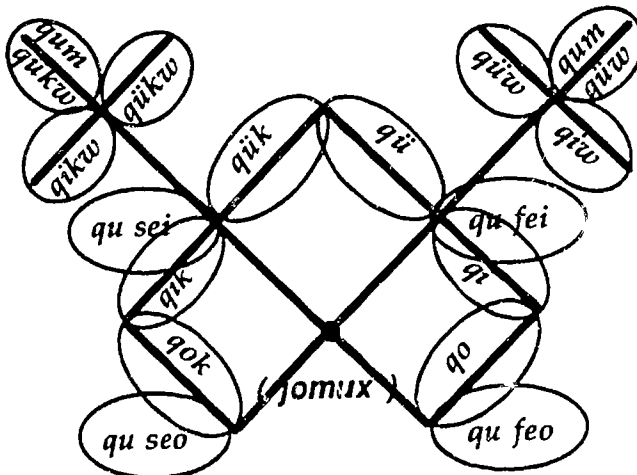

Collection of Spatial Signals

(SPA - KOL)

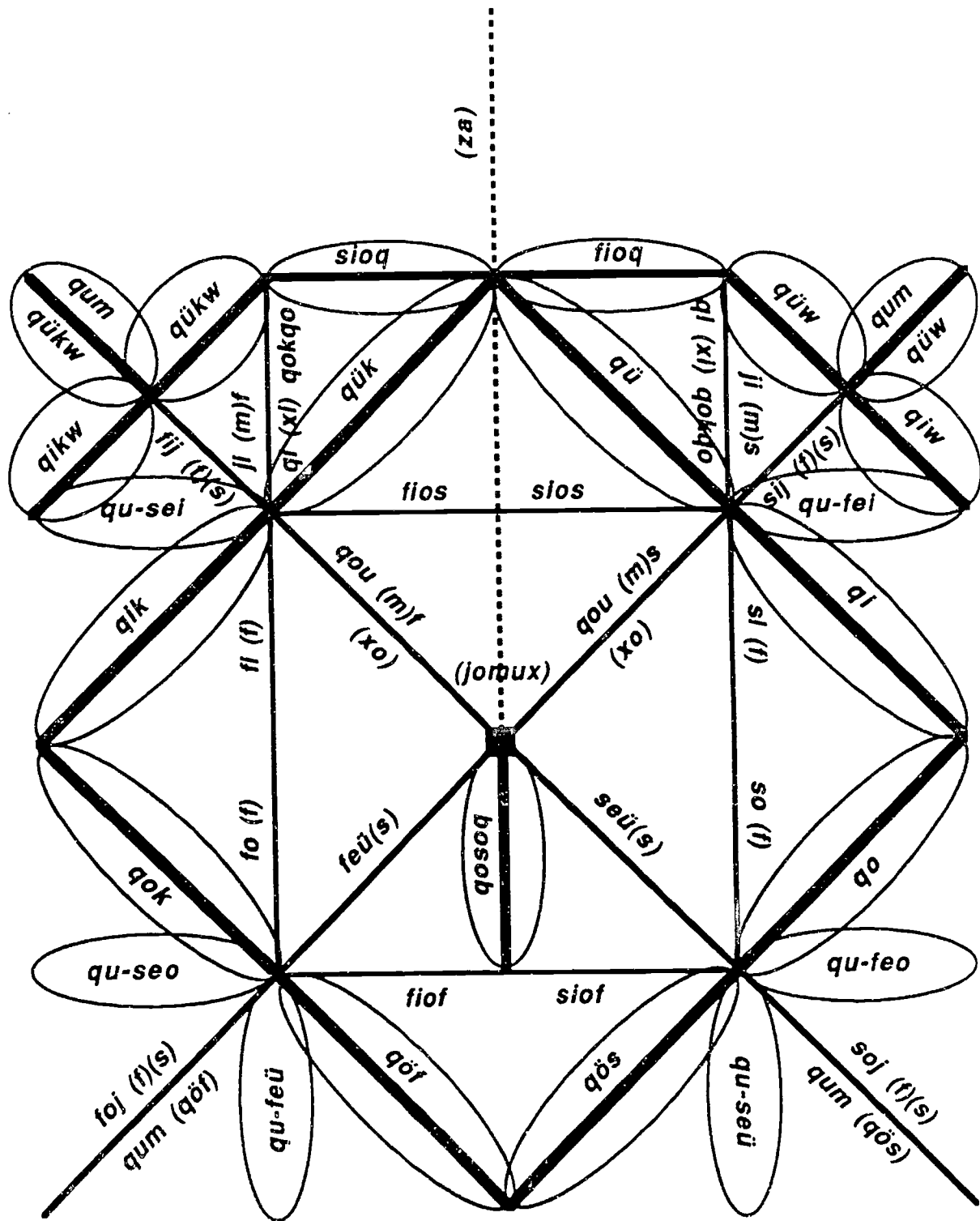

APPENDIX 42

Placement of Dynamic Levels













NOM		KOD	SIG
(a)	(TEM-NUX) (time hub) DYN-NUX (dynamics hub) (normal position) (SPA-NUX) (space hub)	(jamux) jymux (jomux)	
(b)	INI-MOL (initial weak level)	(fu)qy	
(c)	INI-FOR (initial strong level)	(su)qy	
(d)	INI-KAP (initial, in open field) (score top placement) (non-invertible) (score middle placement) (score bottom placement)	qyos qyo qyof	
(e)	INI-ABS (initial, absolute level in decibels)	qu-sey	
(f)	INI-KOM (comparative level; beginning)	fyq	
(g)	MOL-NOR (normally weak accent)	fy	
(h)	MOL-EXT (extremely weak accent)	fyf	
(i)	FOR-NOR (normally strong accent)	sy	
(j)	FOR-EXT (extremely strong accent)	syf	
(k)	DES-OPT (descriptive optional accent)	fsy	
(l)	TRA-MOL (intra weak level)	(fu)qyw	
(m)	TRA-FOR (intra strong level)	(su)qyw	
(n)	TRA-ABS (intra absolute level in decibels)	qu-seyw	
(o)	TER-MOL (terminal weak level)	(fu)qym	
(p)	TER-FOR (terminal strong level)	(su)qym	
(q)	TER-ABS (terminal, absolute level in decibels)	qu-seym	
(r)	TER-KOM (comparative level; ending)	syq	

Fluctuating Dynamics

NOM	KOD	SIG
<u>(1) DECREASE</u>		
(a) TER-LED (inter, slow decrease)	<i>fyjf</i>	
(b) TER-NOD (inter, ordinary decrease)	<i>fyj</i>	
(c) TER-VED (inter, rapid decrease)	<i>fyjs</i>	
(d) KOM-LED (intra beginning, slow decrease)	<i>fufyjf</i>	
(e) KOM-NOD (intra beginning, ordinary decrease)	<i>fufyj</i>	
(f) KOM-VED (intra beginning, rapid decrease)	<i>fufyjs</i>	
(g) FIN-LED (intra ending, slow decrease)	<i>sufyjf</i>	
(h) FIN-NOD (intra ending, ordinary decrease)	<i>sufyj</i>	
(i) FIN-VED (intra ending, rapid decrease)	<i>sufyjs</i>	
<u>(2) INCREASE</u>		
(a) TER-LEK (inter, slow increase)	<i>syjf</i>	
(b) TER-NOK (inter, ordinary increase)	<i>syj</i>	
(c) TER-VEK (inter, rapid increase)	<i>syjs</i>	
(d) KOM-LEK (intra beginning, slow increase)	<i>fusyjf</i>	
(e) KOM-NOK (intra beginning, ordinary increase)	<i>fusyj</i>	
(f) KOM-VEK (intra beginning, rapid increase)	<i>fusyjs</i>	
(g) FIN-LEK (intra ending, slow increase)	<i>susyjf</i>	
(h) FIN-NOK (intra ending, ordinary increase)	<i>susyj</i>	
(i) FIN-VEK (intra ending, rapid increase)	<i>susyjs</i>	
<u>(3) LIMIT and OTHERS</u>		
(a) AMP-TER (inter termination)	<i>fsyx</i>	
(b) DYN-OPT (optional dynamics)	<i>xy</i>	
(c) DYN-ABS (absence, silent key depression, etc.)	<i>yx</i>	

APPENDIX 44

Table of Dynamics

NOM	Decibels	KOD	SIG
(1) MOL-DEG (SOFTER LEVELS)	(approx.)	(fu)qy	(for initial levels only)
(a) ppppp (almost inaudible)	1 +	zy	
(b) pppp (extremely soft)	10 +	ty	
(c) ppp (radically soft)	20 +	by	
(d) pp (very soft)	30 +	ly	
(e) p (soft)	40 +	ry	
(f) mp (moderately soft)	50 +	cy	
(2) FOR-DEG (LOUDER LEVELS)		(su)qy	
(a) mf (moderately loud)	60 +	gy	
(b) f (loud)	70 +	py	
(c) ff (very loud)	80 +	vy	
(d) fff (radically loud)	90 +	ny	
(e) ffff (extremely loud)	100 +	dy	
(f) fffff (almost unbearable)	110 +	hy	

APPENDIX 45





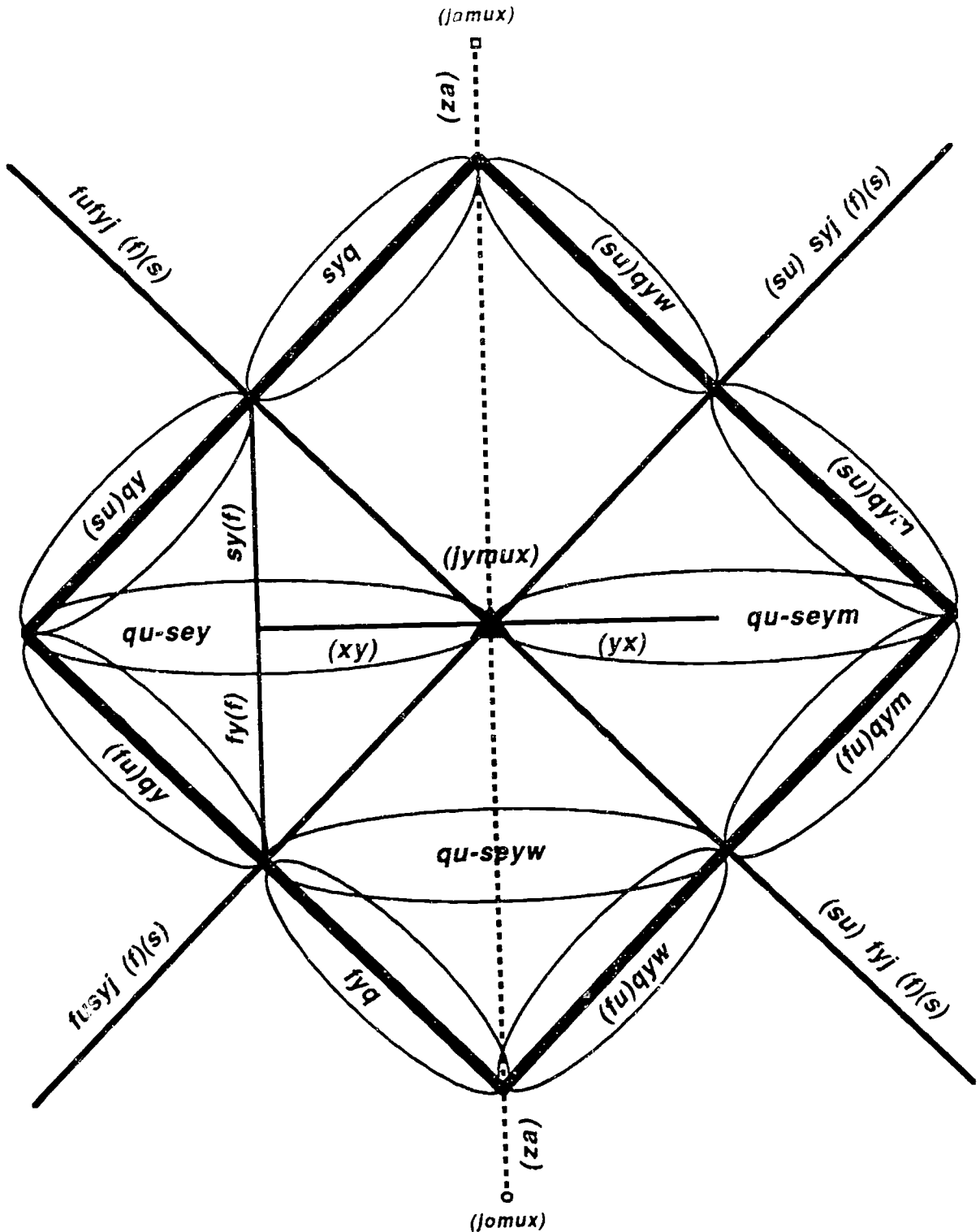









Collection of Dynamic Signals

(DYN - KOL)

















APPENDIX 46

Personnel Assignments

NOM	KOD	SIG
(a) TIM-NUX (timbre hub)	<i>jämux</i>	◆
(1) <u>QUANTIFIED ASSIGNMENT</u>		
(b) QAN-CAR (cardinal amount)	<i>qu-sä</i>	
(c) QAN-ORD (ordinal assignment)	<i>qu-fä</i>	
(2) <u>DESCRIPTIVE ASSIGNMENT</u>		
(d) KON-PAU (few)	<i>fäu</i>	
(e) KON-MIP (very few)	<i>fäuf</i>	
(f) KON-MUL (many)	<i>säu</i>	
(g) KON-MAM (very many)	<i>säus</i>	
(h) KON-NOR (customary)	<i>fsäu</i>	
(3) <u>COMPARATIVE ASSIGNMENT</u>		
<u>Specific:</u>		
(i) REF-MUL (specific multiple)	<i>qäu</i>	
(j) REF-DIV (specific division)	<i>äuq</i>	
<u>Indefinite:</u>		
(k) MIS-MIN (slightly fewer)	<i>fufäu</i>	
(l) MIS-MAX (considerably fewer)	<i>fufäuf</i>	
(m) MAS-MIN (slightly more)	<i>sufäu</i>	
(n) MAS-MAX (considerably more)	<i>sufäus</i>	
(o) IND-PRO (proximate)	<i>fsäuufs</i>	

APPENDIX 47

Spectra Distinction and Symbols Delimitation

NOM	KOD	SIG
(1) <u>QUANTIFIED HARMONICS</u>		
(a) QAN-OUT (output)	<i>qä</i>	
(b) QAN-PAR (partial)	<i>äq</i>	
(2) <u>DESCRIPTIVE HARMONICS</u>		
(c) SPA-SIM (sparse, simple)	<i>fä</i>	
(d) SPA-SIS (sparse, very simple)	<i>fäf</i>	
(e) DEN-KOM (dense, complex)	<i>sä</i>	
(f) DEN-KOS (dense, very complex)	<i>säs</i>	
(g) DES-BAL (balanced)	<i>fsä</i>	
(3) <u>INHARMONICS</u>		
(h) NOT-MIN (barely noticeable)	<i>fäx</i>	
(i) NOT-MAX (quite noticeable)	<i>sufäx</i>	
(j) DOM-MOD (moderately dominant)	<i>säx</i>	
(k) DOM-FOR (strongly dominant)	<i>susäx</i>	
(4) <u>SYMBOLS DELIMITATION</u>		
(l) SIN-ART (for single articulation)	<i>jäj</i>	mark or text
(m) SIN-TRA (for page breaks, staff transfers, etc.)	<i>jäjfs</i>	(mark or text)
(n) ART-KOM (beginning of articulations)	<i>jäjz</i>	 mark or text
(o) KOM-TRA (beg. for page breaks, staff transfers, etc.)	<i>jäjzuf</i>	 mark or text
(p) ART-FIN (ending of articulations)	<i>jäyx</i>	mark or text 
(q) FIN-TRA (end. for page breaks, staff transfers, etc.)	<i>jäyxus</i>	mark or text 

Media, Voice and Selected Acoustic Instruments
--

Section A

PRIMARY MEDIUM

SOLO - alone
 ENSE - ensemble
 DUET - duet
 TRIO - trio
 KVAR - quartet
 KVIN - quintet
 SEXT - sextet
 SEPT - septet

VOX - voice

MULV - woman's voice
 SOPO - soprano
 MESO - mezzo-soprano
 ALTO - (contr)alto

PUEV - boy's voice

VIRV - man's voice

TENO - tenor
 BATO - baritone
 BASO - bass

VENT - wind instruments

LIGU - wood
 PIKO - piccolo (flute)
 FLAU - flute
 FLAD - recorder
 KLAR - clarinet
 KLAB - bass clarinet
 SAXO - saxophone
 BASE - basset horn
 OBOE - oboe
 OBOA - oboe d'amore
 OBOK - oboe da caccia
 KORI - English horn
 FAGO - bassoon
 KOFA - contrabassoon
 PIFA - shawm
 KROM - crumhorn
 BOMB - bombard
 RANK - ranket
 HEKE - heckelphone
 SARU - sarrusophone

OKTE - octet

NONE - nonet

KORO - chorus

BAND - band

ORKE - orchestra

SECONDARY MEDIUM

MIKR - amplified

TAPE - tape

FONO - phonograph

FILM - (motion-picture) film

ORIK - brass

TROM - trumpet

KORN - French horn

TRON - trombone

TUBA - tuba

KORT - cornet

FLUG - flugelhorn

EUFO - euphonium

HELI - helicon

SAHO - saxhorn

KLER - bugle

BAHO - bass horn

KORD - string instruments

FRIK - bowing

VINO - violin

VILA - viola

VILO - (violon)cello

VIBA - string bass

VIOL - viol

VIDA - viola d'amore

VIGA - viola da gamba

REBE - rebec

BARY - baryton

KARP - plucking

LAUT - lute

GIT - guitar

MANI - mandolin

VIHU - vihuela

CHYN - chyn

KOTO - koto

ZITE - zither

HARP - harp

PSAL - psaltery

APPENDIX 49

Media, Voice and Selected Acoustic Instruments

Section B

PERK - percussion

TIMP - timpani
 TABO - tabor
 TAMO - snare drum
 TAMI - tambourine
 TEND - tenor drum
 GRAK - bass drum
 TOMT - tom-tom
 ROTM - roto tom
 BONG - bongo
 TAMT - gong
 PIAT - cymbals
 PIAS - suspended cymbal
 KAST - castanets
 KROT - antique cymbals
 FLEX - flexatone
 KAMA - chimes
 KARI - carillon
 TINT - bell
 HERG - cowbells
 TUBF - tubaphone
 TRIA - triangle
 XYLO - xylophone
 MARI - marimba
 XYRI - xylorimba
 GLOK - glockenspiel
 VIFO - vibraphone
 ANVI - anvil
 KALE - wood block
 KLAS - claves
 TEMB - temple blocks
 GUIR - guiro
 RAGA - rattle
 GLAS - glass harmonica
 FLAG - whip
 MARA - maracas
 TURK - Turkish crescent
 CIMB - cimbalom

KLAT - keyboard instruments

ORGA - organ
 HARU - harmonium
 REGA - regal
 ORGO - portative
 ORGI - positive
 AKOR - accordion
 VIRG - virginal
 ÇEMB - harpsichord
 KLA - clavichord
 FORP - fortepiano
 PIAN - piano
 ÇELE - celesta

VARI - various instruments

GREL - sleighbells
 SERL - singing saw
 FIST - whistle
 TARO - tárogató
 ALPO - alphorn
 SIRE - siren
 HARA - harmonica
 ŞENG - sheng
 MAND - mandola
 BANO - banjo
 BALA - balalaika
 UKUL - ukulele
 VINA - vina
 KANU - kanun
 REBE - rebec
 DULS - dulcimer
 KATE - chain
 ZYMB - cymbal star
 MIRL - mirliton
 ARES - sandpaper block
 DOMA - thunder machine
 VEMA - wind machine

APPENDIX 50

Collection of Timbre Signals

(TIM - KOL)

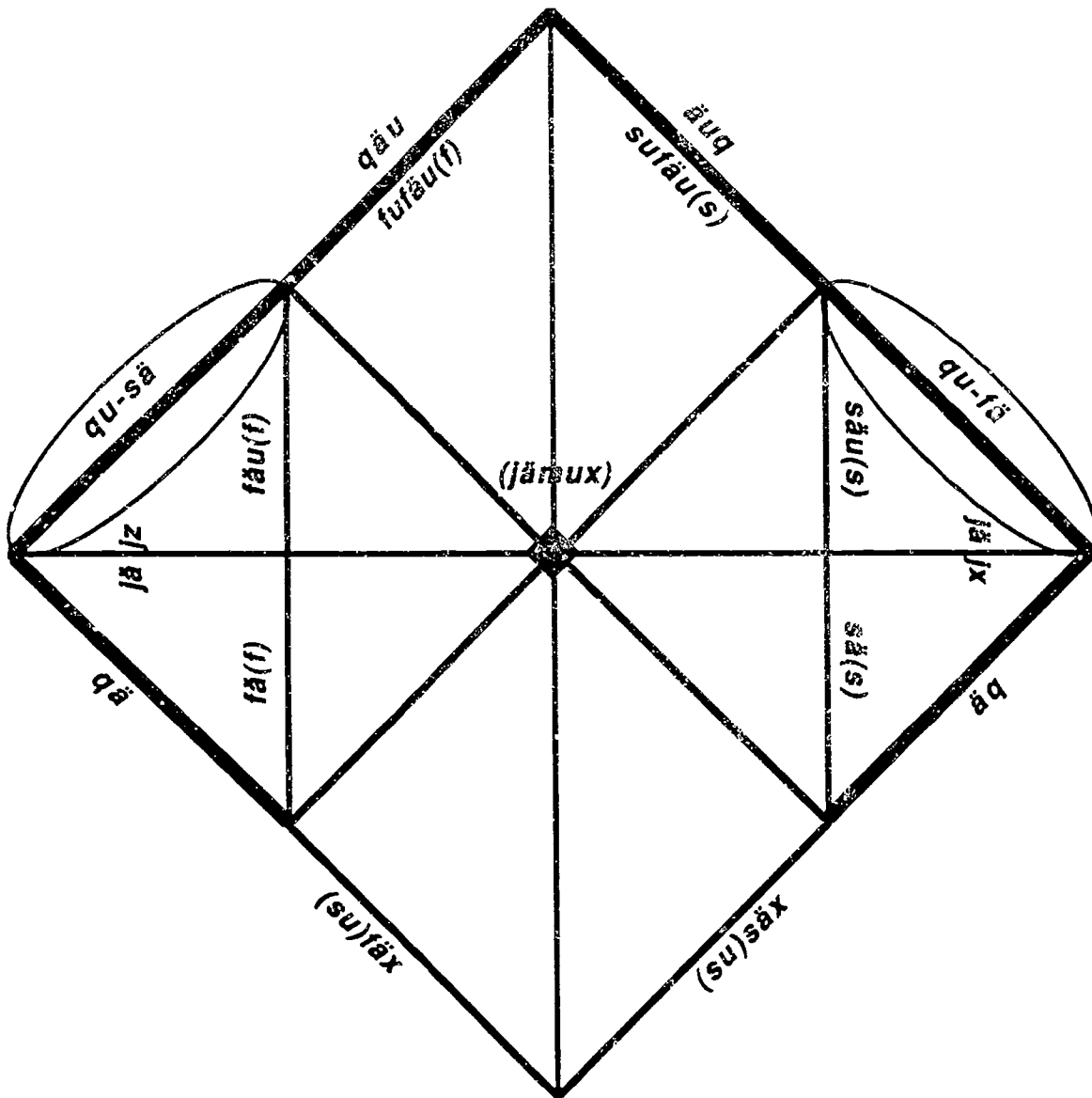

APPENDIX 51 Table of PANUM / PANOT Number Systems

PANUM DECIMAL (DUM)				PANOT ICON	PANUM DUODECIMAL (KUM) (modulo 12)			
NUM	KOD (Formal)	KOD (Informal)	KOD (Optional)		NUM	KOD (Formal)	KOD (Informal)	KOD (Optional)
0	zu(d)	zu		To form ordinal numbers add a dot behind the number or the consonant "t" as the last letter of the code 	0	zu(k)	zu	
1	tu(d)	tu			1	tu(k)	tu	
2	bu(d)	bu			2	bu(k)	bu	
3	lu(d)	lu			3	lu(k)	lu	
4	ru(d)	ru			4	ru(k)	ru	
5	cu(d)	cu			5	cu(k)	cu	
6	gu(d)	gu			6	gu(k)	gu	
7	pu(d)	pu			7	pu(k)	pu	
8	vu(d)	vu			8	vu(k)	vu	
9	nu(d)	nu			9	nu(k)	nu	
10	tu(d)zu	tuzu	du		d	du(k)		
11	tu(d)tu	tutu	dutu		h	hu(k)		
12	tu(d)bu	tubu	dubu		10	tukzu		ku
13	tu(d)lu	tulu	dulu		11	tuktu		kutu
14	tu(d)ru	turu	duru		12	tukbu		kubu
15	tu(d)cu	tucu	ducu		13	tuklu		kulu
16	tu(d)gu	tugu	dugu		14	tukru		kuru
17	tu(d)pu	tupu	dupu		15	tukcu		kucu
18	tu(d)vu	tuvu	duvu		16	tukgu		kugu
19	tu(d)nu	tunu	dunu		17	tukpu		kupu
20	bu(d)zu	buzu			18	tukvu		kuvu
21	bu(d)tu	butu			19	tuknu		kunu
22	bu(d)bu	bubu			1d	tukdu		kudu
23	bu(d)lu	bulu			1h	tukhu		kuhu
24	bu(d)ru	buru		20	bukzu			



S U P P L E M E N T S

SUPPLEMENT 1

STAVAR 1 -- Staff Variant One



1 2 3 4

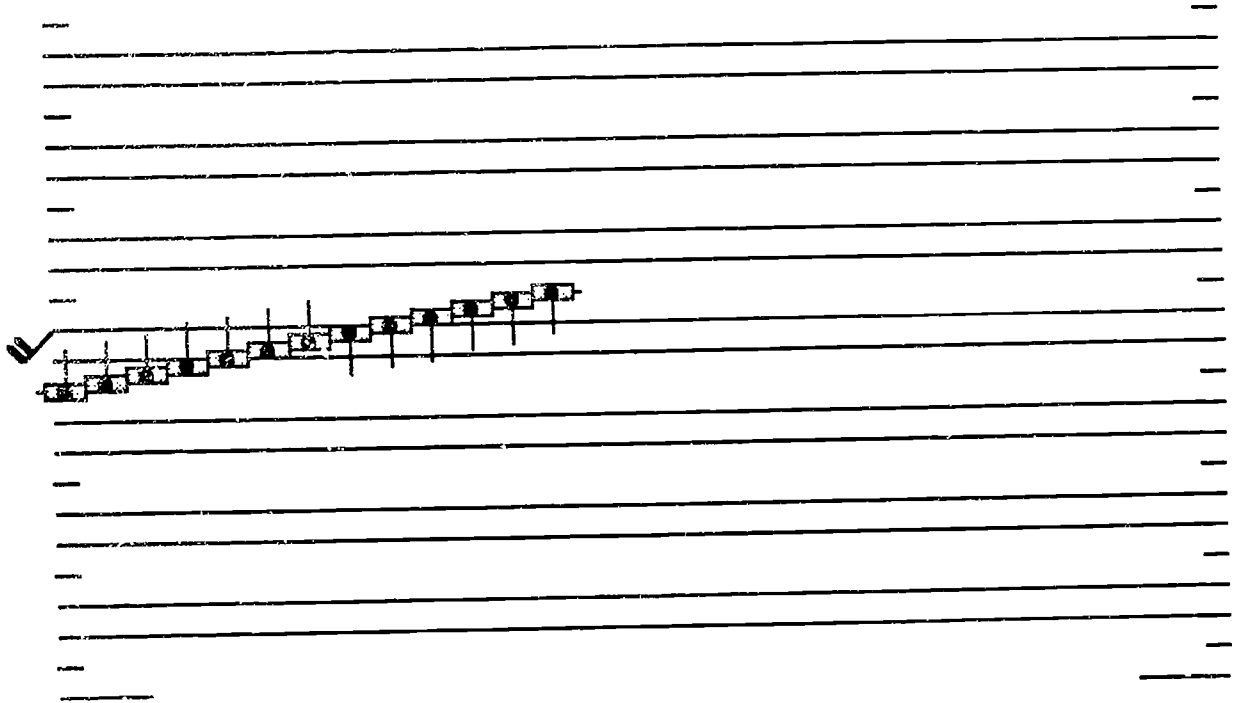

1 2 3 4

SUPPLEMENT 2

STAVAR 2 -- Staff Variant Two



1

2

3

4

A series of horizontal lines, likely representing a musical staff or a data grid. A central section contains a complex, dark, and somewhat illegible pattern that appears to be a scan artifact or a specific data visualization.

1

2

3

4

SUPPLEMENT 3

STAVAR 3 - Staff Variant Three



1

2

3

4

1

2

3

4

SUPPLEMENT 4

STAVAR 4 -- Staff Variant Four



- 1
- 2
- 3
- 4

- 1
- 2
- 3
- 4

SUPPLEMENT 5

STAVAR 5 - Staff Variant Five



1

2

3

4

1

2

3

4

SUPPLEMENT 6

STAVAR 6 - Staff Variant Six



- 1
- 2
- 3
- 4

- 1
- 2
- 3
- 4

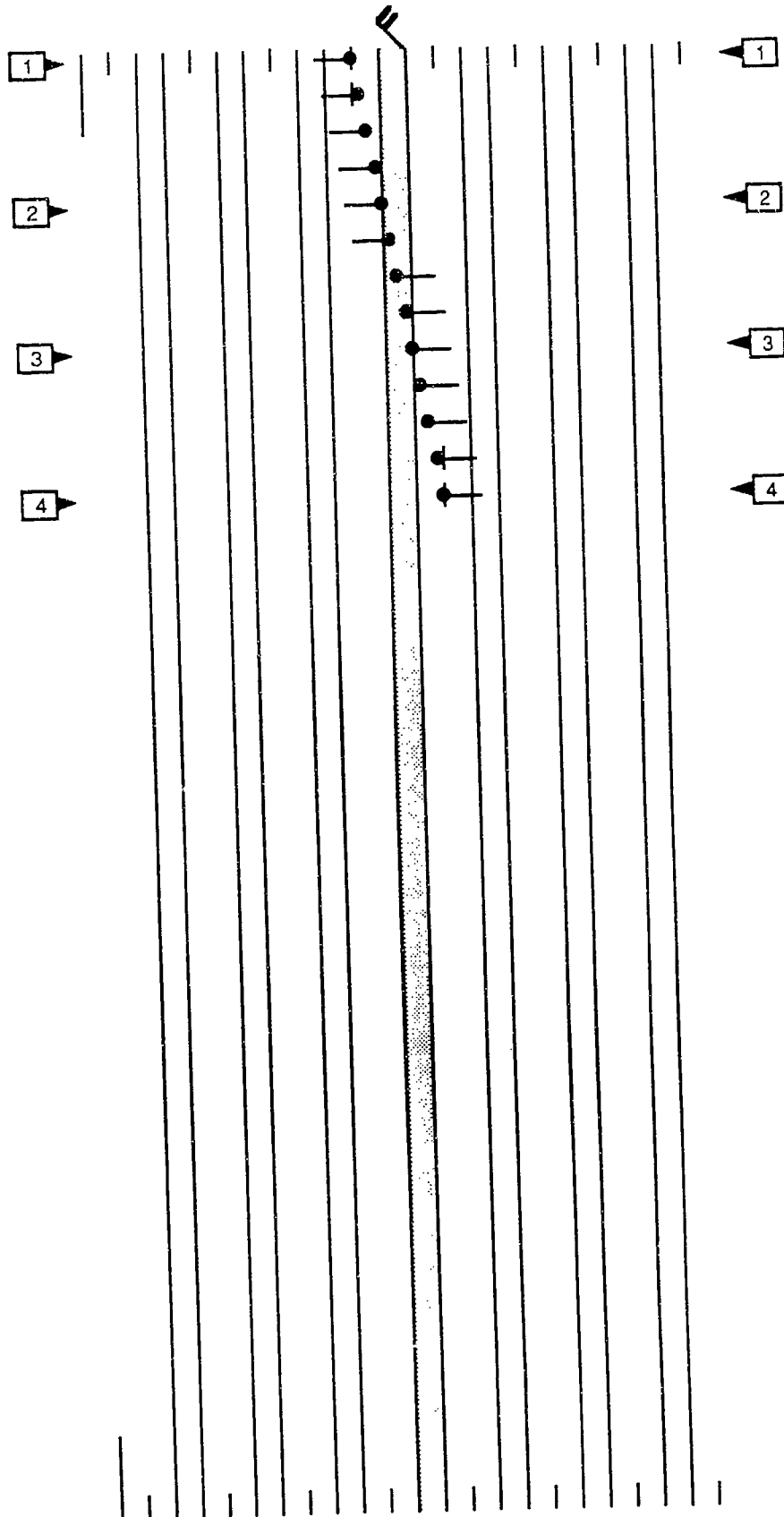

KLAVAR 2 - Variant Two in *Klavarskribo* vertical orientation

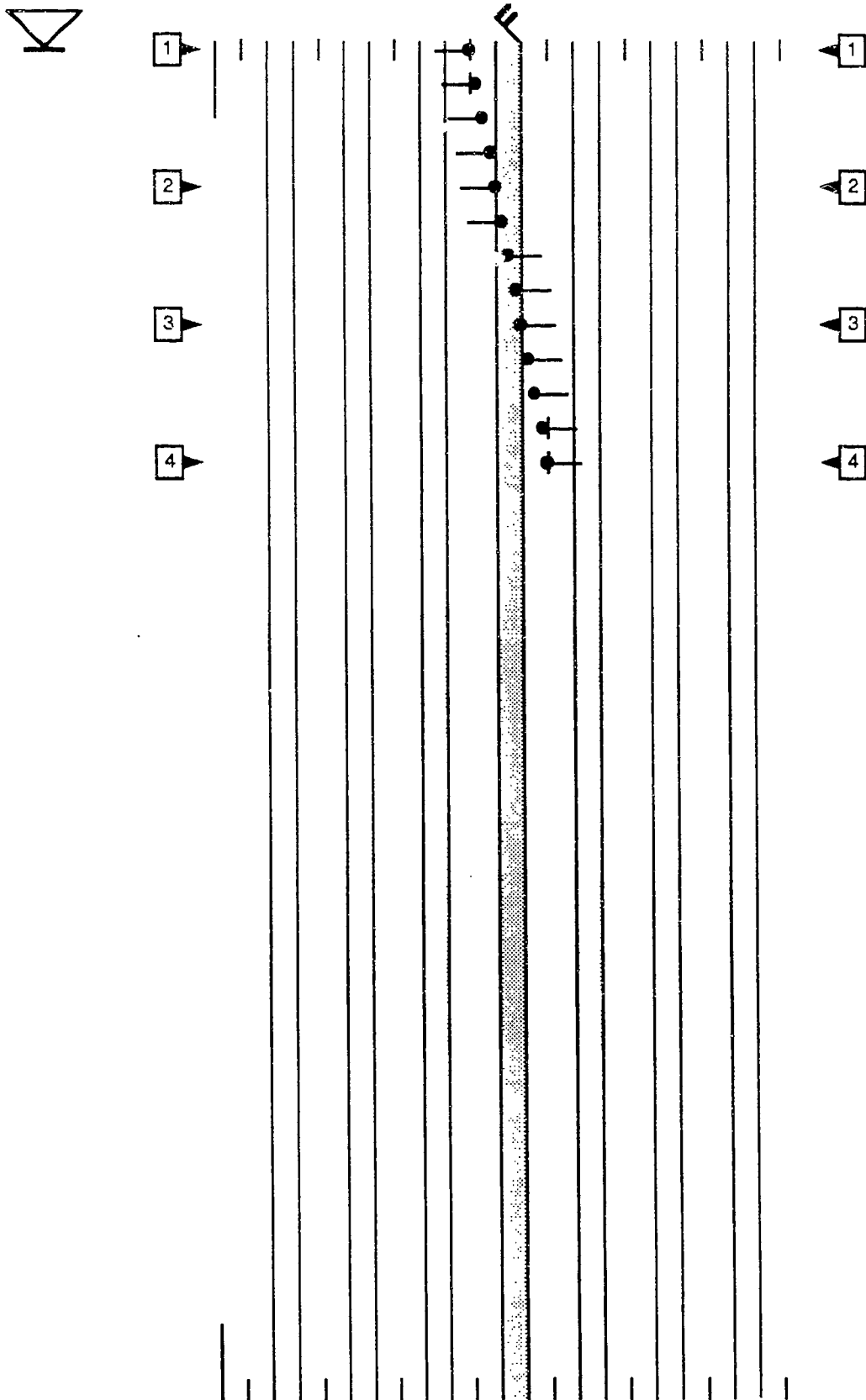

A large grid consisting of approximately 25 vertical lines and many horizontal dashed lines. The grid is mostly empty, with a few small symbols at the bottom corners.

SUPPLEMENT 10 (a)
An excerpt from the opening of St. Matthew Passion (mm. 30-38) by J.S. Bach in TRANOT

30 Flauto traverso I Flauto traverso II Oboe I Oboe II Violino I Violino II Viola Soprano Alto Tenore Bass Organo e continuo

31 Lernet von mir, denn ich bin sanftmütig und demütig.

32

33

34

35

36

37

38

SUPPLEMENT 10 (b)
An excerpt from the opening of *St. Matthew Passion* (mm. 30-38) by J.S. Bach in **TRANOT**

30 31 32 33

Soprano III

Organ & Continuo



SUPPLEMENT 11(a)
An excerpt from the opening of *St. Matthew Passion* (mm. 30-38) by J.S. Bach in **TRANOT**

S11a

Score for Supplement 11(a), mm. 30-38, by J.S. Bach. The score is written in G major and 3/4 time. It features a full orchestra and a vocal soloist. The instruments and parts are: Flauto traverso I, Flauto traverso II, Oboe I, Oboe II, Violino I, Violino II, Viola, Violoncello, Contrabbasso, Soprano, Alto, Tenore, and Organ e Continuo. The vocal part has the lyrics: "am Saum der Erde an geschick". The instrumental parts include various rhythmic patterns and melodic lines. The score is marked with measure numbers 34, 37, and 38. The tempo/mood is indicated as *Andante* at the end of the page.

SUPPLEMENT 11 (b)
An excerpt from the opening of St. Matthew Passion (mm. 30-38) by J.S. Bach in TRANOT

34 37 38

Flauto traverso I
 Flauto traverso II
 Oboe I
 Oboe II
 Violino I
 Violino II
 Viola
 Soprano
 Alto
 Tenore
 Basso
 Organo e Continuo

6 6 6



SUPPLEMENT 12 (a)
An excerpt from the opening of St. Matthew Passion (mm. 30-38) by J.S. Bach in PANOT

30 31 32 33 34

PUEV
FLAU (1)
FLAU (2)
OBOE (1)
OBOE (2)
VINO (1)
VINO (2)
VILA
SOPO & ALTO
TENO
BASO
ORGA
&
Continuo

O R K E
S E E
K O R O

30 31 32 33 34



SUPPLEMENT 12 (b)

An excerpt from the opening of St. Matthew Passion (mm. 30-38) by J.S. Bach in PANOT

The musical score consists of the following parts and measures:

- FLAU (1)**: Measure 30 (rest), Measure 31 (quarter rest), Measure 32 (quarter rest), Measure 33 (quarter rest), Measure 34 (quarter rest).
- FLAU (2)**: Measure 30 (rest), Measure 31 (quarter rest), Measure 32 (quarter rest), Measure 33 (quarter rest), Measure 34 (quarter rest).
- OBOE (1)**: Measure 30 (rest), Measure 31 (quarter rest), Measure 32 (quarter rest), Measure 33 (quarter rest), Measure 34 (quarter rest).
- OBOE (2)**: Measure 30 (rest), Measure 31 (quarter rest), Measure 32 (quarter rest), Measure 33 (quarter rest), Measure 34 (quarter rest).
- VINO (1)**: Measure 30 (rest), Measure 31 (quarter rest), Measure 32 (quarter rest), Measure 33 (quarter rest), Measure 34 (quarter rest).
- VINO (2)**: Measure 30 (rest), Measure 31 (quarter rest), Measure 32 (quarter rest), Measure 33 (quarter rest), Measure 34 (quarter rest).
- VILA**: Measure 30 (rest), Measure 31 (quarter rest), Measure 32 (quarter rest), Measure 33 (quarter rest), Measure 34 (quarter rest).
- SOTO**: Measure 30 (rest), Measure 31 (quarter rest), Measure 32 (quarter rest), Measure 33 (quarter rest), Measure 34 (quarter rest).
- ALTO**: Measure 30 (rest), Measure 31 (quarter rest), Measure 32 (quarter rest), Measure 33 (quarter rest), Measure 34 (quarter rest).
- TENO**: Measure 30 (rest), Measure 31 (quarter rest), Measure 32 (quarter rest), Measure 33 (quarter rest), Measure 34 (quarter rest).
- BASO**: Measure 30 (rest), Measure 31 (quarter rest), Measure 32 (quarter rest), Measure 33 (quarter rest), Measure 34 (quarter rest).
- ORGA**: Measure 30 (quarter note), Measure 31 (quarter note), Measure 32 (quarter note), Measure 33 (quarter note), Measure 34 (quarter note).
- &**: Measure 30 (rest), Measure 31 (quarter rest), Measure 32 (quarter rest), Measure 33 (quarter rest), Measure 34 (quarter rest).
- Continuo**: Measure 30 (rest), Measure 31 (quarter rest), Measure 32 (quarter rest), Measure 33 (quarter rest), Measure 34 (quarter rest).

K O R O 2
S E M
O B K M 2



SUPPLEMENT 13 (a)
An excerpt from the opening of St. Matthew Passion (mm. 30-38) by J.S. Bach in PANOT

ORCHESTER

KOROR

am Stamm des Kreuzes geschrien...
 Kilch... gen... se... he... den Brä... u... gen...
 als wie ein Lamm... sehr ihn... als wie ein Lamm...
 als wie ein Lamm... sehr ihn... als wie ein Lamm...
 als wie ein Lamm... sehr ihn... als wie ein Lamm...

SUPPLEMENT 13 (b)
An excerpt from the opening of St. Matthew Passion (mm. 30-38) by J.S. Bach in PANOT

FLAU (1) FLAU (2) OBOE (1) OBOE (2) VINO (1) VINO (2) VILA SOPO ALTO TENO BASO ORGA & Continuo

Wie? Wie? Wie? Wie? Wie? Wie? Wie? Wie?

34 35 36 37 38



SUPPLEMENT 14 (ab)

An excerpt from the opening of St. Matthew Passion (mm. 30-38) by J.S. Bach in PANOT (Choral Parts)

K O R O 1

SOPO
 O Lamm Gottes un . . . schuld dig
 Lamm, kommt — ihr Töch- - ter, helft mir kla

ALTO
 Lamm, kommt — ihr Töch- - ter, helft mir kla . . . gen, helft mir kla

TENO
 Lamm, kommt — ihr Töch- - ter, helft mir kla gen, helft mir kla

BASO
 Lamm, kommt ihr Töch- - ter, helft mir kla gen, helft mir kla



SUPPLEMENT 15 (ab)
An excerpt from the opening of St. Matthew Passion (mm. 30-38) by J.S. Bach in PANOT (Choral Parts)

KORO 1

PUEV
 34 am Stamm des Kreuzgeschlach... 35 36 37 38
 SOPO
 34 kla... gen, se... het
 35 sieht ihn
 36 als wie ein Lamm, se... het
 37 den Bräu... ti... gam, sieht ihn
 38 als wie ein Lamm

KORO 2

ALTO
 34 kla... gen, se... het
 35 sieht ihn
 36 als wie ein Lamm, se... het
 37 den Bräu... ti... gam, sieht ihn
 38 als wie ein Lamm

TENO
 34 kla... gen, se... het
 35 sieht ihn
 36 als wie ein Lamm, se... het
 37 den Bräu... ti... gam, sieht ihn
 38 als wie ein Lamm

BASO
 34 kla... gen, se... het
 35 sieht ihn
 36 als wie ein Lamm, se... het
 37 den Bräu... ti... gam, sieht ihn
 38 als wie ein Lamm

KORO 2

SOPO
 34 kla... gen, se... het
 35 sieht ihn
 36 als wie ein Lamm, se... het
 37 den Bräu... ti... gam, sieht ihn
 38 als wie ein Lamm

ALTO
 34 kla... gen, se... het
 35 sieht ihn
 36 als wie ein Lamm, se... het
 37 den Bräu... ti... gam, sieht ihn
 38 als wie ein Lamm

TENO
 34 kla... gen, se... het
 35 sieht ihn
 36 als wie ein Lamm, se... het
 37 den Bräu... ti... gam, sieht ihn
 38 als wie ein Lamm

BASO
 34 kla... gen, se... het
 35 sieht ihn
 36 als wie ein Lamm, se... het
 37 den Bräu... ti... gam, sieht ihn
 38 als wie ein Lamm



SUPPLEMENT 16

An excerpt from the opening of St. Matthew Passion (mm. 30-38) by J.S. Bach in PANOT (Condensed Score)

407

SUPPLEMENT 17

An Etude for Piano in f-minor (Op. 25, No. 2) by Chopin in TRANOT

406

0 1 2 3 4 5 6

7 8 9 10 11 12

13 14 15 16 17 18

19 20 21 22 23 24

Agitato

legato

p

Musical score for piano, measures 25-48. The score is written in a grand staff with treble and bass clefs. It features a complex melodic line in the right hand and a supporting bass line in the left hand. The key signature has two flats (B-flat and E-flat). Measure numbers 25, 26, 27, 28, 29, 30, 31, 32, 33, 34, 35, 36, 37, 38, 39, 40, 41, 42, 43, 44, 45, 46, 47, and 48 are indicated in small boxes above the staff. Performance markings include accents (A), piano (p), and a ritardando (rit.) in measure 45. The score concludes with a double bar line in measure 48.

Musical score system 1, measures 49-54. The system consists of two staves. The upper staff contains a melodic line with various rhythmic values and accidentals. The lower staff contains a bass line. A dynamic marking of *mf* is present in measure 50. A tempo marking of *a tempo* is present in measure 51. Measure numbers 49, 50, 51, 52, 53, and 54 are indicated in boxes above the staff.

Musical score system 2, measures 55-60. The system consists of two staves. The upper staff continues the melodic line. The lower staff continues the bass line. A dynamic marking of *mf* is present in measure 57. Measure numbers 55, 56, 57, 58, 59, and 60 are indicated in boxes above the staff.

Musical score system 3, measures 61-66. The system consists of two staves. The upper staff continues the melodic line. The lower staff continues the bass line. Measure numbers 61, 62, 63, 64, 65, and 66 are indicated in boxes above the staff.

Musical score system 4, measures 67-69. The system consists of two staves. The upper staff continues the melodic line. The lower staff continues the bass line. A dynamic marking of *pp* is present in measure 68. Measure numbers 67, 68, and 69 are indicated in boxes above the staff.

SUPPLEMENT 18

An Etude for Piano in f-minor (Op. 25, No. 2) by Chopin in PANOT

414

415

The image displays a musical score for S18.1, organized into two systems. Each system consists of two staves. The first system contains measures 1 through 11, and the second system contains measures 12 through 24. The notation includes various rhythmic values, stems, and beams. Performance markings such as 'K' and 'Y' are placed above specific notes. A diamond-shaped box labeled 'PLAN' is located at the beginning of the first system, with a '53' written above it. The score is presented in a clear, black-and-white format.

NO COPY AVAILABLE

The image displays a musical score for S18.2, organized into two systems. Each system consists of two staves. The first system contains measures 2 through 37, with measure numbers 2, 3, 4, 5, 6, 7, 8, 9, 10, 11, 12, 13, 14, 15, 16, 17, 18, 19, 20, 21, 22, 23, 24, 25, 26, 27, 28, 29, 30, 31, 32, 33, 34, 35, 36, and 37 marked in boxes. The second system contains measures 38 through 49, with measure numbers 38, 39, 40, 41, 42, 43, 44, 45, 46, 47, 48, and 49 marked in boxes. The notation includes various note values, rests, and dynamic markings.

A musical score for a string quartet, consisting of four staves. The score is divided into measures, each numbered in a small box at the beginning of the staff. The measures are numbered 4, 5, 6, 7, 8, 9, 10, 11, 12, 13, 14, 15, 16, 17, 18, 19, 20, 21, 22, 23, 24, 25, 26, 27, 28, 29, 30, 31, 32, 33, 34, 35, 36, 37, 38, 39, 40, 41, 42, 43, 44, 45, 46, 47, 48, 49, 50, 51, 52, 53, 54, 55, 56, 57, 58, 59, 60, 61, 62, 63, 64, 65, 66, 67, 68, 69, 70, 71, 72, 73, 74, 75, 76, 77, 78, 79, 80, 81, 82, 83, 84, 85, 86, 87, 88, 89, 90, 91, 92, 93, 94, 95, 96, 97, 98, 99, 100. The score includes various musical notations such as notes, rests, and dynamic markings. There are also performance markings like 'K' and 'T' above the staves. A large bracketed section at the bottom of the score, spanning measures 63 to 100, contains a complex arrangement of notes and rests, possibly a double bar or a specific performance instruction. The score is presented in a clear, black-and-white format.

SUPPLEMENT 19

An Etude for Piano in f-minor (Op. 25, No. 2) by Chopin in PANOT (*KLAVAR* orientation)



0 PLAN

53

1

2

3

4

5

6

7

8

9

10

11

12

13

14

15

16

17

18

19

20

21

22

23

24





The musical score is organized into four systems, each containing two staves. The measures are numbered as follows:

- System 1: Measures 49, 50, 51, 52, 53, 54.
- System 2: Measures 55, 56, 57, 58, 59, 60.
- System 3: Measures 61, 62, 63, 64, 65, 66.
- System 4: Measures 67, 68, 69.

The notation includes various musical symbols such as notes, rests, and dynamic markings. A large bracket on the right side of the score spans measures 67 through 69.

SUPPLEMENT 20 (a)

Toccata * by Dolly E. Kessner in TRANOT

The musical score is written for piano and consists of 29 measures. It begins with the tempo marking "Allegro" and the dynamic marking "mf". The score is divided into five systems of five measures each. Measure numbers 1 through 29 are indicated in small boxes at the beginning of each measure. The key signature has one sharp (F#) and the time signature is 4/4. The score includes various musical notations such as slurs, accents, and dynamic markings like "p" (piano), "mp" (mezzo-piano), and "poco rit." (poco ritardando). The piece concludes with a fermata over the final note in measure 29.

S20a

* From Progressive Class Piano, 2nd ed. by Elmer Heere, © Copyright 1984 by Alfred Publishing Co. Used with Permission of the Publisher

SUPPLEMENT 20 (b)

Toccata* by Dolly E. Kessner in PANOT

*The original from *Progressive Class Piano*, 2nd ed. by Elmer Heerema, © Copyright 1984 by Alfred Publishing Co. Used with Permission of the Publisher

Toccata * by Dolly E. Kessner in PANOT (KLAVAR orientation)



* The original from *Progressive Class Piano*, 2nd ed. by Elmer Heerema, © Copyright 1984 by Alfred Publishing Co. Used with Permission of the Publisher

SUPPLEMENT 20 (d)

Toccata * by Dolly E. Kessner in PANOT ("beamed" version)

The musical score is presented in two systems, each with five staves. The first system covers measures 1 to 12, and the second system covers measures 13 to 29. Each measure is indicated by a small numbered box at the start of the staff. The notation includes various rhythmic values, beams, and articulation marks. A double bar line is present at the end of measure 29.

* The original from *Progressive Class Piano*, 2nd ed. by Elmer Heerema, © Copyright 1984 by Alfred Publishing Co. Used with Permission of the Publisher