

DOCUMENT RESUME

ED 394 306

FL 023 702

AUTHOR Berman, Paul; And Others
TITLE School Reform and Student Diversity. Case Studies of Exemplary Practices for LEP Students.
INSTITUTION National Center for Research on Cultural Diversity and Second Language Learning, Santa Cruz, CA.; National Clearinghouse for Bilingual Education, Washington, DC.
SPONS AGENCY Office of Bilingual Education and Minority Languages Affairs (ED), Washington, DC.
PUB DATE Aug 95
CONTRACT T292008001
NOTE 204p.; Produced in collaboration with the Institute for Policy Analysis and Research. A glossary and list of references for this document are available on the Internet at: <http://www.ncbe.gwu.edu>
PUB TYPE Reports - Descriptive (141)

EDRS PRICE MF01/PC09 Plus Postage.
DESCRIPTORS Case Studies; Educational Assessment; *Effective Schools Research; English (Second Language); Instructional Effectiveness; *Limited English Speaking; Program Effectiveness; *School Effectiveness; *School Restructuring; *Second Language Learning; Special Needs Students; Student Development
IDENTIFIERS California; Illinois; Massachusetts; Texas

ABSTRACT

This report describes eight exemplary schools serving minority students with Limited English Proficiency (LEP) in Texas, California, Illinois, and Massachusetts. Schools were chosen by nomination. The report is divided into 10 chapters. Chapter 1 provides an introduction to the report, and provides background information on how the eight schools were chosen. Chapters 2 through 9 each present a case study of one of the schools. Each chapter begins with a brief description of the school and community context, along with demographic information. The next section in each chapter portrays a scene from one or more exemplary learning environments illustrated by a diagram--the physical layouts of the classroom or setting followed by a detailed narrative description of the learning environment. Another section of each chapter pinpoints the curricular or instructional features characteristic of the learning environment and the larger school. A diagram summarizes these features and illustrates their relationship to the school's LEP program. A subsequent section highlights significant structural innovations that could be adapted by other schools. The last section of the chapter identifies factors at the district or state level that support the exemplary practices, and concludes with a brief summary of key findings. Chapter 10 provides lessons about exemplary practices and schools serving LEP students. (NAV)

SCHOOL REFORM AND STUDENT DIVERSITY

Case Studies of Exemplary Practices for LEP Students



U.S. DEPARTMENT OF EDUCATION
Office of Educational Resources and Improvement
EDUCATIONAL RESOURCES INFORMATION
CENTER (ERIC)

This document has been reproduced as
received from the person or organization
originating it.

Minor changes have been made to
improve reproduction quality.

Points of view or opinions stated in this
document do not necessarily represent
official OERI position or policy.

PERMISSION TO REPRODUCE AND
DISSEMINATE THIS MATERIAL
HAS BEEN GRANTED BY

Joel Gomez

TO THE EDUCATIONAL RESOURCES
INFORMATION CENTER (ERIC)

*The Institute for Policy Analysis and Research, in collaboration with
the National Center for Research on Cultural Diversity and Second
Language Learning*

11011101

The National Clearinghouse for Bilingual Education (NCBE) is funded by the U.S. Department of Education's Office of Bilingual Education and Minority Languages Affairs (OBEMLA) and is operated under Contract No. T292008001 by The George Washington University, Graduate School of Education and Human Development, Center for Policy Studies. The contents of this publication are reprinted from the NCBE Resource Collection. Materials from the Resource Collection are reprinted "as is." NCBE assumes no editorial or stylistic responsibility for these documents. Nor do the views expressed necessarily reflect the views or policies of the The George Washington University or the U.S. Department of Education. The mention of trade names, commercial products, or organizations does not imply endorsement by the U.S. government. Readers are free to duplicate and use these materials in keeping with accepted publication standards. NCBE requests that proper credit be given in the event of reproduction.

School Reform and Student Diversity
Case Studies of Exemplary Practices for LEP
Students

Paul Berman Catherine Minicucci
Barry McLaughlin Beryl Nelson
Katrina Woodworth

August, 1995

***The Institute for Policy Analysis and Research, in collaboration with
the National Center for Research on Cultural Diversity and Second
Language Learning***

PREFACE

Children who come from cultural and linguistic minority backgrounds often founder in American schools. Many do not gain a solid grounding, either in English reading and writing or mathematics and science, by the time they enter high school. Consequently, as young adults they are inadequately prepared for higher education or for all but the most menial employment.

Solving the challenge of educating language minority students to the high standards we expect of all children requires a willingness to reform the usual practices at many of today's public schools. And new practices, in turn, require a new perspective—one that takes into account linguistic, cognitive, and social/psychological influences on achievement.

To facilitate the process of rethinking and restructuring, the Office of Educational Research and Improvement (OERI) of the U.S. Department of Education issued an RFP to identify and study exemplary approaches to the education of language minority students. This report describes eight exemplary schools serving students with limited English proficiency (LEP). The same case studies are the basis of a complementary volume, *School Reform and Student Diversity: Findings and Conclusions*, which analyzes results across these exemplary sites. Both reports, as well as a technical appendix describing the research design and methodology of the study, are available through OERI. The study also commissioned research papers which have been edited and published as a book, *Language and Learning: Educating Linguistically Diverse Students* (Beverly McLeod, editor, SUNY Press, 1994).

OERI has funded eleven other companion studies that examine different aspects of education reform. The entire set of reports will thus provide a comprehensive description and analysis of reform from the empirical perspective of outstanding practices in the field.

ACKNOWLEDGMENTS

The generous hospitality, cooperation, and patience of the teachers, principals, staff, students, and parents at each of our case study schools made this research possible; we thank those who welcomed us into their school communities and opened their doors to our team of researchers. We have been inspired by their creative approaches to confronting and overcoming the many challenges they face as they work steadily toward this goal. Their optimistic outlook and perseverance will serve as an inspiration to all school professionals as they face very similar challenges.

We came away from each visit deeply impressed by the unfailing commitment that teachers, principals, and staff have made to improving the education and overall well-being of their students and their families. The principals who welcomed us at each school and supported our efforts deserve special mention: Richard Camacho, Linda Vista Elementary School, San Diego, California; Roy Ford, Hollibrook Elementary School, Houston, Texas; Eva Helwing, Inter-American School, Chicago, Illinois; Richard Murphy, Horace Mann Middle School, San Francisco, California; Gloria Polanco-McNealy, Del Norte Heights Elementary School, El Paso, Texas; Leonard Solo, Graham and Parks Alternative Public School, Cambridge, Massachusetts; Carmen Stearns, Harold Wiggs Middle School, El Paso, Texas; and Charles Vidal, Evelyn Hanshaw Middle School, Modesto, California. Outstanding teachers at each of the schools opened their doors to us. In large part this volume represents their experiences; we salute them for their skill and dedication. We would also like to thank the district staff who graciously spent time working with us and provided valuable insight during our site visits.

Several people who assisted us in the conceptualization, design, implementation, and dissemination of this study merit our gratitude and recognition. First, we would like to thank our contract monitor Carol Chelemer, at the U.S. Department of Education, Office of Educational Research and Improvement, for her constant support, patience, and interest in our work. We would also like to thank Rene Gonzalez, our former contract monitor at OERI.

We would also like to express our appreciation to the Study Advisors—Courtney Cazden, Harvard University; Eugene Cota-Robles, University of California, Berkeley (Emeritus); Ronald Gallimore, University of California, Los Angeles; Kenji Hakuta, Stanford University; Henry Levin, Stanford University; Walter Secada, University of Wisconsin, Madison; Catherine Snow, Harvard University; and Merrill Swain, The Ontario Institute for Studies in Education. These talented scholars assisted us with the conceptualization of the study, reviewed key products, and helped with the selection of sites.

Other invaluable members of the study team were Stephanie Dalton and Roland Tharp of the National Center for Research on Cultural Diversity and Second Language Learning at the University of California at Santa Cruz, and Faith Conant of Princeton, New Jersey, who conducted classroom observation in Haitian Creole classes at one of the study sites. We would also like to express our gratitude to Sabrina Maras for capturing our descriptions of classroom settings with her sketches and to Glenn Fieldman for her careful editing of this manuscript.

Finally, the study team would like to recognize the hundreds of people who nominated schools during the initial phase of the study's site selection process. We would like to acknowledge the following individuals for contributing to our initial pool of nominated sites:

Estella Acosta
Bilingual Teacher Training
Programs
Office of the Orange County
Superintendent of Schools
Costa Mesa, CA

Alice Addison
School Improvement
California Department of
Education
Sacramento, CA

Nilda M. Aguirre
Multicultural Education
Department
School Board of Broward
County
Ft. Lauderdale, FL

Tim Allen
San Diego City Unified
School District
San Diego, CA

Shirley Altick
Washoe County Schools
Reno, NV

Diana G. Anderson
Multifunctional Resource
Center
San Diego, CA

Richard C. Anderson
Reading Research and
Education Center
University of Illinois
Champaign, IL

Arthur N. Applebee
National Research Center on
Literature Teaching and
Learning
State University of New York
Albany, NY

Maria Arias
Socorro Independent School
District
El Paso, TX

Elena Arriola
Bilingual Teacher Training
Programs
Office of the Los Angeles
County Superintendent of
Schools
Downey, CA

Kathryn H. Au
American Association of
Higher Education
Washington, DC

Leonard Baca
Bueno Center for
Multicultural Education
School of Education
University of Colorado
Boulder, CO

Eva Baker
National Research Center on
Assessment, Evaluation, and
Testing
University of California
Los Angeles, CA

John Bargnesi
Black Rock Academy
Buffalo, NY

Sylvia Barrios
North Dorchester Middle
School
Hurlock, MD

Lilia Bartolome
Harvard Graduate School of
Education
Cambridge, MA

Clara Basch
Illinois State Board of
Education
Springfield, IL

Carol Beaumont
University of California
Berkeley, CA

Sue Beaugard
Galef Institute
Los Angeles, CA

Charles D. Beck Jr.
The Education Diffusion
Group
Denver, CO

Adelyn Becker
Multifunctional Resource
Center
Providence, RI

John Berriozaobal
University of Texas
San Antonio, TX

Sandra Berry
Department of Education
Juneau, AL

Jomills H. Braddock II
Center for Research on
Effective Schooling for
Disadvantaged Students
Johns Hopkins University
Baltimore, MD

Vangie Bradshaw
Culver City Unified School
District
Culver City, CA

Judy Bramlett
Education Service Region VI
Dallas, TX

Marcia Brechtel
Guided Language
Acquisition
Fountain Valley School
District
Fountain Valley, CA

Mary E. Brenner
Graduate School of
Education
University of California
Santa Barbara, CA

Sylvia Brooks-Brown
Baltimore County Public
Schools
Baltimore, MD

Jere Brophy
Center for the Learning and
Teaching of Elementary
Subjects
Michigan State University
East Lansing, MI

Cynthia Brown
Council of Chief State
School Officers
Washington, DC

Sandy Brown
Charlotte/Mecklenburg
Schools
Charlotte, NC

Liz Brown
Yukon-Koyukuk School
District
Nenana, AK

Ron Bryant
Orange County Schools
Orlando, FL

Barbara Cabrillo
Hacienda-La Puente Unified
School District
City of Industry, CA

Peter Cappelli
National Center on the
Educational Quality of the
Workforce
University of Pennsylvania
Philadelphia, PA

Sue Carpenter
Florida Department of
Education
Tallahassee, FL

Carol Carr-Colglazier
Marin Teachers' Learning
Cooperative
Office of the Marin County
Superintendent of Schools
San Rafael, CA

Argelia Carreon
El Paso Independent School
District
El Paso, TX

Lupe Castillo
New Mexico Department of
Education
Santa Fe, NM

Mary Cazabon
Cambridge Public Schools
Cambridge, MA

Courtney Cazden
Harvard Graduate School of
Education
Cambridge, MA

Susan Chavez
Multifunctional Resource
Center
San Diego, CA

Donna Christian
Center for Applied
Linguistics
Washington, DC

Lorraine Clayton
Florida Department of
Education
Tallahassee, FL

Grace Coates
Project EQUALS
Lawrence Hall of Science
Berkeley, CA

Trudy Collier
Maryland Department of
Education
Baltimore, MD

Deanna Cortez
Bilingual Education and
Indian Programs
Utah Office of Education
Salt Lake City, UT

Eugene Cota-Robles
University of California
Berkeley, CA

Gilberto Jose Cueva
School of Education
University of Miami
Coral Gables, FL

Theresa Dale
Baltimore City Public
Schools
Baltimore, MD

Mary Lynda Daley
University of Massachusetts
Boston, MA

Arlene Dannenberg
Salem Public Schools
Salem, MA

Phil Daro
Office of the President
University of California
Berkeley, CA

Lucia David
Institute for Learning and
Teaching
University of Massachusetts
Boston, MA

Don Davies
Center on Families,
Communities, Schools, and
Children's Learning
Boston University
Boston, MA

Denise De La Rosa Salazar
National Council of La Raza
Los Angeles, CA

Michael de la Torre
Bilingual Education
Nevada Department of
Education
Carson City, NV

David R. Delgado
Bilingual Teacher Training
Programs
Office of the Monterey
County Superintendent of
Schools
Salinas, CA

Myrna Delgado
Department of Education
Harrisburg, PA

David Dolson
Bilingual Education Office
California Department of
Education
Sacramento, CA

John Dominguez
Migrant/Bilingual
Education
Van Buren Intermediate School
District
Lawrence, MI

Dora S. Dominguez
Migrant Education Program
Michigan Department of
Education
Lansing, MI

Jan Drum
Stanley Foundation
Muscatine, IA

Barbara Duffy
Association of California
School Administrators
Burlingame, CA

Thaddeus Dumas
Middle Grades Office
California Department of
Education
Sacramento, CA

Costanza Eggers-Pierda
Institute for Learning &
Teaching
University of Massachusetts
Boston, MA

Andrea England
Instruction Division
Texas Education Agency
Austin, TX

Ruben Espinosa
Multifunctional Resource
Center
San Diego, CA

Pola Espinoza
Alianza Elementary School
Watsonville, CA

Mary Ester Bernal
San Antonio Independent
School District
San Antonio, TX

Joanne Foster
El Paso Independent School
District
El Paso, TX

Sarah W. Freedman
National Center for the Study
of Writing and Literacy
University of California
Berkeley, CA

Susan Fuhrman
Center for Policy Research in
Education
Rutgers University
New Brunswick, NJ

J. Michael Gaddis
Office of Federal Relations
and Instructional Services
Colorado Department of
Education
Denver, CO

Annette Gaddis
Fort Lupton School District
Fort Lupton, CO

Alejandro Gallard
Science Education
Florida State University
Tallahassee, FL

Ronald Gallimore
Department of Psychiatry &
Behavioral Sciences
University of California
Los Angeles, CA

Patricia Gandara
Division of Education
University of California
Davis, CA

Yvonne Garcia
Multifunctional Resource
Center
San Diego, CA

Nilda Garcia
Austin Public Schools
Austin, TX

David Garza
Texas Higher Education
Coordinating Council
Austin, TX

Robert Glaser
National Research Center on
Student Learning
University of Pittsburgh
Pittsburgh, PA

Jose M. Gonzalez
Department of Educational
Administration
Teachers College
Columbia University
New York, NY

Tony Gonzalez
Bilingual Teacher Training
Programs
Office of the San Mateo
County Superintendent of
Schools
Redwood City, CA

Antonio Gonzalez
Bilingual Education
Granite School District
Salt Lake City, UT

James Gray
California Writing Project
University of California
Berkeley, CA

Steve Grubis
College of Rural Alaska
Fairbanks, AK

Elisa Guitierrez
Bilingual Education
Texas Education Agency
Austin, TX

Clemens I. Hallman
University of Florida
Gainseville, FL

Else Hamayan
Illinois Resource Center
Des Plaines, IL

Jan Hawkins
Center for Technology in
Education
Bank Street College of
Education
New York, NY

Kati Haycock
American Association of
Higher Education
Washington, DC

Gilman Hebert
Bureau of Equity in
Language Services
Quincy, MA

Stella Helvie
Second Language Programs
Clark County Schools
Las Vegas, NV

Frances Hensley
Georgia Facilitator Center
Athens, GA

Maria A. Hernandez
Bureau of Bilingual
Education
New Jersey Department of
Education
Trenton, NJ

Geraldine Herrera
Office of Bilingual/ESL
Education
Los Angeles Unified School
District
Los Angeles, CA

Elaina Herschowitz
School Leadership Center
San Diego County Office of
Education
San Diego, CA

Ray Holman
Berrien Springs Public
Schools
Berrien Springs, MI

Juan Hurtado
Multifunctional Resource
Center
San Diego, CA

Elsie Ireland
La Feria Independent School
District
La Feria, TX

Julia Jackson
Educational Service Center
Region II
New York, NY

Kamil Jbeily
Curriculum & Textbooks
Texas Education Agency
Austin, TX

Frederick L. Jenks
Florida State University
Tallahassee, FL

Judy Kass
American Association for the
Advancement of Science
Washington, DC

Mary Kennedy
National Center for Research
on Teacher Learning
Michigan State University
East Lansing, MI

Anne Kiefer
Chicago Project for Learning
and Teaching
National College of
Education
Evanston, IL

Barbara Knapp
Minnesota State Facilitator
Office
The Exchange at CAREI
Minneapolis, MN

Nancy Kreinberg
Project EQUALS
Lawrence Hall of Science
Berkeley, CA

Ruta Krusa
Healdsburg Union School
District
Healdsburg, CA

Judith Kysh
CRESS Center
University of California
Davis, CA

Hernan La Fontaine
School of Education
Southern Connecticut State
University
New Haven, CT

Beverly Lancaster
Winston Salem/Forsyth
County Schools
Winston Salem, NC

Diane Lassman
Minnesota State Facilitator
Office
The Exchange at CAREI
Minneapolis, MN

Elva Laurel
University of Texas
Brownsville, TX

Wei-lin Lei
Multifunctional Resource
Center
San Diego, CA

Henry Levin
Stanford University
Palo Alto, CA

Robert L. Linn
National Center for Research
on Assessment, Evaluation,
and Testing
University of California
Los Angeles, CA

Ann Lippencott
University of California
Santa Barbara, CA

Alicia Lomas
Bilingual Teacher Training
Programs
Office of the Tulare County
Superintendent of Schools
Visalia, CA

Nancy Love
The Network
Andover, MA

Ramon Magallanes
Fort Worth Independent
School District
Fort Worth, TX

Maria Helena Malagon
Division of ESOL/Bilingual
Programs
Montgomery County Public
Schools
Rockville, MD

Tina Martinez
Bilingual Teacher Training
Programs
Office of the Riverside County
Superintendent of Schools
Riverside, CA

Lila Martir
Bilingual Teacher Training
Programs
Office of the Imperial County
Superintendent of Schools
El Centro, CA

Pedro Maymi
Yonkers Public Schools
Yonkers, NY

Niki McCurry
Alaska Writing Program Yukon
Koyukuk School District
Nenana, AK

Milbrey McLaughlin
Center for Research on the
Context of Secondary
School Teaching
Stanford University
Palo Alto, CA

Maria Medina Seidner
Bilingual Department
Illinois Board of Education
Chicago, IL

Hugh Mehan
University of California
San Diego, CA

Shirley Menendez
Statewide Facilitator Project
Metropolis, IL

Naomi Millender
Chicago Teacher's Center
Chicago, IL

Edgar Miranda
Rochester City School
District
Rochester, NY

Peter Mitchell
International Reading
Association
Newark, DE

Marci Mitchell
Progress Independent School
District
Progress, TX

Jesse Montano
Bilingual Education Unit
Minnesota Department of
Education
St. Paul, MN

Guadalupe Montez
South San Antonio
Independent School
District
San Antonio, TX

Albert Moreno
Bilingual Teacher Training
Programs
San Jose Unified School
District
San Jose, CA

Rocio F. Moss
Multifunctional Resource
Center
San Diego, CA

Marisol Naso
Bilingual Education
San Bernardino City Unified
School District
San Bernardino, CA

Matty Nelson
Office of Outreach Services
American Association of
School Librarians
Chicago, IL

Freya Neumann
Equity and Multicultural
Education Section
Madison, WI

Fred M. Newmann
Center on Organization and
Restructuring of Schools
University of Wisconsin
Madison, WI

Sonya Nieto
School of Education
University of Massachusetts
Amherst, MA

Mary Nordhouse
New Mexico Bureau of
Education, Planning &
Development
Santa Fe, NM

James O'Connor
Boston Public Schools
Boston, MA

Albert Ochoa
Teacher Education
San Diego State University
San Diego, CA

Laurie Olsen
California Tomorrow
San Francisco, CA

Preddy Oseguerra
Bilingual Education
Salt Lake City School
District
Salt Lake City, UT

Julio Palecios
Curriculum Department
Edcouch-Elsa Independent
School District
Edcouch, TX

Philip Pasmanick
Berkeley Teachers' Center
Berkeley, CA

Verma Pastor
Arizona Department of
Education
Phoenix, AZ

Alice S. Paul
College of Education
University of Arizona
Tucson, AZ

Ron Pearlman
Illinois Resource Center
Des Plaines, IL

Sylvia Pena
Department of Curriculum
and Instruction
University of Houston
Houston, TX

Carmen Perez-Hogan
Division of Bilingual
Education
New York Department of
Education
Albany, NY

Alice Petrossian
Glendale Unified School
District
Glendale, CA

C. William Phillips
Division of Inservice
Education
Ohio Department of
Education
Columbus, OH

Barbara Piekarski
Catawba County Schools
Newton, NC

Anabel Pinero
Davis School District
Farmington, UT

Delia Pompa
National Coalition of
Advocates for Students
Boston, MA

Charlotte Powers
Professional Development
Seminars
San Jose, CA

David Ramirez
California State University
Long Beach, CA

Arnulfo Ramirez
Department of Foreign
Languages & Literature
Louisiana State University
Baton Rouge, LA

Carmen L. Ramos
Hispanic Policy Development
Project
New York, NY

Akram Rana
Curriculum Department
Weslaco Independent
School District
Weslaco, TX

James L. Ratcliff
National Center on
Postsecondary Teaching,
Learning, and Assessment
Pennsylvania State
University
University Park, PA

Porter Reed
Illinois State Board of
Education
Springfield, IL

Joseph Renzulli
National Research Center on
the Gifted & Talented
University of Connecticut
Storrs, CT

Lauren Resnick
National Research Center on
Student Learning
University of Pittsburgh
Pittsburgh, PA

Mary Alice Reyes
Curriculum Department
Edcouch-Elsa Independent
School District
Edcouch, TX

Nancy Rhodes
Center for Applied
Linguistics
Washington, DC

Charlene Rivera
The Evaluation Assistance
Center
George Washington
University
Arlington, VA

Laraine M. Roberts
Program Development
Center
California School
Leadership Academy
Hayward, CA

Janine Roberts
Los Angeles Teacher Center
Encino, CA

Robert E. Robison
Columbus City Schools
Columbus, OH

Cliff Rodrigues
Bilingual Teacher Training
Programs
Office of the Ventura County
Superintendent of Schools
Ventura, CA

Michelle Rohr
National Council of
Supervisors of Mathematics
Houston, TX

Thomas Romberg
National Center for Research
in Mathematical Sciences
Education
University of Wisconsin
Madison, WI

Sharon Rorhke
Modesto City Schools
Modesto, CA

Ira Rosenholtz
Illinois Council of Teachers
of Mathematics
Eastern Illinois University
Charleston, IL

Robert E. Rossier
Intercultural Development
Research Association
San Antonio, TX

Al Rubio
Greensboro City Schools
Greensboro, NC

Miguel Ruiz
Michigan Department of
Education
Lansing, MI

Rosalia Salinas
Bilingual Teacher Training
Programs
Office of the San Diego
County Superintendent of
Schools
San Diego, CA

Cecelia Santa Ana
Michigan Department of
Education
Lansing, MI

Maria Santory
New York City Public
Schools
Brooklyn, NY

Maria Schaub
Montgomery County Public
Schools
Rockville, MD

Walter Secada
Curriculum & Instruction
University of Wisconsin
Madison, WI

Deborah Sercombe
Edison Middle School
Boston Public Schools
Brighton, MA

Rodolfo Serna
Department of Language and
Cultural Education
Chicago Board of Education
Chicago, IL

Christine Sleeter
University of Wisconsin,
Parkside
Kenosha, WI

Roberta Smith
New Mexico Bureau of
Education, Planning &
Development
Santa Fe, NM

Catherine Snow
Harvard Graduate School of
Education
Cambridge, MA

Michelle Soria-Dunn
Department of Public
Instruction
Des Moines, IA

Rochelle Spiegel-Coleman
Los Angeles County Office
of Education
Los Angeles, CA

Susan Spoeneman
The Teacher's Center
Huntington Beach, CA

Elizabeth Stage
California Science Project
University of California
Berkeley, CA

Holly Stein
Prince Georges County
Schools
Bladensburg Instructional
Service Center
Bladensburg, MD

Loretta Strong
Bilingual Teacher Training
Programs
Healdsburg Union School
District
Healdsburg, CA

Daniel Stufflebeam
National Center for Research
on Educational Accountability
and Teacher Evaluation
Western Michigan University
Kalamazoo, MI

Merrill Swain
The Ontario Institute for
Studies in Education
Toronto, Canada

Winnie Tang
San Francisco Federal
Teacher Center
San Francisco, CA

Roland Tharp
University of California
Santa Cruz, CA

Deborah Tippins
Science Education
Department
University of Georgia
Athens, GA

Maria Torres
Southwest Regional
Educational Laboratory
Los Alamitos, CA

Jerry Toussaint
North Carolina State
Department of Education
Raleigh, NC

G. Richard Tucker
Carnegie Mellon University
Pittsburgh, PA

Martha Valdez
Ysleta Independent School
District
El Paso, TX

Johanna Vetcher
South Bay Union School
District
Imperial Beach, CA

Joseph Voccolo
Buffalo City Schools
Buffalo, NY

Daniel Wagner
National Center on Adult
Literacy
University of Pennsylvania
Philadelphia, PA

Susan Walker
Teacher Outreach
Foxfire Fund
Rabun Gap, GA

Catherine Walsh
Multifunctional Resource
Center
Boston, MA

Margaret C. Wang
National Research Center on
Education in the Inner Cities
Temple University
Philadelphia, PA

Beth Warren
TERC
Cambridge, MA

Lucille J. Watahomigie
Tradition & Technology
Project
Peach Springs School
District
Peach Springs, AZ

Leon L. Webb
Educational Diffusion
Systems, Inc.
Mesa, AZ

Arthur L. White
National Center for Science
Teaching and Learning
Ohio State University
Columbus, OH

Lola Williams
Harlingen Independent
School District
Harlingen, TX

Martha L. Williams
Dayton Public Schools
Dayton, OH

Karen Yeager
Kalamazoo Public Schools
Kalamazoo, MI

Peter Zachariou
Pacific View Staff
Development Center
Pacifica, CA

TABLE OF CONTENTS

Preface	i
Acknowledgments	iii
Case Studies	1.1
Chapter 1. Introduction.....	1.1
Chapter 2. Del Norte Heights Elementary School, Ysleta Independent School District, El Paso, Texas (K-6)	2.1
Chapter 3. Hollibrook Elementary School, Spring Branch Independent School District, Houston, Texas (pre-K-5).....	3.1
Chapter 4. Linda Vista Elementary School, San Diego Unified School District, California (pre-K-6).....	4.1
Chapter 5. Inter-American School, Chicago Public Schools, Illinois (pre-K-6).....	5.1
Chapter 6. Graham and Parks Alternative Public School, Cambridge School District, Massachusetts (K-8)	6.1
Chapter 7. Hanshaw Middle School, Modesto City Schools, California (7-8)	7.1
Chapter 8. Horace Mann Academic Middle School, San Francisco Unified School District, California (6-8).....	8.1
Chapter 9. Harold Wiggs Middle School, El Paso Independent School District, Texas (6-8).....	9.1
Chapter 10. Lessons About Exemplary Practices and Schools Serving LEP Students.....	10.1
Glossary.....	G.1
References	R.1

LIST OF FIGURES

Figure 2-1 The Classroom Layout, Del Norte.....	2.4
Figure 2-2 Instruction, Curriculum, and Program Map, Del Norte.....	2.10

Figure 2-3	School Structure and District Support, Del Norte	2.17
Figure 2-4	Del Norte's Block Schedule	2.19
Figure 3-1	The Classroom Layout, Hollibrook	3.4
Figure 3-2	The Classroom Layout, Hollibrook	3.8
Figure 3-3	Instruction, Curriculum, and Program Map, Hollibrook	3.12
Figure 3-4	School Structure and District Support, Hollibrook	3.17
Figure 4-1	The Classroom Layout, Linda Vista	4.4
Figure 4-2	Instruction, Curriculum, and Program Map, Linda Vista	4.8
Figure 4-3	School Structure and District Support, Linda Vista	4.12
Figure 4-4	Linda Vista's Daily Schedule	4.16
Figure 5-1	The Classroom Layout, Inter-American	5.4
Figure 5-2	Instruction, Curriculum, and Program Map, Inter-American	5.10
Figure 5-3	School Structure and District Support, Inter-American	5.14
Figure 6-1	The Classroom Layout, Graham and Parks	6.4
Figure 6-2	Instruction, Curriculum, and Program Map, Graham Parks	6.10
Figure 6-3	School Structure and District Support, Graham Parks	6.14
Figure 7-1	The Classroom Layout, Hanshaw	7.4
Figure 7-2	The Classroom Layout, Hanshaw	7.6
Figure 7-3	The Classroom Layout, Hanshaw	7.10
Figure 7-4	School Structure and District Support, Hanshaw	7.14
Figure 7-5	Instruction, Curriculum, and Program Map, Hanshaw	7.18
Figure 8-1	The Auditorium Layout, Horace Mann	8.4
Figure 8-2	Instruction, Curriculum, and Program Map, Horace Mann	8.8
Figure 8-3	San Francisco Project 2061 Assessment System, Horace Mann	8.10
Figure 8-4	School Structure and District Support, Horace Mann	8.14
Figure 8-5	One Horace Mann Family's Daily Schedule	8.16
Figure 9-1	The Classroom Layout, Wiggs	9.4
Figure 9-2	School Structure and District Support, Wiggs	9.10
Figure 9-3	Instruction, Curriculum, and Program Map, Wiggs	9.14

CASE STUDIES

CHAPTER 1

INTRODUCTION

In the next century American schools will face an unprecedented challenge: to educate the world's most linguistically diverse student body, and to do so in a way that prepares students to participate fully in the highly skilled, prosperous economy and vital democracy that most Americans envision. In an increasingly competitive and globalized economy, all citizens will need more than rudimentary literacy and numeracy; they must be able to gain knowledge through the printed word, communicate in clear and thoughtful prose, and solve problems by applying scientific principles.

Fifty years ago the United States was a country of factories and farms—for eighty percent of Americans, work was manual work, either in agriculture or at a shipyard, steel mill, or assembly plant. These and other heavy industries benefited from and also sustained immigrants and minorities who joined the workforce; high-level English, scientific, and communication proficiency were not necessary for a person to be employed and make an economic contribution. Thus the acquisition of language and more sophisticated academic skills could be more leisurely processes. Now, however, two-thirds of Americans work in offices; even in today's factories, the use of computers has transformed manual into mental work. As doors into the workplace and full participation in American life are closing for those without the requisite language and problem-solving skills, the 9.9 million school children who come from language-minority families (1990 U.S. census) —more than one in five—are at risk of being left behind, with adverse consequences for the whole nation's prosperity and quality of life. Preparing these children—many of whom do not speak English as a first language—for the highly skilled economy of the next century is a special challenge that educators are now learning to meet.

Creating new classroom environments that will facilitate the acquisition of high-level language and reasoning skills by every student is a multi-dimensional project involving new pedagogical methods, curricula, and governance structures. It requires, on the one hand, a re-examination of what it means to be educated (with an emphasis on reasoning, problem solving, and communication facility), and on the other, careful attention to how a highly heterogeneous student population actually learns, and constructing learning methods which build reasoning, problem solving, and language ability into the very context of students' lives.

This volume describes eight schools which have created exemplary learning environments for language-minority students who have limited English proficiency (LEP)—that is, they lack an adequate command of English reading or writing for their grade level. The schools were chosen via an extensive process of nomination and selection which is described in Section B of this chapter. All of them, however, are engaged in the task of reconfiguring education for the post-industrial era, and because they are intent on extra consideration to the needs and potential of

LEP students. Each chapter of this study describes a school's effort to integrate these educational tasks by combining LEP program features with more general restructuring.

A. THE LEP STUDENT POPULATION

Limited English-proficient students, who constitute at least one-fourth,¹ and perhaps as many as three-fourths,² of language of language-minority students, face multiple challenges. According to the 1990 Census, more than 40 percent of LEP students are immigrants and are more than twice as likely as other students to be poor. While comprehensive data on the academic accomplishment of LEP students are not available, the sparse data extant suggest that they are more likely to get lower grades or drop out of school, and less likely to be accepted to college, than their English-fluent contemporaries.³

The vast majority (72 percent) of LEP students are concentrated in just six states—California, Florida, Illinois, New Jersey, New York, and Texas. New York and Texas each have more than a half a million, and California almost a million.⁴ In California, about one in five students is classified as LEP. Though the most common native language of LEP students is Spanish, 24 of the 25 largest metropolitan areas had 10 or more non-English languages represented, with Los Angeles having more than 90.⁵

LEP students who do not progress beyond the basics offered in the early elementary school years—deciphering text, translating speech into written language, and manipulating numbers—risk falling behind in future grades. The later years of elementary school (grades 4 through 6) are a particularly crucial period for consolidating the fledgling skills acquired in the primary grades into a foundation of literacy that enables students to learn a wide variety of subjects during the rest of their schooling. Thus, LEP students who do not progress beyond the basics in these years to master English reading, writing and comprehension, as well as critical analysis and academic discourse skills, risk falling behind in future grades. Although data on the academic progress of LEP children are not available, a reasonable inference can be made from general data on language minority groups. By the time they reach high school, Hispanic students on average score three

¹ GAO/HEHS, *Limited English Proficiency: A Growing and Costly Educational Challenge Facing Many School Districts*, 94-38 (Washington, D.C.: United States General Accounting Office, January 1994).

² *Numbers and Needs: Data from the 1990 Census of Population* 4, no. 4 (July 1994).

³ L. Olsen, *Immigrant Youth in California Public Schools: Crossing the Schoolhouse Border* (San Francisco: California Tomorrow, 1988); National Coalition of Advocates for Students, *New Voices: Immigrant Students in U.S. Public Schools* (Boston, MA: National Coalition of Advocates for Students, 1988); U.S. Department of Education, *Language Characteristics and Academic Achievement: A Look at Asian and Hispanic Eighth Graders in NELLS: 88* (Washington, D.C.: U.S. Department of Education, February 1992).

⁴ *Numbers and Needs: Data from the 1990 Census of Population* 2, no. 3 (May 1992).

⁵ GAO/HEHS-94-38, 1994.

years behind their non-Hispanic white counterparts in writing.⁶ Detailed studies suggest that underdeveloped English writing and reading skills are at the heart of the problem. These difficulties can be traced in part to limited or inadequate programs for LEP students. Weak writing skills at the secondary level can severely constrain academic options for LEP (or former LEP) students in other subjects, as suggested by a study of LEP students in California secondary schools.⁷

Mathematics and science courses in middle school introduce students to inductive and deductive reasoning and provide them with experience in the practice of science. LEP students who do not have full access to these courses are unlikely to do well in the high school mathematics and science courses that are prerequisites for college entry. Hispanic 8th graders are more likely than non-Hispanic whites to be taking no science courses, and Hispanics are more likely than any other group of students to be taking remedial mathematics or English courses. Hispanic high school students lag four years behind non-Hispanic Whites in science and mathematics proficiency.⁸ The California study found that LEP students are often denied access to regular science and mathematics courses, and that very few schools offer comparable courses for LEP students in their native language or provide access in other ways.⁹

The study of exemplary schools profiled in this document focuses on these crucial skills and periods for LEP students—language arts in grades 4 through 6 and mathematics and science in grades 6 through 8. It is neither desirable or possible to separate the LEP program at these grade levels from the entire experience of students at a school. Therefore, exemplary practices will be documented in the context of school reform and the ways that school reform affects the entire curriculum and program of instruction for LEP students.

B. OVERVIEW OF METHODOLOGY

Descriptions of eight schools selected in an extensive nationwide search appear in this volume. (The methodology for selecting the schools is reported in detail in *Volume III: Technical Appendix, Research Design and Methodology*.) They are not the only exemplary programs in the country, though they are among the small number of schools and programs that

⁶D. De La Rosa and C. Maw, *Hispanic Education: A Statistical Portrait 1990* (Washington, D.C.: Policy Analysis Center, Office of Research, Advocacy, and Legislation, National Council of La Raza, 1990).

⁷C. Minicucci and L. Olsen, *An Exploration of Programs for Pupils with Limited Proficiency in English*, vol. 5 of *Meeting the Challenge of Language Diversity: An Evaluation of Programs for Pupils with Limited Proficiency in English* (Berkeley, CA: BW Associates, February 1992).

⁸De La Rosa and Maw, 1990.

⁹Minicucci and Olsen, 1992.

provide outstanding education for LEP students at the grade levels and curriculum foci pertinent to this study.

To select the exemplary schools featured here, we solicited nominations from knowledgeable people at the national, state, or local levels; nominators were asked to identify exemplary language arts programs in grades 4 through 6 and exemplary science and mathematics programs in grades 6 through 8 for LEP students. One-hundred and fifty-six schools were initially nominated from the twenty states with the largest populations of LEP students. We found it much more difficult to locate exemplary mathematics or science programs than language arts programs. Of the 156 nominated sites, approximately two-thirds were language arts sites and the remaining were mathematics and/or science sites.

Next, we screened 75 of the most promising nominated sites using extensive telephone interviews to identify schools that exhibited excellence with regard to three major criteria: 1) high quality language arts, mathematics, or science programs for LEP students; 2) significant school restructuring—i.e., with respect to governance, organization of teaching, uses of time; and 3) implementation of a well-designed English language acquisition program. Each school was assessed in terms of these criteria using six indicators of excellence: 1) *Innovation*—the school departs from standard instruction, scheduling, organization, and/or curriculum segmentation in order to facilitate program goals. 2) *Embedded*—the practices for LEP students are not isolated, but are part of the entire school program and are articulated with the practices used in earlier and later grades. 3) *High standards*—school staff have embraced and can articulate the program's philosophy including its vision of quality education for LEP students. 4) *Longevity*—the school's use of the identified practices is a serious long-term effort. 5) *Qualified staff*—staffing and staff training are appropriate to the practices being implemented with LEP students. 6) *Generalizability*—the school serves students who are fairly typical of LEP students nationally and its situation (e.g., funding) is not so unique as to preclude other schools learning from it.

The results of the phone interviews were used to reduce the number of sites that had potential for in-depth study to 25. From that pool, demographic, geographic, and programmatic variables were used to select 15 schools for one-day preliminary field visits to gather further information to determine which programs would become the final case study sites. One-day visits by one or two researchers to each of the 15 sites were designed to provide the research team with information that would allow the selection of eight case study sites that best met study criteria. During the preliminary visits, field staff interviewed persons in responsible administrative positions at both the district and site levels as well as resource teachers and classroom teachers. The issues briefly explored in the preliminary visits included questions about program design (e.g., the purpose of the reform, the program's conceptual framework, curriculum, instructional strategies, materials,

grouping strategies, and the role of external partners in the design of the program), implementation (e.g., the forces and factors that influenced reform, program organization, staffing, and school climate), and program impact (e.g., evidence of improvements in student learning and previous program evaluations).

Based on these preliminary visits, eight schools were selected for more intensive study. Data on student outcomes which are comparable across the sites are not available, particularly because LEP students are often not given the standardized tests (in English) that districts or states require of most students.¹⁰ Therefore, we cannot demonstrate quantitatively that the eight case study sites are exemplary in the sense that they manifest significantly higher student achievement scores. Nevertheless, the nomination, screening, and field visits all led to the conclusion that these schools are highly innovative and follow practices that are considered by researchers to provide outstanding learning opportunities for LEP—and all—students.

On the second visits to the final eight sites, research teams of two to four people interviewed teachers, school support staff, and administrators. We also held focus group meetings with students preparing to move to English instruction and with parents of LEP students, and observed classes and staff meetings. The research team included people fluent in Spanish or Haitian Creole who could observe classes and conduct focus groups in these languages where appropriate. As necessary, we used interpreters for Asian languages to clarify some aspects of the school or classroom situation. We also collected available demographic, financial, and evaluative information. Finally, we interviewed external partners and district and state officials familiar with each school and with state and district policies (see *Volume III* for a detailed description of our interview instruments and procedures).

¹⁰P. Berman et al., *Meeting the Challenge of Language Diversity: An Evaluation of Programs for Pupils with Limited Proficiency in English*, 5 vols. (Berkeley, CA: BW Associates, February 1992).

C. NATURE OF EXEMPLARY SCHOOLS

The schools described here depart from the standard approach to educating LEP students.¹¹ Most sites emphasize cooperative learning in untracked classes, in which students with different proficiency levels work together in groups. The exemplary schools demonstrate the power of cooperative learning as a tool to unleash students' ability to learn from one another. Some schools use practical strategies for keeping students with the same teacher(s) for several years. These students develop a sense of identity with their group; moreover the teachers are more easily able to coach them through their development as learners. Instead of placing students who lag behind in remedial classes, some schools assume that all students can learn to high levels and use an accelerated learning environment to get students on track quickly.¹²

Furthermore, the cases demonstrate approaches that inspire curiosity in children and encourage them to think critically, rather than focusing narrowly on basic skills or rote learning.¹³ Mathematics and science are taught in a context that is meaningful to students, rather than as abstract subjects.¹⁴ And all the cases demonstrate teaching styles that provide LEP students with adequate opportunities to produce oral and written English and emphasize an exchange of ideas in an intellectual conversation.¹⁵ In these classrooms, teachers break the mold of the lecture format

¹¹For studies that describe effective programs for LEP students, see W. Tikunoff, *Applying Significant Bilingual Instructional Features in the Classroom* (Rosslyn, VA: National Clearinghouse for Bilingual Education, 1985); T. Carter and M. Chatfield, "Effective Bilingual Schools: Implications for Policy and Practice," *American Journal of Education* 95 (1986): 200-234; C.E. Snow, "Perspectives on Second-Language Development: Implications for Bilingual Education," *Educational Researcher* 21 (1986) (2): 16-19; E. Garcia, "Attributes of Effective Schools for Language Minority Students," *Education and Urban Society* 20 (1988): 387-398; K. Lindholm and H. Fairchild, *Evaluation of an Exemplary Bilingual Immersion Program* (Los Angeles: UCLA, Center for Language Education and Research, 1988); L. Pease-Alvarez, *Education and Cultural and Linguistic Pluralism: Innovative Schools. Case Studies: United States (California)* (Paris: Centre for Educational Research and Innovation, Organization for Economic Co-operation and Development, 1989); P. Berman et al., 1992.

¹²H.M. Levin, "New Schools for the Disadvantaged," *Teacher Education Quarterly* 14, no. 4 (1987): 60-83.

¹³L. Wong-Fillmore, "Language and Cultural Issues in Early Education" and "The Care and Education of America's Young Children: Obstacles and Opportunities," *90th Yearbook for the National Society for the Study of Education*, ed. S.L. Kagen (in press, 1989).

¹⁴A.A. Zucker, "Review of Research on Effective Curriculum and Instruction in Mathematics" in *Better Schooling for the Children of Poverty: Alternatives to Conventional Wisdom*, eds. M.S. Knapp and P.M. Shields (Berkeley, CA: McCutchan, 1991), 189-203; W.G. Secada, "Race, Ethnicity, Social Class, Language and Achievement in Mathematics," in *Handbook for Research on Mathematics Teaching and Learning*, ed. D. Grouws (New York: Macmillan, 1992), 623-660; D.G. Thornburg and K.S. Karp, *Resituating Mathematics and Science Instruction for Language Different Students*, poster presented at the meeting of the American Educational Research Association, San Francisco, CA, April 1992; M. Brenner, "A Communication Framework for Mathematics: Exemplary Instruction for Culturally and Linguistically Diverse Students," in *Language and Learning: Educating Linguistically Diverse Students*, ed. B. McLeod (Albany, NY: State University of New York Press, 1994), 233-267.

¹⁵R.G. Tharp and R. Gallimore, "Rousing Schools to Life," *American Educator* (Summer 1989): 23.

and experiment with varied activities, groupings, and materials in order to build on their students' cognitive styles and thereby enhance their learning.¹⁶

The exemplary schools also demonstrate respect for their students' cultural backgrounds. LEP students face the challenge of learning a new language, often under different conditions. They rarely see their culture reflected in the books they are assigned to read and they do not see people like themselves revered as leaders. They may have experienced traumatic events in their young lives, and may have teachers who expect them to fail, a school climate that condones racism, a cultural peer group—perhaps a gang—that disdains academic achievement, and parents who are overwhelmed by poverty and intimidated by the school. These case studies show how school climates can be created to honor diversity as well as the experiences of their students. The schools featured here break down alienation between their community and the school by embracing the culture and language of students, and by welcoming parents and community members into the school in innovative ways.

Our goal in describing these exemplary activities is to illuminate strategies and learning models that work for LEP students, rather than to present ethnographically detailed descriptions or historically developed stories of these schools. The case studies are deliberately selective. They highlight what is exemplary in the classroom, school, or district. They do not review barriers or difficulties in implementation. A more comprehensive analysis is presented in *Volume I: Findings and Conclusions*, in which the sites are compared and implementation issues are raised. The need in the field today is for knowing what works and under what conditions; these cases provide specific information that ground *Volume I*'s conclusions in the empirical reality of outstanding teachers and successfully, though perhaps only partially, reformed schools.

D. THE PRESENTATION OF THE CASE STUDIES

Each of the following chapters begins with a brief description of the school and community context, along with demographic information where pertinent, to set the stage.

The next section in each chapter portrays a scene from one or more exemplary learning environments to give the reader a sense of the reality of exemplary practices. The learning environment is illustrated by a diagram—the physical layout of the classroom or setting, followed by a detailed narrative description of the exemplary learning environment. To deepen the richness of the narrative, we have annotated the text to highlight unique or critical features of the learning environment. The reader may first want to read through the narrative, ignoring the annotations,

¹⁶R.G. Tharp, "Psychocultural Variables and Constants: Effects on Teaching and Learning in Schools," *American Psychologist* 44 (1989): 1-11.

and then return to pick up key pedagogic or contextual points. It will be evident that these learning environments do not look or sound like traditional classrooms.

Another section of each chapter pinpoints the curricular or instructional features characteristic of the learning environment and the larger school. A diagram summarizes these features and illustrates their relationship to the school's LEP program which is explained in its own section.

Because all of the schools portrayed in this study are involved in a dynamic and ongoing restructuring process, they are evolving in ways that cause constant questioning and continuous renewal. Their programs for LEP students also change as the demographics of schools and districts shift. The cases are a snapshot in this flow. However we use a section in each chapter to highlight significant structural innovations that could be adapted by other schools.

The next to last chapter section identifies factors at the district or state level that support the exemplary practices. The causal link from state to district to school to classroom learning environment is not direct, but the influences of more remote policies on teaching and learning are nonetheless real. We describe cases in which districts pursue policies that further the education of LEP students, and identify the crucial aspects of those policies. Where a case study makes little or no mention of the district, it means that the school has become exemplary on its own initiative, with at best the benign neglect of the district. Similarly, we emphasize state policies that produce positive effects.

Many of the exemplary schools are supported with varying intensity by external partners such as university research groups or technical assistance organizations. Their contributions are described in those sections where their role can be seen in the context of other relevant school or programmatic activities.

Each chapter concludes with a brief summary of key findings.

CHAPTER 2

DEL NORTE HEIGHTS ELEMENTARY SCHOOL YSLETA INDEPENDENT SCHOOL DISTRICT EL PASO, TEXAS (K-6)



A. SCHOOL AND COMMUNITY CONTEXT

Del Norte Heights Elementary School is located in the Ysleta Independent School District in El Paso, Texas (pop. 600,000). The Rio Grande separates El Paso from Ciudad Juarez, its sister city directly across the border in Mexico. The metropolitan area comprised of El Paso, Juarez and the suburbs of each city is home to more than 2 million.

The 27 year-old single story school building is located in a neighborhood of neat single family homes only blocks from the freeway that bisects the city. Del Norte is a neighborhood school which has been well-maintained over the years and is surrounded by neat gardens of drought-resistant flowers, plants, and trees. A number of the students are second generation Del Norte students. Parents of some Del Norte students who grew up in the neighborhood now work and live in other parts of the city. They drop off their children at the homes of grandparents who still live in the Del Norte Heights neighborhood.

Inside the well-maintained school, the halls and classrooms are cheerfully decorated with student work, posters, and award displays. Staff in the cheerful, welcoming administration office speak both Spanish and English. The principal and office staff greet students and visiting parents by name.

The school's 650 students are served by 50 staff members, including teachers, support staff, a counselor, and a nurse. Eighty-five percent of the students are eligible for free or reduced price lunch; Spanish-speaking LEP students make up 40 percent of the school's population. An estimated six percent of them are recent immigrants—the majority of the remaining students were born in the United States. LEP students are typically from homes where only Spanish is spoken. While the typical recent immigrant is literate in Spanish and has had fairly consistent schooling in Mexico, a small number of students arrive without literacy in Spanish.

Parents of most students work in blue-collar jobs, and a significant number of students are from single-parent households. A recently built apartment complex in the neighborhood houses families who are stationed at Fort Bliss—one of the local military institutions. The student population is very stable; few arrive mid-year. A substantial number of the students enter at kindergarten and remain throughout their school years.

The next section describes an hour in Ms. Magaña's fourth grade class, one of Del Norte's 32 classrooms.

Figure 2-1
The Classroom Layout, Del Norte

The classroom is arranged into cooperative learning groups, which are teacher-assigned and flexible. The teacher uses class space in ways that match her teaching style. Her desk, for example, is at the back of the classroom and is used to store her materials, rather than as the focus of the class. The carpeted area is partitioned by low bookcases to provide a quiet reading space.

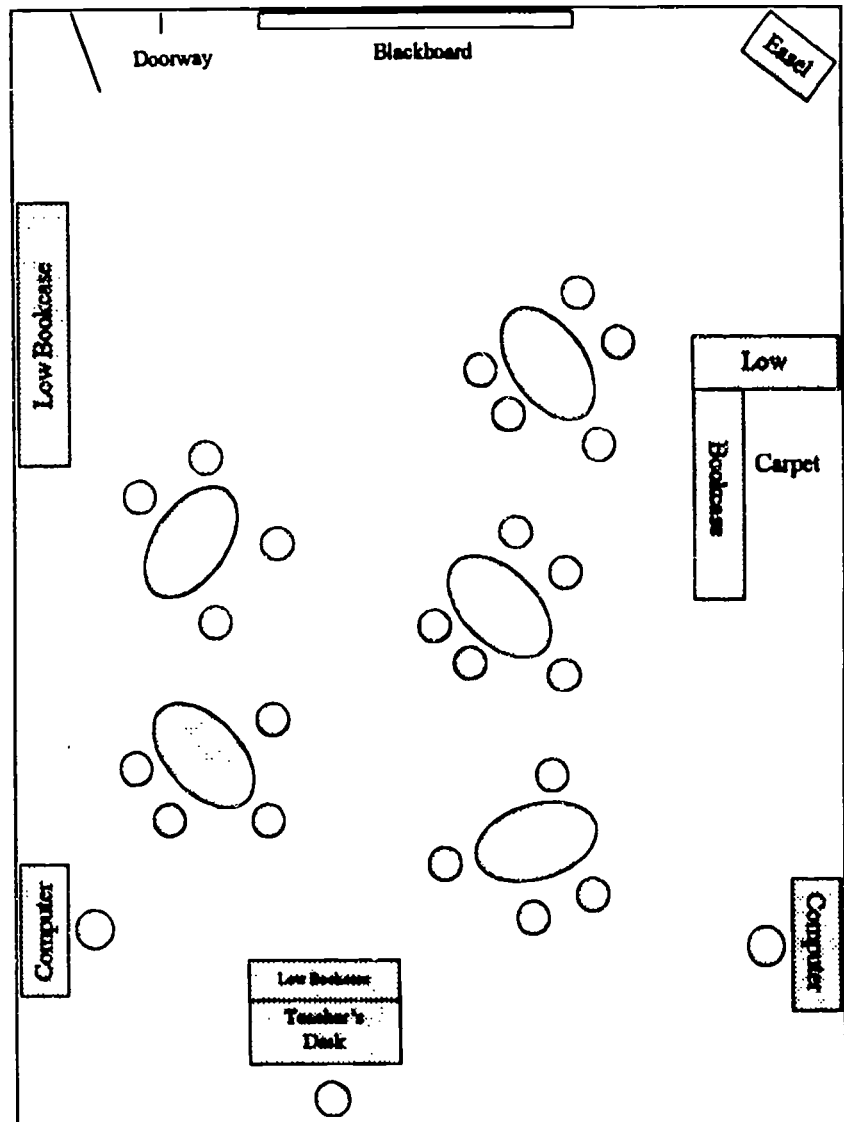

Peer instruction and mutual help are a key feature of a cooperative learning group. English is the primary language of instruction in this classroom, but students use Spanish for helping each other when necessary.



B. AN EXEMPLARY LEARNING ENVIRONMENT

Books, student work, and colorful posters decorate the walls of Ms. Magaña's fourth-grade classroom. One poster illustrates the parts of a computer; another describes steps in the Writers' Workshop process; a third depicts an exhibit at the National Museum of Mexico. The riot of color and form create a cheerful space.

Lively classroom visuals reinforce instructional strategies, validate student work and culture, and display tools and technology.

Five student tables are arranged around the classroom and the 22 students sit around the tables in groups of four or five. There are two computer work stations in the room. One is a new Macintosh with a CD ROM. Low bookcases surround two sides of a carpeted area set aside for quiet reading.

Classroom layout facilitates cooperative learning, and provides quiet space for reading.

Ms. Magaña assembles them in a semicircle of chairs at the front of the room to begin their language arts activities for the day. Students move their chairs quickly and wait expectantly.

Students in this class are all designated LEP; four of them are newcomers to this country.

Ms. Magaña reads the poem of the week to her students in English. Students can follow the poem's text, which is printed on a large white pad that rests on an easel in the front of the room. The poem pokes fun at the parts of speech, sentence structure, and other elements of grammar, and ends with a tone of resignation about the necessity of learning grammar. At the same time, the poem highlights the joys of stories and reading.

A whole week spent on one poem allows full exploration of meaning.

Poster-sized printed text allows students to read along.

I Have No Time to Visit with King Arthur

*I have no time to dream a dream,
Or think a splendid thought,
Or visit with King Arthur
In the land of Camelot.*

*I've underlined one hundred nouns,
And circled thirty verbs,
While wishing that this workbook
Had a story to its words.*

*I could travel to another time
With Huck Finn on his raft,
Or read a poem by Silverstein
That really makes me laugh.*

*Instead I fill in compound words,
A neverending chore.
How I long to be with Gulliver
On a strange and distant shore!*

*Nouns and verbs and compound words
Are sad and dull and stale,
Unless they're filled with the spark
Of a mighty, wondrous tale.*

Modeling through dramatic reading is a Whole Language approach

Students are asked to reflect on the meaning of the entire poem, not just specific words.

The poem provides examples of compound words - a topic the class has been studying.

Student risk-taking is supported

Students are asked to agree or disagree with, rather than criticize, peers.

Ms. Magaña reads expressively, dramatizing key words and ideas. She says to the class, "Now it's your turn to read." The students read the poem aloud in unison, and Ms. Magaña questions them in English about its meaning. "What is the author trying to say to us?" Students answer in English, "He is saying that he doesn't like grammar," "He's making fun of some of the stuff that we have to learn." One student responds to a follow-up question, "I think he's trying to tell us that we can laugh at things and still learn them."

Ms. Magaña asks students to identify the compound words in the poem, and invites Maria to remind her classmates of the definition of a compound word. Maria responds, "A compound word is a word made up of two other words ... like birthday." Ms. Magaña agrees and asks if the students can find compound words in the poem. One student calls out, "Workbook is one." Another raises her hand: "What about underlined?" The discussion continues for a few minutes. Ms. Magaña asks for confirmation from the class that breakfast is a compound word and asks one student to identify the two words that make up underlined. The student does so and the discussion continues.

One student identifies 'distant' as a compound word; Ms. Magaña says, "Jose says that distant is a compound word—she points to the word in the poem—do you agree?" Most of the class disagrees. Ms. Magaña asks the class why they don't they think 'distant' is a compound word. One student responds that you cannot write two words just using the letters in 'distant'. Ms. Magaña agrees and asks Jose if he understands why.

*The discussion continues for a few more minutes and the students identify most of the compound words in the poem. Ms. Magaña asks the students to move their chairs back to their tables, and asks four of the five student groups to take out the English language books they are reading independently. She asks the fifth group to take out the book the whole class is reading—Roald Dahl's *James and the Giant Peach*. (Students, accomplished Cooperative Learners, engage in the new tasks quickly.)*

Transitions between tasks are made quickly.

*As the students begin to read, Ms. Magaña moves around the class. She asks one student, "Are you enjoying *Charlie and the Chocolate Factory*?" to another, "What page have you gotten to in your book?" to a third, "I enjoyed reading the book review in your journal ... you are a real *Judy Blume* fan, aren't you?" Students have chosen their own books for independent reading, and they reflect a wide diversity of interests—*Beauty and the Beast*, *The Baby-sitter Club*, *Sweet Valley High*, *Aladdin* . . .*

Students keep journals about their reading (a Whole Language Strategy) in English or Spanish. Teacher's comments are supportive, not normative.

*The class settles down to read and Ms. Magaña sits at the table with the group reading *James and the Giant Peach*. The four students in this group are recent arrivals and are reading the book in Spanish. Ms. Magaña discusses the story with them in Spanish, checking to make sure they understood their homework assignment. She asks one student to describe the relationship between James and his aunts, and another student why James's aunts were selling tickets in front of their house. Students answer her questions in Spanish and with some prompting, extend their discussion of the book. At various points in the discussion, Ms. Magaña asks a student to read a passage from the book. In response to her questions, students predict what they think will happen next in the story.*

Opportunities for LEP students to read, hear, write and speak their first language reinforce student literacy, support English language acquisition, and increase students' comfort.

*While the class is reading, two students work on a computer to create material for the class newsletter. One student is at a different computer answering a series of questions about *Charlotte's Web*.*

Spanish-language previews of lesson support English language acquisition for newcomers.

Students use computers to publish their own newsletter, and take tests for Accelerated Reading.

Text for the whole class is available in either English or Spanish.

Ms. Magaña asks for the attention of the class and directs everyone to get out their copies of James and the Giant Peach. Students, at their tables, move quickly to put away their books and get out their copies of James and the Giant Peach. Some copies are in Spanish, others in English. Students take the opportunity to talk among themselves, mostly about their reading materials. Most of them talk to each other in English.

Students from the newcomer group who previewed the chapter in Spanish perform in the Reader's Theater. Reader's Theater is a Whole Language technique that gets students engaged with the text.

One group of students performs a portion of the book in a Reader's Theater after Ms. Magaña has assigned each student the role of a character from the book. Students read with emotion, in English, as they enact the scene.

Preview in Spanish helps a newcomer student join a discussion in English.

Afterward, Ms. Magaña discusses the book with the entire class. They converse entirely in English. She asks students to describe what happened in the book. "Why is James living with his aunts?" A student responds, "His mother and his father died when he was a little boy." Ms. Magaña asks several other questions; in response, students summarize the events in the book. Ms. Magaña asks "How do you think James feels about living with his aunts?" One of the students from the group that had performed in the Reader's Theater proudly speaks up, "He hates living with his aunts because they are . . . [he struggles for the English word and finally says "mean" in Spanish] . . . mean to him." Ms. Magaña supplies the English word.

Other topics and subjects are integrated with language learning: from a story comes a math lesson.

Ms. Magaña asks the Reader's Theater group to act out several other passages from the book as the discussion progresses through the book's plot. The appearance of the word 'shilling' in one scene offers an opportunity for a brief practical math lesson. Ms. Magaña asks, "What is a shilling? Look at it in the sentence and see if you can tell its meaning." "It is money," a student responds. Ms. Magaña provides a description of the value of pounds and shillings with reference to the peso. She also demonstrates on the blackboard the conversion of pounds, shillings, and pesos to dollars and cents.

Now Ms. Magaña displays a chart on the overhead projector, which has at its center a circle with the word 'character' inside. Radiating out from the circle are rectangles with the words 'acts', 'looks', 'says' and 'feels'. Ms. Magaña asks about each character in turn; what the character says, how he or she acts, looks, and feels. She asks the class, "How do you know this is how they feel?" Familiar with such character maps, the students move easily into the discussion. They respond at a level indicating a mature understanding of both the text and its meaning. Her questions about James's aunts, Sponge and Spiker, elicit the liveliest discussions among the students. "I think Sponge and Spiker both hate James," says one. "I think they want him to do all of the work around the house while they drink lemonade" responds another. "I think they are lazy." "I think they are mean to James and they beat him," add two other students.

A character map (a Whole Language device) provides another framework for talking about a story.

Placing the name of each character at the center of one transparency, Ms. Magaña summarizes the students' description of each character, creating a character map for each character in the book.

Throughout the discussion with the whole class, Ms. Magaña asks some of the same questions in English that she had previously asked the small group of new immigrants in Spanish. These students appear comfortable with the discussion and several participate enthusiastically. All students remain engaged in the discussion, eagerly asking questions of their own and predicting what will happen next in the story.

Ms. Magaña describes the homework assignment: students are to write a letter from James to his aunts Spiker and Sponge, telling them how he feels and why. Because they have been working on persuasive writing, Ms. Magaña asks the students to use their letters to persuade the aunts to treat him better. She is careful to detail the assignment in both English and Spanish. She also asks the students to read the next chapter.

Homework assignment links the reading lesson to a form of writing the students have been learning.

Figure 2-2

Instruction, Curriculum and Program Map, Del Norte

Innovative Instruction/ Curriculum Features

- Whole Language
- Cooperative Learning
- Literature-based curriculum
- Writers' Workshop
- Previewing
- Accelerated Reading program

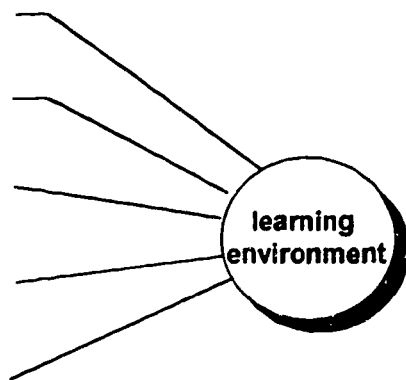

LEP Program Features

- 6th } *English + Spanish support*
- 5th }
- 4th — *20% Instruction in Spanish*
- 3rd — *60% Instruction in Spanish*
- 2nd } *90% Instruction in Spanish*
- 1st }
- K }

C. INNOVATIVE CURRICULUM AND INSTRUCTION STRATEGIES

The learning environment created by Ms. Magaña exhibits a pedagogical approach quite different from those used in traditional classrooms, particularly for LEP students. In the classroom, the various strategies are woven into one seamless fabric. For the sake of analysis, however, the following subsections discuss each main strategy in turn. Figure 2-2 on the facing page identifies them.

Although Ms. Magaña's students are in the fourth grade, the curriculum and instruction strategies are employed school-wide. Figure 2-2 shows how the program features for LEP students at various grade levels are integrated with innovative and holistic pedagogy used throughout the school. The LEP student program features will be elaborated in Section D.

Whole Language Techniques

The Whole Language approach is designed to create opportunities for students to use language in ways that reflect real-world purposes and functions and are authentically related to their life experiences. Whole Language strategies therefore rely on students *using* language rather than learning *about* language. Examples of Whole Language strategies were evident throughout the school; as students in Del Norte's classes maintained journals, wrote news stories, illustrated books, and published their work. Whole Language techniques figured prominently in Ms. Magaña's teaching of literature. For example, the students were encouraged to seek meaning from the text of a poem, not just to understand the words. In the discussion of *James and the Giant Peach*, Ms. Magaña used the Reader's Theater process to keep the students involved with the language of the book and used character maps to help them understand the characters and their motivations.

Cooperative Learning

Teachers throughout the school use cooperative learning techniques. In a strategy that has been adopted by all the teachers in the school, students work in pairs, trios, and larger groups on various learning tasks. Classrooms are arranged to facilitate cooperative activities—Ms. Magaña's classroom, illustrated in Figure 2-1—represents one example. Teachers in the program for LEP students use groups to provide support for students who are struggling with the language or with concepts. Typically, a student with a weakness in a particular subject or one who needs more English language support is assigned to work with students who have stronger skills.

One fifth grade class that included LEP students, for example, performed proficiently as cooperative learners—they shared their knowledge and problem-solved quickly and effectively as a group. The teacher divided his class into seven heterogeneous groups of four students each, building groups by matching the relative strengths and weaknesses of the four students. Within the groups,

students took turns filling the group roles of Chairperson, Recorder, Organizer, and Manager. Each role had a specific set of assigned tasks and the students took them seriously. One of the rules for the group was that no one could ask a question unless the whole group did not know the answer. The teacher used various strategies (including rolling dice) to ensure that all students participated in class discussions and that no one dominated.

Literature-based Curriculum

A literature-based curriculum complements the Whole Language strategies described above. Story books and novels were plentiful throughout the school—bookshelves in classrooms were stocked with sets of novels and with single copies of a number of other books. The library, a warm and inviting room, was crammed with bookshelves and a large collection of reference books, novels and story books, biographies, etc. The school sponsors a monthly book fair staffed by parents, and students are encouraged to purchase low-priced books of their own.

One fifth grade class engaged in literature studies. Every few weeks, the teacher allowed students to choose one of six or seven books; students who chose to read the same book formed a discussion group. The books they read are at the seventh and eighth grade levels (*Diary of Anne Frank, Summer of the Monkeys*, etc.), and students chose to read in either Spanish or English. They maintained Literature Logs of chapter summaries, opinions, and criticisms of their books. Literature groups met weekly to discuss their reading as they progressed; and students talked about the books' themes and characters with a high level of sophistication. Students wrote an evaluation of each of the books they had read during the year. They drew character maps and illustrations for parts of the books and wrote postcards recommending (or advising against) the book to their friends.

Writers' Workshop

Teachers at all grade levels teach writing as a process. All students have learned the Writers' Workshop process, in which they begin by drafting their work, move on to evaluate their own work and that of their peers, edit with the teacher, and finally to write a final version and publish their work. Posters describing the Writers' Workshop process are displayed in many classrooms. In one second grade class, for example, a group of students provided feedback to their peers on a story they had written in Spanish.

Previewing

Previewing is a pedagogical technique developed for ESL classes. It was developed based on the insight that for LEP students, an overview of an upcoming lesson in simplified English can help them follow the lesson when it is presented to the entire class using more complex English. With the

advantage of the preview discussion, LEP students can participate actively in the full class discussion. In the instructional sequence described in the narrative, Ms. Magaña adapted the previewing technique for Spanish-dominant students by carrying out their preview in Spanish. A few of the students in the class were relatively new immigrants who were more comfortable reading the assigned book in Spanish. The Spanish-language preview helped the LEP students feel more comfortable about participating in the class-wide English language discussion.

Accelerated Reading Program

The Accelerated Reading program was developed at the University of Wisconsin and is designed to increase student reading and comprehension. Every six weeks, the teacher and students negotiate individual student reading goals. The students commit to read a specific number of pages in books they select over the course of the six weeks. Reading is done primarily outside of class time and is tracked by a computer. To get credit for pages read, students take a computer-based comprehension test on each book.

All of the students in one fifth grade class started with a goal of 300 pages for the first six weeks. For the second six weeks, the goal for each student was increased to 400 pages. In subsequent six-week periods, the goal was increased on a student-by-student basis. At the time of our visit near the end of the school year, one student had a goal of 1200 pages and other students were in the 800 to 1000 page range. Students were challenged by the Accelerated Reading program and excited by their accomplishments—many were reading more than 900 pages every six weeks; the class read an average of 42 books during the year. Parents were pleased that their children were choosing reading over other activities and were excited by what they were reading.

The Accelerated Reading program is enormously successful at Del Norte. Students become self-motivated by the process and read increasingly difficult books. Among the students, there was healthy competition around the number of pages read. The school has awards ceremonies to reward students for their reading accomplishments. The librarian has had to order additional books to keep up with the demand, and teachers voted to spend more of the school's discretionary money on books. Bilingual students can read books in either Spanish or English, and some bilingual students have requested more sophisticated books in Spanish so they can maintain their Spanish reading skills.

The Accelerated Reading program started in sixth grade about six years ago and has now been extended down to third grade. The comprehension tests for each book help prepare students for the Language Arts section of the statewide assessment test—the Texas Assessment of Academic Skills (TAAS). Students manage at their own pace—they log onto the computer, choose the test for their book, and answer the questions on it. The computer program scores the test, lets the student know the results, and maintains a cumulative record for each student.

D. PROGRAM FOR LEP STUDENTS

Del Norte's program for LEP students from kindergarten through sixth grade is illustrated in the right column of Figure 2-2. As the schematic indicates, it is a graduated program in which students are given a larger proportion of instruction in English as they progress upward. Program elements are discussed below.

Structure and Staffing

Del Norte's program for LEP students begins with kindergarten—the entry point for most LEP students. Two of the five classrooms at each grade level from kindergarten through second grade are designated for LEP students and in those classes, students receive approximately 90 percent of their instruction in Spanish with the remaining ten percent (including ESL instruction) in English. At third grade, two of the five classes are designated for LEP students, but the proportion of English language instruction increases to about 40 percent; in fourth grade, it increases to approximately 80 percent. By the end of fourth grade, most LEP students who entered Del Norte at kindergarten or first grade are ready to be redesignated fluent English proficient (FEP) and make the transition to an all-English environment.

Students who have not been redesignated by the end of fourth grade are assigned to one of two fifth-grade "split" classes where instruction is primarily in English with clarification in Spanish. Split classes also enroll redesignated students whose parents request that they continue in an environment where Spanish is supported. In split classes, students are given the opportunity to maintain their Spanish language skills through reading literature and completing some of their assignments in Spanish. Depending on the availability of space in the split classes, students who were never LEP are enrolled with parent permission. Most of the students who were never LEP are second- or third-generation Hispanic students who are not fully bilingual but speak some Spanish. At sixth grade, there is one split class with instruction in English and clarification as necessary in Spanish. Again, the class is composed of both LEP students and students who were never LEP.

Split classes allow the school to achieve several goals. They allow the flexibility to accommodate newcomers in a setting where they are instructed by a teacher with training in language acquisition and strategies for teaching a second language, and who have Spanish language proficiency. The classes also allow continued support for Spanish literacy for redesignated LEP (FEP) students and allow for LEP and former LEP students to have close instructional contact with their English-only counterparts. Most of the school's students are Hispanic, and the strategy of split classes works well both instructionally and socially. English-speaking students learn some Spanish while LEP students have instructional contact with English-speaking peers and improve their English skills.

All of the teachers in classes designated for LEP students and the split classes have both bilingual and ESL certificates, and all are bilingual. They have received specialized training in language development.

Student Placement and Redesignation

Students are identified as LEP based on parents' completion of the Home Language Survey and on their scores on the Language Assessment Survey (LAS). LEP student placement and redesignation are based on the recommendation of the school Language Proficiency Assessment Committee (LPAC), which is composed of two of teachers in the program for LEP students, a parent, and the vice-principal. In making redesignation decisions, the LPAC is guided by test scores and teacher recommendations. Most students who enter at kindergarten or first grade are redesignated by the end of fourth grade when they have successfully completed the transfer program. At redesignation, most students are enrolled in mainstream classes, but some are assigned to split classes for fifth and sixth grades at the request of their parents.

Recent Immigrants

Del Norte enrolls a relatively small number of recent immigrants beyond first grade. These students are assigned to classes for LEP students if they enter at second through fourth grades. Texas law mandates a maximum class size of 22 students for all classes in grades kindergarten through four, giving teachers in those grades the opportunity to individualize instruction for new immigrants.

The small number of LEP students who enter Del Norte beyond fourth grade are assigned to split classrooms along with continuing LEP students and students described above (redesignated LEP students whose parents want them to remain in designated classes and English-dominant students.)

Most new immigrants who enter Del Norte later than first grade had continuous schooling in Mexico and have learned (or are learning) to read in Spanish. The small number of immigrant LEP students who enter in the later grades arrive without literacy in Spanish. Those students are provided with intensive ESL as well as Spanish instruction to help them understand concepts. The school does not try to teach Spanish reading to students who enter beyond fourth grade, because by the end of sixth grade, students must be able to function in an all-English environment in middle school. The district's middle school program for LEP students relies on an ESL model with little or no native language support.

One fifth grade split class has only one Spanish dominant student. The student was assigned to cooperative groups with bilingual students who were able to translate as necessary for him. The

teacher explained concepts to the student in Spanish and class materials were available to him in Spanish as necessary.

E. SCHOOL STRUCTURE

Del Norte has evolved a school organizational structure that allows the school to create an interesting, productive learning environment for all students. The organizational structure supports the curriculum and instructional strategies examined in the previous section. Figure 2-3 illustrates the key school organizational features that have evolved at Del Norte.

Site-based Governance

Two committees, (The Campus Educational Improvement Council (CEIC) and the Campus Communication Committee (CCC)), have responsibility for school governance: The CEIC is made up of four parents, three teachers and the principal. It makes budget and substantive decisions about issues that impinge on student achievement, including decisions on staffing, testing, and school-wide priorities.

The CCC consists of one teacher representative per grade level, representatives from special programs (Chapter I, Gifted and Talented, Special Education), and the principal. It addresses non-academic student issues, working conditions, morale among staff and students, and issues of school climate.

Del Norte has embraced enthusiastically the district's move to site-based management; with the exception of salary items, the school has control over its budget. Because decisions on budget expenditures are made by the CEIC and the CCC, teachers and other staff members are aware of the impact of expenditures—and much more frugal. School staff understand the trade-offs and make hard decisions on administrative expenditures to allow for maximum funding for the academic program.

Teacher Collaboration

Teachers throughout the school hold grade level meetings from one to three times per week. They share effective strategies, coordinate and align the curriculum across the grade level, and plan common curriculum themes. All teachers at the grade level—both teachers of monolingual English students and teachers of LEP students—participate in grade level meetings. The goal is to create a unified school where all children are challenged, held to high standards, and are exposed to a common curriculum. Grade level meetings that allow teachers to collaborate support the goal of program integration.

Figure 2-3

School Structure and District Support, Del Norte

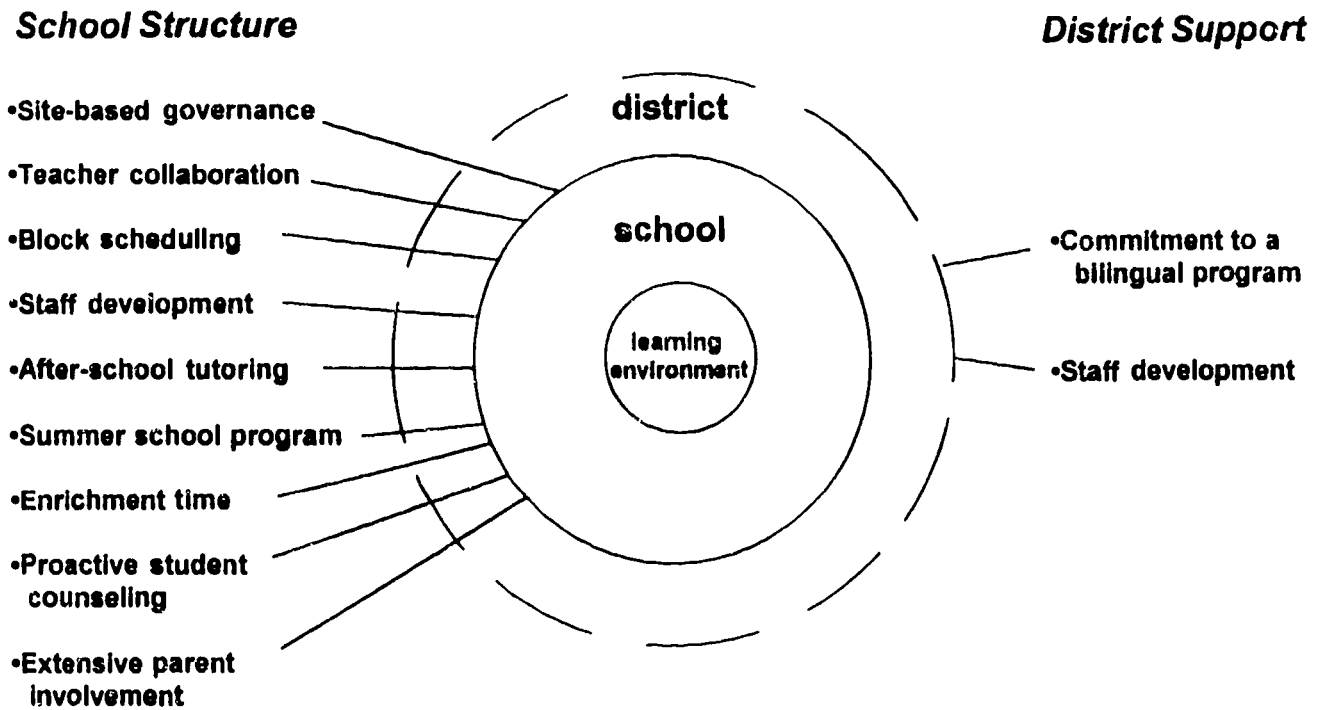

Teachers in the program for LEP students meet and coordinate their curriculum across grade levels. Bilingual teachers work together to share strategies for working with particular students, for teaching particular topics, and for maintaining student engagement. Teachers also share strategies for implementing Whole Language strategies, using the Writing Workshop process, developing thematic units, and using technology. Teachers sometimes team teach when it seems appropriate for a particular curriculum unit or theme, with team teaching sometimes occurring within the bilingual program and at other times at grade level.

Block Scheduling

The school has reorganized the way time is used during the week to allow for larger blocks of time for core subjects. Figure 2-4 illustrates the block scheduling at Del Norte. From Monday through Thursday, students have a block of time devoted to language arts and a block devoted to mathematics; individual teachers choose whether to teach mathematics in the morning or in the afternoon. On these days, students also have a 40 minute period for instruction in art, music, drama, or library research. Enrichment Time (described below) is a part of the language arts block.

On Fridays, the day is again divided into two instructional blocks, with students spending the full day studying science and social studies. Teachers have discretion about which subject to teach in the morning and which in the afternoon. The longer time blocks allow teachers to plan more complex lessons and provide students with more problem-solving activities. They are able to plan science labs, get students engaged in social studies research, and allow students time for sustained reading and writing.

After-School Tutoring

Del Norte cultivates its close links to the community by sponsoring several after-school activities. With support from Chapter I funds, classroom teachers provide after-school tutoring twice a week for 45 minutes. Students whose teachers feel they need extra support are encouraged to use this tutoring to reinforce their basic skills or language skills; roughly 100 students participate in the after-school tutoring program at any given time. Students who need more reading support also participate in an after-school reading program.

Del Norte students also participate in the national Odyssey of the Mind program, which requires that teams of students design and build a vehicle to take them on a journey that they imagine, design the scenic background for their journey, and present their odyssey to judges and an audience. In addition, they participate in the University Interscholastic League, a literature-based program. Both Odyssey of the Mind and University Interscholastic League activities are bilingual.

Figure 2-4

Del Norte's Block Schedule

	Monday	Tuesday	Wednesday	Thursday	Friday
Morning 8-11:45 am	Language Arts	Language Arts	Language Arts	Language Arts	Science
	Enrichment Time				
Lunch and Recess					
Afternoon 12:30-3:00 pm	Mathematics	Mathematics	Mathematics	Mathematics	Social Studies
	Library Research, Physical Education, Art or Music				

Summer School Program

Del Norte offers a four-week summer school program that operates for four hours each day. School staff view this time as a way to enhance student learning. Forty percent of all students attend summer school; they are accepted into the program according to their need for assistance—students who need extra help in English and students who are at risk of being retained. Many students who might otherwise be retained have become ready for the next grade as a result of attending summer school. The program has also provided a way to extend language development for LEP students over the summer months.

Enrichment Time

Enrichment Time (ET) is a schoolwide language support program. Every day, this 45 minutes of the Language Arts block is devoted to one of four activities: Spanish as a Second Language, ESL, reading improvement, or reading enrichment. Enrichment Time is scheduled by grade level so that, for example, all first graders might have ET from 9:00 to 9:45 a.m. During that time students from the five first grade classes are assigned by their teacher to one of the four ET activities. The five first grade teachers are supplemented during ET by three resource teachers (two funded by Chapter I). The approximately 110 first graders are divided among the eight teachers for the 45-minute block of time, making intensive and individualized instruction easier.

Staff Development

Staff development is seen as an effective way to support Del Norte's goals. Principal and faculty have adopted a strategy that focuses staff development on improving specific aspects of the instructional program. The school staff analyzed the school's TAAS results in order to tailor their school focus, including staff development. Because in years past, Del Norte students had not performed well on the Language Arts section of the TAAS, school staff refocused on Language Arts, instituted the Writing Workshop process, engaged the students in literature-based studies, and intensively supported the language arts curriculum with schoolwide staff development activities. Schoolwide language arts scores on the TAAS have since increased dramatically.

Staff next identified mathematics as the focus for their development activities—again chosen because it was identified as a student weakness. Staff use their early dismissal days during the year to work with a mathematics professor from the University of Texas at El Paso (UTEP) to align the mathematics curriculum across the grade levels and improve mathematics instruction. They are developing ways to use manipulatives and critical thinking skills as they introduce algebraic concepts. Across all grade levels, teachers have adopted the new mathematics techniques in their classrooms. Mathematics instruction is grounded in the real world, with some classes using menus

from local restaurants and catalogs as learning materials. Next year, UTEP plans to assign 13 student teachers who have trained with the mathematics professor who has been working with the Del Norte teachers. The teachers-in-training will do their student teaching at Del Norte and at the same time further support the mathematics program.

Del Norte teachers often receive training and then train and coach their colleagues, thereby increasing teacher buy-in. Recent staff training has been in the use of technology in the classroom, alternative assessment methods, and site-based management. The district provides a menu of staff development opportunities, and Del Norte Heights staff take advantage of the district menu. Other staff development is paid for through school funds, and decisions on training activities are made based on staff recommendations to the CEIC.

Proactive Student Counseling

The counselor's role at Del Norte is more active and prevention-oriented than that of many elementary school counselors. Fluent in both Spanish and English, the counselor makes classroom presentations at every grade level on topics such as study skills, drug awareness, child abuse, sexual abuse, the responsibilities of citizenship, self-esteem, dealing with strangers, and gang awareness. According to the counselor, her materials contain two consistent messages: first, how students can recognize dangerous elements in their environment and second, how they can accept responsibility for their choices and the consequences of those choices.

The counselor discusses her presentations with classroom teachers in order to link each one to a theme the teacher is already working on. She believes that reinforcement with the students is much easier when she can anchor her message to the curriculum in some way.

Additionally, the counselor works with groups of students who need counseling support on particular topics. The district uses a series of indicators to identify students at risk for school failure—students who are over-age for grade, who have been detained, who are from single-parent households, who are LEP, etc. The district provides the counselor with a printout of those students—a large percentage of the students at Del Norte—and she organizes student groups to work on student-identified issues. During the 1993-94 school year, she was working with 18 groups, each with between six and 14 students. The groups have different foci which change from year to year. In 1993-94, for example, she had two children of divorce groups and one group each on getting along with others, self-esteem, and peer pressure. An influx of military families caused an increase in her caseload because "it takes these kids a long time to adjust." In addition to working with groups, she counsels individual students, parents and/or families, and occasionally teachers.

The counselor has organized a Mother-Daughter Program at Del Norte which is coordinated with the district Mother-Daughter Program and the University of Texas at El Paso. She recruits female Del Norte students who are doing well in school, but who don't have a parent or other close relative who has been to college. She pairs these girls and their mothers with Latina professionals in a mentoring, supportive, information-sharing relationship. The goal of the program is to connect with mothers as well as daughters so that mothers can expand their horizons and envision their daughters going on to college. Including the mother may also allow the impact of the program to extend to the other children of the family.

Extensive Parent Outreach and Involvement

An outstanding feature of Del Norte Heights Elementary School is its effort to involve parents in the school life of their children. Parents play key roles in the governance process, are involved in some of the classrooms, support schoolwide activities, and volunteer in the cafeteria and for other school activities such as the school book fair. They are invited to read to their children's classes. School staff have worked hard to create and maintain that level of parent involvement and to ensure that parents of the school's LEP students also become part of the school community. The role of the Chapter I Home Liaison is key to the latter goal.

The bilingual Home Liaison lives in the neighborhood and her children (now adults) attended Del Norte. Her roles include serving as attendance liaison, providing ESL instruction to parents, offering parent training, and staffing the parent activity center. Del Norte does not have a truancy problem but some students do stay out of school while their families make extended visits to Mexico. The Home Liaison works with families of students, particularly the families of LEP students, to let them know how important it is for their students to be in school every day.

In addition, the Home Liaison has developed and carries out a series of activities designed to encourage school participation by parents of the school's LEP students. She has turned space in a portable adjacent to the school into a combination classroom and comfortable space for parents to sew, do crafts, or just visit.

Parents come to the school for an ESL class three mornings a week. They work mostly on oral language development, with some reading; the curriculum and a teacher's manual were developed by the district to be used for ESL for adults. The Home Liaison supplements the curriculum materials with materials she has developed over the years to "make learning English fun." She also meets weekly with a Parents' Group on topics about parenting and essential survival skills agreed on by the group, including a module on nutrition that includes both planning a healthy diet for the family and shopping on a budget. She has also presented a unit on banks, their forms, requirements, tips on budgeting, and relating to bank personnel. A behavioral psychologist recently gave a seminar—

Talking to Your Children— on communication skills. The school also sponsors career awareness activities for parents.

Parent participation at school events varies: In the fall about 60 to 70 percent of the parents attend each event, with some decline over the course of the year. The exception is when the children are performing some form of drama, music, or dance; then, there is standing room only. The school has a full-time fine arts teacher who puts on several performances a year with the students.

The district has a Gang Awareness Task Force that presents an 8-hour course for parents of 4th through 6th graders. It helps parents understand gangs, the way they recruit children, and how to identify and counteract their techniques. About 40 Del Norte parents participated—a turnout that was among the highest of all of the schools in the district.

F. DISTRICT SUPPORT

Staff at the Ysleta School District share the view that bilingualism is an asset and that all students, regardless of their first language, can learn. District staff facilitates and supports the program at Del Norte and helps with staff development, bilingual teacher recruitment, and site-based management.

Commitment to a Bilingual Program

Schools in the Ysleta district have a great deal of flexibility to design their programs for LEP students, and most have chosen to provide some native language support into the later grades. District schools are responsive to the needs of individual children and the goals of the parents when considering how to structure their programs. Bilingual education is institutionalized in the district, and the expectation is that students who enter at kindergarten will be allowed five years to learn their second language. Most district elementary principals actively support the bilingual program and understand the importance of integrating it with the rest of the school's program. Del Norte is viewed as a long-standing example of the success of an elementary bilingual program. The excellent test results of its students support the district's view that "they are doing lots of things right over there."

Staff Development

About half of the district funding for bilingual education is devoted to staff development. The district bilingual coordinator works closely with the staff development director to ensure that all staff development activities are coordinated and that they support the same methods. Whole Language strategies and a literature-based curriculum have been themes of both district-wide staff development

activities and the bilingual program. District efforts have included a summer program for teachers who went to Mexico to be trained in children's literature in Spanish.

The district's bilingual office has provided a great deal of staff development on Whole Language literacy and on ESL techniques for all classroom teachers. Teachers in non-bilingual classrooms are now requesting ESL training. Teachers throughout the school, not just bilingual teachers, are being trained in ESL and sheltering techniques, perhaps because the district has disaggregated test data and holds schools accountable for the results for all kids. According to one administrator, "Psycholinguistics should be a required component of teacher preparation programs so that all teachers know what it means to have limited proficiency in English. Otherwise, the inability to understand where the children are coming from will remain a barrier."

The district has conducted "massive training" in cooperative learning for elementary and middle school staff. It is also planning a district-wide training program in which teachers will learn to observe their colleagues and give them feedback on their teaching (peer coaching), an especially important tool for districts like Ysleta in which governance and management are site-based. One district administrator noted that she would like to see principals require colleague observation as a component of all staff development and evaluation. "If campuses are to be self-sufficient, they must be able to monitor themselves and be responsible for professional growth."

G. SUMMARY

LEP programs are too often low priority add-ons at many schools across the country. Del Norte Heights Elementary School, by contrast takes an integrative approach. Its program for LEP students is coherent and articulated across grade levels. Teachers and the principal share a vision which includes the proportion of native language instruction that is appropriate to each grade level, the consistency of learning strategies throughout the school, and the importance of supporting student culture. Teachers, the principal, district staff, students, and parents all expressed the belief that bilingualism and biliteracy are important values, and are confident that LEP students can achieve them. Their vision includes high expectations for all students, and the coordination of the school program and staff development activities in order to meet those expectations.

Emphasis on Development of Language Skills

Block scheduling, the Accelerated Reading Program, Whole Language strategies, cooperative learning, literature-based curriculum, and the availability of advanced reading materials in Spanish all support a schoolwide emphasis on development of language skills. Students throughout the school are becoming readers and learning to interact with literature.

Multiple Support Structures for Acquiring a Second Language

Del Norte's formal program for LEP students is supplemented with a number of flexible activities that support student acquisition of a second language. The after-school tutoring program using teachers from the school provides special help for students with identified needs. Enrichment Time during Language Arts allows for a range of added help and enrichment for all children without the stigma of a pull-out program.

CHAPTER 3

HOLLIBROOK ELEMENTARY SCHOOL SPRING BRANCH INDEPENDENT SCHOOL DISTRICT HOUSTON, TEXAS (PRE-K-5)

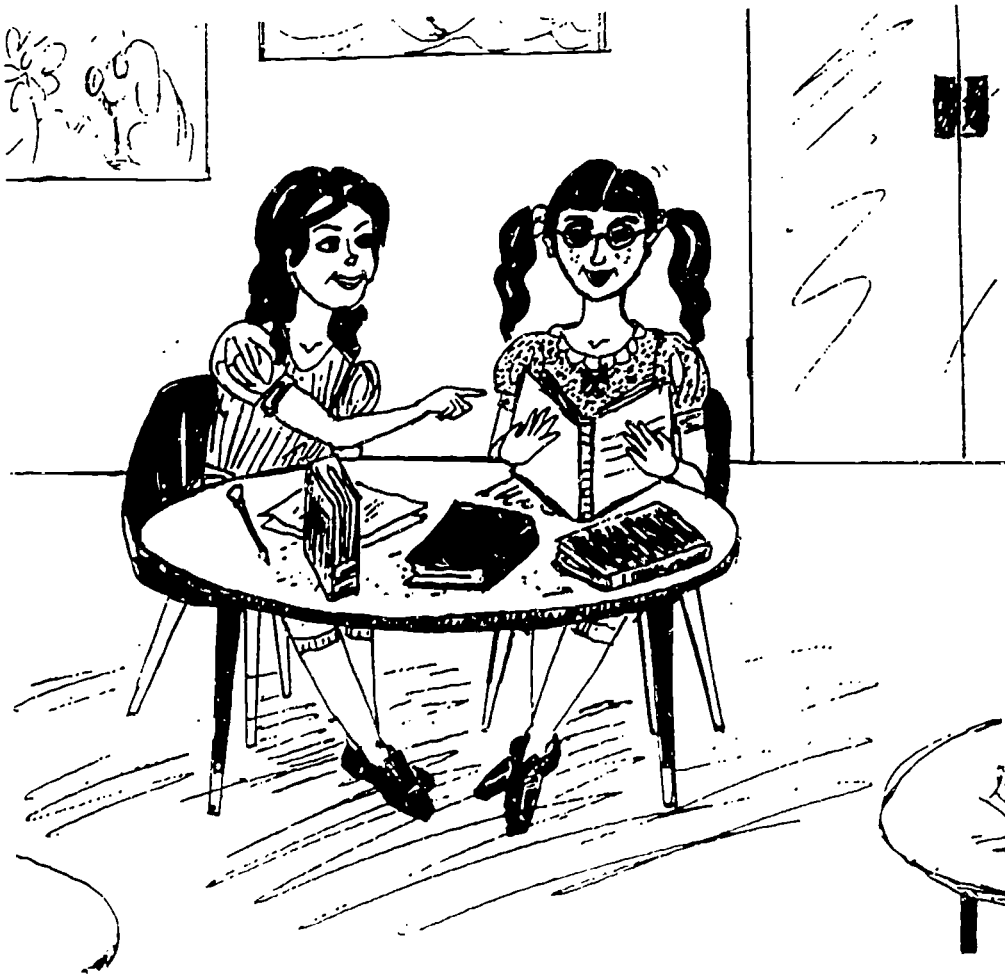

A. SCHOOL AND COMMUNITY CONTEXT

The economic decline of Houston in the 1980s led to abandonment of this neighborhood on the West side of Houston by middle class families, followed by a large influx of poor families who could afford the low rents. Hollibrook Elementary enrolls 1000 children from pre-K through fifth grade. Eighty five percent of it's students are Hispanic, 12 percent are White (non-Hispanic), and threc percent are African American. The great majority, (87 percent) qualify for free or reduced-fee lunch; the school also provides a breakfast program. Sixty seven percent of the students are LEP. The student population is relatively stable; while there used to be a high turnover—over 100 percent annually—turnover is now down to 30 percent.

The Hollibrook community is relatively homogeneous economically, consisting largely of blue collar workers and laborers. Most families of LEP students are first generation immigrants, with the children born here of Mexican parents. The school is surrounded by large apartment complexes, most of which have major security and drug problems. Across the street from the school, an empty apartment complex is boarded up and scheduled for demolition. The dense population of mainly minority families has little access to recreation facilities, parks, libraries, and other civic amenities. Students are exposed to violence on the street, and sometimes in the home. However, the school campus is the site for a new park playground that is being built in collaboration with the city.

The next section provides descriptions of two Hollibrook learning environments—a self-contained fourth grade class and a team taught second grade class.

Figure 3-1
The Classroom Layout, Hollibrook
Ms. Mignonga's Fourth Grade Bilingual Class

The classroom is organized into different learning areas, with spaces created for small working groups of students. A separate space for group work is provided apart from the main classroom area. Furniture can be moved to facilitate different learning activities. The classrooms in this building are separated only by low partitions about four feet high. Openings in the partitions, rather than doors, serve as entryways into the classroom.

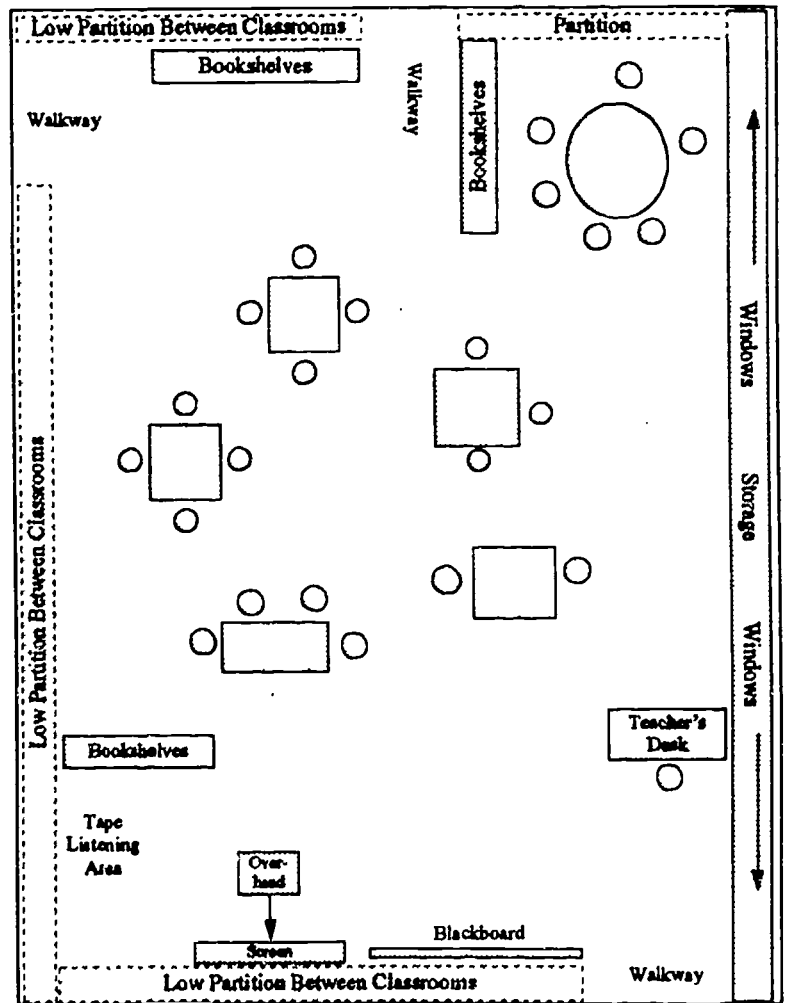

Two Hollibrook 4th graders engage in Readers' Workshop. One girl reads while the other listens and reflects on the reading strategies she is using. Later the girls switch roles and the listener will become the reader.

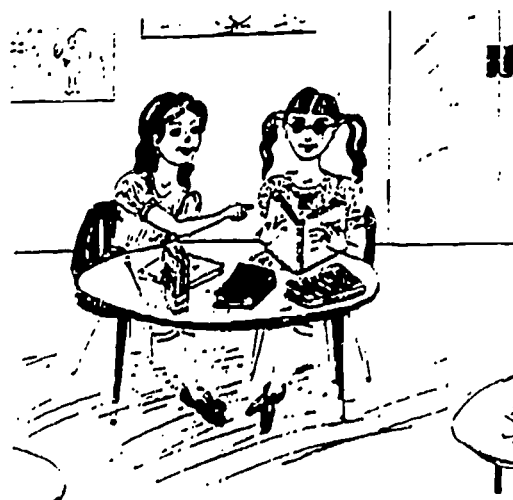

B. AN EXEMPLARY LEARNING ENVIRONMENT

Ms. Mignonga's Fourth Grade Bilingual Class

Nine year old Jorge's eyes twinkle with excitement as he leads his 22 classmates through a nine-item agenda during a class meeting:

1. Conferences
2. Partnership
3. Pictures
4. Helpers
5. Visitors
6. Thought for the day
7. Math challenge
8. Miscellaneous
9. Celebration

For agenda item #7, "math challenge," Jorge poses a problem to the class. He shows them a picture of some lines and asks them to determine which two lines are perpendicular. Each student who wants to speak raises her or his hand and waits for acknowledgment from Jorge. The discussion is lively and all in English. For agenda item #9, "celebration," Jorge asks students to say what they have to celebrate today. Miralda raises her hand eagerly and when called on says, "I celebrate our visitors."

The class is in a bright, open setting with learning centers (reading nook, tape listening area, art corner) defined by storage unit barriers and low bookshelves. Other groups are meeting in different areas of this large space, but the sound of their work is muted. Student work is shown everywhere; signs denoting various learning centers hang from the ceiling; posters and displays in English and Spanish cover the walls.

When Jorge completes the agenda, Ms. Mignonga tells the students their Writers' Workshop is about to start. She begins by discussing genres of fiction. She speaks in English and clarifies in Spanish, asks open-ended questions, and builds on student answers to engage the class in reflecting on different types of fiction and non-fiction.

Student leadership of class activities builds confidence and lets students use English.

Students have learned to work cooperatively; 14 of them have been together since first grade.

The teacher's open-ended questions elicit thoughtful responses from students. Clarification in Spanish makes discussions comprehensible to all students.

Ms. Mignonga asks the students to work for an hour on the books they are writing. She says they may work in either English or Spanish, in a genre of their choice—fiction or non-fiction. She asks them to work independently or in pairs, as they wish. The students immediately go to work. Some work alone, while some work with a partner and begin to confer on the assignment.

Two uninterrupted hours for a single activity allows depth; students have all the time they need.

The students work alone without direction from the teacher. After an hour, Ms. Mignonga calls the class together for a group discussion of their writing. She asks open-ended questions in a soft voice and makes eye contact with the students who answer. She allows the discussion to flow according to student interest, but gently brings it back on track if the focus goes astray. There are no bells or interruptions, and Ms. Mignonga and her class devote two hours to the Writers' Workshop.

Students are familiar with the framework of the Readers' Workshop. The chart delineating the process was student-generated; it is added to as students learn new strategies.

The next day, Ms. Mignonga's class meets for a Readers' Workshop. A chart hangs from the ceiling with directions to students:

*Readers' Workshop:
Express punctuation
Ask the meaning of words
Summarize
Use personal experience
Talk to yourself
Guess
Make predictions
Talk about your feelings
Make connections*

The students feel connected to the subject of the book. Expectations for each partner in the pair are well understood by the students.

*All the students in transition to English literacy are reading *Where the Broken Heart Still Beats* by Carolyn Myer, a book about Native Americans. They work in pairs: One student reads a paragraph aloud to her partner, the partner employs a reading strategy (such as "talk about your feelings"), and then the reader tells her partner what reading strategies she has used. Then the students switch roles. The classroom sparks with energy.*

Because the students are capable independent learners, the teacher is free to offer intensive assistance to the new arrivals.

The students continue to work independently, while in one corner of the classroom area Ms. Mignonga works intensively for

45 minutes with the six newcomer students. All but one of the new arrivals is literate in Spanish.

At the end of the Readers' Workshop, Ms. Mignonga calls all the students together. She asks individual volunteers to talk about their reading. She asks open-ended questions which subtly draw out her students' language abilities. Her voice is soft, her tone gentle, her gestures small. She sits close to the students arranged around her. Students respond in either English or Spanish, but their responses are full sentences.

Open-ended questions are designed to challenge the students to think, to make connections, to expand on their thoughts.

Teacher models behavior by speaking quietly.

Comments

The unique learning environment created in this classroom is remarkable for several reasons. First, the children have been with the same teacher since kindergarten. As a result, the students and teacher know one another very well. This provides a stable environment for students who may experience a lot of instability in their lives. Continuum classes like this also foster parent involvement, as parents know the teachers well.

Second, the transition from Spanish to English is accomplished gradually over a period of five years. Literacy in Spanish is supported, as well as literacy in English. The students work extremely hard at learning to read and write in English, while the teacher also takes care to nurture the development of students' Spanish literacy skills. Transition to English literacy is tailored to fit the student, and "gaps" between teachers of each grade are eliminated. As a bilingual teacher capable of teaching in Spanish or English, Ms. Mignonga is able to clarify meaning when necessary and can remove language barriers to student comprehension of complex ideas.

Third, specific instructional strategies supported the exemplary learning environment. The students in the fourth grade bilingual class showed a remarkable ability to concentrate and spend extended periods of time without adult direction—reading, conferring, and writing. Because Ms. Mignonga could rely on the independence of the skilled cooperative learners, she was able to work with a small group for special reading instruction.

The framework provided by Writing and Readers' Workshops helped the students understand what was expected of them. The specific process laid out in the workshops supported language development in students, encouraged deeper understanding of material, and helped children learn to appreciate the beauty of the spoken and written word. The book the children were reading was relevant to their experience as Mexican Americans in the American Southwest. Ms. Mignonga's subtle approach in the classroom discussions fostered the students language development.

Figure 3-2 The Classroom Layout, Hollibrook

Ms. Crawford's and Ms. Williams' Second Grade Bilingual Class

This large double classroom accommodates a combined second grade class taught by two teachers. Bookshelves and low partitions define two large learning areas. The learning environment can be changed to fit the grouping strategy being used. Small tables, chairs and rugs on the floor enable the students to group themselves comfortably during different learning activities. One section has a rug and large rocking chairs for reading stories. Ample storage space is provided for student work and books.

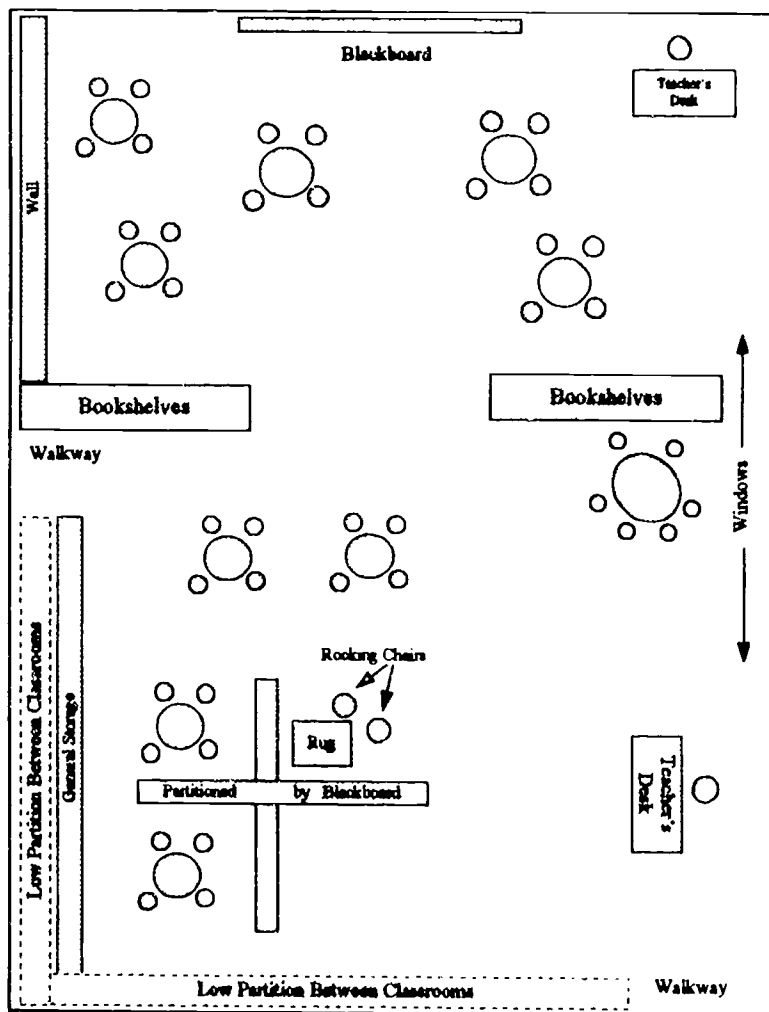

Ms. Crawford's and Ms. Williams' Second Grade Bilingual Class

Children's voices signal the arrival of 45 students. Their large, double-sized classroom is divided into activity areas defined by open bookshelves. There are small tables, listening centers, a rug. There are signs in English (written in black) and Spanish (written in red). A large rocking chair and several large chairs are in the front of the room.

At the teachers' signal, Writers' Workshop begins. Ms. Williams brings together the English-speaking students for a mini lesson on English words that begin with spr. She asks students to volunteer words that begin with spr and to define them.

Ms. Crawford gathers the Spanish-speaking students to think of English words that begin with th. She writes them on the board as the students respond.

Splitting the class this way enables the teachers to specialize instruction when necessary. Here, English speakers study the relatively hard-to-pronounce words beginning with spr, while LEP students tackle the unfamiliar th sound, which is not used in Spanish.

Later, students pull down document boxes containing their writing materials and select the space where they want to work. They work alone, in pairs, or in groups of three. Ms. Crawford and Ms. Williams explain the goal: Each student is to produce a book. A sign is displayed on an easel in the middle of the classroom:

Writing process:

- 1. Draft number 1*
- 2. Conference with self*
- 3. Conference with friend, friend signs it*
- 4. Revised copy*
- 5. Teacher edit, teacher signs*
- 6. Final copy book form*

Second grade LEP and English-only students have been together with this team of bilingual teachers since kindergarten.

Flexible grouping strategies help to accomplish specific learning goals. Grouped with monolingual English children, LEP children learn from native speakers, and grouping monolingual English and LEP children separately enables teachers to tailor language learning.

Independent learning is expected and cultivated in large and small ways. For example, students store and retrieve their own work in "document boxes."

7. Share

Substantial blocks of time are set aside for writing

The students work diligently on their own for 90 minutes, with minimal supervision by the teachers. They focus intently on their work, while the teachers work one-on-one with students for ten to 15 minutes at a time, reviewing their stories and offering suggestions.

While the class works independently, teachers confer with individual students. Such interactive (not directive) tutoring can be especially helpful for students who are just learning English.

Ms. Crawford works closely with one girl for 15 minutes. The teacher sits on the floor next to the student, speaking softly to her. All around them, children are focused on their writing; no one pays attention to the teacher-student dialogue. Ms. Crawford alternates between Spanish and English. She helps the girl understand her story, clarifies vocabulary and syntax, and has the girl explain it in English and Spanish. She then asks the girl to re-write the story in English. When Ms. Crawford finishes, she softly calls a boy over to repeat the process.

Student-led discussions after a Writer's Workshop provide opportunities for oral English development and reflection

A group of students gathers around on the floor with Ms. Williams to share their stories. Individual students read their stories to the group and the group gives feedback, commenting on the story line and prose. The students reading their stories sit in the large rocking chair, dubbed the "author's chair" and call on their fellow students for responses. The students listen attentively. While these students are engaged in storytelling and response, Ms. Crawford continues to work with individual students on English writing.

With two teachers, one can lead a group activity while the other works with individual students. The result—a productive classroom.

Comments

Like Ms. Mignonga's, this is also a continuum class, but larger because two full second grade classes are taught as one. While Ms. Mignonga's students are all Spanish-speaking LEP children, this combined class includes native English speakers with LEP students. The teachers took advantage of the class's size and diversity to group and re-group students according to the learning activity.

This class also used Writers' Workshop as a learning tool. Students knew what was expected of them and were able to perform as independent learners. Remarkable concentration was demonstrated by students two years younger than those in the fourth grade class described earlier.

Ms. Crawford and Ms. Williams designed their team teaching strategy themselves. Given discretion to create a team, plan their program, and decide how to use the school day, they learned each other's strengths and designed instruction to capitalize on them. For example, one teacher's superior Spanish language fluency makes her the ideal teacher to assist students with Spanish writing skills, while the other's strength in math is drawn upon to teach math to all 45 students. After some trial and error, they feel confidence in their control over the learning environment, and it shows. Transitions are brisk, little time is wasted, and both teachers are always working with students.

**Figure 3-3
Instruction, Curriculum, and Program Map, Hollibrook**

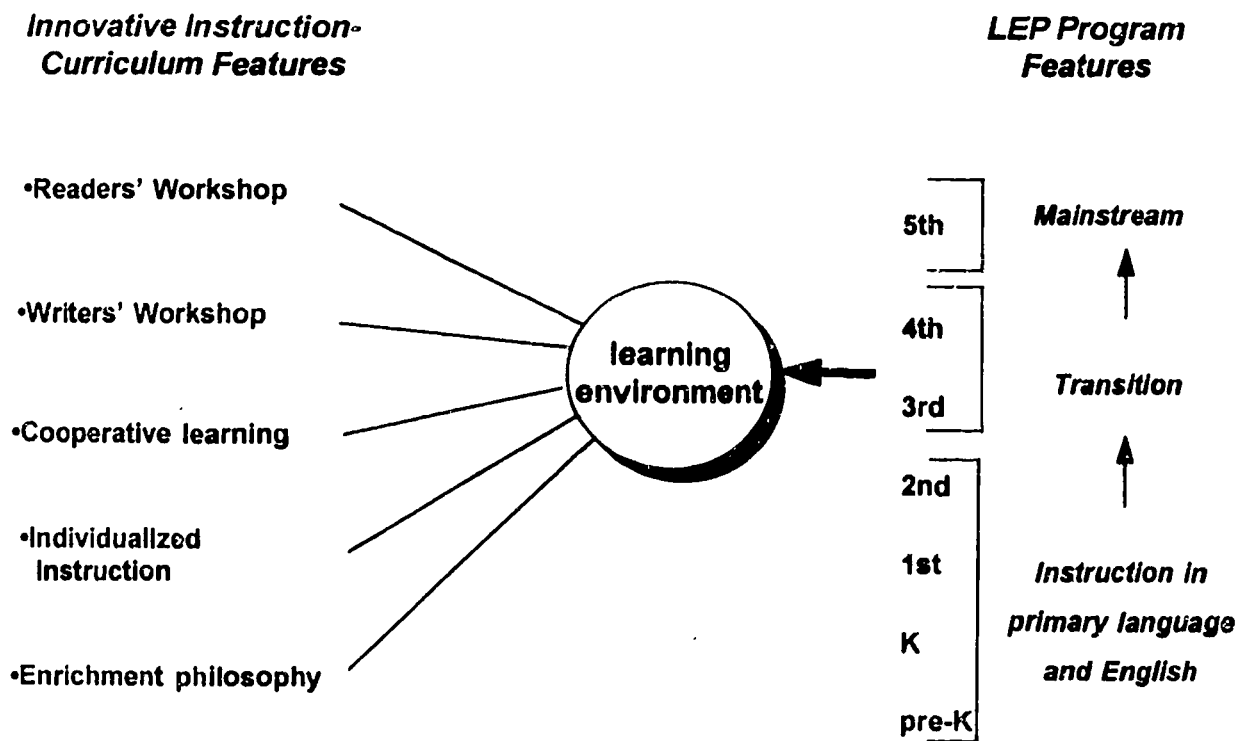

C. INNOVATIVE CURRICULUM AND INSTRUCTIONAL STRATEGIES

Many of the educational strategies employed at Hollibrook were developed by school faculty and staff in consultation with parents and students using the Accelerated Schools inquiry method, which provided the framework for an intensive, full-scale review of all aspects of schooling at Hollibrook. Accelerated Schools—and Professor Henry Levin of Stanford University—first came to the attention of the Hollibrook principal in 1987 through an article published that year in an educational journal. She contacted Levin, and Hollibrook faculty and staff worked intensively between 1989 and 1992 to implement the Accelerated Schools process. While that principal eventually left Hollibrook, staff still use the Accelerated Schools process to set school-wide priorities, and participate in workshops at both the state and national level.

The cornerstone of Accelerated Schools is its inquiry method in which all faculty members participate in committees or cadres to examine important questions developed by the faculty, administration, parents, and students. Accelerated Schools is a process of reviewing the needs of the school and the staff's vision for the future, taking steps to accomplish the vision, and working with an outside "coach" who provides independent guidance to the participants.

Through the Accelerated Schools process, the faculty developed the idea of the continuum class, the bilingual approach, and the strong emphasis on language development schoolwide. In later years, the Accelerated Schools process contributed to the creation of full-day kindergarten, hiring social workers in place of school counselors, and investing heavily in technology for the school.

The Accelerated Schools process affected most aspects of schooling at Hollibrook, including curriculum and instructional strategies. These pedagogical strategies and the program for LEP students are inextricably linked at Hollibrook. Hollibrook also uses teaching strategies and curriculum that deviate significantly from more traditional models. Student populations and teaching staff are arranged in different classroom configurations—while the fourth grade class of all LEP students was taught by one teacher, the second grade classroom combined English-dominant and LEP students and was taught by a two-person team.

Readers' Workshop

The first description of an exemplary learning environment at Hollibrook illustrates students' use of the Readers' Workshop to approach their literature-based language arts curriculum. In Ms. Mignonga's classroom, the list of steps in the workshop process resulted from a brainstorming session in which students identified strategies that help them achieve their reading goals. The list not only provided students with a framework for guided reading, but increased their sense of ownership of the learning process itself.

Writers' Workshop

In the narrative description of the team-taught classroom, students were engaged in a Writers' Workshop. The multi-stage procedure—working on initial drafts, reviewing, getting feedback, revising, and sharing—mirrors the process that will be required of students as they continue their education and enter the world of work. At a young age, Hollibrook students are already comfortable with the sequence of steps involved in writing. They know what is expected of them and are able to work independently for extended periods on self-directed writing projects.

Cooperative Learning

Hollibrook teachers used cooperative learning strategies in several ways and students showed remarkable ability to concentrate and spend extended periods of time without adult direction. In one instance, students worked in groups of four or five on different projects relating to one theme—weather. They played different roles within their groups, but all were responsible for contributing to the final product. Over the course of the month-long theme, students rotated among the various related projects. As students moved through the cycle, their cooperative groups changed and they had the opportunity to work with almost all of their classmates. These classrooms unleashed a powerful ally to teachers' efforts—the innate desire of children to learn and to help one another.

Individualized Instruction

Because the teachers could rely on the independence of their skilled cooperative learners, they were able to work one-on-one with students for 15 or 20 minutes at a time, or work with a small group for special reading instruction. Under these circumstances, instruction aimed at effecting student transition to English literacy could be tailored to fit each child.

Enrichment Philosophy

Another result of Hollibrook's work with Accelerated Schools is their adoption of the philosophy that "at-risk" students need enrichment, not remediation, in order to perform at levels appropriate to their age group by the end of elementary school. For example, in order to bring students to grade level in language arts, Hollibrook teachers preview challenging literature with students who are not yet reading at grade level. Through advance exposure to the curriculum, students are able to succeed in whole class discussions and in group work with their classmates. This strategy eliminates the need for pull-out remedial reading instruction. Previewing, as well as other "accelerated" strategies, is evident in the powerful curriculum and creative school organization seen at Hollibrook.

D. PROGRAM FOR LEP STUDENTS

Hollibrook's LEP students typically receive instruction in Spanish until third grade, at which point they begin their transition to an all-English environment. The program structure is exhibited in Figure 3-3. The use of language and strategies for transition are discussed below.

Bilingual Program

The Hollibrook bilingual model was developed at the school as part of the Accelerated Schools. The goal is that all Hollibrook students will become bilingual— Spanish-speaking LEP students, English-dominant Hispanic students, and monolingual-English students. The use of both languages creates a non-threatening environment conducive to risk-taking and continuous language acquisition. There is less emphasis on attaining Spanish literacy for English speaking students, for whom oral Spanish language skills are stressed.

The intent of the bilingual approach is to honor both languages with a bilingual teaching staff, by using Spanish speakers as a resource for English speakers and developing valuable language skills for both LEP and non-LEP students. Grouping English-speaking students with Spanish-speaking students, particularly in team teaching environments, creates opportunities for LEP students to interact with native speakers and accelerates their learning of English.

Transition to English Literacy

As explained in the comments on exemplary learning environments, the students in the featured classrooms had been with the same teacher(s) over a period of years. Continuum classes (described in the subsequent section) provided a great deal of support for the implementation of innovative curriculum and instructional strategies, as well for students' transition to English. Because the students have been with them for several years, the continuum teachers have intimate knowledge of their students' language development. This knowledge enables teachers to tailor instruction to individual students' strengths and weaknesses, a significant advantage when students are making the transition to English literacy. Students in continuum classes like staying with one teacher because, as one student said, "She has confidence in us and that gives us confidence."

E. SCHOOL STRUCTURE

The exemplary learning environments at Hollibrook are supported by several school-wide features; these include strong parent and community outreach programs, flexible use of time, and the implementation of the Accelerated Schools' inquiry method. These features, as well as supportive district and state programs and policies, are shown on Figure 3-4.

Continuum Classes

In Hollibrook's continuum classes, students stay with the same teacher for a period of years. The goal of this strategy is to introduce stability in the children's lives in contrast with the mobility, unemployment, and social instability in the surrounding neighborhood. Also, it was hoped that continuum classes would foster parent involvement as parents got to know the teachers well over several years.

Continuum classes offer unique advantages. Less time is spent setting standards (class expectations) and establishing rapport. The capacity of students to work alone or in pairs for extended time periods is developed in the continuum class. This enables the teacher to devote time to individualized learning.

Figure 3-4
School Structure and District Support, Hollibrook

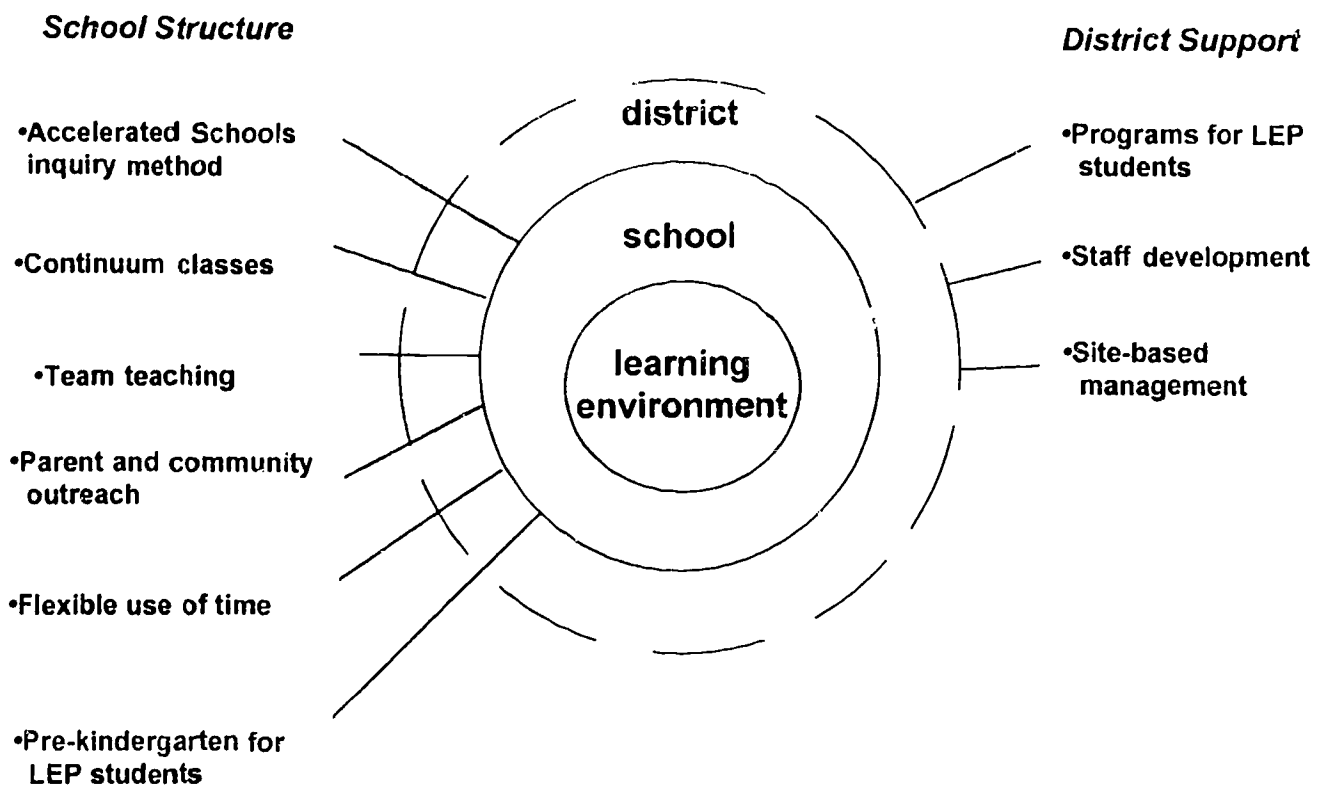

Not all classes at Hollibrook are continuum classes, however. The large elementary school is divided into two teams, each headed by an assistant principal. One team has continuum classes; the other, self-contained classes. Both teams have full-day kindergartens.

Team Teaching

When the continuum approach is combined with team teaching as in the second grade class, larger groups of students can be grouped and re-grouped depending on the task. Teachers who work together for several years with the same students learn to be a proficient team. Since single classes usually have about 20 students, teamed classes are still manageable in size. As a rule, there are no aides in the classroom.

Parent and Community Outreach

Hollibrook School is located in an environment of poverty, violence, and gangs. School staff believed that without an active effort on their part, there would be alienation between the poor families in the crowded apartment buildings and the teachers and staff of the elementary school. The school uses five main strategies to bridge the gap with parents: a parent center on campus, social workers, teacher outreach to apartment buildings, keeping students with the same teacher over a period of years, and an after-school activities program.

The Parent Center is a room devoted to parent meetings; it is equipped with a refrigerator, a microwave oven, and toys for toddlers to play with while their parents participate in school activities. It is a colorful room, decorated with photos of children, families, and staff, and with student artwork. It provides a place for parents to meet, work on projects for teachers, and socialize. There is a Parent University program, including ESL classes, for parents of LEP students. The center is bustling most of the day, with parents coming in and going out. The center gives parents a place of their own in the building, a place to go. It also brings parents into the school, welcoming them with babies in strollers and toddlers underfoot. The principal greets many parents by name.

Hollibrook uses school site resources from the Spring Branch Independent School District to hire two social workers who maintain ties to the apartment building managers, work with city agencies and police, make referrals to outside agencies for counseling and health services, and help families obtain needed services. Both social workers are bilingual, as are the office staff. The school decided it was more appropriate to employ two social workers and one counselor rather than three traditional school counselors.

Hollibrook also runs an After School Activities Program (ASAP) seven days a week. Developed as a gang prevention program, the program offers family and community recreation as well as tutoring. ASAP is staffed by teacher volunteers and a City of Houston parks employee.

Flexible Use of Time

All of Hollibrook's teachers design the way in which they will use their time during the day. Music, PE, and health teachers take students at times convenient for the classroom teachers, which enables classroom teachers to meet for planning purposes.

Pre-Kindergarten for LEP Students

Hollibrook is one of four schools in Spring Branch with a state-supported bilingual pre-K program for LEP students. Students move from the pre-K to the Chapter I-funded full-day kindergarten program.

F. DISTRICT SUPPORT

Spring Branch Independent School District supports the learning environment at Hollibrook by assisting in the implementation and development of programs for LEP students, providing staff development, and by facilitating site-based management. Figure 3-4 shows how this support complements the school features mentioned above.

Programs for LEP Students

The student population of the Spring Branch Independent School District has changed dramatically over the last decade. Ten years ago it was primarily a White upper-middle-class district, but declining overall enrollment (from 47,000 to 27,000 students) and increasing minority student enrollment resulted in Spring Branch becoming 50 percent minority of which 40 percent were Hispanic. The rest of the minority students are Asian or African American.

A high proportion of students in the district speak a first language other than English. To assist this large population, the district recently hired a bilingual program director and staff assistant for K through 6th grade (6,500 of the 14,000 students are LEP). Of 24 district elementary schools, 13 have bilingual and ESL programs. Most have K-3 bilingual programs, though some programs include the fourth grade as well.

The district emphasis in bilingual education has been to strengthen student assessment and reclassification procedures, develop a district framework for bilingual programs, support recruitment of additional bilingual teachers, and initiate staff development in second-language learning.

Assessment. Districtwide assessment tools and procedures are employed to place LEP students in appropriate programs. The measure for English oral fluency is the IPT (IDEA Oral Language Proficiency Test), which is administered to students based on their home language survey. Non-English speakers are enrolled in bilingual education programs if they are Spanish speakers. Students

are tested annually on the IPT until they are considered fluent in English. SRA tests are used to measure English reading, writing, and math skills. The criterion for exiting bilingual and ESL programs is the 40th percentile rank in reading, writing, and mathematics on the SRA.

State law requires an annual review of LEP students' progress by a Language Proficiency Assessment Committee (LPAC), composed of the bilingual coordinator for the site, the principal, and a teacher in the school's bilingual program. The review process had not been fully developed in the district until this year, when the district instituted formal reviews of LEP student records and assessment and exiting practices. The district is seeking more consistency among schools and better programs for LEP students in the upper elementary grades.

Every spring, an LPAC reviews all LEP student records to determine which students meet the criteria to exit the program. After students leave, they are monitored for a year by a specialist and reassessed by an LPAC at the end of the year.

Bilingual Task Force. The district appointed a task force of school representatives charged with developing a concept statement for bilingual education. The task force is forging a policy statement on K-6 bilingual programs, has developed long range goals, and presented a concept paper which was unanimously approved by the School Board. The task force will continue to meet monthly in the future to work on a handbook for curriculum and staff development, with the goal of fostering biliteracy and bilingualism. Hollibrook staff are active on the task force.

Staff Recruitment. Until recently, the district played a minor role in recruiting bilingual teachers for the elementary schools, and a shortage of bilingual staff has hampered Hollibrook's bilingual program in the upper elementary grades. The district now pays a \$3,000 stipend to bilingual teachers and the new district bilingual office staff plans to help schools recruit bilingual teaching staff. District bilingual office staff are starting to provide work-study for paraprofessionals to become certified; teachers are also encouraging their high school students to pursue teaching careers.

LEP Program Staff Development. The district is starting a staff development program for mainstream teachers who have advanced LEP students in their classes. The bilingual unit in the district sponsors teacher training in conjunction with its two Title VII grants. While there is no systematic training program for teachers of LEP students, the district pays for teachers to take courses in ESL, language acquisition, and bilingual teaching, and provides districtwide staff development with seminars led by consultants, some of their own teachers, and district bilingual education staff.

Staff Development

Faculty at every district school prepare a staff development plan connected to a schoolwide improvement plan. From these documents, the district develops a staff development strategy. Examples of Hollibrook's involvement in district-supported staff development activities include training with Susan Kovalik & Associates and a 15-day Writers' Workshop course for fourth-grade teachers.

Susan Kovalik & Associates. Susan Kovalik & Associates' Brain Compatible Learning training helps teachers to create a non-threatening learning environment that builds on students' own experiences to help them make connections and extend their understanding of concepts. Kovalik stresses reducing anxiety about learning so that student concentration reaches new levels of intensity. Hollibrook and the district are interested in pursuing further involvement in this approach, which is described further in the case study of Hanshaw Middle School in Modesto, California.

Writers' Workshop. Hollibrook's fourth grade teachers spent 15 days learning to use the Writers' Workshop approach with students who are learning the process of writing. The sequence of writing steps, in which students learn to write, revise, and edit their writing with their peers and with the teacher, was used effectively in the exemplary learning environments described at the beginning of this case study. After participating in the training, the fourth-grade teachers came back to the school and taught other teachers how to use Writers' Workshop; this typifies the Hollibrook approach to staff development.

Site-Based Management

Spring Branch Independent School District has a strong tradition of site-based management in which schools control their own budgets. While the average per-pupil expenditure in Spring Branch is \$5300, the statewide average is about \$4500. Hollibrook's budget includes \$83,000 from the district for materials and supplies and \$200,000 from Chapter I funds. Hollibrook has full-day kindergarten, a technology specialist, and a social worker paid out of site discretionary funds, and it pays a parent volunteer to teach classes at Hollibrook's Parent University. Hollibrook decided on its spending priorities through its Accelerated Schools goal-setting and decision-making process.

Spring Branch Independent School District also supports site-based decision-making related to school restructuring. Its model of review and planning by site was adopted by the state for all Texas districts. The Campus Improvement Plan is state-mandated; Hollibrook's plan addresses the TAAS scores, ESL/Bilingual issues, and community outreach.

G. SUMMARY

Hollibrook School has created learning environments that support LEP students' learning of Spanish and English language arts and their transition to English literacy. The three unique aspects of Hollibrook's approach include keeping students together for a long period of time with the same teacher, instructional strategies that develop independent motivated learners, and reaching out to the wider community in a way that creates a learning community larger than the school itself.

Continuum Classes

Teachers are free to decide whether they want to start a continuum class and when it will stop, and parents are free to choose whether their children will be enrolled in a continuum class. Continuum classes become learning environments in which the teacher knows the strengths and weaknesses of each student as a learner and the students learn how to work together efficiently. Children know one another very well after multiple years together. The inevitable gaps in learning that occur between teachers in an elementary school grade structure are eliminated in continuum classes.

Continuum classes are particularly beneficial to LEP students, who face the challenge of achieving English literacy. The transition is accomplished gradually over time, with a trained bilingual teacher who has expertise in second language acquisition and fluency in the students' primary language.

Development of Independent Learners

Hollibrook teachers in the continuum classes employ instructional strategies that develop the students into independent learners, capable of working on learning activities for extended periods on their own or in groups. The instructional strategies serve to unleash the potential for self-directed learning in children. Children learn for the joy of it, not to please the teacher or gain recognition. The benefit to the children in these classes is enormous, as their confidence in themselves grows. As one student said, "My teacher (Ms. Mignonga) makes me feel confident."

Aside from the benefits to the children, the ability of students to work without direct teacher supervision frees teacher time to work with small groups or individuals on specific tasks. In such a class, students receive much more individual attention from the teacher.

Creating a Learning Community

Hollibrook administrators and staff turn outward to the community they serve. The principal, assistant principal, social workers, and staff reach out to apartment owners, police officials, elected officials, and city government in order to improve the safety and quality of life in the community.

Because the community lacks recreation facilities and other amenities, the school is building a park in cooperation with the city and business leaders. The principal and staff concern themselves with the formation of gangs in the neighborhood and work with a task force on gang prevention. One strategy for gang prevention is mentorships for fifth grade students who might be drawn to gang involvement.

The school welcomes parents through a number of different approaches. There is a Parent Center equipped to entertain younger siblings of Hollibrook students while their parents engage in school-related activities. The school has a Parent University to teach ESL to parents every morning on the campus. Social workers concern themselves with the health and well-being of children and families and connect families to outside resources they need.

CHAPTER 4

LINDA VISTA ELEMENTARY SCHOOL
SAN DIEGO UNIFIED SCHOOL DISTRICT
CALIFORNIA (PRE-K-6)



A. SCHOOL AND COMMUNITY CONTEXT

Linda Vista is located in an inner-city San Diego neighborhood composed of government housing, inexpensive apartments, and public housing projects. The neighborhood is a point of entry for new immigrants who move on as they gain an economic foothold in their new country. This transiency has meant constant change in the distribution of languages spoken at the school. Spanish-speaking limited English proficient (LEP) students have always made up a large fraction of the enrollment, and in recent years their numbers have been increasing. At the same time, the number of languages spoken at Linda Vista has increased as political and economic refugees arrive from Southeast Asia and other parts of the world. Students' parents typically work in low-skill jobs; many are unemployed. The neighborhood has significant problems with gang activity.

Linda Vista enrolls nearly 1000 students from pre-kindergarten through sixth grade. The student population is 44 percent Hispanic (mostly from Mexico and Central America), 38 percent Indochinese (Hmong, Vietnamese, and Laotian), seven percent non-Hispanic white, five percent African American, three percent Filipino, two percent other Asian, and one percent "other." Sixty-six percent of the students are designated limited English-proficient; the vast majority of these students speak either Spanish (50%), Hmong (22%), Vietnamese (16%), or Lao (6%). The home country educational experiences of Linda Vista's immigrant students varies significantly—from none to excellent. Eighty-eight percent of the school population is eligible for free or reduced-fee lunch.

The next section describes an exemplary learning environment at Linda Vista for an ungraded class of Spanish-speaking LEP students.

Figure 4-1
The Classroom Layout, Linda Vista

The classroom is arranged to facilitate cooperative learning and computer-based instruction. Flexible groups assigned by the teacher work at desks and at multimedia workstations scattered throughout the room. The teacher circulates in the work space to assist groups and individual students.

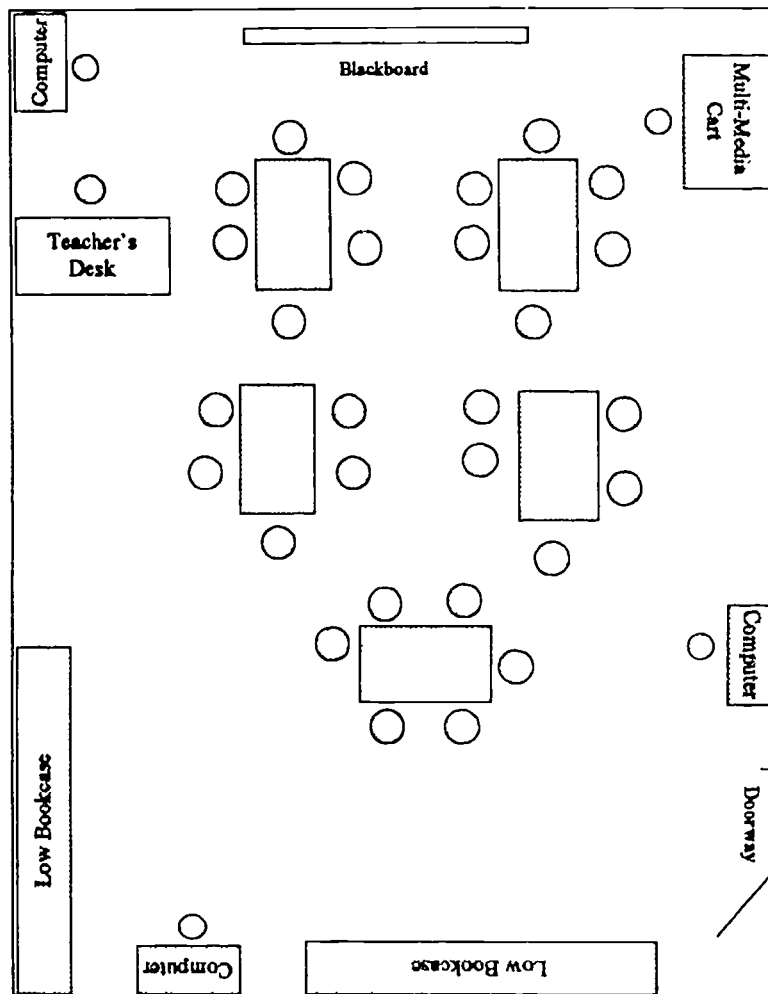

Students are comfortable working together in cooperative groups. The use of multimedia software supports group work, drawing on the different skills of each student—visual, written, and dramatic. This taps into individual strengths, allowing each group member an opportunity to excel.



B. AN EXEMPLARY LEARNING ENVIRONMENT

The walls of the bright classroom are covered with student artwork; shelves are crammed with books and games. Twenty-eight students sit at clustered desks or at one of four computer work stations. They chatter in Spanish and English; their laughter fills the room. Ms. Taylor holds up a hand and the buzzing stops; she asks the students to get out their independent reading books for 15 minutes of silent reading. They are reading a wide range of books, from Dr. Seuss to novels. All the books are in English.

*When the 15 minutes are up, Ms. Taylor directs the students to their assigned reading, Beverly Cleary's **Ralph and the Motorcycle**. She reminds them that their work groups are responsible for finishing assigned chapters and contributing to a class-wide multimedia book report. She tells students who have completed their reading in the Cleary book but are not yet ready to work on their chapter of the class-wide book report that they are also responsible for individual book reports on their self-selected books. Groups of students immediately go off in a number of different directions. Some stay at their desks; others move to another cluster of desks; the rest head for the computer work stations. Ms. Taylor immediately begins circulating among them.*

*The students who remain at their desks either pull out **Ralph and the Motorcycle** and begin reading or start on their book reports. Some students work on their book reports in longhand; others use Powerbooks (portable Macintosh computers) at their desks. Some are writing new material, others are re-writing their drafts or drawing illustrations to go with their text. Ms. Taylor sits with one student who appears to be having some trouble with the reading. She reads a little to him then asks him to read a little to her, helping him when he stumbles across a difficult word.*

All the students in this ungraded (4th, 5th, 6th) class are Spanish-speaking LEP students who are making the transition to English-language instruction.

Students select books at a reading level with which they are comfortable. The range of assignments accommodates the varied paces at which students work.

Students know what is expected of them and, as a result, quickly get to work.

Students work independently, allowing the teacher to work one-on-one with students who need extra help.

Writing is taught as a process, involving drafts, edits, and revisions.

Reading aloud helps a student to understand the story and to feel comfortable with oral English.

Multimedia software supports group work by drawing on individual strengths; each member gets a chance to excel.

The teacher plays a supportive, facilitative role; she allows students to direct their own work.

A range of skill levels provides an opportunity for students to teach their peers.

The teacher asks questions to check comprehension but also encourages critical thinking and student dialogue.

Meanwhile, other students work in groups of three, brainstorming about how they plan to present their assigned chapter in the class multimedia book report. They talk about who will draw which graphics, which sections of dialogue they will record (and who will play each character), and what key aspects of the chapter need to be included in the written summary. The student groups easily establish a division of labor. In one group, a student—apparently the artist in the group—is most enthusiastic about the visual elements of the project; another student is anxious to read the dialogue aloud (he wants to play Ralph); the third student proposes ideas regarding the key events of the chapter and takes notes on their discussion. The students talk in English, sometimes interjecting Spanish words or expressions. After a few minutes, Ms. Taylor circulates among the groups to see if they need help or direction. A few students tell her their ideas. She responds in warm and supportive tones, praising the students and encouraging further thought. In one case she suggests a slightly different way of presenting something.

The students at the computer work stations use HyperCard to create their chapters of the multimedia book report. Their familiarity with the software varies, but each group appears to include one "expert." The least experienced students sit at the computer keyboards while the expert students advise, explain, and occasionally grab the mouse from an adjacent position. All students are actively engaged in intense discussion about the software and ideas for how to present the chapters in the book report. Most of the discussion is in English, though student explanations of how to use HyperCard tend to be in Spanish.

*Over the course of the next hour, some of the readers begin working on their individual book reports. When the hour ends, Ms. Taylor asks the students to return to their desks and open their copies of *Ralph and the Motorcycle*. She leads a group discussion about the chapters that were recently assigned, and poses questions to the class about the last two chapters they have read. The questions require a range of student responses, from short*

answers that can only be either right or wrong to impressions and extrapolation. The students display considerable eagerness to give their interpretations of the book. After a lengthy discussion of the assigned chapters, Ms. Taylor reminds the students that the next section of the book must be read by the end of the week. She asks them if they would like her to read a little of the next chapter aloud. They respond enthusiastically.

Most students seem intellectually engaged by the story and their ability to respond to the teacher's questions demonstrates a high level of comprehension.

**Figure 4-2
Instruction, Curriculum, and Program Map, Linda Vista**

Innovative Instruction-Curriculum Features

- Placement and grouping strategies
- Cooperative Learning
- Whole Language, literature-based instruction
- Computer-based instruction
- Cultural validation



LEP Program Features

- | | |
|-------------------------------|---|
| Upper Wing] | Sheltered, L1, and Transition Instruction |
| Middle Wing] | Sheltered, L1, and Transition Instruction |
| Primary Wing] | Sheltered and L1 Instruction |
| Early Primary (incl. pre-k)] | Sheltered and L1 Instruction |

C. INNOVATIVE CURRICULUM AND INSTRUCTIONAL STRATEGIES

The learning environment described in the narrative illustrates many of the innovative pedagogical strategies used at Linda Vista. This particular class is composed of Spanish-speaking LEP students. Previously in Spanish bilingual classes, these students are now making the transition to English and being prepared for mainstream classes. Figure 4-2 on the opposite page depicts the key instruction and curriculum features seen in this classroom and others at Linda Vista. Each of these strategies is explained more fully in the discussion below. LEP student program features are elaborated in Section D.

Placement and Grouping Strategies

Clustering students with similar English language abilities for language arts allows the teacher to tailor instruction to the appropriate English-language level. Linda Vista employs a variety of placement strategies throughout the school day, taking different variables into consideration. Within each class, however, students are typically grouped heterogeneously. Heterogeneous student grouping ensures that each group has a mix of students who have complementary strengths. In the learning environment described above, student computer skills were taken into account by the teacher when she selected the heterogeneous groups.

Cooperative Learning

Ms. Taylor's lesson was striking because of the variety of activities in which the students were engaged. This variety was made possible because the students were expert cooperative learners and were able to direct their own work. Because most teachers use cooperative learning strategies, most students are accustomed to this style of instruction by the time they reach the middle and upper grades. All of the classrooms at Linda Vista are arranged so as to facilitate cooperative activities. The opportunity to work in groups gives students an opportunity to work collaboratively—to teach and learn from one another, expanding on their strengths and overcoming their weaknesses.

Whole Language, Literature-based Instruction

Whole Language strategies—the use of oral language, reading, and writing to reflect real-life situations—are seen in a variety of forms at Linda Vista. Literature served as the core of most language arts activities. For example, in the learning environment described above, students were encouraged to seek meaning as they read the novel, and to express their interpretations in written form in a book report, in a multimedia presentation, and orally in class discussion. Other examples of whole language strategies used at Linda Vista include research-based writing (i.e., biographies and autobiographies), directed and "free" journal writing, and dramatic interpretations of literature.

Computer-based Instruction

Ms. Taylor used the computer-based multimedia system as an instructional tool, but did not rely on it for instruction; she treated it as a means for getting the students excited about writing and about producing oral language. She also used technology to help emphasize students' different strengths—ensuring that each group had a complementary mix of students with respect to academics, computer skills, and English fluency. The computers facilitated her goal of providing hands-on, self-directed learning. With the help of computer-based instruction and with the ability of students to work alone or in cooperative groups, she was free to work one-on-one with students who needed extra support.

Much of the technology in this classroom—and the teacher's skill in using it for instruction—is the result of Linda Vista's partnership with Apple Classrooms of Tomorrow (ACOT).¹ When Linda Vista first became an ACOT school, two teachers went to a Teacher Development Center and learned how to use the equipment and integrate it into their classrooms; since then, two more teachers have gone for training. Linda Vista now has four ACOT classrooms. The ACOT classrooms each have four Macintosh computers with CD-ROM drives; they share ten Powerbooks. These classrooms also have scanners, televisions, VCRs, and laserdisc players, and one has a Palmcorder.

While ACOT heavily impacts a few classrooms, Linda Vista's Senate Bill 1274 Restructuring Demonstration Grant provides the foundation for the school's technology program. SB 1274, California's school restructuring legislation, supports schools in a number of ways, including direct grants. Linda Vista uses a 1274 grant (\$172,000 annually for five years) to improve students' English language proficiency through the use of innovative practices; part of this effort is focused on the use of technology. The 1274 funds are used to pay for three staff members to focus solely on technology (a technology resource teacher, a part-time clerk, and a part-time technical person). The grant has also paid for mobile "multimedia carts" that hold a TV, a computer with a CD-ROM drive, a printer, a scanner, and a laserdisc player. The technology resource teacher provides training for teachers in how to use the equipment; so far, one-third of the staff have gone through training. She also develops curriculum ideas to help teachers and gives demonstrations in classrooms as the teachers begin to use the technology.

¹ Linda Vista was recently selected by ACOT to be a Teacher Development Center (TDC); its involvement is funded by Apple Computers, Inc. and the National Alliance for Restructuring Education. There are ten TDCs in the country; seven (including Linda Vista) are new this year and part of the National Alliance. The concept of TDCs was developed to support teachers in making the significant pedagogical shifts that effective use of educational technology require and to develop an intensive, national staff-development model. The result is an ongoing program of week-long teacher practicums at sites that are designated TDCs. As a TDC, Linda Vista teachers will train other National Alliance teachers to investigate new models of learning, integrate technology into the learning process, and develop student-produced projects.

Cultural Validation

Linda Vista's commitment to help students maintain their primary language and a connection with the culture of their home country (described below) indicates to students that their language and culture are valued. In addition, teachers try to develop curriculum and lessons that connect with the students' experiences (i.e., interviewing people in their community, writing about themselves), making the work meaningful to the students.

D. PROGRAM FOR LEP STUDENTS

The basic structure of Linda Vista's LEP student program is outlined in the right column of Figure 4-2. To fully understand the LEP student program it is necessary first to understand that the program for LEP students is integral to the school's organization and structure. For all students, each day begins with more than two hours of uninterrupted language arts instruction. These classes are the students' homeroom classes.

LEP students are grouped with students who have similar levels of English proficiency or, in the case of the Spanish-speaking students, with students who speak the same home language. In both cases, students are heterogeneously grouped with respect to educational background. Non-Spanish-speaking LEP students—grouped according to English language ability—are provided instruction using Sheltered English. Spanish-speaking students receive language arts instruction in Spanish until they are ready to move into English (see below for further explanation). Monolingual English and fluent-English (FEP) students are instructed in an unsheltered, all-English environment. The following describes the progression of Sheltered and Bilingual language arts classes, both of which conclude in an unsheltered, all-English environment.

Sheltered English. In response to demographic shifts and an increase in the number of languages spoken by the student population, Linda Vista chose to replace the fragmented ESL pull-out program previously offered to non-Spanish-speaking LEP students with Sheltered English instruction. They felt that bilingual teaching was not feasible because of the diversity of the students' languages and the scarcity of Vietnamese, Hmong, and Laotian bilingual teachers. The Sheltered English program consists of five levels: Entry, Sheltered A, Sheltered B, Transition A, and Transition B. The different levels are offered as needed within each wing. In the primary wing, Sheltered classes predominate; in the middle wing, there is a balance between Sheltered and Transition classes; and in the upper wing, Transition and "English" classes outnumber Sheltered classes. Students are assessed at entry and placed in classes according to their English language proficiency (as determined by schoolwide language arts standards). Students progress to the next level by meeting schoolwide language arts criteria for each level (see discussion of assessment system for more information). The

Figure 4-3
School Structure and District Support, Linda Vista

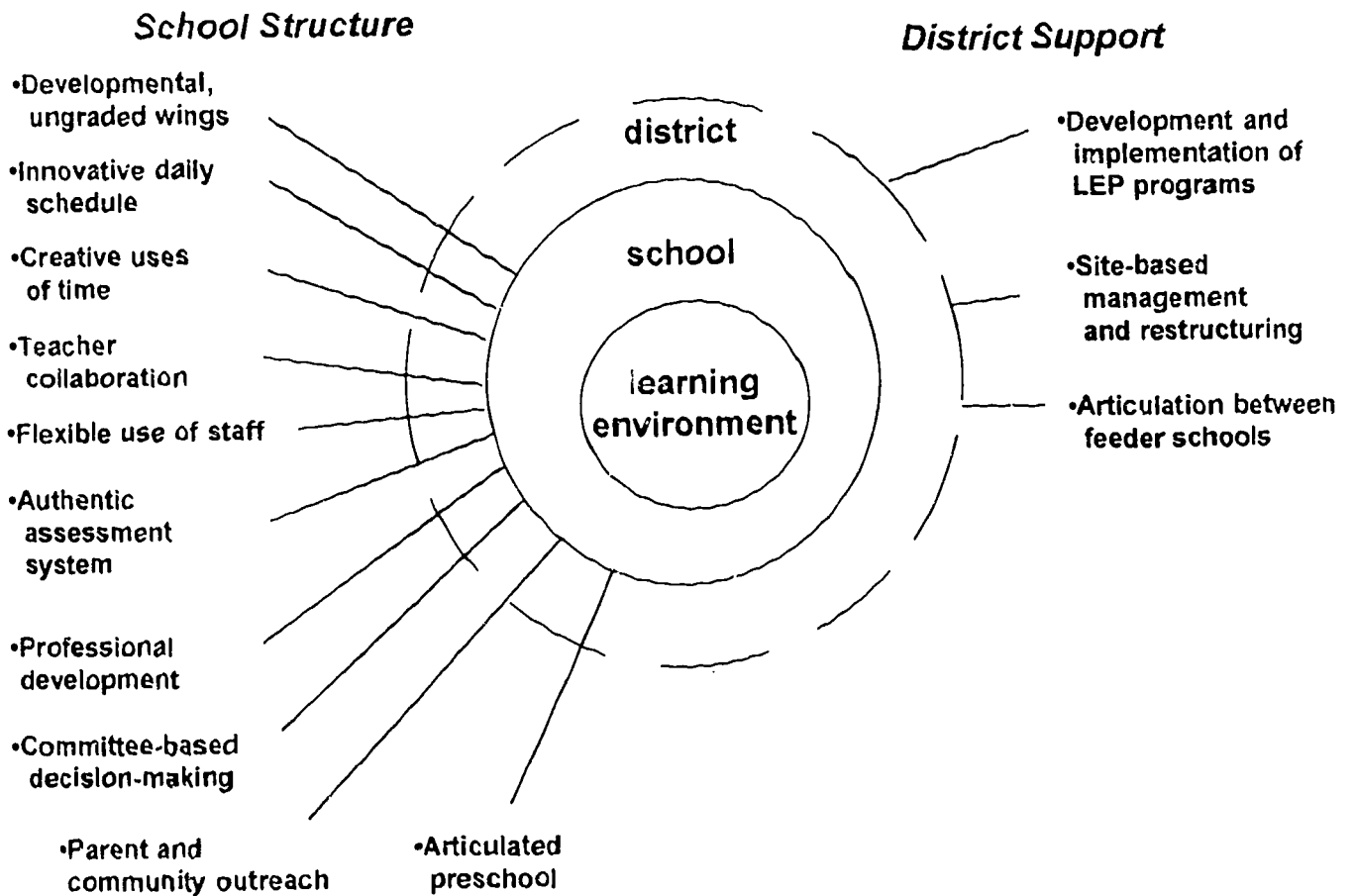

Entry class is for middle and upper grade/age students who arrive at the school with no English; these students (usually 12 to 15 at a time) stay in the Entry class until they meet the language criteria to be moved to a Sheltered A class. Ten of the 16 Sheltered teachers hold the Language Development Specialist (LDS) credential; the six others are in the process of acquiring it. All of them have had extensive training in Sheltered English methodology. Paraprofessionals who speak the native languages of the students are often assigned to classrooms to work with teachers.

Bilingual. The intent of the bilingual program is to allow students to develop literacy—reading and writing—in Spanish and to prepare them for all-English classrooms by the upper grades or by junior high school. The goal is for students to be reading in Spanish at the second or third grade level before they move to English classrooms. The level of English-language proficiency among students in the bilingual program is more varied than in Sheltered classes, partly because newcomer Spanish-speaking students enter directly into the age-appropriate bilingual class. Language arts are taught entirely in Spanish until the students are deemed ready for transition to English; at this point students are moved to an all-English transition class composed of transitional Spanish-speaking students or students who are exiting the Sheltered program. All of the teachers are fully bilingual, except in the case of the all-English transition classes; seven of the nine bilingual teachers hold a bilingual credential.

Students in both the Sheltered and Bilingual programs move through each level of instruction at their own pace—movement of students to the next level (i.e., transition or unsheltered, all-English classes) is based on a review of student progress by the LEP Review Team. This team includes the student's current teacher, a resource teacher, and the principal. Students exit the program based on district redesignation criteria: fluent English speaking according to the IPT (IDEA Oral Language Proficiency Test) test; forty percent or higher on the mathematics applications, language expression, and reading comprehension components of the Abbreviated Stanford Achievement Test (ASAT); teacher recommendation; and parent consultation.

E. SCHOOL STRUCTURE

As a result of its ongoing restructuring process, Linda Vista features an innovative organizational structure. The restructuring process, the school-within-a-school organization, and the daily schedule are described below. Additional elements of restructuring that impact student learning include creative uses of time, teacher collaboration, flexible use of staff, a forward-looking assessment system, staff development, committee-based governance, parent and community outreach, and an articulated preschool. All of the schoolwide features are shown in Figure 4-3.

Six years ago, Linda Vista began an intensive restructuring effort with a number of specific goals in mind, including establishing more appropriate instructional groupings for LEP students and minimizing pull-out instruction. These goals were particularly challenging because of Linda Vista's dynamic student population: New LEP children immigrated continuously, undermining grouping strategies based solely on age; the previous schooling of immigrant children ranged from none to intermittent to excellent; the number of different languages spoken by the student population was increasing. Prior to restructuring, Linda Vista had relied on a bilingual program for its Spanish-speaking population and a series of pull-out programs for its more diverse Southeast Asian population. School staff identified this fragmentation of programming for LEP students as one of the major problems facing the school; their vision of a restructured school included solutions to that problem. The faculty and the principal recognized that given their student population, educating LEP students must be conceived of as an integral part of the school's mission. They rejected the pull-out approach because the school day was becoming too fragmented for students and staff, and no single teacher had responsibility for learning outcomes. Teachers wanted to redesign the school to accommodate the varied levels of previous schooling; support the individual pace of student acquisition of English; and meet the needs of the students from the multiple language groups represented at their school in an integrated whole-school environment.

The restructuring effort was initially led by the principal and featured strong collaboration among faculty members. The principal created a climate at the school that supported experimentation, in which faculty could take risks, make mistakes, and correct them in order to develop and implement effective practices. Within this climate, the principal acted as instructional leader among the faculty by assisting with curriculum development, placement decisions, and instructional techniques. The principal recognized that designing and implementing effective programs for LEP students requires training and time for teachers to plan together. The active participation of teachers in re-designing the school has empowered teachers and improved communication among staff; as a result, it has enabled faculty to respond to the constantly changing needs of the student population and to develop an evolving program.

The ability to adapt programs in response to changing needs—a major strength of the school's restructuring process—is perhaps best illustrated by the school's development of two distinct language acquisition programs for LEP students in response to shifts in community demographics. When Linda Vista began its restructuring process, the Spanish-speaking population was decreasing and the number of different (primarily Southeast Asian) languages spoken by students at the school was on the rise. In response to this change in their student population, the Linda Vista staff implemented a Sheltered English program (with a native-language component in Spanish, Hmong, Vietnamese, and Lao) for all LEP students. The selection of the Sheltered English model was the

direct result of the dramatic shift in the languages spoken by LEP students and the declining Spanish-speaking LEP population. A few years into the restructuring, the Spanish-speaking population began to grow again and the influx of Asian immigrants began to level off. Because they once again had a critical mass of Spanish-speaking students, as well as access to Spanish-speaking bilingual teachers, the staff reinstated bilingual instruction for the Spanish-speaking LEP students while continuing to use Sheltered English instructional strategies with non-Spanish-speaking LEP students.

Linda Vista's partnership with Apple Classrooms of Tomorrow and the National Alliance for School Restructuring, as well as their Restructuring Demonstration Grant (SB 1274), all illustrate ways in which Linda Vista's educational program has been enhanced by grants and partnerships with outside organizations. These grants and partnerships are the result of the entrepreneurial spirit embraced by staff throughout the school's restructuring process. Linda Vista's teachers are "initiators in terms of seeking grants and driven toward being on the cutting edge"; this is one aspect of their shared vision and "commonality of mind." All of Linda Vista's grants and partnerships enhance the core vision developed at the school; they are not add-on or peripheral projects.

As a result of the school's restructuring, Linda Vista's LEP student programs are totally integrated into the whole school program and it is impossible to describe either the school or the LEP student programs in isolation. Two key elements of the school's structure—developmental, ungraded wings and the structured daily schedule with varying student grouping strategies—set the context for language acquisition programs. The restructuring has allowed the school to virtually eliminate pull-out instruction, primarily through the use of multigrade classes and team teaching.

Developmental, Ungraded Wings

To accommodate the constant flow of newcomer students and the widely varying educational backgrounds of students, Linda Vista established developmental, ungraded "wings" (early childhood, primary, middle, and upper). The wings function like four schools within the school, each composed of students within a relatively close age range (typically spanning two grade levels), but with mixed levels of English language fluency and various educational backgrounds. In typical elementary schools the classroom is the only entity at the sub-school level. But Linda Vista has added another level of organization—the wing—between school and classroom. This distinction is important because students receive all of their instruction within their wing, as opposed to a self-contained classroom as in most elementary schools. The instructional program within each wing is designed by the teachers in that wing. For example, in the upper wing's daily schedule, students are homogeneously grouped by home language or English language level for language arts, ESL, and social studies instruction and heterogeneously grouped and regrouped during the rest of the day for mathematics, science, art, music, and physical education.

Innovative Daily Schedule

One motivation for school restructuring was to enhance the meaningful integration of LEP and English-only students; the daily schedule described here is the result. Linda Vista's Sheltered English and Spanish language-based programs include all-LEP student classes; as a result, students are isolated for a period of time from their English-only peers. In order to facilitate the interaction of LEP, bilingual, and English-only students with one another during the remainder of the school day, staff at Linda Vista designed a daily schedule in which students would receive instruction that is appropriate for their stage of English language development *and* be provided opportunities to interact with their diverse peer group. They did this in order to foster racial and ethnic integration and to give LEP students an opportunity to practice their English with native speakers and hear English spoken in natural settings. Figure 4-4 lays out a typical day's schedule for LEP students at Linda Vista.

Figure 4-4
Linda Vista's Upper Wing Daily Schedule

	8:00-10:15 Language Arts	10:30-11:15 Social Studies	11:15-12:10 Mathematics Rotation	1:00-2:20 Afternoon Rotation
Class composition for non-Spanish-speaking students (language of instruction)	Students grouped by English language ability (English)	Students grouped by primary language (primary language: Hmong, Vietnamese, or Lao)	Students from all language groups mixed, mathematics level considered (English)	All students mixed (English)
Class composition for pre-transition Spanish-speaking students (language of instruction)	Spanish-speaking students grouped together (Spanish)	Spanish-speaking students grouped together (English)	Students from all language groups mixed, mathematics level considered (English)	All students mixed (English)
Class composition for transitioning Spanish-speaking students (language of instruction)	Spanish-speaking students either grouped together or mixed with non-Spanish-speaking students (English)	Spanish-speaking students grouped together (Spanish)	Students from all language groups mixed, mathematics level considered (English)	All students mixed (English)

Social Studies. Linda Vista is committed to provide social studies instruction in students' primary languages if they receive their language arts in English. In order to accommodate this, non-Spanish-speaking LEP children are regrouped after language arts with other LEP students of the same language group, and either a teacher or a paraprofessional under the supervision of a resource teacher provides social studies instruction in the home language of the students. The social studies curriculum is based on the state frameworks and is supplemented with the study of the culture and traditions of the students' home countries. Meanwhile, pre-transition Spanish-speaking LEP students stay with the same group of students, but a different teacher, for social studies instruction in English. (These students are taught ESL via social studies as the district's ESL curriculum (ELEPS) is social studies based.) Since students in the transitional bilingual classes, such as the one described at the beginning of this case study, get their language arts instruction in English, they get their social studies instruction in Spanish.

Mathematics Rotation. In the upper wing, mathematics is team taught and each teacher takes responsibility for a "concept area." Students spend about four weeks on each concept area with one teacher; at the end of a unit, they progress to the next area. (The teachers move from class to class.) By the end of the year, each student is exposed to all of the concept areas. The upper grades concept areas include: multiplication and division, statistics and probability, measurement, decimals and percentages, fractions, geometry, and algebra and functions. Students are placed into classes based on their mathematics skills as assessed by a placement test that each wing develops; students start the year in the area where they have the greatest need. The result is that students tend to be homogeneously grouped in terms of mathematics skills and heterogeneously grouped in terms of language; Spanish-speaking LEP, non-Spanish-speaking LEP, bilingual, and monolingual English students are all mixed together. Mathematics is taught in an integrated, applied way so that the concepts do not appear isolated; teachers try to make mathematics fun for students by teaching it in a hands-on way (i.e., using manipulatives, working on mathematics-based projects). The lessons are mostly based on Mathematics Replacement Units and/or teacher-developed curriculum. The mathematics rotation is intended to increase the quantity and improve the quality of mathematics instruction: school staff want to guarantee that all students are exposed to mathematics every day and that they are exposed to a wide range of mathematics concepts. The faculty also anticipate that this approach will improve the quality of mathematics instruction by allowing teachers to develop and refine curriculum for fewer concept areas. Teachers reported that individually they "can put together a really good unit on one topic," but that they could not be as well prepared to teach all mathematics subjects and "some topics would suffer."

Afternoon Rotation. After lunch and ten minutes in homeroom, all students are heterogeneously grouped (to represent the wing's diversity in terms of ethnicity, gender, English proficiency level, and

academic level) within their wing for science, art, music, and physical education. Each student takes two subjects for ten days and then rotates to two other subjects; within a thirty day cycle, each student receives instruction in a maximum of six subjects. The subjects always include science lab, science garden, art, music, and physical education; each wing has the autonomy to offer other elective-type classes during this time period. Teachers reported that the extended time in subjects less dependent on academic language fosters LEP students' interaction with their English-speaking peers.

Students return to their homeroom for ten minutes before being dismissed at the end of the day.

Creative Uses of Time

The restructuring process has also caused Linda Vista staff to rethink how time is used. In addition to their innovative everyday schedule, they have also been thoughtful about yearly and weekly schedules.

Year-round Schedule. Linda Vista operates on a single-track, year-round schedule. The school is open for four nine- to ten-week sessions; the academic year begins in July and ends in June, with four three- to four-week breaks during the year. The year-round schedule diminishes the need for review at the beginning of the year, and avoids long summer breaks which can impede the progress of English-language learners. During the breaks, the school offers half-day two-week intersessions funded with summer school money. Linda Vista moved to the year-round schedule five years into the restructuring process.

Time for Planning. Students are dismissed early every Wednesday to build in time for weekly meetings. School staff established this schedule as they restructured and realized the time needed to meet and plan the implementation of innovations. The time allows for staff development, committee meetings, joint planning among teachers, and "nuts and bolts" meetings. Both the governance structure and teacher collegiality are supported by the built-in meeting time.

Teacher Preparation Time. Each teacher at Linda Vista has two 45 minute prep periods a week, made possible by the flexible daily schedule. For example, Sheltered teachers may use the social studies block as a prep while their students are getting native language instruction. Another possibility is for Sheltered teachers to offer social studies-based ESL instruction to Spanish-speaking LEP students, in effect "giving prep" to a bilingual teacher.

Teacher Collaboration

At Linda Vista, teachers acknowledge that they are engaged in a collective effort and act accordingly. Most of the collaboration takes place at the wing level, but there is also schoolwide communication and cooperation. One pervasive example of this collaboration is the teachers' practice

of peer observation; it is not uncommon for teachers to use their "prep" time to go into another teacher's class to observe the implementation of a new instructional strategy (i.e., a technology-based lesson). In this spirit, all classrooms are open for observation at all times. In addition to in-class observation, teachers discuss issues they encounter with particular students or with an instructional strategy, and collaborate to solve problems. The process of working as a team, as well as the sharing of students, empowers teachers at Linda Vista to feel a heightened sense of ownership of the whole-school environment, as well as their own classrooms. The absence of isolated teaching and the collegiality among staff are among the main strengths of the school; it is reinforced by the school's organizational structure. "Everybody knows everybody else's kids."

Flexible Use of Staff

Linda Vista uses instructional staff in flexible ways to respond to programmatic priorities; for example, the resource teachers support all of the major schoolwide initiatives, part-time staff allow reduced class sizes at the lower grades during language arts, social studies, and mathematics instruction, and paraprofessionals provide individualized, as well as native-language instruction (under the supervision of the resource teachers).

Resource Teachers. Two resource teachers play critical roles by making the complex organizational structure and daily schedule functional; they do this by assessing and placing LEP students in classrooms, reclassifying LEP students, coordinating the curriculum for LEP students, and providing support for teachers in the classroom. They also play a major role in the implementation of the assessment system. For example, they support teachers by going over the standards and rubrics with them and helping them think about which student work to keep for assessment. They are able to respond to teacher needs by helping directly or by finding resources from elsewhere to provide assistance. Direct help may take the form of consultations with teachers, demonstration teaching, observing teachers and providing feedback, or covering classes for teachers when necessary (e.g., so that teachers can observe their peers). The resource teachers locate resources in the community if they can not assist the teachers directly. If enough teachers express a common need, the resource teacher typically arranges for an inservice. Resource teachers also conduct monthly staff development activities with new teachers at the school. In addition, they work to increase parent involvement and plan parent activities such as Open House. The resource teachers are funded by Chapter I and integration funds; they are responsible for the administrative paper work for Chapter I and LEP compliance. Both resource teachers have many years of prior classroom experience. (As described in Section C, a third resource teacher focuses on technology.)

Part-time Teachers. Three part-time teachers work in the morning to reduce class size during language arts, social studies, and mathematics instruction. Two of these teachers are funded by the school's SB 1274 Restructuring Demonstration Grant; the third is funded by Chapter I funds.

Paraprofessionals. Every teacher has a paraprofessional assistant for three and a half hours in the morning. Many of the paraprofessionals at Linda Vista are bilingual in English and one of the languages of the students. In these cases, paraprofessionals may help clarify concepts for students, or help provide primary language instruction (i.e., social studies) under the supervision of the resource teachers. Paraprofessionals also work with small groups of students, help to facilitate student work in cooperative groups, and support the teachers by doing prep and administrative work. Some of the paraprofessionals are working on their teaching credentials.

Authentic Assessment System

Linda Vista is well into a process of revamping its assessment system. After redesigning the organizational structure of the school, staff decided they needed to develop an assessment system appropriate for an ungraded learning environment in which students are at many different levels of English language fluency. The result is a system that relies on authentic, portfolio-based assessment to record students' growth as they progress toward specified learning outcomes or standards. School staff acknowledge that the development of standards and the means of measuring student growth are part of a constantly evolving process. Teachers reported that the standards and rubrics that have been developed so far make it easier to assess development and help to guide instruction. Support for teachers as they implement the new assessment system is provided by resource teachers (see section below on staffing).

Linda Vista's teachers developed language arts learning outcomes that define the expectations and requirements for all students at each wing level: there are oral, written, and reading standards for each wing. They also developed rubrics that attach a descriptor to the various levels of student performance as they progress toward the standard; "anchor papers" are used to help with scoring. Student work is placed in an "electronic portfolio"; student progress shown in these portfolios—in which student work is scanned and stored on the computer—is recorded in the "Growth Record." Portfolios and Growth Records are shared with parents and used for assessing LEP student progress and readiness to advance. If students consistently perform well against the standards, their placement is re-examined.

Mathematics learning outcomes have been developed more recently, and have not yet been implemented. A professional development activity is being planned to introduce the mathematics outcomes. Teachers developed the mathematics standards and rubrics based on national- (National Council of Teachers of Mathematics) and state- (California Learning Assessment System) level

standards and rubrics in an effort to prepare Linda Vista students for the requirements of the larger community. To assess students' mathematics skills and knowledge, each wing has developed annual pre- and post-assessments along with an assessment at the end of each unit. Teachers use the results of the interim and end-of-unit assessments to guide them in their instruction and course development.

As one of ten designated Leadership in Accountability Demonstration (LAD) schools in the district, Linda Vista is supported to increase student achievement through accountability. Substitutes are provided through the district's LAD program so that teachers can participate in assessment-related inservices and planning meetings during school time.

Linda Vista's SB 1274 School Restructuring Demonstration Grant also supports the development of an effective and appropriate assessment system. Grant funds are used to support the development of the electronic portfolio system and support the implementation of the new assessment system by funding staff development activities on alternative assessment. For example, three teachers went to the Summer Institute in Assessment run by Harvard's PACE (Performance Assessments for Collaboratives in Education).

Professional Development

Linda Vista's staff have made staff development a high priority—one that is supported by a number of their grants and partnerships. As mentioned earlier, Linda Vista's involvement with ACOT supports staff development in computer-based instruction, and their participation in the LAD schools program has afforded them staff development in alternative assessment methods. In addition to these sources of staff development, Linda Vista uses its SB 1274 Restructuring Demonstration Grant to provide staff development in committee processes, student access, team teaching, cooperative learning, language acquisition, and bilingual teaching.

Committee-Based Decision-Making

The restructured school allows teachers much greater involvement in determining how the school is run. A committee-based decision-making structure was established in which every faculty member serves on two committees: a curriculum committee and one of the site responsibility committees. The latter include standing committees for Staff Involvement, Parent Involvement, Student Involvement, Technology, and Library. Decisions on all phases of school operation are made by these committees. Teachers frequently seek out training to support their committee work.

Parent and Community Outreach

At Linda Vista cultural and linguistic diversity is respected, honored, and appreciated. This cultural validation is achieved primarily through the attitudes of the staff and the type of interaction

that is promoted among the students and between the students and staff. Beyond this general positive climate, the school employs specific strategies to foster harmony and tolerance, primarily by encouraging parent and community involvement.

Teachers regularly interact with parents about student academic performance, and work with them via the Parent Outreach Committee. Linda Vista's three community aides, however, take on the bulk of the responsibility for parent and community outreach. The aides have been at Linda Vista for 15, 20, and 30 years respectively; among the three, they speak English, Lao, Hmong, Spanish, and Vietnamese. The aides' job is to provide a bridge between the school, the families of the children, and the larger community. Their status as long term community residents gives them a level of credibility in the community that would not necessarily be afforded to others from the school. Their responsibilities include making calls to the homes of students who have missed a day of school to find out why the children are absent; translating written materials into the various languages of the parents; interpreting at parent-teacher conferences; making home visits about attendance (after three to four days if not satisfied by phone) or other school-related problems; and helping to plan and implement parent workshops. The community aides report that parent workshops are the major vehicle for getting parents into the school; four to six workshops are scheduled each year on topics selected with input from the parents (e.g., drug and gang issues). Community aides also provide other services to parents and Linda Vista students; for example, they help families obtain medical care and they provide support for students who need clothing and/or shoes.

The community is racially and ethnically integrated in the truest sense: "We all live together and we have made the decision to live together peacefully." In the early years of the school's population shift, there were episodes of name calling among the children. The community dealt with it head on: they brought the students together to discuss the problems and worked out a resolution. Students now play together on the playground with little distinction based on ethnicity.

Articulated Preschool

Linda Vista's developmental preschool is part of an early childhood program that operates much like the primary, middle, and upper wings at the higher grade levels. The preschool, like the rest of the school, offers Sheltered English and Spanish classes. In the Sheltered classes, the preschool makes use of Southeast Asian bilingual paraprofessionals. Team teaching is used to integrate students at different times in the day with students of different ethnicities and levels of English proficiency.

F. DISTRICT SUPPORT

The district supports Linda Vista in three main areas: development and implementation of LEP student programs; site-based management and restructuring; and facilitation between feeder schools. Figure 4-3 illustrates this support.

Development and Implementation of LEP Student Programs

District policies encourage site autonomy and restructuring and allow individual schools to develop LEP student programs to meet their students' needs, provided that basic compliance issues are satisfied. Within this context, the district second-language director has played a facilitative role as the school has developed programs to meet the needs of its changing student population. The district's second languages office provides assistance in testing the primary language fluency of candidates for paraprofessional positions; it helps secure funding for staff training designed at the site level; and it has helped obtain the necessary waivers of state rules and regulations to permit the consolidation of a number of categorical funding sources into a single unified program. The second languages department works with the personnel department in order to help find and screen appropriately trained bilingual teachers.

Site-based Management and Restructuring

The district supports Linda Vista by being responsive to the needs expressed by the school's staff. Linda Vista staff clearly take the lead in developing the school's program, but they are operating within a district that encourages site-based management and restructuring.

The San Diego City Schools' overall vision has been refined recently as a result of the district's collaboration with the National Alliance for Restructuring Education, a New American Schools Development Corporation (NASDC)-supported effort directed by the National Center on Education and the Economy. Its "Break the Mold" approach to educational reform is based on five Design Tasks that have been adopted by the district: 1) Curriculum, Instruction, Assessment, and Technology, 2) Standards and Accountability, 3) Health and Human Services, 4) Public Support and Engagement, 5) High-Performance Organization. The district broke these five tasks into 16 specific expectations, giving schools autonomy in determining the best ways to meet the expectations. Each school is required to develop its own school improvement plan. Linda Vista's goals fit with the Design Tasks, and goals include revising and expanding the assessment system; improving community involvement in the school; and enhancing the site-based management structure. While the National Alliance partnership is district-wide, Linda Vista is one of a handful of schools in the district whose staff are supported to attend national conferences for National Alliance schools. Topics of

conferences that Linda Vista staff have attended include school-to-work transition, content-area standards, high-performance organizations, and health and human services.

Linda Vista receives supplemental funding because its White student population is below 35 percent. The Academic Enrichment Grant goes to schools that have a high percentage of minority students, but were not mandated to become magnet schools for desegregation purposes, as many San Diego schools were. The supplemental funds are intended to support increased parent involvement, improved academic achievement, and supplemental social services. Linda Vista uses the funds to support a parent volunteer coordinator, a reading recovery teacher, and counselors who work with students in a number of areas, including peer mediation and conflict resolution.

Articulation Between Feeder Schools

The district office has been restructured into "areas" with assistant superintendents responsible for clusters of feeder schools. The implementation of the cluster concept helps with communication among schools, facilitating student articulation. Communication is fostered by events such as the monthly "feeder breakfasts" at which administrators, teachers, parents, and community members share concerns and ideas.

G. SUMMARY

Linda Vista created an effective learning environment for LEP—and all—students by redesigning the school to best meet the needs of their student population, emphasizing language development, and accessing resources from the broader community.

Shared Commitment to the Education of LEP Students

The driving force behind Linda Vista's restructuring is a shared commitment to the education of LEP students. The carefully planned daily schedule and thoughtful placement of students into developmental wings and content-area classes allows the school to eliminate pull-out instruction. The organization of students is supported by a great deal of teacher collaboration and an appropriate and useful assessment system based on authentic means of assessing student progress toward learning outcomes. The design and operation of the program is also supported by the highly functional site-based management structure.

The commitment to LEP students is also expressed through support of the students' home languages, the use of culturally appropriate curricula, and efforts by community outreach workers to involve parents in the education of their children. School staff also recognize that year-round operation is particularly effective in educating LEP students, as it prevents losses in language

development over long summer breaks. Finally, the articulated preschool provides an opportunity for LEP children to get a much-needed jump-start on language development.

Focus on Language Development

The use of the two-hour morning block to focus on sustained language arts activities (in classrooms where students have been carefully placed) effectively responds to LEP students' need to be engaged in a language-rich environment at an appropriate level. The instructional strategies used during the language arts block—Cooperative Learning, Whole Language, the use of technology—are also carefully chosen to elicit language development. The development of literacy in Spanish for Spanish-speaking LEP students allows them to develop literacy in English with greater ease and confidence; the support provided to all students during the transition to mainstream classes—via the designated transition classes—facilitates their future success in an unsheltered, all-English environment with English-dominant students.

Entrepreneurial Approach

Linda Vista's educational program is significantly enhanced by grants and partnerships with outside organizations. The spirit of entrepreneurialism at the school is reflective of the staff's constant striving to continuously improve their programs. Their use of additional resources for staff development in a whole range of areas also shows their commitment to being part of a community of learners.

CHAPTER 5

INTER-AMERICAN SCHOOL CHICAGO PUBLIC SCHOOLS ILLINOIS (PRE-K-6)



A. SCHOOL AND COMMUNITY CONTEXT

Inter-American School is located in the Chicago Public School District. In a neighborhood with a mixture of single-family homes, older apartment buildings, and multiple-family houses, most of brick or stone construction and many in the process of being remodeled. The school building is a three-story structure that appears to date from the 1950s. The blacktop surrounding the school contains space for parking, basketball hoops, and a brand new play area with modern plastic playground equipment and sand pits. The building shows multiple signs of aging both inside and out but is nonetheless warm and welcoming. The school's hallways display an impressive array of awards won by individual teachers and the school, as well as numerous articles written about the school's staff and programs.

Inter-American enrolls 650 students in grades pre-kindergarten through eight. Of those students, 69 percent are Hispanic, 17 percent are White, 13 percent are African American, and the remaining students are Asian, Pacific Islander, or Native American. The majority (56 percent) are low income and 36 percent are limited English-proficient. Some entering LEP students have lived in Chicago for several years, while others are recent immigrants. The principal estimates that of the LEP students, 30 percent are from Mexico, 25 percent are from Puerto Rico, 5 percent are from Cuba, and 27 percent come from other Latin American countries.

The school is a districtwide dual immersion magnet that attracts students from throughout the district. Each class at the school enrolls about half Spanish-dominant and half English-dominant students. Parents must apply to send their children to Inter-American, and for many years the popular school has had substantially more applicants than it could accept. Because the school is a magnet, the diversity of the student population is controlled by the district. A computer lottery is held to select students for the school in order to maintain an ethnic and gender balance. Separate quotas are established for each ethnic group and for male and female students within each ethnic group.

Students are chosen from the waiting list to replace students from the same ethnic group and the same gender who have declined admission. The principal has a small number of discretionary slots that she typically uses to admit the children of teachers at Inter-American; she feels strongly that teachers who want to do so should be allowed to enroll their children at the school. Of the 60 openings per year, two or three slots are filled at the principal's discretion.

The school's population is remarkably stable—only a few students leave before eighth grade. When parents move to other parts of the district, their children usually continue at Inter-American. The next section describes an hour in one of Inter-American's 23 classrooms—Mr. Segal's sixth grade language arts class.

Figure 5-1
The Classroom Layout, Inter-American

Classroom walls are colorfully decorated with student work, posters and maps. Students sit at desks, some grouped for easy collaboration. The teacher introduces instructional activities, then circulates the room responding to questions and offering support while students work on assignments.

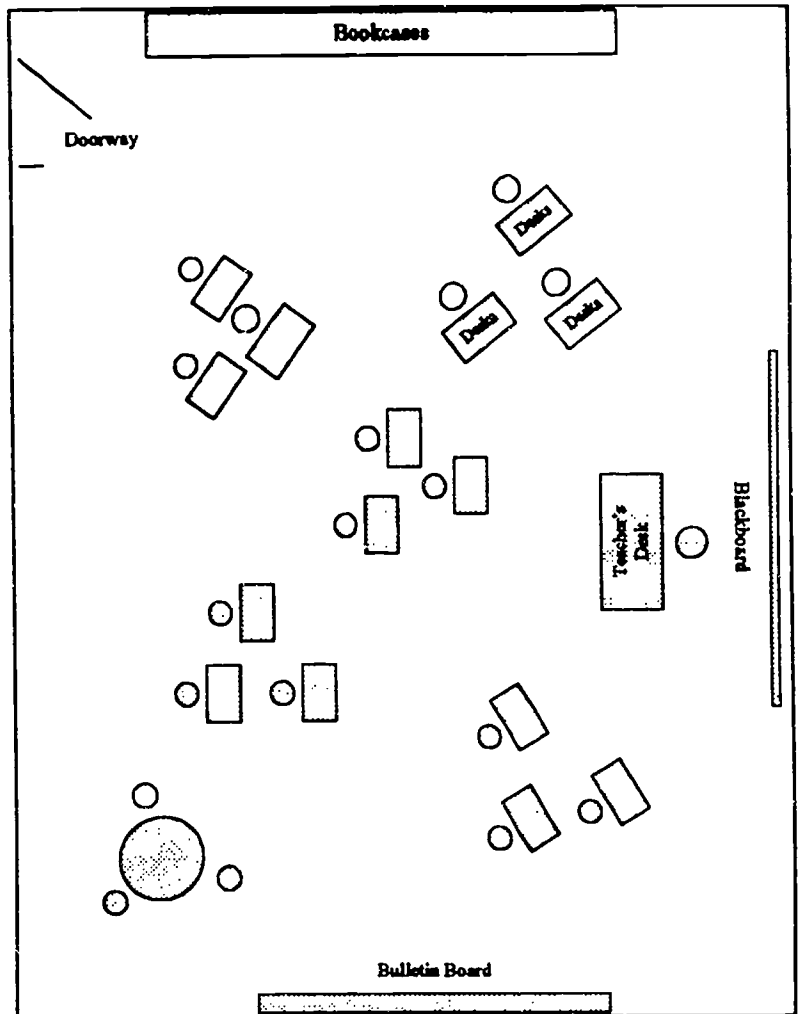

A sixth grade student reads a children's story he has written to his first grade partner. Their classes have formed a relationship to provide the students with practice in cooperative learning.



BEST COPY AVAILABLE

B. AN EXEMPLARY LEARNING ENVIRONMENT

The 18 students in Mr. Segal's sixth-grade class are engaged in reading, writing, or talking excitedly in small groups. Students are drafting essays, discussing their ideas with other students, and editing the work of their classmates. The teacher is working with a small group of students.

A map of the world, one of Illinois, and one of Chicago are pinned to the classroom walls, together with examples of student work, enlarged photographs of Mexican scenes, and posters from Guatemala and the Caribbean. Plants and books complete the classroom decor. Students sit at desks, some grouped together to allow for easy collaboration.

Mr. Segal gets the attention of the class and asks what progress students have made in the Writers' Workshop process. Several students report that they are midway through the peer editing process; others report that they are revising their essays after getting feedback from their peers. Mr. Segal asks them to continue working for about another 15 minutes. He continues to circulate, offering words of encouragement to one student as he stops to read over her shoulder. "You've made a lot of progress on your paper—who did you choose to help you edit?" He asks another student as he stops at her desk and reads what she is writing, "How did you finally decide to write about your little brother? I thought you had chosen another topic." She responds, "My little brother was so outrageous yesterday that I wanted to write it down so I wouldn't forget it." Mr. Segal continues to meet with individuals and groups of students for the remainder of the 15 minutes. He then calls time and asks students to put away their essays. He lets the students know that they will have class time the following day to work on their essays, but will have to turn in their completed work at the end of that day. "Those of you who have not met with your editor should plan to do so tomorrow so that you will be able to finish up."

Half of the 18 students in the class began school as LEP; the other half as English-only. After six or seven years in a developmental program, all are bilingual.

The culture, history and traditions of the Spanish-speaking world and Africa are the focus for the entire school.

The teacher acts as facilitator and coach during Writers' Workshop. His comments are supportive, not critical.

Mr. Segal describes the next activity to the students. He has identified a list of words that students have contributed from their reading and has reproduced them on small slips of paper that he distributes to the class. He asks the students to write sentences using these words:

*Unintelligibly, committee, prop, rambunctious,
intention, loyalist, instinctively, elaborated,
defiantly, daintily*

"Use the dictionary if you don't know the meaning of the word. Be creative ... think about the word and write a good sentence ... a short story or a novel sentence. Don't just repeat the definition—don't write: 'A prop is an object used in a play.' Write something more like: 'Anna approached Jane wielding the ax menacingly, convincing the audience that the huge weapon had real substance, making them believe that it was more than a mere stage prop'." First, a few students giggle at Mr. Segal's dramatic delivery of his sentence as he swings through the air with his imaginary ax. By the time he finally utters 'prop', everyone is laughing. Mr. Segal interrupts the laughter, "By the way, no one gets credit for writing down that sentence."

Students settle down to work, many still smiling. They discuss the words among themselves, use the dictionary, try out their sentences on each other. "Did you already look up 'intention'? What did the dictionary say?"

"I looked up 'unintelligibly' and I still can't figure out what it means," says one student. "That's sorta what it means ... you can't quite understand," replies another.

The noise level in the room increases as students discuss the assignment. The students begin to write sentences using the words: 'My sister tiptoed daintily across the room to get the cookies.' 'Mr. Segal elaborated on his vacation in Mexico.' 'My brother climbs trees, runs through the house, yells and makes lots of noise and my mother says he is rambunctious.'

Words to be used for sentences were identified by students in their reading as words that they had to look up because they couldn't understand them in context.

Students see their fellow students as resources and ask questions of each other.

While students are writing their sentences, Mr. Segal does paperwork at his desk and organizes materials in the classroom. Occasionally a student raises a hand and asks him a question but most students ask questions only of one another.

After about 15 minutes, Mr. Segal warns that students should wrap up their sentences and suggests that students who haven't finished do so as part of their homework. He asks which word students had most trouble with. Several students have candidates for the toughest word, including 'instinctively' and 'defiantly'.

Mr. Segal then asks the class to put away their writing and reference materials and prepare for the next activity. He explains that they will be joined by a first grade class, to whom they will read stories they have written.

Mr. Segal asks the students to pick up their stories from a table near his desk, and as they begin to do so, the first grade teacher, Ms. Rivera, appears at the door of the classroom and catches Mr. Segal's attention: "Are you ready for us to come in?"

Mr. Segal invites her and her class to join his sixth graders. "Welcome, come in." About twenty first grade students file into the classroom. He asks his students to greet the first-grade students and find a comfortable space for reading. Pairs of students sit at tables and on the floor. Mr. Segal tells his sixth grade class that they should begin by reading to their first graders the books they have written. When they have finished their stories, they are to exchange books with one of their peers and read a second story. "We have about half an hour; you should continue to read until time is up."

The sixth graders and first graders pair off and the older students begin to read. The books are stapled together and illustrated with drawings, photographs, and pictures cut from magazines. English is the dominant language of the books, but a few are written in Spanish. Others include a few Spanish words or phrases.

The sixth grade class has established a relationship with a first grade class that provides both the older and younger students with cross-age learning experiences. In a prior writing exercise, the sixth graders have written children's stories for students about age six. The sixth graders were allowed to write in either Spanish or English.

Student-written and illustrated books are a Whole Language strategy.

Students teach other children in both English and Spanish, helping to build fluent bilingualism in all students.

Teachers view their roles as facilitators in the interaction between the students. Students—both first graders and sixth graders—direct the activity.

One story, about a young girl whose dreams of being a rock star distract her from her homework, contains very detailed, full-color illustrations of the girl, scenes she imagines on stage and scenes of her home and family. The native English-speaking sixth grader reading the story explains complex words and concepts to the native Spanish-speaking first grader, switching easily between English and Spanish to get her ideas across.

In another part of the room, a native Spanish-speaker reads a story in Spanish to a native English-speaker, similarly elaborating in Spanish and switching to English as necessary to get his point across to the first grader. The first graders ask lots of questions and the sixth graders answer patiently and kindly.

When the first reading session ends, the sixth graders exchange books and read the stories their classmates have written. Mr. Segal and M. Rivera watch the interaction, intervening only to facilitate the exchange of books and make gentle suggestions to particular pairs that are getting noisy and need to settle down. The first graders use the time between books to ask the older students questions or to report details of their day.

In the middle of a story of a small boy locked in at the zoo after he gets separated from his family, the first grader declares, "I wouldn't be scared...All of the animals are in cages. I'd just wait until morning." The sixth grader counters, "I think I'd be scared to death...I'd imagine all of the bad things that could happen to me...the animal noises would really scare me." "I'd take care of you...I wouldn't let the tigers get you," the first grader responds in a brave voice.

After about 25 minutes of reading, Mr. Segal tells the students that it is almost time for the first graders to leave. He asks his class to finish the stories they are reading and discuss with the first graders what they liked and disliked about the stories. "They can be your critics. Ask them what interests them. Let them give you ideas on what they are interested in. It will help you write the next story."

The first grade students respond: "I really like stories with little kids in them," "That story had too many big words," "My mother reads slower, you read too fast." "Did you draw all of those pictures? I liked the one with the bears."

Finally, Mr. Segal calls time and the sixth graders say good-bye to the younger students. Ms. Rivera assembles her students in a line, asks them to thank Mr. Segal and his class for reading to them, and leads them out.

Figure 5-2

Instruction, Curriculum, and Program Map, Inter-American

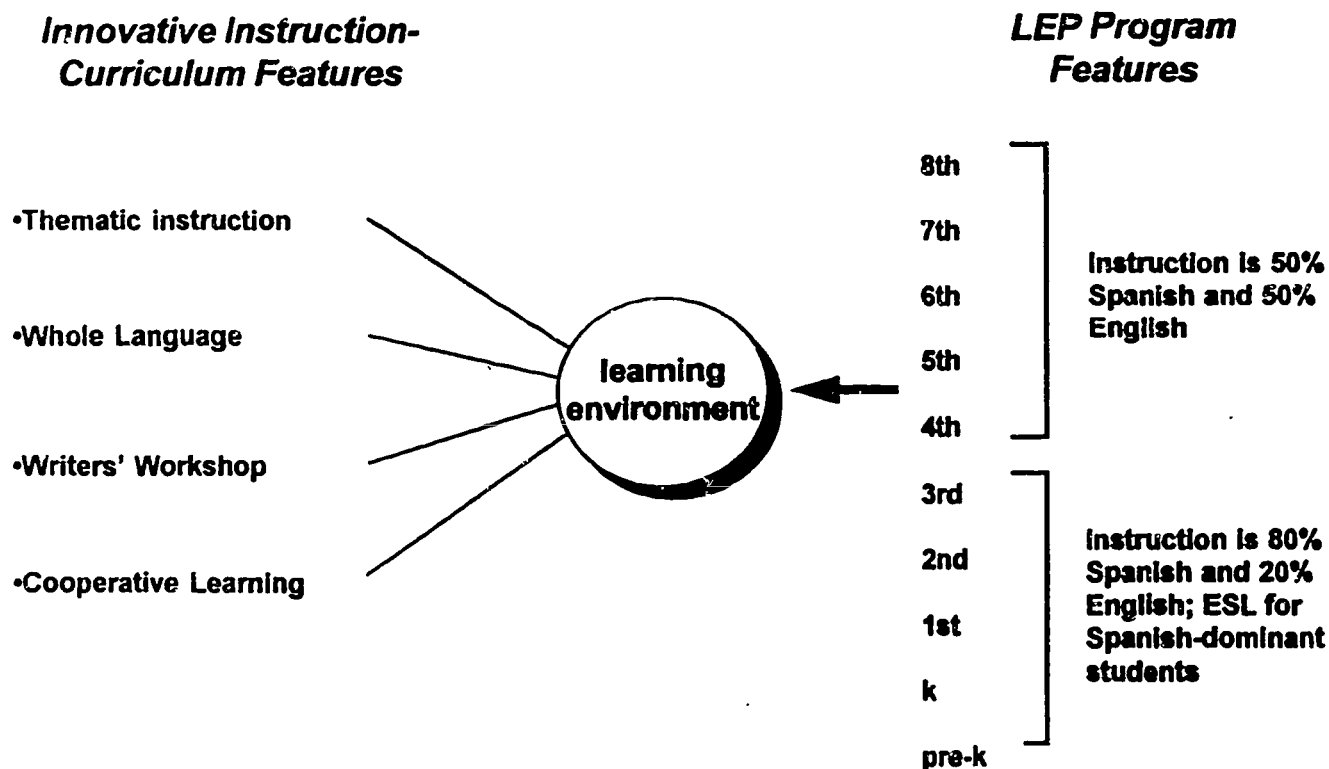

C. INNOVATIVE CURRICULUM AND INSTRUCTIONAL STRATEGIES

Mr. Segal has created a learning environment distinct from that seen in traditional classrooms. Students assume responsibility for their learning, serve as resources for one another, get feedback on their work from an audience, and engage in teaching experiences with younger students. This level of interaction did not happen by accident; these sixth graders are enrolled at a school where the pedagogical approaches have been designed to support students who play an active role in their learning process. Figure 5-2 on the facing page outlines some of the curriculum and instructional strategies that created this exciting learning environment; they will be examined below, while the LEP program features will be discussed in the following section.

Thematic Instruction

The Inter-American curriculum is built around broad district goals and has been tailored to fit the cultural background of its students. The school emphasizes study of the Americas and includes the study of Africa, especially as African history and culture have influenced the Americas. For example, African influences on the Caribbean islands are studied, since many Inter-American students have emigrated from those islands.

Teachers often develop their curriculum around themes many of which are drawn from the study of the Americas. For example, the fourth grade teachers plan their curriculum together and use social studies-based themes to create eight thematic units per year. One unit was a study of Mayan civilization; as part of this unit, the fifth grade classes visited the Field Museum to see an exhibit on Mayan culture, architecture, and religion. Teachers used the thematic unit as an opportunity to integrate across curriculum areas. In social studies, students studied the geographic spread of the Mayan civilization as well as its religion and cultural traditions. In science, students studied Mayan agriculture and architecture, while in language arts, students wrote stories about the Mayans.

Thematic instruction lets students see the natural connections between traditional disciplines, while linking themes to students' cultures allows students to learn about their culture and the cultures of their fellow students.

Whole Language

Whole Language strategies were in evidence in all of Inter-American's classrooms. The Whole Language approach calls for students to use language rather than merely learn about language. Teachers use this approach to create opportunities for students to use language in ways that reflect real-world purposes and functions, and are authentically related to their life experiences. In the exemplary classroom described above, for example, Mr. Segal modeled the type of sentence he wanted students to create using rich language. Journals were a feature of language arts instruction in

many classrooms and teachers often had students write, illustrate, and publish books (also a feature of Mr. Segal's class).

Inter-American's language arts curriculum has been carefully developed over the years to include a great deal of literature drawn from a number of sources. Many of the featured works relate to the school's overall focus on the study of the Americas. Students read literature in both Spanish and English by authors from the Americas and on topics relevant to the schoolwide theme.

Writers' Workshop

Teachers at all grade levels make use of Writers' Workshop strategies, in which writing is taught as a process. As part of the Writers' Workshop, each student writes a draft of her paper, gets one of her peers to edit the draft, and meets with the 'editor' to discuss the work-in-progress. Authors revise their work based on feedback from their editors before submitting it to the teacher for an edit. After editing the work, the teacher consults with the students, and the authors then produce draft papers. Students learn that writing is a process and that giving and receiving feedback are important steps in that process.

In the sixth grade classroom described at the beginning of this chapter, students were proficient at the Writers' Workshop process. They had used the process over a number of years and had no hesitation about asking for feedback from their peers. Students also were experienced editors, giving constructive and supportive feedback to their fellow students.

Cooperative Learning

Cooperative Learning strategies were in place throughout the school. Students worked in pairs and in groups of three, four, or more on a number of projects and activities. They have learned the skills of learning cooperatively, including looking to their fellow students as resources for learning.

Teachers typically created groups that were heterogeneous across gender, language dominance, and content-area strength. Students were sometimes assigned roles to play within their group, such as facilitator, recorder, artist, timekeeper, etc. By sixth grade, students were able to carry out the activity on their own and attend to their tasks with little teacher direction. Teachers made use of the time when students were engaged in cooperative activities to work with selected groups or with individual students.

D. PROGRAM FOR LEP STUDENTS

Inter-American is one of nearly 500 elementary schools in Chicago, and houses the oldest of Chicago's ten Developmental Bilingual (two-way) programs. Inter-American was founded by a group of parents and teachers who wanted to establish a school that honored multiculturalism and supported bilingualism for Spanish speaking LEP students and for monolingual English students. Figure 5-2 contains a schematic of the program that grew from the vision of that group of parents almost 20 years ago.

Comprehensive Developmental Bilingual Program

The level of bilingualism among the sixth graders in the classroom described above is a direct outgrowth of the Developmental Bilingual program at Inter-American school. The school has three classrooms at each grade level from pre-kindergarten through seventh grade and two classrooms at the eighth grade level. The school offers three half-day pre-kindergarten programs: one for three-year-olds (in the afternoon) and two for four-year-olds (one in the morning and one in the afternoon). Most of the students enter Inter-American school at pre-kindergarten and remain through eighth grade.

At all grade levels, English-dominant and Spanish-dominant students are mixed in the same classrooms in approximately equal proportions because the goal of the program is that students all become bilingual and biliterate, based on the philosophy that bilingualism and biliteracy are assets. The language program is based in the research literature which argues that the best time to learn a second language is early in life, that with exposure and motivation children can learn another language, and that with appropriate instruction and the necessary home/school support all children can achieve their fullest potential in all areas of the curriculum. School staff believe that "a multicultural bilingual setting fosters second-language acquisition and the appreciation of other cultures and prepares students to live in a pluralistic world."

Inter-American's program begins in pre-kindergarten where the core subjects are taught in Spanish. In the early grades, approximately 80 percent of the teaching is in Spanish. Spanish-dominant students receive ESL instruction and English-dominant students receive instruction in Spanish as a second language. The 80/20 ratio of Spanish to English instruction remains through third grade, with all core subjects continuing to be taught in Spanish. English instruction increases in the middle grades through eighth grade, with instruction divided equally between the two languages.

Teachers relate to each other across the span of two grade levels. The teachers at pre-kindergarten and kindergarten, 1 and 2, etc. plan together, exchange students across grade levels and classrooms, and work together on thematic units. The three floors of the school are organized to

Figure 5-3
School Structure and District Support, Inter-American

School Structure

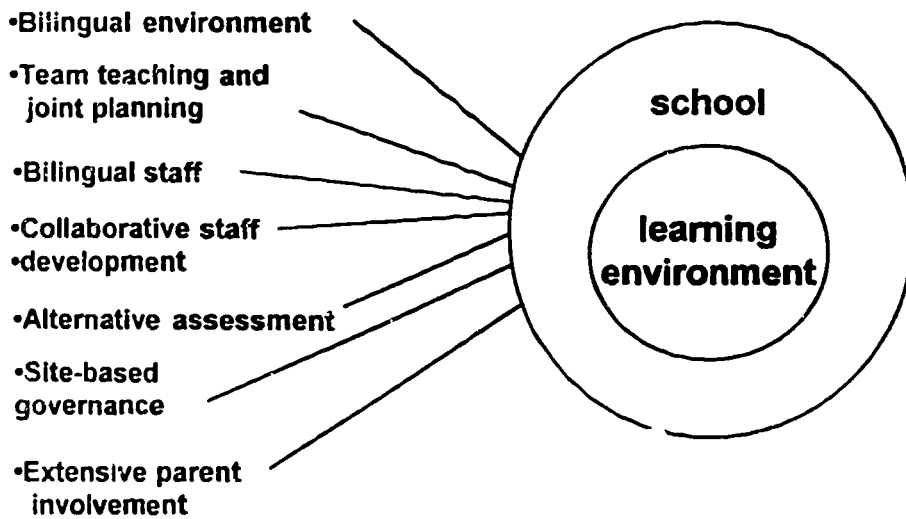

facilitate interaction across grade levels. The first level houses pre-kindergarten, kindergarten, first and second grades. The second floor contains grades 6, 7, and 8, and the third level is home to grades 3, 4, and 5. At the fourth, fifth, and sixth grades in particular, teachers team, plan together, and often exchange students, with one teacher, for example, teaching science to two fifth grade classes while the other teaches mathematics. Teachers work together to plan and implement the curriculum, which helps ensure curriculum articulation both within and across grades.

In grades 7 and 8, Inter-American has implemented a modified departmental structure with students assigned to homerooms and teachers specializing in mathematics, science, Spanish, English, and social studies. In sixth grade, the three teachers each have a homeroom and the students mix for the remainder of the day. One teacher teaches Spanish social studies and language arts, another teaches science and mathematics in both languages, and the third (Mr. Segal) teaches English reading and language arts.

Students at the upper grades move from class to class as in a traditional middle school program. Because of the school's small size, there are only about 125 students in grades 7 and 8 and a class of students moves together from one subject to another. Thus the upper grades feel more like a school-within-a-school than like a traditional middle school. Teachers collaborate to make adjustments as needed to the traditional 55-minute-per-subject schedule, to provide more time for science labs or thematic units.

E. SCHOOL STRUCTURE

Inter-American's program for LEP students is, in fact, also the program for all students at the school. Spanish-dominant and English-dominant students learn together in each of the school's classrooms. Figure 5-3 shows several key aspects of the school structure that support the unique learning environment; the following section discusses each of these factors.

A Bilingual Environment

Inter-American School was founded in 1975 by a small group of parents and teachers as a bilingual preschool under the auspices of the Chicago Public Schools. The parents and teachers envisioned a multicultural school where children were respected as individuals and where their languages and cultures were respected as well. The school grew by one grade per year until it reached its current grade configuration of pre-kindergarten through grade 8. Inter-American was designated as a district magnet school in 1980.

The vision for Inter-American was that of a school where both Spanish-dominant and English-dominant students could become bilingual and biliterate in an environment that honored and

celebrated the cultures of all of its students. This vision grew, developed and has been passed down from the founding parents and teachers for nearly 20 years. Faculty, parents, and principal have refined the program over time, basing their language program development decisions on research in language acquisition, relying primarily on Stephen Krashen's work in the early years and later on the work of Jim Cummins as well.

An earlier section described the ways Spanish and English are used instructionally. The halls, playground, and cafeteria at Inter-American are filled with the sounds of Spanish and English—students, teachers, and staff use both languages comfortably. Books in the library, posters in the halls, and announcements in the office are in Spanish or in English. The message throughout the school is that both languages are valued and accepted.

Team Teaching and Joint Planning

Teachers at each grade level coordinate their activities and instruction. On Fridays, students are dismissed early and teachers use that time as well as their own time in the evenings, weekends, and the summer to plan and coordinate their activities.

The three fourth grade teachers work together to share learning activities, plan joint field trips, coordinate their curriculum, and plan the thematic units they have created during the course of the year. Two of the teachers have adjoining classrooms separated by a pocket door, and for the past two years these two teachers have teamed up for a number of activities. They often plan activities either after school or on a weekend, at one of their homes.

The three fifth grade teachers are all new this year to Inter-American. They met during the summer to develop an initial plan for their curriculum, and to plan joint activities and thematic units. They continue to meet at their homes about once a month. In addition, the three teachers have three prep periods a week together and use the Friday afternoon early dismissal time to plan together.

The third, fourth, and fifth grade teachers are working together to develop and link their goals, objectives, and outcomes. One of the teachers pointed out that coordination and alignment across grade levels is especially important in a program with the goal of bilingualism, biliteracy, and delivery of a full curriculum. They meet during the afternoons on Friday to plan together. Seventh and eighth grade teachers share students; these teachers meet together to plan coordinated activities, integrate themes across subject matter areas, and develop joint solutions for reaching particular students.

Bilingual Staff

All Inter-American teachers are required to be bilingual. More than half the teachers are native Spanish speakers; most of the others have excellent Spanish-language skills. The librarian and the

music teacher are the only non Spanish-speaking staff (the principal is learning Spanish, though she is not yet fluent.) The staff recruit new teachers both from the ranks of their former student teachers and from other schools in the district. The school has good relations with local universities, which recommend some of their best students to student teach at Inter-American. The school's positive reputation attracts veteran teachers as well.

Collaborative Staff Development

Inter-American has instituted a modified schedule to accommodate staff development. Students are dismissed early on Fridays, and faculty meetings and/or staff development activities are scheduled for those afternoons. Usually, meetings begin with the whole faculty and then break out into groups of individuals or pairs by grade level. Typically, staff development is teacher initiated, with the staff coming to consensus about the kinds of training they need. Staff development is often focused on topics that grow out of a need to improve an aspect of the school's program. Recent staff development activities have centered around alternative assessment, dual language strategies, ESL approaches, cooperative learning, and peer coaching. The previous year, the staff had three months of in-service training on mathematics and science instruction, because mathematics and science had been identified as schoolwide priorities.

Alternative Assessment

The Illinois Goal Assessment Program (IGAP) is required by the state. This state-developed test covers reading, writing, mathematics, science, and social studies at various grade levels. The state's goal in developing this test was to find a tool that could measure students' mastery of the curriculum. The IGAP is given annually in March. LEP students are tested on the IGAP only after they have been in a program for three or more years.

The ITBS on the other hand is the assessment instrument that has been adopted by the Chicago Public Schools. The test is not necessarily related to the curriculum. All CPS students were tested on ITBS before the state implemented the IGAP. Inter-American students do much better on the IGAP than on the Iowa Test of Basic Skills (ITBS). The district is deciding whether to continue using the ITBS. LEP students who have been in the program for three years or fewer are exempt from the ITBS, but are required to take La Prueba de Realización Español instead.

Inter-American staff have adopted the portfolio assessment process for their students and are using portfolios in conjunction with teacher-designed tests. Some teachers are also using published tests as a way of providing greater exposure for their students to that form of test. The seventh and eighth grade mathematics teacher, for example, uses published mathematics tests. Teachers have

participated in a series of staff development sessions with experts on alternative assessment, and the staff has requested continuing training in alternative assessment methods.

Many teachers rely almost entirely on the portfolio system. Students are given assignments all week. They are given some class time to complete the assignments and are expected to finish their work at home. One sixth grade teacher, for example, maintains a list of all the assignments on a board at the back of the class for student reference. At the end of the week, students turn in portfolios containing all their assignments for teacher assessment.

One fourth grade teacher keeps portfolios that contain student-selected work samples; he adds work to the portfolios throughout the year. Students can look back to see how much progress they have made in (for example) writing—or in the level of mathematics knowledge—and get a real sense of progress. The portfolios remain in the students' files for the following year. Teachers are also exploring and experimenting with broader methods of assessing students, including demonstrations and performances. Multiple forms of assessment allow teachers to "tell the whole story of student achievement."

Site-based Governance

Illinois has mandated school-level governance for all Chicago Public Schools. The state mandate, coupled with Inter-American's history and tradition of parent involvement in decision-making, means that staffing, instructional, and budget decisions are made at the school level by three standing committees.

The Local School Council (LSC). The 11-member LSC—mandated by the state—is the school's governing body, comprised of six parents, two community members, two teachers, and the principal. The LSC sets school policies, hires and evaluates the principal, and is involved in interviewing teachers; it controls school funding from both discretionary and categorical state and federal programs (e.g., Chapter I funds, Eisenhower technology grants, Drug-Free Schools grants) and makes decisions on the way categorical programs are implemented. Its subcommittees focus on areas such as restructuring, facilities, curriculum, and fundraising. LSC members are elected to two-year terms; parents and community members are elected by parents and community members, and teachers are elected by the faculty. The teacher representatives on the LSC seek input from other teachers prior to votes. Teacher representatives serve on every LSC committee, and many are chaired by teachers. The team that interviews new teachers always has teacher representation.

The Professional Personnel Advisory Committee (PPAC). The PPAC is comprised of the whole faculty. According to the principal, at other schools, this committee usually consists of representatives—it is unusual for the PPAC to include all faculty members. The committee

determines schoolwide priorities and has responsibility for the instructional program; members often form sub-committees on different subjects or concerns. Some of these sub-committees are permanent and some are temporary; some are very active while others are less so. According to one teacher, "teachers are very empowered." Teachers are in charge of the instructional program and have freedom as long as they meet the state objectives.

The Parent Advisory Committee (PAC). The PAC is a voluntary parent organization; all parents are eligible for membership. Those parents who play an active role in the PAC appear to be representative of the student body. Given the school's history, it was not surprising to discover that many parents continue the tradition of involvement in the school decision-making process. As the organized voice of the parents to the school staff and to the LSC, the Parents' Advisory Committee gives policy input, supports volunteer activity, and raises funds.

Extensive Parent Involvement

Inter-American parents are involved in all aspects of school life. They participate in governance through the PAC and the LSC, and because of Inter-American's history and tradition of substantive parent involvement, parents take their responsibilities seriously. Parents play a major role in fundraising for the school through various sales, auctions, and contact with businesses. They volunteer in the library, in the classrooms, and for special school events. The school has two part-time parent volunteer coordinators who have been assigned space at the school and who take responsibility for contacting parents about school activities.

The school's yearly science fair shows off student projects demonstrating scientific principles and the scientific process. Parent volunteers, along with volunteers from a nearby medical center, have served as judges for the fair. Using a teacher-designed form, the volunteers interview students about their experiments, eliciting a description of the method, materials, and hypotheses.

Parents also are engaged in the classroom—for example, two or three parents visit one fourth grade class regularly—sometimes to lead instruction. One of the regular visiting parents is an artist who has worked with the teacher to build art into the curriculum. As part of the unit on Mayan civilization, she led a class on Mayan mythology and worked with the students to produce wonderfully detailed images of Mayan gods in full regalia. Other parents provide support for the non-instructional part of the teacher's work in order to free up teacher time for instructional tasks.

The staff has put a great deal of effort into making the school an inclusive community. The school sponsors parenting workshops, including a highly successful parenting workshop about teenage issues. The PAC sponsors "dream sessions" during which parents and community members can express their dreams for the school; all of their ideas are considered by the PAC and some are

passed on to the LSC. Inter-American's collaborative process can be cumbersome, but staff feel it is important not to have top-down decision-making .

F. SUMMARY

Inter-American School has created a uniquely successful bilingual learning environment. Its strength rests in the ability of the staff to sustain a vision of a school that values and celebrates the cultures of all its students, promotes bilingualism and biliteracy for the whole student population, and holds all students to high expectations.

Consistent Strategies across Grade Levels

Throughout the school, teachers are trained in and make use of the same instructional strategies—including whole language, sheltered instruction, cooperative learning, reading and writing workshops, and hands-on mathematics and science. Because they encounter these strategies at each grade level, by the time students reach sixth grade they are experienced cooperative learners, have mastered the Writers' Workshop process, and are able to view their classmates as resources.

Engaged Learning Environment

In classrooms throughout the school, students were actively engaged in their learning. They participate in groups, give and receive feedback from their peers, and help create their learning experiences. The school's curriculum has been designed to promote student involvement in learning.

Parent Involvement

Parents of Inter-American students must apply to enroll their students in this unique learning environment. The school's traditions and practice support giving parents a meaningful role in the education of their children.

CHAPTER 6

GRAHAM AND PARKS ALTERNATIVE PUBLIC SCHOOL CAMBRIDGE SCHOOL DISTRICT MASSACHUSETTS (K-8)

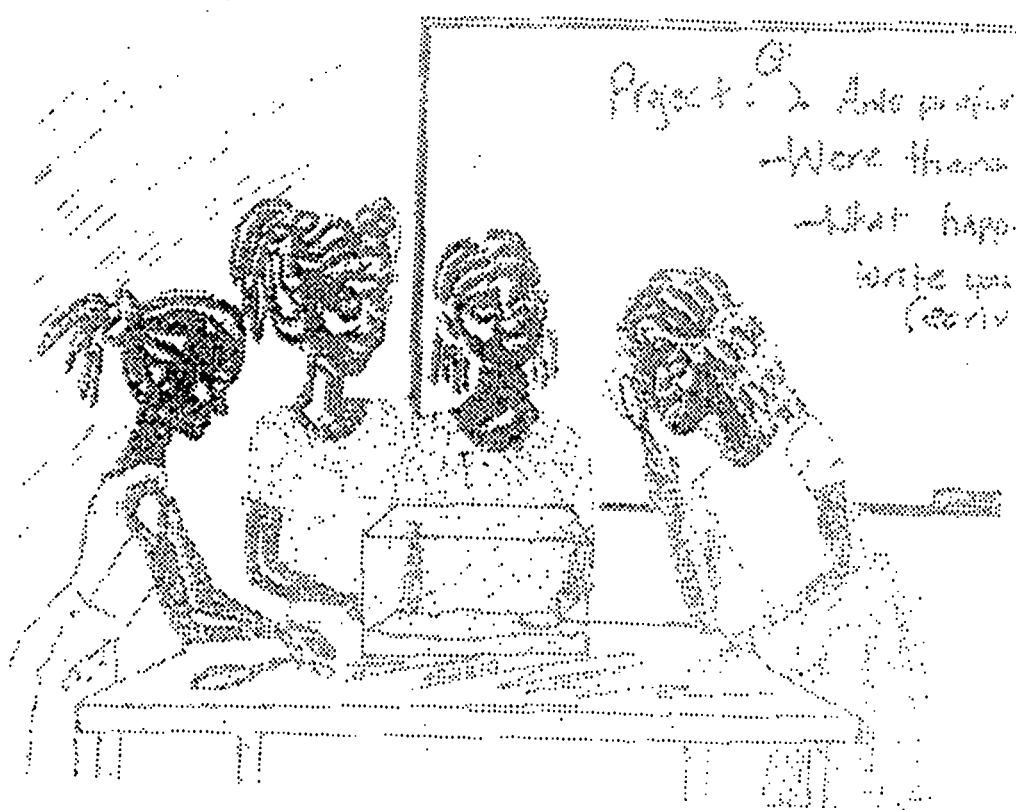

A. SCHOOL AND COMMUNITY CONTEXT

The Graham and Parks Alternative Public School is a K-8 school in Cambridge, Massachusetts, formed by the merger of two existing school populations. One of the buildings was renovated and renamed for local activist Saundra Graham and civil rights heroine Rosa Parks. A beautiful mural in the school entry depicts both women at the school's dedication ceremony. The old building, in excellent condition, has three stories and a basement. Its setting, in a residential neighborhood near Central Square in Cambridge, is urban but not impoverished.

Graham and Parks has a stable student population. More than 75 percent of the students in seventh grade have been enrolled since kindergarten. Of the 365 enrolled students, 17 percent are LEP and more than one-third of the students qualify for free or reduced-price lunch. Most LEP students are Haitian immigrants; a few are US-born children of immigrants. All except the Haitian bilingual students enroll in Graham and Parks through a choice system which is part of the Cambridge district desegregation plan.

Political upheaval in Haiti and the search for a better life have led many Haitians to immigrate to the United States. By the fall of 1993, immigration in the Cambridge area had stabilized, but between then and Spring 1994, there was an influx of new Haitian immigrants. The recent arrivals are younger, have a more limited education, and many suffered trauma in Haiti. Most of the Haitian students at the school immigrated to the United States with or without their immediate families as a result of the political upheaval in their native country. The majority are very poor; most of their parents or guardians work in low-paying service jobs. When these children enter Graham and Parks School, some are malnourished, most are unschooled. As a rule, they have no literacy in Creole or English. They have experienced hunger and violence and many are separated from their closest relatives. Working with the children who have been traumatized this way is challenging because they are often distracted by their fears and bad memories and may have a sense of hopelessness about the future. Seemingly innocuous cues can set off bad memories for the children, and the teachers have to help them work through these fears and return to academic subjects. This takes time, patience, and sympathy.

On the other hand, and in sharp contrast to the suffering in these children's lives, is their apparent *joie de vivre*. In classrooms, on the school yard, and in the hallways, students exhibit an exuberant and joyful attitude toward life. While many students have experienced violence and trauma, they still enjoy coming to school and are eager to learn. The principal of Graham and Parks has been at the school for nineteen years and is a moving force in the school's vision of how education should work. The science program described in the following section builds on the students' curiosity about the world around them.

Figure 6-1
The Classroom Layout, Graham and Parks

This is a large double-sized classroom for a grade 5-8 bilingual class of Haitian/Creole-speaking students. Two instructional areas are defined with bookshelves and a blackboard on wheels. This enables the team of teachers to group students for various instructional activities. The furniture can be moved around to facilitate instruction; there is ample room for various arrangements. The classroom is brightly lit with natural light and is decorated with many posters and student art work.

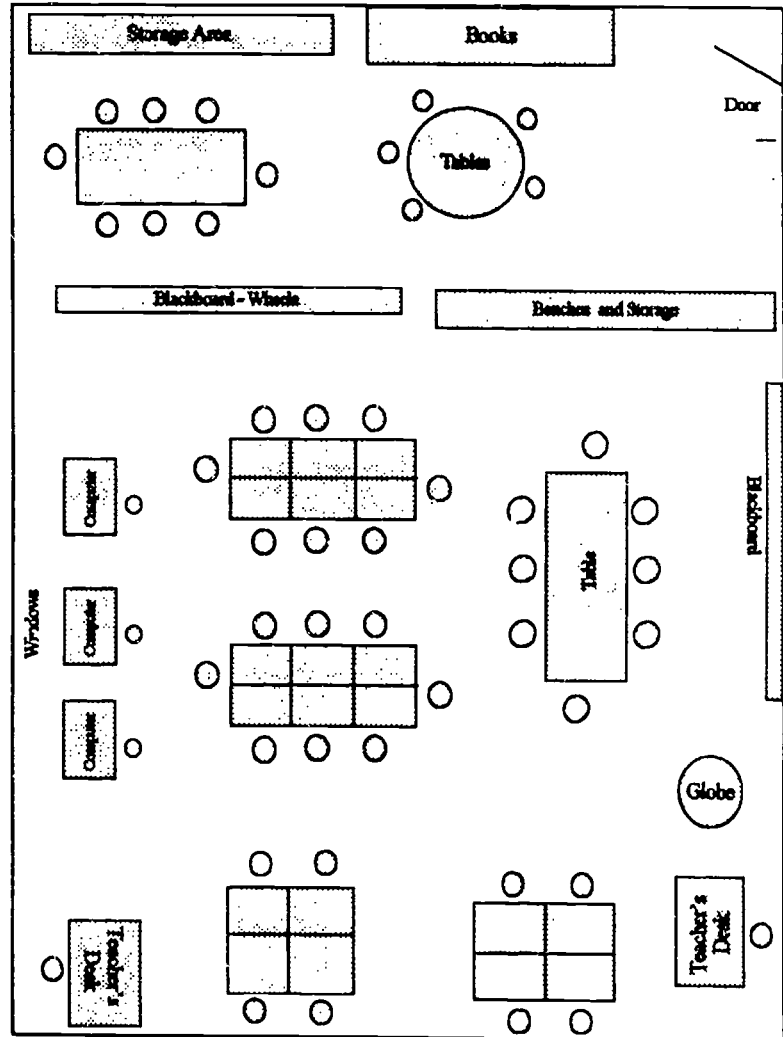

Four Haitian/Creole-speaking girls observe their ant farm to answer questions posed by the teacher and written on the blackboard. The TERC approach to teaching science develops students' powers of observation and helps them learn science through application.

B. AN EXEMPLARY LEARNING ENVIRONMENT

Polished wood wainscoting lines the wide hallways of the old school, which are decorated with brightly colored student work. Despite its age, the school is airy, well maintained and inviting. The classroom for Haitian bilingual students has wood paneling halfway up the walls, high ceilings, and natural light from large windows. There is sufficient space for two classes. The classroom feels jumbled but comfortable.

The classroom space is divided into two main instructional areas; the smaller has one rectangular and one round table, each of which seats about eight students, and contains reading materials, displays, a blackboard, and lots of material to work with. The second space is much larger, with desks arranged so that groups of four students can sit in clusters. This area has another blackboard, science materials, and displays in English and Creole that depict scenes in Haiti and the U.S. African-American history is featured prominently. The following list is displayed on one wall:

*Listen to each other
Be cool but not too cool
Don't pretend friendships
No name calling or insults
Say good peaceful words
No fighting or pushing
Everyone be friendly
Do homework
Follow teacher's direction
Do not steal or cheat
Have fun
No gossiping
Laugh and be happy
Don't worry too much*

Twenty-three students of mixed ages are in the room. The students sit at desks and tables in groups of four or five. Young people's conversation, in low tones, fills the room as the students speak to each other in Creole. One of their teachers, Ms. Berkley,

Classroom furniture can be rearranged to facilitate different grouping strategies and facilitate cooperative learning.

Displays honor Haitian-Creole heritage and the experience of African-Americans.

Haitian immigrant students have developed this list of behavioral rules for the classroom. The list reflects student culture and values.

Students span several traditional grade levels; some are very recent arrivals, while others have been at the school for 2 to 3 years.

asks in English for their attention. The students fall silent, awaiting the start of the science lesson. Ms. Berkley speaks to the students mainly in English, while her colleague Mr. Hyppolite repeats the instructions in Creole.

The team provides both an English- language and a Creole- language role model for the students.

There are boxes of ants on each student table. The students manipulate lighting conditions for the ant investigations using lamps or by placing ants near the windows or under a cardboard box. The teachers give instructions to the student groups to work on their own with their experiments, and direct the students' attention to instructions in English written on the blackboard:

- 1. Take out journals and a pencil.*
- 2. Open journals to 4/26. Did you write an hypothesis for your investigation?*
- 3. For the first 15 minutes observe experiment, write observation. Write at least 1 question.*

Teachers act as facilitators for student learning. Using the inquiry method, teachers ask open-ended questions, encourage students to formulate answers, and encourage students to pose additional questions of their own.

Ms. Berkley and Mr. Hyppolite move from group to group, asking the students what they are thinking and writing, and helping, where necessary, to keep students focused on their task. They ask questions: "Were there changes in your boxes?" "What happened to the box that was in the dark?"

Students work in cooperative groups and discuss the experiment among themselves in English and Creole making both written and oral observations about their experiments.

One boy says that some water got into his box and the ants drowned; the teacher instructs him to write what has happened since the last time he looked in the box. After fifteen minutes, the student groups begin to discuss what they have found. They speak to one another in Creole; some make their journal entries in Creole, some in English.

The teachers call the class together and announce the next activity—the science talk. The students sit in a circle of chairs, boys alternating with girls. Most discussion is in Creole. Mr. Hyppolite poses questions: "What have you observed in your investigations?" "What do you think about the issue of light and dark and the preference of the ants?" "What additional questions

would you want to ask?" He asks if the results of their investigations are similar or in conflict. The students discuss their results and find that they do not agree. Speaking in Creole, they begin to discuss their investigations and explain their results:

Student 1: I think the ants are not too hot or cold; and they have protection against the sun. The sun and the lamp light aren't the same. The sun is stronger.

Mr. Hyppolite: So you think the sun is stronger than the light? You think they should die more in the sun than in the light?

Student 2: No, because they don't die in the sun!

Students (several): Ants live underground, not outside.

Student 3: Why did you put it so close to the light?

Student 4: The big ones have more resistance. ...

Student 5: When ants are living in nature, does the sun kill them? No.

Student 3: They have to come out to eat.

Student 6: They live in the light.

Student 6 to Student 5: How long were yours in the light?

Student 5: indicates he does not know

Student 7: Mine were there exactly 15 minutes. Yours were only there three minutes or so.

The students become deeply engaged in the science talk, sharing ideas, reporting observations, making hypotheses and presenting evidence and counter-evidence. They discuss conditions such as the effect of heat, light, distance from light, amount of time in the light, size of the ant, water in the box, number of ants in the box, lamp light versus sunlight. Students demand that other students provide evidence for their hypotheses, and there are some sharp disagreements. They listen carefully to one another and take turns presenting their cases. The discussion is animated, at times heated. The teachers keep the students on track, follow up on student ideas by asking more questions, and make sure that all the students participate.

The science circle is a regular feature of the science lessons. The discussion is primarily in Creole. Mr. Hyppolite translates students' more complex Creole sentences into English for Ms. Berkley.

Following months of observation and journal-keeping, students interviewed a myrmecologist (expert on ants) who came to their classroom. The teachers and students have identified a question that could be explored experimentally: Do ants prefer light, dark, or both? Students in their cooperative groups have designed experiments to answer the question.

Students direct the discussion. Students are learning to express scientific thoughts, sharpen their powers of observation, analyze information and make connections.

Use of Creole enables the LEP students to gain access to science concepts while they are learning English.

The science talk leads to the next set of science experiments and activities. Students learn that their spoken contributions lead to important consequences. The lesson models the importance of observation and shared discussion.

At the conclusion of their science talk, students and teachers list a set of observations and a number of key arguments. Mr. Hyppolite points out that these observations and arguments will form the basis of the next set of experiments. He explains that during the next science lesson, students will redesign their investigations to include the measurement of heat and graphs of ant mortality rates—for small and large ants.

C. INNOVATIVE CURRICULUM AND INSTRUCTIONAL FEATURES

In their science lesson with Creole-speaking LEP students spanning four grade levels, Mr. Hyppolite and Ms. Berkley were able to sharpen student thinking and language skills by engaging them in active exploration of real-world phenomena and encouraging them to test their observations and conclusions in open discussion with their peers. The teachers supported student speculation and hypothesis-building, directing the process only to keep the discussion on track. Their questions were designed to elicit student reflection, not to demonstrate that some students had "right" answers. The students learned that the real world is complex, that clear answers are often hard to find, and that ideas need to be tested by data.

These and other strategies used as at Graham and Parks are identified in Figure 6-2 on the following page. The teachers were able to meet the unique challenge posed by Haitian immigrant students in Cambridge because they have unique abilities, but they also have critical support from the Graham and Parks School and an external partner, TERC, which helped to develop the science program. Innovative strategies listed in Figure 6-2 —the inquiry method and cooperative learning— are discussed below in the context of the science program developed by TERC. Figure 6-2 also provides a schematic of the program for LEP students which, along with additional curriculum and instructional strategies, will be discussed in the next section.

TERC Science Program

TERC (a non-profit educational research firm located in Cambridge) and Graham and Parks teachers collaborated to develop the school's science program with grants from the National Science Foundation and the US Department of Education, Office of Bilingual Education and Minority Language Affairs and Office for Educational Research and Improvement. Graham and Parks and several other schools in the Boston area have served as living laboratories for the development of the TERC's sense-making approach to learning science.

Inquiry method. TERC has been working with Graham and Parks for six years in the Haitian Creole bilingual program. TERC studies what and how LEP students learn in an inquiry-based science classroom. In project classes, science is viewed as a way of knowing and thinking, so students are encouraged to determine what is studied and to decide which questions to explore within a given topic. Early TERC projects, for example, examined the quality of drinking water at the school. The Graham and Parks TERC project, at the time the program was reviewed, was devoted to biology, particularly organisms such as snails, hornworms, and ants. The ant farm in the narrative is the basis for lessons in which students develop questions from observation and then set about trying to find answers to them. While instruction is in English or Creole, most student writing is done in English.

Figure 6-2

Instruction, Curriculum, and Program Map, Graham and Parks

Innovative Instruction-Curriculum Features

- Inquiry method
- Cooperative Learning
- Whole Language
- Building on student experiences

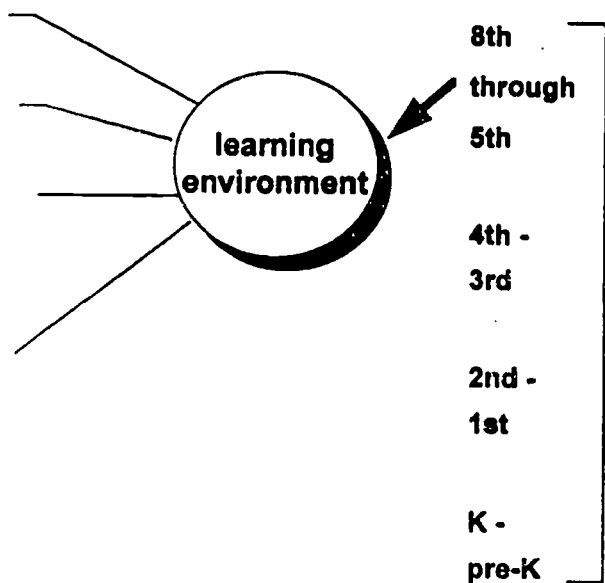

LEP Program Features

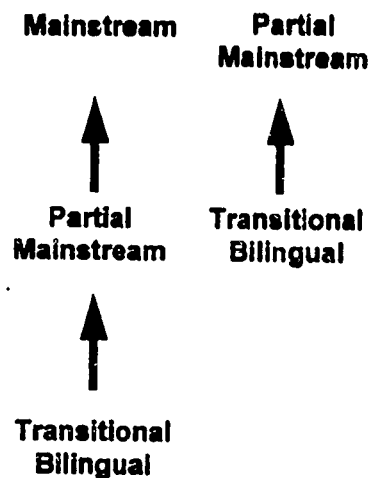

TERC staff develop extensive background material for the teachers, who attend two-week summer programs and then bi-weekly seminars with all the teachers in the Boston area working on TERC science projects. In the seminars, teachers and TERC staff read scientific literature and analyze classroom practice using video tapes, transcripts of lessons and samples of student work. Participating teachers receive a \$3,000 stipend annually. The two bilingual teachers in the grades 5 through 8 grade classroom described above have been participating in the TERC project for two and a half years, in which they have learned to do scientific investigations and critically explore issues in their teaching.

TERC supplies materials for the student projects and helps provide support and guidance to teachers as they work through developing students' firsthand knowledge and inquiry. TERC staff have a close in-classroom relationship with teachers. They videotape classroom lessons and discuss them with the teachers, exploring ways, for example, to generate more student talk and less teacher-dominated talk.

Some advanced LEP students also get mainstream science taught by the 7th and 8th grade science teacher. The curriculum, while not identical to that of the TERC project, draws on the teacher's experience in the TERC project to incorporate more discussion in her science program.

Science at Graham and Parks before the TERC program consisted of a science specialist giving a lesson once a week to each class. Now, K-3 science classes studying growth are using approaches the teachers developed in collaboration with TERC. Children measure growth of a baby brought to class occasionally, or a pet dog. They video children walking and measure their strides. The science specialist likes the inquiry approach to science for all students, including monolingual English speakers.

The TERC approach levels the playing field in scientific inquiry by giving LEP students greater access to science learning opportunities. The program hones the children's power of observation and natural curiosity. Teachers anticipate that the TERC approach will have an impact on students through 8th grade and beyond.

Cooperative Learning. Students conduct their scientific investigations within cooperative groups of three to five students. The teachers act as facilitators while the students, driven by their own curiosity, collaborate and question one another.

D. PROGRAM FOR LEP STUDENTS

Graham and Parks is home to a Haitian Creole bilingual program, the only one in the district. Incoming students are assessed for their primary language and parents are given choices of programs. The bilingual classes are organized into pre-K-K, 1-2, 3-4 and 5-8 grades. Figure 6-2 includes a diagram which outlines the program for LEP students.

Each pre-K bilingual class is teamed with a monolingual English class; team teaching allows mixing and grouping of students. In general, it takes most students five to seven years to become fully bilingual; however, students usually move to all-English classes after two or three years in the bilingual class. Entering kindergartners can expect to enter the mainstream by 2nd, 3rd, or 4th grade. Students exit when they attain sufficient English literacy to participate in the English classes. If students arrive with a solid educational background, they can enter the mainstream in 12-18 months. While literacy in Creole is considered very important to each child's education, the main goal is transition to English literacy. All of the Haitian bilingual teachers are native Creole speakers and completely fluent in both Creole and English.

Throughout Graham and Parks' Creole bilingual program, students make the transition as they are ready, many in the early grades. Students may also be in mainstream classes for only part of the day—for example, several LEP students go to the all-English class to learn science. Students new to the mainstream receive academic support after school in a homework center staffed by Creole-speaking staff and English-speaking volunteers.

The grades 5-8 bilingual class is in one classroom with two teachers. Transition to English literacy occurs within the classroom; both English and Creole are used throughout the school day. The classroom is a unique bilingual environment where both languages are respected, enjoyed, and learned. Because there is wide variation in English fluency among the students, the teachers present important concepts in both languages. (One teacher is a native Creole speaker; he speaks only Creole in the class.) Students are allowed to choose English or Creole to ask or answer a question; however, their desire to speak English encourages them to use English as soon as they are able.

The Haitian people speak Creole, the "mother tongue" of Haiti. Although in history and tradition it has been as an oral language, in the 1970s an official spelling was endorsed by the Haitian government. Now all written Creole materials use the same spelling. A goal of the Graham and Parks bilingual program is that students learn to read and write Creole. Teachers report that developing biliteracy inspires self-esteem and a sense of empowerment and validates the students' home language and country.

In most bilingual programs, simultaneous translation presents some serious shortcomings, particularly the risk that students wait for the language they know best to understand what the teacher is saying, and effectively "tune out" half of the instruction. However, in the Graham and Parks grades 5 to 8 bilingual classroom, switching between Creole and English seems natural and does not appear to interfere with the students' learning core content or English.

With a small class size (23 students with two teachers) and students who spend two years in the same multi-grade class, the teachers know the bilingual program students well, which helps them to

hasten the students' transition to English. For example, in the science talk described in the opening section of this case study, a student expressed a thought in Creole and the native Creole-speaking bilingual teacher asked him to repeat the thought in English, because, as the teacher said, "I know he can do it."

Whole Language. Grades 5-8 teachers use whole language approaches. Oral reading, writing, creating books, and writing poetry are all part of the language arts program. To provide a context for learning, the students are taken on field trips around the Boston area. Language arts and social studies are taught thematically and woven together.

Building on student experiences. The inquiry method and encouragement of student participation stressed in the TERC science program are evident in the language arts program as well. Students are encouraged to produce oral and written language and to relate to the subject matter from their own experience. Mr. Hyppolite understands that students vary in previous schooling, primary language literacy and trauma level. Some come to Graham and Parks with no schooling. For this group he uses the Paulo Freire method of teaching literacy, drawing from their own experience to generate stories. He lets students make up stories and develop vocabulary lists: "You have to use what the students know about Haitian culture." He starts with common human themes of fear and happiness. He asks students, "What do you fear?" They fear death and Ton tons Macoutes. The students generate 16 words, draw pictures, use them for literacy. They create oral folk tales written in Creole.

Ms. Berkley tries to create an atmosphere of acceptance and respect in class. She feels the teacher should model respectful behavior. She uses field trips whenever possible to show the students places of historical interest in the Boston area and to help them learn American history and vocabulary. She weaves field trips together with books and their own experiences in language arts.

Teaching Strategies for Transition to English

The Creole bilingual teacher (Mr. Hyppolite) and the English-as-a-second-language teacher (Ms. Berkley) for grades 5 through 8 function as a team, one serving as the Creole-speaking role model and the other as the English-language role model. Each brings a unique set of strengths to the class. Mr. Hyppolite has a deep understanding of the students' culture, history, and educational experiences in Haiti; their high level of trust in him enables him to push and challenge them to learn more and try harder. The US-born teacher also speaks Creole, but not at the fluency level of the

Figure 6-3

School Structure and District Support, Graham and Parks

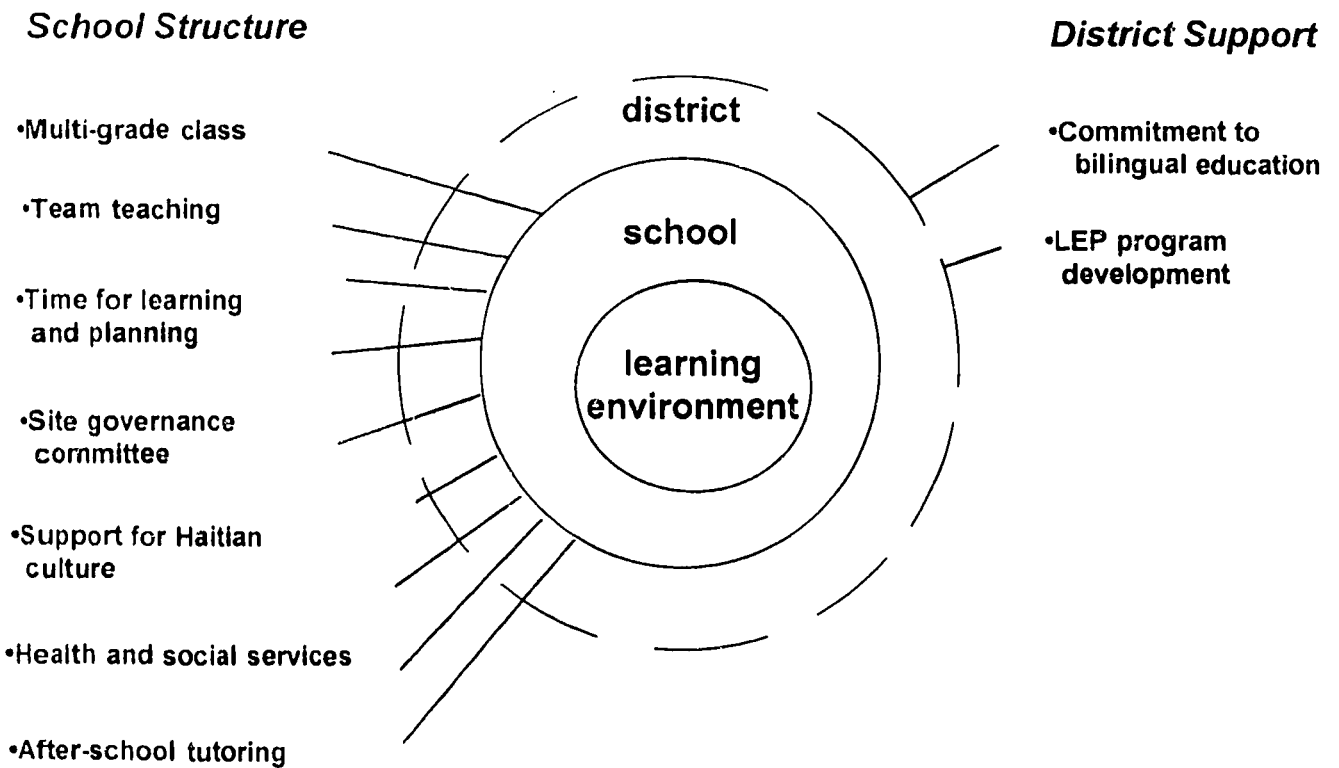

native speaker. She is concerned about the whole experience of her students, at home, in the community and at school. She helps students resolve health and social difficulties outside of school. She will take students to the doctor, or drive a family to an appointment with a social worker. She is sensitive to the developmental needs of the young adolescent students in her class.

Mr. Hyppolite believes there is a close tie between learning science and English-language development: "Thinking comes first, then writing, then reading." Students learn scientific vocabulary and how to express themselves in both Creole and English. Because of the informal nature of the science class, students share their observations and questions in either language; students also write in their journals daily in whichever language they feel most comfortable. Students are, however, continually exposed to English in the class. The teachers notice that over time, students are more likely to use English in the science class; in turn, the science class offers an opportunity for English-language development that helps prepare students for the transition to all-English classes.

Haitian Creole LEP students who are about to move to all-English instruction identified the following strategies that helped them to learn English:

- trying to read the hardest book they can, underlining parts they don't understand and asking the teacher;
- watching American situation comedies on television;
- listening to the radio;
- staying after school to get help with homework; and
- getting help from friends and older siblings.

Some of the students were taking both TERC science in their bilingual classroom and mainstream science in the monolingual English 8th grade class. They were struggling in the monolingual class, but proud of their good grades and of being in the mainstream class. They relied heavily on tutorial support after school from Creole-speaking tutors and their English teacher to help them master the all-English class. Their love of science from the TERC approach carried over into the monolingual class, which relies more heavily on writing and reading than the bilingual science class.

E. SCHOOL STRUCTURE

Graham and Parks' unique curriculum and instructional program and the design of the program for LEP students are supported by a series of school organizational and support features. The left column of Figure 6-3 illustrates key elements of the school structure at Graham and Parks; they are described below.

All schools in Cambridge are in an open enrollment system in which parents indicate their top three choices and selections are made to balance each school racially. Graham and Parks is regarded

as a very desirable choice for Cambridge families. Originally, it was a magnet school, designed after the British infant school model. Among monolingual English families, there are three to four applicants for every space at the school, which struggles to stay small.

Multi-grade classes. The school is organized into self-contained classes, each covering two grades. Because of the small number of LEP students in the upper grades, the 5-6 and 7-8 grade classes are combined in the Haitian Creole bilingual program. Teachers stay with the students for two years. School staff have learned that in the second year of the two-year period, there is increased academic growth. This arrangement allows closer relationships among teachers, students, and parents. It also enhances the sense of community among students in the class.

Time for learning and planning. For grades 7 and 8, a department structure with block scheduling allows for sustained learning activities. Language arts, social studies, and mathematics and science are taught in two-hour blocks. Teachers in grades 7 and 8 meet three times a week for common planning. All teachers meet a half day a month; teams meet every week.

Site governance committee. Graham and Parks has had considerable site autonomy since 1974. A steering committee for school decision making, composed of school counselors, staff, parents, community representatives, and the principal, meets monthly and makes decisions on the design of programs and how to structure team teaching. Staff selection is done by faculty and parents, and the principal is supportive of recruiting Creole teachers. The teachers plan the school's curriculum. By law, all schools have a school improvement plan; if there is a bilingual program it must be included in the plan. Graham and Parks is a very well-funded school. Relative to other districts in Massachusetts, Cambridge has a high per-pupil expenditure. In addition to district funds, the school receives Chapter I, school lunch, desegregation support, technology grants, and other support. There is considerable internal training for faculty on educational concepts.

Support for Haitian culture. Haitian teachers and counseling staff provide support for Haitian culture, and are available to speak to parents in Creole. Morning announcements are given in both English and Creole. Ample displays throughout the school feature Haitian geography, history, language and current events. Student writing is published in Creole and English both schoolwide and by classes. A Haitian family day was sponsored by the school and the district bilingual department.

Health and social services. Graham and Parks maintains a Student Support Team made up of the principal, parent liaison, assistant principal, nurse, school psychologist, teachers, and interns. Grants allow the school to hire external staff and provide services, including a bilingual parent coordinator. The district funds a Haitian resource room teacher and a Haitian mediation specialist. They meet each Monday and take a case study approach with students referred by teachers, providing individual and group counseling. The mediation specialist is also counseling a caseload of students and consulting

with teachers. He offers short-term direct services to students, and connects them with other agencies if needed. Social workers report that physical abuse is a serious problem; they inform Haitian immigrant families about U.S. child abuse laws. The school has some, but not many, resources to deal with the mental health issues presented by the recent Haitian arrivals. A Haitian social worker on the staff who works with families. Counseling is available at Cambridge Hospital, which is the Harvard Psychiatric program's teaching hospital, and there is a community counseling program for Haitians in Cambridge. All these resources, however, are strained to the limit by the needs of new arrivals.

F. DISTRICT SUPPORT

The district's desegregation policy, described below, has influenced the design of Graham and Parks' instructional program in two very important ways: desegregation policies and LEP program oversight.

Desegregation

Under desegregation mandates, Cambridge engages in a systematic program of open enrollment and parental choice in which parents choose the school to which they wish to send their children. Schools are magnets, developing their own curriculum approaches in order to attract students. Parents choose three schools in order of preference, and racial balance is taken into account in the final placement decision. The programs for LEP students have been developed in this framework. Various bilingual, transitional, and immersion programs are located at different schools.

Thus, the Haitian Creole bilingual program came to be housed at magnet school Graham and Parks, and the students in the non-LEP portion of the population are there by parental choice. Haitian Creole parents of LEP students in Cambridge have the choice of bilingual, ESL or no program. For Creole speakers, the only bilingual option is Graham and Parks.

Program for LEP Students

The district plays a strong role in assessment and reclassification and in LEP program development. The district assesses all incoming LEP students and counsels parents about their school and program choices. Annual tests of oral fluency, reading, and writing are done with district-adopted instruments. Each year a representative of the district helps site-based committees review each LEP student's progress towards reclassification and mainstreaming. During the annual January placement meeting, the ESL teacher, the primary-language teacher, the bilingual education department representative from the district, and the principal review LEP students' progress through both developmental and chronological age assessments. The bilingual department assists schools with

strategies for moving students into the mainstream and with academic support for LEP students entering English classrooms.

Each year, the district must submit an end-of-year report to the state Department of Education. After three years they must give a reason for continuing a LEP student in a LEP program. It is therefore unusual for a student to spend more than three years in the program. The common reason is slow progress in learning academic subjects.

Program development is done with the leadership of the district bilingual office. That office helps school sites develop programs for LEP students, recruits bilingual teachers and aides, and provides training opportunities for LEP program staff. Cambridge's bilingual office has had a series of Title VII grants and is regarded as innovative in the statewide bilingual education community. Spanish bilingual programs include a two-way program (Amigos), created and evaluated with the help of Wallace Lambert of McGill University in Canada. The district also has a variety of programs available for speakers of other languages in the district.

G. SUMMARY

Graham and Parks is a special place which has developed superb programs for teaching science to students learning English. The school's success is grounded in three elements: the language development program, the partnership with TERC, and the district and community context.

Language Development Program

The Haitian Creole program at Graham and Parks offers transitional bilingual education to immigrant Haitian students who enter the school with wide variations in previous schooling, exposure to literacy, and level of trauma. The Graham and Parks programs for this varied group of children are flexible and provide ample opportunity for sustained contact between teachers and students. The school offers classes that are team-taught by native Creole-speaking teachers and native English-speaking teachers. In grades pre-K to 4, Haitian children are grouped with monolingual English speaking children for part of the school day. For most students, transition to English is accomplished over a four-to-six year period. Transition is assisted by after-school tutorials for students new to the mainstream, who get help from Creole-speaking teachers.

The school has programs designed to address the myriad health, mental health, and social issues confronting the Haitian immigrant population. Support staff, including mediation specialists and counselors, are bilingual in Creole and able to work with parents, children, siblings and family members. School staff, including bilingual teachers, advocate on behalf of Haitian families with public and private agencies.

Partnership with TERC

The science program for the grades 5-8 bilingual class was developed and implemented in partnership with TERC. Funded by NSF and the U.S. Department of Education, OERI, TERC and Graham and Parks staff are developing and studying a sense-making approach to science, using the school as a "living laboratory." Graham and Parks teachers receive special summer training and regular opportunities to discuss science learning with other teachers in the metropolitan area who are implementing TERC science in their classrooms.

TERC staff and teachers construct their own understanding about science and learning at seminars in which they reflect on classroom practice, conduct investigations and explore scientific understanding; they receive a stipend for participating. TERC offers teachers a window to the academic community of those working to improve science education in the schools. Working with TERC helps Graham and Parks teachers feel connected to a much broader endeavor of introducing young people to scientific learning.

District and Community Support

Cambridge is a community steeped in science; local universities like Harvard and MIT are home to world-class scientists. Partnership opportunities are rich for both the district and the school, both with universities and with scientific corporations in the area. Multiple organizations are working on ways to improve science education for children in public schools. This combination of resources creates a very supportive backdrop for the efforts of TERC and Graham and Parks.

The Cambridge district is supportive of bilingual programs, providing a wide array of choices in LEP programs within a context of a desegregated system of magnet schools. The district helps recruit and train bilingual teachers, offers staff development opportunities, assists with assessment efforts for LEP students, and helps schools with program development. Schools feel supported by the district in their efforts to educate LEP students.

CHAPTER 7

HANSHAW MIDDLE SCHOOL MODESTO CITY SCHOOLS CALIFORNIA (7-8)

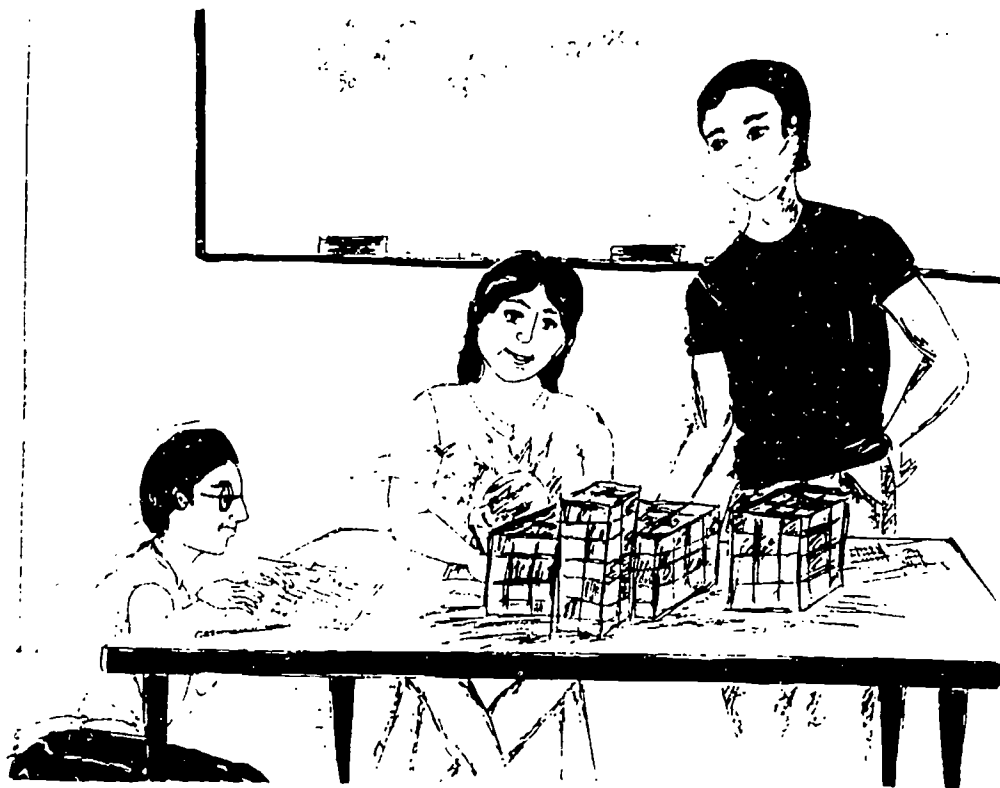

A. SCHOOL AND COMMUNITY CONTEXT

Hanshaw Middle School is a 7th and 8th grade middle school enrolling 850 students. The new school, opened in 1991, receives students from five feeder elementary schools in low income neighborhoods in Modesto, a small city in California's Central Valley. Most students are poor; very few are middle income: 23 percent of Hanshaw's students are on AFDC and 94 percent qualify for free or reduced-fee lunch.

The school is 76 percent Hispanic and 29 percent LEP. The LEP population is 79 percent Spanish speaking; most are from Mexico. The school's Southeast Asian students speak a variety of languages, including Cambodian (10%), Lao (5%), and Hmong (3%). Many LEP students are continuing—they entered in elementary school and continued as LEP students in middle school. These students tend to be orally fluent in English, but have limited English reading comprehension and writing skills. LEP students' literacy in their home language is often irregular as well. While elementary bilingual programs in Modesto for Spanish speakers are designed to develop Spanish literacy to some extent, the elementary school programs for speakers of Southeast Asian languages are not designed to promote literacy in the students' primary languages.

Some LEP students are new immigrants. Of the recent arrivals, some enter with excellent previous schooling. Others were migrants or traveled back and forth to Mexico throughout their school careers, and have gaps in schooling. Since the school opened, the number and percentage of LEP students have remained constant.

The neighborhoods around Hanshaw contain modest single family homes, with bars on the windows and fences around the yards. There are no sidewalks; some of the streets look like village paths rather than suburban streets. The economy is agricultural and service-oriented. Unemployment in January of 1994 was about 19 percent. Some multi-generational families are on welfare; seasonal employment picking crops is the only employment available to many. Twenty-nine gangs are active in the school's attendance area; gang graffiti mark every signpost, fence, bench, and store. In contrast, the state-of-the-art new school is immaculate and beautifully landscaped. School failure and school dropouts are endemic problems in the neighborhoods surrounding Hanshaw. One third of Hanshaw parents only have an 8th grade education level.

The classrooms at Hanshaw are filled with students eager to learn. The following descriptions provide a glimpse of the exciting learning environments that have been carefully created at the school.

Figure 7-1
The Classroom Layout, Hanshaw
Ms Roth's Spanish Language Science and Math Class

The classroom is uncluttered and well-lit with natural light. The furniture is arranged so that the students can easily see the teacher and one another in class discussions. Students are grouped by the teacher. The teacher stands at her workstation when leading class discussions. She walks from table to table during group work.

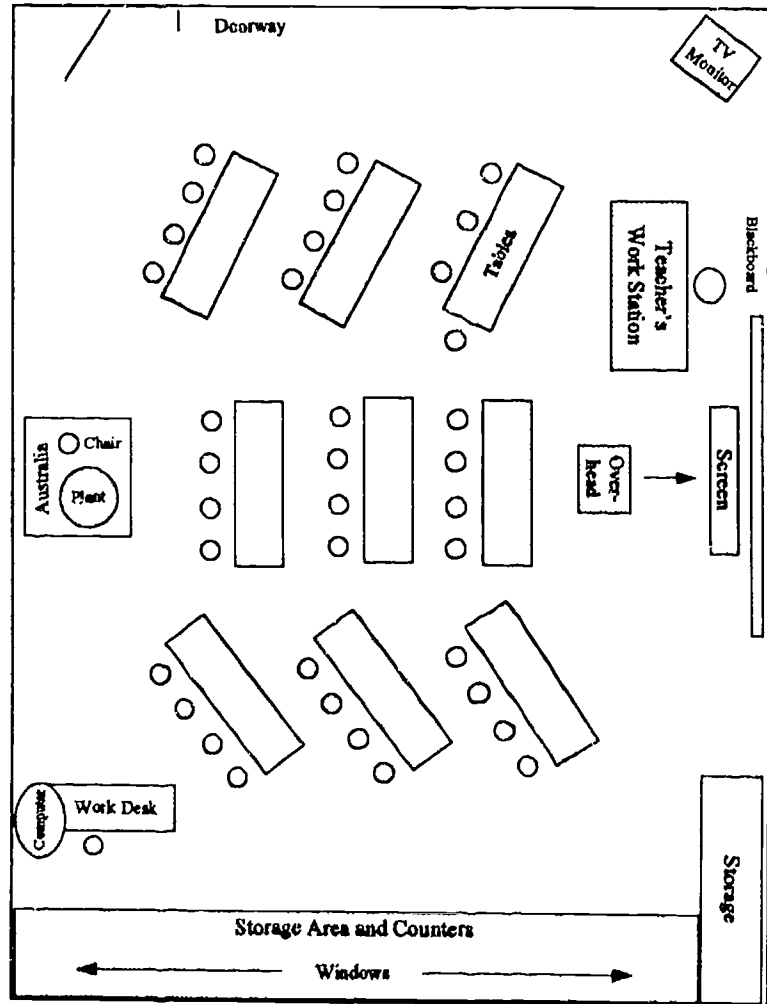

B. AN EXEMPLARY LEARNING ENVIRONMENT

Ms. Roth's Spanish Language Science and Math Class

The sun streaming into the classroom glints on the TV monitor in the corner and illuminates walls covered with student work in English and Spanish. For a moment, the room is quiet as Ms. Roth prepares to greet her Spanish-language science and math class. She moves from her streamlined work station at the front of the room to a computer in the back corner, checking to ensure that everything is in order. The silence does not last long. Two dozen students soon begin to file into class and their voices fill the room, the sound partially muted by wall-to-wall carpeting. They sit at modern tables for four, arranged in a semicircle facing the teacher. One retreats to an area in the back called "Australia" that has been set aside for students who need some time out and aren't ready to participate. He is soon ensconced in a big chair with a comforter.

The science lesson is devoted to levers. Ms. Roth leads a discussion in Spanish about how simple machines work, explaining force, fulcrums, and levers. Using a wood pole, she shows how pushing on one end allows her to raise the other, and engages the class in a discussion of the principle she has illustrated. When the discussion shows signs of lagging, she quickly goes on to demonstrate other types of levers by moving a table with the wooden pole and sweeping a broom across the floor. All the items she uses to demonstrate the lesson are large and easily visible from any point in the room.

Ms. Roth makes a quick transition to the next lesson, which deals with the connection between simple machines and the body. She encourages students to talk about the jaw and to compare chewing to a nutcracker and to arms and lifting. She asks open-ended questions and students do most of the talking. Students quickly get the point and eagerly introduce new ideas about the relationship of body motions to the principles of levers. The

Furniture can be positioned to facilitate different grouping strategies. Technology is available to support learning. Student work and the Spanish language are prominently displayed on the walls.

Ms. Roth teaches the class in Spanish, using appropriate scientific terms in Spanish. Use of the primary language for instruction enables LEP students full access to science concepts and terms.

The teacher uses demonstrations to stimulate student discussion of scientific concepts.

Ms. Roth prompts student talk and lets students introduce new topics related to the lesson. Students reveal skill while engaging in group discussion about science topics.

Figure 7-2
The Classroom Layout, Hanshaw
Ms. Hickman's English Mainstream Science Class

The science laboratory and tables are arranged so students can perform experiments in cooperative groups of five or six. Their tables are in close proximity to additional work space. The teacher walks between tables and lab counters, answering questions and monitoring group progress.

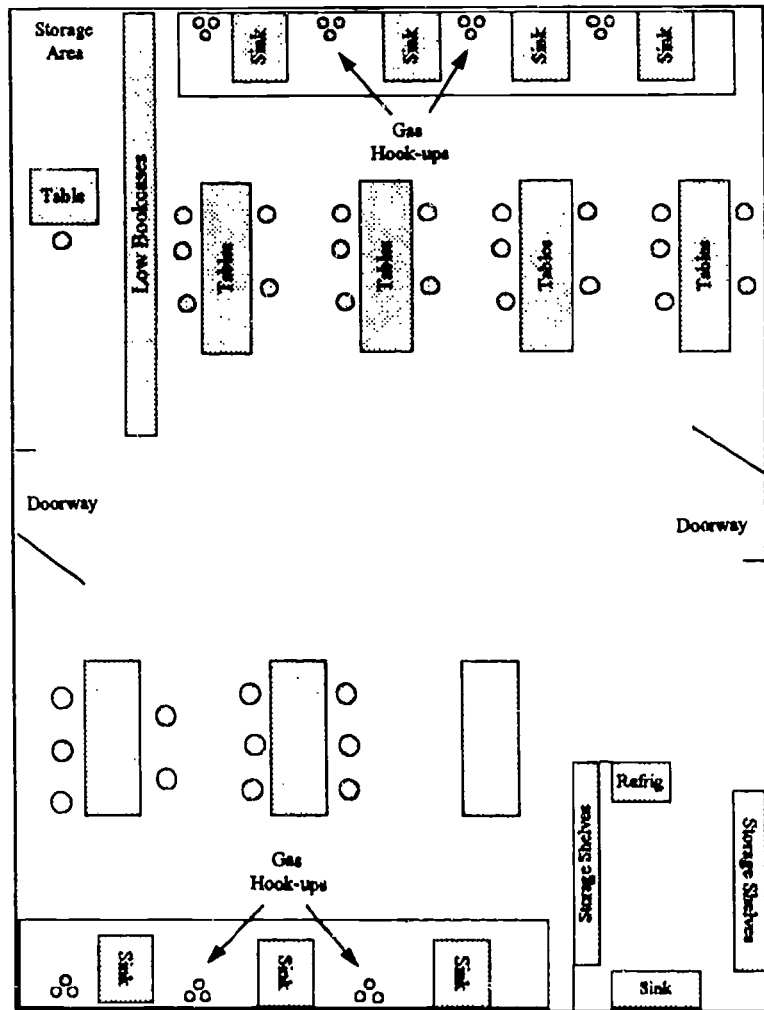

students who speak support their ideas and respond respectfully to the views of others. All discussion is in Spanish.

Ms. Roth asks the students to get out a piece of paper, select one of three body parts (jaw, wrist, arm), draw the part they select, and describe how it works, how it serves us in life, and what life would be like without it. She instructs the students to use all of the Spanish scientific terms they have learned, such as force, fulcrum, and resistance. The class needs little prompting; the students quickly fall silent as they focus on their written work. Most students write in Spanish; some in English. The teacher focuses on the substance of their writing, not the language used.

Ms. Roth's Sheltered English Science/Math Class

Twenty-four students enter the room, speaking in low tones. They take their seats and turn their attention to the teacher. Seven languages other than English are spoken by students in this class.

The lesson turns to science. To illustrate the concept of classification, Ms. Roth asks all the boys to come up to the front of the room, and sorts them according to a criterion she does not reveal to the class. She asks the students to guess the criterion—wearing sneakers, wearing plaid shirts, etc. She repeats this exercise several times, asking student volunteers to re-group the boys at the front of the class and call on their classmates to determine the basis of their re-grouping. She asks the girls to do the same thing. The discussion is animated, the students excited; at the end, they reveal a clear understanding of classification on the basis of criteria.

Ms. Hickman's English Mainstream Science Class

The science laboratory on the first floor is new and brightly lit. Wet sinks, heating apparatus, gas hookups, lab tables crammed with beakers, tubes, pipettes, thermometers and other gear, a refrigerator, and other equipment pack the room. Lab tables along each wall each seat four to five students. Ms. Hickman's eighth grade science class is studying salinity and

Ms. Roth fosters language development by incorporating writing into the science lesson, allowing students to choose a part of the body to describe as a lever. Students are free to write in Spanish or English.

The teacher employs a Sheltered instructional strategy—using students' bodies, clothing and hairstyles to teach the principle of classification to a group of LEP students speaking a variety of primary languages.

Advanced LEP students are clustered together in a mainstream English science class. The laboratory is fully equipped for science instruction.

temperature in currents. The 31 students arrange themselves in six self-selected cooperative groups of four to five students each and turn their attention to the teacher.

In English, Ms. Hickman gives a brief overview of an experiment she wants the students to perform; the class has been discussing air and water currents and this experiment will build on their previous work. Students fill two bottles with water. In one bottle, they dissolve one half teaspoon of salt and add a drop of food coloring. They place a 3 X 5 card on top of the salt water bottle and carefully invert it; the upward pressure of the air holds the card in place. Then they place the salt water bottle on top of the fresh water bottle, have someone remove the card, and observe the results. Ms. Hickman asks them to repeat the process twice with minor variations. She asks each student group to select one person to gather equipment, and directs everyone to take notes on the results so that they will be able to answer questions. The students move quickly to their work.

Students perform hands-on experiments in cooperative groups; one student gathers equipment.

Some student groups ask Ms. Hickman questions as they begin the experiment. She reminds them that they have resources other than the teacher—the lab sheet and others in their group. If questions remain after those sources have been consulted, she says, she will be glad to help.

When students ask questions, Ms. Hickman encourages them to use other students as learning resources.

The students seem accustomed to working in groups and comfortable dividing up tasks. Ms. Hickman moves from group to group, lending advice. To one group, she says, "I think you should add more water to your bottle." She asks another group that is moving more quickly to predict what will happen in the experiment. With a third group, she points out, "You should read the whole experiment. When you have read it, you might want to choose a color of food coloring other than yellow—Karen, can you tell me why?" After Karen answers, Ms. Hickman gives the same advice to the whole class, again asking a student to describe why yellow might not be a good color (it will be difficult to see when the salt water and plain water mix). She encourages class

Ms. Hickman circulates among groups of students performing the experiment. The teacher acts as a facilitator of learning for students, she does not dominate group discussion or unduly direct their learning.

discussion and asks frequent questions, supporting students who want time to figure out their answers.

The lab is buzzing with activity and lively discussion. Students coordinate their efforts to stack the two bottles and pull out the card. One group of students has a particularly startling result—the water forms very distinct layers in the space created by the necks of the two bottles. The group calls over Ms. Hickman, who is surprised and pleased at this unusual outcome and points out their result to nearby groups.

Ms. Hickman moves from group to group asking students to consider their results from various perspectives. "What do you think will happen?" "Why do you think they are not mixing?" "How is this experiment like the salinity one?" "What do the two experiments together tell us about the ocean?" To a group of students who have finished their work, the teacher asks "What would happen if we used sugar instead of salt?" The group then guesses what would happen with sugar water. Two students in the group disagree and Ms. Hickman suggests that they try the experiment again with sugar rather than salt and report on their findings. The students go off to try it, with group members taking sides.

LEP students in the class are concentrated in two of the groups. At least one student needs help in Spanish; another student in the group translates the directions or answers questions in Spanish. The groups with LEP students perform the experiments as proficiently as the non-LEP groups, but they need more time to answer the questions and they consult more with their peers than do the native English-speakers. They spend some time in a prolonged discussion (in English and Spanish) about the thought questions from the lab sheet. Though Ms. Hickman spends time with each of the groups, she takes a little more time with those that include LEP students.

The teacher asks open-ended questions to stimulate student thinking and expression.

The teacher is ready with a new challenge for students who finish their experiment ahead of the class.

The class is modified for LEP students by clustering them together in cooperative groups, allowing them to speak Spanish, and allowing them more time for their experiment.

Figure 7-3
The Classroom Layout, Hanshaw
Ms. Simis' English-mainstream Math Class

The furniture can be arranged according to learning task. Cooperative groups of students are formed by the teacher; LEP students speaking the same primary language are grouped together.

The teacher uses the overhead to project problems and help work solutions.

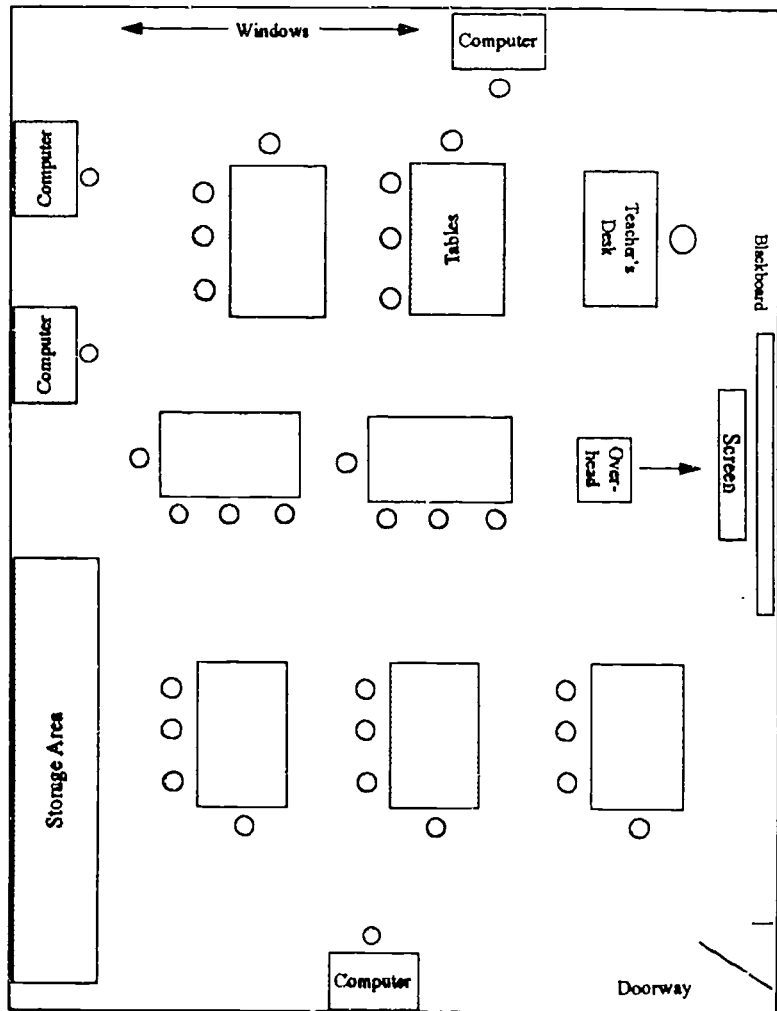

Students work in groups of two or three on a spatial math problem using Legos and graph paper. LEP students speak to one another in their primary language and in English as they work on the problem.

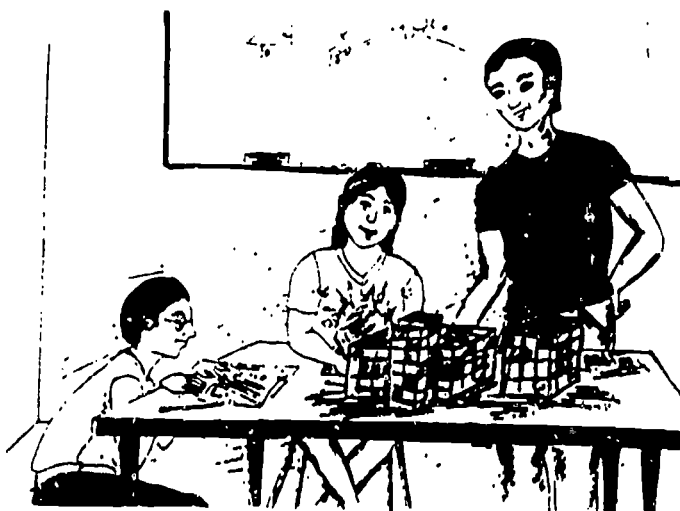

Ms. Simis' English-mainstream Math Class

Twenty-eight students sit in groups of four at tables scattered throughout the bright and spacious classroom. Several computers sit at small workstations along walls covered with bulletin boards that are crowded with student work and other displays, all in English. An overhead projector points at a screen in front of the room, ready for use.

Ms. Simis' eighth grade advanced math class includes 15 LEP students. They speak a number of primary languages and have varying degrees of oral English fluency, but have sufficient English reading and writing skills to participate in an all-English environment. Ms. Simis conducts the class in English.

Ms. Simis asks the class to correct their algebra homework together and solve a problem she projects on the screen. She involves the students in her plan for pacing and organizing instruction: "I'm going to do ten minutes of direct instruction and then you are going to work in groups." When group work begins, the LEP students participate fully in the lesson, talking with their partners about how to solve the problem. Some students speak in their primary language, some in English.

After the students have worked for a few minutes, Ms. Simis asks "Who hasn't completed the problem? How many know the answer? Raise your hand but don't say the answer out loud." She goes directly to students who don't have their hands raised, looks at their work, offers suggestions.

Too many students have not finished; Ms. Simis asks the class to stop work. "I see some of you are getting stuck on one aspect of the problem. Look up here and let me work it through with you." She moves through the exercise, focusing on the technique for solving the problem, emphasizing that knowing how to solve problems is even more important than getting correct answers. She encourages students to suggest different problem-solving techniques and praises a student who solves the problem using an alternate approach. The class is highly animated; everyone wants

Intermediate and advanced LEP students speaking a variety of languages other than English are clustered together into a mainstream math class.

LEP students speaking the same primary language sit together. The teacher allows them to talk with one another in the primary language as they work on the math lesson. Students are allowed to choose which language they will use in discussions with their peers.

The teacher acts as facilitator for learning. She brings out high levels of participation by girls and LEP students.

The teacher notes problems being experienced by several students and stops the class to provide clarification.

The teacher promotes problem-solving rather than arriving at a single correct answer.

to participate in the discussion. LEP students and girls do not hang back, but participate fully.

By sharing her own difficulty mastering spatial math, the teacher makes herself an example as a learner.

The next lesson is about spatial math. At the start of the lesson, the teacher tells the students that she once found this aspect of mathematics to be difficult. With patience and persistence, she says, the students will understand it just as she did. Ms. Simis asks students to design three-dimensional buildings using Legos, following a number of specific constraints: "Preserve the right and front view but extend the building." As she introduces the lesson, she asks a student to restate her constraints and instructions; after the second attempt he does so. She then suggests that student "experts" in each group assist other students. The "experts" are not necessarily the most accomplished; Ms. Simis selects students who have struggled to learn something, so they can help others who are struggling.

The teacher finds multiple ways to draw on students as learning resources for other students.

The students use Lego blocks to model the building, and then draw the structure from all angles on special paper. As they extend the buildings in new ways, Ms. Simis calls these innovations to the attention of the class. When one group says "We're finished," she challenges, "Now solve it another way."

C. SCHOOL STRUCTURE

While instructional approaches and the language of instruction differed among the four classes described above, they shared some common features. First, there was a palpable sense of students striving to learn. Their motivation was not to please the teacher so much as it was to learn how to solve a problem, or learn a scientific principle or new mathematics skill. Second, the classes were challenging, but utilized instructional strategies modified to enable LEP students to have access to core mathematics and science content. Third, the instruction was well planned and well paced, and each student understood her or his role. Students had become experienced cooperative learners; there was no time lost to disruptions or discipline problems.

How did Hanshaw achieve these learning environments? The answer is the unusual way in which the school re-invented itself, beginning with a unique structure. Building upon the structural features described below, the school community - with assistance and inspiration from an external partner - translated its culture of learning and shared values into curriculum and instructional features which will be discussed in later sections of this chapter.

History of Hanshaw: Confronting Alienation between Schools and the Community

Modesto City Schools decided to establish a beautiful new middle school in a poor part of town. The district superintendent selected an unusual principal for this new school, a man whose professional career spanned a number of alternative programs for troubled, pregnant, or delinquent students. He was given a year to plan the school program and recruit a faculty.

The principal started planning the school program by conducting an intensive dialogue with the community. He personally visited 500 homes, talking to parents about their perceptions of school. During those home visits, he found there was much about standard schools that was not responsive to the values of the families he met—or sensitive to the pressures in their lives. The parents had not had good experiences with schools when they were young, and many of the neighborhood teenagers themselves had dropped out of school. The family interviews revealed alienation between the existing K-12 schools and the community that would be served by Hanshaw.

The principal concluded from his conversations with community families that the new school should not follow the traditional pattern where schooling is unrelated to the experiences of the students and does not lead to clear benefits for them. Instead, he felt the new middle school would have to engage the students in relevant ways if they were to succeed and eventually graduate from high school. Shortly before the school opened, the principal took teachers on a bus tour of the neighborhoods their school would serve in order to help them gain perspective on the lives of their students. They were stunned at the poverty. Together, principal and faculty decided on a simple but

Figure 7-4
School Structure and District Support, Hanshaw

School Structure

District Support

- Reduced alienation
- House organization with block scheduling
- Linkage to state university system
- Professionals as teachers
- Cultural and individual validation
- Integrated health and counseling center

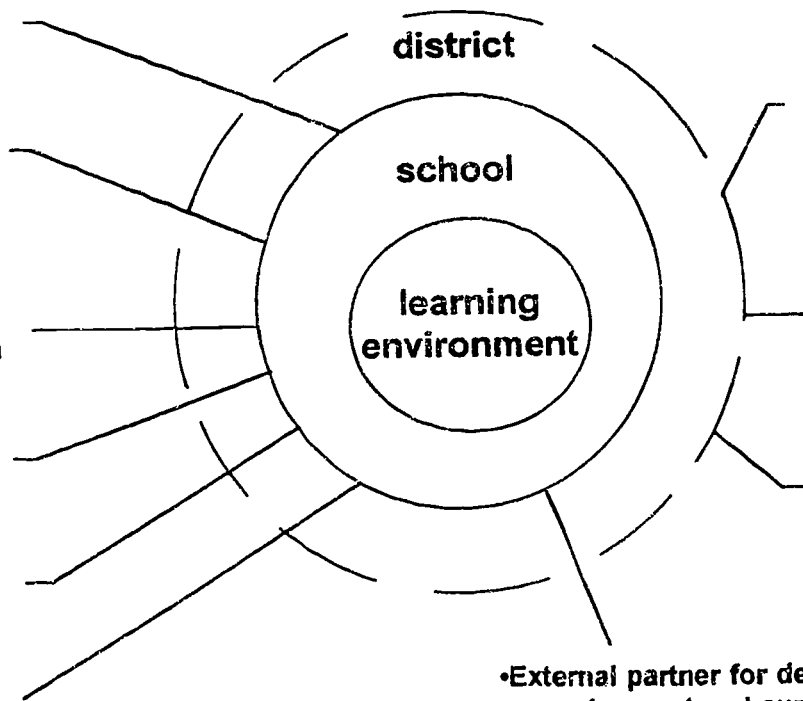

- Support for program for LEP students
- Promotion of middle school model
- Staff development
- External partner for developing meaning centered curriculum and teaching skills

profound goal: Hanshaw School should become a beautiful place, an oasis from the often harsh life in the community. The principal summarizes the cornerstone of the Hanshaw philosophy as, "Children are valuable and their value doesn't have to be earned."

Using information gleaned from the family interviews, the principal and faculty agreed on four principles to develop the school's program, namely:

- High expectations for all students (including Latino students, who are the predominant group at the school)
- Support for the Latino and Chicano experience
- A meaning-centered curriculum
- A conscious effort to impart life skills as part of the curriculum.

These principles guided the school's development and its approach to curriculum and instruction. They were revealed in the above narrative description of learning environments at Hanshaw, and we will show how these principles were implemented in all aspects of the school's organization and curriculum. Figure 7-4 illustrates key characteristics of the school structure and organization that Hanshaw evolved. Those features are described in greater depth in the following section.

House Organization with Block Scheduling

Hanshaw Middle School is organized into five houses, each named for a campus of the California State University system. The houses are organized by grade level; each contains six to nine teachers, including one teacher who acts as team leader. One or two core teams of two teachers each (one for math/science and one for language arts/social studies) are assigned to each house, along with physical education teachers, teachers of electives, and clerical staff. Students take their core classes and some of their electives in their own house and some electives in other houses. From the teachers' point of view, the intimate and clear organization of the school into houses is more efficient and, most importantly, is a key to the school's ability to realize its guiding principles.

Because the Hanshaw staff decided that high expectations for their students had to be conveyed in ways that were both symbolic and concrete, a crucial symbolic decision was made to name the houses for CSU campuses and forge a partnership with each house's namesake university. Each year, all students in a house visit their namesake CSU campus for a day, meet college students from minority groups, go to classes, and spend about 20 minutes each with a professor. At the end of the day they receive a T-shirt and a diploma recognizing their participation. This step was designed to accomplish three goals: (1) It would direct the students towards a future that could include higher education, conveying faith that it was possible for them to go to college. (2) It would provide an alternative identification to the gang affiliations prevalent in the neighborhood. (3) Through annual

visits to their namesake CSU campuses, new vistas would open up to students who might never have seen a college or came from families where no one had attended college.

Within a house, students have two core classes lasting 90 minutes each. One core is for language arts and social studies; the second is for mathematics and science. In addition, students take electives and exploratory courses. LEP students take a daily period of ESL in lieu of an elective.

Ninety-minute blocks of time for core classes allow teachers to teach without interruption, facilitates thematic instruction, and enables teachers to know their students better via extended contact. The classrooms of each pair of core teachers are adjoining, which enables them to cooperate closely in providing thematic learning activities.

Culture and Individual Validation

The house structure is an aspect of the more general efforts of Hanshaw faculty and administrators to validate and support both the culture of the community they serve and each student as an individual. They honor the Spanish language by having Spanish-speaking classified staff in the front office and other offices that deal with parents and families; by organizing multicultural events like a "World Fair"; or by using bilingual Family Resource Center staff (see below) to provide health, dental and social services. Faculty convey respect for the primary language of students by teaching core content in Spanish to Spanish-speaking LEP students. The school is currently attempting to add language resources for students who speak Southeast Asian languages.

Hanshaw sees validation of each student as an individual to be equally important. In the view of the principal, "The students are starving for routine and character building. They need relief from the violence in the community." Hanshaw students are called "citizens" by the faculty and staff, a title intended to set a tone of dignity and respect.

Gang insignia and clothing are prohibited on the grounds of the school. The school staff stress that school is a safe, neutral place, free of gang identification and conflict. Students wear the T-shirts of the college affiliated with their house as symbolic identification with their house and school.

The school is new and modern in design. It is organized around a central courtyard, with classroom buildings, cafeteria, auditorium, and administration offices facing onto an open space planted with flowers and shrubs. It is the most beautiful building in the poor neighborhoods surrounding the school. Free of graffiti, it stands in stark contrast to the neighborhoods it serves. The new facility sends a message to the community and to each student: you are important and we care.

Professionals as Teachers

When the school opened in the fall of 1991, the principal recruited the staff from industry, from other schools in the district, and from schools of education. The resulting mix is diverse. Of the three teachers introduced in the narrative, the Spanish/Sheltered English teacher was recruited from a feeder elementary school. She is a credentialed bilingual teacher fluent in Spanish and English. The mathematics teacher and science teacher both came from private industry. The mathematics teacher had worked as a carpenter before earning her teaching credential at a local college. She also has a Language Development Specialist credential and expertise in second-language acquisition. The science teacher was certificated, but had not taught before because she disliked typical school organizations and working environments. At the time she was recruited to teach science at Hanshaw, she was running a children's museum in Modesto.

A high degree of collegiality among the faculty is reflected in collaborative planning and willingness to help one another. The science teachers, for example, meet informally every morning in the lab prep area to discuss lessons and share ideas. Faculty reported that the principal reinforces their professionalism in a number of ways, large and small. For example, teachers are spared lunch duty; cafeteria staff serve the teachers buffet style. The atmosphere in the teachers' eating lounge is friendly and comfortable.

Teachers, by consensus, adopt the discretionary budget for the school covering expenditures (including expenditures for administration) other than for teachers' and administrators' salaries. Team leaders of each house and department chairs (for math, science, language arts, social studies, etc.) make budget allocation decisions. Extensive staff development is purchased with categorical aid funds from federal Chapter I and state School Improvement funds. Common planning time for teachers within houses is 44 minutes per day. There are monthly team meetings for all the teachers in each house.

Integrated Health and Counseling Services

The school addresses the non-educational needs of families with a comprehensive Family Resource Center program called Healthy Start. Healthy Start is a state-sponsored initiative to bring health, social services and mental health services onto school campuses to serve the families of students attending the schools. Its purpose is to provide needed support in non-educational areas for children and families in the hope that it will improve educational outcomes for children. The Hanshaw Healthy Start program offers individual and group counseling, case management for families involved with more than one public agency, and referral to community agencies. Group counseling is provided by a mental health clinician. A probation officer is stationed at the school

Figure 7-5

Instruction, Curriculum, and Program Map, Hanshaw

Innovative Instruction-Curriculum Features

- Meaning-centered curriculum
 - Integrated core classes
 - High academic expectations
- Life skills curriculum
- Thematic instruction

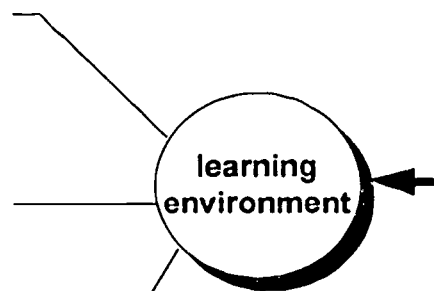

LEP Program Features

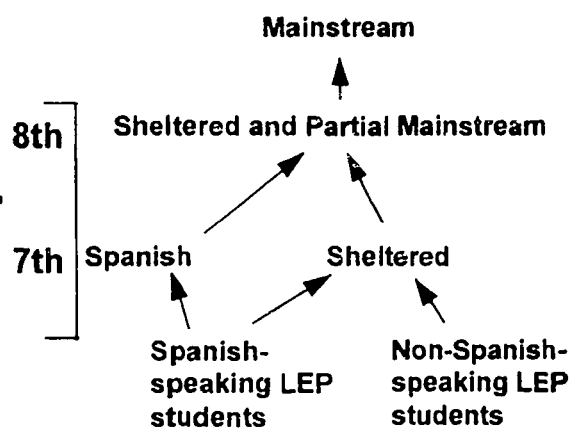

part-time to monitor probation wards on campus. A full service health and dental care program was to become operational in the summer of 1994. Almost all of the staff are bilingual in Spanish and English. A Laotian college student conducts in-home visits with Laotian families in their primary language to inform them about services available at the center and learn about their service needs

The Healthy Start project was spearheaded by district staff. In cooperation with Hanshaw staff, the district entered into cooperative agreements with county public service agencies and private medical providers to bring a wide range of health and social services onto the campus.

Healthy Start uses a holistic, family-centered approach in which an entire family may receive services, including siblings of Hanshaw students attending other schools. The Healthy Start program at Hanshaw reinforces the concept of school as resource for families and communities.

D. INNOVATIVE CURRICULUM AND INSTRUCTIONAL STRATEGIES

Hanshaw Middle School has developed a curriculum that is relevant to students and provides life skills they need. This approach to curriculum is so pervasive throughout the school that it constitutes an integral part of the school's structure.

Hanshaw's unique approach to curriculum and instruction arose out of a partnership with an external entity, Susan Kovalik & Associates of Washington State, a firm that assists schools, districts, and states in comprehensive school reform efforts. Figure 7-5 identifies a number of curriculum and instructional strategies that summarize the school's approach. The following description includes details on each strategy in the context of the whole program at Hanshaw. LEP program features will be explained in Section E.

Meaning-Centered Curriculum

One cardinal principle that guides Hanshaw teachers' curriculum design decisions is the requirement that the lesson or skill must be relevant to the students' lives. Any child can challenge any teacher to explain the relevance of what is taught. This rule is repeated frequently by faculty and reiterated to students. Teachers start from students' own experience and build on these experiences in thematic instruction.

The new principal of Hanshaw contacted Kovalik early in the development of the school's program, seeking assistance with training faculty and developing curriculum. Kovalik's "brain compatible learning" starts with a synthesis of brain research to draw conclusions about how children learn. Learning environments that are compatible with the way the brain works feature absence of threat, meaningful content, choices, adequate time, enriched environment, collaboration,

Kovalik Associates has helped the Hanshaw faculty integrate life skills and meaning-based curricula through intensive training during the summer and at weekend retreats in which all teachers participate. Initial summer workshops last twelve hours a day for five days. Three-day intensive institutes are held at the beginning of every school year, while one-day intensive institutes are held throughout the school year. Topics include creating a life skills curriculum, "brain compatible learning" and thematic instruction.

A coach from Kovalik Associates, Ann Ross, works with the school one day per month during the school year. She helps to design curriculum, coach individual teachers, model instruction, and identify problems and solutions with faculty. The coach helps the teachers to assess the absence of threat in the school and their classrooms on a monthly basis. Ms. Ross offers special expertise in educating multicultural student populations and in teaching science. Several Hanshaw teachers participate as summer trainers for Kovalik Associates and work with schools around the country.

The involvement of Kovalik Associates at Hanshaw has been extensive and continuous. Teachers meet off site with the external partner, and make plans for creating the meaning-centered curriculum and thematic learning. The early work focused on life skills and brain-compatible learning. This year and last, the Kovalik Associates emphasis with Hanshaw teachers has been on integrated curriculum and thematic instruction.

Life Skills Curriculum

Hanshaw explicitly teaches life skills (e.g., students taking responsibility for their own learning throughout the curriculum). A specific life skills curriculum is taught in the first month of school, when students are oriented to the culture of Hanshaw and expectations for their behavior. Life skills include:

- **Integrity:** To act according to what's right and wrong
- **Initiative:** To do something because it needs to be done
- **Flexibility:** To be able to alter plans when necessary
- **Perseverance:** To continue in spite of difficulties
- **Organization:** To plan, arrange, and implement in an orderly way
- **Sense of Humor:** To laugh and be playful without hurting others
- **Effort:** To do your best
- **Common Sense:** To think it through
- **Problem Solving:** To seek solutions in difficult situations
- **Responsibility:** To be accountable for your actions
- **Patience:** To wait calmly for someone or something
- **Friendship:** To make and keep a friend through mutual trust and caring

- **Curiosity:** To investigate and seek understanding
- **Cooperation:** To work together toward a common goal
- **Caring:** To feel and show concern

Hanshaw students are rewarded with "thunderbolts" for behavior which exemplifies these life skills, such as flexibility and responsibility. Specific rewards, such as T-shirts, banners, lunches with the principal, etc. are given to students who accumulate enough thunderbolts. Students are encouraged to offer a compliment when they observe a fellow student demonstrating a life skill, such as patience or friendship.

Thematic Instruction

Hanshaw teachers use curriculum themes to integrate instruction across the disciplines of science, math, language arts and social studies. Lessons are designed to help students make connections and achieve a deeper understanding of a concept by studying it from several disciplinary viewpoints.

Themes differ in their scope, the number of classes involved, and the length of time they are taught. Some themes are house-wide. In Sonoma House, for example, the house-wide theme for the 1993/94 school year was "I Have A Dream," from the Martin Luther King speech. The theme was built around the dreams held by many people and the ways they set about to accomplish them. In Sheltered core class for language arts and social studies, students interviewed an immigrant—their parents, a relative, neighbor or friend—using questions developed by the class. Students conducted the interviews, wrote essays about the immigrants' experience, and explored the immigrants' dreams for living in the United States.

Another house adopted the theme "Trekking Through Life Skills" in which activities centered on exploration of the Western United States in the late 1800s. Students read a book called *Bone People* about explorers in Montana excavating dinosaur bones and the conflicts and rivalries that ensued. Students then built a scale model of a large dinosaur, learning measurement through the exercise, and learned geology and paleontology as well.

Some themes are shorter in duration. For example, students studied weather for science and for math. Another theme was the Tuolumne River, which originates in the Sierra Nevada Mountains and flows through Modesto. Students studied the river in social studies, learning about how the California Indians used the river for food and travel. Students learned about natural resources, ecology, and the food web in the life of the river. They took a field trip into the Sierras to see the river closer to its source. One student created a large scale drawing of the river, from the headwaters to its termination feeding the California Aqueduct.

Themes evolve over the years—activities that work are extended and those that don't succeed are dropped. At the conclusion of a theme on weather, for example, the teachers examined the curriculum topics that were covered and those that were not covered adequately. Hanshaw teachers have found that science is easier than mathematics to incorporate into themes. The math/science core teacher felt that probability was not sufficiently covered, so she taught several lessons on that subject alone. Teachers cooperatively plan themes and review the success of the activities at the conclusion of the thematic projects. Development of themes requires intensive work initially, but themes can be used year after year, with the lessons learned in one year repeated and extended in subsequent years with new groups of students. Documentation of the successes and failures of the themes is very important to the continuous improvement of the curriculum.

One important example of thematic instruction is in science and math. The development of the curriculum in science and mathematics uses the California state frameworks for middle school science and mathematics as its starting point. In science, students in 7th grade are expected to learn:

Geology	rocks, minerals and soils
Meteorology	properties of air and water
Ecology	biomass, food web, biomes, natural resources
Human body systems	nutrition
Life processes	cells, five kingdoms, classification

For math, 7th graders are expected to learn circles, linear equations, numbers and operations, logic, plane geometry, inequalities, congruent triangles, probability/statistics, and polynomials.

Teachers work together to plan themes that will incorporate the framework topics. They lay out the topics that students are supposed to learn, then brainstorm on a theme that can incorporate required elements from the science, math, and social studies frameworks. They devise a theme and develop learning activities that will last a week, a month, or longer. After the theme is developed and implemented, the teachers review the extent to which the original framework topics were covered.

E. PROGRAM FOR LEP STUDENTS

The language development program at Hanshaw includes instruction in primary language in core subjects for Spanish-speaking LEP students; Sheltered classes for more advanced LEP students and for mixed languages; and transition strategies in the mainstream classes. The schematic on the right side of Figure 7-5 outlines the program for LEP students at Hanshaw.

LEP students whose comprehension of English is very limited and who speak Spanish are placed in Spanish core classes for math/science and language arts/social studies. They receive English instruction in their language arts/social studies core class and in the ESL class taken in lieu of an

elective. LEP students who are speakers of languages other than Spanish are enrolled in Sheltered core classes for math/science and language arts/social studies. Advanced Spanish speakers who have some oral English fluency but limited reading comprehension and writing are also placed in the Sheltered core classes. Students are reviewed annually with the help of district staff for their progress towards transition to English instruction. Once they are deemed ready, LEP students are clustered together in core math/science and language arts/social studies classes taught in English by teachers trained in second-language acquisition.

Many of Hanshaw's teachers have the Language Development Specialist credential (LDS), and expertise in second-language acquisition. These teachers prepare LEP students for transition into regular English classes, making necessary modifications to instruction. Keeping LEP students together in English classes and allowing them to converse when needed in their primary language also helps ready them for transition. School organization and teacher collegiality promote continuity among programs in subjects and in houses.

When students enter the school, they are assessed by district staff on the Language Assessment Scale (LAS) and the SOLOM for their English oral fluency, and on the California Test of Basic Skills for achievement in reading, mathematics and language. Students are placed initially in core math/science and language arts/social studies classes based on the results of this assessment.

Teaching Strategies

Transition to English literacy is advanced through the ESL classes, through core classes and in the curriculum. Strategies include cooperative learning, peer coaching, and after-school tutorials with community college students

One of the mainstream mathematics teachers explained her approach with LEP students. She does not believe in watering down language for LEP students; she uses "rich language" as well as pictures; she speaks slowly and repeats words. She provides clarification through the use of examples. She generally does not think that language causes communication barriers in her class; she believes that if students can't understand something they know that they can consult with peers. She thinks "it's real important for students to develop language around math."

This teacher also encourages LEP students to sit in on another class of hers to hear the same lesson again if they don't understand. She has them use partners. "Students must have respect for their own language," she says. "Teachers here go beyond the boundaries."

Another teacher shared her educational philosophy for helping LEP students achieve high learning goals. "We try to hit on all eight intelligences; for example, when presenting new materials, I

try to demonstrate while talking. We think about artistry when choosing colors. Typically, behavior problem students are spatial learners; we try to give them spatial learning opportunities."

Other teachers mentioned that they try to create a threat-free environment in order to reduce stress and anxiety. They honor the students' backgrounds so they feel valued, and respect the students' previous experience, particularly the migrant students who have seen and learned a lot in their travels.

LEP Students' Views of Transition To English

Transitioning students reported that Hanshaw teachers have helped them to learn English, particularly teachers who are patient and answer questions, bilingual teachers, and teachers with a sense of humor. Fellow students also helped them learn. Students favor:

- group discussions of what has been read
- practice in speaking English in front of the class
- friends who speak English
- learning new words by playing baseball or soccer

Other helpful strategies included reading a book in English at least 30 minutes every day, books with glossaries showing pronunciation, and after-school tutorials in elementary and middle school.

The statement of an eighth grade girl conveys the school's emphasis on teaching life skills and learning English. She said, "We are always taught to give our personal best, to keep trying. If you're struggling, teachers will help you get the steps to solving the problem. They don't just give you the answer. If you practice you will get better at it."

F. DISTRICT AND STATE SUPPORT

Hanshaw's unique learning environment is supported by the Modesto City School district and the California Department of Education. The school district supports primary language instruction at the middle school level, helps to recruit bilingual teachers, and assesses students at entry and periodically to measure their progress in learning English. Key elements of district support are shown in Figure 7-4.

Laws and Policies Relating to LEP Students

The district plays a role in overseeing the LEP program at Hanshaw Middle School. Assessment and reclassification are done by district assessment staff. The district initiated a systematic review of LEP children in the 1992-93 school year to determine whether some students could be reclassified Fluent English Proficient; over 500 FEP students were identified. The following year, the district

redesignated 200 or so students. In the first "sweep," Hanshaw had 43 students redesignated as fluent; in the second year 30 students were redesignated.

In order to be designated Fluent English Proficient, students must achieve specified levels on various assessment instruments. The reclassification criteria are set writing samples. The district assessment staff review CTBS scores to identify students potentially ready to be redesignated. A review of their SOLOM scores, grades and writing sample follows. The Assessment Center also uses the LAS.

The district supports primary-language instruction in core content classes for middle school LEP students, the hiring of bilingual teachers in middle school, and the utilization of primary-language textbooks. The district has extensive elementary bilingual programs for Spanish speakers and has placed an increasing emphasis on primary-language instruction for Spanish speakers in the middle schools. A new effort to expand services for Southeast Asian students is a district priority.

The district also supports an additional period of instruction for two middle schools (Hanshaw and another middle school) with large LEP populations, to accommodate the LEP students' need for more instructional time. This funding supports the cost of the ESL teacher for LEP students.

Promotion of Middle School Model

The state Department of Education in California supports movement toward the middle school model. In 1987 the state published *Caught in the Middle*, a primer on middle school education. The state set up and supported networks of middle schools so that schools could confer with one another on implementation issues. The ideas in the state report formed an underlying structure for Hanshaw, with many of the important state model design features incorporated into the Hanshaw structure. The state model supports schools within schools such as "houses" at Hanshaw; extended core periods so that students will have more sustained contact with a limited number of teachers; cooperative learning; and learning centered on the real-life issues students face outside of school; and attention to the development needs and predilections of the young adolescent.

Curriculum Frameworks

The state of California has developed curriculum frameworks in all the major subject areas—science, math, language arts and social studies. These frameworks are used to set specifications for textbook adoption (a state-level process). They set forth in general terms what should be taught to students at various grade levels, and suggest instructional approaches; the frameworks are also used as a basis for the state testing program. The state frameworks in science and mathematics are the underpinnings of Hanshaw's curriculum.

Staff Development

California has developed an extensive network of staff development entities organized around different principles. Many of the teaching strategies employed by Hanshaw teachers were learned in state-sponsored training projects. One group of training entities are organized by subject-matter, such as the Writing Project, The Mathematics Project, etc. The subject-matter projects provide continuous training opportunities for teachers and school staff on innovative approaches to instruction.

A second network of training organizations prepare bilingual teachers and Language Development Specialists. These Multi-functional Teacher Training Institutes or bilingual training programs are usually operated by county offices of education. Intensive teacher training is available on an ongoing basis.

G. SUMMARY

Hanshaw is a school with a unique flavor that is community-based and centered on core values.

Attention to Community Alienation and School Climate

The school staff recognizes the alienation felt by many in the community towards schools. Teachers and administrators understand that for most parents, school was a negative experience, and that many of Hanshaw students' older siblings have dropped out of school. Hanshaw's long term view of schooling as an avenue for success is conveyed by focusing each house on a CSU campus and challenging each class to make learning relevant to students' lives.

In a community torn by gang rivalries, the principal and the teachers have managed to make the school a safe neutral zone. They have done this by trying to eliminate gang clothing and graffiti and instituting a conflict management process run by students. In place of gang affiliations, the school encourages affiliation with the Hanshaw student body and with houses. The focus on Hanshaw "citizens," student recognition (thunderbolts), or school song might seem over-emphasized to adults but seem to appeal to adolescents who need to feel pride in themselves. Probably the most moving tribute to the success of the school is that it stands, beautiful and perfectly clean of graffiti, in a neighborhood in which every spare space is covered with gang insignia.

Attention to Language Development

Content area teachers across the spectrum talk knowledgeably about teaching LEP students at Hanshaw. LEP students are the mainstream in this school, and are not considered remedial or marginal. Teachers who have mainstreamed LEP students have a series of strategies to help them

learn mathematics and science. The LEP program offers primary language instruction, Sheltered instruction, and ESL classes.

Hanshaw as a Learning Community

Hanshaw teachers are open to new ideas and innovation. They participate in teachers' associations in mathematics and science. They enjoy the training provided by Kovalik Associates and incorporate ideas from a wide range of sources into their classrooms.

Learning is a process, not an end product at this school. Teachers strive to help students know the "why" of an answer, or multiple answers, or multiple ways of getting to an answer, rather than one single answer. There is an absence of pretense, pomposity, and social hierarchy among teachers and students. The learning environment at Hanshaw is consciously designed to enable all students, including those learning English as a Second Language, to reach their full potential.

CHAPTER 8

HORACE MANN ACADEMIC MIDDLE SCHOOL SAN FRANCISCO UNIFIED SCHOOL DISTRICT CALIFORNIA (6-8)



A. SCHOOL AND COMMUNITY CONTEXT

Horace Mann is located in San Francisco's Mission District, a vibrant, predominately Latino immigrant neighborhood. Murals by Chicano artists decorate the streets of the Mission, where one is as likely to hear Spanish as English. It is a densely populated community, with small apartments shared by multi-generational families. Kids play noisily in urban playgrounds, families shop for groceries, music emerges from cars and storefronts, and people file in and out of churches. Gang graffiti, broken bottles, and notices offering work services are everywhere.

Horace Mann enrolls 650 students in grades 6 through 8. The school is promoted and recognized as an academic middle school and has a good reputation in the community. Under the district's open-enrollment policy, all students in the district can apply to their preferred schools; at Horace Mann, many more students apply than can be accommodated. Students are selected to enroll based on a lottery system that is largely driven by the district's desegregation policy, which specifies that no more than 40 percent of the students at a school can be from one ethnic group. As a result, the ethnic diversity of the student population is as follows: Spanish Surname (38%), Other White (20%), Other Non-White (13%), Chinese (14%), African American (9%), and Filipino (6%). Twenty to 25 percent of the student population is limited English proficient (LEP). The LEP students at Horace Mann are predominantly Spanish speaking (63%), but there is a significant Cantonese-speaking LEP population (23%). The LEP students' backgrounds vary considerably, ranging from those who were born here to immigrant parents to those who arrived in the country during the school year. While Horace Mann receives some recent arrivals, the school population is relatively stable because it attracts students from all over the city. Most families are low-income, but there is a growing middle-class population.

The following section describes an exemplary learning environment at Horace Mann involving eighth grade students.

Figure 8-1
The Auditorium Layout, Horace Mann

At the culmination of their projects, groups of students give presentations in the school auditorium. The use of the auditorium allows the students to reach a broad audience, including their peers, community members, and teachers. Small groups tour the models, to hear the students' presentations and engage in dialogue with them.

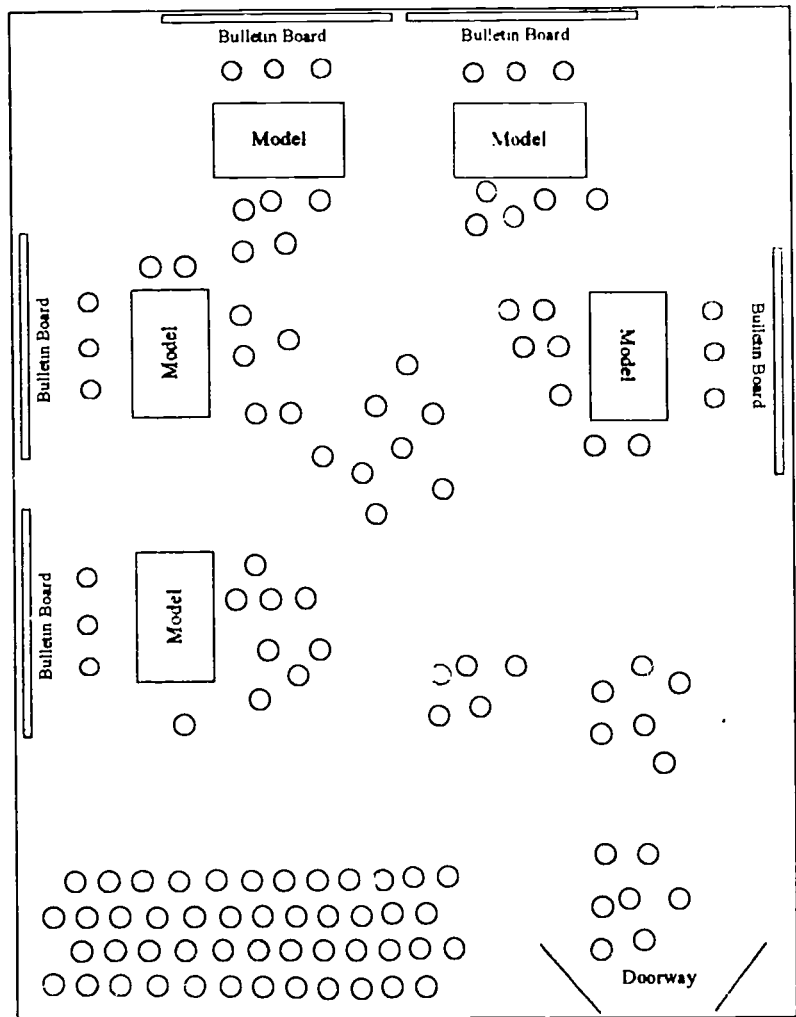

Experienced cooperative learners, the students present their work collaboratively. Students display a high level of ownership towards the projects they have created, reflecting their pride in knowledge gained through active discovery.



B. THE EXEMPLARY LEARNING ENVIRONMENT

There are almost 100 eighth grade students in the room, but in the vastness of the auditorium their numbers seem smaller. These students are assembled to demonstrate the results of a week's intensive work designing a sustainable, non-violent community, a "blueprint for a violence-free community in the year 2001."

The students break into five groups spread throughout the auditorium. Their excitement is palpable; their enthusiasm infectious. The students come from many cultures and speak with many accents, but they work together smoothly. African American, Asian, Latino, and Anglo students all seem intensely focused on the task at hand, eager to begin.

The students have built scale models of "future communities" from wood, construction paper, paint and aluminum foil. Teachers are organizing small groups to tour the models, and the students explain their work and answer questions. Three students from each group give English-language presentations on their model to the teachers, parents, community members, and other students who have been invited to the exhibition, and are now beginning to fill the auditorium. The presenters work closely together.

The presentations show that the student designers have learned many practical applications of science and mathematics; the students also discuss many profound issues faced by communities in the real world.

Reflecting the students' school and neighborhoods, all the model communities are ethnically diverse and multilingual. All address energy use: alternative transportation options ranging from bicycles to public transportation to electric cars, recycling centers, solar power. Concern for aesthetics is a common theme: All the model communities have many parks; some have fountains and waterfalls. In some models the housing is similar so wealth differences are not apparent; other models propose a variety of housing options. Buildings in all of the models tend to be brightly painted and widely separated. One model suggests the use of

Students are affiliated with "families" of 100 students each; the school has six families.

The students are ethnically mixed, and grouped heterogeneously in terms of academic skills—gifted to special education—and fluency in English. All the work leading up to the culminating presentation has been done in groups of 19; smaller groups worked on specific areas of the model.

Students present their models collaboratively; the broad audience provides them with the experience of presenting to people beyond their classmates and teachers. Every student in each group makes a presentation.

The work requires the students to apply principles of natural science, mathematics, and technology to social issues that are meaningful to the students and their community; the presentations enable students to engage in dialogue about such topics.

Because of the range of issues addressed by the models, all students—regardless of different strengths, interests, and experiences—can contribute in a meaningful way.

energy efficient designs for public buildings. All the model communities include youth recreation and activity centers (some open 24 hours a day); most feature child care and senior centers; some have cross-age activity centers. Police in many of the communities interact with people by patrolling on bike or on foot. All the models have a town hall for public meetings, which, according to the student presenters, include frequent gatherings of neighbors to air grievances and discuss community issues.

Students display a high level of ownership of what they have learned which does not come from knowledge passively received; they have arrived at this point through a process of active discovery.

As students present their models they launch into detailed explanations of their decisions, justifying their choices for each feature. Questions from peers and adults lead to thoughtful discussions of renewable energy, the need for community and recreational centers, religion, government, aesthetics, communication in a multilingual society — the range of issues the students have been working on. In one exchange, a student asks a presenter why her group's model community does not allow cars. The presenter explains that public transportation and bicycle riding are a better alternative because "Cars cause air pollution and use up our natural resources...buses and (trains) can use renewable energy, like electricity, that doesn't pollute." Another presenter adds that sharing public transportation will help alleviate violence in the community because "In their cars, people don't talk to other people; if they ride the bus together, they might get to know their neighbors and watch out for them."

The learning environment is nurturing and non-threatening; students clearly feel safe presenting their work to strangers and have little hesitation trying out their English language skills.

The project topic validates students' experiences and allows them to view their experiences as a resource upon which they can draw.

At another presentation, a visitor asks how people in a multilingual society will be able to communicate; the student presenter reflects for a moment and then responds, "Everyone will speak English, but they will also speak the language of the country they are from." The presenters refer to scientific diagrams to support their models; their discussions appear to draw on both their work at school and their personal experience in their homes and neighborhoods.

C. INNOVATIVE CURRICULUM AND INSTRUCTIONAL STRATEGIES

The exemplary learning environment described above illustrates pedagogical strategies that are dramatically different from those used in a traditional middle school, particularly a middle school with a culturally and linguistically diverse student population. The student "Challenge" presentations exemplify Horace Mann's implementation of the San Francisco Project 2061 Model—a curriculum model designed to increase science literacy.¹ These strategies are also visible in classrooms throughout the school on a regular basis; the principles of the Project 2061 approach are the same as those that define Horace Mann's schoolwide approach to science and mathematics education. Horace Mann's innovative curricular and instructional strategies are identified in Figure 8-2; the figure also provides a schematic of the school's program for LEP students, which will be discussed in the next section.

Integrated, Thematic Curriculum

Horace Mann faculty strengthen their academic program by making connections between the core subjects (language arts, social studies, science, and mathematics) through the development of curricular themes. Development and elaboration of the themes are facilitated by the school's organization (see subsequent discussions on family structure, teacher collaboration, and joint planning time). Consistent with the schoolwide interdisciplinary approach, the learning experience described above—based on San Francisco Project 2061's curriculum model—maximizes opportunities for students to make connections across natural sciences, mathematics, and technology as well as social sciences and humanities.

Meaningful, Project-based Curriculum

The informed, enthusiastic participation described in the narrative shows how Horace Mann's approach makes the content of projects meaningful to students. It embraces the diversity of the

¹ The goal of Project 2061—launched by the American Association for the Advancement of Science in 1985—is to transform K-12 science, mathematics, and technology education to ensure science literacy for all high school graduates who would live to see the return of Haley's Comet in 2061. A team of over 300 scientists, mathematicians, engineers, and historians participated in defining learning goals (including knowledge, skills, values, and attitudes) for science literacy as outlined in *Science for All Americans*. Educators collaborated with Project 2061 in specifying steps likely to lead to these understandings and habits of mind—by the end of grades 2, 5, 8, and 12. Focusing on the understanding and interconnection of concepts, rather than memorization of discrete facts, these specifications appear in *Benchmarks for Science Literacy*. San Francisco Unified School District is one of six national sites participating in Project 2061; curriculum models developed as a result of the project are intended to be tools for reforming K-12 science, mathematics, and technology education. San Francisco Project 2061's curriculum model relies on instructional strategies that have been widely embraced by Horace Mann faculty (three of the five middle school teachers who helped to develop the San Francisco model are teachers at Horace Mann).

Figure 8-2
Instruction, Curriculum, and Program Map, Horace Mann

Key Instruction-Curriculum Features

- Integrated, thematic curriculum
- Meaningful, project-based curriculum
- Active, Cooperative Learning
- Authentic assessment
- Community of learners
- Mathematics across the curriculum

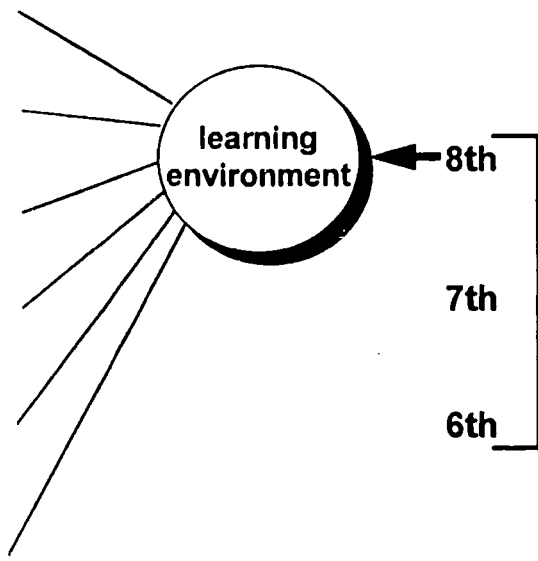

LEP Program Features

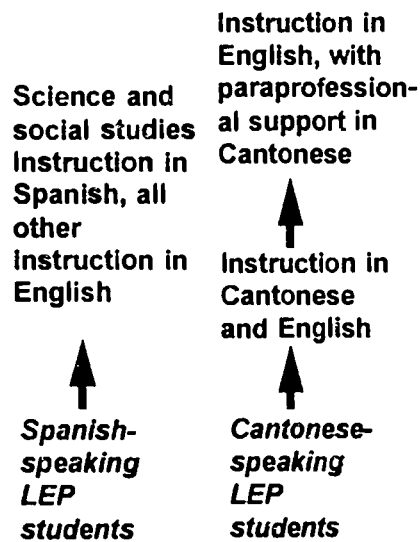

multicultural and multilingual student population and has real life applications; this serves to engage the students in a learning process that is not detached from their experiences. One of the pedagogical strategies employed by Horace Mann teachers (and the San Francisco Project 2061 curriculum model) is to challenge students to address real environmental and social issues of local and global scope. This results in instruction that is meaningful and purposeful, as opposed to the de-contextualized learning that often takes place at traditional schools. The validation of cultural diversity in the curriculum exemplifies the staff's commitment to all students—their belief that all students can learn. This inclusive environment sets the stage for student achievement.

The use of project-based curricula contributes to LEP students' language development and in-depth understanding of sophisticated scientific and mathematical concepts. Language development occurs as students conduct research based on written material, produce original written material, and present their work orally.

Active, Cooperative Learning

Horace Mann staff try to ensure that students become actively engaged in learning experiences that emphasize investigation, problem solving, and creating products. They also orchestrate student collaboration in heterogeneous, cooperative groups. The use of active and cooperative learning strategies can be seen in many science and mathematics classes; teachers link concrete mathematics and science concepts with hands-on, activity-oriented instruction. The intent is to engage students actively in the learning process, rather than expect them to passively receive information.

The absence of student tracking at Horace Mann distinguishes it from traditional middle schools. Opportunities for peer interaction and support provide a natural arena for language development, as well as facilitate meaningful discussions of mathematics and science concepts. Mathematics teachers use both heterogeneous and homogeneous grouping strategies within cooperative learning groups; heterogeneous groups provide a greater opportunity for students to learn from one another, while homogeneous groups allow the teacher to assign varied levels of work within the same class. In science, teachers consistently make use of heterogeneously mixed groups for lab work.

While problem-solving strategies are used across all content areas, mathematics teachers in particular emphasize this approach in order to accommodate the widely varied academic levels of students in their classes. As one teacher said, "Problem-solving meets the needs of all children because they can come at a problem from so many different levels." Problem-solving strategies also encourage critical thinking and promote an understanding of the applications of mathematics by presenting the material in a context that is meaningful to the students.

Authentic Assessment

Most teachers base their student assessment system on portfolios and performance. These tools, as well as teacher-designed tests, are used to assess student progress toward specific schoolwide outcomes on the premise that meaningful assessment of student progress and achievement is integral to the educational process. Staff use assessment tools to measure students' ability to construct and apply knowledge, rather than reproduce it.

In San Francisco Project 2061's curriculum model, learning outcomes are defined as part of the Challenge; assessment tools—portfolios of student work, substantive dialogue with peers, projects, and cooperative performance—are embedded in the process of meeting the Challenge. In fact, the products and performances of the Challenges are a critical part of the assessment, as they provide the evidence that goals and benchmarks have been reached by demonstrating depth of understanding and competence in a range of skills. In addition to the products of the Challenge, performances are used as assessment tools to provide insight into students' thinking, level of cognition, and ability to work as team members. For example, in the San Francisco Project 2061 Challenge described earlier, student progress and achievement were measured by teacher observation as students worked cooperatively on their project; they were also assessed as they presented their work to a broad audience. In addition, students wrote evaluations of their peers' work, as well as of their own, and were administered pre- and post-tests on mathematics, science, and social studies concepts. The following diagram shows the repertoire of assessment tools used to inform teachers about students' progress toward specified learning goals.

Figure 8-3

San Francisco Project 2061 Assessment System

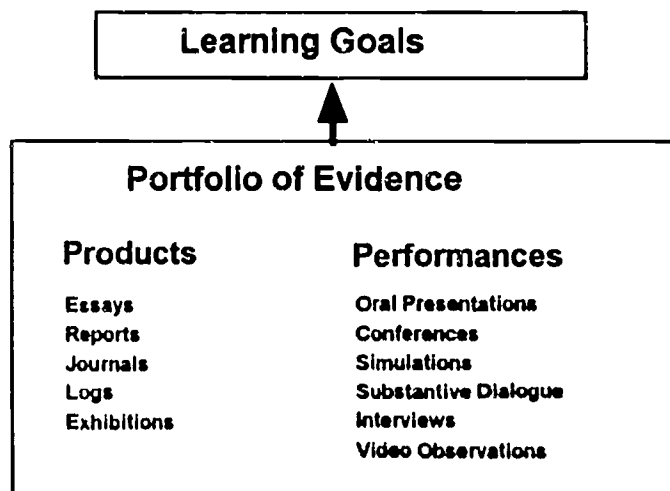

Community of Learners

A critical component of the San Francisco Project 2061 curriculum model—embraced by all teachers at Horace Mann—is project documentation. As the model is designed to cultivate thoughtful, reflective students, it is also designed to promote thoughtful and reflective educators, in effect creating a community of learners. Guided by focus questions that they develop as part of the San Francisco Project 2061 Challenge, teachers document the implementation of the project by reviewing and reflecting on what worked and what didn't work. This process of project documentation is informed by teacher observations and fieldnotes; structured student interviews and open-ended questionnaires; and data collection, analysis, and interpretation. The result of the documentation process is two-pronged: first, it allows the teacher to become a researcher, promoting the concept of a community of learners; second, it creates a dynamic, continually improving curriculum.

Before implementing the Challenges, goals are set and standards and criteria by which to assess student learning are established. Afterward, teachers evaluate the first round of Challenges with a set of research questions which assess the impact on student learning according to the standards and criteria. The evaluations lead to revisions and adaptations in an effort to improve the implementation of future Challenge-based learning experiences.

At the end of the second year of implementation, teachers are very comfortable with the model. San Francisco Project 2061 staff attribute this confidence to the use of the "constructivist approach" in implementing innovations, i.e., deriving meaning through participation in the creative process. As the San Francisco Project 2061 Director explained, "In order for teachers to buy in, teachers have to have a sense of ownership; the coach can play a role in facilitation, but must allow the teachers to be creative."

While gains in language development for LEP students have not been documented, San Francisco Project 2061 staff expressed an interest in developing focus questions and tools to assess LEP student growth as part of their learning challenge.

Mathematics across the Curriculum

Teaching mathematics across the curriculum—that is, applications of mathematics—is a very high priority at Horace Mann after concerns were expressed by teachers and parents during a recent review of the quality of instructional programs. The entire staff has since received extensive training in mathematics thinking skills and ways these skills can be supported outside of math-designated classes. The types of mathematics concepts that are now integrated across the content areas include patterns, problem solving, and sequential thinking. Staff and departmental brainstorming sessions

have devised ways to integrate these concepts with other content areas. Language arts and social studies faculty, for example, have incorporated mathematics issues into several of their in-service training sessions and departmental meetings.

D. PROGRAM FOR LEP STUDENTS

Because the program for LEP students is intricately connected with the school's organizational structure, it is not possible to describe the former without an understanding of the latter. This section discusses the program for LEP students, as illustrated in the right column of Figure 8-2, in the context of the school's "family" structure.

Family Structure

All students at Horace Mann are placed into one of six families, two at each grade level, of approximately 100 students and four core teachers. Students take all of their core classes (language arts, social studies, science, and mathematics) and some of their electives with the family; other electives and P.E. are offered outside of the family structure. All families are composed of heterogeneous student populations ranging from gifted to special education.

The family structure allows teachers to develop closer relationships with students at this transitional time in their lives. The teachers and students in each family get to know each other very well. The family structure also gives the students a sense of belonging to a group. Families engage in activities together outside of the typical classroom environment, such as the learning experience described above, and take field trips. LEP students particularly benefit from the family arrangement because teachers have a deeper understanding of their language development. Within the family, students are clustered into strands of approximately 25 students with whom they take their core content courses (in some families, strands are combined for some of their core courses). Spanish-speaking LEP students are grouped into Spanish bilingual strands; non-Spanish-speaking LEP students are also clustered in the same way as the Spanish bilingual strands. Newcomer Cantonese-speaking LEP students are served in a self-contained class that is not part of a family.

The program for Spanish-speaking LEP students promotes the maintenance of Spanish literacy, while the program for Cantonese-speaking LEP students employs a transitional approach. Only Cantonese-speaking students with very little English fluency receive primary language instruction, and maintenance of literacy in Cantonese is not supported. The design of each of these programs is described in greater detail below. Both programs are supported by bilingual and Language Development Specialist (LDS)-trained teachers and aides: almost half of the teachers in the school are bilingual and all teachers are encouraged to get an LDS credential (many have the credential, others are being trained in on-site LDS classes). Three Cantonese-speaking bilingual aides and two

Spanish-speaking bilingual aides assist classroom teachers. English as a Second Language (ESL) is handled differently by each family, but most families offer ESL instruction to LEP students within the family structure, either during the "family elective" or in language arts classes. In the latter case, students are placed in language arts classes according to their English language development. LEP students who speak very little English participate in a schoolwide ESL pull-out program.

Spanish Bilingual Program

All Spanish-speaking LEP students are assigned to the families that have a Spanish bilingual strand. (A few Spanish-speaking LEP students opt out of primary language instruction and are not placed in the Spanish bilingual strand.) This program emphasizes English-language development and Spanish-language maintenance for LEP and bilingual students; the goal is biliteracy for all students. Students enrolled in the program receive half of their core course instruction (science and social studies) in Spanish and half in English (language arts and mathematics). The program is composed of newcomers, LEP students, bilingual students whose parents want them to maintain Spanish, and English-dominant students who are proficient in Spanish because they attended a nearby Spanish-English two-way immersion elementary school. In addition to the bilingual students—those whose first language is Spanish and those whose first language is English—in the bilingual strand, LEP students interact with non-LEP students during family and schoolwide electives and in P.E. Science and social studies teachers in this program are bilingual (all either have or are getting their bilingual credential) and language arts teachers have LDS credentials. Mathematics teachers are assisted by bilingual aides who help to clarify instruction when necessary.

Chinese Transition Program

This program is implemented in two parts. One part serves newcomer students who receive instruction in both Cantonese and English in a self-contained class. All of the students are very limited in English, as most have been in this country less than a year. In the self-contained class, all subjects are taught in both Cantonese and English and the content area instruction is supplemented by English as a Second Language (ESL) instruction. Class size averages around 15 and, except for a few new arrivals over the course of the year, the composition of the class remains stable. The students' educational backgrounds range from none to grade level. After one to two years in the self-contained class, students are moved into a family for the second phase of the program. Transfer into a family usually occurs at the beginning of the school year, but students often make a partial transition midway through the year. Students in the 'partial' category take some of their classes (i.e., math, science, and electives) with a family, but return to a self-contained

Figure 8-4
School Structure and District Support, Horace Mann

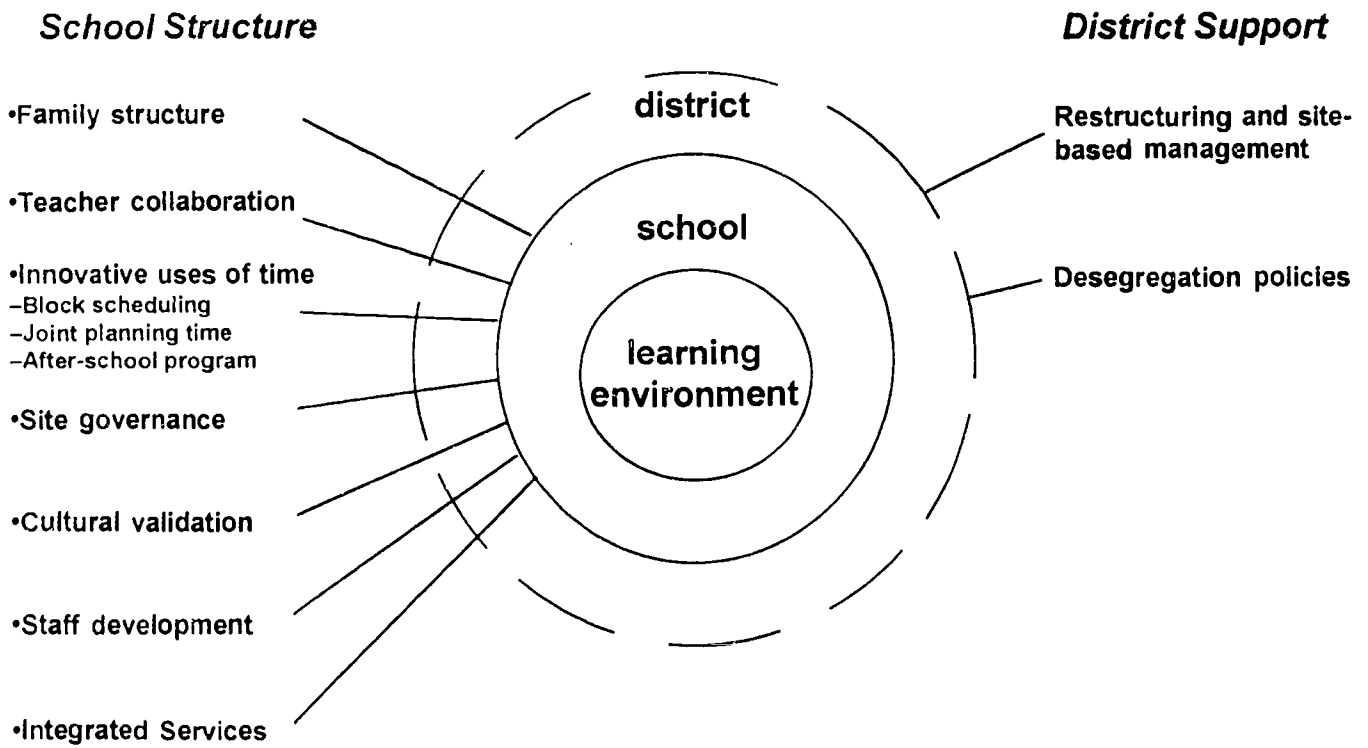

classroom for their remaining classes. Students in these strands are placed in classes with teachers who have LDS credentials and are experienced with the language acquisition process; these classes are composed of English-only and bilingual students, as well as LEP students. The family classes are taught in English, but primary language support is available from Cantonese-speaking paraprofessionals. Students who are partially mainstreamed are always accompanied by a Cantonese-speaking paraprofessional. Horace Mann's program for Cantonese-speaking LEP students differs from the program for Spanish-speaking LEP students because there are not sufficient numbers of Cantonese-speaking LEP students placed at the school to allow for a Cantonese bilingual strand.

E. SCHOOL STRUCTURE

While the school's division into families is one of the most visible elements of school restructuring at Horace Mann, a number of other schoolwide factors support the learning environment. The following innovative practices are among the other elements of restructuring in place at Horace Mann. These features are identified in Figure 8-4.

Teacher Collaboration

The four core teachers of a family work together to enhance the academic experiences of each student. They are able to do joint planning and coordinate activities during common prep periods. Working in teams, the teachers strengthen the academic program by making curricular connections between the core subjects (language arts, social studies, science, and mathematics). They decide on themes and collaborate to integrate the curriculum across disciplines. For example, in the learning experience described above, teachers collaborated to design the Challenge and then worked together to implement it with the whole family. Teachers within the family structure also take on counseling functions (i.e., appropriate student placement) since they have a close relationship with the students. They can see when there are problems, and they can involve all of the teachers in working out a solution. Teachers in the family also agree on common discipline strategies.

Innovative Uses of Time

Block Scheduling. With a six-period day, Horace Mann uses a block schedule in which students have two academic blocks each day; each academic class meets every other day. Students have a single period of physical education every day and they alternate between schoolwide electives (art, music, and computer science) and family electives during the remaining period. Family electives vary, but examples include leadership, ecology, photography, journalism, Spanish-as-a-second language,

and Spanish for native speakers. The block schedule allows students the opportunity to carry out sustained research and project-based work without interruption, which in turn enables them to produce the type of work described at the outset of this chapter. The following figure illustrates a typical schedule for one family; each family has a different daily schedule.

**Figure 8-5
One Horace Mann Family's Daily Schedule**

	1°-2°	3°	4°	5°-6°
Family-based teachers	Academic Curriculum (M-F)		Family Electives (M, W, F)	Academic Curriculum (M-F)
Non-family teachers (planning time for family teachers)		PE (M-F)	Schoolwide Electives (T, Th)	

Joint Planning Time. The teachers in each family have a common prep period every day while the students are at P.E.; they also have a second prep time two days a week while the students go to their schoolwide electives (students are at family electives on the other three days). This second prep is designated for family meetings. The two preps are contiguous, so teachers are able to meet for double periods twice a week; they often use this time for joint planning. Scheduled joint planning time for teachers allows them to collaborate on curriculum development and discuss issues pertaining to individual students. Providing teachers time to collaborate is essential for the design and implementation of learning experiences that cross traditional curricular lines and require coordination among multiple staff members.

After-School Program. Each family operates an after-school program for "special needs" students (includes LEP students). The programs vary by family in terms of schedule, frequency, and student participation. For example, one family offers before-*and*-after school study hall. Some teachers are available every day after school, others are available two or three days a week. One teacher holds a study hall at the school every Saturday. In some families students are required to stay after school to get extra help; in other families, teachers make themselves available and suggest to students that they stay after school. Students reported that they take advantage of the after-school program; they said specifically that it helps them learn English and mathematics.

Site Governance

In addition to family-level administration, a number of governing bodies address schoolwide issues at Horace Mann. The governance structure is important, as it affects communication and broad ownership of schoolwide decisions. The involvement of a wide range of constituents enables the school staff to provide a coherent and meaningful academic and social program. The school has full faculty meetings twice a month, when there is an opportunity for joint problem solving among all faculty. Most decision-making is done by the Curriculum and Staff Development Committee (a faculty group). They are guided by the Horace Mann Community Council, the school's advisory body, which is made up of parents, teachers, and students. The council meets once a month, providing an opportunity for input into the decision-making process. Both the Community Council and the Curriculum and Staff Development Committee are involved in decisions regarding the spending of grant money and other supplemental funds, school governance issues, and staff development offerings.

Cultural Validation

Teachers report that a main strength of the school is the faculty's shared vision of a school in which multiculturalism and multilingualism are valued. The learning experience described above shows that the students have also embraced this vision. A large number of the staff are bilingual, setting a tone for the school and for the kind of environment they are attempting to establish. The hallways of the school are filled with student work representing all the languages of the school; the content of the work displayed frequently addresses issues relating to cultural diversity. For example, the walls are decorated with student posters from the poster contest that is a culminating event of September's month-long thematic unit called "Awareness Month."

Awareness Month is one of the main vehicles through which Horace Mann staff promote their vision of multicultural harmony and non-violence. The schoolwide curriculum during this month focuses on developing students' respect for diversity. Each grade level has a theme: 6th grade's is "Building Communities"; 7th grade's is "Celebrating Diversity"; and 8th grade's is "Social Responsibility." Each family implements the theme for its grade level, integrating all of the core subjects as well as the electives. In addition to the poster contest, the projects also culminate in oral presentations, either to the whole school or to the family.

The school is accessible to non-English-speaking parents through the bilingual teachers, as well as through the Spanish-speaking parent liaison; the school hopes to hire an additional Cantonese-speaking parent liaison. All home-school communication is written in three languages (English, Spanish, and Cantonese); the main office staff speak English and Spanish.

Staff Development

Senate Bill 1274, California's school restructuring legislation, supports schools in various ways, including Restructuring Planning and Demonstration Grants. Horace Mann received one of these grants, which includes a discretionary budget (\$60,000 for the planning year and \$119,000 each year for four years of implementation) that supports staff development and teacher collaboration.

SB 1274 funds are used to pay teacher stipends for time spent on joint planning and staff development. Teachers use joint planning time to set priorities for the school, develop themes, and plan activities. The Curriculum and Staff Development Committee plans the school's staff development program; its activities and structure are selected based on the interests of the whole staff. Consequently, the focus of and approach to staff development activities vary. Bicultural awareness and writing across the curriculum have been topics of past staff trainings; presently, alternative assessment and mathematics across the curriculum are the emphases. Teachers' knowledge of the language acquisition process—based on their experience teaching LEP students and training they have sought out—is critical to the successful implementation of the curricular and instructional strategies described above.

Integrated Services

Horace Mann is also using funds from its SB 1274 Grant to expand the health and social services offered. The school recently hired a Social Services Coordinator whose role is to conduct a needs assessment and recommend a more extensive integrated services program for the school. In order to develop a plan for Horace Mann, the Social Services Coordinator has surveyed students, teachers, and parents to gain a better understanding of the issues that need to be addressed; she is also researching integrated services models at other schools. She has convened an Advisory Council in hopes of getting the school community involved in the development of the program. In the meantime, she has established relationships with local community-based organizations to refer students for specific social services. Staff at Horace Mann are also in the process of establishing a relationship with a local medical university. The university will send their students who are in need of internships to Horace Mann to serve as school-based nurse practitioners and counselors.

F. DISTRICT SUPPORT

As shown in Figure 8-4, the district assists Horace Mann through its support for restructuring and site-based management. District desegregation policies have also had a profound impact on the school.

Restructuring and Site-based Management

Horace Mann has been at the forefront of the restructuring movement in San Francisco; it has paved the way for other schools in the district that have begun to restructure more recently. The district has been supportive of Horace Mann in its restructuring and its implementation of site-based management, and now regards Horace Mann as a model of restructuring for other schools in the district.

Desegregation Policies

As one of a handful of district schools targeted by a court-ordered consent decree that requires desegregating San Francisco schools, Horace Mann was "reconstituted" ten years ago. It was at this point that Horace Mann became a magnet school, adopting an academic focus and becoming subject to San Francisco's districtwide open-enrollment policy. The consent decree also led to the districtwide limit (40%) on the number of students of any one ethnic group at a given school. As a school targeted by the consent decree, Horace Mann receives \$480,000 annually in supplemental funding. This funding supports nine extra positions that have lowered class size, enabling the school to reduce the student-teacher ratio to 25 to 1. The reduced class size is a major strength of the school.

G. SUMMARY

Horace Mann staff have made far-reaching improvements to their instructional programs, driven by a schoolwide commitment to *all* students' academic and social development. Staff acknowledge and embrace the students as they are and build on the experiences that students bring with them. They embrace multiculturalism and multilingualism, show respect for the background and experiences of the students, and offer instruction to maintain literacy in Spanish, the students' main primary language. Staff strive for continuous improvement, are willing to take risks, and adopt an entrepreneurial approach to obtain supplemental resources. Horace Mann's involvement with Project 2061 is an example of this special dedication; staff have used this resource—among others—to leverage change and experiment with new approaches.

Organization of Students

As the principal at Horace Mann said, "Everyone learns better by working together." The integration of all students—gifted, special education, LEP—in families and classes provides an opportunity for all students to learn from one another. The intimacy afforded by the family structure creates a non-threatening environment in which students feel comfortable actively participating in the learning process. It is a context in which heterogeneous groups of cooperative learners flourish.

Rich, Meaningful Curriculum

Learning at Horace Mann is fostered by a curriculum that is rich and meaningful, taking into consideration the experiences, realities, and interests of the students. The San Francisco Project 2061 Challenge described at the beginning of this case study is perhaps the best example of the curricular incorporation of student experiences with mathematics and science concepts, but teachers strive on a daily basis in all subject areas to present curriculum in a way that has meaning for students. The integration of content areas and the incorporation of student experiences enriches, rather than waters down, the curriculum.

CHAPTER 9

HAROLD WIGGS MIDDLE SCHOOL EL PASO INDEPENDENT SCHOOL DISTRICT TEXAS (6-8)



A. SCHOOL AND COMMUNITY CONTEXT

Harold Wiggs Middle School is located in El Paso, Texas about three miles from downtown in this city of 600,000. Because El Paso is separated only by the Rio Grande from Ciudad Juarez, its sister city in Mexico, the blend of Mexican and American cultures is apparent throughout the community.

The school's neighborhood is composed primarily of single-family homes. Many of the houses close to the school clearly began as homes of the middle class, but now show signs of aging and disrepair. Homes slightly farther away from the school, but still in Wiggs' attendance area, are large and well-kept. A spacious, well-tended park with benches, flowers, and trees serves as the centerpiece of the upscale neighborhood. Children from both parts of the community attend school at Wiggs.

The modern three-story school building opened in 1987 and has been well maintained, with trees and shrubs surrounding the school grounds. Eight portables on its site reflect a growing student population. The cheerful interior of the school features displays of colorful posters, student artwork, awards, and other decorative touches. During passing periods between classes, school halls are filled with a mixture of middle school students who are orderly and welcoming.

Wiggs enrolls approximately 1,000 students in grades 6 through 8, of which about 70 percent are from economically disadvantaged homes and about 15 percent are from affluent families. Most of the school's students are eligible for free and reduced-fee breakfast and lunch programs. Paper, pencils, and other school supplies are offered by the school to students who need them, and the school nurse maintains a supply of clothing which she provides to students in need.

Eighty-nine percent of the student body at Wiggs is Hispanic, ten percent is White, and the remaining one percent Asian/Pacific Islander or African American. Wiggs' Hispanic students are a mixture of first-, second-, and third-generation Mexican immigrants. About 28 percent of all students at Wiggs are LEP; a large majority of these are recent immigrants, but a few are LEP students continuing from elementary school. Most of the immigrant students are from Ciudad Juarez and have had fairly consistent schooling. Some families, however, move back and forth between El Paso and Ciudad Juarez and students have missed parts of their education because of the shifts. Other students are from more rural areas of Mexico and have had severely interrupted schooling.

Figure 9-1
The Classroom Layout, Wiggs

The desks in the classroom are arranged in small groups to facilitate cooperative learning. After the teacher assigns students to small groups to work on project, they quickly cluster their desks in separate areas of the room. The teacher moves from group to group, encouraging individual students.

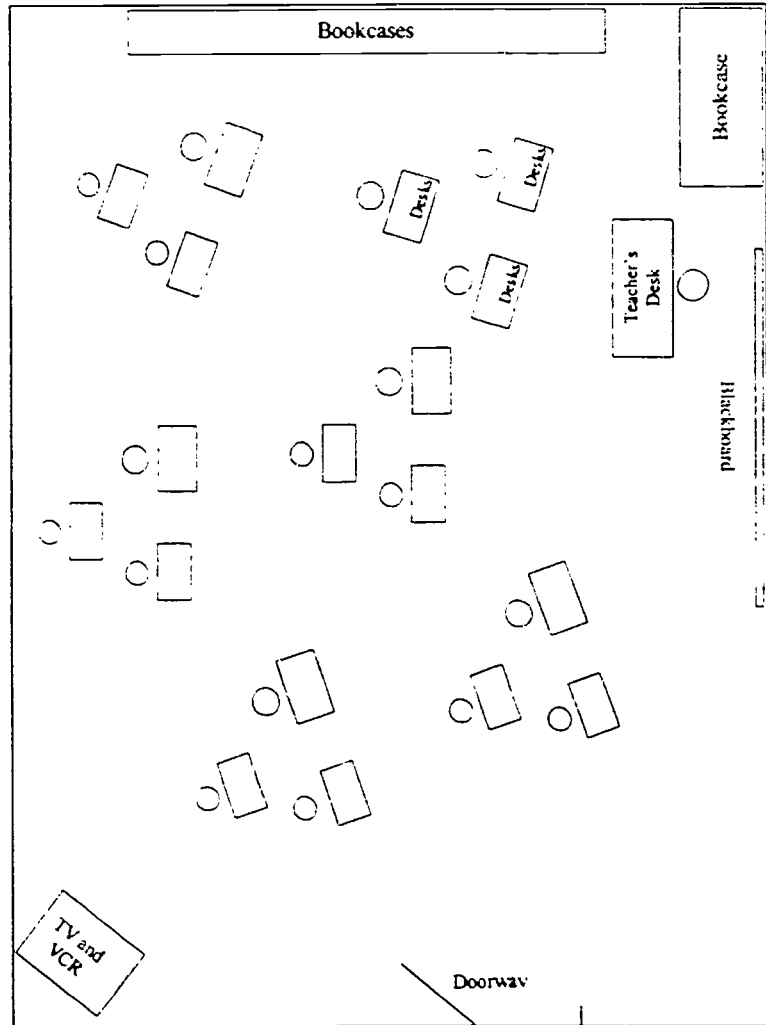

After the teacher identifies three roles within each group for a project, the students assign the tasks amongst themselves. Students use both Spanish and English while working together to design a poster, write a description, and plan their presentation.



B. AN EXEMPLARY LEARNING ENVIRONMENT

It is mid-morning, and the noise level in Ms. Svedman's seventh-grade math class begins to build as 17 chattering students file into her classroom and quickly find their seats. The classroom walls display student work on brightly colored backgrounds, illustrations of mathematical concepts, a display listing the school's goals for student achievement, and posters reflecting Mexican themes and culture. Speaking in English, Ms. Svedman greets the students with questions about a recess soccer game, then encourages a brief discussion of a videotape the students saw that morning. The ensuing discussion is animated. Students would clearly like to spend more time on these pleasant subjects, but Ms. Svedman directs their attention to the lesson for the day.

Students are all very recent immigrants from Mexico. Almost all have had consistent previous schooling.

Classroom displays celebrate student culture.

Ms. Svedman explains to the students that they will work in cooperative groups to prepare for a sale at a "shop" where they work. She says that each group will receive an item for "sale." They will establish a price for the item, then compute a sale discount, tax, and final price.

The lesson combines language use and math concepts.

Throughout her discussion, Ms. Svedman maintains close eye contact with her students. She uses her hands to make word pictures, and uses synonyms for words that she senses students might find difficult. She speaks clearly and slows her speech a bit when she uses a difficult word or phrase. When she uses a colloquialism, she asks if anyone knows its meaning. Students guess and she encourages them to speculate.

Making eye contact with students, using total physical response, speaking slowly and distinctly are all Sheltered English techniques.

After computing sales prices, the student groups will write descriptions of their items for an advertisement and produce a poster advertising their sale. One person in each group will be responsible for the writing, another for designing and decorating the poster, a third for making a presentation about the sale. As their teacher explains the assignment, students listen carefully and several ask questions.

One student asks, "When is it to be turned in?"

Another calls, "What things will we sell?"

Using cognates as a way of connecting two languages is a technique of ESL instruction.

*Ms. Svedman responds that they will work on the assignment in class both today and tomorrow, begin to make their presentations tomorrow, and continue the next day. In response to the question about items for sale, she tells the class that she has brought several "precious and valuable" items from home to be placed on sale in their shops. But first she reminds the students how to compute a discount using what they have learned about percentages. One student, a recent arrival from Mexico, frowns a bit during her explanation. She makes eye contact with him and connects the Spanish word *dividir* to the English word *divide* to help the student understand the discussion. The student nods his understanding.*

Ms. Svedman then quickly assigns the students to six groups of three and suggests a section of the classroom where each group can meet. She gives each group an item she has brought from her home that they are to prepare for "sale": a beanie with a propeller, a large athletic bag, a stuffed tiger, a leather purse, a flute, a lap desk. Before she distributes the items, she shows each to the class and asks: "What do you think this is?" "What is it used for?" "How would you describe this?"

Students produce a great deal of oral English throughout the class.

The students are encouraged to describe the items and they quickly get into the spirit of the exercise. The beanie with the propeller provokes some joking remarks, with students volunteering that someone might wear the beanie "to the circus" or "to a party." There is some confusion in the group about the lap desk and Ms. Svedman continues to ask questions until a student identifies its purpose.

The teacher makes effective use of Cooperative Learning strategies.

Ms. Svedman asks one student from each group to get a large sheet of poster board and markers. She asks each group to choose one student as the writer, one as the poster maker, and one who will give the sale presentation. She explains that each student in the group will contribute to the whole process.

The noise level in the class increases again as the groups converse among themselves and decide which roles each student

will take, speaking in a mixture of Spanish and English. Some groups (including the group with the newcomer) lean more heavily toward Spanish. In one group, two members quickly agree that the third student will create the poster. "You are an artist—you should make the poster," they tell him. He agrees, and one of the other students agrees to write the description of the item if the others will help her. The third agrees to make the presentation to the class the following day. Ms. Svedman moves from group to group encouraging students to make decisions and asking who in each group will have each role.

As the groups begin to work, Ms. Svedman encourages two groups that are lagging behind to make their decisions. With a little additional discussion, each group decides how much their item will sell for and what the discount should be. There is much animated conversation as the students begin to work. They are clearly focused on the task at hand; all are deeply engaged in the work of their groups. In one group, a student takes on the informal role of facilitator, asking another student who had been quiet, "How much do you think we should charge?"

As Ms. Svedman moves from group to group, she comments on how well students are doing and asks questions. To one group, she says, "You have figured out what the price would be with a 20 percent discount. How much would the item cost if the discount were 25 percent?" To another group, "Will you figure the tax on the original price or on the sale price? Why?" Although students use both Spanish and English in their group discussions, they speak to Ms. Svedman mostly in English.

As students finish their pricing exercise, they begin to write 'copy' for their ads, which must describe the items for sale and be glued to their posters. Ms. Svedman suggests that the students use the Spanish-English dictionaries scattered around the room and students make liberal use of them as they struggle to find the right English words. The group with the sports bag decides to emphasize the number of things the bag can be used for and how

Students are competent cooperative learners who adapt their behavior to involve other members of the group.

The teacher talks in a way that is supportive and encouraging. Students are asked questions to extend their understanding.

many things it will hold. They ask Ms. Svedman what the bag is made of: "Is it plastic or is it real leather?" Ms. Svedman continues to circulate, spending more time with one group that is having difficulty coming up with ad copy.

Ms. Svedman asks the students to finish up for the day and reminds them that they will complete their posters tomorrow.

C. SCHOOL STRUCTURE

Ms. Svedman created an exciting, active, and involved learning environment for students who arrived from Mexico only a few month previously. The classroom echoed with the enthusiasm of its students, but it was enthusiasm carefully directed by a teacher who knew where she wanted her class to go and how to get there. While taking pains to build an atmosphere of friendly support, the teacher motivated the students without being overly directive. Students were encouraged to be active in discovering for themselves the things they needed to learn, with the teacher providing assistance, direction, and occasional gentle prodding. As a result, most students appeared to feel at ease about expressing their views and asking questions, and became intensely involved in solving the problems that had been put to their groups. In short, the emphasis in this classroom was on learning rather than instruction, with the teacher acting as strategic director, expert guide, facilitator, and resource. This instructional approach reflects the organization and culture of the school and the goals of its program for LEP students, as explained below. Figure 9-2, on the following page, identifies key structural elements of the school; the balance of this section examines each of those elements in turn.

Family Structure

When Harold Wiggs Middle School opened in 1987 it was the first middle school in the El Paso district and one of the first in the state. The founding principal's vision was of a middle school organized into "families," allowing small groups of students to have close, ongoing instructional contact with a small number of staff in their core classes. Wiggs student body and staff are organized into eight families—two families at each grade level in grades 6, 7, and 8, and two additional families for newcomer students. Each family has between 125 and 150 students, with the exception of the newcomer families which have between 50 and 60 students each. Students in the newcomer families span the three grade levels at the school but have their mathematics and science classes at the appropriate grade level. Students at Wiggs have seven academic periods, a homeroom period, and an advisory period.

The family structure at Wiggs creates schools-within-a-school that allow students and faculty to create a layered learning community. Each student family works with a consistent group of faculty members, reducing the isolation students feel in a more impersonal traditional junior high school setting and easing their transition from elementary school to high school. The family structure allows teachers to get to know students as individuals and students are able to form relationships with their teachers. The team structure also facilitates establishing and maintaining contact with parents. Student problems are typically first discussed by the team of teachers, who make the

Figure 9-2

School Structure and District Support, Wiggs

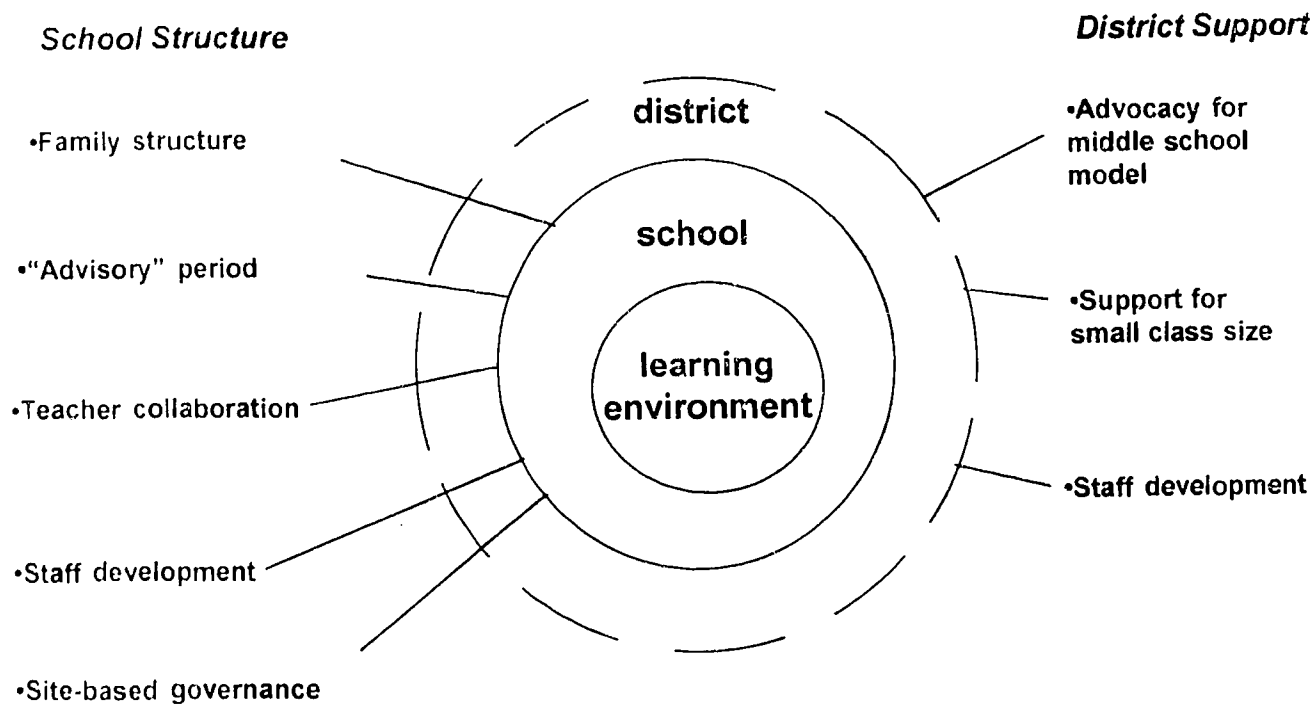

decision to contact the parents. Because they meet with parents as a team, teachers are able to give parents a full picture of their child's progress.

Advisory Period

All Wiggs students conclude their class day with an advisory period—a half-hour block of time during which each teacher meets individually with a small group of students. Every teacher at the school has advisees, including those who work outside the teams—the PE and other special teachers. Advisories are therefore smaller than regular classes; some are as small as nine students. Teachers use the time to get to know their students, follow up on changes of behavior in school, and work with them on individual problems with teachers, fellow students, or issues outside the school. Students reported that the more personal Advisory relationship with a teacher made them feel more connected to school; it gave them the opportunity to “talk to a teacher like a real person.”

Teacher Collaboration

Wiggs teachers have two planning periods each day; one which they can use for individual conferences or for preparation, the second synchronized with other members of their team. Teams can therefore meet together on a daily basis to plan thematic units, work on common problems, discuss strategies for reaching individual students, and plan whole-family instructional activities. Because the five teachers on each team work together as a unit to plan, they are able to keep their curriculum aligned. The team structure provides multiple opportunities to integrate themes across disciplines. Mathematics and science teachers, for example, often collaborate to develop compatible, mutually reinforcing themes. Similarly, English and social studies teachers develop complimentary themes that allow students to explore the links between the two subjects.

Staff Development

Wiggs has been designated as a state Mentor School, meaning that it serves as a laboratory for others, especially those wanting to implement the Middle School concept. Mentor schools' staffs are called upon to offer staff development training to teachers at other sites and participate in training activities and conferences sponsored by the Texas Mentor Schools Network. Wiggs teachers also participate in staff development offered by the district, and by the University of Texas at El Paso, as well as schoolwide, site-based training. All El Paso schools have six district staff development days; and schools can decide how those days are used. Because Wiggs is a Mentor School, it receives an additional ten staff development days.

Wiggs staff have established a fruitful relationship with the El Paso Collaborative for Academic Excellence; as part of their work with the collaborative, Wiggs teachers have participated in a Mathematics Institute which helped them restructure the school's mathematics curriculum. The

principal also participates in the Collaborative's Principals' Seminar, where she works with other principals from the El Paso area to share strategies for improving schooling.

Teachers who participate in off-site staff development activities come back to Wiggs to provide training for their fellow teachers. Much of the in-school training in recent years has been on implementing parts of the Middle School concept, including effective use of student advisories, developing interdisciplinary units, block scheduling, and alternative assessment measures. Multicultural education and language development represent the two other school-wide themes.

Individual teachers and teams of teachers also participate in conferences and workshops outside the district on issues such as implementing the state's Science Framework and the uses of computers in the classroom. Next year Wiggs staff will spend some training time with colleagues from the high school and feeder elementary schools to work on common themes and issues and to facilitate articulation.

Site-based Governance

As part of the restructuring efforts in Texas, a great deal of attention is being paid to site-based management. When it was reviewed for this report, Wiggs was in its first year as an official site-based school; it is one of the second group of schools in the district to become site-based. The school-level governing body—called the Campus Improvement Committee (CIC)—is composed of seven teachers, two parents, the principal, a paraprofessional, and a community representative. The CIC prepares a yearly Campus Improvement Plan that relates the school's goals and objectives to the Superintendent/Board goals, the state's Academic Excellence Indicators, and the El Paso Independent School District Strategic Objectives. The Committee meets on a bi-monthly basis and makes decisions on the school's discretionary budget, school policies and activities, relationships with the community, and strategies for involving parents and community members as partners in the school. The principal's style is a collaborative one and the CIC is the primary decision-making body for the school.

D. INNOVATIVE CURRICULUM AND INSTRUCTIONAL STRATEGIES

Thematic and Integrated Curriculum

Carefully chosen themes not only integrate and add coherence to the curriculum, but are the focus of the whole school's activities. Thematic units are typically related to topics that are relevant to the students' world and allow them to explore those topics in greater depth and from a variety of angles. Students also learn to make connections between traditional academic disciplines, and see how various disciplines can provide different perspectives on a question.

The teachers of newcomers (called the LAMP families) plan appropriate thematic units for these two families of students as well. Recently, for example, the beginning LAMP team developed an integrated unit on chiles for their family. In social studies, students learned about the historic and continuing tensions between Mexico and New Mexico over the chile crop. In mathematics, students made graphs plotting the relative heat of the chiles, studied crop yields in different parts of the world, and computed yield of chiles by acre. Students developed salsa recipes using fractions, adjusting recipe proportions for smaller and larger batches of salsa. In Spanish class, students read literature about the chile god and composed their own stories extending the myth. In science, students studied chiles during the unit on green plants, dissected chiles, and learned about chile seed dispersal.

LAMP staff have developed a science curriculum to respond to the curriculum framework developed by the state, and have related their curriculum to district-developed exit criteria. The LAMP science curriculum covers fewer topics than the regular science curriculum, but in the same depth. LAMP science teachers take more time with the topics, offering more experiments and other hands-on activities as part of the science program.

Teachers use the district-adopted English language science textbook as a reference for their students because El Paso has no district-adopted Spanish language science texts at the middle school level. For newcomer students, teachers adapt the text in order to present the material in more accessible language, or provide source material in Spanish. LAMP science teachers take examples from real life for their science demonstrations and experiments, since textbook examples can be artificial and have little relevance to the students.

Innovative Use of Technology

Wiggs has a television monitor in every classroom, and a number of VCRs that are paid for in part through the school's participation in Channel 1. The school has a computer lab equipped with both Macs and PCs, and students must enroll in a computer literacy course in the sixth or seventh grade.

Twelve Wiggs teachers have been designated as technology clinical teachers; they work with the University of Texas at El Paso (UTEP) to receive training in innovative instructional uses of computers. The twelve teachers each have 3 Macintosh LC III computers with CD-ROM drives, an LCD panel, a scanner, and two printers in their classrooms. They have been assigned student teachers who were trained in instructional uses of technology as well as in the hardware and a number of applications. Teachers and teacher interns will be paired for the year and will continue their training together on applications like HyperCard, etc. This project is funded by a grant to UTEP from the National Science Foundation.

Figure 9-3

Instruction, Curriculum, and Program Map, Wiggs

Innovative Instruction-Curriculum Features

•Thematic and integrated curriculum

•Innovative use of technology

•Cooperative Learning



LEP Program Features

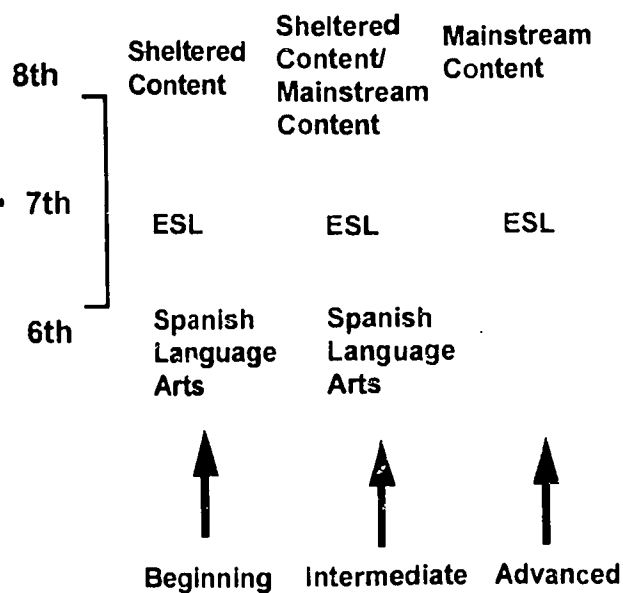

The designated technology teachers make instructional use of the computers with their classes. One of them uses the computers with her newcomer LEP students in a number of ways. For example, the class used the computers to research an on-line database, gathering demographic and economic data on several states for reports they were preparing. The technology was integral to the lesson, and students were proficient in its use.

Cooperative Learning

Teachers throughout the schools make effective use of cooperative learning strategies. Teachers formed heterogeneous groups of three to four, often assigning roles to ensure that all students were encouraged to contribute to a project. Teachers believed in the importance of students learning to work together and learning to view their fellow students as resources, giving more complex assignments to students who were able to join their resources to complete them. Students thus gained confidence in their own ability to make contributions to a group effort and had opportunities to problem-solve with their peers. Cooperative strategies were particularly effective with the school's LEP, students both as boosts to their confidence and as a way of providing them many opportunities to write and speak.

E. PROGRAM FOR LEP STUDENTS

Ms. Svedman's class, described earlier, is part of a carefully designed program for newcomer students that prepares them for transition to a mainstream instructional environment. Figure 9-3 displays a schematic of the newcomer program; the following section examines its features.

Language Acquisition Program

Wiggs uses a Language Acquisition for the Middle School Program (LAMP) which consists of a Sheltered English program with a strong ESL component. It is supplemented by Spanish-language classes and implemented by teachers who are specially trained in ESL and in Sheltered English. Most of the teachers in the program are fluent in Spanish, the native language of their students. LAMP classes are smaller than regular classes, averaging between 14 and 15 students per class, allowing teachers to provide intensive instruction to LEP students and track individual students' progress.

Students in the LAMP classes are newcomers, and remain in LAMP only as long as it takes to prepare them to function in the mainstream instructional environment of the school. Upon entry, newcomer students are assigned a LAMP level based on their level of English fluency and take content and ESL classes with teachers who are specially trained to offer Sheltered instruction. At Wiggs, the LAMP program has three levels:

- *Beginning LAMP*: students take all Sheltered content classes along with an ESL class. Sheltered classes are taught by a LAMP teacher; all beginning students also take a Spanish language arts class.
- *Intermediate LAMP*: students take some Sheltered content classes, mainstream classes for which they are prepared, an ESL class, and a Spanish language arts class.
- *Advanced/Transitional*: students take mainstream classes but get ESL support from LAMP staff.

LAMP students are assigned to one of two LAMP families, beginning or advanced. Each LAMP family spans grades 6 through 8, allowing the program the flexibility to accommodate all newcomer students. Students are placed at grade levels according to their age. Newcomers who are not literate in their native language receive an individualized instructional program which is tailored to the strengths and needs of the student.

Staff work to keep students at grade level and making progress through the grades while they are acquiring English. The program's structure allows staff the flexibility to move a student from the beginning family to the advanced when he or she is ready to move, and the program is able to accommodate newcomers arriving throughout the year.

Students in the LAMP program have an intensive ESL class that replaces an English language arts class. Beginning and intermediate LAMP students take a Spanish language arts class to encourage them to continue their Spanish language development. Their content classes, including mathematics and science, are taught by teachers trained in sheltered English instructional techniques. The LAMP mathematics and science teachers hold secondary certificates in their subject area. (In Texas, the elementary credential qualifies a teacher to teach at the middle school. Most secondary certificate holders teach at the high school.) Staffing in the LAMP program is stable—most LAMP teachers have taught at Wiggs for several years.

The goal of the LAMP program is to prepare students to move into an all-English environment. This is especially important because the district's high school program is in English and there is little support at the high school for English language development. LAMP teachers at Wiggs believed that their students stood a much better chance of succeeding in a high school setting and ultimately graduating if they could take the regular high school classes. When students are ready to move from the advanced LAMP program to all-English classes, they are able to smooth the transition with help from the LAMP teachers who track their progress and assist them as necessary.

Language Use and Language Acquisition Strategies

Teachers report using a number of strategies to help students learn English. Content teachers in the beginning LAMP family use Spanish for clarification with students who speak no English. Teachers use more English as the year progresses, always employing Sheltered English strategies—repeating key concepts, speaking slowly, using key words and phrases consistently, and incorporating expressive inflections and many examples—to make students comfortable. Non-verbal methods like gestures and body language are also valuable instructional tools.

While LAMP teachers speak to their students primarily in English, students speak to their teachers and to each other in either English or in Spanish. The exception is ESL. Here, the teachers speak and respond to their students only in English, even though students may speak to them either in Spanish or English. ESL teachers stress the importance of serving as an English language role model, but encourage students to use their Spanish when they are unable to express themselves in English.

Teachers use cognates both orally and in written language to show the transferability of words. Because most of the teachers in the program are fluent in Spanish, they understand and make use of the similarities between Spanish and English. A teacher explained, “I would say ‘terminates’ rather than ‘ends’ so students would make the association with ‘terminado,’ then I would say ‘end’ and ‘terminate’ to connect the words for them.” Writing words out is another helpful technique. Mathematics teachers have found that if they write terms on the board in English, students will understand them because they will see that English mathematical terminology is nearly identical to the Spanish. Teachers use students’ Spanish literacy as a key to unlock the door to English. “If students are literate in Spanish, they can be easily transitioned to English.”

LAMP Team and Departmental Relationship

The five teachers from each LAMP family meet on a daily basis to plan collective and schoolwide activities, discuss problems individual students are facing, and work on transition issues for students moving into the mainstream.

These interactive, collegial relationships between teachers pay off for students; each member of the teaching team can “follow” a particular student through all of his classes. As a result of these meetings, teachers have deep knowledge of the students in their family, their school progress, and their home situations, and are alert to signs of problems in any area. They check on student absences, contact parents when there are academic issues, and work collaboratively with parents and students to find solutions.

the department. In the science department, for example, the LAMP teachers share ideas with the mainstream science teachers on how to present materials, and coordinate activities and departmental themes. One of the LAMP science teachers at Wiggs is the only LAMP teacher in the district whose classroom is a science lab.

Parent Involvement

The team structure also facilitates productive working relationships with parents. Student academic matters are handled by each family team; the whole team meets with the parent of a student having academic difficulty so parents can get a sense of how their student is doing in each subject and teachers are able to speak to a student's strengths and weaknesses. The LAMP teams request parent conferences not only to get parents' help with problem situations, but also to give praise. Communications from school can therefore be positive as well as negative or disciplinary; a letter from a child's teachers might be an invitation rather than an ultimatum.

Parents of newcomer students want their students to do well and are typically unfamiliar with how U.S. schools work. Team meetings with newcomer parents are an effective way to introduce them to school. Since most members of the two LAMP teams are fluent in Spanish, parents feel comfortable relating to their child's teachers. Once the barrier is broken, it is much easier for parents to become involved in other school activities.

Wiggs conducts all communications with parents in two languages and all meetings are conducted bilingually. The school has had good responses from the parents of newcomer students; many parents have participated in parent information and training activities on study skills and parenting strategies.

F. DISTRICT SUPPORT

Advocacy for Middle School Model

The El Paso Independent School District is embracing the middle school concept and has appointed an Assistant Superintendent for Middle Schools. The district supports the family structure as the most effective way to keep track of and maintain connections with students, especially minority students. Staff at the district are conversant with the literature showing the connection between student achievement and the organization of schools into smaller units.

Wiggs was the first school in the district to move to a family structure and serves as a model for other middle schools considering moving toward the middle school concept. The district supports a wide range of staff development activities geared toward implementing the middle school concept.

Support for Lowered Class Size

The district supports reduced class size in classrooms for LEP students because district staff believe that smaller class size allows for more individualized support for LEP students—particularly as they were preparing to move into an all-English environment. At the beginning and intermediate LAMP levels, the district has established a class size limit of 10-15 students, while the regular program has a class size of about 25 students at the middle school level. The district combines state compensatory funds, bilingual education funds, and district funds to pay for these class size reductions; it also pays a \$1,000 stipend to bilingual and ESL teachers.

Staff Development

The El Paso district supports staff development for staff at Wiggs and other district schools on issues surrounding the implementation of the middle school model as well as a range of other staff development activities. Teachers at Wiggs have taken classes with the district on Sheltered English techniques, cooperative learning strategies, alternative assessment techniques, and other topics relevant to the program at Wiggs. The district tries to be responsive to needs for staff development expressed by school staff throughout the district.

G. SUMMARY

Wiggs Middle School has created an exciting and effective program for LEP students by focusing on the range of LEP student needs and crafting a flexible instructional program designed to meet them. The family structure of the school and the staff's emphasis on language acquisition strategies have paid particular dividends.

Family Structure. The organization of the school into families has made it possible for Wiggs teachers to develop in-depth knowledge of their students' academic strengths and weaknesses and the quality of students' home support structures. They have put this knowledge to good use—designing instruction that is best suited to students' needs, advising individual students, and ensuring, wherever possible, that parents become involved in their children's education. The family structure has lent itself to curriculum coordination across subjects and grade levels, the development of curriculum themes, and team teaching. It has also made it easier for Wiggs teachers to pursue cooperative learning strategies; in turn, these strategies have made it possible for teachers to devote time to individual students while other students work in cooperative groups.

Use of Language Acquisition Strategies. Wiggs has made a point of focusing special attention on LEP students through a Sheltered English program with a strong ESL component. Classes for LEP students average only 14-15 students per class, and are taught by content area teachers who are

specialty trained to offer Sheltered instruction. Students are placed in grade levels according to their age; Wiggs staff are determined to keep students at grade level—and making progress through the grades—even if their English language skills are deficient at first. Teachers use Spanish with students when necessary, but make a point of speaking to the students in English in order to provide as much English language practice as possible. They employ the range of Sheltered instructional techniques—repeating key concepts, speaking slowly, using body language, using many examples, etc.—in order to move their students from Spanish to English as rapidly as possible while ensuring student understanding of curriculum content.

CHAPTER 10

LESSONS ABOUT EXEMPLARY PRACTICES AND SCHOOLS SERVING LEP STUDENTS

The case studies presented in preceding chapters show how exemplary pedagogical practice within a framework of support provided by the school, district and/or external factors can create effective and exciting education for LEP students. We intended our portraits of learning environments *in vivo* to convey the stimulating atmosphere in outstanding classrooms, while highlighting findings and lessons that might inform both practitioners and policymakers. Necessarily, our descriptions are snapshots that do not cover the full range of positive or negative activities at the sites. The snapshots nonetheless represent the fruits of school staffs' commitment to become better at meeting the complex challenges of language diversity and their willingness to experiment, reflect, and experiment again, making adjustments over time as they learn and as conditions change.

These cases tell us **what is possible**, not what is average. Indeed, our past research indicates clearly that the schooling at these sites is fundamentally unlike the schooling most LEP children receive. The classrooms we studied were winnowed according to criteria and methods described in Chapter 1, and were never intended to be representative of all schools with LEP students or even of all secondary schools. But therein lies the power of the cases: From them, practitioners can gain clues about strategies for improving education for LEP—and perhaps all—students, while policymakers can learn about the types of strategies that can support and nourish excellence in the classroom. The body of this chapter sketches the broad lessons that arise from looking across of the eight sites, setting the stage for the more extensive treatment of findings presented in *School Reform and Student Diversity, Volume I: Findings and Conclusions*.

While our classrooms are not representative, their successes—and they are successful with culturally and linguistically diverse students, many of whom are poor and/or recent immigrants—demonstrate what can be done elsewhere. The innovations we describe stemmed from a commitment at the sites to teach every student well; solutions came from reflective, problem-solving searches. While none of the sites described here has yet realized its goal totally, each has demonstrated the LEP students can learn challenging content in language arts, math, and science while becoming literate in English. Further, LEP students can realize the high expectations for academic achievement and personal development expected from all other students.

The results achieved at these sites help put to rest the unwarranted assumption that schools must wait to provide LEP students with ambitious curriculum until they have mastered English. The exemplary sites instead began with the conviction that mastering high quality curriculum and acquiring English are best done together. To meet this challenge, they developed the innovative strategies and approaches which are synthesized into the lessons described below.

Lesson #1. A comprehensive school-wide vision provided an essential foundation for developing outstanding education for LEP students.

The exemplary schools all developed, often by means of an extended process, a schoolwide vision of what quality schooling should be like for all their students, including their LEP students. Though the specifics of the vision differed across the sites, five clear themes emerged independently at every site.

First, all the schools expected LEP students—all students—to learn the language arts, math and science curriculum to the high standards necessary for successful adult lives. Individual strengths and needs were respected, and efforts were made to help every student realize his or her potential. At the same time, students' attainment of fluency in written and oral English were assumed to be fundamental and universally achievable, as evidenced by the placement of students in heterogeneous groups.

Second, these schools embraced the culture and language of students, welcoming parents and community members into the school in innovative ways. This cultural validation broke down alienation and helped the schools create a climate without fear or subtle put-downs.

Third, they worked on developing a community of learners in which teachers were treated as professionals, allowed to learn from each other, and given the time to develop programs. It was well understood that teachers of LEP students should be fluent in the native language and/or trained in language acquisition, and that continuing professional development was essential to improving the educational program. The community of learners extended beyond teachers and students, often involving parent and community education. And the community itself became a source for meaningful learning experiences.

Fourth, the exemplary sites were open to outside help. They welcomed and, at times, actively sought, external partners or research information from the outside in order to advance their understanding of how to realize their school vision.

Fifth, they saw the need to change in a comprehensive way, with implications for the entire school. The *system* of schooling needed to be re-examined in order to realize ambitious goals for students. The structure and content of the curriculum, the instructional paradigm and learning environments, language development strategies, the organization of schooling and the use of time, and school decision-making were understood to be interconnected. Though all elements were not necessarily addressed at once in all schools, staff at the exemplary sites believed systemic change was necessary.

The combination of these five dimensions of a shared vision—high expectations, cultural validation, community of learners, openness to external partners and research, and comprehensiveness—gave the exemplary schools an air of caring, optimism, and confidence, despite the great challenges they faced.

Lesson #2. Effective language development strategies were adapted to different local conditions in order to ensure LEP students access to the core curriculum.

All the exemplary schools adopted twin goals—that the LEP students would achieve English language fluency and master the content of the core curriculum provided for all students. Some schools added the third goal of developing and maintaining fluency in the students' native language. Whether or not they also sought maintenance in the native language, the exemplary schools varied in their approach to English language acquisition. The demographics of the LEP students at their school, the desires of the community, the vision for the school, the availability of qualified staff, and district and state policies influenced the particulars of their approach. However, some important similarities emerged.

All schools used students' primary language—either as a foundation for developing literacy skills, as a tool for delivering content, or both. In many cases, teachers also relied on high quality sheltered English. Sheltered English and primary language-based programs were typically complemented by ESL instruction. In addition, content area instruction—including language arts, mathematics, and science—was integrated into bilingual and sheltered programs for LEP students and was used as the context for oral and written language production.

All the language development programs were flexibly constructed to accommodate students with varying levels of fluency and, where appropriate, students from different language backgrounds. Rather than trying to fit all the LEP students into one mold, teachers could adjust curriculum, instruction, and the use of primary language to meet the varying needs of students. Such flexibility is necessary because of the diversity of students, and the schools found that the key to flexibility was having qualified and trained staff. In most classrooms with LEP students, teachers had been trained in language acquisition. In all cases where instruction occurred in the students' primary language, and in many cases where instruction was delivered using sheltered English, teachers were fluent in the home language of their students. To promote interaction between LEP and English-only students, teachers team taught and employed a wide range of grouping strategies.

Finally, transition from classes where instruction was delivered in students' primary language or sheltered English to mainstream classes was gradual, carefully planned, and supported with

supported with activities such as after-school tutoring to ensure students' success at mastering complex content in English.

The net result of these approaches was that the exemplary schools assured LEP students access to the core curriculum while simultaneously developing their English language skills.

Lesson # 3. High quality learning environments for LEP students involved curricular strategies that engaged students in meaningful, in-depth learning across content areas led by trained and qualified staff.

The exemplary schools created and delivered a high quality curriculum to their LEP students that paralleled the curriculum they delivered to other students at the same grade level. The curriculum was presented in a way that was meaningful to LEP students by making connections across content areas and building into the curriculum real-life applications relevant to the students' experiences. Middle schools linked science and mathematics curricula, as well as social studies and language arts, allowing students to explore more complex relationships between the traditional disciplines. Similarly, the elementary schools created opportunities for students to use their language arts skills across the curriculum. Language arts curriculum was often literature-based and students read and wrote about topics that were relevant to their culture and experience. In science, the schools created curriculum that drew on the students' environment to maximize possibilities for hands-on exploration. Mathematics was often taught using frameworks such as thematic units or project-based activities to build students' conceptual understanding and computational skills in an applied context that related to real-life situations. Finally, by focusing on concepts over an extended period of time, teachers emphasized depth of understanding over breadth of knowledge.

Lesson #4. Innovative instructional strategies which emphasize collaboration and hands-on activities engaged LEP students in the learning process.

Since schools vary greatly in their demographic conditions, the cultural and educational backgrounds and experiences of LEP students, values of local communities, school resources, and the supply of trained teachers fluent in native languages, each exemplary site had to develop its own mix of instructional strategies for meeting the challenge of language diversity. However, across the exemplary sites, the strategies tended to be based on similar pedagogic principles and approaches to creating highly effective learning environments. These innovative principles aimed to engage students actively in their own learning. Teachers created nurturing learning environments that facilitated students working independently and in heterogeneous, cooperative groups. Instruction often consisted of students engaged in self-directed, hands-on experiential

learning, including inquiry and active discovery methods. These features, as implemented in the exemplary sites, are living examples of the new reform approaches to teaching language arts, science, and mathematics.

The overall lesson is that such strategies, combined with the curriculum approaches suggested in Lesson #3, are effective for LEP students at different levels of English oral, reading, and writing competency—assuming they are taught by trained and qualified teachers. Though most exemplary schools used various forms of student assessment, only a few made assessment a key element of reform by integrating assessment into everyday learning tasks, establishing long-term learning goals benchmarked to authentic assessments, and gathering such assessments into student portfolios.

Lesson #5. A schoolwide approach to restructuring schools' units of teaching, use of time, decision-making, and external relations enhanced the teaching/learning environment and foster the academic achievement of LEP students.

Each exemplary schools restructured its school organization to implement its vision of effective schooling, to facilitate the language development strategies and innovative learning environments described above, and, more generally, to increase the effectiveness of their human, educational, community, and financial resources. A key element of the sites' restructuring was their innovative use of time so that the academic schedule would respect the flow of learning units within classes. Such flexibility provided students with protected time to learn and allowed them to engage in self-directed learning activities within cooperative groups. Blocks of time were allocated appropriately for the pedagogic needs of different subject matter or themes (science projects, for example, could occupy a double period in middle schools). The school day and year were structured or extended to accommodate teacher planning, collaboration, and professional development, and to provide extra support for LEP students' transition to English and the incorporation of newcomers into the LEP program. In short, creative uses of time helped to tailor the educational program to the students' strengths and needs.

The exemplary sites at both the elementary and middle school levels also restructured their schools into smaller school organizations such as "families" which heightened the connections among students, between teacher and students, and among teachers. In some cases, the restructuring allowed a small group of students stay with the same teacher over four or five years; such continuity enabled the students to become skilled at cooperative learning, be highly responsible in their learning tasks and build self-esteem; it also enabled teachers to build their understanding of each student as well as to develop their capacity to apply new instructional

approaches in practice. "Families" with LEP students were consistent with learning environments throughout the school.

Finally, exemplary schools had redesigned their governance structures through a process of democratic decisionmaking that often involved teachers, parents, and community members to insure that restructuring was supported by a broad consensus. The exemplary schools delivered a range of integrated health and social services which reflected their vision of the school as an integral part of the surrounding community.

Lesson #6. External partners had a direct influence on improving the educational program for LEP students.

The exemplary schools drew on outside resources as they developed curriculum, implemented new instructional strategies, and designed meaningful assessment systems. External partners brought new ideas into the schools and reduced isolation by connecting schools with larger, often national, reform efforts. The role of external partners was particularly critical as schools reconceptualized their programs and undertook the challenge of extensive reforms in science and mathematics instruction, as well as in the integrated use of technology. In addition, schools collaborated with external partners to work through complex issues surrounding organizational change, such as the development of a system for site-level decisionmaking.

Lesson #7. Districts played a critical role in supporting quality education for LEP students.

Districts varied with respect to the amount and kinds of support they offered to the exemplary schools. However, those districts that supported the development and implementation of high quality programs for LEP students made direct, and in some cases, crucial contributions. Personnel in such districts believed that LEP students could learn to high standards, valued bilingualism, and employed specific strategies in support of LEP student programs. Districts recruited and offered stipends to bilingual teachers, provided staff development in bilingual teaching and second language acquisition, and made provisions to allow for reduced class sizes for LEP students. Districts supported the implementation of more powerful curriculum and instruction by providing staff development in response to the needs and interests of the teachers. Finally, districts supported school restructuring by shifting some decisionmaking responsibilities to the site level and participating in, or establishing, networks of schools undergoing restructuring, particularly schools implementing the middle-school model.

NCBE

**The George Washington University
The National Clearinghouse for Bilingual Education
1118 22nd Street, NW ■ Washington, DC 20037**