

## DOCUMENT RESUME

ED 391 288

EC 304 537

AUTHOR Borden, Peter A., Ed.; And Others  
 TITLE Trace ResourceBook: Assistive Technologies for Communication, Control & Computer Access. 1996-97 Edition.  
 INSTITUTION Wisconsin Univ., Madison. Trace Center.  
 SPONS AGENCY National Inst. on Disability and Rehabilitation Research (ED/OSERS), Washington, DC.  
 REPORT NO ISBN-0-945459-0401  
 PUB DATE 95  
 NOTE 962p.; For previous edition, see ED 363 079. Photographs may not copy well.  
 AVAILABLE FROM Trace Research & Development Center, S-151 Waisman Center, University of Wisconsin-Madison, 1500 Highland Avenue, Madison, WI 53705 (\$50).  
 PUB TYPE Reference Materials - Directories/Catalogs (132)  
 EDRS PRICE MF07/PC39 Plus Postage.  
 DESCRIPTORS \*Accessibility (for Disabled); \*Assistive Devices (for Disabled); Augmentative and Alternative Communication; \*Communication Aids (for Disabled); Computer Interfaces; \*Computer Peripherals; Computer Software; \*Disabilities; Equipment; Input Output Devices; Low Vision Aids; Microcomputers; Mobility Aids; Prostheses; Rehabilitation; Sensory Aids; Technology  
 IDENTIFIERS Switches

## ABSTRACT

This resource book lists approximately 1,500 products designed specifically for the needs of people with disabilities. Typically, each product is pictured; basic information is provided including manufacturer name, product cost, size, and weight; and the product is briefly described. The book's four sections each describe products designed for certain purposes. Part 1 covers communication aids, including speech aids, pointing and typing aids, training and communication initiation aids, non-electronic communication aids, electronic communication and writing aids, mounting systems, and telecommunication devices for the deaf. Part 2 covers switches and environmental controls. Part 3 focuses on computer adaptations, including modifications for standard keyboards and mice, alternate inputs, input adapters for computers, voice-output screen readers and reading machines, magnification products for computer displays, braille and tactile output systems, speech synthesizers, and other software and hardware adaptations. Part 4 describes application software for special education and rehabilitation, including training and therapy software, adaptive educational software, and personal tool and aid software. Six indexes list products by their functions, by their input and output features, by computer, by manufacturer, and by name. A listing of manufacturer addresses is also provided. Appendices provide lists of other resources such as books and pamphlets, disability resources on the Internet, software resources, computer assessment and training programs, organizations and self-help groups, and service centers for augmentative communication and computer access. A glossary is also appended. (DB)

ED 391 288

# Trace Resourcebook

U.S. DEPARTMENT OF EDUCATION  
Office of Educational Research and Improvement  
EDUCATIONAL RESOURCES INFORMATION  
CENTER (ERIC)

This document has been reproduced as received from the person or organization originating it  
 Minor changes have been made to improve reproduction quality

• Points of view or opinions stated in this document do not necessarily represent official OERI position or policy

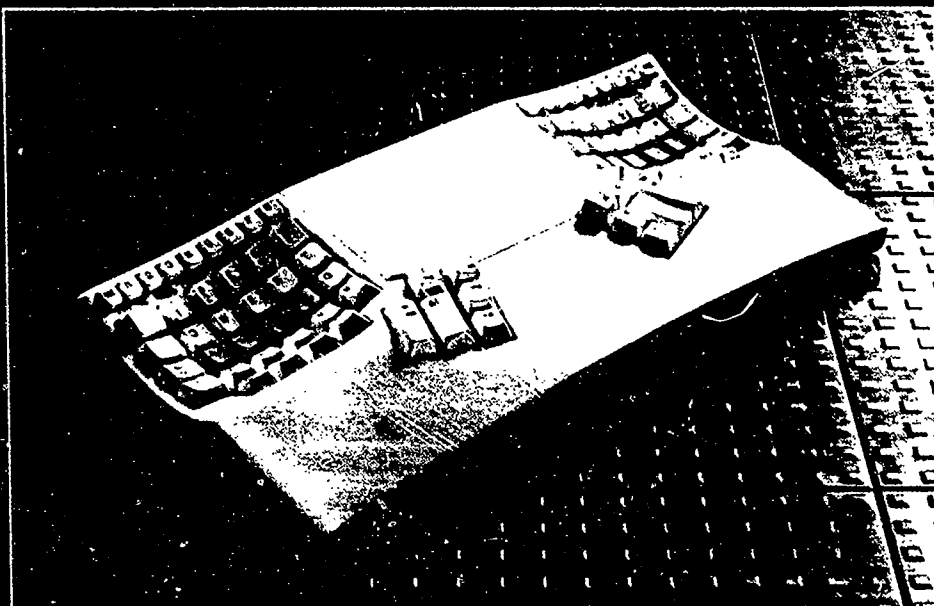

"PERMISSION TO REPRODUCE THIS MATERIAL HAS BEEN GRANTED BY

*M. E. Brady*

TO THE EDUCATIONAL RESOURCES INFORMATION CENTER (ERIC)."

## 1996-97 Edition

### Assistive Technologies for Communication, Control and Computer Access

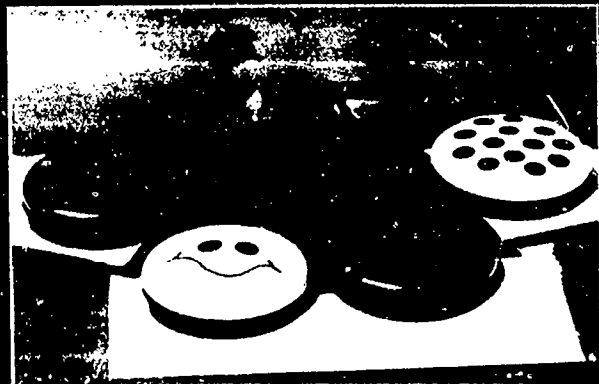

# Trace Center

# **Trace ResourceBook**

---

**Assistive Technologies for  
Communication, Control  
& Computer Access**

---

**1996-97 Edition**

---

*The Trace ResourceBook, 1996-97 Edition supercedes the earlier Trace ResourceBook, 1993-94 Edition. The information on products in the earlier edition has been revised and updated, and new information added.*

---

# **Trace ResourceBook**

**Assistive Technologies for  
Communication, Control & Computer Access**

## **1996-97 Edition**

*Editors*

Peter A. Borden  
Jaime L. Lubich  
Gregg C. Vanderheiden, Ph.D.



**Trace Research and Development Center  
Waisman Center  
University of Wisconsin-Madison**

Trace Research and Development Center  
S-151 Waisman Center  
University of Wisconsin-Madison  
1500 Highland Avenue  
Madison, WI 53705  
Voice: (608) 263-2309  
TDD: (608) 263-5408  
Fax: (608) 262-8848  
Internet: info@trace.wisc.edu

© 1995 by the Trace Research and Development Center,  
Waisman Center on Mental Retardation and Human  
Development, University of Wisconsin-Madison

In order to maximize dissemination of the information contained, no restrictions on dissemination have been made. Most of the photographs and drawings contained herein, however, are covered by other copyrights and, therefore, should *not* be duplicated in any way without obtaining permission from the author or source of the photograph or figure. It is requested that any excerpting of information from this document be done carefully to retain its accuracy and that use of this document be appropriately acknowledged.

ISBN 0-945459-0401

## Acknowledgements

Thanks are due to the many Trace Center staff members who have helped make the ResourceBooks an ongoing success.

Thanks to Candace Hill-Vegter, on whose original work the ResourceBooks have been based.

Thanks to Sharon Esser, Kate Vanderheiden and the rest of the office staff, for their assistance and their tolerance.

Thanks to all the companies who provided information and photographs.

Thanks to the agencies and companies who have helped support the Trace Center's information projects, particularly the National Institute on Disability and Rehabilitation Research (NIDRR), U.S. Dept. of Education.

And, once again, thanks to Dave Kelso for his programming magic, without which this book could never be so accurate or look so good.

*Peter Borden  
Jaime Lubich  
Gregg Vanderheiden*

Produced at the Trace R&D Center.  
Waisman Center, University of Wisconsin-Madison,  
in cooperation with

RESNA  
An association for the advancement of rehabilitation technology

Work leading to this book was funded in part by the National Institute on Disability and Rehabilitation Research, U.S. Department of Education.

# Preface: How to Use This Book

## Overview

The application of technology in the areas of augmentative communication, special education and rehabilitation is continually growing and changing. Private industries and public research institutions are always seeking new ways of addressing the needs of people with physical, sensory and cognitive disabilities. Fortunately, their work has borne considerable fruit. Unfortunately, it can be a bewildering task to keep track of what has been developed.

This book is for anyone who needs to know "what's out there": people with disabilities, parents, rehabilitation professionals, educators, administrators, therapists. The intent of the **Trace ResourceBook** is to help you understand and be able to locate useful tools quickly and efficiently, so you can devote your time and energy to applying them successfully. This volume lists products pertaining to communication, control, and computer access, as well as special software. For each product we have provided a vendor's name, a few basic facts about it, a photograph (if available and relevant), and a short description of the product's functions and capabilities.

This volume is a complete update, replacing the 1993-94 edition of the *Trace ResourceBook*. Information on products previously listed has been updated, obsolete products have been deleted, and new products have been added. The product information, including prices, were confirmed as of September, 1995.

## This Book Includes Special Devices and Software

This ResourceBook lists products designed specifically for the needs of people with disabilities. We recognize that there are a large number of products designed for the general public that can be useful to people with disabilities; however, we cannot list these due to the volume of material they represent. We have chosen to address this issue by including various "generic" entries in each chapter that provide basic information on where to look for mass-market solutions, rather than attempting to list them individually. The one exception to this rule is in the area of products--either hardware or software--which provide access to computers (Chapters 10 - 17). Some were designed for the general computer user but provide a clear enough advantage to certain computer users with disabilities that we have decided to include them in the ResourceBook.

## What You'll Find in This Book

Each section of this book contains products designed for different basic purposes. Part 1 covers "communication." This includes products primarily designed as aids to communication, both electronic and non-electronic. It includes aids that supplement speech or replace speech, as well as products that help with the process of non-speech communication. Some products in Parts 2 and 3 can aid in this process as well (you can find these using the "Special Indexes" described below).

Part 2 covers "control." It includes special switches--which can be used to control many of the products in all three parts of the book--plus environmental controls and calling devices. Part 3 covers "computer access." Chapters 11 - 18 list products which provide access to computers for people with disabilities. Chapters 19 - 21 list special software written specifically for the needs of people with disabilities.



Be sure to check the title page of each chapter for an explanation of what types of products can be found in that chapter.

## **Special Indexes Help You Find Products that Meet Special Needs**

Indexes 1 - 6 in the back of this book are designed to help you in your search for products that meet specific needs. These indexes cover all of the products listed in the ResourceBook. They allow you to search for products by certain characteristics. They won't necessarily provide you with one or two "perfect choices," but they can help you to narrow down your options, after which you can check the individual product descriptions to see which ones might be useful to you. You should then contact the manufacturer of the product (see Index 5 for addresses) to ask questions and to obtain detailed pricing and ordering information.

Index 1 lists products by their functions; Index 2 lists products (except switches) by their input and output features; Index 3 lists switches by their input and output features; Index 4 lists products by computer; Index 5 lists products by manufacturer, and provides manufacturer's addresses; Index 6 lists all of the products alphabetically. The index pages have been color coded to make them easier to locate.

The title page of each index provides directions on using that index. The page after the title page provides a list of the categories, or "codes," by which products are classified in that index. If you want to know what a particular function or feature code means, turn to that code in the index. There you will find a short description of what that code covers, along with a list of all the products that it applies to.

## **Products Are Not Indexed by Disability**

Products are not indexed by disability since we believe that this is not a useful approach. While some products are clearly for someone who is visually impaired, nonvocal, physically impaired, etc., many products could be used by people with any disability, just as standard software can be useful to people with disabilities as well as those without disabilities. For these reasons we believe that emphasis should move away from etiology labels, and toward a concentration on the functions a person desires and the input and output features required to make those functions accessible to that person.

## **Additional Sources of Information Are Also Provided**

Although information on products can be extremely useful in making decisions about assistive technologies, there will probably be other information you need as well. Appendices A and B provide lists of other resources and contacts that you may want to pursue in order to find the right solution for a particular situation. The appendices are divided into several lists, with titles such as "Computer Assessment and Training Programs," "Newsletters and Journals," and "Service Centers for Augmentative Communication and Computer Access." For the titles of these lists, check the Detailed Table of Contents at the beginning of this volume, or the title page of each appendix. If you locate a particularly knowledgeable resource that we do not have listed, please inform us or encourage the organization to send information to the Trace Center, so that we can cite them in future editions of the ResourceBook.

We particularly encourage you to check Appendix B (Service Providers and Organizations). In that appendix are two very important lists: the members of the Alliance for Technology Access, a nation-wide network of grassroots assistive technology groups (Appendix B-1); and all of the state programs funded under the federal Technology-Related Assistance for Persons with Disabilities Act (Appendix B-8). These lists can help you get in contact with the people in your immediate area who are most familiar with assistive technology and resources for obtaining it.

Appendix C is a glossary of special vocabulary used in product descriptions. In some cases a definition represents universal usage in the field; in other cases it is provided to clarify the use of a term in this book. The Glossary is not intended to be a comprehensive one for the field, only a useful adjunct to the product

descriptions in this ResourceBook. Like the indexes, Appendices A-C are also color coded (in two other colors) to make them easy to locate.

## **Changes in This Edition**

Users of past editions of the ResourceBook will notice some changes in this edition. Due to the incredible proliferation of software in special education and rehabilitation, we have had to limit the products listed in Chapters 19 - 21. In limiting the listings, we chose to focus on software directly used by people with disabilities. For example, we no longer list rehabilitation facility management software or software for analyzing test results.

This edition now includes approximately two dozen "generic" entries. In the fields of augmentative communication, control, and computer access, many beneficial assistive devices are not products designed, manufactured, and distributed specifically for people with disabilities. To assist the ResourceBook user in finding these products, we have written these generic entries of commercial mass-market products and placed them in chapters respective to the solutions they might provide.

You may also notice some changes in the chapter structure. There is a new chapter on "Mounting Systems." To make it easier to locate computer output adaptations, we have divided what was two chapters into three chapters: one for speech output, one for large print and one for braille. We've also broken what was one chapter (Education, Training and Therapy Software) into two (Training and Therapy Software and Adapted Educational Software). Although the line between "Education" and "Training" can be a fuzzy one, for the sake of readability we had to split up what had become an enormous chapter. We hope these changes will make the book a little easier for you to use.

## **A Caution: We Make No Endorsements**

The information contained in product entries is not evaluative, and inclusion in these books does not imply recommendation or endorsement. We have made every effort to make the entries consistent and informative. But because we are not able to use every product ourselves, a description includes only what the product is designed to do, not how effectively the product does it. The product descriptions have been written based upon information provided by the manufacturers.

## **This Volume Is One Part of Your Complete Search for Answers**

Remember, no product will work for you unless it is not only selected properly but implemented successfully. If you do not have a lot of experience with the technology, be sure to seek out as many people to help you as you can find. Besides resources such as those listed in Appendix B ("Service Providers and Organizations"), you may wish to contact vocational rehabilitation agencies, local school systems, hospitals, and private rehabilitation firms to determine if they have the necessary background and expertise in the areas of technology that you are interested in.

# Summary Table of Contents

<b>Preface: How to Use This Book</b> .....	vii
--	-----

## Part I: Communication Aids

<b>Chapter 1: Speech Aids</b> .....	1
Prosthetic and orthotic aids to oral speech, such as artificial larynges and speech amplifiers.	
<b>Chapter 2: Pointing and Typing Aids</b> .....	15
Headsticks, mouthsticks, handsplints, lightbeam headpointers, and any other devices for facilitating an individual's ability to point or press keys.	
<b>Chapter 3: Training and Communication Initiation Aids</b> .....	27
Electronic devices designed to initiate communication or train individuals in the use of switches or selection techniques.	
<b>Chapter 4: Non-Electronic Communication Aids</b> .....	67
All communication aids which do not involve any electricity.	
<b>Chapter 5: Electronic Communication and Writing Aids</b> .....	115
Electronic aids which are designed for conversation or writing.	
<b>Chapter 6: Mounting Systems</b> .....	163
Devices used to mount a switch, communication system, or computer access device so that an individual can access it optimally.	
<b>Chapter 7: Telecommunication Devices for the Deaf (TDD's)</b> .....	177
Devices which have been specifically designed for deaf individuals to communicate over phone lines using ASCII, Baudot, or touchtones.	

## Part II: Switches and Environmental Controls

<b>Chapter 8: Switches and Controls</b> .....	199
Switches and user interfaces which are marketed as separate devices and which are intended to be used with a wide range of communication or control aids. Switches and controls which work with only a single aid are listed as accessories for that aid.	
<b>Chapter 9: Environmental Controls and Telephone Adaptations</b> .....	261
Devices and systems whose function is to control some other device in the person's environment. This includes page turners, telephone dialers, remote appliance controls, television controllers, etc.. Training aids are in Chapter 3; computer access aids are in Chapter 12.	
<b>Chapter 10: Call, Monitoring, and Memory Systems</b> .....	309
Special call buzzers, adaptations to hospital call systems, telephone emergency call systems, activity monitors for elderly or disabled persons, and memory aids or reminder systems for elderly individuals and those with retardation or brain damage.	

## Part III: Computer Adaptations

<b>Chapter 11: Modifications for Standard Keyboards and Mice</b> .....	<b>329</b>
Keyguards, keylatches, foot operated shift controls, and software adaptations for rearranging or modifying the operation of the standard computer keyboard.	
<b>Chapter 12: Alternate Inputs</b> .....	<b>371</b>
Alternate input systems which are only designed to work with all of the standard software which is written for the computer. This includes systems which work directly with all software, as well as interfaces which require some adaptor in order to work with all software.	
<b>Chapter 13: Input Adapters for Computers</b> .....	<b>451</b>
Special adapters that go between switches, controls, keyboards, etc., and the standard computer in order to allow them to work together.	
<b>Chapter 14: Voice-Output Screen Readers and Reading Machines</b> .....	<b>465</b>
Software or software/hardware products which provide access to standard software through voice output. It also includes optical character recognition (OCR) reading systems with voice output.	
<b>Chapter 15: Magnification Products for Computer Displays</b> .....	<b>491</b>
Software and hardware products whose primary purpose is to magnify the image on a standard computer screen. Products in this chapter are designed to work with all or most software.	
<b>Chapter 16: Braille and Tactile Output Systems</b> .....	<b>505</b>
Braille printers and other tactile devices that provide access to a standard computer screen.	
<b>Chapter 17: Speech Synthesizers</b> .....	<b>523</b>
Hardware and software based speech synthesizers that are designed to be used by other application programs.	
<b>Chapter 18: Other Software and Hardware Adaptations</b> .....	<b>539</b>
Disk loaders, special desks, devices to slow down computers, screen print routines, software conversion programs, and other miscellaneous adaptations for computers.	

## Part IV: Application Software for Special Ed and Rehab

<b>Chapter 19: Training and Therapy Software</b> .....	<b>553</b>
Software that is designed for training and therapy of basic skills, ADL skills, communication skills, etc.	
<b>Chapter 20: Adaptive Educational Software</b> .....	<b>711</b>
Application software and software/hardware packages whose primary function is to educate.	
<b>Chapter 21: Personal Tool and Aid Software</b> .....	<b>735</b>
Software programs designed to be used on a long-term basis by an individual as a personal tool or prosthetic aid. This includes programs that facilitate an individual's ability to communicate, write, draw, control, move about, etc.	

## Appendixes

<b>Appendix A: Information Resources</b> .....	<b>775</b>
Sources of information about a variety of topics relevant to the application of technology in special education, rehabilitation and augmentative communication.	

**Appendix B: Service Providers and Organizations** ..... 799  
 Resource lists of people and organizations that provide services relevant to the application of technology in special education, rehabilitation and augmentative communication.

**Appendix C: Glossary** ..... 827  
 Definitions of terminology used in the product descriptions which might be new or unfamiliar to many readers.

**Indexes**

**Index 1: Products Listed by Function** ..... 835

**Index 2: Products Listed by Input/Output Feature** ..... 861

**Index 3: Switches Listed by Input/Output Feature** ..... 879

**Index 4: Products Listed by Computer** ..... 885

**Index 5: Manufacturers Listed with their Products** ..... 901

**Index 6: Alphabetical Listing of all Products** ..... 921

# Detailed Table of Contents

<b>Preface: How to Use This Book</b> .....	<b>vii</b>
<b>Chapter 1: Speech Aids</b> .....	<b>1</b>
ADDvox III System.....	3
Amplifiers.....	3
Cooper-Rand Electronic Speech Aid.....	4
Denrick Speech Aid.....	4
Electronic Artificial Larynx.....	5
Electronic Speech Clarifiers.....	5
Handset for Speech Amplification.....	6
Mini Vox Amplifier.....	6
Nu-Vois.....	7
Park Speech Amplifier.....	7
Passy-Muir Speaking Valves.....	8
Rand Voice Amplifier.....	8
Robot Voice Synthesizer.....	9
SERVOX Inton.....	9
Speech Enhancer 100, 200 & 400.....	10
Speechmaker.....	10
Tokyo Artificial Larynx.....	11
Voice Amplificaid.....	11
Voicette.....	12
<b>Chapter 2: Pointing and Typing Aids</b> .....	<b>13</b>
Adjustable Head Pointer.....	15
Adjustable Head Pointer.....	15
Adjustable Head Pointer PC 7590.....	16
Baton Laser Pointer.....	16
Clear-View Head Pointer.....	17
F73216-100 Page Turner/Keyboard Aid.....	17
Gripper Prehensor.....	18
H71830 Adjustable Head Pointer.....	18
H7321 7 Mouth Held Page Turners.....	19
Handpointers.....	19
Head Pointers: AD-1, AD-2, AD-3.....	20
Heyer-Abadie Modular Mouthstick.....	20
Laser Light Pointer.....	21
Light Beam Indicator.....	21
Light Pointer.....	22
Light Pointer.....	22
Light Pointers.....	23
LightBeam.....	23
Mouthsticks.....	24
RedLite.....	24
Slip-On Typing Aid.....	25
Talking Laser Beam.....	25
Vacuum Wand.....	26
Viewpoint Optical Indicator.....	26
<b>Chapter 3: Training and Communication Initiation Aids</b> .....	<b>27</b>
Ability Switch Tester (S955).....	29
AC Adaptor FRE-103C.....	29
Activity Board.....	30

Activity Boxes.....	30
AND Module.....	31
And Or Box.....	31
Battery Adapter.....	32
Battery Device Adapter.....	32
Battery Interrupter.....	33
Battery Interrupters.....	33
Buzzer Box.....	34
Card Communicator.....	34
Chime Box.....	35
Clear Clock Communicator.....	35
Clock Communicator.....	36
Comboard (2615).....	36
Communiclock.....	37
Commulight 24.....	37
Compartmentalized Clock Communicator.....	38
Compartmentalized Communicator.....	38
Counter Box.....	39
Counter Module.....	39
Delay Timer Box.....	40
Dial Scan.....	40
Dual Action Latch.....	41
Dual Channel Latching Switch Interface.....	41
Dual Clock Communicator.....	42
Duo-Responder.....	42
E-Tran Scanner.....	43
Environmental Control for Kids.....	43
Intention Module.....	44
Invertor Module.....	44
Keypad (2425).....	45
Latch Box.....	45
Light Activated Switch Panel.....	46
Lighted Vibrating Signalling Buzzer.....	46
LinkSwitch.....	47
Multi-Switch Module.....	47
Music Button.....	48
Nine Compartment Row/Column Scanner.....	48
Nine Volt Battery Adapter Module.....	49
On/Off Module.....	49
Peg Switch.....	50
PigTail Adapters.....	50
Portable Sound Source II.....	51
Puzzle Switches.....	51
Quad Talk.....	52
Rhythm Generator.....	52
Round Clock Communicator.....	53
ScanLite.....	53
Sequential Scanner.....	54
Series Adapter.....	54
Six Position Activity Box.....	55
Slide Projector Control.....	55
Steeper Communication/Teaching Aid.....	56
Switch Latch (4388).....	56
Switch Latch and Timer.....	57
Switch Latch/Timer.....	57
TDD Trainer System.....	58
Three Position Activity Box.....	58
Timer Module.....	59
Toy Adapter.....	59
Toy Adapter Cables: CA-9/CA-12/CA-16.....	60
Toy Cables (4378, 4379).....	60
Trace Beeper Box.....	61
Training Aid 2.....	61
Tri-Responder.....	62

Tubular Vibrator .....	62
Universal Module .....	63
Versascan .....	63
Vibrating Sack .....	64
VoiceMate, SwitchMate, ScanMate (2701-2708) .....	64
WPS Loquitur 115 and 250 .....	65
<b>Chapter 4: Non-Electronic Communication Aids .....</b>	<b>67</b>
AccessBliss 2.2 .....	69
Alphabet Board Kit .....	69
AlphaPad .....	70
Appointment Book .....	70
Attainment Communication Collection .....	71
Blissymbol Templates .....	71
Blissymbol Vocabulary Stamps .....	72
Blissymbols Gallery .....	72
Boardmaker 3.0 .....	73
Boardmaker for Windows .....	73
Bradley Board Communication Aid .....	74
Calendars .....	74
Chain Talk .....	75
Cleo Communication Board .....	75
Communication Binder .....	76
Communication Board .....	76
Communication Board Builder .....	77
Communication Displays for Engineered Preschool Env. ....	77
Communication Folder and Tri-Folder .....	78
Communication Icon Galleries CD-ROM .....	78
Communication Sheets .....	79
Communication Symbol Holders .....	79
Core Picture Vocabulary .....	80
Core Vocabulary .....	80
Deluxe Communication Board Kit .....	81
Deluxe Talk Board .....	81
DynaSyms .....	82
Emotional Moods & Needs-G 3&4 .....	82
Eye Transfer Communication System .....	83
Eye-Com .....	83
Eye-Com Board .....	84
Fold It System .....	84
Foods I Like Menu Book .....	85
Help Me at Home & School-G 5&6 .....	85
Help Me to Help Myself Handbook .....	86
Holiday Kit .....	86
ICU-G 1&2 .....	87
Illustrated Menu .....	87
Imaginart Gallery .....	88
Individualized Communication Systems .....	88
Life Experiences Communication Kit .....	89
Long Wallet .....	89
Mealtime Stickers .....	90
Mega-Book .....	90
Mid-Sized Communication Book .....	91
Mini Picture Set .....	91
Nu-View-Cue .....	92
Oakland Schools Picture Dictionary .....	92
Object Communicator .....	93
Object Display .....	93
Object Stand or Calendar Box (3 or 5) .....	94
Object-Picture Talk Board .....	94
Opticommunicator .....	95
Passport Kits .....	95
PCS Color Stickers .....	96



PCS Stamps .....	96
PCS Wordless Edition .....	97
PEACEbook .....	97
Pick 'n Stick Color Micros .....	98
Pick 'N Stick Color Packs .....	98
Pick 'N Stick Fast Food .....	99
Pick 'n Stick on Disk .....	99
Pick 'n Stick Primary Pack .....	100
PICSYMS Categorical Dictionary .....	100
Picture Communication Symbols - Combination Book .....	101
Picture Communication Symbols, Books I, II & III .....	101
Picture Prompt Cards .....	102
Picture Prompt Stickers .....	102
Picture Prompt System .....	103
Picture Your Blissymbols .....	103
Pictures, Please! .....	104
Pocket Book .....	104
Pocket Picture Holder .....	105
Pocket-Sized and Double Pocket-Sized Communication Book .....	105
Porta Boards .....	106
Porta Book .....	106
Select-A-Meal and Shopping Smart .....	107
Self-Talk Stickers .....	107
Silent Speaker .....	108
Stickers for Talk Boards .....	108
Talking Pictures Communication Board .....	109
Talking Pictures, Kits I - VII .....	109
Touch 'N Talk Communication Board .....	110
Touch 'N Talk Communication Notebook .....	110
Touch 'N Talk Communication Stickers .....	111
Touch 'N Talk Micros .....	111
WordWise Language & Master Cards .....	112
WordWise Sticker Set .....	112
Writing Utensil Grips .....	113
Zoo Kit .....	113

**Chapter 5: Electronic Communication and Writing Aids .....** 115

A.I.P.S. Wolf (Alternate Input Peripheral System) .....	117
Able2Speak .....	117
Abovo PCD .....	118
ActionVoice .....	118
AlphaTalker .....	119
Attainment Fifteen Talker .....	119
Attainment Five Talker & Talker Plus .....	120
Attainment Two Talker .....	120
Audible Cursor Routine .....	121
AudScan II .....	121
BIGmack .....	122
BlackHawk .....	122
Canon Communicator CC-7S and CC-7P .....	123
CarryCom .....	123
Cheap Talk 4 & 8 .....	124
Communication Programs .....	124
Companion 401 Communicator .....	125
Crespeaker .....	125
Crestalk .....	126
DAC .....	126
DeltaTalker .....	127
DigiTalk 1 .....	127
DigiVox .....	128
Dvorak One-Hand Typewriter .....	128
DynaVox2 & DynaVox2c .....	129
DynaVox2 DOS & DynaVox2 Mac .....	129

EasyTalk.....	130
Electronic Speech Synthesizers.....	130
Equalizer.....	131
EvalPAC with RealVoice.....	131
Eyegaze Computer System.....	132
FingerFoniks.....	132
Gus! Multimedia Speech System.....	133
Handheld Computers and Personal Organizers.....	133
Handy Speech Communication Aide.....	134
Hawk.....	134
Heidico Intertalk.....	135
Help U Type and Speak.....	135
HyperBliss 3.2.....	136
I Can Speak.....	136
IntelliTalk.....	137
Liberator.....	137
LightWRITER SL35.....	138
LightWRITER SL5.....	138
LightWRITER SL85.....	139
Lingraphica.....	139
Lynx.....	140
Macaw Series.....	140
MegaWolf.....	141
MessageMate 20.....	141
MessageMate 40.....	142
Messenger.....	142
Meta4.....	143
Mini Talking Card Reader.....	143
Mini-MessageMate.....	144
Parrot.....	144
Pegasus.....	145
Personal Trainer.....	145
Picture Icon X-CHANGE.....	146
Polycom.....	146
ReadyScan.....	147
RealVoice.....	147
Say-It-All II Plus.....	148
Say-It-Simply Plus.....	148
Scan Com.....	149
Scan-It-All.....	149
ScanPAC.....	150
Scribe.....	150
Secretary.....	151
Shadow Talker.....	151
SpeakEasy.....	152
Speaking Dynamically.....	152
Specialist.....	153
Switch Module.....	153
Switchboard.....	154
System 2000.....	154
Talk Back III.....	155
Talk Back VI.....	155
Talk:About.....	156
Talking Screen.....	156
Talking Screen for Windows.....	157
Talking Switch Plates.....	157
TS2010X Text to Speech Personal Communicating Device.....	158
VisionKey.....	158
Vocal Assistant.....	159
VoiceBachs.....	159
VoicePal.....	160
VoicePal Plus.....	160
VOIS 160.....	161
WalkerTalker.....	161

Whisper Wolf .....	162
Yak Bak .....	162
<b>Chapter 6: Mounting Systems .....</b>	<b>163</b>
Adaptive Fixtures Kit .....	165
Communication Station .....	165
Daessy Desktop Mount .....	166
Daessy Folding Mount .....	166
Flexible Wheelchair/Table Mounting Kit .....	167
Head Mounting Kit .....	167
Laptrays .....	168
Low-Tech Adaption Materials .....	168
Magic Arm System .....	169
Mighty Mount .....	169
Moulded Plastic Wheelchair Tray .....	170
Mounting Packages & Switches .....	170
Mounting Switch Mount .....	171
PowerBook Mounting Plate .....	171
Quick 'n Easy 2 .....	172
Slim Armstrong .....	172
Support Station .....	173
Switch Mounting Hardware .....	173
Switch Mounting Kit .....	174
Switch Mounts .....	174
TASH Mounting Plates .....	175
Universal Switch Mounting System .....	175
WCMK .....	176
<b>Chapter 7: Telecommunication Devices for the Deaf (TDD's) .....</b>	<b>177</b>
ASCII-TDD Software .....	179
Atlantic 144 TTY .....	179
Compact TTY .....	180
Dialogue TTYs .....	180
Dialogue VCO Read & Talk Telephone .....	181
Futura-TTY .....	181
InfoTouch .....	182
Intele-Modem .....	182
Lite Touch Telephone Communicator .....	183
Message Center .....	183
MIC300i Computer Modem .....	184
Minicom IV .....	184
Miniprint 425 .....	185
NexCom 300vi & 300ve .....	185
Pay Phone TTY .....	186
Personal Communication Terminal (PCT) .....	186
Phone-TTY CM-4 Computer Modem .....	187
Porta Printer Plus .....	187
PortaView .....	188
Positron Express .....	188
SIDDD (Software Interface for the Deaf and Disabled) .....	189
SM85 Smart ASCII/Baudot Modem .....	189
Supercom 4400 TTY .....	190
Superprint 100, 200, 400 .....	190
Superprint 4425 .....	191
Superprint ES TTY .....	191
TDD 2700, 2730, and 2830 .....	192
TDD Detector .....	192
TeleBraille III .....	193
TeleView 40 & 80 .....	193
ToneTalker .....	194
UltraSilent .....	194
Uniphone 1000 .....	195

Uniphone TDD/TT .....	195
VCS 3500 with TDD Software .....	196
WinTalk .....	196
Writalk Electronic Pen Pad .....	197
<b>Chapter 8: Switches and Controls .....</b>	<b>199</b>
4-Plate Switch: CM-15 .....	201
4-Pneumatic Switch: CM-17 .....	201
4-Pushbutton Switch: CM-16 .....	201
4-Switch Joystick: CM-19 .....	202
5-Pushbutton Switch: CM-18 .....	202
5-Tread Switch Slot Control: CM-50 .....	202
Adjustable Pressure Switch .....	203
Air Cushion Switch .....	203
Air Cushion Switch (Single or Dual) .....	203
Air Switch .....	204
Air Wave Switch .....	204
Analog Switch Pad .....	204
Arm Slot Control .....	205
Armslot Switch Controller ASC-5 .....	205
BASS Switches .....	205
Big Red, Yellow, Green, and Blue .....	206
Body Parts Switch .....	206
Body Switch BS-1 .....	206
Breath Input Device .....	207
Buddy Button (5710-5773) .....	207
Button Switch .....	207
Button Switch .....	208
Cap Switch (5806) .....	208
Capacitive Touchplate Interface .....	208
Clamp-On Bump Switch .....	209
Classic Paddle Switch .....	209
Coil Spring Wobble Stick Switch .....	209
Computer Keyboard Switch .....	210
Computer Switch Plate .....	210
Continuous Movement Switch (CMS) .....	210
Controflex Foot Switches .....	211
Controflex Ribbon Switches .....	211
Control & Momentary Control Center Switches .....	211
Crestwood Converter Switch .....	212
Crestwood Touch Latch Switch .....	212
Cup Switch (5807) .....	212
Cushion Switch .....	213
Custom-Made Switches .....	213
Cylindrical Touch Switch (5300) .....	213
Deluxe Paddle Switch II and Mini Deluxe Paddle Switch .....	214
Double Paddle Switch .....	214
Double Sip & Double Puff Switches .....	214
Double Touch Switch .....	215
Dual Plate Switch: CM-12 .....	215
Dual Pneumatic Switch: CM-14 .....	215
Dual Puff-Sip Switch DPS-2 .....	216
Dual Pushbutton Switch: CM-13 .....	216
Dual Rocking Lever Switch .....	216
Dual Tongue Switch TS-2C .....	217
Ellipse Switches .....	217
Eyebrow Switch .....	217
Facial Switch .....	218
Finger Flex Switch .....	218
Finger Isolation Button .....	218
Flex Switch (5855) .....	219
Flexi-Switch .....	219
Flexit Switch .....	219

Flexswitch II.....	220
Grasp Switch (5865).....	220
Grip & Puff Switch.....	220
Grip Switch.....	221
HD Latching Pneumatic Switch.....	221
Head Control Switch.....	221
Head Position Interface.....	222
Head Switch.....	222
Head Switch Kit.....	222
Headband Switch.....	223
High Tech/Low Cost.....	223
Intention Switch.....	223
IST Switch.....	224
Jelly Bean.....	224
Joystick.....	224
Joystick Interface Control.....	225
Joystick with Pad Switch (5012).....	225
Jumbo Plate Switch.....	225
L.T. Switch.....	226
LD Latching Puff Switch.....	226
Leaf Switch.....	226
Leaf Switch.....	227
Leaf Switch (5860).....	227
Leaf Switch: CM-2/CM-7.....	227
Left/Right Rocker Switch.....	228
Lever Switch: CM-8/CM-9.....	228
Light-Activated Switch.....	228
LightSwitch.....	229
Low Force Adjustable Rod Switch.....	229
Magnetic Finger Switch.....	229
Mat Switch.....	230
Membrane Plate Switch.....	230
Mercury Switch.....	230
Mercury Tilt Switch.....	231
Micro Light Switch (5850).....	231
Micro Switch.....	231
Mini Cup Switch (5808).....	232
Mini Joystick with Push Switch (5020).....	232
Mini Rocking Lever Switch.....	232
Minimal Motion Splint-Mounted Switch Kits.....	233
Mounting Switch.....	233
Multi-Control Press Switch.....	233
Normally Closed Sensing Cell.....	234
Normally Open Sensing Cells.....	234
Omron Switch.....	234
Overhead Pull Switch.....	235
P-Switch.....	235
Patty Cake Press.....	235
Penta Switch (5024).....	236
Petite Pillow Switch.....	236
Photocell Switch.....	236
Pillow Switch (5875).....	237
Pinch Switch.....	237
Pinch Switch.....	237
Plate Switch.....	238
Plate Switch.....	238
Plate Switch (5830-34).....	238
Plate Switch On Stand.....	239
Plate Switch: CM-10.....	239
Plate Switches.....	239
Plate Switches.....	240
Play Mat Switch.....	240
Pneumatic Switch.....	240
Pneumatic Switch (5100, 5101).....	241

PRC Joystick.....	241
Pressure Switch .....	241
Pressure Switch .....	242
Pull Switch.....	242
Pull Switch.....	242
Pushbutton Switch: CM-11 .....	243
Remote Ability Switch Adapter .....	243
Rocker Switch (5505) .....	243
Rocking Plate Switch .....	244
Roller Switch Music Box.....	244
Round Pad Switch (5805).....	244
SCATIR Switch.....	245
Sensor Switch .....	245
Shadow Switch.....	245
Signal Buzzer Plate .....	246
Signal Switch.....	246
Single Rocking Lever Switch.....	246
Sip & Puff Switch.....	247
Snappy Switch.....	247
Soft Switch (5820, 5821).....	247
Specs Switch.....	248
Sponge Nurse Call Switch.....	248
Square Pad Switch (5810).....	248
Squeeze Switch.....	249
Standard Paddle Switch .....	249
Star Switch (5026).....	249
String Switch .....	250
String Switch .....	250
Super-Sensitive Normally Open Switch.....	250
Switchskins.....	251
Tactile Touch Pad.....	251
Taction Pads.....	251
TAS Switch.....	252
Thumb Switch: CM-5 .....	252
Tilt Switch.....	252
Tip Switch (5840).....	253
Tongue Switch.....	253
Tongue Switch.....	253
Touch Pads.....	254
Touch Switch: CM-4.....	254
Tread Switch: CM-1.....	254
Treadle Switch (5880).....	255
Twin Plate Switch.....	255
Twinkle Switch.....	255
Twitch Switch.....	256
Ultimate Switch .....	256
Universal Adaptive Switch System.....	256
Vertical Plate Switch.....	257
Vertical Wobble Switch .....	257
Vibration Switch.....	257
Voice Activated Switch .....	258
Voice Switch.....	258
Wafer Switch (5018).....	258
Wobble Switch .....	259
Wobble Switch .....	259

## **Chapter 9: Environmental Controls and Telephone Adaptations.....261**

911 Telephone Terminal.....	263
AbiliTech Commander IR.....	263
AbiliTech Commander X-10 .....	264
AbiliTech Communicator.....	264
AbiliTech Home Control System .....	265
Ability Switch Phone Sequencer.....	265

Able-Phone 100WA.....	266
Able-Phone 1900 and 2000.....	266
Able-Phone 6000SX.....	267
ACS Headsets.....	267
Adapted Telephone Interfaces.....	268
APT Automaddak Page Turner System.....	268
Automatic Drapery Opener System.....	269
Bed Control (DBC-1).....	269
Big Button Bed Control.....	270
Butler-in-a-Box.....	270
CCT Environmental Control.....	271
CINTEX2.....	271
Control 1.....	272
Controller.....	272
Custom Speaker Phone.....	273
DEUCE.....	273
E.A.S.I.dialer (2110).....	274
EASICORDER.....	274
Environment Control.....	275
Environmental Control Units.....	275
Expanded Keyboard for Automatic Telephone.....	276
EZ-TV Adapted Infrared Remote Control for Televisions.....	276
EZRA.....	277
F71863 Touchables Touch Phone Attachments.....	277
First Aide Kit.....	278
Fone Holder.....	278
FreeSwitch.....	279
GEWA Infra-Link Speaker-Telephone.....	279
GEWA Infra-Link System.....	280
Gewa Page Turner.....	280
Giant Push Button Telephone Adapter.....	281
HandiPHONE.....	281
HECS-1.....	282
Home Control Systems.....	282
HomeAccess.....	283
In & Out Automatic Door Controller.....	283
Infrared Remote Control IRTI-1.....	284
Kincontrol (4105).....	284
Mastervoice Environmental Control Single User Unit.....	285
Memory Button Telephones.....	285
Mini-Environmental Control (ECU) Box.....	286
Magnitized Easel.....	286
MultiPhone.....	287
Next Page Page Turner (4600).....	287
On/Off Remote Switch.....	288
Phone Manager.....	288
PhoneAccess.....	289
Portable Telephones.....	289
PowerLink 2.....	290
PROXi.....	290
RC5000 Radio Home Control System.....	291
RELAX (8200).....	291
Remote Control Speakerphone Model RC3000.....	292
Saltus Reader.....	292
Sapura S2000 CL.....	293
Scanning Director.....	293
Scanning Remote Control (SRC).....	294
Scanning X-10 Powerhouse.....	294
SenSei System.....	295
Simplicity Series ECUs.....	295
Single-Appliance Continuous Control Unit.....	296
Single-Switch Multi-Appliance Control Unit & Modules.....	296
Single-Switch TV Control Unit.....	297
Sip/Puff Bed Control.....	297

Speaker Phones.....	298
Synergy Integrated Remote.....	298
T-140 Series Puff/Sip Speakerphones.....	299
TEAM.....	299
Telephone Holder & Line Connector.....	300
Telephone Management System.....	300
Touch Turner.....	301
TVRC and TVRCS.....	301
U-Control.....	302
Ultra 4 Remote System & Scanning Ultra 4.....	302
Universal Control System with Tongue Touch Keypad.....	303
Universal Remote Controls.....	303
Universal Telephone Adapter.....	304
Universal Television Remote Control.....	304
URC-400 Series Universal Remote Control.....	305
VX-5000 Cordless Phone.....	305
Wireless TV & VCR Remote Controls.....	306
X-10 Home Control Interface.....	306
X-10 Powerhouse System.....	307
<b>Chapter 10: Call, Monitoring, and Memory Systems.....</b>	<b>309</b>
Accularm.....	311
AlertCom.....	311
Auto Call Single Number Dialer.....	312
Beep-in-Touch.....	312
Beeper.....	313
Call Alert Model CA-100.....	313
Call Bell (4500).....	314
Call Signal 2.....	314
Chime Alarm.....	315
Cord-Mate.....	315
Digitized Speech Message Machines.....	316
E-Z Call.....	316
Emergency Call Alarm.....	317
Home Intercom Systems.....	317
Intercom (4395).....	318
JANICE Model 100 Invalid Security Alert System.....	318
Lighted Extra Loud Signalling Buzzer.....	319
Lighted Signalling Buzzer.....	319
NeuroPage.....	320
Omni Page System.....	320
PA-1 Portable Alarm.....	321
People Pager.....	321
Personal Alert Receiver.....	322
Personal Pager.....	322
Personal Pager.....	323
Personal Pagers.....	323
Remote Wireless Paging Alarm.....	324
Screamer Alarm.....	324
SideKick Receiver.....	325
Signal Buzzer.....	325
Sound Advice System.....	326
Vibra-Call Receiver.....	326
Watchman Master.....	327
WatchMate.....	327
WatchMate LC.....	328
Wireless Personal Pager.....	328
<b>Chapter 11: Modifications for Standard Keyboards and Mice.....</b>	<b>329</b>
I-Key.....	331
Access Pack for Microsoft Windows.....	331
AccessDOS.....	332



Articulating Drawers.....	332
ASER Ergonomic Keyboard Layout.....	333
Aurora for Windows.....	333
Braille Keytop Labels.....	334
Brailled Keyboard Overlay for the Apple IIGS.....	334
CarpalRest.....	335
Combination Braille/Large Print Keytop Labels.....	335
Comfortype.....	336
Custom Keyguard.....	336
DataArm.....	337
Dvorak Computer Keyboard.....	337
Dvorak Conversion Keytop Labels.....	338
Dvorak Keyboard Layouts.....	338
E Z Keys.....	339
Easy Access.....	339
Ergorest Articulated Forearm Rests.....	340
Expanded Keyboard Emulator.....	340
Filch.....	341
FlexShield Keyboard Protectors.....	341
Half-QWERTY One-handed Keyboard Software.....	342
HandiKEY and HandiKEY Deluxe.....	342
HandiSHIFT.....	343
HandiWORD and HandiWORD International.....	343
Help U Type.....	344
High Dots.....	344
Home-Row Key Indicators.....	345
HX-20 Protective Cover.....	345
JDN Shorthand (5073).....	346
KeyAbility.....	346
Keyboard Covers.....	347
Keyboard Overlays for Apple IIe and IIGs.....	347
Keyboard Wrist Rest.....	348
Keycache.....	348
KeyGuard.....	349
Keyguard.....	349
Keyguards.....	350
Keylocks.....	350
KeyMagic.....	351
KeyREP.....	351
KeyStopper.....	352
KeyWiz.....	352
LAP CAT.....	353
Left or Right Handed Keyboards.....	353
MacQWERTY.....	354
Magic Fingers.....	354
Moisture Guard.....	355
MOUSE PERCH.....	355
NOHOLD.....	356
Notebook Computer Wrist Rest.....	356
OmniKey Keyboards.....	357
On/Off Adaptor Switch.....	357
One-Hand Keyboard Package.....	358
PAL.....	358
PECK Computer Software.....	359
PowerPad Keyguard.....	359
PRD+ (Productivity Plus) Basic Edition.....	360
Prefix.....	360
ProKey.....	361
QuicKeys.....	361
Reinforced Keyguard.....	362
Roll & Slide Keyboard Wrist Support.....	362
SafeSkin Keyboard Protector.....	363
Step On It! Computer Control Pedals.....	363
Stick-On Keylocks.....	364

Stickey.....	364
Tempo for Windows.....	365
Tempo II Plus.....	365
TempoEZ.....	366
TimeOut UltraMacros.....	366
Uni-Key.....	367
VT520 Terminals - Accessibility Features.....	367
WordWriter.....	368
WRIST PERCH.....	368
ZoomCaps.....	369
<b>Chapter 12: Alternate Inputs.....</b>	<b>371</b>
Access-I.....	373
Adap2U.....	373
ADAPTA-LAN.....	374
Adaptive Firmware Card Model G32e.....	374
AlphaSmart Pro.....	375
AmTRAC.....	375
Apple Adjustable Keyboard.....	376
Aurora 2.0 for DOS.....	376
BaltPoint Mouse.....	377
BAT Personal Keyboard.....	377
Big Keys.....	378
BioMuse.....	378
Bloorview Miniature Keyboard.....	379
Breakthru Box.....	379
Cirque GlidePoint Trackpads.....	380
Comfort Keyboard System.....	380
Concept Keyboard.....	381
Cordless WinMouse.....	381
DARCI TOO.....	382
Doors II.....	382
DragonDictate Starter, Classic, and Power Editions.....	383
EEK.....	383
ErgoLogic Model 7.1 Keyboard.....	384
Ergonomic Keyboard Systems.....	384
Expanded Keyboard for Apple Macintosh and Apple IIGS.....	385
Expanded Keyboard for IBM Computers.....	385
Expanded Keyboards for the Talking BlissApple.....	386
Expanded Numeric Keypads.....	386
Expert Mouse.....	387
Eye Slaved Pointing System.....	387
ezMorse for Windows.....	388
ezScan.....	388
FastTRAP.....	389
Felix.....	389
First-Finger WinTrack.....	390
FlexPro.....	390
GEWA FTB 108 Enlarged Keyboard.....	391
GEWA METB 121 Reduced Size Keyboard.....	391
HAL (Home Automation Link).....	392
Hand Controls.....	392
HandiCODE and HandiCODE Deluxe.....	393
HeadMaster Plus.....	393
HeadMouse.....	394
Help U Key.....	394
Help U Keyboard.....	395
Hereward Tracker Ball & Joystick Module.....	395
Icontroller.....	396
IN-CUBE Voice Command for SPARC Stations.....	396
IN-CUBE Voice Command for Windows, NT.....	397
Instant Access.....	397
IntelliKeys.....	398

## Detailed Table of Contents

IntroVoice V.....	398
IntroVoice VI.....	399
IRIS Reading Interface 3.0.....	399
Jouse.....	400
Joystick to Mouse Driver.....	400
JustVoice.....	401
K-U-I.....	401
Ke:nx.....	402
Ke:nx On:Board (M43).....	402
Key Largo.....	403
Keyport 176.....	403
Keyport 300.....	404
Keyport 60.....	404
Kinesis Ergonomic Keyboard.....	405
King Keyboard (2440).....	405
Kurzweil VOICE.....	406
Kurzweil VOICE for Windows.....	406
Laser Optic Keyboard.....	407
LIAISON.....	407
LightBoard.....	408
LipStick and WordWriter.....	408
Listen for Windows.....	409
MacKing.....	409
MacMini.....	410
Macrat.....	410
MacroMaster/pro.....	411
MacTRAC.....	411
Magic Wand Keyboard with McKey Mouse Option.....	412
Maltron Keyboard.....	412
MICE.....	413
Micro IntroVoice.....	413
Micro IntroVoice II.....	414
Microsoft Natural Keyboard.....	414
Microsoft Windows Sound System.....	415
MIKE (Mouse Interface & Keyboard Emulation).....	415
Mini Keyboard (2443 or 2450).....	416
Mini-Keyboards.....	416
MiniErgo-MF2.....	417
Minimal Motion Computer Access System.....	417
Morse Code WSKE II.....	418
Morsek Version 1.1.....	418
Mouse Keys.....	419
Mouse-Trak.....	419
MouseMan Cordless.....	420
MouseMover - Mac (5005).....	420
MouseMover - PC Windows (5004).....	421
MousePen.....	421
MouseStick II.....	422
Mouth Operated Joystick for Genesis Video Game.....	422
Muppet Learning Keys.....	423
My First Keyboard.....	423
My-T-Mouse.....	424
MyKey.....	424
Narwhal Expanded Keyboards for Adaptive Firmware Card.....	425
Nintendo & Super Nintendo Joystick Module.....	425
NoMouse.....	426
OfficeTALK for Windows.....	426
One Access.....	427
One-Hand Operated Joystick for Genesis Video Game.....	427
OneStrk.....	428
Optimouse.....	428
OsCaR.....	429
PC-IRAC.....	429
Pen Style Mouse.....	430

PKD 84 and 101 .....	430
PortaPoint.....	431
PowerKey Software for IBM.....	431
PowerPad .....	432
PowerPad Starter Kit.....	432
PowerSecretary.....	433
Pre-Dict-ate.....	433
ProPoint.....	434
Proportional Keystroke Scanner .....	434
QUADLynx Trackball .....	435
Reading Edge.....	435
Remote Keyboard for the Apple II+ and IIe.....	436
RemotePoint .....	436
RevolvingDoors.....	437
Scanning WSKE II.....	437
ScottBridge Speech Access System.....	438
ScreenDoors.....	438
Select-Ease Keyboard .....	439
Serial Trackball and PS/2 Trackball .....	439
So!Type.....	440
Speak Out VOILA.....	440
Speech Recognition Systems.....	441
Stingray .....	441
Switch Modified PowerPad .....	442
Switch-Adapted Mouse (SAM).....	442
Switch-Back.....	443
SwitchMouse .....	443
SynergyMac and SynergyPC .....	444
TouchWindow .....	444
Trackball Pro .....	445
TrackMan Live!.....	445
TrackMan Voyager .....	446
Trak101 Keyboard .....	446
Turbo Mouse 4.0 .....	447
Turbo Trackball.....	447
Vertical.....	448
Voice Mouse/Keyboard (VMK) Controller .....	448
Voice User .....	449
WinKing Keyboard (2448F, 2448Q).....	449
WinMini Keyboard (2447F, 2447Q).....	450
WiViK 2.0 (Windows Visual Keyboard).....	450
<b>Chapter 13: Input Adapters for Computers.....</b>	<b>451</b>
Apple Computer Input Adapter.....	453
BEST Switch Interface.....	453
ClickIt! .....	454
Computer Interface Box.....	454
Computer Switch Interface .....	455
CrossScanner .....	455
DA-II Adapter.....	456
Input Adapter.....	456
Internal I/O Port Adapter .....	457
Judy Lynn PC Adapter.....	457
Keyboard Expander.....	458
Keyboard Interfaces .....	458
Mac PowerPad Interface for Single Switches .....	459
Macintosh Switch Interface (M09).....	459
PCMaster & Windows Master.....	460
PlayMAGIC .....	460
Porter, The.....	461
PowerSwitch .....	461
SS-ACCESS! .....	462
SuperPort .....	462

Switch Interface.....	463
T-TAM Keyboard and Mouse Emulator.....	463
Universal Input Adaptor.....	464
WinSCAN: Limited Edition.....	464
<b>Chapter 14: Voice-Output Screen Readers and Reading Machines.....</b>	<b>465</b>
Artic TransBook.....	467
Artic TransType.....	467
ASAP (Automatic Speech Access Program).....	468
BookWise.....	468
Braille 'n Speak.....	469
Braille 'n Speak Classic.....	469
Braille Lite.....	470
BrailleMate 2.....	470
Business Vision.....	471
David.....	471
Echo II with Textalker & Echo II with Textalker-GS.....	472
Emacspeak.....	472
Gizmo.....	473
HandiCHAT and HandiCHAT Deluxe.....	473
IBM Screen Reader/2.....	474
IBM Screen Reader/DOS.....	474
Infovox 210.....	475
JAWS for Windows.....	475
JAWS Screenreader.....	476
Keynote Companion.....	476
Language Master Special Edition - LM6000SE.....	477
Magnum.....	477
Myna.....	478
Open Book.....	478
Open Book Unbound.....	479
outSPOKEN 1.7.....	479
outSPOKEN for Windows.....	480
Protalk23 for Windows.....	480
PROVOX.....	481
Reading AdvantEdge.....	481
ScanTELL.....	482
ScreenPower.....	482
ScreenPower for Windows.....	483
Seckline.....	483
Slimware.....	484
Slimware Window Bridge.....	484
SoundProof.....	485
Speaqualizer Speech Access System.....	485
Textalker-GS.....	486
Tinytalk.....	486
Type 'n Speak.....	487
Vocal-Eyes.....	487
Win Vision.....	488
Window-Eyes.....	488
WINKLiNE.....	489
WordScholar.....	489
<b>Chapter 15: Magnification Products for Computer Displays.....</b>	<b>491</b>
Adjustable EZ Magnifier.....	493
B-Pop.....	493
Beamscope.....	494
Big-W.....	494
CloseView.....	495
Compu-Lenz.....	495
GNK Magnifier.....	496
inLARGE 2.0.....	496

Large-Type Display Utility Software.....	497
Lens 2.03.....	497
LP-DOS & LP-Windows.....	498
MAGic and MAGic Deluxe.....	498
Magnum Deluxe.....	499
Magnum GT.....	499
NuVu Magnifier.....	500
Panorama.....	500
Powerama.....	501
Screen Magnifier/2.....	501
Vantage CCD.....	502
Vista.....	502
ZoomText 5.....	503
<b>Chapter 16: Braille and Tactile Output Systems.....</b>	<b>505</b>
ALVA Braille Terminals.....	507
Braille Blazer.....	507
Braille BookMaker and Braille Express 100 & 500.....	508
Braille-N-Print.....	508
BrailleAccess.....	509
BRAILLEX-2D.....	509
Braillo 200.....	510
Braillo 400 S.....	510
Braillo Comet.....	511
DM80/FM.....	511
Index Basic.....	512
Index Basic-D.....	512
Index Everest-D.....	513
INKA.....	513
Juliet Braille.....	514
KTS Braille Display.....	514
Marathon Braille.....	515
MasterTOUCH.....	515
Mountbatten Braille.....	516
NOMAD Talking Touch Pad & NOMAD Gold.....	516
Notex 486.....	517
Ohtsuki BT-5000 Braille/Print Printer.....	517
Optacon II.....	518
Paragon Braille Printer.....	518
PowerBraille 40, 65, & 80.....	519
Ransley Braille Interface (RBI).....	519
Romeo Braille Model RB-25.....	520
Romeo Braille Model RB-40.....	520
TEXTALKER.....	521
Thomas Braille.....	521
TranSend System.....	522
VersaPoint-40 Braille Embosser.....	522
<b>Chapter 17: Speech Synthesizers.....</b>	<b>523</b>
Accent-MC.....	525
Accent-PC.....	525
Accent-SA.....	526
Artic TransPort.....	526
Audapter Speech System.....	527
CallText 5000.....	527
DECtalk.....	528
DECtalk PC & DECtalk Express.....	528
DJ ProPack Speech Module.....	529
Echo II.....	529
Echo LC.....	530
Echo PCH.....	530
Echo-PC.....	531

Infovox 500, 700 & 750 .....	531
Keynote GOLD .....	532
Lite Talk .....	532
Messenger-IC .....	533
Mini Transport II .....	533
MultiVoice .....	534
SmarTalk .....	534
Sounding Board .....	535
Speak-Out .....	535
SynPhonix 210 and 215 .....	536
SynPhonix 310 and 315 .....	536
SynPhonix P27 .....	537
VocaLite .....	537
VoiceCard .....	538

**Chapter 18: Other Software and Hardware Adaptations ..... 539**

AbleOffice .....	541
ADJUSTable .....	541
Apple IIGS Owner's Guide: Disk Edition .....	542
AppleWorks Manuals: Special Editions .....	542
Brailled Keyboard Model--Apple IIe .....	543
CompuDesk HCP .....	543
Computer Workstation Furniture .....	544
Comtel .....	544
Disk Guide (2485) .....	545
DOS Tape .....	545
Dual Channel Headset .....	546
EasyRiser .....	546
Generation IV Adjustable Computer Tables .....	547
Governor (2464) .....	547
IntelliKeys Overlay Maker .....	548
Ke:nx Easy Overlays .....	548
Media Handling Products .....	549
Modular Turntable Desks .....	549
Rx WorkStation .....	550
Scanning Conversion Program .....	550
Talk-to-Me Tutorial Cassettes .....	551
Talking Utilities for ProDOS .....	551
TarsalRest .....	552
Variable Height Desk .....	552

**Chapter 19: Training and Therapy Software ..... 553**

101 Animations .....	556
Adult Switch Progressions .....	556
Adventures of Jimmy Jumper - Prepositions .....	557
Antonyms and Synonyms (Cognitive Disorders 12) .....	557
APH Presents the Talking Apple Computer .....	558
Aphasia Series: I through VIII .....	558
Association Pictures .....	559
Attention, Perception & Discrimination Plus for Windows .....	559
Audio Braille Game Tutorial .....	560
Babysitting Basics .....	560
Be a Winner Series .....	561
Bear Jam .....	561
BEST Faces .....	562
Big/Little I and II .....	562
Blocks in Motion .....	563
Blueprint for Decision Making .....	563
Body Builder .....	564
Bozons' Quest .....	564
Braille Tutorial .....	565
Breakthrough to Language: Clinical Edition .....	565

Bread:through to Language: Home Edition.....	566
Buddy's Body.....	566
Build-A-Scene.....	567
Cafet-for-Voice.....	567
CanSpeak.....	568
Captain's Log: Cognitive Training System.....	568
Categories Plus for Windows.....	569
Category Discrimination and Reasoning Plus for Windows.....	569
Category Naming and Completion Plus for Windows.....	570
Cause & Effect.....	570
Cause 'n Effect.....	571
CAV-ASL.....	571
Children's Switch Progressions.....	572
Circletime Tales & Circletime Tales Deluxe.....	572
Cognitive Disorders I, II, III, IV.....	573
Cognitive Rehabilitation Software.....	573
Cogrehab Vol. 1.....	574
Cogrehab Vol. 2.....	574
Cogrehab Vol. 3 Version 2.0.....	575
Cogrehab Vol. 4.....	575
Cogrehab Vol. 5.....	576
Cogrehab Vol. 6.....	576
Cogrehab Vol. 7: Quest.....	577
COINSNKEYS.....	577
Color Find.....	578
Colorful Concept Software.....	578
Colors and Shapes.....	579
Communication Training Program.....	579
Community Signs.....	580
Community Vehicles.....	580
Completion From Partial Information Plus for Windows.....	581
Computer CUP.....	581
Computer Literacy Series.....	582
CONCENTRATE! On Words & Concepts.....	582
Construc.....	583
Core Reading and Vocabulary Development.....	583
Creature Antics and Creature Capers.....	584
Creature Cartoons.....	584
Creature Chorus.....	585
Creature Features.....	585
Creature Magic.....	586
CrossWords.....	586
Data Entry.....	587
Deductive Reasoning Plus for Windows.....	587
Definitions Plus for Windows.....	588
Dino-Games.....	588
Dinosaur Game.....	589
Dollars & Cents Series.....	589
Early and Advanced Switch Games.....	590
Early Concepts.....	590
Early Emerging Rules Series.....	591
Early Learning 3.5/Complete Early Learning 5.25.....	591
Early Learning I.....	592
Edmark Functional Word Series.....	592
Fency-Weency Spider Game.....	593
Elementary Signer.....	593
Employment Signs.....	594
English on the Job.....	594
Every Day Is A Holiday.....	595
Exploring Early Vocabulary Series.....	595
Family Fun.....	596
Fast Food Game.....	596
Feelings.....	597
Find the Buttons.....	597



Fingerspeller.....	598
Fingerspelling & Numbers.....	598
FingerZoids.....	599
First Categories.....	599
First Mate.....	600
First Step Software.....	600
First Verbs and Primeros Verbos.....	601
First Words.....	601
First Words II.....	602
Following Directions: One- and Two-Level Commands.....	602
Following Directions: Left and Right.....	603
Food Facts.....	603
Foundations I.....	604
Foundations II.....	604
Function Pictures.....	605
Functional Vocabulary Plus for Windows.....	605
Fundamental Concepts.....	606
Further Adventures of Jimmy Jumper - Perseverance.....	606
Getting Clean with Herkimer Level I, II, III.....	607
GrammarPlay with Alps and Droops.....	607
Grocery Store Words.....	608
Hierarchical Attention Training.....	608
Homographs.....	609
Homophones.....	609
Human Being Machine.....	610
If You're Happy and You Know It.....	610
Improving Your Self-Concept.....	611
Inferential Naming for Cognitive and Language Disorders.....	611
Inferential Naming Plus for Windows.....	612
Information Signs.....	612
Initial Phoneme Cuing for Aphasics.....	613
Interaction Games.....	613
Interaction Games II.....	614
Job Readiness Series.....	614
Job Seeking Series.....	615
Job Success Series.....	615
Join the Circus.....	616
Joystick Trainer.....	616
Keyboarding by Ability.....	617
Keyboarding for Individual Achievement.....	617
Keyboarding for People with Cerebral Palsy.....	618
Keyboarding Program with Voice Output.....	618
Keyboarding with One Hand.....	619
Keys to Success: Comp. Keybd. Skills for Blind Children.....	619
Laryngograph.....	620
Learn to Scan.....	620
Learning Activity Packets (LAPs).....	621
Learning How to Learn Series.....	621
Learning to Count.....	622
Learning to Reason Series.....	622
Learning to Spell Braille Signs.....	623
Less, More, Make Equal.....	623
Let's Go Shopping I and II.....	624
Let's Go to the Circus.....	624
Letter Find.....	625
LetterTALK+.....	625
Listen With Your Ears.....	626
Living Alone.....	626
Logi.....	627
Logo TouchTools for the PowerPad.....	627
Magic.....	628
Make It In Time.....	628
Make It Scan.....	629
Mastering Personal Information (MPI).....	629

Math Max .....	630
Math on the Job .....	630
Maze .....	631
Medical Words .....	631
Memory for Animated Sequences Plus for Windows .....	632
Memory I .....	632
Memory II .....	633
Micro Guide to Careers Series .....	633
Micro-LADS and Micro-LADS in French .....	634
Microcomputer Evaluation of Career Areas (MECA) .....	634
Mind Castle I and II .....	635
Minimal Contrast Stories Plus for Windows .....	635
Minimal Contrast Therapy .....	636
Mix 'N Match .....	636
Money Matters .....	637
Money Skills .....	637
Motor Training Games .....	638
Motor Training Games .....	638
Multi-SCAN .....	639
Multiple Meaning Words I Plus for Windows .....	639
Multiple Meaning Words II Plus for Windows .....	640
MusicWare .....	640
MusicWare - Age Appropriate .....	641
MY HOUSE: Language Activities of Daily Living .....	641
My Paint & Talking Coloring Books .....	642
MY SCHOOL: Language Activities of Daily Living .....	642
MY TOWN: Language Activities of Daily Living .....	643
Nasometer Model 6200-3 .....	643
New Frog & Fly .....	644
Numeric Concepts I and II .....	644
Occupations .....	645
Octobus .....	645
Old MacDonald's Farm I and II .....	646
On the Job Series - Career Interests .....	646
On the Job Series - Communication Skills .....	647
On the Job Series - Mathematics .....	647
On the Job Series - Problem Solving Skills .....	648
One Switch Picasso .....	648
Opening Windows .....	649
Opposites and Similarities Plus for Windows .....	649
Order Processing .....	650
Padded Food .....	650
Padded Vehicles .....	651
Paper Dolls I and II .....	651
PC Typer .....	652
Personal Development Software Series .....	652
Pick-A-Meal .....	653
Pictalk .....	653
Picture Cue Dictionary .....	654
Picture Identification Plus for Windows .....	654
Picture Naming Plus for Windows .....	655
Picture Scanner .....	655
Picture/Theme Disks .....	656
Pictures Programs: I, II and III .....	656
Point to Pictures .....	657
Positive Parenting .....	657
PowerPad Preschool Pack I & II .....	658
PowerTalker .....	658
Prefix .....	659
Preposition Fill-Ins .....	659
Press to Play .....	660
Primer 83 .....	660
Problem Solving I .....	661
R.A.P.S. Software Series I PowerPad .....	661

Rabbit Scanner .....	662
Race the Clock .....	662
Rate Drill in Articulation, Language and Fluency .....	663
Reactions (R73).....	663
Reading a Ruler - English & Metric .....	664
Reading Comprehension for Adolescents .....	664
Reasoning Skills on the Job.....	665
Rhyming Pictures.....	665
Rockets to the Moon.....	666
Run Rabbit Run .....	666
Safety Signs .....	667
Scan & Match 1, 2, 3, and 4 .....	667
Scan It - Switch It.....	668
Scanning Picasso.....	668
Seasons .....	669
Seek & Find.....	669
Semantic Development Using Code Breaking Strategies .....	670
Sentence Completion Plus for Windows .....	670
Sentence Key & Picture Sequence Key .....	671
Sentence Master.....	671
Shell Game & Mouse Game.....	672
Sight Words .....	672
Silly Sandwich.....	673
Simple Sentence Structure.....	673
SimpleCom I: Yes/No Communication .....	674
SimpleCom II: Needs/Wants Communication .....	674
Single Switch Software.....	675
Single Switch/MatchBox Pack I.....	675
Son of Seek and Find.....	676
Sorting by Category Plus for Windows .....	676
Sound Scope.....	677
Special Education Public Domain Software .....	677
SpeechViewer II.....	678
Steps for Career Choice .....	678
Storytime Series .....	679
Storytime Series for Macintosh.....	679
Studio4.....	680
Subtle Messages.....	680
Survival Words.....	681
Swim, Swam, Swum: Mastering Irregular Verbs .....	681
Switch Arcade .....	682
Switch Arcade .....	682
Switch Art.....	683
Switch It - Change It .....	683
Switch It - See It .....	684
Switch Puzzles.....	684
SwitchEnsemble.....	685
Talking Hands .....	685
Talking Literacy Kit for the Apple IIc (TALK IIc).....	686
Talking Nouns, Talking Nouns II, and Talking Verbs .....	686
Talking Touch Window .....	687
Talking Typer.....	687
Talk Time with Tucker .....	688
Tea Party.....	688
Teenage Switch Progressions.....	689
Telling Time .....	689
Telling Time, Parts of the Face, Learning Colors .....	690
THINKable/DOS.....	690
This is the Way We Wash Our Face .....	691
This Old Man .....	691
Timekeeper.....	692
Touch and Match .....	692
Touch and Sec .....	693
TouchMoney .....	693

Traffic Signs Plus for Windows .....	694
Transportation Signs .....	694
Trip to the Zoo .....	695
Turn-Talking .....	695
Twenty Categories .....	696
UKanDu Little Books .....	696
UKanDu Switches, Too! .....	697
Understanding Attributes .....	697
Verb Fill-Ins .....	698
Verbal Analogies .....	698
Verbal Analogies Plus for Windows .....	699
Video Voice Speech Training System .....	699
Visi-Pitch Model 3300 .....	700
Visual Confrontation Naming Plus for Windows .....	700
Visual Memory Plus for Windows .....	701
Visual Motor Skills .....	701
Visual Pattern Memory Plus for Windows .....	702
Visuospatial Skills I .....	702
Visuospatial Skills II .....	703
Vortex Machine Assisted Reader Software .....	703
Wheels On The Bus I, II, III .....	704
Wheels on the Bus I, II, III - Intellipics Activity .....	704
Wheels on the Bus: COMPLETE .....	705
Where is Puff? .....	705
Word Association Plus for Windows .....	706
Word Order in Sentences .....	706
Word Order Plus for Windows .....	707
Words and Concepts I, II, III .....	707
WordWise Software .....	708
Worm Squirm .....	708
WSCC (Washington State Cooperative Curriculum) .....	709
Zoo Time .....	709
<b>Chapter 20: Adaptive Educational Software .....</b>	<b>711</b>
Access to Math .....	713
APH/SEI Talking Software .....	713
Arithmetic 1, 2, and 3 with Speech .....	714
Basic Learning Skills Courseware .....	714
CAMEO .....	715
Career English .....	715
Complete Spelling Program .....	716
Drive to Live .....	716
Early Learning II .....	717
Early Learning III .....	717
Edmark Reading Program, Level 1 Software .....	718
Elementary Volume 1 - Mathematics .....	718
ERIN (Early Recognition Intervention Network) .....	719
Focus on Facts .....	719
Focus on Nations .....	720
Geometric Figures and Spatial Concepts .....	720
H:2 Handicapped Arithmetic Flash Cards .....	721
JOKUS Software .....	721
K.C. & Clyde in Fly Ball .....	722
Learning the Alphabet .....	722
Listen and Spell .....	723
Prefixes .....	723
Program for Aphasics .....	724
Readable Stories Series .....	724
Reading Horizons .....	725
Sensible Speller: Talking APH Edition .....	725
Sharon's Programs .....	726
Sight Word Spelling .....	726
Speaking Speller .....	727

Spell-A-Word & 2+2 .....	727
Spell-Talk .....	728
Spelling Tutor.....	728
SPELLIST.....	729
Spin and Spell.....	729
Study Buddy .....	730
Talking Public Domain Disks.....	730
Talking Riddles .....	731
Voice Math.....	731
Voice Reading Ability Drill.....	732
Wordplay with Alps and Droops.....	732
Write.....	733
Write This Way .....	733
Zero to Five .....	734

**Chapter 21: Personal Tool and Aid Software..... 735**

APH Scientific Calculator: for Apple II Computers.....	737
Atlas Speaks .....	737
Auto Braille .....	738
B-Edit.....	738
BEX 3.1.....	739
BIG for 1-2-3.....	739
BIG for WordPerfect.....	740
Big:Calc .....	740
Biggy.....	741
BlissWrite .....	741
Braille-Talk.....	742
Braille-Term Program.....	742
Calc-Talk .....	743
Calcworthy.....	743
Checkbook Program .....	744
CINTEX I.....	744
Co:Writer .....	745
Duxbury Braille Board for Microsoft Windows .....	745
Duxbury Braille Font.....	746
Duxbury Braille Translator (DBT).....	746
Duxbury Braille Translator for WordPerfect (DUXWP) .....	747
Easy-Braille Translator .....	747
Edgar .....	748
Electric Crayon and Electric Crayon Deluxe .....	748
ETgraphX .....	749
ExerciseBreak.....	749
Eye Relief .....	750
File-Talk.....	750
Finish Line.....	751
FormMate .....	751
Freedom Writer .....	752
H:I Handicapped Word Games.....	752
I Can Play, Too! .....	753
IBM-VBII .....	753
Keysoft.....	754
Keyterm .....	754
Large Print Word Processors.....	755
Letter Art with Braille Translator.....	755
Mac-Apple Communications Aid.....	756
Magic Slate II .....	756
Me Too! .....	757
MegaDots.....	757
MicroBraille 2 .....	758
MicroIllustrator .....	758
Minspeak Application Programs (MAP).....	759
Multi-Line Dial-A-News System .....	759
NAMES .....	760

Noteworthy .....	760
PC Braille .....	761
Picture Braille .....	761
Picture Perfect.....	762
PowerPad Toolkit 4.....	762
Predict It.....	763
RAPIDTEXT .....	763
SeeBEEP .....	764
Strider .....	764
Talking Data Acquisition System Software .....	765
Talking Sensible Speller .....	765
Talking Utilities for DOS 3.3.....	766
Talking Writer & Four Games.....	766
TeleDesk Visually Impaired Operator Console .....	767
Telepathic II.....	767
Term-Talk .....	768
TextGrabber.....	768
Trace Math Aid.....	769
TurboBraille.....	769
TypeIt4Me .....	770
VersaBraille Electric Webster.....	770
VisAbility .....	771
WinDOTS .....	771
Wish Writer.....	772
WiVox .....	772
Word-Talk.....	773
Work-Station Pro.....	773
Write:OutLoud.....	774
WriteAway .....	774
<b>Appendix A: Information Resources .....</b>	<b>775</b>
A-1: Books and Pamphlets.....	777
A-2: Disability Resources on the Internet .....	781
A-3: Information Resources for Blind and Visually Impaired Individuals.....	782
A-4: Information Resources for Deaf and Hearing Impaired Individuals .....	786
A-5: Networks, Bulletin Boards and Databases.....	788
A-6: Newsletters and Journals.....	791
A-7: Selected Resources on Computers and Learning Disabilities .....	794
A-8: Software Resources .....	796
<b>Appendix B: Service Providers and Organizations .....</b>	<b>799</b>
B-1: Alliance for Technology Access: Member Sites.....	801
B-2: Computer Assessment and Training Programs for Disabled Individuals.....	804
B-3: Conferences .....	807
B-4: Organizations, Advocacy Groups and Self-Help Groups.....	808
B-5: Professional Associations .....	812
B-6: Resources on the Americans with Disabilities Act .....	813
B-7: Service Centers for Augmentative Communication and Computer Access.....	815
B-8: Technology-Related Assistance Act: State Programs.....	822
B-9: Training Programs in Technology for Special Education .....	826

**Appendix C: Glossary** .....827

**Index 1: Products Listed by Function** .....835

**Index 2: Products Listed by Input/Output Feature**.....861

**Index 3: Switches Listed by Input/Output Feature**.....879

**Index 4: Products Listed by Computer**.....885

**Index 5: Manufacturers Listed with their Products**.....901

**Index 6: Alphabetical Listing of all Products**.....921

# Chapter 1

## Speech Aids

This chapter includes prosthetic and orthotic oral speech systems. Basically, these are devices which make oral speech possible for a person for whom oral speech would otherwise be difficult, impossible, or hard to understand. These should not be confused with communication aids, which supplement or replace oral speech with some other mode of communication, such as pointing to pictures or typing on a portable computer.

Devices that fit in the category of speech aids include: artificial larynges, speech adaptations for tracheostomies, speech clarifiers, and speech amplifiers (including speech amplifiers in telephone handsets). Hearing aids and telephone amplifiers for hearing impaired people are not included in this ResourceBook.

The products in this chapter are listed under various "function" codes in the first cross-reference index in the back of this volume. Related function codes include: Artificial Larynx (AL), Voice Amplifier (VA), and Speech Aid (SA).



*The following product entries appear in this chapter:*

ADDvox III System, 3  
Amplifiers, 3  
Cooper-Rand Electronic Speech Aid, 4  
Denrick Speech Aid, 4  
Electronic Artificial Larynx, 5  
Electronic Speech Clarifiers, 5  
Handset for Speech Amplification, 6  
Mini Vox Amplifier, 6  
Nu-Vois, 7  
Park Speech Amplifier, 7  
Passy-Muir Speaking Valve., 8  
Rand Voice Amplifier, 8  
Robot Voice Synthesizer, 9  
SERVOX Inton, 9  
Speech Enhancer 100, 200 & 400, 10  
Speechmaker, 10  
Tokyo Artificial Larynx, 11  
Voice Amplificaider, 11  
Voicette, 12



**Product Name:** ADDvox III System

**Vendor:** Stanton Magnetics

**Size:** 2.75" x 4.75" x 1"

**Weight:** 7 oz.

**Power Source:** Rechargeable battery

**Cost:** \$325.00 - \$370.00

The ADDvox III is a speech enhancement system for those who have difficulty projecting their voice. The amplifier speaker box is available with either a headband or neckband microphone. The ADDvox III system consists of an amplifier speaker box, extension cable, neck or headband microphone, four Ni-Cad batteries, and a recharger adaptor. The newest model features a switchable outlet for personal button receiver listening in speech training usage.



**Product Name:** Amplifiers

**Vendor:** Various (Generic Product)

**Cost:** Varies

A number of modern communication technology products such as computers and telephones produce sound output without the ability to vary the volume or the maximum volume is too low. Additionally, many products used as components of communication systems depend on speech output. Sound amplification systems are essential for setting volumes specific to the needs of environments as well as for individuals with hearing impairments. Trial periods should be performed to observe whether these products meet the particular amplification need.

Amplification systems powered by batteries are available from mass market sources including electronic mail order catalogs, local electronic parts and appliance stores, in the electronic departments within larger variety stores. Specific sources can be found in local yellow pages, in the manufacturer list of this book, in listings from local rehabilitation service delivery programs, and often in gift specialty catalogs that carry personal convenience types of devices.

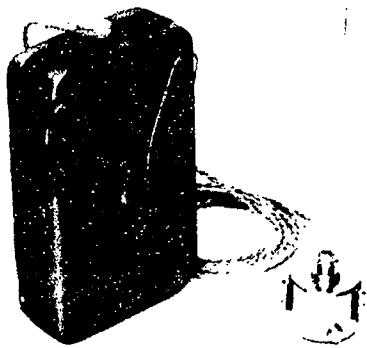

**Product Name:** Cooper-Rand Electronic Speech Aid

**Vendor:** Luminaud, Inc.

**Size:** 2.63" x 4.13" x 1.5"

**Weight:** 7 oz.

**Power Source:** 9V battery

**Cost:** \$465.00 - \$485.00

Cooper-Rand Electronic Speech Aid is an artificial larynx. The user inserts a tube projecting from the tone generator into the mouth; a tone from this tube supplies the individual's missing or insufficient vocal tone. The tone can be turned on and off and pitch can be adjusted. A puff switch control that requires only mouth air is also available. Various other versions which require little or no use of hands or arms are available.

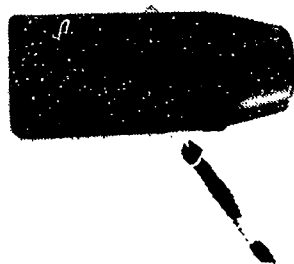

**Product Name:** Denrick Speech Aid

**Vendor:** Luminaud, Inc.

**Size:** 5.25" long

**Weight:** 5 oz.

**Power Source:** 9V battery

**Cost:** \$375.00

The Denrick Speech Aid is an artificial larynx designed for individuals who have lost the use of their own larynx. The device has three tones for variety in speech and easy pitch adjustment. One charge lasts for up to a full day in normal use. The Denrick can be used with an oral adapter. The Denrick Speech Aid is produced by Denrick, Inc.

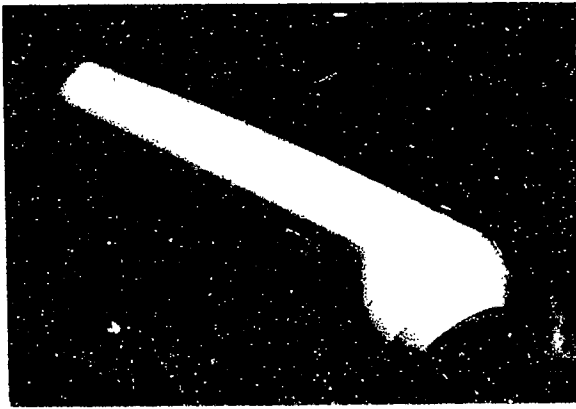

**Product Name:** Electronic Artificial Larynx  
**Vendor:** AT & T Accessible Communication Products Center  
**Size:** 6" x 2"  
**Weight:** 4 oz.  
**Power Source:** 9V battery  
**Cost:** \$229.99

The Electronic Artificial Larynx is a speaking aid for individuals who have lost the use of their larynx. The tip of the cylindrical device is pressed against the throat. Vibrations transmitted to the throat substitute for the lost vocal tone, and the user forms words with the mouth in normal fashion. The Electronic Artificial Larynx produces electronic vibrations that roughly simulate the natural vibrations of the human voice.



**Product Name:** Electronic Speech Clarifiers  
**Vendor:** National Institute for Rehabilitation Engineering  
**Power Source:** Internal battery  
**Cost:** \$850.00 - \$1,250.00

Electronic Speech Clarifiers can be used to enhance the quality and intelligibility of an individual's speech. The user's voice is filtered through the speech clarifier, and the result is spoken by the machine. Three types of clarifiers are available: worn in the ear, mounted on eyeglass frames, or worn on the belt. Each speech clarifier is custom-made based on the user's needs.

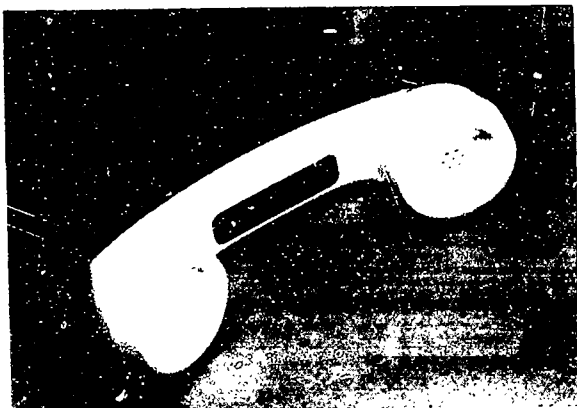

**Product Name:** Handset for Speech Amplification

**Vendor:** AT & T SourceBook

**Size:** 8" long

**Weight:** 1 lb.

**Cost:** \$95.00

The Handset for Speech Amplification is identical to a normal telephone handset, but offers a volume adjustment that can amplify a user's voice up to 30%. A small dial on the handset is used to adjust the volume. The handset has a standard modulator phone connection and can be connected in place of the standard phone handset. Contact manufacturer for further information on connectors and price.

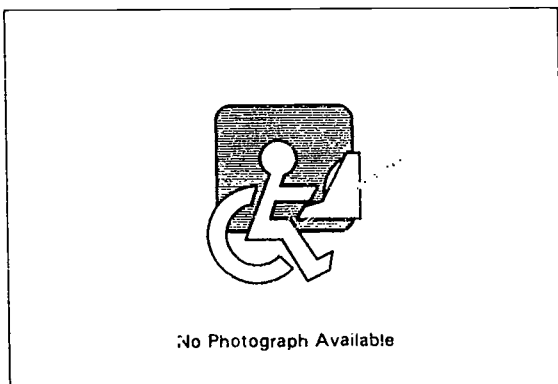

**Product Name:** Mini Vox Amplifier

**Vendor:** Luminaud, Inc.

**Size:** 8" x 6.75" x 9.5"

**Weight:** 5.25 lbs.

**Power Source:** C cell batteries

**Cost:** \$240.00 - \$590.00

Mini Vox Amplifier is a portable, battery operated voice amplifier. The device is available with either "plug-in" or wireless microphones. Various hands-free microphones are also available. Volume level can be adjusted from levels suitable for one to one communication up to groups of 200 plus. Mini Vox can also be powered by a rechargeable battery pack.



**Product Name:** Nu-Vois  
**Vendor:** Luminaud, Inc.  
**Weight:** 4.5 oz.  
**Power Source:** 9V battery  
**Cost:** \$495.00

The Nu-Vois is an artificial larynx with full control of volume and a self contained pitch adjusting screwdriver. The device is made of durable materials and includes a neck cord. The Nu-Vois operates with one light touch control button. Nu-Vois is produced by Mountain Precision Engineering, Inc.

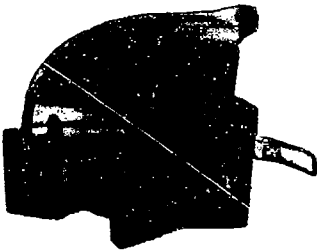

**Product Name:** Park Speech Amplifier  
**Vendor:** Park Surgical Company, Inc.  
**Size:** 4" x 2.25" x 1.14"  
**Weight:** 4 oz.  
**Cost:** \$270.00 - \$320.00

Park Speech Amplifier is a small battery-powered portable amplifier. Connected to the amplifier is a microphone that the user speaks into and a speaker that broadcasts the amplified voice. Three microphone models are available: hand-held (\$270.00), throat (\$270.00) or headset (\$320.00). The unit uses two rechargeable batteries and includes a one year warranty.



**Product Name:** Passy-Muir Speaking Valves

**Vendor:** Passy-Muir, Inc.

**Size:** 1" x 1"

**Cost:** \$75.00 per set

The Passy-Muir Tracheostomy and Ventilator Speaking Valves are patented "positive closure" design one-way valves that fit on the 15 mm hub of adult and pediatric tracheostomy tubes. The valves re-direct exhaled air around the tracheostomy tube and out the oronasopharynx which allows for speech.

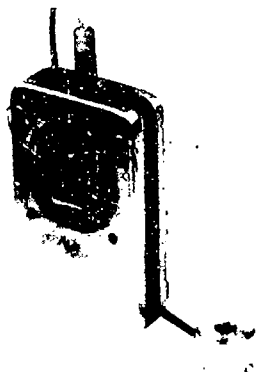

**Product Name:** Rand Voice Amplifier

**Vendor:** Luminaud, Inc.

**Size:** 2.63" x 4.13" x 1.04"

**Weight:** 10.5 oz.

**Power Source:** 9V battery

**Cost:** \$170.00

Rand Voice Amplifier is a small, portable voice amplifier that can be clipped on to a person's pocket or belt. A small unidirectional microphone is held to the lips; the voice comes out amplified through the main unit amplifier.

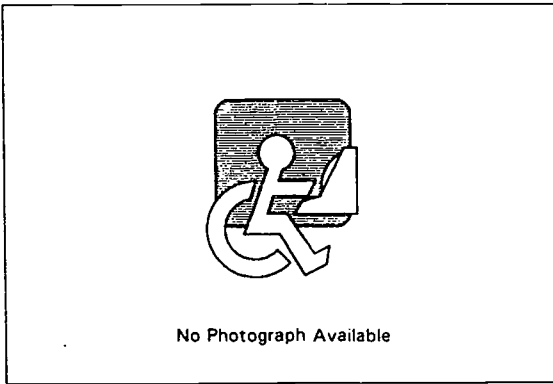

**Product Name:** Robot Voice Synthesizer

**Vendor:** Crestwood Company

**Size:** 4" tall

**Cost:** \$25.95

The Robot Voice Synthesizer is a temporary device for laryngectomees and children with tracheotomy. A tube attached to the toy robot is placed in the mouth. When words are mouthed slowly, the voice synthesizer sounds like a robot's voice.

Price includes two toy robots. The manufacturer will not except returns on this product.

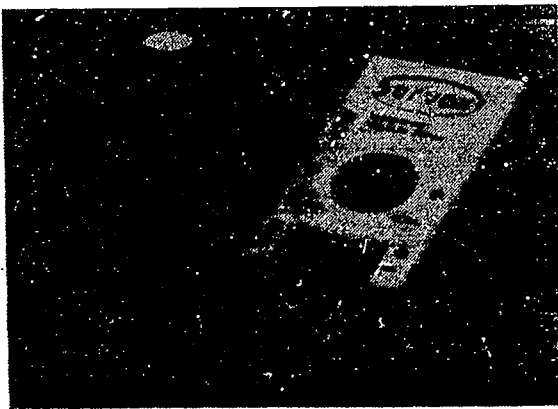

**Product Name:** SERVOX Inton

**Vendor:** Siemens Hearing Instruments, Inc.

**Size:** 4.7" x 1.4" diam.

**Weight:** 6.5 oz.

**Power Source:** Rechargeable battery

**Cost:** \$599.00 - \$699.00

SERVOX Inton is an enhanced version of the SERVOX artificial larynx. The user holds the SERVOX Inton's vibrating membrane up to the throat, a tone is transmitted through the vocal tract, and the user articulates it into speech. The SERVOX Inton features soft-touch buttons, volume control and intonation capability. An oral connector is available for intra-oral use (extra).





**Product Name:** Speech Enhancer 100, 200 & 400

**Vendor:** Luminaud, Inc.

**Size:** 9" x 7" x 3"

**Weight:** 2.5 lbs.

**Power Source:** 120V AC or Battery

**Cost:** \$1,095.00 - \$1,895.00

The Speech Enhancers are automated speech processing devices for electronic speech clarification of dysarthric speech. Voice level compensation allows for a normal range of vocal modulation and expression for natural-sounding conversation. A proprietary proximity microphone and electronic processing discriminates the talker's voice from the surrounding noise and reduces the possibility of feedback.

Model 400 (Professional Enhancer) is designed for evaluation and treatment in a clinical environment and sells for \$1895.00. Model 200 (Transportable Personal Enhancer) operates from an internal rechargeable cell and sells for \$1449.00. Model 100 (Powered Personal Enhancer) incorporates the full Enhancer speech processing capability but runs off of a wheelchair's batteries.



**Product Name:** Speechmaker

**Vendor:** Williams Sound Corporation

**Size:** 5.5" x 4.5" x 1.88" (speaker)

**Weight:** 17.5 oz.

**Power Source:** Rechargeable battery

**Cost:** \$329.00

The Speechmaker is a body-worn personal speech amplifier designed to increase the volume of a weak or esophageal voice. The system consists of a microphone that can be mounted on either side of the talker's mouth, a compact amplifier, and a loudspeaker to reduce feedback. The body speaker can be worn at various positions on the body, mounted on a wheelchair, or placed on a flat surface. Speechmaker also includes a rechargeable battery, battery charger, belt clip, and a carrying case.



**Product Name:** Tokyo Artificial Larynx

**Vendor:** Artificial Speech Aids

**Size:** 7.5" long

**Weight:** 3 oz.

**Cost:** \$96.00

Tokyo Artificial Larynx is a breath-powered artificial larynx designed for laryngectomees. A cup the size of one and one-half inches fits over the stoma and conducts the lung wind to a unit containing a rubber diaphragm. This diaphragm vibrates, generating a tone which is then conducted through a tube into the user's mouth. The user articulates this tone into speech with the normal movements of the mouth and tongue.

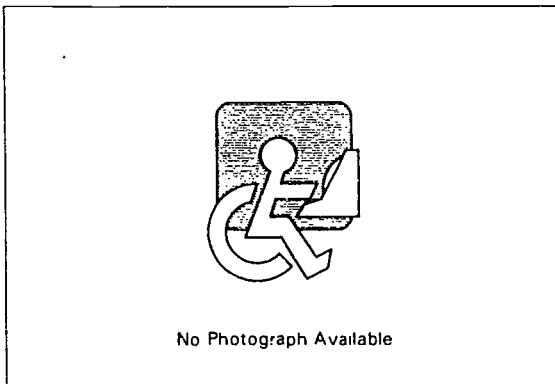

**Product Name:** Voice Amplificaider

**Vendor:** Crestwood Company

**Power Source:** 2 9V & 4 C batteries

**Cost:** \$279.95

The Voice Amplificaider is a wireless amplification system with adjustable volume control. The set consists of a clip-on microphone with transmitter, receiver, speaker, and earphones for private conversation. Very low level voices can be heard and understood by others up to 50 feet away.



**Product Name:** Voicette

**Vendor:** Luminaud, Inc.

**Size:** 6.5" x 6.5" x 3"

**Weight:** 2 lbs.

**Power Source:** Rechargeable batteries

**Cost:** \$165.00

Voicette is a small, portable, battery-operated voice amplifier. The user speaks into a microphone, and the voice comes out amplified through Voicette's speaker/amplifier. Voicette comes with a carrying case. Voicette is powered by a rechargeable battery pack that can be charged on 120V AC (250V/50 cycle charger also available).

# Chapter 2

## Pointing and Typing Aids

This chapter includes devices whose purpose is to facilitate an individual's ability to point to objects or press keys. Headsticks, mouthsticks, and lightbeam pointers are all included. There are other devices which are useful for pointing and typing which have not been included, however, such as hand splints or typing sticks. Pointing devices can also be customized or fabricated, so don't think that the commercially available devices in this chapter are your only options.

If a pointer is only meant to work with one specific model or brand of communication aid, it will not be listed in this chapter. Instead it will appear as part of the description of the device that it works with. If you want to find all of the devices in the ResourceBook which are operated by headpointing, look in Index 2 (Index by Input/Output Feature), under the heading "Input Type: Head Controlled."

Other mechanical devices that can help in using keyboards or computers are keyguards and disk loaders. See Chapter 11 (Modifications for Standard Keyboards and Mice) and Chapter 18 (Other Software and Hardware Adaptations) for these devices. Electric page turners and telephone holders and latches are found in Chapter 9 (Environmental Controls and Telephone Adaptations). A related function found in Index 1 (Index by Function) is Book/Paper Handling (BP).

*The following product entries appear in this chapter:*

Adjustable Head Pointer, 15  
Adjustable Head Pointer, 15  
Adjustable Head Pointer PC 7590, 16  
Baton Laser Pointer, 16  
Clear-View Head Pointer, 17  
F73216-100 Page Turner/Keyboard Aid, 17  
Gripper Prehensor, 18  
H71830 Adjustable Head Pointer, 18  
H73217 Mouth Held Page Turners, 19  
Handpointers, 19  
Head Pointers: AD-1, AD-2, AD-3, 20  
Heyer-Abadie Modular Mouthstick, 20  
Laser Light Pointer, 21  
Light Beam Indicator, 21  
Light Pointer, 22  
Light Pointer, 22  
Light Pointers, 23  
LightBeam, 23  
Mouthsticks, 24  
RedLite, 24  
Slip-On Typing Aid, 25  
Talking Laser Beam, 25  
Vacuum Wand, 26  
Viewpoint Optical Indicator, 26

*The following products from other chapters can also be used as Pointing or Typing Aids:*

High Tech/Low Cost, 223  
Media Handling Products, 549  
Writing Utensil Grips, 113

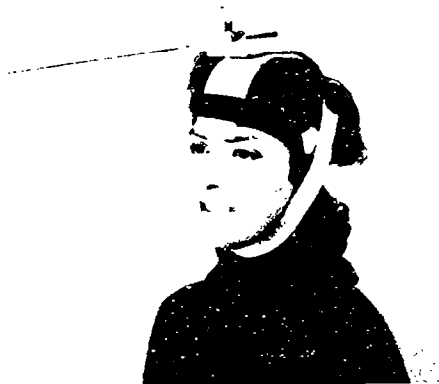

**Product Name:** Adjustable Head Pointer

**Vendor:** Cleo of New York

**Weight:** 1 lb.

**Cost:** \$34.95

This head pointer has a foam-lined aluminum frame that can be bent to accommodate various size heads. The frame is held in place by an elastic headband and chin strap, both of which have adjustable hook-and-loop fasteners. Pointer length is also adjustable with velcro straps.

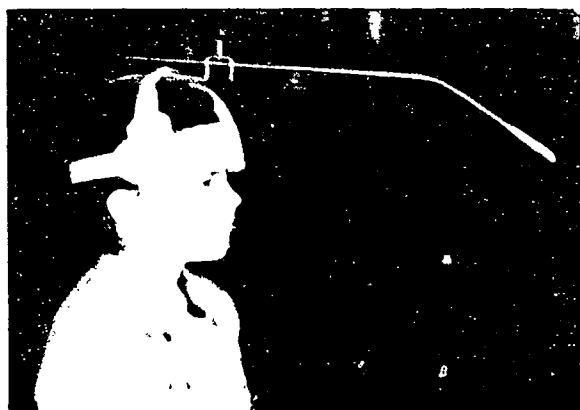

**Product Name:** Adjustable Head Pointer

**Vendor:** Fred Sammons, Inc.

**Size:** 18.5" long

**Weight:** 1 lb.

**Cost:** \$34.95

The Adjustable Head Pointer is an aluminum pointer that projects from above the forehead. Size and shape of the frame, as well as the length and angle of the pointing rod are adjustable. The elastic head band and chin strap attach with hook-and-loop material.

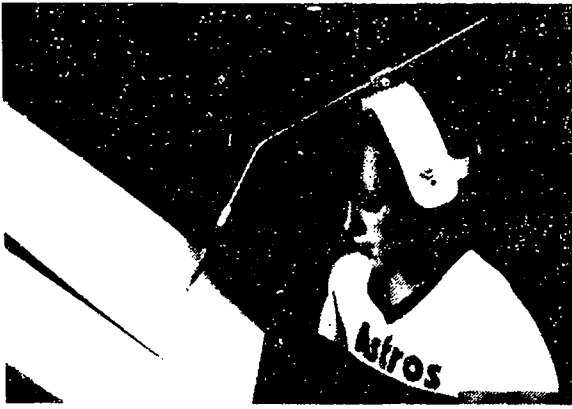

**Product Name:** Adjustable Head Pointer PC 7590

**Vendor:** Sammons-Preston Corporation

**Size:** 19" long

**Weight:** 1.5 lbs.

**Cost:** \$115.52

Adjustable Head Pointer is a pointer that fastens on the head with a plastic head band, and projects out over the user's forehead. The head band and the length and angle of the pointer rod are all adjustable.



**Product Name:** Baton Laser Pointer

**Vendor:** Innocomp

**Cost:** \$595.00

Baton Laser Pointer is a head mounted pointer with an integrated sip-puff switch to enable the user to turn the laser on and off. The unit is supplied with 10 replacement mouth pieces, head gear, and battery. A sealed switching mechanism prevents the device from being damaged by fluids.



**Product Name:** Clear-View Head Pointer

**Vendor:** Fred Sammons, Inc.

**Size:** 24" long

**Weight:** 2 lbs.

**Power Source:** None

**Cost:** \$84.95

Clear-View Head Pointer is a headpointer that projects out at jaw level. The design of extending the pointer from jaw level rather than forehead level places the pointer in closer proximity to the object being selected, and does not interrupt the user's field of vision during use. Clear-View Head Pointer is adjustable six ways.



**Product Name:** F73216-100 Page Turner/Keyboard Aid

**Vendor:** Maddak, Inc.

**Size:** 8.75" x 1"

**Cost:** \$17.75

Page Turner/Keyboard Aid consists of a lightweight cuff attached to a wooden dowel that has a rubber friction tip. The cuff fits on the user's hand by means of a D-ring and Velcro closure.



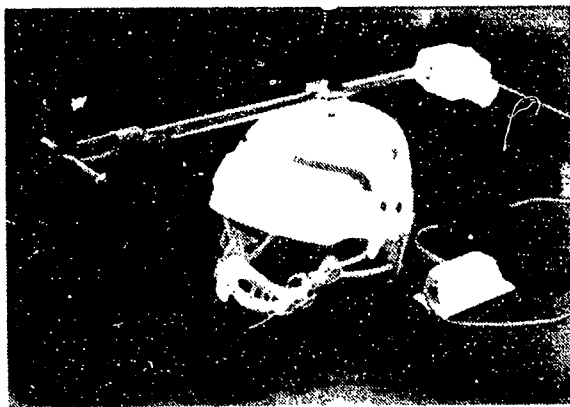

**Product Name:** Gripper Prehensor

**Vendor:** Toys for Special Children, Inc.

**Cost:** \$425.00

Gripper Prehensor is a product designed to enable the user to pick up parts at his or her work station. It resembles a trimmed down bicycle helmet with a rod attached to it. The device is activated by depressing a button. A variety of gripping and manipulating devices, including magnetic, vacuum, and mechanical pickup, can be attached depending on the task to be performed.

The standard Gripper comes mounted on a helmet and is powered by an air compressor. Contact manufacturer for details about customizing the Gripper for use with different input devices.

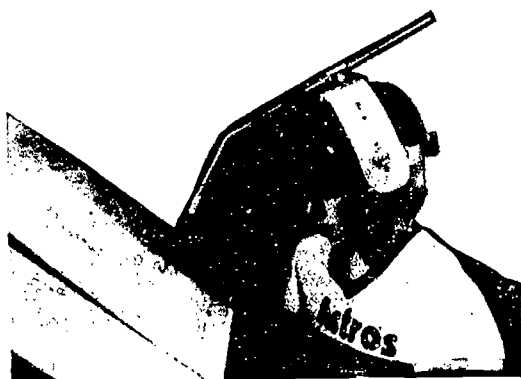

**Product Name:** H71830 Adjustable Head Pointer

**Vendor:** Maddak, Inc.

**Size:** 19" long

**Weight:** 8 oz.

**Cost:** \$94.50

This headpointer is held on the head with plastic bands adjustable to the size of the user's head. The pointer rod, which projects from the top of the head, has adjustable length and angle and a pencil holder at the tip.

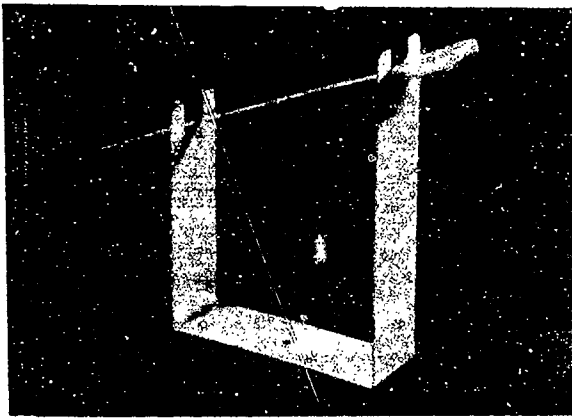

**Product Name:** H73217 Mouth Held Page Turners

**Vendor:** Maddak, Inc.

**Size:** 12" long

**Weight:** 0.75 oz.

**Cost:** \$24.90 - \$29.70

Mouth Held Page Turners are mouthsticks equipped with rubber tips designed for gripping pages. Mouthpieces are heart shaped, flat, and rubber coated; shafts are plastic. Two widths are available: 1.5" and 2". A stand that can be used with either of the models is available for \$9.90.

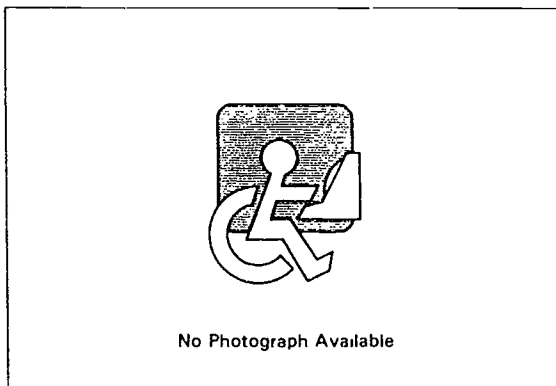

**Product Name:** Handpointers

**Vendor:** Various (Generic Product)

**Cost:** Varies

Handpointers provide a method for focusing uncoordinated movements to better indicate and manipulate targets, and can assist in pointing accuracy by allowing the user to stabilize movement.

Some pointers, attached to wrist splints, are available from rehabilitation equipment companies; others are custom fabricated by therapists or orthotists.

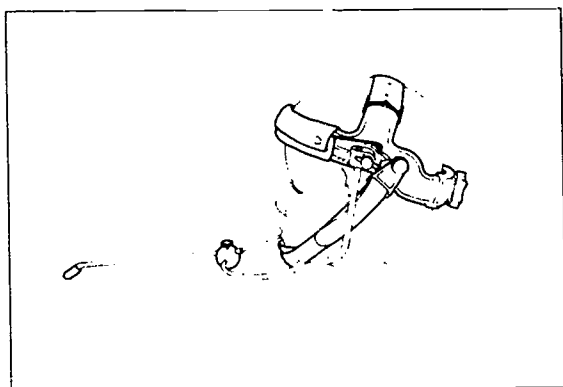

**Product Name:** Head Pointers: AD-1, AD-2, AD-3

**Vendor:** Zygo Industries, Inc.

**Size:** 10" long

**Weight:** 8 oz.

**Cost:** \$170.00

These Head Pointers use the chin rather than the forehead as a point of reference for the pointer. The Standard Pointer (model AD-1) may be individually fitted to head sizes ranging from 20 to 25 inches in circumference. "Tiny Tot" (AD-2) and hook-and-loop closure (AD-3) models are also available.

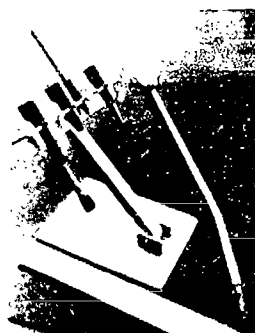

**Product Name:** Heyer-Abadie Modular Mouthstick

**Vendor:** Extensions for Independence

**Size:** See text

**Weight:** 2.2 oz.

**Cost:** \$120.00 - \$530.00

Heyer-Abadie Modular Mouthstick is a telescoping mouthstick system with an aluminum or stainless steel V-shaped mouthpiece. The design of the mouthpiece allows the user to talk while working the stick. The mouthstick is the basic element to which special purpose telescoping "bodies" are attached. Various mouthstick bodies and tip attachments are available.



No Photograph Available

**Product Name:** Laser Light Pointer

**Vendor:** Innocomp

**Power Source:** 2 "AAA" batteries

**Cost:** \$300.00

The Laser Light Pointer is designed for use with the Scan-It-All (see entry) but can also be used for light pointing to communication boards, objects, pictures, or people. The diode laser has less than 1.0 m W max output and is a Class II laser product.

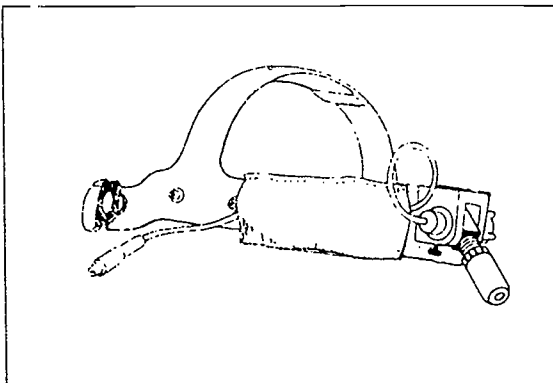

**Product Name:** Light Beam Indicator

**Vendor:** Jim's Instrument Manufacturing, Inc.

**Size:** 22" long

**Weight:** 11.5 oz.

**Power Source:** 3 "C" batteries

**Cost:** \$175.00 - \$425.00

Light Beam Indicator is a head-mounted pointing system using both a pointing rod and an adjustable padded nylon headset with a light pointer. The rod projects out over the forehead and downward. The light pointer is positioned over the forehead and projects a concentrated light beam. Three models are available: rod and headset; rod, headset, headstick, and optics; and headstick only.

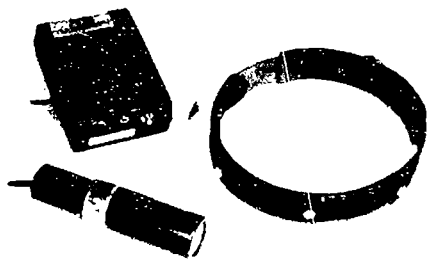

**Product Name:** Light Pointer

**Vendor:** ACS Technologies, Inc.

**Size:** 5.5" x 1.3" diam.

**Weight:** 3 oz.

**Power Source:** Rechargeable battery

**Cost:** \$435.00

Light Pointer is a cylindrical device that projects a red light spot. The Light Pointer may be attached to the part of the body with which the user wants to point (head, etc.). The user then indicates selections by directing the red dot of light at the desired selection. The Light Pointer may be used on such systems as communication boards, or may serve as direct input to the ScanPAC or EvalPAC communication aids.

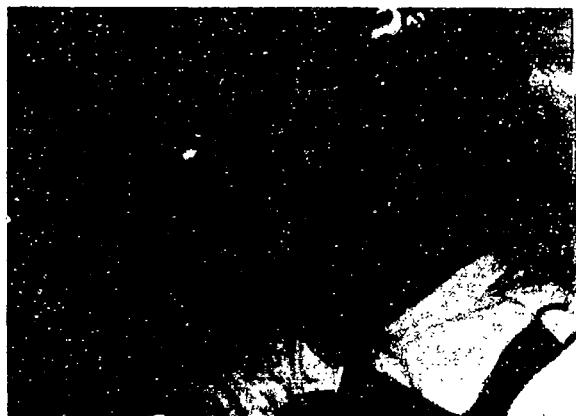

**Product Name:** Light Pointer

**Vendor:** Burkhart, Linda J.

**Cost:** \$28.95

Light Pointer is a device that projects a spot of light. The pointer is designed to be mounted on the user's head and pointed toward objects. The Light Pointer can also be used to activate the Light Activated Switch (also available from Linda Burkhart).

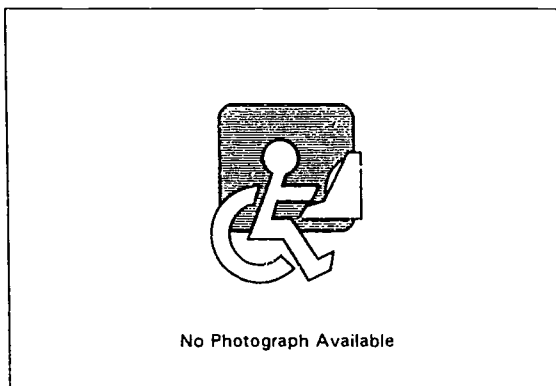

**Product Name:** Light Pointers

**Vendor:** Various (Generic Product)

**Cost:** Varies

Many light pointers used for manual communication boards and pointing systems are designed by rehabilitation manufacturers. In recent years light pointers have been developed for other commercial applications and can be found in mass market specialty stores. For example, flashlights designed to be portable, light weight, and with a focused beam are available for camping applications from recreational and camping stores. Features to consider for all light pointers include the length of time the batteries last with heavy or constant use and the ease in which the batteries can be recharged.

Laser light pointers designed for pointing to slide and overhead projection screens are available from office supply stores, some book stores, and some science stores and catalogs. Specific sources can be found in local yellow pages, in the manufacturer list of this book, in listings from local rehabilitation service delivery programs, and also often in gift specialty catalogs that carry personal convenience types of devices.

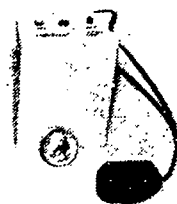

**Product Name:** LightBeam

**Vendor:** Ability Research, Inc.

**Weight:** 0.5 oz.

**Power Source:** Rechargeable or 9V

**Cost:** \$229.00 - \$299.00

LightBeam is a small battery-operated light pointer that can be mounted on headband, eyeglasses, etc. for head pointing. LightBeam can be controlled by an ability switch, has adjustable brightness, and can project up to three feet. The device is LightSwitch and ACS compatible.

Model LBM-1 uses a 9V Alkaline cell (not included), provides up to 20 hours operation, and includes an AC adapter. Model LBM-R uses a built-in rechargeable battery, provides up to 16 hours operation per charge, and includes an AC adapter and charger.

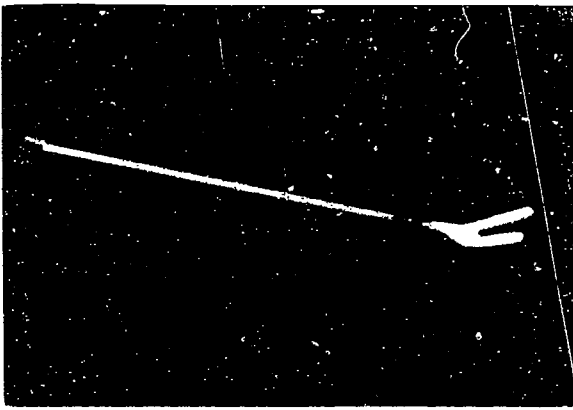

**Product Name:** Mouthsticks

**Vendor:** Fred Sammons, Inc.

**Size:** 10" - 20" long

**Weight:** 1 - 1.5 oz.

**Cost:** \$26.95 - \$61.25

The six models of mouthsticks all have a V-shaped mouthpiece that allows tongue movement. The Wand Mouthstick has a rubber tip and can be used for typing or page turning. Clamp-On Mouthstick holds a pencil, pen, or brush. The Vertical Pincher Mouthstick has a tongue-controlled pincher at the end which can be used to insert paper into a typewriter. Also available is a Wand Mouthstick with a bend adapter that can be adjusted to the desired angle and two models of Telescoping Bendable Mouthsticks with a holder for a pen, pencil, brush, etc. or a rubber tip. Contact manufacturer for pricing information.

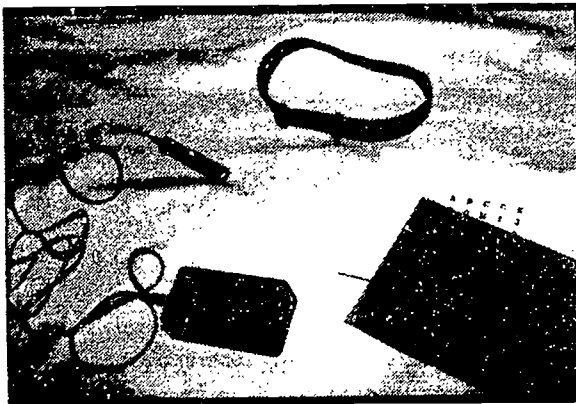

**Product Name:** RedLite

**Vendor:** See A Need

**Size:** 0.63" diameter x 3" long

**Weight:** 0.75 oz.

**Power Source:** 2 "C" batteries

**Cost:** \$90.00

RedLite is an optical pointer that produces a focused red target pattern (0.75" diameter) at a distance of two to three feet from the pointer. The pointer is attached to a hat, headband or the temple of a pair of eyeglasses and is used to select items from an alphabet or communication board. RedLite consists of the pointer, battery pack, five-foot connecting cable and mounting instructions.

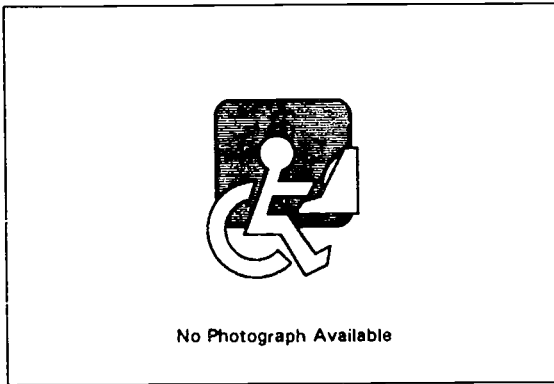

**Product Name:** Slip-On Typing Aid

**Vendor:** Access to Recreation, Inc.

**Cost:** \$14.95

The Slip-On Typing Aid slides onto the hand and is tightened with Velcro straps. A flexible wrist and elbow are needed to properly use this typing tool. Available for left or right hands.

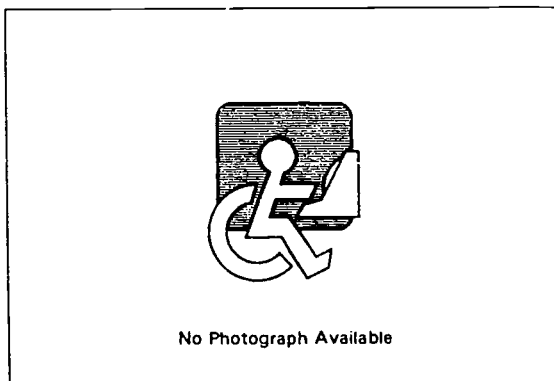

**Product Name:** Talking Laser Beam

**Vendor:** Crestwood Company

**Weight:** 2 or 7 oz.

**Power Source:** 2 "AA" batteries

**Cost:** \$209.95

The Talking Laser Beam is a pointing aid designed as a communication tool for nonverbal users who can move a head, hand, or foot. The red light beam can project up to 100 feet on a board, wall, or ceiling. Up to 50 hours of use before battery change is required. The manufacturer suggests using the Talking Laser Beam with its Alphabet Board Kit (see entry).

The standard 7 oz. Talking Laser Beam mounts on a visor cap and is available in either adult or child size. An adapted 2 oz. version is also available that can attach to the hand or foot.



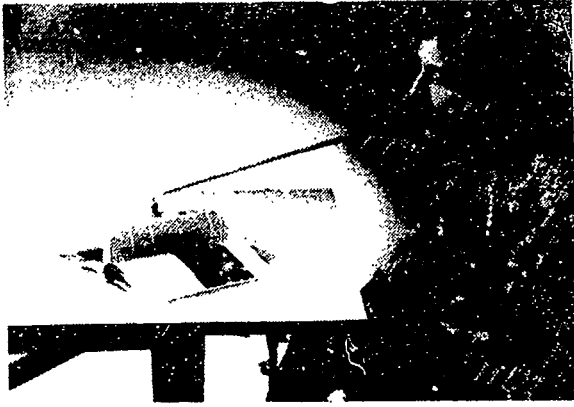

**Product Name:** Vacuum Wand

**Vendor:** Fred Sammons, Inc.

**Size:** 18" long

**Cost:** \$25.95

Vacuum Wand is a mouthstick with a suction cup tip. The aluminum shaft can be cut to the desired length. Two interchangeable tips are provided.



**Product Name:** Viewpoint Optical Indicator

**Vendor:** Prentke Romich Company

**Size:** 2.75" x 1.75"

**Weight:** 3.5 oz.

**Power Source:** Rechargeable batteries

**Cost:** \$390.00

Viewpoint Optical Indicator is a small lightbeam projector that mounts on the user's head with a headband. The user can point to things (such as selections on a communication board) by directing the spot of light from the Viewpoint Optical Indicator toward the desired place. The spot of light is approximately 0.63" in diameter at a distance of 2 feet. The position and angle of the pointer are adjustable.

# Chapter 3

## Training and Communication Initiation Aids

This chapter includes all electric and electronic devices which can be used to initiate communication or train individuals in the use of switches, selection techniques, and other augmentative communication skills. A variety of simple devices for training and recording switch operation are listed. These include switch activation timers and counters, switch latches, and switch adapters for battery-operated toys. Electronic communication aids with fewer than 32 selections and no voice output, such as rotary scanners (choices arranged in a circle) and linear scanners (choices arranged in a single row) are also included. Electronic communication aids with fewer than 32 selections but offer voice output capacities were previously listed here in past editions but are now included in Chapter 5.

Products in this chapter are cross-referenced under a number of categories in Index 1 (Index by Function). Functions related to items in this chapter include: Conversation/Interaction (CI), Environmental Control (EC), and Assessment (AS).

***The following product entries appear in this chapter:***

Ability Switch Tester (5955), 29  
 AC Adaptor FRE-103C, 29  
 Activity Board, 30  
 Activity Boxes, 30  
 AND Module, 31  
 And Or Box, 31  
 Battery Adapter, 32  
 Battery Device Adapter, 32  
 Battery Interrupter, 33  
 Battery Interrupters, 33  
 Buzzer Box, 34  
 Card Communicator, 34  
 Chime Box, 35  
 Clear Clock Communicator, 35  
 Clock Communicator, 36  
 Comboard (2615), 36  
 Communiclock, 37  
 Communilight 24, 37  
 Compartmentalized Clock Communicator, 38  
 Compartmentalized Communicator, 38  
 Counter Box, 39  
 Counter Module, 39  
 Delay Timer Box, 40  
 Dial Scan, 40  
 Dual Action Latch, 41  
 Dual Channel Latching Switch Interface, 41  
 Dual Clock Communicator, 42  
 Duo-Responder, 42  
 E-Tran Scanner, 43  
 Environmental Control for Kids, 43  
 Intention Module, 44  
 Invertor Module, 44  
 Keypad (2425), 45  
 Latch Box, 45  
 Light Activated Switch Panel, 46  
 Lighted Vibrating Signalling Buzzer, 46  
 LinkSwitch, 47  
 Multi-Switch Module, 47  
 Music Button, 48  
 Nine Compartment Row/Column Scanner, 48  
 Nine Volt Battery Adapter Module, 49  
 On/Off Module, 49  
 Peg Switch, 50  
 PigTail Adapters, 50  
 Portable Sound Source II, 51  
 Puzzle Switches, 51  
 Quad Talk, 52  
 Rhythm Generator, 52  
 Round Clock Communicator, 53  
 Scanlite, 53  
 Sequential Scanner, 54  
 Series Adapter, 54  
 Six Position Activity Box, 55  
 Slide Projector Control, 55  
 Steeper Communication/Teaching Aid, 56  
 Switch Latch (4388), 56  
 Switch Latch and Timer, 57  
 Switch Latch/Timer, 57  
 TDD Trainer System, 58  
 Three Position Activity Box, 58  
 Timer Module, 59  
 Toy Adapter, 59  
 Toy Adapter Cables: CA-9/CA-12/CA-16, 60  
 Toy Cables (4378, 4379), 60  
 Trace Beeper Box, 61  
 Training Aid 2, 61  
 Iri-Responder, 62  
 Tubular Vibrator, 62  
 Universal Module, 63  
 Versascan, 63

Vibrating Sack, 64  
 VoiceMate, SwitchMate, ScanMate (2701-2708), 64  
 WPS L.ouiquir 115 and 250, 65

***The following products from other chapters can also be used as Training or Communication Initiation Aids:***

101 Animations, 556  
 Accularm, 311  
 ActionVoice, 118  
 Adult Switch Progressions, 556  
 Attainment Fifteen Talker, 119  
 Attainment Five Talker & Talker Plus, 120  
 Attainment Two Talker, 120  
 Audible Cursor Routine, 121  
 Beeper, 313  
 BIGmack, 122  
 Call Bell (4500), 314  
 Call Signal 2, 314  
 Cause & Effect, 570  
 Cheap Talk 4 & 8, 124  
 Chime Alarm, 315  
 Communication Programs, 124  
 Communication Training Program, 579  
 Companion 401 Communicator, 125  
 Computer Keyboard Switch, 210  
 Computer Switch Plate, 210  
 Core Picture Vocabulary, 80  
 Creature Antics and Creature Capers, 584  
 Creature Chorus, 585  
 Creature Features, 585  
 DigiTalk 1, 127  
 Dino-Games, 588  
 Dinosaur Game, 589  
 Emergency Call Alarm, 317  
 Finger Isolation Button, 218  
 Hawk, 134  
 High Tech/Low Cost, 223  
 I Can Play, Too!, 753  
 Interaction Games, 613  
 Interaction Games II, 614  
 Joystick Trainer, 616  
 Learn to Scan, 620  
 Lighted Extra Loud Signalling Buzzer, 319  
 Lighted Signalling Buzzer, 319  
 Lynx, 140  
 MessageMate 20, 141  
 MessageMate 40, 142  
 Messenger, 142  
 Mini Talking Card Reader, 143  
 Mini-MessageMate, 144  
 Motor Training Games, 638  
 Multi-SCAN, 639  
 New Frog & Fly, 644  
 Object Stand or Calendar Box (3 or 5), 94  
 Object-Picture Talk Board, 94  
 Parrot, 144  
 Personal Trainer, 145  
 Pictalk, 653  
 Picture Scanner, 655  
 Picture/Theme Disks, 656  
 Point to Pictures, 657  
 PowerTalker, 658  
 Press to Play, 660  
 Rockets to the Moon, 666  
 Say-It-Simply Plus, 148  
 Scan & Match 1, 2, 3, and 4, 667  
 Scan It - Switch It, 668  
 Secretary, 151

Shadow Talker, 151  
 Signal Buzzer, 325  
 SimpleCom I: Yes/No Communication, 674  
 SimpleCom II: Needs/Wants Communication, 674  
 Single-Appliance Continuous Control Unit, 296  
 Specialist, 153  
 Storytime Series, 679  
 Storytime Series for Macintosh, 679  
 Switch Module, 153  
 Switch Puzzles, 684  
 SwitchEnsemble, 685  
 Talk Back III, 155  
 Talk Back VI, 155  
 Talking Nouns, Talking Nouns II, and Talking Verbs, 686  
 Talking Switch Plates, 157  
 Talking Touch Window, 687  
 This is the Way We Wash Our Face, 691  
 Turn-Talking, 695  
 VoicePal, 160  
 VoicePal Plus, 160  
 Wheels On The Bus I, II, III, 704  
 Worm Squirm, 708  
 Yak Bak, 162

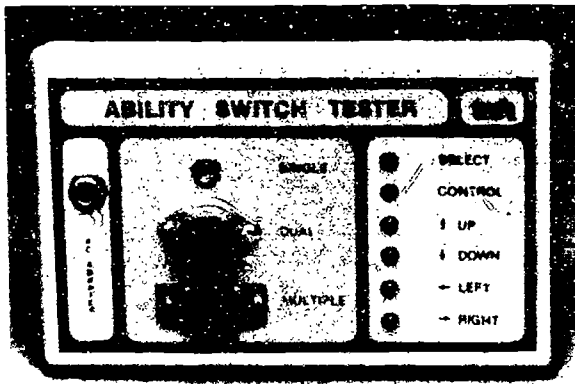

**Product Name:** Ability Switch Tester (5955)

**Vendor:** TASH, Inc.

**Size:** 6" x 3.5" x 1.5"

**Weight:** 8 oz.

**Power Source:** 9V battery

**Cost:** \$120.00

Ability Switch Tester is a device that provides visual and auditory indication when a person activates a switch. The switch is plugged into the tester, and switch closure is indicated by a light and a tone. The auditory feedback can be switched off.

Ability Switch Tester has three different kinds of jacks, for single, dual, and multiple switches. Contact manufacturer about compatibility with a particular switch.

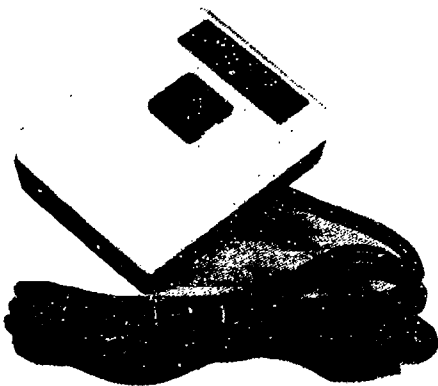

**Product Name:** AC Adaptor FRE-103C

**Vendor:** Creative Switch Industries

**Size:** 4.38" x 3.25" x 1.5"

**Weight:** 8 oz.

**Power Source:** 120V AC

**Connector Type:** Mini-phone plug

**Cost:** \$75.50

AC Adaptor FRE-103 is a device that allows a single switch to be used to control an electrical appliance. This adaptor allows operation of any 110 volt appliance up to 1200 watts. The unit has a miniature input jack allowing use by any type of switch. The adaptor has a six foot cord.

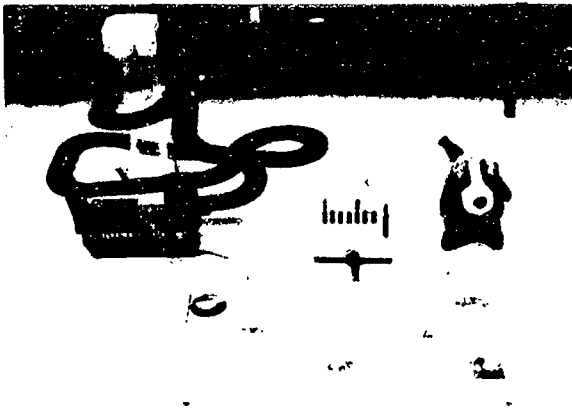

**Product Name:** Activity Board

**Vendor:** EKEG Electronics Company LTD

**Size:** 12" x 24" x 1"

**Weight:** 5 lbs.

**Cost:** \$375.00

Activity Board is a communication training aid consisting of 21 three-inch squares in a seven by three array. The array is covered by a sheet of clear plastic that may be removed so that pictures, symbols, letters, numbers, colors, or shapes may be placed in the grid squares. Selections are made by pressing on a square. Multiple overlays may be constructed for a variety of users. The 21 squares on the Activity Board may be grouped to represent larger activation areas if desired. The Activity Board may be used to operate a battery-operated toy or device by connecting it to a jack on the device's control box corresponding to the proper square on the board.

The Activity Board may be used to operate any battery-operated toy or device, but should not be used to control any device powered by 110V line current. A forty-square (ten by four array) version of the Activity Board is also available. Contact the manufacturer for details. One toy is included in the price of the board. A cable that allows any battery-operated device to be connected to the board is available for \$25.00.

---

**Product Name:** Activity Boxes

**Vendor:** Therapeutic Toys, Inc.

**Cost:** \$124.95 each

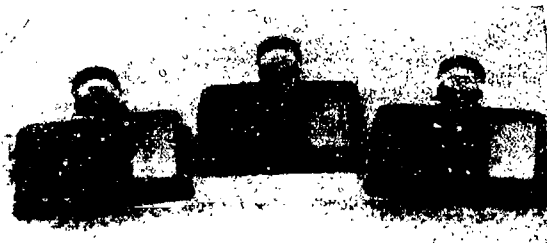

Activity Boxes feature a round touch switch, a rectangular touch switch, and a pull switch that activate a small fan. Models are available for visually impaired users, hearing impaired users, and both hearing and visually impaired users.

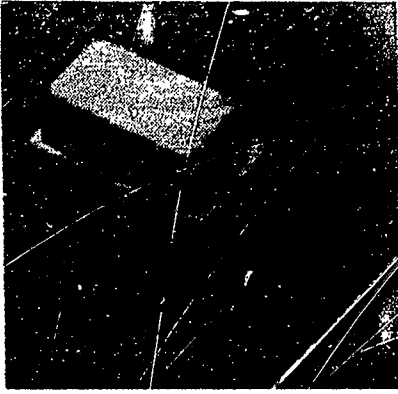

**Product Name:** AND Module

**Vendor:** Toys for Special Children, Inc.

**Cost:** \$21.00

The AND Module connects between two switches and a toy or device. Both switches must be activated simultaneously for the device to operate. One user may activate both switches, or two users may activate the switches cooperatively.

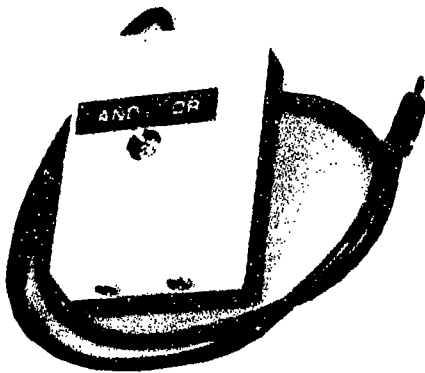

**Product Name:** And Or Box

**Vendor:** Creative Switch Industries

**Size:** 2.5" x 3.75" x 1.75"

**Weight:** 4 oz.

**Connector Type:** Mini-phone plug

**Cost:** \$37.50

And Or Box is a device that connects two switches either in series or in parallel, and in turn connects to a switch-operated device. When the switches are in parallel, activating either one will turn on the switch-operated device. In series, both switches need to be activated at the same time. The two modes are selected using a switch on top of the box.

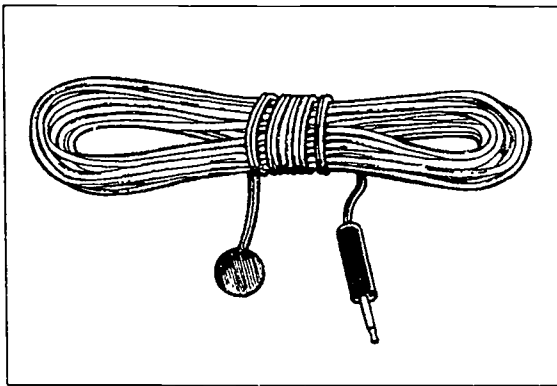

**Product Name:** Battery Adapter  
**Vendor:** Don Johnston Incorporated  
**Connector Type:** 1/8" phone plug  
**Cost:** \$11.50

Battery Adapter is an interface for any battery operated toy or device that allows it to be operated using a single switch. A small metal plate at one end goes between a battery and the battery clip, or is inserted between two batteries in a device. A switch plugs into the jack at the other end of the cable. When the switch is plugged into the jack, the user activates the switch, and the device is turned on.

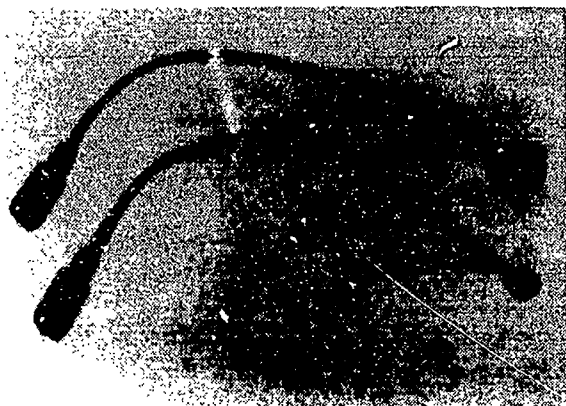

**Product Name:** Battery Device Adapter  
**Vendor:** AbleNet, Inc.  
**Size:** 12"  
**Weight:** 1 oz.  
**Connector Type:** Mini-phone plug  
**Cost:** \$7.50

The Battery Device Adapter is a cable which connects to and adapts battery-operated devices for external switch control. The cable is available in two sizes for use with a wide variety of battery-operated toys and devices powered by "AA," "C," or "D" batteries. The Battery Device Adapter consists of a circular, flexible copper disc and thin lead wire. A switch jack permits connection to AbleNet's Big Red switch (see entry) or other compatible switches.

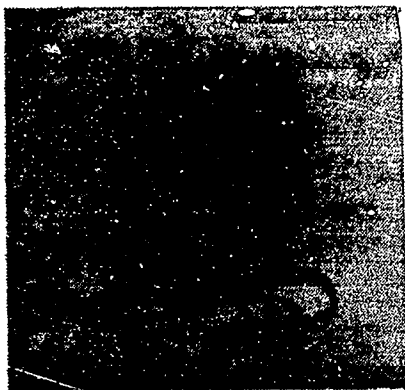

**Product Name:** Battery Interrupter

**Vendor:** Toys for Special Children, Inc.

**Cost:** \$9.00

Battery Interrupter (formerly Battery Adapter) is a cable that fits between any battery-operated toy or device and a switch, permitting the toy or device to be operated by switch. Two versions of the Battery Interrupter are available: one to be used with a device powered by "AA," and one for "C," or "D" batteries.

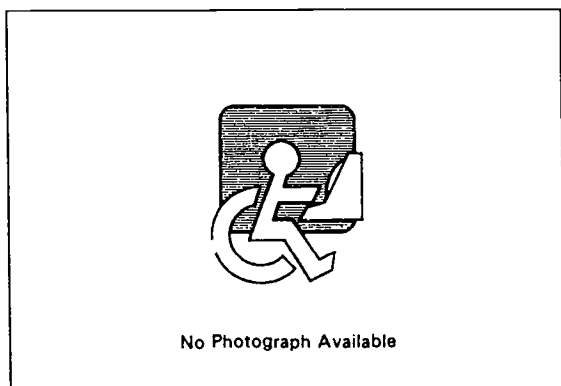

**Product Name:** Battery Interrupters

**Vendor:** Creative Switch Industries

**Cost:** \$7.75 - \$8.75

Battery Interrupters are devices which allow battery-operated devices to be controlled using an ability switch. The interrupter consists of a cable that connects the switch to the device to be controlled. When the interrupter is in place, the battery connection is interrupted; a switch may then be used to restore the electrical circuit and control the device.

Three models are available: Model no. 250100 (\$7.75) for "AA" batteries, model no. 250140 (\$8.25) for "C" or "D" batteries, and model no. 250130 (\$8.75) for 9V batteries.



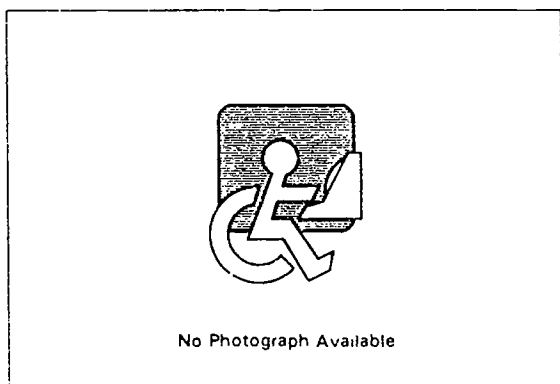

**Product Name:** Buzzer Box  
**Vendor:** Kapable Kids  
**Connector Type:** 1/8" jack  
**Cost:** \$26 00

The Buzzer Box can be activated by any switch to provide auditory feedback. The device can also be used as a simple call aid.

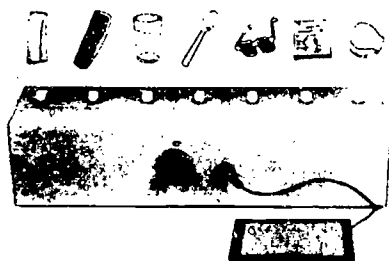

**Product Name:** Card Communicator  
**Vendor:** Crestwood Company  
**Size:** 18.25" x 4.13" x 3.13"  
**Connector Type:** 1/8" phone jack  
**Cost:** \$134.95 - \$184.95

The Card Communicator is a scanning communication aid which holds up to seven symbol cards. In addition, it can enable people with limited hand movement to play card games using seven cards or less. The scanning light moves horizontally from left to right and is controlled by a single switch (not included). The scanning speed is adjustable.

The Card Communicator alone costs \$134.95. The Card Communicator with Jumbo Plate Switch (see entry) costs \$184.95.

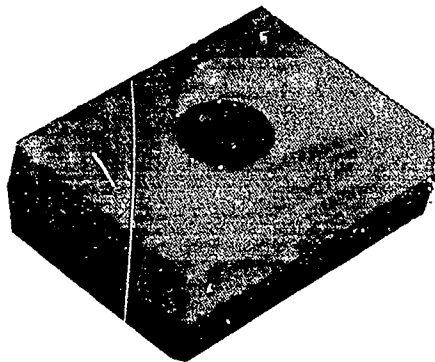

**Product Name:** Chime Box

**Vendor:** Creative Switch Industries

**Power Source:** 9V battery

**Cost:** \$49.00

The Chime Box is a device that produces a chiming sound on switch activation. When a switch is connected to the miniature jack, a "ding-dong" sound is produced as long as the switch is activated. The Chime Box is powered by a 9-volt battery (included).

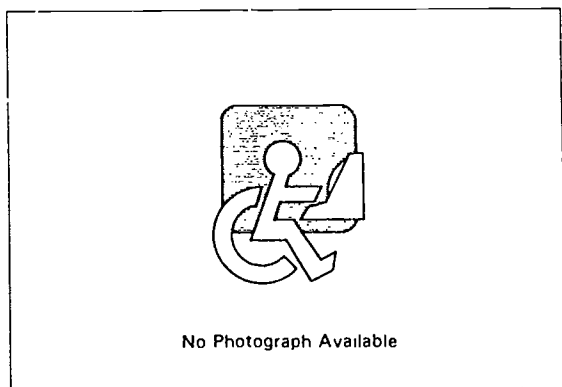

**Product Name:** Clear Clock Communicator

**Vendor:** Toys for Special Children, Inc.

**Cost:** \$73.00

Clear Clock Communicator is a communication device with a clock hand that sweeps around and points to the desired picture, word, or object affixed to the clockface. The device features single or double switch capability (one switch moves the hand clockwise, the second switch moves it counter-clockwise) and a transparent face to allow face-to-face communication.

**Product Name:** Clock Communicator  
**Vendor:** Toys for Special Children, Inc.  
**Power Source:** 1 "D" battery  
**Connector Type:** 1/4" or 1/8" phone plug  
**Cost:** \$51.00 - \$76.00

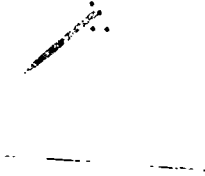

Clock Communicator is a communication training aid with a dial face. Activation of a single switch causes a pointer to revolve. The user releases the switch when the desired position is reached. Any words, pictures, or symbols may be placed on the face of the Clock Communicator to be selected by the user. The speed of the pointer's movement is adjustable.

Two sizes are available. A musical version of the Clock Communicator, with a built-in electronic music box that plays while the pointer is moving, is also available.

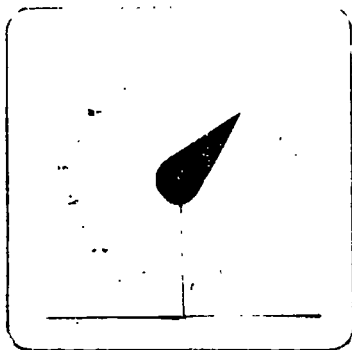

**Product Name:** Comboard (2615)  
**Vendor:** TASH, Inc.  
**Size:** 20" x 20" x 2.5"  
**Weight:** 5 lbs.  
**Power Source:** 4 "C" batteries  
**Connector Type:** 9- or 5-pin DIN, 3.5 mm phone  
**Cost:** \$240.00

Comboard is a scanning communication training device with a dial face. The user activates a single switch to move the pointer clockwise, two single switches to move the pointer clockwise or counterclockwise, or a dual switch to move the pointer either clockwise or counterclockwise. The speed of the pointer movement is adjustable. Comboard comes with adhesive labels for over 100 basic needs, letters, numbers, and pictures.

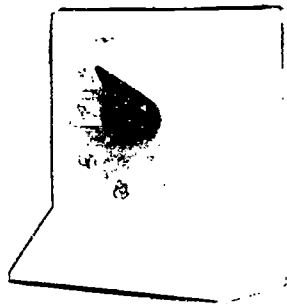

**Product Name:** Communiclock

**Vendor:** Crestwood Company

**Size:** 15.75" x 14.25" x 8"

**Weight:** 4.75 lbs.

**Power Source:** Battery

**Cost:** \$214.95 - \$259.95

Communiclock is a patented scanning communication training device operated by either a single button on the device or an external switch. As long as the switch is closed, the pointer on Communiclock turns clockwise. The user releases the control switch to stop the pointer at the desired selection. The direction of the pointer can be reversed with a flipper switch. Six blank overlays are provided, as well as 246 stickers including: 96 pictures from the Talking Pictures Board (see entry), 50 frequently used words, 50 numerals and alphabet, and 50 blanks.

The Communiclock alone costs \$214.95. The Communiclock with Jumbo Switch Plate (see entry) costs \$259.95.

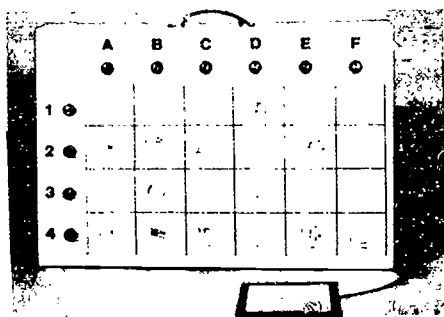

**Product Name:** Communilight 24

**Vendor:** Crestwood Company

**Power Source:** Battery included

**Connector Type:** 1/8" phone jack

**Cost:** \$349.95 - \$394.95

The Communilight 24 is a light scanning system that enables the user to express wants and needs quickly and easily. The red light travels across the top row horizontally until the user stops it with a switch (not included). When stopped, the red light blinks. The green light then travels down the left column until the user stops it and the green light blinks. The symbol at the intersection represents the user's choice. The light speed is adjustable.

Communilight 24 alone costs \$349.95. Communilight 24 with a Jumbo Plate Switch (see entry) costs \$394.95. Comes with four interchangeable overlays and 246 picture, word, letter, number, and blank stickers. Six additional overlays are available for \$24.95.

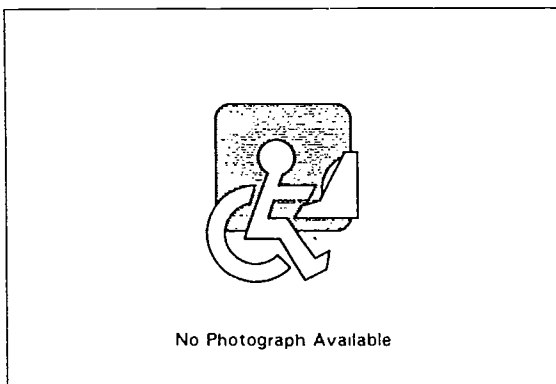

**Product Name:** Compartmentalized Clock Communicator

**Vendor:** Toys for Special Children, Inc.

**Cost:** \$75.00

The Compartmentalized Clock Communicator is a communication device with a rotary clock hand activated by a single switch and recessed compartments in which objects may be placed. The clock speed is adjustable.

---

**Product Name:** Compartmentalized Communicator

**Vendor:** Toys for Special Children, Inc.

**Power Source:** 4 "C" batteries

**Connector Type:** See text

**Cost:** \$71.00 - \$131.00



Compartmentalized Communicator is a direct selection communication training aid that consists of a row of switches, each in its own compartment. Each switch produces a distinct sound when pressed.

Compartmentalized Communicator is available with three or five sections, and with sounds only or sounds and lights. Switches (extra) allow the clinician to turn off individual compartments if desired. Contact manufacturer for more information on switches and connector types.

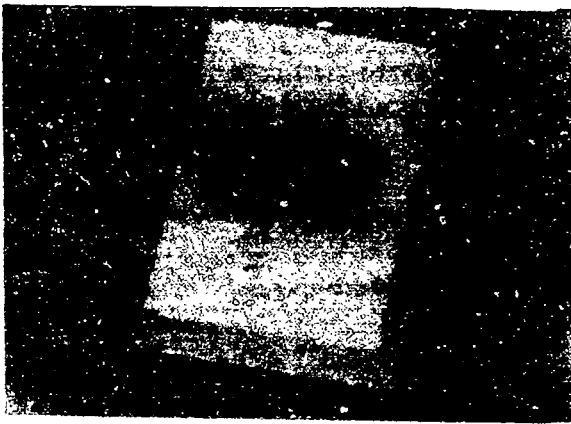

**Product Name:** Counter Box

**Vendor:** Creative Switch Industries

**Size:** 4.25" x 3.25" x 2"

**Weight:** 6 oz.

**Power Source:** See text

**Connector Type:** 1/8" phone plug

**Cost:** \$98.50

Counter Box is a device that counts the number of times a switch is activated. The switch is plugged into the Counter Box, and the number of activations is displayed on an LCD readout on the face of the device. A zero button allows the counter to be reset at any time. The Counter Box is powered by two "N" cells (provided) with a nominal battery life of 4 years.



**Product Name:** Counter Module

**Vendor:** Toys for Special Children, Inc.

**Power Source:** 9V battery

**Connector Type:** 1/4" or 1/8" phone plug

**Cost:** \$53.00

Counter Module is a device that counts the number of times a switch has been activated. The module is connected between the switch and the device activated by the switch. An electronic digital counter displays the number of activations. The Counter Module uses large (1/4") phone connectors; a version with 1/8" connectors is available on request.



**Product Name:** Delay Timer Box  
**Vendor:** Nassau Applied Technology Resource Center  
**Size:** 2.4" x 4.4" x 1"  
**Power Source:** 9V battery  
**Connector Type:** Mini-phone plug  
**Cost:** \$115.00

The Delay Timer accepts input from any momentary switch and in turn provides variable timed output which keeps an appliance or toy on for a preset period of time after the switch is activated. The length of the activation time is adjustable from one to 60 seconds. Delay Timer may be used as a training aid for individuals using a switch for the first time.

Output may be made from Delay Timer to any unmodified toy when a battery interrupter cable is used, or to any toy or appliance modified to accept single switch input.

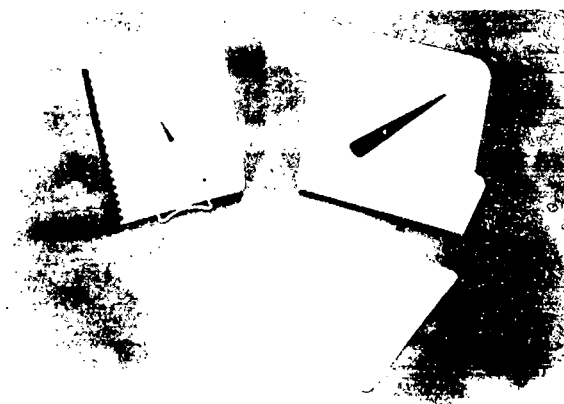

**Product Name:** Dial Scan  
**Vendor:** Don Johnston Incorporated  
**Size:** 12" x 12"  
**Weight:** 2.2 lbs.  
**Power Source:** 4 "C" batteries  
**Connector Type:** 1/8" phone plug  
**Cost:** \$195.00

Dial Scan is a rotary scanning communication training device with a dial face. A single or dual switch is used to rotate a pointer on the dial, and the user releases the switch when the proper selection is reached. Five blank overlays are provided: photos, pictures, or symbols may be placed on them to suit the user's needs. Scanning speed is adjustable. The clear face allows for interactive communication.

The Dial Scan can be used with a Switch/Latch Timer (see entry) to modify switches to operate in either a Time or Latch mode. Additional overlays (2 clear, 3 paper) are available for \$12.00. A wheelchair mount system for Dial Scan is available for \$110.00.

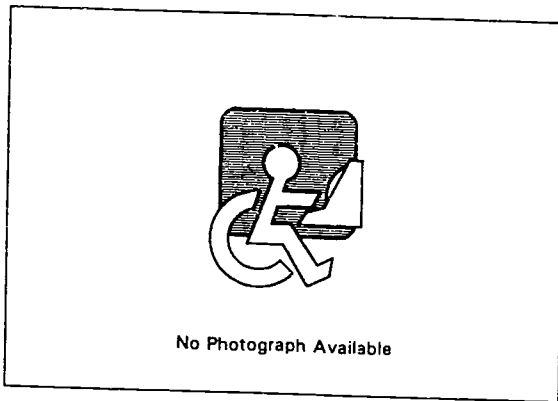

**Product Name:** Dual Action Latch  
**Vendor:** Kapable Kids  
**Power Source:** 9V battery  
**Connector Type:** 1/8" jack and plug  
**Cost:** \$62.00

The Dual Action Latch allows battery operated toys to run for five to 50 seconds after a momentary switch is activated. The Dual Action Latch also allows a momentary switch to operate as a latching switch.

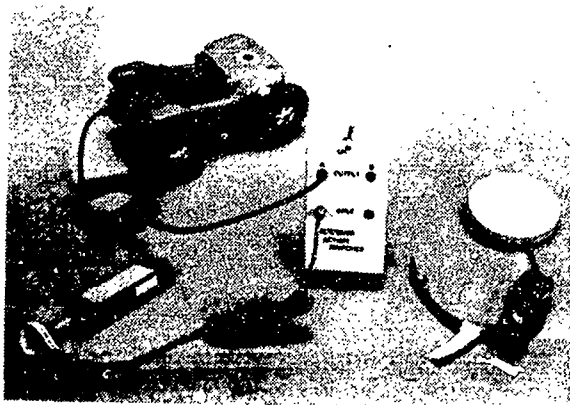

**Product Name:** Dual Channel Latching Switch Interface  
**Vendor:** Hugh MacMillan Rehabilitation Centre  
**Size:** 2.5" x 3.5" x 1.25"  
**Weight:** 5.4 oz.  
**Power Source:** 9V battery  
**Connector Type:** 3.5 mm phone plug  
**Cost:** \$150.00 Canadian

The Dual Switch Latching Interface connects between single switches and a battery operated devices such as a toy, radio or tape recorder to change the operation of the switch. When connected, the Dual Switch latching interface causes the switch to operate in an on/off fashion. Two separate and independent devices may be controlled from two different switches. Each input requires a 3.5mm mini-phone plug connector. Each output requires a 3.5mm mini-phone plug connector which is then connected to the device to be controlled.



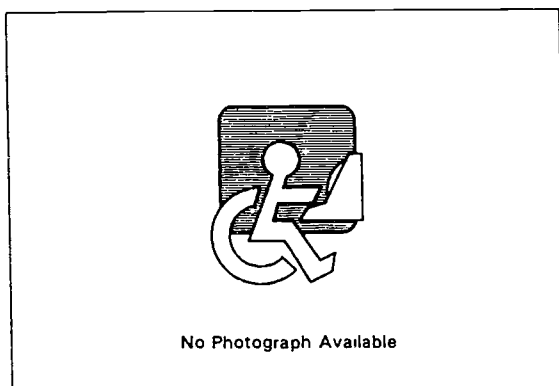

**Product Name:** Dual Clock Communicator  
**Vendor:** Toys for Special Children, Inc.  
**Connector Type:** 1/4" or 1/8" phone jack  
**Cost:** \$75.00

Dual Clock Communicator is a rotary scanning communication training aid that allows objects to be used as symbols. A switch is connected to the communicator and activation of the switch causes a clock hand pointer to move. The user selects a symbol or object by stopping the hand at the desired point. The dual Clock Communicator has seven niches in which objects can be placed to serve as communication symbols. The clock-hand pointer can be replaced with a disk with a single hole in it. When the disk rotates, the objects in the niches are revealed one at a time.

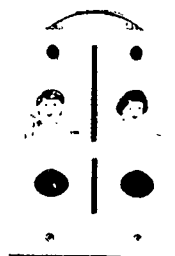

**Product Name:** Duo-Responder  
**Vendor:** Crestwood Company  
**Size:** 7.5" x 5.25" x 6.5"  
**Weight:** 10 oz.  
**Power Source:** Battery included  
**Cost:** \$104.95

The Duo-Responder is designed as a beginner's communication training aid. 20 blank cards and 20 picture cards are included. The picture cards include yes-no, eat-drink, like-don't like, hot-cold, open-close, want-don't want, etc. The left button activates chimes and a green light, the right button activates a buzzer and a red light. Any two switches can also be used (not included).

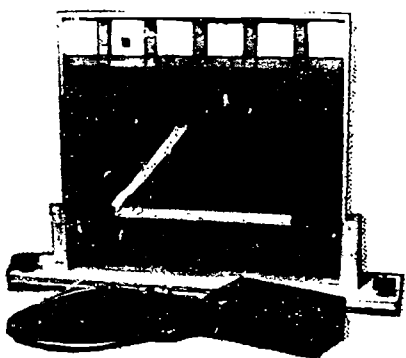

**Product Name:** E-Tran Scanner

**Vendor:** Nassau Applied Technology Resource Center

**Size:** 20" x 20" x 1.5"

**Power Source:** Rechargeable batteries

**Connector Type:** Mini-phone plug

**Cost:** \$1,400.00

E-Tran Scanner is a communication training system designed for an individual just learning to use an electronic aid. Eighteen selection areas are assembled around a central area, allowing the user a clear viewing path. The user scans the selection areas with a single switch in either automatic or manual scanning modes; in automatic scanning, the scanning continues in sequence until the switch is closed, and in manual scanning, a different area lights every time the switch is operated. When the correct area is scanned, a lamp lights the entire selection area on both sides of the device. The message receiver can therefore sit on the opposite side of the E-Tran Scanner and maintain eye contact with the user. The buzzer provided with E-Tran Scanner may be used for audio feedback during selection, or as a call signal. The E-Tran Scanner has eighteen message areas, and the device may be configured to scan only six. Scanning rate is adjustable.

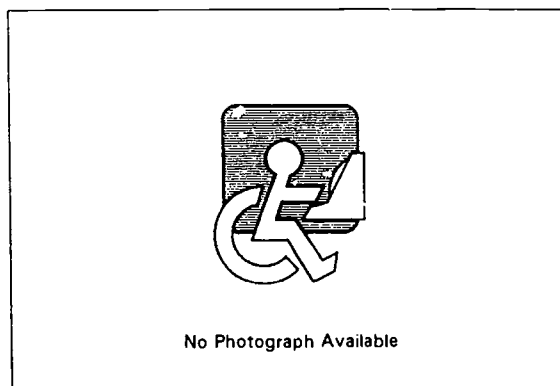

**Product Name:** Environmental Control for Kids

**Vendor:** Various (Generic Product)

**Cost:** Varies

Commercial toy markets are inventing and distributing new toys with specialty control systems as general play items. Many of these toys are particularly helpful for individuals with disabilities. These types of toys can be used with children as alternate access of as training devices for communication systems. For example, toys that are voice activated are now emerging on the market. Other useful toys are robotic like and controlled by a single switch or a simple joystick. Wireless remote control cars and trucks also fall into this category.

These alternate control toys are available from all large toys stores and many electronic product stores. Specific sources can be found in local yellow pages, in the manufacturer list of this book, in listings from local rehabilitation service delivery programs, and also often in gift specialty catalogs that carry personal convenience types of devices.

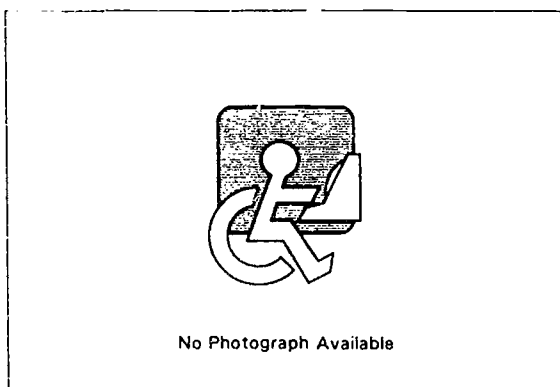

**Product Name:** Intention Module

**Vendor:** Toys for Special Children, Inc.

**Connector Type:** 1/4" or 1/8" phone jacks

**Cost:** \$40.00

The Intention Module is designed for people with uncontrolled movements. When any switch is plugged into the module, sustained and purposeful pressure is required before a closure can occur. This device can be pre-set for a 1 to 12 second delay before activation.

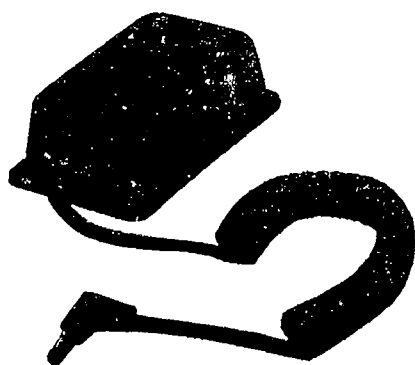

**Product Name:** Invertor Module

**Vendor:** Toys for Special Children, Inc.

**Size:** 5" x 3" x 2"

**Connector Type:** 1/4" or 1/8" phone plug

**Cost:** \$23.00

Invertor Module is a device that reverses switch operation. The Invertor Module connects between a single switch and a switch-operated device (such as a toy). When the switch is not being activated, the toy stays on. When the switch is activated, the toy turns off.



**Product Name:** Keypad (2425)

**Vendor:** TASH, Inc.

**Size:** 15" x 10"

**Weight:** 1.5 lbs.

**Connector Type:** 9-pin D

**Cost:** \$200.00

Keypad is a 3 x 5 array of switches, each activated by pressing on a square plate. The Keypad is low-profile, and each switch is 2.75" square. The switches are covered by a transparent, seamless, flexible plastic cover. Picture or word overlays for each key can be placed underneath the cover. Switches produce an audible click when pressed, and require 100 grams of pressure to activate.

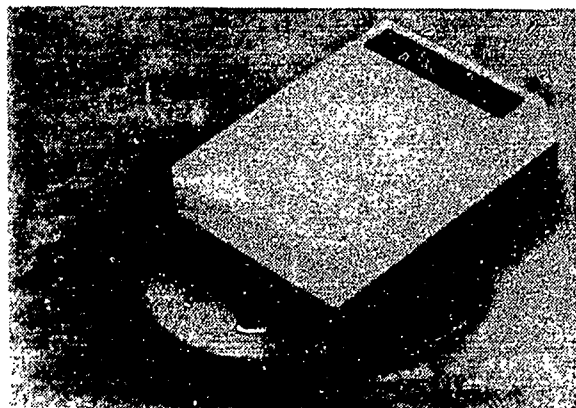

**Product Name:** Latch Box

**Vendor:** Creative Switch Industries

**Cost:** \$70.50

The Latch Box is an electrical relay that converts a switch from a momentary status switch to an on/off switch. A switch and appliance or reinforcing device (such as a toy) are connected to the Latch Box; activating the switch turns the appliance or device on until the switch is activated a second time.

The Latch Box has a 3.5 mm input jack and a 3' output cord with a 3.5 mm plug. The box may be interface with any ability switch and electrical control unit or battery device adaptor.

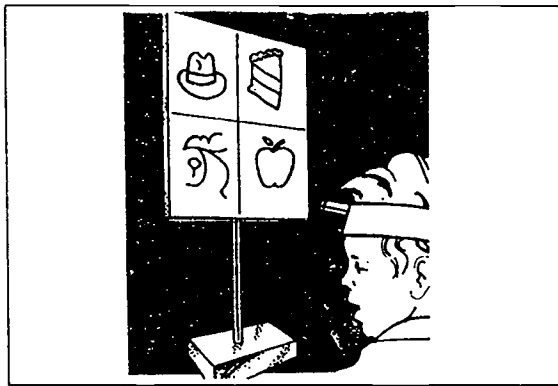

**Product Name:** Light Activated Switch Panel

**Vendor:** Creative Communicating

**Size:** 6.5" x 9"

**Cost:** \$250.00 - \$450.00

The Light Activated Switch Panel is a communication training aid for the cognitively young child and beginning communicator without the use of hands. Free standing panels with four locations offer switch output to multiple group selection, activated by headlamp (included). The panels can be moved or rotated for customization and come with a stand for normal table use.

The panels work with the PowerPad, AIPS Wolf, Switch Introtalker, the Parrot by Zygo, SpeakEasy by AbleNet, Switch Module by Toys for Special Children, and many other devices.

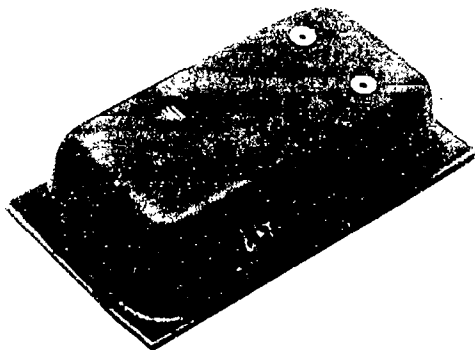

**Product Name:** Lighted Vibrating Signalling Buzzer

**Vendor:** Toys for Special Children, Inc.

**Power Source:** Battery

**Connector Type:** 1/4" or 1/8" phone plug

**Cost:** \$40.00

Lighted Vibrating Signalling Buzzer is a buzzer unit activated by a single switch. When a switch connected to the unit is activated, a buzzer sounds, a light on top of the unit is lit, and the unit vibrates. This tactile feedback can be useful in the training of children with sensory impairments.

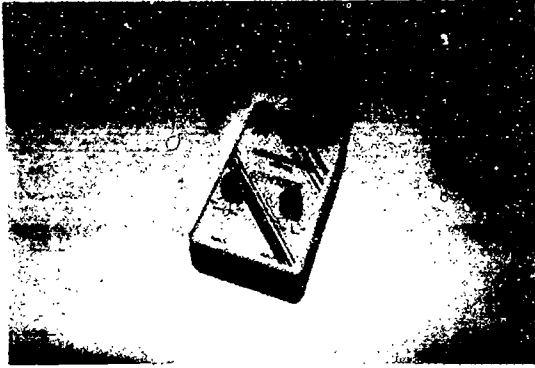

**Product Name:** LinkSwitch

**Vendor:** Adaptivation, Inc.

**Size:** 3" x 4.5" x 2.5"

**Weight:** 0.5 lb.

**Power Source:** 9V battery

**Cost:** \$59.00 - \$99.00

The LinkSwitch is an interface switch that enables the user to activate adapted devices using any ability switch or Adaptivation's Taction Pads (see entry). The device comes with one Taction switch. The LinkSwitch can be mounted with straps, Velcro, or Dual Lock.

There are two versions of the LinkSwitch. The single-channel unit has timing, momentary, and latching capabilities and sells for \$59.00. The dual-channel unit includes momentary and latching capabilities plus a timer and sells for \$99.00.



**Product Name:** Multi-Switch Module

**Vendor:** Toys for Special Children, Inc.

**Size:** 5" x 3" x 2"

**Connector Type:** 1/4" or 1/8" phone plug

**Cost:** \$36.00

Multi-Switch Module is an adaptor which allows several switches to be connected to the same switch-operated device (such as a toy). Which of the switches controls the toy is determined by the setting of toggle switches on top of the module. The module has four jacks for plugging in switches and one output plug for connecting to the toy. The plug can also be connected to a computer for running software equipped for switch input.

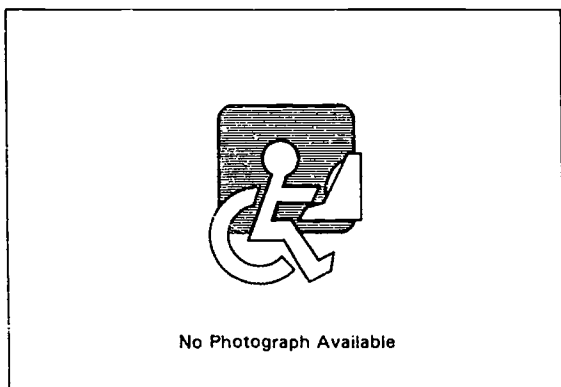

**Product Name:** Music Button

**Vendor:** Toys for Special Children, Inc.

**Cost:** \$17.00

Music Button is a training device for developing fine motor coordination. When the button is pressed, 30 seconds of music is played.

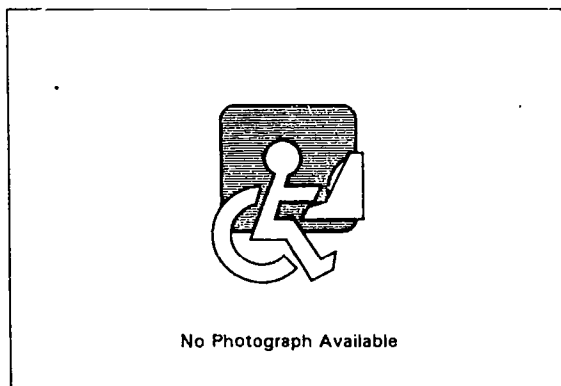

**Product Name:** Nine Compartment Row/Column Scanner

**Vendor:** Toys for Special Children, Inc.

**Cost:** \$98.00

The Nine Compartment Row/Column Scanner is a communication training device designed to introduce the user to the concept of row/column scanning. This device is meant to be an intermediate step between four-position sequential scanners and the more complex scanners with a greater number of units. The compartments hold small objects and feature for single switch scanning.



No Photograph Available

**Product Name:** Nine Volt Battery Adapter Module

**Vendor:** Toys for Special Children, Inc.

**Connector Type:** 1/4" or 1/8" phone plug

**Cost:** \$15.00

The Nine Volt Battery Adapter Module allows toys or devices which operate on a 9V battery but are not adapted for switch use to be used with a single switch.



No Photograph Available

**Product Name:** On/Off Module

**Vendor:** Toys for Special Children, Inc.

**Connector Type:** 1/4" or 1/8" jack and plugs

**Cost:** \$30.00

The On/Off Module allows a device with only one input jack to be operated by two switches. One switch turns the device on and the second turns it off.



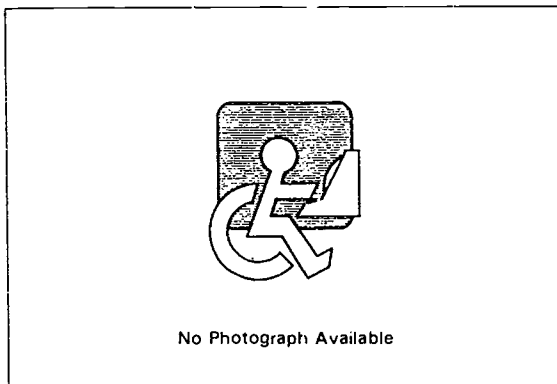

**Product Name:** Peg Switch

**Vendor:** Kapable Kids

**Size:** 5/8" diam.

**Connector Type:** 1/8" plug

**Cost:** \$29.00

The Peg Switch is activated when the peg is placed in the non-skid wood base. The device will remain on for as long as the peg is in place. The Peg Switch is designed to encourage visual attention while developing eye-hand coordination.

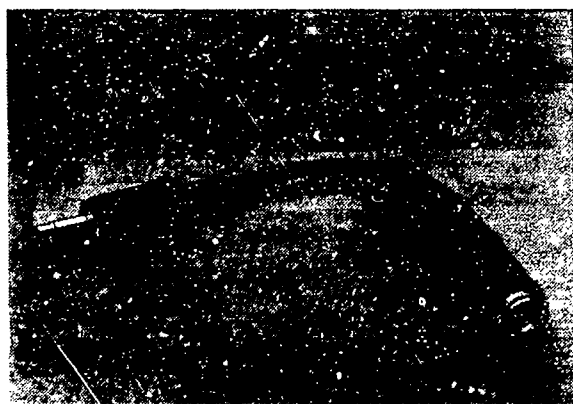

**Product Name:** PigTail Adapters

**Vendor:** AbleNet, Inc.

**Cost:** \$5.00 each

PigTail Adapters are adapters for 1/4", 1/8", and 3/32" plugs. The adapters help link equipment together which does not have corresponding plug end sizes. There are six conversions available: 1/8" to 1/4", 1/8 to 3/32", 1/4" to 1/8", 1/4" to 3/32", 3/32" to 1/8", and 3/32" to 1/4".

The adapters are all sold separately; each adapter is \$5.00. Specify plug conversion sizes when ordering.

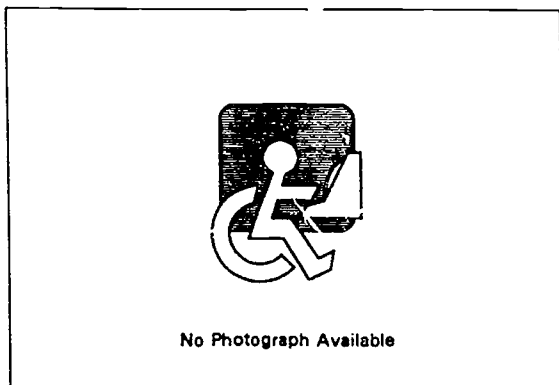

**Product Name:** Portable Sound Source II  
**Vendor:** American Printing House for the Blind (APH)  
**Size:** 8" x 9" x 3.5"  
**Weight:** 6 lbs.  
**Power Source:** 12V battery (included)  
**Cost:** \$148.65

Portable Sound Source II produces a pulsing tone that provides a source of auditory directional cues for training and daily living situations. Rate of the tone is continuously variable from 36 to 360 pulses per minute. Pitch is continuously variable from 600 hertz to 1200 hertz. On/off switch and rate, volume, and tone knobs are mounted on the front face. Speaker measures 3.5".



**Product Name:** Puzzle Switches  
**Vendor:** Toys for Special Children, Inc.  
**Cost:** \$20.00 - \$45.00

Puzzle Switches require the user to perform a visual-motor task to activate the device attached to the switch. Shape Switches require correct placement of one, two, or three pegs. Shape Switch Music Box is similar, but will play a tune if no device is attached when the pegs are placed correctly. The Shapeboard requires all five shapes to be placed correctly, the Round Peg Board features six wooden pegs and a base, the Up/Down Switch features pegs of different lengths that must be placed to form an even row, and the Jumbo Shape Fit Switch features four large wooden pieces.

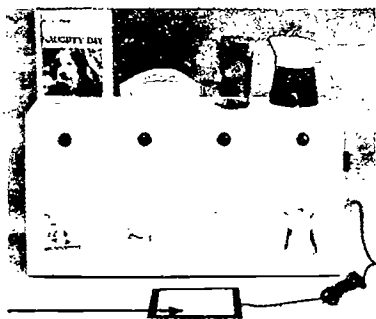

**Product Name:** Quad Talk

**Vendor:** Crestwood Company

**Cost:** \$209.95 - \$254.95

Quad Talk is a patented training device designed to aid students in responding to object and picture stimuli. Four stimulus picture cards, with a light above each one, and four corresponding objects may be placed on the Quad Talk. Each light is activated in turn; the student presses a switch (extra) when the light is over the picture corresponding to an answer or need. The scanning light speed is adjustable. Objects and pictures are not included.

Quad Talk alone costs \$209.95. The Quad Talk with a Jumbo Plate Switch (see entry) costs \$254.95.



**Product Name:** Rhythm Generator

**Vendor:** Toys for Special Children, Inc.

**Size:** 5" x 3" x 2"

**Power Source:** 9V battery

**Connector Type:** 1/4" or 1/8" phone plug

**Cost:** \$46.00

Rhythm Generator is a device that rhythmically activates a switch-operated device, such as a toy. The Rhythm Generator is connected between the switch and the toy. While the switch is activated, the toy turns on and off in a regular rhythm. While the switch is released the toy stays off. The speed of the rhythm is adjustable.

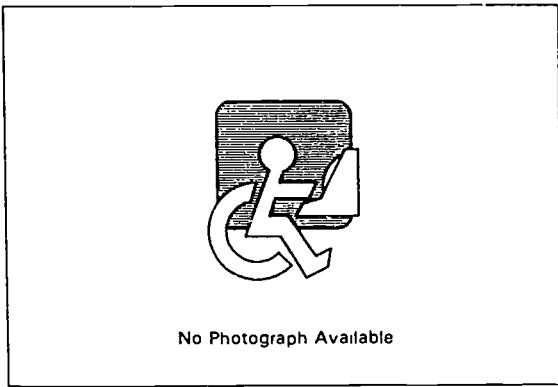

**Product Name:** Round Clock Communicator  
**Vendor:** Toys for Special Children, Inc.  
**Cost:** \$70.00

Round Clock Communicator is a rotary scanning communication device. A switch is connected to the device, and activating the switch causes a clock-hand pointer to move around the face of the Communicator. The user selects symbols or objects by stopping the pointer at the desired place. Round Clock Communicator is equipped with a universal clamp on a rigid gooseneck for attachment to a wheelchair, bedframe or table. The clock face is available in clear or white.

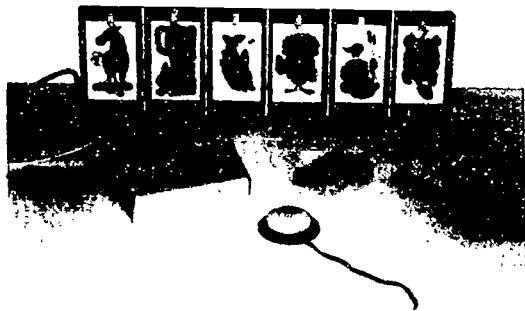

**Product Name:** ScanLite  
**Vendor:** ORCCA Technology, Inc.  
**Power Source:** Rechargeable batteries  
**Cost:** \$250.00

ScanLite is an adaptable, switch-operated scanning selection aid that can be used for assessment and training in scanning. The device consists of a receiver and control unit, a transmitter unit, and an array of lighted indicators that are scanned sequentially. ScanLite can be controlled by radio remote or direct single switch. Scan rate, number of indicators to be scanned, and scan mode (automatic or step) are controllable.

The receiver/control unit and application accessories are sold separately. The receiver/control unit is \$250.00. A variety of accessories are available and each can be connected to the same receiver/control unit. Available accessories include: three-item object board (\$80.00), three-item toy selection and activation board (\$165.00), four-item flexible array (\$75.00), four-item linear picture board (\$75.00), six-item linear picture board (\$80.00), PPVT assessment easel (\$125.00), six-item two-row picture board (\$95.00), four-item sound and picture board with feedback (\$250.00). An auditory prompt module connects to the ScanLite and provides auditory digital scanning along with visual scanning (\$130.00).

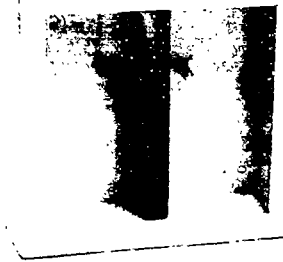

**Product Name:** Sequential Scanner  
**Vendor:** Toys for Special Children, Inc.  
**Size:** 6" x 10"  
**Power Source:** 1 "D" battery  
**Connector Type:** 1/4" or 1/8" phone plug  
**Cost:** \$71.00 - \$98.00

Sequential Scanner is a communication training aid with compartments. An external switch (extra) is attached to the device. Every time the switch is activated, a light moves from one compartment to the next. Objects may be placed in each compartment.

Sequential Scanner is available with two, four, or nine compartments.



**Product Name:** Series Adapter  
**Vendor:** AbleNet, Inc.  
**Size:** 8" long  
**Weight:** 1 oz.  
**Connector Type:** 1/8" phone plug  
**Cost:** \$12.00

Series Adapter is a device that allows two switches to be connected in series. The user plugs two switches into the Series Adapter, along with some device to be controlled (such as a modified battery-operated toy). When they are connected in series, both switches must be activated before the toy will turn on.

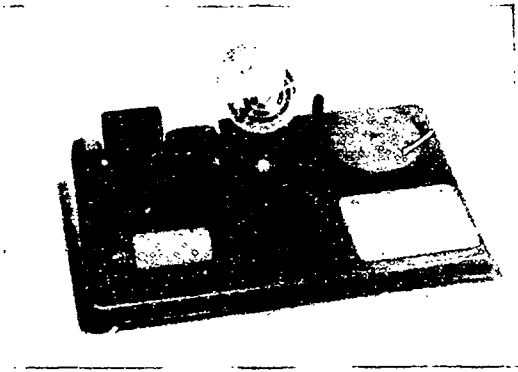

**Product Name:** Six Position Activity Box

**Vendor:** Therapeutic Toys, Inc.

**Cost:** \$169.95

The Six Position Activity Box features a round touch switch, a rectangular touch switch, a pull switch, a leaf switch, and a wooden roller that activate a small fan.



**Product Name:** Slide Projector Control

**Vendor:** AbleNet, Inc.

**Cost:** \$52.00

The Slide Projector Control links a single switch to most models of Kodak Carousel slide projectors. The device's five-prong plug connects to the remote control input port on the slide projector. The switch must be activated, released and reactivated to advance a single slide.

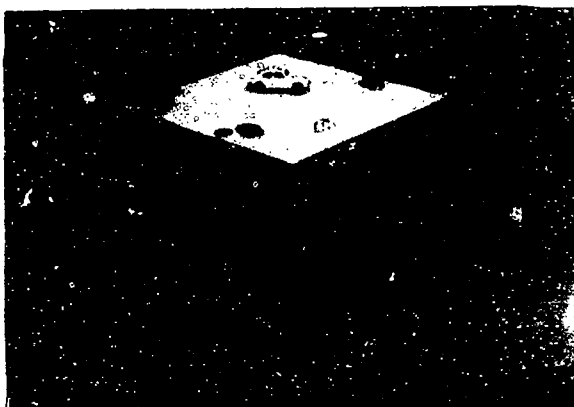

**Product Name:** Steeper Communication/Teaching Aid

**Vendor:** Zygo Industries, Inc.

**Size:** 14.5" x 11.25"

**Weight:** 5.5 lbs.

**Power Source:** 120V AC

**Cost:** \$1,695.00

Steeper Communication/Teaching Aid is a programmable 16-position scanning communication aid. The aid consists of a translucent panel mounted on a base. The panel can be horizontal, tilted 30 degrees, or tilted 60 degrees. The panel is divided into 16 squares, each with a light behind the panel. Communication symbols or objects can be placed on these squares, and the user indicates a choice by scanning with a single switch. In manual scanning mode the user activates the switch, causing the squares to light up sequentially. The user releases the switch when the desired choice is reached. In automatic scanning mode the squares illuminate sequentially, and the user activates the switch to stop the scanning when the desired choice is reached. A control keyboard in the rear of the unit allows the sequence of lights to be programmed, as well as the speed of automatic scanning. A remote control switch allows the direction of scanning and the starting and stopping of automatic scanning to be controlled with an external switch.

A modification is available to permit selections on the Steeper Communication/Teaching Aid to access the voice output of the Zygo Parrot-JK.

---

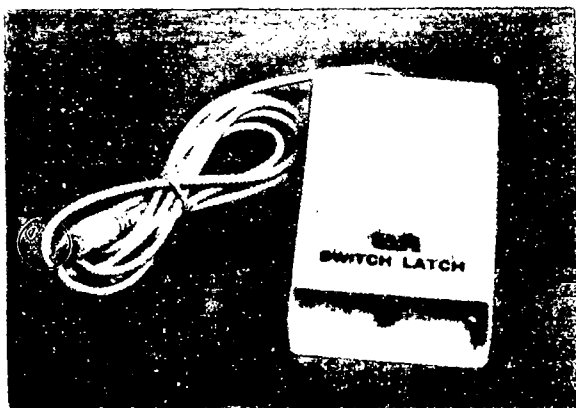

**Product Name:** Switch Latch (4388)

**Vendor:** TASH, Inc.

**Size:** 4" x 2" x 1"

**Weight:** 4 oz.

**Power Source:** 9V battery

**Connector Type:** 1/8" phone plug

**Cost:** \$150.00

Switch Latch is a device that takes momentary input from a single switch and converts it to latched on/off output. Activating the switch once will turn the toy or device on. The toy remains on until the switch is activated again. Switch Latch is designed to be used with battery operated devices such as toys. The Switch Latch will work with any switch having a 1/8" phone jack.

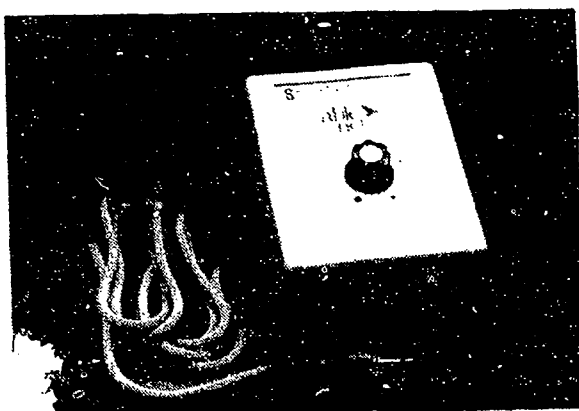

**Product Name:** Switch Latch and Timer

**Vendor:** AbleNet, Inc.

**Size:** 3.25" x 4.5"

**Power Source:** 9V battery

**Cost:** \$54.00

The Switch Latch and Timer allows timer and latch control between a switch and the device it is activating. The device had a timed mode which allows a device to run for one to sixty seconds after the switch is activated. The one-shot timer stops at the end of the preset timing interval even if the switch is held down. In the latch mode, one touch of the switch turns the device on. The device stays on until the switch is activated again.



**Product Name:** Switch Latch/Timer

**Vendor:** Don Johnston Incorporated

**Size:** 4.75" x 2.5" x 1.5"

**Power Source:** Rechargeable batteries

**Connector Type:** 1/8" phone plug

**Cost:** \$145.00

Switch Latch/Timer is a device that connects between a switch and a battery powered switch operated device (such as a modified toy) and adjusts how the switch functions. In latch mode, activating the switch causes the toy to turn on and stay on until the switch is activated again. In timer mode, activating the switch causes the toy to turn on and stay on for a specific period of time. The Switch Latch/Timer can connect to one or two switches and one or two toys. The Switch Latch/Timer itself has an on/off switch so battery power is conserved when the unit is not in use. Each channel can be controlled separately, and unique auditory feedback is supplied for each channel.

The Switch Latch/Timer accepts switches with 1/8" mini-phone plugs.





**Product Name:** TDD Trainer System

**Vendor:** Deafworks

**Size:** 3.5" x 3.5" x 8"

**Weight:** 3 lbs.

**Power Source:** 120V AC

**Cost:** \$129.00

The TDD Trainer System is designed to train persons to use telecommunication devices for the deaf. The system is a "two-way" trainer which allows the users to practice receiving and sending TDD messages. The training device plugs into a wall outlet and its telephone handsets connect the TDDs to the unit.

The training system does not include TDDs.

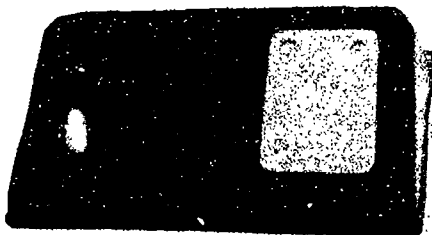

**Product Name:** Three Position Activity Box

**Vendor:** Therapeutic Toys, Inc.

**Cost:** \$105.00

The Three Position Activity Box features a round touch switch, a rectangular touch switch, and a pull switch mounted in a plastic case.



**Product Name:** Timer Module

**Vendor:** Toys for Special Children, Inc.

**Size:** 2" x 3" x 1"

**Power Source:** 9V battery

**Cost:** \$43.00

Timer Module is a device that sets the amount of time that a switch-operated device will remain on after the switch is activated. The amount of time that the Module activates the device is adjustable from 0 to 30 seconds.

Operation of the Timer Module requires a 9 volt battery. Contact manufacturer for information on types of switches and connectors applicable for the Timer Module.

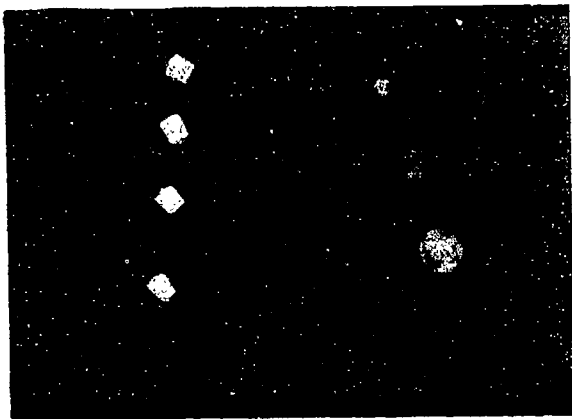

**Product Name:** Toy Adapter

**Vendor:** Burkhardt, Linda J.

**Connector Type:** Mini-phone plug

**Cost:** \$7.95

Toy Adapter is a device that allows a single switch to control the operation of a battery-powered device such as a toy. A switch is plugged into one end of the adapter, and a small plate at the other end is inserted between the battery and the battery contacts in the toy. The switch will then turn the toy on and off.

Toy Adapters come in three sizes, depending on the size of battery in the toy: "D," "C," or "AA." The adapters may be ordered with submini or mini jacks.

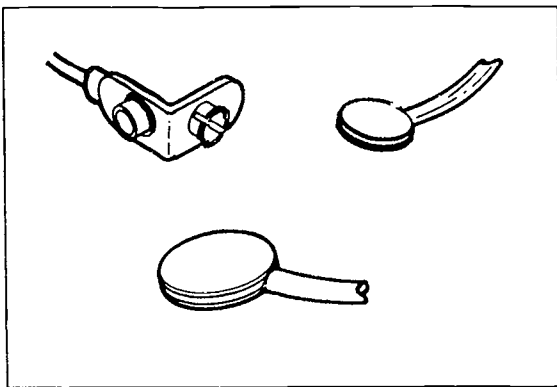

**Product Name:** Toy Adapter Cables: CA-9/CA-12/CA-16

**Vendor:** Zygo Industries, Inc.

**Connector Type:** 1/8" mini-phone plug

**Cost:** \$25.00

Toy Adapter Cables allow battery operated toys or devices to be turned on using most single switches (switches not included). The device consists of a cable with a jack for a single switch at one end, and a small metal plate at the other. The plate is inserted between two batteries in a battery-operated device, such as a toy, or between a battery and a battery contact. When a switch is plugged into the jack, the switch will turn the toy on and off.

Toy Adapter Cables are available for "C," "AA," and 9V transistor batteries.



**Product Name:** Toy Cables (4378, 4379)

**Vendor:** TASH, Inc.

**Size:** 6' long

**Connector Type:** 1/8" mini-phone plug

**Cost:** \$7.00

Toy Cables allow battery operated devices, such as a toy, to be turned on using most single switches (switches not included). It is a cable with a small metal plate at one end and a jack for a single switch at the other. The plate is inserted between two batteries in a battery-operated device or toy, or between a battery and a battery contact. When a switch is plugged into the jack, the switch will turn the toy on and off.

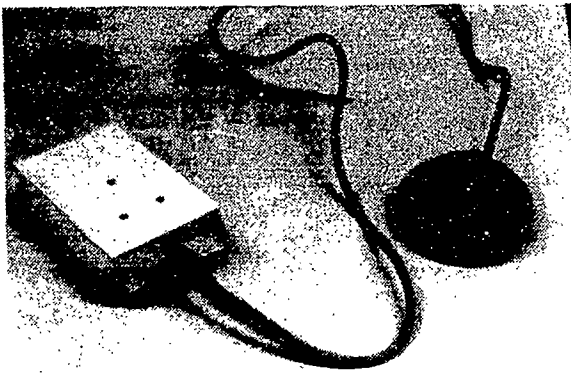

**Product Name:** Trace Beeper Box

**Vendor:** Trace Center

**Power Source:** 9V battery

**Cost:** \$83.00

Trace Beeper Box is a portable switch-activated box with adjustable sound used to provide simple auditory feedback for switch use training, for switch use evaluation, or for simple communication response. A switch is plugged into the standard switch jack on the box. When the switch is activated, a tone is emitted. The tone may be adjusted by the user to permit discrimination between boxes when more than one box is used. Pitch settings range from 400 to 3,000 Hz, and the pulse rate may be adjusted from 0 Hz (steady sound) to 12 Hz (fast pulse). The box runs on a 9-volt battery.

Battery and switch are not included.

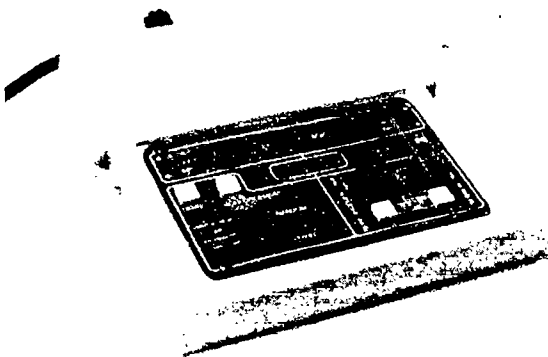

**Product Name:** Training Aid 2

**Vendor:** Prentke Romich Company

**Size:** 8" x 9" x 2"

**Weight:** 2.75 lbs.

**Power Source:** 120V AC

**Connector Type:** Mini-phone plug

**Cost:** \$655.00

Training Aid 2 is a device that allows two switches to be used to control two household current- or battery-operated devices. The Training Aid 2 has an internal clock which allows training sessions to be a set length, up to 20 minutes. During each training session, internal counters record the activations of each switch and the number of times each reinforcement was turned on. The activation of the reinforcement by the switch can be set to be momentary, latching, or timed. Only one switch and one reinforcement can be used if desired.

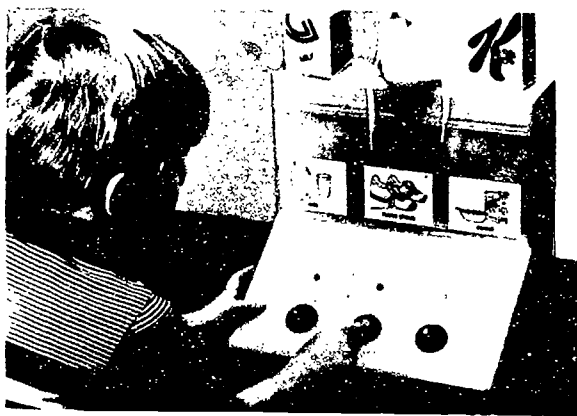

**Product Name:** Tri-Responder  
**Vendor:** Crestwood Company  
**Size:** 10.5" x 16" x 11"  
**Power Source:** Battery  
**Cost:** \$159.95

Tri-Responder is a training device designed to aid students in responding to object and picture stimuli. Three stimulus picture cards and three corresponding objects may be placed on the Tri-Responder. The student responds to directions by pressing one of three large buttons which produce a buzzing sound, colored light, or both. No distinction is made between correct and incorrect responses.

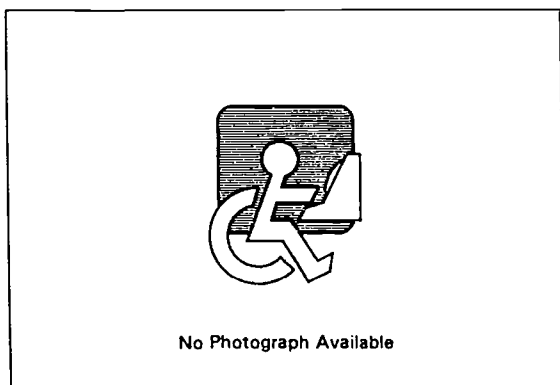

**Product Name:** Tubular Vibrator  
**Vendor:** Toys for Special Children, Inc.  
**Size:** 46" long x 1.5" diameter  
**Cost:** \$25.00

Tubular Vibrator is a switch activated two-speed vibrator that can be wrapped around almost any part of the body providing the individual with vibro-tactile feedback.

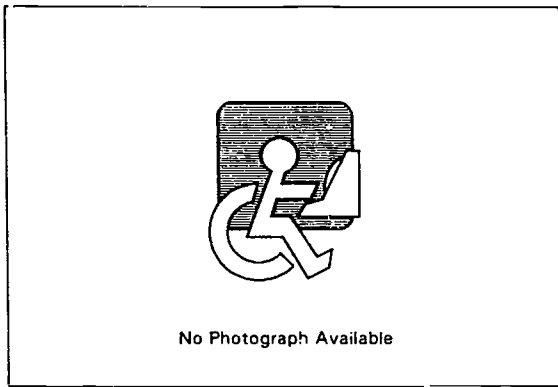

**Product Name:** Universal Module

**Vendor:** Toys for Special Children, Inc.

**Cost:** \$100.00 - \$125.00

The Universal Module increases the flexibility of switch closures by providing alternate actions (on/off), intention delays, and timed outputs. The device can be used with one or two switches.

The Universal Module without a counter is \$100.00, and with a counter is \$125.00. The digital counter registers the timer mode and any switch closure connected to the module.

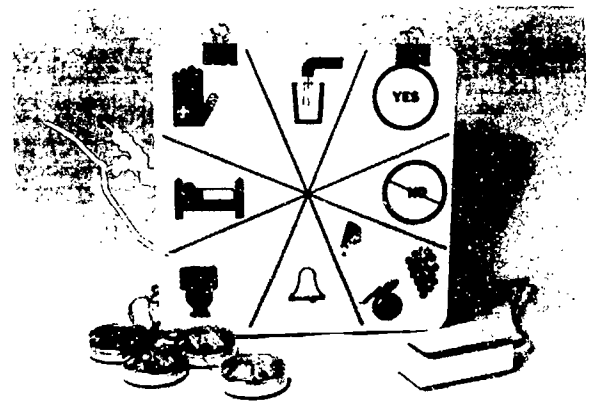

**Product Name:** Versascan

**Vendor:** Prentke Romich Company

**Size:** 12.5" x 11" x 3"

**Weight:** 4.75 lbs.

**Power Source:** Rechargeable batteries

**Cost:** \$925.00

Versascan is a scanning communication training aid having on its face 16 lamps arranged in a circle. When the user activates a switch, the lamps light in sequence. When the desired position is reached the user releases the switch, stopping the movement of the light. Symbols or words may be placed next to the lamps, or translucent overlays may be used, allowing the lamps to shine through. Removeable colored lamp covers are provided that allow positions to be color coded. The lamps are removeable as well, so 2-16 position scanning is possible.

Optional remote lamps are available which plug into the sockets that the standard Versascan lamps plug into. These may be used to create a larger display area for scanning, such as a wall.

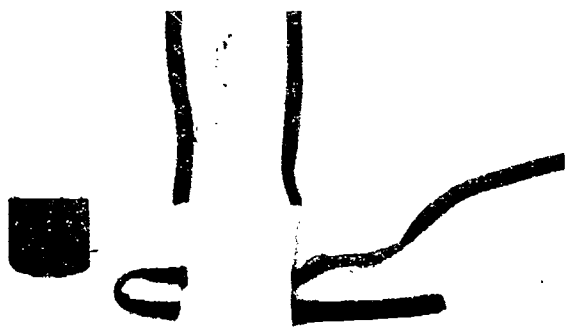

**Product Name:** Vibrating Sack

**Vendor:** Toys for Special Children, Inc.

**Power Source:** 1 "C" battery

**Cost:** \$36.00

Vibrating Sack is a soft cloth bag with a vibrating unit inside. When a single switch connected to the sack is activated, the sack vibrates gently. The tactile feedback provided by the vibrating of the device can be a useful reinforcement for training young children with sensory impairments, to associate the cause and effect of their actions.

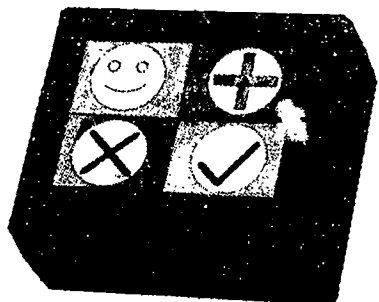

**Product Name:** VoiceMate, SwitchMate, ScanMate  
(2701-2708)

**Vendor:** TASH, Inc.

**Size:** 3" x 2.5" x 1.25"

**Weight:** 8 oz.

**Power Source:** 4 "AAA" batteries

**Cost:** \$325.00 - \$385.00

VoiceMate is a device which allows the user to record four phrases of four seconds each for digitized playback. Phrases are recorded and recalled by using a keypad on the top of the device. SwitchMate allows the connection of four other switches to the VoiceMate for recall of messages. ScanMate provides further connection for single or dual switches for automatic or step scanning. ScanMate 8 allows the user to record eight phrases of four seconds each.

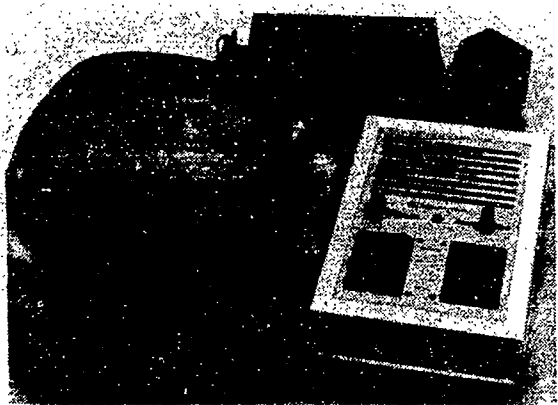

**Product Name:** WPS Loquitur 115 and 250

**Vendor:** Western Psychological Services

**Size:** 9.5" x 6.5" x 2"

**Weight:** 2.5 lbs.

**Cost:** \$495.00

Loquitur 115 and 250 are voice recorders designed to provide immediate and continuous feedback of digitized human speech. The recorders have built-in microphones which allow for recording of an individual client or a small group. Model 115 can operate with a tape player; Model 250 can act as a stand-alone communication aid. On Model 250, between one and four messages can be recorded and played back using either the switches built into the device or external switches connected to any of its four jacks.

Options for both model include a rechargeable battery pack and charger (\$160.00), a tape player (\$55.00), and a carrying case (\$75.00).



# Chapter 4

## Non-Electronic Communication Aids

This chapter includes communication aids which do not use electricity, as well as materials used in developing non-electronic communication systems. This includes communication boards, eye-gaze boards, pre-printed communication symbols, software for creating boards, etc. Headsticks and other non-electronic pointing devices are not included, since they appear in Chapter 2.

Many products in this chapter are also cross-listed by function in Index 1. Related functions include Conversation/Interaction (CI) and Assessment (AS). Many are also cross-listed by "Symbol System" in Index 2, under such categories as Pictures, Blissymbols, and User Selectable symbols.

**The following product entries appear in this chapter:**

AccessBliss 2.2, 69  
Alphabet Board Kit, 69  
AlphaPad, 70  
Appointment Book, 70  
Attainment Communication Collection, 71  
Blissymbol Templates, 71  
Blissymbol Vocabulary Stamps, 72  
Blissymbols Gallery, 72  
Boardmaker 3.0, 73  
Boardmaker for Windows, 73  
Bradley Board Communication Aid, 74  
Calendars, 74  
Chain Talk, 75  
Cleo Communication Board, 75  
Communication Binder, 76  
Communication Board, 76  
Communication Board Builder, 77  
Communication Displays for Engineered  
Preschool Env., 77  
Communication Folder and Tri-Folder, 78  
Communication Icon Galleries CD-ROM, 78  
Communication Sheets, 79  
Communication Symbol Holders, 79  
Core Picture Vocabulary, 80  
Core Vocabulary, 80  
Deluxe Communication Board Kit, 81  
Deluxe Talk Board, 81  
DynaSyms, 82  
Emotional Moods & Needs-G 3&4, 82  
Eye Transfer Communication System, 83  
Eye-Com, 83  
Eye-Com Board, 84  
Fold It System, 84  
Foods I Like Menu Book, 85  
Help Me at Home & School-G 5&6, 85  
Help Me to Help Myself Handbook, 86  
Holiday Kit, 86  
ICU-G 1&2, 87  
Illustrated Menu, 87  
Imaginart Gallery, 88  
Individualized Communication Systems, 88  
Life Experiences Communication Kit, 89  
Long Wallet, 89  
Mealtime Stickers, 90  
Mega-Book, 90  
Mid-Sized Communication Book, 91  
Mini Picture Set, 91  
Nu-View-Cue, 92  
Oakland Schools Picture Dictionary, 92  
Object Communicator, 93  
Object Display, 93  
Object Stand or Calendar Box (3 or 5), 94  
Object-Picture Talk Board, 94  
Opticomunicator, 95  
Passport Kits, 95  
PCS Color Stickers, 96  
PCS Stamps, 96  
PCS Wordless Edition, 97  
PEACEbook, 97  
Pick 'n Stick Color Micros, 98  
Pick 'N Stick Color Packs, 98  
Pick 'N Stick Fast Food, 99  
Pick 'n Stick on Disk, 99  
Pick 'n Stick Primary Pack, 100  
PICSYMS Categorical Dictionary, 100  
Picture Communication Symbols -  
Combination Book, 101  
Picture Communication Symbols, Books I, II  
& III, 101  
Picture Prompt Cards, 102  
Picture Prompt Stickers, 102

Picture Prompt System, 103  
Picture Your Blissymbols, 103  
Pictures, Please!, 104  
Pocket Book, 104  
Pocket Picture Holder, 105  
Pocket-Sized and Double Pocket-Sized  
Communication Book, 105  
Porta Boards, 106  
Porta Book, 106  
Select-A-Meal and Shopping Smart, 107  
Self-Talk Stickers, 107  
Silent Speaker, 108  
Stickers for Talk Boards, 108  
Talking Pictures Communication Board, 109  
Talking Pictures, Kits I - VII, 109  
Touch 'N Talk Communication Board, 110  
Touch 'N Talk Communication  
Notebook, 110  
Touch 'N Talk Communication Stickers, 111  
Touch 'N Talk Micros, 111  
WordWise Language & Master Cards, 112  
WordWise Sticker Set, 112  
Writing Utensil Grips, 113  
Zoo Kit, 113

**The following products from other chapters can also be used as Non-Electronic Communication Aids:**

High Tech/Low Cost, 223  
Picture Cue Dictionary, 654  
Specialist, 153

**Product Name:** AccessBliss 2.2

**Vendor:** Blissymbolics Communication International

**Computer:** Apple Macintosh Family

**Cost:** \$100.00

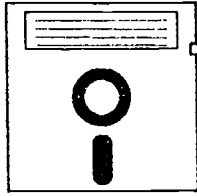

AccessBliss 2.0 is a software program that enables the user to find and retrieve any currently approved Blissymbol (approximately 2400). The Blissymbols are copied to the clipboard for subsequent use in virtually any Macintosh application. AccessBliss allows the user to find any Blissymbol in less than five seconds, use a choice of four different search methods, add indicator to a symbol with mouse click, save standard reference grid along with the symbol, save the word along with the symbol, format the clipboard in rows or columns, access any symbol synonym directly, and save the Blissymbol in text or picture form.

Package includes AccessBliss program, user's guide, BlissTemplate Font and manual, and a manual for creating Blissymbol grid displays.

---

**Product Name:** Alphabet Board Kit

**Vendor:** Crestwood Company

**Size:** 8.5" x 11"

**Cost:** \$12.95

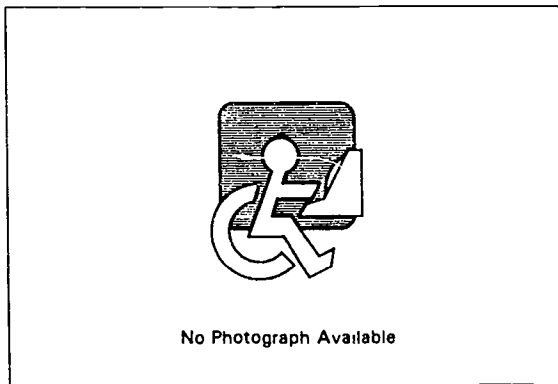

The Alphabet Board Kit includes two boards, two sheet protectors, and 150 pressure sensitive letter, number, word, and blank stickers. An easel is not included but is available from the manufacturer for \$15.50.



**Product Name:** AlphaPad

**Vendor:** New Breakthroughs

**Size:** 8" x 12"

**Cost:** \$9.95

AlphaPad is a non-electronic communication board. The board is a large QWERTY keyboard printed on strong, washable neoprene. The non-skid mouse pad style and oversize type is designed to aid students with vision and/or motor problems.



**Product Name:** Appointment Book

**Vendor:** Attainment Company

**Cost:** \$14.00

The Appointment Book is a folder designed to hold Picture Prompt Cards (see entry).

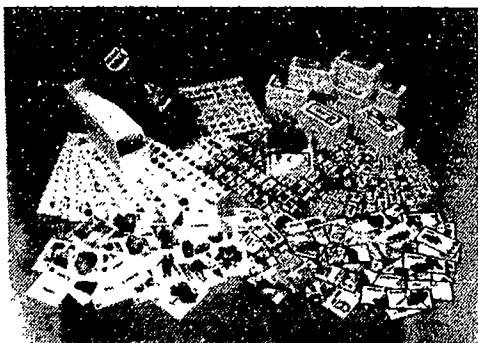

**Product Name:** Attainment Communication Collection

**Vendor:** Attainment Company

**Cost:** \$189.00

Attainment Communication Collection contains the cards and stickers from the WordWise Language and Picture Prompt programs (see entries). Over 1,000 laminated, color illustrated cards and 1,752 stickers are included.

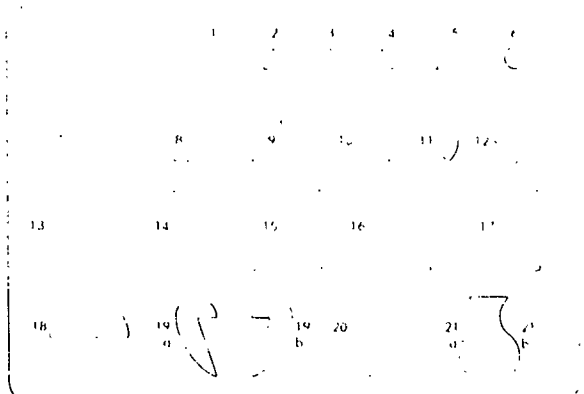

**Product Name:** Blissymbol Templates

**Vendor:** Blissymbolics Communication International

**Size:** 1", 11 mm, 21 mm

**Cost:** \$12.00 - \$17.00

Blissymbol Templates are patterns of Blissymbol elements. The templates are designed as an aid to drawing Blissymbols more accurately. The Large Metric Template has a large square 21 mm in size and costs \$17.00. The Small Metric Template has a large square 11 mm in size and costs \$17.00. The Imperial Template has a 1" large square and costs \$12.00.

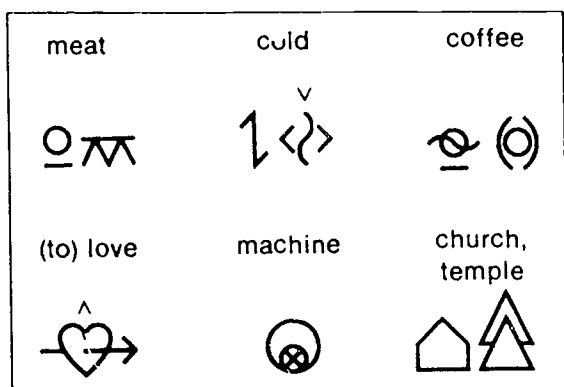

**Product Name:** Blissymbol Vocabulary Stamps  
**Vendor:** Blissymbolics Communication International  
**Size:** 8.5" x 11"  
**Cost:** \$35.00

Blissymbol Vocabulary Stamps are sheets of Bliss symbols printed on square, peel-back, self-adhesive labels. Each stamp is 7/8" square, and the sheets contain 108 stamps apiece. The word corresponding to the symbol also appears on each stamp. The package contains 1400 stamps and 145 of the newest symbols. Color coded and black-and-white are available.

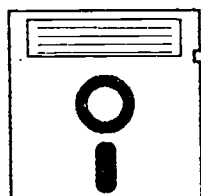

---

**Product Name:** Blissymbols Gallery  
**Vendor:** Don Johnston Incorporated  
**Computer:** Apple Macintosh Family  
**Cost:** \$199.00

Blissymbols Gallery is a software series of approximately 2,500 icons color-coded by time, people, noun, action, and other categories. Designed for use with Ke:nx to build personalized communication displays with the Blissymbolics language system.



**Product Name:** Boardmaker 3.0

**Vendor:** Mayer-Johnson Company

**Computer:** Apple Macintosh Family

**Cost:** \$399.00

Boardmaker is a software program that allows access to over 3,000 symbols from the Picture Communication Symbols (PCS) Books I, II, and III (see entry). The symbols have been translated into ten languages: English, Spanish, French (Canadian), Portuguese, Danish, Swedish, German, Dutch, Norwegian, and Italian. The symbols may be reduced or enlarged to any size. The program includes a built-in drawing program for creating custom communication boards or overlays for virtually any size grid or matrix. Boardmaker may also be used with a desk top publishing program to make educational materials using the symbols. Hard copy may be printed and the display saved on disk.

System requirements include a Macintosh computer, 4 MB RAM, and a hard disk.

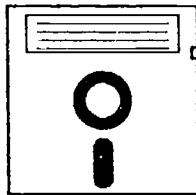

**Product Name:** Boardmaker for Windows

**Vendor:** Mayer-Johnson Company

**Computer:** IBM PC Family

**Cost:** \$399.00

Boardmaker for Windows is a combined graphics database and drawing program with over 3,000 Picture Communication Symbols (see entry) in bitmapped clip art form. The program allows the user to find symbols and paste them into the display with a mouse click, make the pictures any size, print and save copy, and more. The symbols can be found and printed in any of the following languages: English, Spanish, French (Canadian), German, Swedish, Italian, Portuguese, Dutch, Danish, and Norwegian. Symbols can be copied with no text, one language, or any two languages.

System requirements include: 4 MB of RAM, Microsoft Windows, and a hard disk with 6 to 14 MB available.

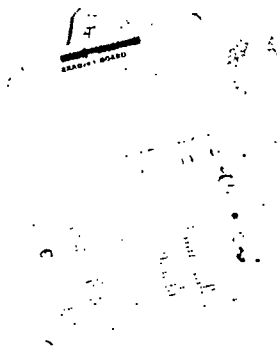

**Product Name:** Bradley Board Communication Aid

**Vendor:** Bradley Enterprises

**Size:** 10.75" x 13.75"

**Weight:** 5 oz.

**Cost:** \$12.00

The Bradley Board Communication Aid is a laminated, two-sided board designed to aid nonvocal individuals. The board has 56 items pictured and a word list which the user may point to or mark to create sentences. The aid also has an area for writing with an attached felt tip pen. The entire board can be cleaned and markings erased using a damp cloth. A pen is included with the board.

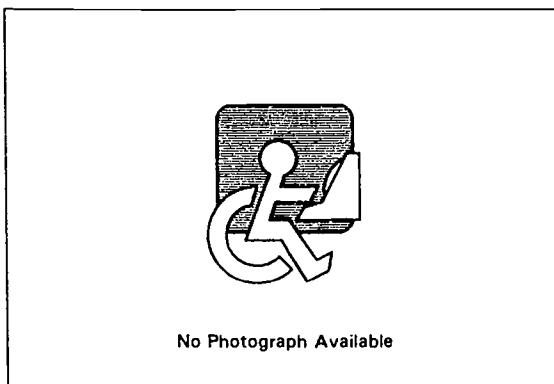

**Product Name:** Calendars

**Vendor:** Various (Generic Product)

**Cost:** Varies

Calendars often create an alternative augmentative communication medium by organizing topics and pointing targets in spatial arrangements and also in time. Formats that are helpful vary on individual needs. Types of formats include full page, purse size, pocket, and electronic calendars.

Calendars are available in book stores, department stores, variety stores, and others. Specific sources can be found in local yellow pages and often in gift specialty catalogs that carry personal convenience types of devices.



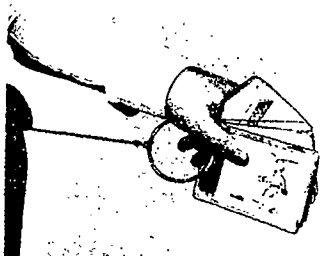

**Product Name:** Chain Talk

**Vendor:** Crestwood Company

**Size:** 2.5" x 3.25"

**Cost:** \$19.50

Chain Talk is a communication device that holds up to 20 symbols. A retractable chain clips to the belt or waistband of pants. At the end of the chain is a ring and 10 heavy duty vinyl envelopes that hold the symbols (not included).

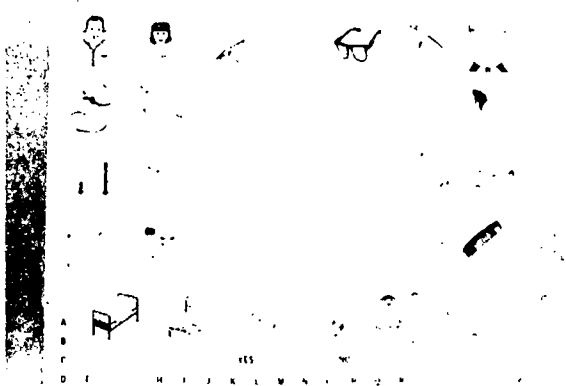

**Product Name:** Cleo Communication Board

**Vendor:** Cleo of New York

**Size:** 17" x 22"

**Weight:** 1 lb.

**Cost:** \$18.00

Cleo Communication Board is a laminated board containing drawings suggesting various needs. The user indicates selections by pointing, or by writing with a water-soluble marker (extra). Pictures include dressing, grooming, eating and medical requests. The reverse side contains diagrams of the body for indicating areas of pain or discomfort.

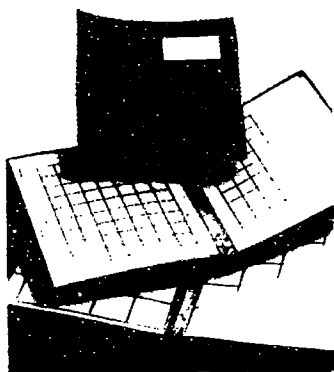

**Product Name:** Communication Binder  
**Vendor:** Mayer-Johnson Company  
**Size:** 8.88" x 11.38"  
**Cost:** \$11.00

Communication Binder is a three-ring binder containing sheets to which communication symbols can be attached. The pages are printed with blank grids of one- or two-inch squares, and have non-glare vinyl sleeves. The vinyl on the sheet protectors and pockets resists the transfer of toner copying ink from photocopied symbols. The front cover of the binder has a pocket for an identification card.

Each binder comes with five vinyl sheet protectors with two grids each, and one extra grid sheet. Additional grids and protectors are available.

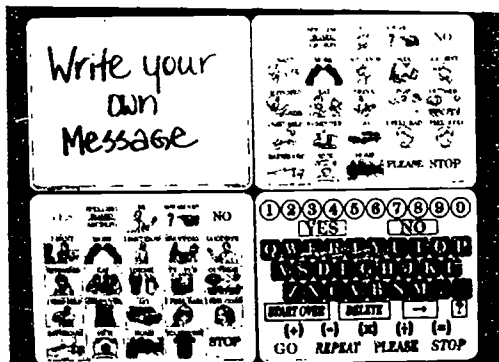

**Product Name:** Communication Board  
**Vendor:** Graley Marketing  
**Size:** 8.5" x 11"  
**Cost:** \$21.95

The Communication Board is a two-sided non-electric communication device suitable for children and adults who can spell and point. One side features 25 squares with child or adult appropriate pictures and words including yes, no, hi, sick, bathroom, play, home, computer, eat, I want, and others. The other side has a typewriter style layout including numerals, some punctuation, and mathematical symbols. Also on the spelling side are the words yes, no, start over, delete, go, repeat, please, and stop. An additional model offers typewriter style layout on one side and a blank dry erase side on the opposite side.



**Product Name:** Communication Board Builder

**Vendor:** Mayer-Johnson Company

**Computer:** Apple Macintosh Plus,  
Apple Macintosh SE/II

**Cost:** \$169.00

Communication Board-Builder is a HyperCard stack that enables the user to create customized communication boards. The program includes over 3,000 symbols from the Picture Communication Symbols (PCS) Books I, II, and III (see entry). Symbols are printed in 1.25" size. The page size is 6.25" x 3.75" and contains up to 15 symbols. Hard copies of the pages may be printed in any two languages by hitting a translate button. Boards may be saved to disk.

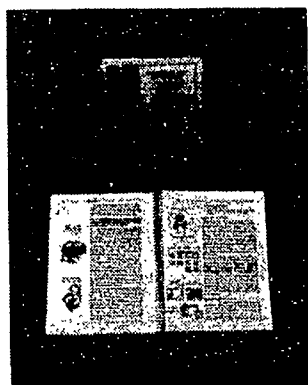

**Product Name:** Communication Displays for  
Engineered Preschool Env.

**Vendor:** Mayer-Johnson Company

**Cost:** \$129.00

Communication Displays for Engineered Preschool Environments Books I and II provide a total of 396 communication displays based on 100 activities of preschools. The activities deal with daily routines, self help skills, toys, fine motor skills, pretend play, and gross motor skills. Book I contains 123 displays with 16 symbols each, and 114 horseshoe eye-point displays with 13 symbols each. Book II contains 80 displays with 32 symbols each, and 79 displays with 36 symbols each. One or more of these types of displays will fit the PowerPad, Communiclock, Talking Eye-point Board, Say-it-Simply Plus, Clock Communicator, Comboard, MegaWolf, SuperWolf, Dial Scan, Touch Talker, Unicorn Expanded Keyboard, IntroTalker, MessageMate 40, Great Green Macaw, Macaw, and LightTalker (see entries). Some may require enlargement or reduction on a photocopy machine.

Each book is available separately for \$69.00 each.

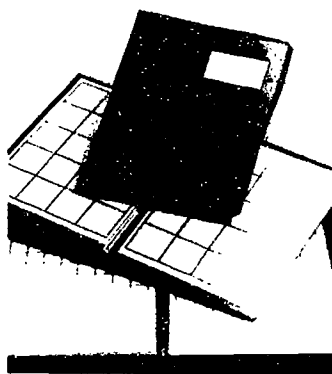

**Product Name:** Communication Folder and Tri-Folder

**Vendor:** Mayer-Johnson Company

**Size:** See text

**Cost:** \$6.00 - \$9.00

Communication Folder is a vinyl covered folder that contains sheets with one- or two-inch grids printed on them. Communication symbols can be affixed to the grids, which are covered with clear, non-glare vinyl pockets. The vinyl pockets resist the transfer of toner copying ink from photocopied communication symbols. A small pocket is provided on the front of the folder for an identification card.

Two models are available: the Communication Folder with two panels, which opens to 19.25" x 11.63" to display three 8.5" x 11" grids; and the Tri-folder with three panels, which opens to 29.5" x 11.63" (folds to 9.5" x 11.63") to display four 8.5" x 11" grids. Two spare grid sheets are provided; more are available.

---

**Product Name:** Communication Icon Galleries CD-ROM

**Vendor:** Don Johnston Incorporated

**Computer:** Apple Macintosh Family

**Cost:** \$650.00

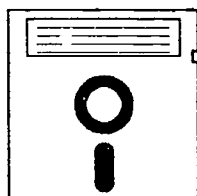

The Communication Icon Galleries CD-ROM is an encyclopedia of more than 7,000 icons in all. The CD includes the Core Picture Vocabulary Gallery, Kids In Action Gallery, COMPIC Gallery, DynaSyms Gallery, and PCS Gallery. The Galleries allow the user to set up communication boards with the symbols and print them as overlays for Key Largo, Unicorn, 510 membrane keyboards, and Ke:Nx On:Board (see entries) Words and phrases can be assigned to each symbol and software can be used for voice output communication with the chosen keyboard. Also included on the CD is the DJ Speech ProPack to bring voices to the computer, Ke:nx Create 3.0, and communication ready setups for Ke:nx.

Each gallery is also available separately for \$50.00 - \$399.00 each.

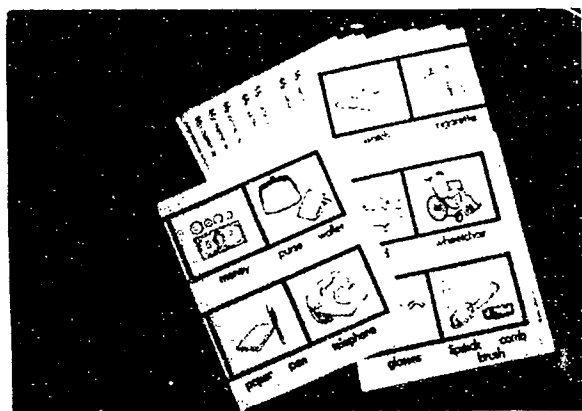

**Product Name:** Communication Sheets

**Vendor:** Fred Sammons, Inc.

**Size:** 2" x 3"

**Weight:** 11 oz.

**Cost:** \$4.95

Communication Sheets are sheets of paper containing black-and-white line drawings with accompanying words. The user communicates by pointing to the desired picture.

Each package of Communication Sheets consists of ten "basic" sheets and ten "advanced" sheets.

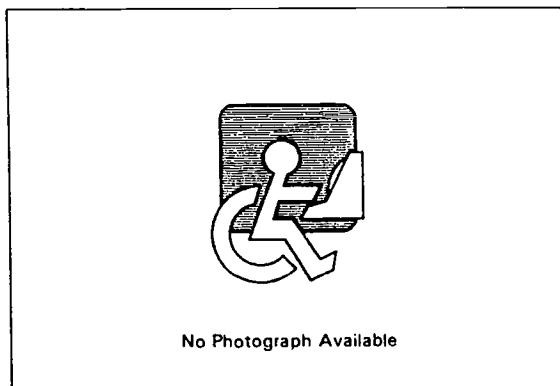

**Product Name:** Communication Symbol Holders

**Vendor:** Various (Generic Product)

**Cost:** Varies

Communication boards and notebooks can be custom designed, printed, and covered with some type of durable plastic. Other commercially available alternatives include notebook, binder, pocket, and wallet formats. Many types of plastic sleeves and plastic sleeve booklets are available from a variety of sources. For example, presentation page holders are available as 8-1/2" x 11" plastic pockets and plastic sleeve pages are available as photo albums in large format binder sizes to very small wallet size booklets. Features to consider when searching for these types of display materials are durability and flexibility of the plastic, the size of the presentation format, number of the pockets within the format, and binding requirements.

Photo albums and pages are available from photo accessory stores and most department and variety stores, credit card holders that slide into wallets are available from luggage and wallet stores, and presentation page holders are available from office supply stores. Specific sources can be found in local yellow pages, in the manufacturer list of this book, in listings from local rehabilitation service delivery programs, and also often in gift specialty catalogs that carry personal convenience types of devices.

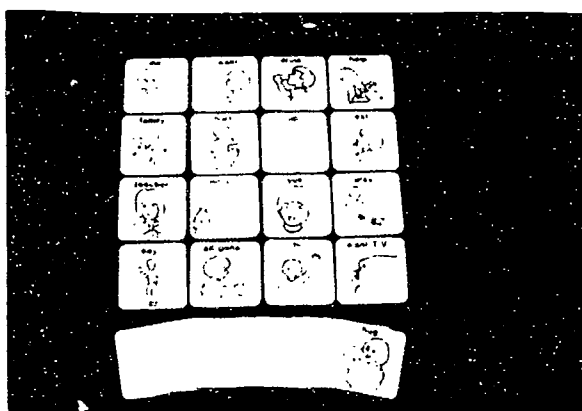

**Product Name:** Core Picture Vocabulary

**Vendor:** Don Johnston Incorporated

**Size:** 2.75" x 2.75"

**Cost:** \$28.00 - \$36.00

The Core Picture Vocabulary is a basic communication and training system. The set contains 160 cards depicting functional vocabulary words such as "eat," "drink," "mother," and "my." Cards designed to allow the user to construct two to three word combinations representing recurrence, possession, etc. Written words corresponding to the message of each picture are printed on each card. Core Picture Vocabulary Double Sided has pictures and words printed on both sides, for use with see-through communication devices.

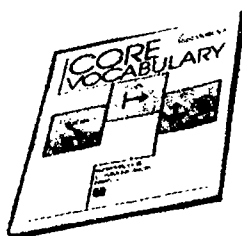

**Product Name:** Core Vocabulary

**Vendor:** Blissymbolics Communication International

**Size:** 8.5" x 11"

**Cost:** \$25.00

Core Vocabulary is a set of commonly used Blissymbols. The set contains five copies each of 207 Blissymbols. The symbols are printed on adhesive-backed material, for use with symbol boards and other communication systems. Included are 17 complete sentences for communication.

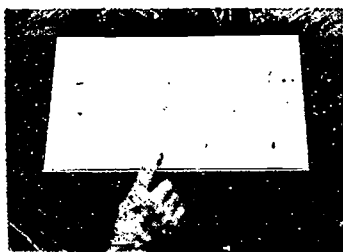

**Product Name:** Deluxe Communication Board Kit

**Vendor:** Crestwood Company

**Size:** 11.5" x 19"

**Cost:** \$78.95

The Deluxe Communication Board Kit consists of a black acrylic case which can be used on lap, tray, or table top. A sturdy see-thru acrylic removable top holds and protects interchangeable communication boards. Storage space holds extra boards, stickers, etc. and the removable top can be used as a communication board by itself. Four reversible mat boards and 246 stickers of pictures, words, letters, and blanks are included.

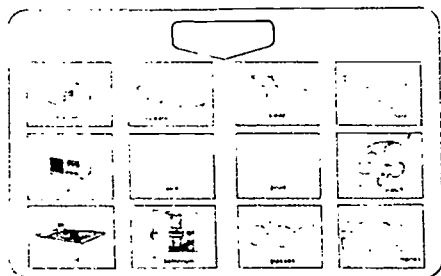

**Product Name:** Deluxe Talk Board

**Vendor:** Crestwood Company

**Size:** 10.63" x 16.88"

**Cost:** \$21.95

The Deluxe Talk Board is an impact-resistant white board with carrying handle. Pictures, words, and letters can be applied to both sides. Objects can also be used and the board can be written on with a wipe-off pen.

Price includes the Talk Board, vinyl envelopes, and one pen. Symbols are not included.

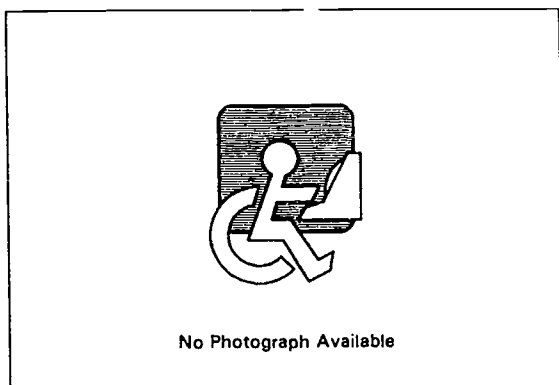

**Product Name:** DynaSyms

**Vendor:** Poppin and Company

**Cost:** \$7.00 - \$79.00

DynaSyms are picture symbols designed for placement on communication devices. Four packages are available. The DynaSyms Sampler (\$7.00) has 88 full color stickers that sample the range of categories available. The DynaSyms 1700+ Stickers package (\$79.00) has 20 sheets of 88 full color stickers each with an index for symbol location. The DynaSyms 1700+ Cut and Paste package (\$20.00) has 20 sheets of 88 full color symbols each with an index for symbol location. The Cut and Paste with 1000+ DynaSyms (\$15.00) is a paperback book in black and white with an explanatory text, an index of symbols, and over 1000 different DynaSyms in three sizes.

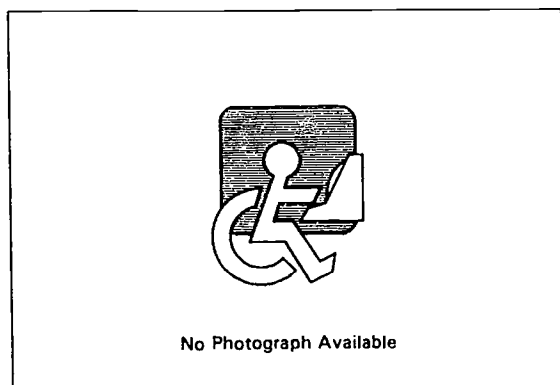

**Product Name:** Emotional Moods & Needs-G 3&4

**Vendor:** Help Me to Help Myself Communication Aids

**Size:** 11.25" x 14.25"

**Weight:** 0.6 oz.

**Cost:** \$2.50

Emotional Moods & Needs-G 3&4 is a communication chart with over 50 printed words and phrases expressing psycho-social feelings and needs. Examples include: "I feel lonely," "I feel encouraged," "Are you worried?", "Please hold me." An alphabet board permits expression of intimate and special thoughts.



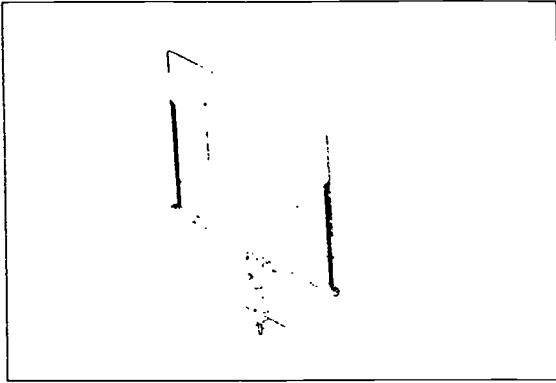

**Product Name:** Eye Transfer Communication System

**Vendor:** Zygo Industries, Inc.

**Size:** 15" x 20"

**Weight:** 1 lb.

**Cost:** \$415.00 - \$595.00

Eye Transfer Communication System is a clear plastic panel with an open area in the center. Communication symbols are placed on the panel so as to be visible from both directions. The user and the person with whom he is communicating position themselves on opposite sides of the panel, and the user conveys messages by gazing at the appropriate symbols while the other person follows his gaze.

The Eye Transfer Communication System comes with a support frame for mounting. Various combinations of mounting hardware are also available (extra).



**Product Name:** Eye-Com

**Vendor:** Pitts Corporation

**Size:** 16" x 16"

**Weight:** 1 lb.

**Cost:** \$65.00

Eye-Com is a portable non-electronic communication aid. The operator of the device stands near the user and gazes at the user through the center of the device. The operator rotates the letter wheel until the pointer rests on the desired letter. The user then gives a signal (such as an eye blink) to signal the operator to stop. Letters are then recorded on paper by the operator, and the process is repeated until an entire word or thought is expressed.

Both right-handed and left-handed models of Eye-Com are available.

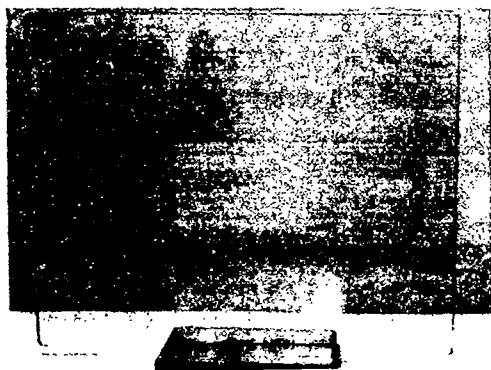

**Product Name:** Eye-Com Board  
**Vendor:** Imaginart International, Inc.  
**Size:** 15" x 19" x 0.125"  
**Cost:** \$41.95

Eye-Com Board is a clear acrylic board inserted in a wooden stand. User-specifiable symbols are affixed to the board, and the user and the person with whom he is communicating sit on opposite sides of the board. The user's message is "read" by following his eye gaze. Eye-Com Board can be used for communication when pointing is not feasible, or for training augmentative communication skills.

Options available for the Eye-Com Board include a pack of 5 blank overlays (\$17.95) and a Pocket Overlay with eight pockets for holding pictures or three-dimensional objects (\$14.95).

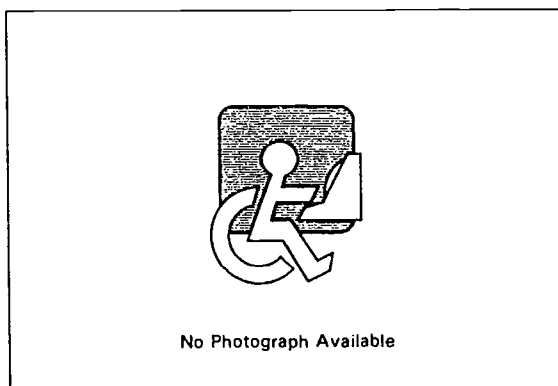

**Product Name:** Fold It System  
**Vendor:** Communication Development Products, Inc.  
**Size:** 15.5" x 7.5"  
**Cost:** \$27.00 - \$37.00

Fold It Systems are folding communication boards designed for organizing picture symbol cards. Two sizes are available: one holding 48 cards, the other holding 8. The larger tri-folder communication board measures 15-1/2" x 7-1/2" while folded, and 15-1/2" x 22-1/2" when open. The smaller version of the board measures 7" x 9". Spaces are designed to hold communication cards of up to three inches square.

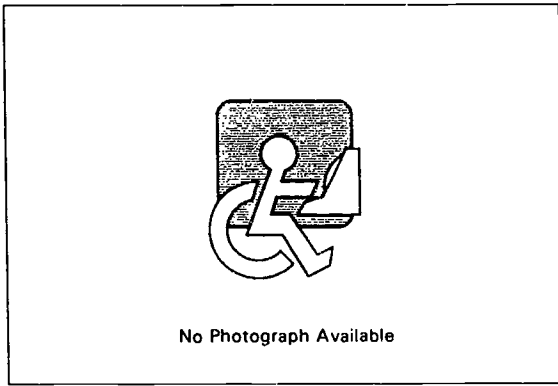

**Product Name:** Foods I Like Menu Book  
**Vendor:** Help Me to Help Myself Communication Aids  
**Size:** 8.5" x 11"  
**Weight:** 2 oz.  
**Cost:** \$3.00

Foods I Like Menu Book is a non-electric communication aid. The book contains 12 pages of large print listing 150 foods by groups on paper.

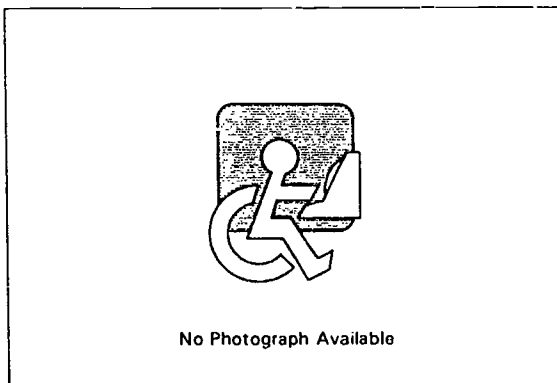

**Product Name:** Help Me at Home & School-G 5&6  
**Vendor:** Help Me to Help Myself Communication Aids  
**Size:** 11.25" x 14.25"  
**Weight:** 0.6 oz.  
**Cost:** \$2.50

Help Me at Home & School-G 5&6 is a communication chart with over 40 illustrations of daily events and basic needs of nonvocal children. Examples of included illustrations are happy, sad, where it hurts, prosthetic devices, up in wheelchair, sit on floor, down on mat, child in bed, mother, father, thirsty, etc.

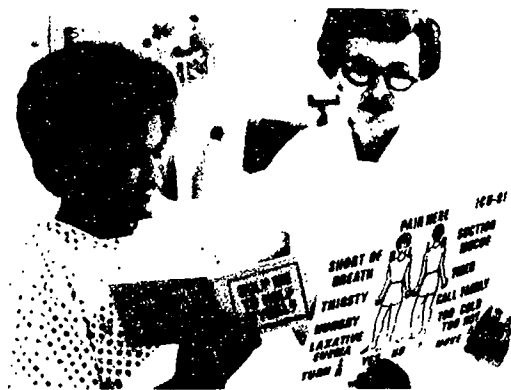

**Product Name:** Help Me to Help Myself Handbook

**Vendor:** Help Me to Help Myself Communication Aids

**Size:** 5.75" x 4.25"

**Weight:** 2.6 oz.

**Cost:** \$5.00

Help Me to Help Myself Handbook is a non-electric communication aid. The book contains 50 pages in six color-coded sections showing basic physical needs by words in both print and cursive writing, illustrations, a SPELL IT alphabet, numbers, and the words "Pain where?" in 20 languages.

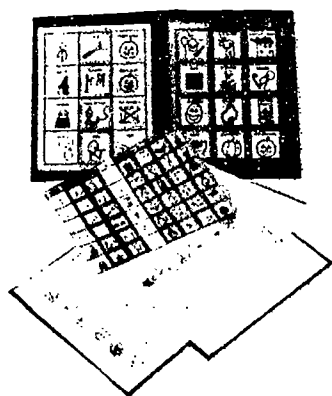

**Product Name:** Holiday Kit

**Vendor:** Mayer-Johnson Company

**Cost:** \$29.00

Holiday Kit is a set of boards, using the Picture Communication Symbols (PCS), intended to motivate spontaneous conversation about holidays and other special days. Pre-made boards in 1" and 2" sizes are included for Christmas, New Years Eve, Easter, birthdays, Halloween, Mothers Day, Fathers Day, Thanksgiving, and Valentine's Day. Duplicable symbol masters are included for the above holidays, plus Labor Day, July 4, St. Patrick's Day, six Jewish holidays, Memorial Day, Presidents' Day, April Fool's Day, Veterans' Day, and Martin Luther King, Jr. Day. The symbol masters include over 250 symbols, 130 of which are not in Picture Communication Symbols Book 1 or 2 (see entry). Blank 1" and 2" color-coded boards (six of each), a vinyl folder, an information sheet about each special day, and two reproduceable worksheet masters (one to be filled in before a special day and one to be filled in afterwards) are also included.

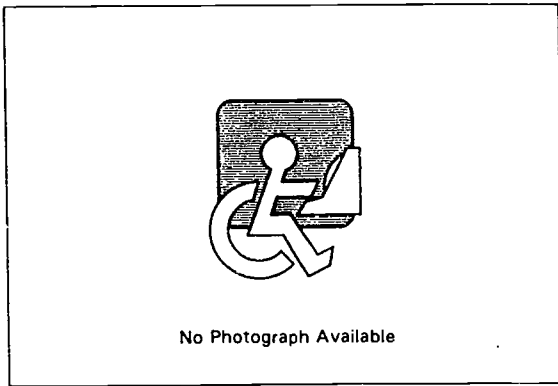

**Product Name:** ICU-G 1&2

**Vendor:** Help Me to Help Myself Communication Aids

**Size:** 11.25" x 14.25"

**Weight:** 0.6 oz.

**Cost:** \$2.50

ICU-G 1&2 is a communication chart with 20 words or phrases and 20 illustrations showing basic needs for use in intensive and coronary care, recovery and emergency units. The chart is available in English and Spanish.

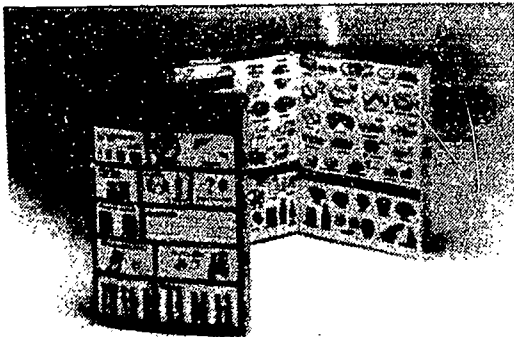

**Product Name:** Illustrated Menu

**Vendor:** Attainment Company

**Cost:** \$12.00

Illustrated Menu is a picture menu to help the user with food and beverage selection. The product has over 200 pictures of various foods and beverages as well as important key phrases (such as "Where is the rest room?") and a tip finder. The Illustrated Menu contains several pages to flip through and all are laminated so that they can be written on.



**Product Name:** Imaginart Gallery  
**Vendor:** Don Johnston Incorporated  
**Computer:** Apple Macintosh Family  
**Cost:** \$225.00

The Imaginart Gallery is a Macintosh software gallery of more than 1,000 color illustrated icons to use with Keynote from the Pick 'n Stick set by Imaginart. Includes pictures of feelings, family and friends, clothing, toys, household items, favorite fast foods, restaurants, animals and more.

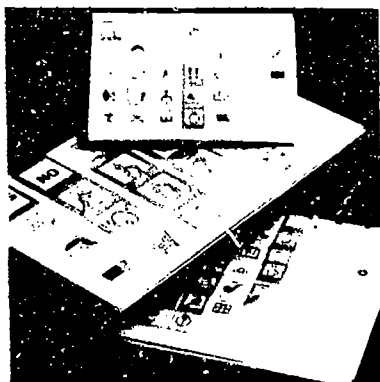

**Product Name:** Individualized Communication Systems  
**Vendor:** Mayer-Johnson Company  
**Size:** 8.5" x 11" or 11.75" x 19"  
**Cost:** \$19.00 - \$29.00

Individualized Communication Systems are plastic boards with clear vinyl pockets one or two inches square. The boards are designed to aid teachers and therapists in training non-vocal persons to use picture symbols, and are not intended to be used as a long-term communication system. Communication symbols of any kind can be placed in the pockets, and a clear, non-glare plexiglass cover snaps on top. Each Individualized Communication System package comes with seven colors of card stock paper on which to mount communication symbols.

Individualized Communication System boards come in three types: an 8.5" x 11" board with 1" pockets, a 11.75" x 19" board with 1" pockets, and an 11.75" x 19" board with 2" pockets.

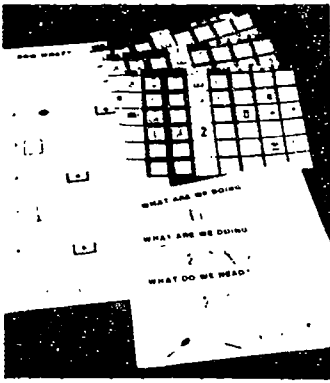

**Product Name:** Life Experiences Communication Kit

**Vendor:** Mayer-Johnson Company

**Size:** 8.5" x 11"

**Cost:** \$39.00

Life Experiences Communication Kit provides the materials for an instructor to teach 11 separate lessons in daily life experiences to non-speech or limited speech students. The lesson plans included cover such activities as "Make Juice," or "Wash Face," or "Go Restaurant." Each lesson comes with an 8.5" x 11" Mini Communication Board with the appropriate color-coded Mayer-Johnson Picture Communication Symbols (a total of six boards; some are for more than one lesson), a step-by-step Picture Direction Sheet for the student, and an instruction sheet for the teacher.

Additional boards and symbols are available at extra cost.

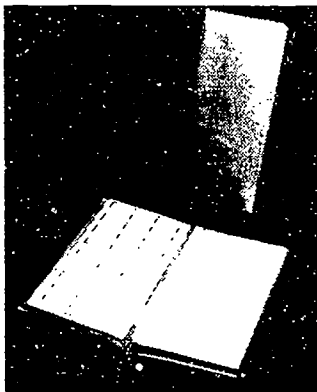

**Product Name:** Long Wallet

**Vendor:** Mayer-Johnson Company

**Size:** 4" x 8.5"

**Cost:** \$8.00

The Long Wallet is designed to carry up to 576 one inch communication symbols. This product has twelve clear, non-glare, top loading pages. The Wallet comes with a grommet so that it can be attached to a belt with a strap or clip; it also fits into a back pocket or purse.

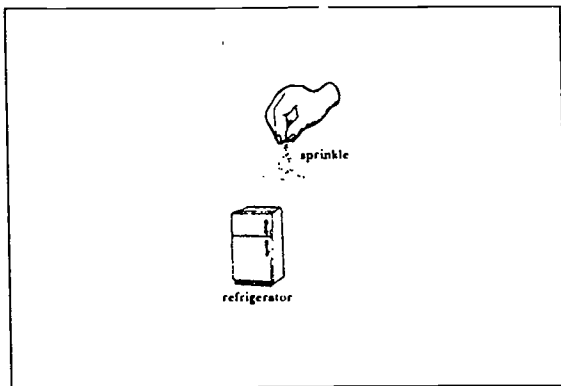

**Product Name:** Mealtime Stickers

**Vendor:** Attainment Company

**Cost:** \$19.00

Mealtime Stickers is a set of 192 vinyl stickers and three 4" x 6" polyboards. The stickers feature line drawings and words to represent items like "refrigerator" and "glass" and actions like "sprinkle." The vinyl stickers are removable and reusable.

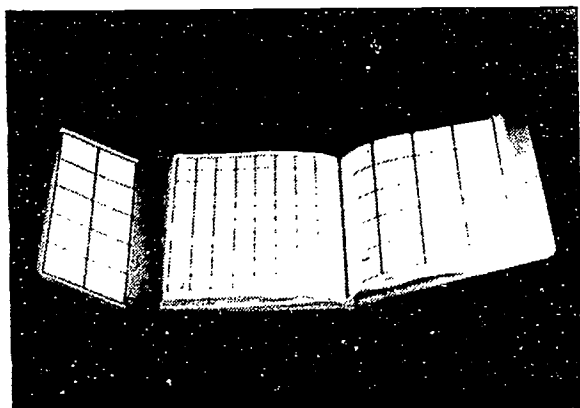

**Product Name:** Mega-Book

**Vendor:** Mayer-Johnson Company

**Cost:** \$18.00

The Mega-Book is a full size folder designed to hold communication symbols. The book contains twelve top loading sheets seamed into it which can hold one or two inch symbols. Each of the clear cover sheets has an 8-1/2" x 11" display area. The total capacity of the book is 2,320 one inch symbols or 580 two inch symbols. The book contains an additional half page cover to be used for displaying common vocabulary.

Grids can be used in the Mega-Book but must be purchased separately.



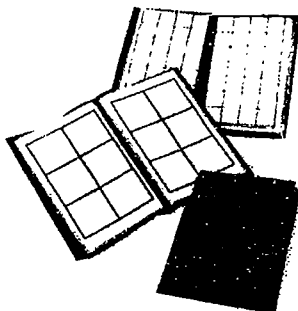

**Product Name:** Mid-Sized Communication Book

**Vendor:** Mayer-Johnson Company

**Cost:** \$9.00

Mid-Sized Communication Book is a 5.13" x 6.75" vinyl covered folder to accommodate 624 one-inch or 156 two-inch communication symbols. Twelve non-glare vinyl page covers are included. The vinyl resists the transfer of toner copying ink from photocopied communication symbols.

Replacement grids are available; contact manufacturer for details. The books also include a grommet for attachment to a belt clip or strap.

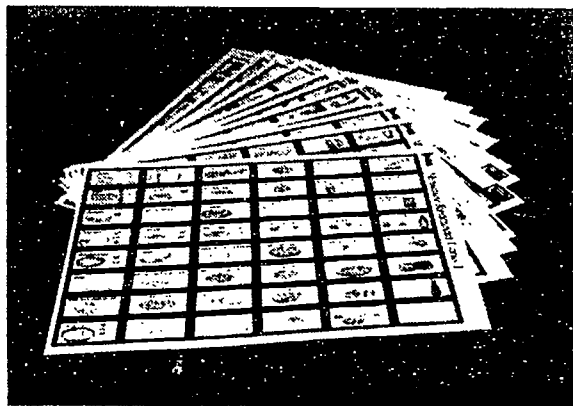

**Product Name:** Mini Picture Set

**Vendor:** Attainment Company

**Cost:** \$25.00

Mini Picture Set is a group of communication symbols which may be used for making communication boards or illustrated lists. The symbols are in black and white so that they may be photocopied. There are twelve pages with a total of 576 symbols. Symbols are grouped on pages according to subject area; topics include: daily routine, shopping, restaurants, and choices for planning the day.

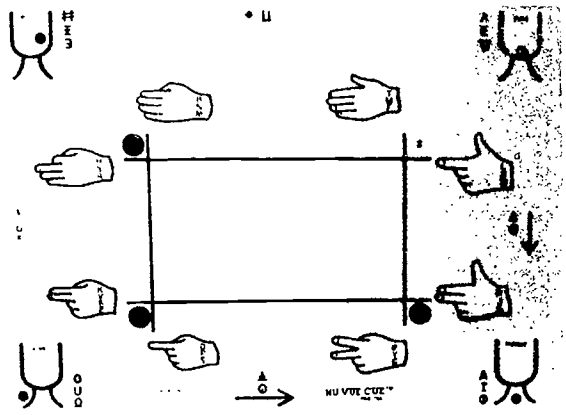

**Product Name:** Nu-Vue-Cue

**Vendor:** R.D. Clark, Inc.

**Size:** 15" x 20"

**Cost:** \$25.00 - \$125.00

Nu-Vue-Cue is a clear plastic eyegaze communication system. The system is divided into eight sections: the user looks at different sections in sequence in order to select one of the forty basic phonetic sounds. Each of the sounds is represented by symbols called cue scripts, which combine eight hand symbols with four facial positions. The person receiving the message sits on the other side of the board, facing the user, and translates the accumulated phonemes into words and phrases. The user and the message receiver may maintain eye contact throughout the process, and as the system is learned, the user and the receiver may communicate without the presence of the plexiglas board.

Price of system depends on how many of the components are needed by the user; the plexiglass board is \$50.00, an explanatory book for the system is \$25.00, and Apple disks which train both the Nu-Vue-Cue system and Standard Cued speech are \$50.00. Videotapes are also available to help teach the system. Contact manufacturer for details.

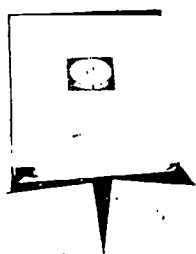

**Product Name:** Oakland Schools Picture Dictionary

**Vendor:** Oakland Schools-Communication Enhancement Center

**Size:** 0.5", 1", or 2" squares

**Cost:** \$45.00

The Oakland Schools Picture Dictionary is a collection of over 600 simple line drawings which may be used for communication or language training. Three sizes of drawings are provided: half inch, one inch and two inch. An alphabetical and categorical index is provided so that symbols may be located quickly.

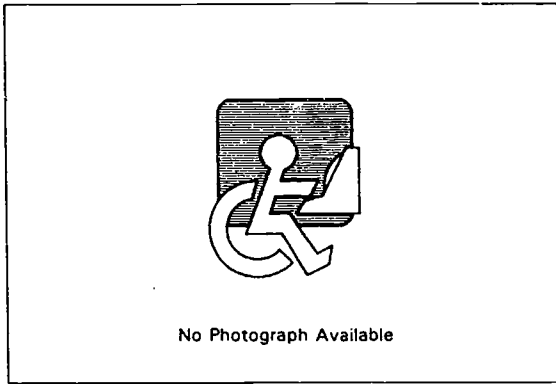

**Product Name:** Object Communicator

**Vendor:** Crestwood Company

**Size:** 11" x 17.5"

**Cost:** \$64.95 - \$96.95

The Object Communicator is an eye communication board that holds four objects on four-sided shelves. The user focuses eyes on object needed. There is room to mount pictures near object for training in association of picture to object.

The Object Communicator alone costs \$64.95. The Object Communicator with 17 objects, picture cards, and a carrying pail costs \$96.95. A stand is not included but a table stand is available for \$36.95 and a floor stand is available for \$87.95.

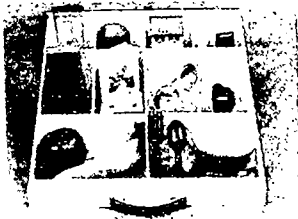

**Product Name:** Object Display

**Vendor:** Crestwood Company

**Size:** 8" x 14.25" x 13.12"

**Cost:** \$69.95

The Object Display can display up to 12 objects on three elevated tiers. The case is white acrylic with a clear acrylic cover and carrying handle. There are ten various sized compartments.

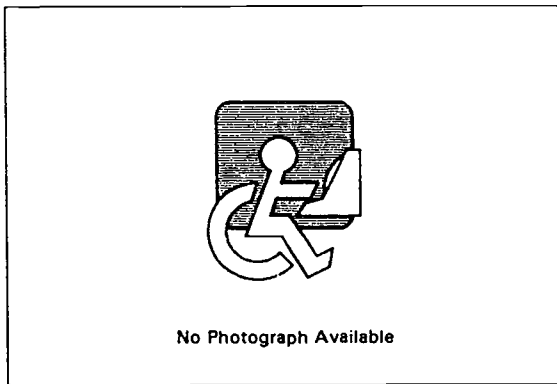

**Product Name:** Object Stand or Calendar Box (3 or 5)

**Vendor:** Crestwood Company

**Size:** 6" x 6" x 18"

**Cost:** \$64.95 - \$74.95

This device can be used as an object stand for communication and training of eye gaze or pointing skills, or as a calendar box to train sequencing of the day's events. Three objects can be placed in the cubicles in order of temporal usage. The black door lays flat on top of the box when open.



**Product Name:** Object-Picture Talk Board

**Vendor:** Crestwood Company

**Size:** 5.75" x 6.75"

**Cost:** \$36.95 - \$64.95

Object-Picture Talk Board is a communication board that uses objects and models of objects. The plastic board provided is washable, so names of objects can be written in water soluble marker. Objects can be mounted securely to the board with Dual Lock Tape. Objects provided include: watch, TV, toilet, phone, food, and so forth.

The complete Object-Picture Talk Board Kit (\$64.95) includes the board, 17 objects, 17 corresponding picture cards, a storage pail for the objects, Dual Lock Tape, and a water-soluble marker. The objects, cards, and pail are also available separately (\$36.95).

**Product Name:** Opticommunicator

**Vendor:** Crestwood Company

**Size:** 11" x 17.5"

**Cost:** \$59.95 - \$81.95

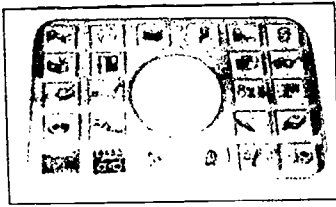

Opticommunicator is a patented eyegaze communication device made of transparent acrylic. The user makes selections by gazing at the location of the desired letter, word, or picture on the Opticommunicator. The receiver sits directly across from the user and watches the direction of the user's gaze through an open space in the center of the clear board.

Three models are available. The Opticommunicator (\$59.95) includes 246 picture stickers and an acrylic base stand. Opticommunicator Maxx (\$81.95) includes an acrylic base stand, four color-coded overlays, 246 picture stickers, and one vinyl envelope to store stickers and overlays. Object Communicator (\$64.95) holds 4 objects and corresponding pictures. A floor stand (\$87.95) and table stand (\$36.95) are also available.

**Product Name:** Passport Kits

**Vendor:** Crestwood Company

**Size:** 4" x 3.25"

**Cost:** \$17.95 - \$43.95

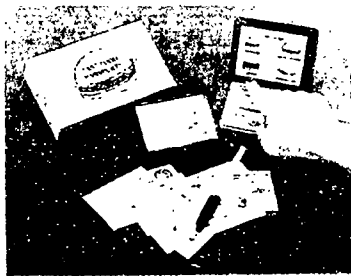

Passport Kits are versions of the small Porta Book portable communication book (see entry, Crestwood Company) provided with pictures appropriate to the specific category. The user can communicate by opening the book and pointing to the desired item, or by circling items ahead of time using a water-soluble marker on the clear vinyl that covers each page. Twelve kits are available: Fast Food Passport (\$20.95 with 44 cards); Personal Needs Passport (\$20.95 with 47 cards, available for either males or females); Recreation Passport (\$37.95 with 225 cards); Supermarket Shopping Passport (\$49.95 with 315 cards); Casual Dining Passport (\$26.95 with 135 cards); Shopping Center Passport (\$42.95 with 270 cards); School Passport (\$37.95 with 225 cards); Drug Store Passport (\$32.50 with 180 cards); VIP Phone Passport (\$12.95 with 50 cards); Breakfast Passport (\$14.95 with 60 cards); Table Talk Passport (\$22.95 with 60 cards); and Health Passport (\$20.95 with 60 cards).

Passport Kits includes the small (4" x 3.25") Porta Book, picture cards, dividers, a water-soluble marker, and a storage case. Extra markers are available.

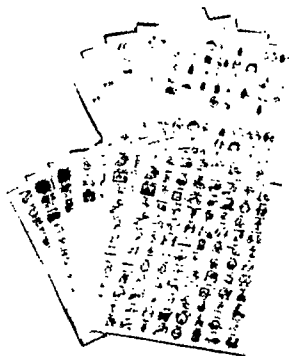

**Product Name:** PCS Color Stickers

**Vendor:** Mayer-Johnson Company

**Size:** 0.75" square

**Cost:** \$24.00

PCS Color Stickers are versions of the Mayer-Johnson Picture Communication Symbols printed as peel-and-stick stickers. The stickers are available in a 3/4" square size only. The backgrounds are printed in six different colors, according to topic. The set includes two copies each of 560 of the most commonly used PCS vocabulary items from Picture Communication Symbols, Book I and Book II (see entry).

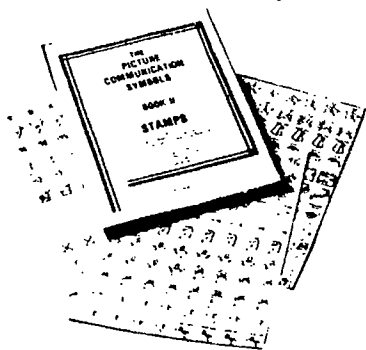

**Product Name:** PCS Stamps

**Vendor:** Mayer-Johnson Company

**Size:** 1" square

**Cost:** \$29.00 - \$44.00

PCS Stamps are versions of the Mayer-Johnson Picture Communication Symbols printed as lick-and-stick stamps. They are available in a one-inch square size only.

Six different sets are available, containing 4-12 copies each of 1,100 symbols. Book I Black on White Stamps (\$29.00) contains a total of 5,400 stamps (700 symbols). Book I Color-Coded Stamps (\$34.00) contains the same number, color-coded by topic. Book II Black on White (\$39.00) contains 9,100 stamps (over 1,100 symbols), as does Book II Color-Coded (\$44.00). Book III Black on White Stamps costs \$39.00 and Book II Color-Coded costs \$44.00.

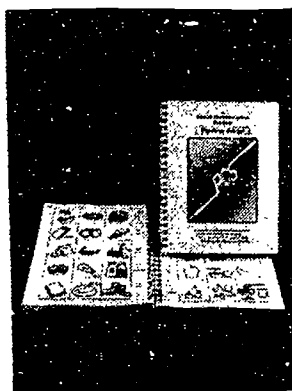

**Product Name:** PCS Wordless Edition

**Vendor:** Mayer-Johnson Company

**Size:** 2", 1", and 0.75" squares

**Cost:** \$59.00

The PCS Wordless Edition contains all of the Picture Communication Symbols from Books I and II (see entry) without the word printed above the picture. A space is left above each symbol so that the user may write in any word desired. The suggested English word for each symbol is provided for translation when needed. The original Book I guide and alphabetical and subject indexes are included.

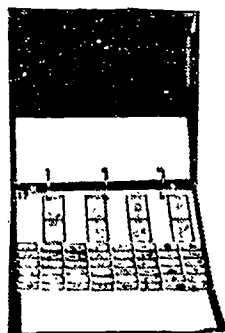

**Product Name:** PEACEbook

**Vendor:** TIGER Communication System, Inc.

**Size:** 9" x 8" x 2"

**Cost:** \$85.00

PEACEbook is a picture communication book. The book is a three-ring binder with 66 laminated pages of color-coded symbols with corresponding words. The user can point to tabs to select a subject page, and by pushing down on the tab and then flipping up, open the book to that page of symbols. Pages can be removed and used as small communication boards or overlays for expanded keyboards. PEACEbook includes TIGER Language Symbols, a supplemental label set providing 1,340 additional picture symbols.

PEACEbook is also available with an add-on voice output keyboard at additional cost; see separate product descriptions for Personal Trainer and Specialist.

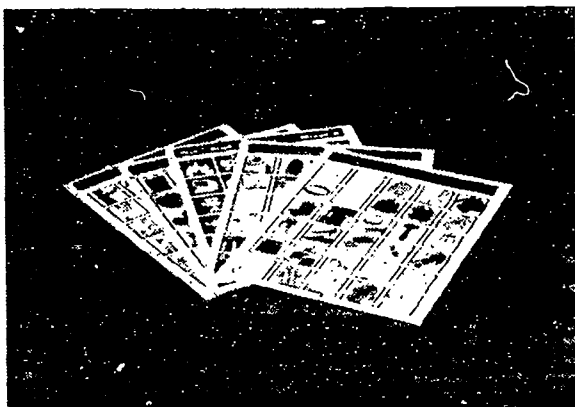

**Product Name:** Pick 'n Stick Color Micros

**Vendor:** Imaginart International, Inc.

**Size:** 4.5" x 3.5"

**Cost:** \$54.95

Pick 'n Stick Color Micros are 5/8" square color symbol stickers with an adhesive backing. The package includes pictures found in Pick 'n Stick Color Packs A and B (see entry), as well as stickers designed to represent abstract ideas. Blank stickers are also included. The stickers can be attached to communication aids or other electronic devices.

The package includes 23 4.5" x 3.5" sheets, with 30 stickers per sheet.

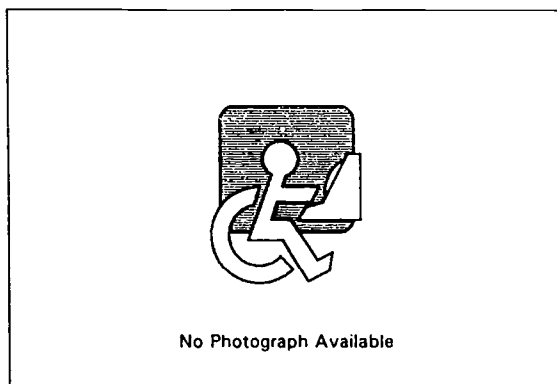

**Product Name:** Pick 'N Stick Color Packs

**Vendor:** Imaginart International, Inc.

**Size:** 1.5" square

**Cost:** \$4.50 - \$110.00

Pick 'N Stick Color Packs are full-color symbol stickers with adhesive backing. Each sticker is 1.5" square and contains a colored drawing indicating some message or unit of a message to be communicated. Pick 'N Sticks are designed to be adhered to communication aids, communication boards, notebooks, and electronic device overlays. The stickers come in sheets of 30, categorized by subject.

Pick 'N Sticks are available in four packages. Color Pack A includes: Feelings, Family and Friends, At Home (Rooms and Spaces), Common Activities, Events, Places, Common Items, Toys, Clothing, Transportation, Food, Health, Emergency, and Miscellaneous. Color Pack B includes: Common Activities, Spatial Concepts, Plurals, Opposites, Body Parts, Occupations, and Animals. Color Pack C includes: more Common Items and Activities, Kitchen Chores, school and work related images, and more. Color Pack D includes: Stores & Restaurants, Feelings, more Common Activities, Events, Television, Common Items, Animals, Clothes, Transportation, Food, Health, Symbols/Words, People, and Canadian Currency. Corresponding word packs and packages of duplicated common symbols are also available.



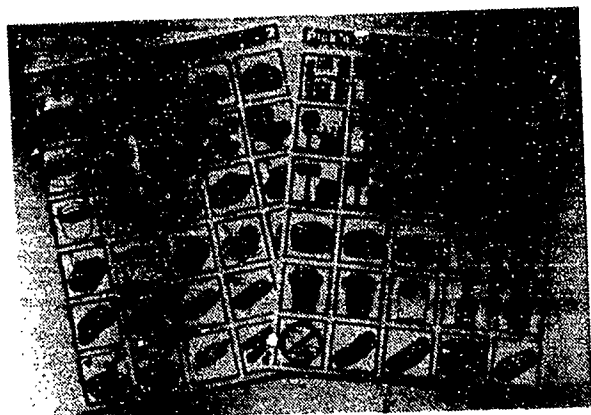

**Product Name:** Pick 'N Stick Fast Food

**Vendor:** Imaginart International, Inc.

**Size:** 1.5" square

**Cost:** \$15.00

Pick 'N Stick Fast Food Packs are full-color symbol stickers with adhesive backing. Each sticker is 1.5" square and contains a colored drawing indicating some message or unit of a message relevant to ordering in a fast food restaurant. Symbols are included for standard fast food chains and standard food orders (burgers, fries, salads, coffee, burritos, etc.) Pick 'N Sticks are designed to be adhered to electronic communication aids, communication boards, notebooks, etc. The stickers come in sheets of 30 (120 stickers total). Corresponding word pack available (\$4.50).

**Product Name:** Pick 'n Stick on Disk

**Vendor:** Imaginart International, Inc.

**Computer:** Apple Macintosh Family, IBM PC Family

**Cost:** \$149.00 - \$199.00



Pick 'n Stick on Disk features the symbols from the Touch 'n Talk and Pick 'n Stick series (see entries) on a software clip art library. Over 1,200 full-color and over 1,200 black and white illustrations are included and are organized by subject into the following categories: people, feelings, food, clothes, things around the house, common activities, occupations, etc. The images are presented in a format designed to be easily imported into word-processing, publishing, and other programs for building communication boards and other applications.

Images are provided in PICT format for the Macintosh and in TIFF format for the PC. The IBM version requires a 386 or above, a monitor that supports 256 colors or grays, at least 1 MB RAM, DOS 3.3 or higher. The Macintosh version requires a Mac Classic or above with a monitor capable of displaying 256 colors or grays, system 6.0.7 or above with at least 2 MB RAM or system 7 with at least 4 MB RAM.

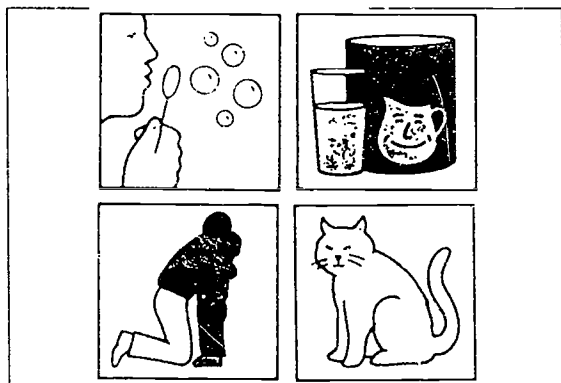

**Product Name:** Pick 'n Stick Primary Pack

**Vendor:** Imaginart International, Inc.

**Size:** 2.5" squares

**Cost:** \$29.00

Pick 'n Stick Primary Pack is a set of larger and less complex Pick 'n Stick (see entry) symbol stickers designed for use with young children. The 96 stickers are organized into the following categories: things to do, things around the house, toys, food, friends & family, feelings, transportation, and adaptive aids.

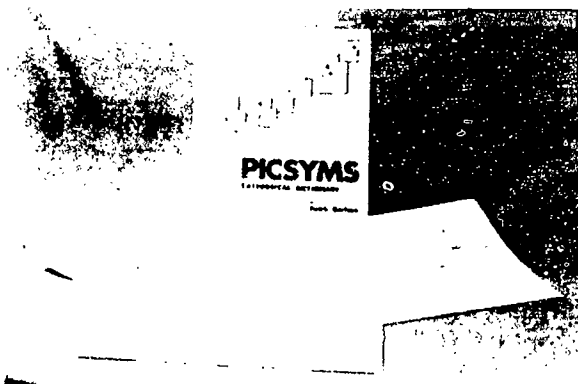

**Product Name:** PICSYMS Categorical Dictionary

**Vendor:** Poppin and Company

**Size:** 1.25", 2", or 2.75" squares

**Cost:** \$35.00

PICSYMS Categorical Dictionary is an instructional manual that teaches how to draw communication symbols. In addition, over 800 example PICSYMS in three sizes are included. The pages are printed on both sides, but may be copied for placement on communication devices.



**Product Name:** Picture Communication Symbols - Combination Book

**Vendor:** Mayer-Johnson Company

**Size:** 2", 1", & 0.75" squares

**Cost:** \$119.00

Picture Communication Symbols - Combination Book contains all of the symbols from the Picture Communication Symbols Books I, II, and III (see entries) organized in a 2" binder. In addition, a few new symbols have been added such as "glue stick" and "recycle." An updated guide is included in a separate booklet.

A wordless edition of the Combination Book is also available for \$99.00.



**Product Name:** Picture Communication Symbols, Books I, II & III

**Vendor:** Mayer-Johnson Company

**Size:** 1" or 2" squares

**Cost:** \$45.00 - \$49.00

Picture Communication Symbols, Books I, II, and III are three sets of pages of black-and-white line drawings on one- and two-inch squares. Each drawing is labeled with a word; some more abstract concepts are simply represented by a word. The pages are intended to be photo-copied and cut apart so that the separate symbols can be used in non-vocal communication systems such as communication boards.

Book I contains over 700 different communication symbols, and comes with a starter guide illustrating the basics of making communication boards. Book II is a supplement to Book I, which contains 1,100 additional symbols, featuring such topic areas as fast food restaurants, religion, sexuality, computers, and conversational discourse phrases such as "please repeat." Book III supplements the other books with an additional 1,400; it gives theme sections (such as playing games, shopping, etc.), holidays, brand names, story characters, fast food logos and items, and more communication facilitating symbols.



**Product Name:** Picture Prompt Cards

**Vendor:** Attainment Company

**Cost:** \$85.00

Picture Prompt Cards include 576 laminated cards featuring shopping, meal time, and daily activities. Included in the set are eight storage boxes and a marking set for personalizing the cards.

The cards can be placed in communication books (not included) available in three sizes. The communication books cost \$9.00 - \$24.00.

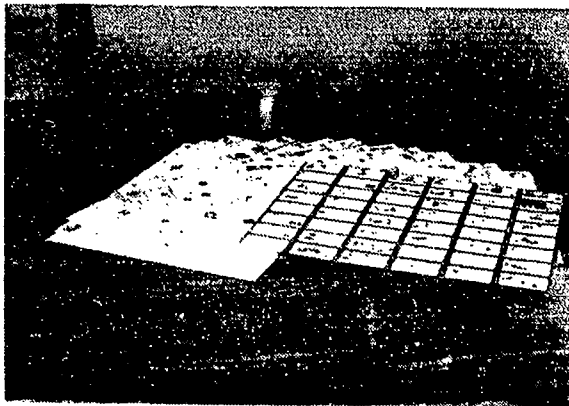

**Product Name:** Picture Prompt Stickers

**Vendor:** Attainment Company

**Cost:** \$59.00

Picture Prompt Symbols are vinyl communication symbols for making communication boards or illustrated lists. There are 576 symbols which depict activities, objects, and situations; some topics included are shopping, housekeeping, restaurants, and daily planning. The symbols are on twelve vinyl sheets with 48 on each.

Three 4" x 6" display boards, three sticker booklets, carrying case, and directions are included.

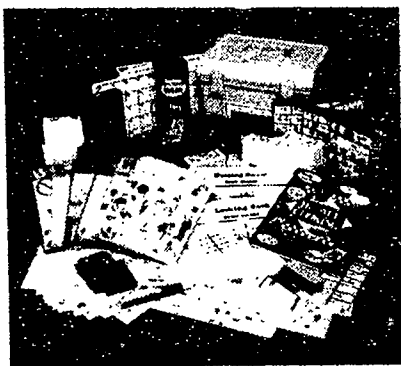

**Product Name:** Picture Prompt System

**Vendor:** Attainment Company

**Cost:** \$447.00

The Picture Prompt System includes the picture prompt and hands-on material from the manufacturer's life skill programs. This system is designed to help nonreaders and people with communication difficulties acquire shopping, dining, cooking, personal care, housekeeping, and scheduling skills. The system includes hundreds of shopping, routine, and choice cards, 588 illustrated language cards, six illustrated Learn About Life guides, 12 sheets of picture prompt stickers, five illustrated guides, a full-color picture sequenced cookbook, two step-by-step picture sets, display book, and store and carry box.

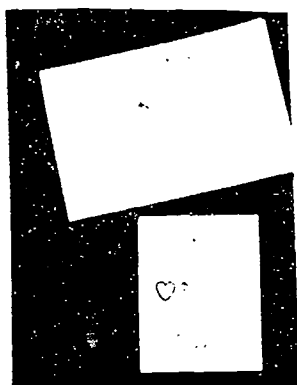

**Product Name:** Picture Your Blissymbols

**Vendor:** Blissymbolics Communication International

**Cost:** \$55.00 - \$105.00

Picture Your Blissymbols is a set of large 2-5/8" illustrated Blissymbols in stamp or flashcard format. Vocabulary items support interactive communication. An unembellished set of Blissymbols that can be personalized is also provided.

The complete kit sells for \$105.00 and includes a teaching manual, stamp and flashcard book, Blissymbols for Use, teaching aids, and carrying bag. The kit without the teaching aids and carrying bag is available for \$75.00, and the stamp and flashcard book with teaching manual alone is available for \$55.00. In addition, a core vocabulary set consisting of 207 of the most frequently used Blissymbols is available for \$25.00.



**Product Name:** Pictures, Please!

**Vendor:** Communication/Therapy Skill Builders

**Size:** 8.5" x 11"

**Cost:** \$45.00

Pictures Please! is a set of reproducible line illustrations for either language or articulation activities. The pictures are large black and white drawings on pages in a three-ring binder, which can be easily reproduced and used for games, flashcards, drills, or communication boards. Pictures Please! A Language Supplement has 1,232 illustrations on 224 pages which are arranged according to five major parts of speech: nouns, verbs, prepositions, pronouns, and modifiers. Entries are coded and cross-referenced for teaching various semantic and syntactic language concepts. Pictures Please! An Articulation Supplement has 1,242 pictures on 290 pages arranged for 43 different sounds, emphasizing sounds and blends that are common areas of difficulty such as /sh/, /ch/, and /r/.

The Language and Articulation Supplements are both sold separately for \$45.00 each, or as a set for \$79.00. Each set includes instructions, planning and activity sheets that are also reproducible.

---

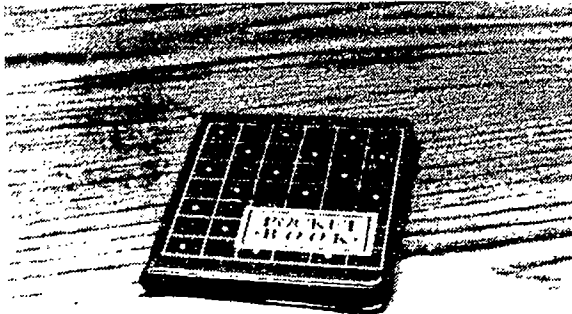

**Product Name:** Pocket Book

**Vendor:** Attainment Company

**Cost:** \$9.00

Pocket Book is an organizing case for communication symbols. The case has plastic pockets to hold the symbols and they are arranged on pages like a book. The pockets are designed to hold symbols from other Attainment Company products; check other entries for symbol sizes.

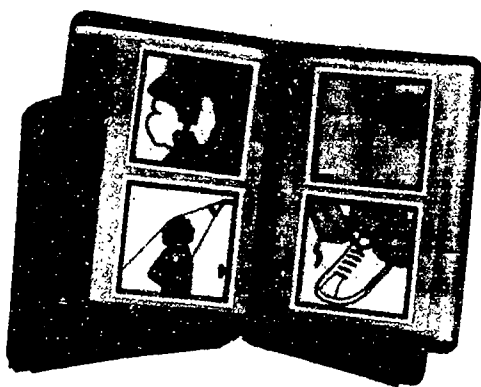

**Product Name:** Pocket Picture Holder

**Vendor:** Imaginart International, Inc.

**Size:** 4.5" x 3"

**Cost:** \$7.95

Pocket Picture Holder is a pocket-size notebook designed to hold communication symbols. Two 1.5" square symbols will fit on each vinyl page. The book can hold up to 64 1.5" square symbols. Different color cards (included) can be inserted as background in order to color code pages of symbols. A card is also provided which contains ID information and an explanation to the "listener" about the purpose of the symbol book.

Symbols must be purchased separately.

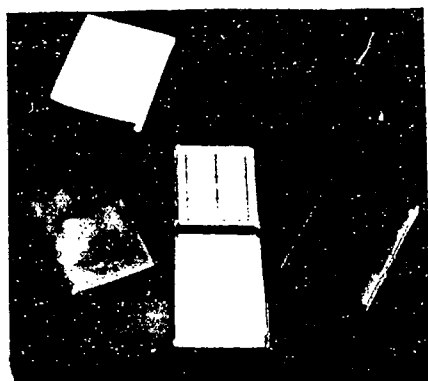

**Product Name:** Pocket-Sized and Double Pocket-Sized Communication Book

**Vendor:** Mayer-Johnson Company

**Size:** See text

**Cost:** \$3.00 - \$5.00

Pocket-Sized Communication Book is a small (3.2" x 4.2") vinyl covered notebook able to hold 144 one-inch symbols. Double Pocket-Sized Communication Book measures 4" x 5.38" and can hold 288 one-inch symbols. Communication symbols can be affixed to the pages of either book; the pages come with clear, non-glare vinyl protectors that resist the transfer of toner copying ink from photocopied communication symbols.

Additional grid pages are available (extra). The books also include a grommet for attachment to a belt clip or strap.

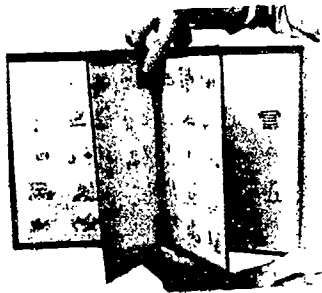

**Product Name:** Porta Boards  
**Vendor:** Crestwood Company  
**Size:** 9" x 12"  
**Cost:** \$10.95 - \$21.95

Porta Boards are communication devices that hold Talking Pictures cards/stickers (see entry) or other non-electronic communication aids. Each has see-thru vinyl pockets that can be written on with wipe-off pens and card stock sheets for mounting symbols. The Deluxe Porta Board has two large symbol sheets, one on each side, and sells for \$10.95. The Folding Porta Board has four pockets, a detachable shoulder strap and sells for \$22.95. The Triple Porta Board has six pockets and sells for \$18.95. The Maxi Porta Board has eight pockets, a carrying strap and sells for \$21.95.

Picture cards and stickers are not included.

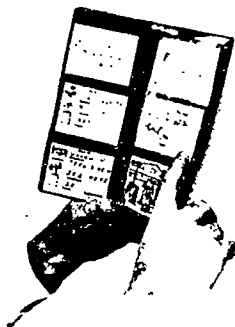

**Product Name:** Porta Book  
**Vendor:** Crestwood Company  
**Size:** See text  
**Cost:** \$8.50 - \$18.95

Porta Book is a folding communication aid that contains picture symbols and their corresponding words. Porta Book is available in four sizes. The Small Porta Book (\$8.50) holds up to sixteen picture cards (4" x 3.5"); the Standard Porta Book (\$11.50) holds up to 24 picture cards (4" x 3.5"); the Large Porta Book (\$13.50) holds up to 36 picture cards (9" x 4.5"); and the Porta Notebook (\$18.95) has eight bound vinyl pages plus room for two symbol sheets on inside hard covers.

Large page clips (extra), to aid in turning pages, are available for the Porta Books.



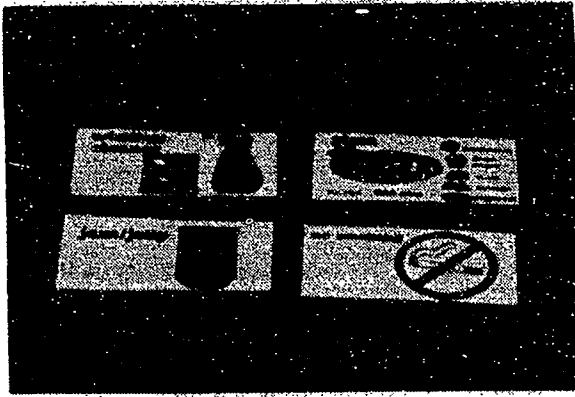

**Product Name:** Select-A-Meal and Shopping Smart

**Vendor:** Attainment Company

**Cost:** \$45.00 per set

Select-A-Meal (formerly Restaurant Cards) and Shopping Smart (formerly Shopping Cards) are two sets of 3.5" x 2" full-color laminated cards that can be inserted in a card case (included) and carried to the restaurant or store. Select-A-Meal includes 144 cards in nine color-coded menu categories (dinner, side dishes, beverages, condiments, etc.) and an illustrated menu. Shopping Cards includes 240 cards of food items, clothing, household, and personal care items. Also included in each set are wipe-off markers which can be used for writing specifics (flavor, brand, etc.) on the card.

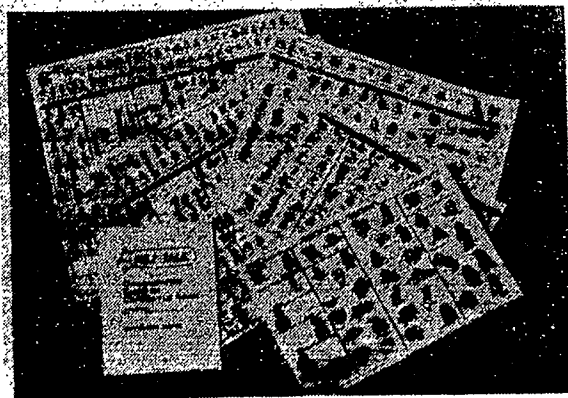

**Product Name:** Self-Talk Stickers

**Vendor:** Communication/Therapy Skill Builders

**Size:** 9" x 12"

**Cost:** \$49.00

Self-Talk Stickers are stickers that are enlarged versions of the pictures and words used on levels 1 through 5 of the Self-Talk Communication Boards (see entry). Each sticker is 1.5" x 2"; 441 different stickers are included. The package consists of two sets of 13 full-color sticker sheets and one set of black and white sticker sheets. Each sheet shows picture stickers with smaller word stickers below each picture. Blank stickers are included for personal drawings, photographs, or other pictures.

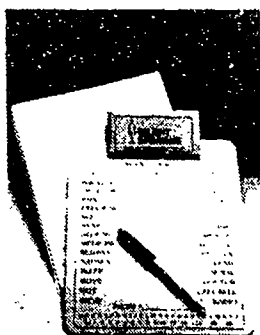

**Product Name:** Silent Speaker

**Vendor:** Trademark Medical

**Size:** 9" x 11"

**Cost:** \$19.95

Silent Speaker is a communication aid for use in health care situations. Nine models are available for a variety of situations including intensive care, rehabilitation or home care, ER assessment, trauma, neurological, and obstetric. Spanish and large type versions are also available. Each model features printed key words and phrases that can be pointed to or circled to express the patient's needs or desires, a line drawing of a human form for pointing to areas of pain or need of attention, and letters and numbers.

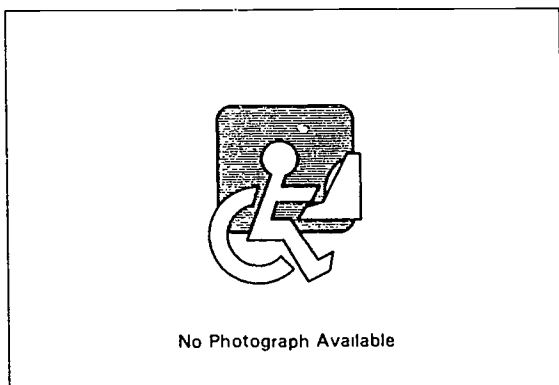

**Product Name:** Stickers for Talk Boards

**Vendor:** Crestwood Company

**Size:** 1.63" x 2"

**Cost:** \$9.50 - \$19.95

Stickers for Talk Boards are the pressure sensitive stickers from the Talking Pictures Kits (see entry). The Survival Needs set includes 96 stickers for \$9.50, the Community Needs set includes 216 stickers for \$19.95, the Daily Needs set includes 216 stickers for \$19.95, and the Fast Foods set includes 144 stickers for \$13.95.



**Product Name:** Talking Pictures Communication Board

**Vendor:** Crestwood Company

**Size:** 11" x 17.25"

**Cost:** \$36.95

Talking Pictures Communication Board is a portable communication board that comes with nearly 200 symbol stickers and fifty blank stickers from which a vocabulary may be developed. The Talking Pictures Communication Board may have symbols applied to both sides, and two heavy vinyl envelopes to hold the board are provided.

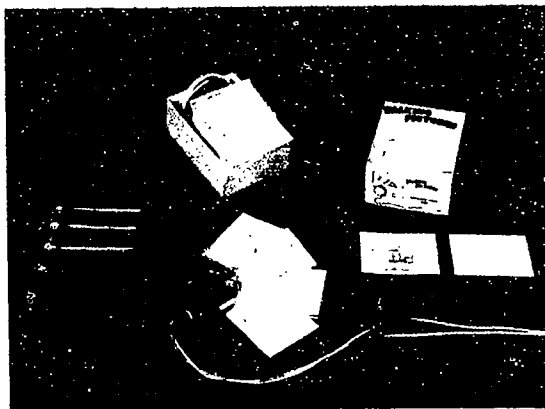

**Product Name:** Talking Pictures, Kits I - VII

**Vendor:** Crestwood Company

**Size:** 2.5" x 3.75"

**Cost:** \$29.50 - \$46.95 each

Talking Pictures, Kits I - VII are patented sets of cards with a word and line drawing, organized by different categories of living needs. Kit I - Survival Living Needs (\$29.50) is a set of 115 picture cards divided into eight classifications of living needs (room, bathroom, health, aids, food, clothing, people, and miscellaneous). Stickers from this kit are available for \$9.50. Kit II - Community Living Needs (\$46.95) is a set of 220 cards in nine categories (people, transportation, places, interests, money, signs, weather, school/office equipment and activities). Kit III - Daily Living Needs (\$46.95) is a set of 220 cards divided into eleven classifications (parts of home, furniture, kitchen, clothing, grooming, food and beverages, fruits and vegetables, home activities, communication, and outside the home). On the reverse of each card in kits I - III, the words are listed in five languages: English, Spanish, German, French, and Italian. Kits V, VI, and VII have the same pictures as kits III, II, and I respectively but also features sign language on the back.

Included are 10-20 vinyl envelopes on a metal ring and a vinyl cord.

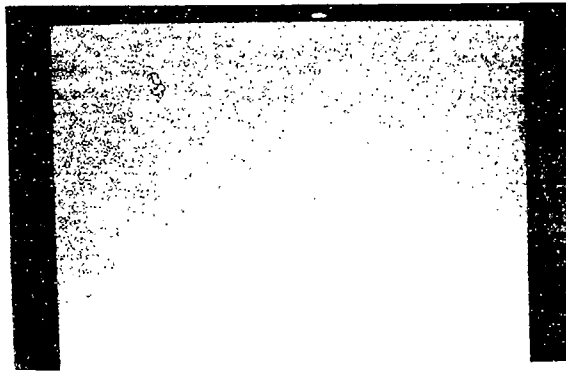

**Product Name:** Touch 'N Talk Communication Board

**Vendor:** Imaginart International, Inc.

**Size:** 11.25" x 14" or 14.5" x 19"

**Weight:** 12 oz. or 20 oz.

**Cost:** \$16.00 - \$20.00

Touch 'N Talk Communication Board is a rigid, waterproof, white plastic board. Touch 'N Talk stickers or other user-specifiable symbols can be affixed to the board for direct-selection communication through pointing. The board can also be written on with a water-based marking pen.

Touch 'N Talk Communication Boards are available in two sizes. Transparent slip-on vinyl covers are available for both (extra). A Touch 'N Talk Tote Board, the same basic design but with a built-in handle, is also available in the same two sizes.

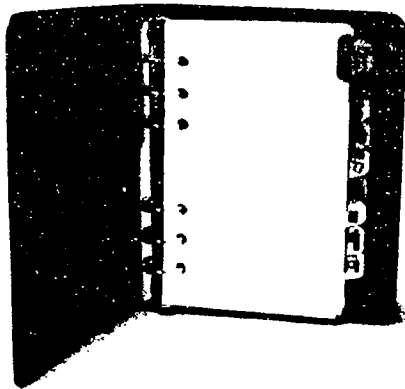

**Product Name:** Touch 'N Talk Communication Notebook

**Vendor:** Imaginart International, Inc.

**Size:** 7.38" x 5.75"

**Cost:** \$18.50 - \$29.95

Touch 'N Talk Communication Notebook is a small looseleaf binder with blank pages. User-specifiable symbols such as Touch 'N Talk stickers can be affixed to the pages for communication through pointing. Sections are separated by dividers with color tabs on them. Each tab contains a graphic symbol for a category of message (food, people, feelings, etc.).

Extra blank pages (\$3.50 each) and notebook page protectors (\$14.95 each or \$29.95 for twenty protectors and the Notebook) are available for the Touch 'N Talk Communication Notebook.

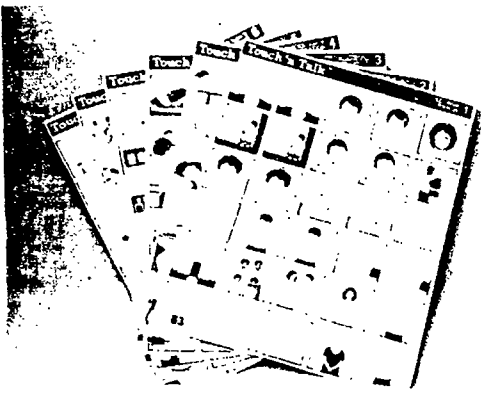

**Product Name:** Touch 'N Talk Communication Stickers

**Vendor:** Imaginart International, Inc.

**Size:** 1.5" x 1.5" each

**Cost:** \$15.50 - \$45.95

Touch 'N Talk Communication Stickers are 1.5" square stickers, each containing a black-and-white drawing suggesting some message or unit of a message to be communicated. The adhesive on the back of the stickers is made to adhere to surfaces such as communication boards. One set contains 420 stickers, divided into categories such as feelings, family and friends, clothing, etc. Doubles are provided of the most commonly used symbols.

The basic sticker set is \$35.50. A Touch 'N Talk Supplement of an additional 180 stickers is also available for \$15.50. Both sets together are \$45.95.



**Product Name:** Touch 'N Talk Micros

**Vendor:** Imaginart International, Inc.

**Size:** 0.6" x 0.6" each

**Cost:** \$27.95

Touch 'N Talk Micros are smaller (5/8" square) versions of the Touch 'N Talk Communication Stickers designed to be affixed to the overlays of electronic communication devices. These stickers can be used to indicate which keys have been programmed to speak an entire word or phrase. Included in the 660-sticker set are Touch 'N Talk Symbols: specific graphic symbols that can be used to identify broad categories or abstract ideas.



**Product Name:** WordWise Language & Master Cards

**Vendor:** Attainment Company

**Size:** 3" x 3.5"

**Cost:** \$49.00 - \$69.00

WordWise Language Cards are full-color picture cards. Each illustrates a word with the word printed in English and Spanish on the back. The 588 cards include nouns, verbs, adjectives, adverbs, prepositions, and expressions in functional everyday vocabulary. The cards are designed for use in conversation, word recognition, writing, spelling or sentence building. A laminated surface allows the user to write and erase on cards. The cards come collated and ready to use. WordWise Master Cards feature the Language Cards as reproducible black and white masters with space provided for writing the word under the picture. The Master Cards come in a spiral-bound format.

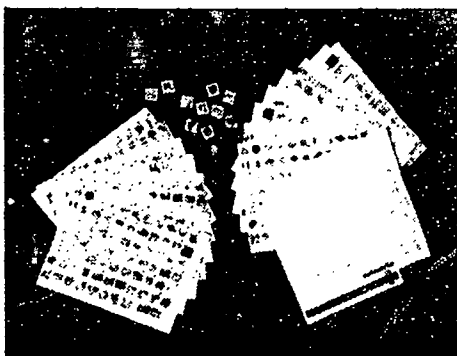

**Product Name:** WordWise Sticker Set

**Vendor:** Attainment Company

**Size:** 1" squares

**Cost:** \$39.00

WordWise Sticker Set includes two sets of 588 color stickers illustrating nouns, verbs, adjectives, adverbs, prepositions, and expressions. The stickers are designed for use with flash cards, illustrated worksheets, student word lists, and augmentative communication. The manufacturer recommends using the stickers with their Attainment Talkers (see entries).

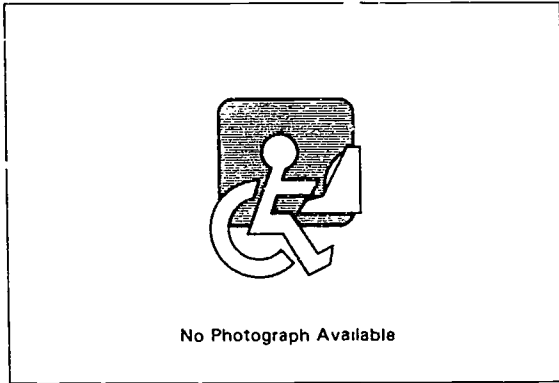

**Product Name:** Writing Utensil Grips

**Vendor:** Various (Generic Product)

**Cost:** Varies

Numerous writing utensil adaptations are available from specialty rehabilitation catalog houses and local rehabilitation supply stores. Alternatively, many individuals with disabilities find mass market writing utensil grips helpful and much less expensive than specialty rehabilitation products. Writing utensil grips vary in color, sizes, shapes, and methods in which they are applied to pencils, pens, and markers. These grips are often foam cylinders (available as insulating foam for plumbing and found at hardware stores), triangles with holes for the utensil, balls, and specialty finger conforming grips.

These grips are available from most office supply stores, many book stores, and educational or learning shops (supplies for parents and teachers). Additionally, many grips can be custom made by modifying tennis balls (drilling holes through them), ping pong balls, or other rubber balls found at local toy stores.

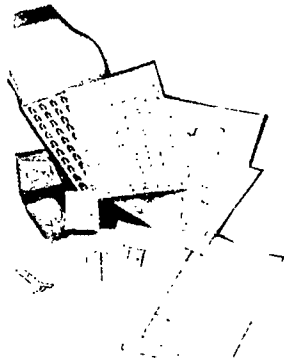

**Product Name:** Zoo Kit

**Vendor:** Mayer-Johnson Company

**Cost:** \$29.00

The Zoo Kit is a group of materials designed for teaching basic language skills using the Picture Communication Symbols (PCS). The kit focuses on 53 zoo animal nouns, descriptors, and verbs. Included are either 44 or 88 stamps for each symbol, two decks of 54 playing cards with 2" versions of the picture symbol set, masters of duplicable worksheets, large stimulus cards to promote discussion of themes, suggestions for adapting materials, masters of symbols, and instructions for suggested activities.

## **Chapter 5**

# **Electronic Communication and Writing Aids**

This chapter contains dedicated electronic conversation and writing aids. Communication aids that have fewer than 32 distinct selections but offer voice output capacities were formerly listed in Chapter 3 (Training and Communication Initiation Aids) but are now included here. Software programs that work with computer systems for communication and computer/software packages that are designed specifically for communication are listed here. If you want to locate all of the products that are designed for communication, both electronic and non-electronic as well as products with other primary functions, look in Index 1 under the function "Conversation/Interaction."

Other related functions in Index 1 include: Conversation/Interaction (CI), Portable Writing (PW), Alternate Input to a Computer (TI or TW), Word Processing (WP), and Environmental Control (EC).

Several appendixes provide additional useful information. Appendix B lists Service Centers for Augmentative Communication and Computer Access; Appendix A lists Newsletters and Journals, Books and Pamphlets.



**The following product entries appear in this chapter:**

A.I.P.S. Wolf (Alternate Input Peripheral System), 117  
Able2Speak, 117  
Abovo PCD, 118  
ActionVoice, 118  
AlphaTalker, 119  
Attainment Fifteen Talker, 119  
Attainment Five Talker & Talker Plus, 120  
Attainment Two Talker, 120  
Audible Cursor Routine, 121  
AudScan II, 121  
BIGmack, 122  
BlackHawk, 122  
Canon Communicator CC-7S and CC-7P, 123  
CarryCom, 123  
Cheap Talk 4 & 8, 124  
Communication Programs, 124  
Companion 401 Communicator, 125  
Crespeaker, 125  
Crestalk, 126  
DAC, 126  
DeltaTalker, 127  
DigiTalk I, 127  
DigiVox, 128  
Dvorak One-Hand Typewriter, 128  
DynaVox2 & DynaVox2c, 129  
DynaVox2 DOS & DynaVox2 Mac, 129  
EasyTalk, 130  
Electronic Speech Synthesizers, 130  
Equalizer, 131  
EvalPAC with RealVoice, 131  
Eyegaze Computer System, 132  
FingerFoniks, 132  
Gus! Multimedia Speech System, 133  
Handheld Computers and Personal Organizers, 133  
Handy Speech Communication Aide, 134  
Hawk, 134  
Heidico Intertalk, 135  
Help U Type and Speak, 135  
HyperBliss 3.2, 136  
I Can Speak, 136  
IntelliTalk, 137  
Liberator, 137  
LightWRITER SL35, 138  
LightWRITER SL5, 138  
LightWRITER SL85, 139  
Lingraphica, 139  
Lynx, 140  
Macaw Series, 140  
MegaWolf, 141  
MessageMate 20, 141  
MessageMate 40, 142  
Messenger, 142  
Meta4, 143  
Mini Talking Card Reader, 143  
Mini-MessageMate, 144  
Parrot, 144  
Pegasus, 145  
Personal Trainer, 145  
Picture Icon X-CHANGE, 146  
Polycom, 146  
ReadyScan, 147  
RealVoice, 147  
Say-It-All II Plus, 148  
Say-It-Simply Plus, 148  
Scan Com, 149  
Scan-It-All, 149  
ScanPAC, 150  
Scribe, 150

Secretary, 151  
Shadow Talker, 151  
SpeakEasy, 152  
Speaking Dynamically, 152  
Specialist, 153  
Switch Module, 153  
Switchboard, 154  
System 2000, 154  
Talk Back III, 155  
Talk Back VI, 155  
Talk:About, 156  
Talking Screen, 156  
Talking Screen for Windows, 157  
Talking Switch Plates, 157  
TS2010X Text to Speech Personal Communicating Device, 158  
VisionKey, 158  
Vocal Assistant, 159  
VoiceBachs, 159  
VoicePal, 160  
VoicePal Plus, 160  
VOIS 160, 161  
WalkerTalker, 161  
WhisperWolf, 162  
Yak Bak, 162

**The following products from other chapters can also be used as Electronic Communication or Writing Aids:**

Aurora 2.0 for DOS, 376  
Communilight 24, 37  
T-TAM Keyboard and Mouse Emulator, 463

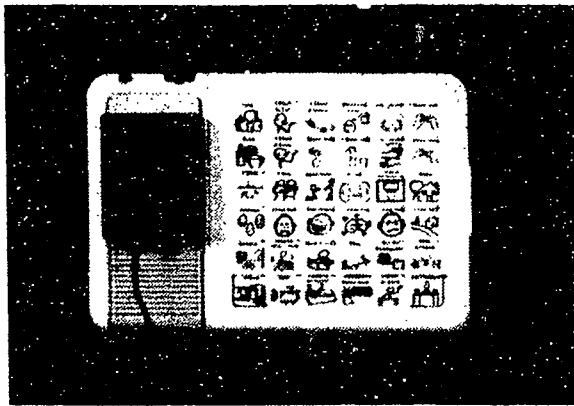

**Product Name:** A.I.P.S. Wolf (Alternate Input Peripheral System)

**Vendor:** Wayne County Regional Education Service Agency

**Size:** 14.5" x 10" x 2.75"

**Weight:** 2 lbs. 15 oz.

**Power Source:** Rechargeable batteries

**Cost:** \$500.00

A.I.P.S. Wolf is a portable communication aid with synthesized voice output. The aid can be activated by using either the built-in touch panel or by selecting with up to nine single switches. The nine switch jacks are arranged to correspond with the touchpanel functions. The aid features four memory sections. The fixed memory section has a capacity of 500 words, the user section can store 800 words; and the other two sections can be left blank and extra fixed or user sections later added.

Switches are not included; switch jacks are standard 1/8" size. The optional WolfKey is available for \$345.00 to allow access to computers for A.I.P.S. Wolf users.

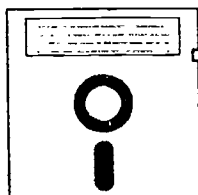

**Product Name:** Able2Speak

**Vendor:** Axis Corporation

**Computer:** IBM PC Family

**Cost:** \$1,295.00

Able2Speak is a software program that allows a PC with Microsoft Windows to become an augmentative communication device. Able2Speak scans a screen of letters and words until the user interrupts it using a single switch (not included). The software features large, easy-to-read letters and a window which displays the phrase being entered and the five previous phrases. Able2Speak builds a database of words and phrases as it is used. A two-level menu system switches to a "help" screen so the user can communicate emergencies or other problems. The Windows Sound System is supported so the user can vocalize thoughts and all text is saved in an ASCII file so the program can be used for composing.

System requirements include a 386 or higher CPU with 4MB of RAM, 5MB of hard disk space, VGA graphics, and Microsoft Windows. Customized versions can be prepared for users with special needs.

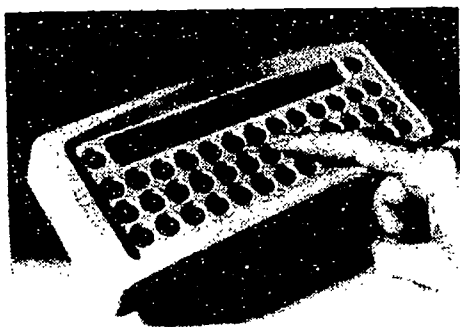

**Product Name:** Abovo PCD

**Vendor:** D.C. & D., Inc.

**Size:** 8.5" x 4" x 1.75"

**Weight:** Under 2 lbs.

**Cost:** \$300.00 - \$525.00

The Abovo PCD (Personal Communicating Device) is a portable electronic device designed for persons who wish to communicate through single finger typing. The alphabet keys are given in alphabetical order or in QWERTY style with numbers zero through nine beneath it. Messages are displayed on a 40 character LCD display on the surface of the device.

An optional remote display unit allows the PCD user to send a message by wireless infra-red signal up to 20 feet away, allowing for more natural communication. A multi-remote distribution unit is also available to connect up to eight remote displays for communicating with a group. The user can also interface and download the memory of the PCD to a personal computer with the optional PC wedge. Carrying cases and typing stands are optional. A built-in printer model is available (\$525.00).

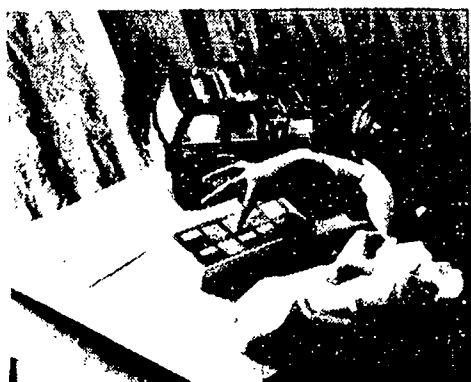

**Product Name:** ActionVoice

**Vendor:** Ability Research, Inc.

**Size:** 7.5" x 4" x 1.5"

**Weight:** 13 oz.

**Power Source:** 9V battery & AC

**Cost:** \$399.00 - \$595.00

ActionVoice is a combination voice recorder and switch controller. Messages can be recorded and accessed by the built-in keypad, external switches, single and dual switch scanning, or LightBoard. Two switch outputs allow the user to turn devices on or off, on for a time, or on for a desired number of times with any key. Other features include a built-in speaker, built-in microphone, auxiliary audio input, and inlays.

Model 1 provides 10 messages and 60 seconds of total recording time. Model 2 provides 18 messages (on two levels), 120 seconds of total recording time, and auditory scanning.

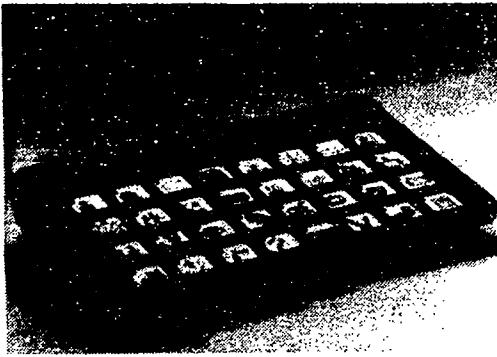

**Product Name:** AlphaTalker

**Vendor:** Prentke Romich Company

**Computer:** Apple II Family,  
Apple Macintosh Family, IBM PC Family

**Size:** 13.75" x 8.25" x 2.25"

**Weight:** 3 lbs.

**Cost:** \$1,595.00

AlphaTalker is an electronic communication device with digitized speech output designed for users with limited communication needs, or as an introductory communication device, as an evaluation tool, or for someone with short-term speech loss. The device comes with a 32-location keyguard but can be configured with four or eight locations. Three minutes of standard or 5-1/4 minutes of extended speech are available. The messages are accessed through the keyboard, with a headpointer, or by scanning (switches and headpointer not included). AlphaTalker features icon prediction which causes icons that are sequenced with the selected icon to light up. Vocabulary can be stored to a computer disk and up to 32 commands can be sent to a computer through the AlphaTalker.

Available accessories include: optical headpointer, remote switch adapter, carrying case, carrying straps, operating kits to configure the device with four or eight locations, and a memory module to add up to 25 minutes of speech.

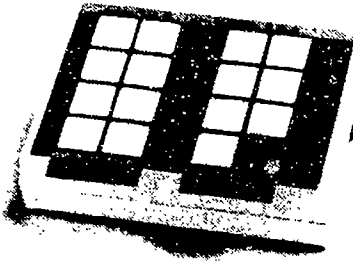

**Product Name:** Attainment Fifteen Talker

**Vendor:** Attainment Company

**Weight:** 13.3 oz.

**Power Source:** 9V battery

**Cost:** \$429.00

Attainment Fifteen Talker is a communication and training aid that allows up to fifteen digitized speech messages of eight seconds each. Laminated inserts slide into two transparent pockets and the messages are accessed by pressing the corresponding symbol. Volume is adjustable and the messages can be re-recorded as needed.

Laminated inserts, battery, and marking set are included. An optional Clip 'n Go canvas tote case with a transparent front and adjustable strap for attaching to the user's shoulder or waist is available for \$49.00.

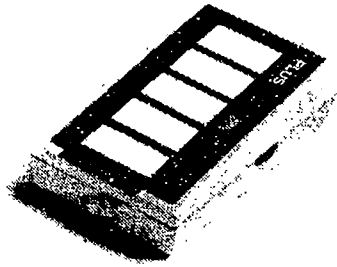

**Product Name:** Attainment Five Talker & Talker Plus  
**Vendor:** Attainment Company  
**Size:** 5.5" x 3" x 1.5"  
**Power Source:** 9V battery  
**Cost:** \$229.00 - \$329.00

The Attainment Five Talker is a communication and training aid which allows up to five different recorded messages. Laminated inserts that slide into a transparent sleeve are included and can be personalized for the individual user. Messages are accessed by pressing the corresponding message button. Other features include volume control and multifunction LEDs for visual cues during playback.

Laminated inserts, battery, protective case, and marking set are included. An optional Clip 'n Go canvas tote case with a transparent front and adjustable strap for attaching to the user's shoulder or waist is available for \$35.00. The standard Talker features 32 seconds of memory and Attainment Five Talker Plus features two minutes of memory.

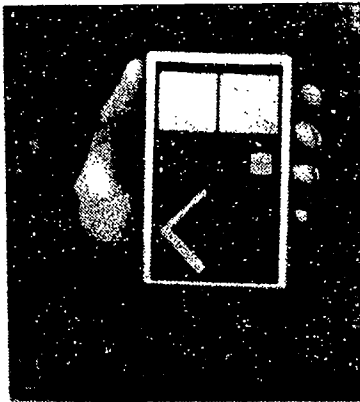

**Product Name:** Attainment Two Talker  
**Vendor:** Attainment Company  
**Weight:** 5.9 oz.  
**Power Source:** 9V battery  
**Cost:** \$149.00

Attainment Two Talker is a communication aid and training device with digitized speech output. The device holds two messages for up to eight seconds each. Messages are accessed by pressing the corresponding symbol and can be re-recorded as needed. A battery and protective case are included.

**Product Name:** Audible Cursor Routine

**Vendor:** Favin, David

**Computer:** Texas Instruments TI 99/4A

**Manual Form:** Printed Manual

**Cost:** Free

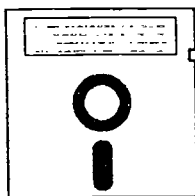

Audible Cursor Routine is a program for communication which employs auditory scanning. The user is presented with a selection of words or phrases spoken by a speech synthesizer and transmitted to the user via earphone. The user activates a switch when the program reaches the desired item. Once a selection is made, it automatically causes a sentence or preassigned speech to be spoken by a loudspeaker.

Audible Cursor Routine requires a speech synthesizer. This program was developed through the Telephone Pioneers of America, and is free to anyone interested.

---

**Product Name:** AudScan II

**Vendor:** Words+, Inc.

**Computer:** IBM PC Family, Toshiba Laptops

**Cost:** \$1,395.00

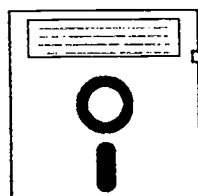

AudScan II is a computer software program that allows a laptop computer to be used as an electronic communication aid with auditory scanning. Pressing the ESC key pops up a main menu; a letter corresponding to the desired menu option is then pressed. Four levels of scanning are provided. The top level is contexts, which are general categories (e.g., "Mealtime," "Television"). Up to 25 contexts may be set up; it is then possible to select only the ones needed at a given time. Below each context is a set of categories (e.g., appropriate categories under Mealtime would be "Food," "Drink," and "Cleanup"). The next level is Cue Words (which for Drink might be "Milk," "Coke," or "Juice"). Finally, Cue Words are used to select the spoken Phrase associated with that word--e.g., selecting Milk might elicit the sentence "May I have some milk, please?" Two, three, or all four levels may be used for any set of vocabulary. Different contexts may be set up and saved for different users. An on-line help feature is included, and a full-screen Exception Table is included under the Voice Menu.

Any serial port speech synthesizer may be used with AudScan II.



**Product Name:** BIGmack  
**Vendor:** AbleNet, Inc.  
**Size:** 5" diam., 2.25" high  
**Power Source:** 9V battery  
**Connector Type:** Mini-phone jack  
**Cost:** \$74.00

BIGmack is a self-contained switch and digitized voice output. The large surface works as a pressure input switch to activate a message up to 20 seconds long. One activation of the switch plays the entire message and must be activated again to repeat the message. Other features include a built in speaker, volume control, and quick message recording. In addition to the built-in switch surface, BIGmack has an external jack to accommodate any switch.

An optional mini-amplifier speaker system is available for use in especially noisy environments and sells for \$25.00.

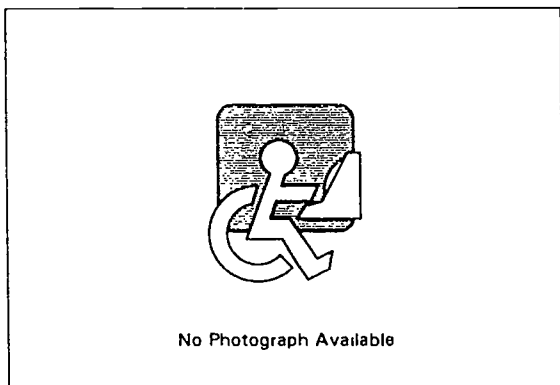

**Product Name:** BlackHawk  
**Vendor:** Wayne County Regional Education Service Agency  
**Size:** 9.5" x 6" x 1.75"  
**Weight:** 1.5 lbs.  
**Cost:** \$650.00

BlackHawk is a voice output communication aid. The device offers four minutes of digital voice recording that is accessed through a soft-pressure membrane touch-panel. The touch-panel is arranged in a four by four matrix of one inch cells, with an additional four cell column for accessing each of four separate levels for a total of sixty-four messages. Other features include one button programming, tri-color LED feedback, built-in microphone, and memory protection if device is turned off. An input connector is included to attach the AIPS (not included) adapter for switch use.

An optional gridded attachment for aided finger pointing is available.

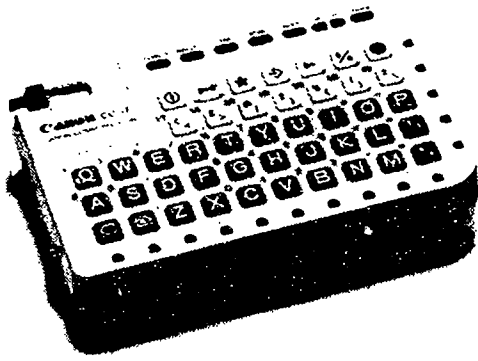

**Product Name:** Canon Communicator CC-7S and CC-7P

**Vendor:** Canon U.S.A., Inc.

**Size:** 7" x 4.19" x 1.44"

**Weight:** 17.7 oz. - 18.75 oz.

**Power Source:** Rechargeable battery

**Connector Type:** 1/8" phone plug

**Cost:** \$850.00 - \$1,100

Canon Communicator CC-7S and CC-7P are portable communication aids. The CC-7P uses a small keyboard for input and has a single-line strip printer for output. The CC-7S also uses the same keyboard and printer, but in addition offers the option of input through single-switch scanning and output through voice. The voice output allows up to 240 seconds total of pre-recorded (digitized) speech, segments of which can be stored for each of the 26 letter keys on the keyboard. Either model allows the user to store up to 7,000 characters worth of messages in memory. A message is recalled by pressing a key on the keyboard. Both models include a built-in calculator and an alarm buzzer key to signal for attention. Printing on the strip printer can be printed in an enlarged size (double width). Both Canon Communicators comes with "memory mates" picture stickers to allow the keys to be labeled for non-spellers.

Options include wheelchair attachment, arm belt, keyguard, saliva guard, external switch, cable for connecting external audio amplifier, and interface cable for transferring memory between Canon Communicators.



**Product Name:** CarryCom

**Vendor:** Great Talking Box Company

**Computer:** IBM PC Family

**Size:** 11.25" x 5.2" x 2.1"

**Weight:** 4 lbs., 1oz.

**Cost:** \$3,619.00

CarryCom is a small, portable communication aid which has voice output and personal computer capabilities. The device has a small full-featured keyboard, LCD screen, RS-232 serial port, and printer ports. The output can be selected from male, female, or both voices. The user can input messages into the aid, view them on-screen, have them "spoken," and (when connected to a printer) print out messages. Input of messages is done through the keyboard or by scanning. The CarryCom can also act as a computer base with a word processor, spreadsheet, and calculator applications.

An optional eight letter scrolling screen (Message Sender) can be added to the back for \$363.00.



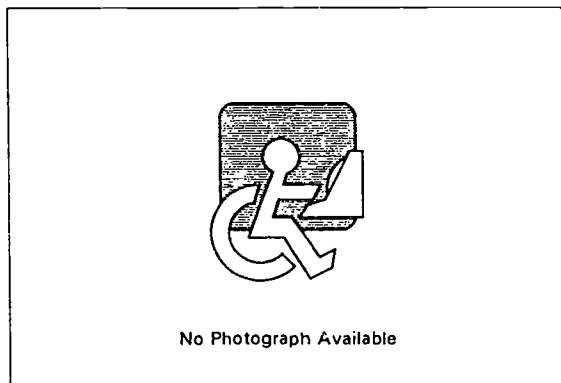

**Product Name:** Cheap Talk 4 & 8

**Vendor:** Toys for Special Children, Inc.

**Cost:** \$69.00 - \$300.00

Cheap Talk is an electronic communication device with four or eight digitized voice messages of up to five seconds each. Symbols or words can be inserted over each square for each message.

Cheap Talk 4 is available as a direct activation model for \$69.00 or \$95.00 with jacks for attaching switches, as a scanning device with jacks for \$150.00, and as a direct and scanning model for \$250.00 or for \$275.00 with jacks. In addition, the direct models are available with the squares arranged in inline style or square style. Cheap Talk 8 is available as a direct activation model for \$135.00 or for \$150.00 with jacks, as a scanning model with jacks for \$200.00, and as a direct and scanning model for \$250.00 or for \$300.00 with jacks.

---

**Product Name:** Communication Programs

**Vendor:** Favin, David

**Computer:** Texas Instruments TI 99/4A

**Manual Form:** Printed Manual

**Cost:** Free

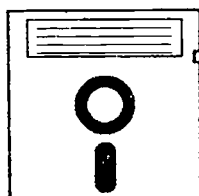

These Communication Programs are designed to provide synthesized voice communication. There are two programs. The first is designed primarily for telephone communication. The user types messages on the computer keyboard and the synthesizer speaks them. The second program uses single switch scanning. Words are presented to the user in the form of a system of menus. A cursor moves through the choices and the user activates a switch when the cursor reaches the desired word. In this way the words can be selected to form sentences. The sentences can be spoken by the speech synthesizer or printed on a printer. The word menus can also contain environmental control commands.

A speech synthesizer is required for voice output. Contact the manufacturer for information on adapting the second program for environmental control. These programs were developed through the Telephone Pioneers of America, and are free to anyone interested.

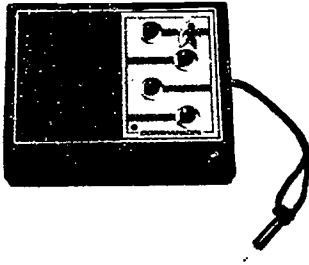

**Product Name:** Companion 401 Communicator

**Vendor:** Luminaud, Inc.

**Size:** 5.3" x 4" x 2"

**Weight:** 12 oz.

**Power Source:** 9V battery

**Cost:** \$125.00

The Companion 401 Communicator is a portable communication and training aid with digitized speech. The Communicator holds four phrases for a total message time of 20 seconds and can be programmed at any time. Battery failure will not result in lost messages. The messages can be activated by push buttons located on the unit or by external switches. The device has a jack for connection to phone with 911 Telephone Terminal (see entry).

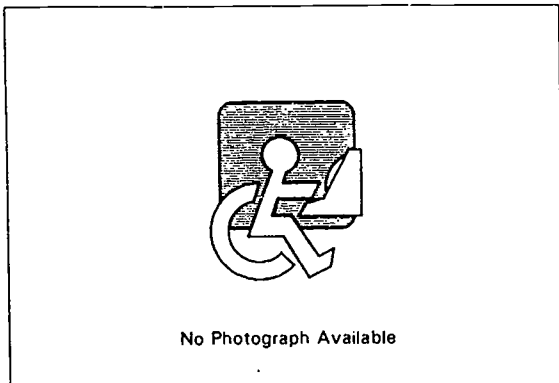

**Product Name:** Crespeaker

**Vendor:** Crestwood Company

**Size:** 3.28" x 5.28" x 0.5"

**Weight:** 4.5 oz.

**Power Source:** 3 "AAA" batteries

**Cost:** \$199.95

Crespeaker is a small handheld communication device with voice output that says the word, phrase, and sentence entered by the user on the integrated keyboard. Up to 100 characters or about 18 words can be entered and spoken at a time. The device speaks in English and Spanish and has the capability to translate a word from one language to the other. Other features include adjustable volume, screen brightness control, and built-in phrases. Crespeaker can be used to converse on the telephone.

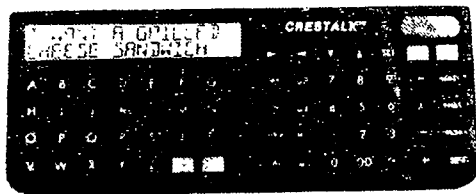

**Product Name:** Crestalk

**Vendor:** Crestwood Company

**Size:** 3.5" x 8.25" x 1"

**Weight:** 9 oz.

**Power Source:** Batteries

**Cost:** \$134.95

The Crestalk is a small and lightweight electronic communication aid. The user presses alphabetic or numeric keys to convey messages which appear in a small liquid crystal display. The display shows up to sixteen characters per line on a two line panel; longer messages will scroll. The aid has a 20K memory and sentences can be programmed into the device. The Crestalk has a full set of alphabetic keys and a functioning calculator feature. Crestalk does not have voice output.

The aid is battery operated; batteries are included which provide up to five months of continuous use. A carrying case is also included.

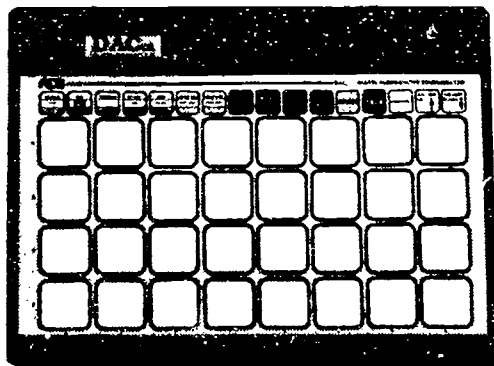

**Product Name:** DAC

**Vendor:** ACS Technologies, Inc.

**Size:** 11" x 13" x 2"

**Cost:** \$3,295.00 - \$3,995.00

The Digital Augmentative Communicator (DAC) is a programmable battery operated communication device with sound output. DAC has 128 keys which can be programmed with a word, phrase, or sentence. The size of the keys can be adjusted by programming each separately or joining several together. The device has memory for up to 8,000 words; the memory is divided into one, two, or four levels allowing access to programs stored on different levels. The information programmed into DAC can be accessed by using pictures and spelling. When the user makes a selection, the character, word, or phrase will be "spoken" and appear on the device's small display screen. Sound output must be programmed into the aid by recording a person's voice and storing it in DAC's memory. The aid is available with 18, 36, or 72 minutes of useable memory for sound output. DAC features a built-in 3 1/2" disk drive as well.

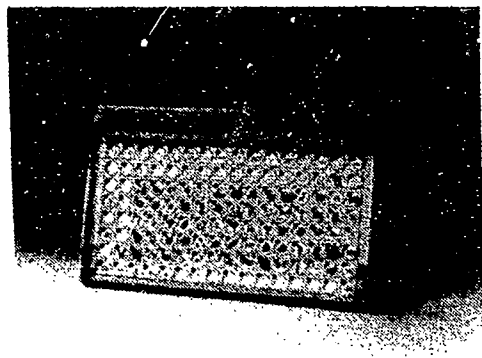

**Product Name:** DeltaTalker  
**Vendor:** Prentke Romich Company  
**Size:** 13.75" x 8.25" x 2.25"  
**Weight:** 4 lbs.  
**Power Source:** NiCad batteries  
**Cost:** \$4,995.00

DeltaTalker is an electronic communication device that offers both synthesized speech and digitized speech. The device has 128 locations but can be configured for 8 or 32 locations. Messages are accessed by pressing keys on the keyboard, through optical pointing, or by scanning (pointer and switches not included). Icon prediction is designed to promote learning of symbol sequences by lighting locations which can be sequenced with a selected icon. Other features include audible prompts and the ability to store vocabulary to a disk. An infrared option permits the user to operate TVs, VCRs, and other devices through the DeltaTalker.

Available accessories include: optical headpointer, carrying case and straps, operating kits to configure the device with 8 or 32 locations, and memory module to increase digitized speech to 14 minutes.

---

**Product Name:** DigiTalk 1  
**Vendor:** Sentient Systems Technology, Inc.  
**Cost:** \$350.00



DigiTalk 1 is software for the DigiVox communication aid designed for individuals who are beginning to use augmentative communication tools. DigiTalk can be accessed through either direct selection or scanning. The program allows the user to take an active part in interactions on subjects such as needs, body parts, actions, mealtimes, feelings, colors, shapes, clothing, and nursery rhymes.

DigiTalk includes eleven disks which include over 400 audio messages, over 30 preprinted overlays, visual symbols for making custom overlays and messages, and a written tutorial. Use of DigiTalk requires a DigiVox and a DigiVox disk drive.



**Product Name:** DigiVox

**Vendor:** Sentient Systems Technology, Inc.

**Size:** 11.62" x 8.87" x 1.87"

**Weight:** 3.8 lbs.

**Power Source:** Rechargeable batteries

**Cost:** \$2,150.00 - \$2,995.00

DigiVox is an electronic communication aid that records and saves spoken messages. The user may record variable message lengths. The device saves the phrases or sentences and plays them back using digitized speech. There are three methods to activate messages: direct selection, visual scanning, and auditory scanning.

The ability to load speech files onto a diskette using a disk drive is an available option. The price of DigiVox depends on the length of recording time desired; four and one half, nine, thirteen, or eighteen minutes may be chosen. DigiTalk 1 (see entry) is optional software designed to train beginning individuals in the use of DigiVox.

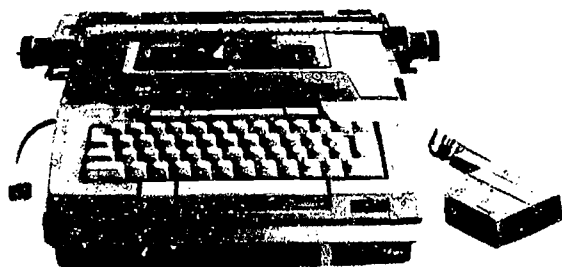

**Product Name:** Dvorak One-Hand Typewriter

**Vendor:** Typewriting Institute for the Handicapped

**Weight:** 49 lbs.

**Power Source:** 120V AC

**Cost:** \$1,595.00

Dvorak One-Hand Typewriter is an IBM Correcting Selectric III with an altered keyboard layout. The layout used is the Dvorak one-hand layout, which distributes the typing load more evenly amongst the fingers of a one-handed typist than does the standard layout.

An optional device called Shift-Easy Bar is available (extra). Shift Easy Bar allows the typist to hold down the shift key with the thumb or palm while leaving the fingers in the home row.

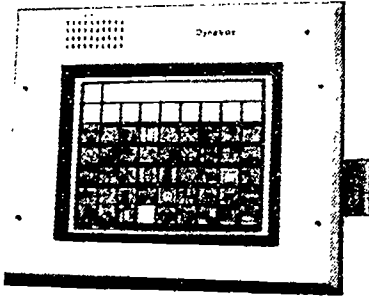

**Product Name:** DynaVox2 & DynaVox2c  
**Vendor:** Sentient Systems Technology, Inc.  
**Size:** 11.75" x 9.5" x 4"  
**Weight:** 6 lbs.  
**Power Source:** Rechargeable battery  
**Cost:** \$4,995.00 - \$7,995.00

DynaVox2 & DynaVox2c (Dynamic Voice Output Communication Aid) are electronic communication aids with changeable touch screen displays. The user can arrange symbols in any manner on the screen choosing from a built-in vocabulary. Symbols can represent one word or phrase; they also can act as "basic category displays" which enable the user to view an entire category by selecting one symbol. Once symbols are depressed on the touch screen they appear at the top of the display in order of choosing. When a pictorial "sentence" of symbols and appropriate text is complete, DynaVox2 "speaks" the message using DECtalk speech. The device has three keys which can be used to edit symbolic selections. Dynavox 2 units are available with either 8 MB or 20 MB memory.

DynaVox2 is a monochrome system and DynaVox2c is a color system.

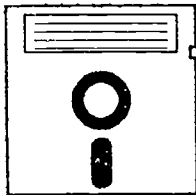

---

**Product Name:** DynaVox2 DOS & DynaVox2 Mac  
**Vendor:** Sentient Systems Technology, Inc.  
**Computer:** Apple Macintosh Family, IBM PC Family  
**Cost:** \$995.00

DynaVox2 DOS and DynaVox2 Mac are software programs designed to allow caretakers to program the DynaVox2 (see entry) without taking away the user's device. The software offers 2,600 symbols, an expanded page layout, "concept-tagged" vocabulary list, concept browser, expanded speech control and capabilities, page browser, user manager, and outcome reports. Once overlays are programmed on the computer screen, they can be saved and downloaded to the DynaVox2.

DynaVox2 DOS requires 4MB RAM and a 386 or higher. DynaVox2 Mac requires 8MB RAM and system 7.0 or higher.

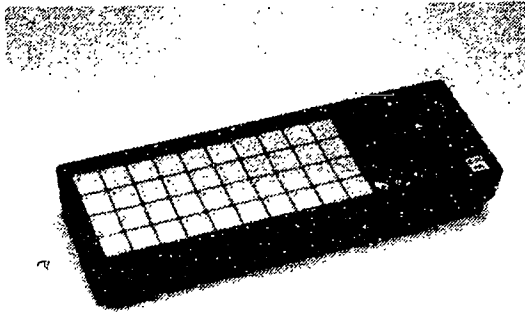

**Product Name:** EasyTalk  
**Vendor:** Great Talking Box Company  
**Size:** 12" x 4.1" x 1.35"  
**Weight:** 2 lbs., 1 oz.  
**Power Source:** Rechargeable batteries  
**Cost:** \$995.00

The EasyTalk is a communication aid that uses digitized recordings to provide voice output. Six software controlled keyboard designs are possible and the same key can hold four messages allowing for a total of 160 messages. With up to 20 minutes of message capacity, each key can record a variable length message. Keyguards guide fingers into correct location and adjustable hold time can tune out unwanted selections. Other standard features include memory protection even if batteries are removed, built-in microphone, and multiple scanning options. The EasyTalk is available in blue, yellow, green, red or black.

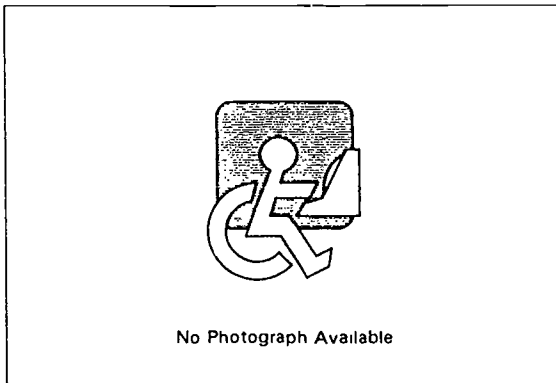

**Product Name:** Electronic Speech Synthesizers  
**Vendor:** National Institute for Rehabilitation Engineering  
**Power Source:** AC or battery  
**Cost:** \$1,240.00 - \$2,850.00

Electronic Speech Synthesizers are keyboard-operated electronic communication devices. The devices generate synthesized speech output; printed output may be generated as well. Available input configurations include: typing the entire word to be spoken, typing abbreviations which are then expanded by the system, and typing phonetic spellings. A variety of configurations are available in size, weight, keyboard, and operating features; contact manufacturer for further information.



**Product Name:** Equalizer

**Vendor:** Words+, Inc.

**Computer:** IBM PC Family

**Manual Form:** Printed Manual

**Cost:** \$1,395.00

Equalizer is augmentative communication software that incorporates several strategies. A user-modifiable stored vocabulary provides up to 2,750 words. The five most frequently used word endings are provided and may be added to stored words to provide different forms. An adaptive word prediction feature "learns" the user's word patterns; after a word is selected, this feature presents the words most likely to then be used. Word processing and voice output capability are built in; a serial port text-to-speech speech synthesizer or SmoothTalker (extra) is required to use voice output. Access may be accomplished by using a single or dual switch, joystick, mouse, trackball, mouse-emulating pointer (all extra) or by using the arrow keys on the keypad of the computer keyboard. Calculator, drawing, music, and game software are included.

Equalizer works with IBM PC and compatible computers, including some portables. Contact manufacturer for information on purchasing a complete system, starting at \$2,935.00, and on environmental control capabilities.



**Product Name:** EvalPAC with RealVoice

**Vendor:** ACS Technologies, Inc.

**Computer:** Apple IIe

**Size:** 14.75" x 8.5" x 1.75"

**Weight:** 8.5 lbs.

**Cost:** \$4,395.00

The EvalPAC is a communication aid that has Adaptive Communication Systems' RealVoice built in. RealVoice is a full-featured, diphone-based voice synthesizer with more natural rhythm and intonation available in either male or female voice. The keyboard may be configured to adjust for user abilities. Additional features include: a text-to-speech capability permitting messages to be typed or selected and spoken or printed; an abbreviation expansion program allowing storage and recall of messages; capability of assigning voice output to single picture selection or picture sequencing of up to 5 symbols; adjustable time delays and volume control; and ability to store programs and vocabulary on tape. Fifteen memory levels are available. Memory capacity is 27,000 characters. The aid can be accessed by direct key, lightpointer, or switch input.

Options include environmental controls, alternative keyboards, and wheelchair mounting systems; contact manufacturer for details.





**Product Name:** Eyegaze Computer System

**Vendor:** LC Technologies, Inc.

**Weight:** 60 - 80 lbs.

**Cost:** \$17,500.00-\$25,000.00

The Eyegaze Computer System is a communication system that is controlled by the use of one eye. Nothing is attached to the user's body. Using a camera and an infrared light source, the computer interprets where the eye is focused on a computer screen. Various options (extra) permit the user to turn on lights and appliances, dial and receive telephone calls, and run IBM DOS-type software.

The Basic System (\$17,500.00) includes Eyegaze tracking software, an applications software package, a 486 DX computer with a manual keyboard, 3.5" floppy disk drive, a 540 MB hard drive, an infrared-sensitive camera, two monitors, a surge protector, a monitor support arm, cables, connections, installation, training, and one year's support. Additional options include a speech synthesizer, Ink Jet Printer, programmable TV/VCR controller, an X-10 Powerhouse appliance controller for lights and appliances (see entry), speaker phone and modem, and a Second Computer Program with a T-TAM Interface to allow control of a second computer. A Transportable System is offered that allows the Eyegaze System to be used at two places with one portable computer. Contact the manufacturer for option pricing details.

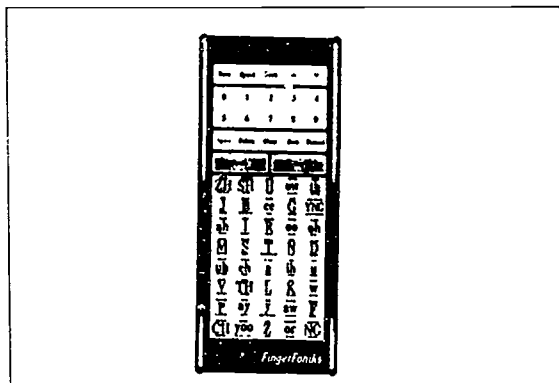

**Product Name:** FingerFoniks

**Vendor:** Words+, Inc.

**Cost:** Contact manufacturer

FingerFoniks is a personal hand-held communication system that produces speech output by selecting phonemes directly from the keyboard and combining them into words and sentences. The user can have the phonemes played as they are selected to approach real-time conversational speech, or the user can store phonetic combinations and play them when the message is complete. An assortment of phonetic symbol sets, long-life rechargeable battery, illustrated user's manual, customizable voice style, and control of key accept time are also standard features of FingerFoniks.

One minute multi-message voice recorder, external interface to keyboard or computer, pitch controller for real-time inflection or singing, and carrying case are optional features.



**Product Name:** Gus! Multimedia Speech System

**Vendor:** Gus Communications, Inc.

**Computer:** IBM PC Family

**Manual Form:** Printed Manual

**Cost:** \$795.00

The Gus! Multimedia Speech System converts any Microsoft Windows compatible computer into a dynamic display augmentative communication system with digitized and synthetic speech. Any page can have 2 to 72 buttons and unlimited layers can be used. Speech can be in male or female voices and in English, French, German, and Spanish. The system also includes a talking keyboard with word prediction, sentence prediction, abbreviation expansion, and speech output: a speak clipboard that provides access to speech output from any Windows program; a home control program (requires X-10 modules, not included); a symbol selector program to add symbols or pictures to the sound buttons; an abbreviation program; and a Gus! Mouse that is also a switch interface.

System requirements include MS-DOS 3.1 or later, Microsoft Windows, 386SX or higher microprocessor, 8 MB of memory, 10 MB of hard disk space, one 3.5" high-density disk drive, VGA graphics card or compatible video and monitor, Microsoft Mouse or compatible, and Windows compatible sound device. A Gus! version of the Mayer-Johnson Symbol Set is available for \$255.00.

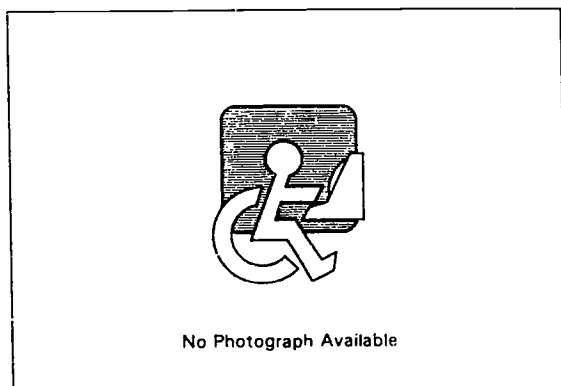

**Product Name:** Handheld Computers and Personal Organizers

**Vendor:** Various (Generic Product)

**Cost:** Varies

Nonvocal individuals may require a simple device for typing messages that are intended to be read, either silently or aloud, by another person. Handheld computers and electronic personal organizers may fulfill this role: they are compact, lightweight, and include a variety of useful features, including ability to store phrases and check spelling. These devices can also be used as note takers for individuals who might have difficulty remembering things or whose handwriting is illegible.

Portable typewriters and handheld computers are available on the mass market in department stores, electronics stores, and bookstores at relatively low cost. Specific sources can be found in local yellow pages, in the manufacturer list of this book, in listings from local rehabilitation service delivery programs, and also often in gift specialty catalogs that carry personal convenience types of devices.

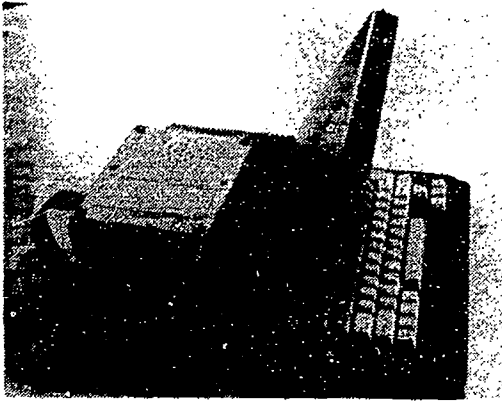

**Product Name:** Handy Speech Communication Aide  
**Vendor:** Consultants for Communication Technology  
**Computer:** IBM PC Family  
**Size:** 8.5" x 11"  
**Weight:** 4 - 6 lbs.  
**Cost:** \$300.00 - \$2,500.00

The Handy Speech Communication Aid is an electronic communication system that requires only basic reading skills and features voice output. The system consists of three components: software for the IBM PC or compatible, a speech synthesizer, and a laptop computer. The software can be customized to each user with onscreen editing. Other features include word prediction, "scanning by blocks", and logical letter coding designed to increase the speed of communication for physically challenged users. The system can be accessed by a keyboard, mouse, joystick, or any single switch.

English and Spanish versions are available. The complete system with the CCT synthesizer costs \$2,500. For MultiVoice add \$550.00. The software alone is \$300.00 and can be used with the CCT synthesizer or with MultiVoice. CCT synthesizer costs \$700.00. The system may be rented; contact manufacturer for details.

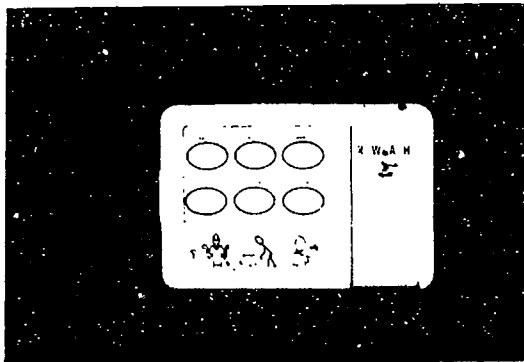

**Product Name:** Hawk  
**Vendor:** Wayne County Regional Education Service Agency  
**Weight:** 2 lbs., 11 oz.  
**Power Source:** Rechargeable batteries  
**Cost:** \$250.00

Hawk is a Voice Output Communication Aid (VOCA) intended for training in early language situations and in specific IEP-related activities. The 7.5" x 7.5" membrane touch panel is divided into nine selection areas. A built-in microphone and simple record procedure facilitates the recording of up to five seconds worth of digital speech into each selection area.

Hawk is equipped with built-in rechargeable batteries and a wall adapter for overnight charging. Under normal usage, the Hawk should go from three to seven days on a single charge.

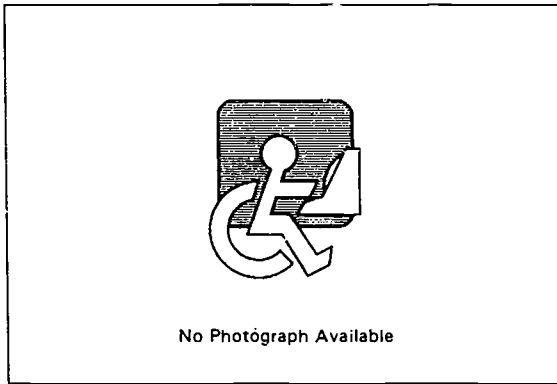

**Product Name:** Heidico Intertalk

**Vendor:** Heidico, Inc.

**Cost:** \$69.95

Heidico Intertalk connects TDDs for direct private communication between hearing and non-hearing people. Up to five TDDs can be connected. Everything typed on one will immediately appear on the others.

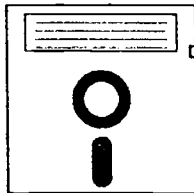

---

**Product Name:** Help U Type and Speak

**Vendor:** World Communications

**Computer:** IBM PC Family, IBM PS/2 Family

**Manual Form:** Printed Manual

**Cost:** \$595.00

Help U Type and Speak is a version of Help U Type (see entry) which also incorporates the ability to have complete sentences spoken via a text to speech converter. These sentences can be stored, or the user can form ad hoc sentences using words from the dictionary.

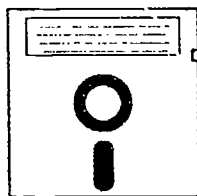

**Product Name:** HyperBliss 3.2

**Vendor:** Blissymbolics Communication International

**Computer:** Appie Macintosh Family

**Cost:** \$100.00

HyperBliss 3.2 is a personalized communication program that enables Blissymbol users to access any currently approved Blissymbol by its component parts. HyperBliss learns the Bliss communication patterns of the user and then offers a prioritized list of potential Blissymbols. Users can choose from their own prioritized list of symbols and any word can be reassigned to the chosen Blissymbol with audio output. Other features include a teaching aid that prepares users for proficient use, an automatic scanning mechanism that facilitates one switch selection, a symbol-library, and desktop facilities to allow printing of symbol charts and Bliss dictionaries.

HyperBliss requires at least 1 MB RAM, a hard disk, and Macintosh. HyperBliss is not yet system 7.0 compatible.

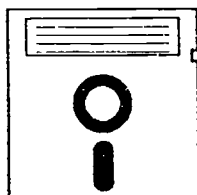

**Product Name:** I Can Speak

**Vendor:** World Communications

**Computer:** IBM PC Family

**Cost:** \$495.00

I Can Speak is a software program designed for augmentative communication with Microsoft Windows. The program combines pictures, text, and sentences. Sixteen groups or boards with 32 items each can be defined. Distinct icons and labels as well as a sentence can be assigned to each item within the main. The associated sentence is spoken by selecting that item through multiple access methods such as mouse, trackball, and scanning with single switch or cursor keys. A library of 500 Mayer-Johnson PCS symbols is also available.

System requirements include: IBM PC running Windows, 4 MB free disk space, and an external text-to-speech synthesizer such as RealVoice or DecTalk.



**Product Name:** IntelliTalk

**Vendor:** IntelliTools, Inc.

**Computer:** Apple II Family,  
Apple Macintosh Family, IBM PC Family

**Manual Form:** Printed Manual

**Cost:** \$39.95

IntelliTalk is a software program for writing and communication with voice output. The program will speak text as it is typed, review a piece of text in voice, change type size (and font, on the Macintosh version), save text and print text. The program can also be used with IntelliKeys and IntelliKeys Overlay Maker (see entries) to make voice-output communication boards.

The Macintosh version allows the user to choose from among 10 MacinTalk2 voices and comes with a built-in pronunciation editor. The IBM PC version is specifically designed for users who can't see the screen easily and works with popular sound cards including the Sound Blaster and Echo PCII. The Apple II version has all of the same features and works with the Echo speech synthesizer.

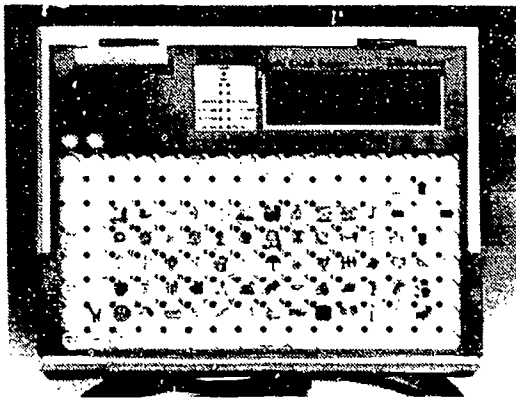

**Product Name:** Liberator

**Vendor:** Prentke Romich Company

**Computer:** Apple II Family,  
Apple Macintosh Family, IBM PC Family,  
IBM PS/2 Family

**Size:** 13.75" x 10.38" x 3.75"

**Weight:** 7.8 lbs.

**Cost:** \$7,345.00 - \$8,575.00

The Liberator is a portable, electronic communication device with 512K of memory. This product uses Minspeak so that symbols are used to represent words, sentences, or phrases. The user can select any symbol or set of symbols by pressing the keys with the appropriate icons on the Liberator's keyboard. An optional infrared pointer (extra) can also be used to select symbols. Selected words and sentences will be "spoken" using DECTalk speech; ten different age and gender appropriate voices can be chosen. Words are also shown on the 8-line back-lit display screen and can be printed on the built-in printer or an external printer. The device also features icon prediction; when an icon is selected, those icons that follow in established sequences light up. Direct Action software and the DiRECTOR allows the Liberator to become an environmental control system. Other features include: built-in calculator, scratch pad, notebooks, Minserts, and a built-in speech dictionary.

The Liberator consists of Minspeak software, DECTalk speech, printer, keyguard, battery charger, 7 overlays, icon sticker sheets, operator manuals, quick reference guide, and three vouchers for training.

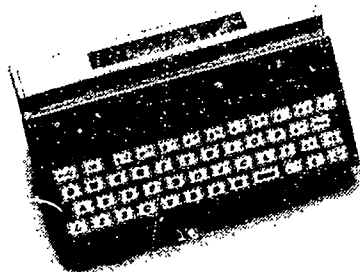

**Product Name:** LightWRITER SL35

**Vendor:** Zygo Industries, Inc.

**Size:** 8.43" x 5.13" x 2"

**Weight:** 1 lb. 12 oz.

**Power Source:** Rechargeable batteries

**Cost:** \$2,175.00

LightWRITER SL35 is a portable dual-display communication aid with optional speech output. The user types messages on the device's keyboard, and the messages appear on two displays: one facing the user and one facing the person being communicated with. The device has 7K of internal memory which can be used for abbreviation expansion: the user can type short abbreviations and the LightWRITER will display a full phrase. Two types of keyboard are available: a membrane type or raised rubber keys. Two keyboard layouts are also available: QWERTY or ABCDE. The LightWRITER SL35 is available with or without a built-in Dectalk speech synthesizer (the option is \$1,595.00), and it can also drive an external speech synthesizer or a printer through its serial port. Four male, four female, and one child voices are offered.

Options include keyguard, carrying pouch, backlighted displays, remote displays, external speakers, and plug-in scan module.

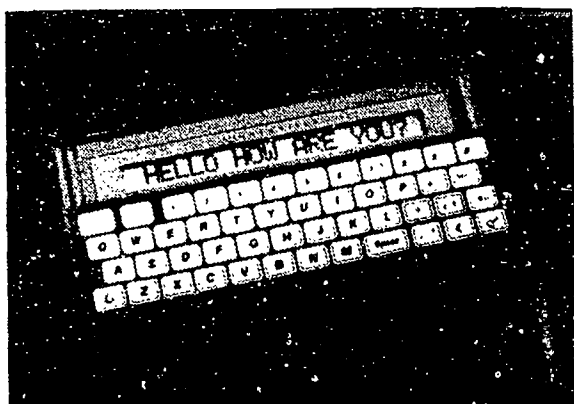

**Product Name:** LightWRITER SL5

**Vendor:** Zygo Industries, Inc.

**Power Source:** Rechargeable batteries

**Cost:** \$895.00

LightWRITER SL5 is a portable dual-display communication aid. The user generates messages by typing on the device's keyboard, and messages appear on two displays: one facing the user and one facing the person being communicated with. Messages can be typed one letter at a time, or up to 36 messages can be stored and then recalled by pressing the "mem" key and then a particular letter. There is a choice of keyboard type: either flat membrane or raised rubber keys. There is also a choice of keyboard layout: either QWERTY or ABCDE. Keyguard is available as an option. Backlighted displays are also available.

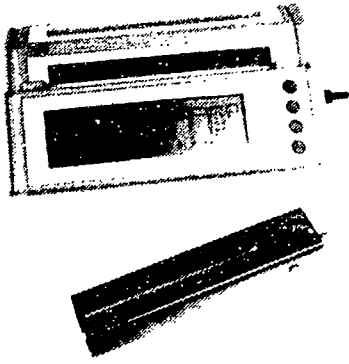

**Product Name:** LightWRITER SL85  
**Vendor:** Zygo Industries, Inc.  
**Size:** 8.43" x 5.12" x 2"  
**Weight:** 1 lb. 12 oz.  
**Power Source:** Rechargeable batteries  
**Cost:** \$2,595.00

LightWRITER SL85 is a portable dual-display communication aid that uses switch input. The user composes messages by selecting letters with single-switch scanning. Messages appear on two displays: one facing the user and one facing the person being communicated with. Messages can also be spoken by an optional internal speech synthesizer (\$1,595.00). The device has 7K of memory for abbreviation expansion. The SL85 displays the full alphabet in an array, and the user selects by row-column scanning. The SL85 comes with two low-force click switches, but any switches can be used. External keyboards for direct access and backlit displays are standard features.

Options include carrying bag, remote display, and wheelchair mounting systems.

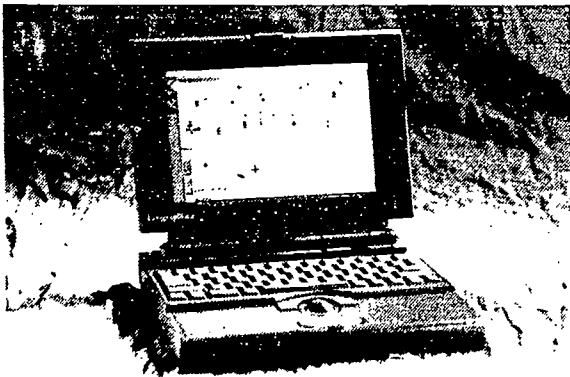

**Product Name:** Lingraphica  
**Vendor:** Tolfa Corporation  
**Weight:** 5.75 lbs.  
**Power Source:** Rechargeable battery  
**Cost:** \$6,450.00

Lingraphica resides in a laptop computer. The device is a communication aide designed to help persons with severe aphasia. The user selects from among 2,000 pictures by using a trackball. Pictorial selections result in animation, text, and sound. Once messages are composed, they can be saved and retrieved. All pictures can be customized easily.

Lingraphica is available to patients, hospitals, and clinics for \$6,450.00. Individuals who wish to purchase the aide have to obtain a physician's prescription to do so. Contact the manufacturer for ordering information. The device can also be rented or leased.



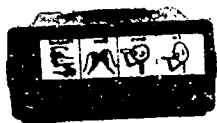

**Product Name:** Lynx

**Vendor:** Wayne County Regional Education Service Agency

**Power Source:** Rechargeable batteries

**Connector Type:** 1/8" jack

**Cost:** \$250.00

Lynx is a Voice Output Communication Aid (VOCA) designed for a variety of functions. The four digitized voice messages of up to four seconds each can be programmed by speaking into the integrated microphone and quickly changed for specific occasions. Activation is through snap-action membrane switches on the front panel, with provision for inserting a 1" x 1.5" symbol over each key.

Lynx was designed with a compact size for use as a portable communication aid for ambulatory students in school-context tasks and community-based interactions. Four jacks are included to allow a single switch to be paired with each message for use as a table-top device for low cognitive students. In addition, each switch has a corresponding relay output for attachment to a switch-adapted toy or appliance. Lynx can also be put into scanning mode for physically impaired students with feedback provided by red LED lamps paired with the symbol overlay. For assessing and training, Lynx's visual scanning can be enhanced with auditory scanning.

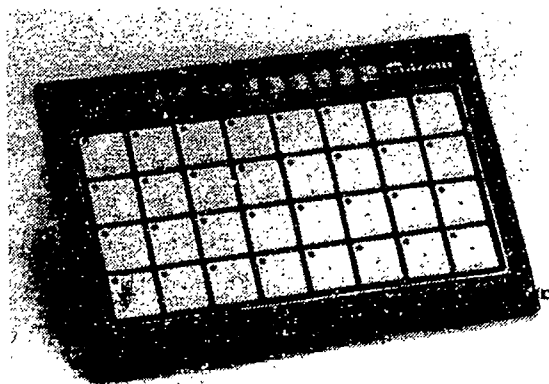

**Product Name:** Macaw Series

**Vendor:** Zygo Industries, Inc.

**Size:** 11.5" x 7.75" x 2.5"

**Weight:** 2.5 lbs.

**Power Source:** Rechargeable batteries

**Cost:** \$1,245.00 - \$4,995.00

The MACAW series of portable communication aids uses digital recording and playback. Messages may be accessed either directly through the keyboard or by using visual and/or auditory scanning with external switches. The standard keyboard configurations are 32-keys or 128-keys and either can be configured to as few as one large key. The keys may contain individual messages and may be key-linked for more. Units vary to include as many as 32 levels for individual and/or key-linked messages, and internal hard-disks to contain over 13 hours of recording time. Controllable features include quick copying of recorded messages from key to key, and Key-Link which permits up to 80 sequential selections to determine spoken messages.

Options include memory modules, keyguards, enlarged-key keyboards, full color key labels, and mounting systems. Contact manufacturer for further information.

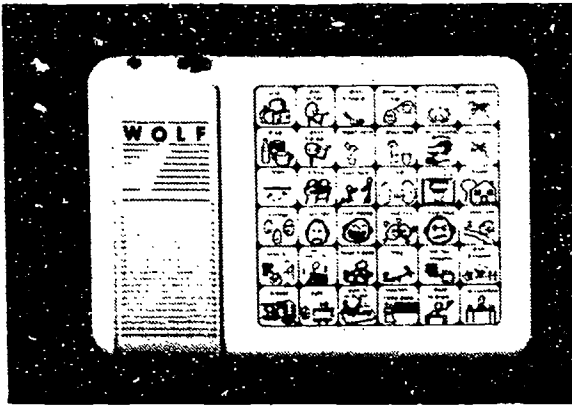

**Product Name:** MegaWolf

**Vendor:** Wayne County Regional Education Service Agency

**Size:** 14.5" x 10" x 1.75"

**Weight:** 2 lbs.

**Power Source:** Rechargeable batteries

**Cost:** \$400.00

MegaWolf is a portable communication aid with synthesized voice output. The user presses touch sensitive keys on the surface to make selections. Four memory sections are provided for the storage of words and phrases. The Fixed Section, which has a maximum capacity of 500 words organizable into up to 36 levels, is programmed by the manufacturer either per user custom specifications or with WOLF Curriculum Activity Packages (WOLFCAPS). The User Section has a capacity of approximately 800 words, organizable into as many as 36 levels, and is programmable by the user via either a 400-word "dictionary" of preprogrammed entries or a "phoneme page." The two additional memory sections can be left blank for extra User Sections or used as extra Fixed Sections with additional programmed vocabulary (WOLFCAPS).

Additional WOLFCAPS are \$30.00 each. The optional WolfKey is also available for \$345.00 to allow MegaWolf users to have access to computer software written for a variety of input modes. An auditory scanning version of the Wolf (Whisper Wolf) and a switch operated version (A.I.P.S. Wolf) are also available (see separate entries).



**Product Name:** MessageMate 20

**Vendor:** Words+, Inc.

**Size:** 11.74" x 3" x 1.25"

**Weight:** 1.5 lbs.

**Power Source:** Rechargeable battery

**Cost:** \$499.00

MessageMate 20 is a voice output communication aid with digitized speech output. The user selects a message by pressing one of the 3/4" squares on the surface of the device or by scanning with a single switch. There is no ability to type unique phrases and have them spoken (text-to-speech). Scanning can be done in a linear fashion or row-column, with one or two switches. Scan rate can be adjusted from 1/4th of a second to 8 seconds per step and there is a choice of four different accept times (time a choice must be held before the device accepts it). Scanning can be silent or accompanied by an audible click.

The 20-key models are available with 20 seconds, 40 seconds, 60 seconds or 120 seconds of total message time. Keyguard, carrying case, and message stickers are options.

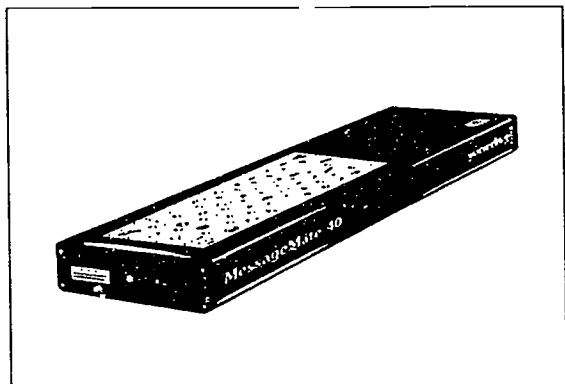

**Product Name:** MessageMate 40  
**Vendor:** Words+, Inc.  
**Size:** 11.75" x 4" x 1.25"  
**Power Source:** Rechargeable batteries  
**Cost:** Contact manufacturer

MessageMate 40 is a voice output communication aid with digitized speech output. The user selects a message by pressing one of the 3/4" squares on the surface of the device or by scanning with a single switch. There is no ability to type unique phrases and have them spoken. Scanning can be done in a linear fashion or row-column, with one or two switches. Scan rate can be adjusted from 1/4th of a second to 8 seconds per step and there is a choice of four different accept times (time a choice must be held before the device accepts it). In addition, the scanning LEDs are inside the area of each key rather than next to it.

The 40 key models are available with 60, 120, or 240 seconds of message time. Keyguard, carrying case, and message stickers are options.

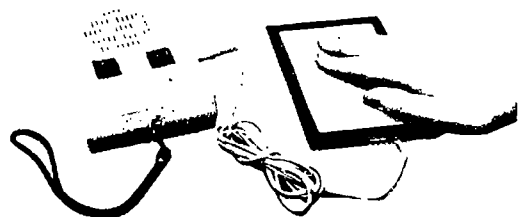

**Product Name:** Messenger  
**Vendor:** Crestwood Company  
**Size:** 5" x 4" x 1.5"  
**Weight:** 6 oz.  
**Power Source:** 9V battery  
**Connector Type:** 1/8" phone jack  
**Cost:** \$92.95

The Messenger is a portable communication and training aid that enables nonverbal children and adults to carry a message up to 20 seconds long with them. The message is easy to change and can reprogram instantly. The Messenger comes adapted for switch use but can be used without a switch as well.

The Messenger alone costs \$92.95. The Messenger with a Jumbo Plate Switch (see entry) costs \$154.95.

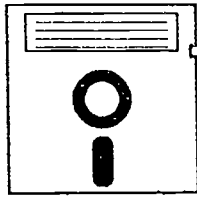

**Product Name:** Meta4

**Vendor:** Consultants for Communication Technology

**Computer:** IBM PC Family

**Manual Form:** Printed Manual

**Cost:** \$495.00

Meta4 is augmentative communication software that turns any PC into a personalized conversation tool. Meta4 is designed for individuals with perceptual and/or physical difficulties in addition to severe speech impairments. The program accepts input from a joystick, touch tablet, single switch, mouse, mouse emulator and others. Output is to a speech synthesizer or printer. The flexible page display can be manipulated to customize for a wide range of abilities.



**Product Name:** Mini Talking Card Reader

**Vendor:** Crestwood Company

**Size:** 6" x 5" x 2"

**Weight:** 14 oz.

**Power Source:** 4 "AA" batteries

**Cost:** \$69.95

Mini Talking Card Reader is a hand-held device that records and plays back strips of audio tape attached to cards. Audio tape with adhesive backing is placed on a card, photo, etc. The card is then placed in a slot of the Reader, which can either record or play back the tape's contents. Two seconds of sound fit on each inch of applied tape. Applications include answering the phone (introductory and emergency messages), relaying a small set of messages, calling for help, and as a therapy tool to help improve auditory, pre-reading, language, and speech skills.

The cost includes one Talking Card Reader, 180 inches of Talk Tape, 25 blank cards, and 4 AA batteries. Additional Talk Tape is available in 500 inch lengths at \$13.95, extra cards are available in a package of 50 at \$9.95, and a vinyl case is available for \$9.95.

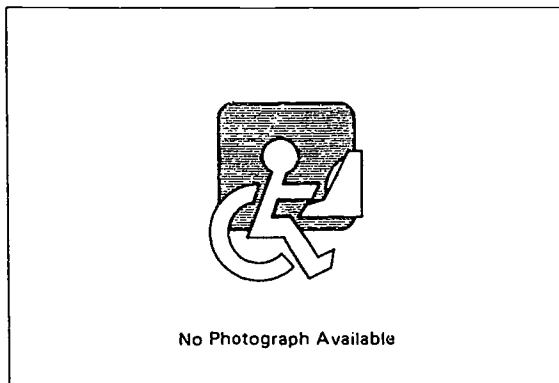

**Product Name:** Mini-MessageMate

**Vendor:** Words+, Inc.

**Cost:** \$299.00 - \$349.00

Mini-MessageMate is a hand-held communication device with digital speech output. Eight messages can be recorded and played back by pressing the corresponding symbol on the device or through eight external single switches.

Two models are available: Mini-MessageMate 8/16 (\$299.00) has two seconds of record time per key for a total of 16 seconds. Mini-MessageMate 8/48 (\$349.00) has six seconds of record time per key for a total of 48 seconds.



**Product Name:** Parrot

**Vendor:** Zygo Industries, Inc.

**Size:** 5.25" x 4" x 1.5"

**Weight:** 13 oz.

**Power Source:** Rechargeable batteries

**Cost:** \$750.00 - \$850.00

The Zygo Parrot is a communication aid that uses digitized recordings to provide voice output. The recorder/playback unit has enough recording time for 16 brief messages. A built-in microphone and neckstrap are provided.

The basic Parrot is priced at \$750.00. The Parrot-JK, which sells for \$850.00, provides for external connection to individual switches or scanning systems.

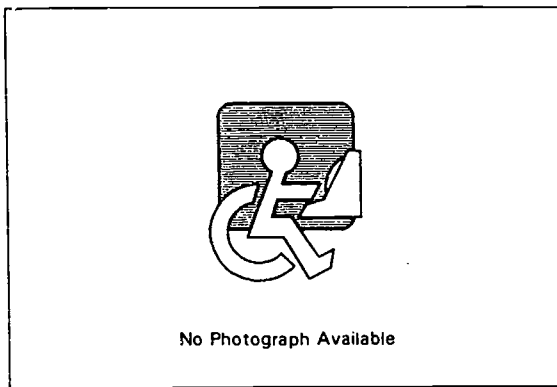
**Product Name:** Pegasus**Vendor:** Words+, Inc.**Size:** 12" x 13" x 5"**Weight:** 11 - 12 lbs.**Cost:** \$7,995.00

Pegasus is a computer-based, integrated augmentative communication system with speech output through a built-in DECTalk synthesizer. The device features a dynamic 256-color LCD display, a built-in TouchWindow, CD-quality stereo sound, infrared environmental control, a 486/66 MHz processor, 256K cache memory for extra speed, 8MB of RAM, 350MB hard disk, CD-ROM drive, Microsoft Windows 3.1 capabilities, external keyboard, and an external floppy disk drive. When combined with Talking Screen for Windows (see entry), Pegasus provides color photographs, stereo sound, and full-motion video with sound. Thousands of color symbols, including Mayer-Johnson's, Blissymbols, and Imaginart's, can be accessed and custom symbols or photographs can be imported.

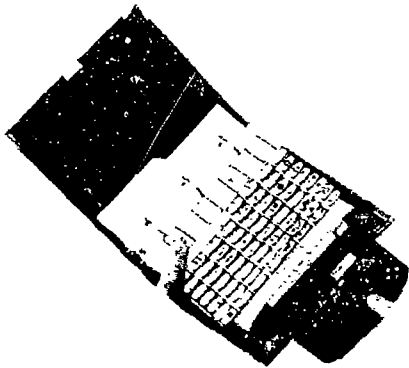
**Product Name:** Personal Trainer**Vendor:** TIGER Communication System, Inc.**Size:** 9" x 8" x 2"**Weight:** 4 lbs.**Power Source:** 4 "AAA" batteries or AC**Cost:** \$150.00

The Personal Trainer combines a picture communication book with a voice output keyboard. TIGER Communication System's PEACEbook picture binder comprises 64 color-coded laminated pages with line drawings and upper-case captions. The Bookman MWS-840 compact electronic voice output keyboard by Franklin Electronic Publishers provides single-word voice output. The MWS-840 fits inside the Peacebook by means of a flexible hinge which allows it to fold out for use and in for protected portability. Close proximity between the pictures' captions and the keyboard itself encourage the user to develop spelling skills. The user refers to the caption and types in the word letter-by-letter followed by voice output from the MWS-840. The MWS-840 does not need specialized Bookman cartridges.

A keyguard for the MWS-840 is available from TIGER Communication Systems, Inc.

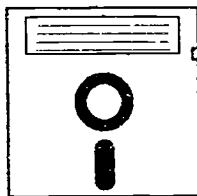

**Product Name:** Picture Icon X-CHANGE

**Vendor:** Academic Software, Inc.

**Computer:** Apple IIGS, Apple IIe

**Manual Form:** Printed Manual

**Cost:** \$40.00

Picture Icon X-CHANGE is a utility program that provides access to thousands of picture icons in sizes and formats needed by authoring programs such as AppleWorks GS, HyperCard GS, HyperStudio, LessonMaker (Edmark), PowerPad Toolkit (Dunamis), TutorTech (Techware), Worksheet Generator and Breakthrough to Writing (both Creative Learning), and other similar software packages. Picture icons are stored in specially-formatted picture libraries which are sold separately. Graphics can be selected from a library and viewed individually in full-size or in groups; then resized and/or inverted and saved automatically on disk in a variety of formats and resolutions.

Picture Icon X-CHANGE requires at least one graphic library and a system with two 5-1/4" disk drives, a combination of 3-1/2" and 5-1/4" disk drives, or a hard disk.

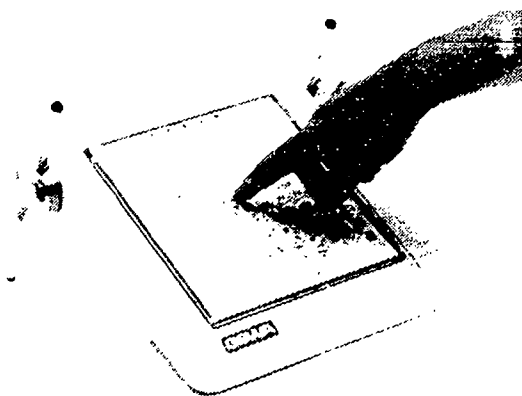

**Product Name:** Polycom

**Vendor:** Zygo Industries, Inc.

**Cost:** \$2,995.00 - \$6,495.00

Polycom is battery-operated electronic communication aid which has simple word processing functions and telecommunication capabilities. The device has a keyboard which requires only one hand for input. A display screen, which has five lines and can show up to 100 characters simultaneously, allows the user to make choices from a menu. Polycom can act as a simple word processor and as an electric writing pad. The device has a phrase memory which stores short phrases and sentences which can be recalled using two keys. By using a coupling device (extra), Polycom can be used as a portable text telephone, sending communications over push button telephones and computers.

Prices vary according to equipment options: Polycom alone costs \$2,995.00; with Polytalk and American English the price is \$5,995.00; with Polytalk, American English, and one other language the cost is \$6,495.00.

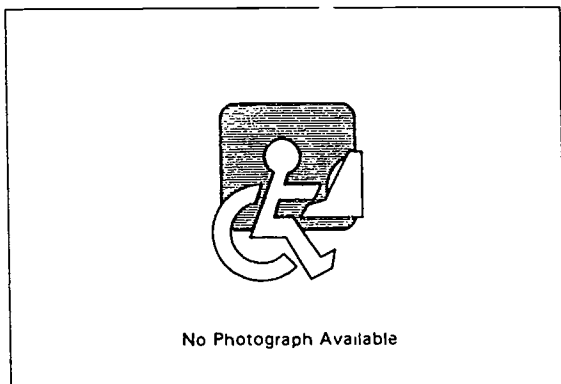

**Product Name:** ReadyScan

**Vendor:** SPECTECH

**Cost:** Contact manufacturer

ReadyScan is a portable input device that allows the user to type, save, edit, and retrieve documents through any single switch. The user scans the alphabet and selects letters to compose messages. Up to 10 pages of text, or 8K, can be stored. The device features a four line, 40 character display and can be connected to a printer.

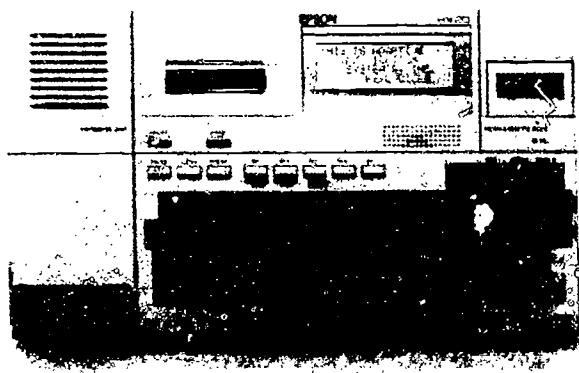

**Product Name:** RealVoice

**Vendor:** ACS Technologies, Inc.

**Size:** 14.75" x 8.5" x 1.75"

**Weight:** 6 lbs.

**Power Source:** Rechargeable batteries

**Cost:** \$3,295.00

The RealVoice is a portable communication aid. Built into the RealVoice aid is a full-featured, diphone-based speech synthesizer with natural-sounding rhythm and intonation available in either male or female voice. Additional features include: a text-to-speech capability permitting messages to be typed and spoken or printed; an abbreviation expansion program allowing storage and recall of messages; adjustable time delays and volume control; and ability to store programs and vocabulary on tape. The memory capacity is 27,000 characters.

Options include environmental controls, Memkey alternative keyboards, and wheelchair mounting systems; contact manufacturer for details.



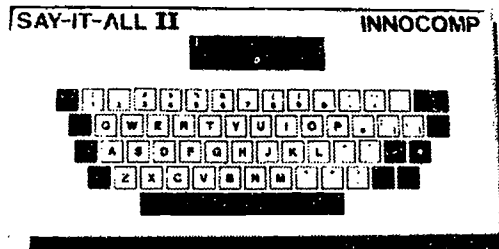

**Product Name:** Say-It-All II Plus

**Vendor:** Innocomp

**Size:** 15" x 7" x 1.5"

**Weight:** 2.25 lbs.

**Power Source:** Rechargeable battery

**Cost:** \$1,995.00

Say-It-All II Plus is a portable communication aid with synthesized voice output. The user types words or phrases on the Say-It-All's membrane keyboard. These words or phrases are then converted to correct English phonetic pronunciation and spoken by a built-in speech synthesizer. The user can change the pitch of the voice from low to high. Messages can be sent to a printer or computer via a built-in RS232 serial port. The surface of the keyboard is flat, seamless and moisture-proof. Up to 846 whole words or phrases may be stored and recalled. The user stores phrases by spelling them out, and recalls them by pressing a few keys. Overlays containing words, symbols or pictures can be created and placed on the keyboard to show the location of vocabulary items. MSL II software (included) allows phrases to be stored on levels or pages.

The Say-It-All II Plus includes manual, battery charger, liquid crystal display, nine overlays, and Touch 'N Talk Micro Communication Stickers. Options include a keyguard, overlays and stickers, external printer, Clarity male/female speech synthesizer, IBM-compatible Voc-Load software, and CARE software with abbreviation expansion, semantic compaction, and logical letter coding capabilities.

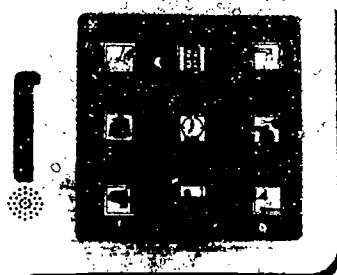

**Product Name:** Say-It-Simply Plus

**Vendor:** Innocomp

**Size:** 19" x 17" x 1.5"

**Weight:** Under 5 lbs.

**Power Source:** Rechargeable battery

**Cost:** \$1,995.00

Say-It-Simply Plus is a portable communication aid with synthesized voice output and a user-definable keyboard area. The keyboard of the Say-It-Simply is a 12" x 12" membrane surface. The user can define how many areas this keyboard is divided into, from one to 144 areas. Particular vocabulary can be programmed for each area. When that area is pressed, the programmed word or phrase is spoken by a built-in speech synthesizer. Multiple vocabularies (up to 28) can be created and stored, with a total capacity of 762 words or phrases. Overlays can be created for different vocabulary sets. The voice pitch may be changed from low to high. MSL II software (included) permits phrases to be stored in levels. A built-in RS 232 serial port allows the device to be attached to a printer or computer.

Say-It-Simply Plus includes a manual, battery charger, instructional overlay with attached frame, set of five overlays, and Pick 'N Stick Color Pack Communication Stickers (see entry). Options include keyguards, additional overlays, overlays with frames, and stickers, an external printer, and Clarity - a speech synthesizer that permits choice of male and female. Say-It-Simply Plus can be purchased with DECtalk for \$3,495.00.

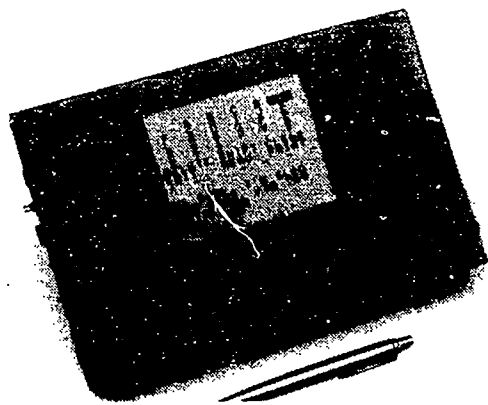

**Product Name:** Scan Com  
**Vendor:** Med Labs, Inc.  
**Size:** 9.5" x 6.3" x 1.5"  
**Weight:** 1.5 lbs.  
**Power Source:** 120V AC  
**Cost:** \$1,600.00 - \$2,620.00

Scan Com is a device which uses single switch input to type messages on television screens or computer monitors. The device automatically scans its main menu on-screen until the user activates a single switch device (extra) to select the desired menu item when it is highlighted. The screen then displays a sub-menu. Sub-menus can scan three types of items: previously stored messages, an alphabet board to "type" a new message, and commands which allow the user to go to another menu, edit, store, recall a message, and control system functions like scan rate. The unit can also decode Morse Code messages. English or Spanish languages are selectable.

Scan Com accepts a variety of single switch input devices including breath control, tilt, and bite-or-puff. There are four available models: Scan Com-B (basic), Scan Com-P (portable), Scan Com-S (speech), and Scan Com-PS (portable and speech). With optional Environmental and Entertainment Control, Scan Com can turn on and off AC powered lamps, fans, etc. and fully control a TV and VCR. The starting price for Scan Com is \$1,160.00, contact the manufacturer for further price information.

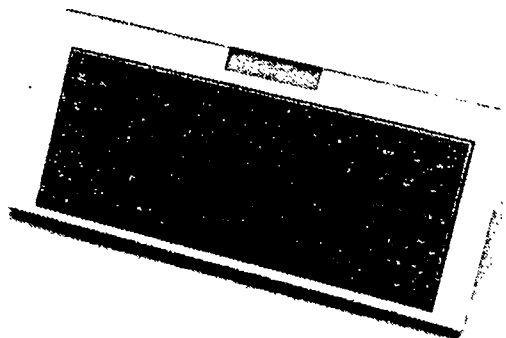

**Product Name:** Scan-It-All  
**Vendor:** Innocomp  
**Size:** 19" x 9.25" x 2.38"  
**Weight:** Under 5 lbs.  
**Power Source:** Rechargeable batteries  
**Cost:** \$3,495.00

Scan-It-All is an electronic communication aid with voice output. The device accepts most single switches and allows for several scanning modes including vertical or horizontal element scanning, row-column scanning, column-row scanning, and segment scanning. The surface of the aid is divided into one inch squares which have lights on all four corners; the lights provide the user with visual feedback during scanning. Once the user has made a selection, the selected phrase is "spoken" using Clarity Speech; it also appears in a small liquid crystal display at the top of the device. Scanning speed is adjustable. Scan-It-All can be used with a head pointed laser beam for direct selection as well. The device features an automatic turn off timer which can be set for one to sixty minutes.

Scan-It-All includes keyboard for direct select programming, laser light pointer, set of eight overlays, Imaginart Touch 'n Talk micros, charger, and manual. Software which allows storage of up to 800 phrases in Scan-It-All is included.

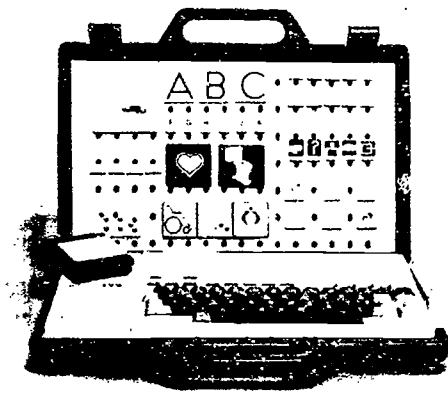

**Product Name:** ScanPAC

**Vendor:** ACS Technologies, Inc.

**Size:** 14.75" x 8.5" x 1.75"

**Weight:** 8.5 lbs.

**Power Source:** Rechargeable batteries

**Cost:** \$3,995.00

The ScanPAC is a portable communication aid. Built in to the ScanPAC is Adaptive Communication Systems' RealVoice, a full-featured, diphthone-based voice synthesizer with more natural rhythm and intonation available in either male or female voice. The keyboard may be configured to adjust for user abilities. Additional features include a text-to-speech capability permitting messages to be typed or selected and spoken or printed, an abbreviation expansion program allowing storage and recall of messages, and capability of assigning voice output to single picture selection or picture sequencing of up to 5 symbols. Fifteen memory levels are available. Storage capability is 27,000 characters and activated through direct key or switch input.

Options include environmental controls, alternative keyboards, and wheelchair mounting systems; contact manufacturer for details.

---

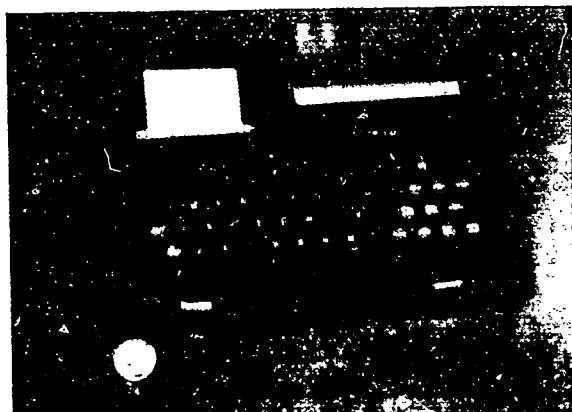

**Product Name:** Scribe

**Vendor:** Zygo Industries, Inc.

**Size:** 9.63" x 6" x 1.88"

**Weight:** 28 oz.

**Power Source:** Rechargeable batteries

**Cost:** \$1,450.00

Scribe (formerly Q.E.D. Scribe) is a communication aid with printed output. The user types messages on the device's alphanumeric keyboard. The message appears on a 24-character LCD display, and once the message is composed it can be printed on the built-in printer. Messages can be up to 240 characters long before they are printed. The user can store up to 26 messages of up to 55 characters apiece. A stored message can be recalled by pressing two keys. Both upper and lower case letters can be typed and printed. The keyboard has a membrane surface with built-in keyguard, and pressing the keys produces audible feedback. The on and off switches are also keys. The Scribe has a timed automatic shut-off feature.

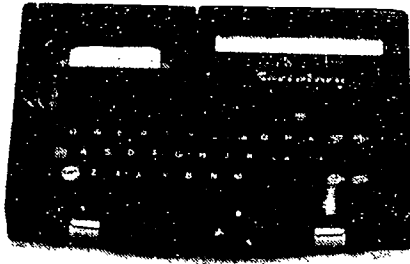

**Product Name:** Secretary

**Vendor:** Zygo Industries, Inc.

**Size:** 9.63" x 6" x 1.88"

**Weight:** 2 lbs.

**Power Source:** Rechargeable batteries

**Cost:** \$2,295.00

Secretary is a portable writing-talking communication aid. The aid has digitized recording capabilities plus text writing and message storing capabilities. The speech recorder/playback unit is able to store up to 10 brief messages. The keyboard is available with American, British, or Swedish characters; optional versions are available with keyboards for other languages. A microphone is built in; connections are provided for use of external microphones and speakers. The membrane keypad is color coded and has a keyguard. A carrying handle is included.

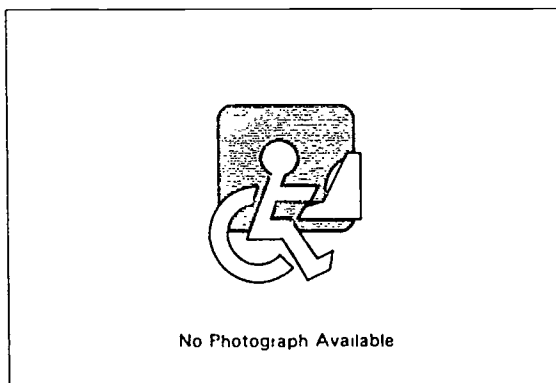

**Product Name:** Shadow Talker

**Vendor:** Toys for Special Children, Inc.

**Cost:** \$110.00

The Shadow Talker is a communication aid for a user who has difficulty activating devices by pressing. Any body movement that creates a shadow over one of the four stations will activate a pre-recorded message of up to five seconds. Each station has a slot to accommodate pictures or words that correspond to the message.

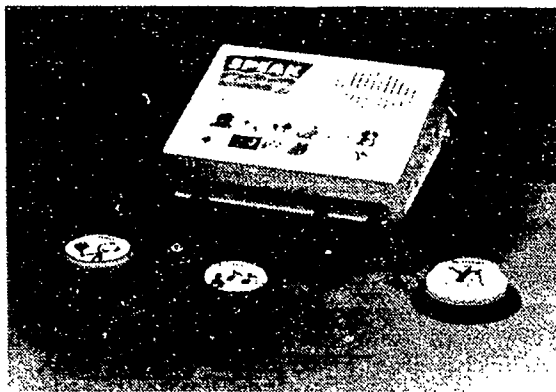

**Product Name:** SpeakEasy

**Vendor:** AbleNet, Inc.

**Size:** 8" x 6" x 3"

**Weight:** Under 3 lbs.

**Power Source:** Battery or AC

**Cost:** \$365.00

SpeakEasy is an augmentative voice output communication aid that can store and playback recorded messages. Up to twelve messages may be recorded on the device's digital sound chip. These messages are retrieved by pressing the corresponding symbol on the twelve-key membrane keyboard that is built-in to the device. Symbols may be changed in accordance with message changes. Stored messages may also be retrieved through single switch input; there are twelve switch input jacks to correspond with the stored messages and the membrane keys.

SpeakEasy is splash-resistant and comes with a detachable shoulder strap. The aid uses either built-in battery or AC adapter (both included).

---

**Product Name:** Speaking Dynamically

**Vendor:** Mayer-Johnson Company

**Computer:** Apple Macintosh Family

**Cost:** \$299.00

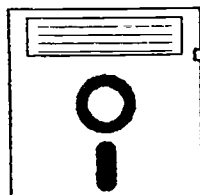

Speaking Dynamically is a software program for making customized, multi-level, picture or word communication boards with speech output. Speech output is provided by using recorded speech, Macintalk, MultiVoice, or the Infovox (speech synthesizers). The user designs the activities and decides what actions will happen when a picture is selected. Selecting a picture can make it talk, change screens, or talk and change screens. The final result is a dynamic changing display of multiple screens. A picture may be selected using many different access methods. Using the Speaking Dynamically program in conjunction with Boardmaker (see entry) program provides access to the Picture Communication Symbols in the PCS books I, II, and III. For text users, Speaking Dynamically also utilizes on screen keyboards, word prediction, and abbreviation expansion.

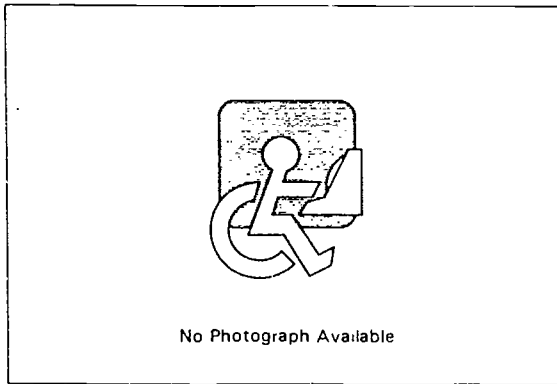

**Product Name:** Specialist

**Vendor:** TIGER Communication System, Inc.

**Size:** Book: 9" x 8" x 2"; keyboard: 6" x 5.5" x .75"

**Cost:** \$585.00

The Specialist is a picture communication book with a fold-out electronic voice output keyboard. The book is a three-ring binder with 66 laminated pages of color-coded symbols with corresponding words. The pages themselves, which can be removed from the binder, can be used as a direct communication aid. The fold-out keyboard (the Franklin LM 6000-SE) can also be used for communication: it produces sentence-length digitized speech with a set vocabulary (110,000 words) and also allows unique messages to be typed and then spoken with synthesized speech. The device can also read words aloud, spell words aloud and pronounce words syllable by syllable. Up to 26 unique messages can be pre-stored for quick speech. The device displays messages in large print (1/4" inch high) on its screen. Menu options allow tailoring of character display and voice output to meet individual needs.

The voice-output keyboard device is also available separately for \$490.00. An optional keyguard costs \$30.00, a keyboard pouch costs \$25.00, and a portable binder costs \$30.00.

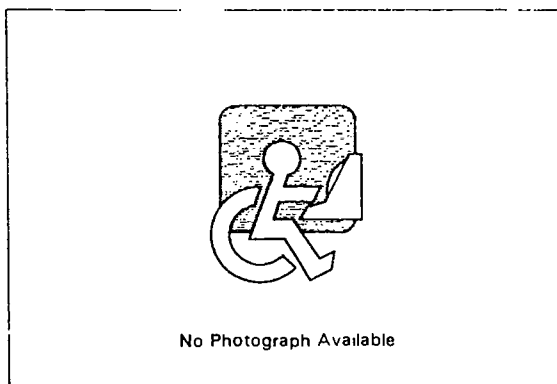

**Product Name:** Switch Module

**Vendor:** Toys for Special Children, Inc.

**Connector Type:** 1/4" or 1/8" phone jacks

**Cost:** \$45.00 - \$100.00

Switch Module is a self-contained 20 second recorder-talker that accepts switches to activate the messages. Either four or eight messages are available.

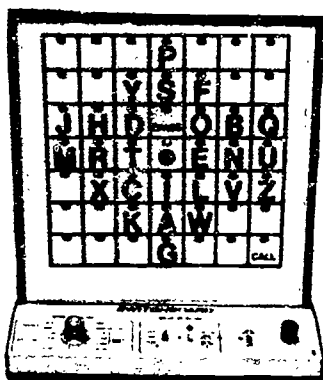

**Product Name:** Switchboard  
**Vendor:** Zygo Industries, Inc.  
**Size:** 17" x 16" x 8"  
**Weight:** 4 lbs.  
**Power Source:** 120V AC  
**Cost:** \$1,745.00

Switchboard is a row-and-column scanning communication aid that can be configured with 4, 12, 16, 28, or 49 positions. Selections can be made in the four-position configuration by direct selection using four switches. Automatic and manual scanning work in 4, 12, 16, and 28 positions. Row-and-column scanning and directed scanning work in the 49-position mode exclusively. Automatic scanning can use one or two switches (forward or backward) and has a rate adjustable from 0 to 42 seconds to over a minute. In manual scanning, two switches are used to move the light forward or backward one position at a time; a third switch indicates selection. In row-and-column scanning, a single switch is used to scan row, then column, then selection. In cursor control, the user can scan in either of two directions (with two switches) or in any of four directions (with four switches or a joystick). The user can also scan in a circular pattern, in automatic and manual scanning modes only.

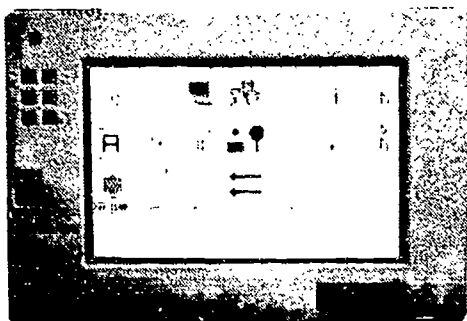

**Product Name:** System 2000  
**Vendor:** Words+, Inc.  
**Size:** 12.4" x 8.6" x 1.6"  
**Weight:** 6 lbs. 7.5 lbs.  
**Power Source:** rechargeable battery  
**Cost:** \$4,995.00 - \$6,995.00

System 2000 is a portable electronic communication aid with a changeable display touch screen. The device displays words or picture symbols on its screen and the user touches the desired symbol to communicate a message. Messages can also be selected with switches, using scanning or Morse code. System 2000 can speak with a synthesized voice (allowing unique messages to be spelled out and spoken) and digitized speech (allowing words or sounds to be recorded and then played back). System 2000 can be used with "Talking Screen" software, which presents sets of picture/word vocabulary choices on the screen. Levels of vocabulary can be selected from screen, in which case the display changes to show the vocabulary items at that level. Levels, symbols, and vocabulary can be customized for each user. System 2000 can also be used with "E Z Keys" software, in which vocabulary is presented in alphabetic form and the user can accelerate their typing rate using either abbreviation expansion or word prediction.

System 2000 is available with 8 MB of RAM, with a 320 MB or larger hard drive, and Vocal.ite or MultiVoice synthesizer. A total of 2-6 hours of digitized sound can be stored for playback.

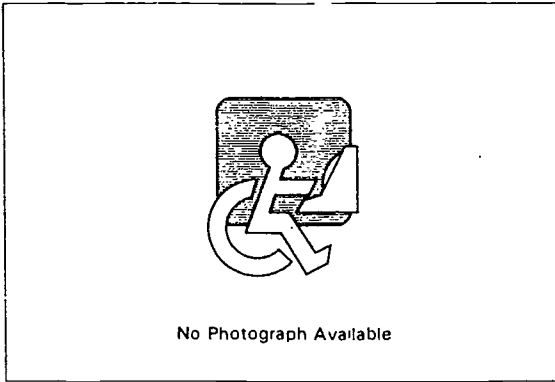

**Product Name:** Talk Back III  
**Vendor:** Crestwood Company  
**Weight:** 1.5 lbs.  
**Power Source:** 9V battery  
**Connector Type:** 1/8" phone jack  
**Cost:** \$274.95 - \$379.90

The Talk Back III is a communication aid with three messages for a total of 20 seconds. Messages can be activated by lightly pressing one of the three colored buttons or through any external switch (not included). The Talk Back III has a built in microphone allowing for re-recording of the messages. Other features include a shelf to hold three corresponding pictures, a carrying handle, and message protection in the case of battery failure.

Talk Back III alone costs \$274.95. Talk Back II with a control center switch costs \$379.90.

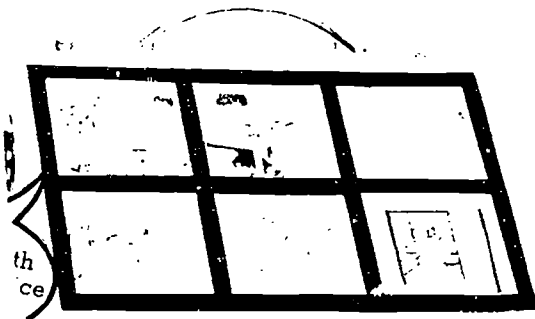

**Product Name:** Talk Back VI  
**Vendor:** Crestwood Company  
**Size:** 8.28" x 8"  
**Weight:** 2.5 lbs.  
**Power Source:** 6 "AA" batteries  
**Cost:** \$395.00

Talk Back VI is a communication aid and training device with digitized speech output. Up to six individual messages can be recorded for a total of 60 seconds. Messages are accessed by pressing the corresponding picture attached to a 2 1/4" square on the device. Other features include a built in microphone, volume control, included batteries, and memory protection in case of power failure. Six inserts on which pictures or words are mounted and inserted into pockets are also included.

A package of six extra inserts is available for \$12.50.





**Product Name:** Talk:About

**Vendor:** Don Johnston Incorporated

**Computer:** Apple Macintosh Family

**Cost:** \$490.00

Talk:About is a Macintosh based software communication aid designed to let individuals who are non-speaking participate in conversational communication. Talk:About offers text-to-speech output or digitized voices and also works with external speech synthesizers. Through features called Quick:Chat, Story:Talk, and Story:Panel, the user can quickly greet others, begin a conversation, use previous stories, create new novel communication, and wrap up a conversation.



**Product Name:** Talking Screen

**Vendor:** Words+, Inc.

**Computer:** IBM PC Family

**Cost:** \$1,395.00

Talking Screen is a software program designed to be used as a direct selection communication system. The user or clinician may configure the on-screen picture display and determine the message linked to each picture or sequence of two or more pictures. Configurations may be saved to disk and different setups may be loaded for different users. Screen layouts, programmed responses, and other settings may be printed out. A menu-driven system permits access to various features including on-line help. An optical pointer, mouse, or trackball may be used to access pictures. A text-to-speech spelling option with abbreviation expansion is included.

Contact manufacturer for information on complete portable systems, beginning at \$5,000.00.

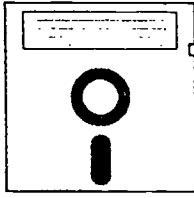

**Product Name:** Talking Screen for Windows

**Vendor:** Words+, Inc.

**Computer:** IBM PC Family

**Cost:** Contact manufacturer

Talking Screen for Windows is a dynamic display communication program with voice output that works with Microsoft Windows. Talking Screen provides commercial symbol sets, clip art, and photographic images from CD-ROM. A built-in paint program provides the ability to customize symbols and personal photographs can be imported. The page layout can have up to eight rows and 16 columns on a page and the separation between rows and columns can be adjusted. A feature called "Groups" lists symbol names with a given trait or theme in common. The user can select two or more groups and the program creates a page that contains all the symbols that are in both groups. A number of preprogrammed pages are provided and a "QuikPage" feature automatically sizes and generates a preliminary layout for a page.

Talking Screen for Windows requires Microsoft Windows, 8MB of RAM, 40MB of hard disk space, and a display set for 256 color mode. For synthesized voice output, a MultiVoice or other supported voice synthesizer is required. For digitized sound, a SoundBlaster-compatible sound capability or the Words+ digitized sound kit is required.

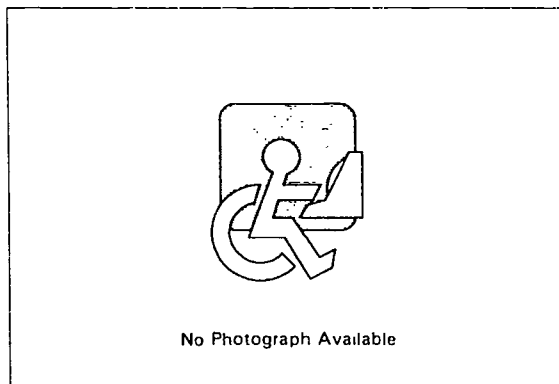

**Product Name:** Talking Switch Plates

**Vendor:** Toys for Special Children, Inc.

**Size:** 5" x 8" or 5" x 16"

**Cost:** \$55.00 - \$65.00

Talking Switch Plates offer one or two recorded messages in either a single switch format or a rocking plate model. Pressing the plate activates the message of up to 20 seconds.

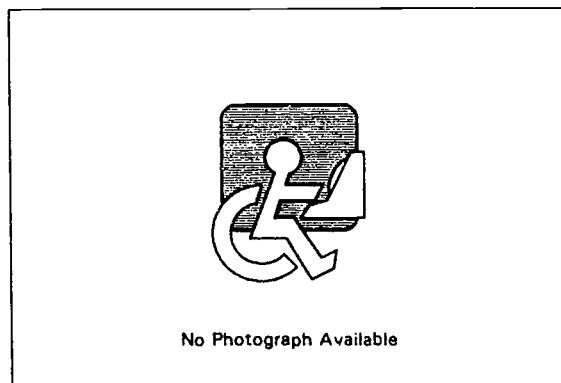

**Product Name:** TS2010X Text to Speech Personal Communicating Device

**Vendor:** D.C. & D., Inc.

**Cost:** Contact manufacturer

The TS2010X is a portable text-to-speech communication device. Input is through a keyboard with either alphabetical or QWERTY style layout. In addition to synthesized speech output, the device features a 40 character LCD display.

A variety of simple mounting options are also available. Spanish and French speech versions are currently being developed; contact manufacturer for details.

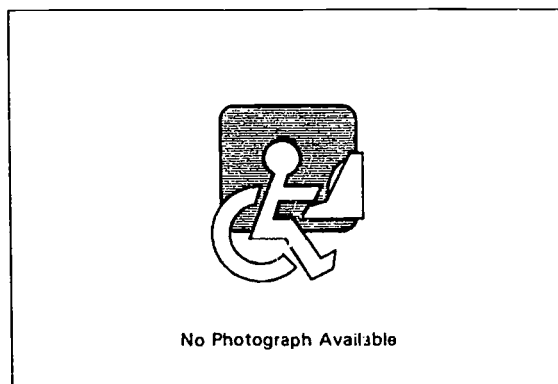

**Product Name:** VisionKey

**Vendor:** H.K. EyeCan, LTD

**Computer:** Apple Macintosh Family, IBM PC Family

**Size:** 9" x 5" x 2" (display unit)

**Weight:** 2 oz.

**Cost:** \$2,500.00

VisionKey is an assistive communication aid operated by eye movements that can also be used as an input device for computers. An eye tracker is combined with a virtual 49-position keyboard within a lightweight eyepiece mounted upon standard glasses frames. The user selects letters, characters, or commands from the keyboard, and an intelligent controller confirms the eye position with a backlight. The selection is shown on a dual-facing 20-character LCD display unit and can be sent to a computer. VisionKey has four graded ability levels from basic keywords to full computer control. The display unit is wheelchair mountable and fully mobile. The system is controlled by internal software and can be customized for special needs.

Price does not include the cost of the frames and the optometrist or optician measurement and fitting fees. Both purchase and leasing options are offered. Contact manufacturer for further information.



**Product Name:** Vocal Assistant

**Vendor:** GMR Labs

**Size:** 3.75" x 6.5"

**Weight:** 10 - 11 oz.

**Power Source:** 9V battery

**Cost:** \$395.00 - \$495.00

The Vocal Assistant is a portable communication device designed to provide basic speech for individuals who are vocally-impaired or non-verbal. Application settings include the home, school, hospital, rehabilitation center, extended care facility, restaurants, and social activities. Model I and II can each record and play back 16 messages that are digitally recorded by another person. A paper overlay slides into the keypad so the contents of each key can be illustrated with words or pictures.

Model I features 16 standard length messages of a few seconds each. Model II features six extended-length messages and ten standard length messages as well as an audio scan switch input. Both models are available with an optional remote speaker, telephone interface, and keyguard.

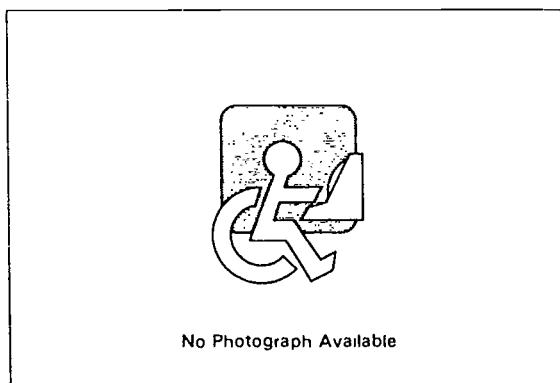

**Product Name:** VoiceBachs

**Vendor:** Magic Laboratories, Inc.

**Size:** 12" x 10.5" x 1" (Lynn Tablet)

**Weight:** 3 lbs.

**Power Source:** Rechargeable batteries

**Cost:** \$5,800.00

VoiceBachs is a portable augmentative speech system consisting of the LynnTablet 1100, VoiceBachs 1100 computer, speakers, and backpack for the computer. The LynnTablet is designed to be sturdy and features a 70 key QWERTY-based membrane keyboard. The keyboard is 5.75" x 4" and each key is .5" square, while an LCD screen displays 16 lines of 40 characters. The LynnTablet can be mounted on a wheelchair, rested on the lap, or carried by ambulatory adults. Software features of the VoiceBachs computer include: user-definable word prediction and abbreviation expansion, a notebook so the user can give presentations, take notes, etc., a pre-loaded phrasebook, date book, and others. In addition to speech synthesis in twelve voices, the user can record up to 30 minutes of digitized sound. Batteries, microphone, charger, speaker mounts, and all cables are also included.

An optional finger guide overlay is available for \$75.00.

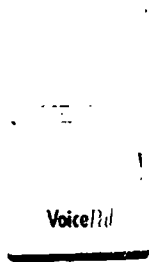

**Product Name:** VoicePal  
**Vendor:** Adaptation, Inc.  
**Size:** 4" x 6.5" x 1.8"  
**Weight:** 1.5 lbs.  
**Power Source:** "AA" batteries  
**Cost:** \$369.00

VoicePal is a self-contained communication training aid with up to 20 seconds of sound on five different channels. The messages are activated by touching the included Taction Pads (see entry) or any other switch. Batteries typically last six months under normal use and messages are protected if batteries are disconnected.

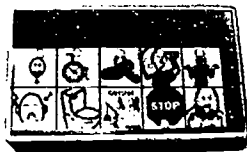

**Product Name:** VoicePal Plus  
**Vendor:** Adaptation, Inc.  
**Size:** 4" x 6.5" x 1.8"  
**Weight:** 1.5 lbs.  
**Power Source:** "AA" batteries  
**Cost:** \$419.00 - \$539.00

VoicePal Plus is a communication training and aid device that allows up to 10 six-second messages to be recorded and played back by touching the built-in keyboard, through external switches, or through a visual and auditory scanning mode. Features include: delayed activation, relay activation, reinforcement delay, scan activation selection, interauditory pause, scanning cycle mode, and inactivity shut down.

VoicePal Plus with direct select sells for \$419.00 alone or for \$469.00 with five Taction Pads (see entry). VoicePal Plus with scanning sells for \$489.00 alone or for \$539.00 with five Taction Pads.

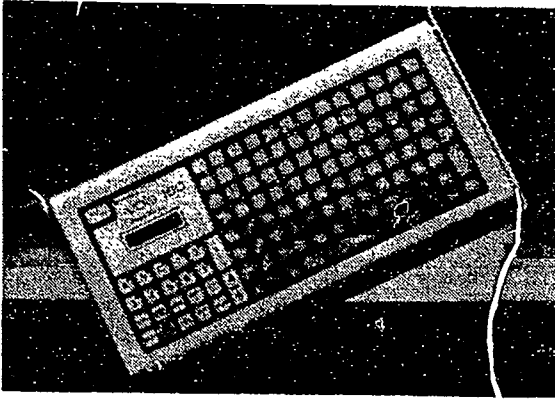

**Product Name:** VOIS 160

**Vendor:** Phonic Ear Inc.

**Size:** 8.75" x 16.5" x 3.18"

**Weight:** 5 lbs.

**Power Source:** Rechargeable batteries

**Cost:** \$4,352.00

VOIS 160 is an electronic communication aid that generates synthesized speech. Words and phrases can be typed in and may be saved under a specific key location or as a sequence of keys. The VOIS 160 has a flat membrane keyboard that can be configured to contain up to 104 keys; key size is variable. The device may also be attached to any computer that has an RS232 interface; commands from the computer for programming and saving vocabulary to a backup file can be accepted by the VOIS 160. There are two software systems which can be used with this device: P.A.L.L.S. and VoisShapes. P.A.L.L.S. features a Three Talk Buffers function which permits separate conversations to be conducted simultaneously; the user can switch among the three buffers. The contents of the Talk Buffers can also be viewed on an internal display screen and edited. VoisShapes provides keyboard emulation including editing functions. The software also has hot keys (which recall frequently used words), grabber keys (which immediately interrupt any mode to speak a message), and grammatical keys.

Options (extra) include keyguards for 8, 24, or 104 keys, a carrying case, and programming software.

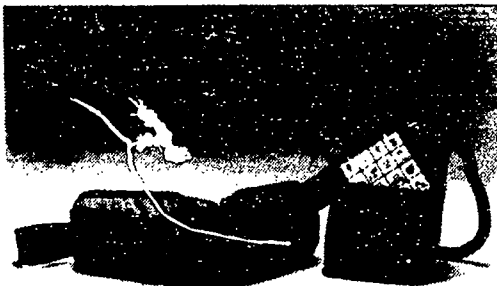

**Product Name:** WalkerTalker

**Vendor:** Prentke Romich Company

**Weight:** 2 lbs.

**Cost:** \$1,195.00 - \$1,495.00

WalkerTalker is a digitized speech-output communication device that is carried in a belt that straps around the user's waist. Vocabulary is coded with Minspeak and the 16-key keyboard can be sequenced to produce hundreds of words, phrases, and sentences. Messages are accessed by removing the keyboard from its carrying pouch and pressing the keys. Five overlays and a symbol sheet are included with the device.

Vocabulary can be saved onto a computer disk with the optional Memory Transfer Interface.

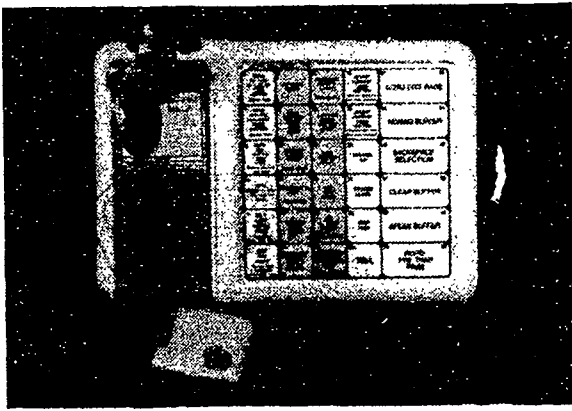

**Product Name:** WhisperWolf

**Vendor:** Wayne County Regional Education Service Agency

**Size:** 14.5" x 10" x 1.75"

**Weight:** 2 lbs., 10.5 oz.

**Power Source:** Rechargeable batteries

**Cost:** \$450.00

WhisperWolf is a portable communication aid with synthesized voice output. The user can make selections by single-switch auditory scanning. The vocabulary items are read sequentially, through a private speaker which can be placed by the user's ear. When the desired selection is reached, the user activates the switch and the choice is spoken aloud through another speaker. Four memory sections are provided. The Fixed Section, which has a maximum capacity of 500 words organizable into up to 36 levels, is programmed by the manufacturer either per user custom specifications or with WOLF Curriculum Activity Packages (WOLFCAPS). The User Section has a capacity of approximately 800 words, organizable into as many as 36 levels, and is programmable by the user via either a 400-word "dictionary" of preprogrammed entries or a "phoneme page." The two additional memory sections can be left blank for extra User Sections or used as extra Fixed Sections. Auditory scanning options include: row/column or sequential scanning, selectable scan rate, rest mode, and continue after select vs. continue at start. Switch not included.

The optional WolfKey is available for \$345.00 to provide computer access for WhisperWolf users.

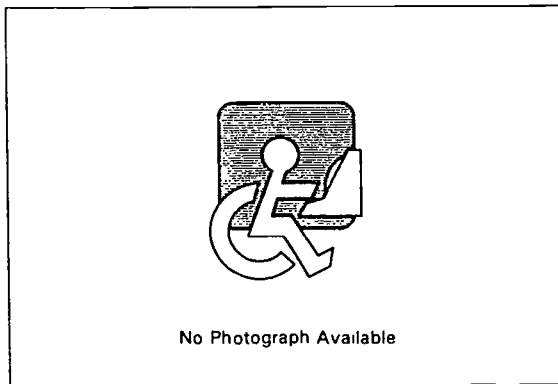

**Product Name:** Yak Bak

**Vendor:** YES! Entertainment Corporation

**Power Source:** Included battery

**Cost:** Varies

Yak Bak is a small, hand-held recording and play back device that holds one message of up to six seconds in length. The device features two buttons, one labeled "say" and the other labeled "play." Messages are recorded by holding the "say" button down and speaking into the combination speaker and microphone. Messages are played by depressing the "play" button.

Yak Bak is available at toy stores, department stores, and novelty stores.

# **Chapter 6**

## **Mounting Systems**

This chapter includes devices used to mount a switch, communication system, or computer access device so that an individual can access it optimally. Mounting systems for wheelchairs, tables, beds, and other applications are included here.

Devices that might be mounted with these systems can be found in the following chapters: Chapter 5 (Electronic Communication and Writing Aids); Chapter 8 (Switches and Controls); Chapter 9 (Environmental Controls and Telephone Adaptations); Chapter 10 (Call, Monitoring and Memory Systems); and Chapter 12 (Alternate Inputs).



*The following product entries appear in this chapter:*

Adaptive Fixtures Kit, 165  
Communication Station, 165  
Daessy Desktop Mount, 166  
Daessy Folding Mount, 166  
Flexible Wheelchair/Table Mounting Kit, 167  
Head Mounting Kit, 167  
Laptrays, 168  
Low-Tech Adaption Materials, 168  
Magic Arm System, 169  
Mighty Mount, 169  
Moulded Plastic Wheelchair Tray, 170  
Mounting Packages & Switches, 170  
Mounting Switch Mount, 171  
PowerBook Mounting Plate, 171  
Quick 'n Easy 2, 172  
Slim Armstrong, 172  
Support Station, 173  
Switch Mounting Hardware, 173  
Switch Mounting Kit, 174  
Switch Mounts, 174  
TASH Mounting Parts, 175  
Universal Switch Mounting System, 175  
WCMK, 176

201

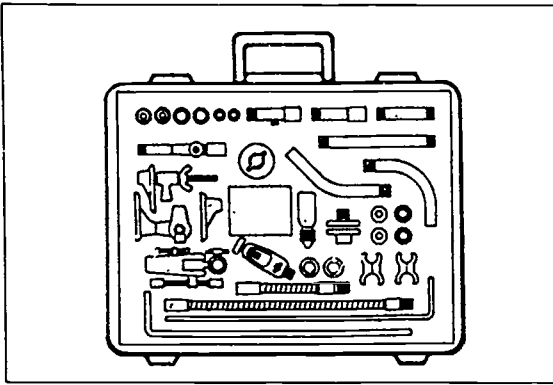

**Product Name:** Adaptive Fixtures Kit

**Vendor:** Zygo Industries, Inc.

**Size:** 18.5" x 15" x 13.5"

**Weight:** 12 lbs.

**Cost:** \$625.00

The Adaptive Fixtures Kit contains a variety of parts for mounting and positioning devices such as switches. The kit is designed to be used in either of two ways: as a replacement part set for the user, or as an evaluation tool to experiment with various mountings and then order an individual's prescribed mounting from the factory. The kit contains selected quantities from Zygo's Adaptive Fixtures parts listing.



**Product Name:** Communication Station

**Vendor:** D.J. Technical Sales, LTD

**Cost:** Contact manufacturer

Communication Station is a wheelchair mounting system that is designed to mount communication devices, notebook computers, switches, and other items to wheelchairs. The system features a push-together Wedge Base/Plate connection system designed to simplify attaching the device to the mount and the mount to the wheelchair. A variety of sizes of Monoclamps adapt to all round, square, and rectangular tubing. Four basic models are available: Fold Down Mount, Rigid Mount, Desk Mount, and PowerBook Mount.

**Product Name:** Daessy Desktop Mount

**Vendor:** Prentke Romich Company

**Cost:** \$305.00

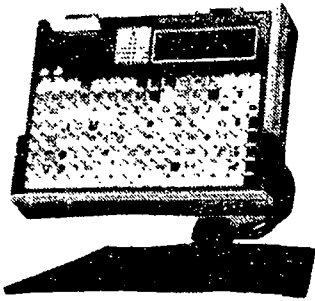

Daessy Desktop Mount provides a stable, hands-free support for the Liberator, Touch Talker, Light Talker, IntroTalker and AlphaTalker on any flat surface. Adapters are required for Light Talker (\$60.00) and for older Touch Talkers (\$75.00).

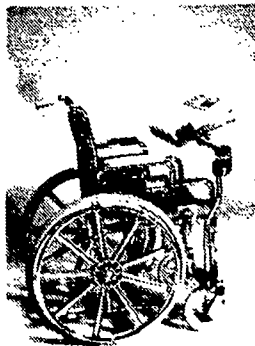

**Product Name:** Daessy Folding Mount

**Vendor:** Prentke Romich Company

**Cost:** \$765.00 - \$840.00

Daessy Folding Mount provides a stable and adjustable platform for mounting communication devices on wheelchairs. The entire communication device can be rotated down and out of the way and the platform can be adjusted to meet the positioning needs of each individual.

Daessy is available in three tubing diameters, (7/8", 3/4", or 1") and with either a 6" or 12" offset. Daessy is available for the following communication devices: Liberator, Touch Talker, IntroTalker, Light Talker, and AlphaTalker. A quick release adapter is required for use with the Light Talker (\$60.00) and older Touch Talkers (\$75.00).

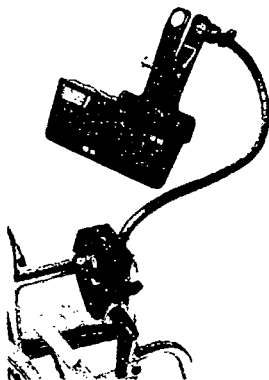

**Product Name:** Flexible Wheelchair/Table Mounting Kit

**Vendor:** Crestwood Company

**Cost:** \$104.95

The Flexible Wheelchair/Table Mounting Kit allows items up to three pounds in weight to be clipped to a 20" arm and mounted on a wheelchair or table. Items that can be mounted include: Opticommunicator Maxx, Crestalk, Jumbo Plate Switch, and Crestalk (see entries).

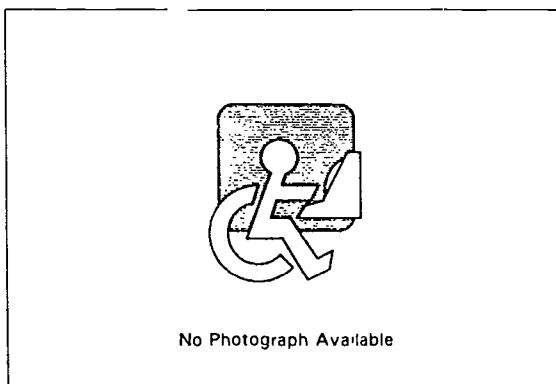

**Product Name:** Head Mounting Kit

**Vendor:** Don Johnston Incorporated

**Cost:** \$95.00

The Head Mounting Kit is designed to mount the L.T. Switch or the Plate Switch (see entries) on a wheelchair. A push-button disconnect allows quick removal from the chair. Kit includes: mounting plate, right-angle tube, pushbutton disconnect, 13" flexible gooseneck, wheelchair clamp. Switches are not included.

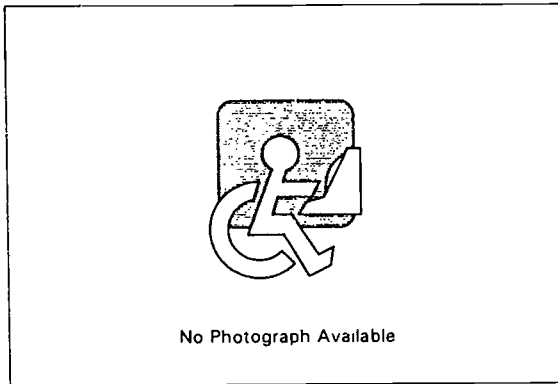

**Product Name:** Laptrays

**Vendor:** Various (Generic Product)

**Cost:** Varies

One common method of mounting portable computers, keyboards, and communication systems for use by persons who use wheelchairs is to utilize laptrays already developed for other purposes. Laptrays can be very secure bases for mounting communication systems, but the following criteria should be considered when selecting a laptray for this purpose: construction of shatterproof material; a secure connection to the wheelchair; a proper cutout for fitting around the user's body; a width that spans the wheelchair but does not hang over far enough to obstruct passage through doorways; a length that provides ample work space but allows materials to be accessed visually and physically; a rim around the edges to prevent items from rolling off; the ability to swing away and fold down the tray for persons who transfer independently from the chair; light weight to facilitate the handling of the tray by the user or assistants; material durable enough to withstand the drilling of holes and a variety of weather conditions; and overall aesthetic attractiveness.

Many styles of laptrays are available from rehabilitation product manufacturers, or may be custom fabricated by rehabilitation engineers.

---

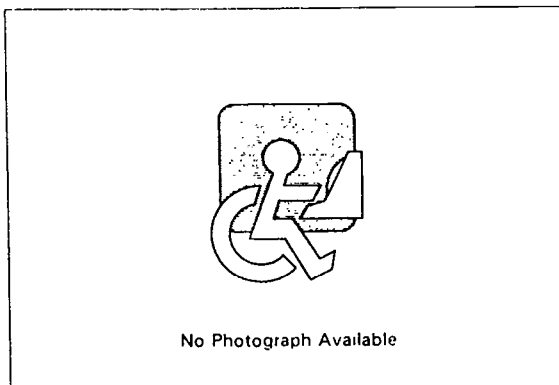

**Product Name:** Low-Tech Adaption Materials

**Vendor:** Various (Generic Product)

**Cost:** Varies

Communication, control, and computer access systems often depend on low technology materials to make them functional. These materials are frequently difficult to locate or forgotten in how helpful they might be. Examples of these materials are: contact paper, soft fabric hook and loop fasteners, heavy duty plastic hook and loop fasteners, poster tack putty, non-slip rubber or plastic sheets, and low temperature splinting thermoplastics.

Vendors of these materials can be elusive, but include hardware stores, large variety stores, hobby shops, and fabric stores. Often local rehabilitation therapists are knowledgeable of where these products can be purchased locally. Specific sources can also be found in local yellow pages and often in gift specialty catalogs.

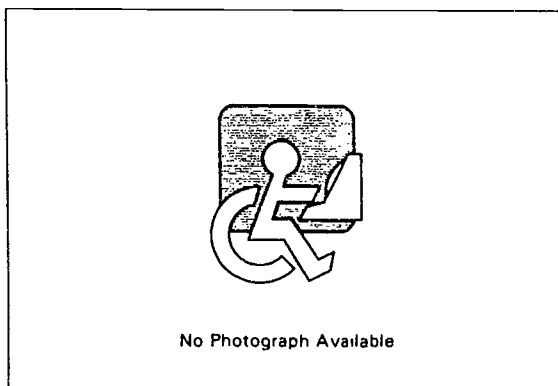

**Product Name:** Magic Arm System

**Vendor:** R.J. Cooper & Associates

**Cost:** \$200.00

Magic Arm System is a mounting arm for a single switch that attaches to a variety of places, including wheelchair tubing and tables. A dial at the elbow tightens all three joints: one at the base, the elbow, and the switch end. When the dial is tightened everything stays in place. A variation of the Magic Arm, the Articulated Arm, has three knobs, is not as strong, and costs \$100.00.

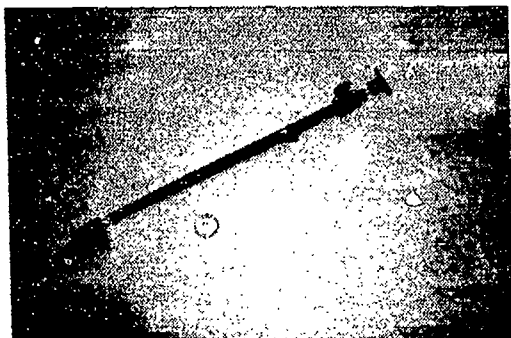

**Product Name:** Mighty Mount

**Vendor:** TASH, Inc.

**Weight:** 4 lbs.

**Cost:** \$125.00

Mighty Mount is a switch mounting system for TASH switches. The device attaches to a table, bed, or wheelchair. The system features adjustable arm length, arm angle, and switch angle.

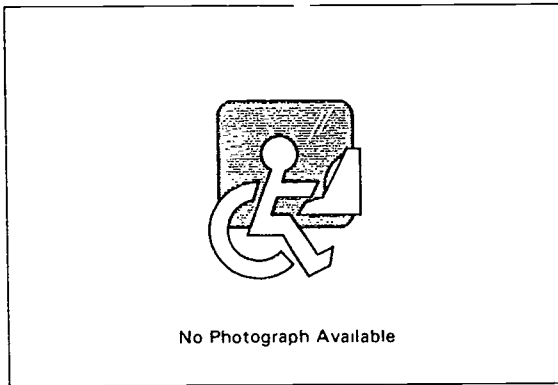

**Product Name:** Moulded Plastic Wheelchair Tray

**Vendor:** Variety Ability Systems, Inc. (VASI)

**Size:** See text

**Weight:** 6 - 7.6 lbs.

**Cost:** \$163.50 - \$178.50

The Moulded Plastic Wheelchair Tray consists of a laminate base of tough, thermoformed Kydex plastic mounted onto a lacquered plywood core. The tray is provided with an oversized proximal end to allow for individualized trunk cutouts. The tray can be modified for accomodating augmentative communication devices and electronic wheelchair interfaces.

The tray is available in two sizes: 22" x 24" x 1/2" or 24" x 28" x 1/2".



**Product Name:** Mounting Packages & Switches

**Vendor:** Crestwood Company

**Cost:** \$85.00 - \$105.00

The Mounting Package creates customized tubular mountings on either wheelchair or table. The preassembled packages include a Universal swivel clamp, 16" straight tube, and a wheelchair or table mounting clamp.

The wheelchair package sells for \$85.00 and the table package sells for \$105.00.

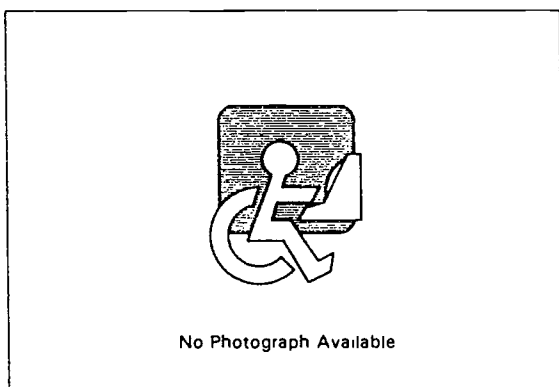

**Product Name:** Mounting Switch Mount

**Vendor:** Don Johnston Incorporated

**Cost:** \$60.00

The Mounting Switch Mount is designed for the Mounting Switch (see entry). The mount is designed for permanent placement on a wheelchair for an individual user. Package includes 1/4" mounting rod and wheelchair clamp with 1/4" rod adapter. Switch is not included.

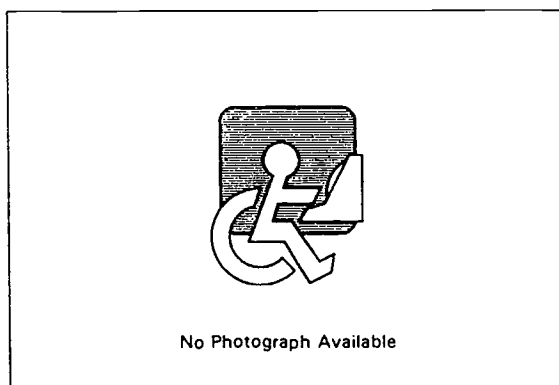

**Product Name:** PowerBook Mounting Plate

**Vendor:** Don Johnston Incorporated

**Cost:** \$110.00

The PowerBook Mounting Plate has brackets and fasteners to hold the Macintosh PowerBook and allows it to be mounted to a wheelchair or other mounting system. The device is compatible with mounting systems from Daedalus Technologies, D.J. Technical, and Mitek Industries.



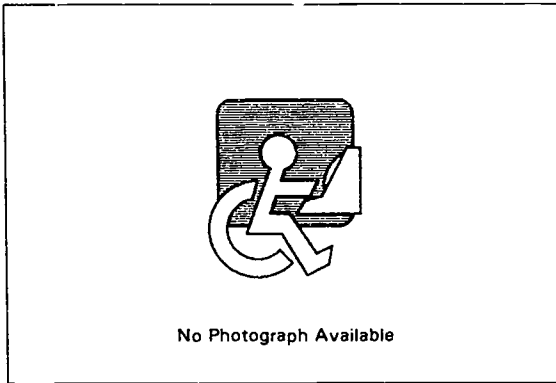

**Product Name:** Quick 'n Easy 2

**Vendor:** ACS Technologies, Inc.

**Cost:** Contact manufacturer

Quick 'n Easy 2 is a wheelchair mounting system for computers, communication devices, lap trays, and other devices. The system is designed to allow users in wheelchairs to raise and lower the device themselves. Tension control adjustments in moving parts allow for adjustment for weight of device and convenience of user. The system is adaptable for right or left side use.

A small Quick 'n Easy mounting system is also available for mounting lightweight devices and switches. The small system mounts securely to the armrest and can be put in numerous different positions.



---

**Product Name:** Slim Armstrong

**Vendor:** AbleNet, Inc.

**Cost:** \$175.00

Slim Armstrong is a mounting system with a clamp that can be anchored to many kinds of surfaces. The system also features a ball joint for easy positioning, telescoping arm that stretches from 10.5" to 20.5", flexor rod to reach around tight angles, and a small rectangular mounting plate. Switches are not included.



**Product Name:** Support Station

**Vendor:** Support Engineering Associates

**Cost:** Contact manufacturer

Support Station is a wheelchair accessible computer mounting system that mounts to walls, partial walls, panel walls, partitions, cubicles, modular walls, file cabinets, lockers. The components of the computer can be mounted at any height and all trays adjust and swivel.

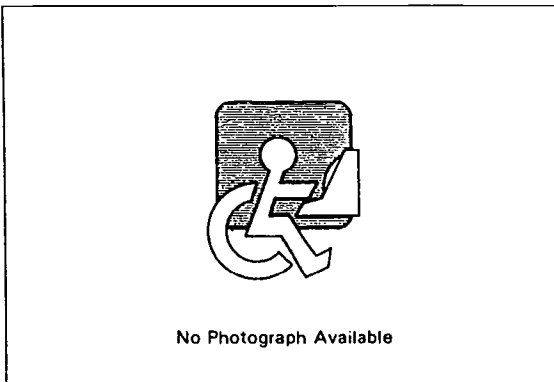

**Product Name:** Switch Mounting Hardware

**Vendor:** Toys for Special Children, Inc.

**Cost:** Contact manufacturer

Switch Mounting Hardware can be custom designed by Toys for Special Children, Inc. for individual mounting requirements. The manufacturer will bend rods or tubes, make device mountings, machine special fixtures, or join together specific hardware components. The hardware includes the following general categories: fixed attachments, adjustable wheelchair mounting clamps, clamp with swivel, weighted base, clamps, flanges, mounting rods, microphone tubing, mounting plates, and interconnectors. Contact manufacturer for further details.

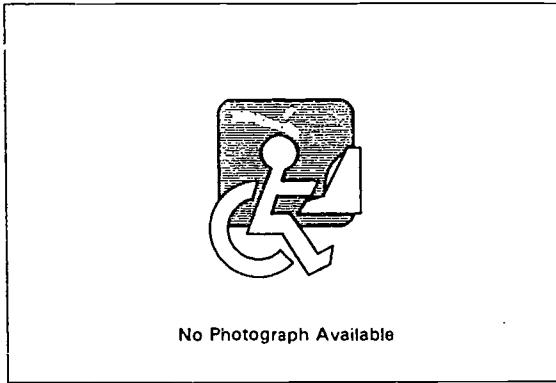

**Product Name:** Switch Mounting Kit

**Vendor:** Don Johnston Incorporated

**Cost:** \$165.00

The Switch Mounting Kit is designed to create customized, permanent mounts for an individual user. The kit includes: Dual Lock, three wheelchair clamps, six aluminum rods, two adapters, two thumb screws, 13" flexible gooseneck with pushbutton disconnect, right-angle tube, mounting plate, and tools needed for setup. Complete instructions are also included.

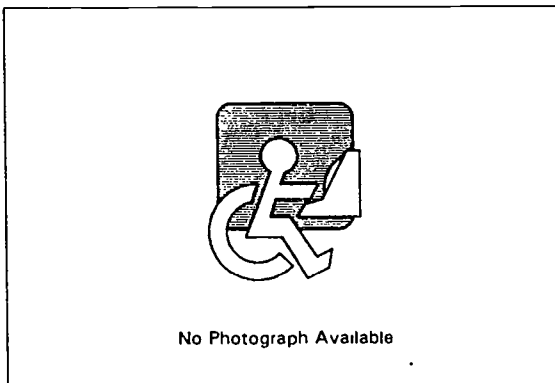

**Product Name:** Switch Mounts

**Vendor:** Various (Generic Product)

**Cost:** Varies

Often, the key to successful switch use is the way in which it is mounted. Switches do not need to lie flat on a laptray or table top; for example, they may be mounted upside-down or sideways to eliminate problems with gravity, or so they can be swung away from the user when not in use. Camera specialty mounts and tripods often serve well as switch mounts. Some clamp to tables, some have suction cups for flat surfaces, some provide multi-joint adjustments for variable positioning in space.

Many switch mounting devices are available from switch manufacturers or rehabilitation equipment vendors. Tripod and camera mounting equipment is available in photographic supply stores. Specific sources can be found in local yellow pages, in the manufacturer list of this book, in listings from local rehabilitation service delivery programs, and often in gift specialty catalogs that carry personal convenience types of devices.

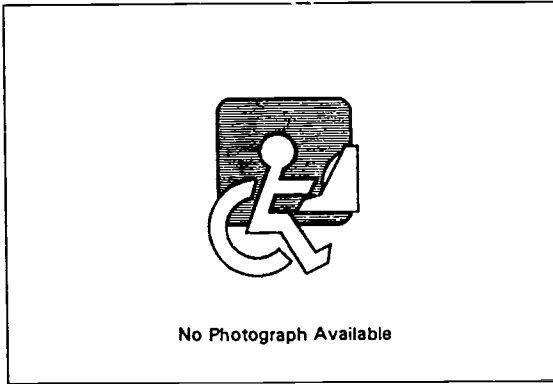

**Product Name:** TASH Mounting Parts

**Vendor:** TASH, Inc.

**Cost:** Contact manufacturer

TASH, Inc. sells hardware to mount all of their switches, transmitters, and mini-keyboards on wheelchairs, tables, and beds. Available parts include: several types of clamps, tubes, goosenecks, etc. Contact the manufacturer for information on how to choose the appropriate parts.

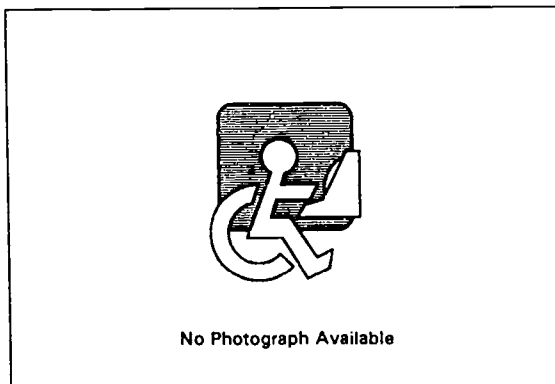

**Product Name:** Universal Switch Mounting System

**Vendor:** AbleNet, Inc.

**Cost:** \$185.00

The Universal Switch Mounting System is designed for quick and easy switch placement in any position. The system clamps onto table or wheelchair, holds up to five pounds, and fully extends to 20.5". Four mounting plates are available for \$13.00 each: a small triangular plate designed for AbleNet's Jelly Bean switch (see entry), a small rectangular plate, a large rectangular plate for Speak Easy and the Jelly Bean Holders (see entries), and a large triangular plate for the Big Red switch (see entry).

An extension package that includes three extension rods plus a swivel attachment adding 6, 9, or 12 inches is available for \$45.00. A Universal Base is also available for \$52.00 to allow the system to be placed on the floor or other flat surface.

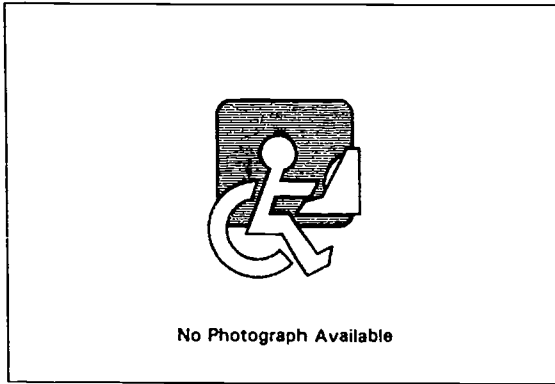

**Product Name:** WCMK

**Vendor:** Prentke Romich Company

**Size:** 22" or 28" long

**Cost:** \$340.00 - \$405.00

The WCMK series is a system for mounting various communication devices on wheelchairs. WCMK can be attached to either side of the chair and the entire assembly can be removed. The system offers a wide range of adjustments, including rotation to the front or side for transferring. Four tube diameters, from 5/8" to 1", and two lengths, 22" and 28", are available.

WCMK is available for the following devices: Versascan (\$390.00), IntroTalker (\$390.00), Liberator (\$340.00), Light Talker (\$390.00), and Touch Talker (\$340.00 - \$405.00).

## **Chapter 7**

# **Telecommunication Devices for the Deaf (TDD's)**

This chapter includes only those devices which have been specifically designed for deaf or non-speaking individuals to communicate over telephone lines. It includes systems which use ASCII code, Baudot code, or touch tones transfer information. Also included are software programs that allow a computer and modem to act as a TDD, devices for individuals who are deaf and blind, and a variety of accessories for TDDs. It does not include devices that produce a synthesized voice: those are listed in Chapter 5. TDDs were known in the past as TTYs, and have recently come to be called Text Telephones (TTs).

Related "function" codes found in Index 1 include Telecommunication (TL), Conversation/Interaction (CI), and Phone Control (PC).

Appendix A includes a list of Information Resources for Deaf Individuals.

***The following product entries appear in this chapter:***

ASCII-TDD Software, 179  
Atlantic 144 TTY, 179  
Compact TTY, 180  
Dialogue TTYs, 180  
Dialogue VCO Read & Talk Telephone, 181  
Futura-TTY, 181  
InfoTouch, 182  
Intele-Modem, 182  
Lite Touch Telephone Communicator, 183  
Message Center, 183  
MIC300i Computer Modem, 184  
Minicom IV, 184  
Miniprint 425, 185  
NexCom 300vi & 300ve, 185  
Pay Phone TTY, 186  
Personal Communication Terminal (PCT), 186  
Phone-TTY CM-4 Computer Modem, 187  
Porta Printer Plus, 187  
PortaView, 188  
Positron Express, 188  
SIDD (Software Interface for the Deaf and Disabled), 189  
SM85 Smart ASCII/Baudot Modem, 189  
Supercom 4400 TTY, 190  
Superprint 100, 200, 400, 190  
Superprint 4425, 191  
Superprint ES TTY, 191  
TDD 2700, 2730, and 2830, 192  
TDD Detector, 192  
TeleBraille III, 193  
TeleView 40 & 80, 193  
ToneTalker, 194  
UltraSilent, 194  
Uniphone 1000, 195  
Uniphone TDD/TT, 195  
VCS 3500 with TDD Software, 196  
WinTalk, 196  
Writalk Electronic Pen Pad, 197

***The following products from other chapters can also be used as Telecommunication Devices for the Deaf:***

Heidico Intertalk, 135  
Multi-Line Dial-A-News System, 759  
TDD Trainer System, 58

**Product Name:** ASCII-TDD Software

**Vendor:** Gallaudet Research Institute-TAP

**Cost:** Free

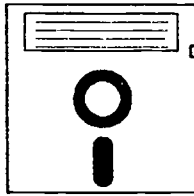

ASCII-TDD Software assists in communication between standard modems and TDDs that have ASCII option. Because of the hardware design in standard modems, this software cannot let modems talk to TDDs that operate only in Baudot mode. This software is designed to simplify communication by computers with TDDs operating under 300 baud ASCII.

The software can be downloaded from <ftp://fshb41.gallaudet.edu> or <http://fshb41.gallaudet.edu>, or purchased by mail for \$3.00.

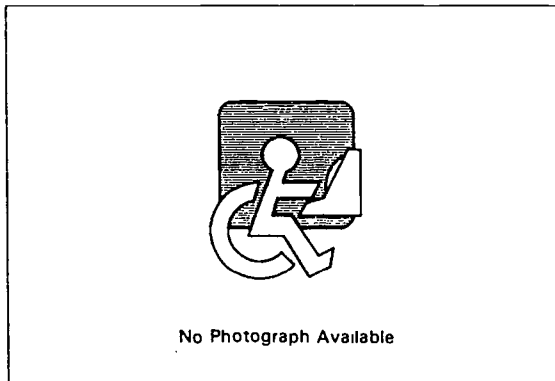

**Product Name:** Atlantic 144 TTY

**Vendor:** Atlantic Technologies, Inc.

**Computer:** IBM PC Family

**Cost:** \$399.00

Atlantic 144 TTY is a fax and data modem with the ability to communicate with TDD devices. The modem supports fax and data communications at 14.4 kbps and is shipped with SofNets Faxworks software as well as Comit data software.



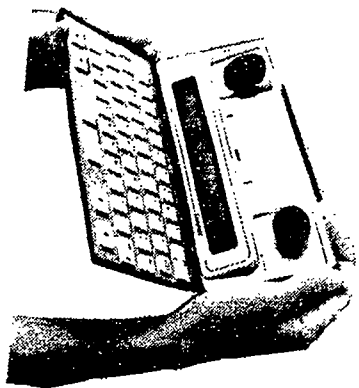

**Product Name:** Compact TTY

**Vendor:** Ultratec, Inc.

**Size:** 8.8" x 3.9" x 1.2"

**Power Source:** Rechargeable batteries

**Cost:** \$299.00

Compact TTY is a portable telecommunications device for the deaf (TDD) that features an 80-character, two-line display. The unit has a 57-key keyboard and an acoustic coupler that adjusts to fit square or round telephone handsets. Compact also has built-in clock and date functions. The device's memory can store hundreds of phone numbers or text for future use. A voice announcement alerts the recipient of a call from Compact that she needs to receive the call on a TDD. Contact manufacturer for further details.



**Product Name:** Dialogue TTYs

**Vendor:** Ameriphone, Inc.

**Size:** 10.25" x 12" x 3"

**Weight:** 3 - 3.25 lbs.

**Power Source:** Rechargeable batteries

**Cost:** \$229.00 - \$489.00

Dialogue TTYs are battery operated telecommunications devices for the deaf (TDD) with a four row keyboard and a 20 character vacuum fluorescent display with six mm character height. All models have an Emergency Call Announcer, call status indicator, flexible cups for round or square handsets, "GA" and "SK" keys, AC adapter, carrying handle, and standard or international Baud speeds.

Optional features offered in some of the six models include: direct telephone line connection, bright incoming call ring signaler, automatic answering system, phone directory, large 32K memory, password, programmable personalized greeting, built in printer, date and time stamp of calls, ASCII code, redialing, auto-busy redial, Toll Saver, Express type, and others.



**Product Name:** Dialogue VCO Read & Talk Telephone

**Vendor:** Ameriphone, Inc.

**Size:** 7.25" x 9.25" x 2.75"

**Weight:** 4 lbs.

**Power Source:** 120V AC & batteries

**Cost:** \$189.95

Dialogue VCO Read & Talk Telephone is a telecommunications device for the deaf (TDD) designed specifically for use with local relay services or for anyone who cannot hear but wishes to use their own voice when communicating with hearing people. The user reads the responses from the other person in text typed by the communications assistant at the local relay service. The Dialogue VCO features a 30 decibel amplifier, dedicated relay number button, no keyboard, no typing required to initiate a voice carry over call, built-in text answering machine which is compatible with voice answering machines, and a two-line 20 character backlit LCD text display.

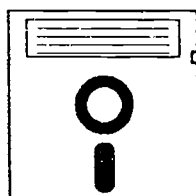

---

**Product Name:** Futura-TTY

**Vendor:** Futura Wave Communications, Inc.

**Computer:** IBM PC Family

**Cost:** \$69.95

The Futura-TTY is software designed for use with external and internal TTY/ASCII translation modems. By using this software and a TDD modem (extra), an individual using an IBM PC computer can receive and send TTY calls. The Futura-TTY software features include: autodial and redial, 500 phone/name directory, makes relay calls automatically, text/numeric paging, on-line help, and answering machine functions including forwarding new messages to other part or pagers. The program will also save and print conversations.

An IBM PC or compatible with 350K of RAM memory is required. The Nexion 300 (internal and external), Ultratec Intel-Modem, Phone-TTY CM-4, or Krown SM-85 TTY modem is also required to interface the computer with TTYs. Hayes compatible modems are supported for ASCII calls only. Futura-TTY software is compatible with Microsoft Windows 3.0, 3.1, and 95. A demo version is available for \$5.00.

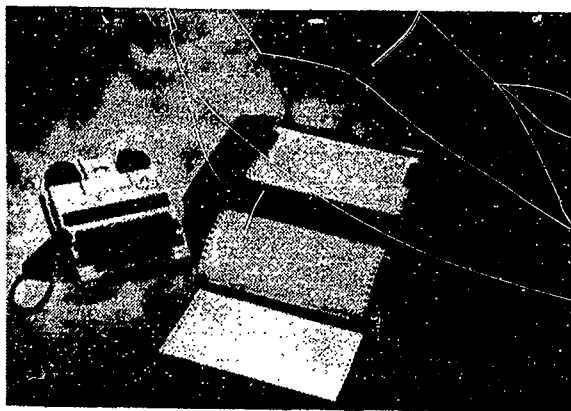

**Product Name:** InfoTouch

**Vendor:** Enabling Technologies Company

**Cost:** \$3,295.00 - \$4,695.00

InfoTouch is a three component system which gives deaf-blind persons access to the TDD network. It includes either model of the Romeo Braille Printer (see entry), a Superprint Modem (see entry) which can be used in either the conventional QWERTY or six key braille typing modes, and a vibrating detector which alerts the user to a dial tone, ring, or busy signal. Carrying cases are included.

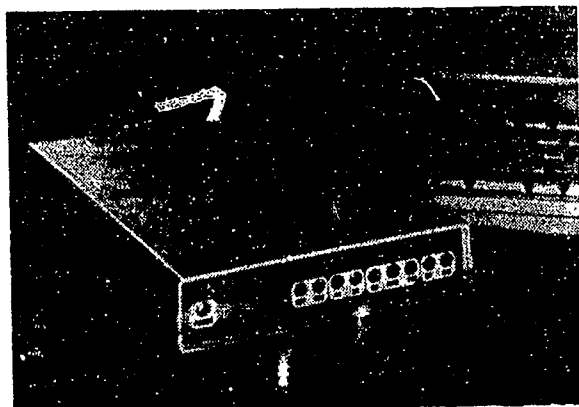

**Product Name:** Intel-Modem

**Vendor:** Ultratec, Inc.

**Size:** 6.3" x 1.4" x 9.5"

**Weight:** 24 oz.

**Power Source:** AC adapter

**Cost:** \$329.00

The Intel-Modem receives both Baudot and ASCII coded incoming telecommunication messages. When attached to this modem, a telecommunication device for the deaf is able to convert ASCII calls into Baudot code automatically. Intel-Modem connects directly to a phone line. The modem allows the user computer control if desired and works with standard communication software. This product also provides call progress monitoring by indicating dial tone, ringing, or busy. Lights on the front panel also indicate current operating mode (originate/answer, full or half duplex) and line status.

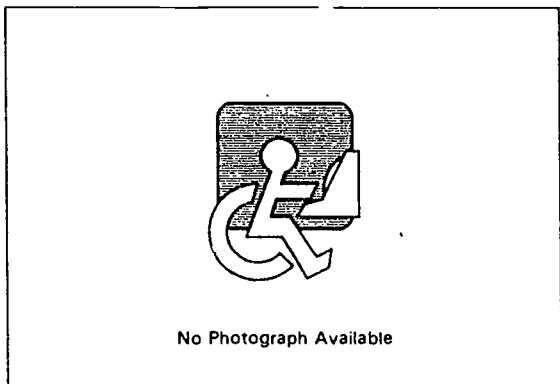

**Product Name:** Lite Touch Telephone Communicator

**Vendor:** Blazie Engineering

**Size:** 11" x 13" x 2.5"

**Weight:** 6 lbs.

**Power Source:** Rechargeable battery & AC

**Cost:** \$4,600.00

The Lite Touch Telephone Communicator is a system designed especially for people who are deaf and blind consisting of the Braille Lite personal data assistant, the SuperPrint E modified TDD (see entries), and a tiny signal detector. Incoming messages automatically scroll across Braille Lite's display and messages can be sent by using either the TDD's QWERTY keyboard or Braille Lite's Perkins keyboard. The signal detector emits a strong vibration when the telephone detects a ring, busy signal, or audible indication that the other party is speaking.

Lite Touch is also available as an upgrade to an existing Braille Lite for \$1,300.00. No modification to Braille Lite is required.

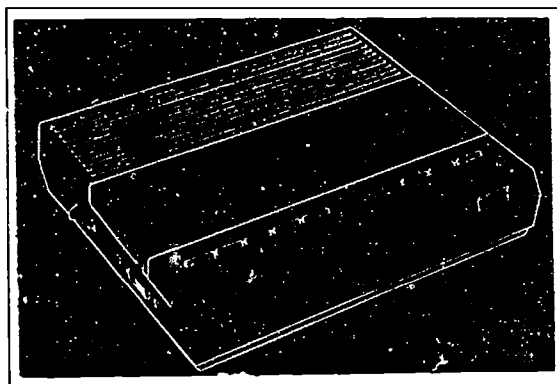

**Product Name:** Message Center

**Vendor:** Heidico, Inc.

**Cost:** \$149.95

The Message Center is manufactured by AT&T and programmed by Heidico, Inc. to simplify voice and/or TDD communication by and between the hearing and the hearing impaired user. The message center can be accessed from any phone or TDD to transmit, receive, store, and retrieve memos, messages, and other voice/TDD communications. Features include: audio cassette for storing communications, auto answer, personal memo, call indicator, remote access, and more. The device is volume controllable, hearing aid compatible, and works with all types of TDDs.

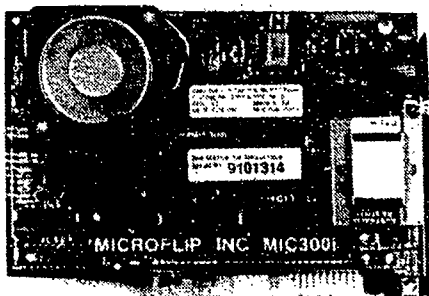

**Product Name:** MIC300i Computer Modem  
**Vendor:** Microflip, Inc.  
**Computer:** IBM PC Family, IBM PS/2 Family  
**Cost:** \$349.00

The MIC300i computer modem enables an IBM personal computer to act as a telecommunication device for the deaf. The modem is packaged with software which allows the computer to accept ASCII and Baudot coded incoming calls. The MIC300i has an "answering service" capability which can receive and record up to one thousand incoming TDD messages. The messages can be displayed on either a forty or eighty column screen. Other features include: help menu, auto redial, scrolling up to five pages of conversation, and a built-in speaker.

The software can be configured to be memory resident.

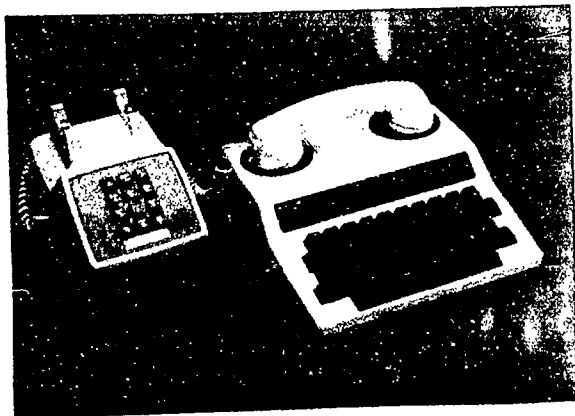

**Product Name:** Minicom IV  
**Vendor:** Ultratec, Inc.  
**Size:** 8.9" x 10" x 2.5"  
**Weight:** 2.5 lbs.  
**Power Source:** Rechargeable batteries  
**Cost:** \$239.00

Minicom IV is a portable TTY with 20-character LED display. The Minicom transmits using the standard Baudot TTY code. The keyboard includes backspace and shift keys. A signal light informs the user when there is a dial tone, busy signal, ring signal, or answer at the other end. Minicom IV has a 4-row keyboard with 43 keys.

Minicom IV uses either rechargeable batteries or an AC adapter.



**Product Name:** Miniprint 425  
**Vendor:** Ultratec, Inc.  
**Size:** 10" x 9.5" x 3"  
**Weight:** 3.6 lbs.  
**Power Source:** Rechargeable batteries  
**Cost:** \$419.00

Miniprint 425 is a printing TTY with a four row, 47 key keyboard and a 20 character display. Turbo Code technology allows telephone conversations to be in real time if both units are Turbo equipped and Auto ID automatically sends TTY tones to alert the answering party that the call will be on a TTY. The built in 24 character printer has three print sizes and prints in upper and lower case. Direct connection allows for clearer TTY conversations, keyboard dialing, two jacks for easy attachment of both a signaling system and a telephone line, and a call progress indicator that spells out "ringing" or "busy" after a number is dialed.

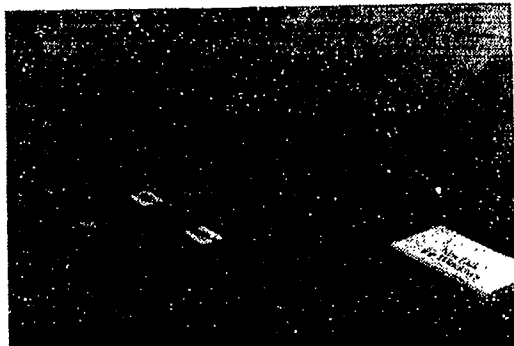

**Product Name:** NexCom 300vi & 300ve  
**Vendor:** Nexion, Inc.  
**Computer:** Apple Macintosh Family, IBM PC Family  
**Cost:** \$299.00 - \$389.00

NexCom 300vi is an Internal Card Modem and NexCom 300ve is an External Modem. Both can operate as an industry standard Hayes compatible fax modem and as a TDD. NexCom features Autodetect that automatically detects and connects to incoming calls from TDDs, high speed modems, or FAX as well as detecting what is answering an outgoing call. The NexCom 300 also features call transfers to other extensions with either a TDD or a modem, "Speed Jump" to change the connection speed in the middle of a call, and a sound and transmitting light on the computer screen so the user can monitor sounds and transmission on the line. Included software for Microsoft Windows provides vertical split screen chat so both parties can type at the same time, an answering machine function, a conversation viewer for saving and printing messages and conversations, and other features for placing and receiving calls to or from TDDs, BBSs, and relay services.

The 300vi sells for \$299.00 and the 300ve sells for \$389.00. The NexCom 300 can be used with any communication software for the Macintosh.



**Product Name:** Pay Phone TTY

**Vendor:** Ultratec, Inc.

**Size:** 10.8" x 11.3" x 4"

**Weight:** 30 lbs.

**Power Source:** AC adapter

**Cost:** \$995.00 - \$1,495.00

The Pay Phone TTY is a telecommunications device for the deaf that can be attached to any public pay phone. The TTY keyboard unit is housed in a metal drawer which is bolted underneath the phone. The user takes the phone receiver and places it to the side of the phone and dials a TTY number. When the call is answered by a TTY, the drawer will open. The TTY feature does not interfere with standard use of the pay phone.

The Pay Phone TTY can store a conversation in a 2,000 character memory so the user can scroll through the conversation. When the call is completed, the memory is cleared.

---

**Product Name:** Personal Communication Terminal (PCT)

**Vendor:** Trident Technologies

**Cost:** \$649.00



The Personal Communication Terminal (PCT) is a telecommunications device for the deaf which can display both sides of a conversation on its screen. The Tabletop model has a screen which can accommodate 25 lines of text at 40 or 80 characters per line spacing and has a full QWERTY keyboard. The PCT features incoming call signaling, programmable telephone number directory, autodialing, memory for storing phrases and conversations, a serial printer interface, and text answering machine.

The PCT can recognize both Baudot and ASCII codes.

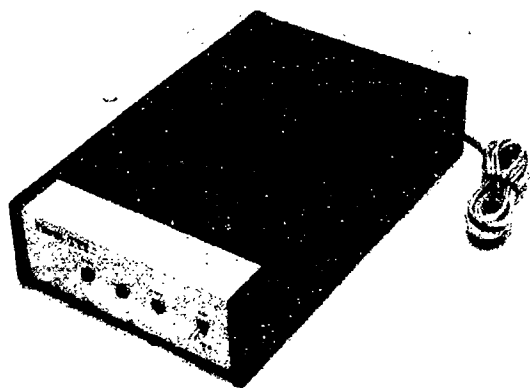

**Product Name:** Phone-TTY CM-4 Computer Modem

**Vendor:** Phone TTY, Inc.

**Computer:** IBM PC Family

**Size:** 8" x 5" x 2.5"

**Cost:** \$349.00

Phone-TTY CM-4 Computer Modem is a modem that can communicate in either Baudot (TDD) code or ASCII (standard computer) code. The user connects the modem to a computer via the RS-232 port, and sends and receives messages via the computer. The CM-4 Modem is compatible with both US and International modes of TDD communication, and with ASCII communication at 110 or 300 baud. The modem automatically detects the code of the incoming call and responds appropriately.

The Phone-TTY CM-4 Computer Modem is designed to be used only with special software: PC/TDDA Software (see entry). This software allows the user to send and receive messages, auto-dial phone numbers, and automatically answer and record incoming calls. PC/TDDA Software is designed for the IBM-PC, running under PC-DOS. The CM-4 Modem and this software are sold as a package: the price listed is for both items.

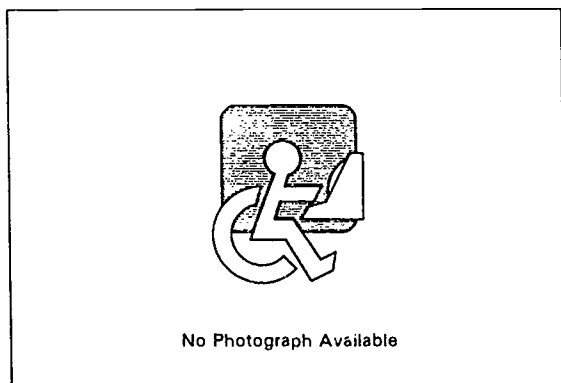

**Product Name:** Porta Printer Plus

**Vendor:** Telcom International

**Weight:** 5 lbs.

**Cost:** Contact manufacturer

Porta Printer Plus is a TDD with a 20 character thermal line printer and a 20 character fluorescent display. Porta can be used as a display only device or with display and printer operating simultaneously. Characters in the display can move across the screen in the traditional right to left mode or in a smooth left to right wrap-around mode. The device comes with a carrying case and an AC adapter/charger.

Optional features include dual acoustic/direct connect capability and ASCII code format.



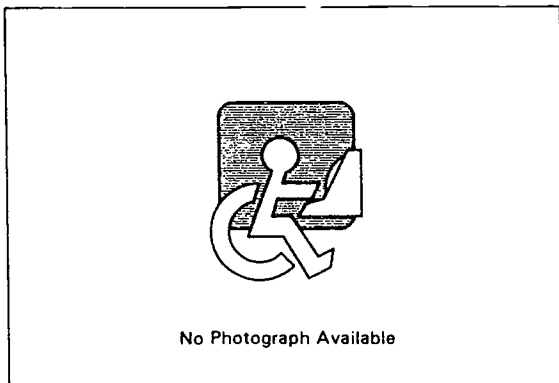

**Product Name:** PortaView

**Vendor:** Telcom International

**Size:** 10" x 2.5"

**Weight:** 3 lbs.

**Cost:** \$219.00 - \$269.00

PortaView is a line of three portable and lightweight TDDs. Each model features a four row keyboard and a 20-character display.

PortaView Junior has the above standard features and a 3-hour rechargeable battery. PortaView Senior includes the standard features plus direct connect, keyboard dialing, auto answer, international code, and a printer port (printer not included). PortaView Plus includes the features of PortaView Junior and Senior plus 8,192 character memory, memory dialing, tone pulse dialing, built-in directory, remote message retrieval, electronic voice, and an optional ASCII code modem.

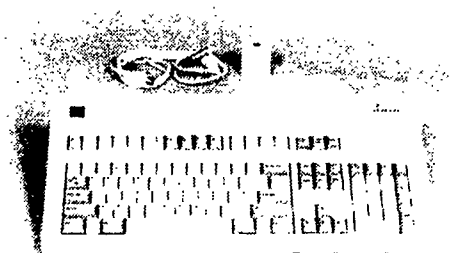

**Product Name:** Positron Express

**Vendor:** HARC Mercantile, LTD

**Computer:** IBM PC Family

**Cost:** Contact manufacturer

Positron Express is a computer keyboard with built in TDD/TT permitting direct communication with a TDD/TT caller. The device replaces the standard computer keyboard and simply connects to any telephone. An LCD display shows the conversation and a built-in printer provides a record of each call. Communication can be in Baudot or ASCII. The 102 key and 12 function key keyboard can function as the PC keyboard as well.

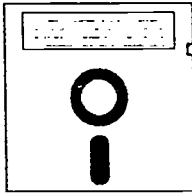

**Product Name:** SIDD (Software Interface for the Deaf and Disabled)

**Vendor:** Comm-Tel

**Computer:** IBM PC Family

**Manual Form:** Electronic Manual, Printed Manual

**Cost:** \$1,050.00

SIDD is a software program that allows an organization to provide voicemail capabilities to TDD callers. SIDD is installed on an IBM compatible PC and connected to the organization's TDD number. TDD callers then access automated information about the organization or can chat with a representative. The software can be customized in a number of ways with simple to detailed menu layouts with sub-categories.

Price includes software, TDD modem, installation manual, basic use manual, and necessary cables. Contact manufacturer for further details.

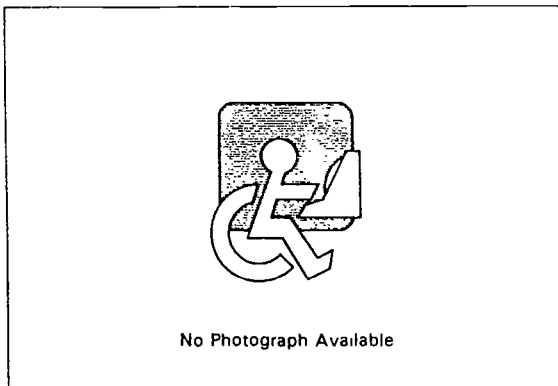

**Product Name:** SM85 Smart ASCII/Baudot Modem

**Vendor:** Krown Research, Inc.

**Computer:** All (Hardware Independent)

**Size:** 9.5" x 6.25" x 1.38"

**Weight:** 1.25 lbs.

**Power Source:** 120V AC

**Cost:** \$349.00 - \$428.00

SM85 Smart ASCII/Baudot Modem is a modem that allows devices that communicate in standard computer ASCII code to communicate with TDDs, which commonly communicate in Baudot code. The SM85 Modem receives an incoming call, determines whether the call is in ASCII or Baudot code, and responds accordingly. The messages are relayed to the user's computer (or other ASCII terminal) in ASCII code. The user's responses are translated into the correct code for transmission to the caller. The SM85 can be programmed to automatically send a message to incoming callers. Memory holds up to 4,096 characters, and the user can store commonly-used responses, log-on numbers, or passwords. Automatic dialing of up to 10 pre-programmed phone numbers is possible.

The SM85 connects to the phone line with an standard modular phone jack. Connection to the user's terminal or computer is via an RS-232 serial port (RS-232 cable and adapter are included), communicating at a rate of 300 Baud. BBS firmware is available on request. The SM85 is \$349.00, or \$428.00 including a clock calendar.

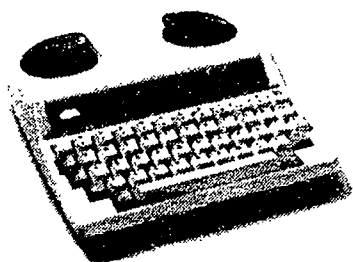

**Product Name:** Supercom 4400 TTY

**Vendor:** Ultratec, Inc.

**Size:** 8.9" x 10" x 2.5"

**Weight:** 2.5 lbs.

**Power Source:** Rechargeable batteries

**Cost:** \$339.00

Supercom 4400 TTY is a non-printing TTY with a four row, 50-key keyboard and a 20-character display. Turbo Code for real time conversations and Auto ID are standard features of the Supercom 4400. In addition, Supercom has a programmable relay voice announcer which directs a hearing caller to call a relay service. A 32K memory enables the user to name and save conversations, memos, outgoing messages, and telephone numbers in a directory. Auto-Answer allows Supercom to work like a TTY answering machine with remote message retrieval capabilities. A built-in ring flasher will identify incoming calls.



**Product Name:** Superprint 100, 200, 400

**Vendor:** Ultratec, Inc.

**Size:** 12.5" x 9" x 3"

**Weight:** 4.75 lbs.

**Power Source:** Rechargeable batteries

**Cost:** \$399.00 - \$529.00

Superprint is a portable TDD with a 20-character vacuum fluorescent display and a built-in 24-column printer. Superprint has a 8,000 character memory for composing and sending messages, and is available with the capability of automatically answering incoming calls and sending a stored message to the caller. Superprint is also available with the capability of sending ASCII code as well as the standard Baudot code.

The Superprint line consists of three models. Superprint 100 must be hooked to an external printer (extra) in order to print. Superprint 200 comes with a built-in 24-column printer. Superprint 400 comes with the auto-answer feature, and can be directly connected to a phone line without using the receiver. All models come with a hard case. ASCII capability can be added to any of the units for \$49.95. A TDD Announcer feature is available for both new and existing Superprint models. A large visual display is also available, with several options as to the color in which the characters appear; contact manufacturer for details.

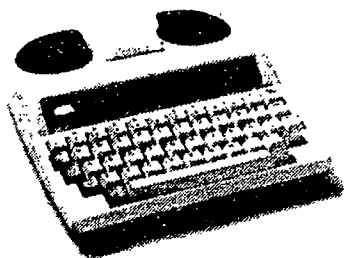

**Product Name:** Superprint 4425

**Vendor:** Ultratec, Inc.

**Size:** 10" x 9.5" x 3"

**Weight:** 3.6 lbs.

**Power Source:** Rechargeable batteries

**Cost:** \$499.00

Superprint 4425 is a printing TTY with a four row, 50-key keyboard and a 20-character display. Superprint 4425 has the same Auto ID and Turbo mode technology as the Miniprint 425 that allows for real time conversation. In addition, Superprint has a relay voice announcer which directs a hearing caller to call a relay service. A 32K memory enables the user to name and save conversations, memos, outgoing messages, and telephone numbers in directories. An auto answer feature of the Superprint 4425 allows the device to work like a TTY answering machine with remote message retrieval. The Superprint 4425 also includes time and date stamping and a built in ring flasher.

ASCII code, a built in ring flasher, and printing of the date and time are optional features.

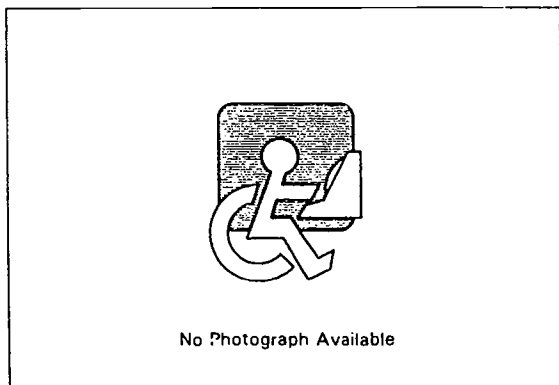

**Product Name:** Superprint ES TTY

**Vendor:** Ultratec, Inc.

**Size:** 12.5" x 9" x 3"

**Weight:** 4.75 lbs.

**Power Source:** Batteries or AC adapter

**Cost:** \$650.00

The Superprint ES is a telecommunication device for the deaf (TDD) designed for use by emergency services personnel who may receive TTY calls from persons who are deaf. The unit consists of a TTY keyboard and electronic display, and a built-in printer. The date and time is printed at the beginning of each call. Phone numbers may be stored in memory; the last 3,000 characters of conversation are automatically stored and may be reprinted. Superprint ES can accept calls in either ASCII (computer) or Baudot code. An Auto-Answer feature works as an answering machine to record TTY calls.

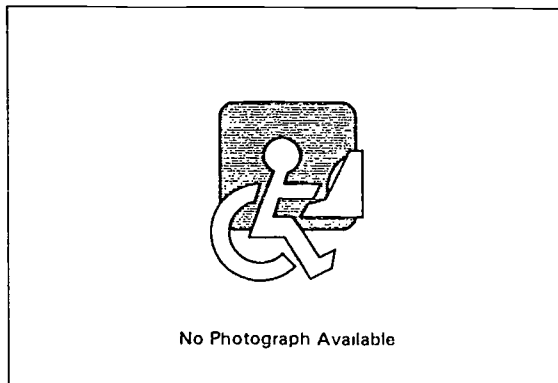

**Product Name:** TDD 2700, 2730, and 2830

**Vendor:** AT & T Accessible Communication Products Center

**Weight:** 2.5 - 3 lbs.

**Cost:** \$249.99 - \$549.99

TDD 2700, 2730, and 2830 are lightweight telecommunication devices for the deaf. All models have an alpha-numeric keyboard, 20 character lighted display, signal indicator (which shows dial tone, ringing, and busy signal), connector for external printer, low battery indicator. The TDDs have sensitivity switches to compensate for telephone line static. The handset couplers fit both round and square handsets. In addition to these features, some models have a pulse dialing feature and can run on standard household current as well as rechargeable batteries.

TDD 2700 costs \$249.99 and weighs 2.5 lbs.; TDD 2730 costs \$369.99, TDD 2830 is \$549.99.

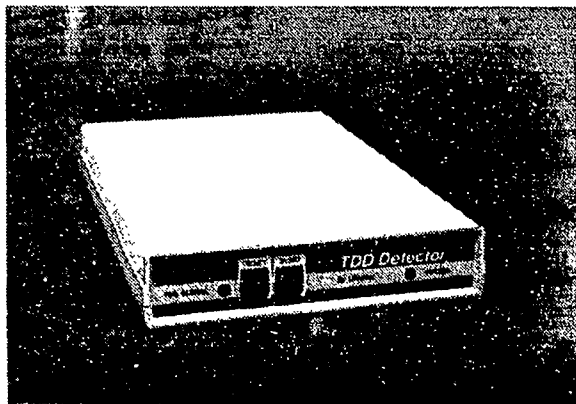

**Product Name:** TDD Detector

**Vendor:** Ultratec, Inc.

**Size:** 1.4" x 6.3" x 9.5"

**Weight:** 1.3 lbs.

**Power Source:** AC adapter

**Cost:** \$359.00

TDD Detector is a telephone line monitoring device designed to alert emergency service workers to an incoming TDD call. The unit continuously monitors an incoming phone line; when a TDD call is detected, TDD Detector alerts the operator with a built-in voice announcement. The device can also transmit a message to the TDD caller while the call is transferred to a TDD-equipped operator or while a TDD is connected to the phone line.

TDD Detector recognizes Baudot TDD code. The device has two standard telephone jacks, an off-hook input jack, and a speaker output phone jack. Contact the manufacturer for specific price and telephone system information.



**Product Name:** TeleBraille III

**Vendor:** TeleSensory Corporation

**Size:** 9" x 9"

**Power Source:** Rechargeable batteries

**Cost:** \$5,750.00

TeleBraille III is a modified TDD system that provides braille input and output. The system consists of two units. One resembles a standard TDD, with a standard alphabet keyboard and visual character display; the other has a braille keyboard and refreshable braille display. In face-to-face conversation, the sighted speaker types text into the standard TDD unit, and the text is translated into braille and can be read by the deaf-blind speaker on the refreshable display. Conversely, the braille text entered by the deaf-blind user appears as standard text on the sighted speaker's visual display. The TeleBraille system can also be used to communicate with other standard TDDs over telephone lines using either Baudot or ASCII code.

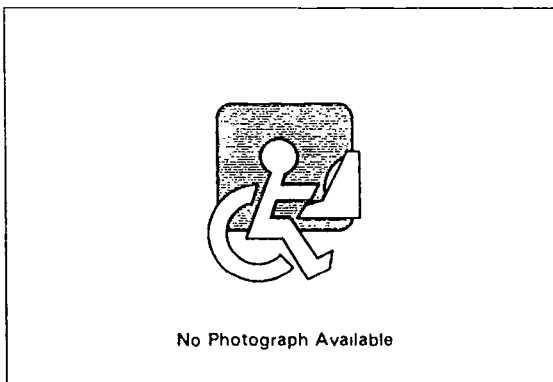

**Product Name:** TeleView 40 & 80

**Vendor:** Telcom International

**Cost:** \$399.00 - \$499.00

TeleView 40 & 80 is a series of six models of printing TDDs. The standard unit features a high speed, thermal printer, a 20 character display, and a 49-key, four row keyboard with 18 function keys. Each model also features a built-in voice announcement, international and American speed, and 32K memory. TeleView operates in Baudot code.

The TeleView 40 line and the TeleView 80 line differ only in the size of the printer. Model 40 uses 3" paper and Model 80 uses 4.25" paper. The Model 40T and 80T feature built-in direct connect to save time and to use the unit without a telephone handset, an auto answering machine with multiple outgoing messages, and remote message retrieval. Model 40TDD and 80TDD are each a telephone and TDD in one unit, have a built-in ringer and on/off switch, and will hang up the phone with a push of a button. Optional features available for all models include: large display for visually impaired users, clock and calendar, built-in phone flasher, and ASCII code modem.

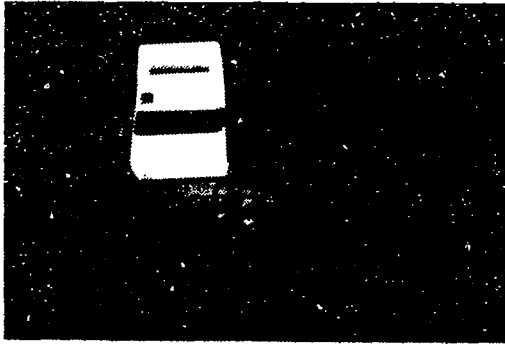

**Product Name:** ToneTalker

**Vendor:** Consultants for Communication Technology

**Size:** 4" x 2" x 0.5"

**Weight:** 8 oz.

**Power Source:** 9V battery

**Cost:** \$300.00

ToneTalker is a portable text telephone device that enables a hearing impaired person to see messages sent from any touchtone phone. The device has a display and a microphone on a suction cup that attaches to the telephone receiver. The person on the other end of the line uses the keys on the touchtone telephone to spell words that are displayed on the display of the ToneTalker. Built-in words and phrases are generated by a two-key code.

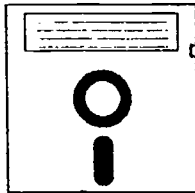

**Product Name:** UltraSilent

**Vendor:** DiRAD Technologies, Inc.

**Cost:** Contact manufacturer

UltraSilent enables personal computer-based automated telephone systems to be directly accessible to individuals who use Telecommunication Devices for the Deaf (TDDs). Typically, such automated telephone systems offer a variety of features such as automated attendant, voice mail, transaction processing, and interactive voice response (IVR), and are generally purchased by businesses, government agencies, and other organizations with a relatively large volume of incoming calls from customers or consumers. The incorporation of UltraSilent technology on such systems makes their services directly and equally accessible.

UltraSilent can be purchased on DiRAD's own automated telephone system or can be incorporated onto virtually any other manufacturer's automated telephone system.



**Product Name:** Uniphone 1000

**Vendor:** Ultratec, Inc.

**Size:** 8.6" x 7.1" x 2.5"

**Weight:** 1 lb., 12.5 oz

**Power Source:** 9V battery

**Cost:** \$229.00

Uniphone 1000 is a combination TTY, standard telephone with volume control, and Voice Carry Over (VCO). Uniphone has a four row QWERTY keyboard with an LCD display of two lines of 24 characters. Turbo Code technology allows for near real-time conversations and Auto ID lets hearing people know that a TDD is calling. VCO facilitates more natural conversation for users who can speak but not hear and wish to use both voice and text at the same time. In addition, it is helpful for calls placed through a relay service. Uniphone operates on standard Baudot code.

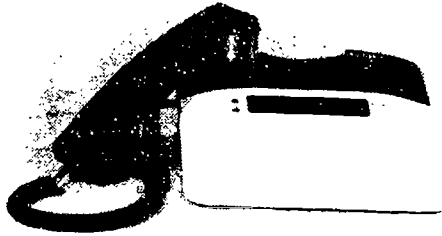

**Product Name:** Uniphone TDD/TT

**Vendor:** HARC Mercantile, LTD

**Cost:** Contact manufacturer

Uniphone combines standard telephone and TDD/TT functions. Uniphone features three modes for communicating: voice mode allows voice to text communication, TDD/TT mode allows TDD/TT text to text communication, and Voice Carry Over (VCO) mode allows both voice/text communication. A signal light shows what mode is being used. Other features include: a display key to control the contrast of the two-line display window, volume key for amplification of the handset and ring switch to set loudness of the ring, timer to keep track of the length of calls, Turbo Code in the TDD/TT mode, and 9V battery for usage during power failure.





**Product Name:** VCS 3500 with TDD Software

**Vendor:** Microlog Corporation

**Computer:** IBM PC Family

**Cost:** \$15,000 - \$100,000

The Voice Connect System (VCS) 3500 is a software-based telephone communications system which has voice mail, automated transaction processing, and automated attendant capabilities. The TDD Software module which is available for this system allows persons with telecommunications devices for the deaf to utilize all the functions of a VCS 3500 system. When a TDD user places a call to a number which uses VCS 3500, the person is given a menu of options from an automated attendant which can transfer or forward calls and take messages. From this menu, the user can access any of the system's functions including accessing public information services, such as job lines or transportation schedules, which use an automated audiotex message format. The automated transaction processing function interacts with TDD callers who are requesting forms, publications, or specific documents to be sent to them; information from callers can be transcribed without disrupting the system.

For more information about the configuration of the VCS 3500 contact the manufacturer. Price of the system depends on particular configuration but the base system cost is \$15,000.

---

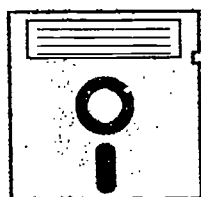

**Product Name:** WinTalk

**Vendor:** Microflip, Inc.

**Computer:** IBM PC Family

**Cost:** \$49.95

WinTalk is a telecommunications software program designed to work with the MIC300i Internal Modem (see entry) and Microsoft Windows, allowing the computer and modem to be used for TDD communication. The icon-driven program features multi-tasking that allows the user to receive and record incoming messages in the background while working with another application. The icon library includes such features as: Rolodex, call transfer, privacy screen lock, alarm clock, calculator, diary, library of fonts, identify caller, and many other features for managing, placing, and answering calls.

WinTalk will work under OS/2, Windows 3.1, Windows for Workgroups 3.11, and Windows NT.

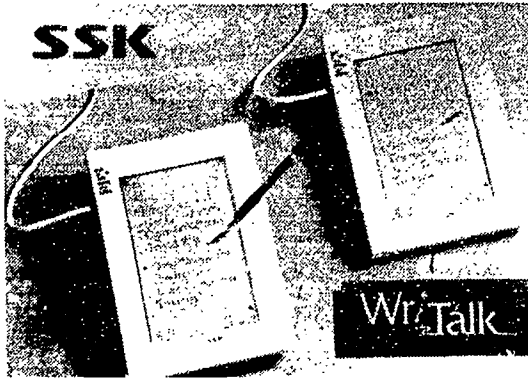

**Product Name:** Writalk Electronic Pen Pad

**Vendor:** SSK Technology, Inc.

**Weight:** 1.15 lbs.

**Power Source:** 120V AC

**Cost:** \$1,999.00

Writalk is a device that allows users to have written conversations with other Writalk users over ordinary telephone lines. Letters and pictures that are written on one pad simultaneously appear on the receiver's pad. The device is equipped with screen storage and will print to a fax machine. Writalk also features an answering machine function and an auto access function that allows preprogrammed numbers to be dialed with the touch of a button.

# Chapter 8

## Switches and Controls

This chapter includes separately marketed switches and user interfaces (such as joysticks). It covers the wide variety of special switches designed to be operable by people with different physical capabilities. A variety of aids can be controlled with switches, including environmental controls (see Chapter 9), communication aids and training devices (see Chapters 3 and 5), and computer access systems (see Chapter 12).

All switches perform the same basic function: they close and open an electrical circuit; that is, they turn something on and off. Some are single switches (which control one circuit), and some are dual or multiple switches. Unless otherwise specified, all the switches are "momentary contact" (the switch is "on" only while the user is activating it) and "normally open" (the switch is on while the user is activating it, off when the user is not activating it). Devices for changing these two modes of operation can be found in Chapter 3.

Switches and user controls which only work with a single communication aid are listed as accessories for that aid. Those that are designed to work only with a particular computer and are not generally usable with other devices do not appear here, but are listed in Chapter 12 or Chapter 13.

Switches have their own separate cross reference index (Index 3) where they are listed by their input and output features. Appendix B lists Service Centers which will evaluate people for selecting switches and controls.

*The following product entries appear in this chapter:*

- 4-Plate Switch: CM-15, 201
- 4-Pneumatic Switch: CM-17, 201
- 4-Pushbutton Switch: CM-16, 201
- 4-Switch Joystick: CM-19, 202
- 5-Pushbutton Switch: CM-18, 202
- 5-Tread Switch Slot Control: CM-50, 202
- Adjustable Pressure Switch, 203
- Air Cushion Switch, 203
- Air Cushion Switch (Single or Dual), 203
- Air Switch, 204
- Air Wave Switch, 204
- Analog Switch Pad, 204
- Arm Slot Control, 205
- Armslot Switch Controller ASC-5, 205
- BASS Switches, 205
- Big Red, Yellow, Green, and Blue, 206
- Body Parts Switch, 206
- Body Switch BS-1, 206
- Breath Input Device, 207
- Buddy Button (5710-5773), 207
- Button Switch, 207
- Button Switch, 208
- Cap Switch (5806), 208
- Capacitive Touchplate Interface, 208
- Clamp-On Bump Switch, 209
- Classic Paddle Switch, 209
- Coil Spring Wobble Stick Switch, 209
- Computer Keyboard Switch, 210
- Computer Switch Plate, 210
- Continuous Movement Switch (CMS), 210
- Controflex Foot Switches, 211
- Controflex Ribbon Switches, 211
- Control & Momentary Control Center Switches, 211
- Crestwood Converter Switch, 212
- Crestwood Touch Latch Switch, 212
- Cup Switch (5807), 212
- Cushion Switch, 213
- Custom-Made Switches, 213
- Cylindrical Touch Switch (5300), 213
- Deluxe Paddle Switch II and Mini Deluxe Paddle Switch, 214
- Double Paddle Switch, 214
- Double Sip & Double Puff Switches, 214
- Double Touch Switch, 215
- Dual Plate Switch: CM-12, 215
- Dual Pneumatic Switch: CM-14, 215
- Dual Puff-Sip Switch DPS-2, 216
- Dual Pushbutton Switch: CM-13, 216
- Dual Rocking Lever Switch, 216
- Dual Tongue Switch TS-2C, 217
- Ellipse Switches, 217
- Eyebrow Switch, 217
- Facial Switch, 218
- Finger Flex Switch, 218
- Finger Isolation Button, 218
- Flex Switch (5855), 219
- Flexi-Switch, 219
- Flexit Switch, 219
- Flexswitch II, 220
- Grasp Switch (5865), 220
- Grip & Puff Switch, 220
- Grip Switch, 221
- IID Latching Pneumatic Switch, 221
- Head Control Switch, 221
- Head Position Interface, 222
- Head Switch, 222
- Head Switch Kit, 222
- Headband Switch, 223
- High Tech/Low Cost, 223
- Intention Switch, 223
- IST Switch, 224
- Jelly Bean, 224
- Joystick, 224
- Joystick Interface Control, 225
- Joystick with Pad Switch (5012), 225
- Jumbo Plate Switch, 225
- L.T. Switch, 226
- LD Latching Puff Switch, 226
- Leaf Switch, 226
- Leaf Switch, 227
- Leaf Switch (5860), 227
- Leaf Switch: CM-2/CM-7, 227
- Left/Right Rocker Switch, 228
- Lever Switch: CM-8/CM-9, 228
- Light-Activated Switch, 228
- LightSwitch, 229
- Low Force Adjustable Rod Switch, 229
- Magnetic Finger Switch, 229
- Mat Switch, 230
- Membrane Plate Switch, 230
- Mercury Switch, 230
- Mercury Tilt Switch, 231
- Micro Light Switch (5850), 231
- Micro Switch, 231
- Mini Cup Switch (5808), 232
- Mini Joystick with Push Switch (5020), 232
- Mini Rocking Lever Switch, 232
- Minimal Motion Splint-Mounted Switch Kits, 233
- Mounting Switch, 233
- Multi-Control Press Switch, 233
- Normally Closed Sensing Cell, 234
- Normally Open Sensing Cells, 234
- Omron Switch, 234
- Overhead Pull Switch, 235
- P-Switch, 235
- Patty Cake Press, 235
- Penta Switch (5024), 236
- Petite Pillow Switch, 236
- PhotoCell Switch, 236
- Pillow Switch (5875), 237
- Pinch Switch, 237
- Pinch Switch, 237
- Plate Switch, 238
- Plate Switch, 238
- Plate Switch (5830-34), 238
- Plate Switch On Stand, 239
- Plate Switch: CM-10, 239
- Plate Switches, 239
- Plate Switches, 240
- Play Mat Switch, 240
- Pneumatic Switch, 240
- Pneumatic Switch (5100, 5101), 241
- PRC Joystick, 241
- Pressure Switch, 241
- Pressure Switch, 242
- Pull Switch, 242
- Pull Switch, 242
- Pushbutton Switch: CM-11, 243
- Remote Ability Switch Adapter, 243
- Rocker Switch (5505), 243
- Rocking Plate Switch, 244
- Roller Switch Music Box, 244
- Round Pad Switch (5805), 244
- SCATIR Switch, 245
- Sensor Switch, 245
- Shadow Switch, 245
- Signal Buzzer Plate, 246
- Signal Switch, 246
- Single Rocking Lever Switch, 246
- Sip & Puff Switch, 247
- Snappy Switch, 247
- Soft Switch (5820, 5821), 247
- Specs Switch, 248
- Sponge Nurse Call Switch, 248
- Square Pad Switch (5810), 248
- Squeeze Switch, 249
- Standard Paddle Switch, 249
- Star Switch (5026), 249
- String Switch, 250
- String Switch, 250
- Super-Sensitive Normally Open Switch, 250
- Switchskins, 251
- Tactile Touch Pad, 251
- Taction Pads, 251
- TAS Switch, 252
- Thumb Switch: CM-5, 252
- Tilt Switch, 252
- Tip Switch (5840), 253
- Tongue Switch, 253
- Tongue Switch, 253
- Touch Pads, 254
- Touch Switch: CM-4, 254
- Tread Switch: CM-1, 254
- Treadle Switch (5880), 255
- Twin Plate Switch, 255
- Twinkle Switch, 255
- Twitch Switch, 256
- Ultimate Switch, 256
- Universal Adaptive Switch System, 256
- Vertical Plate Switch, 257
- Vertical Wobble Switch, 257
- Vibration Switch, 257
- Voice Activated Switch, 258
- Voice Switch, 258
- Wafer Switch (5018), 258
- Wobble Switch, 259
- Wobble Switch, 259

*The following products from other chapters can also be used as Switches or Controls:*

- ActionVoice, 118
- Apple Computer Input Adapter, 453
- Battery Adapter, 32
- Battery Interrupter, 33
- First Aide Kit, 278
- FreeSwitch, 279
- Input Adapter, 456
- LinkSwitch, 47
- Mini-Environmental Control (ECU) Box, 286
- Peg Switch, 50
- PowerLink 2, 290
- Puzzle Switches, 51
- Step On It! Computer Control Pedals, 363
- Switch-Back, 443
- Toy Adapter Cables: CA-9/CA-12/CA-16, 60
- Toy Cables (4378, 4379), 60
- WinSCAN: Limited Edition, 464

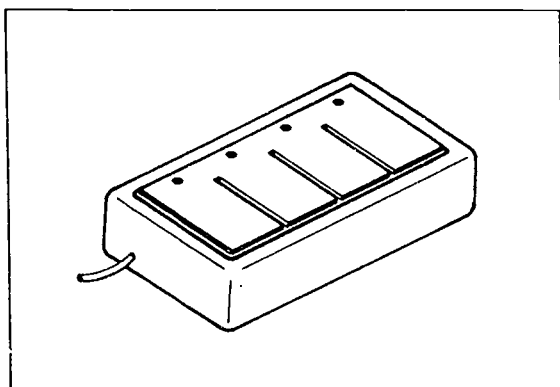

**Product Name:** 4-Plate Switch: CM-15

**Vendor:** Zygo Industries, inc.

**Number of Switches:**  
Multiple switches (3 to 16 Switches)

**Activation Pressure:** 8 oz.

**Connector Type:** 5-pin DIN

**Cost:** \$175.00 - \$210.00

4-Plate Switch is a set of four switches housed side-by-side. Each switch is activated by pressing down on its rectangular plastic plate. An audible click accompanies switch activation.

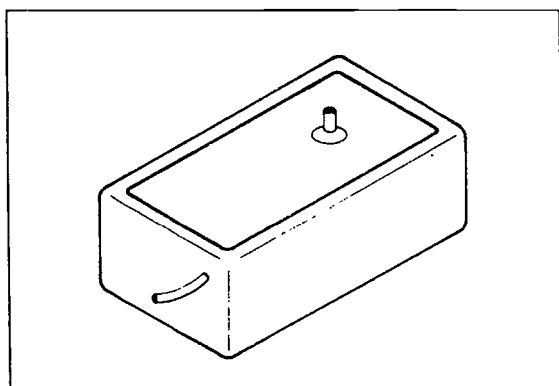

**Product Name:** 4-Pneumatic Switch: CM-17

**Vendor:** Zygo Industries, Inc.

**Number of Switches:**  
Multiple switches (3 to 16 Switches)

**Activation Pressure:** 0.1 and 0.2 psi

**Connector Type:** 5-pin DIN

**Cost:** \$290.00

4-Pneumatic Switch is a switching unit that accepts input from one sip-and-puff tube. Different combinations of light and heavy sip and puff serve to activate each of four switches. Any desired tube may be used; one is available as well from the manufacturer (extra). Switch activation is silent.

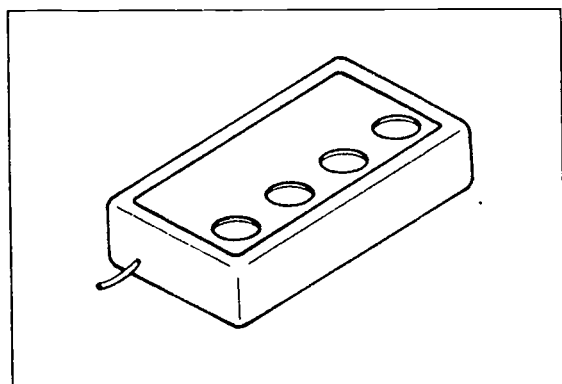

**Product Name:** 4-Pushbutton Switch: CM-16

**Vendor:** Zygo Industries, Inc.

**Number of Switches:**  
Multiple switches (3 to 16 Switches)

**Activation Pressure:** 4 oz.

**Connector Type:** 5-pin DIN

**Cost:** \$175.00

4-Pushbutton Switch is a set of four snap-action button switches housed side-by-side, each in a 0.5" diameter recess. Pressing each button activates one switch. An audible click accompanies switch activation.

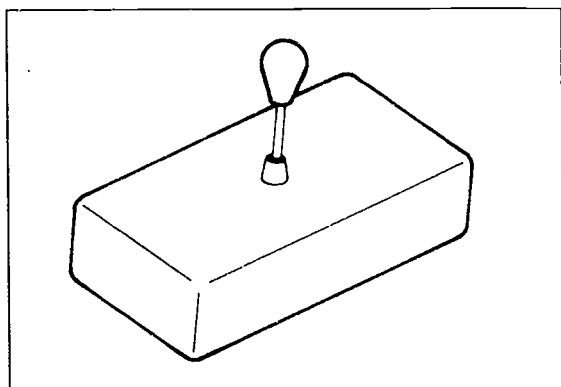

**Product Name:** 4-Switch Joystick: CM-19  
**Vendor:** Zygo Industries, Inc.  
**Number of Switches:** Joystick (4 or 5 Switches)  
**Activation Pressure:** 11 oz.  
**Connector Type:** 5-pin DIN  
**Cost:** \$345.00

4-Switch Joystick is a joystick lever that may be moved in any of four directions. Moving it in a particular direction will activate one switch. This joystick is also available with an additional pushbutton switch.

---

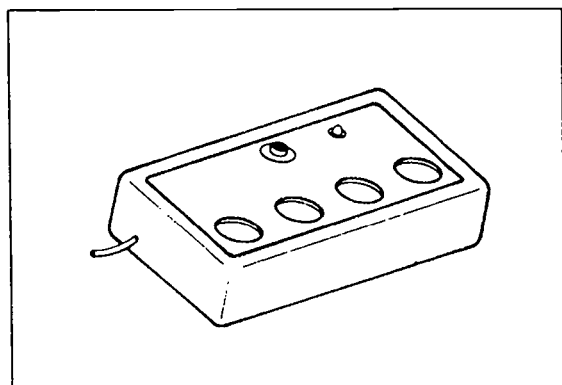

**Product Name:** 5-Pushbutton Switch: CM-18  
**Vendor:** Zygo Industries, Inc.  
**Number of Switches:**  
Multiple switches (3 to 16 Switches)  
**Activation Pressure:** 6 oz.  
**Connector Type:** 7-pin DIN  
**Cost:** \$290.00

5-Pushbutton Switch is a set of four snap-action button switches housed side-by-side, each in a 0.5" diameter recess, with an additional raised pushbutton on the same housing. All switches are activated by being pressed. An audible click accompanies switch activation.

---

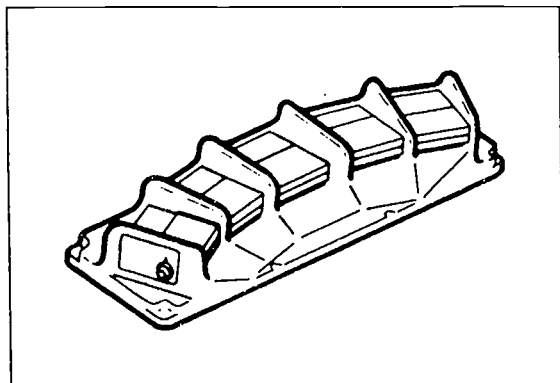

**Product Name:** 5-Tread Switch Slot Control: CM-50  
**Vendor:** Zygo Industries, Inc.  
**Number of Switches:**  
Multiple switches (3 to 16 Switches)  
**Activation Pressure:** 5 oz.  
**Connector Type:** 7-pin DIN  
**Cost:** \$315.00 - \$345.00

5-Tread Switch Slot Control is a set of five Tread Switches (see Tread Switch, Zygo Industries, Inc.) mounted in an arc array, with dividers between them. The user activates the switches by moving the arm (or other activator) into the appropriate slot and pressing down on the switch. Activation produces a click.

---

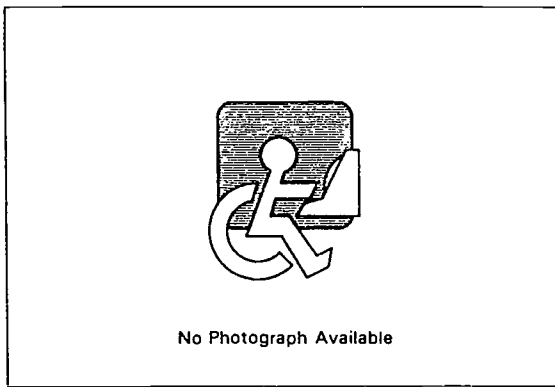

**Product Name:** Adjustable Pressure Switch  
**Vendor:** Nassau Applied Technology Resource Center  
**Cost:** \$108.00

Adjustable Pressure Switch is an air switch with adjustable sensitivity. An internal Call Buzzer is included.

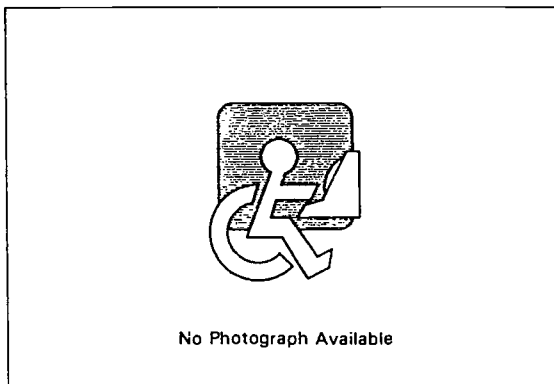

**Product Name:** Air Cushion Switch  
**Vendor:** Toys for Special Children, Inc.  
**Number of Switches:** Single Switch  
**Connector Type:** 1/4" or 1/8" phone plug  
**Cost:** \$41.00

The Air Cushion Switch is activated by mild pressure on the cushion.



**Product Name:** Air Cushion Switch (Single or Dual)  
**Vendor:** Prentke Romich Company  
**Number of Switches:** Dual Switch, Single Switch  
**Activation Pressure:** 1.7 oz.  
**Connector Type:** Mini-phone plug  
**Cost:** \$125.00 - \$235.00

These switches consist of an air bellows with a tube leading from it to a switching unit. A light touch on the bellows sends air pressure to the switching unit, where the change in pressure activates a switch. Switching units are available with one or two sets of bellows for single or dual switching. The bellows have a threaded hole for mounting. The single switch (ACS-1) is \$125.00; the dual switch (ACS-2) is \$235.00.

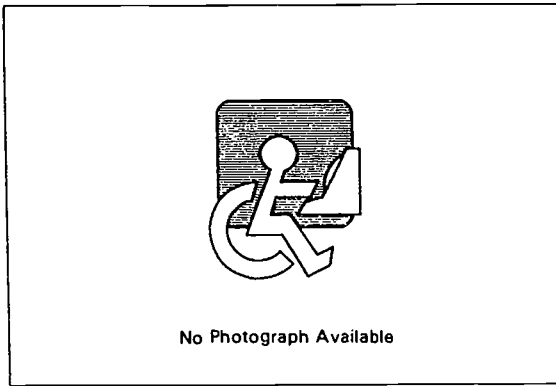

**Product Name:** Air Switch

**Vendor:** Nassau Applied Technology Resource Center

**Cost:** \$78.00 - \$95.00

Air Switch is activated by squeezing the attached bellows. Three models are available: standard, with internal buzzer, and adjustable pressure with buzzer.

---

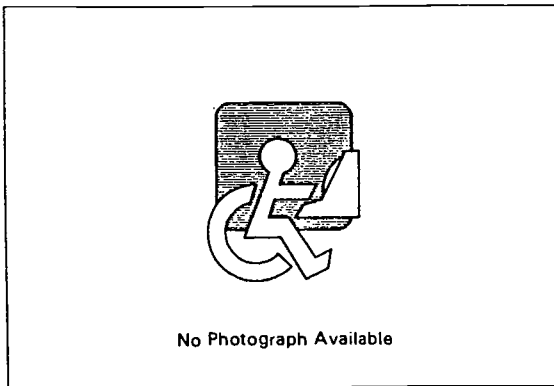

**Product Name:** Air Wave Switch

**Vendor:** Tapeswitch Corporation

**Number of Switches:** Single Switch

**Cost:** \$102.30

Air Wave Switch is a high sensitivity membrane switch that operates from light air pressure or vacuum. Adjustable contact permits normally-closed operation. Contact manufacturer for further technical information.

---

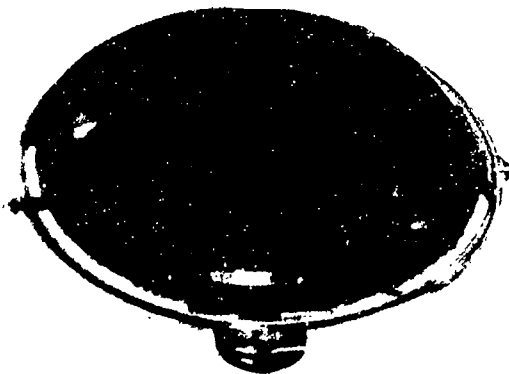

**Product Name:** Analog Switch Pad

**Vendor:** Academic Software, Inc.

**Number of Switches:** Single Switch

**Activation Pressure:** 0.5 - 32 oz.

**Connector Type:** 3.5 mm phone jack

**Cost:** \$89.00 - \$99.00

Analog Switch Pad is a touch-activated, force-adjustable, low-voltage DC electronic switch that features a large activation area that is soft and compliant to the touch. Other features include a small LED lamp that glows when the switch is activated by user pressure and a cable to connect the Switch Pad with other controls or computer interfaces.

---





**Product Name:** Arm Slot Control

**Vendor:** Prentke Romich Company

**Number of Switches:**  
Multiple switches (3 to 16 Switches)

**Activation Pressure:** 4.6 oz.

**Connector Type:** DC-9 connector

**Cost:** \$360.00

Arm Slot Control is a semicircular array of five lever switches, each in its own slot. The user can activate any of the switches by guiding an arm into the slot and then pressing down on the switch. Dividers between the switches prevent more than one switch from being activated at a time. An audible click is heard when a switch is activated.

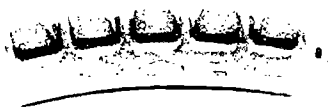

**Product Name:** Armslot Switch Controller ASC-5

**Vendor:** APT Technology, Inc.

**Number of Switches:**  
Multiple switches (3 to 16 Switches)

**Connector Type:** P310 connector

**Cost:** \$310.00

The Armslot Switch Controller ASC-5 contains five paddle switches arranged in a semicircle so that arm movement cannot activate more than one switch at a time. The switch functions (forward, back, left, right, and select) may be installed in any slot in the configuration best suited to the user. An audible click is heard when a switch is activated.

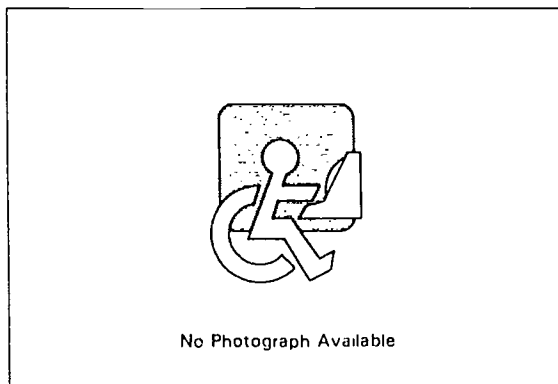

**Product Name:** BASS Switches

**Vendor:** Don Johnston Incorporated

**Cost:** \$48.00 each

BASS Switches are large area single switches. The surface area of the switches is 6" x 3.75". The switches provide auditory feedback when activated. BASS switches are available in six colors: blue, yellow, red, green, black, and white. The black and white ones can be purchased together for \$90.00, the other colors together for \$175.00, or individual switches are \$48.00.



**Product Name:** Big Red, Yellow, Green, and Blue  
**Vendor:** AbleNet, Inc.  
**Number of Switches:** Single Switch  
**Activation Pressure:** 20 - 30 g  
**Connector Type:** Mini-phone plug  
**Cost:** \$42.00 each

Big Red, Yellow, Green, and Blue are single push switches made of shatterproof plastic. The switches are 5" in diameter and may be activated by a light touch anywhere on the top surface. They come with a six foot cable and a mini-phone plug connector. An audible click is provided when switch is activated. Each color is sold separately.

---

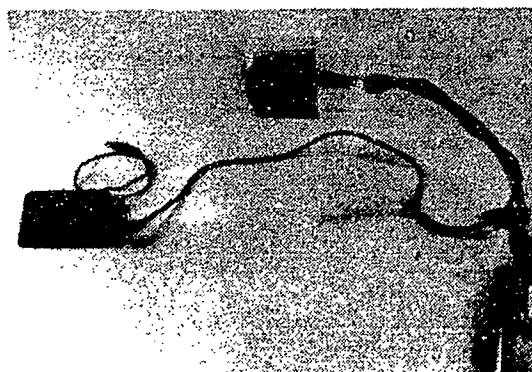

**Product Name:** Body Parts Switch  
**Vendor:** Therapeutic Toys, Inc.  
**Number of Switches:** Single Switch  
**Cost:** \$99.95

The Body Parts Switch is a pressure activated switch mounted on a gooseneck extension with clamp mounting.

---



**Product Name:** Body Switch BS-1  
**Vendor:** APT Technology, Inc.  
**Number of Switches:** Single Switch  
**Activation Pressure:** 3 oz.  
**Connector Type:** Mini-phone plug  
**Cost:** \$49.00

The Body Switch is a single switch with a 1.5" diameter pushbutton. The switch is activated by pressure from any convenient body part and can withstand up to 100 lbs. of pressure. Activation is accompanied by an audible click. The Body Switch is intended for use with any device requiring a low current, single switch signal.

---



**Product Name:** Breath Input Device  
**Vendor:** Neil Squire Foundation  
**Number of Switches:** Dual Switch  
**Activation Pressure:** 2" of water  
**Connector Type:** See text  
**Cost:** \$250.00

Breath Input Device (formerly Breath Switch) is a dual switch operated by sip and puff. Three different connectors are available: IBM game port, 25-pin serial, and 9-pin serial. A 25-pin serial will be sent unless otherwise specified.

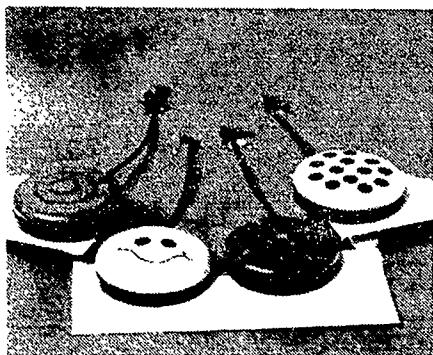

**Product Name:** Buddy Button (5710-5773)  
**Vendor:** TASH, Inc.  
**Cost:** \$39.00

Buddy Buttons are round switches available in a variety of bright colors: red, green, purple, pink, yellow, and blue. Also available in the following patterns: red plaid, yellow smiley face, blue and green bulls-eye, and yellow and red polka dots.



**Product Name:** Button Switch  
**Vendor:** Creative Switch Industries  
**Number of Switches:** Single Switch  
**Cost:** \$34.50

Button Switch is a switch activated by pressing on a round sensing pad with at least one ounce of pressure. The sensing pad is 0.30" in diameter. The switch has an adhesive back and 18" of cord.

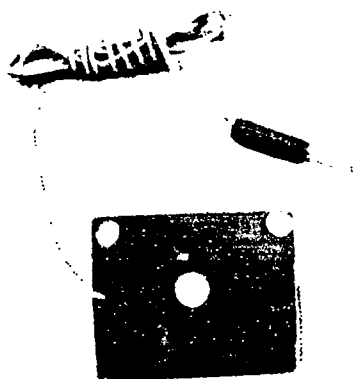

**Product Name:** Button Switch

**Vendor:** Toys for Special Children, Inc.

**Number of Switches:** Single Switch

**Connector Type:** 1/4" or 1/8" phone plug

**Cost:** \$21.00

Button Switch is activated by pressing a button similar to a doorbell. The button is mounted on a rectangular base with suction cup feet.

---



**Product Name:** Cap Switch (5806)

**Vendor:** TASH, Inc.

**Number of Switches:** Single Switch

**Activation Pressure:** 9 oz.

**Connector Type:** 3.5 mm phone plug

**Cost:** \$40.00

Cap Switch is a small single switch controlled by pressing the top surface. Cap Switch provides auditory feedback upon activation.

---

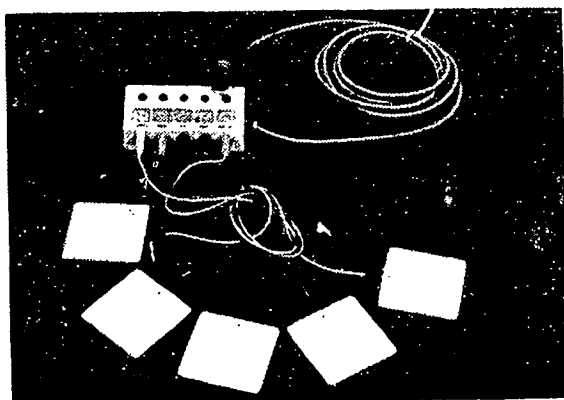

**Product Name:** Capacitive Touchplate Interface

**Vendor:** Hugh MacMillan Rehabilitation Centre

**Number of Switches:**

Multiple switches (3 to 16 Switches)

**Activation Pressure:** None

**Connector Type:** 9-pin DIN or Bundy 14

**Cost:** \$1,200.00

The Capacitive Touchplate system has five individual capacitive touch plate channels. The touch plate is operated from the body's capacitance and requires only contact, no pressure. Three versions are available that alter positions and sizes, to adapt for limited range of motion or force output. The system can control communication aids or wheelchairs.

---

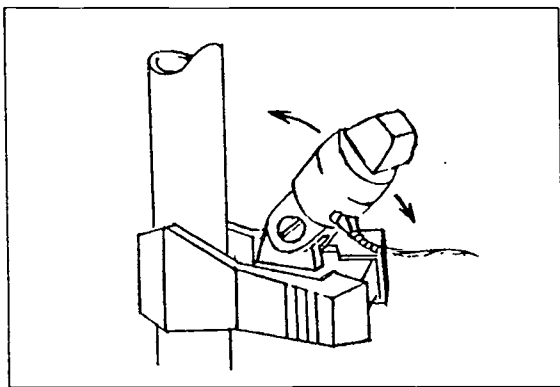

**Product Name:** Clamp-On Bump Switch  
**Vendor:** Luminaud, Inc.  
**Number of Switches:** Single Switch  
**Activation Pressure:** 2 oz. or 4 oz.  
**Connector Type:** 3.5 mm phone plug  
**Cost:** \$45.00

Clamp-On Bump Switch is activated by 2 oz. of pressure on its tip. This switch is designed to be attached to a bed, chair, table, etc. and activated by any convenient part of the body. Both momentary and toggle models are available.



**Product Name:** Classic Paddle Switch  
**Vendor:** Creative Switch Industries  
**Number of Switches:** Single Switch  
**Activation Pressure:** 2 lbs.  
**Connector Type:** Mini-phone plug  
**Cost:** \$60.00

Classic Paddle Switch is a single switch activated by pressing on a treadle lever. The base of the switch is made of aluminum with a non-skid base. The treadle travels one inch.

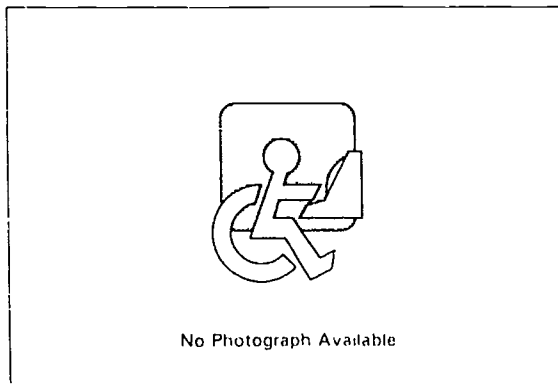

**Product Name:** Coil Spring Wobble Stick Switch  
**Vendor:** Creative Switch Industries  
**Number of Switches:** Single Switch  
**Activation Pressure:** 3 oz.  
**Connector Type:** Mini-phone plug  
**Cost:** \$98.50

Coil Spring Wobble Stick Switch is a single switch activated by any movement of a 4.5" flexible coiled spring. The base is oak. The switch is available for vertical mounting, with either normally open or normally closed contacts.

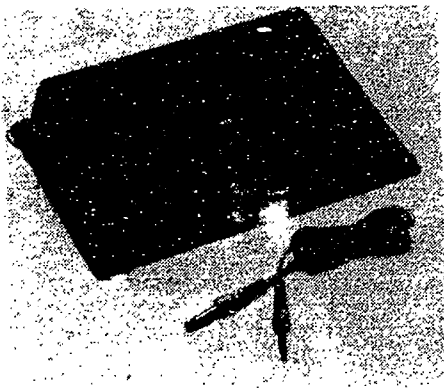

**Product Name:** Computer Keyboard Switch  
**Vendor:** Toys for Special Children, Inc.  
**Number of Switches:** Single Switch  
**Connector Type:** 1/4" or 1/8" phone plug  
**Cost:** \$60.00

Computer Keyboard Switch is a small version of a computer keyboard that functions as a single switch. Pressing any key activates the same switch closure. This switch is designed to accustom the user to causing an event by pressing on a keyboard, and cannot actually function as a computer keyboard.

---

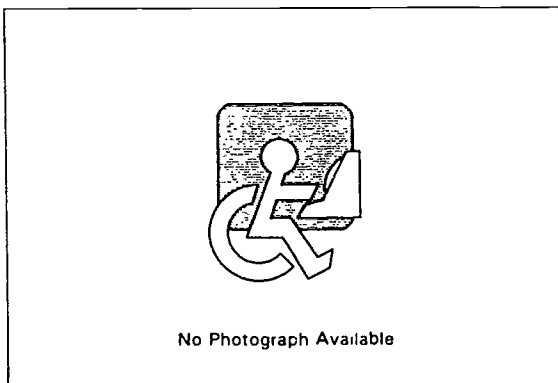

**Product Name:** Computer Switch Plate  
**Vendor:** Toys for Special Children, Inc.  
**Number of Switches:** Single Switch  
**Connector Type:** 1/4" or 1/8" phone plug  
**Cost:** \$25.00

Computer Plate Switch is a plate switch with a picture of a computer keyboard laminated to the surface of the plate. This switch is designed to accustom the user to striking a computer keyboard to achieve some effect, without the user needing to handle actual computer equipment.

---

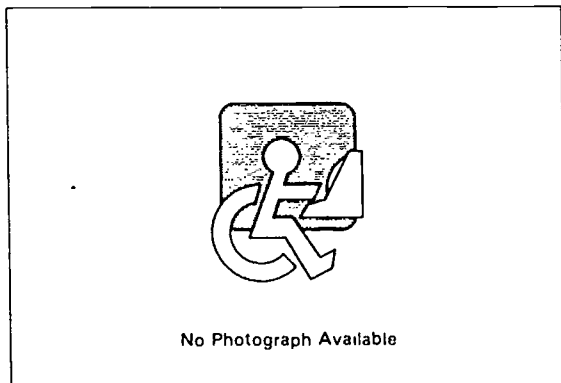

**Product Name:** Continuous Movement Switch (CMS)  
**Vendor:** Toys for Special Children, Inc.  
**Number of Switches:** Single Switch  
**Connector Type:** 1/4" or 1/8" phone plug  
**Cost:** \$98.00

The Continuous Movement Switch requires the user to keep the switch arm in motion for activation. The speed of motion can be adjusted from four to 10 RPMS and the range can be set at uni-directional rotation or bi-directional.

---

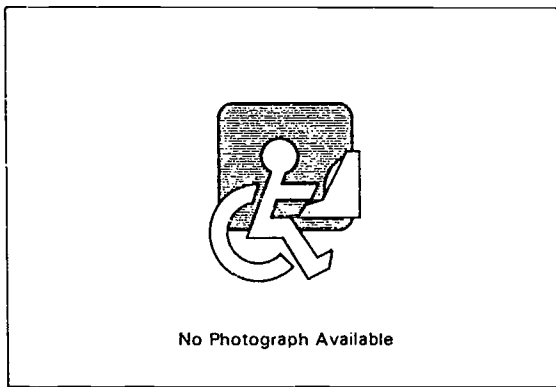

**Product Name:** Controflex Foot Switches

**Vendor:** Tapeswitch Corporation

**Number of Switches:** Single Switch

**Activation Pressure:** 40 oz.

**Cost:** \$21.25

Controflex Foot Switches are sealed, black vinyl pads rated for nominal foot pressure.

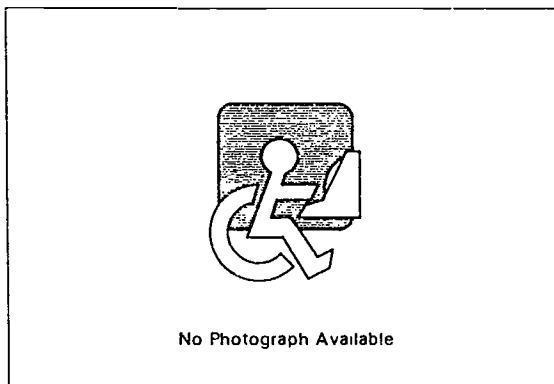

**Product Name:** Controflex Ribbon Switches

**Vendor:** Tapeswitch Corporation

**Number of Switches:** Single Switch

**Cost:** \$21.25

Controflex Ribbon Switches are normally open momentary contact switches, activated by pressing on a flat ribbon-like strip. Twelve models are available for use in a variety of situations and activation pressures. Contact manufacturer for further details.

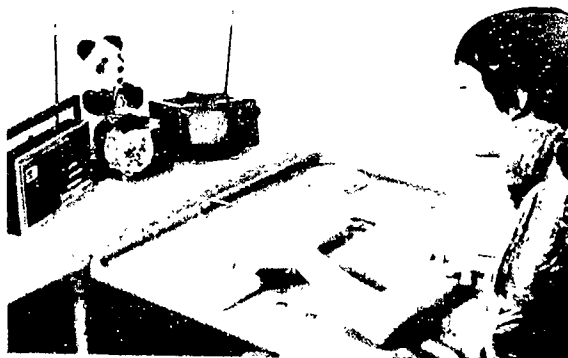

**Product Name:** Control & Momentary Control Center Switches

**Vendor:** Crestwood Company

**Number of Switches:**  
Multiple switches (3 to 16 Switches)

**Cost:** \$159.95

The Control & Momentary Control Center Switches are three touch switches built into one panel. The Control Center Switches operate in the latching mode and feature an audible click and three five-foot cables. The Momentary Control Center Switches are identical except the switch must be held down in order to operate the devices.



**Product Name:** Crestwood Converter Switch  
**Vendor:** Crestwood Company  
**Number of Switches:** Single Switch  
**Connector Type:** 1/8" phone jack and plug  
**Cost:** \$95.00

The Crestwood Converter Switch converts any momentary switch into a continuous latch switch. One touch on any momentary switch turns on the device, second touch turns it off.

---

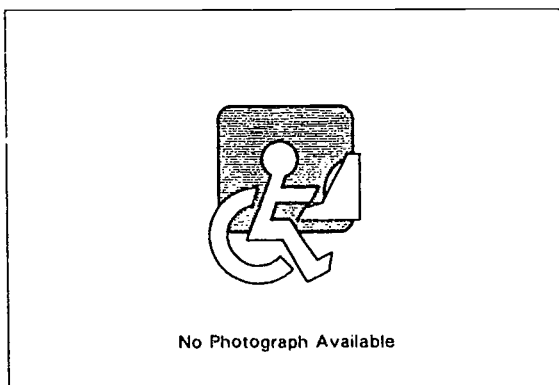

**Product Name:** Crestwood Touch Latch Switch  
**Vendor:** Crestwood Company  
**Number of Switches:** Single Switch  
**Cost:** \$90.00

The Crestwood Touch Latch Switch is a light touch switch. First touch makes switch stay on continuously, second touch turns it off. An audible click sounds when switch is activated or deactivated.

---

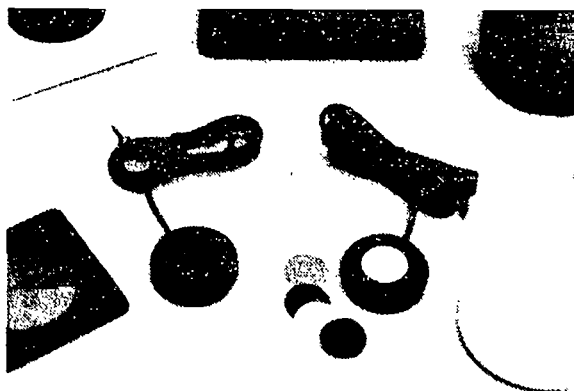

**Product Name:** Cup Switch (5807)  
**Vendor:** TASH, Inc.  
**Number of Switches:** Single Switch  
**Activation Pressure:** 9 oz.  
**Connector Type:** 3.5 mm phone plug  
**Cost:** \$50.00

The Cup Switch is a Cap Switch (see entry) "cupped" in a plastic base. The base provides a surface for easy mounting on table, pillow or wheelchair bracket. The switch is operated by pressing the top surface.

---



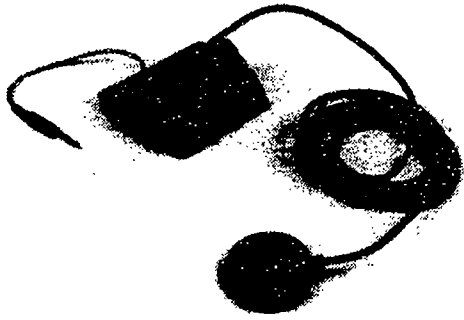

**Product Name:** Cushion Switch  
**Vendor:** Therapeutic Toys, Inc.  
**Number of Switches:** Single Switch  
**Cost:** \$48.00

The Cushion Switch is a round, pressure activated switch.

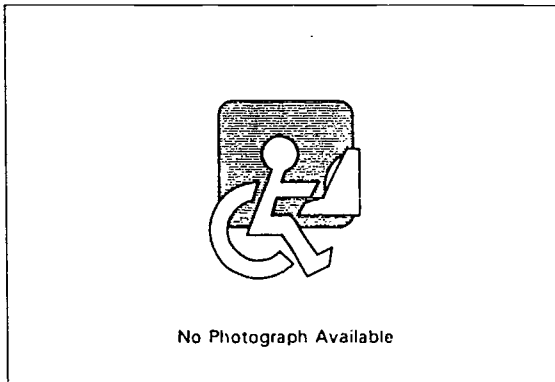

**Product Name:** Custom-Made Switches  
**Vendor:** Various (Generic Product)  
**Cost:** Varies

Generally, at least one of the commercially available switches will work for a client, even if creative mounting is required. However, sometimes existing switches do not suit highly specific needs, and many clinicians continue to make their own switches. It is important for practitioners to understand how switches work, how they will be maintained, safety issues, and product liability before attempting to construct them.

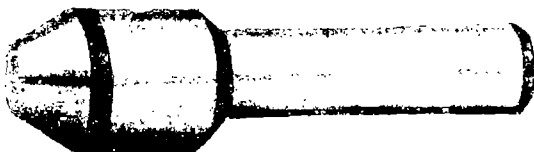

**Product Name:** Cylindrical Touch Switch (5300)  
**Vendor:** TASH, Inc.  
**Number of Switches:** Dual Switch  
**Activation Pressure:** None  
**Connector Type:** 5-Pin DIN  
**Cost:** \$350.00

Cylindrical Touch Switch is a switch activated by skin contact. Two surfaces on the switch can be contacted; each activates a different switch. Cylindrical Touch Switch requires a power supply (included) to be operated.



**Product Name:** Deluxe Paddle Switch II and Mini Deluxe Paddle Switch

**Vendor:** Creative Switch Industries

**Number of Switches:** Single Switch

**Connector Type:** Mini-phone plug

**Cost:** \$45.00 - \$53.50

Deluxe Paddle Switch is a single switch activated by pressing on a 4" x 4" acrylic plate. Activation pressure is adjustable. Deluxe II Paddle Switch has a captive lip on the plate to prevent the plate from being raised inadvertently. Mini Deluxe Paddle Switch is 2.25" x 4" and is designed for mounting on a wheelchair.

---

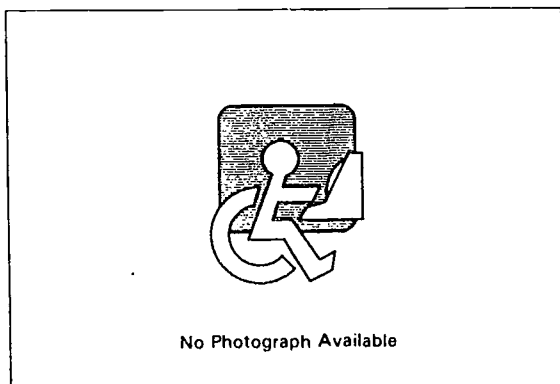

**Product Name:** Double Paddle Switch

**Vendor:** Creative Switch Industries

**Cost:** \$77.00 - \$79.00

Double Paddle Switch consists of a 12" wooden base with 4" plates at both ends. Two 3' output cords (included) allow two devices to be controlled. A bilateral version of the switch is available; contact manufacturer for details.

---

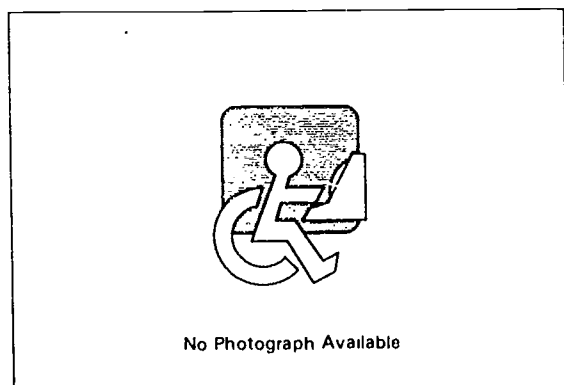

**Product Name:** Double Sip & Double Puff Switches

**Vendor:** Toys for Special Children, Inc.

**Number of Switches:** Dual Switch

**Cost:** \$60.00 each

Double Sip Switch is activated by sipping in slightly on the tube to create the first switch closure. Further sipping continues the first switch closure while providing a second closure. The Double Puff Switch is the same except the switch closure is activated by puffing on the tube.

---

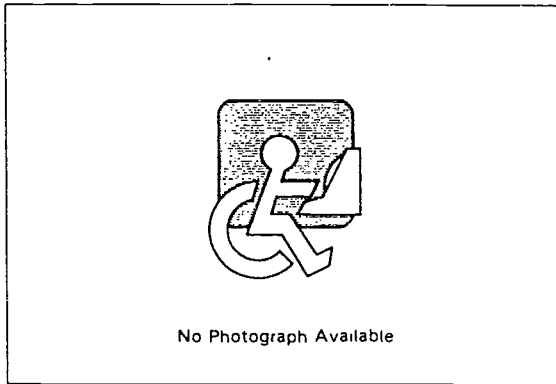

**Product Name:** Double Touch Switch  
**Vendor:** Toys for Special Children, Inc.  
**Number of Switches:** Single Switch  
**Connector Type:** 1/4" or 1/8" phone plug  
**Cost:** \$46.00

The Double Touch Switch can activate a toy or device only when both metal plates are touched simultaneously by any body parts.

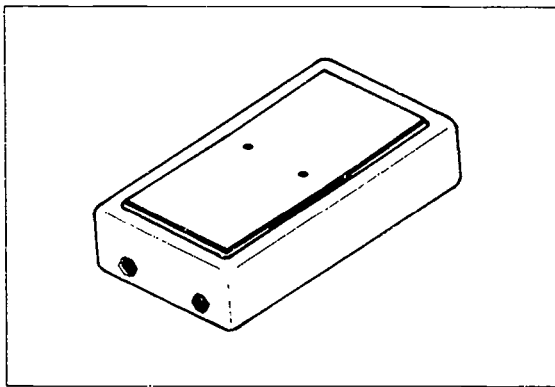

**Product Name:** Dual Plate Switch: CM-12  
**Vendor:** Zygo Industries, Inc.  
**Number of Switches:** Dual Switch  
**Activation Pressure:** 8 oz.  
**Connector Type:** Mini-phone plug  
**Cost:** \$115.00 - \$140.00

This switch is activated by pressing either end of a rocking plate. Pressing one end activates one switch; pressing the other activates the second switch.

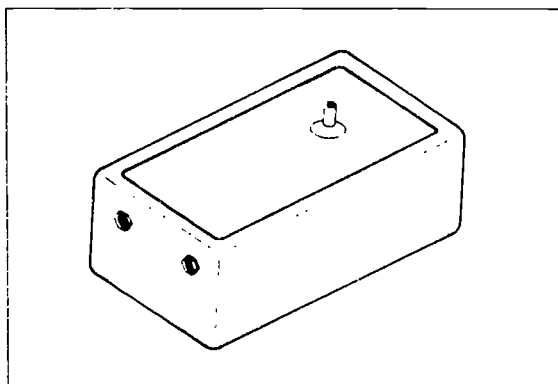

**Product Name:** Dual Pneumatic Switch: CM-14  
**Vendor:** Zygo Industries, Inc.  
**Number of Switches:** Dual Switch  
**Activation Pressure:** 0.1 psi  
**Connector Type:** Mini-phone plug  
**Cost:** \$220.00 - \$265.00

Dual Pneumatic Switch is a switching unit activated by sipping or puffing on a tube. Each of the two actions activates a different switch. Any chosen tube may be used; one is available as well from the manufacturer (extra).

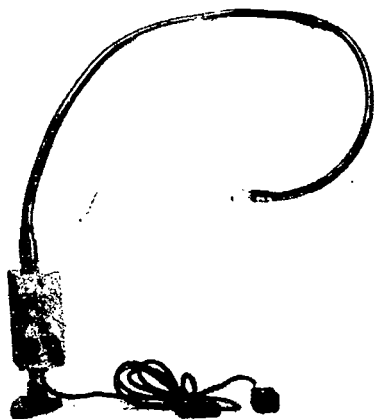

**Product Name:** Dual Puff-Sip Switch DPS-2

**Vendor:** APT Technology, Inc.

**Cost:** \$295.00

The Dual Puff-Sip Switch is a pneumatic dual switch activated by blowing and sucking on the mouthpiece. The switch is mounted in a box that also includes two buttons to permit manual switch operation. The box is mounted on a 34" internally reinforced gooseneck with a clamp. Adapters are available to interface the P-306 plug (included) with other input requirements.

---

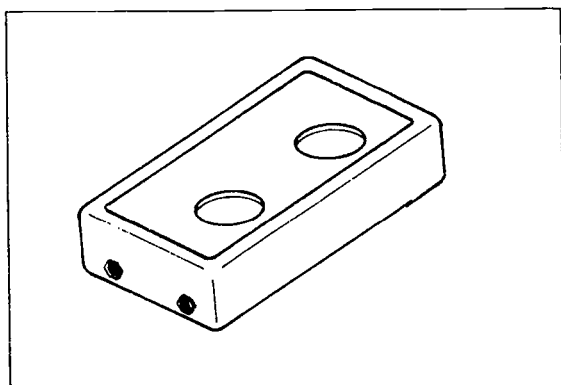

**Product Name:** Dual Pushbutton Switch: CM-13

**Vendor:** Zygo Industries, Inc.

**Number of Switches:** Dual Switch

**Activation Pressure:** 8 oz.

**Connector Type:** Mini-phone plug

**Cost:** \$115.00 - \$140.00

Dual Pushbutton Switch is a pair of snap-action button switches housed side-by-side, each in a 1.25" diameter recess. Switches are activated by pressing. An audible click is provided when switch is activated.

---

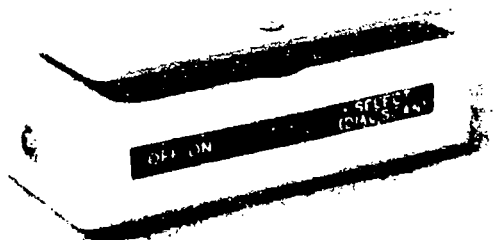

**Product Name:** Dual Rocking Lever Switch

**Vendor:** Prentke Romich Company

**Number of Switches:** Dual Switch

**Activation Pressure:** 1.6 oz. to 4.5 oz.

**Connector Type:** 3.5 mm phone plug

**Cost:** \$90.00 - \$110.00

Dual Rocking Lever Switch is a dual switch operated by pushing on either end of a plate. One end activates one switch, the other activates the other switch. The housing is made of plastic, with rubber feet and a threaded hole for mounting. Dual Rocking Lever Switch is available in two models: low or medium activation force.

---

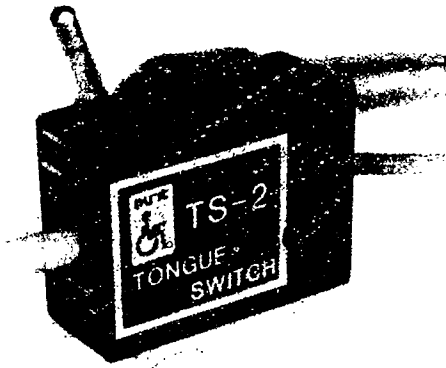

**Product Name:** Dual Tongue Switch TS-2C  
**Vendor:** APT Technology, Inc.  
**Number of Switches:** Dual Switch  
**Activation Pressure:** 0.75 oz. (adjust.)  
**Connector Type:** P306 connector  
**Cost:** \$245.00

Dual Tongue Switch TS-2C is a minimum pressure, small movement, momentary operation dual switch designed to be operated by tongue, nose, chin, cheek, finger, or other small movement. The switch comes complete with gooseneck and table mounting hardware. An audible click sounds on activation. The switch activates after about .06" travel.



**Product Name:** Ellipse Switches  
**Vendor:** Don Johnston Incorporated  
**Cost:** \$65.00 - \$70.00

Ellipse Switches are a family of light-touch switches shaped to fit the hand. The switches have 1/8" miniplugs that can be attached to the I/O port on the Adaptive Firmware Card, the Multiple Switch Box, or FRED (see entries). Switch closure is indicated by a clicking sound. Three sizes are available: Ellipse 1 (\$65.00), 3 (\$67.50), and 6 (\$70.00).



**Product Name:** Eyebrow Switch  
**Vendor:** Words+, Inc.  
**Number of Switches:** Single Switch  
**Connector Type:** Mini-phone plug  
**Cost:** \$35.00

This switch is mounted on a visor. A lever projects down in front of the forehead, resting against it. When the user wrinkles the forehead or raises the eyebrow, the switch is activated. An audible click is provided with switch activation.

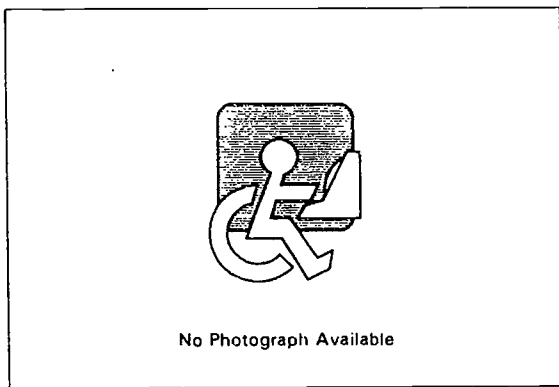

**Product Name:** Facial Switch  
**Vendor:** Whitmyer Biomechanix, Inc.  
**Number of Switches:** Single Switch  
**Connector Type:** 1/8" phone plug  
**Cost:** \$90.00

The Facial Switch is attached to wheelchair head rest systems. The contact surface is padded with replaceable "ear pads" like those used on stereo headphones. Pressure by the head activates the switch. The switch is available in several mounting configurations. Contact manufacturer for details.

---

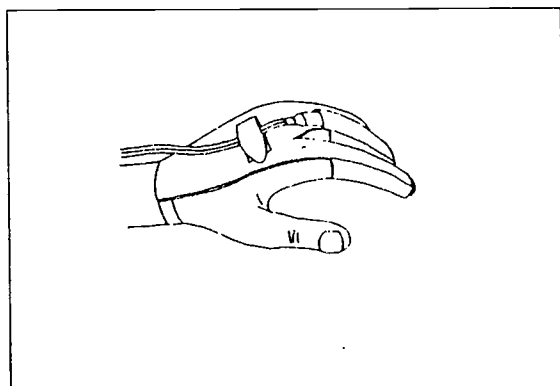

**Product Name:** Finger Flex Switch  
**Vendor:** Luminaud, Inc.  
**Number of Switches:** Single Switch  
**Activation Pressure:** 10 - 25 degrees flex  
**Connector Type:** 3.5 mm phone plug  
**Cost:** \$45.00

Finger Flex Switch is a switch built into a partial glove. Bending a finger activates the switch. The switch uses a 3.5 mm mini-phone plug as a connector.

---

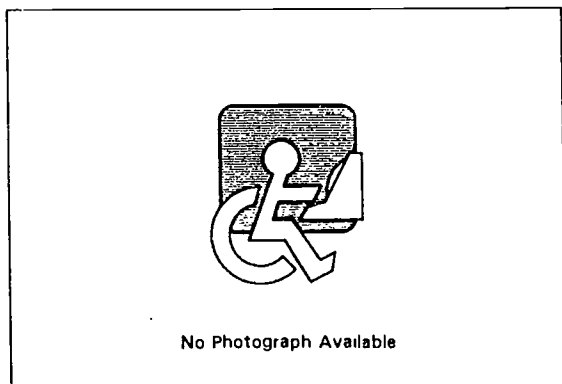

**Product Name:** Finger Isolation Button  
**Vendor:** Toys for Special Children, Inc.  
**Number of Switches:** Single Switch  
**Cost:** \$28.00

Finger Isolation Button is a switch featuring a recessed button that encourages isolated touch. This device is designed to train motor skills for using computer keyboards.

---

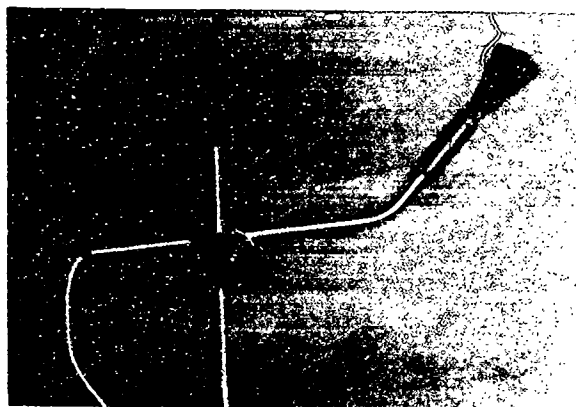

**Product Name:** Flex Switch (5855)  
**Vendor:** TASH, Inc.  
**Number of Switches:** Single Switch  
**Activation Pressure:** 6 oz.  
**Connector Type:** 1/8" phone plug  
**Cost:** \$135.00

Flex Switch is a single switch operated by bending the flexible rubber tip 0.5 inches in any direction. Flex Switch comes mounted on an angled metal rod. The rubber tip can be removed and rotated.

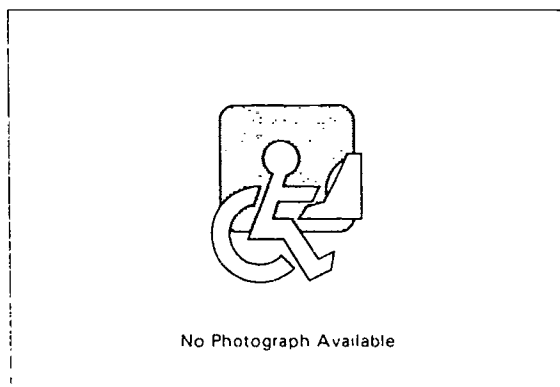

**Product Name:** Flexi-Switch  
**Vendor:** Kapable Kids  
**Number of Switches:** Single Switch  
**Cost:** \$16.00

The Flexi-Switches come covered in a variety of fabrics and are activated by bending or squeezing. A 7' cord is included.

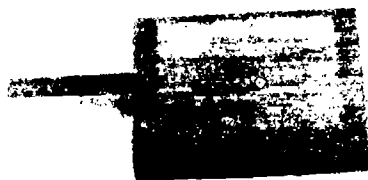

**Product Name:** Flexit Switch  
**Vendor:** Creative Switch Industries  
**Number of Switches:** Single Switch  
**Activation Pressure:** 2 oz.  
**Connector Type:** Mini phone plug  
**Cost:** \$31.50 - \$41.00

Flexit Switch is a single switch activated by bending a flexible strip. The strip protrudes from a wooden base. Flexit Switch is available in horizontal, vertical, or hand-held models. Activation is silent.

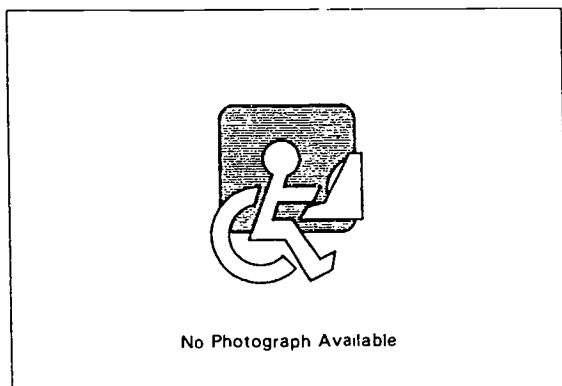

**Product Name:** Flexswitch I.  
**Vendor:** Tapeswitch Corporation  
**Number of Switches:** Single Switch  
**Activation Pressure:** 4 oz.  
**Cost:** \$32.20

Flexswitch II is a paddle switch with an integral mounting bracket. The switch is activated by bending the paddle.

---



**Product Name:** Grasp Switch (5865)  
**Vendor:** TASH, Inc.  
**Number of Switches:** Single Switch  
**Activation Pressure:** 10.5 oz.  
**Cost:** \$100.00

The Grasp Switch from TASH is a single switch that is activated by pinching or squeezing a 1" diameter rubber hand grip. The operating force is 10.5 oz.

---

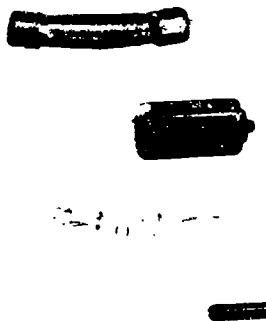

**Product Name:** Grip & Puff Switch  
**Vendor:** Toys for Special Children, Inc.  
**Number of Switches:** Single Switch  
**Connector Type:** 1/4" or 1/8" phone plug  
**Cost:** \$46.00

Grip & Puff Switch consists of a rubber cylindrical air bellows connected by a tube to a switching unit. Grasping the cylinder and exerting slight pressure activates the switching unit. Grips in varying diameters are available at additional cost. Removing the grip allows the switch to be used as a puff switch.

---





**Product Name:** Grip Switch  
**Vendor:** Therapeutic Toys, Inc.  
**Number of Switches:** Single Switch  
**Cost:** \$45.00

The Grip Switch is a ball shaped switch attached to a plastic base by a clear tube and activated by squeezing.



**Product Name:** HD Latching Pneumatic Switch  
**Vendor:** Luminaud, Inc.  
**Number of Switches:** Single Switch  
**Cost:** \$120.00

The HD (heavy duty) Latching Pneumatic Switch plugs into a 3-pin power receptacle, allowing control of 120 V appliances. The air cushion actuator may be mounted with screws, Velcro, or tape. Can be used safely in damp areas and washed. A puff version of this switch is available for those with sufficient breath power.

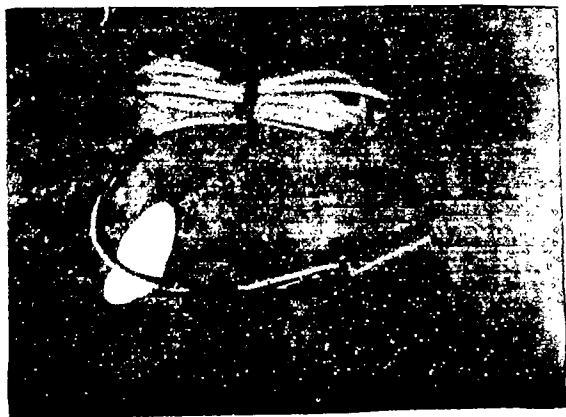

**Product Name:** Head Control Switch  
**Vendor:** Stellan Limited  
**Number of Switches:** Single Switch  
**Cost:** \$78.00

Head Control Switch is a single switch activated by being tilted. The switch can be mounted on the head or another body part.

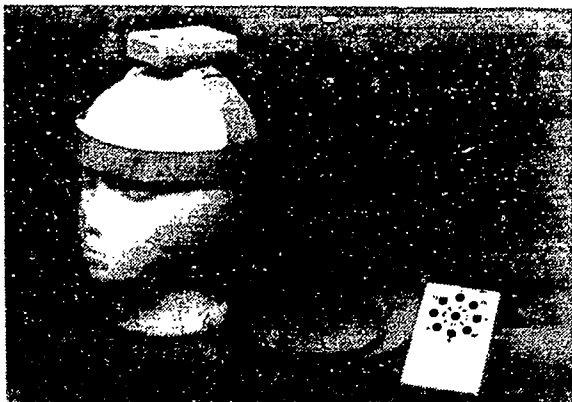

**Product Name:** Head Position Interface  
**Vendor:** Hugh MacMillan Rehabilitation Centre  
**Number of Switches:** Joystick (4 or 5 Switches)  
**Connector Type:** 6-pin DIN  
**Cost:** \$950.00

Head Position Interface is a switching unit that uses four mercury tilt switches to trigger switch closures based upon eight possible positions of the user's head. The control unit is mounted on the user's headband and plugs into the control box of the wheelchair. The seven positions are FWD, REV, FWD RIGHT, FWD LEFT, REV RIGHT, REV LEFT, and DIAG. There is also a neutral position.

---

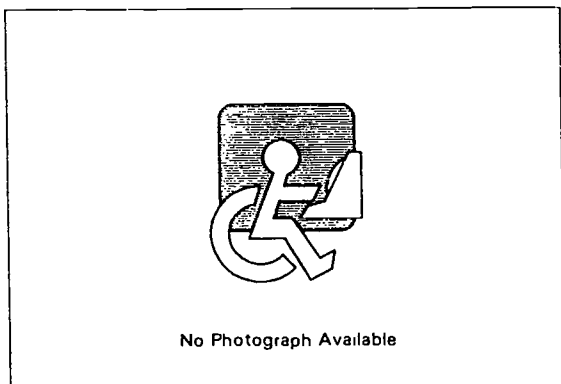

**Product Name:** Head Switch  
**Vendor:** Toys for Special Children, Inc.  
**Cost:** \$75.00

The Head Switch is a switch that can be activated by small motions from any body part. Contact manufacturer for information on switch mounting kits (extra).

---

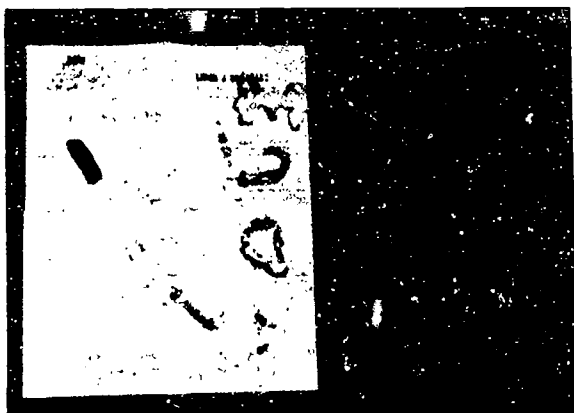

**Product Name:** Head Switch Kit  
**Vendor:** Burkhardt, Linda J.  
**Number of Switches:** Single Switch  
**Connector Type:** Mini-phone plug  
**Cost:** \$11.50

Head Switch Kit provides all the materials for making a tilt-activated switch. The switch can be mounted on the head or other body parts, and is activated when tilted.

---

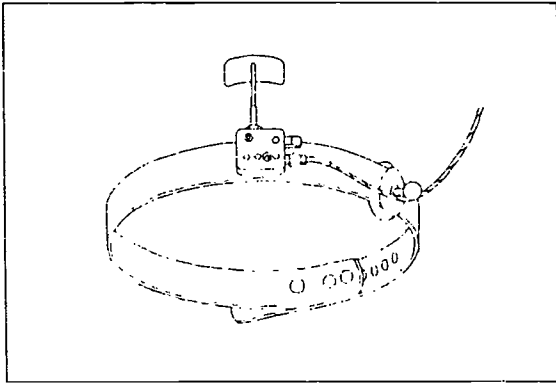

**Product Name:** Headband Switch

**Vendor:** Luminaud, Inc.

**Number of Switches:** Single Switch

**Activation Pressure:** 1 - 2 oz.

**Connector Type:** 3.5 mm phone plug

**Cost:** \$65.00

Headband Switch consists of an adjustable headband equipped with a switch that has a small paddle for a lever. The paddle rests on the forehead; raising the forehead muscles activates the switch. The paddle must be taped to the forehead. The switch has a 3.5 mm plug.

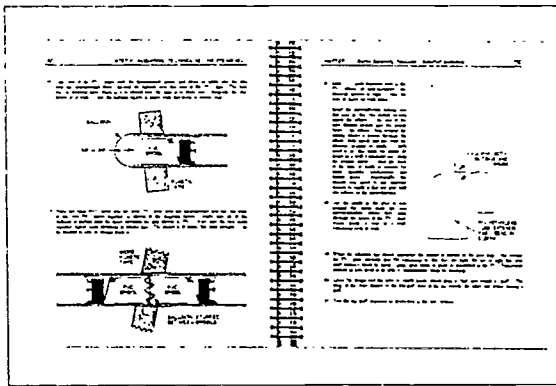

**Product Name:** High Tech/Low Cost

**Vendor:** TechnoGenesis, Inc.

**Cost:** \$60.00

High Tech/ Low Cost is a manual and videotape that shows how to build assistive devices inexpensively. Projects range from simple switches to electronic AAC devices. Contact manufacturer for free brochure.

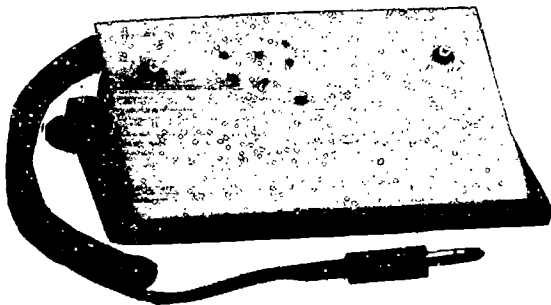

**Product Name:** Intention Switch

**Vendor:** Toys for Special Children, Inc.

**Number of Switches:** Single Switch

**Activation Pressure:** 1 oz.

**Connector Type:** 1/4" or 1/8" phone plug

**Cost:** \$46.00

Intention Switch is a single switch activated by pressing on a plastic plate. The Intention Switch must be pressed for a specific pre-set amount of time before it will activate a device. The required activation time is adjustable (0-12 seconds).

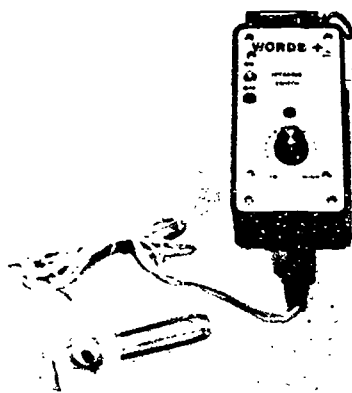

**Product Name:** IST Switch  
**Vendor:** Words+, Inc.  
**Number of Switches:** Single Switch  
**Connector Type:** Mini-phone plug  
**Cost:** \$295.00 - \$495.00

The IST (Infrared, Sound, Touch) Switch (formerly Infrared Switch) is a zero-force switch that can be used with virtually any body movement. A sensitivity adjustment allows the switch to be set to detect different movements. The switch is \$295.00 with any one of the sensors and \$495.00 with all three.

---

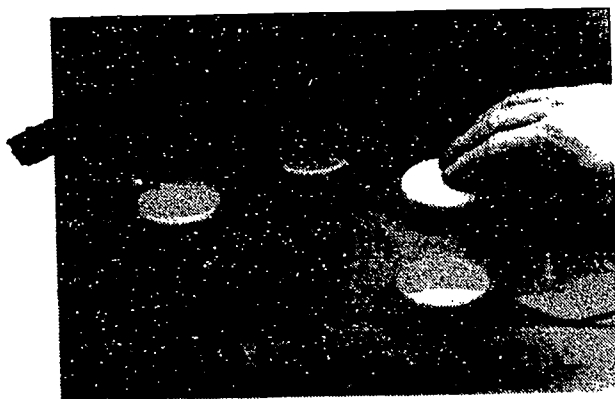

**Product Name:** Jelly Bean  
**Vendor:** AbleNet, Inc.  
**Number of Switches:** Single Switch  
**Cost:** \$42.00

Jelly Bean is a switch activated by light pressure. The switch is contained in a shatter-proof disk which is two and one half inches in size. The entire surface of Jelly Bean is sensitive, so it can be used while placed on a table, wall, or tray surface as well as operated through head control. A Jelly Bean Mounting Plate is available (extra). This switch comes in seven colors: red, green, yellow, blue, purple, pink, and black.

---

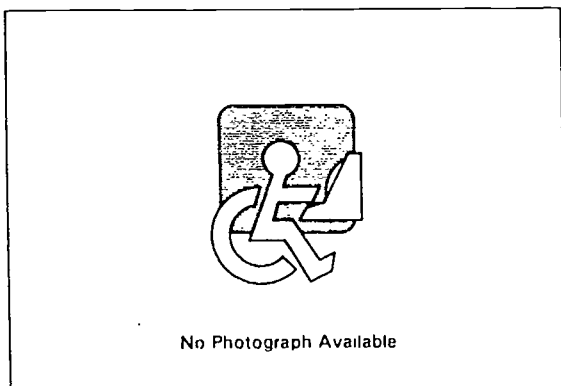

**Product Name:** Joystick  
**Vendor:** Toys for Special Children, Inc.  
**Number of Switches:** Joystick (4 or 5 Switches)  
**Connector Type:** 1/4" or 1/8" phone plug  
**Cost:** \$50.00

This joystick has a cylindrical handle and a thin base. Pushing the handle in each of four directions activates one of four devices.

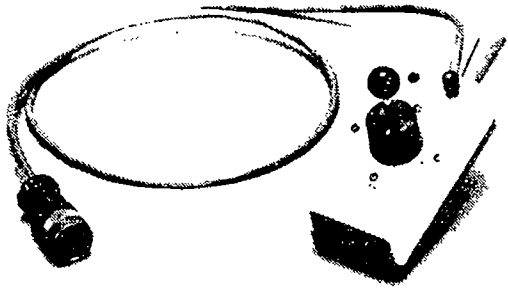

**Product Name:** Joystick Interface Control  
**Vendor:** Hugh MacMillan Rehabilitation Centre  
**Number of Switches:** Joystick (4 or 5 Switches)  
**Activation Pressure:** 1.13" travel  
**Connector Type:** See text  
**Cost:** \$700.00

The Joystick Interface Control is a four-microswitch, non-gated, eight-position joystick that can activate switches individually or adjacent switches simultaneously. It is adaptable to communication aids using this kind of switching. The Joystick is of the "X" format and the push travel to activate the switches is 1-1/8". A variety of connectors, knobs and bars are available; contact Hugh MacMillan for details.

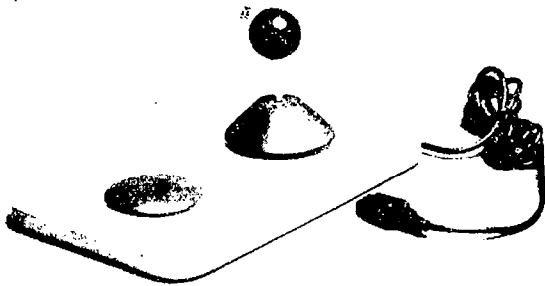

**Product Name:** Joystick with Pad Switch (5012)  
**Vendor:** TASH, Inc.  
**Number of Switches:** Joystick (4 or 5 Switches)  
**Activation Pressure:** 7 oz.  
**Connector Type:** 9-Pin DIN  
**Cost:** \$275.00

Joystick with Pad Switch is a four position gated joystick, with four slotted directions of movement. The fifth switch is a pad switch used for control action.



**Product Name:** Jumbo Plate Switch  
**Vendor:** Crestwood Company  
**Number of Switches:** Single Switch  
**Activation Pressure:** 2 oz.  
**Cost:** \$80.00

The Jumbo Plate Switch is large enough for a whole hand. The momentary switch is thin, durable, and requires a light touch. Surface color is orange.



**Product Name:** L.T. Switch  
**Vendor:** Don Johnston Incorporated  
**Number of Switches:** Single Switch  
**Activation Pressure:** 0.75 oz.  
**Connector Type:** Mini-phone plug  
**Cost:** \$45.00

The L.T. Switch is designed for users with limited strength. The L.T. Switch is activated with 0.75 ounce of pressure, and emits a click when activated.

---



**Product Name:** LD Latching Puff Switch  
**Vendor:** Luminaud, Inc.  
**Connector Type:** 1/8" phone plug  
**Cost:** \$95.00

The LD (Light Duty) Latching Puff Switch latches mechanically to an on or off position. No external power is needed to maintain the latching action. A gentle puff of mouth air will set the switch to the on position and another gentle puff will turn it off. The switch is supported by a light weight head band.

---

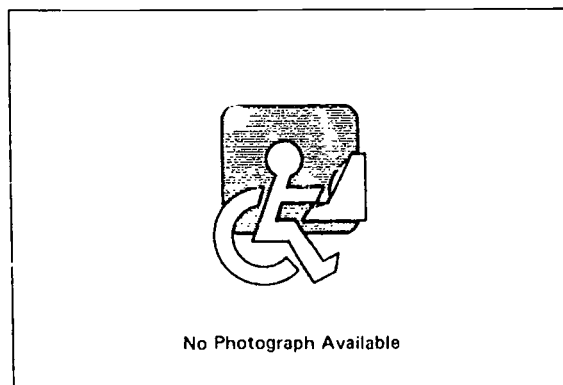

**Product Name:** Leaf Switch  
**Vendor:** Kapable Kids  
**Number of Switches:** Single Switch  
**Connector Type:** 1/8" plug  
**Cost:** \$25.00

The Leaf Switch is activated by swatting or random movement. A hardwood non-skid base and 7' cord are included.

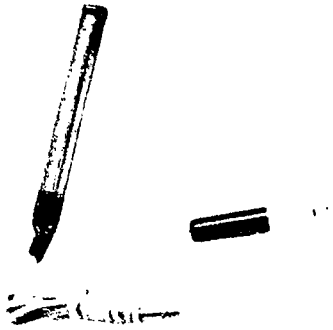

**Product Name:** Leaf Switch

**Vendor:** Toys for Special Children, Inc.

**Number of Switches:** Single Switch

**Connector Type:** 1/4" or 1/8" phone plug

**Cost:** \$26.00

This switch consists of a vinyl covered flexible spring. When a very light, delicate touch is applied, the switch is activated. The deflection angle should not exceed 45 degrees.

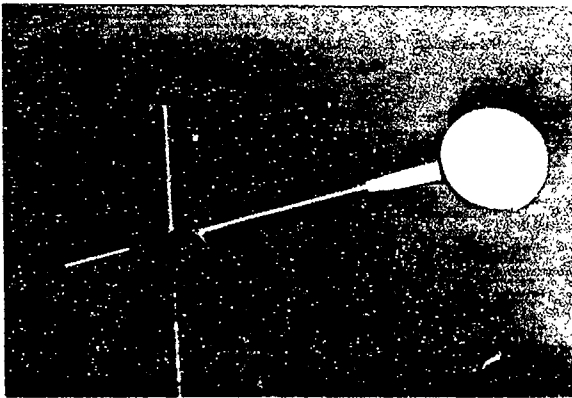

**Product Name:** Leaf Switch (5860)

**Vendor:** TASH, Inc.

**Number of Switches:** Single Switch

**Activation Pressure:** 2 oz.

**Connector Type:** 1/8" phone plug

**Cost:** \$100.00

The Leaf Switch is a single switch operated by pressing one side of the leaf. The tip of the leaf requires 1/4" of movement for operation. The Leaf Switch has a removeable 3" diameter foam pad. Mounting requires additional tubular mounting hardware.

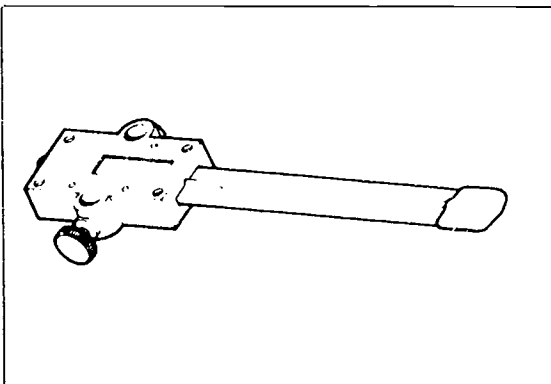

**Product Name:** Leaf Switch: CM-2/CM-7

**Vendor:** Zygo Industries, Inc.

**Number of Switches:** Single Switch

**Activation Pressure:** 1 oz.

**Connector Type:** Mini-phone plug

**Cost:** \$65.00

This switch has a protruding flat vinyl-covered metal leaf. Any flexion of the leaf activates a switch. The base has holes for mounting. Two different leaf lengths are available.

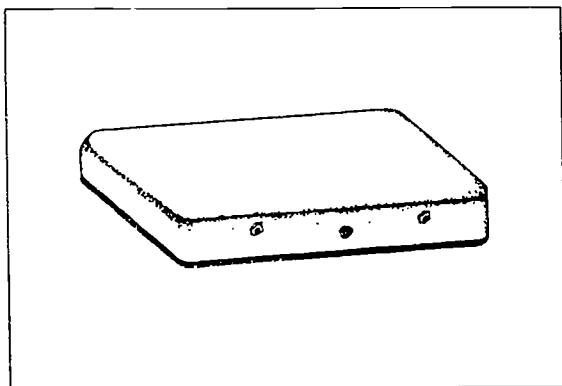

**Product Name:** Left/Right Rocker Switch  
**Vendor:** Don Johnston Incorporated  
**Number of Switches:** Dual Switch  
**Activation Pressure:** 5 oz.  
**Connector Type:** 1/8" phone plug  
**Cost:** \$75.00

Left/Right Rocker Switch is a dual switch activated by pressing the plate on either side. Pressing one end activates one switch; pressing the other end activates the second. An auditory click is produced when a switch is activated.

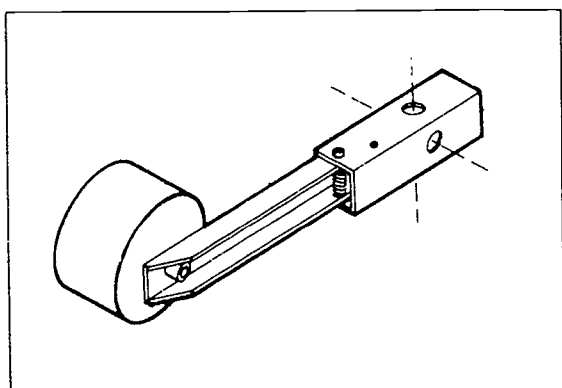

**Product Name:** Lever Switch: CM-8/CM-9  
**Vendor:** Zygo Industries, Inc.  
**Number of Switches:** Single Switch  
**Activation Pressure:** 4 - 8 oz.  
**Connector Type:** Mini-phone plug  
**Cost:** \$110.00

This switch is activated by pressing against a padded lever. The lever must travel 0.06" for activation. Switch CM-8 is 9" long; switch CM-9 is 7" long. A variety of mounting systems are available, including double-sided and quick-adjust swing-away.

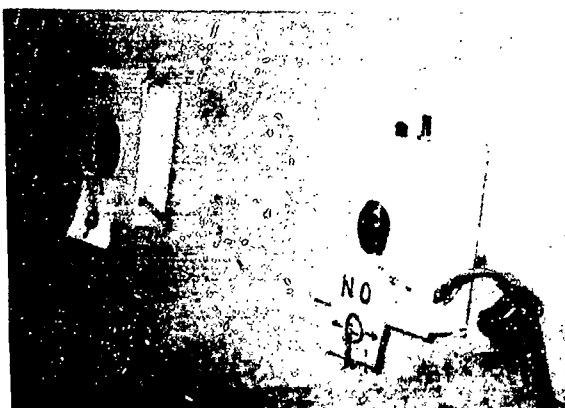

**Product Name:** Light-Activated Switch  
**Vendor:** Burkhart, Linda J.  
**Number of Switches:** Single Switch  
**Connector Type:** Mini-phone plug  
**Cost:** \$49.95

Light-Activated Switch is a switch activated by directing a light pointer at a light-sensitive panel. A Light Pointer is available from the same manufacturer (see entry); certain models by other manufacturers will also work.



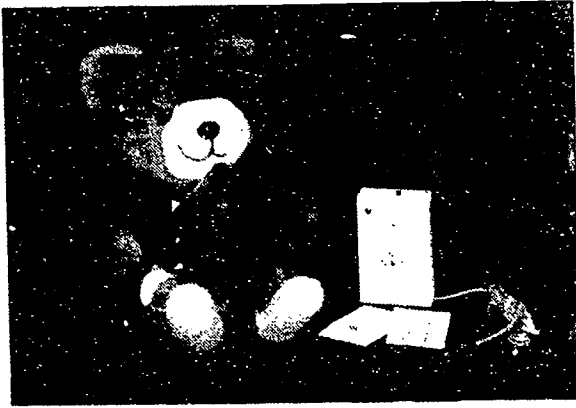

**Product Name:** LightSwitch  
**Vendor:** Ability Research, Inc.  
**Number of Switches:** Single Switch  
**Cost:** \$139.00

The LightSwitch is a light-activated switch which can control electronic devices and toys. The switch is activated by using a light pointer or a penlight (extra). When a light spot of up to 3" in diameter is directed at this switch it responds by providing a switch closure. The switch can be activated for a moment, by using a pushbutton, or continuously, by using the on/off control. Two press-on overlays are included.

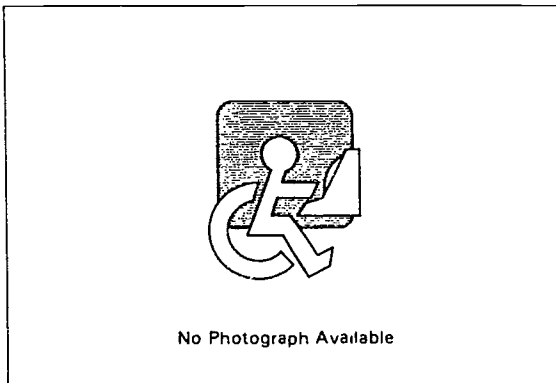

**Product Name:** Low Force Adjustable Rod Switch  
**Vendor:** Creative Switch Industries  
**Number of Switches:** Single Switch  
**Activation Pressure:** 2 oz.  
**Connector Type:** Mini-phone plug  
**Cost:** \$82.00

Low Force Adjustable Rod Switch is a single switch activated by pushing or pulling on a thin 6" rod. The rod bracket can be adjusted 360 degrees horizontally, and the rod can be adjusted 270 degrees vertically. The rod can also be bent to form a loop or other desired configuration.

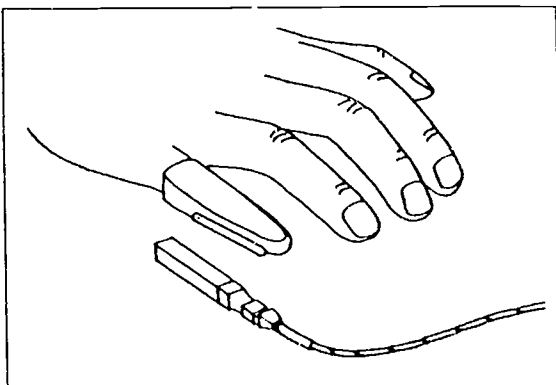

**Product Name:** Magnetic Finger Switch  
**Vendor:** Luminaud, Inc.  
**Number of Switches:** Single Switch  
**Activation Pressure:** 0.38" movement  
**Connector Type:** 3.5 mm phone plug  
**Cost:** \$45.00

Magnetic Finger Switch consists of a finger sleeve containing a magnet, plus a small external switch unit. A small movement of the finger toward the switch unit activates the switch. The switch has a 3.5 mm plug.

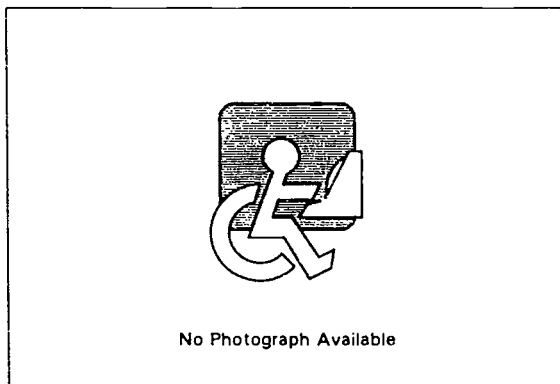

**Product Name:** Mat Switch  
**Vendor:** Creative Switch Industries  
**Connector Type:** 3.5 mm phone plug  
**Cost:** \$53.00 - \$146.00

Mat Switches are flexible mats available in three sizes (small 6" x 23" with 18" cord; medium 17" x 23" with 6' cord; large 23" x 35" with 6' cord) with a switch that requires five pounds of pressure to activate. All mats are equipped with a 3.5 mm miniature plug and washable denim covers.

---

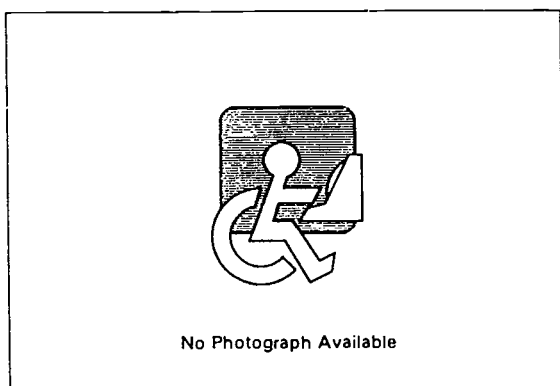

**Product Name:** Membrane Plate Switch  
**Vendor:** Crestwood Company  
**Number of Switches:** Single Switch  
**Activation Pressure:** 2.0 oz.  
**Connector Type:** Mini-phone plug  
**Cost:** \$60.00

The Membrane Plate Switch is a thin membrane switch operated by 2.0 ounces of force. The Membrane Plate Switch comes with a five foot cable and a mini-phone plug connector.

---

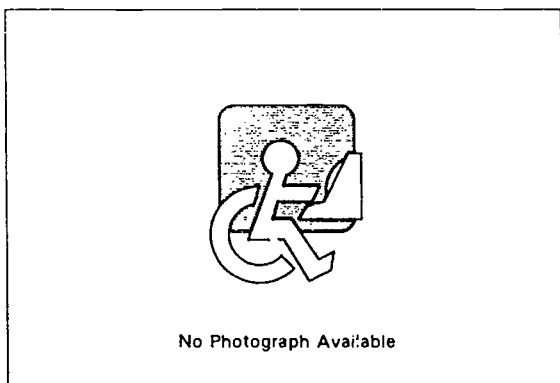

**Product Name:** Mercury Switch  
**Vendor:** Creative Switch Industries  
**Number of Switches:** Single Switch  
**Connector Type:** Mini-phone plug  
**Cost:** \$16.50 - \$27.50

Mercury Switch is a single switch activated by tilting. Three models of handles are available: miniature cylinders for head mounting, wood handles, and plastic tubes for hand use.

---

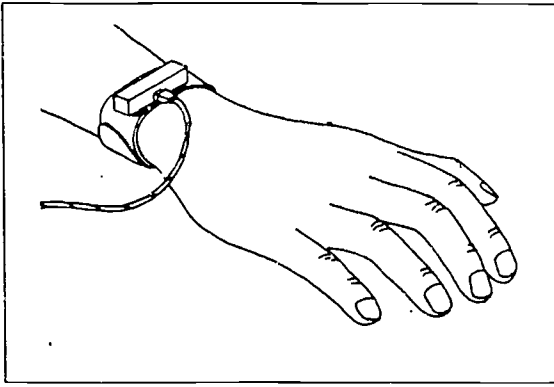

**Product Name:** Mercury Tilt Switch  
**Vendor:** Luminaud, Inc.  
**Number of Switches:** Single Switch  
**Connector Type:** 3.5 mm phone plug  
**Cost:** \$45.00

Mercury Tilt switch is activated by a change in position. This switch comes with a Velcro band for attaching to the wrist, arm, leg, etc. The switch has a 3.5 mm plug.

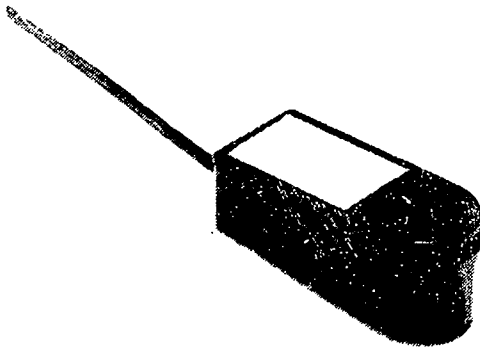

**Product Name:** Micro Light Switch (5850)  
**Vendor:** TASH, Inc.  
**Activation Pressure:** 0.5 oz.  
**Cost:** \$60.00

Micro Light Switch is a pressure switch requiring 0.5 oz. of pressure for activation. The switch features a threaded screw insert (screw must be purchased separately) or may be mounted with double-sided tape or Velcro.

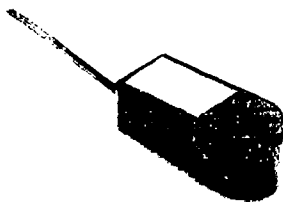

**Product Name:** Micro Switch  
**Vendor:** Crestwood Company  
**Number of Switches:** Single Switch  
**Activation Pressure:** 0.5 oz.  
**Cost:** \$55.00

The Micro Switch is a small, light pressure, highly sensitive switch. A threaded insert on the bottom is provided for mounting using a stand 4-40 screw obtained from any electronic store.



**Product Name:** Mini Cup Switch (5808)

**Vendor:** TASH, Inc.

**Number of Switches:** Single Switch

**Activation Pressure:** 5 oz.

**Connector Type:** 3.5 mm phone plug

**Cost:** \$40.00

This is the smallest single switch produced by TASH, Inc. As with the larger Cup Switch, it is a Cap Switch in a plastic base which provides a surface for easy mounting on table, pillow or wheelchair bracket. The switch is operated by pressing the top surface.

---

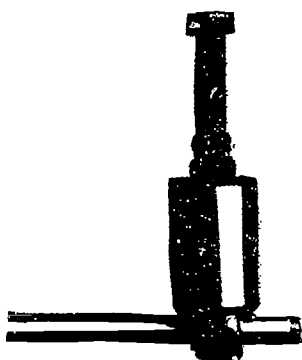

**Product Name:** Mini Joystick with Push Switch (5020)

**Vendor:** TASH, Inc.

**Number of Switches:** Joystick (4 or 5 Switches)

**Activation Pressure:** 4 - 7 oz.

**Connector Type:** 9-Pin DIN

**Cost:** \$230.00

Mini Joystick with Push Switch is a four position short stroke (0.5") ungated joystick with a flexible rubber shaft. This joystick can have two switch closures simultaneously, such as moving both diagonally and down the screen. Pushing down on the shaft activates the fifth switch.

---

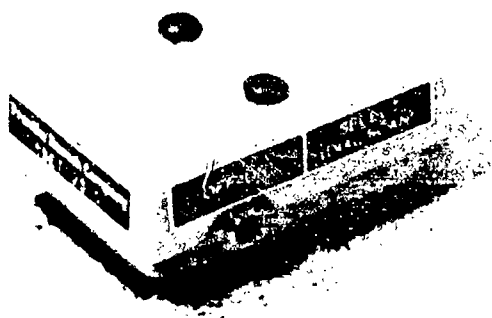

**Product Name:** Mini Rocking Lever Switch

**Vendor:** Prentke Romich Company

**Number of Switches:** Dual Switch

**Activation Pressure:** 1.7 oz.

**Connector Type:** Mini-phone plug

**Cost:** \$165.00

Mini Rocking Lever Switch is a small dual switch operated by pressing the plate on top. Pressing one side activates one switch; pressing the other side activates the other. Hook-and-loop type material for mounting comes on the bottom.

---

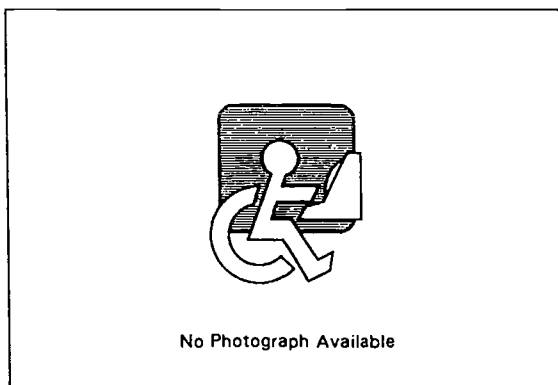

**Product Name:** Minimal Motion Splint-Mounted Switch Kits

**Vendor:** Equal Access Computer Technology, Inc.

**Activation Pressure:** None

**Cost:** \$220.00 - \$570.00

Minimal Motion Splint-Mounted Switch Kits are zero-force contact-sensitive switches for mounting on thermoplastic splints. Each kit can accommodate from one to seven switches. Available with 1/8" plug terminations for standard switch applications, or with a serial port interface for use with the Minimal Motion Computer Access System.

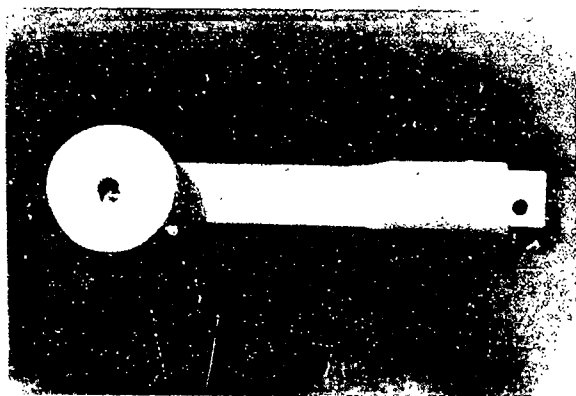

**Product Name:** Mounting Switch

**Vendor:** Don Johnston Incorporated

**Number of Switches:** Single Switch

**Activation Pressure:** 1 - 3 oz.

**Connector Type:** 1/8" phone plug

**Cost:** \$85.00

The Mounting Switch is a versatile switch that may be mounted in a variety of locations and shaped for optimal positioning. The activation pressure of the Mounting Switch may be adjusted from one to three ounces. An audible click is emitted by the Mounting Switch when the switch is closed.



**Product Name:** Multi-Control Press Switch

**Vendor:** Creative Switch Industries

**Number of Switches:** Dual Switch,  
Multiple switches (3 to 16 Switches), Single Switch

**Activation Pressure:** 1.5 lbs.

**Connector Type:** Mini-phone plug

**Cost:** \$82.00 - \$87.00

Multi-Control Press Switch is a single, dual or triple switch. One switch is activated by pressing on a large plate. One or two side bars requiring slightly higher activation pressure comprise the other switches.

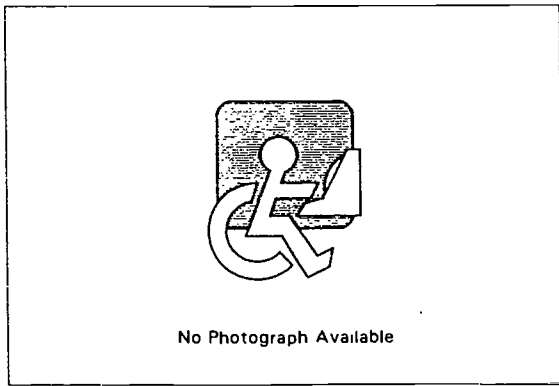

**Product Name:** Normally Closed Sensing Cell  
**Vendor:** Tapeswitch Corporation  
**Number of Switches:** Single Switch  
**Activation Pressure:** 2.5 lbs.  
**Cost:** \$25.90

Normally Closed Sensing Cell is a low profile, sealed sensing switch in wafer form.

---

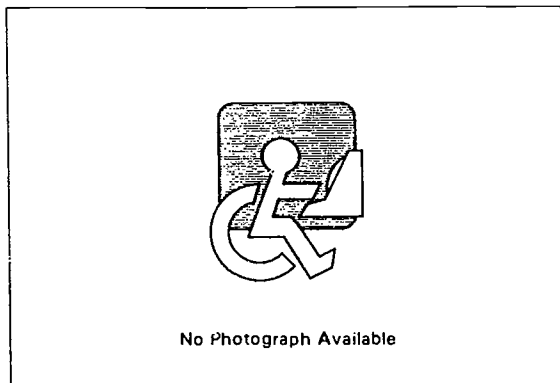

**Product Name:** Normally Open Sensing Cells  
**Vendor:** Tapeswitch Corporation  
**Activation Pressure:** 2.5 lbs.  
**Cost:** \$7.50

Normally Open Sensing Cells are low profile, sealed sensing switches in wafer form.

---

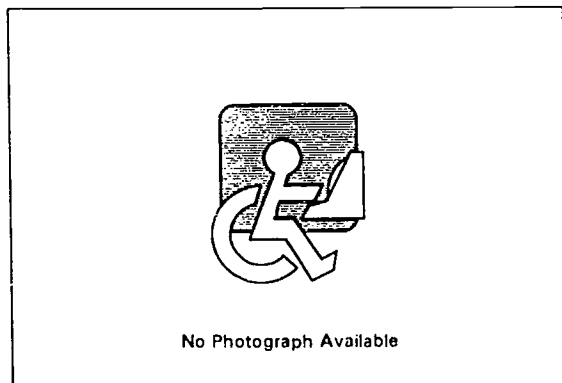

**Product Name:** Omron Switch  
**Vendor:** Nassau Applied Technology Resource Center  
**Cost:** \$63.00 - \$89.00

Omron Switch is a switch operated by flexing the thin strip that is attached to a base. A model with an internal buzzer is also available.

---

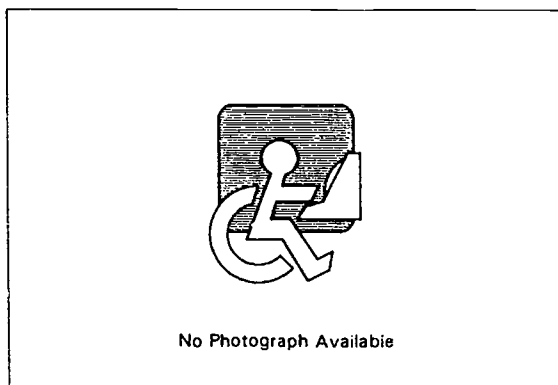

**Product Name:** Overhead Pull Switch  
**Vendor:** Toys for Special Children, Inc.  
**Number of Switches:** Single Switch  
**Connector Type:** 1/4" or 1/8" phone plug  
**Cost:** \$42.00

The Overhead Pull Switch is activated by pulling down. The switch is mounted on a flexible 13" gooseneck and can be attached to most surfaces via a three-way clamp. Comes with interchangeable ring and pull-ball.



**Product Name:** P-Switch  
**Vendor:** Prentke Romich Company  
**Number of Switches:** Single Switch  
**Connector Type:** Mini-phone plug  
**Cost:** \$265.00

The P-Switch is a sensitive electronic switch which can be activated by almost any muscle movement. When any surface in contact with the switch moves (e.g., the skin of the forehead when the brow is wrinkled), the wafer sends a signal to the switch unit. Sensitivity of the P-Switch can be adjusted. Light and optional audible tone indicate when the switch is activated.

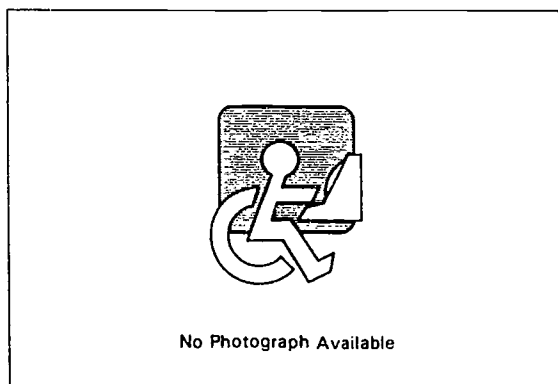

**Product Name:** Patty Cake Press  
**Vendor:** Kapable Kids  
**Number of Switches:** Single Switch  
**Activation Pressure:** 4 oz.  
**Cost:** \$28.00

The Patty Cake Press is a circular switch with ten contact points for activation. Pressure anywhere on the textured pad will activate the switch. Available in assorted fabrics.



**Product Name:** Penta Switch (5024)  
**Vendor:** TASH, Inc.  
**Number of Switches:**  
Multiple switches (3 to 16 Switches)  
**Activation Pressure:** 4 oz.  
**Connector Type:** 9-Pin DIN  
**Cost:** \$150.00

Penta Switch is a set of five small button switches fitted in a disk-shaped housing.

---



**Product Name:** Petite Pillow Switch  
**Vendor:** Toys for Special Children, Inc.  
**Connector Type:** 1/4" or 1/8" phone plug  
**Cost:** \$28.00

The Petite Pillow Switch is a foam-encased switch covered with a removable soft velvet bag. The Petite Pillow is designed for users with limited head and limb movement. Hook and loop tape can be sewn to the cover for mounting.

---

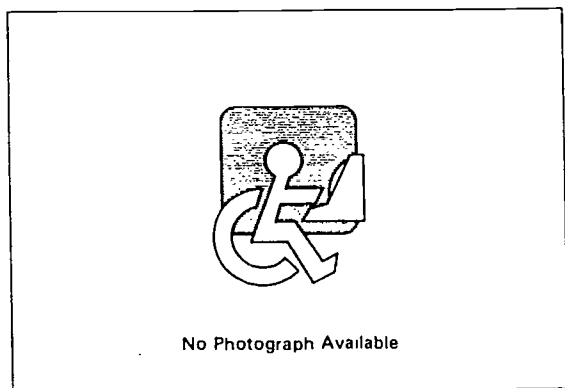

**Product Name:** Photocell Switch  
**Vendor:** Toys for Special Children, Inc.  
**Number of Switches:** Single Switch  
**Connector Type:** 1/4" or 1/8" phone plug  
**Cost:** \$41.00

The Photocell Switch can be activated by any body movement that creates a shadow over the electronic photocell.

---





**Product Name:** Pillow Switch (5875)

**Vendor:** TASH, Inc.

**Number of Switches:** Single Switch

**Activation Pressure:** 6 oz.

**Connector Type:** 1/8" phone plug

**Cost:** \$80.00

The Pillow Switch is a single switch operated by pressing the top foam surface. A pin and a velcro strip are attached to the bottom of the switch for fastening to a pillow or to clothing.

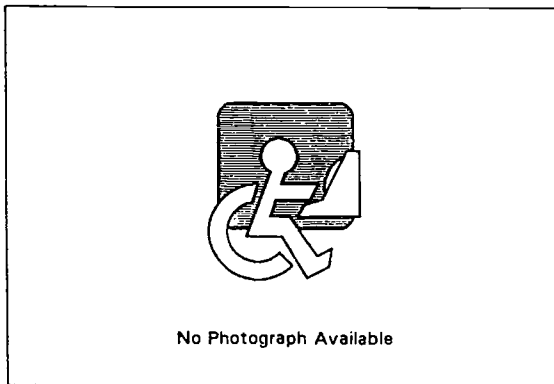

**Product Name:** Pinch Switch

**Vendor:** Creative Switch Industries

**Number of Switches:** Single Switch

**Activation Pressure:** 2 lbs.

**Connector Type:** Mini-phone plug

**Cost:** \$16.50 - \$17.00

Pinch Switch is a single switch activated by pinching on a small round or rectangular tab. Activation is silent.



**Product Name:** Pinch Switch

**Vendor:** Toys for Special Children, Inc.

**Number of Switches:** Single Switch

**Connector Type:** 1/4" or 1/8" phone plug

**Cost:** \$21 00

This switch consists of a small, thin, wafer-like wand. The user pinches lightly on the wafer and the switch is activated.



**Product Name:** Plate Switch  
**Vendor:** Don Johnston Incorporated  
**Number of Switches:** Single Switch  
**Activation Pressure:** 3 oz.  
**Connector Type:** Mini-phone plug  
**Cost:** \$45.00

This Plate Switch is activated by 3 ounces of pressure, and offers a click as audible feedback.

---



**Product Name:** Plate Switch  
**Vendor:** Toys for Special Children, Inc.  
**Number of Switches:** Single Switch  
**Connector Type:** 1/4" or 1/8" phone plug  
**Cost:** \$17.00 - \$50.00

Plate Switches are available as a momentary switch, with a timer, with a latch, and with a counter. Other models available include: Vibrating Plate, Lighted Musical Plate switch, Music Box Plate Switch, Mirror Plate Switch, Lighted Plate Switch, Sensory Plate Switch, and Lighted Sensory Plate Switch.

---

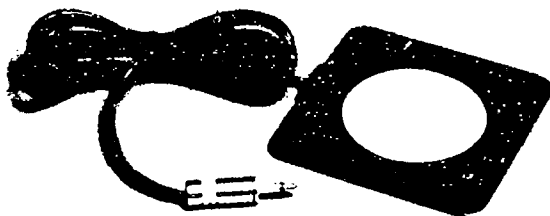

**Product Name:** Plate Switch (5830-34)  
**Vendor:** TASH, Inc.  
**Number of Switches:** Single Switch  
**Activation Pressure:** 2 oz.  
**Connector Type:** 1/8" phone plug  
**Cost:** \$60.00

This Plate Switch is a very thin single membrane switch. A colored circle on the surface marks the pressure sensitive area. Available in red, green, yellow, blue and orange.

---

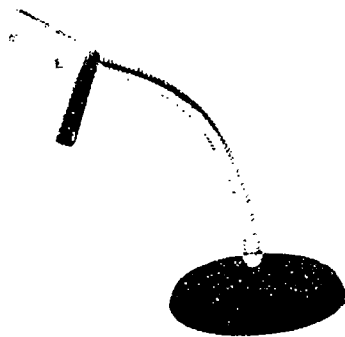

**Product Name:** Plate Switch On Stand  
**Vendor:** Toys for Special Children, Inc.  
**Number of Switches:** Single Switch  
**Connector Type:** 1/4" or 1/8" phone plug  
**Cost:** \$38.00

Plate Switch on Stand is a switch activated by pressing on a plate. The switch is mounted on a gooseneck which has a stand for stability.

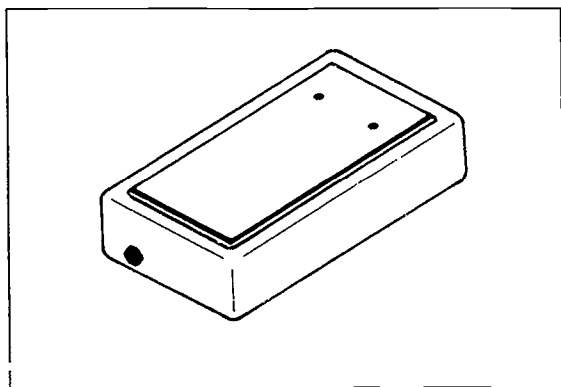

**Product Name:** Plate Switch: CM-10  
**Vendor:** Zygo Industries, Inc.  
**Number of Switches:** Single Switch  
**Activation Pressure:** 1.5 oz.  
**Connector Type:** Mini-phone plug  
**Cost:** \$95.00

This single switch is activated by pressing on the plate on top. An audible click accompanies activation.

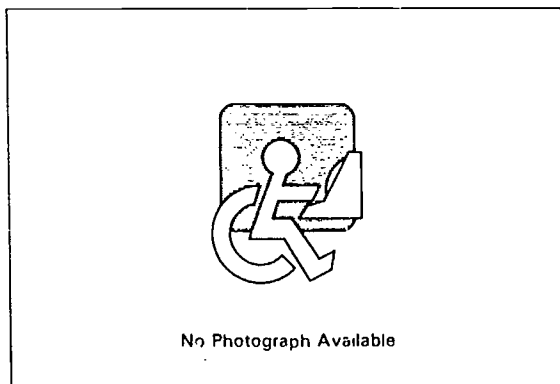

**Product Name:** Plate Switches  
**Vendor:** Nassau Applied Technology Resource Center  
**Number of Switches:**  
 Multiple switches (3 to 16 Switches), Single Switch  
**Cost:** \$34.50 - \$76.00

Plate Switches are single switches activated by pressing on the large top. Several models are available: standard, with internal buzzer, with internal light and buzzer, angled, angled with internal buzzer, angled with internal light and buzzer, and three shape (three switches in one).

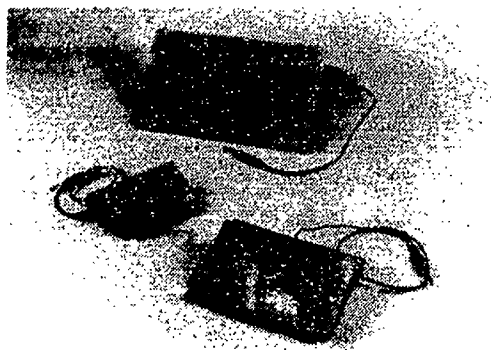

**Product Name:** Plate Switches  
**Vendor:** Therapeutic Toys, Inc.  
**Number of Switches:** Single Switch  
**Cost:** \$24.00 - \$55.00

Plate Switches are available in three sizes and several operating modes. The large switch is available only as a momentary switch. The small switch is available as a momentary or latching switch. The medium switch is available as a momentary, latching, momentary with music, momentary with vibration, and momentary with light switch.

---

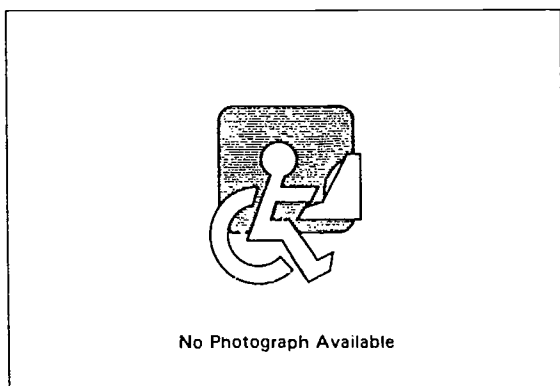

**Product Name:** Play Mat Switch  
**Vendor:** Kapable Kids  
**Cost:** \$36.95

The Play Mat Switch operates as a momentary switch. Switch closure can be made by rolling, jumping, patting, hopping, or shifting weight on the mat.

---

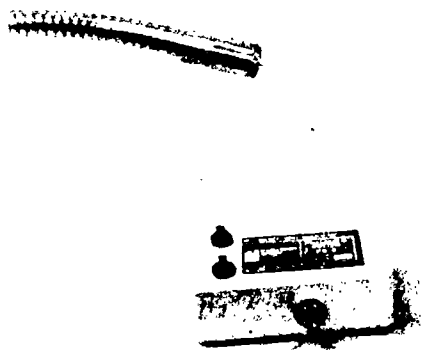

**Product Name:** Pneumatic Switch  
**Vendor:** Prentke Romich Company  
**Number of Switches:** Dual Switch  
**Activation Pressure:** 4 cm of water  
**Connector Type:** Mini-phone plug  
**Cost:** \$300.00

Pneumatic Switch is a dual switch activated by sipping or puffing. A tube (which can be mounted for convenient access) has a mouthpiece attached. The user sips or puffs on the mouthpiece, and the change in air pressure is transferred along the tube to a switching unit. This unit activates one switch for sipping, one for puffing.

---

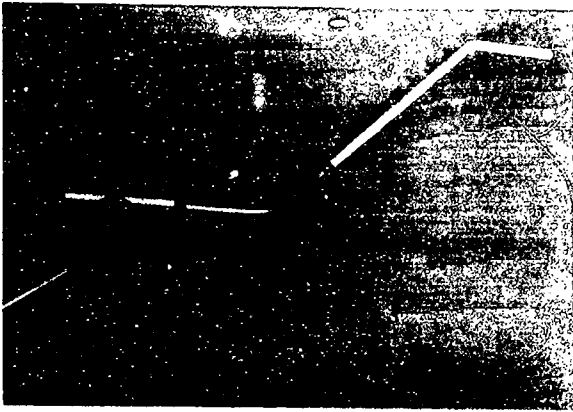

**Product Name:** Pneumatic Switch (5100, 5101)  
**Vendor:** TASH, Inc.  
**Number of Switches:** Dual Switch  
**Connector Type:** 5-Pin DIN  
**Cost:** \$235.00

Pneumatic Switch is a dual switch operated by breathing through a tube. Sipping activates one switch; puffing activates the other. Pneumatic Switch has an internal saliva trap which can be cleaned. The mouthpiece is a disposable straw. Model 5101 is the pneumatic switch on an extended tube.

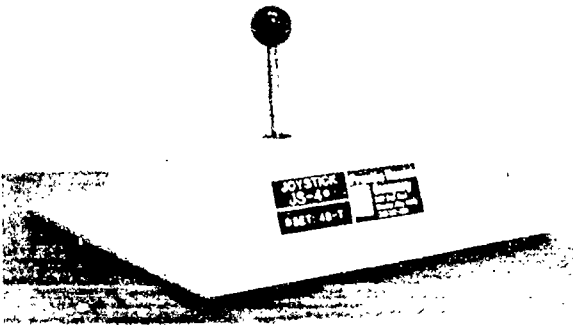

**Product Name:** PRC Joystick  
**Vendor:** Prentke Romich Company  
**Number of Switches:** Joystick (4 or 5 Switches)  
**Activation Pressure:** 5.1 oz.  
**Connector Type:** DC 9  
**Cost:** \$230.00

The PRC joystick is activated by pushing the handle in any of four directions. Each direction activates one of four switches. When used to control a scanning device, pushing diagonally may allow for diagonal scanning.

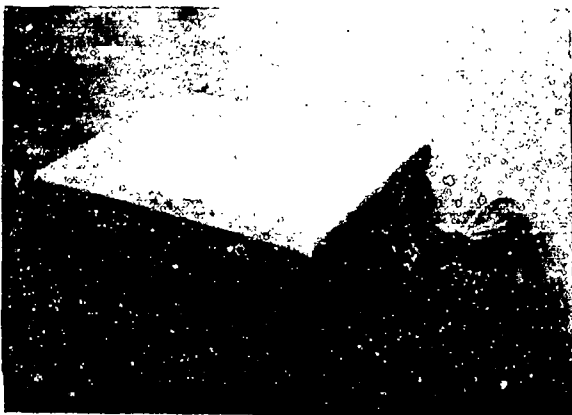

**Product Name:** Pressure Switch  
**Vendor:** Burkhardt, Linda J.  
**Number of Switches:** Single Switch  
**Connector Type:** Mini-phone plug  
**Cost:** \$24.50

Pressure Switch is a single switch activated by lightly pressing on a large plastic plate. The plate is 7" x 10" and the base of the switch is made of wood.

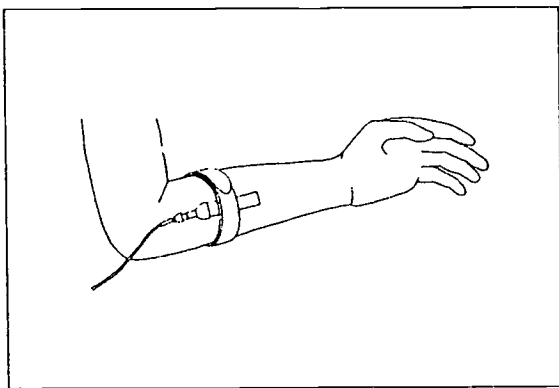

**Product Name:** Pressure Switch  
**Vendor:** Luminaud, Inc.  
**Number of Switches:** Single Switch  
**Activation Pressure:** Adjustable  
**Connector Type:** 3.5 mm phone plug  
**Cost:** \$45.00

Pressure Switch is designed to be worn on the upper arm, lower arm, knee, etc. Pressure against the switch activates it.

---

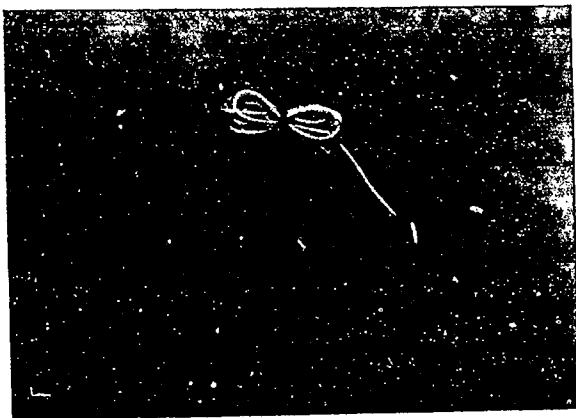

**Product Name:** Pull Switch  
**Vendor:** Burkhardt, Linda J.  
**Number of Switches:** Single Switch  
**Connector Type:** Mini-phone plug  
**Cost:** \$18.95

Pull Switch is a single switch activated by pulling on a ring attached to a cord. The switch is designed to be suspended above the user with the ring hanging down.

---

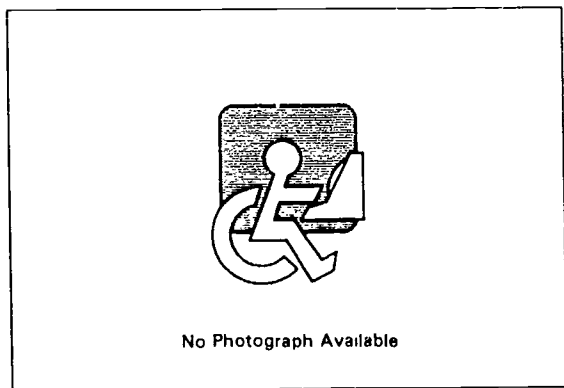

**Product Name:** Pull Switch  
**Vendor:** Toys for Special Children, Inc.  
**Cost:** \$25.00

Pull Switch is activated by a gentle tug on a ball. Suction cups are included for mounting.

273

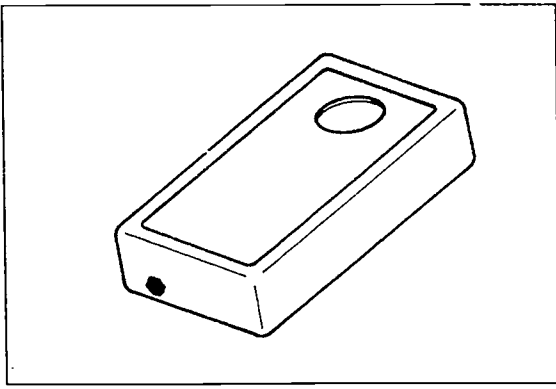

**Product Name:** Pushbutton Switch: CM-11  
**Vendor:** Zygo Industries, Inc.  
**Number of Switches:** Single Switch  
**Activation Pressure:** 2 oz.  
**Connector Type:** Mini-phone plug  
**Cost:** \$95.00

Pushbutton Switch is a single snap-action switch. To activate the switch, the user presses a round button located in a 1.25" diameter recess.

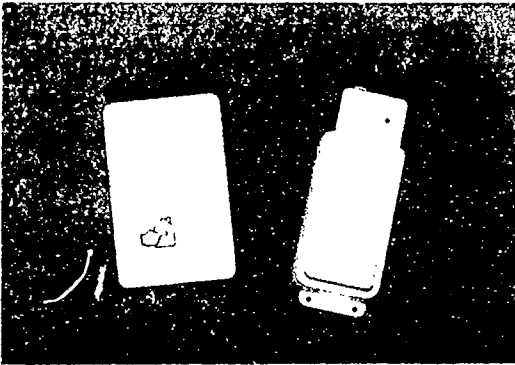

**Product Name:** Remote Ability Switch Adapter  
**Vendor:** Easy Home Control  
**Number of Switches:** Single Switch  
**Cost:** Contact manufacturer

The Remote Ability Switch Adapter converts almost any ability switch into a wireless. The ability switch is plugged into the transmitter and the receiver is plugged into the controlled device, allowing the switch to work up to 50 feet away. The remote has a three position channel to prevent other transmitters from triggering the switch.

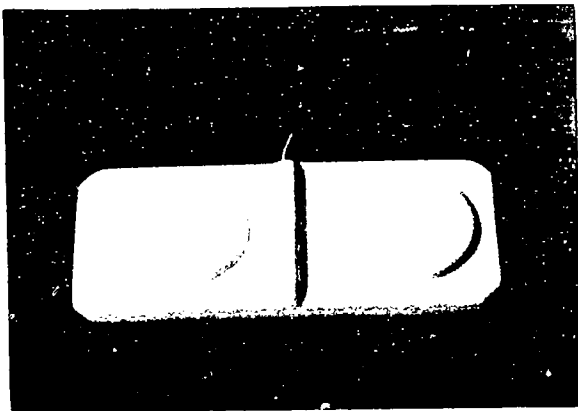

**Product Name:** Rocker Switch (5505)  
**Vendor:** TASH, Inc.  
**Number of Switches:** Dual Switch  
**Activation Pressure:** 5 oz.  
**Connector Type:** 5-Pin DIN  
**Cost:** \$110.00

The Rocker Switch is a dual switch operated by pressing either side of the switch. The Rocker Switch may be used to control a device requiring two switches for operation, or to control two devices requiring a single switch.



**Product Name:** Rocking Plate Switch  
**Vendor:** Toys for Special Children, Inc.  
**Number of Switches:** Dual Switch  
**Connector Type:** 1/4" or 1/8" phone plug  
**Cost:** \$27.00 - \$36.00

Rocking Plate Switch (\$27.00) and Small Rocking Switch (\$36.00) are dual switches activated by pressing on either end of a long plate. Pressing one end activates one switch; pressing the other end activates the second. Suction cup feet are provided for stability.

---

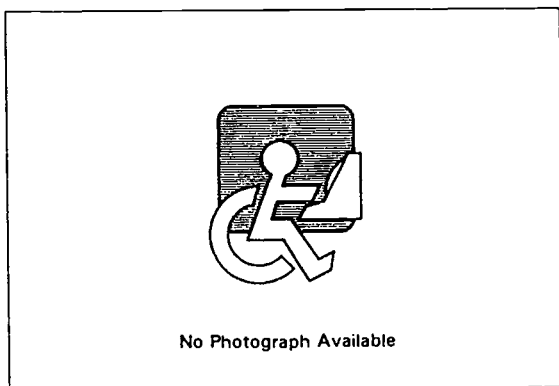

**Product Name:** Roller Switch Music Box  
**Vendor:** Toys for Special Children, Inc.  
**Cost:** \$33.00

The Roller Switch Music Box is a wooden cylinder switch that may be attached to a toy or other device. The device is activated when the cylinder is rolled in either direction. The switch will play music when no device is attached.

---



**Product Name:** Round Pad Switch (5805)  
**Vendor:** TASH, Inc.  
**Number of Switches:** Single Switch  
**Activation Pressure:** 6 oz.  
**Connector Type:** 1/8" phone plug  
**Cost:** \$70.00

Round Pad Switch is a disk-shaped single switch activated by pressure on the top surface.



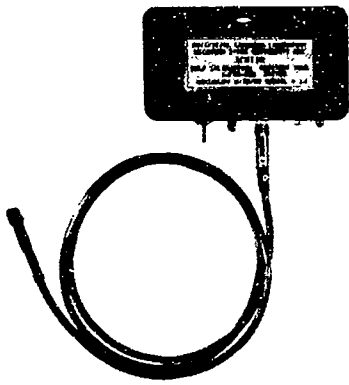

**Product Name:** SCATIR Switch

**Vendor:** Artificial Language Laboratory

**Cost:** \$145.00

The Self-Calibrating Auditory Tone Infrared (SCATIR) switch is activated by the movement of any body part from a distance of up to 3" from the sensor. Two modes (manual and self-calibrating) set this activation distance. A gooseneck mounted sensor is available for \$30.00.

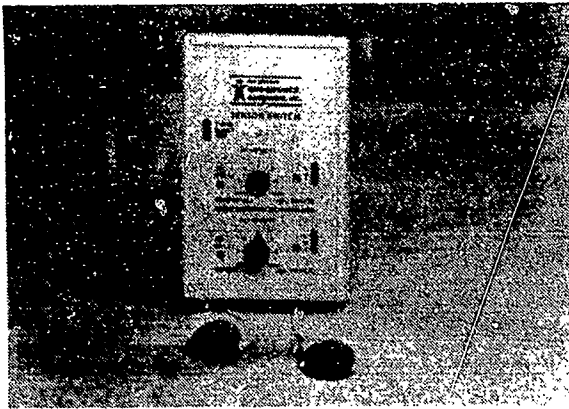

**Product Name:** Sensor Switch

**Vendor:** Don Johnston Incorporated

**Number of Switches:** Single Switch

**Cost:** \$285.00

The Sensor Switch is a dual switch activated by small controlled muscle movement. Auditory and visual feedback is provided. The switch comes with a head band for mounting. The switch operates in latch, timed, or momentary modes.



**Product Name:** Shadow Switch

**Vendor:** Crestwood Company

**Number of Switches:** Single Switch

**Connector Type:** 1/8" phone plug

**Cost:** \$74.95

The Shadow Switch is a patented switch that is activated when the user waves a hand over the photocell and blocking incoming light on the top. Can be used in momentary and latching modes.



**Product Name:** Signal Buzzer Plate  
**Vendor:** Therapeutic Toys, Inc.  
**Number of Switches:** Single Switch  
**Cost:** \$30.00 - \$39.95

The Signal Buzzer Plate is a large, yellow, rectangular plate switch available in two sizes.

---

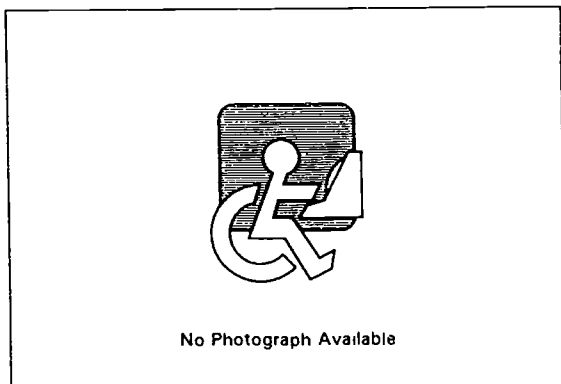

**Product Name:** Signal Switch  
**Vendor:** Toys for Special Children, Inc.  
**Number of Switches:** Single Switch  
**Connector Type:** 1/4" or 1/8" phone plug  
**Cost:** \$25.00

The Signal Switch is a low-profile, very sensitive switch with texture to encourage activation.

---

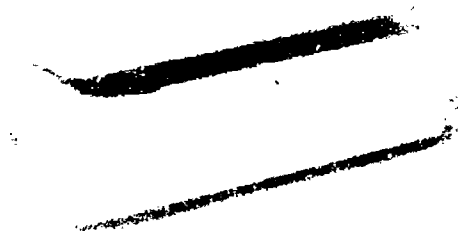

**Product Name:** Single Rocking Lever Switch  
**Vendor:** Prentke Romich Company  
**Number of Switches:** Single Switch  
**Activation Pressure:** 1.2 - 3.9 oz.  
**Connector Type:** Mini-phone plug  
**Cost:** \$75.00

Single Rocking Lever Switch is a single switch activated by depressing the plate on top. The switch housing is made of plastic, has rubber feet on the bottom and a threaded hole for mounting. Single Rocking Lever Switch comes in two models: low and medium force.

282



**Product Name:** Sip & Puff Switch

**Vendor:** Toys for Special Children, Inc.

**Number of Switches:** Single Switch

**Connector Type:** 1/4" or 1/8" phone plug

**Cost:** \$37.00

This single switch is activated by either sipping or puffing into a tube. The tube is attached to a housing where the actual switch is located.

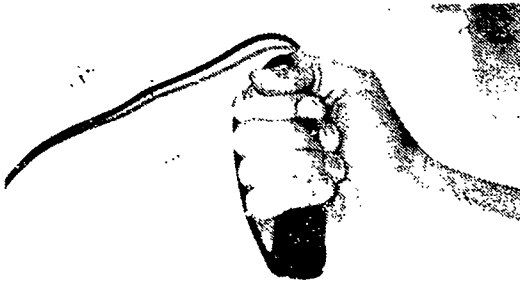

**Product Name:** Snappy Switch

**Vendor:** ORCCA Technology, Inc.

**Cost:** \$39.00

Snappy Switch is a grip switch with an elastic loop that keeps the switch in the user's hand and is activated by squeezing. The soft foam Snappy Switch features tactile feedback.

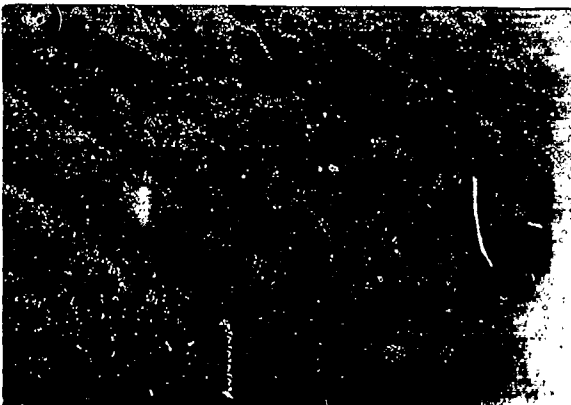

**Product Name:** Soft Switch (5820, 5821)

**Vendor:** TASH, Inc.

**Number of Switches:** Single Switch

**Activation Pressure:** 29 oz.

**Connector Type:** 1/8" phone plug

**Cost:** \$75.00

Soft Switch is a single switch with a soft surface. Soft Switch comes in a velvet bag that can be removed and washed.

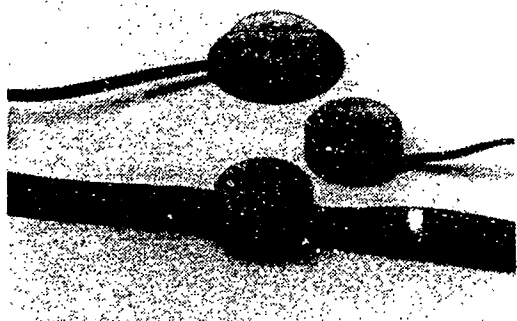

**Product Name:** Specs Switch

**Vendor:** AbleNet, Inc.

**Cost:** \$42.00

The Specs Switch is round switch that is activated by light pressure. The switch comes with three interchangeable bases: a flush base, flange base, and a strap-adaptable base. The switch is designed to be easily mounted in a variety of configurations. Seven colors are available: red, blue, green, yellow, black, pink, and purple.

---

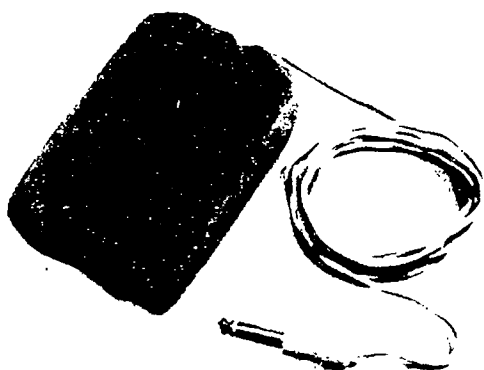

**Product Name:** Sponge Nurse Call Switch

**Vendor:** Dickey Engineering

**Number of Switches:** Single Switch

**Connector Type:** 1/4" phone plug

**Cost:** \$62.50

The Sponge Nurse Call Switch is a cloth covered single switch. Any slight movement may activate the switch. A ten foot cord is provided with a 1/4" phone plug. A miniature plug is also available.

---



**Product Name:** Square Pad Switch (5810)

**Vendor:** TASH, Inc.

**Number of Switches:** Single Switch

**Activation Pressure:** 21 oz.

**Connector Type:** 1/8" phone plug

**Cost:** \$80.00

Square Pad Switch is a large single switch operated by pressing the top surface. A large target area is designed to compensate for the user's lack of controlled movement.

---

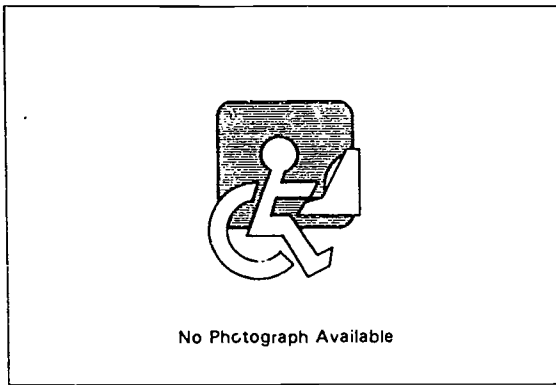

**Product Name:** Squeeze Switch  
**Vendor:** Kapable Kids  
**Number of Switches:** Single Switch  
**Connector Type:** 1/8" plug  
**Cost:** \$20.00

The Squeeze Switch is a foam covered switch with fabric enclosure and is designed to encourage maintained grasp. Minimal resistance and moderate resistance models are available. Both come with a 7' cord.

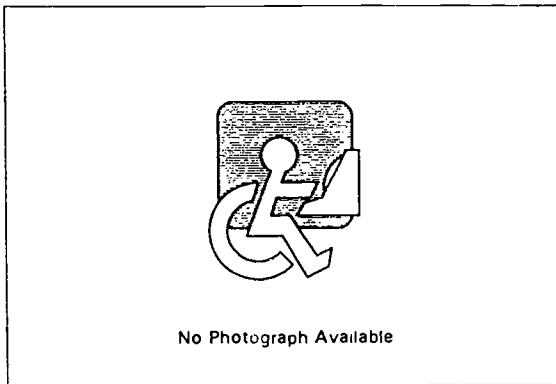

**Product Name:** Standard Paddle Switch  
**Vendor:** Creative Switch Industries  
**Number of Switches:** Single Switch  
**Activation Pressure:** 2 oz.  
**Connector Type:** Mini-phone plug  
**Cost:** \$34.50

Standard Paddle Switch is a single switch activated by pushing on a plastic 4" x 4" plate. The base of the switch is made of oak; the cord is three feet long.



**Product Name:** Star Switch (5026)  
**Vendor:** TASH, Inc.  
**Number of Switches:** Single Switch  
**Activation Pressure:** 4 oz.  
**Cost:** \$180.00

The Star Switch contains five mechanical switches arranged in the shape of a plus sign. The 2.25" keys are slightly recessed. Tactile and auditory feedback are provided by the switch.

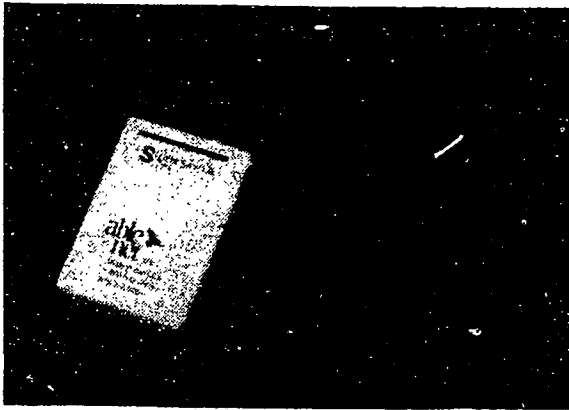

**Product Name:** String Switch

**Vendor:** AbleNet, Inc.

**Activation Pressure:** 0.5 oz.

**Cost:** \$26.00

The String Switch consists of a pull cord attached to a microswitch. A string or piece of yarn can be attached to lengthen the pull cord; the string is wrapped around any moveable body part and activated with less than 0.5 oz. of pressure.

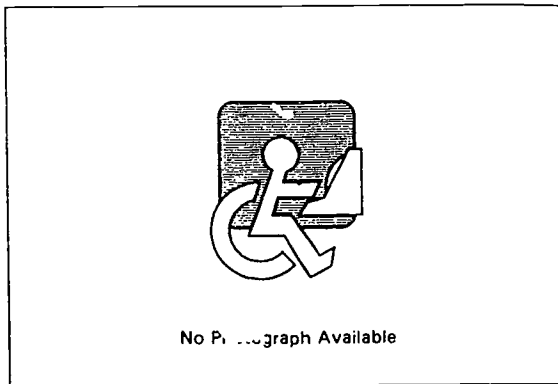

**Product Name:** String Switch

**Vendor:** Toys for Special Children, Inc.

**Number of Switches:** Single Switch

**Activation Pressure:** 0.5 oz.

**Connector Type:** 1/4" or 1/8" phone plug

**Cost:** \$19.00

The String Switch is activated by pulling on a string. The switch has suction cups for convenient attachment to most surfaces. For users who have poorly controlled movements, it is helpful to attach a rubber band "shock absorber" between the user and the switch.

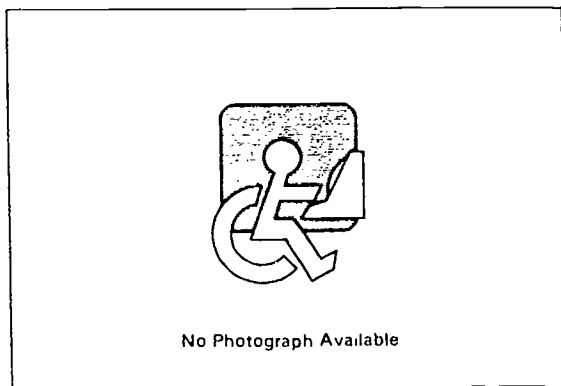

**Product Name:** Super-Sensitive Normally Open Switch

**Vendor:** Tapeswitch Corporation

**Number of Switches:** Single Switch

**Activation Pressure:** 1 oz.

**Cost:** \$85.40

Super-Sensitive Normally Open Switch is a switch activated by 1 oz. of pressure on a small button.

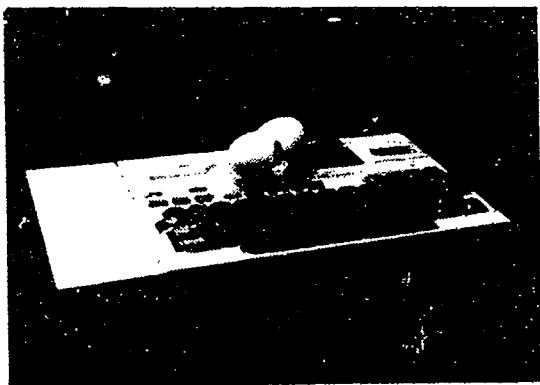

**Product Name:** Switchskins

**Vendor:** Embracing Concepts, Inc.

**Cost:** \$25.00 - \$70.00

Switchskins are pre-molded, form-fitting, pliable protective membranes for a variety of switches and power chair controls. Switchskins are made from abrasion and puncture resistant clear plastic film and are available for many devices made by TASH, AbleNet, Zygo, and Prentke Romich as well as joystick and chin controls for powered wheelchairs. Custom molded membranes can be made.

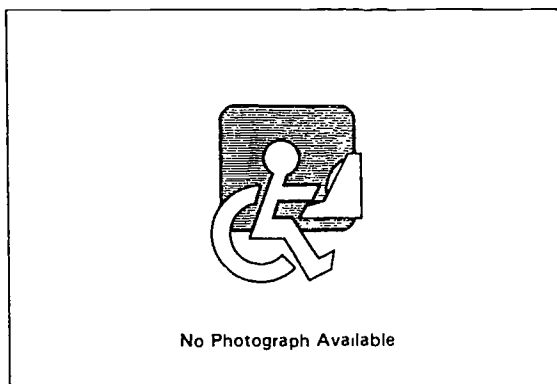

**Product Name:** Tactile Touch Pad

**Vendor:** Kapable Kids

**Number of Switches:** Single Switch

**Activation Pressure:** 4 oz.

**Connector Type:** 1/8" plug

**Cost:** \$25.00 - \$27.00

The Tactile Touch Pad is designed with four point contact to activate with a very light touch. The lightweight plastic frame with fabric top is designed to enhance sensory awareness. A 7' cord is included. The small touch pad sells for \$25.00 and the large touch pad for \$27.00.

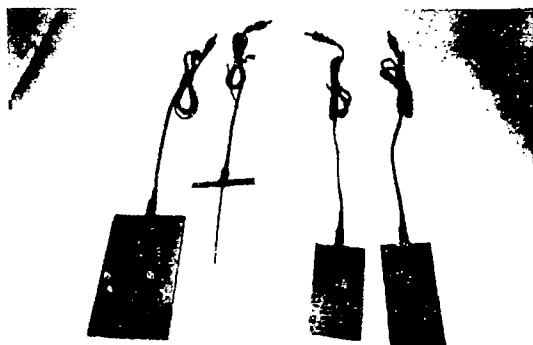

**Product Name:** Taction Pads

**Vendor:** Adaptation, Inc.

**Number of Switches:** Single Switch

**Cost:** \$12.50 each

Taction Pads are see-through touch sensitive switches that allow most objects or surface areas to be turned into switches. Three sizes are available: 2" x 4" rectangle, 1.5" x 10" arc, and 24" x .1" strip. Taction Pads were designed to operate with Adaptation's line of devices and will not work with other devices unless accompanied by the LinkSwitch (see entry).

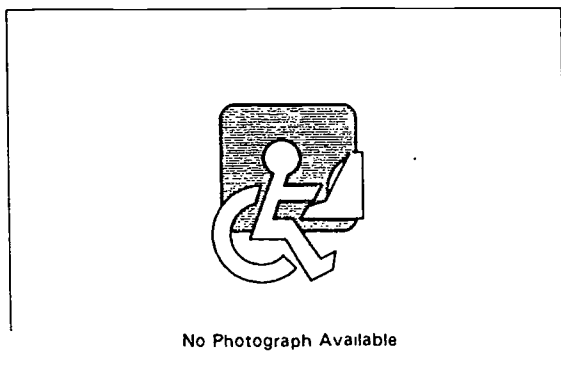

**Product Name:** TAS Switch  
**Vendor:** Artificial Language Laboratory  
**Number of Switches:** Single Switch  
**Activation Pressure:** 1.5 oz.  
**Connector Type:** 3.5 mm jack  
**Cost:** \$50.00

The TAS (Totally Active Surface) Switch is a momentary contact switch which can be activated by pressing any point on its surface. TAS responds when pressed with both an auditory and tactile click. Activation pressure can be decreased by adjustment or by replacing the microswitch with a more sensitive model. Mounting holes are provided.

---

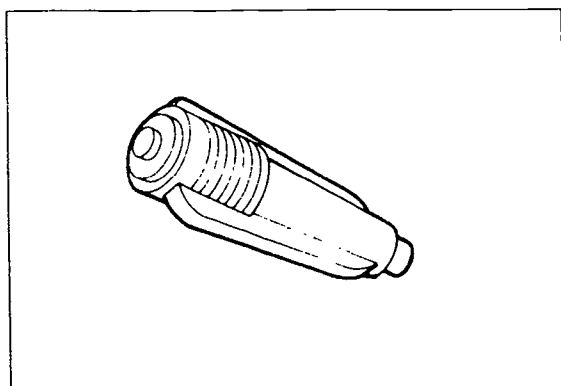

**Product Name:** Thumb Switch: CM-5  
**Vendor:** Zygo Industries, Inc.  
**Number of Switches:** Single Switch  
**Activation Pressure:** 20 oz.  
**Connector Type:** Mini-phone plug  
**Cost:** \$50.00

Thumb Switch is a conical housing with a button switch located at one end. The switch is held in the palm of the hand, and the button is pressed with the thumb. The switch is styled as a traditional nursing call alarm switch.

---



**Product Name:** Tilt Switch  
**Vendor:** Toys for Special Children, Inc.  
**Number of Switches:** Single Switch  
**Connector Type:** 1/4" or 1/8" phone plug  
**Cost:** \$19.00

Tilt Switch is a small unit containing a single mercury switch. When the unit is tilted, the switch is activated. The unit is mounted on a band which can be strapped to the desired part of the body.



**Product Name:** Tip Switch (5840)

**Vendor:** TASH, Inc.

**Number of Switches:** Single Switch

**Activation Pressure:** 5 degree tilt

**Connector Type:** 3.5 mm phone plug

**Cost:** \$60.00



Tip Switch is a mercury switch with smooth surface to allow easy mounting/positioning. The switch is operated by tipping it 5 degrees from its horizontal position.

**Product Name:** Tongue Switch

**Vendor:** Prentke Romich Company

**Number of Switches:** Dual Switch

**Activation Pressure:** 1.7 oz.

**Connector Type:** Mini-phone plug

**Cost:** \$135.00

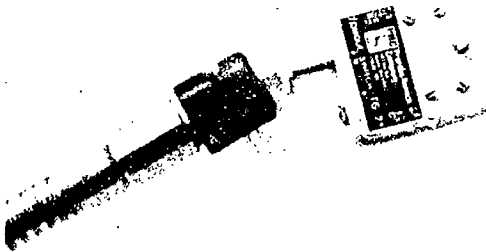

Tongue Switch is a dual switch activated by pushing up or down on a short lever. The switch has a threaded hole for mounting, for easier access by the body part used to activate it.

**Product Name:** Tongue Switch

**Vendor:** Toys for Special Children, I.r.c.

**Cost:** \$26.00 - \$52.00

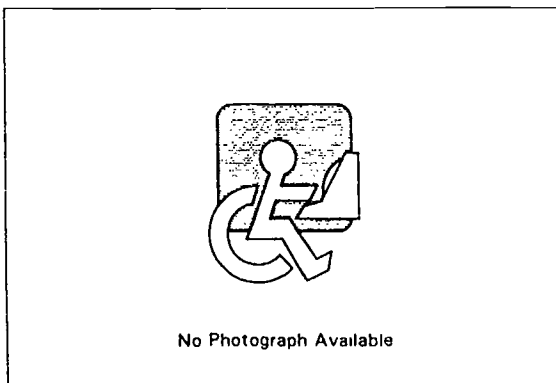

Tongue Switch is activated by slight lateral tongue movements against a protruding spring lever. Three models are available: one without the gooseneck mounting stand (\$26.00), one single switch with gooseneck (\$49.00), and one double switch with gooseneck (\$52.00).

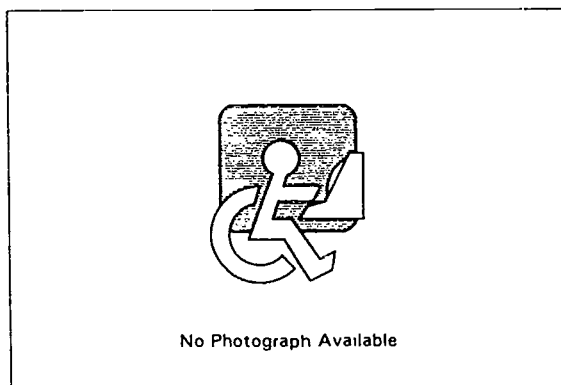

**Product Name:** Touch Pads  
**Vendor:** Tapeswitch Corporation  
**Number of Switches:** Single Switch  
**Activation Pressure:** 3 oz.  
**Cost:** \$25.10

Touch Pads are sealed, moisture-resistant, pressure-activated switches available in two sizes.

---

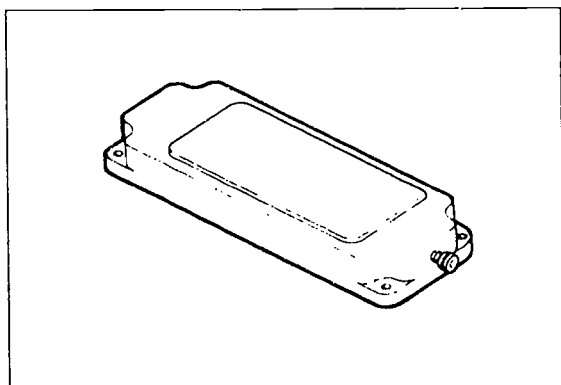

**Product Name:** Touch Switch: CM-4  
**Vendor:** Zygo Industries, Inc.  
**Number of Switches:** Single Switch  
**Activation Pressure:** 3 oz.  
**Connector Type:** Mini-phone plug  
**Cost:** \$90.00

Touch Switch is a single switch activated by very light pressure on a plastic plate.

---

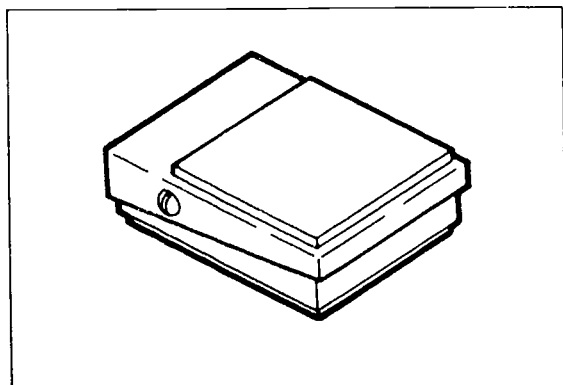

**Product Name:** Tread Switch: CM-1  
**Vendor:** Zygo Industries, Inc.  
**Number of Switches:** Single Switch  
**Activation Pressure:** 5 oz.  
**Connector Type:** Mini-phone plug  
**Cost:** \$60.00

Tread Switch is a single switch operated by depressing a treadle type lever. An audible click accompanies activation. The lever and the bottom of the switch are foam rubber coated. A tapped mounting hole is provided on the bottom of the switch.

250

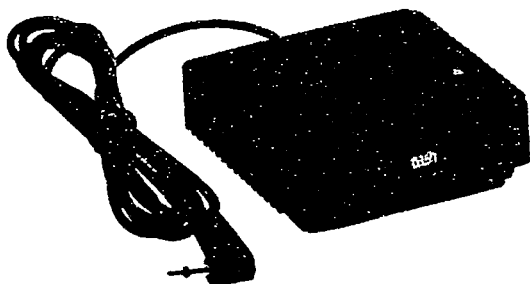

**Product Name:** Treadle Switch (5880)

**Vendor:** TASH, Inc.

**Number of Switches:** Single Switch

**Activation Pressure:** 25 oz.

**Connector Type:** 1/8" mini-phone plug

**Cost:** \$35.00

Treadle Switch is a single switch operated by pressing the hinged top surface. This switch allows the user to rest the body part used for activation on the switch's surface between activations.

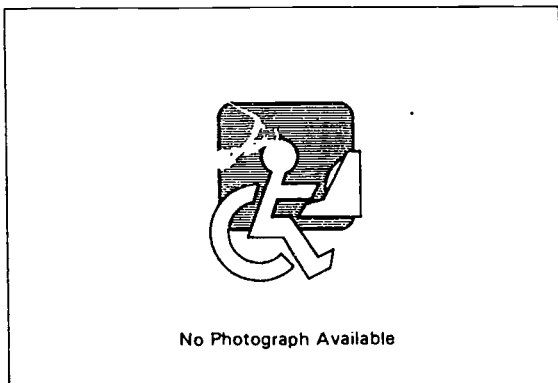

**Product Name:** Twin Plate Switch

**Vendor:** Crestwood Company

**Number of Switches:** Dual Switch

**Activation Pressure:** 2 oz.

**Cost:** \$115.00

Twin Plate Switch is a momentary pressure switch with two membrane switches in red and yellow built into one unit. Two five-foot cables are included.

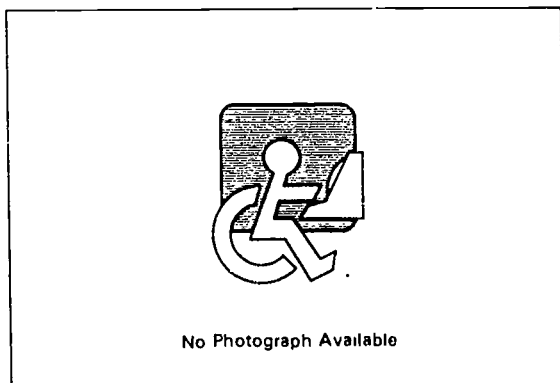

**Product Name:** Twinkle Switch

**Vendor:** ACS Technologies, Inc.

**Number of Switches:** Dual Switch, Single Switch

**Cost:** Contact manufacturer

The Twinkle Switch is operated by left to right eye movement for use with any scanning device. The Twinkle Switch system includes two electrodes placed on the sides of the face, a remote sender, and a remote receiver.

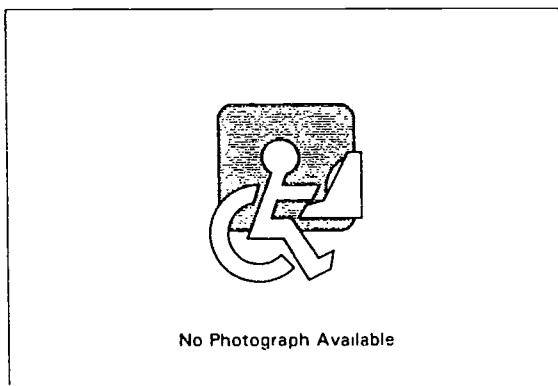

**Product Name:** Twitch Switch

**Vendor:** Toys for Special Children, Inc.

**Number of Switches:** Single Switch

**Cost:** \$65.00

The Twitch Switch is activated by small muscle movement, such as wrinkling the forehead, and can be adjusted to increase or decrease the amount of muscle movement needed to activate it. Non irritating tape attaches the sensor to the forehead, arm, or other part. The Twitch Switch can be operated in latch, momentary, or time mode.

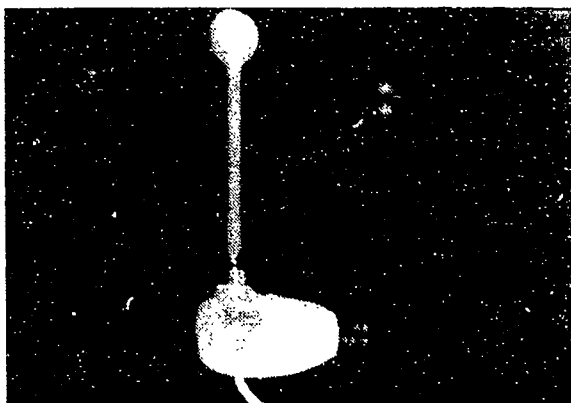

**Product Name:** Ultimate Switch

**Vendor:** Toys for Special Children, Inc.

**Number of Switches:** Single Switch

**Cost:** \$42.00 - \$65.00

Ultimate Switch is a universal switch which requires only one gram of activating force. The switch may be mounted in a variety of ways so that any body part can be used for activation. Alone the switch is \$42.00, with a clamp and gooseneck it is \$65.00.

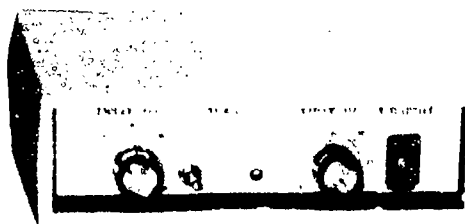

**Product Name:** Universal Adaptive Switch System

**Vendor:** Academic Software, Inc.

**Number of Switches:** Dual Switch,  
Multiple switches (3 to 16 Switches), Single Switch

**Activation Pressure:** 1 oz. - 30 oz.

**Cost:** \$195.00 - \$250.00

The Universal Adaptive Switch (UAS) is a low-voltage DC switch with momentary, latching, and time-delay modes and remote control capability. The UAS works with any single switch to control various devices. With the built-in transmitter option, UAS can control up to nine remote receivers. Time delay is variable up to 90 seconds; remote control range is approximately 50 feet.

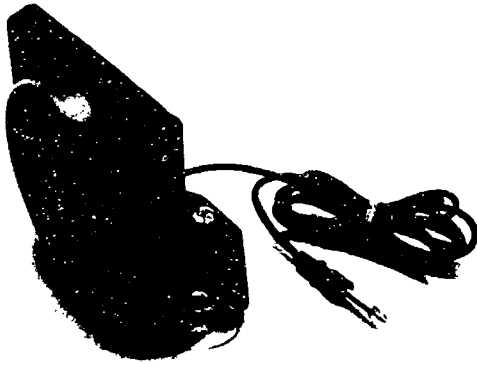

**Product Name:** Vertical Plate Switch  
**Vendor:** Toys for Special Children, Inc.  
**Number of Switches:** Single Switch  
**Connector Type:** 1/4" or 1/8" phone plug  
**Cost:** \$36.00

Vertical Plate Switch is a switch activated by pressing a circular plate. The plate is mounted on a right-angle bracket to allow it to be activated from the side. The bracket can be attached to a horizontal surface with provided suction cups, screws, or double-sided tape.

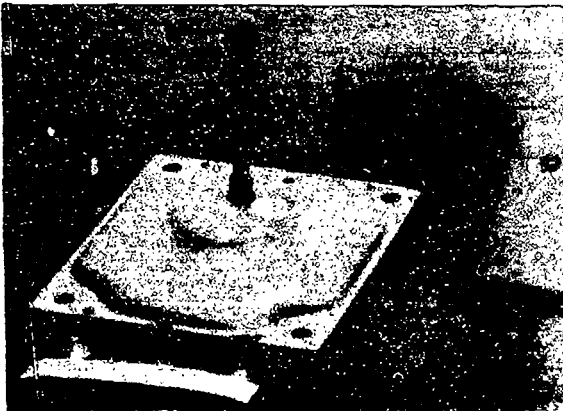

**Product Name:** Vertical Wobble Switch  
**Vendor:** Toys for Special Children, Inc.  
**Number of Switches:** Single Switch  
**Activation Pressure:** 1 oz.  
**Connector Type:** 1/4" or 1/8" phone plug  
**Cost:** \$41.00

Vertical Wobble Switch is a single switch activated by bending a flexible rod. The switch is designed for mounting so the rod can be in any position. Suction cups (included), tape, or screws can be used for mounting.

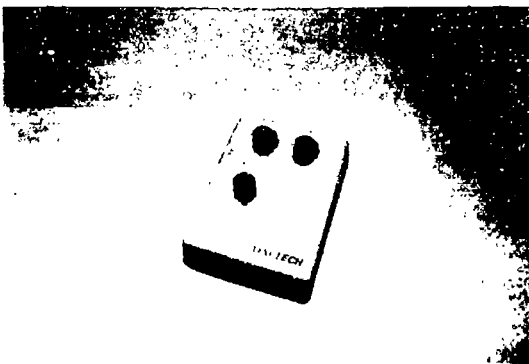

**Product Name:** Vibration Switch  
**Vendor:** Adaptation, Inc.  
**Number of Switches:** Single Switch  
**Connector Type:** 1/8" phone jack  
**Cost:** \$99.00

The Vibration Switch is activated by a light tap or hard pounding (depending on sensitivity selected) on the table it is resting on. The switch operates in momentary, latched, or timed mode. Requires cable CC-6 (not included).

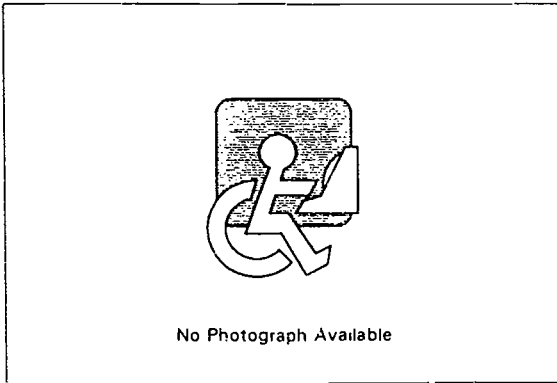

**Product Name:** Voice Activated Switch  
**Vendor:** Toys for Special Children, Inc.  
**Number of Switches:** Single Switch  
**Connector Type:** 1/4" or 1/8" phone plug  
**Cost:** \$85.00

Voice Activated Switch is a switch unit with a self-contained microphone. When the microphone detects a sound (such as speech), the switch is activated. The sound threshold level, the length of time the switch will stay on, and latching or momentary modes can be adjusted.

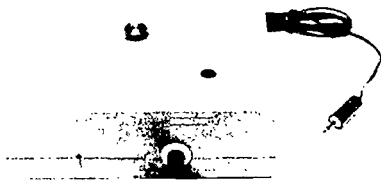

**Product Name:** Voice Switch  
**Vendor:** Crestwood Company  
**Number of Switches:** Single Switch  
**Connector Type:** 1/8" phone plug  
**Cost:** \$109.95

The Voice Switch is designed as both a control switch and a voice therapy tool. The patented switch can be used either in momentary or latch modes. In momentary mode the device and red light stays on as long as the user is talking, in the latch mode the device stays on until the user's voice turns it off again. Sensitivity control is also available.

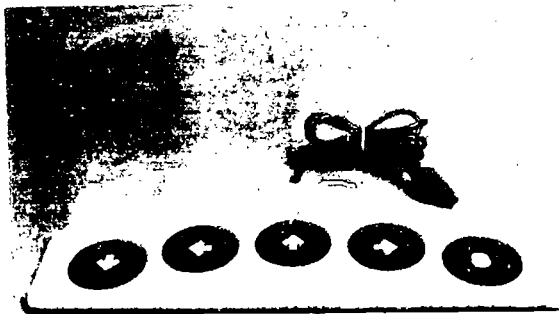

**Product Name:** Wafer Switch (5018)  
**Vendor:** TASH, Inc.  
**Number of Switches:**  
Multiple switches (3 to 16 Switches)  
**Activation Pressure:** 4 oz.  
**Connector Type:** 9-Pin DIN  
**Cost:** \$180.00

Wafer Switch consists of five membrane switches in one low profile housing. The pressure plates are 2.25 inches in diameter, and have directional cursor control markings. This can be used for joystick-type control.

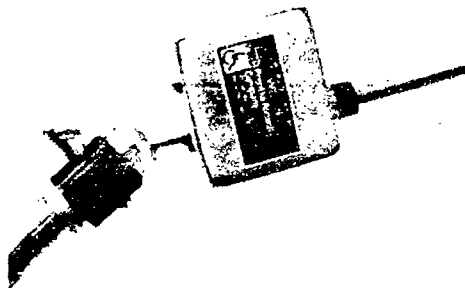

**Product Name:** Wobble Switch  
**Vendor:** Prentke Romich Company  
**Number of Switches:** Single Switch  
**Activation Pressure:** 1.8 oz.  
**Connector Type:** Mini-phone plug  
**Cost:** \$115.00

This switch is activated by pushing against a lever. The lever has a spring built in, and can be pushed in any direction for activation. The Wobble Switch comes with a threaded hole for mounting.

---

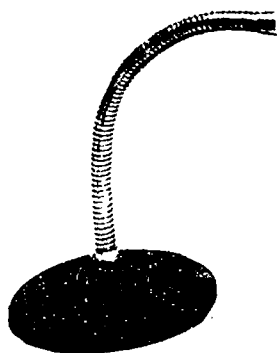

**Product Name:** Wobble Switch  
**Vendor:** Toys for Special Children, Inc.  
**Number of Switches:** Single Switch  
**Connector Type:** 1/4" or 1/8" phone plug  
**Cost:** \$66.00

This switch is activated by any flexion of the spring lever. The lever comes mounted on a gooseneck and stand.

## Chapter 9

# Environmental Controls and Telephone Adaptations

For the purposes of this chapter, "environmental controls" are defined as devices or systems whose function is to control some other device in the person's environment. Exceptions are (1) devices used to control computers and (2) devices used to control battery-operated devices (such as toys) for the purpose of teaching or encouraging switch operation or communication skills. The former are found mostly in Chapters 12 and 13, the latter in Chapter 3.

This chapter does include electric page turners, telephone dialers, remote appliance switches, television controllers, and so forth. Many of these systems can be controlled using the switches and controls listed in Chapter 8. Certain special non-electronic telephone accessories are also included in this chapter.

Devices which are not primarily environmental controls, but which can function as such, are cross-listed (along with the products in this chapter) in Index 1, under the function Environmental Control (EC). Some other related functions appearing in Index 1 are Phone Control (PC) and Book/Paper Handling (BP). Index 2 cross-lists products by input and output features. Some features to check are Input Type: Switch Input, Input Type: Wireless, and Input Type: Speech Recognition.



*The following product entries appear in this chapter:*

911 Telephone Terminal, 263  
 AbiliTech Commander IR, 263  
 AbiliTech Commander X-10, 264  
 AbiliTech Communicator, 264  
 AbiliTech Home Control System, 265  
 Ability Switch Phone Sequencer, 265  
 Able-Phone 100WA, 266  
 Able-Phone 1900 and 2000, 266  
 Able-Phone 6000SX, 267  
 ACS Headsets, 267  
 Adapted Telephone Interfaces, 268  
 APT Automaddak Page Turner System, 268  
 Automatic Drapery Opener System, 269  
 Bed Control (DBC-1), 269  
 Big Button Bed Control, 270  
 Butler-in-a-Box, 270  
 CCT Environmental Control, 271  
 CINTEX2, 271  
 Control 1, 272  
 Controller, 272  
 Custom Speaker Phone, 273  
 DEUCE, 273  
 E.A.S.I.dialer (2110), 274  
 EASICORDER, 274  
 Environment Control, 275  
 Environmental Control Units, 275  
 Expanded Keyboard for Automatic Telephone, 276  
 EZ-TV Adapted Infrared Remote Control for Televisions, 276  
 EZRA, 277  
 F71863 Touchables Touch Phone Attachments, 277  
 First Aide Kit, 278  
 Fone Holder, 278  
 FreeSwitch, 279  
 GEWA Infra-Link Speaker-Telephone, 279  
 GEWA Infra-Link System, 280  
 Gewa Page Turner, 280  
 Giant Push Button Telephone Adapter, 281  
 HandiPHONE, 281  
 HECS-1, 282  
 Home Control Systems, 282  
 HomeAccess, 283  
 In & Out Automatic Door Controller, 283  
 Infrared Remote Control IRTI-1, 284  
 Kincontrol (4105), 284  
 Mastervoice Environmental Control Single User Unit, 285  
 Memory Button Telephones, 285  
 Mini-Environmental Control (ECU) Box, 286  
 Motorized Easel, 286  
 MultiPhone, 287  
 Next Page Page Turner (4600), 287  
 On/Off Remote Switch, 288  
 Phone Manager, 288  
 PhoneAccess, 289  
 Portable Telephones, 289  
 PowerLink 2, 290  
 PROXi, 290  
 RC5000 Radio Home Control System, 291  
 RELAX (8200), 291  
 Remote Control Speakerphone Model RC3000, 292  
 Saltus Reader, 292  
 Sapura S2000 CL, 293  
 Scanning Director, 293  
 Scanning Remote Control (SRC), 294  
 Scanning X-10 Powerhouse, 294  
 SenSei System, 295  
 Simplicity Series ECUs, 295

Single-Appliance Continuous Control Unit, 296  
 Sinele-Switch Multi-Appliance Control Unit & Modules, 296  
 Single-Switch TV Control Unit, 297  
 Sip/Puff Bed Control, 297  
 Speaker Phones, 298  
 Synergy Integrated Remote, 298  
 T-140 Series Puff/Sip Speakerphones, 299  
 TEAM, 299  
 Telephone Holder & Line Connector, 300  
 Telephone Management System, 300  
 Touch Turner, 301  
 TVRC and TVRCS, 301  
 U-Control, 302  
 Ultra 4 Remote System & Scanning Ultra 4, 302  
 Universal Control System with Tongue Touch Keypad, 303  
 Universal Remote Controls, 303  
 Universal Telephone Adapter, 304  
 Universal Television Remote Control, 304  
 URC-400 Series Universal Remote Control, 305  
 VX-5000 Cordless Phone, 305  
 Wireless TV & VCR Remote Controls, 306  
 X-10 Home Control Interface, 306  
 X-10 Powerhouse System, 307

*The following products from other chapters can also be used as Environmental Controls or Telephone Adaptations:*

Activity Board, 30  
 CINTEX 1, 744  
 Communication Programs, 124  
 Delay Timer Box, 40  
 Dual Channel Latching Switch Interface, 41  
 E Z Keys, 339  
 EvalPAC with RealVoice, 131  
 Eye Slaved Pointing System, 387  
 Eyegaze Computer System, 132  
 HAL (Home Automation Link), 392  
 Head Position Interface, 222  
 High Tech/Low Cost, 223  
 Intercom (4392), 318  
 LIAISON, 407  
 Liberator, 137  
 Media Handling Products, 349  
 Pegasus, 145  
 RealVoice, 147  
 Scan Com, 149  
 Scan-It-All, 149  
 ScanPAC, 150  
 Slide Projector Control, 55  
 Switch Latch (4388), 56  
 Timer Module, 59  
 Training Aid 2, 61

297

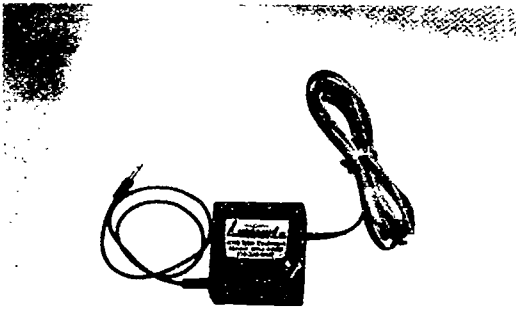

**Product Name:** 911 Telephone Terminal

**Vendor:** Luminaud, Inc.

**Size:** 2.2" x 2.3" x 1"

**Weight:** 4 oz.

**Cost:** \$49.00

The 911 Telephone Terminal provides direct telephone connection for the Voicette Amplifier, Companion 401 Communicator, Vocaid, Vocal Assistant, and most major brands of electronic communication aids. The 911 is a box with inputs from the telephone wall line, the telephone, and the communication device. When the user wishes to make a call or answer the telephone, the user hooks the communication device into the 911, picks up the handset, and converses through the device with all outside noise blocked out.



**Product Name:** AbiliTech Commander IR

**Vendor:** AbiliTech Inc.

**Computer:** IBM PC Family

**Size:** 4.25" x 2.5" x 1.5"

**Weight:** 12 oz.

**Cost:** Contact manufacturer

AbiliTech Commander IR is a computer operated environmental control for most infra-red remote controlled devices including TV, VCR, stereo, cable box, DSS system and others. This system is designed to provide the user with complete control of the systems listed including timed controls for recording, channel change on/off and others using a personal computer. All input is done with a mouse or mouse emulating device (Trackball, PRC HeadMaster, Freewheel, etc.). The system requires no keyboard input.

The system includes an RS232 interface, receiving/transmitting device, power supply, and Microsoft Windows based software.

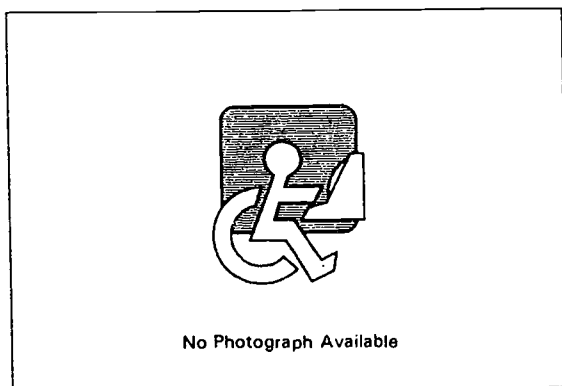

**Product Name:** AbiliTech Commander X-10  
**Vendor:** AbiliTech Inc.  
**Computer:** IBM PC Family  
**Size:** 7" x 5" x 2"  
**Weight:** 1.5 lbs.  
**Cost:** \$295.00

AbiliTech Commander X-10 is a computer operated environmental control system for use with most home appliances, lights, security devices, etc. The system provides on/off control for electric appliance and on/off dimmer control for lighting. This system is designed to provide the user with complete control of the items listed including pre-set, timed controls for operating lights, air conditioners, security systems, etc. using a home computer. All computer input is done with a mouse or mouse emulating device (Trackball, PRC HeadMaster, Freewheel, etc.). The system requires no keyboard input from the user.

The system includes an RS232 interface, receiving/transmitting device, power supply, and Microsoft Windows based software.

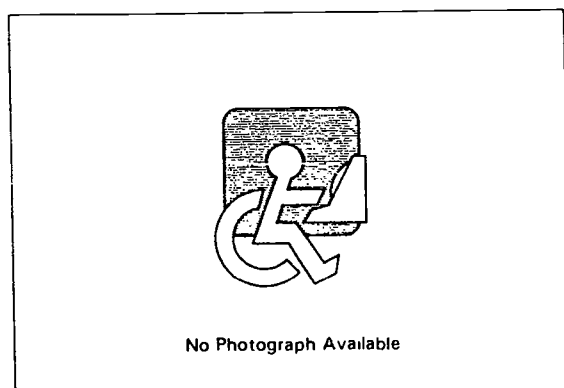

**Product Name:** AbiliTech Communicator  
**Vendor:** AbiliTech Inc.  
**Computer:** IBM PC Family  
**Size:** 4.25" x 2.5" x 1.5"  
**Weight:** 3 lbs.  
**Cost:** \$325.00

AbiliTech Communicator is an internal computer interface card including modem, voice mail, speaker phone, and Adlib/Sound Blaster compatible sound on a single card. The software provides a hands-free speaker phone with memory dial, visual keypad, mute toggle, last number redial, etc. All computer input is done with a mouse or mouse emulating device (Trackball, PRC HeadMaster, Freewheel, etc.). The system requires no keyboard input from the user.

The system includes an internal 16 bit interface board, and Microsoft Windows based software.

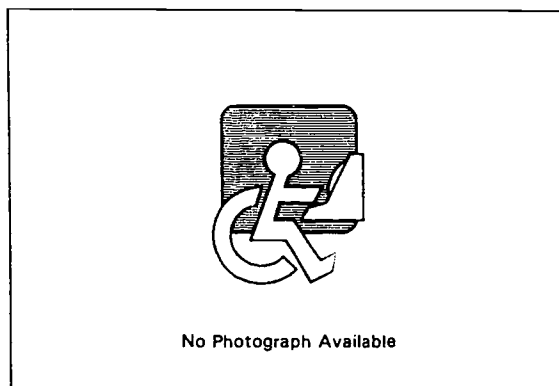

**Product Name:** AbiliTech Home Control System

**Vendor:** AbiliTech Inc.

**Computer:** IBM PC Family

**Cost:** Contact manufacturer

AbiliTech Home Control System is a custom IBM computer system made to order. The system is designed especially for people who are unable to use a standard keyboard for input. Optional equipment allows the user to control lights, appliances, TV, VCR, DSS, speaker phone, FAX, modem and others. Devices include PRC wireless HeadMaster (see entry), AbiliTech Commander IR, Commander X-10 and Communicator (see entries), CD-ROM drive, choice of hard drives, choice of memory amount, all necessary drivers, and the user's choice of software. All software and components will be set up, configured, tested, and labeled for installation.

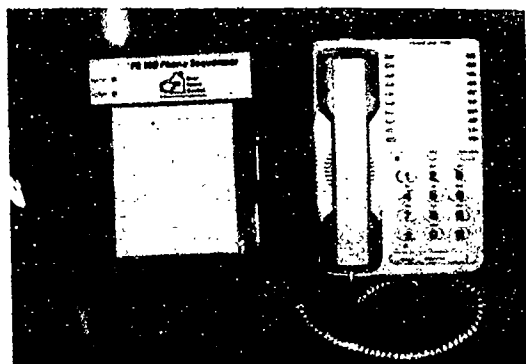

**Product Name:** Ability Switch Phone Sequencer

**Vendor:** Easy Home Control

**Cost:** Contact manufacturer

The Ability Switch Phone Sequencer is a touch tone speaker phone with a 20-number one touch speed dialing that operates from any ability switch. Through the phone sequencer the hands free speaker phone may be answered or calls may be placed via the speed dialing.

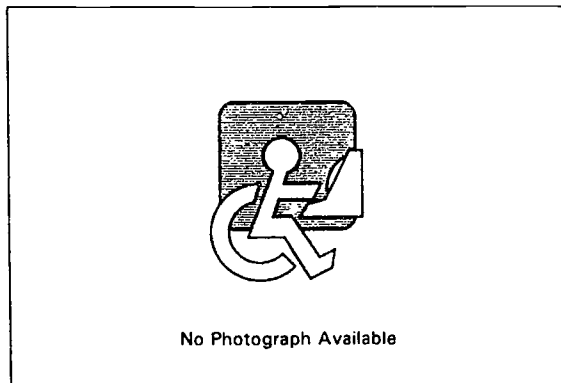

**Product Name:** Able-Phone 100WA

**Vendor:** DQP, Inc.

**Weight:** 5 lbs.

**Cost:** \$595.00

The Able-Phone 100WA is a cordless headset telephone. To answer incoming calls, the user whistles into the headset and a connection is established. Outgoing calls are made similarly, as a whistle by the user can also place a call directly to the operator. The headset is connected to a remote unit which sends signals to a base receiver from up to 750 feet away. In addition to a whistle switch, optional plug-in switches (which allow activation by puff, puff-sip, touch, lever, or plate switches) can also be used; all switches are extra.

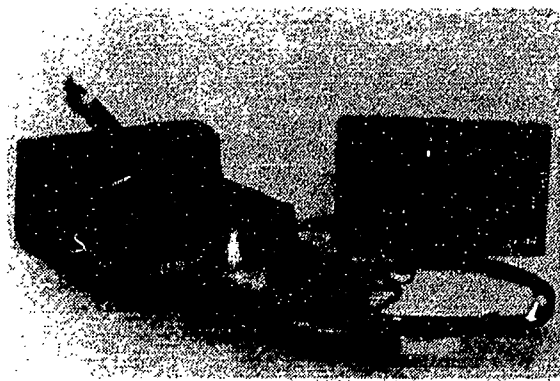

**Product Name:** Able-Phone 1900 and 2000

**Vendor:** DQP, Inc.

**Size:** 4.5" x 10.5" x 8.5"

**Weight:** See text

**Cost:** \$295.00 - \$395.00

Able-Phone 1900 and 2000 are speaker phones intended for use by people with mobility impairments. Able-Phone 1900 (6.5 lbs.; \$295.00) has a built-in puff switch and microphone mounted on an adjustable gooseneck. Able-Phone 2000 (4.5 lbs.; \$395.00) is activated by an adjustable whistle tone, or by wireless remote, puff-and-sip, or lever switches (extra). Both phones, when activated, will automatically dial the operator or a user-programmed number. A large keypad, which can be accessed with one finger or a mouth or head stick, is provided for additional auto-dialing capability.

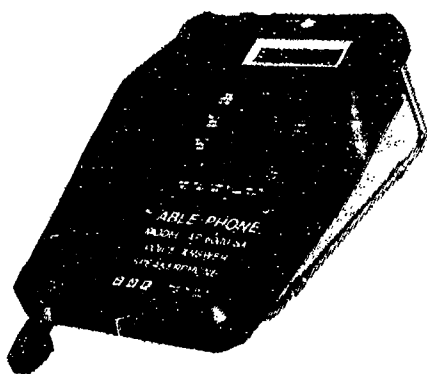

**Product Name:** Able-Phone 6000SX

**Vendor:** DQP, Inc.

**Cost:** \$495.00

The Able-Phone 6000SX is a speakerphone which places phone calls when the user whistles or makes any sound. To place a call the user whistles to scroll through the phone's directory memory. When the name of the person appears on the phone's small display, the user whistles again and the number will be automatically dialed. To terminate a call the user just whistles and the connection will be ended. The Able-Phone 6000SX has a call waiting feature; to activate the feature the user must whistle twice in succession (within four seconds) and answer the waiting call. To return to the original caller, the user whistles twice again and can continue the conversation. The phone can be manually activated and has a speaker feature. In addition, Able-Phone 6000SX has an adjustable volume control, date and clock, electronic lock, adjustable angle control, weak battery indicator, and programmable reminders. To answer an incoming call, the user says "hello" after the second ring.

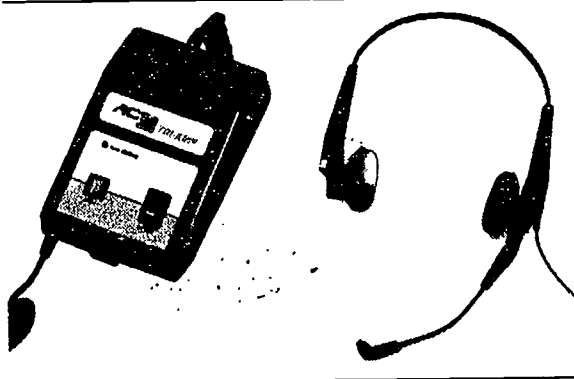

**Product Name:** ACS Headsets

**Vendor:** ACS Communications

**Weight:** 0.5 oz. - 2 oz.

**Cost:** Contact manufacturer

ACS Headsets are lightweight headsets combining headphones and microphone, designed to be used in place of a standard telephone receiver. There are seven models. The Orator Monaural and Binaural have headsets with phones that rest on the outside of the ear. The NWII Monaural and NB II Binaural have headsets with phones that fit inside the ear. The Elation is a monaural headset which is ultralight (.5 oz.) and easily removable. The Contour LX and MicroSet hook over a single ear and have an in-ear phone.

An option for all models is the Tri-Amp, which provides sound amplification and volume control and suppresses loud data signals that can come over ISDN systems before those signal reach the ear. The Tri-Amp is also packaged with headsets specifically for hearing aid wearers and visually impaired users.

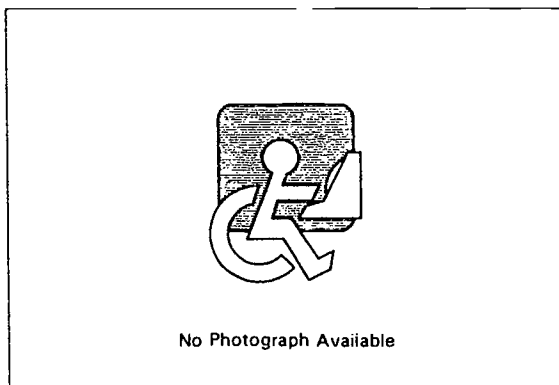

**Product Name:** Adapted Telephone Interfaces

**Vendor:** Various (Generic Product)

**Cost:** Varies

While a number of specific telephone adaptations are included in this book, many adaptations are available as features within existing telephone systems. In many cases careful shopping for a telephone can provide the adequate and appropriate features required for an individual with a disability. Different types of designer telephones may also be of particular advantage or disadvantage in its design. For example, many telephones come with memory buttons for rapid dial but the location, size, and recall usage of these buttons vary from telephone to telephone.

Telephones with various types of features are available from stores that specialize in selling telephones. Specific sources can be found in local yellow pages, in the manufacturer list of this book, in listings from local rehabilitation service delivery programs, and also often in gift specialty catalogs that carry personal convenience types of devices.

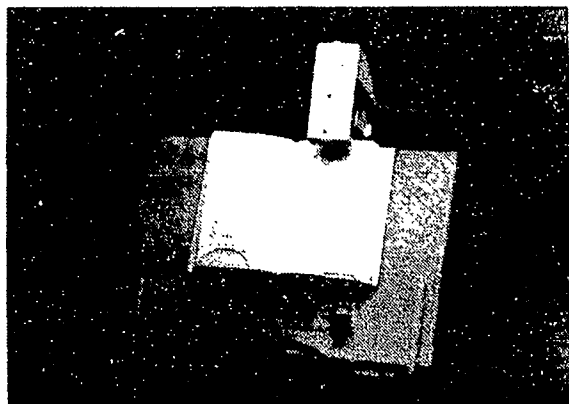

**Product Name:** APT Automaddak Page Turner System

**Vendor:** Maddak, Inc.

**Size:** 7.25" x 6.75" x 3.36"

**Weight:** 11 lbs.

**Power Source:** 120V AC

**Cost:** \$1,199.00

APT Automaddak Page Turner System is a wooden reading stand equipped with a motorized arm that turns the pages of a book or magazine. The front and back covers are held by adjustable clips. Upon the signal from a switch, an adjustable arm tipped with a pad of silicone moves across the book from left to right, picks up a single page and brings it over to the left. A thin wire loop then follows in to hold the page in place.

Automaddak Page Turner is available in 115V and 220V AC models. Various switches are available. Contact manufacturer for information on the Automaddak Page Turner System, which includes the Page Turner, wooden bookstand, and automatic page hold-down device.

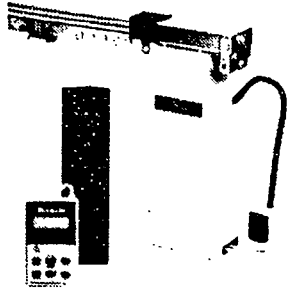

**Product Name:** Automatic Drapery Opener System

**Vendor:** Makita

**Cost:** \$505.00 - \$950.00

The Automatic Drapery Opener System is an environmental control system that operates on a timer or via an infrared remote control to open drapes. The system can handle 60 pounds of draper weight and rod lengths up to 20 feet per minute. An internal disconnect mechanism allows the draperies to be manually opened or closed at any time.

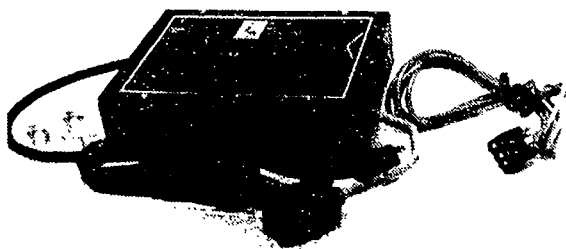

**Product Name:** Bed Control (DBC-1)

**Vendor:** APT Technology, Inc.

**Cost:** \$475.00

The Bed Control controls all standard functions of a powered hospital bed using a single switch or one channel of an environmental control unit. The control can adjust six functions of the bed, typically head up/down, foot up/down and whole bed up/down. The bed must be the type which has a removable pendant which plugs and unplugs electrically.

The Bed Control will accept a variety of input types including tongue, body, and puff-sip switches. It also interfaces with most ECUs. Contact manufacturer for details before ordering.



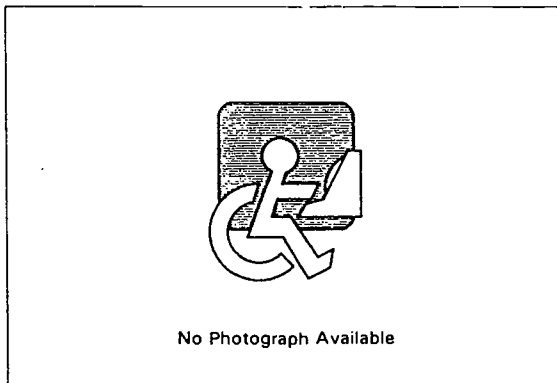

**Product Name:** Big Button Bed Control

**Vendor:** KY Enterprises

**Cost:** \$75.00

Big Button Bed Control is a device that replaces the standard small-button controller on an electric hospital bed. The device features six large, heavy-duty buttons that control head up or down, foot up or down, and bed raise or lower.

Contact the manufacturer for information on specifications of bed model.

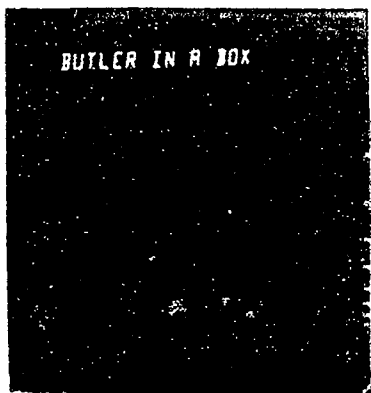

**Product Name:** Butler-in-a-Box

**Vendor:** AVSI

**Computer:** IBM PC Family

**Size:** 10.6" x 8.8" x 3.1"

**Weight:** 5 lbs.

**Cost:** \$2,995.00

Butler-In-A-Box is a two voice-activated environmental control system with speech output that allows users hands-free operation of appliances, lights, and telephones. Once the users have trained the Butler to recognize particular utterances, these utterances can be used as commands to activate various appliances: lights, TV, stereo, electric beds, etc. Timers (included) can also be set to turn appliances on or off at particular times. Appliances are activated remotely using X-10 remote control modules. A telephone is built in, allowing the user to remotely dial, answer, and use the system as a speakerphone. Butler-In-A-Box can also be programmed to detect the presence of intruders and request that they identify themselves.

Options (extra) include a Voice Mouse (for retrieving data from an IBM computer), an I.C.I. Infrared Controller Interface, the RAM Pack, the Voice Cartridge, and the Sprinkler Controller. Contact manufacturer for further information about similar systems which may be activated by one or four users.

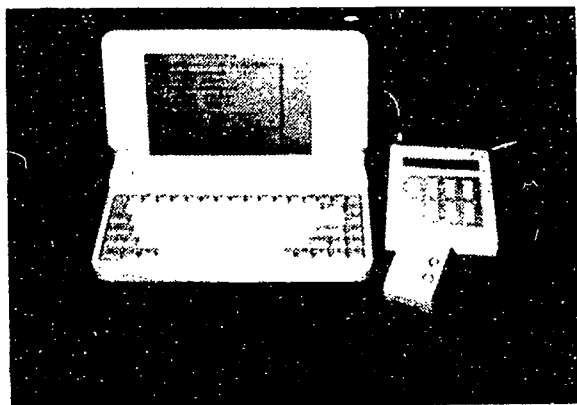

**Product Name:** CCT Environmental Control

**Vendor:** Consultants for Communication Technology

**Computer:** IBM PC Family

**Cost:** \$470.00

The CCT Environmental Control is an environmental control system designed for people with disabilities that create mobility impairments. With the activation of a single switch, directly from the keyboard or the computer, up to 16 electrical switches and outlets can be controlled on the screen. The infrared control features allows the user to control any device that has an infrared control such as TV's, stereos, and VCR's. The user has full control over all command features including volume, channel, etc. All signals are transmitted through the existing electrical wiring in the home using the X-10 module.

The CCT Environmental Control can be purchased as an integrated part of the Handy Speech system (see entry) or alone. English and Spanish versions are available.

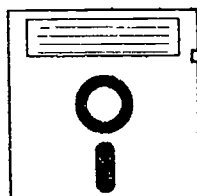

**Product Name:** CINTEX2

**Vendor:** NanoPac, Inc.

**Computer:** IBM PC Family

**Manual Form:** Electronic Manual, Printed Manual,  
Videotape Manual

**Cost:** \$695.00 - \$2,285.00

CINTEX2 is an environmental control software package that allows the user to control up to 256 appliances, dial and answer the phone, flash for call waiting, dial from a directory, control TVs, VCRs, stereos, etc. by voice when used in conjunction with a voice recognition program (not included). The system includes necessary hardware and a starter set of voice macros that can be tailored to the users personal needs and new macros can be added. CINTEX2 pops up over current applications and can be used with most popular keyboard alternatives. CINTEX2 may also be controlled with a mouse only and is compatible with most vision-enhanced software.

CINTEX2 requires a spare serial port and an internal modem. A "phone only" version and a deluxe version with full ECU support are available. Contact manufacturer for information on other current and planned options for use with CINTEX2.



**Product Name:** Control 1

**Vendor:** Prentke Romich Company

**Computer:** All (Hardware Independent)

**Size:** 3.75" x 17" x 11"

**Weight:** 9 lbs.

**Power Source:** 120V AC

**Cost:** \$1,965.00

Control 1 is an environmental control unit with eight control receptacles that may operate various electrical devices, and a telephone. Control 1 can operate any telephone (including speaker phones, cordless phones, and handsets mounted on a gooseneck) and may store up to ten phone numbers. The device can be used to operate the three functions (head, bed, and foot) of an electric bed; a bed cable (BC-4) for the specific bed must be requested when ordering. All control receptacles may be latched (turned on and left on) or momentarily turned on. Control 1 may be controlled by a dual switch, a communication aid, or a microcomputer. If desired, the user may customize computer software to operate the Control 1. The device may also be used to control data output to a computer.

One AC Appliance Module and one Lamp Module are included, and with optional control modules (extra), the user may control up to 256 AC appliances. Options for the Control 1 include Call Signal 2 (extra; see entry). Additional options and adapters are also available.

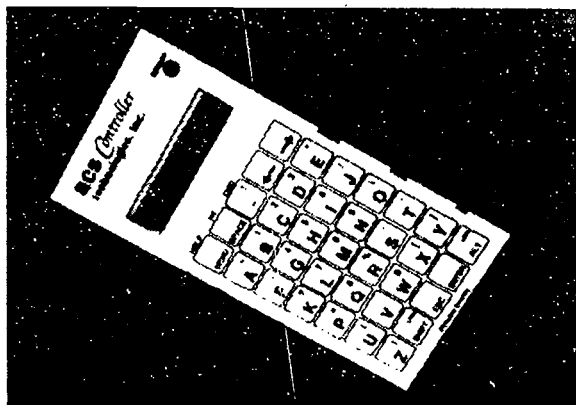

**Product Name:** Controller

**Vendor:** ACS Technologies, Inc.

**Cost:** \$2,195.00 - \$3,995.00

The Controller is an infrared environmental control unit. The control has a two line, sixteen character display and a seven row by five column membrane keyboard. The device is operable by keyboard input or by using the keyboard as a scanning panel. Voice control is also an available option (extra). Controller will activate most devices which respond to infrared remote signals.

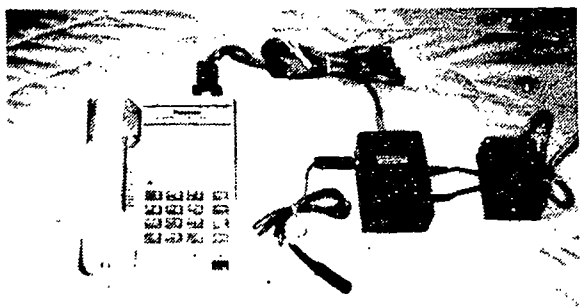

**Product Name:** Custom Speaker Phone

**Vendor:** KY Enterprises

**Size:** 7" x 9"

**Weight:** 1 lb.

**Power Source:** 120V and phone plug

**Cost:** \$170.00

The Custom Speaker Phone is a Panasonic speaker phone activated by a sip-and-puff switch. To answer incoming calls or end a call, the user puffs. To automatically dial the operator, the user sips. This product has an optional autodialing feature which requires separate switches for each auto-dial memory location.

The product package includes the speaker phone, a flexible stand, and two puff switches.

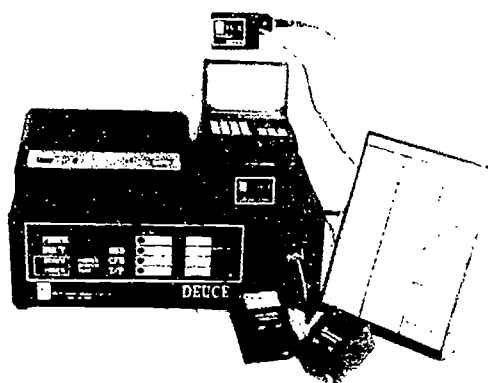

**Product Name:** DEUCE

**Vendor:** APT Technology, Inc.

**Size:** 12" x 10" x 3.5"

**Weight:** 10 lbs.

**Power Source:** 120V AC

**Cost:** \$1,500.00

DEUCE is a home or hospital environmental control unit that allows control of telephone and various appliances through infrared remote control, scanning, or non-scanning direct input. Phone control capabilities include getting on and off line, dialing numbers up to 31 digits, and storing up to 18 numbers plus last number dialed. Four low current switch closures provide control of accessories such as page turners, and four powered AC outlets provide control of on/off appliances such as fans and radios. The DX10K option (extra) provides control of an additional 16 lights and/or appliances through the X-10 control system. DEUCE provides visual and auditory feedback with operation; audio prompts for users with visual impairments can be configured by entering a simple numeric code. Input into DEUCE is made through a dual switch, IR remote, or non-scanning direct inputs. Outputs include phone connection, four latched and four momentary controlled AC outlets, capacity for sixteen X-10 modules, and morse code or scanning for input to computers or communication aids. X-10 modules, bed controls, call signals, control switch, and phone are all extra. Price varies depending on options ordered.

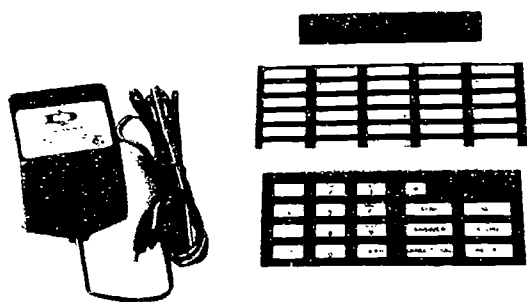

**Product Name:** E.A.S.I.dialer (2110)

**Vendor:** TASH, Inc.

**Cost:** \$800.00

E.A.S.I.dialer is a device that allows a single switch to be used to dial a phone and control many other appliances. The scanning speed and switch closure time are adjustable. Up to 60 numbers can be stored in memory and dialed with the activation of a single switch. Other features include easy-to-read display of phone numbers, a built-in speaker phone, privacy mode, and volume control.

E.A.S.I.dialer can also be used to access a television when used with the Relax (see entry) and control up to 16 electrical appliances connected to X-10 modules. Contact manufacturer for information on purchasing X-10 modules and Relax.

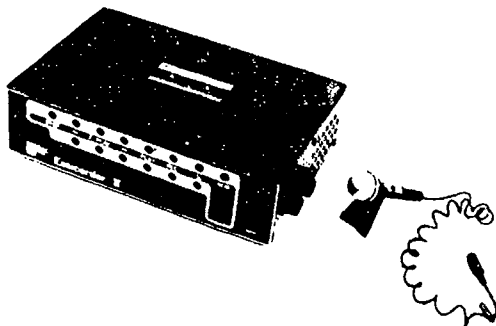

**Product Name:** EASICORDER

**Vendor:** APT Technology, Inc.

**Size:** 12" x 8.25" x 3.5" or 23" x 25"

**Weight:** 11 lbs.

**Power Source:** 12V or 24V DC

**Cost:** \$2,100.00 - \$2,450.00

EASICORDER is a single- or dual-switch operated tape recorder designed for people with physical disabilities but useable vision to use for note taking, dictation and information recording. By scanning with a single switch, the user can select normal tape recorder functions (stop, play, reverse, fast forward, record) as well as special functions. Special functions include standard speed (1-7/8 ips) or half speed (1-15/16 ips); single track operation in which each channel of stereo can be recorded or played separately, in effect doubling the running time of a tape; "underline" mode, which inserts beeps audible during fast forward play; and "commentary" mode, which allows insertion of comments on parallel stereo track during recording (comments are then automatically inserted during playback). Switching input to EASICORDER is through a single switch (included), audio input is through external microphone (included). Audio output is through internal speaker (included), external speaker (extra), or headphones (extra). A second switch (extra) permits a pause function. EASICORDER is available in cabinet and wheelchair lapboard models.

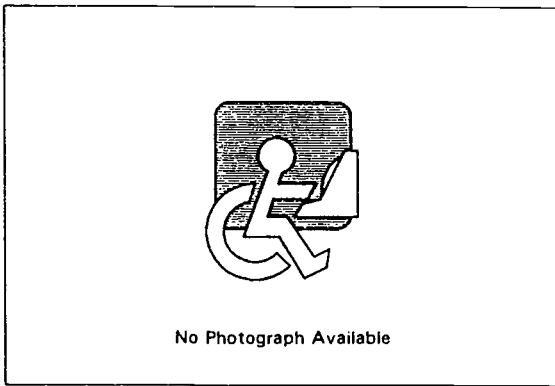

**Product Name:** Environment Control  
**Vendor:** Favin, David  
**Computer:** All (Hardware Independent)  
**Size:** 6" x 6" x 2"  
**Weight:** 6 oz.  
**Power Source:** 120V AC  
**Cost:** Free

Environment Control is a computer interface that provides up to 128 selective controlled switch closures. These closures may be placed in parallel with manually-controlled switches to provide computer control of these switches. The interface connects to a computer's parallel port.

The circuit diagram and BASIC computer program, which were developed by the Telephone Pioneers of America, are free on request.

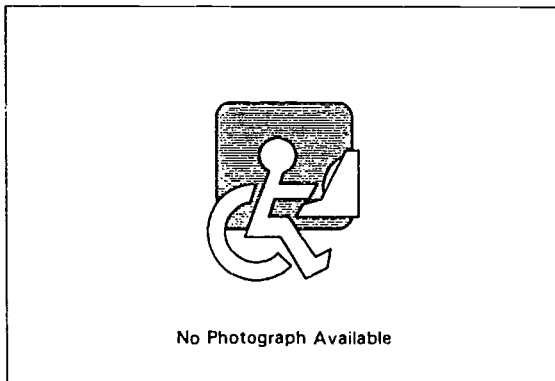

**Product Name:** Environmental Control Units  
**Vendor:** Various (Generic Product)  
**Cost:** Varies

While some environmental control units are highly sophisticated, many environmental control needs can be met with low technology rehabilitation devices or items available from hardware stores. Light switch extension levers, for example, are available in most rehabilitation product catalogs. Appliance and light timers can be purchased from department stores. Lamp switch adapters, such as those that permit the lamp to be turned on and off by touching its base, are available in most hardware stores. Solutions may also be fabricated, such as taping a wooden tongue depressor over a call button so the depressor may be used as a lever to push down the button. Low tech and high tech solutions may even be used in combination where appropriate.

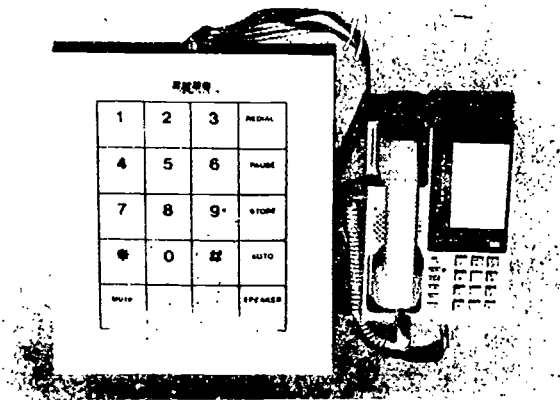

**Product Name:** Expanded Keyboard for Automatic Telephone

**Vendor:** EKEG Electronics Company LTD

**Size:** 12" x 14" x 1"

**Weight:** 4.5 lbs.

**Cost:** \$475.00 - \$675.00

Expanded Keyboard for Automatic Telephone is a system consisting of a speaker phone and an expanded keyboard that allows the user to dial by pressing 2"-square keys. The telephone unit contains a combination speaker and microphone, and does not require the user to pick up the receiver to answer or to talk into the phone.

Two models are available, one with space for 10 stored phone numbers for automatic dialing (\$475.00) and the other with space for 32 stored phone numbers (\$675.00). Both models will work on rotary dial or touch tone exchanges, and thick plastic-coated wire grid keyguards are available for both models (\$50.00). An adjustable microphone is also available.

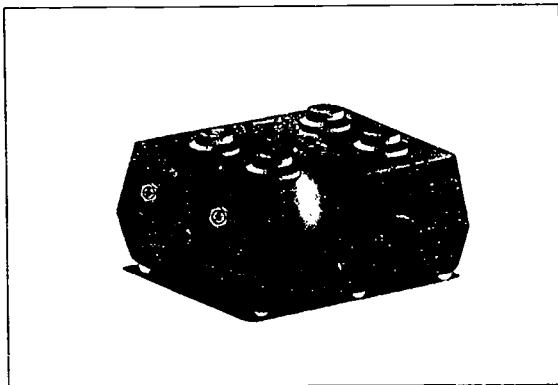

**Product Name:** EZ-TV Adapted Infrared Remote Control for Televisions

**Vendor:** ORCCA Technology, Inc.

**Power Source:** Battery

**Cost:** \$125.00

The EZ-TV Adapted Infrared Remote Control for Televisions allows the channel and volume to be controlled by four large, colored, push-button switches or four external single switches. The control can be programmed to control any television that uses an infrared remote control. Channel and volume are activated one step at a time with each button press or external switch activation.

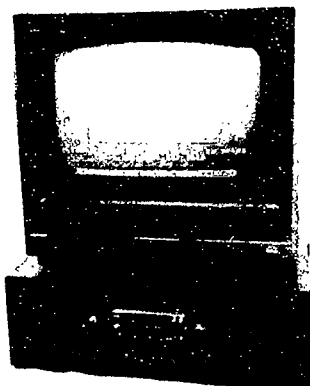

**Product Name:** EZRA  
**Vendor:** KY Enterprises  
**Size:** 19" x 4" x 14"  
**Power Source:** 120V AC  
**Connector Type:** Mini-phone plug  
**Cost:** \$950.00

EZRA is a single-switch environmental control system. Options are displayed on a list of menus that appear on a TV screen; the cursor scans the options, permitting selection of desired function using a wireless single switch. With the base system, the user can control a TV and radio, lights and appliances, and an electronic door.

Options include control of an electric bed, VCR, telephone, compact disk player, intercom, a limited vocabulary speech synthesizer, and puff switch. Contact manufacturer for information before ordering. Video tape available for \$10.00.



**Product Name:** F71863 Touchables Touch Phone Attachments  
**Vendor:** Maddak, Inc.  
**Size:** 3.5" x 4" x 1.25"  
**Cost:** \$19.95

Touch Phone Attachment is a device that fits over the buttons of an existing touch tone phone. On the surface of the attachment are enlarged keys with large-type letters and numbers on them. The user dials the phone by pressing these buttons.



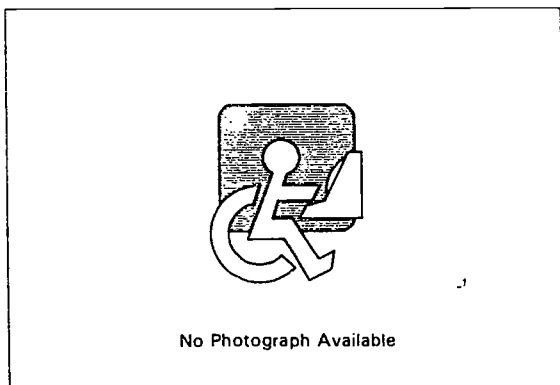

**Product Name:** First Aide Kit

**Vendor:** Infra-Link, Inc.

**Cost:** Contact manufacturer

The First Aide Kit is an environmental control system consisting of a universal infra-red transmitter, a remote controlled speaker-telephone, a controller for AC appliances, sip-or-puff switch, and an IV stand on wheels. The system allows for flexible control of the telephone, TV, radio, VCR, lamps, alarms, and electric bed functions and does not require permanent installation. The IV stand is used for mounting the switch and transmitter.



**Product Name:** Fone Holder

**Vendor:** Fred Sammons, Inc.

**Size:** 24" long

**Cost:** \$54.95

The Fone Holder is a 24" gooseneck with a clamp at the end which holds a telephone receiver. The gooseneck can be clamped to a convenient surface such as the edge of a table. The Fone Holder holds the receiver where it can be used most conveniently.



**Product Name:** FreeSwitch  
**Vendor:** Adaptivation, Inc.  
**Size:** 3" x 4.5" x 2.5"  
**Weight:** 1 lb.  
**Power Source:** 9V battery  
**Cost:** \$229.00

FreeSwitch is a environmental control system that allows the user to remotely operate up to four appliances. The device comes with one see-through Taction Pad (see entry) that allows virtually any object or surface to become a switch. Additional Taction Pads are available for \$12.50 each.

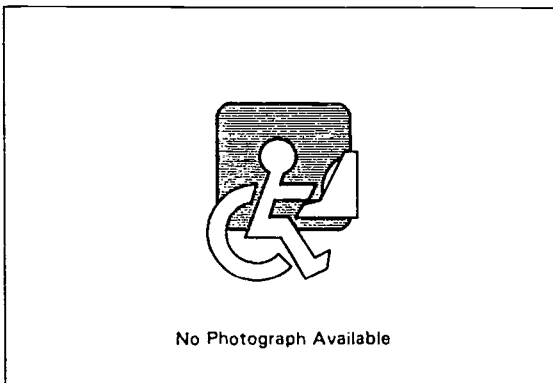

**Product Name:** GEWA Infra-Link Speaker-Telephone  
**Vendor:** Infra-Link, Inc.  
**Connector Type:** 3.5 mm jack  
**Cost:** Contact manufacturer

The GEWA Infra-Link Speaker-Telephone is a remote access system to an included Panasonic Speaker-Phone. Any single switch can be used to answer the phone or to dial the first number in memory. For users with more capabilities, all the features of the telephone are accessible with infra-red remote control (not included). Either single switch scanning or multi-switch transmitters can be set to access desired features or all features of the phone.

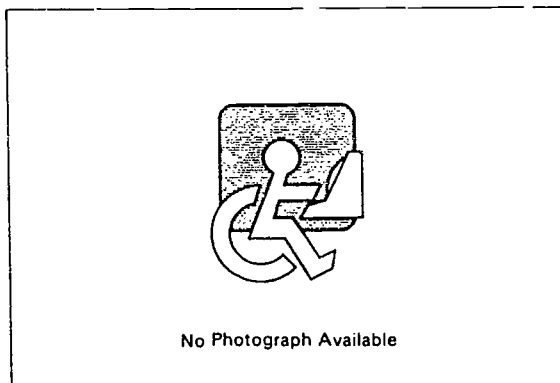

**Product Name:** GEWA Infra-Link System

**Vendor:** Infra-Link, Inc.

**Cost:** Contact manufacturer

The GEWA Infra-Link System (also known as Smart House) allows operation of all electrical functions by Infra-Red transmitters. Infra-Link enables a personal with a physical disability to make and/or receive calls independently, enter or leave the home, change TV channels, turn lights on and off, security lock entry doors, and perform other household functions from a hand-held transmitter with push-buttons or from an adapted single switch. Other system features include electric window opening, a front door intercom with lock release, a service telephone to enable the user to seek help or screen visitors, and an alarm system.

Prices vary widely depending on the size of the home and the desired features. Contact the manufacturer for details.

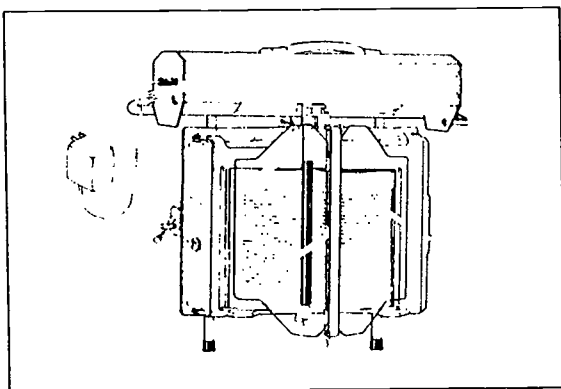

**Product Name:** Gewa Page Turner

**Vendor:** Zygo Industries, Inc.

**Size:** 20" x 24" x 8"

**Weight:** 15 lbs.

**Power Source:** 120V AC

**Cost:** \$3,995.00 - \$4,200.00

Gewa Page Turner is an automatic page turning system that can accommodate most textbooks, paperbacks, magazines, and smaller newspapers, of maximum size 12" x 9", and 2" thick. A built-in clamp attaches the Page Turner to support item, and unit can be tilted for bed reading. A rubber roller manipulates pages forward and backward, singly or continuously, with no adjustments necessary for size, texture or style of document.

Options of multi-switch (\$2,975.00) or single switch (\$3,185.00) controls are available to accommodate level of user skill, and additional options for mounting and positioning the Gewa Page Turner are available from distributor (contact for details).

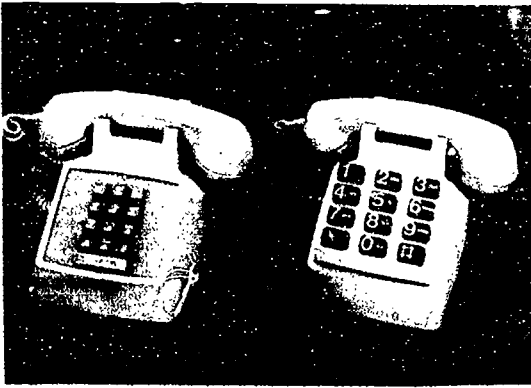

**Product Name:** Giant Push Button Telephone Adapter

**Vendor:** Fred Sammons, Inc.

**Size:** 0.88" x 0.56"

**Cost:** \$7.95

Giant Push Button Telephone Adapter is a device that fits over the buttons of a home or pay touch tone phone. The user can then dial the phone by pushing the 7/8" x 9/16" buttons on the face of the Adapter.

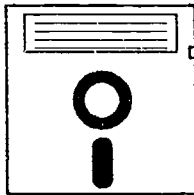

**Product Name:** HandiPHONE

**Vendor:** Microsystems Software Inc.

**Manual Form:** Printed Manual

**Cost:** \$595.00

HandiPHONE is a computer controlled hands-free telephone which allows input through voice recognition products, switch access, trackball, mouse, or joystick from within any software application. The complete system includes PopDIAL software, modified 2400 Baud modem, and speakerphone with powerpack. It is also compatible with any conventional telephone or phone system and requires 1.4K (with EMS) or 20K (without EMS).

Contact the manufacturer for details on renting the system.

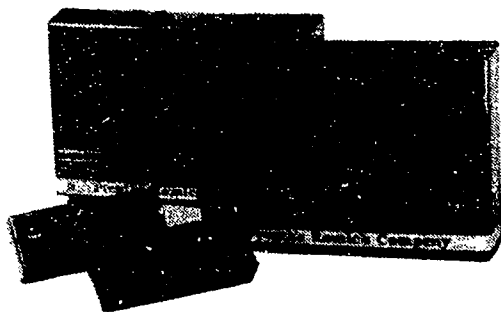

**Product Name:** HECS-1

**Vendor:** Prentke Romich Company

**Size:** 13.5" x 9" x 3.25"

**Weight:** 11 lbs.

**Cost:** \$3,860.00

HECS (Hospital/Home Environmental Control System) is a device that permits persons with limited motor skills to operate electrical devices within a room. The user may select the desired functions from a large-character back-lit menu display. Functions include: all bed functions (up/down, etc.), phone control functions (answer, hang up, dial, and redial), turning lights on and off, and operating a pendant-controlled television. The system may be integrated with a standard or facility-specific call system. A variety of switches (sip-puff, rocking lever, tongue, etc.) may be used to operate the system. The display may be moved on an adjustable holding arm (included), or rotated from side to side.

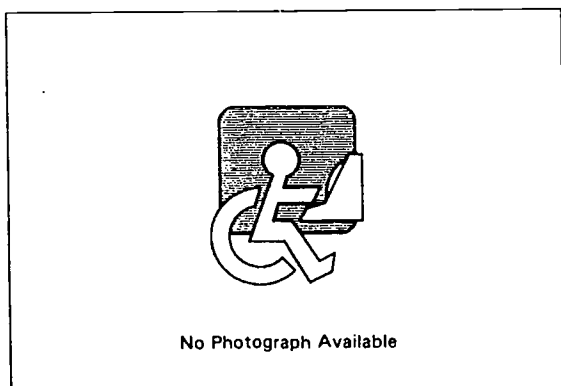

**Product Name:** Home Control Systems

**Vendor:** Various (Generic Product)

**Cost:** Varies

This book includes a number of environmental control products designed specifically for people with disabilities, but a large variety of environmental control systems are available as home automation and home security systems for general use. For example, systems are available for turning on lights by touching the base of the lamp, by motion detection (ultrasound), and by keyrings or from controls kept in a car. Also, automatic thermostat systems which can be programmed for seasonal or individual events are available. Automatic garage door openers are helpful for the purpose for which they were designed and similar systems are also available for pulling window draps and opening and closing windows and doors throughout the home.

These types of home automation and home security products are available from many hardware stores, electronic supply stores, home improvement or building supply stores, and specialty catalogs. Specific sources can be found in local yellow pages, in listings from local rehabilitation service delivery programs, and from local home builders.

31.



**Product Name:** HomeAccess

**Vendor:** MRF Adaptive Resources, Inc.

**Computer:** Apple Macintosh Family, IBM PC Family

**Cost:** Contact manufacturer

HomeAccess is a computer hardware and software system for controlling devices in the home or office environment through voice recognition or single switch input. Up to 256 electrical devices, 6 to 12 infrared controlled devices, and 128 timers can be controlled. Other special features include automatic "sun-up" and "sun-down" calculation, "on-off" to turn a device on and then off automatically, "sleep" to automatically turn a device off after a pre-defined period, on-line help, a graphical interface, and printed setup report.

The IBM version requires Microsoft Windows and supports Listen for Windows and Dragon Dictate. The Macintosh version requires a Mac Plus computer or later and System 7.0 or higher and supports PowerSecretary, Voice Navigator, and PlainTalk.

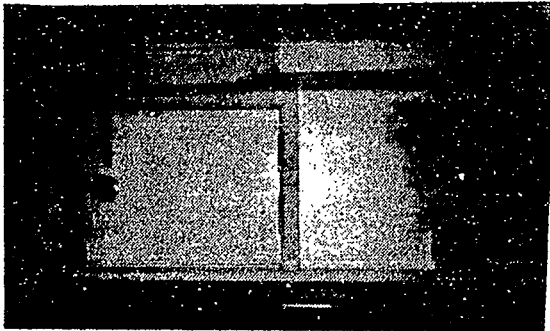

**Product Name:** In & Out Automatic Door Controller

**Vendor:** KY Enterprises

**Weight:** 11 lbs.

**Power Source:** 120V AC/12V battery

**Cost:** \$560.00

In & Out Automatic Door Controller is an environmental control system that opens and closes a door by an activation of a wireless switch. An electric strike can be added to lock the door. The system is designed for light-weight residential doors and can interface to an ECU system on a wheelchair. The system includes two switches or one-switch timer circuit.

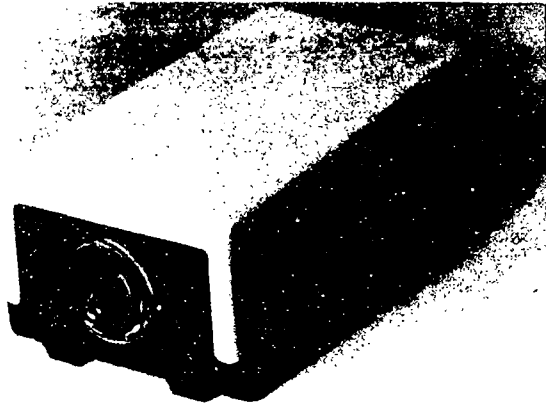

**Product Name:** Infrared Remote Control IRTI-I

**Vendor:** APT Technology, Inc.

**Cost:** \$395.00

Infrared Remote Control IRTI-I is a system allowing remote control of electrical devices through a DEUCE environmental control unit (extra; see entry). The package consists of a small box which accepts a dual control switch. The receiver unit is built into DEUCE.

Infrared Remote Control IRTI-I runs on two internal 9V batteries. Adapters are available to operate the device from other manufacturers' wheelchairs, permitting infrared control of DEUCE from the chair; contact manufacturer for further information.

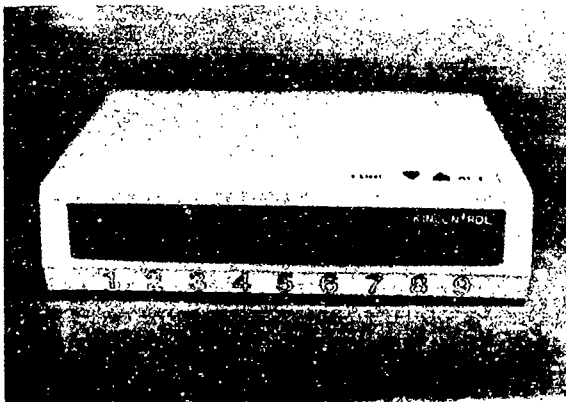

**Product Name:** Kincontrol (4105)

**Vendor:** TASH, Inc.

**Size:** 8.75" x 6.75" x 2.5"

**Weight:** 3 lbs.

**Power Source:** 120V AC

**Cost:** \$800.00

Kincontrol is an environmental control unit operated by single or dual switch scanning. A function switch allows the system to be set up to control one to eight outputs. The outputs can be switched appliances connected directly to the Kincontrol unit, or Ultra 2T ultrasonic remote control transmitters (also available from TASH). The latter option allows control of appliances anywhere within a room without direct wiring. The Kincontrol can also operate up to 16 electrical appliances connected to X-10 modules or four different electrical appliances connected to ultrasonic power modules.

Ultra 2T transmitters and receivers must be purchased separately. Contact TASH for more information on prices and features.



**Product Name:** Mastervoice Environmental Control Single User Unit

**Vendor:** AVSI

**Size:** 10.6" x 8.8" x 3.1"

**Weight:** 5 lbs.

**Power Source:** 120V AC

**Cost:** \$1,795.00

The Mastervoice Environmental Control Unit is a voice-activated environmental control system with speech output. Once trained the unit can recognize particular words as commands to activate various appliances. The unit can also control devices through sixteen built-in timers, manual control, and infrared sensor. Up to 256 appliances can be activated including lights, television, stereo, and electric beds. The control unit has a built-in telephone which is voice-activated allowing the user to dial, answer, and speak remotely; devices can also be controlled through telephone commands. An alarm system which detects intruders and asks them to identify themselves is another one of the device's features.

The control unit has a serial port for computer interface. An alarm jack, modem, and X-10 receive feature are available options.

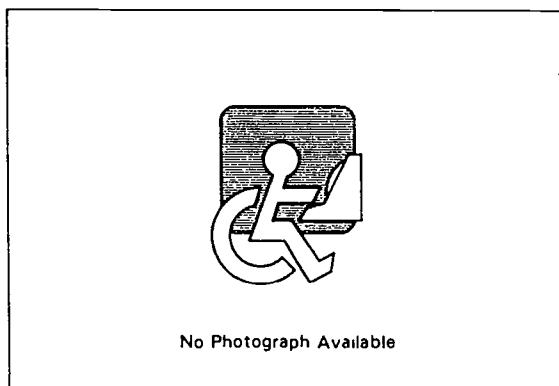

**Product Name:** Memory Button Telephones

**Vendor:** Various (Generic Product)

**Cost:** Varies

Telephones with memory buttons can be useful to persons who have trouble remembering telephone numbers or persons with physical disabilities who need a quick and easy method of dialing. For persons with cognitive disabilities, the complexity of button use should be considered. Some phones have multiple levels of buttons which require toggling a switch then pressing a button to access some numbers; these phones should be avoided. Other considerations include the size and spacing of labels. Some button labels are so small that cognitive discrimination of the words or symbols placed on them would be difficult. For persons with motor disabilities, the size and space between each memory button is critical.

Memory button telephones are available in most department stores, electronic stores, and telephone stores. Specific sources can be found in local yellow pages, in the manufacturer list of this book, in listings from local rehabilitation service delivery programs, and also often in gift specialty catalogs that carry personal convenience types of devices.





**Product Name:** Mini-Environmental Control (ECU) Box

**Vendor:** Nassau Applied Technology Resource Center

**Size:** 7.5" x 4.38" x 2.5"

**Cost:** \$232.00

Mini-Environmental Control can be interfaced with standard, 1170 watt or lower appliances (small hair dryers, lamps, popcorn machines, etc.) to allow them to be run using a single switch. A latch switch permits the control to be used in either momentary or latched mode.

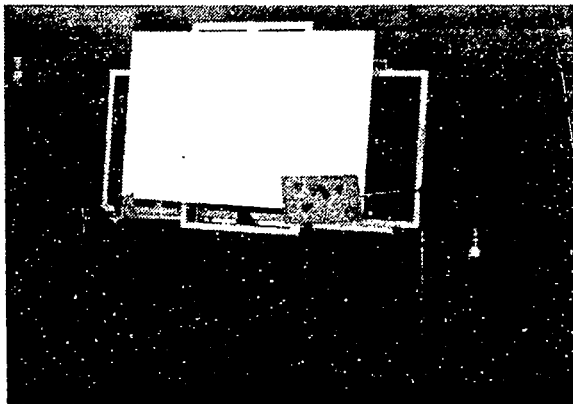

**Product Name:** Motorized Easel

**Vendor:** Extensions for Independence

**Size:** See text

**Power Source:** 120V AC

**Cost:** \$3,000.00

The Motorized Easel is an adjustable easel designed mainly for use by mouth artists. The height and angle are adjustable, and has two electric motors which move the drawing board portion up, down, or side-to-side, and an actuator which controls the angle of the work. The motors and actuator are activated by tongue, mouthstick, or paint brush with micro-switch control (included). The drawing board is available in 24" x 36" or 36" x 48" sizes. The frame can adjust in height from 34" to 54".

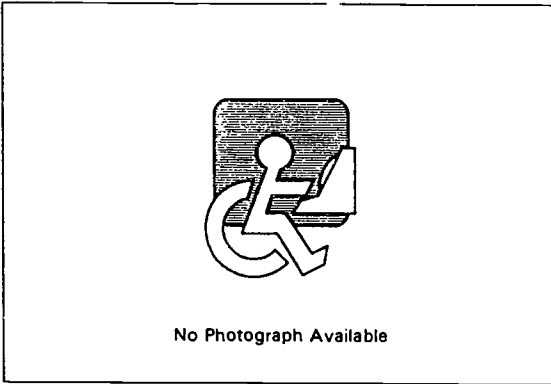

**Product Name:** MultiPhone

**Vendor:** Institute on Applied Technology, Children's Hospital

**Size:** 5.5" x 2.5" x 1.25"

**Power Source:** 120V AC

**Cost:** \$249.00

MultiPhone provides private and independent phone access through computer based communication systems, including dedicated AAC devices and integrated laptop computer systems. MultiPhone uses standard touch tones to obtain dial tone, answer incoming calls, and hang-up and allows for clear output of synthesized or digitized speech to the phone line. A buzzer notifies the user of incoming calls and an extra telephone jack for extension hookup is provided.

Headphones are provided and the speaker is optional, but the device includes a standard size output jack. MultiPhone is compatible with any electronic AAC device that can output digitized or synthesized speech.

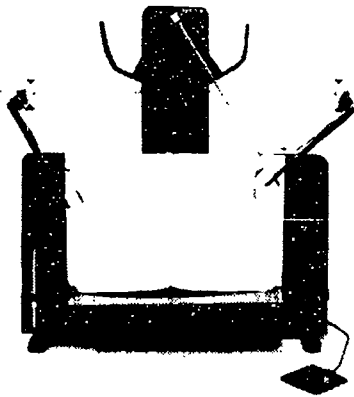

**Product Name:** Next Page Page Turner (4600)

**Vendor:** TASH, Inc.

**Size:** 24" x 9" x 24"

**Weight:** 10 lbs.

**Power Source:** 12 volt DC adapter

**Cost:** \$3,000.00

Better Page Turner is an electronically controlled page turner. Its features include single, dual, or multiple switch control and bi-directional page turning. This page turner can handle books, magazines, paperbacks, and three-ring binders. Books up to 2" in thickness and 9.5" x 11.5" can be used. Switches are not included but a scanning mechanism is built-in to the page turner.

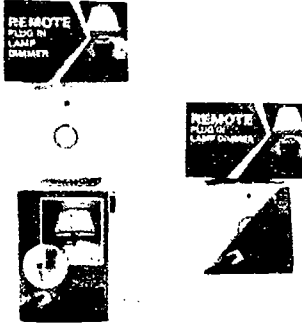

**Product Name:** On/Off Remote Switch

**Vendor:** Dimango Products

**Size:** 3" x 2" x 1"

**Weight:** 1 lb.

**Cost:** \$20.00

On/Off Remote Switch is a system consisting of a small hand-held transmitter unit with a button on top and a receiver unit that plugs into a wall outlet. The appliance to be controlled is plugged into the receiver, and the user can turn it on and off at a distance of up to 50 feet by pressing the button on the transmitter unit.

Three different frequencies of receivers with corresponding transmitters are available: a lamp model (750 watts max.), an appliance model (1800 watts max.), and a motor and fan model (900 watts max.). Separately purchased receivers are also available.

---

**Product Name:** Phone Manager

**Vendor:** Consultants for Communication Technology

**Computer:** IBM PC Family

**Cost:** \$300.00

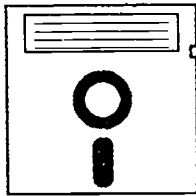

The Phone Manager is software that allows the user to dial an out-going call directly from the computer, even with a single switch. The user can select one of ten prerecorded messages of greeting. The software includes a customizable phone directory and automatic emergency dialing. In an emergency the Phone Manager will dial an emergency number and transmit a prerecorded message with only one keystroke. Speech is sent directly over the telephone line using the Handy Speech (see entry) synthesizer. A software program allows the caller to pre-plan entire conversations so the dialogue between caller and receiver can flow smoothly. The Phone Manager is a memory resident program. When the phone rings, the software will automatically appear on the screen.

English and Spanish versions are available. A synthesizer (CCT or MultiVoice) is required and not included.



**Product Name:** PhoneAccess

**Vendor:** MRF Adaptive Resources, Inc.

**Computer:** Apple Macintosh Family, IBM PC Family

**Cost:** Contact manufacturer

PhoneAccess is a computer-based hands-free phone control program. The program can be voice or switch activated to dial numbers, make calls, and answer the phone. The program also features unlimited telephone number storage.

The IBM version requires Microsoft Windows.

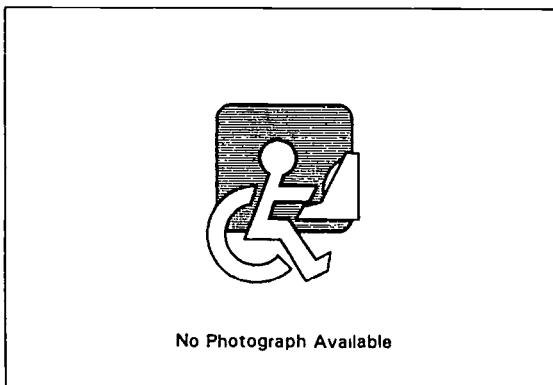

**Product Name:** Portable Telephones

**Vendor:** Various (Generic Product)

**Cost:** Varies

Portable telephones can be helpful for individuals who have mobility impairments to access the telephone. There are two major types of portable telephones: the cordless telephone used within a house or in a household vicinity and the cellular portable telephone used within a whole community or across geographical regions. This second type of wireless system is dependent on the availability of cellular telephone service which has not yet reached some rural and remote areas. In both of these wireless circumstances, the telephone can be kept with the user instead of the user having to go with the telephone. This is ideal for an individual who is in a wheelchair or has severe mobility impairments.

Cordless and cellular telephones are available from telephone specialty distributors and from many department stores. Specific sources can be found in local yellow pages.

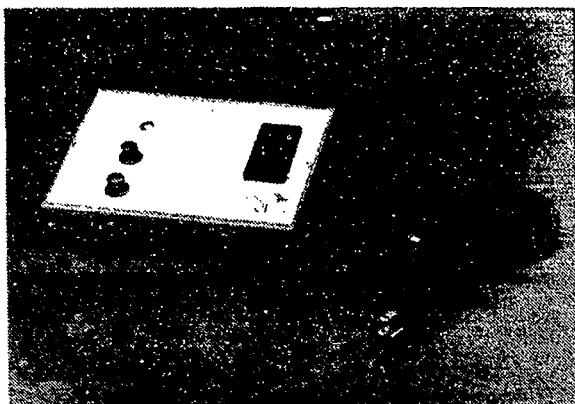

**Product Name:** PowerLink 2

**Vendor:** AbleNet, Inc.

**Cost:** \$150.00

PowerLink 2 (formerly AbleNet Control Unit) is an environmental control unit which allows the user to operate two appliances simultaneously. Using any single switch (extra), the user may operate appliances using either a direct, timed, or latched mode. Direct control keeps the appliance on while the switch is activated. Timed control may be set to turn devices on for one second to sixty minutes; the timer stops at the end of the pre-set timing interval even if the switch remains activated. Latched control provides one-touch on and one-touch off.

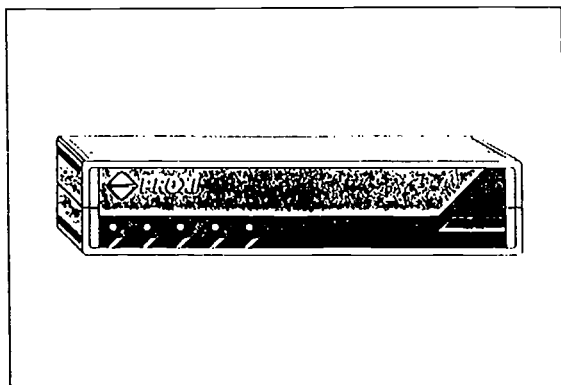

**Product Name:** PROXi

**Vendor:** Madenta Communications, Inc.

**Computer:** Apple Macintosh Family, IBM PC Family

**Cost:** Contact manufacturer

PROXi is a wireless environmental control system based on either a Macintosh computer or an IBM compatible PC running Microsoft Windows. Special software shows picture symbols for electrical devices (telephone, lights, TV, etc.) and the user can select the desired device by clicking with the mouse, or using an adapted input device for the Macintosh (purchased separately). The system can control lights and appliances (through X-10 control modules), telephone (including a variety of phone features such as speed dial and redial), intercom, and electronic devices that have remote controls such as TVs, VCRs and stereos. PROXi consists of special software plus an interface that connects to infrared controllers and X-10 controllers for appliances.

Voice command input is an option for the PROXi. A wireless remote microphone is available so that the user can command the system from a distance. PROXi can also be controlled by a wide variety of products in the disability industry.

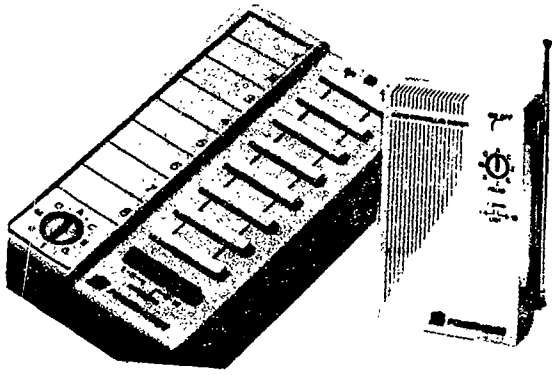

**Product Name:** RC5000 Radio Home Control System

**Vendor:** X-10 (USA), Inc.

**Weight:** 4.5 lbs.

**Power Source:** 120V AC

**Cost:** \$49.99

RC5000 Radio Home Control System is a radio-operated appliance control system. The RC5000 broadcasts a signal strong enough that the user can operate appliances (turn on lights, for instance) even from outside the house. The user presses a button on a hand-held transmitter. This transmitter broadcasts to a transceiver (transmitter/receiver) unit which has an electrical device plugged into it. This one device can be turned on or off, plus up to eight additional X-10 appliance control modules can be controlled by the transceiver. Thus the system can control up to eight appliances, each having a separate button on the hand-held transmitter unit.

The price listed is for the transmitter and transceiver unit (capable of controlling one appliance). Additional X-10 appliance control modules are available at extra cost (\$14.99).

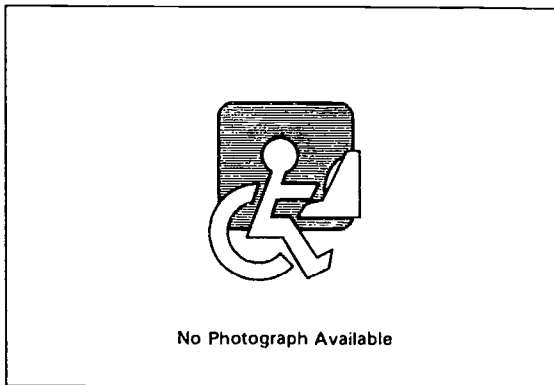

**Product Name:** RELAX (8200)

**Vendor:** TASH, Inc.

**Size:** 6" x 2.5" x 1"

**Cost:** \$500.00

RELAX is a portable infra-red remote control system that can be used to remotely control VCRs, CD players, tape recorders, stereos, and televisions. The unit can be programmed to accept up to 40 remote functions (TV on/off, volume higher/lower, etc.).

A single switch for controlling RELAX must be purchased separately. Contact manufacturer for details on price and capabilities.

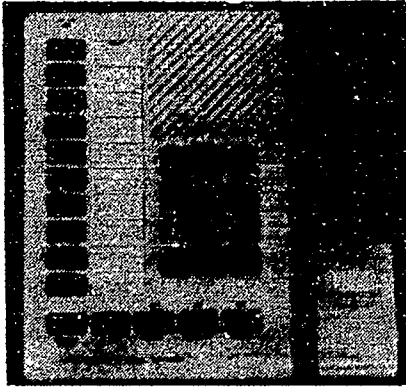

**Product Name:** Remote Control Speakerphone Model RC3000

**Vendor:** Ameriphone, Inc.

**Size:** 10" x 7" x 2"

**Weight:** 3 lbs.

**Power Source:** 120V AC

**Cost:** \$499.00

Remote Control Speakerphone is a programmable speakerphone and remote control unit. When the button on top of the remote control is pressed, a preprogrammed number (such as OPERATOR) is automatically dialed. The same remote control is used to answer incoming calls. The base unit and the remote control can also be controlled via various types of switches, and may have a headset or lapel microphone attached. Additional features include: oversized buttons, capacity for 18 programmable numbers, and NiCad battery backup.

A version without the remote control is available for \$399.00.

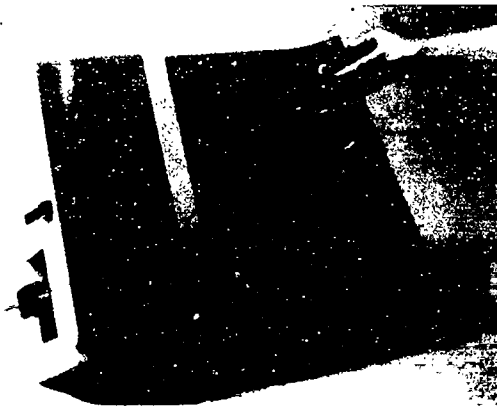

**Product Name:** Saltus Reader

**Vendor:** Dickey Engineering

**Size:** 9" x 11"

**Weight:** 20 lbs.

**Power Source:** Rechargeable battery

**Cost:** \$480.00

The Saltus Reader is a page turning device with 9 x 11 inch clear plastic pockets. Pages from textbooks or magazines must be taken out of the book/magazine and placed in the pockets, which the user scrolls through sequentially. Scrolling may be incremental or page at a time, both forward and back through the available pages. Only one side of the page is visible when scrolled, so two copies of the material to be read are needed.

A variety of switches are available to operate the Saltus Reader. Contact the manufacturer for details.



**Product Name:** Sapura S2000 CL

**Vendor:** Temasek Telephone, Inc.

**Weight:** 3 lbs.

**Cost:** \$99.00

Sapura S2000 CL is a programmable voice activated telephone. Incoming calls can be answered by giving a spoken command within several feet of the phone and conversation can be carried on using the speakerphone or the standard handset. The phone automatically cuts off the connection when the other party hangs up. This product also features recall memory for up to 20 numbers, auto redial, last number redial, hold, flash, and shows duration of outgoing calls.

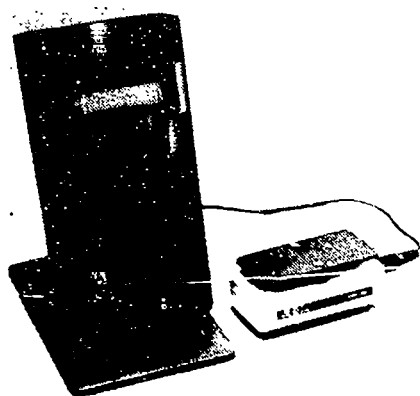

**Product Name:** Scanning Director

**Vendor:** Prentke Romich Company

**Size:** 7.75" x 4" x 1.5"

**Weight:** 14 oz.

**Power Source:** Rechargeable batteries

**Cost:** \$685.00

Scanning Director allows multiple devices which use a remote control to be operated by a single or dual switch. Scanning Director offers both auto and manual scanning and adjustable scanning speed and acceptance time. Prompts in the back lit LCD display can be personalized up to 16 characters in length. Scanning Director allows the user to pick a channel number and then send it to the TV or radio rather than requiring the user to scan through each channel. Infrared emitters on both the top and back allow for a wide range of placement options.

Available optional equipment includes a Memory Transfer Interface to store commands onto a computer disk and reload them later (\$115.00), Command Center to control incandescent lights or other appliances anywhere in the house (\$135.00), and mounting kits for wheelchair (\$145.00) or table (\$110.00).



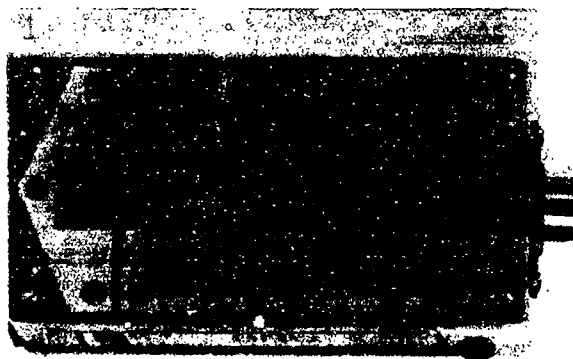

**Product Name:** Scanning Remote Control (SRC)  
**Vendor:** APT Technology, Inc.  
**Size:** 6" x 3.25" x 1.75"  
**Weight:** 1 lb.  
**Power Source:** 12V DC  
**Cost:** \$490.00

Scanning Remote Control (SRC) is a scanning remote environmental control system that can operate two infrared controlled appliances, including TVs, VCRs, satellite systems, and home entertainment systems, or one appliance and up to 16 lights/appliances through the X-10 system. The SRC has two rows of selections, one row for each appliance. The user controls the appliances by scanning and selecting the various options with one or two switches. The user first selects the appliance to control, then scans through the various options--including turning an appliance on or off, selecting TV channels, and controlling a VCR. The SRC allows remote control of appliances (except telephones) in the same room as the user, or distributed throughout the house and yard and controlled by X-10.

There are three models of the SRC: the SRC-DWC, which uses the DU-IT wheelchair control system; the SRC-ECU, which uses a DU-IT MECCA or other environmental control system; and the SRC-IND, which can be controlled with just a single or dual switch. The appliance to be controlled must be equipped for infrared remote control, and the SRC must be custom programmed by DU-IT.

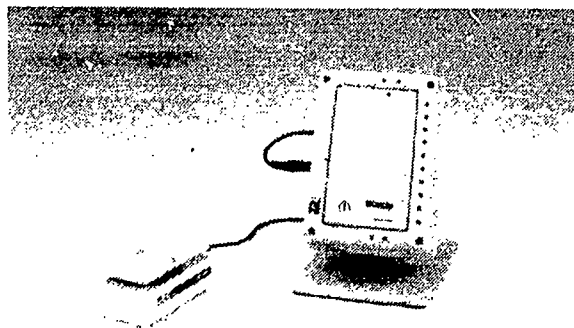

**Product Name:** Scanning X-10 Powerhouse  
**Vendor:** Prentke Romich Company  
**Size:** 6.75" x 4" x 2.5"  
**Weight:** 1 lb.  
**Power Source:** 4 "AA" batteries  
**Cost:** \$640.00

Scanning X-10 Powerhouse is a portable environmental control unit that can remotely turn appliances (lights, radio, etc.) on and off. Using a main control panel, the user selects any one of 8 - 16 appliances in the house and then chooses to turn it on or off. Selections are made by scanning with either one or two switches. The unit sends a radio signal through the household wiring to individual X-10 control units, which turn an appliance on or off. The user can control appliances from anywhere in a particular room, house or apartment.

Scanning X-10 Powerhouse will work with any standard switches (extra). Lamp/appliance modules are purchased separately as needed. With some wheelchairs there is also the option of controlling the unit from the wheelchair's joystick.

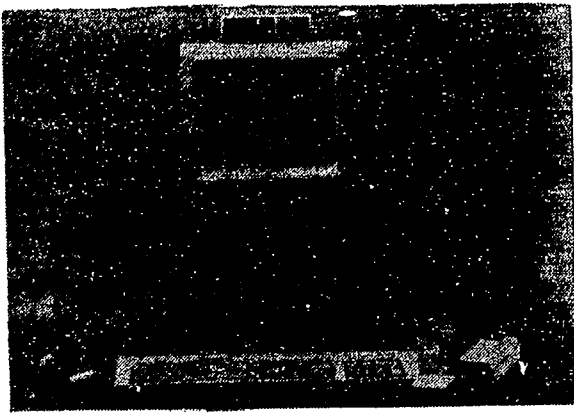

**Product Name:** SenSei System  
**Vendor:** Safko International, Inc.  
**Computer:** Apple Macintosh SE/II  
**Cost:** \$3,900.00 - \$9,900.00

SenSei is an integrated environmental control, augmentative communication, and computer input system for the Macintosh computer that is designed to be accessible to people with disabilities. The included software and alternate input devices such as HeadMaster, modified joysticks, and trackballs give users the ability to control lights, televisions and other infrared devices, electric door locks, and other appliances. In addition, SenSei's augmentative communication features give the user the ability to write and send faxes, communicate by e-mail, and to talk on the telephone. Also, the system includes applications such as word processing, graphics, spreadsheets, and databases.

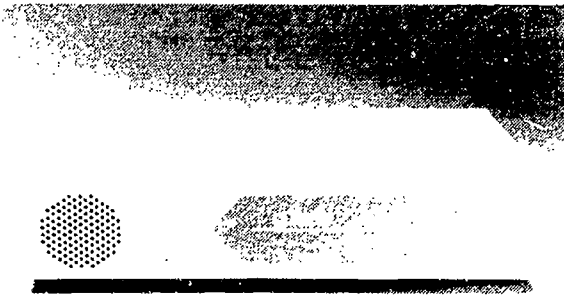

**Product Name:** Simplicity Series ECUs  
**Vendor:** Quartet Technology, Inc.  
**Cost:** \$3,985.00 - \$5,185.00

Simplicity Series ECU's are environmental control devices that can control up to 32 lights and appliances, telephone, up to six infrared remote control devices, electric bed, and accessories. Four models are available and can be purchased separately or as a package together.

Simplicity Series 5 and 6 are voice activated units for users with consistent voices. Series 7 and 7M are switch activated units designed for users without strong verbal abilities. Series 6 and 7M also enable the user to control a personal computer.

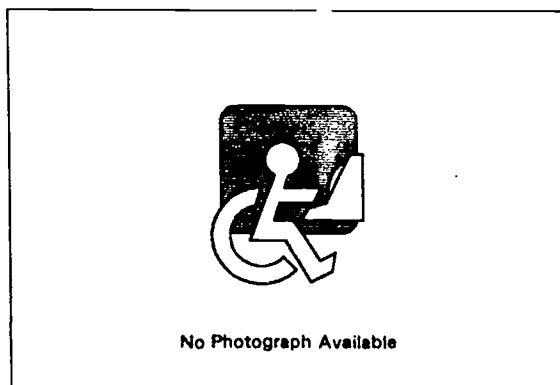

**Product Name:** Single-Appliance Continuous Control Unit

**Vendor:** Toys for Special Children, Inc.

**Cost:** \$65.00 - \$75.00

The Single-Appliance Continuous Control Unit allows the user to operate any AC appliance or device by continuously depressing the cordless remote switch. The appliance is plugged into the receiver module and goes on when the switch is pressed and stays on until the switch is released. The unit can also accommodate two switches to perform the on and off functions.

A momentary or two-switch latch model is also available. The device goes on when the switch is pressed and stays on until the switch is released, or one switch turns the appliance on and the other switch turns it off.

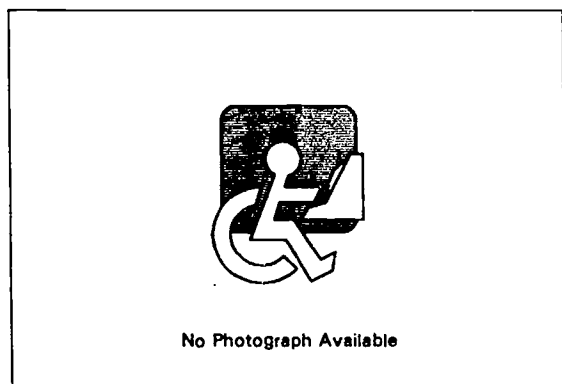

**Product Name:** Single-Switch Multi-Appliance Control Unit & Modules

**Vendor:** Toys for Special Children, Inc.

**Cost:** \$200.00 and up

This device allows the user to control up to eight AC appliances or devices by operating a single remote switch. When the switch is pressed, a row of lights on the unit indicates whether each appliance is on or off. By holding the switch down, the user can scan from one light to the next until the desired appliance is selected. Releasing the switch turns the selected appliance either on or off. Momentarily pressing the switch again will return the selected appliance to its former state. The number of appliances to be scanned can be pre-selected from three up to eight, and a rate dial sets the scanning speed. The unit can be placed on a table top, or attached to a wheelchair or bedrail by means of a gooseneck and clamp.

The control unit costs \$200.00 and the optional gooseneck with clamp is \$23.00. The Plug-Mounted Module plugs into any electrical outlet and costs \$16.00. The Wall Outlet Module that actually replaces the standard electrical outlet sells for \$25.00. The Wall Switch Module which replaces standard wall switches and controls overhead and other built in lights sells for \$16.00.

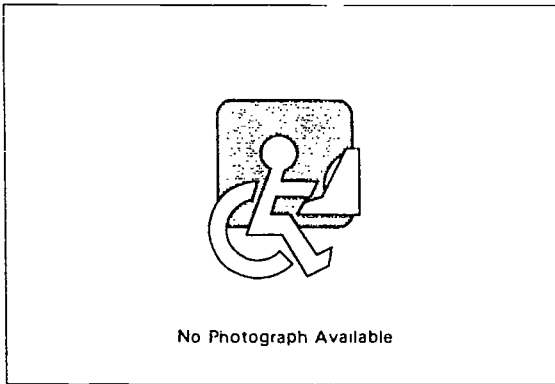

**Product Name:** Single-Switch TV Control Unit

**Vendor:** Toys for Special Children, Inc.

**Cost:** \$140.00

This cordless unit allows the user to control the basic functions of any television set by operating any single switch. When the switch is activated and held, the various function indicators will start to light up in sequence. The user selects the desired function by releasing the switch when the corresponding light goes on. The user then can either scan through the selected function until the desired channel or volume is reached, or can change the channel or volume one step at a time by momentarily pressing the switch. The speed at which the unit scans can be adjusted to suit the user's abilities.

An optional gooseneck with clamp for mounting is available for \$23.00.



**Product Name:** Sip/Puff Bed Control

**Vendor:** KY Enterprises

**Weight:** 1 lb.

**Cost:** \$115.00 - \$195.00

Sip/Puff Bed Control uses a puff switch to operate an electric hospital bed. The system includes a flexible tube and stand. One, two, or all of the following functions can be controlled: head up or down, foot up or down, and bed raise or lower.

Contact the manufacturer for information on specifications of bed model. One functions costs \$115.00, two functions costs \$155.00, and three functions costs \$195.00.

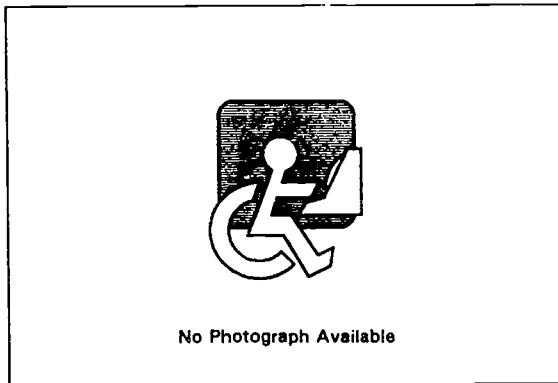

**Product Name:** Speaker Phones  
**Vendor:** Various (Generic Product)  
**Cost:** Varies

Speaker phones can frequently be an alternative to the standard phone for persons with severe motor disabilities who may have trouble using a standard receiver. Instead of picking up the receiver and holding it to their ear, speaker phone users can simply press the "off hook" button to answer the phone or to initiate the phone calling process. However, the phones may need to be adapted so the off hook button is more accessible to persons using the system. Installing external switches or attaching a simple extension lever to the button will often solve the button access problem.

Speaker phones are widely available at electronics and hardware stores, and are relatively inexpensive. Specific sources can be found in local yellow pages, in the manufacturer list of this book, in listings from local rehabilitation service delivery programs, and also often in gift specialty catalogs that carry personal convenience types of devices.

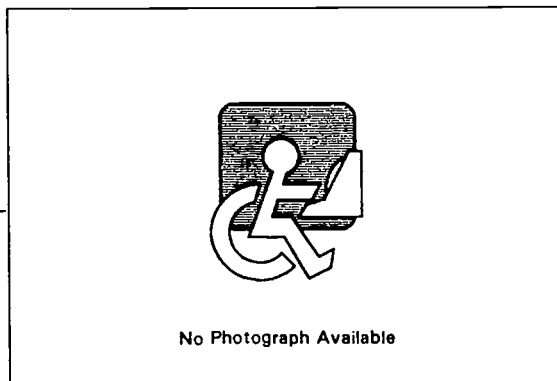

**Product Name:** Synergy Integrated Remote  
**Vendor:** Synergy  
**Computer:** IBM PC Family  
**Cost:** \$345.00 - \$675.00

The Synergy Integrated Remote is an environmental control unit internal to the Synergy Computer System (see entry). The SIR allows the user to use the PC to turn any appliance on or off and operate any infrared controlled device. No additional equipment needs to be mounted to the user's wheelchair or control center.

The SIR requires a Command Center in each room from which the user wants to be able to send commands. The PC must be facing the Command Center in order for it to receive signals from the computer, so more than one is required if the user wishes to send commands from more than one location. One Command Center is included with the SIR and extras can be purchased for \$60.00 each. X-10 modules (\$25.00 each) are also required for each of the electrical items the user wishes to control.

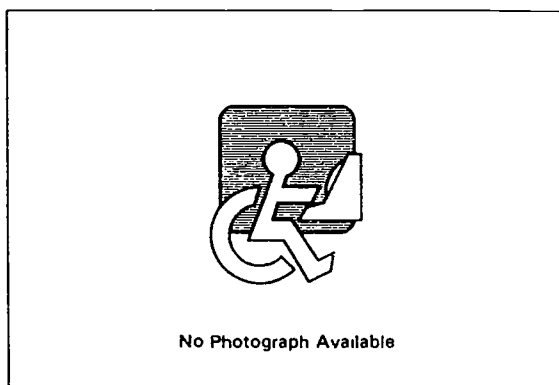

**Product Name:** T-140 Series Puff/Sip Speakerphones

**Vendor:** Envirotrol Company, Inc.

**Cost:** \$475.00

T-140 Series Puff/Sip Speakerphones are modified speakerphones that allows the user to place and answer calls through a sip and puff switch. The phone is fitted with a heavy-duty flexible gooseneck to permit precise positioning of the tubing. No additional power supply is required and the phone can be used by others by depressing a button on the phone.

Four models are available. The T-140 allows one number, usually "0" for operator, to be stored in the memory. The T-142 provides non-verbal communication capability. The T-144 has two tubes mounted on the end of the gooseneck that allow two additional numbers to be stored. The T-145 uses an external switch rather than the puff tube. Optional features include: remote "whisper" microphone, a privacy speaker with volume control, a gooseneck extension kit, counter-weight-slips to counter-balance the extended gooseneck, and a miniature pendant radio transmitter and receiver. Contact manufacturer for details.

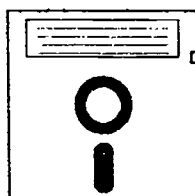

**Product Name:** TEAM

**Vendor:** Microsystems Software Inc.

**Computer:** IBM PC Family

**Manual Form:** Printed Manual

**Cost:** \$495.00

The Transparent Environmental Access Module (TEAM) system is an environmental control based on a PC. The software, called Pop-ECS, can manage up to 256 different devices right from the computer within any application. TEAM can be activated from the keyboard or through alternate input systems including voice recognition products.

The TEAM system includes Pop-ESC software, manual, infrared controller, infrared receiver and X-10 controller, RS-232 cable and Security ID. Additional X-10 accessory modules are available from Radio Shack. Requires DOS 3.0 or higher and Windows 3.0 or higher.

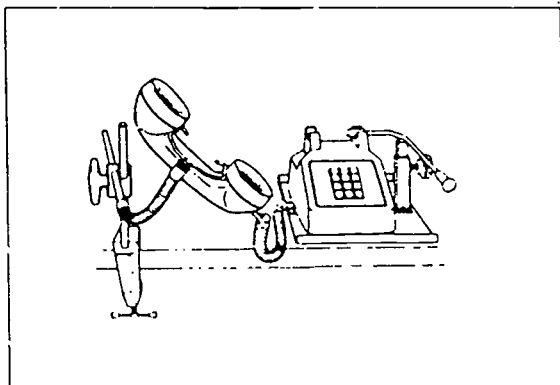

**Product Name:** Telephone Holder & Line Connector

**Vendor:** Zygo Industries, Inc.

**Size:** 33" long

**Weight:** 1.5 lbs.

**Cost:** \$160.00 - \$295.00

Telephone Holder and Line Connector is a system for operating and speaking into a phone without having to pick up or hang up the receiver. The Telephone Holder is a clamp that holds the receiver. It is attached to mounting hardware for affixing to a stable surface. The Line Connector consists of a platform on which the phone rests and a lever mounted on the platform. By pressing on one end of the lever, the user causes the other end to either press down or release the receiver buttons.

The Telephone Holder is available separately (\$110.00) and with the Line Connector (\$200.00).

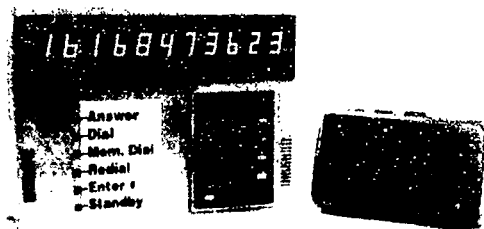

**Product Name:** Telephone Management System

**Vendor:** IC-Systems

**Weight:** 4 lbs.

**Power Source:** 9V and 2 "AA" batteries

**Cost:** \$550.00

The Telephone Management System allows the user full use of telephone functions with a single switch. The user activates a switch twice to answer calls and then once to end the call. When the user wants to make a call, the device cycles through types of functions, such as dial and redial, allowing the user time to select from these. Then the product cycles through the numbers also allowing time for the user to make selections. If time elapses with no selections made, the product will begin its cycle again. The time allowed for selecting functions and numbers can be adjusted to three different speeds. This system also features memory dial, last number redial, speaker phone, and large number display. The key pad on the telephone can also be used without switch input.

A switch is not included with the system although a headset and wireless remote control are available as options. The device has a standard 1/8 inch plug and is compatible with most switches.

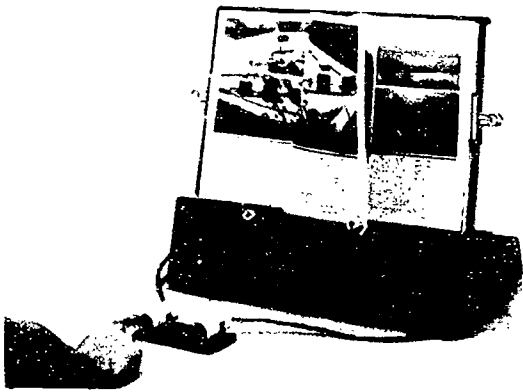

**Product Name:** Touch Turner

**Vendor:** Touch Turner

**Size:** 18" x 9" x 15"

**Weight:** 14 lbs.

**Power Source:** 8 "D" batteries

**Cost:** Contact manufacturer

Touch Turner is a device that holds books and magazines, turning the pages automatically. Once a book is placed on the stand, the user can turn the pages simply by activating a single or dual switch. Activating the switch causes electrically powered turning arms to turn one page at a time.

Two models of Touch Turner are available: one that turns pages of hardcover books and magazines in one direction (single switch) and one that turns pages of hardcover books and magazines in either direction (dual switch). Touch Turner comes with one or two lever switches as appropriate. Other switches, including sip-and-puff, joy stick, and large target switches, and a 110-volt adapter are available at extra cost.



**Product Name:** TVRC and TVRCS

**Vendor:** APT Technology, Inc.

**Cost:** \$645.00 - \$685.00

TVRC and TVRCS are remote controls for TVs which allow control of a variety of functions. The TVRC and TVRCS are designed to be attached to TVs that are not already equipped with remote controls, allowing them to be operated with a single or dual switch using the Scanning Remote Control (also from DU-IT; see entry). The SRC is included as part of the package. The TVRC can control channel selection and will return the TV to the last channel selected after being turned off (not to channel two like most sets). The TVRCS provides non-scanning control of the TV. Two levels of simplified TV control are available.





**Product Name:** U-Control  
**Vendor:** Words+, Inc.  
**Computer:** IBM PC Family  
**Size:** 7" x 2.5" x .5"  
**Weight:** 4 oz.  
**Cost:** \$495.00

U-Control is an environmental control unit operated from a computer-based communication aid. U-Control can be operated from any Words+ communication or computer access system, including EZ Keys, WSKE, or Talking Screen. U-Control can control any household device currently controlled with an infrared remote control, such as TV, stereo or cable control box. U-Control can also control appliances such as lights, radio, fan, or power door locks, using remote appliance control units (X-10 controllers). The U-Control device sends signals to activate appliance control units, so no wire connections between the U-Control and the appliances are necessary.

The basic system consists of serial cable for connecting to communication aid, serial port infrared transmitter, infrared command center, one X-10 alarm/relay module and two X-10 appliance control modules. Additional appliance control modules are available. For items such as power locks and power drapes, additional equipment and installation may be required.



**Product Name:** Ultra 4 Remote System & Scanning Ultra 4  
**Vendor:** TASH, Inc.  
**Power Source:** 1 "AA" battery  
**Cost:** Contact manufacturer

Ultra 4 Remote System is a remote environmental control system utilizing ultrasonic signals. A transmitter offering up to four channels of ultrasound transmission transmits to as many as four remote appliance control modules. These modules plug into a wall socket; the controlled appliance then plugs into the module. The transmitter and modules are color coded. Appliances must be no more than 500 watts, and must have two-prong plugs. The transmitter will not transmit through walls.

Transmitters available include a hand-held unit with four small buttons, a larger unit with four one-inch diameter buttons, a four direction joystick, a dual sip and puff transmitter, and a unit that accepts dual switch input. Scanning Ultra 4 allows the user to control four different signals with a single switch. Receivers available include wall socket modules, and a single or dual switch emulator. Contact manufacturer for price information for various components.

337

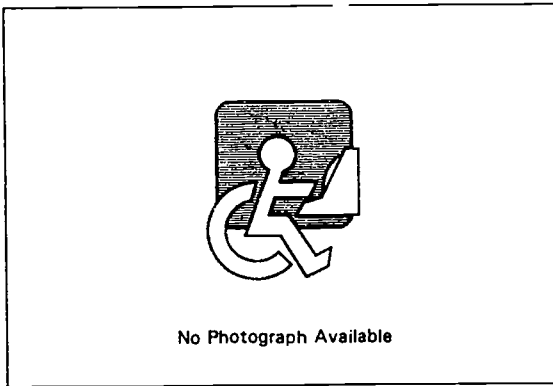

**Product Name:** Universal Control System with Tongue Touch Keypad

**Vendor:** New Abilities Systems, Inc.

**Computer:** Apple Macintosh Family

**Cost:** Contact manufacturer

The Universal Control System (UCS 1000) provides the user with environmental control, computer access, and mobility control. The system mounts onto the user's chair and activates external equipment using radio frequency and infrared links. The TongueTouch Keypad is the input device for the system. The keypad has nine keys which are built into a standard dental retainer and activated through tongue pressure.

The TouchTongue is customized for each individual and is made from biocompatible materials that enable it to be worn at all times except during dental hygiene and meals. Contact the manufacturer for specific price and system customization information.

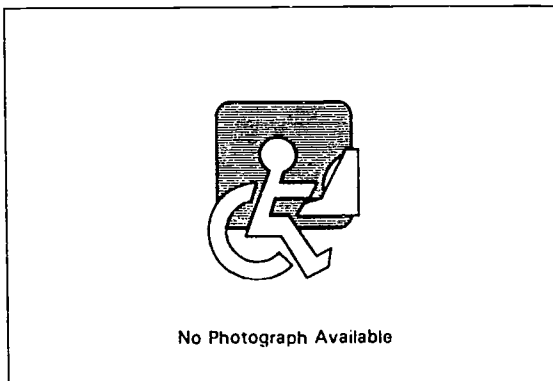

**Product Name:** Universal Remote Controls

**Vendor:** Various (Generic Product)

**Cost:** Varies

Remote controls of commercial electronic appliances, such as stereos and televisions, are common in the current mass market. While a remote control can be a major advantage for individuals with physical disabilities, if more than one remote control is being used, accessing multiple little handheld boxes can be difficult. One option to remove this barrier is a universal remote control which can be programmed to run multiple remote control infrared remote control units. This can particularly be helpful for individuals who use wheelchairs and/or have limited mobility and where accessing one device is more reasonable than dealing with several.

Universal remote controls are available from local electronic part stores and most electronic appliance stores, such as TV and stereo distributors. Specific sources can be found in local yellow pages, in the manufacturer list of this book, in listings from local rehabilitation service delivery programs, and often in gift specialty catalogs that carry personal convenience types of devices.

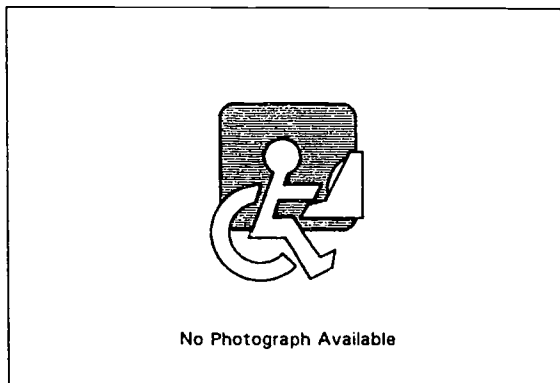

**Product Name:** Universal Telephone Adapter

**Vendor:** Extensions for Independence

**Cost:** \$13.00

The Universal Telephone Adapter is a self-contained device for phone operation that consists of a gooseneck that holds the handset, and a toggle-type lever that allows the user to engage or disengage the receiver. Both the gooseneck and the lever are mounted on a base that also accommodates the phone (phone not included). The lever is adjustable for various types of phones.

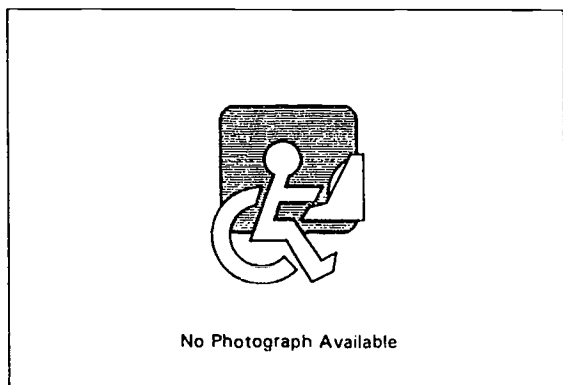

**Product Name:** Universal Television Remote Control

**Vendor:** KY Enterprises

**Size:** 3" x 2"

**Weight:** 0.5 lb.

**Power Source:** "AAA" batteries

**Cost:** \$115.00

Universal Television Remote Control is available in two models, puff switch and large buttons. The puff switch model operates channel up and down with more switches available at an additional cost. The large button model features oversize, heavy-duty buttons that control on and off, channel up and down, and volume up and down.

337

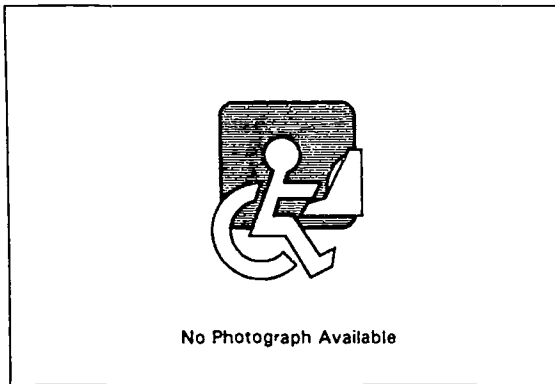

**Product Name:** URC-400 Series Universal Remote Control

**Vendor:** Envirotrol Company, Inc.

**Cost:** \$345.00

URC-400 Series Universal Remote Control allows the user to control TVs, VCRs, and radios through a single remote control with either big buttons or a sip and puff switch. The unit can turn on and off a TV and change channels, turn on and off a radio and scan through 20 AM or FM stations, and perform record and play-back functions on a VCR. The URC can also be set to control different combinations of equipment in four different locations. Up to eight separate remote controls can be replaced with this device.

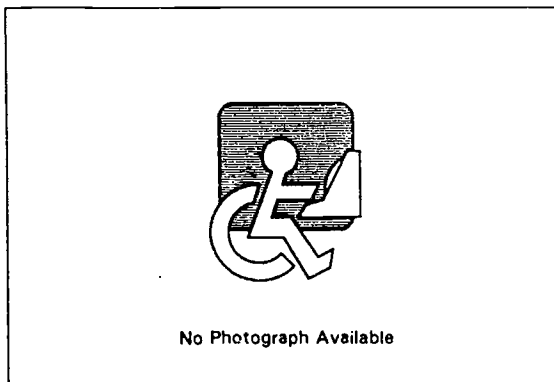

**Product Name:** VX-5000 Cordless Phone

**Vendor:** Advanced Peripheral Technologies

**Cost:** \$699.00 (basic unit)

The VX-5000 is a completely handsfree telephone communication system. The system consists of a base unit, a compact cordless transceiver unit, and a Sip&Puff headset. The base unit plugs into an existing modular telephone outlet located anywhere in the home and the transceiver unit mounts on the user's wheelchair or is otherwise easily accessible. The user is able to connect to the operator by blowing and then sipping. The VX-5000 also has eight programmable memory locations for telephone numbers that are dialed often. The user may dial any of these telephone numbers by puffing through a menu and then sipping to select the desired number.

Three additional IBM computer based options are also available for an additional cost. Option one allows the user to move a modified joystick or use an optical keyboard to scroll through a computerized address book and select the desired person. Option two and three allow the user to call another party directly by using only voice. Contact the manufacturer for information on how to create or modify a system for individual needs.

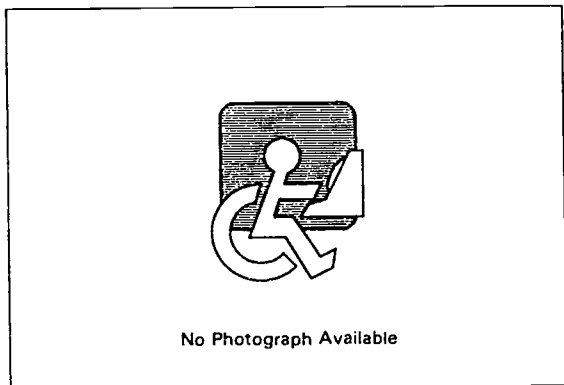

**Product Name:** Wireless TV & VCR Remote Controls

**Vendor:** Toys for Special Children, Inc.

**Cost:** \$85.00 each

This Wireless TV & VCR Remote Controls provide large striking areas with colorful, clearly labeled 2" buttons for controlling the power, channel, volume on TV and appropriate VCR functions on the VCR model. The units use infrared technology and are compatible with most remote controlled TV's, cable boxes, and VCR's. Also, input jacks allow the use of any combination of external capability switches to control any or all functions.

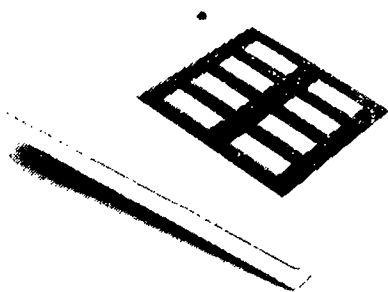

**Product Name:** X-10 Home Control Interface

**Vendor:** X-10 (USA), Inc.

**Computer:** Apple IIc, Apple IIe,  
Apple Macintosh Family, Commodore 64,  
IBM PC Family

**Cost:** \$69.99

X-10 Home Control Interface is a system for remote appliance control using a microcomputer (not included). The system consists of a computer control panel that connects to the computer and a series of X-10 Control Modules (see entry for X-10 Powerhouse System). The modules control individual appliances, lamps, thermostats, etc. An image of a particular room appears on the computer monitor, and the user adds a symbol for each appliance to be controlled in that room. Once the image of the room is composed, and the appropriate appliances are plugged into their control modules in that room, the user may display the room on the computer screen and control the appliances with a joystick. The joystick may also be used to initially select the desired room. The X-10 Home Control Interface can also be programmed using the computer and then disconnected and used separately.

Various types of control modules with various power ratings are available from the manufacturer. Cost of the system will vary depending on the number and type of controls desired.

341

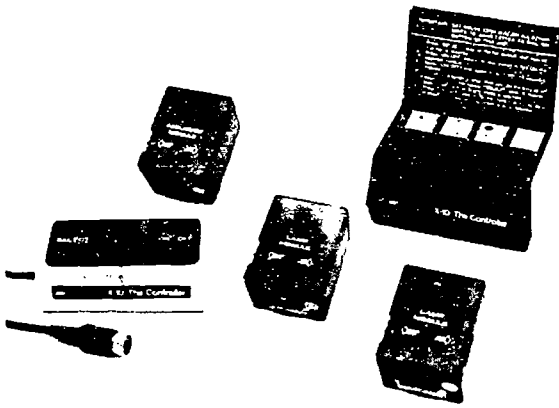

**Product Name:** X-10 Powerhouse System

**Vendor:** X-10 (USA), Inc.

**Cost:** Contact manufacturer

X-10 Powerhouse System (formerly called X-10 System and BSR X-10 System) is a flexible remote appliance control system. A central control panel is plugged into a wall socket, and the desired appliances are plugged into appliance control modules around the house. The user selects which appliance he wants controlled on the central control panel, and a signal is broadcast through the house wiring to the appropriate control module. The module then turns the appliance on, off, up, down, etc. Many different types of control modules are available, including socket, wall switch, telephone, and thermostat models.

The system and components are sold by various manufacturers under various names. Some companies have versions with scanning control panels. Contact X-10 (USA) about what systems are available. Cost will vary. X-10 also offers a remote radio transmitter that allows control from a greater distance, such as outside the home.

# Chapter 10

## Call, Monitoring, and Memory Systems

This chapter contains special call buzzers, adaptations to hospital call systems, telephone emergency call systems, activity monitors for elderly and disabled persons, and memory aids and reminder systems for who are elderly or have cognitive disabilities. Automatic fire alarms, burglar alarms, etc. are not included in this chapter, although some aids which appear in this chapter could also have such features.

Some related functions found in Index 1 are Assessment (AS) and Training and Communication Initiation Aid (TR). Some of the related Input Types in Index 2 are Pressure Sensitive, Switch Input, and Noise.

*The following product entries appear in this chapter:*

Accularm, 311  
AlertCom, 311  
Auto Call Single Number Dialer, 312  
Beep-in-Touch, 312  
Beeper, 313  
Call Alert Model CA-100, 313  
Call Bell (4500), 314  
Call Signal 2, 314  
Chime Alarm, 315  
Cord-Mate, 315  
Digitized Speech Message Machines, 316  
E-Z Call, 316  
Emergency Call Alarm, 317  
Home Intercom Systems, 317  
Intercom (4392), 318  
JANICE Model 100 Invalid Security Alert System, 318  
Lighted Extra Loud Signalling Buzzer, 319  
Lighted Signalling Buzzer, 319  
NeuroPage, 320  
Omni Page System, 320  
PA-1 Portable Alarm, 321  
People Pager, 321  
Personal Alert Receiver, 322  
Personal Pager, 322  
Personal Pager, 323  
Personal Pagers, 323  
Remote Wireless Paging Alarm, 324  
Screamer Alarm, 324  
SideKick Receiver, 325  
Signal Buzzer, 325  
Sound Advice System, 326  
Vibra-Call Receiver, 326  
Watchman Master, 327  
WatchMate, 327  
WatchMate LC, 328  
Wireless Personal Pager, 328

*The following products from other chapters can also be used as Call, Monitoring, or Memory Systems:*

Buzzer Box, 34  
Companion 401 Communicator, 125  
EZRA, 277  
First Aide Kit, 278  
Handheld Computers and Personal Organizers, 133  
High Tech/Low Cost, 223  
RC5000 Radio Home Control System, 291  
Vocal Assistant, 159





**Product Name:** Accularm

**Vendor:** Hugh MacMillan Rehabilitation Centre

**Size:** 2.5" x 3.5" x 1.25"

**Weight:** 1 lb.

**Power Source:** 9V battery

**Cost:** \$245.00 Canadian

The primary function of the Accularm is to provide a timed signal to a subject at regular intervals. It provides a chiming audio tone to an enclosed speaker or to an external ear phone. The amplitude level of the tone can be manually adjusted. The timing interval can be pre-set for 1 to 99 seconds. Internal circuits in the Accularm can be altered by manufacturer or engineering personnel to change this interval from seconds to minutes, and thus provide a timed interval of 1 to 99 minutes. This device can be used in research, clinical or therapy situations to remind or condition patients to perform a given task in the prescribed time interval. The Accularm can be used to remind subjects with difficulty in controlling drooling to swallow, or to remind persons with little sensation to move about to avoid pressure sores.

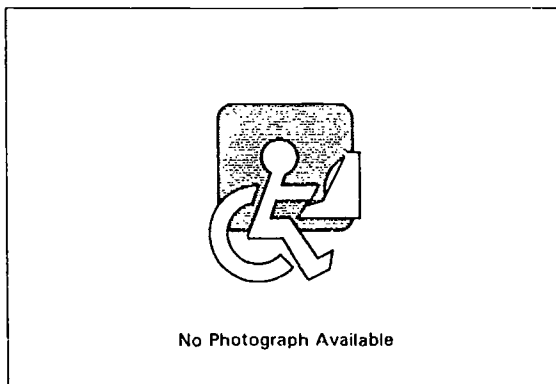

**Product Name:** AlertCom

**Vendor:** USA Company

**Size:** See text

**Weight:** 0.75 oz.

**Power Source:** Lithium battery

**Cost:** \$495.00

ALERTCom Alarm Speakerphone is a wireless, two way security telephone and emergency response system. The system consists of a hands-free speaker phone and a wrist or pendant transmitter. Pushing the transmitter activates the emergency response system and automatically dials 911 or an alternate emergency number. The microphone in the telephone allows the 911 operator to listen-in and communicate with the user. Up to three emergency numbers can be programmed into the device. When activated, the first number is dialed. If after five rings there is no answer, the unit then dials the second number and so on. The telephone console base measures 6" x 8" x 3" and the transmitter measures 1" x 1" x 0.25".

Five models of transmitters are available: a pendant on a chain, a wrist-watch type on an expanding bracelet or a leather clasp with a clasp, a pin-on brooch type, a hang-on beeper type, and a Velcro backed stick-on type.

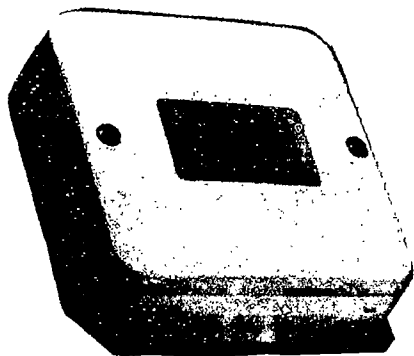

**Product Name:** Auto Call Single Number Dialer

**Vendor:** Ameriphone, Inc.

**Cost:** \$195.00 - \$249.00

The Auto Call is a 16-digit programmable dialer designed for "hot line" or emergency calls. Lifting the telephone handset or pushing a button will cause the pre-programmed number to be dialed. The Auto Call features true dial tone detection, and does not require an external transformer or batteries.

The Auto Call is available in two models: Model 1001 with pulse output (\$195.00), and Model 2501 with touch-tone output (\$249.00).

---

**Product Name:** Beep-in-Touch

**Vendor:** Hersh & Treadgold

**Computer:** Apple Macintosh Family, IBM PC Family

**Cost:** \$295.00



Beep-in-Touch is a time management and cueing software program based on the NeuroPage program (see entry). Beep-in-Touch allows the user or caregiver to program cues and schedules for transmission at any time and date. At the appointed time and date the program retrieves the file, determines the cue to be delivered, and transmits the cue by modem to the transmitter of a paging company. The cue is converted to a radio signal and transmitted to the receiver. Beep-in-Touch can be used on home computers for up to three users.

The Macintosh version requires system 7 or higher, a Hayes compatible modem, and 4MB RAM minimum. The IBM version requires Microsoft Windows 3.0 or higher, a Hayes compatible modem, and 4MB RAM minimum. An alphanumeric receiver and a contract with a paging company for transmission service are also required.

340



**Product Name:** Beeper  
**Vendor:** Crestwood Company  
**Size:** 5.5" x 5.5"  
**Weight:** 11.5 oz.  
**Power Source:** 9V battery  
**Cost:** \$37.95 - \$52.95

The Beeper is a device that can be used to attract attention or to train individuals who are beginning to use a single switch.

Three models are available. The Beeper (\$37.95) consists of a flat plate which is activated by pressure on the top surface. This signal allows single switch signalling for producing individual codes or Morse codes. The Adapted Beeper (\$47.95) has a 1/8" plug for attaching a single switch. The Adapted Light Beeper (\$52.95) is the Adapted Beeper with a light that goes on when the beeper is activated.



**Product Name:** Call Alert Model CA-100  
**Vendor:** Ameriphone, Inc.  
**Size:** 1" x 3" x 4.5"  
**Weight:** 0.25 lb.  
**Cost:** \$34.95

Call Alert is a signalling device that may be used to provide visual indication of an incoming phone or TDD call. The device is plugged into a lamp. When a call is received, Call Alert causes the lamp to flash on and off.

A lamp using a bulb of up to 300 watts is required. Contact manufacturer for further details.

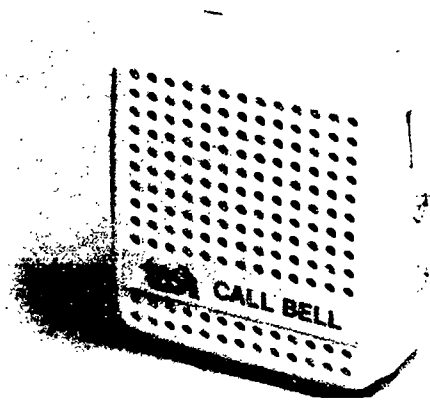

**Product Name:** Call Bell (4500)

**Vendor:** TASH, Inc.

**Size:** 4" x 2" x 1"

**Weight:** 8 oz.

**Power Source:** 9V battery

**Connector Type:** 3.5 mm phone plug

**Cost:** \$75.00

Call Bell is a device that sends out a tone when activated by a single switch. The single switch is connected to the jack on the Call Bell. Momentary contact triggers one tone of predetermined length. Call Bell volume is increased with the addition of a 9 volt battery.

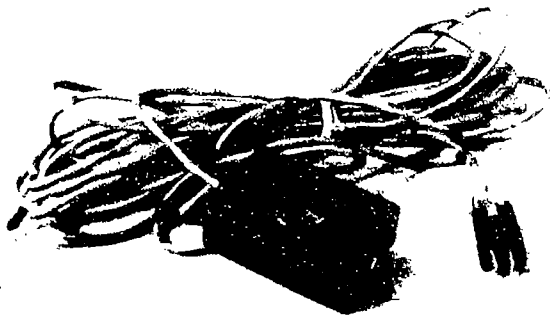

**Product Name:** Call Signal 2

**Vendor:** Prentke Romich Company

**Size:** 4.75" x 2" x 2"

**Weight:** 1 lb.

**Power Source:** Rechargeable batteries

**Cost:** \$70.00

Call Signal 2 is a signaling device activated by any single or dual switch. If a dual switch is used, activation of either switch will produce a tone, and one of two lamps on the Call Signal 2 will light. Activation with a single switch produces a tone only. Call Signal 2 may also be used as an evaluation and training device for individuals learning the use of control devices. Call Signal 2 comes with a 25-foot cord.

Input is made to Call Signal 2 by any single or dual switch (extra). Call Signal may be used as an accessory to the Control 1 environmental control system (see entry, Prentke Romich).

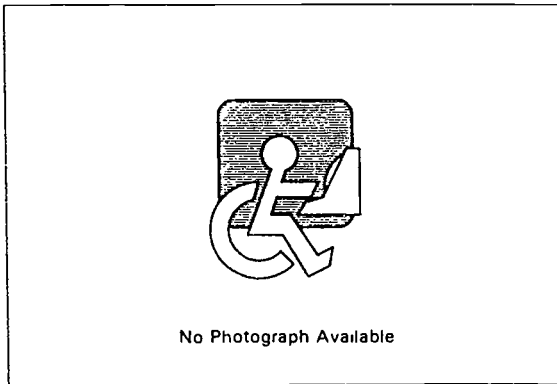

**Product Name:** Chime Alarm  
**Vendor:** Don Johnston Incorporated  
**Power Source:** 9V battery  
**Connector Type:** Mini-phone plug  
**Cost:** \$55.00

Chime Alarm is a switch operated device that emits a musical tone. The distinct tone may be used to call for help or begin a conversation. The tones may also be used to indicate "yes" and "no."

Chime Alarm may be activated by any single switch with a 1/8" mini plug.

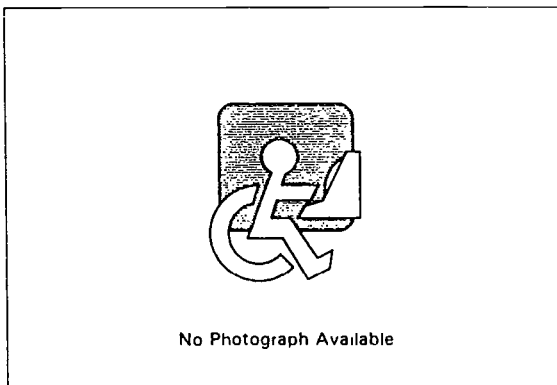

**Product Name:** Cord-Mate  
**Vendor:** Cord-Mate, Inc.  
**Cost:** \$275.00

Cord-Mate is a wireless emergency call system that works with existing pull-cord or push-button call systems in care facilities. The system consists of a transmitter with a large button that can be worn on a necklace or wristband and a receiver that attaches to the facility call system. When the button is activated the receiver activates the call system and staff is notified.



**Product Name:** Digitized Speech Message Machines

**Vendor:** Various (Generic Product)

**Cost:** Varies

A number of low cost digitized and recordable speech message makers are available for people who have communication or cognitive disabilities where recorded voice output is desirable. While there are many uses for message makers they tend to fall under one of two categories: to provide auditory messages to oneself or to provide vocal messages to other individuals. In the first category, they are used for personal reminders such as a brief grocery list, where the car is parked, appointments, etc. In the second category, they are used somewhat like a telephone answering machine by individuals who cannot physically or cognitively use written notation.

Digitized and recordable message makers are available from most electronic stores, office product stores, many gift types of catalogs, and some toy stores. Specific sources can be found in local yellow pages, in the manufacturer list of this book, and in listings from local rehabilitation service delivery programs.



**Product Name:** E-Z Call

**Vendor:** Med Labs, Inc.

**Connector Type:** 1/4" phone plug

**Cost:** \$48.50

E-Z Call is a switch designed to activate a hospital nurse call system. The pressure plate is mounted where the user may apply slight pressure to it with some part of the body in order to activate it. A 10-foot cord is provided.

Technically, E-Z Call is only a switch; it must be connected to a hospital call system to operate. The manufacturer also makes a portable alarm which E-Z Call may be plugged into (see entry for PA-1 Portable Alarm, Med Labs).

350

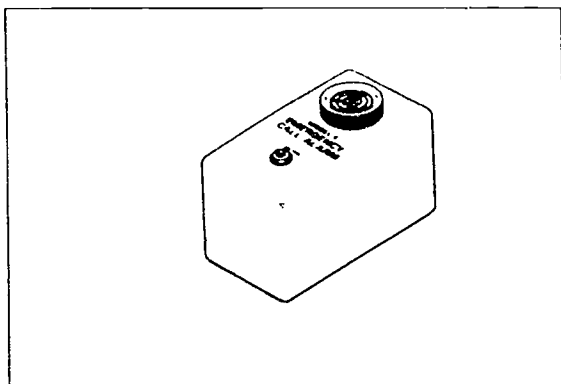

**Product Name:** Emergency Call Alarm

**Vendor:** Zygo Industries, Inc.

**Size:** 2.5" x 4.6" x 3.6"

**Weight:** 9.5 oz.

**Power Source:** 2 9V batteries

**Connector Type:** Mini-phone plug

**Cost:** \$210.00

Emergency Call Alarm is a signalling device that emits a piercing, fast-pulse, intermittent tone. A single switch (not included) is used to activate the alarm.

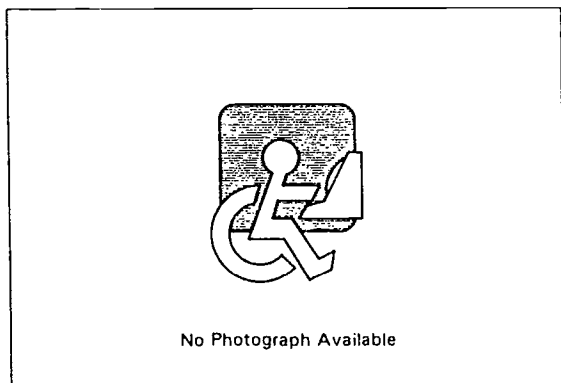

**Product Name:** Home Intercom Systems

**Vendor:** Various (Generic Product)

**Cost:** Varies

Home intercom systems are helpful for allowing individuals with severe motor disabilities to communicate with someone in a different part of the home. In some cases these systems can be used from within a home to the immediate outside vicinity. Home intercom systems are of several types: specific devoted home intercom systems that are mounted and wired within the walls of the home, portable types of home intercom systems such as commonly used as baby monitors, and telephones which have home intercom mechanism within them.

Home intercom systems are available from most electronic product stores. Additionally, some home builders are familiar with intercom systems that can be built into a home. Specific sources can be found in the local yellow pages, in the manufacturer list of this book, and in listings from local rehabilitation service delivery programs.

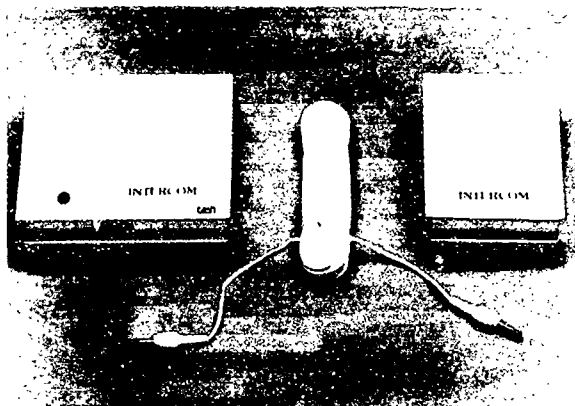

**Product Name:** Intercom (4392)

**Vendor:** TASH, Inc.

**Size:** 4.75" x 4" x 1.75"

**Weight:** 4 oz.

**Power Source:** 120V AC

**Connector Type:** 3.5 mm phone plug

**Cost:** \$300.00

Intercom Unicontrol is an intercom system that can be controlled from one end by a single switch (extra). One momentary activation of a switch connected to the base station allows the user to listen to the remote station. A second activation of the switch allows the user to be heard at the remote station. Intercom Unicontrol switches off automatically 15 seconds after the last switch closure.

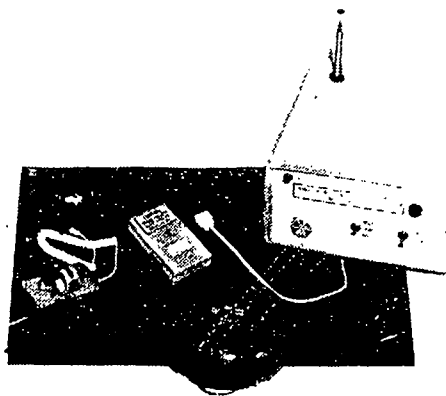

**Product Name:** JANICE Model 100 Invalid Security Alert System

**Vendor:** JANICE Invalid Security Alert Systems, Inc.

**Size:** 2" x 4" x 0.75"

**Weight:** 4 oz.

**Power Source:** 9V battery & AC

**Cost:** Contact manufacturer

The Janice Invalid Security Alert System is an alarm system that may be attached to standard wheelchairs, clipped on a belt, or carried by hand. The system is designed to ring an alarm to signal a need for help, either in the building where the user is or at an outside location. The system can be activated by hand, and will activate automatically if a wheelchair user falls from or tips over in the wheelchair. The system may also be used as a burglar alarm. The system may be customized to individual needs.

Contact manufacturer for information on availability and pricing.





**Product Name:** Lighted Extra Loud Signalling Buzzer

**Vendor:** Toys for Special Children, Inc.

**Connector Type:** 1/4" or 1/8" phone plug

**Cost:** \$35.00

Lighted Extra Loud Signalling Buzzer is a buzzer activated by a single switch. When the switch (extra) connected to the buzzer is depressed, a light on the buzzer lights, a loud piercing buzz sounds, and the unit vibrates (informing the deaf/blind user that the device has been activated).



**Product Name:** Lighted Signalling Buzzer

**Vendor:** Toys for Special Children, Inc.

**Connector Type:** 1/4" or 1/8" phone plug

**Cost:** \$30.00

Lighted Signalling Buzzer is a buzzer unit activated by a single switch (extra). When the switch is depressed, the buzzer sounds and a light on the unit lights.

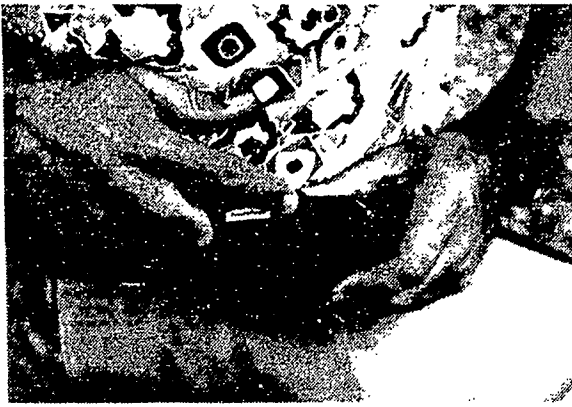

**Product Name:** NeuroPage  
**Vendor:** Hersh & Treadgold  
**Size:** 3" x 2" x 1"  
**Cost:** Contact manufacturer

NeuroPage is a cognitive prosthesis reminder system that operates through a standard commercial paging system. The user wears a small pager which provides specific reminders of things which need to be done at the time they need to be done. The device will beep, and also display a short message of up to 250 characters. The text of the reminders and their times are typed into a personal computer. One computer can be set up to serve 100 individuals or more. When a message is due to go out, the computer sends it by modem to the paging service, which then sends it out by radio wave to the paging unit the individual is wearing. If desired, the system can request that the individual call back to verify that a task was done, and can automatically record that the call-back occurred without having a person answer the call. Since the system uses a commercial paging service, an individual can be reached anywhere that the paging service can access, allowing NeuroPage to be used in both inpatient and outpatient settings.

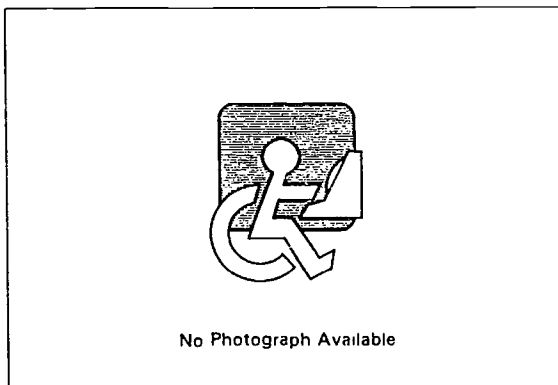

**Product Name:** Omni Page System  
**Vendor:** Silent Call Corporation  
**Size:** See text  
**Power Source:** Rechargeable battery  
**Cost:** \$224.85

Omni Page is a wireless paging system that permits the user to signal another person within an effective range of 100 feet. The system includes a pager (2.25" x 1.25" x 0.5"), a receiver (5" x 3" x 1.25"), and a battery charger. Pressing a button on the pager transmits a signal to the receiver and the receiver will vibrate.

A head activated switch for use with Omni Page is also available.

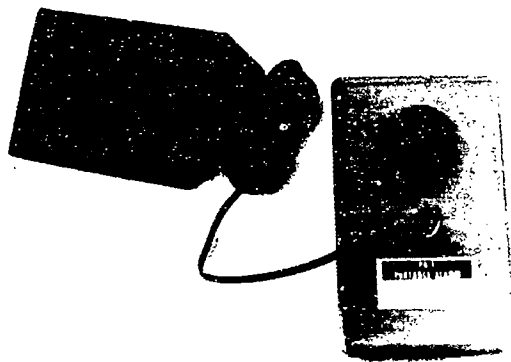

**Product Name:** PA-1 Portable Alarm

**Vendor:** Med Labs, Inc.

**Power Source:** 9V battery

**Connector Type:** 1/4" phone plug

**Cost:** \$39.00

PA-1 Portable Alarm is a portable alarm unit intended for use with the E-Z Call nurse call switch (see entry, Med Labs) where a central call system is not available. When the switch plugged into the PA-1 is activated, the PA-1 emits a shrill whistle, similar to a tea kettle.

---

**Product Name:** People Pager

**Vendor:** HARC Mercantile, LTD

**Cost:** Contact manufacturer

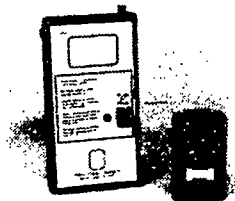

People Pager is a paging system that uses sound and vibrating action as a communication link between people. The hand-held transmitter includes a rechargeable battery and is activated by pushing a button on it. The receiver is a compact belt-pack that beeps and vibrates when the transmitter is activated. The system features a paging range of over 1,500 feet and can be used indoors or out-of-doors.



**Product Name:** Personal Alert Receiver  
**Vendor:** Silent Call Corporation  
**Size:** 5" x 3" x 1.25"  
**Weight:** 7 oz.  
**Power Source:** Rechargeable batteries  
**Cost:** \$199.95

Personal Alert Receiver is a receiver that alerts the hearing impaired user to a variety of stimuli in the household. The user wears the receiver unit that will simultaneously vibrate in response to a signal from any of several transmitted signals. Transmitters are available for detecting: sound (such as a baby's cry), smoke in the house, telephone ringing, door bell ringing, or a pager. The receiver unit has four different signals that can light up, indicating the four transmitters. A pager transmitter is also available which one person can use to signal another person in or around the home.

Available components include the Personal Alert Receiver, Smoke Detector with transmitter (\$99.95), Doorbell transmitter (\$59.95), Telephone transmitter (\$59.95), Rechargeable Sound Monitor (\$98.95), Pager transmitter (\$59.95), Sleep-Alert/Charger for 24 hour operation (\$106.95), Bed vibrator (\$29.95), and a strobe light (\$89.95).

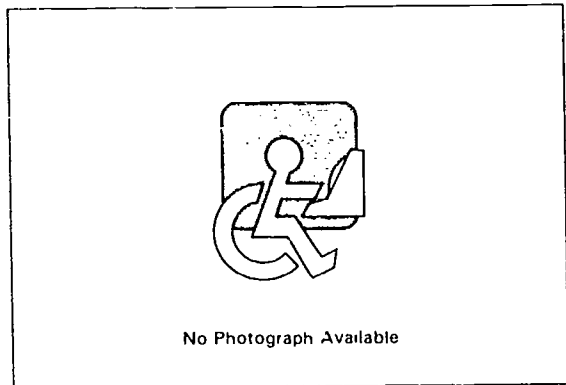

**Product Name:** Personal Pager  
**Vendor:** Access to Recreation, Inc.  
**Power Source:** 12V & 2 "AA" batteries  
**Cost:** \$39.95 - \$89.95

The Personal Pager can send a call signal up to 100 feet through most walls and floors. The transmitter includes a cord and the receiver has a clip for attachment to a belt. The receiver is available with chime or vibrating notification.

350



**Product Name:** Personal Pager

**Vendor:** Adaptation, Inc.

**Size:** 1.5" x 4.5" x 1" (transmitter)

**Weight:** 1 lb.

**Power Source:** 1 9V and 3 "AA" batteries

**Connector Type:** Mini-phone jack

**Cost:** \$59.00

Personal Pager is a wireless, battery operated call device consisting of a transmitter and a receiver. The transmitter can be activated by pushing the button on the device or through an adaptive switch (not included). The device runs on three selectable channels so up to three Personal Pagers can be used in the same area.

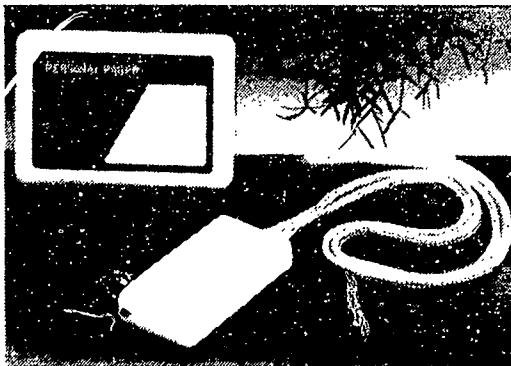

**Product Name:** Personal Pagers

**Vendor:** Greatest of Ease Company

**Power Source:** 12V & 2 "AA" batteries

**Cost:** \$39.95 - \$89.95

The Personal Pagers consist of a portable and lightweight transmitter and receiver with a range of about 100 feet. A beeping or vibrating receiver is available. Both can be clipped to a belt or carried in the pocket and the beeping model can also be mounted on a wall. A push button or sound activated transmitter is also available. The sound activated model features an adjustable sensitivity control.



**Product Name:** Remote Wireless Paging Alarm

**Vendor:** Crestwood Company

**Connector Type:** 1/8" phone plug

**Cost:** \$34.95 - \$49.95

The Remote Wireless Paging Alarm signals up to 100 feet away. The transmitter is activated by pushing a button on the device; a chime is sounded on the receiver. A switch adapted version (\$49.95) is also available that allows the device to be operated by a single switch. No sound is emitted in the room with the transmitter.

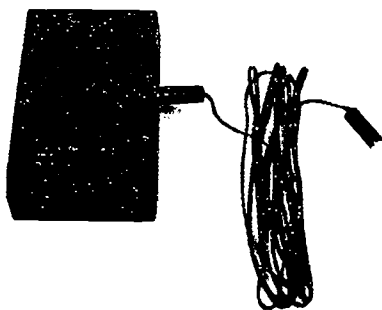

**Product Name:** Screamer Alarm

**Vendor:** Crestwood Company

**Power Source:** 9V battery

**Cost:** \$49.95

The Screamer Alarm emits a high-pitched signal and can be activated by any switch (not included). Comes with a 10 foot cord so alarm can be placed in hallway or away from user. Battery is included.

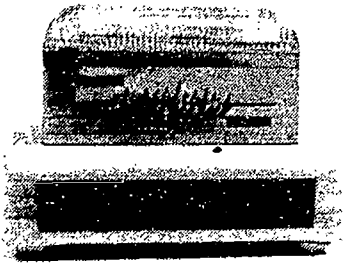

**Product Name:** SideKick Receiver

**Vendor:** Silent Call Corporation

**Size:** 5" x 3" x 1.25"

**Power Source:** 120V AC

**Cost:** \$167.95

The SideKick Receiver offers the same monitoring capabilities as the Personal Alert Receiver (see entry), but is equipped with an ADA approved flashing strobe light and optional bed vibrator. The SideKick is a portable, tabletop unit that plugs into a wall outlet. When the SideKick receives a signal from a transmitter, the strobe light is activated and flashes for 20 seconds and then shuts off automatically. The device works with any of the manufacturer's transmitters. The SideKick features a range of up to 100 feet.



---

**Product Name:** Signal Buzzer

**Vendor:** Toys for Special Children, Inc.

**Size:** 3" x 5", 5" x 8", 8" x 13"

**Connector Type:** 1/4" or 1/8" phone plug

**Cost:** \$25.00 - \$37.00

Signal Buzzer is a plate switch with a built-in buzzer. When the plate on top is pressed, the buzzer sounds. Three sizes are available: 3" x 5", 5" x 8", and 8" x 13". The Signal Buzzer is available with either 1/4" or 1/8" phone plugs. Extra loud models in each size are also available.

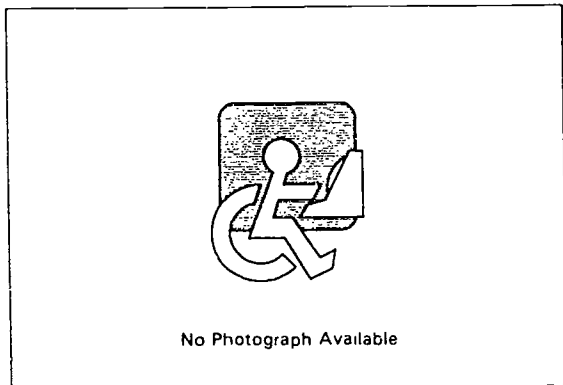

**Product Name:** Sound Advice System

**Vendor:** Sound Advice Systems, Inc.

**Size:** See text

**Weight:** See text

**Cost:** See text

The Sound Advice System is a nonintrusive audible signage using a wireless transmission to capture information and direct it to a user. The system is viable in standard "sign" applications, i.e. Automated Teller Machines, electronic games, subways, worksite applications, etc. The user carries a receiver and ear-piece (3" x 1" x 2", 6 oz.) that picks up a private signal emitting from a radio-based transmitter (8" x 3" x 7", 13 oz.).

Receivers cost \$45.00 each. Price for transmitters varies; jobs are quoted by application.

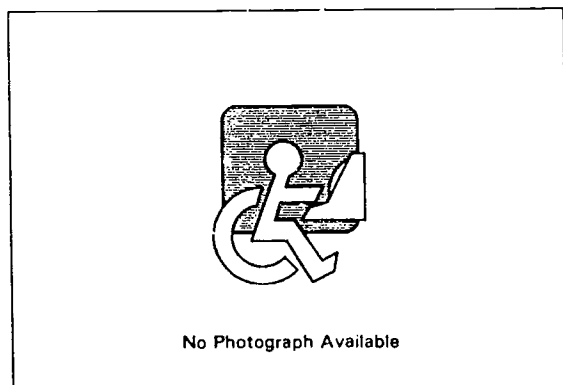

**Product Name:** Vibra-Call Receiver

**Vendor:** Silent Call Corporation

**Size:** 5" x 3" x 1.25"

**Weight:** 7 oz.

**Power Source:** Rechargeable battery

**Cost:** \$329.95

Vibra-Call is a receiver that can be used to alert persons who are deaf-blind to a variety of household stimuli. The user wears the receiver unit that vibrates in response to a signal from any of several transmitters around the house or workplace. The user then presses each of the four push-button switches on the top panel of the receiver; this causes the receiver to revibrate to indicate which transmitter was activated. The system can be used with one receiver and as many transmitters as desired.

Components may be purchased separately: receiver (\$329.95), smoke detector with transmitter (\$99.95), doorbell transmitter (\$59.95), telephone transmitter (\$59.95), rechargeable sound monitor (\$98.75), pager transmitter (\$59.95), sleep-alert/charger (\$106.95) for 24 hour operation, and bed vibrator (\$29.95).





**Product Name:** Watchman Master

**Vendor:** Ultratec, Inc.

**Size:** 6" x 3.5" x 1.75"

**Weight:** 26 oz.

**Power Source:** 120V AC

**Cost:** \$34.95 - \$49.95

Watchman Master (formerly Watchman Phone Master) is a system for detecting sounds around the household. The system consists of two units, a master and a receiver. When the master unit detects a sound, it flashes any household lamp plugged into it. The master unit can be set to send a signal to a receiver unit, so a lamp can be flashed elsewhere in the home as well. As many masters and receivers as needed can be added to the system. Sensitivity and flash rate are adjustable.

The master unit is available for \$59.95; the receiver is available for \$34.95.

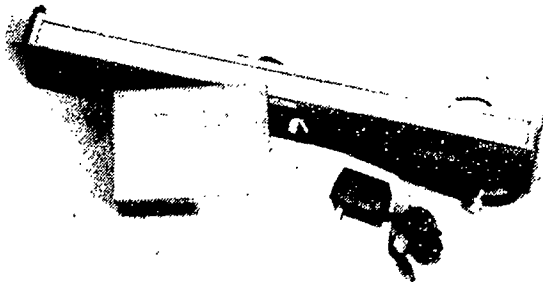

**Product Name:** WatchMate

**Vendor:** Instantel

**Cost:** Contact manufacturer

WatchMate is a monitoring system designed to allow people to move freely within designated areas and alert care providers through wireless transmitters if the person has left the designated area. The basic system is comprised of transmitters, sensors and a monitor. Each person wears a transmitter which emits a unique identification signal.

Various optional features include a pager interface to alert staff while away from the monitor, a portable locator, a central controller for various monitors, and WatchMate software to provide access to security control.

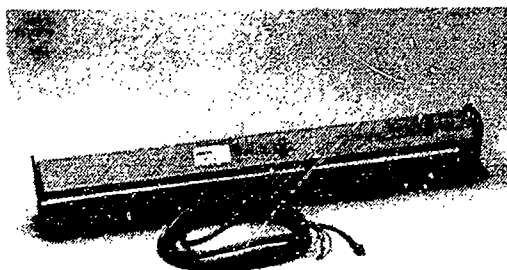

**Product Name:** WatchMate LC

**Vendor:** Instantel

**Cost:** Contact manufacturer

WatchMate LC is designed with the same technology as WatchMate but is smaller in scale and price. Features include a radio frequency escort key that can be used by staff to turn off an alarm or to escort a monitored person through the door. Sensors can be installed without facility modification. Tags are waterproof and easily cleaned.

Contact the manufacturer for further information on customized systems.

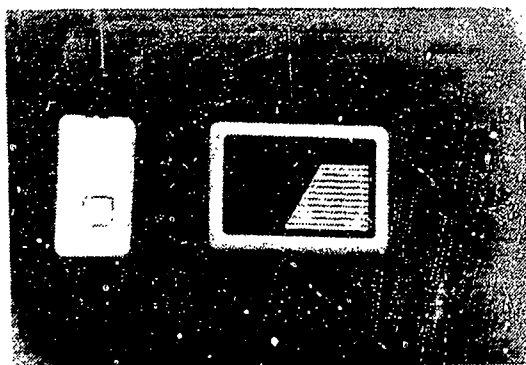

**Product Name:** Wireless Personal Pager

**Vendor:** Luminaud, Inc.

**Power Source:** 12V & 2 "AA" batteries

**Cost:** \$35.00 - \$75.00

The Wireless Personal Pager can summon help or attention from up to 100 feet away by pressing a button on the transmitter. Either standard beeping or vibratory receiver units are available.

# Chapter 11

## Modifications for Standard Keyboards and Mice

This chapter contains hardware and software which modify how a computer's standard keyboard operates. Hardware adaptations in this chapter include keyguards, key latches, moisture guards, foot operated shift keys, etc. Software adaptations include programs for adjusting the keyboard repeat rate, programs for rearranging the keyboard, and programs that electronically "lock" keys such as SHIFT.

This chapter only lists products which adapt a computer's standard keyboard. Actual alternative keyboards are listed in Chapters 12 and 13. Adaptations and modifications for parts of the computer other than the keyboard can be found in Chapter 18 (Other Adaptations).

Relevant function codes for this chapter include Keyguard (KG), Typing Acceleration Program (TA), and Repetitive Strain Injury Prevention (RS). A number of the products in this chapter are cross-listed by function in Index 1, and by input/output features in Index 2. A related input feature is Input Expand/Accel: Abbreviation Expansion. Appendixes A-C include many information summaries of interest to disabled computer users.

*The following product entries appear in this chapter:*

1-Key, 331  
Access Pack for Microsoft Windows, 331  
AccessDOS, 332  
Articulating Drawers, 332  
ASER Ergonomic Keyboard Layout, 333  
Aurora for Windows, 333  
Braille Keytop Labels, 334  
Bridged Keyboard Overlay for the Apple IIGS, 334  
CarpalRest, 335  
Combination Braille/Large Print Keytop Labels, 335  
Comfortype, 336  
Custom Keyguard, 336  
DataArm, 337  
Dvorak Computer Keyboard, 337  
Dvorak Conversion Keytop Labels, 338  
Dvorak Keyboard Layouts, 338  
E.Z. Keys, 339  
Easy Access, 339  
Ergorest Articulated Forearm Rests, 340  
Expanded Keyboard Emulator, 340  
Filch, 341  
FlexShield Keyboard Protectors, 341  
Half-QWERTY One-handed Keyboard Software, 342  
HandiKEY and HandiKEY Deluxe, 342  
HandiSHIFT, 343  
HandiWORD and HandiWORD International, 343  
Help U Type, 344  
High Dots, 344  
Home-Row Key Indicators, 345  
HX-20 Protective Cover, 345  
JDN Shorthand (5073), 346  
KeyAbility, 346  
Keyboard Covers, 347  
Keyboard Overlays for Apple IIe and IIGS, 347  
Keyboard Wrist Rest, 348  
Keycache, 348  
KeyGuard, 349  
Keyguard, 349  
Keyguards, 350  
Keylocks, 350  
KeyMagic, 351  
KeyREP, 351  
KeyStopper, 352  
KeyWiz, 352  
LAP CAT, 353  
Left or Right Handed Keyboards, 353  
MacQWERTY, 354  
Magic Fingers, 354  
Moisture Guard, 355  
MOUSE PERCH, 355  
NOHOLD, 356  
Notebook Computer Wrist Rest, 356  
OmniKey Keyboards, 357  
On/Off Adaptor Switch, 357  
One-Hand Keyboard Package, 358  
PAL, 358  
PECK Computer Software, 359  
PowerPad Keyguard, 359  
PRD+ (Productivity Plus) Basic Edition, 360  
Prefix, 360  
ProKey, 361  
QuietKeys, 361  
Reinforced Keyguard, 362  
Roll & Slide Keyboard Wrist Support, 362  
SafeSkin Keyboard Protector, 363  
Step On It! Computer Control Pedals, 363

Stick-On Keylocks, 364  
Stickey, 364  
Tempo for Windows, 365  
Tempo II Plus, 365  
TempoEZ, 366  
TimeOut UltraMacros, 366  
Uni-Key, 367  
VT520 Terminals - Accessibility Features, 367  
WordWriter, 368  
WRIST PERCH, 368  
ZoomCaps, 369

*The following products from other chapters can also be used as Modifications for Standard Keyboards or Mice:*

Adaptive Firmware Card Model G32e, 374  
Gus! Multimedia Speech System, 133  
Help U Type and Speak, 135  
MacroMaster/pro, 411  
MiniErgo-MF2, 417  
T-TAM Keyboard and Mouse Emulator, 463



**Product Name:** 1-Key

**Vendor:** Neil Squire Foundation

**Computer:** IBM PC Family, IBM PS/2 Family

**Manual Form:** Electronic Manual, Printed Manual

**Cost:** \$15.00

1-Key is designed to allow the one finger, headstick, or mouthstick computer user to use standard software for the IBM PC series of computers. The program remains resident in the computer once invoked. The program allows one finger use of the Shift keys, Control key and Alt key. Depressing and releasing one of these keys once makes it active for the next key. 1-Key also allows the standard key repeat function to be turned off (e.g., only one letter will be typed regardless of how long the key is held down).



**Product Name:** Access Pack for Microsoft Windows

**Vendor:** Microsoft Corporation

**Computer:** IBM PC Family, IBM PS/2 Family

**Cost:** Free

The Access Pack for Microsoft Windows contains access features for IBM computers running Microsoft Windows. The program is customizable. The driver implements the following: BounceKeys (prevents double characters from being typed when a key is accidentally hit when releasing or pressing it), StickeyKeys (provides latching or locking of "modifier" keys such as SHIFT, CTRL, and ALT), RepeatKeys (permits adjusting of both the amount of time a key is held down before it starts to repeat and the key repeat rate), SlowKeys (permits specification of how long a key must be held down before it is registered by the computer), MouseKeys (provides emulation of mouse functions from the keyboard keypad), ToggleKeys (provides tones representing the status of the Caps Lock, Scroll Lock, and Num Lock keys), and SerialKeys (permits communication aids to be used as computer input devices). Separate purchase of Access Pack for use with Windows 95 is not required; all features are integrated into the operating system.

The Access Pack can be downloaded from Microsoft OnLine, CompuServe, Genie, via FTP at [trace.wisc.edu](http://trace.wisc.edu) or [microsoft.com](http://microsoft.com), or may be ordered from Microsoft at (206) 637-7098.

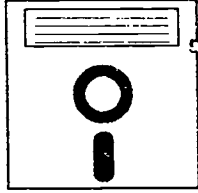

**Product Name:** AccessDOS

**Vendor:** IBM Corporation

**Computer:** IBM PC Family, IBM PS/2 Family

**Cost:** Free

AccessDOS is a software program which provides keyboard modifications. StickyKeys allows the user to press each key separately when performing a multiple key operation. MouseKeys enables the numeric pad to emulate the mouse. RepeatKeys controls how fast keys repeat when they are held down (or turns repeat off); SlowKeys determines how long a key must be held down before it is activated. BounceKeys prevents double characters from being typed when a key is accidentally hit when releasing or pressing it. SerialKeys controls the keyboard and mouse functions using a special input device (extra) attached to the serial port. ToggleKeys uses a "beep" to indicate when the Caps Lock, Num Lock, or Scroll Lock have been activated. ShowSounds displays a small musical note or blinks the screen when the computer makes a sound.

AccessDOS is compatible with IBM computers. The program comes with a user's guide, registration card, one 3.5" disk, and one 5.25" disk. For information on this product contact the IBM Corporation Special Needs Systems; to order the program, call 1-800-426-7282 (in U.S.), 1-800-465-7999 (in Canada), 112-800-465-1234 (in British Columbia), and 1-414-633-8108 (in Alaska).

---

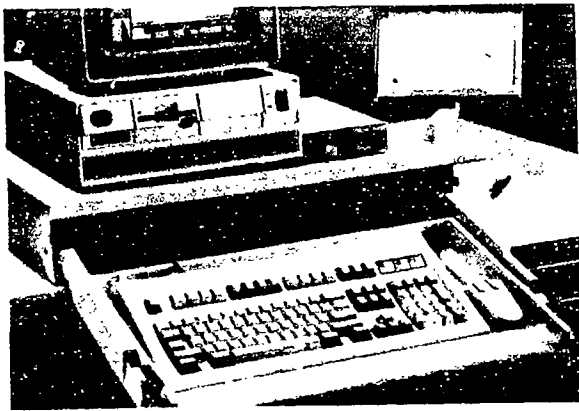

**Product Name:** Articulating Drawers

**Vendor:** AliMed Inc.

**Computer:** All (Hardware Independent)

**Cost:** \$159.95 - 169.95

The Articulating Drawer is a plastic molded tray designed to hold a keyboard and mouse. The drawer is mounted on ball bearings and can be extended up to fifteen inches from its housing. The keyboard can be left in the drawer at all times.

Articulating Drawers are available in two models. The Extended Drawer (\$169.95) can be raised or lowered up to five inches. This drawer model is pulled in and out of a metal housing; the user's computer is placed on top of the housing. The Underdesk Drawer (\$159.95) is mounted under the desk top. This second model allows the user to store the keyboard under the desktop when it is not in use.

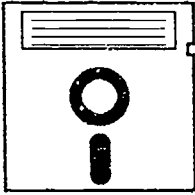

**Product Name:** ASER Ergonomic Keyboard Layout

**Vendor:** AliMed Inc.

**Computer:** IBM PC Family

**Cost:** \$99.00

ASER Ergonomic Keyboard Layout is designed to reduce typing related stress by cutting finger travel in half. The package consists of software, on-line tutorial, and keytop labels. Frequently used letters are moved to home row and transparent labels show both keyboard layouts simultaneously. To ease transition, letters are kept near their original placement.

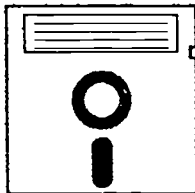

---

**Product Name:** Aurora for Windows

**Vendor:** Aurora Systems, Inc.

**Computer:** IBM PC Family

**Manual Form:** Printed Manual

**Cost:** \$430.00

Aurora for Windows is a word prediction and communication program for Microsoft Windows applications. Multiple Word Prediction allows the user to enter two, three, or more words with a single keystroke without preprogramming. Aurora Prediction applies grammatical rules to reduce the number of inappropriate words presented in prediction. The program starts with a dictionary of about 190,000 words and phrases and is virtually unlimited in size. Conversational communication can be accomplished through the Talk feature, which lets the user compose messages at any time for speech output. Speech output is provided through most popular synthesizers including the CarryCom, Multivoice Dectalk, SoundBlaster, AWE32 DecTalk, PC RealVoice, and Soundblaster Monolog for Windows.

Aurora for Windows requires 80386 CPU, Windows with 4 MB RAM, and 12 MB disk space.

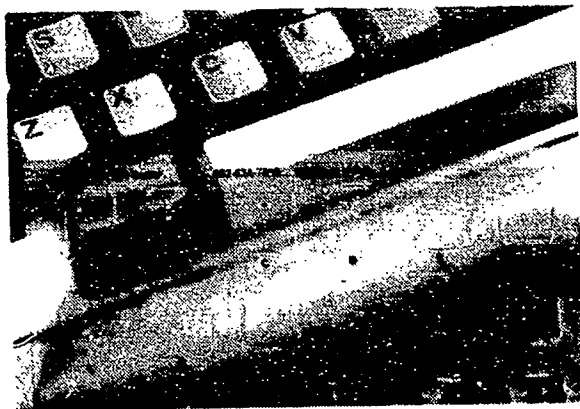

**Product Name:** Braille Keytop Labels

**Vendor:** Hooleon Corporation

**Computer:** IBM PC Family

**Cost:** \$19.95

Braille Keytop Labels are kits of transparent adhesive labels with braille symbols on them. The labels can be stuck to keytops to allow for tactile recognition of keys. They are designed to fit IBM PC and look-alike keyboards.

Quantity discounts are available on Braille Keytop Labels.

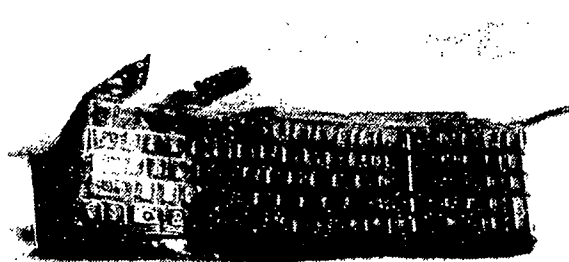

**Product Name:** Brailled Keyboard Overlay for the Apple IIGS

**Vendor:** American Printing House for the Blind (APH)

**Computer:** Apple IIGS

**Size:** 15" x 4"

**Cost:** \$25.95/package of five

The Brailled Keyboard Overlay for the Apple IIGS is a molded plastic cover with braille symbols that fits over the computer keyboard. The cover provides braille symbols for every key on the keyboard. The shape of each key and the appropriate braille symbol are raised for easy tactile recognition.



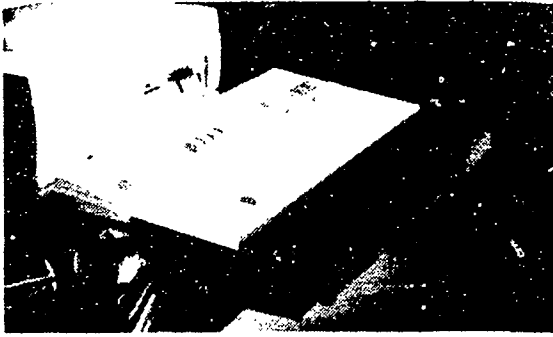

**Product Name:** CarpalRest

**Vendor:** Fox Bay Industries, Inc.

**Computer:** All (Hardware Independent)

**Cost:** \$34.95 - \$259.95

CarpalRest is a family of wrist supports for computer users. In addition to the standard non-adjustable model, CarpalRest is available as adjustable height, high-profile for taller keyboards, articulating, and integrated into a keyboard drawer. Supports for laptop computers and mouse use are also available. Carpal Rest supports are covered with soft fabric in a variety of colors.

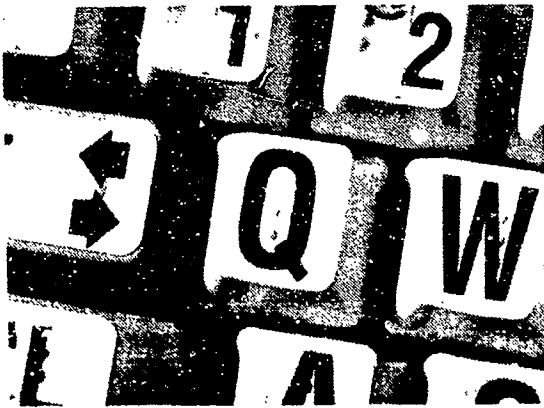

**Product Name:** Combination Braille/Large Print  
Keytop Labels

**Vendor:** Hoolcon Corporation

**Computer:** IBM PC Family

**Cost:** \$21.95

Combination Braille/Large Print Keytop Labels are adhesive labels with braille symbols and large print characters on them. The labels are designed to be affixed to top of computer keyboard keys for easier recognition of the keys. They are intended for IBM PC and other 101-style keyboards.

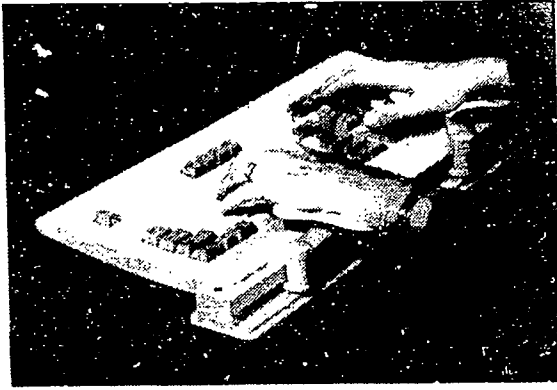

**Product Name:** Comfortype  
**Vendor:** Van Duerr Discovery Industries  
**Computer:** All (Hardware Independent)  
**Size:** 9.75" x 21.5"  
**Weight:** 4 lbs.  
**Cost:** \$149.00

Comfortype is a multi-position hand, wrist, and arm support that provides a full range of keyboarding movement including use of a mouse. The device features a keyboard lift bar for height adjustment to raise or lower the keyboard, two pivoting support arms that slide along the edge of desk with the arms, and individually-contoured palm rests in two sizes.

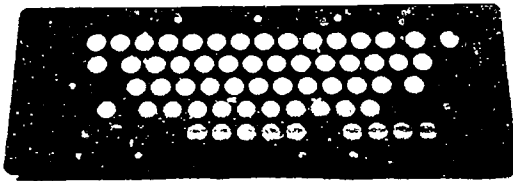

**Product Name:** Custom Keyguard  
**Vendor:** Prentke Romich Company  
**Computer:** Apple II Family,  
Apple Macintosh Family, Atari Family,  
Commodore 64, IBM PC Family,  
Texas Instruments TI 99/4A  
**Weight:** 12 oz.  
**Cost:** \$220.00

These keyguards are made of dark brown plastic Kydex and have 0.6"-diameter holes for each key location. The keyguard prevents the user from inadvertently pressing more than one key at a time. These keyguards feature keylocks to hold down keys such as SHIFT that must be depressed at the same time as other keys. The IBM PC model utilizes software rather than keylocks to allow single finger input. Hook-and-loop type fasteners are provided for attaching and detaching from the keyboard. For custom keyguards for computer brands not listed, contact Prentke Romich Company. The keyboard will need to be shipped to ensure exact fit for some custom keyguards.

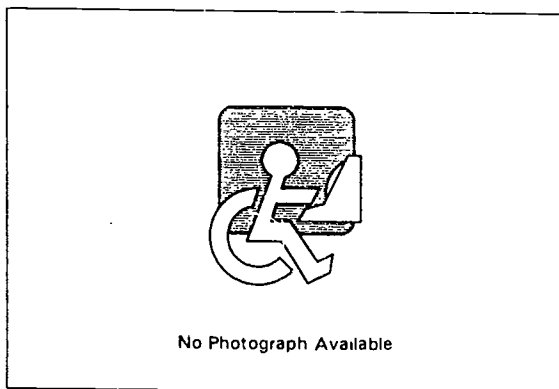

**Product Name:** DataArm

**Vendor:** Maxi Aids, Inc.

**Computer:** All (Hardware Independent)

**Cost:** \$189.95

DataArm is an arm rest designed to reduce repetitive motion injuries by taking the weight off of the muscles in the neck and shoulders. DataArm clamps to the desk and the user rests forearms in curved and padded arm rests. The arm rests move with the user's hands.

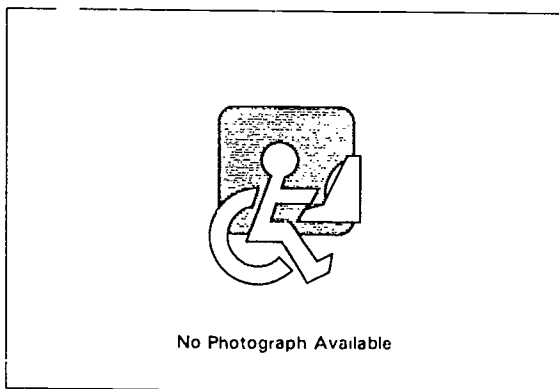

**Product Name:** Dvorak Computer Keyboard

**Vendor:** Typewriting Institute for the Handicapped

**Computer:** IBM PC Family, IBM PS/2 Family

**Cost:** \$975.00

Dvorak Computer Keyboards are alternate computer keyboards that function exactly like the standard keyboard but have the keys laid out in the one-hand Dvorak configuration, a system that reduces strain and increases efficiency for a person typing with only one hand. The one-hand Dvorak layout distributes the typing load more evenly for each finger on the one-hand typist's hand than does the standard layout. Right handed and left handed models are available.

Dvorak Keyboards are \$900.00 for the IBM PC, XT versions; \$975.00 for the IBM AT and PS/2 versions.

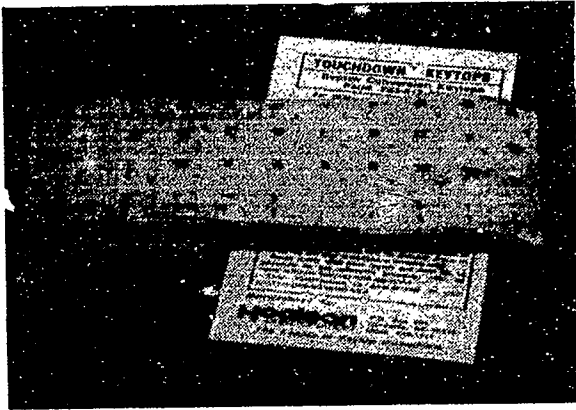

**Product Name:** Dvorak Conversion Keytop Labels

**Vendor:** Hooleon Corporation

**Computer:** Apple II Family,  
Apple Macintosh Family, IBM PC Family

**Cost:** \$26.95

Dvorak Conversion Keytop Labels are labels designed to be placed over a standard set of keyboard keys to reflect the Dvorak ANSI X4.22 keyboard layout. The labels have the Dvorak key legend imprinted in black in the upper left hand corner and the corresponding Qwerty key legend in smaller red lettering in the lower right hand corner. Included are options that account for the placement of brackets and symbols that may vary according to the conversion software used.

Two versions are available: one for IBM keyboards and one for Apple II and Macintosh keyboards.

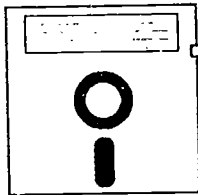

**Product Name:** Dvorak Keyboard Layouts

**Vendor:** Microsoft Corporation

**Computer:** IBM PC Family

**Cost:** Contact manufacturer

Dvorak Keyboard Layouts are designed to make the keyboard more accessible to people who have difficulty using the standard "QWERTY" layout. Three Dvorak layouts are available: two-handed, left hand alone, and right hand alone. The Dvorak Keyboard Layouts can be downloaded from CompuServe, GENie, Microsoft On-line, Microsoft download service (206-936-MSDL), and various user-group bulletin boards under GA0650.ZIP or GA0650.EXE. The program can also be ordered on a disk directly from the manufacturer.

The layouts are available for MS-DOS 5.0 and 6.0, Microsoft Windows 3.1, Windows for Workgroups 3.1, and Microsoft Windows NT 3.1.



**Product Name:** E Z Keys

**Vendor:** Words+, Inc.

**Computer:** IBM PC Family

**Manual Form:** Electronic Manual

**Cost:** \$1,395.00

E Z Keys is a RAM-resident program that provides four main categories of assistance to users of standard keyboards. The categories are: complete keyboard control, dual word prediction, abbreviation expansion, and speech output. Keyboard control includes adjustable accept time and repeat rate, as well as the ability to press key combinations in sequence rather than simultaneously. The dual word prediction and abbreviation expansion features reduce the number of keystrokes needed to generate text, and word endings may be added automatically. A 5,000 word vocabulary is included. Voice output can be generated at any time using most serial port text-to-speech voice synthesizers (extra) or SmoothTalker (extra). Since E Z Keys runs transparently, all features are available at all times while standard software is being run. The program is menu-driven and includes on-line context-sensitive help features and a full-screen exception table. Included with E Z Keys is the Bank Street Writer word processor.

The E Z Keys software comes with voice output. Contact manufacturer for information on environmental control capability.

---

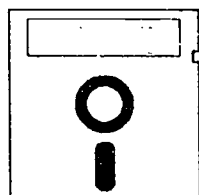

**Product Name:** Easy Access

**Vendor:** Apple Computer, Inc.

**Computer:** Apple Macintosh Family

**Manual Form:** Printed Manual

**Cost:** Sold bundled only

Easy Access is a set of utilities built into the Apple Macintosh operating system that allow the user to modify the operation of the keyboard and mouse. The Easy Access features are provided with the operating system at no additional cost. StickyKeys is a feature that allows single-finger operation of the keyboard. With StickyKeys turned on, the "modifier" keys (such as SHIFT) can be pressed before the key they modify, rather than at the same time. Pressing the modifier key once modifies the next keystroke only; pressing it twice locks it on until it is turned off by being pressed again. Multiple modifier key sequences (like SHIFT-OPTION) can be executed using StickyKeys. MouseKeys is a feature that allows the keys on the numeric keypad to be used in place of the mouse. SlowKeys is a utility that allows the user to adjust response rate of the keyboard.

Easy Access is included in operating systems 4.1 and above.

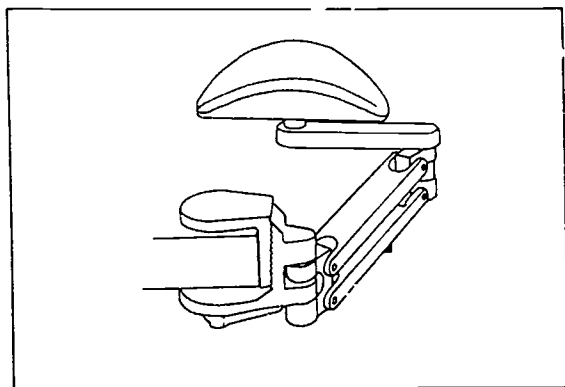

**Product Name:** Ergorest Articulated Forearm Rests

**Vendor:** Willow Pond Tools, Inc.

**Computer:** All (Hardware Independent)

**Cost:** \$145.00 - \$378.00

ErgoRest Articulated Forearm Rests are movable, adjustable arm supports that clamp on to the computer table or work station. ErgoRest is designed to reduce the effects of repetitive motion, for use in injury recovery, and as an accomodative device for people with limited use of the arms and hands. ErgoRest adjusts vertically 3" and can fit on table tops from 0.63" to 2.5".

The standard ErgoRest sells for \$145.00 each and \$290.00 for a pair. An Extension ErgoRest is also available for standing work and assembly at \$189.00 each and \$378.00 for a pair.

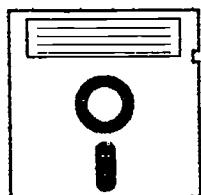

**Product Name:** Expanded Keyboard Emulator

**Vendor:** Words+, Inc.

**Computer:** IBM PC Family

**Cost:** \$695.00 - \$1,395.00

Expanded Keyboard Emulator is a software program for configuring alternative keyboards and providing typing acceleration methods. The program may be used to change key size, set acceptance time and repeat rate, and control keyboard arrangement. The acceleration methods are word prediction (up to six words beginning with the letter(s) typed appear on the screen; the user may then press the number next to the desired word to have the entire word typed), automatic word endings (one of ten common word endings, such as "ing" and "s", may be selected; spelling will then automatically be adjusted so that "swim" and "ing" become "swimming"), and abbreviation expansion (commonly used phrases may be coded as abbreviations, so that typing "tyfyl" will send "Thank you for your letter" to the screen; any key may be programmed to be equivalent to a word, phrase, or command). An additional feature permits automatic correct spacing before and after punctuation. The Bank Street Writer word processor is included.

The Expanded Keyboard Emulator is \$695.00. Expanded Keyboard Emulator/Voice (speech synthesis hardware not included) is \$1,395.00.

374



**Product Name:** Filch

**Vendor:** Kinetic Designs, Inc.

**Computer:** Atari ST Family, Commodore Amiga, Datavue Spark, Grid, IBM PC Family, IBM PS/2 Family, NEC (some or all models), Toshiba Laptops

**Manual Form:** Electronic Manual, Printed Manual

**Cost:** \$89.00 - \$130.00

Filch is a program that alters some of the ways that keys function on an IBM-PC. First, Filch alters the auto-repeat function of all keys on the keyboard. In order to accommodate circumstances in which the user desires the auto-repeat to operate (such as cursor movement), the repeat rate can also be toggled from a user-specified slow speed to the standard speed, with a single keystroke. The delay may be set at up to 13.2 seconds. Second, Filch makes the CONTROL, ALT, and right SHIFT keys into toggles, permitting one-finger operation. These keys may be latching, may latch until the release of the next non-shift key pressed, neither, or both. Filch also allows audio and visual feedback to indicate operation. Macro capability (which permits complex commands to be executed with minimal keystrokes) is also included.

Filch will operate with any program that does not also tamper with the BIOS (keyboard interpretation program) of the PC as long as the keyboard interrupts are shared. It will not work with Microsoft Windows. Version 2.2 is \$89.00 and Version 3.0 is \$130.00. "Evaluate," a program for evaluating a person's keyboarding abilities, is included free with the purchase of Filch (see separate entry for Evaluate).

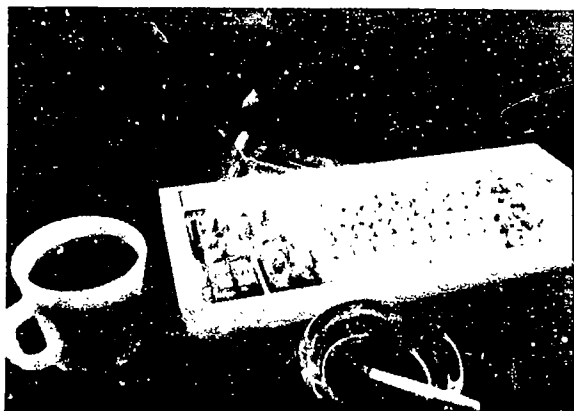

**Product Name:** FlexShield Keyboard Protectors

**Vendor:** Hoolcon Corporation

**Computer:** All (Hardware Independent)

**Cost:** \$18.95

FlexShield Keyboard Protectors are clear, flexible plastic covers that fit over a keyboard and protect the board from dirt, dust or liquids while allowing unrestricted use of the keyboard. Alternative keyboard labels can be stuck on the protector's surface, allowing the user to change labels on any keys simply by changing the protector.

FlexShield Keyboard Protectors are available for a wide variety of computers. Custom FlexShields can be made to the user's specifications.

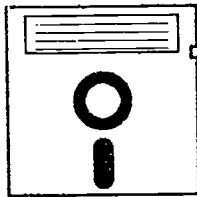

**Product Name:** Half-QWERTY One-handed Keyboard Software

**Vendor:** Matias Corporation

**Computer:** Apple Macintosh Family, IBM PC Family

**Manual Form:** Electronic Manual, Printed Manual

**Cost:** \$395.00

The Half-QWERTY One-handed Keyboard Software is a program designed to remap the computer keyboard so that the user can touch type using one hand. The standard keyboard arrangement is divided in half. On either side of the keyboard, keys may be used to type the keys which normally appear there or the keys usually on the other side of the keyboard. The keyboard halves are set up in mirror image so that QWERT is one half and YUIOP is the other. The space bar is used to alternate and flip the two in mirror image. The program also has a sticky key feature which allows for modified use of function keys. The program does not interfere with standard two-handed typing.

This program is compatible with Macintosh and IBM computers. A free demo disk is available upon request from the manufacturer.

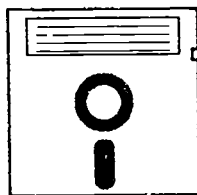

**Product Name:** HandiKEY and HandiKEY Deluxe

**Vendor:** Microsystems Software Inc.

**Computer:** Grid, IBM PC Family, IBM PS/2 Family, ITT, NEC (some or all models), TRS-80 Model 100, TRS-80 Model 200, Tandy 1000, Toshiba Laptops

**Manual Form:** Printed Manual

**Cost:** \$395.00 - \$495.00

HandiKEY is a software program that permits selection of desired letters or phrases (from one to 2,000 characters in length) from a user-definable matrix of cells, using a single key interface (single key, mouse, joystick, digitizer tablet, trackball, or switch). Standard matrices, including ones for the PC keyboard, DOS commands, and the numeric keypad, are included; these may be used as they are or modified, or new matrices may be created. The user activates the single key interface when the scanning cursor reaches the desired row in the matrix. The interface is then released when the desired cell is highlighted. Other selection modes include auto scan, direct scan, and auditory scan.

HandiKEY Deluxe includes speech output capabilities (compatible with DECTalk, Votrax, Echo, or Computalker speech synthesizers), an HW-005 connector, and an additional port connector of choice. HandiKEY Deluxe works with the Headmaster (see entry) and can be configured to provide auditory scanning. A Microsoft Windows version of HandiKEY is also available with limited speech capability in the form of user defined speech matrices.



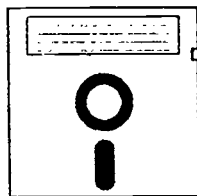

**Product Name:** HandiSHIFT

**Vendor:** Microsystems Software Inc.

**Computer:** Grid, IBM PC Family, IBM PS/2 Family, ITT, NEC (some or all models), TRS-80 Model 100, TRS-80 Model 200, Tandy 1000, Toshiba Laptops

**Manual Form:** Printed Manual

**Cost:** \$49.00

HandiSHIFT is a software program that permits one-finger typists or headstick and mouthstick users to access keystrokes that require depression of more than one key at a time. HandiSHIFT provides three modes: one that affects only the character typed immediately after the Shift key is depressed, and two that work as a shift lock (one for the right hand Shift key and one for the left hand Shift key). All modes provide an optional visual shift state indicator, permitting the user to monitor the state of the shift keys. A single depression of the shift key will cause only the immediately following character to be shifted, two depressions of the key will initiate shift lock, and three will deactivate HandiSHIFT. The program also has a "key-click" feedback option so that the user can tell when keys have been activated. An option is included to disable the key repeat function for those who are slow to move off a key.

---

**Product Name:** HandiWORD and HandiWORD International

**Vendor:** Microsystems Software Inc.

**Computer:** Grid, IBM PC Family, IBM PS/2 Family, ITT, NEC (some or all models), TRS-80 Model 100, TRS-80 Model 200, Tandy 1000, Toshiba Laptops

**Manual Form:** Printed Manual

**Cost:** \$295.00 - \$395.00

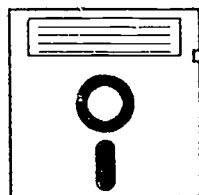

HandiWORD is a word prediction and abbreviation expansion computer program that works transparently with most application programs. An on-line dictionary is provided with HandiWORD. As a user types individual letters, words from the dictionary that begin with those letters appear; the user may then directly choose the desired word, saving on the number of keystrokes required to type the word. HandiWORD records the frequency with which individual words are chosen and "learns" to predict words according to this frequency. Words may be added to or erased from the dictionary by the user, and word prediction libraries may be created for specific applications. The word prediction line may be set to appear on any line on the computer screen or in a box next to the cursor.

HandiWORD is \$295.00. It is available in DOS or Microsoft Windows version. HandiWORD International (\$395.00) includes translation from English to French and French to English, and a natural language dictionary for French. Spanish, German, and Italian are also included. All versions include HandiSHIFT features (see entry).



**Product Name:** Help U Type

**Vendor:** World Communications

**Computer:** Block Transfer Terminals,  
IBM PC Family, IBM PS/2 Family

**Manual Form:** Printed Manual

**Cost:** \$395.00 - \$595.00

Help U Type is a computer program that simplifies use of standard programs by one-finger, headstick, mouthstick, and keyguard typists. Features include a word prediction menu with user-definable dictionaries, "sticky key" capability to enable the SHIFT, ALT, and CTRL keys to be pressed sequentially before the keys they affect, repeat key rate control, and user-defined macros to program often-used words and phrases for retrieval. The word prediction and macro features can be used in combination

Help U Type (\$395.00) runs transparently with most IBM software. A free demo disk is available from the manufacturer. Two optional versions are also available: one is for IBM PC computers that emulate IBM 3270-type terminals (\$495.00) and the other version works with Microsoft Windows (\$395.00); these versions contain all features except macro capabilities. A free demo disk is available.

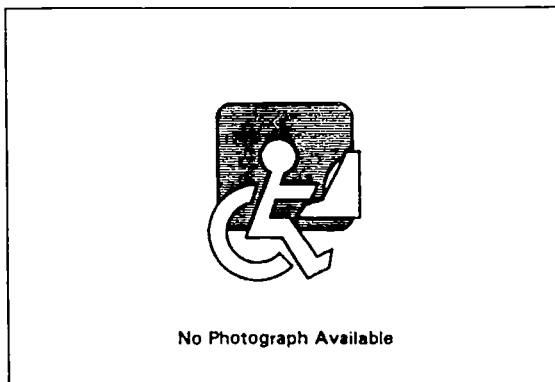

**Product Name:** High Dots

**Vendor:** Exceptional Teaching Aids

**Computer:** All (Hardware Independent)

**Cost:** \$8.25

High Dots are spongy, adhesive-backed dots that can be attached to computer keyboard keys, providing tactual reference points. Each packet of dots includes 112 small dots, 48 medium dots, and 32 large dots; the largest dots are slightly smaller than a dime.

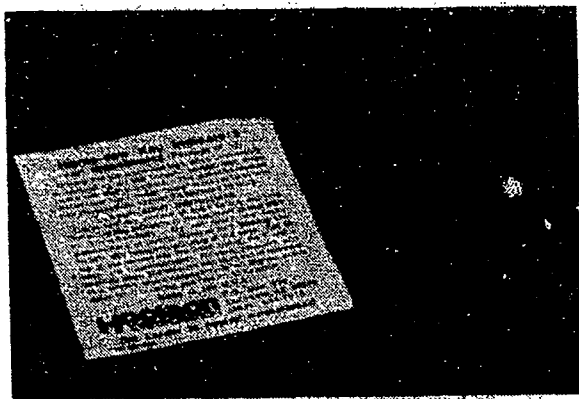

**Product Name:** Home-Row Key Indicators

**Vendor:** Hooleon Corporation

**Computer:** All (Hardware Independent)

**Cost:** \$4.95

Home-Row Key Indicators are small adhesive-backed labels that can be attached to home row or any appropriate keys. A raised bump in the center of the indicators serves as a tactile guide for placing the fingers.

Home-row Key Indicators come in packages of twelve for \$4.95. A package of 50 is available for \$18.95; a package of 100 is available for \$32.95.

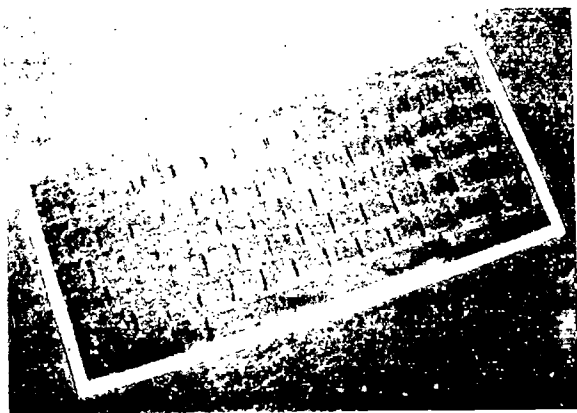

**Product Name:** HX-20 Protective Cover

**Vendor:** ACS Technologies, Inc.

**Computer:** Epson HX-20

**Cost:** \$49.00

The HX-20 Protective Cover is a clear plastic keyboard cover designed for the RealVoice. The Protective Cover prevents moisture from entering the computer through the keyboard, and does not interfere with the normal operation of the keyboard. The cover fits the Epson HX-20 portable computer and most communication aids based on that computer.

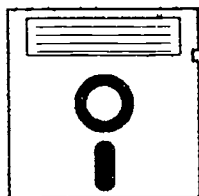

**Product Name:** JDN Shorthand (5073)

**Vendor:** TASH, Inc.

**Computer:** IBM PC Family

**Cost:** \$250.00

JDN Shorthand is an abbreviation software package which allows the user to type entire words with a single keystroke. The program also automatically inserts spaces and capital letters where required.

JDN requires a hard drive, any version of DOS, and 1 MB RAM.

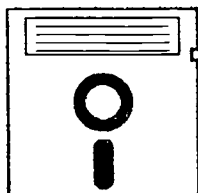

**Product Name:** KeyAbility

**Vendor:** Meeting the Challenge

**Computer:** IBM PC Family

**Cost:** \$198.00

KeyAbility is a software application that allows a standard IBM computer keyboard to be remapped as either a right- or left-handed Dvorak keyboard. The application has a one-finger mode which enables the user to execute certain functions by pressing keys one at a time rather than simultaneously. KeyAbility also features a pop-up menu for program options and "hot keys" which provide direct access to all program options. At the DOS prompt, the program provides an optional visual indication when either Dvorak layout is selected.

KeyAbility is a memory resident program and requires DOS 2.1 or higher.

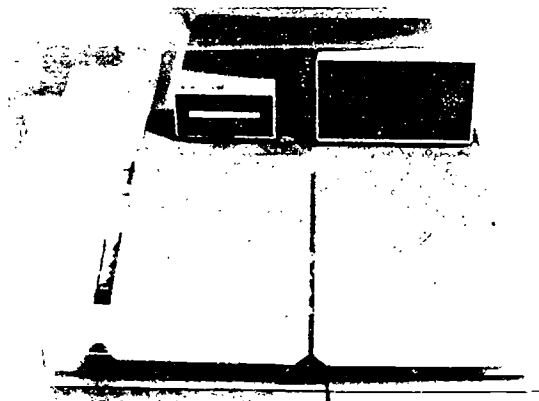

**Product Name:** Keyboard Covers

**Vendor:** Toys for Special Children, Inc.

**Computer:** Apple IIe

**Cost:** \$36.00

Keyboard Covers are a set of hinged plastic plates that go over a standard keyboard. They are designed for use with computer programs which require only one or a few keys to be pressed. Special bumpers are placed on the bottom of each cover over the desired keys. When the cover is struck, the bumpers strike the desired keys. Keyboard Covers are attached to the keyboard with hook-and-loop material, and can be used in one, two, or four striking area configurations.



**Product Name:** Keyboard Overlays for Apple IIe and IIgs

**Vendor:** Marblesoft

**Computer:** Apple IIgs, Apple IIe,  
Apple Macintosh Family

**Cost:** \$8.00 - \$50.00

Keyboard Overlays for the Apple IIe and IIgs are molded flexible plastic strips that cover rows of keys on the computer keyboard, while still allowing the keys to be pressed. The overlays provide a way of temporarily labelling keys with colors, shapes, etc. The overlays can be changed to correspond to different software programs that use different keys.

These Keyboard Overlays were designed for use with Marblesoft's educational software, but are available without labels on them as well. Clear (unlabeled) overlays are \$8.00 for the Apple IIe or for the IIgs. Overlays labeled with colors, shapes, numbers or letters are \$8.00. A package of seven overlays with labels are \$50.00.

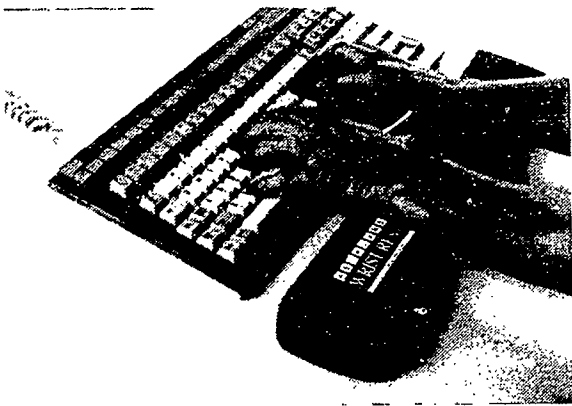

**Product Name:** Keyboard Wrist Rest  
**Vendor:** AiMed Inc.  
**Computer:** All (Hardware Independent)  
**Cost:** \$19.95 - \$29.95

The Keyboard Wrist Rest is a pad which rests against the lower edge of the keyboard. Keyboard users rest their wrists on the padding which is available in one to two inch heights. The support has a no-skid bottom to prevent the pad from sliding during typing.

The Wrist Rest is available with an Extension Support, a thin sheet of plastic that fits under the keyboard. Attached with Velcro strips to a desktop, the Extension Support allows the user to utilize the Wrist Rest even in a place where there is not enough space for both the Wrist Rest and the keyboard.

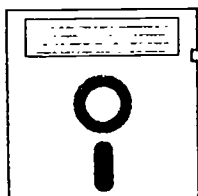

**Product Name:** Keycache  
**Vendor:** OMS Development  
**Computer:** IBM PC Family, IBM PS/2 Family  
**Cost:** \$75.00 - \$140.00

Keycache is a software program that can accelerate typing rates using word prediction. As the user types, Keycache displays a pop-up window showing words that begin with the letters entered. If the desired word is on the list, the user can complete it by pressing a digit key or by clicking the mouse on the window. Keycache can use multiple vocabulary lists, which can be created with any text editor. The program can also add new words to vocabulary lists automatically. Keycache is memory resident; that is, it runs while another software program is running, so the word prediction can be used in other application software such as a word processor. Keycache also provides abbreviation expansion and automatic capitalization.

An evaluation copy of Keycache is available for \$5.00, applicable to the purchase price. Versions are available for DOS (\$75.00) and Microsoft Windows (\$100.00). Both versions can be purchased together for \$140.00.

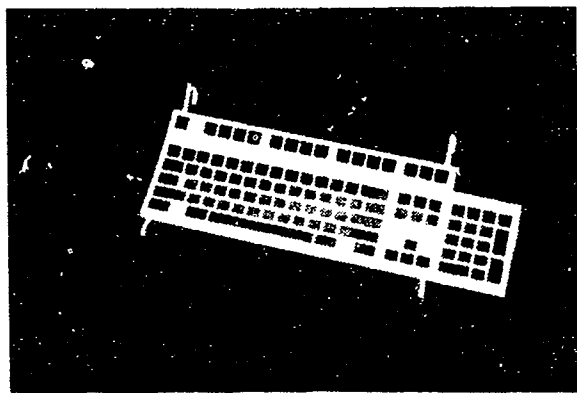

**Product Name:** KeyGuard  
**Vendor:** IBM Corporation  
**Computer:** IBM PC Family  
**Cost:** \$80.00

The Keyguard is a molded plastic overlay for the computer keyboard that has holes for each key. The guard helps to prevent unintentional activation of more than one key at a time. The KeyGuard attaches so that the keyboard can be positioned in any angle.

Information for this product can be obtained from (800) 426-4832 (U.S. voice) or (800) 426-3833 (U.S. TDD). It may be ordered from (800) 426-7630 (U.S. voice) or (800) 426-3383 (U.S. TDD). Canadian information and ordering is handled at (800) 465-7999.

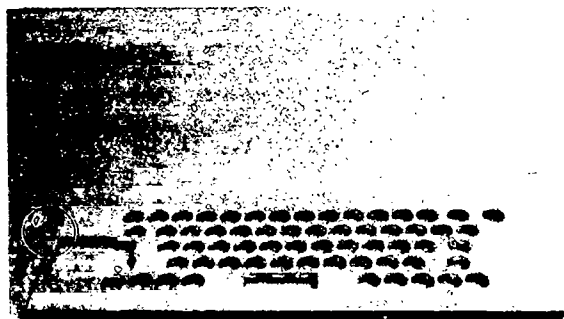

**Product Name:** Keyguard  
**Vendor:** TASH, Inc.  
**Computer:** Apple II Family,  
Apple Macintosh Family, IBM PC Family,  
IBM PS/2 Family  
**Cost:** \$70.00

These keyguards are metal shields with holes over the key positions which help prevent the unintentional activation of more than one key at a time.

Keyguards are available for IBM, Apple, and Macintosh computers. The Apple IIe and II+ models have spaces for the installation of keylocks (extra; see entry for Keylocks: TASH, Inc.). The keyguards mount with Velcro (provided).

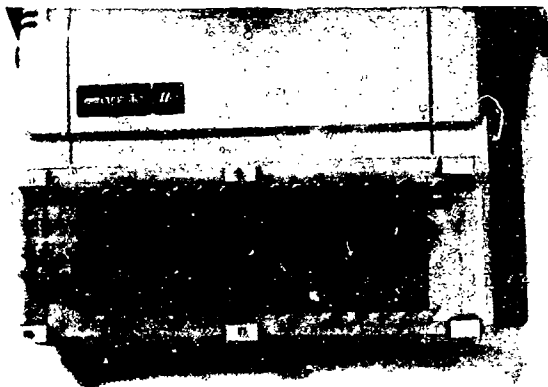

**Product Name:** Keyguards

**Vendor:** Don Johnston Incorporated

**Computer:** Apple IIGS, Apple IIe,  
Apple Macintosh Family

**Cost:** \$45.00 - \$150.00

Keyguards promote accuracy in keypressing by single finger, headstick, or mouthstick typists. These keyguards consist of a panel of clear plastic with holes above each key position. For the Apple II models, latching mechanisms are provided to hold down the SHIFT, OPEN-APPLE, and CONTROL keys.

Keyguards are available for the Apple IIe and IIe numeric (\$135.00), and Apple IIGS (\$150.00), Macintosh Apple Design "N" (\$100.00), Macintosh Apple Design Keyboard (\$100.00), Macintosh Keyboard II (\$100.00), PowerBook (\$95.00), and Trackball (\$45.00). The keyguards are easily attached and removed from the keyboard.

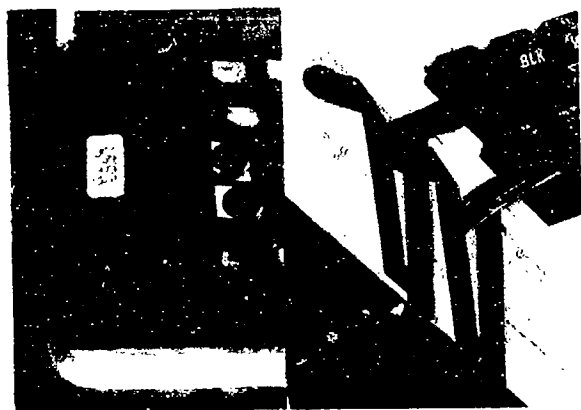

**Product Name:** Keylocks

**Vendor:** TASH, Inc.

**Computer:** Apple II Family

**Cost:** \$65.00

These keylocks fasten to the right side of the keyboard and are used to operate the SHIFT and CONTROL keys. They are engaged by pushing on one side of the levers and released by pushing on the other side.

384



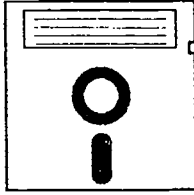

**Product Name:** KeyMagic

**Vendor:** Madenta Communications, Inc.

**Computer:** Apple Macintosh Family

**Cost:** \$95.00

KeyMagic is software that changes the keyboard layout. Multiple layouts can be defined and accessed through a pull-down menu. The user can switch between layouts for different countries and languages quickly and easily. KeyMagic requires 700K RAM and system 6.08 or later.

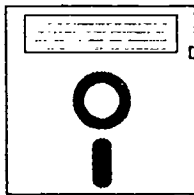

**Product Name:** KeyREP

**Vendor:** Prentke Romich Company

**Computer:** IBM PC Family

**Cost:** \$290.00

KeyREP is a rate enhancement package for keyboard users of Microsoft Windows. KeyREP provides word prediction with an initial 5,000 word dictionary. A number of smaller dictionaries comes with and the user can create a personal dictionary easily. In addition, words not contained in the dictionary are added automatically as the user types. Abbreviation expansion is also provided. Several sets of up to 80 abbreviations can be set up for different tasks or applications. Both word prediction and abbreviation expansion can be used with any application running under Windows except DOS windows.

System requirements are a 286 or higher microcomputer with a hard disk, 2 MB memory, and DOS 5.0.

Pat 385

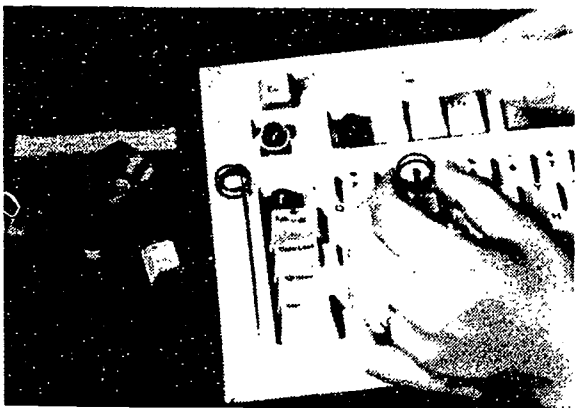

**Product Name:** KeyStopper  
**Vendor:** Hooleon Corporation  
**Computer:** IBM PC Family  
**Cost:** \$11.95

KeyStopper is a set of hardware designed to make it more difficult or impossible to hit certain designated keys on the keyboard. The set for IBM keyboards consists of four solid rings that can be used to stop a key, and four springs that can be used to require that more pressure be exerted on the key for it to work.

A set consists of eight springs, key puller, and either ivory or gray keytops. Keystoppers may be purchased individually for \$.50 a ring.



**Product Name:** KeyWiz  
**Vendor:** Words+, Inc.  
**Computer:** IBM PC Family  
**Cost:** \$695.00

KeyWiz is a computer program that provides a number of access and keystroke-saving features useful to one-finger, headstick, and mouthstick typists. Features include one-finger operation for SHIFT, ALT, and CTRL keys, adjustable acceptance time and repeat rate, optional auditory feedback to indicate if a key has been struck, word prediction based on a 5,000 word dictionary, abbreviation expansion, ten preprogrammed word endings with automatic spelling adjustment (if "s" is selected after "baby," the word is automatically spelled "babies"), and automatic spacing after punctuation.

KeyWiz is essentially a version of E Z Keys (see entry) without the voice capability.

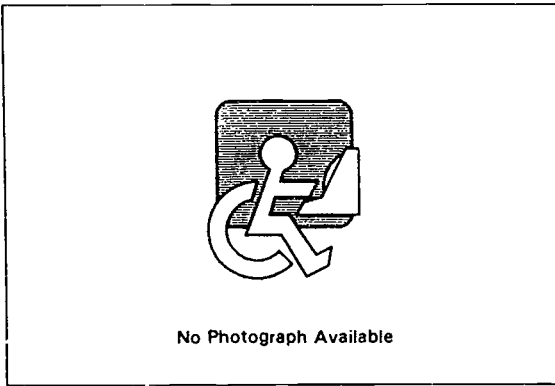

**Product Name:** LAP CAT

**Vendor:** PC Compatibles

**Computer:** All (Hardware Independent)

**Size:** 19" x 10" x 4"

**Cost:** \$39.95

The LAP CAT is a cushioned lap rest for the computer keyboard made of medical grade foam. The device is hypoallergenic, flame retardent and machine washable made of open cell foam which channels away heat and moisture. The built-in wrist rest provides correct positioning for the wrist.

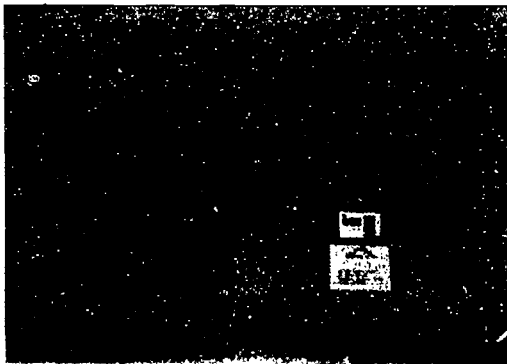

**Product Name:** Left or Right Handed Keyboards

**Vendor:** Maxi Aids, Inc.

**Cost:** \$229.95

The Left or Right Handed Keyboards feature a Dvorak layout allowing for easy access to 60% of the characters used in each word. The shift, ctrl, and alt keys can be controlled with optional foot pedals (\$89.95 each).

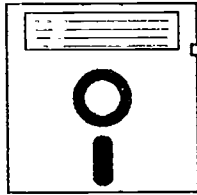

**Product Name:** MacQWERTY

**Vendor:** Nisus Software, Inc.

**Computer:** Apple Macintosh Family

**Manual Form:** Printed Manual

**Cost:** \$49.00

MacQwerty is a software program that enables the standard Macintosh keyboard to be reconfigured as a Dvorak or custom keyboard. A desk accessory version of the two Dvorak keyboard layouts is included to allow configuration to be changed within most programs. The program can also be used to create a custom keyboard layout. Dvorak and blank keyboard pictures are included on the program disk; keytop overlays are also included.

The program can work with System 6.0 or 7.0 and later.

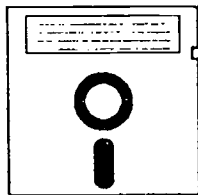

**Product Name:** Magic Fingers

**Vendor:** Words+, Inc.

**Computer:** IBM PC Family

**Cost:** \$39.95

Magic Fingers is a software program that provides abbreviation expansion. The program runs transparently with standard IBM programs. Users can define abbreviations and expansions so that typing a few keystrokes will produce a full string. For example, "syrs" can be defined as "Sincerely yours," so that when the former string is typed it is automatically replaced with the latter. If an expansion occurs where not wanted, it can be erased and fixed. Additional features include an audible click when a key is pressed, extended keyboard buffers, password lockout, and a screen saver; contact manufacturer for further details.

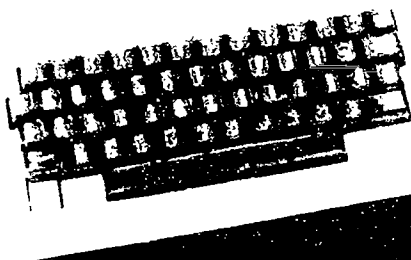

**Product Name:** Moisture Guard

**Vendor:** Don Johnston Incorporated

**Computer:** Apple IIGS, Apple IIe,  
Apple Macintosh Family

**Cost:** \$24.95

Moisture Guards are flexible clear plastic keyboard covers that protect the keyboard from moisture without altering normal keyboard use. The guard attaches to the keyboard with double-sided tape.

Moisture Guards are available for the Apple IIe, IIe numeric keypad, and IIGS, the Macintosh Apple Design Keyboard, PowerBook, Macintosh Extended Keyboards, and Macintosh Keyboard II.

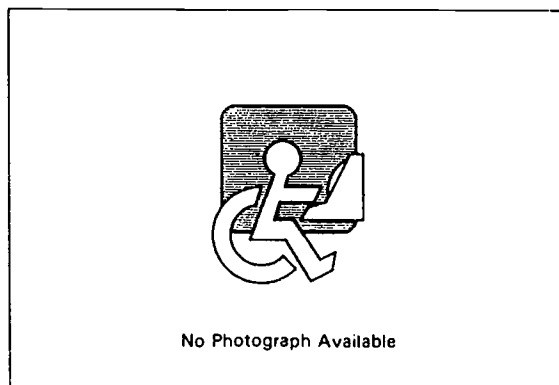

**Product Name:** MOUSE PERCH

**Vendor:** PC Compatibles

**Computer:** All (Hardware Independent)

**Size:** 9" x 10"

**Cost:** \$8.95

The MOUSE PERCH is a wrist support for mouse users. The device features a fast-tracing lexan surface with built-in wrist rest on a sloped, non-skid foam base. Mouse pad area is 7.5" x 8.5".



**Product Name:** NOHOLD

**Vendor:** Computers to Help People, Inc.

**Computer:** IBM PC Family

**Cost:** \$12.00

NOHOLD is a keyboard modification software program. It operates under MS-DOS and eliminates the need for the user to depress more than one key at a time. For example, the SHIFT, ALT, and CTRL affect the next key pressed rather than one held down simultaneously. NOHOLD is designed to be a very low overhead utility.

The program can be turned on or off for different users of the computer.



**Product Name:** Notebook Computer Wrist Rest

**Vendor:** AliMed Inc.

**Size:** 1.5" x 12" x 15"

**Cost:** \$29.97

The Notebook Computer Wrist Rest is a wrist support designed for small notebook size personal computers. The support is foam covered in nylon and comes with a plastic base. The product stands one and one-half inches high and angles the user's hands at 15 degrees.

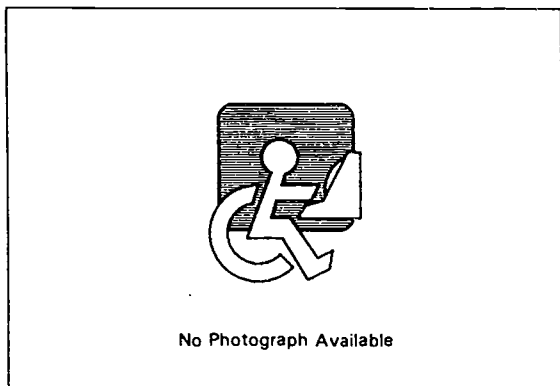

**Product Name:** OmniKey Keyboards

**Vendor:** Northgate Computer Systems, Inc.

**Computer:** IBM PC Family

**Cost:** \$89.00 - \$129.00

The OmniKey keyboards have standard IBM keyboard capabilities plus several features which allow the user to define the way in which keystrokes are recognized. The keyboards have "sticky key", comma/colon/period lock, variable repeat rate, delay rate, and validation time features. The keyboards are available in standard, right-handed, and left-handed Dvorak layouts; key caps can be used to change the configuration of the keyboard.

The keyboards are available in several different models which have a varying number of function keys. Contact the manufacturer for further information about specific models.

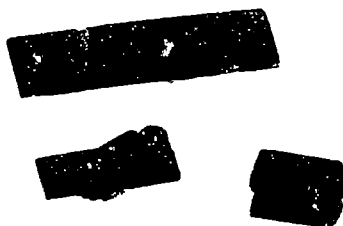

**Product Name:** On/Off Adaptor Switch

**Vendor:** ACS Technologies, Inc.

**Computer:** Epson HX-20

**Cost:** \$15.00

The On/Off Adaptor Switch is designed to allow latching on/off operation of keys which otherwise have to be held down while another key is pressed. The switch is available for the SHIFT, CONTROL, and GRAPHICS keys on the Epson HX-20 portable computer, as well as communication aids based on that computer. A power switch extension is also available. Contact manufacturer for details.

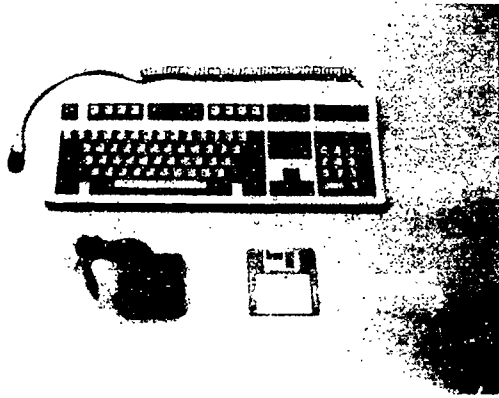

**Product Name:** One-Hand Keyboard Package

**Vendor:** Trask Office Products

**Computer:** IBM PC Family

**Cost:** Contact manufacturer

The One-Hand Keyboard Package consists of an IBM compatible keyboard, foot controlled shift switch, and keyboard tutorial software. The package allows the one-handed computer user to type at speeds of 50 to 60 words per minute. Featuring Dvorak key layouts, the keys are arranged to put the most commonly used letters in the center of the keyboard where the user can reach them without moving the hand from the guide keys. Layouts are included for the right, left, or both hands.

---

**Product Name:** PAL

**Vendor:** Kepler Electronic Publishing, Inc.

**Computer:** IBM PC Family

**Cost:** \$295.00

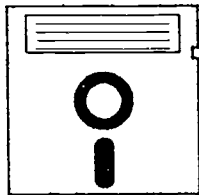

PAL (Predictive Adaptive Lexicon) is a predictive typing acceleration program. By typing a single letter, a likely word is predicted and can be inserted automatically into the document, along with correct punctuation. The program learns the writer's style and vocabulary as work progresses, predicting recent and frequently-used words. Its lexicon can be increased to include specialized vocabularies such as in the sciences and humanities.

PAL requires a basic 286 (AT) or better PC running DOS 4.0 or later and is compatible with most word processing programs.





**Product Name:** PECK Computer Software

**Vendor:** Productivity Software International

**Computer:** IBM PC Family

**Cost:** \$19.95

PECK is a computer program that allows IBM PC computer keyboards to be used by one-finger, mouthstick, or head pointer users. The program allows the SHIFT, ALT, and CTRL keys to be pressed in sequence with the keys they affect, eliminating any need to hold down more than one key at a given time. PECK remains resident in the computer once invoked, and works with most programs written for the IBM PC including Microsoft Windows applications.

PECK can be obtained by sending \$9.95 (includes postage) or a blank disk and sufficient return mail postage (\$2.00 recommended). The program is also included as part of Productivity Software International's PRD+ (Productivity Plus) product line (see entry).

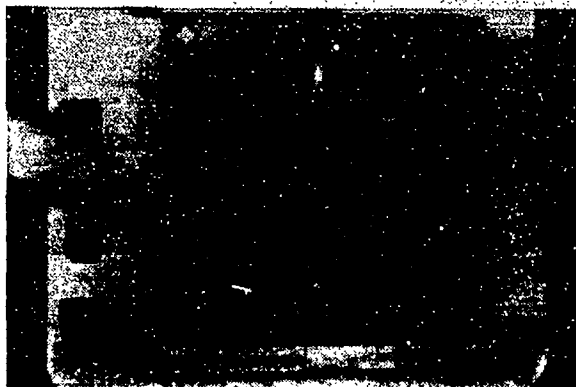

**Product Name:** PowerPad Keyguard

**Vendor:** Dunamis, Inc.

**Cost:** \$99.95

PowerPad Keyguard is a plexiglass keyguard for the PowerPad (see entry). The keyguard has 128 keyholes and attaches with Velcro directly above the surface of the PowerPad. The user activates the PowerPad by pressing through any of the keyholes, reducing the number of unwanted keystrokes.

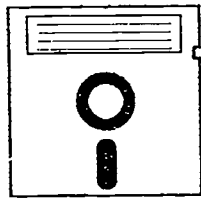

**Product Name:** PRD+ (Productivity Plus) Basic Edition

**Vendor:** Productivity Software International

**Computer:** IBM PC Family

**Manual Form:** Printed Manual

**Cost:** \$479.95

PRD+ (Productivity Plus) Basic Edition is a menu-driven abbreviation/expansion program. The user types a short set of characters (the abbreviation), and when the space bar, enter or punctuation key is pressed, a longer set of characters (the expansion) is triggered. PRD+ functions "transparently" with almost all other DOS or Microsoft Windows applications. Abbreviations can be up to eight characters long; expansions can be up to 4,000 characters. PRD+ features Auto-Abbreviation, Case-Sensitive Capitalization, and Automatic Suffix-Selection functions.

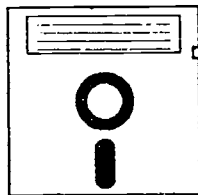

**Product Name:** Prefix

**Vendor:** Simple Works

**Computer:** IBM PC Family

**Manual Form:** Electronic Manual

**Cost:** Contact manufacturer

Prefix is a DOS program that allows keys such as CTRL, ALT, and SHIFT to be pressed independently of other keys; if another key is pressed after one of these keys, the effect will be the same as if both keys had been held down simultaneously.

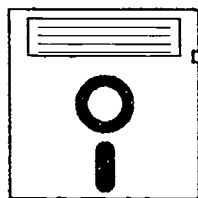

**Product Name:** ProKey

**Vendor:** CE Software, Inc.

**Computer:** IBM PC Family

**Manual Form:** Printed Manual

**Cost:** \$79.00

ProKey is a keyboard enhancement program that allows the user to type long character strings or groups of commands ("macros") by entering a two-keystroke combination, such as ALT-A. ProKey allows the user to include fixed or variable-length pauses in macros. Up to 300 macros may be defined, storing a total of 30,000 characters. Macros are called up by a multiple character name, and may be created and edited while another program is running. Program includes a one-key feature for single-finger operation of SHIFT, ALT, and CONTROL keys. ProKey also contains features such as menus, display messages, cut and paste, abbreviations, history, event scheduling, multiple key playback, and alarm.

Two versions of ProKey are available. One version is available for use with Microsoft Windows, another version is for standard DOS operations.

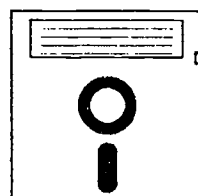

**Product Name:** QuicKeys

**Vendor:** CE Software, Inc.

**Computer:** Apple Macintosh Family

**Manual Form:** Printed Manual

**Cost:** \$119.00

QuicKeys for the Apple Macintosh allows the user to customize keys so that complicated functions can be performed with a single keystroke. The number of keys that can be customized is limited only by the amount of disk space. After the program has been installed, it can be accessed from the Control Panel. QuicKeys can emulate all mouse functions. Other features include "smart" sequences which permit complicated procedures to be recorded and recalled, and Real Time Recording which can be used to "teach" the program to perform routine tasks on the Mac.

A Mac Plus or later model, with 1 Mb of RAM running System 6.04 is the minimum required configuration to run QuicKeys. A hard drive is required.

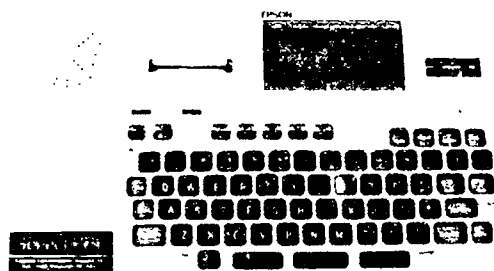

**Product Name:** Reinforced Keyguard

**Vendor:** ACS Technologies, Inc.

**Computer:** Epson HX-20

**Cost:** \$125.00

The Reinforced Keyguard is designed for the keyboard of the Epson HX-20 computer. It is designed to prevent the single finger, mouthstick, or headstick typist from making accidental key presses. The keyboard configuration will work with Adaptive Communication Systems' various communication aids based on the Epson HX-20 as well.



**Product Name:** Roll & Slide Keyboard Wrist Support

**Vendor:** Ability Center of Greater Toledo

**Computer:** All (Hardware Independent)

**Weight:** 2 lbs.

**Cost:** \$120.00

The Roll & Slide Keyboard Wrist Support is a free standing, cushioned aid for keyboard users. The support rests on the same surface as the keyboard and is placed between the user and the keyboard. Two aluminum shafts are attached to non-slip end blocks. Each shaft has two cylindrical foam pads upon which the user's forearms are rested. The pads roll backward and forward as well as side to side as the user types on the keyboard. The support adjusts to two different positions.

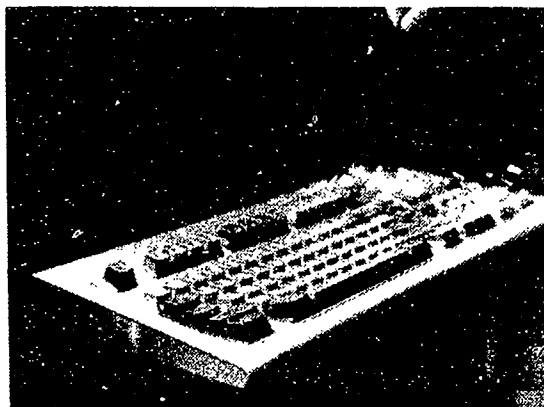

**Product Name:** SafeSkin Keyboard Protector

**Vendor:** Merritt Computer Products, Inc.

**Computer:** All (Hardware Independent)

**Cost:** \$29.95

SafeSkin Keyboard Protectors prevent damage to the keyboard resulting from liquid spills, foreign matter and other hazards. SafeSkin is precision molded to fit the exact contours of the keyboard and is virtually transparent, making keytops and any side markings clearly visible. It remains in place during keyboard use.

SafeSkin is currently available for over 1200 computer models. Custom covers are also available. Contact the manufacturer for a full listing.

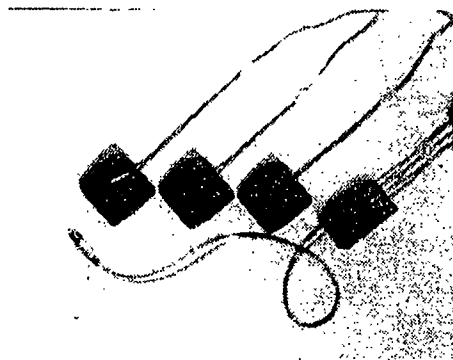

**Product Name:** Step On It! Computer Control Pedals

**Vendor:** Bilbo Innovations, Inc.

**Computer:** IBM PC Family, IBM PS/2 Family

**Weight:** 2 lbs.

**Cost:** \$99.00

Step on It! Computer Control Pedals allow the user to assign any selected keys, key sequences, or mouse button clicks to foot operated switches. Single keys such as "Control", "Shift", or "Alt" or macros up to 13 characters can be assigned to each of the three pedals included. Menu driven software allows the user to assign keys without any programming skills. Step On It! is compatible with any PC and any computer game on the market. DOS or Microsoft Windows must be run to reassign the pedals.

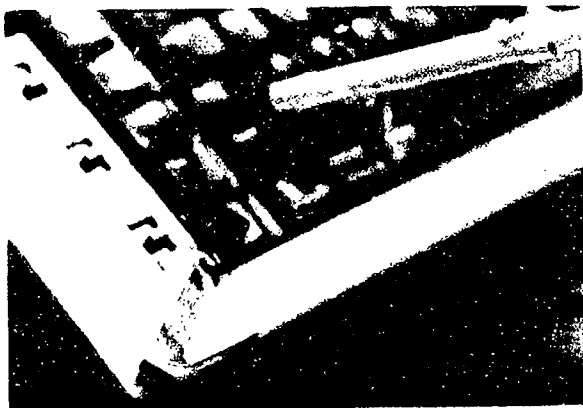

**Product Name:** Stick-On Keylocks  
**Vendor:** Extensions for Independence  
**Computer:** All (Hardware Independent)  
**Cost:** \$23.00

Stick-On Keylocks are one hand keyboard modifications designed to assist one hand and mouthstick typists to perform simultaneous key operations (Ctrl, Shift, Alt, etc.). The keylocks stick to the side of the keyboard next to the keys that frequently must be pressed at the same time as another key. The locks can be operated by a light touch and come in right and left operation styles.

A standard model, which fits most Apple computers and the ALT key on IBM computers, and a spring-loaded model are available. Keylocks include a double-stick pad that adheres to the flat spot on the keyboard surface.

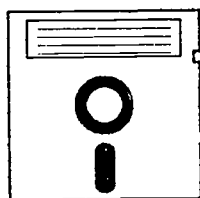

**Product Name:** Stickey  
**Vendor:** C-CAD (Center for Computer Assistance to the Disabled)  
**Computer:** IBM PC Family  
**Cost:** Free

Stickey is a keyboard modification program designed to help the one finger or mouth stick typists perform functions which require two keys to be pressed simultaneously. When pressed, the "control," "alt," and "shift" keys remain activated until the next key is pressed. Stickey is memory retentive and IBM compatible.



**Product Name:** Tempo for Windows

**Vendor:** Affinity Micro Systems, LTD

**Computer:** IBM PC Family

**Cost:** \$99.95

Tempo for Windows is a software program that automates actions within and between applications running under Microsoft Windows 2 and 3. Tempo records any series of keystrokes and mouse clicks in "watch-me" mode, then replays them all as a single command, called a macro. The macro may be replayed by entering a key code or by selecting a name from a list of macros which are assigned either to a specific application or to the "universal" category. Features such as repeat, suspend, ignore next key code, record mouse moves, window- or screen-relative mode and a context-sensitive help file are also available. Tempo for Windows also has the ability to launch applications and to branch to other macros or repeat macros, either directly or based on meeting a specified condition.

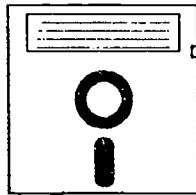

**Product Name:** Tempo II Plus

**Vendor:** Affinity Micro Systems, LTD

**Computer:** Apple Macintosh Family

**Cost:** \$179.00

Tempo II Plus is a software program that allows the user to create "macros": short sets of characters (abbreviations) that trigger longer strings of characters (letters, numbers, commands, etc.). The user can program over 500 macros for each application program, and the length of the macros is only limited by the amount of memory the user wishes to consume. Any chain of commands or text can be linked together, and macros can also contain pauses of various lengths. Mouse movements can also be "recorded" as part of a macro. Tempo is a "chordic" macro program; that is, the abbreviations require that the user press more than one key at a time (COMMAND or OPTION plus another key). Tempo Plus also features externals (small programs which perform special operations like playing sound files), a viewer (allows viewing of any macros as a step by step list), and a menu which lists macros.

Tempo II Plus is compatible with System 6 or 7.

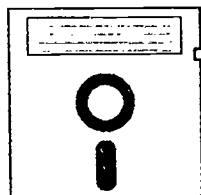

**Product Name:** TempoEZ

**Vendor:** Affinity Micro Systems, LTD

**Computer:** Apple Macintosh Family

**Cost:** \$79.95

TempoEZ is a software program designed to increase productivity by allowing the user to create macros for launching files and applications, reformatting text, selecting tools, importing graphics, and more. TempoEZ records keystrokes and mouseclicks as the user performs them. The recorded actions, including any number of steps, can then be replayed as a single step. In addition to the features found in Tempo II Plus (see entry), TempoEZ has the ability to include simple branch, repeat, and pause steps in macros. Macros can be played by a keycode, from the Tempo Macro Menu, through Tempo's Play By Name direct-entry dialog box, via a Tempo macro icon, or automatically at startup. Macros can be edited with simple mouseclicks.

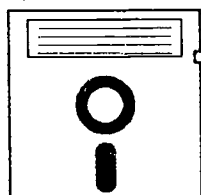

**Product Name:** TimeOut UltraMacros

**Vendor:** Scantron Quality Computers

**Computer:** Apple IIGS, Apple IIc, Apple IIe

**Manual Form:** Printed Manual

**Cost:** \$40.00

TimeOut UltraMacros is a program that allows the user to access built-in commands and macros (strings of frequently used phrases or commands that can be accessed using only one or two keystrokes) or to program sequences of keystrokes as macros. The present macros include programming commands and commands to initiate alarms at specified times. A compiler is incorporated for use in programming. UltraMacros also includes a screen saver that blanks the screen if no keys have been pressed for a period of time, a key-lock feature that allows the SHIFT, CTRL, and ALT keys to be pressed in sequence with other keys instead of simultaneously with them, and a Mouse Control option that allows mouse functions to be controlled from the keyboard.





**Product Name:** Uni-Key

**Vendor:** National Institute for Rehabilitation Engineering

**Computer:** IBM PC Family

**Cost:** \$50.00

Uni-Key is a memory-resident program that modifies the keyboard so that keys can be hit in sequence instead of being held down simultaneously. With Uni-Key installed, the typist may press SHIFT, CTRL, or ALT, and then press the desired letter, number, or function key. The program also includes a "repeat slow" feature. A Microsoft Windows keyboard utility set is included.

Two versions of the program--one for IBM PC and XT computers, the other for IBM PC AT computers--are included on the disk. The \$50.00 purchase price may be considered as a year's membership dues to the National Institute of Rehabilitation Engineering.



**Product Name:** VT520 Terminals - Accessibility Features

**Vendor:** Digital Equipment Corporation

**Computer:** IBM PC Family

**Cost:** Sold bundled only

The VT520 Terminals have several features that provide accessibility to individuals with disabilities. Sticky keys allows the user to press each key separately when performing a multiple key operation. Show sounds blinks the screen or displays a visual image in the display when the computer makes a sound. Bounce keys prevents double characters from being typed if the user bounces on the key when pressing or releasing it.

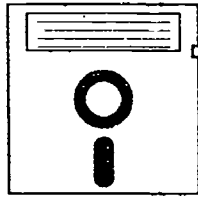

**Product Name:** WordWriter

**Vendor:** Prentke Romich Company

**Computer:** Apple Macintosh Family

**Cost:** \$170.00 - \$240.00

WordWriter is a word prediction program that is compatible with all standard Macintosh applications, including HyperCard. The program appears in a movable "windoid" that can be set to two or three sizes, depending on the size of the monitor. The program offers a dictionary of over 4,000 words to increase typing speed. WordWriter is available for System 6 & 7.

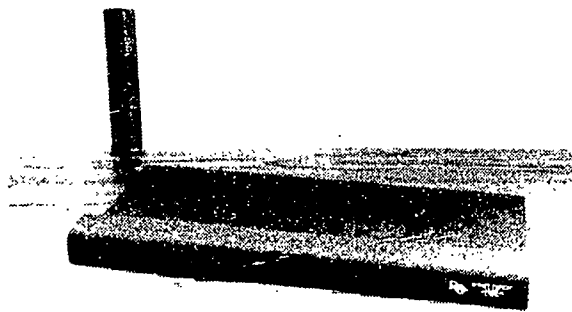

**Product Name:** WRIST PERCH

**Vendor:** PC Compatibles

**Computer:** All (Hardware Independent)

**Size:** 19" x 10" x 1.5"

**Cost:** \$19.95

The WRIST PERCH is a non-skid base for the keyboard with built-in wrist rest that adjusts the slope of the keyboard for correct positioning and more relaxed typing. WRIST PERCH is designed to prevent injury by cushioning wrist and palm while absorbing shock.

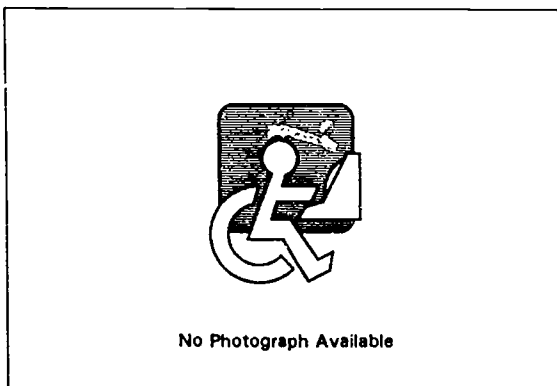

**Product Name:** ZoomCaps

**Vendor:** Meeting the Challenge

**Computer:** Apple II Family,  
Apple Macintosh Family, IBM PC Family

**Cost:** \$14.95

ZoomCaps are large print keytop labels which affix to the keys of either IBM or Apple computer keyboards. The labels are available in white or black letters. There are ninety labels per set.

# Chapter 12

## Alternate Inputs

This chapter includes alternate input systems which provide transparent access to a computer. "Alternate input" refers to a special or adapted device used as an alternative to the computer's standard input devices, including not only keyboards but also joysticks, mice, etc. "Transparent" means that the special input device can perform any operation that its standard equivalent can perform. For example a transparent alternate keyboard would have all the keys included on the standard keyboard, and could operate any keyboard-based software written for that computer.

The chapter title is not meant to indicate that these alternate inputs will operate any and all software, only that they are designed to be equivalent to a standard input device. An alternate keyboard, for instance, would not necessarily be able to control software that requires both a keyboard and a mouse. There may also be compatibility problems with particular commercial software. Contact the manufacturer about questions of compatibility.

Related input/output features in Index 2 include most of the categories that begin with the phrase "Input Type."

*The following product entries appear in this chapter:*

Access-I, 373  
 Adap2U, 373  
 ADAPTA-LAN, 374  
 Adaptive Firmware Card Model G32e, 374  
 AlphaSmart Pro, 375  
 AmTRAC, 375  
 Apple Adjustable Keyboard, 376  
 Aurora 2.0 for DOS, 376  
 BallPoint Mouse, 377  
 BAT Personal Keyboard, 377  
 Big Keys, 378  
 BioMuse, 378  
 Bloorview Miniature Keyboard, 379  
 Breakthru Box, 379  
 Cirque GlidePoint Trackpads, 380  
 Comfort Keyboard System, 380  
 Concept Keyboard, 381  
 Cordless WinMouse, 381  
 DARCITOO, 382  
 Doors II, 382  
 DragonDictate Starter, Classic, and Power Editions, 383  
 EEK, 383  
 ErgoLogic Model 7.1 Keyboard, 384  
 Ergonomic Keyboard Systems, 384  
 Expanded Keyboard for Apple Macintosh and Apple IIGS, 385  
 Expanded Keyboard for IBM Computers, 385  
 Expanded Keyboards for the Talking BlissApple, 386  
 Expanded Numeric Keypads, 386  
 Expert Mouse, 387  
 Eye Slaved Pointing System, 387  
 ezMorse for Windows, 388  
 ezScan, 388  
 FastTRAP, 389  
 Felix, 389  
 First-Finger WinTrack, 390  
 FlexPro, 390  
 GEWA FTB 108 Enlarged Keyboard, 391  
 GEWA METB 121 Reduced Size Keyboard, 391  
 HAL (Home Automation Link), 392  
 Hand Controls, 392  
 HandiCODE and HandiCODE Deluxe, 393  
 HeadMaster Plus, 393  
 HeadMouse, 394  
 Help U Key, 394  
 Help U Keyboard, 395  
 Hereward Tracker Ball & Joystick Module, 395  
 Icontroller, 396  
 IN-CUBE Voice Command for SPARC Stations, 396  
 IN-CUBE Voice Command for Windows, NT, 397  
 Instant Access, 397  
 IntelliKeys, 398  
 IntroVoice V, 398  
 IntroVoice VI, 399  
 IRIS Reading Interface 3.0, 399  
 Jouse, 400  
 Joystick to Mouse Driver, 400  
 JustVoice, 401  
 K-U-I, 401  
 Ke.nx, 402  
 Ke.nx On:Board (M43), 402  
 Key Largo, 403  
 Keypoint 176, 403  
 Keypoint 300, 404  
 Keypoint 60, 404  
 Kinesis Ergonomic Keyboard, 405  
 King Keyboard (2440), 405  
 Kurzweil VOICE, 406  
 Kurzweil VOICE for Windows, 406  
 Laser Optic Keyboard, 407  
 LIAISON, 407  
 LightBoard, 408  
 LipStick and WordWriter, 408  
 Listen for Windows, 409  
 MacKing, 409  
 MacMini, 410  
 Macrat, 410  
 MacroMaster/pro, 411  
 MacTRAC, 411  
 Magic Wand Keyboard with McKey Mouse Option, 412  
 Maltron Keyboard, 412  
 MICE, 413  
 Micro IntroVoice, 413  
 Micro IntroVoice II, 414  
 Microsoft Natural Keyboard, 414  
 Microsoft Windows Sound System, 415  
 MIKE (Mouse Interface & Keyboard Emulation), 415  
 Mini Keyboard (2443 or 2450), 416  
 Mini-Keyboards, 416  
 MiniErgo-MF2, 417  
 Minimal Motion Computer Access System, 417  
 Morse Code WSKE II, 418  
 Morsek Version 1.1, 418  
 Mouse Keys, 419  
 Mouse-Trak, 419  
 MouseMan Cordless, 420  
 MouseMover - Mac (5005), 420  
 MouseMover - PC Windows (5004), 421  
 MousePen, 421  
 MouseStick II, 422  
 Mouth Operated Joystick for Genesis Video Game, 422  
 Muppet Learning Keys, 423  
 My First Keyboard, 423  
 My-T-Mouse, 424  
 MyKey, 424  
 Narwhal Expanded Keyboards for Adaptive Firmware Card, 425  
 Nintendo & Super Nintendo Joystick Module, 425  
 NoMouse, 426  
 OfficeTALK for Windows, 426  
 One Access, 427  
 One-Hand Operated Joystick for Genesis Video Game, 427  
 OneStrk, 428  
 Optimouse, 428  
 OsCaR, 429  
 PC-TRAC, 429  
 Pen Style Mouse, 430  
 PKD 84 and 101, 430  
 PortaPoint, 431  
 PowerKey Software for IBM, 431  
 PowerPad, 432  
 PowerPad Starter Kit, 432  
 PowerSecretary, 433  
 Pre-Dict-ate, 433  
 ProPoint, 434  
 Proportional Keystroke Scanner, 434  
 QUAD Lynx Trackball, 435  
 Reading Edge, 435  
 Remote Keyboard for the Apple II+ and IIe, 436  
 RemotePoint, 436  
 RevolvingDoors, 437  
 Scanning WSKE II, 437

ScottBridge Speech Access System, 438  
 ScreenDoors, 438  
 Select-Ease Keyboard, 439  
 Serial Trackball and PS/2 Trackball, 439  
 SofType, 440  
 Speak Out VOILA, 440  
 Speech Recognition Systems, 441  
 Stingray, 441  
 Switch Modified PowerPad, 442  
 Switch-Adapted Mouse (SAM), 442  
 Switch-Back, 443  
 SwitchMouse, 443  
 SynergyMac and SynergyPC, 444  
 TouchWindow, 444  
 Trackball Pro, 445  
 TrackMan Live!, 445  
 TrackMan Voyager, 446  
 Trak101 Keyboard, 446  
 Turbo Mouse 4.0, 447  
 Turbo Trackball, 447  
 Vertical, 448  
 Voice Mouse/Keyboard (VMK) Controller, 448  
 Voice User, 449  
 WinKing Keyboard (2448F, 2448Q), 449  
 WinMini Keyboard (2447F, 2447Q), 450  
 WiViK 2.0 (Windows Visual Keyboard), 450

*The following products from other chapters can also be used as Alternate Inputs:*

Access Pack for Microsoft Windows, 331  
 AccessDOS, 332  
 AlphaTalker, 119  
 Aurora for Windows, 333  
 Braille 'n Speak, 469  
 Butler-in-a-Box, 270  
 CINTEX I, 744  
 DM80/FM, 511  
 Equalizer, 131  
 EvalPAC with RealVoice, 131  
 Eyegaze Computer System, 132  
 Gus! Multimedia Speech System, 133  
 Liberator, 137  
 Magnum, 477  
 RealVoice, 147  
 ScanPAC, 150  
 SenSci System, 295  
 T-TAM Keyboard and Mouse Emulator, 463  
 VisionKey, 158

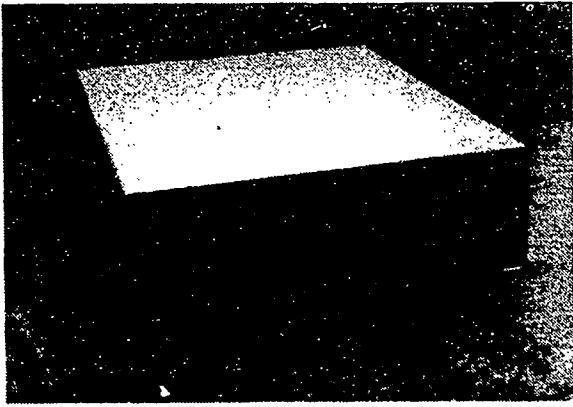

**Product Name:** Access-I  
**Vendor:** WorkLink Innovations  
**Computer:** IBM PC Family  
**Size:** 4" x 12" x 14"  
**Weight:** 17 lb.  
**Cost:** Contact manufacturer

Access-I is an IBM-AT compatible computer which runs off wheelchair batteries. The computer accepts a variety of input devices including headpointers, puff and sip switches, scanning keyboards, morse code, and mouthsticks (all extra). Access-I can also be used with up to five full length 16 bit adapter cards such as DragonDictate and DECtalk. The computer unit measures 4" x 12" x 14" and uses 1 amp of battery power.

Access-I includes a flip-up LCD screen, small full-function keyboard, one 3.5" floppy drive, 210 - 740 MB hard drive, 16 - 32 MB RAM, MS-DOS 6.22, Microsoft Windows 3.1, Windows 95, and a weatherproof bag for storage on the back of a wheelchair. The package can be customized with other options; contact the manufacturer for details.



**Product Name:** Adap2U  
**Vendor:** AdapTek Interface  
**Computer:** IBM PC Family  
**Size:** 1.4" x 6.25" x 9.5"  
**Weight:** 1.5 lbs.  
**Cost:** \$1,095.00

Adap2U Keyboard Emulator is an alternative input interface system that can replace a conventional keyboard and mouse, allowing transparent access to standard IBM compatible computers and all DOS or Microsoft Windows application programs. Adap2U plugs into the keyboard port of the computer and into the serial port for mouse emulation. Adap2U provides control of dynamically interchangeable menus, like custom keyboard layouts, displayed on a separate monitor (sold separately). Dozens of menus may be stored and immediately accessed from the Adap2U's memory. Pointing devices, such as a mouse, trackball, touch screen or pad, or the AdaPoint head-operated pointer (sold separately) and combinations of pointing devices and single or multiple switches can be used and adapted to the user's special needs. Access methods include direct pointing and selection from menus, scanning, morse, or user defineable time codes, all with adjustable modes. Included is a customized starting setup for the user. Also included is a library of different menus and configurations, and software which allows the modification of them or creation of new ones.

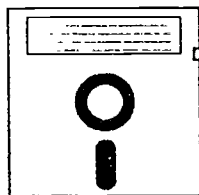

**Product Name:** ADAPTA-LAN

**Vendor:** Microsystems Software Inc.

**Computer:** IBM PC Family

**Manual Form:** Printed Manual

**Cost:** \$2,995.00 per server

Adapta-Lan is a set of local area network programs for persons with disabilities. The set includes: MAGic and MAGic Deluxe (screen magnification software), HandiKEY and HandiCODE (software for access without keyboarding), HandiSHIFT and HandiWORD (programs for limited keyboarding ability), HandiCHAT (program for nonspeaking users), HandiPHONE (phone and modem control for physically limited users with hardware at additional cost), and SeeBEEP (visual indicator of computer audio beep for hearing impaired users).

Adapta-Lan is compatible with most networks including Novell, 3Com, and Banyan. Once installed, the system can be accessed by using IBM computers. Price is for up to 100 users; cost for up to 250 users is \$5,000.00 per server. HandiPHONE hardware sells for \$300.00 per unit.

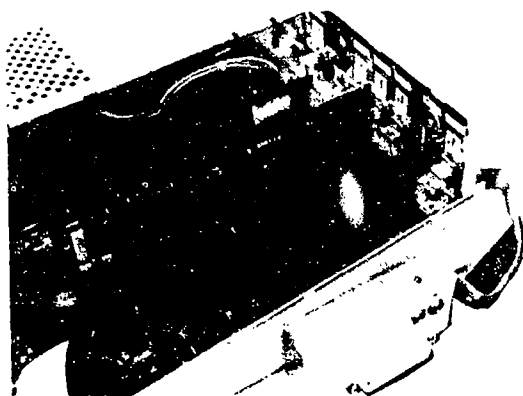

**Product Name:** Adaptive Firmware Card Model G32e

**Vendor:** Don Johnston Incorporated

**Computer:** Apple IIGS, Apple IIe

**Cost:** \$485.00

The Adaptive Firmware Card Model G32e enables various alternative input devices to be plugged into the Apple IIe Enhanced or Apple IIGS computers, so that standard software can be run by people with various disabilities. Alternate input methods supported by the card are alternate keyboards, scanning, assisted keyboards, Morse code, ASCII input, and multiple switch boxes. Standard and talking standard setups are included for each input method; custom setups may be created for use with specific programs. Features include speech feedback for any input method, options for moving the scan line, 20 column scanning, mouse emulation, macros, and a "mini" programming language that allows custom set-ups to be created for particular software. Talking Word Board, an application that may be used to train and assess skills involved in using a talking communication system, is also included.

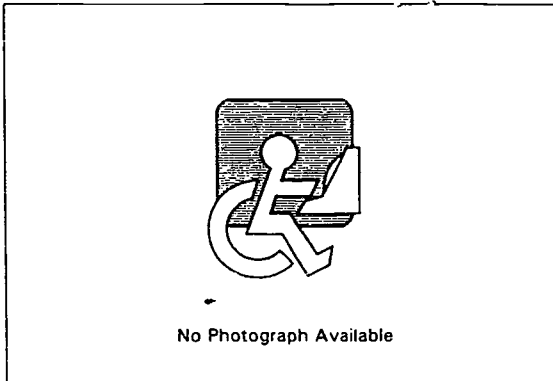

**Product Name:** AlphaSmart Pro

**Vendor:** Intelligent Peripheral Devices, Inc.

**Computer:** Apple IIGS, Apple Macintosh Family, IBM PC Family

**Size:** 1.65" x 11.8" x 8.2"

**Weight:** 2 lbs.

**Cost:** \$279.00

AlphaSmart Pro is a portable note-taking device with a full QWERTY-style keyboard and quick data transfer to Macintosh, Apple IIGS, and IBM compatible computers. The device features eight separate memory files holding a total of 128,000 characters (64 pages of text) and an LCD display of four lines of 40 characters. AlphaSmart is compatible with word processors such as ClarisWorks, Microsoft Works, MacWrite, WordPerfect, and more.

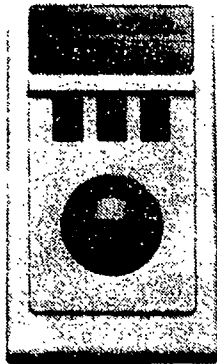

**Product Name:** AmTRAC

**Vendor:** Microspeed Inc.

**Computer:** Commodore Amiga

**Size:** 3.75" x 6.75" x 1.75"

**Weight:** 12 oz.

**Cost:** \$99.00

AmTRAC is a trackball and three buttons contained in a small case. The user moves the trackball manually to emulate mouse cursor control. The left and right buttons, which surround the trackball, emulate the "click" button on the standard mouse. The center button, located above the trackball, toggles the "drag lock" feature that produces a similar effect to holding down the button on a standard mouse; the drag lock eliminates the requirement that a button be held down. The trackball case has a sloped panel that may be used as a wrist rest.

AmTRAC is compatible with Amiga 500, 2000, 2000H, 2500, and 3000 computers.



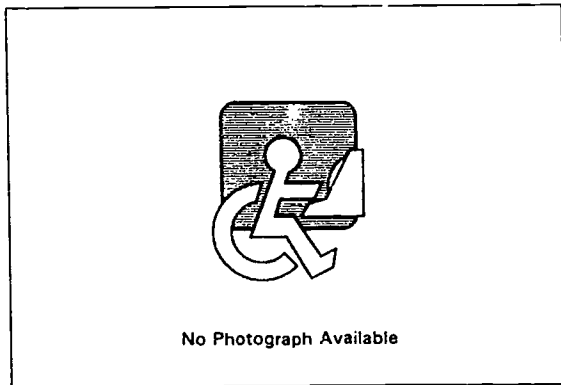

**Product Name:** Apple Adjustable Keyboard  
**Vendor:** Apple Computer, Inc.  
**Computer:** Apple IIGS, Apple Macintosh Family  
**Cost:** \$219.00

Apple Adjustable Keyboard is a keyboard with split sections which can be positioned independently. The keyboard has one section for each hand, and the sections can be separated up to thirty degrees away from each other. The keyboard also has volume, mute, and record buttons. The foldable keyboard resembles the standard smaller-size Apple keyboard. A separate keypad contains all the extended key functions from the standard larger-size Apple keyboard. The keyboard works with all Apple computers that use the Apple Desktop Bus (the Apple IIGS and all Macintoshes except the Plus or older models).

The Adjustable Keyboard is available through Apple Computer dealers. Locate a dealer in your area for more information or to order.

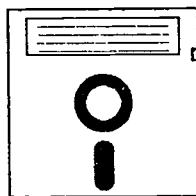

**Product Name:** Aurora 2.0 for DOS  
**Vendor:** Aurora Systems, Inc.  
**Computer:** IBM PC Family  
**Manual Form:** Electronic Manual, Printed Manual  
**Cost:** \$745.00 - \$1,150.00

Aurora 2.0 is a software application designed to provide greater access to computers and communication both for people who can use the standard keyboard and who cannot. Aurora's major features are scanning input for non-keyboard users and Poptalk and speech macros for nonverbal users. For keyboard input, Aurora also offers latching shift keys for one-finger typists and comprehensive keyboard controls including key debouncing, accept, and repeat delays. The PopTalk feature turns Aurora into a computer based communication aid accepting input through the keyboard, scanning, or morse code and providing synthesized speech output. In addition, Aurora and the PopTalk feature includes word completion and prediction that learns the user's writing style, a screen reader, context sensitive online help, text macros, a customizable screen layout and hotkey selections, and others.

Aurora requires DOS 3.1, 384K, and one parallel port. Supports most external speech hardware and is compatible with most popular applications including Microsoft Works, Microsoft Word, and WordPerfect.

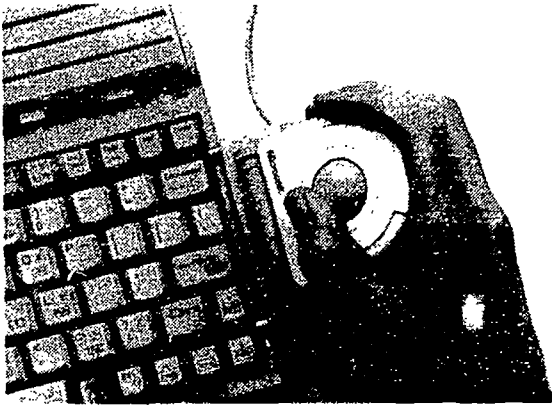

**Product Name:** BallPoint Mouse

**Vendor:** Microsoft Corporation

**Computer:** IBM PS/2 Family

**Cost:** \$175.00

The BallPoint Mouse is a trackball and four button unit which clamps onto a laptop computer keyboard. The unit snaps into a clamp which then can be attached to the side of the keyboard. Moving the trackball manually and pressing combinations of the four buttons provides emulation of a standard mouse.

The BallPoint Mouse fits Compaq, Toshiba, NEC, Zenith, and GRiD families and compatible laptop computers.

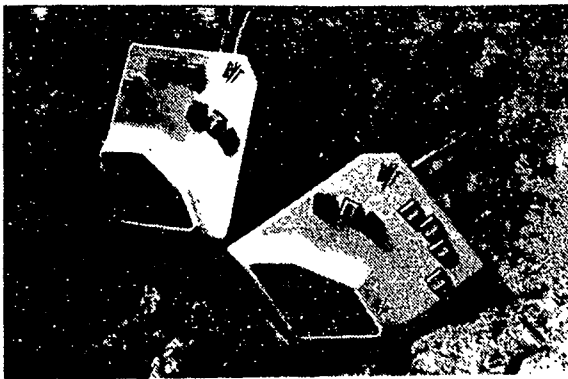

**Product Name:** BAT Personal Keyboard

**Vendor:** Infogrip, Inc.

**Computer:** Apple Macintosh Family, IBM PC Family

**Cost:** \$199.00

The BAT Personal Keyboard is a one-handed, ergonomic, programmable keyboard with only seven keys. The BAT can enter all characters and functions of a traditional keyboard. The keyboard is a little bigger than the average adult hand and can be positioned in a variety of places.

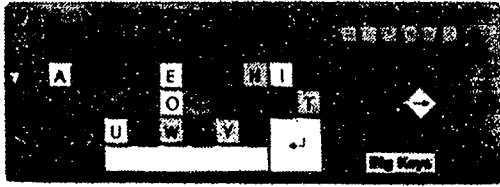

**Product Name:** Big Keys

**Vendor:** Greystone Digital

**Computer:** Apple Macintosh Family, IBM-PC XT, IBM PC AT

**Size:** 7" x 18.75"

**Weight:** 3 lbs.

**Cost:** \$125.00 - \$145.00

Big Keys is a keyboard designed for preschool and special education students. Big Keys features 1" square keys, bright colors, easily read labels, and keys in alphabetical and numerical order. Software designed specifically for teaching early learners the alphabet, words, and numbers is recommended for use with Big Keys.

An optional cable (\$24.95) is available for the IBM keyboards to allow access to the regular keyboard at the same time.

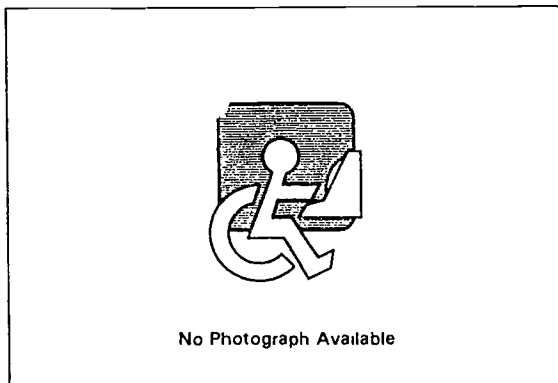

**Product Name:** BioMuse

**Vendor:** BioControl Systems, Inc.

**Computer:** IBM PC Family

**Size:** 17" x 14" x 3.5"

**Weight:** 6 lbs.

**Cost:** \$19,800.00

BioMuse is a bioelectric signal controller which allows the user to control computer functions directly from the electrical activity of the human body. BioMuse receives data from four sources of electrical activity in the human body: muscle activity, eye motion, heart, and brain waves. The signals are then transmitted via non-invasive electrodes attached to the skin. The biosignals are digitized and processed, desired elements extracted, and the elements are mapped to a desired output code to control virtually any digital interface device. A high speed processor enables real-time signal processing, user programmable mapping of all biosignals allows development of many applications, replay feature enables storage of any biosignal for later analysis, and biosignals can be sent via modem.

BioMuse requires IBM compatible 386/486 PC with available serial port running DOS 5.0 or higher or Microsoft Windows. The manufacturer is currently designing a portable version of BioMuse, contact manufacturer for details.



**Product Name:** Bloorview Miniature Keyboard

**Vendor:** TASH, Inc.

**Computer:** Apple IIe, IBM PC Family

**Size:** 7" x 3" x 1"

**Weight:** 10 oz.

**Cost:** \$900.00

The Bloorview Miniature Keyboard operates as an alternative keyboard for a personal computer. The keyboard is based on a Sharp 1360 pocket computer and a custom cable. The keyboard connects into the same computer port as a standard keyboard and has all the capabilities of one. Although the smaller keyboard has fewer keys, a "mode method" allows keys to represent two or more other keys. The mini keyboard provides a faint click to indicate when a key has been pressed. This product also has a "mouse mode" which controls the cursor and button functions of a mouse from the keyboard.

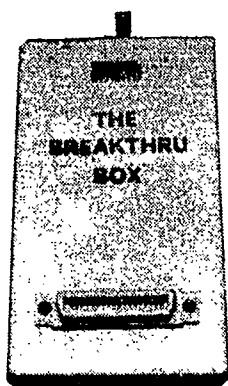

**Product Name:** Breakthru Box

**Vendor:** EKEG Electronics Company LTD

**Computer:** Apple IIGS, Apple Macintosh Family,  
Commodore Amiga, IBM PC Family,  
IBM PS/2 Family

**Cost:** \$475.00 - \$575.00

The Breakthru Box is a device that permits some membrane keyboards to be used as computer input devices. The box contains the electronics used in EKEG's stand-alone keyboards, and plugs into the microcomputer keyboard socket. A membrane keyboard which has at least 84 keys (6 x 14 layout) and a plug configured for the Adaptive Firmware Card is then plugged into the box. Examples of suitable keyboards are the Unicorn Board, MemKey Board, and Membrane Keyboard II (see entries). Additional features include audible click and light flash on key activation, and a DIP switch which allows repeat and delay rate adjustment.

Four models are available. BTB 901AM is for Apple IIGS and Macintosh computers (\$575.00); BTB 901BX is for IBM PC and XT computers (\$475.00); BTB 901BA is for IBM AT and PS/2 computers (\$475.00); and BTB 901CA is for Commodore Amiga 2000 computers.

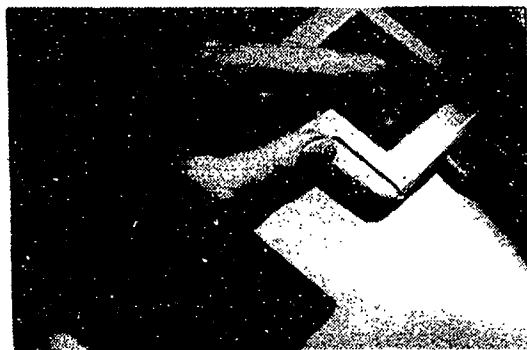

**Product Name:** Cirque GlidePoint Trackpads

**Vendor:** Cirque

**Computer:** Apple Macintosh Family,  
IBM PC Family, IBM PS/2 Family

**Size:** See text

**Weight:** 2 - 5 oz.

**Cost:** \$89.00 - \$139.00

The GlidePoint Trackpad is a pointing device for mouse emulation. The device tracks fingertip movement and moves the cursor on the screen. The user taps once to "click," twice to "double click," and hold to "drag."

Versions are available for portable and desktop computers. The portable versions measure 0.5" x 3.4" x 2.7" and are available for PS/2 connectors and for any standard serial port. The desktop versions measure 0.375" x 4.4" x 4" and are available for both IBM compatible computers and Macintosh computers. Also available is a GlidePoint Keyboard that combines the keyboard and trackpad in one unit and measures 1.7" x 18.8" x 6.8".

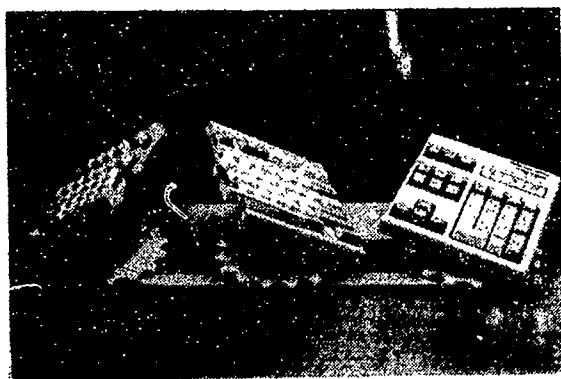

**Product Name:** Comfort Keyboard System

**Vendor:** Health Care Keyboard Company

**Computer:** Apple Macintosh Family, IBM PC Family

**Size:** 6.25" x 22"

**Cost:** \$695.00

Comfort Keyboard System is a keyboard with the standard QWERTY arrangement which has been divided into three equal sections. The sections are mounted onto the keyboard base using a Disc Loc universal mounting system. The user can place the sections onto the base in any order. Each section can be raised, lowered, rotated, and tilted independently to suit the user's needs. Once a position is selected the keyboard sections can be "locked" into place by tightening the discs on which the sections are mounted.

Comfort Keyboard System also features arm supports.

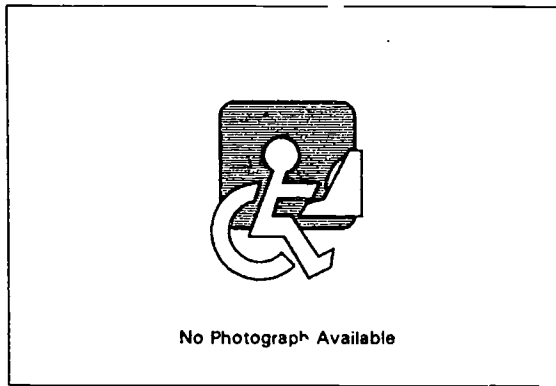

**Product Name:** Concept Keyboard

**Vendor:** Hach Associates

**Computer:** IBM PC Family

**Size:** 11.75" x 9.25" x 1.25"

**Weight:** 2 lbs.

**Cost:** \$595.00 - \$1,145.00

The Concept Keyboard is a touch-sensitive panel that may be configured to function as one or several of the conventional keyboard keys. The keyboards can work in tandem, allowing two to be placed on a single computer and double the amount of functional surface area. Also, two keyboards allows two users to work on the computer at the same time. The Concept Keyboard comes with a software utility for assigning functions to the keyboard.

The Concept Keyboard comes with a user manual, Overlay Manager software, 12-month warranty, connecting cables, and five ready-to-use overlays for \$595.00. A package that includes two keyboards and 10 overlays is available for \$1,145.00.

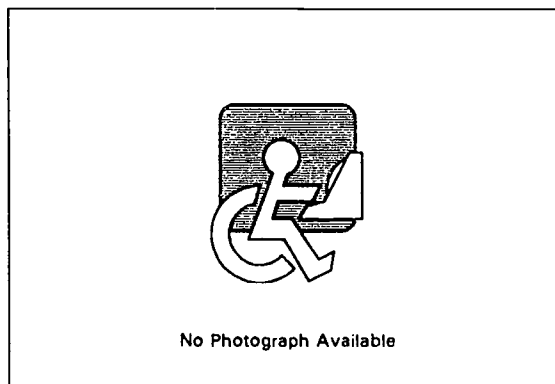

**Product Name:** Cordless WinMouse

**Vendor:** A4 Tech (USA) Corporation

**Computer:** IBM PC Family

**Cost:** \$23.00

Cordless WinMouse replaces the standard mouse and can operate from up to two meters away from the computer using infrared technology. No cables are attached and no radio signal interference is experienced.

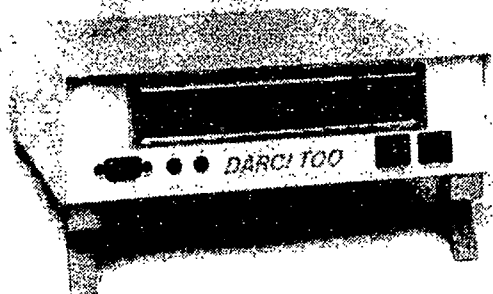

**Product Name:** DARCITOO

**Vendor:** WesTest Engineering Corporation

**Computer:** Apple IIGS, Apple IIe,  
Apple Macintosh Family, IBM PC Family,  
IBM PS/2 Family

**Size:** 10.5" x 9.5" x 3"

**Weight:** 2 lbs.

**Cost:** Contact manufacturer

DARCITOO is an alternative input device for Apple and IBM computers. DARCITOO plugs into the computer via the standard keyboard and mouse connectors; the keyboard may then be connected to DARCITOO and used simultaneously. Five operating modes are available: DARCICode (joystick movement codes developed for the original DARCI), Scanning, Matrix Keyboards, Communication Aid, and Morse Code. In Scan and Morse Code modes, selection is made via single, double, or triple switch, proportional joystick, or video game controller (all extra). A two-row, 40-column display on the unit informs the user of the current input mode and is used to make selections in scan mode. A user programmed vocabulary capability is included; in Scan, Morse Code, or DARCI modes, the user may save keystrokes by selecting words from this vocabulary, or may add words and phrases. The user may also define custom overlays for matrix keyboards. Setup routines, which permit customization, may be saved to disk and downloaded to the unit.

Audio feedback is optional. An interface card is required to use DARCITOO with Apple IIe computers.

---

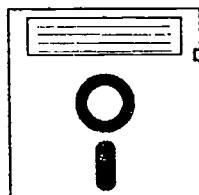

**Product Name:** Doors II

**Vendor:** Madenta Communications, Inc.

**Computer:** Apple Macintosh Family

**Cost:** \$595.00

Doors II is a collection of on-screen keyboards designed to emulate a standard computer keyboard. The on-screen keyboards can be used to type text by selecting the desired character, number or function with the mouse and clicking the mouse button. The program has a word predictor which will offer the user choices from which to select; predicted words are entered into text like any single character by selecting and clicking the mouse. Other features of the word prediction program include: abbreviation expansion, word editing, multiple topics, custom hot keys, and speech synthesis. The user can rely on the built-in dictionary function or program words into the predicting mode. One of the keyboards allows single-switch users to use scanning techniques to make on-screen selections.

Doors II can be used with a variety of inputs including trackballs, joysticks, head pointers, and the mouse. This program is a background application and is compatible with most programs.

415

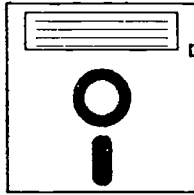

**Product Name:** DragonDictate Starter, Classic, and Power Editions

**Vendor:** Dragon Systems, Inc.

**Computer:** IBM PC Family

**Cost:** \$395.00 - \$1,695.00

DragonDictate is a family of speech recognition systems for a range of needs. Each version offers a customizable active vocabulary and a 100,000 plus word pronunciation dictionary with acoustic models for access to words outside of the active vocabulary. All editions are available for DOS or Microsoft Windows.

The Starter Edition (\$395.00) is an entry level system that offers a 5,000 word active vocabulary, up to 100 global macros that are active across all applications, and up to 500 macros that are active in a state or application. The Classic Edition (\$695.00) is a mid-range system that offers a 30,000 word active vocabulary, up to 5,000 global macros, and up to 2,000 application macros. The Power Edition (\$1,695.00) is a high-end system that offers a 60,000 word configurable active vocabulary with the ability to have either 15,000, 30,000, 45,000, or 60,000 words active, up to 5,000 global macros, and up to 2,000 application macros. The prices include the headset microphone.

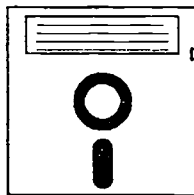

**Product Name:** EEK

**Vendor:** OMS Development

**Computer:** IBM PC Family

**Manual Form:** Electronic Manual

**Cost:** \$120.00

EEK is an on-screen keyboard for Microsoft Windows that allows keystrokes to be sent to Windows applications when keys are clicked. Input can be made with any pointing device such as a mouse, track ball, touch screen, or head pointing system. EEK can be resized and can be customized to run over any other Windows application.

Evaluation copies are available for \$5.00, applicable toward purchase price.



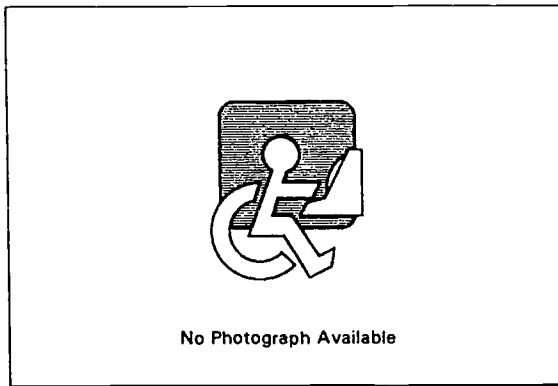

**Product Name:** ErgoLogic Model 7.1 Keyboard

**Vendor:** Ergologic Enterprises, Inc.

**Computer:** IBM PC Family, IBM PS/2 Family

**Size:** 20.5" x 8" x 1.6"

**Cost:** \$399.00

The ErgoLogic Model 7.1 Keyboard features a split keyboard that pop-ups and can be adjusted for the user's comfort. The user has complete control over the angle of elevation and rotation throughout the operating range. Other features include built-in handrests that slide under the palms, a standard QWERTY keyboard, adjustment indicator for situations in which several users share a keyboard, and a HyperSpace Bar that splits the space bar into two and allows each half to work as a space bar, backspace key, or enter key.

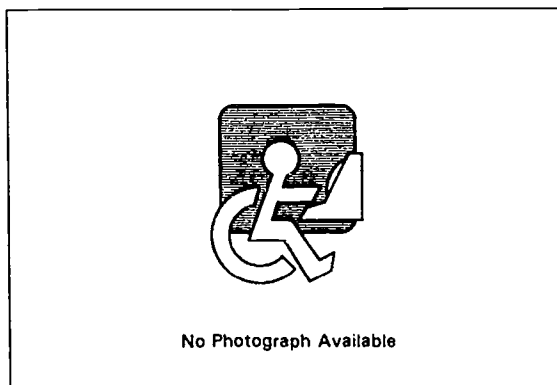

**Product Name:** Ergonomic Keyboard Systems

**Vendor:** Various (Generic Product)

**Cost:** Varies

In recent years a variety of ergonomic keyboards, keyboard wrist supports, mouse wrist supports, and keyboard lowering bracketry have become available. Commonly, these are applied to prevent problems called cumulative trauma disorders or repetitive injury syndromes. A common example is Carpel Tunnel Syndrome.

While many of these products are available from medical and rehabilitation equipment companies, these devices are increasingly available from computer catalog companies, local computer stores, computer sections within department stores, and office supply stores. Specific sources can be found in local yellow pages, in the manufacturer list of this book, in listings from local rehabilitation service delivery programs, and also often in gift specialty catalogs that carry personal convenience types of devices.

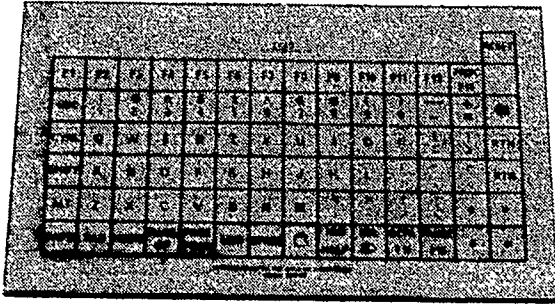

**Product Name:** Expanded Keyboard for Apple Macintosh and Apple IIGS

**Vendor:** EKEG Electronics Company LTD

**Computer:** Apple IIGS, Apple Macintosh Family

**Size:** 12" x 24" x 1"

**Weight:** 4 lbs.

**Cost:** \$850.00

Expanded Keyboard for the Apple Macintosh and the Apple IIGS is a large panel that operates like the standard keyboard, but has membrane keys. The keyboard contains its own microprocessor and has the same connector as the standard keyboard. Provision is made for having the standard keyboard connected and in operation at the same time as the expanded keyboard. Latching keys are provided for those keys such as SHIFT which would normally have to be held down at the same time as another key. The keyboard is flat, allowing overlays to be added. The surface is seamless and moisture-proof. Additional features include audible click and light flash on key activation, and a DIP switch which allows repeat and delay rate adjustment.

The expanded keyboard sends the same output to the computer as the standard keyboard to which it is equivalent, allowing the user to perform all the same functions. A keyguard consisting of a thick, plastic-coated wire grid is also available (extra).

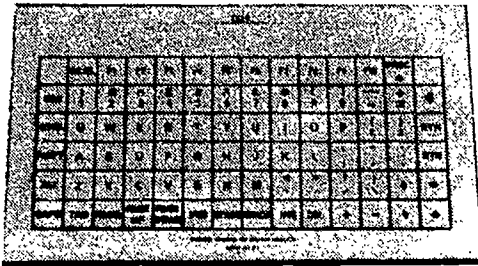

**Product Name:** Expanded Keyboard for IBM Computers

**Vendor:** EKEG Electronics Company LTD

**Computer:** IBM PC Family, IBM PS/2 Family

**Size:** 12" x 24" x 1"

**Weight:** 4 lbs.

**Cost:** \$750.00

Expanded Keyboards for the IBM Computers are large panels designed to operate exactly like standard IBM keyboards, but having substantially larger (1.5" square) keys. Latching keys are provided for those keys such as SHIFT which would normally have to be held down at the same time as another key. The keyboards are flat, allowing overlays to be added.

Expanded Keyboards for the IBM-PC series send the same output to the computer as the standard keyboard to which they are equivalent, allowing the user to perform all the same functions. The expanded keyboards do not automatically work at the same time as the standard keyboard; the Switch Box, an adapter that permits switching between the standard and expanded keyboards, is available for \$95.00. A keyguard consisting of a thick plastic coated wire grid is available for \$50.00.

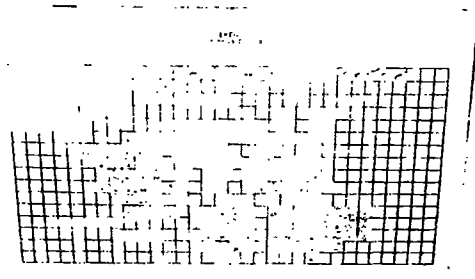

**Product Name:** Expanded Keyboards for the Talking BlissApple

**Vendor:** EKEG Electronics Company LTD

**Computer:** Apple II Family

**Size:** 19" x 31" and 15" x 21"

**Weight:** 6 lbs. and 8 lbs.

**Cost:** \$950.00 - \$1,450.00

Expanded Keyboards for the Talking BlissApple are keyboards with a great number of squares, all the correct size for standard bliss stamps. The Keyboards have been designed for use with the Trace Center's Talking BlissApple program, but contain a small microprocessing unit and can send serial ASCII to any computer or device that will accept it through an RS-232 serial port. Overlays for the Keyboards are user-definable.

Expanded Keyboards for the Talking BlissApple come in two models. One has 512 7/8" squares, measures 19" x 31", and weighs 8 lbs. (\$1,450.00); the other has 220 1" squares, measures 15" x 26", and weighs 6 lbs. (\$950.00). Keyguards for both models are available for \$75.00.

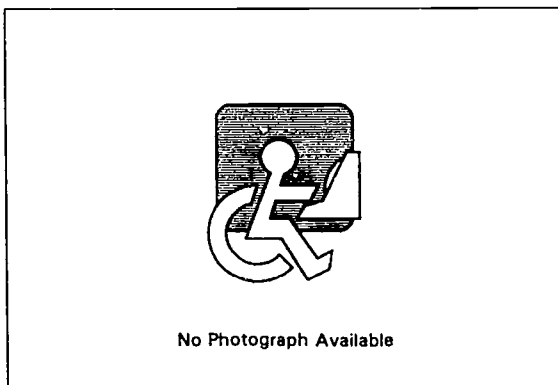

**Product Name:** Expanded Numeric Keypads

**Vendor:** EKEG Electronics Company LTD

**Computer:** Apple IIGS, Apple Macintosh Family,  
Commodore Amiga, IBM PC Family,  
IBM PS/2 Family

**Cost:** \$525.00 - \$675.00

Expanded Numeric Keypads are membrane keypads designed to facilitate data entry by persons with disabilities. The keypads consist of 1.5" keys including: all numeric keys, plus, minus, multiply, divide, period, return, space, backspace, all cursor arrows, and word processing paging control keys. The keys are covered by a transparent waterproof cover which can be raised to allow overlays to be placed over the keys.

Four models are available: for Apple IIGS and Macintosh (\$675.00), for IBM PC and XT (\$525.00), for IBM AT and PS/2 (\$525.00), and Commodore Amiga (\$525.00). Keyguards are available for \$50.00 each.

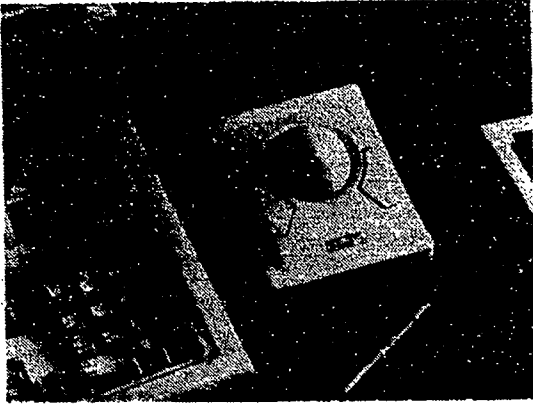

**Product Name:** Expert Mouse  
**Vendor:** Kensington Microware Limited  
**Computer:** IBM PC Family, IBM PS/2 Family  
**Size:** 4.5" x 5.5" x 2.75" casing; 2.25" trackball  
**Weight:** See text  
**Cost:** \$149.95 - \$179.95

Expert Mouse consists of a trackball surrounded by a small box. The user moves the trackball manually to emulate mouse functions. Two "click" buttons are provided, so that the product may be optimally used by left- and right-handed users. Each button may be programmed to emulate different mouse functions. The device can also be used to manipulate a control panel for Microsoft Windows 3.1. Expert Mouse requires less hand movement than a regular mouse, and the trackball requires minimal finger movement.

Two versions are available: a bus version (2.31 lbs.; \$179.95) and a serial version (1 lb., \$149.95).



**Product Name:** Eye Slaved Pointing System  
**Vendor:** ISCAN, Inc.  
**Computer:** IBM PC Family  
**Cost:** \$15,000.00

The Eye Slaved Pointing System is a turnkey computer system which can be completely controlled through eyegaze input. The user can use word processing and modem applications and control external appliances through menu driven software. The system tracks the movement of the user's eye as he or she looks at the computer screen, and then translates the movement into computer input. The Pointing System allows for significant head movement and eye drifting as well as eyeglasses or contact lenses.

The Eye Slaved Pointing System includes an IBM compatible 386 personal computer, printer, modem, system software, external appliance control box, and eye tracking system.

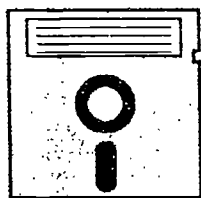

**Product Name:** ezMorse for Windows

**Vendor:** Neil Squire Foundation

**Computer:** IBM PC Family

**Manual Form:** Printed Manual

**Cost:** \$250.00

ezMorse for Windows is a software program that allows Morse Code to be used in place of typing on the IBM-PC keyboard in Microsoft Windows running in enhanced mode. The user activates one or two switches to create Morse codes, which the computer accepts as if the corresponding letter had been typed on the keyboard. The Morse codes are based on the military standard (with a few exceptions), with special mnemonic codes used for all other keys. Speed is adjustable by the user.

The system requires an IBM or compatible computer with a minimum 386DX processor, 4MB of RAM, Windows running in enhanced mode, a game or serial port, and a dual input switch. ezMorse for DOS is included with ezMorse for Windows. A switch cable that allows any switch to be plugged into the computer is included. Switches are not included.

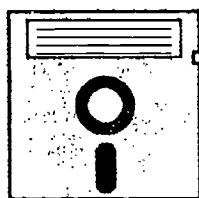

---

**Product Name:** ezScan

**Vendor:** Neil Squire Foundation

**Computer:** IBM PC Family, IBM PS/2 Family

**Manual Form:** Electronic Manual, Printed Manual

**Cost:** \$150.00

ezScan is a software program that allows scanning of an on-screen keyboard to be used instead of a standard keyboard. A series of windows "pop up" on the screen to represent keyboard functions. The pop-up windows can be positioned anywhere on the screen. The user selects characters by scanning with a switch. Five types of scanning can be used, and parameters such as delay time and scan speed can be set.

ezScan requires a computer with a minimum of 64K of memory and a game, serial, or parallel port. The program comes with a cable for plugging in a switch; switches are not included.

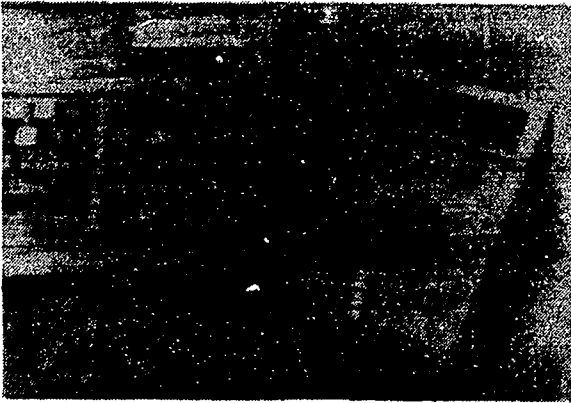

**Product Name:** FastTRAP

**Vendor:** Microspeed Inc.

**Computer:** IBM PC Family, IBM PS/2 Family

**Size:** 7.5" x 4.25" x 2.63"

**Weight:** 12 oz.

**Cost:** \$149.00 - \$169.00

FastTRAP is a trackball, three buttons, and a "third axis" roller, contained in a small box. The user moves the trackball manually to emulate mouse cursor control. The left and right buttons emulate the "click" button on the standard mouse. The center button toggles the "drag lock" feature, producing a similar effect to holding down the button on a standard mouse; the drag lock eliminates the requirement that a button be held down. A keyboard emulation program (included) permits creation of templates for use with some programs that do not customarily support mouse use.

FastTRAP comes in two models: a serial version that can be plugged into the COM1 or COM2 port (\$149.00) and a bus version that can be plugged into any empty expansion slot (\$169.00).



**Product Name:** Felix

**Vendor:** Altra

**Computer:** Apple Macintosh Family, IBM PC Family

**Size:** 6" square

**Cost:** \$69.00

Felix is a six inch square device that emulates the computer mouse. In the center of the square is a one inch square depressed area which corresponds to the computer screen. As the user moves a small pointer over that center area using his or her fingers an equivalent cursor movement occurs on the screen. Felix is self-contained and does not require any surface space to be functional. The device comes with special software which allows the user to program it with functions such as "no-hand" automatic access to window control areas.

There are two models available: one works with IBM and compatible computers and the other with Macintosh computers.

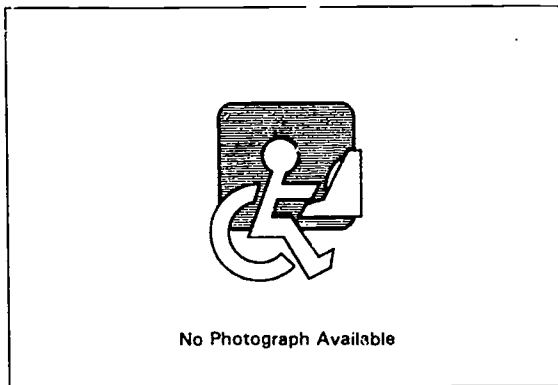

**Product Name:** First-Finger WinTrack  
**Vendor:** A4 Tech (USA) Corporation  
**Computer:** IBM PC Family  
**Cost:** \$18.00

First-Finger WinTrack is a trackball designed to be operated by the first finger. The mouse buttons are located at the corners to be operated by the thumb and other fingers.

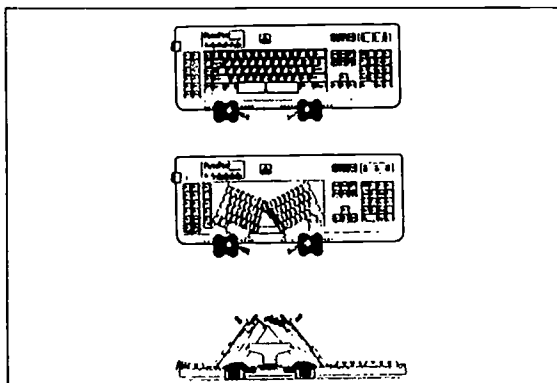

**Product Name:** FlexPro  
**Vendor:** Key Tronic  
**Computer:** IBM PC Family  
**Size:** 20.5" x 8" x 1.6"  
**Weight:** 4 lbs.  
**Cost:** \$199.00

FlexPro is an adjustable keyboard with a 101-key, QWERTY layout. The keyboard is split and tilted by a thumb-wheel control. Other features include adjustable hand rest pads and a built-in measuring scale to set operating positions for multiple users.

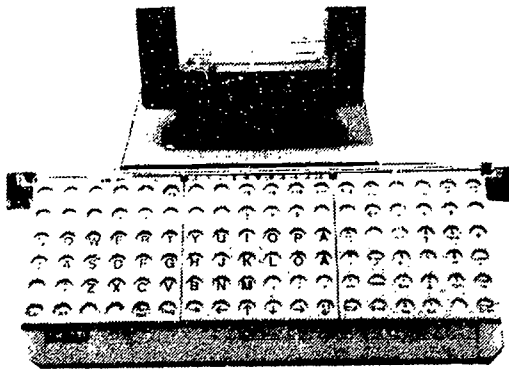

**Product Name:** GEWA FTB 108 Enlarged Keyboard

**Vendor:** Zygo Industries, Inc.

**Computer:** IBM-PC XT, IBM PC AT,  
IBM PS/2 Family

**Cost:** \$1,695.00

The GEWA FTB 108 is an enlarged keyboard for personal computers. The keyboard has 108 keys which can be used with a low amount of force; the enlarged keys corresponds to the standard keyboard keys. The keys are recessed so that they can not be pressed unintentionally. Operation delay and repetition rate functions can be set to limit the number of wrong keystrokes. A "keep-function" allows one-finger typists to activate the CTRL and ALT keys one at a time rather than simultaneously. A programmable memory allows the user to enter frequently used phrases and long commands.

The GEWA FTB 108 is compatible with IBM PS/1, PS/2, AT, and XT computers.

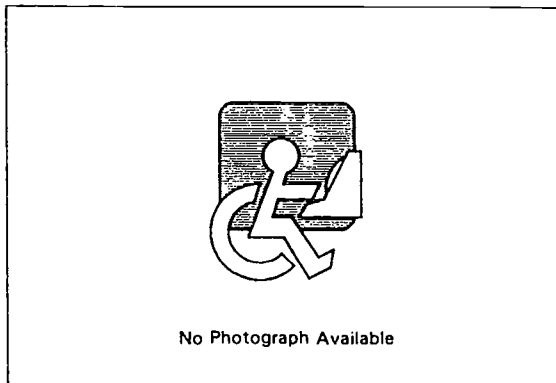

**Product Name:** GEWA METB 121 Reduced Size Keyboard

**Vendor:** Zygo Industries, Inc.

**Computer:** IBM-PC XT, IBM PC AT,  
IBM PS/2 Family

**Cost:** \$1,695.00

The GEWA METB 121 is a reduced size keyboard for personal computers. The keyboard has 121 keys which each correspond to the standard keyboard. Operation delay and repetition rate functions can be adjusted to minimize the number of wrong keystrokes. A "keep-function" allows one-finger typists to activate the CTRL and ALT keys one at a time rather than simultaneously. A built-in memory enables the user to store frequently used phrases and long commands.

The GEWA METB 121 is compatible with IBM PS/1, PS/2, AT, and XT computers. No interface or extra cabling is needed.





**Product Name:** HAL (Home Automation Link)

**Vendor:** Voice Connection

**Computer:** IBM PC Family

**Manual Form:** Printed Manual

**Cost:** \$1,295.00

HAL (Home Automation Link) is a voice input system for the IBM-PC that allows the user full control of the computer by voice, and offers the options of phone control, appliance control, synthesized speech output, and TV and radio tuning control. The HAL program presents the user with "windows" on the computer screen, each displaying a set of control options. The user can select a window, and then command the system to perform control functions, all by speaking words and phrases into a microphone. For 36 different application programs the user can enter all data and commands that would otherwise be entered on the keyboard.

The price listed for HAL includes: the HAL environmental control software, POPSWAP software (presents the windows), AutoMenu software (for application programs), IntroVoice VI voice recognition/synthesis hardware and software (see entry), headset microphone, and the HAL circuit board for voice control of speaker phone. Options available at extra cost include X-10 appliance control, Infrared controller, modem, and speech synthesizer. Contact the manufacturer for prices.



**Product Name:** Hand Controls

**Vendor:** Marblesoft

**Computer:** Apple IIGS, Apple IIc, Apple IIe

**Size:** 4.25" x 2.5" x 1.25"

**Weight:** 8 oz.

**Cost:** \$30.00

Hand Controls are a set of two push switches meant to be used with the Early Learning programs from Marblesoft. The buttons are clearly labeled "YES" and "NO," the two choices the programs offers in switch mode.

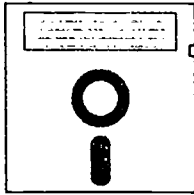

**Product Name:** HandiCODE and HandiCODE Deluxe

**Vendor:** Microsystems Software Inc.

**Computer:** Grid, IBM PC Family, IBM PS/2 Family, ITT, NEC (some or all models), TRS-80 Model 100, TRS-80 Model 200, Tandy 1000, Toshiba Laptops

**Manual Form:** Printed Manual

**Cost:** \$395.00 - \$495.00

HandiCODE is a computer program that converts single, dual, or triple switch Morse code to computer-readable form. The standard Morse code assignments have been extended to include the extra keys on the PC keyboard, plus pre-defined and user-defined commands. A macro facility provides abbreviation expansion for frequently used series of keystrokes. HandiCODE may also be used to control a DECTalk, Votrax, Computalker, or Echo speech synthesizer (extra) to provide voice output capabilities. A training utility, PracticeCODE, is included. Word input speed may be adjusted from 1 to 99 words per minute. HandiCODE provides on-screen help capabilities, and supports 40 or 80 column mode. Morse code paddles and connectors are available from the manufacturer; HandiCODE also supports use of three keyboard keys or other external switches as input devices. HandiCODE will work with most text, graphics, or Microsoft Windows application programs.

HandiCODE is available for \$395.00. HandiCODE Deluxe (for DOS only), which includes word prediction and abbreviation expansion capabilities, is \$495.00.



**Product Name:** HeadMaster Plus

**Vendor:** Prentke Romich Company

**Computer:** Apple IIGS, Apple Macintosh Family, IBM PC Family, IBM PS/2 Family

**Size:** 6.25" x 5.125" x 1.5"

**Weight:** 11 oz.

**Cost:** \$1,195.00

HeadMaster Plus is a headpointing system that replaces the mouse and keyboard of the computer. An ultrasonic transmitting unit sits atop the Mac monitor and sends signals to a lightweight headset that the user wears. HeadMaster translates changes in the user's head position into changes in the cursor's position on the screen. This positioning is relative; i.e., the user does not have to center his head directly in front of the screen. Lightly puffing into a tube connected to the headset is equivalent to pressing the mouse button.

HeadMaster is sold as a separate component. Hard disk and printer are options. HeadMaster may also be purchased with a remote adapter option which eliminates the need for the connecting cable between the headset and the computer (\$995.00). On screen keyboards can be purchased separately for access to keyboard laptop adaptor (\$85.00).

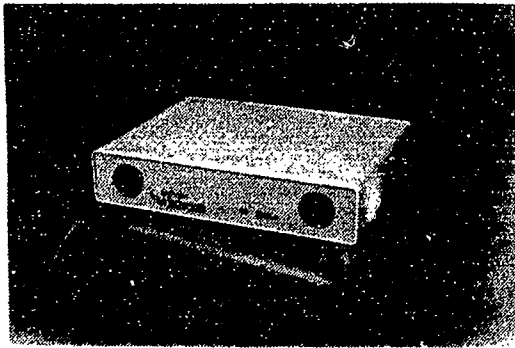

**Product Name:** HeadMouse  
**Vendor:** Origin Instruments Corporation  
**Computer:** Apple Macintosh Family,  
IBM PC Family, IBM PS/2 Family  
**Size:** 7.3" x 5.7" x 1.5"  
**Weight:** 2 lbs.  
**Cost:** \$1,795.00

HeadMouse is an input device that translates the movements of a user's head into directly proportional movements of the computer mouse pointer. HeadMouse is a wireless optical sensor which tracks a paper thin, quarter inch dot that is attached to the user's forehead or glasses. With an on-screen keyboard, text can be entered into standard software applications. Entries are made by positioning the mouse pointer over a key and the actual key press is implemented by dwelling over that key for a set period of time or by using an adaptive switch. High HeadMouse tracking resolution allows the device to be used in drawing and Computer Aided Design applications.

HeadMouse emulates a Microsoft serial port mouse. It can also interface to computers that use the PS/2 format mouse with an Origin Instruments, PS/2 Smart Cable. For Macintosh computers, an Apple Desktop Bus (ADB) Smart Cable is available. The HeadMouse uses standard mouse drivers found on IBM-PC compatibles and Macintosh computers.

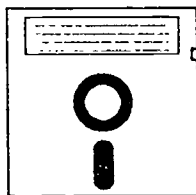

**Product Name:** Help U Key  
**Vendor:** World Communications  
**Computer:** IBM PC Family, IBM PS/2 Family  
**Cost:** \$395.00

Help U Key is a software program that allows a user to control the computer with a single switch or a single keyboard key. The program presents an array of key choices on the screen and the user scans through the selections, indicating a choice by activating the switch or hitting a key. The cursor keys on the keyboard can also be used to move through the array and make choices. Selecting a key in the on-screen array is equivalent to typing that key on the keyboard, so any keyboard-driven software can be operating using Help U Key. The Help U Key software also provides abbreviation expansion capability, and can present word prediction lists based on the initial letters a user types.

Help U Key requires an external switch for switch input. The program supports English, Italian, Spanish, German and French languages. For users with speech impairments, a text-to-speech option is also available.

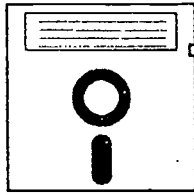

**Product Name:** Help U Keyboard

**Vendor:** World Communications

**Computer:** IBM PC Family, IBM PS/2 Family

**Cost:** \$395.00

Help U Keyboard is software that creates an on-screen keyboard. The user operates a pointing device (such as a mouse or a remote headpointer) to move an on-screen pointer to the image of a desired key. The user can then select that key using the mouse button, a switch, or delay time (key automatically accepted when the pointer has been on it for a certain length of time). The Help U Keyboard software also provides abbreviation expansion capability, and can present word prediction lists based on the initial letters a user types. Many different keyboard layouts are available.

Help U Keyboard requires a pointing device such as a mouse, trackball or remote headpointer. The program supports English, Italian, Spanish, German and French languages. For users with speech impairments, a text-to-speech option is also available.

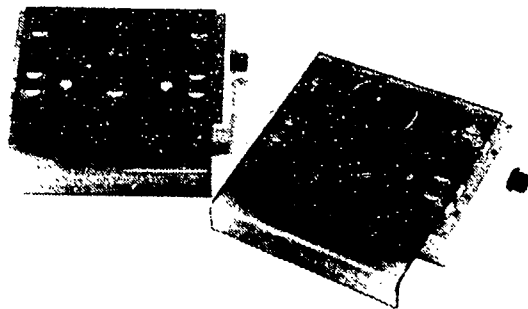

**Product Name:** Hereward Tracker Ball & Joystick Module

**Vendor:** Penny & Giles Computer Products

**Computer:** Apple Macintosh Family,  
IBM PC Family, IBM PS/2 Family,  
Sun Microsystems SPARCstation

**Size:** 10" x 10" x 3.5"

**Cost:** \$480.00 and up

Special Needs Tracker Ball and Joystick Module are alternate input devices that replace a standard mouse. The Tracker Ball has a 3" diameter track ball for control, while the Joystick model has a joystick lever. Both models have buttons for click, double-click, drag, and restrict-movement horizontal or vertical. Buttons are duplicated on both sides of the unit for use with either hand. Switch jacks are provided so that button functions can be accomplished with external switches. Both models have removeable keyguards; the joystick model also has a pair of metal bars next to the joystick lever for resting the hand while moving the lever. A rotary switch on the side of the unit allows cursor movement speed to be set.

Special Needs Tracker Ball and Joystick Module can be connected to a variety of computers, including Macintosh, IBM PC, IBM PS/2, DEC, SUN and Archimedes workstations.



**Product Name:** Icontroller

**Vendor:** Suncom Technologies

**Computer:** IBM PC Family, IBM PS/2 Family

**Cost:** \$19.99

The Icontroller is a mouse emulator that allows for fingertip cursor control and attaches to the keyboard. Either pixel by pixel rate or accelerated speed can be chosen, and three mouse buttons make the Icontroller Microsoft and Mousesystem compatible.

Desktop and laptop models are available.

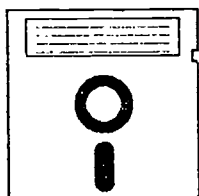

---

**Product Name:** IN-CUBE Voice Command for SPARC Stations

**Vendor:** Command Corp, Inc.

**Computer:** Sun Microsystems SPARCstation

**Cost:** \$495.00

IN-CUBE Voice Command lets SPARC Station users enter commands and data by voice. This real-time continuous speech recognition system provides voice access to all SPARC Station applications including publishing, CAD, and database. IN-CUBE can be customized for any application and is supplied with starter lexicons for FrameMaker, Interleaf, AutoCAD, and MicroStation. No hardware addition is required and IN-CUBE uses the built-in audio input on the SPARC Station to receive commands.

Any microphone compatible with the SPARC Station may be used.

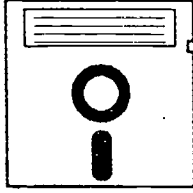

**Product Name:** IN-CUBE Voice Command for Windows, NT

**Vendor:** Command Corp, Inc.

**Computer:** IBM PC Family

**Cost:** \$395.00

IN CUBE Voice Command is a continuous speech-recognition system that can be used, without modification, by people with disabilities. IN CUBE features voice access to the graphic user interface for blind and low-vision users. Voice window navigation and voice macro command input is designed to benefit people with mobility impairments. IN CUBE is also designed to prevent repetitive strain injuries by eliminating repetitive keyboard and mouse operations.

IN CUBE may be used with any Microsoft Windows compatible sound card.

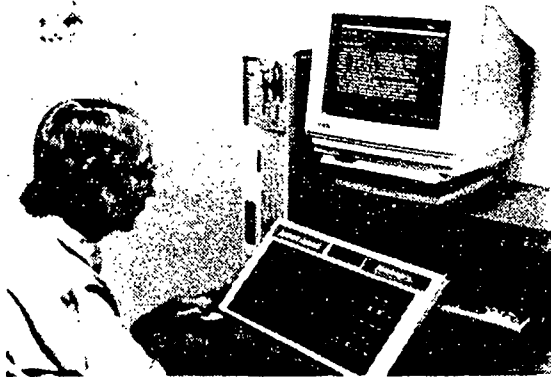

**Product Name:** Instant Access

**Vendor:** Innocomp

**Computer:** Apple Macintosh Family, IBM PC Family

**Size:** 19" x 9.25" x 2.38"

**Weight:** 5 lbs.

**Cost:** \$2,995.00

Instant Access is a computer input device that allows a laser light pointer or any single switch to run any software package. Instant Access plugs directly into the keyboard port of the computer with no special software or hardware required. Software is required for mouse emulation (not included).

Instant Access includes a manual, laser light pointer, and cable.

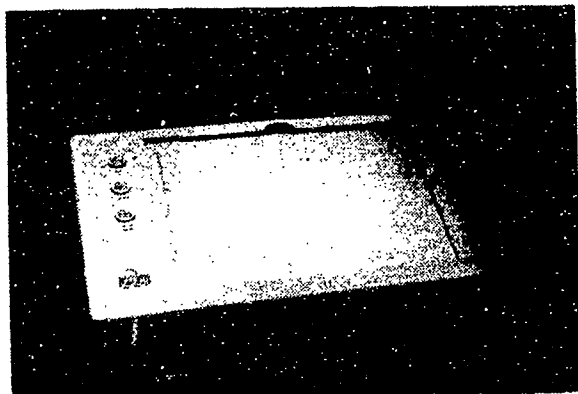

**Product Name:** IntelliKeys

**Vendor:** IntelliTools, Inc.

**Computer:** Apple IIGS, Apple IIe,  
Apple Macintosh Family, IBM PC Family,  
IBM PS/2 Family

**Size:** 10" x 17"

**Weight:** 2 lbs.

**Cost:** \$395.00

IntelliKeys is a touch-sensitive alternate computer keyboard. For Macintosh, Apple IIGS and IBM PC computers, IntelliKeys requires no special interface: the keyboard plugs directly into the keyboard port. (For connecting to an Apple IIe, an additional interface is required.) IntelliKeys can be used to perform standard keyboard and mouse functions, and may also be set up in custom arrangements for operating particular software. The IntelliKeys keyboard has 576 individual keys (24 x 24). IntelliKeys comes with seven overlays: arrows, numbers, alphabet, basic writing, IBM QWERTY, Apple QWERTY, setup, and clear (for protecting custom overlays). When one of these overlays is slipped onto the keyboard, it is instantly recognized and the keyboard is configured appropriately. The Setup overlay permits the adjustment of various keyboard functions.

Custom overlays can be created with the IntelliKeys Overlay Maker (see entry).



**Product Name:** IntroVoice V

**Vendor:** Voice Connection

**Computer:** IBM PC Family

**Cost:** \$350.00

IntroVoice V is a voice input system for the IBM-PC. The user trains the system to recognize certain spoken utterances (up to 1.25 seconds long), and then programs these utterances to trigger strings of characters. When the user speaks a trained utterance into the system's microphone, the programmed string of characters is sent to the computer as if it were input from the keyboard. Sets of trained utterances may be created for each applications program; these vocabularies can contain up to 500 utterances apiece. Subgroups within a vocabulary may also be created. The number of characters triggered by each utterance depends upon how much memory the user is willing to consume; the maximum number of characters is 1,000. The microphone can be turned on and off by voice command.

Software provided includes a program to assist the user in creating vocabularies as well as one with pre-determined vocabularies for certain popular applications software. The system includes a PC board, microphone, manual, and software.



**Product Name:** IntroVoice VI

**Vendor:** Voice Connection

**Computer:** IBM PC Family

**Cost:** \$495.00

IntroVoice VI is a voice input system with a built-in speech synthesizer for voice output. The system consists of an internal circuit card for the IBM-PC computer, special software, and a microphone and speaker. The user "trains" the system to recognize certain words or phrases by speaking them into the microphone. Once the system is trained to recognize a particular utterance, the user can program a character (letter, number, etc.) or set of characters to be associated with that utterance. When the IntroVoice VI "hears" the utterance, it will send the programmed characters to the computer, just as if they had been typed on the keyboard. This allows the user to control standard commercial software by voice alone. The built-in speech synthesizer can be programmed to echo text back to the user. This option can be useful for verifying data entry. The software provided with the IntroVoice VI system is menu-driven, giving the user a structured way to program vocabulary.

IntroVoice VI can be programmed for up to 500 recognized words at one time. The circuit card is half-size. IntroVoice VI is also available packaged with HandiWORD, a word prediction program.

**Product Name:** IRIS Reading Interface 3.0

**Vendor:** VisuAide

**Computer:** IBM PC AT, IBM PS/2 Family

**Cost:** \$495.00

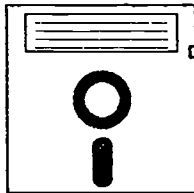

IRIS Reading Interface is a software package that, when combined with the appropriate hardware, allows an IBM PC-AT or PS/2 computer to function as a reading machine using optical character recognition. IRIS uses the numeric pad on the AT-style extended keyboard to control a variety of reading, notetaking, and file management functions. Reading functions include: reading text by character, word, sentence, paragraph, or page; searching text for a word or phrase; and moving to a specific page in a document. IRIS also includes context-sensitive online help, and can send the document being read to a peripheral unit.

IRIS runs on an IBM AT (386 or higher) or PS/2 computer with at least 4 MB of RAM, one floppy disk drive, (5.25" or 3.5"), an AT extended keyboard, and a hard disk. Also required: a Hewlett Packard scanner (ScanJet Plus or higher) and speech synthesis hardware. IRIS does not require a screen review program to operate or read text. Contact the manufacturer for more details about setting up the system.



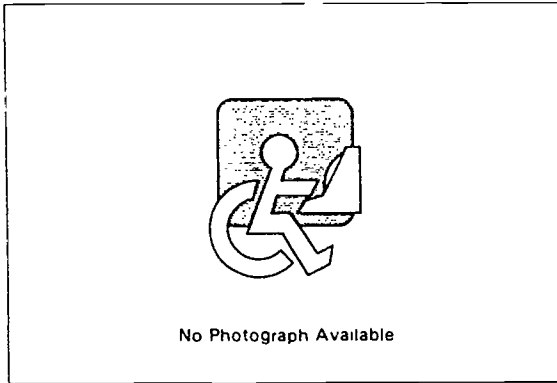

**Product Name:** Jouse  
**Vendor:** Prentke Romich Company  
**Computer:** IBM PC Family  
**Cost:** \$2,300.00

Jouse is a mouth operated mouse that combines sip, puff, and bite switches with a proportional joystick to provide full mouse and keyboarding capability (when using morse code or an on-screen keyboard) using only mouth movement. Cursor movement is achieved by moving the mouthpiece in the direction the user wants the cursor to move. A light bite changes the sip and puff operation between mouse buttons and two auxilliary switch outputs for morse code keyboard emulation or ECU operation. In mouse mode, a puff activates the left mouse button and a sip activates the right. A long puff activates a latching feature for drag operations. Jouse includes an adjustable mounting system.

Jouse works with IBM compatible computers running DOS or Microsoft Windows. An available 9-pin serial port for a serial mouse is required and morse code use requires an additional serial port or game port.

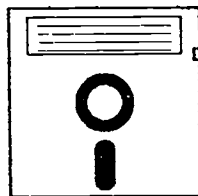

**Product Name:** Joystick to Mouse Driver  
**Vendor:** Innovation Management Group, Inc.  
**Computer:** IBM PC Family  
**Cost:** \$29.95 - \$99.95

Joystick to Mouse is a software application that lets any joystick move the cursor just like a mouse (or any other pointing device). The software supports up to four joystick button assignments and the user can assign any button commands supported by the current mouse driver. Each mouse button command can be set to one of the joystick buttons. The joystick application supports two modes, Absolute and Relative. In Absolute mode the cursor follows joystick position exactly including snap back to center with auto-centering joystick. In Relative mode the cursor follows the joystick position but remains in last known position when the joystick is released and snaps back to center. Joystick to Mouse can also be used with joysticks that support "switches."

The program works with applications running under Windows 3.0 and 3.1, Windows for Workgroups 3.11, and Windows 95. Other operating systems are in development; contact manufacturer for details.

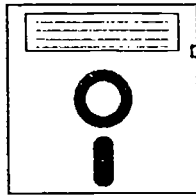

**Product Name:** JustVoice

**Vendor:** Interactive Products, Inc.

**Computer:** IBM PC Family

**Cost:** \$175.00

JustVoice is an unlimited vocabulary speech recognition software package for both Microsoft Windows and DOS users. The purpose of the program is to allow the user to command and control applications via voice templates and macro type commands. One training pass is required (Windows version has verification pass also). Accuracy averages over 98% but the system is speaker dependent, meaning that only one user can access the program. Word utterance length can vary from 150 milliseconds to 2.5 seconds.

JustVoice comes with a VoiceCard and microphone. The VoiceCard will coexist with other sound cards or as a stand-alone device usable as a sound card. System requirements for the DOS version are 286 CPU, DOS 3.3, and an available 8-bit ISA slot. The Windows version requires a 386/25 or faster processor.



**Product Name:** K-U-I

**Vendor:** Softac Corporation

**Computer:** IBM PC Family

**Cost:** \$39.95

K-U-I is a keyboard user interface program for use with Microsoft Windows. The program has a "hot keys" feature which provides mouse emulation through user-defined keystrokes. K-U-I has a built-in magnification feature which provides enlargement of two to eight times original size. The program also allows easy access to DOS commands and user-defined "aliases" to be used instead of commands lines.

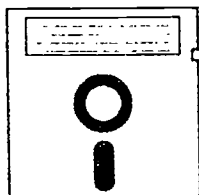

**Product Name:** Ke:nx

**Vendor:** Don Johnston Incorporated

**Computer:** Apple Macintosh Portable,  
Apple Macintosh SE/II

**Manual Form:** Printed Manual

**Cost:** \$780.00

Ke:nx (pronounced "connects") is a software program that permits Macintosh computers to be operated by means other than the standard keyboard and the mouse cursor-control device. Access strategies that may be used with Ke:nx include single switch scanning, Morse code, or ASCII input and a variety of alternative keyboards. Other features include mouse emulation, macro capability, and speech output capability.

Ke:nx works transparently with a variety of standard software programs. Customization possibilities are extensive.



**Product Name:** Ke:nx On:Board (M43)

**Vendor:** Don Johnston Incorporated

**Computer:** Apple Macintosh Family

**Cost:** \$595.00

Ke:nx On:Board is an alternative, touch sensitive keyboard for the Macintosh PowerBook. The keyboard has 128 keys and all the standard features of the PowerBook keyboard. The touch sensitivity of the keyboard may be adjusted accordingly for the user. The area surface of keys is larger than the standard keyboard and the letters or numbers on the keys appear in large print. The mouse, windows, and menus are controlled by using designated keys. Overlays and software (extra) can be used to redefine the keys. Ke:nx On:Board also features a built-in wrist rest. Digitized speech (extra) may be added on to make the keyboard "talk".

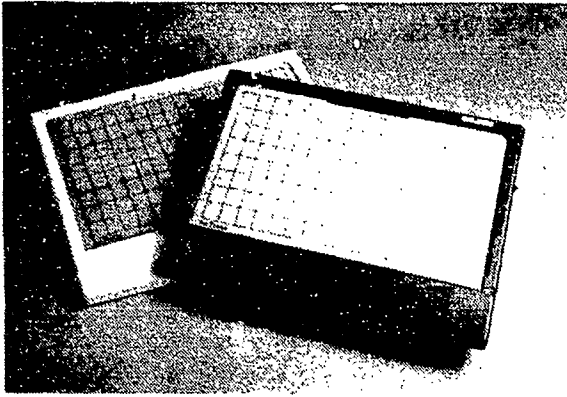

**Product Name:** Key Largo

**Vendor:** Don Johnston Incorporated

**Computer:** All (Hardware Independent)

**Size:** 16" x 12" x 3"

**Weight:** Under 3 lbs.

**Cost:** \$295.00

Key Largo is membrane keyboard designed for use with Ke:nx, Adaptive Firmware Card, and other interfaces (see entries). The keyboard is a medium-sized, light-touch input device. Key Largo may be used to control Apple II programs using the Adaptive Firmware Card or create and print custom overlays using the Ke:nx software. It's membrane surface is divided into 128 squares which can be configured for the user's needs. The keyboard uses paper or plastic overlays the size of a standard legal-sized sheet of paper (8.5" x 14"). Key Largo also features a built-in wrist rest.

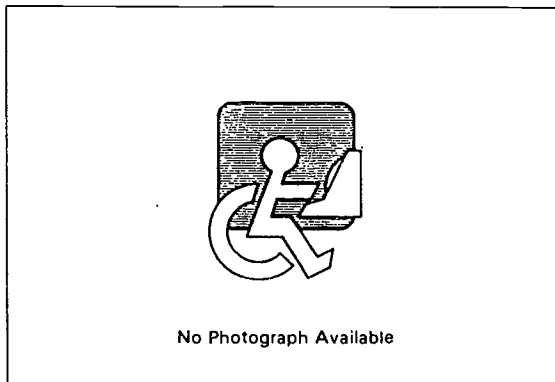

**Product Name:** Keyport 176

**Vendor:** Polytel Computer Products Corporation

**Computer:** IBM PC Family

**Cost:** \$295.00 - \$395.00

Keyport 176 is a membrane keyboard. With the included software, the user can assign any series of commands or characters to a single key on the surface. Each of the 176 keys is a 5/8" square with tactile or dome style keys and larger keys can be created by assigning several adjacent keys the same value. Different patterns of key assignments can be stored on disk and recalled for different applications.

Keyport 176 requires an adapter or interface card from Polytel to plug into the game port of the computer and will work with virtually any software application. The keyboard is also available with a direct keyboard connection for \$395.00.

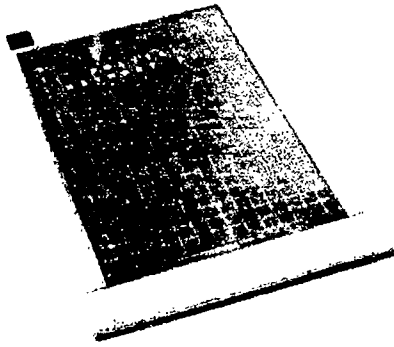

**Product Name:** Keyport 300  
**Vendor:** Polytel Computer Products Corporation  
**Computer:** IBM PC Family  
**Size:** 9.2" x 13.7" x 0.9"  
**Weight:** 26 oz.  
**Cost:** \$195.00 - \$295.00

Keyport 300 is a 300-key alternate keyboard for the IBM-PC. Using the accompanying software (included), the user can assign any series of commands or characters to a single key on the Keyport 300's membrane surface. Different patterns of key assignments can be stored on disk and then recalled when running the appropriate piece of applications software. The user can place different custom overlays on the Keyport corresponding to these different key assignment patterns. Each key on the Keyport 300 is 0.5 inches square; larger keys can be created by assigning several adjacent keys the same value.

Keyport 300 plugs into the game port of the computer, and can be used at the same time as the standard keyboard. (If the computer does not have an active game port, it must be outfitted with one; contact Polytel or your computer dealer.) Keyport 300 will work with virtually any applications software. The keyboard is also available with direct keyboard connection for \$295.00.

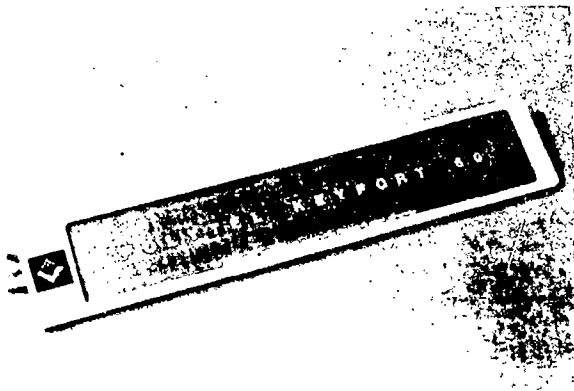

**Product Name:** Keyport 60  
**Vendor:** Polytel Computer Products Corporation  
**Computer:** IBM PC Family  
**Size:** 12.2" x 2.4" x .25"  
**Weight:** 4 oz.  
**Cost:** \$119.00

Keyport 60 is a small membrane keyboard consisting of 60 0.5" square keys in a 3 x 20 layout. Using the accompanying software (included), each key on the Keyport 60 can be assigned a series of characters which then will be triggered when that key is pressed. Keyport 60 and the standard keyboard can be active at the same time. Patterns of key assignments can be stored on disk and then recalled, allowing the user to have a separate custom 60-key keyboard for any applications program. Overlays can be placed on the Keyport's surface to indicate which areas trigger which characters or commands. Larger key areas can be obtained by assigning adjacent keys the same value.

Keyport 60 plugs into the IBM's game port. (If the computer does not have an active game port, it must be outfitted with one; contact Polytel or your computer dealer.) Keyport 60 can be affixed along the top of an IBM keyboard with adhesive pads (provided). Keyport 60 will work with virtually any applications software.

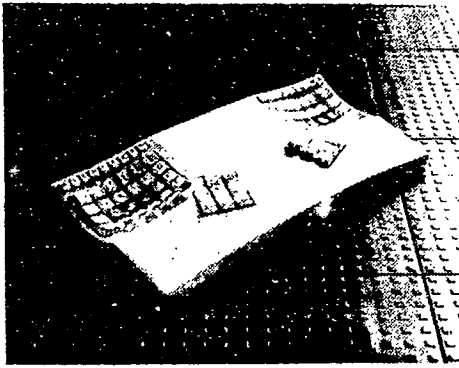

**Product Name:** Kinesis Ergonomic Keyboard

**Vendor:** Kinesis Corporation

**Computer:** Apple Macintosh Family,  
IBM PC Family, Sun Microsystems SPARCstation

**Size:** 16.5" x 8" x 3"

**Weight:** 3 lbs.

**Cost:** \$390.00

The Kinesis Ergonomic Keyboard is a keyboard that conforms to the shape and movements of the body and is designed to reduce physiological stress and increase productivity. The traditional QWERTY key layout is retained but can be reprogrammed for individual preferences and stored in the keyboard itself. The keyboard has separated, concave alphanumeric keypads, separate thumb keypads to redistribute workload from little fingers to the thumbs, closer placement of function keys, a palm rest, and low-force, tactile keyswitches to provide mechanical and audible feedback.

Use with the Macintosh and Sun computers requires an interface box (not included). Two optional foot switches are also available at \$25.00 a piece.

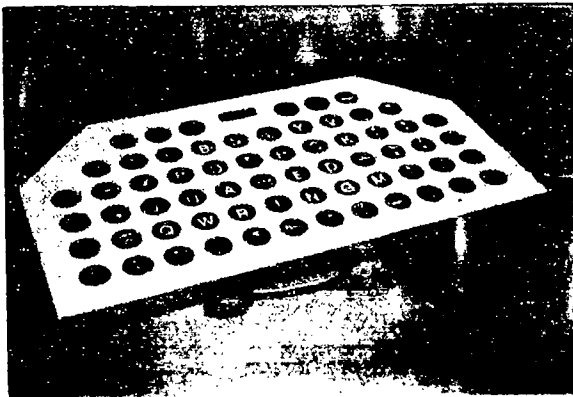

**Product Name:** King Keyboard (2440)

**Vendor:** TASH, Inc.

**Computer:** Apple IIGS, Apple IIe, IBM PC Family,  
IBM PS/2 Family

**Size:** 23.5" x 12" x 1"

**Weight:** 5 lbs.

**Cost:** \$750.00

King Keyboard is an expanded version of the Apple IIe keyboard, with 1.25" diameter keys. The keys are slightly recessed so that the board's surface acts as a keyguard. Operating the keys requires 200 gm of pressure. When used with the Adaptive Firmware Card or Ke:nx (see entry) on Apple computers or DADA Entry (see entries) on IBM computers, all keys can be redefined so that they enter desired words, characters, or phrases: up to 128 messages can be stored and retrieved. Key response time can also be varied, and SHIFT and CONTROL keys are latched.



**Product Name:** Kurzweil VOICE

**Vendor:** Kurzweil Applied Intelligence, Inc.

**Computer:** IBM PC Family

**Cost:** \$2,995.00

Kurzweil VOICE is a voice-activated input system that allows the user who is unable to use a keyboard to run word processing, spreadsheet, database, and other software completely by voice. Kurzweil VOICE comes with a built in vocabulary of 40,000 pre-defined speaker independent words with no system training. Users can also access a 200,000-word on-line dictionary to easily add words up to the 50,000 capacity. Trigger phrases can be defined to act as macros for text and control. Automatic speech adaption leads to improved accuracy with use and error correction usually requires a few spoken utterances. All application commands, selections, and functions can be controlled by voice and more than one application can be run at one time. No programming is required.

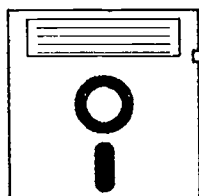

**Product Name:** Kurzweil VOICE for Windows

**Vendor:** Kurzweil Applied Intelligence, Inc.

**Computer:** IBM PC Family

**Cost:** \$995.00

Kurzweil VOICE for Windows supports voice input for dictation and navigation with speaker-independent speech recognition technology. Users can choose either a 60,000-word or a 30,000-word active vocabulary, depending on the amount of RAM available, and have access to a total of 200,000 words in VOICE's on-line knowledge. VOICE adapts to the user's speech and language patterns to provide recognition accuracy of 95%.

Almost all Microsoft Windows applications are compatible with VOICE, including WordPerfect, Lotus, and Microsoft programs. A VGA or higher resolution video adapter is required. VOICE includes a sound board and microphone.

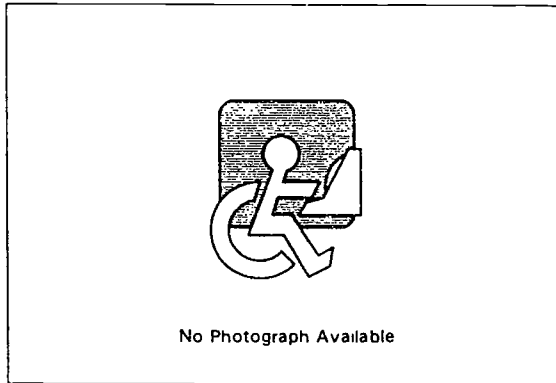

**Product Name:** Laser Optic Keyboard  
**Vendor:** International Technology, Inc.  
**Computer:** IBM PC Family  
**Size:** 10" x 18"  
**Weight:** 2 lbs.  
**Cost:** \$800.00

The Laser Optic Keyboard is a transparent input device for IBM computers which translates head movements into key strokes. The keyboard consists of a small laser unit and interface board. The laser unit is attached to the user's eyeglasses or headband, the wearer then uses head movement to select the desired character on the interface board. When a character is selected a light flashes in visual acknowledgement and a click sounds as an audible signal; the character then appears on the computer screen. The keyboard comes with a word processor and can also be used to operate most standard software on the computer.

The keyboard, including laser, interface board, and software is available for \$800.00. Speech output is an available option.



**Product Name:** LIAISON  
**Vendor:** APT Technology, Inc.  
**Computer:** Apple IIGS, Apple Macintosh Family,  
 IBM PC Family  
**Cost:** \$4,385.00

LIAISON is a device designed to give high-level quadriplegics (C-5 to C-1) access to computers, environmental control, and telephone operation. When attached to a computer, LIAISON may be used to provide alternate input (both keyboard- and mouse-emulating) to most software programs. Input is accomplished by using an on-screen keyboard (displayed on a separate color monitor) and infrared proportional input. Length of time required to activate a key and other variables are programmable. LIAISON can be assigned level type macros so that phrases up to 240 characters can be retrieved by pressing one key and keyboard layouts with up to seven levels can be stored in memory. LIAISON may be used to program telephone numbers and dial a telephone or speakerphone (extra), whether or not attached to a computer. LIAISON is also designed to control four AC outlet groups, 16 remote AC power outlets (requires an X-10 starter kit), and miscellaneous control functions (e.g., switches). The keyboard is configurable.

LIAISON may be controlled using the DU-IT Wheelchair System or as a stand-alone unit using a DU-IT proportional input (chin or tongue/lip).



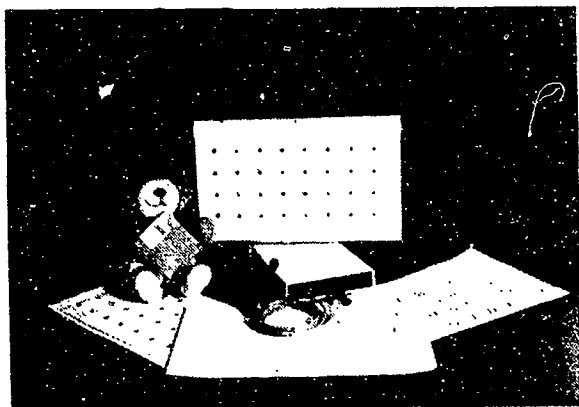

**Product Name:** LightBoard

**Vendor:** Ability Research, Inc.

**Computer:** Apple IIGS, Apple IIe,  
Apple Macintosh Family, IBM PC Family

**Weight:** 2.8 lbs.

**Cost:** \$795.00 - \$995.00

The LightBoard is an alternative computer keyboard which is operated by head motion using an optical pointer. The keyboard is programmable and "keys" can be grouped according to the user's needs. To input text or commands, the user directs the optical pointer to the desired "key". Lightboard provides transparent access for all software applications when used with most adaptive interfaces including the Adaptive Firmware Card and Ke:nx. The product is available with either 128, 72, or 32 "keys".

The LightBoard is compatible with the Unicorn boards and Apple IIe, Apple IIGS, Macintosh, and IBM computers. Keyboard, stand, blank overlays, and head pointer are included.



**Product Name:** LipStick and WordWriter

**Vendor:** McIntyre Computer Systems Division

**Computer:** Apple Macintosh Family

**Cost:** \$150.00 - \$450.00

LipStick is an alternate input system for an Apple Macintosh, employing a joystick or trackball in place of the standard mouse and keyboard. Moving the joystick or rolling the trackball is equivalent to sliding the mouse. Pushing the joystick "fire" button or pressing the trackball button is equivalent to clicking the mouse button. WordWriter is software which presents an image of the keyboard on the computer screen. Included with the keyboard is a predictive vocabulary list of over 4,000 words; users can add and delete words or phrases from this list. The user can perform the equivalent of typing on the keyboard by moving the mouse cursor to a letter or word on the keyboard image and pushing the button. The joystick is available mounted on a gooseneck for mouth operation, but can also be mounted differently and operated by another part of the body. The input system operates transparently, offering the user access to most commercially available software for the Macintosh computer.

The LipStick and mounting are \$300.00; WordWriter is \$150.00; LipStick, mounting, and WordWriter may be purchased together for \$450.00.



**Product Name:** Listen for Windows

**Vendor:** Verbex Voice Systems

**Computer:** IBM PC Family

**Cost:** \$139.00

Listen for Windows is a continuous speech recognition software product that includes speech interfaces for Microsoft Office, Lotus SmartSuite, WordPerfect and over 30 other popular Microsoft Windows applications, ready to use. The system has a speaker independent vocabulary of over 3,000 words and 16,000 commands. Listen also allows users to navigate, command, control, enter data, and make inquiries into Windows applications. Listen is speaker independent for most North American speakers and can be trained to accept any dialect, accent, or language.

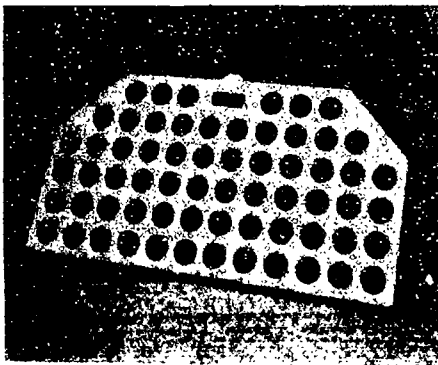

**Product Name:** MacKing

**Vendor:** TASH, Inc.

**Computer:** Apple Macintosh Family

**Size:** 21.5" x 11" x 2.25"

**Weight:** 5.5 lbs.

**Cost:** \$900.00

MacKing is a large size alternative keyboard that plugs directly into a Macintosh computer. Keys are 1.25" in diameter, slightly recessed, and provide both tactile and auditory feedback. The MacKing also has a built-in keyguard. The keyboard controls both keyboard and mouse functions.

Two layouts are available: frequency-of-use (most frequently used letters are placed toward the center of the keyboard) and the standard QWERTY. System requirements include: Macintosh SE or higher, System 6.0.5 or higher, and at least 1 MB RAM.



**Product Name:** MacMini  
**Vendor:** TASH, Inc.  
**Computer:** Apple Macintosh Family  
**Size:** 7.25" x 4.5" x 1"  
**Weight:** 0.9 lb.  
**Cost:** \$750.00

MacMini is a small size alternative keyboard that plugs directly into a Macintosh computer. Membrane keys are less than 0.5" square and are closely-spaced for easy access. MacMini controls both the keyboard and mouse functions.

Two keyboard layouts are available: frequency-of-use (most frequently used letters are placed toward the center of the keyboard) and the standard QWERTY. System requirements include a Macintosh SE or higher, System 6.0.5 or higher, and 1 MB RAM or higher.

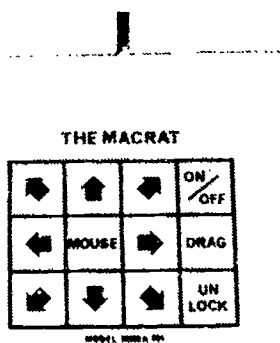

**Product Name:** Macrat  
**Vendor:** EKEG Electronics Company LTD  
**Computer:** Apple IIGS, Apple Macintosh Family  
**Size:** 9" x 9" x 1"  
**Weight:** 1 lb.  
**Cost:** \$475.00

Macrat is a mouse emulating device for the Apple IIGS and Macintosh computers. The device consists of twelve 1.5" membrane keys. Eight of these keys are labeled with arrows pointing up, down, left, right, and towards the four diagonal directions. When one of these keys is pressed, the mouse pointer moves in the corresponding direction on the screen until the key is released. The rate of pointer movement is adjustable from the computer's keyboard. The rest of the keys emulate standard mouse functions (click, drag, and unlock), and turn the Macrat on and off.

Macrat comes with a clear plastic cover and is waterproof. An optional keyguard (extra) is also available. The device requires use of Easy Access which is included as a standard part of Apple IIGS and Macintosh system software. Macrat plugs directly into any Apple Desktop Bus (ADB) port and comes with an eight-foot cord.

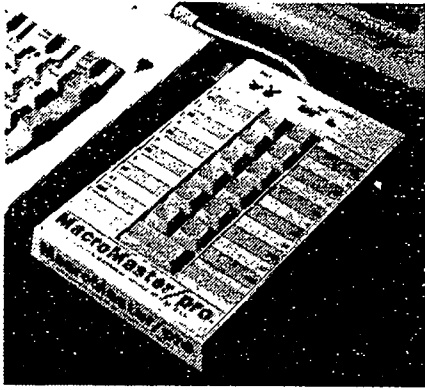

**Product Name:** MacroMaster/pro

**Vendor:** AJ Weiner/New England Computer Products

**Computer:** IBM PC Family, IBM PS/2 Family

**Size:** 8" x 5" x 1"

**Cost:** \$249.00

MacroMaster/pro (formerly called echoBOX) is a keyboard macro storage device. The MacroMaster is connected between the standard keyboard and the computer. The user can define up to 24 macros (strings of characters or commands) into the MacroMaster's memory. When the user presses a key on the MacroMaster, the macro programmed for that key will be sent to the computer just as if it had been typed in full on the standard keyboard. The MacroMaster has 12 keys plus a SHIFT key, and space for the user to affix custom labels by each key. Macros are stored in the MacroMaster/pro in non-volatile memory; that is, they are retained when the system is turned off, and no external power or internal battery is required to retain memory.



**Product Name:** MacTRAC

**Vendor:** Microspeed Inc.

**Computer:** Apple IIc, Apple IIe,  
Apple Macintosh Plus, Apple Macintosh SE/II

**Size:** 3.75" x 6.75" x 1.75"

**Weight:** 12 oz.

**Cost:** \$99.00 - \$119.00

MacTRAC is a trackball and three buttons contained in a small case. The user moves the trackball manually to emulate mouse cursor control. The left and right buttons, which surround the trackball, emulate the "click" button on the standard mouse. The center button, located above the trackball, toggles the "drag lock" feature that produces a similar effect to holding down the button on a standard mouse; the drag lock eliminates the requirement that a button be held down. The trackball case has a sloped panel that may be used as a wrist rest.

MacTRAC is available in two versions: DB-9 (\$99.00), which can be used with Apple IIc and IIe computers equipped with a mouse card (extra) and with Macintosh Plus computers, and ADB (\$119.00), which can be used with the Mac SE and II computers.

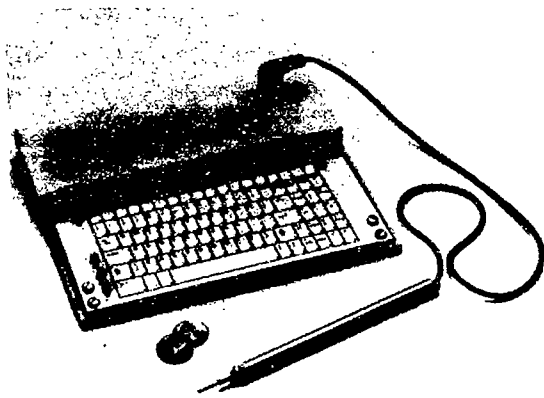

**Product Name:** Magic Wand Keyboard with McKey Mouse Option

**Vendor:** In Touch Systems

**Computer:** Apple IIGS, Apple Macintosh Family, IBM PC Family, IBM PS/2 Family

**Size:** 7" x 6" x 0.5"

**Weight:** 12 oz.

**Cost:** \$1,295.00 - \$1,595.00

The Magic Wand Keyboard is a miniature computer keyboard with zero-force electronic keys that require no strength, reach, or dexterity to operate. The keyboard works with a hand-held wand or mouthstick and provides full keyboard and mouse capability to run all software. The mouse function has 11 speed settings, left and right click, drag, and double click. The CONTROL, SHIFT, and ALT keys latch on with a single touch. No installation or special software is required.

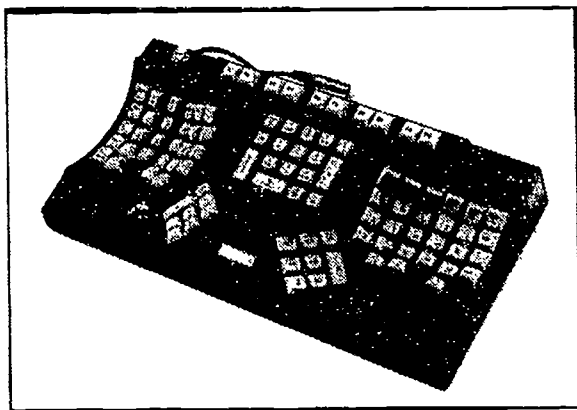

**Product Name:** Maltron Keyboard

**Vendor:** International Management Services, Inc.

**Computer:** IBM PC Family, IBM PS/2 Family

**Cost:** \$595.00 - \$725.00

Maltron Keyboards are specially curved and arranged to suit several varieties of typing styles. There are four different keyboard models: single handed (left), single handed (right), mouth/head stick, and two handed. The single handed keyboards have a depressed area for the alphabet keys, cursor keys on the slope of the concave area, numeric pad on a flat portion to the side of the curved area, and function keys on a flat surface along the top of the keyboard. The right and left handed keyboards are mirror images of one another. The keys on the mouth/head stick keyboard are arranged in a rectangular block with function keys on the top row, alphabet keys to the left, and numeric pad to the right; this keyboard has an overall concave curve. The two handed keyboard has depressed areas on either side, each with alphabetic keys; function keys are along the top, numeric pad in the center, and command keys (CTRL, ALT, etc.) are in two groupings beneath the numeric keys.

The Maltron Keyboards have all the functions of a standard keyboard and are compatible with IBM computers.

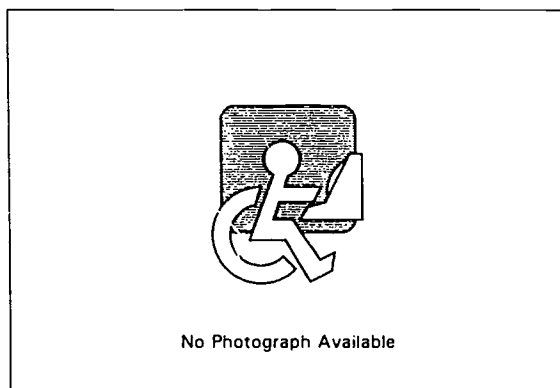

**Product Name:** MICE

**Vendor:** Ballert International, Inc.

**Computer:** IBM PC Family

**Cost:** \$2,754.00

MICE is an input device that allows human joint movement to replace the operations of the computer mouse. Included software allows the therapist to analyze the patients' movements.

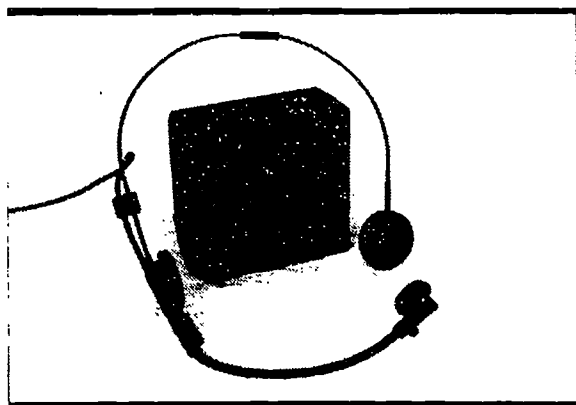

**Product Name:** Micro IntroVoice

**Vendor:** Voice Connection

**Computer:** IBM PC Family

**Size:** 3.125" x 1.75" x 3"

**Weight:** 8 oz.

**Cost:** \$1,495.00

Micro IntroVoice is a voice input system with a built-in speech synthesizer for voice output. The system consists of an internal circuit card for the IBM-PC computer, special software, and a two-way headset or one-way headset with a desktop speaker. The user "trains" the system to recognize certain words or phrases by speaking them into the headset; the system can recognize up to 1,000 isolated words or phrases. Once the system "hears" a word or phrase it sends keystrokes via the serial port to the computer and text to the speech synthesizer for audio prompting and verification.

The Micro IntroVoice can be used with its own specialized software or with any standard software. The system can be purchased with the word prediction program HandiWORD. The system can also work with Microsoft Windows using WinVoice software.

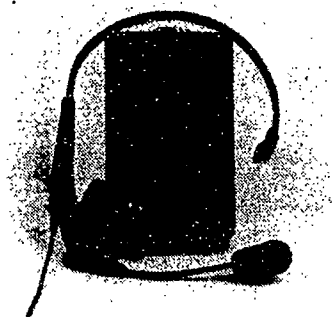

**Product Name:** Micro IntroVoice II

**Vendor:** Voice Connection

**Computer:** IBM PC Family

**Size:** 5.7" x 3.6" x 1.6"

**Weight:** 14 oz.

**Cost:** \$1,695.00

Micro IntroVoice II is a voice recognition device that allows the computer to recognize the human voice as input. It also has an unlimited text-to-speech synthesizer and digitized recorded speech for playing speech back. The device can recognize up to 1,000 words at one time and is 98 percent accurate. IntroVoice II can also be trained and the recognition vocabulary can be updated by using corresponding buttons on the unit. IntroVoice II is a small stand-alone unit that can be plugged into the serial port of any PC, including notebooks and hand-helds, and used for portable applications with eight-hour batteries. The device can be used with any DOS software and in Microsoft Windows applications when using WinVoice software (\$99.00).

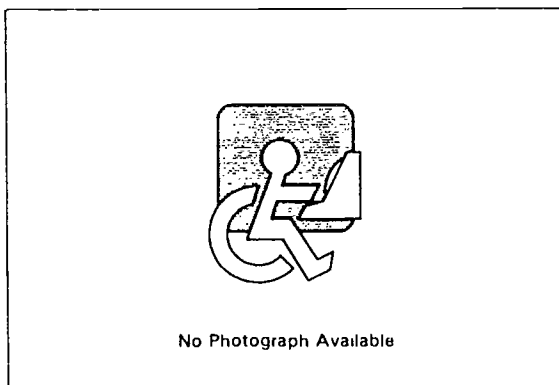

**Product Name:** Microsoft Natural Keyboard

**Vendor:** Microsoft Corporation

**Computer:** IBM PC Family

**Cost:** \$99.95

The Microsoft Natural Keyboard is an ergonomic keyboard designed to prevent strain of prolonged typing. The Natural Keyboard features a split and rotated keypad, a built-in palm rest, an adjustable front edge, and a QWERTY layout. Windows-specific keys are also included to facilitate switching between Windows-based operations with minimal keystrokes. A graphical task manager, keyboard Control Panel display, and Ergonomic Guide are also included to create a custom keyboard layout.

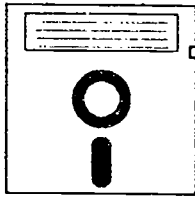

**Product Name:** Microsoft Windows Sound System

**Vendor:** Microsoft Corporation

**Computer:** IBM PC Family

**Cost:** Contact manufacturer

Microsoft Windows Sound System is a combination sound board and software program that allows users to add voice annotations to documents, proofread by voice, and command Windows-based applications by voice. Hardware features include: a hands-free, directional microphone, a 16-bit audio board, stereo CODEC chip, MIDI synthesizer, five connectors, and headphones. Software features include: Quick Recorder with hands-free operation, ProofReader, Voice Pilot with user-specific vocabularies, Sound Editor, Audio Control, Sound Finder, and Games Support. Voice Pilot allows the user to activate any command in the menus of applications for the Windows operating system by voice. Personalized commands can also be created.

System requirements include: Windows, open ISA or EISA slot, 386SX 25 MHz or faster processor, 2MB RAM, hard drive with 10 MB available space, and VGA display.

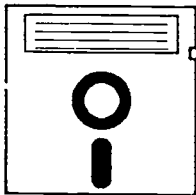

**Product Name:** MIKE (Mouse Interface & Keyboard Emulation)

**Vendor:** Prentke Romich Company

**Computer:** Apple Macintosh Family, IBM PC Family

**Cost:** \$205.00

MIKE (Mouse Interface and Keyboard Emulation) is a software program that allows a Liberator (see entry) communication aid to be used as an input device for an IBM compatible or Macintosh computer. MIKE works with the Minspeak Application Program Words Strategy and puts all the needed keyboard keys and mouse movements into the Liberator's memory. The Liberator user gains control of any standard software on the computer. An emulator must be used to connect the Liberator to a computer. MIKE is compatible with the T-TAM (Trace Transparent Access Module), Access DOS, Access Pack for Windows 3.1 (see entries), and Access in Windows 95 (included in the operating system).



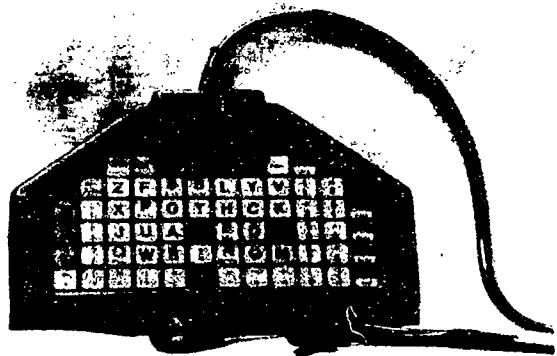

**Product Name:** Mini Keyboard (2443 or 2450)

**Vendor:** TASH, Inc.

**Computer:** Apple IIGS, Apple IIe, IBM PC Family, IBM PS/2 Family

**Size:** 7.5" x 4.5" x 0.5"

**Weight:** 15 oz.

**Cost:** \$375.00

This Mini Keyboard is similar to the Mini Keyboard previously sold by TASH, but the keys on the earlier model, which had to be pressed with a special stylus, have been replaced by small membrane keys which can be pressed with a finger, typing stick, mouthstick, etc. The keys require a force of 100 grams to activate. If used with the Adaptive Firmware Card, all keys on the Mini Keyboard can be redefined, key response time can be adjusted, and SHIFT and CONTROL keys will latch.

The Adaptive Firmware Card is required to use the Mini Keyboard with the Apple IIe or IIGS; Ke:nx for the Macintosh; the DADA Entry is required to use the keyboard with the IBM PC or PS/2. The PC Mini Keyboard (see entry) may be easier to use for PCs and PS/2s, as it contains the full IBM PC keyboard layout. A mini direct plug-in version for the Macintosh and IBM is also available.

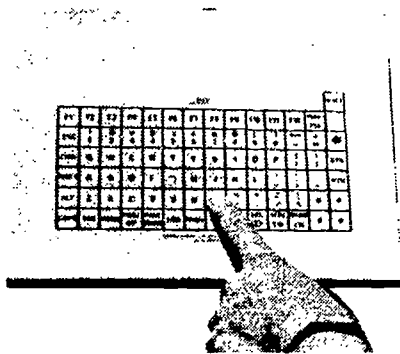

**Product Name:** Mini-Keyboards

**Vendor:** EKEG Electronics Company LTD

**Computer:** Apple IIGS, Apple Macintosh Family, Commodore Amiga, IBM PC Family, IBM PS/2 Family

**Cost:** \$475.00 - \$750.00

Mini-Keyboards are membrane keyboards designed to be compatible with standard software. The keyboards are waterproof, and are covered by a clear plastic cover which can be peeled back to allow the use of overlays. The keyboards plug into the keyboard socket of the computer, and work transparently with most software. Additional features include audible click and light flash on key activation, and a DIP switch which allows repeat and delay rate adjustment.

Three configurations are available: with .5" square keys (\$475.00), with .75" square keys and an active keyboard area of 10.5" x 4.5" (\$625.00), and with 1" square keys and an active keyboard area of 14" x 6" (\$750.00). Each of these configurations is available for use with the Apple IIGS and Macintosh (MIN 901AM), IBM PC and XT (MIN 901BX), IBM AT and PS/2 (MIN 901BA), and Commodore Amiga 2000 (MIN 901CA).

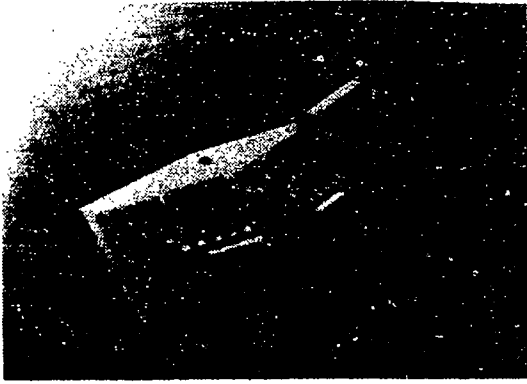

**Product Name:** MiniErgo-MF2  
**Vendor:** Marquardt Switches, Inc.  
**Computer:** IBM PC AT, IBM PS/2 Family  
**Weight:** 5 lbs.  
**Cost:** \$100.00

The MiniErgo-MF2 is an alternate keyboard designed to compensate for the hand's natural angles while typing and prevent Repetitive Strain Injury (RSI). The MiniErgo features a split, V-shaped configuration which gently slopes to the sides and front, a surface with resting area for hands and palms, sculptured keycaps, and QWERTY letter layout.

An optional separate number pad can be placed either at the left or the right of the keyboard. The pad has all important function and command keys and can be connected directly to the PC also for applications in which only numerical data is entered.

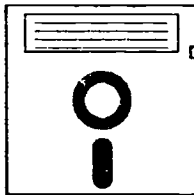

**Product Name:** Minimal Motion Computer Access System  
**Vendor:** Equal Access Computer Technology, Inc.  
**Computer:** IBM PC Family  
**Manual Form:** Electronic Manual, Printed Manual  
**Cost:** \$300.00 (software)

The Minimal Motion Computer Access System is designed for users who can press four or more keys but have difficulty with the full-sized standard keyboard. The user types letters by pressing combinations of keys (chords) on the standard computer keyboard; no additional hardware is required. The user can customize the system for use with whatever group of keys on the keyboard is most comfortable. The system for learning and remembering chords uses an on-screen visual guide and feedback so that novices can begin using the system without having to learn the chords first. The Minimal Motion system lets the user type any key, or accomplish mouse functions, so any standard software on the computer can be operated.

The Minimal Motion Computer Access System usually uses selected keys on the standard keyboard; special chordic switch input devices are available. Contact the manufacturer for further information.

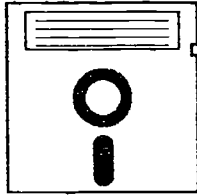

**Product Name:** Morse Code WSKE II

**Vendor:** Words+, Inc.

**Computer:** IBM PC Family

**Manual Form:** Electronic Manual

**Cost:** \$695.00 - \$1,395.00

Morse Code WSKE (Words+ Software Keyboard Emulator) II is a RAM-resident program that allows an IBM-compatible computer to be used as an integrated augmentative communication/computer access system for one- or two-switch Morse code users. The system provides dual word prediction, abbreviation expansion, automatic word endings, punctuation spacing, and capitalization, and voice output capability. The system runs transparently with applications software, including some graphics software.

The Bank Street Writer word processor program is included with Morse Code WSKE. The voice output option (\$1,395.00) will work with most serial port text-to-speech speech synthesizers or SmoothTalker (extra). The No Voice option (\$695.00) permits the program to be used without voice.



**Product Name:** Morsek Version 1.1

**Vendor:** Kinetic Designs, Inc.

**Computer:** IBM PC Family

**Manual Form:** Electronic Manual, Printed Manual

**Cost:** \$130.00

Morsek is emulating software which uses switch input to emulate the standard and enhanced keyboard input for IBM PC/XT/AT and true compatibles, including laptops. Morsek runs through the serial or parallel port and can use one to three switches to run Morse code in timed or untimed modes. Definable options are variable speed cursor movement, key repeat, super key mode, and debounce delays. Morsek can also be run using the keyboard as a "switch."

A hard disk is recommended for running Morsek, particularly if the user has severe disabilities.

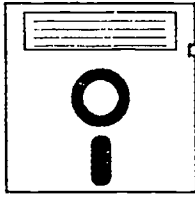

**Product Name:** Mouse Keys

**Vendor:** World Communications

**Computer:** IBM PC Family

**Cost:** \$395.00

Mouse Keys is a software program which allows the mouse to emulate keyboard input. The program provides the user with a visual on-screen keyboard which has all the functions of the standard keyboard. The user makes keyboard selections by using the mouse cursor to activate keys on the visual keyboard. Mouse Keys can also be operated using a remote headpointing device. Mouse Keys features a word prediction function and an auto select keys option.

The program requires Microsoft Windows and an IBM PC or PS/2.

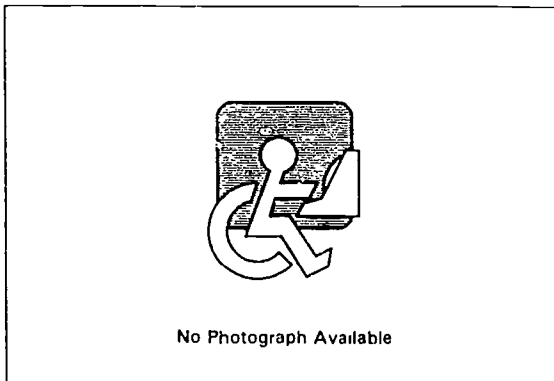

**Product Name:** Mouse-Trak

**Vendor:** ITAC Systems, Inc.

**Computer:** Apple Macintosh Family,  
IBM PC Family, IBM PS/2 Family,  
Sun Microsystems SPARCstation

**Size:** 7.93" x 4" x 2.25"

**Cost:** Contact manufacturer

Mouse-Trak is a trackball designed to replace the standard mouse and reduce fatigue and stress associated with extensive mouse usage. The device features an integral padded area to support the hand while allowing the fingertips to reach and manipulate the ball and three input keys. The keys are user-definable and the cursor velocity can be changed through a built-in control button. Mouse-Trak comes with all necessary cables.

Two models are available; Professional and Industrial. Both have the above features but the Industrial model features a stronger case, enhanced moisture resistance and debris tolerance, and a shielded cable with additional strength.

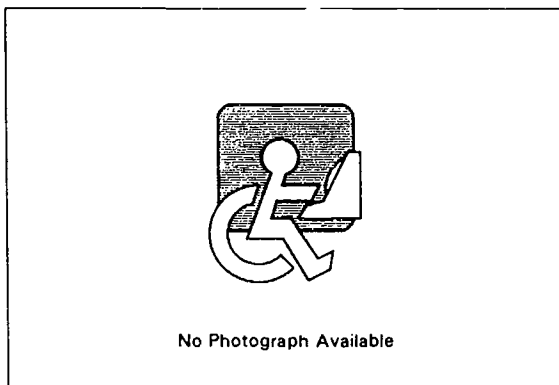

**Product Name:** MouseMan Cordless

**Vendor:** Logitech, Inc.

**Computer:** IBM PC Family

**Cost:** Contact manufacturer

MouseMan Cordless is an ergonomically designed cordless mouse. The device is a radio mouse that transmits cursor positions to a receiver attached to the computer. The mouse transmits through other objects and has a range of up to six feet. The receiver plugs into the serial or mouse port of the computer and all installation software is included.

DOS 3.3 or higher is required.

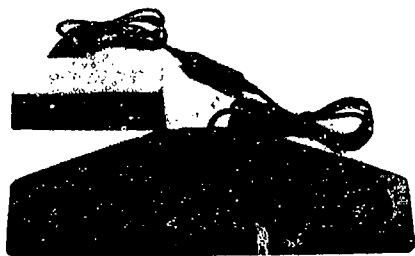

**Product Name:** MouseMover - Mac (5005)

**Vendor:** TASH, Inc.

**Computer:** Apple Macintosh Family

**Size:** 6" x 3.5" x 1.5"

**Weight:** 7.8 oz.

**Cost:** \$275.00

MouseMover - Mac is a device that allows a set of switches to be used in place of a mouse for input to a Macintosh computer. Five input switches are used to produce up, down, left and right cursor movement plus mouse button action. A latching feature is provided to reproduce mouse movement with the mouse button held down ("dragging"). This latching is activated by holding down the mouse button switch for a certain (adjustable) length of time. The speed of cursor movement with the MouseMover goes in two stages. The initial speed when a switch is activated is fixed and slow. After a one second delay the speed increases to a higher value, the magnitude of which is adjustable. The MouseMover plus on-screen keyboard software will also serve in place of the standard keyboard. Special software presents an on-screen image of the keyboard. The user moves the mouse cursor to the desired key and clicks the mouse button in order to "type" that key.

MouseMover is designed to substitute transparently for the mouse, providing access to standard software on all Macintosh computers with an ADB connection.

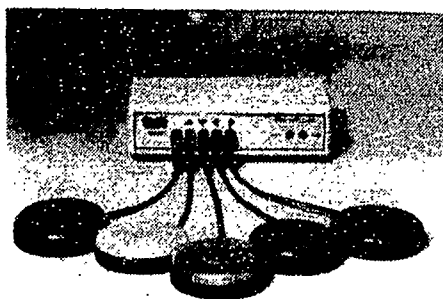

**Product Name:** MouseMover - PC Windows (5004)

**Vendor:** TASH, Inc.

**Computer:** IBM PC Family

**Cost:** \$275.00

MouseMover allows the user to control mouse movement and function through five single switches (not included). The hit of each switch delivers a specific mouse function: click, double click, press and hold, release, and all mouse directional movements on screen. The device plugs directly into the serial port on an IBM or compatible computer.

A Microsoft Mouse Driver is required.

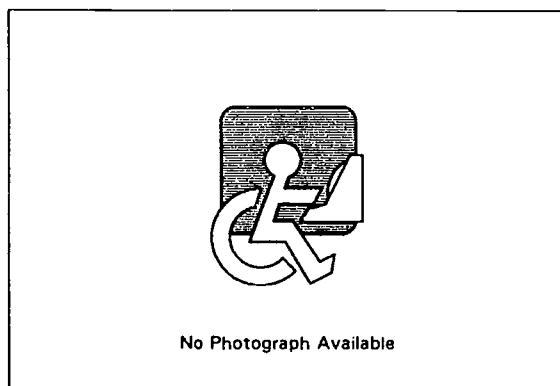

**Product Name:** MousePen

**Vendor:** Appoint

**Computer:** Apple Macintosh Family,  
IBM PC Family, IBM PS/2 Family

**Cost:** \$79.00 - \$90.00

MousePen is a cursor control device which is the approximate shape and size of a traditional writing pen. The click button is located on the shaft of the device.

There are several models available. The MousePen Pro PC is compatible with the standard Microsoft serial and IBM PS/2 mice; the MousePen Pro Portable is designed to work on a variety of surfaces for situations where "mousing" space is limited. Both IBM versions come with the MousePen with PS/2 connector, adapter for DB9 or DB25 serial ports, Microsoft compatible mouse driver with installation program, Menu Maker for using MousePen with non-mouse applications, 3.5" and 5.25" disks, and user manual. MousePen PC comes with a pen holder; MousePen Portable comes with a carrying case. The MousePen Mac, which is compatible with any Apple system using the Apple Desktop Bus (ADB) interface, has a second button that allows cursor velocity to be changed without invoking the control panel. A user manual and pen holder are also included.

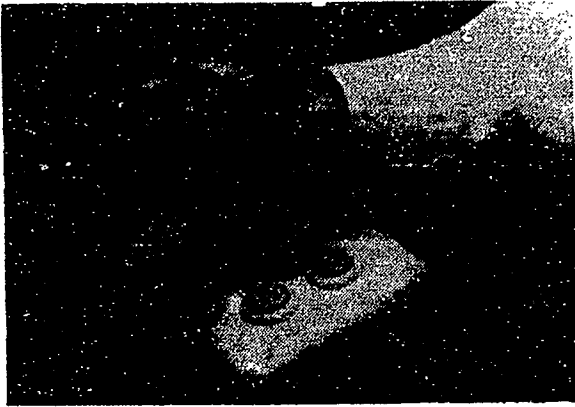

**Product Name:** MouseStick II

**Vendor:** Advanced Gravis Computer Technology Ltd.

**Computer:** Apple Macintosh SE/II

**Size:** Contact manufacturer

**Weight:** 2.4 lbs.

**Cost:** \$69.95

The MouseStick is a joystick that can be used in place of a mouse to move the cursor on the screen. The joystick can also be configured by the user to provide customized response for a variety of software programs. The joystick has five buttons, three on the handle and two on the base; each button responds to a single, double, or triple click. Customized settings can be saved, and designated settings can be automatically loaded when the software package is loaded.

MouseStick works with Macintosh computers which have ADB ports.

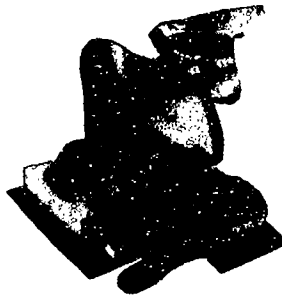

**Product Name:** Mouth Operated Joystick for Genesis  
Video Game

**Vendor:** KY Enterprises

**Size:** 4" x 4"

**Weight:** 1 lb.

**Cost:** \$109.00

The Mouth Operated Joystick for Genesis provides an alternate input method to the video game system. A lever switch is used to start and reset the games. The joystick is moved with the mouth. Button A is operated with a puff and Button B is operated with a sip. Two controllers are provided on the same plug: the Mouth Operated Joystick and a regular hand controller, allowing for team play.

Head movement is required to operate this joystick. Video tape available for \$10.00.

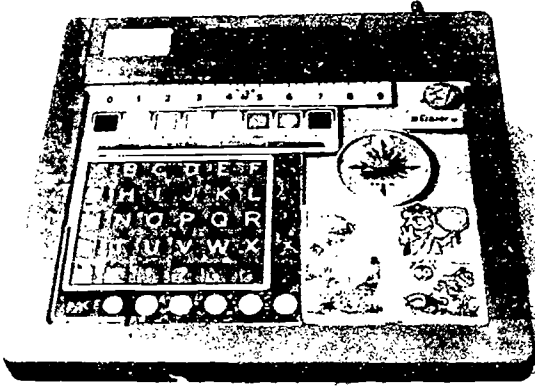

**Product Name:** Muppet Learning Keys

**Vendor:** Sunburst Communications, Inc.

**Computer:** Apple II Family,  
Apple Macintosh Family, IBM PC jr,  
IBM PS/2 Family

**Cost:** \$129.00 - \$199.00

Muppet Learning Keys is an expanded membrane keyboard for Apple II, IBM PC jr/PS2, and Macintosh computers. The keyboard's 83 keys are covered with color cartoons of Jim Henson's Muppets characters illustrating the various functions of the keys.

Muppet Learning Keys is not equivalent to a standard keyboard but must be used with some program that defines a meaning for each key or group of keys. The program provided with the keyboard uses color animated graphics and music to teach letters, numbers, and colors. Some other programs available which use the Muppet Keys are the PEAL Series (PEAL Software) and the Muppet Slate (Sunburst Communications). Contact Sunburst about other programs available or in development. The Apple II and IBM models are \$129.00; the Macintosh version is \$199.00.

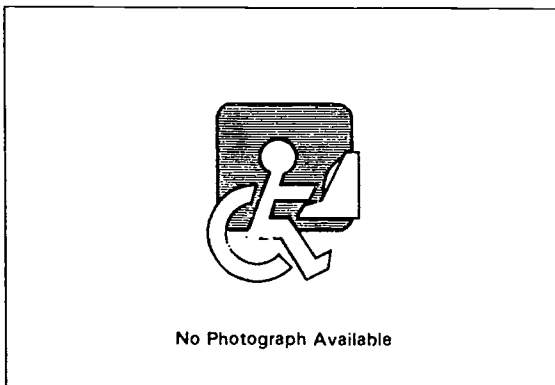

**Product Name:** My First Keyboard

**Vendor:** Kidtech, Inc.

**Computer:** IBM PC Family

**Cost:** \$69.95 - \$99.00

My First Keyboard is a 55-key computer keyboard designed for young children. The keyboard features keys that are bigger than normal, colorful, and in alphabetical order. The keyboard is designed to be rugged, spill proof, and prevent the child from harming the computer. Also, only one response per touch prevents keys from being repeated if the user leans on the keyboard. A standard keyboard plugs directly into the My First Keyboard and a switch allows for toggling from one to the other.

Package includes the keyboard, an extension cable, PS-2 adapters, instructions, and an educational software package.





**Product Name:** My-T-Mouse

**Vendor:** Innovation Management Group, Inc.

**Computer:** IBM PC Family

**Cost:** \$49.95 - \$199.95

My-T-Mouse is a keyboard interface program designed to allow a mouse or any other pointing device (including Trackballs, Pens, Touchscreens, Joysticks, Puffing Devices, Head Mice, InfraRed, and switches) to operate within Microsoft Windows without, or as an addition to, a keyboard. The software contains five different U.S. (ABCD, QWERTY, Dvorak, etc.) and 20 international keyboards, which appear on the screen in a "Heads-Up" format. An unlimited number of user-defined macro buttons can be created that store keystroke sequences to single buttons. These macro functions also allow applications to be launched by them or the application may be set to auto-open the Macro Panels associated with it. The program also features a four functions calculator with memory and savable pop-up calculator tape. More than 125 distinct functions are available, including a magnifier which enhances viewing of the area under the cursor. My-T-Mouse features 11 different screen sizes.

My-T-Mouse currently works with Windows 3.0 and 3.1, Windows for Workgroups 3.11, and Windows 95. Other operating systems are in development; contact manufacturer for further details.

---

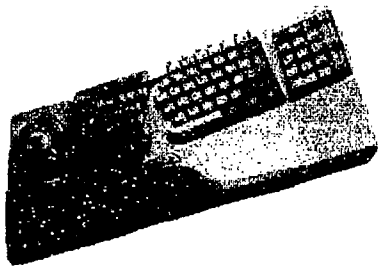

**Product Name:** MyKey

**Vendor:** ErgonomiXX, Inc.

**Computer:** Apple Macintosh Family, IBM-PC XT, IBM PC AT, IBM PS/2 Family

**Size:** 20.5" x 9.17" x 3.05"

**Weight:** 5 lbs.

**Cost:** \$275.00

MyKey is a computer keyboard and trackball combination designed to minimize stresses that lead up to Repetitive Strain Injuries (RSI). MyKey features a v-shaped design with a center-peak and front and rear elevators. Large palm-rests and function keys placed in a circular form are also featured. The center-point trackball and dual spacebars function with the thumbs moving towards the fingers in a grasping motion. The keyboard is designed to fit into under-the-counter computer trays.

MyKey is compatible with IBM compatible computers running under DOS, Microsoft Windows, OS2, and Windows 95 operating systems and with Apple computers.

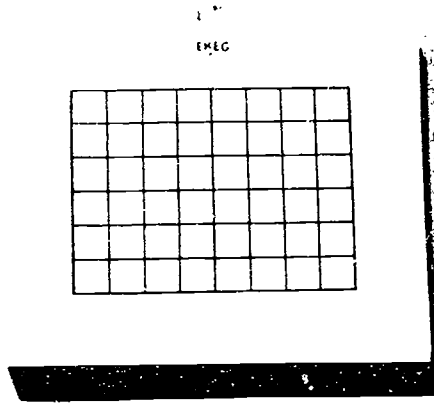

**Product Name:** Narwhal Expanded Keyboards for Adaptive Firmware Card

**Vendor:** EKEG Electronics Company LTD

**Computer:** Apple II+, Apple IIGS, Apple IIe

**Size:** 10" - 12" x 12" - 20" x 1"

**Weight:** 1 - 2 lbs.

**Cost:** \$200.00 - \$350.00

Expanded Keyboards for Use with the Adaptive Firmware Cards are alternate keyboards designed for use with the Trace Center's Talking BlissApple program. Unlike EKEG's other keyboards for the BlissApple program, these do not contain a microprocessor, but must be used with an Apple II+ or IIe equipped with an Adaptive Firmware Card (see entry).

Four models of these Expanded Keyboards are available, one with 48 1" squares, one with 48 1.25" squares, one with 128 1" squares, and one with 128 1.25" squares. Keyguards are available for all these boards, ranging in cost according to model.

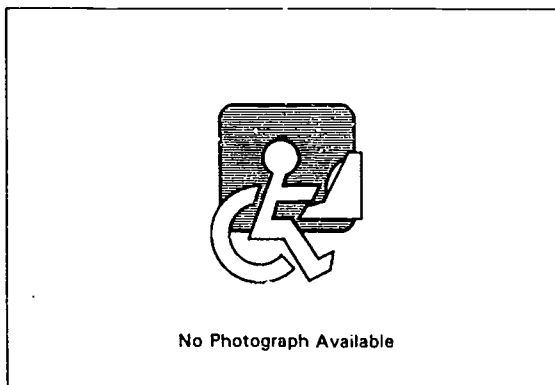

**Product Name:** Nintendo & Super Nintendo Joystick Module

**Vendor:** Toys for Special Children, Inc.

**Computer:** Nintendo

**Cost:** \$90.00 - \$95.00

The Nintendo & Super Nintendo Joystick Module allows individuals with physical limitations to play the popular video games. A joystick module is available for Nintendo at \$95.00 and for Super Nintendo at \$90.00. An interface module is also available without the joystick but with jacks for up to 8 external capability switches for \$90.00.

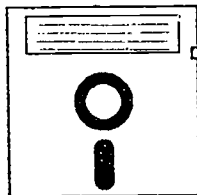

**Product Name:** NoMouse

**Vendor:** Abacus

**Computer:** IBM PC Family

**Manual Form:** Electronic Manual

**Cost:** \$49.95

NoMouse is a software program designed to emulate the functions of the mouse in a Microsoft Windows environment. The program utilizes the four cursor keys to perform mouse functions. By using the cursor keys the user directs an oversize pointer anywhere on the computer screen. A configuration screen allows the user to adjust the program's settings, including tracking speed and acceleration. The user can also designate hot keys and a "home" screen position for the NoMouse pointer. The NoMouse program can be used in conjunction with the standard mouse and any Microsoft Windows applications.

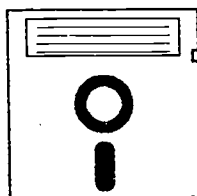

**Product Name:** OfficeTALK for Windows

**Vendor:** Kolvox Communications

**Computer:** IBM PC Family

**Cost:** Contact manufacturer

OfficeTALK for Windows is a speech recognition system that enables the user to command and control any Microsoft Windows application by voice. The user can dictate and edit documents as well as perform such commands as "create" and "print." Trained users can dictate between 70 and 90 words per minute and speed increases as the program adapts to the user's voice. OfficeTALK features a 200,000-word dictionary and a 30,000 or 60,000-word active vocabulary. Recognition rates are greater than 95 percent.

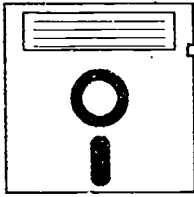

**Product Name:** One Access

**Vendor:** Consultants for Communication Technology

**Computer:** IBM PC Family

**Manual Form:** Printed Manual

**Cost:** \$300.00

One Access is a keyboard emulator that allows a person to access the functions of the computer keyboard with a single switch. The program puts an array of choices on the screen and the user selects by scanning the choices with the switch. Selecting a letter, number or other character in this way is equivalent to typing it on the computer keyboard, so the user can operate any standard software on the computer. The program has a word prediction feature.

One Access can be purchased separately or is available as part of the Handy Speech Communication Aide (see entry). A switch is not included.

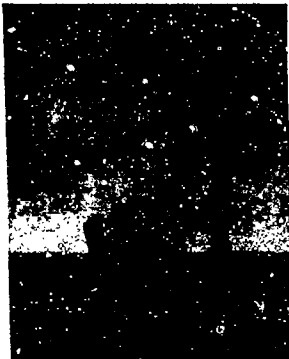

**Product Name:** One-Hand Operated Joystick for Genesis Video Game

**Vendor:** KY Enterprises

**Size:** 4" x 4"

**Weight:** 1 lb.

**Cost:** \$109.00

One-Hand Operated Joystick for Genesis is an alternative input device for Genesis systems. The device is a joystick with a sip and puff switch mounted on a base that can be secured to a table. Specify right or left hand model when ordering. A video tape is available for \$10.00.

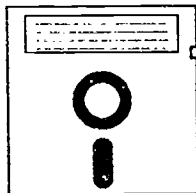

**Product Name:** OneStrk

**Vendor:** E. David & Associates

**Computer:** IBM PC Family

**Cost:** \$19.95

OneStrk is a program that allows complete keyboard input using just one key on the keyboard. Typically the space bar would be selected. OneStrk puts an array of characters on the screen representing the keys on the keyboard, and the user presses the one key to scan through the choices and select a key. Selecting a key in this manner is equivalent to pressing it on the standard keyboard; thus, standard software that uses the keyboard for input can be controlled using OneStrk. OneStrk can be set up to load automatically when the computer is turned on. It can be temporarily shut off for people who don't need it.

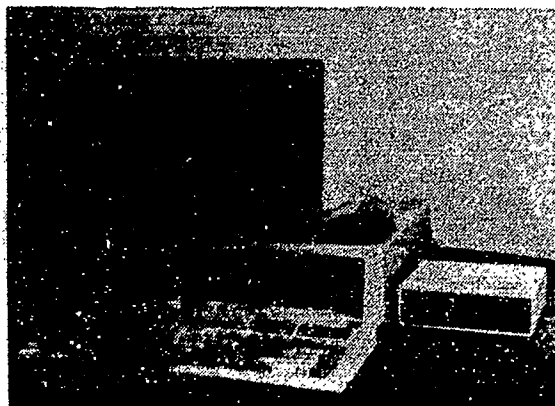

**Product Name:** Optimouse

**Vendor:** ISCAN, Inc.

**Computer:** IBM PC Family

**Size:** 5.75" x .5" diameter (pointer)

**Weight:** 2 oz. (pointer)

**Cost:** \$995.00

Optimouse is a light pen that functions as an alternative mouse. The system consists of a video sensor that plugs into the computer, an image processing card that fits inside the computer, and a hand-held pointer. The pointer is directed towards the computer screen, and is used to move the cursor around on the screen. A reflective spot (extra), which may be affixed to any moveable body part, may be used instead of the hand-held pointer. Mouse button function is emulated by pressing a button on the side of the pointer.

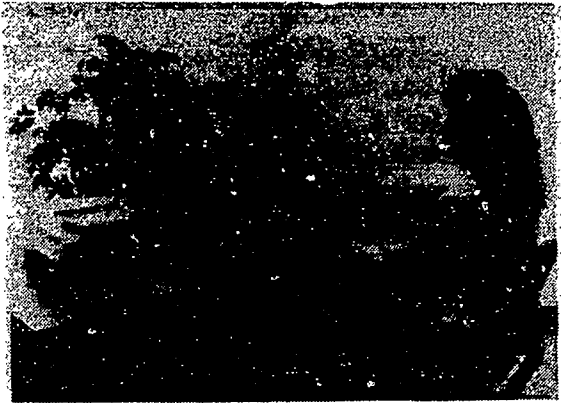

**Product Name:** OsCaR

**Vendor:** TeleSensory Corporation

**Computer:** IBM PC AT, IBM PS/2 Models 50/60,  
IBM PS/2 Models 70/80

**Cost:** \$2,495.00 - \$2,840.00

OsCaR is an optical character recognition (OCR) system that scans typewritten or printed documents and imports the information to a computer text file, which can be read, edited, and saved for later use. The system recognizes text from 6 to 72 points in size, and in type styles such as underlined, boldface, italic, and headline. Text to be scanned can be oriented either vertically (portrait) or horizontally (landscape) on the page. OsCaR has been designed to work with TeleSensory devices such as PowerBraille, Vista, VersaPoint, and the ScreenPower line of screen access hardware and software, and can produce files (including grade 2 Braille) for direct use with these devices.

OsCaR works with 386 & 486 PC's, and uses the OmniPAGE OCR package (from Caere Recognition Systems) to recognize text. The package includes: OsCaR, software, Hewlett Packard ScanJet3p and ScanJet interface card, and OCR software from Caere. A package including Duxbury Braille translation software (see entry) is also available. Contact manufacturer for further price and feature information.

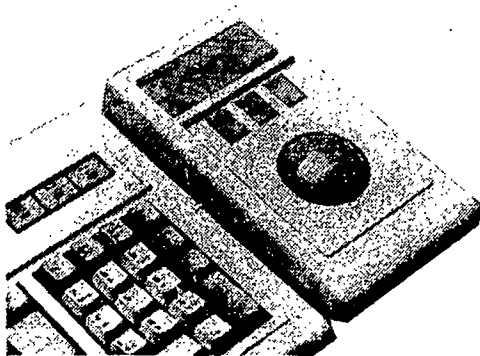

**Product Name:** PC-TRAC

**Vendor:** Microspeed Inc.

**Computer:** IBM PC Family, IBM PS/2 Family,  
Toshiba Laptops

**Size:** 3.75" x 6.75" x 1.75"

**Weight:** 12 oz.

**Cost:** \$119.00 - \$159.00

PC-TRAC is a trackball and three buttons contained in a small case. The user moves the trackball manually to emulate mouse cursor control. The left and right buttons, which surround the trackball, emulate the "click" button on the standard mouse. The center button, located above the trackball, toggles the "drag lock" feature that produces a similar effect to holding down the button on a standard mouse; the drag lock eliminates the requirement that a button be held down. The trackball case has a sloped panel that may be used as a wrist rest.

PC-TRAC is available in three models: a serial version that can be plugged into the COM1 or COM2 port (\$119.00), a bus version that can be plugged into any empty expansion slot (\$159.00), and a PS/2 mouse port-compatible version (\$119.00).

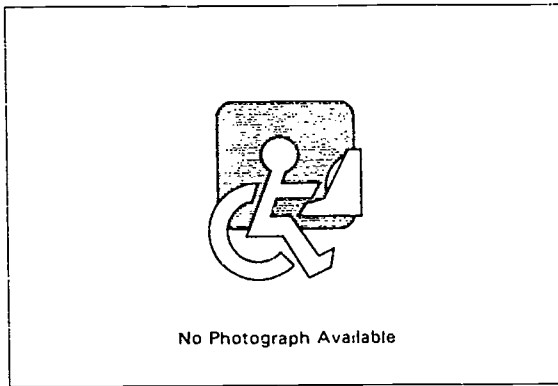

**Product Name:** Pen Style Mouse  
**Vendor:** A4 Tech (USA) Corporation  
**Computer:** IBM PC Family  
**Cost:** \$17.50

Pen Style Mouse is designed to replace the standard mouse on computer systems. The Pen Style is held upright in the hand and mouse buttons are located on top of the device.



**Product Name:** PKD 84 and 101  
**Vendor:** Advanced Input Devices  
**Computer:** IBM PC Family, IBM PS/2 Family  
**Size:** 17.63" x 7.5" x 1.25"  
**Cost:** \$250.00 - \$275.00

The PKD 84 and 101 are IBM compatible flat panel keyboards that use a sealed, printed graphic overlay to replace keys and metal dome switch technology to replace key switches. The PKD 84 is compatible with IBM AT computers; the PKD 101 is compatible with IBM-PC, XT, AT and PS/2 computers.

Contact manufacturer about custom design of keyboards with electrical, mechanical, or graphics options.

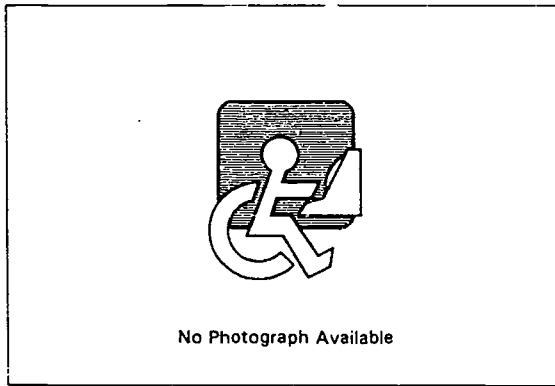

**Product Name:** PortaPoint  
**Vendor:** Interlink Electronics  
**Computer:** IBM PC Family  
**Cost:** Contact manufacturer

PortaPoint is a computer pointing device and finger-tip controlled mouse. Gentle pressure on the button moves the cursor. The device can be used on a desktop with the included cradle, with a portable computer, or as a hand-held pointing device. A serial interface cable, PS/2 adapter, 4 foot extension cable, and a 3.5" VersaPOint DOS and Windows driver diskette are included.

System requirements include a serial port or PS/2 mouse port, MS-DOS 2.0 or newer, and 640K memory. The PortaPoint is also fully compatible with Microsoft Windows.

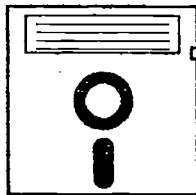

**Product Name:** PowerKey Software for IBM  
**Vendor:** Dunamis, Inc.  
**Computer:** IBM PC Family  
**Manual Form:** Printed Manual  
**Cost:** \$99.95

PowerKey Software for IBM allows standard IBM software programs to run directly from the PowerPad (see entry). Using PowerKey, the user can also design SetUps by defining single or multiple keystrokes. PowerKey includes a 12x12 grid on which overlays can be created: each square can be defined in relation to the surface of the PowerPad.



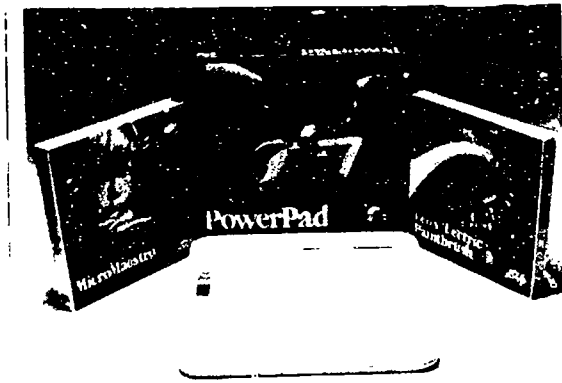

**Product Name:** PowerPad

**Vendor:** Dunamis, Inc.

**Computer:** Apple II+, Apple IIGS, Apple IIe,  
Atari 400, Atari 800, Commodore 128,  
Commodore 64, IBM PC Family

**Size:** 17" x 19" x 1.5"

**Weight:** 4.5 lbs.

**Cost:** \$229.95

PowerPad is a flexible alternate computer input consisting of a grid of 14,400 microswitches covered with a 12" x 12" plastic pad. Depending upon the program used, the surface of the PowerPad can be divided up many ways yielding different sized activation areas. Overlays can then be custom designed to indicate what each "key" on the PowerPad signifies in that program's configuration.

PowerPad connects to the game port of most computers. Many programs have been developed for the PowerPad which are useful for augmentative communication or for rehabilitation training and education. PowerPad Tool Kit Software, a ProDOS authoring program for designing customized PowerPad applications, is available for \$69.95. PowerKey, a software program that permits the PowerPad to be combined with the Adaptive Firmware Card (see entry) and used as an input device for most Apple software, is available for \$99.95. Contact the manufacturer for more information on available software.

---

**Product Name:** PowerPad Starter Kit

**Vendor:** Dunamis, Inc.

**Computer:** Apple IIGS, Apple IIe, IBM PC Family

**Manual Form:** Printed Manual

**Cost:** \$279.95

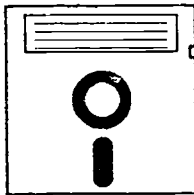

PowerPad Starter Kit is a set of materials for getting started setting up a PowerPad keyboard (see separate entry). The kit includes the PowerPad, cabling, and special software for programming the PowerPad to work as a keyboard or with particular software. The Starter Kit software provides an image of the PowerPad on the computer screen, and the user can type in the desired values for each of the 144 pressure-sensitive areas on the PowerPad.

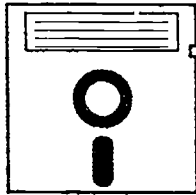

**Product Name:** PowerSecretary

**Vendor:** Articulate Systems, Inc.

**Computer:** Apple Macintosh Family

**Cost:** \$2,495.00

PowerSecretary is a voice input system for the Macintosh computer. PowerSecretary allows users to freely dictate words at speeds up to 50 words a minute into applications ranging from word processors to industry specific applications. The system is a speaker-adaptive, large vocabulary discrete recognition program with a 120,000 word dictionary for spell checking.

PowerSecretary requires a 68040 class Macintosh, a 16 bit sound input card, 20 MB, hard disk with 25 MB free, microphone, and system 7.0 or greater.



**Product Name:** Pre-Dict-ate

**Vendor:** Madenta Communications, Inc.

**Computer:** Apple Macintosh Family

**Manual Form:** Printed Manual

**Cost:** \$395.00

Pre-Dict-ate is a voice input system integrated with word prediction software. The user trains the system to recognize spoken keywords. When a word that stands for a letter (such as "Juliet" for "J") is spoken, the letter appears on the screen and a list of words beginning with that letter appears. The user can either select a word from the list with a voice command or "type" a second letter, which will bring up a list of words beginning with the two letters typed. The program automatically adjusts the word lists to correspond to the particular user's most common word usage. Pre-Dict-ate allows the user to type text or commands in any software running on the computer (word processing, spreadsheet, communications, etc.). Letter-by-letter spelling does not have to be used; the system can also be trained to recognize whole words. Multiple users can each have their own voice files, so that the system will recognize each of the user's voices.

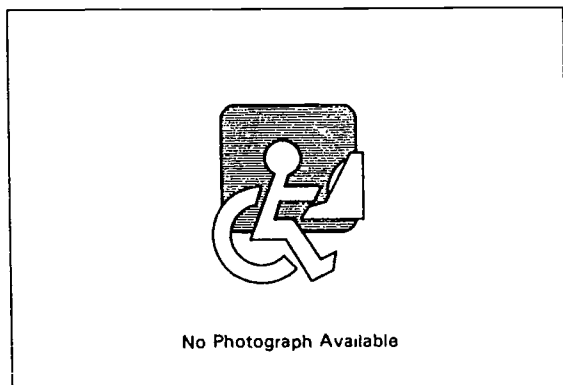

**Product Name:** ProPoint

**Vendor:** Interlink Electronics

**Computer:** IBM PC Family, IBM PS/2 Family

**Cost:** Contact manufacturer

ProPoint is a hand held mouse emulator. It requires no hand or arm movement, is equally usable by both left and right-handed users, and is shaped to fit nearly any hand size. Soft pressure on ProPoint's button gives precise control of the cursor and harder pressure gives faster movement. ProPoint comes with a VersaPoint Windows driver to optimize operation to personal preference.

System requirements are serial port or PS/2 mouse port, MS-DOS 2.0 or newer, 640K memory, and full Microsoft Windows compatibility.

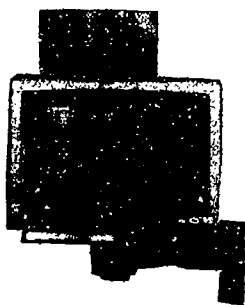

**Product Name:** Proportional Keystroke Scanner

**Vendor:** Ability Systems Corporation

**Computer:** IBM PC Family, IBM PS/2 Models 25/30,  
IBM PS/2 Models 50/60

**Size:** 4" x 8" x 8"

**Weight:** 4 lbs.

**Cost:** \$2,850.00

Proportional Keystroke Scanner is a input device operated by scanning characters at a rate that is proportional to the air pressure the user applies to the puff tube. The system consists of a display module with all the characters of the keyboard on it and an input system that may be controlled by a sip and puff device. The user's current position is indicated by one of the characters being lit up on the display. Each of the four rows of characters can be scanned horizontally by sipping, and the scanning rate is controlled by the amount of force applied by the user's sipping. The user slows down when in the vicinity of the correct character, and stops sipping when it is reached. Characters are selected by puffing gently; they then appear on the computer screen. The user sips sharply to change rows on the display panel, or puffs and holds to repeat the previous selection. The system attaches to the computer by means of the computer's industry-standard RS-232 communications port.

The price listed above includes the sip and puff device and "Abilitywrite" driver software. Available options include a telephone switch hook control module.

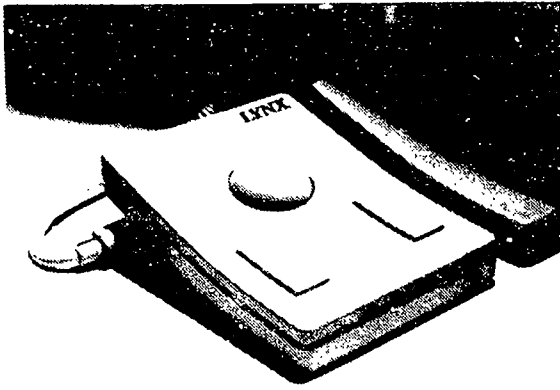

**Product Name:** QUADLynx Trackball  
**Vendor:** Asher Engineering Corporation  
**Computer:** Apple IIc, Apple IIe,  
 Apple Macintosh Plus  
**Cost:** \$99.95

The QUADLynx Trackball plugs directly into the mouse port of the Apple II or Macintosh and handles all software just as the mouse would. The trackball is set in a stationary base, and is designed for precise cursor manipulation, versatility and ease-of-use. The design also reduces the accumulation of dust.

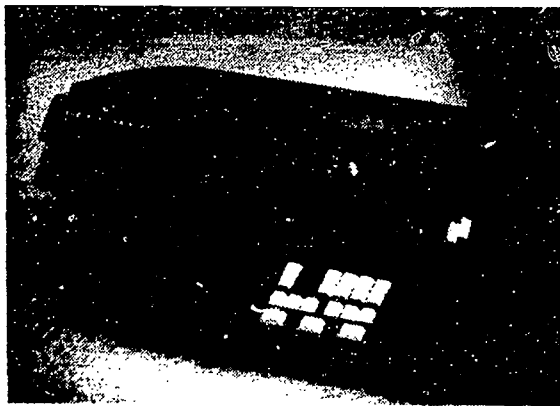

**Product Name:** Reading Edge  
**Vendor:** Xerox Imaging Systems, Inc.  
**Computer:** All (Hardware Independent)  
**Size:** 7.5" x 19.5" x 15"  
**Weight:** 24 lbs.  
**Power Source:** 120V AC  
**Cost:** \$5,495.00

Reading Edge is an optical character recognition (OCR) reading machine with voice output. The user places a piece of printed text on the surface of the device, which scans an image of the page and recognizes the characters (letters, numbers, etc.). The Reading Edge reads the material back to the user in a synthesized voice as it is scanned. Almost any type face or size can be recognized, and multiple columns can be read correctly. Bold and italicized print can be spoken in a different voice. An automatic page orientation feature adjusts for pages which are upside down. The surface of the scanner slants at a 15 degree angle to hold open books more securely. The Reading Edge can recognize different languages, using different memory cards which can be inserted into the device. Scanned documents are saved in the device's memory, and can be edited using built-in braille-style keypad. Documents can also be transferred to a computer through a serial port.

Carrying case and automatic document feeder are options.

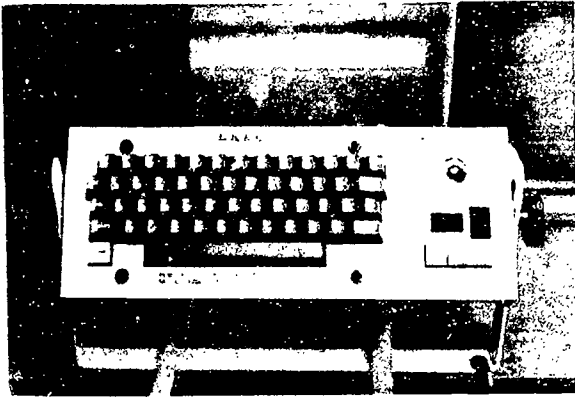

**Product Name:** Remote Keyboard for the Apple II+ and IIe

**Vendor:** EKEG Electronics Company LTD

**Computer:** Apple II+, Apple IIe

**Size:** 15" x 8" x 3"

**Weight:** 3 lbs.

**Cost:** \$750.00

Remote Keyboards for the Apple II+ and IIe are alternate keyboards for these computers that are modified to allow operation with one hand, stylus, headstick, or mouthstick. Size and layout of keys are exactly the same as the standard Apple keyboards, but several features have been added. SHIFT and CONTROL keys are latching, repeat time is adjustable for the II+ version, and can be extended up to five seconds, and a special joystick that can be operated by headstick or mouthstick has been added, allowing the user access to graphics programs that require a joystick.

Remote Keyboards for the Apple II+ and IIe send the same output to the computer as their standard counterparts, and plug into the keyboard and game paddle sockets. They are mounted on brackets that allow raising, lowering, and tilting.

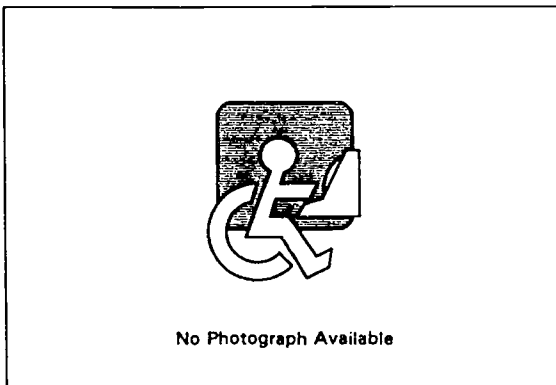

**Product Name:** RemotePoint

**Vendor:** Interlink Electronics

**Computer:** Apple Macintosh Family, IBM PC Family

**Size:** 1.76" x 5.34" x 1.4"

**Cost:** Contact manufacturer

RemotePoint is a wireless, finger-tip controlled mouse that can complete point and click mouse functions from up to 40 feet away from the computer. RemotePoint features pressure-pointing technology that gives cursor control by applying minimal pressure in the direction of desired movement. An IBM compatible version and a Macintosh compatible version are available.

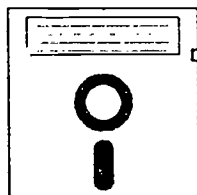

**Product Name:** RevolvingDoors

**Vendor:** Madenta Communications, Inc.

**Computer:** Apple Macintosh Family

**Cost:** \$395.00 - \$695.00

RevolvingDoors is a single switch scanning program for controlling a Macintosh computer. The program allows the user to type any keyboard key or make any mouse movement using a single switch. An on-screen symbol scans through a series of options for controlling the mouse cursor. Any function that is performed by the mouse such as moving, clicking and dragging can be selected. An accompanying on-screen keyboard provides access to keyboard keys through scanning and also presents predictive lists of words for the user to choose from while typing. Scanning features include automatic snapping to "action regions" (such as the close box on a window), intelligent menu scanning, and adjustable scan speeds.

RevolvingDoors requires a switch interface. With a switch interface the cost is \$695.00, the software alone is \$395.00.

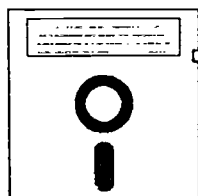

**Product Name:** Scanning WSKE II

**Vendor:** Words+, Inc.

**Computer:** IBM PC Family

**Manual Form:** Printed Manual

**Cost:** \$695.00 - \$1,395.00

Scanning WSKE (Words+ Software Keyboard Emulator) II is a RAM-resident program that allows an IBM-compatible computer to be used as an integrated augmentative communication/computer access system for single switch scanning users. The system provides dual word prediction, abbreviation expansion, automatic word endings, punctuation spacing, and capitalization, and voice output capability. A One Line Scan option permits the scanning window to be reduced to a single line so that only the row being scanned is displayed. The system runs transparently with applications software, including some graphics programs.

The Bank Street Writer word processor program is included with Scanning WSKE. The voice output option (\$1,395.00) will work with most serial port text-to-speech speech synthesizers or SmoothTalker (extra). A No Voice option (\$695.00) permits the program to be run without voice output.

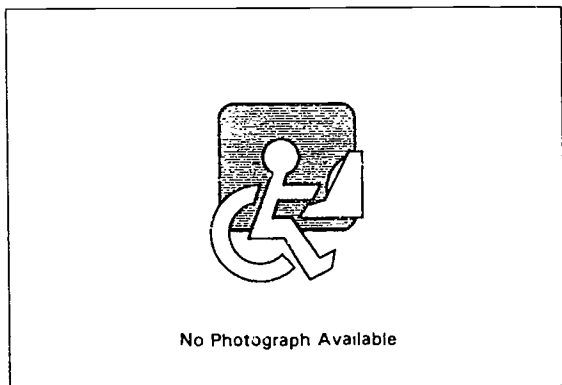

**Product Name:** ScottBridge Speech Access System

**Vendor:** ScottBridge, Inc.

**Computer:** Apple Macintosh Family, IBM PC Family

**Cost:** Contact manufacturer

ScottBridge Speech Access System is a speech recognition system that consists of three basic components. The first component is an Accessor, a CPU unit with DragonDictate 3 installed. The second component is a Total Access Port (TAP) that provides a standardized connection between the accessor and the keyboard and mouse functions of the host computer. The third component is a Sound and Voice Interface (SAVI) that resides in the accessor and translates user input into the standard format recognized by the TAP and provides various user-support functions. ScottBridge operates independently of the host computer and does not affect the speed of the computer or interfere with existing hardware.

ScottBridge works with IBM compatible PCs, Silicon Graphics workstations, Sun Microsystem workstations, the Apple Macintosh, and mainframe computers.



---

**Product Name:** ScreenDoors

**Vendor:** Prentke Romich Company

**Computer:** Apple Macintosh Family

**Cost:** \$425.00

ScreenDoors is an on-screen keyboard application that runs with most Macintosh applications under MultiFinder. The program puts a graphic of a keyboard on the monitor's screen, which then can be activated with a mouse or mouse emulator, such as HeadMaster or TouchWindow (see entries). ScreenDoors features word prediction linked to a dynamic learning dictionary. Multiple topical dictionaries are supported.

ScreenDoors requires System 6.03 or newer, MultiFinder, and 2MB RAM.

471

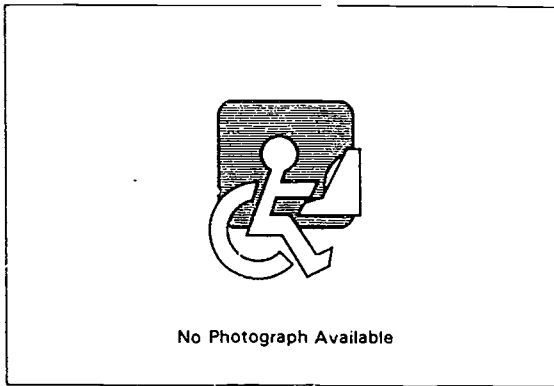

**Product Name:** Select-Ease Keyboard

**Vendor:** Lexmark International, Inc.

**Computer:** IBM PC Family

**Cost:** \$179.00

The Select-Ease Keyboard is an ergonomic keyboard featuring a tilted, split keyboard which the user can shape into a number of different positions. A QWERTY keyboard layout is standard and the backspace key has been moved to right next to the spacebar.

A separate number pad is available for \$20.00.

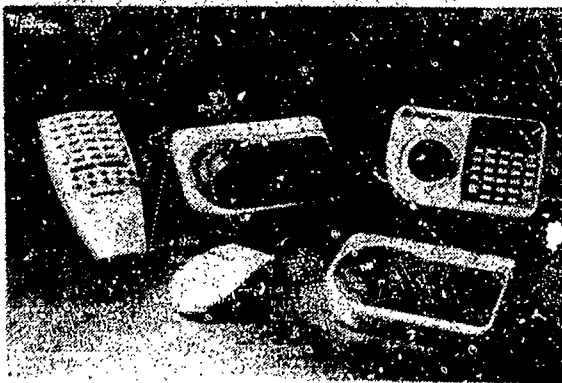

**Product Name:** Serial Trackball and PS/2 Trackball

**Vendor:** ProHance Technologies, Inc.

**Computer:** IBM PC Family, IBM PS/2 Family

**Size:** 6.2" x 4.2" x .14"

**Weight:** 10.6 oz.

**Cost:** \$79.95 - \$99.95

The Serial Trackball and PS/2 Trackball are trackballs designed so that the trackball can be moved using the thumb. Three buttons are located above and to the right of the ball. The devices have three speed ranges with resolutions varying from 50 to 800 dots per inch. The Serial model is capable of emulating both the two-button Microsoft Mouse and the three-button PC Mouse, and automatically invokes one of these modes based on the current configuration of the user's system. The PS/2 model emulates the IBM PS/2 standard mouse. Both trackballs come with 14 drivers, allowing them to work with non-mouse software such as WordPerfect and Lotus 1-2-3. A program to build pop-up menus, allowing mouse support to other non-mouse software, is also included.

The Serial Trackball (\$79.95) and PS/2 Trackball (\$99.95) are compatible with the IBM PC and PS/2 families of computers, respectively. Both models plug into the RS-232 serial port on the computer. A 9-pin to 25-pin adapter for this port is included with both models.



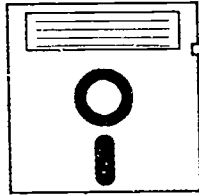

**Product Name:** SofType  
**Vendor:** Access Technology  
**Computer:** IBM PC Family  
**Cost:** Contact manufacturer

SofType is a software program that provides an on-screen, graphical keyboard that works with any alternative input device that provides mouse control for Microsoft Windows. Each of the three versions features a dwell mode that allows keys to be automatically selected when the cursor stays on the key for a specified period of time, custom keyboards, a key repeat feature, and variable key sizing.

SofType Pro has all of the above features plus scanning for single switch input and a "run" feature that provides a shortcut to starting applications. SofType Elite has all of the basic and Pro features plus word prediction and a Dragger Bar that emulates click and drag, double click, and right click with a single click. All three require the following: 386 IBM compatible computer or better, 2 MB RAM, 3.5" disk drive, mouse or an input device that emulates a mouse, and Microsoft Windows.



**Product Name:** Speak Out VOILA  
**Vendor:** VOILA Technology, Inc.  
**Computer:** IBM PC Family  
**Cost:** Contact manufacturer

Speak Out VOILA is a combination voice recognition input and synthesized voice output system with large print. The system has three main components. The Natural Language Interface allows the computer to accept logical voice phrases to execute commands. The Natural Response Interface provides the user with a natural response to their command. The Utterance Confirmation provides audio feedback of what the computer heard and eliminates the need to see a monitor.

Contact manufacturer for pricing information and system requirements.

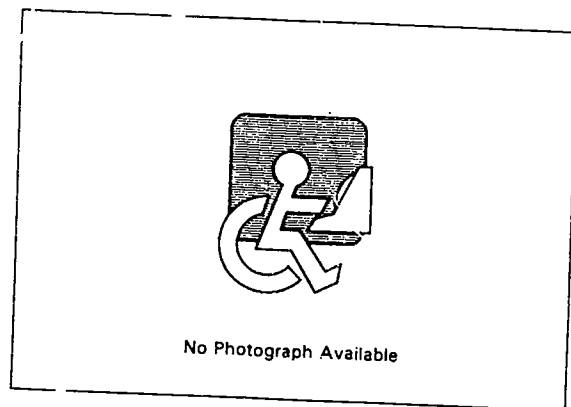

**Product Name:** Speech Recognition Systems

**Vendor:** Voice Recognition Technologies

**Computer:** All (Hardware Independent)

**Cost:** Contact manufacturer

Voice Recognition Technologies (VRT) is a turn key provider of speech recognition systems. Each system is customized to the user's particular needs. VRT adapts any speech recognition product to any software package and provides complete hardware solutions and support. Contact the manufacturer for further information.

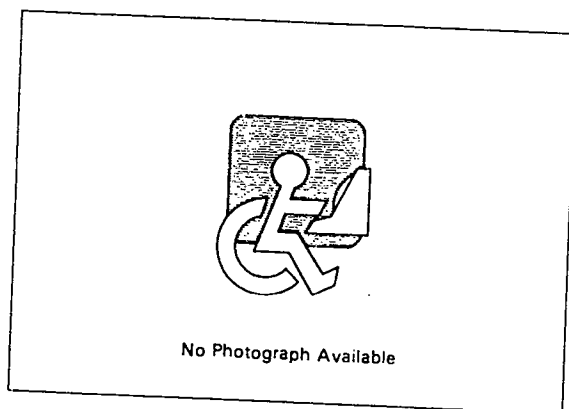

**Product Name:** Stingray

**Vendor:** CoStar Corporation

**Computer:** Apple Macintosh Family

**Size:** 3.63" x 5" x 1.38"

**Cost:** \$99.95

Stingray is a trackball designed to replace the standard mouse. The device features a small ball with large buttons that insure that the user's hand is resting on a button at all times. The buttons have a light tactile touch and can each be set as "click" or "click-lock" buttons. Other features include a pass through ADB port so the user can connect another ADB device to it and a special control panel that allows speed settings to be set up with different programs.

Stingray is available in platinum or black.

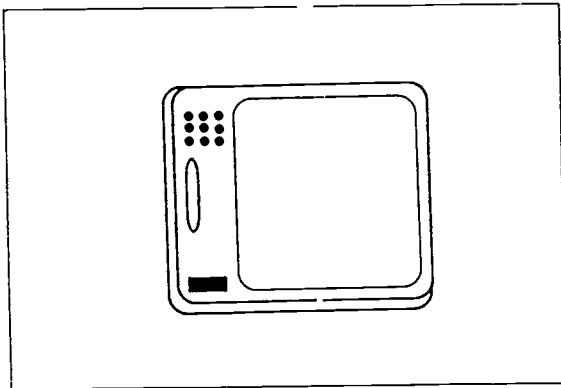

**Product Name:** Switch Modified PowerPad

**Vendor:** Creative Communicating

**Cost:** \$350.00

The Switch Modified PowerPad is a Dunamis PowerPad (see entry) with a bank of nine miniature plugs corresponding to the nine location areas on the PowerPad surface. Available with a new PowerPad or can be added to a user furnished PowerPad. Contact the manufacturer for shipping and price information.

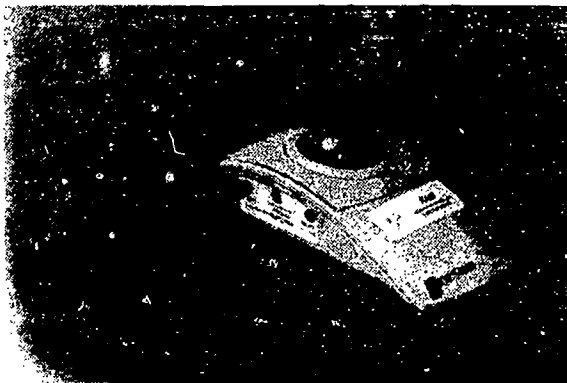

**Product Name:** Switch-Adapted Mouse (SAM)

**Vendor:** R.J. Cooper & Associates

**Computer:** Apple Macintosh Family, IBM PC Family

**Cost:** \$120.00

The Switch-Adapted Mouse is a trackball with inputs for up to three single switches. SAM allows for operation of special software that can be operated by a mouseclick, lets computer activity become a cooperative effort by having one user move the mouse and the other click via a switch, and allows a person with hand control, but not finger control, to move the mouse and click it with another part of the body.

SAM is available with a 9-pin serial or PS/2 round connector for PC use.

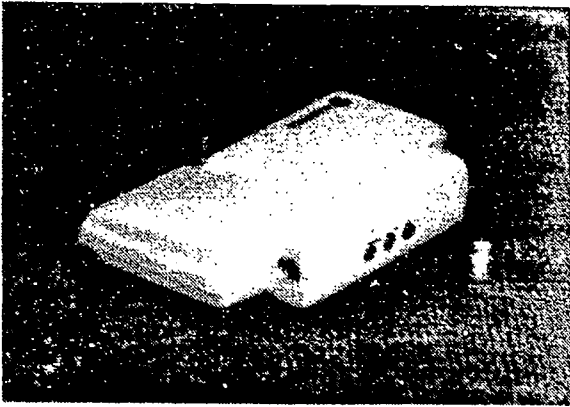

**Product Name:** Switch-Back

**Vendor:** Madenta Communications, Inc.

**Computer:** Apple Macintosh Family

**Size:** 1.3" x 6.2" x 4"

**Weight:** 8 oz.

**Cost:** \$395.00

Switch-Back is a switch interface which connects simple switches to an Apple Macintosh computer that has Desktop Bus firmware. The device accepts from one to six switches and may be connected anywhere on the Apple Desktop Bus (ADB). Switches are plugged into stereo jacks in the back of Switch-Back. When a switch is activated the computer thinks a function key on the keyboard has been pushed. Software tasks can be assigned to function keys F10 - F15 for switches 1 - 6; pressing the switch will activate the specific function. Possible applications include remote on/off and computer logging of phone calls. Such applications can be set up by connecting external input switches to the computer and customizing desired functions using macro programs.

The Switch-Back device comes with an ABD cable and documentation. ABD firmware and input switches are not included.

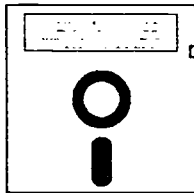

**Product Name:** SwitchMouse

**Vendor:** OMS Development

**Computer:** IBM PC Family, IBM PS/2 Family

**Cost:** \$150.00

SwitchMouse is a switch-controlled mouse emulator for use with Microsoft Windows. Users can use one or two ability switches, an Atari-style joystick, or an IBM-style joystick attached to a serial or parallel port to move the Windows mouse cursor, click and drag. The program provides multiple scanning modes for selection of mouse direction. SwitchMouse can be interfaced to the EEK program (see separate entry) to allow text entry by directed scanning. The program is supplied with one switch adapter (specify serial or parallel); switch is not included.

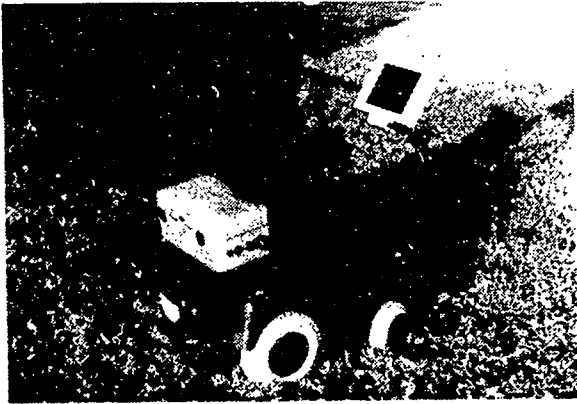

**Product Name:** SynergyMac and SynergyPC

**Vendor:** Synergy

**Computer:** Apple Macintosh Family, IBM PC Family

**Cost:** Contact manufacturer

SynergyMac and SynergyPC are portable systems designed to be mounted to a wheelchair and are user customized based on specific needs. The systems are designed to be rugged and water resistant. Available options include: a unified access method for multiple functions, speech synthesizer and speech output software, environmental control, wireless connection to a desktop computer and/or printer, portable access to standard computer software, internal CD ROM, internal fax modem. The same options are also available on a SynergyMac Carry that is designed to be carried, rather than mounted.

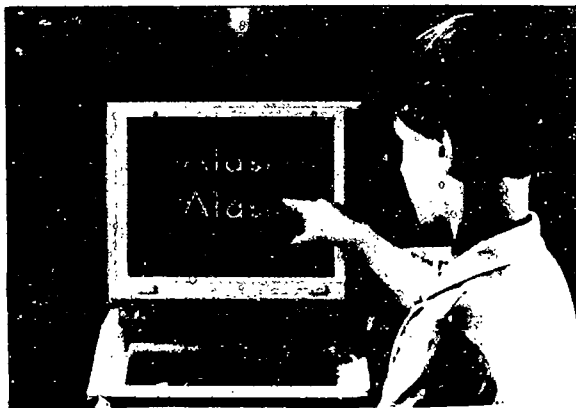

**Product Name:** TouchWindow

**Vendor:** Edmark Corporation

**Computer:** Apple II Family,  
Apple Macintosh Family, IBM PC Family

**Size:** 8.5" x 11"

**Cost:** \$275.00 - \$350.00

TouchWindow is a transparent plastic screen that fits over a computer monitor. When TouchWindow is used with compatible software, touching the screen with finger, stylus, etc. will generate input to the computer. Selection of commands, composition of graphics, and other functions can be performed. Pressure activates only the pixel at the very center of the area touched. TouchWindow can be removed from the monitor and used like a graphics tablet.

Software produced by the manufacturer for use with TouchWindow includes programs for word processing, spread sheets, management information systems, recreation, education, and writing customized programs. Software has also been written for TouchWindow by other companies. Contact the manufacturer for details. Talking TouchWindow, an authoring program for creating TouchWindow applications, is available for \$79.95. TouchWindow models are available for Apple II, IBM, and Macintosh computers. The IBM version comes with mouse emulation software for use with mouse-compatible software.

477

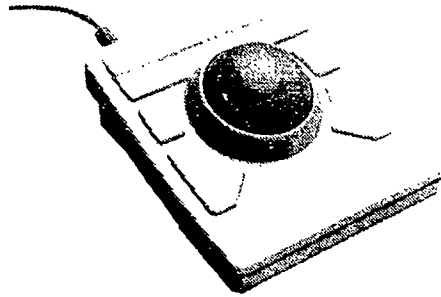

**Product Name:** Trackball Pro

**Vendor:** CH Products

**Computer:** Apple Macintosh Family,  
Commodore Amiga, IBM PS/2 Family,  
Sun Microsystems SPARCstation

**Cost:** \$119.95 - \$179.95

Trackball Pro is a trackball and four buttons contained in a small box. The user moves the ball manually to emulate mouse functions. Each button activates an additional feature; these include a "click-lock" feature which allows dragging, scrolling, and drawing without holding a button down continuously, a total left/right control, and multiple resolutions. The Macintosh version is programmable.

There are seven versions available for Amiga, Sun, Next, Serial, PS-2, and Bus, versions, and Macintosh computers; prices vary accordingly.

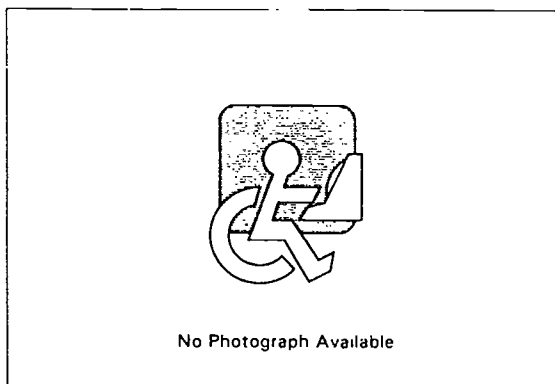

**Product Name:** TrackMan Live!

**Vendor:** Logitech, Inc.

**Computer:** IBM PC Family

**Size:** 1.2" x 6.4" x 2.4"

**Weight:** 4.27 oz.

**Cost:** Contact manufacturer

TrackMan Live! is a cordless trackball with a range of up to 30 feet. The device is designed to fit in the hand, with the thumb controlling the ball and the three differently sized buttons. The receiver plugs directly into the serial or mouse port of the computer.

System requirements include: DOS 3.3 or higher, Microsoft Windows, and an available serial or mouse port.

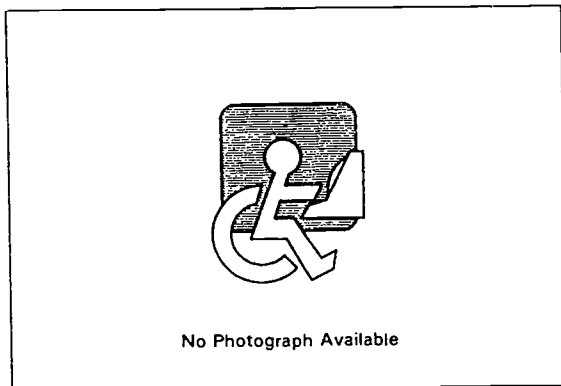

**Product Name:** TrackMan Voyager  
**Vendor:** Logitech, Inc.  
**Computer:** IBM PC Family  
**Size:** 1.36" x 2.92" x 2.14"  
**Weight:** 2.8 oz.  
**Cost:** Contact manufacturer

TrackMan Voyager is a trackball designed for desktop and notebook computers. The device can be attached to notebook computers and doesn't have to be removed when the system is closed. A hard shell cover for the trackball is included.

System requirements include: DOS 3.3 or higher, available serial or mouse port, 3.5" floppy drive.

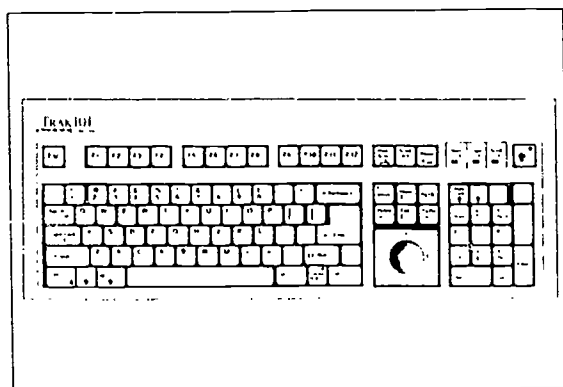

**Product Name:** Trak101 Keyboard  
**Vendor:** Key Tronic  
**Computer:** IBM PC Family  
**Size:** 19" x 8.1" x 1.8"  
**Weight:** 4 lbs., 7 oz.  
**Cost:** \$224.00

Trak101 is a keyboard with a standard 101-key, QWERTY layout and an integrated four-button trackball. Other features include customizable keyboard functions and a cursor ball key for switching between two modes of trackball operation: mouse control and cursor control.

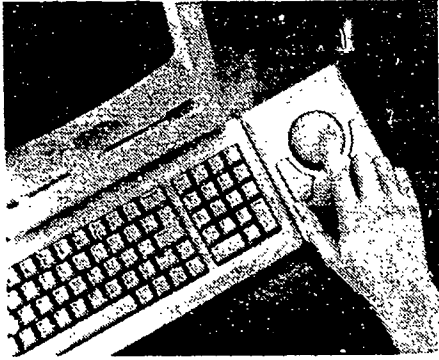

**Product Name:** Turbo Mouse 4.0  
**Vendor:** Kensington Microware Limited  
**Computer:** Apple Macintosh Family  
**Size:** 4.5" x 5.5" x 2.75"  
**Cost:** \$169.95

Turbo Mouse 4.0 consists of a trackball surrounded by a small box and custom software. The user moves the trackball manually to emulate mouse functions. Two "click" buttons are provided, so that the product may be optimally used by left- and right-handed users. The custom software allows the buttons of the trackball to be programmed to emulate specific mouse functions. Other features include a slow cursor, advanced acceleration, and customizable application settings. Turbo Mouse requires less hand movement than a regular mouse, and the track ball requires minimal finger movement.

Turbo Mouse 4.0 works with System 6.05 or higher and has two ADB ports located in the back of the trackball.

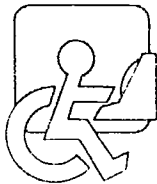

12. Photograph Available

**Product Name:** Turbo Trackball  
**Vendor:** Asher Engineering Corporation  
**Computer:** Apple IIGS, Apple IIc, Apple IIe,  
 Apple Macintosh Family  
**Cost:** \$99.95

The Turbo Trackball consists of a trackball encased in the center of a small box. The user moves the trackball to emulate mouse functions. Two buttons below the trackball allow the user to emulate the "click" function on the standard mouse and to provide a lock feature (so that, for example, a menu will stay held down without requiring the user to continually press a button).

The Turbo Trackball is available in three models. Model LX200-192-D1 is for Macintosh 512 and Plus models and Apple IIc and IIe; Model LX200-192-S1 is for Macintosh SE and II; and Model LX200-192-S3 is for Apple IIGS.



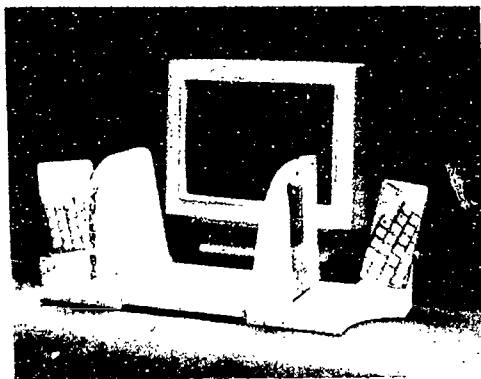

**Product Name:** Vertical

**Vendor:** Ergonomic-Interface Keyboard Systems, Inc.

**Computer:** Apple Macintosh Family, IBM PC Family

**Size:** 16" x 6" x 5"

**Weight:** 24 oz.

**Cost:** \$249.00

The Vertical is a keyboard designed to prevent carpal tunnel syndrome and other repetitive motion injuries. The keyboard is split in two halves, each pointing straight up. Side-view mirrors are installed to allow users to see their fingers on the keys. The user can adjust the width of the keyboard, but not the tilt of each section. The Vertical eliminates the need for a mouse with a finger-accessible cursor control.

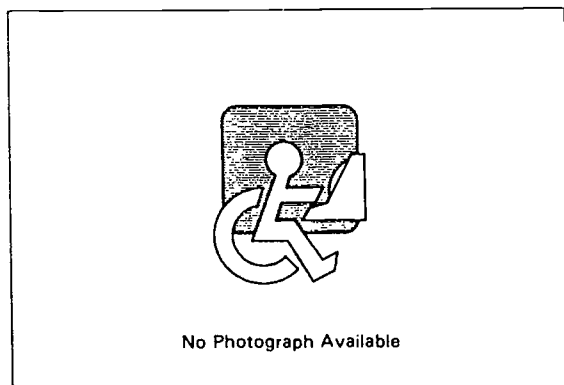

**Product Name:** Voice Mouse/Keyboard (VMK) Controller

**Vendor:** Quartet Technology, Inc.

**Computer:** IBM PC Family

**Cost:** Contact manufacturer

The Voice Mouse/Keyboard (VMK) Controller is a system designed to provide complete voice interface allowing full control of both keyboard and mouse functions for any IBM compatible PC. At spoken command the VMK can perform a variety of functions including: start and stop mouse movement, select any direction for the mouse, click mouse buttons, select any key on keyboard, etc. VMK is operating system independent and does not require any special software to be installed on the computer.

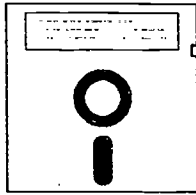

**Product Name:** Voice User

**Vendor:** Cylogic, Inc.

**Computer:** IBM PC Family

**Cost:** \$49.00

Voice User is a voice recognition system that provides voice command access for Microsoft Windows and popular Windows word processors: MS Write, AmiPro 3.1, MS Works 3.0, Window Works 2.0, WordPerfect 5.2 & 6.0, and Microsoft Word 2.0 & 6.0. Voice User features speaker-independent commands for such functions as "open file," "spellcheck," "print," "close window," and others. The system only allows for voice commands and does not offer data input. Voice User is a software-only product that runs on the Microsoft Windows Sound System (see entry).

System requirements for Voice User include: Microsoft Windows and Windows Sound System with a Sound Blaster-compatible sound card, 8 MB of RAM, and up to 4.5 MB of available disk space.

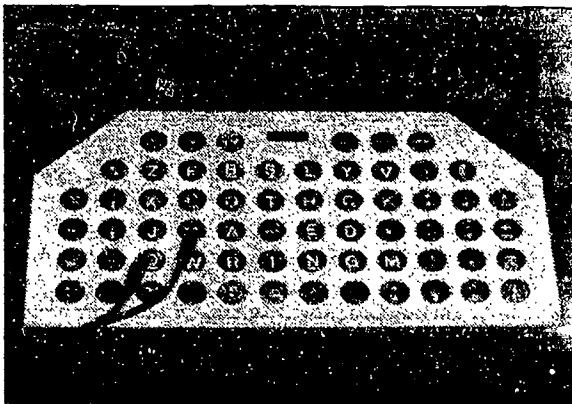

**Product Name:** WinKing Keyboard (2448F, 2448Q)

**Vendor:** TASH, Inc.

**Computer:** IBM PC Family

**Size:** 23.5" x 12" x 1"

**Weight:** 7 lbs.

**Cost:** \$900.00

The WinKing Keyboard has separated and enlarged keys that are slightly recessed, allowing the user to stabilize their arm or leg on the keyboard without activating keys. When activated, the keys provide an audible click as feedback. User may set key response time from 0 to 2 seconds. Latching CTRL, ALT, SHIFT, and function key modes are indicated by lights. Key presses are auto-repeating after an adjustable delay. The keyboard can be operated simultaneously with a standard keyboard. The device plugs directly into an IBM/compatible computer's keyboard port and serial port. Does all keyboard and mouse functions in MS-DOS or Microsoft Windows.

Two layouts are available: frequency of use (the most frequently used letters are placed toward the center of the keyboard) and standard QWERTY.

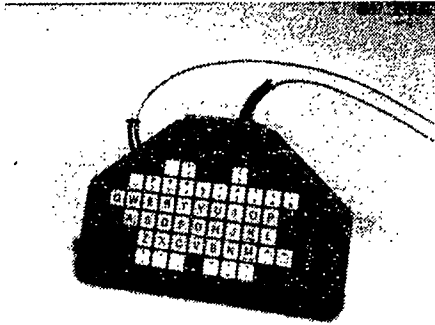

**Product Name:** WinMini Keyboard (2447F, 2447Q)

**Vendor:** TASH, Inc.

**Computer:** IBM PC Family

**Cost:** \$750.00

WinMini Keyboard provides all keyboard and mouse functions for using Microsoft Windows in a small size with a very light touch. The keyboard plugs directly into the computer keyboard port and serial port.

Two layouts are available: frequency of use (the most frequently-used characters are placed toward the center of the keyboard) and standard QWERTY. A Microsoft Mouse Driver is required.

---

**Product Name:** WiViK 2.0 (Windows Visual Keyboard)

**Vendor:** Prentke Romich Company

**Computer:** IBM PC Family, IBM PS/2 Family

**Cost:** \$290.00 - \$415.00

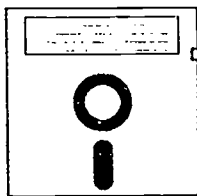

WiViK 2.0 is a software program which provides the user with an on-screen keyboard. This display enables the user to enter text into any application within the Microsoft Windows environment with any pointing device that emulates a standard mouse. The program may be customized for key arrangement, width, labels, label fonts, and spacing. Macro abbreviations of text can be defined by the user. Multiple keyboards can be displayed at one time. The standard keyboard and mouse are unaffected by the use of a visual keyboard. WiViK also has sticky key and quick shift features. Specific features which provide support for touchscreen and headpointer applications are included as well. A direct selection technique called Successive Quartering and Enlargement is designed to aid persons with poor pointing skills and low vision by repeatedly enlarging and redrawing quarter segments of the keyboard.

WiViK2 Scan permits the user to enter text and perform mouse operations using from one to five switches. An optional Writing Rate Enhancement Package (WREP) is available for both versions with word prediction and abbreviation expansion to improve entry speed.

# Chapter 13

## Input Adapters for Computers

This chapter covers special adapters that go between adaptive devices (switches, controls, keyboards, etc.) and the standard computer. These adapters have no function in and of themselves except to act as an adapter to allow the special input device to be plugged into the computer. The adapters may simply adapt from one type of connector to another (for instance a box that connects switch plugs to a joystick plug), or they may provide more sophisticated functions (for example keyboard emulating interfaces for adapting communication aids to computers).

Related functions cross-listed in Index 1 include Keyboard Emulating Interface (KE) and Switch or Control (SW).

Appendices A and B provide a wide variety of resources of interest to disabled computer users, such as Newsletters and Publications; Organizations; Advocacy Groups and Self-Help Groups; and Books and Pamphlets.

***The following product entries  
appear in this chapter:***

Apple Computer Input Adapter, 453  
BEST Switch Interface, 453  
ClickIt!, 454  
Computer Interface Box, 454  
Computer Switch Interface, 455  
CrossScanner, 455  
DA-II Adapter, 456  
Input Adapter, 456  
Internal I/O Port Adapter, 457  
Judy Lynn PC Adapter, 457  
Keyboard Expander, 458  
Keyboard Interfaces, 458  
Mac PowerPad Interface for Single  
Switches, 459  
Macintosh Switch Interface (M09), 459  
PCMaster & Windows Master, 460  
PlayMAGIC, 460  
Porter, The, 461  
PowerSwitch, 461  
SS-ACCESS!, 462  
SuperPort, 462  
Switch Interface, 463  
T-TAM Keyboard and Mouse Emulator, 463  
Universal Input Adaptor, 464  
WinSCAN: Limited Edition, 464

***The following products from  
other chapters can also be used  
as Input Adapters for  
Computers:***

Access Pack for Microsoft Windows, 331  
AccessDOS, 332  
Adaptive Firmware Card Model G32e, 374  
One Access, 427  
SynPhonix 210 and 215, 536



**Product Name:** Apple Computer Input Adapter

**Vendor:** Toys for Special Children, Inc.

**Computer:** Apple II Family

**Cost:** \$41.00

Apple Computer Input Adapter is an adapter which allows special single or dual switches to be used with appropriate software. The Adapter accepts one or two switches and connects to the I/O port of an Apple computer.

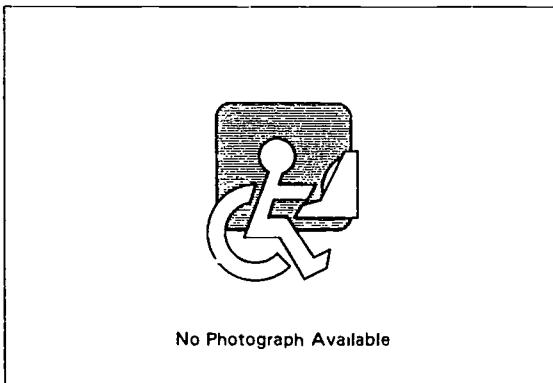

**Product Name:** BEST Switch Interface

**Vendor:** BEST, Inc.

**Computer:** IBM PC Family

**Cost:** \$125.00

BEST Switch Interface is an interface that allows from one to three switches to be connected to a computer and used in place of any three keys on the keyboard. Software is included to allow the user to define which keys the switches will activate. If desired, the Shift, Control and Alt keys can be activated.

Several programs have been written specifically to work with the BEST Switch Interface, including BEST Faces and Colors and Shapes (from BEST, Inc.) and R.J. Cooper's single switch software. The product comes with four public domain game programs for use with three switches.



**Product Name:** ClickIt!

**Vendor:** IntelliTools, Inc.

**Computer:** Apple Macintosh Family

**Cost:** \$99.95

ClickIt! is a software program for the Macintosh computer that allows the IntelliKeys (see entry) or switches to operate mouse driven software. The program creates "hot spots" on the screen that can be scanned with a switch or accessed directly by touching an IntelliKeys overlay. Three scanning modes are included: automatic scan, step scan, and directional scan. "Hot spots" can be created and edited within the program.

A switch interface for attaching switches to the computer is required.

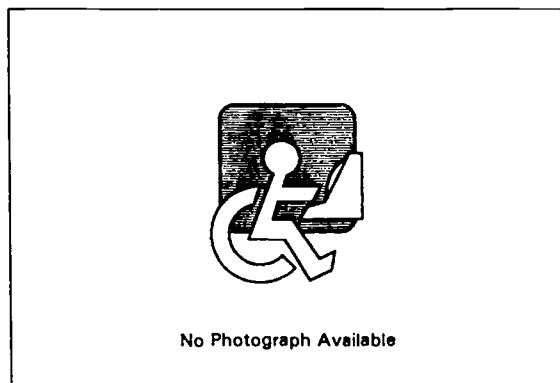

**Product Name:** Computer Interface Box

**Vendor:** Nassau Applied Technology Resource Center

**Computer:** Apple II Family

**Cost:** \$42.00

Computer Interface Box allows a switch. to be attached to an Apple II, Apple IIe, or Apple IIgs computer.

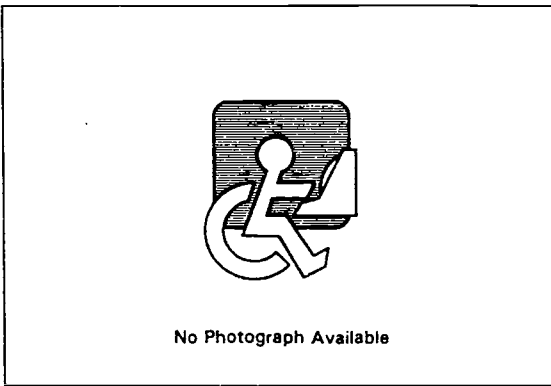

**Product Name:** Computer Switch Interface

**Vendor:** AbleNet, Inc.

**Computer:** Apple II Family

**Size:** 2" x 2.75"

**Weight:** 3 oz.

**Cost:** \$36.00

Computer Switch Interface is an adapter that allows one or two switches to be connected to an Apple II computer via its game port, like a joystick. The switches need to have mini-phone plugs, and the output connector is a 9-pin D game port connector. An adapter is also available to adapt the output connector to the older 16-pin internal game port connector in Apple II computers.

The Computer Switch Interface is meant to be used with software that accepts input from one or two switches.

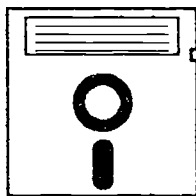

**Product Name:** CrossScanner

**Vendor:** R.J. Cooper & Associates

**Computer:** Apple Macintosh Family, IBM PC Family

**Cost:** \$199.00

CrossScanner is a universal way to run any software including mouse operations and text entry by single switch or any pointing device. In single switch mode, a single switch plugged into any device capable of producing a mouse-click, such as SAM (see entry), can perform all mouse moves and clicks. In direct select mode, a mouse, joystick, or trackball, allows the user to do the same. The user interface is intuitive and all operation is supervisor-controllable to adapt CrossScanner to the needs of the user.

CrossScanner is available for Macintosh and Microsoft Windows.



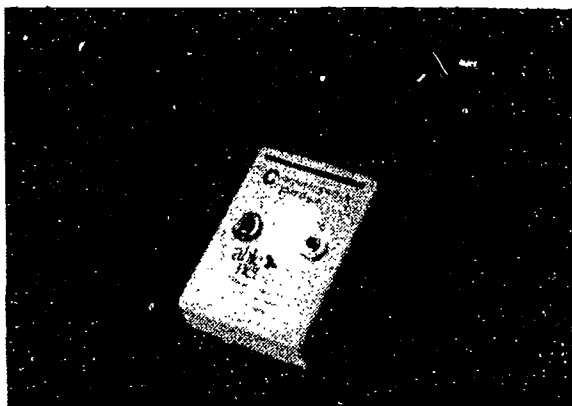

**Product Name:** DA-II Adapter  
**Vendor:** APT Technology, Inc.  
**Computer:** Apple II Family  
**Cost:** \$225.00

DA-II Adapter allows DU-IT proportional controllers to be connected into the game input of an Apple II computer. The DA-II can also serve as the input for some games, simulations, or graphically driven programs. The selector switch of the connected controller can be routed to either the Switch Out (SWO) or Switch In (SWI) inputs of the computer, and there are jacks so that other switches can be connected to these inputs.

The DA-II package includes the adapter, BCPS power supply, and a Proportional Simulations program that allows the user to simulate various DU-IT processes and products.

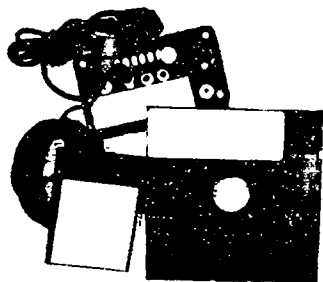

**Product Name:** Input Adapter  
**Vendor:** Life Science Associates  
**Computer:** Apple II Family, IBM PC Family  
**Cost:** \$99.00

The Input Adapter plugs into the game port of Apple II or IBM-PC family computers to permit switch input to computer programs. Four mini phone-plug sockets for plugging in switches are located on the interface box. The Input Adapter was designed to work with Life Science Associates' computer programs, but may be used with other applications requiring switch input.

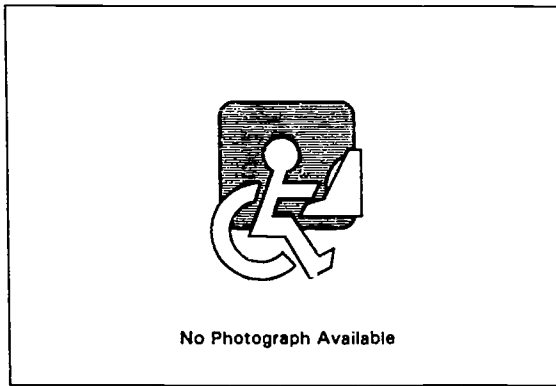

**Product Name:** Internal I/O Port Adapter

**Vendor:** AbleNet, Inc.

**Computer:** Apple II Family

**Cost:** \$13.00

The Internal I/O Port Adapter is a converting cable designed to provide a 9-pin joystick port for Apple II+ and older model computers which do not have such a port.

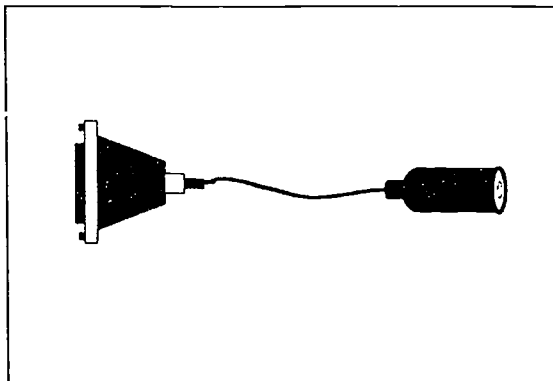

**Product Name:** Judy Lynn PC Adapter

**Vendor:** Judy Lynn Software

**Computer:** IBM PC Family, IBM PS/2 Family

**Cost:** \$23.00

The Judy Lynn PC Adapter connects a single switch to the computer and allows all Judy Lynn software to be run with a switch. Adapters are available for hooking into a 25 pin serial port, a 9 pin serial port, or a 15 pin game port. The adapters can also have either a 1/4" or 1/8" plug for attachment to the switch.

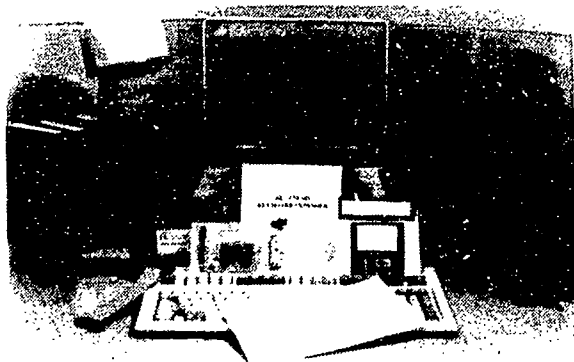

**Product Name:** Keyboard Expander

**Vendor:** Neil Squire Foundation

**Computer:** IBM PC Family, IBM PS/2 Models 25/30

**Cost:** \$340.00

The Keyboard Expander is a software and hardware combination that permits customization and redefinition of keys on any expanded keyboard. The Keyboard Expander also permits user definition of the amount of time a user needs to hold down a key before it repeats and before it produces a letter on the screen. The software component is memory-resident; the hardware consists of a specially designed half-length card that fits inside the computer. The software can hold 9 keyboard layouts in its memory at one time, allowing up to 1,152 keys and/or messages on a Unicorn keyboard (see entry) and 576 keys and/or messages on a TASH Mini keyboard (see entry). The software can define both keyboard keys or messages on the same keyboard layout, and works in all text and graphic modes.

The system requires 64K of memory. A cable is supplied for connecting a Unicorn or Mini keyboard to the Keyboard Expander.

---

**Product Name:** Keyboard Interfaces

**Vendor:** Prentke Romich Company

**Computer:** Apple II Family, IBM PC Family

**Cost:** \$455.00

Keyboard Interfaces are adaptive devices that accept ASCII characters from some input device (such as an electronic communication aid) and translate them into signals that a computer will interpret as keystrokes from a standard keyboard (see glossary: keyboard emulating interface). The standard keyboard can remain active while the interface is connected.

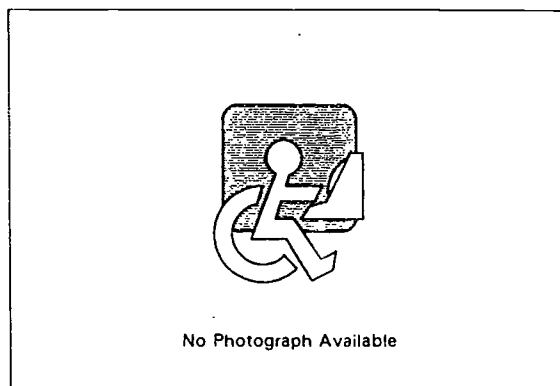

**Product Name:** Mac PowerPad Interface for Single Switches

**Vendor:** Dunamis, Inc.

**Computer:** Apple Macintosh Family

**Cost:** \$250.00

The Mac PowerPad Interface for Single Switches features two input jacks for single switch access to HyperStudio stacks when using The Stack Shop software. There are also two output jacks designed for battery operated toys. In addition, the interface allows any PowerPad to work with HyperStudio and HyperCard software.

Requires a Macintosh with serial port, hard drive, and HyperStudio 2.x software.

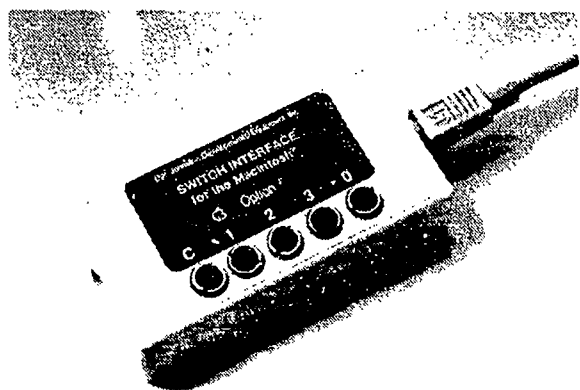

**Product Name:** Macintosh Switch Interface (M09)

**Vendor:** Don Johnston Incorporated

**Computer:** Apple Macintosh Family

**Cost:** \$135.00

The Macintosh Switch Interface can be used to substitute single switch activations for mouse clicks or the numbers 1, 2, 3, and 0. The interface plugs into a Macintosh's ADB port. Up to four switches may be plugged into the device and used for numbers 1, 2, 3, and 0. An additional switch may be plugged in to emulate a mouse click. The device will send Open Apple and Closed Apple commands to run single switch Macintosh programs or Apple IIe programs when run on a Macintosh LC in Apple IIe emulation mode.

**Product Name:** PCMaster & Windows Master

**Vendor:** Blazie Engineering

**Computer:** IBM PC Family

**Cost:** \$395.00 - \$495.00

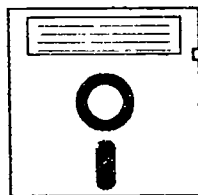

PCMaster & Windows Master are software programs that allow control of the PC through Braille 'n Speak, Braille Lite, or Type 'n Speak (see entries). These programs allow the user to type Grade 2 braille directly into the word processor or editor and to have the computer screen contents read through the device's synthesizer.

PCMaster costs \$395.00 and Windows Master costs \$495.00.

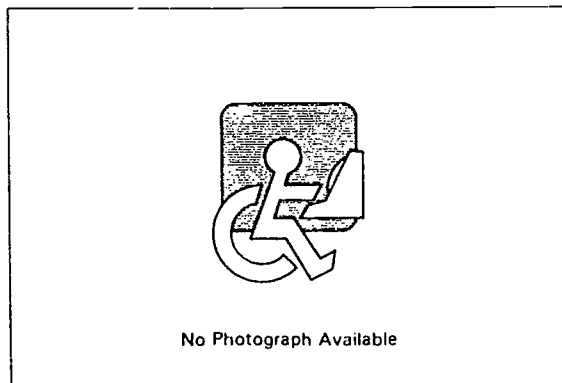

**Product Name:** PlayMAGIC

**Vendor:** Toys for Special Children, Inc.

**Computer:** Nintendo

**Cost:** \$115.00

PlayMAGIC is an input adapter that allows users to access the Nintendo Entertainment System (NES) with any type of switch. No modifications are necessary to the existing NES and the regular controllers can still be utilized. Several modes of operation can be used at the same time including start/select alternating mode, controlling action mode, latched mode, and regular controller mode.

PlayMAGIC does not work with Super Nintendo Entertainment System.

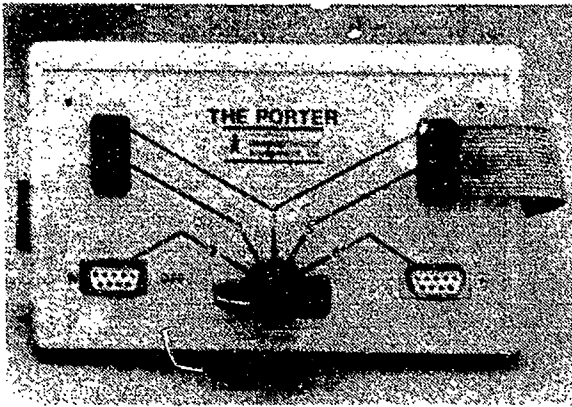

**Product Name:** Porter, The  
**Vendor:** Don Johnston Incorporated  
**Computer:** Apple II Family  
**Cost:** \$99.50

The Porter is a multi-port extender enabling up to four alternative input devices to be attached to the computer simultaneously. The Porter has two 16-pin game input/output ports and two 9-pin joystick ports. A dial selector allows access to peripherals such as joysticks, KoalaPad, TouchWindow, Muppet Learning Keys, and Switch Interfaces (see entries).

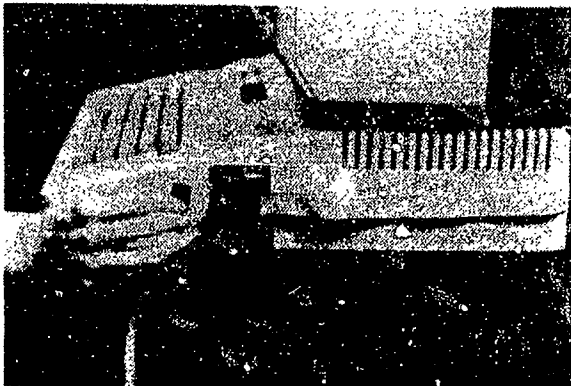

**Product Name:** PowerSwitch  
**Vendor:** Dunamis, Inc.  
**Computer:** IBM PC Family  
**Cost:** \$99.95

PowerSwitch is a four-plug switch interface box and software that allows standard IBM software to be run from up to four single switches. The user can design specific learning activities by defining single switch buttons that represent keystrokes and mouse movements. Buttons can include macros, mouse clicks, auditory feedback, and more.

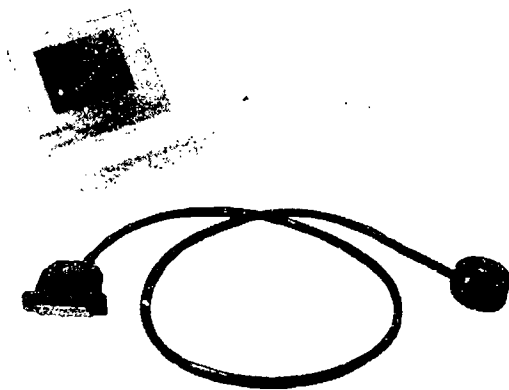

**Product Name:** SS-ACCESS!  
**Vendor:** Academic Software, Inc.  
**Computer:** IBM PC Family  
**Weight:** 4 oz.  
**Cost:** \$60.00

SS-ACCESS! is a single switch PC serial interface with support software designed for IBM and MS-DOS 3.3 and higher operating systems. The device also functions when running in a DOS partition under Microsoft Windows. A user-defined keyboard character is sent to a DOS single switch application each time the user presses the switch. Most single switch software packages that allow the keyboard to emulate the switch are compatible with this mode of access. The support software includes a setup program designed to be user-friendly and a demonstration game.

SS-ACCESS! is available with either a 9-pin serial port connector (for laptops) or a 25-pin connector (for desktops). The adaptive switch port accepts a standard 3.5 mm (1/8") phone plug.

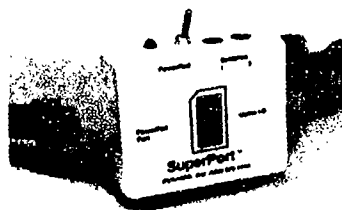

**Product Name:** SuperPort  
**Vendor:** Dunamis, Inc.  
**Computer:** Apple II Family  
**Cost:** \$59.95

SuperPort is an Apple II interface for the PowerPad and single switches, featuring a sturdy 9-pin PowerPad cable. SuperPort is also a switch interface box with two switch jacks. The device has been designed to reduce the possibility for broken PowerPad cable pins.

Requires an Apple IIe or IIgs, PowerPad, and PowerPad software.

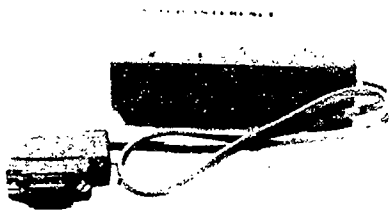

**Product Name:** Switch Interface

**Vendor:** Don Johnston Incorporated

**Computer:** Apple II Family

**Cost:** \$42.00

The Apple Switch Interface allows one or two switches to be used with software written for single switch input. Can be used with any Apple II computer and with a Macintosh LC with an Apple IIe emulator card.

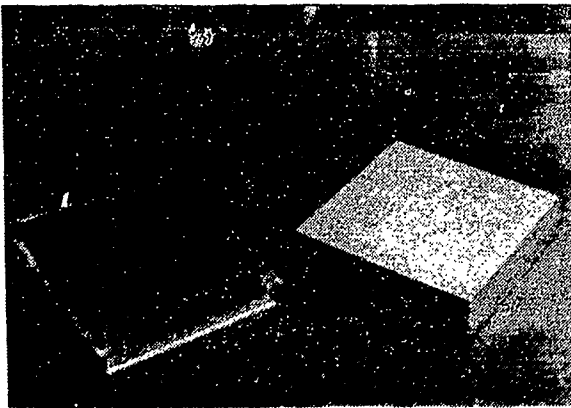

**Product Name:** T-TAM Keyboard and Mouse Emulator

**Vendor:** Prentke Romich Company

**Computer:** Apple Macintosh Family, IBM PC AT, IBM PS/2 Family

**Cost:** Contact manufacturer

The T-TAM (Trace Transparent Access Module) is a box which connects between a computer access aid and the computer. The box translates signals transmitted via the aid's serial port into keyboard or mouse emulating signals, and passes these signals to the computer. In addition to this "SerialKeys" feature, the T-TAM also provides enhancement features for users of the standard keyboard and mouse: StickyKeys (latching or locking of the "modifier" keys such as Shift, Control, Alternate, and Command), RepeatKeys (adjustment for both the amount of time a key is held down until it starts to repeat and the key repeat rate), SlowKeys (user-definable length of time a key is held down before the keystroke is registered by the computer), MouseKeys (cursor control capability via the keyboard's numeric keypad), and ToggleKeys (audible tones representing the status of the Caps Lock, Scroll Lock, and Num Lock keys).

The T-TAM can be used with all software or operating systems (including Microsoft Windows, DOS, and OS/2) that use the standard keyboard or mouse. The standard keyboard and mouse may be used while T-TAM is connected.





**Product Name:** Universal Input Adaptor

**Vendor:** Toys for Special Children, Inc.

**Computer:** Apple II Family

**Cost:** \$46.00

Universal Input Adaptor is an adaptor that allows a variety of controls to be connected to a computer's game port. There are two 1/8" mini-phone jacks and two 1/4" phone jacks for plugging in switches. The Universal Input Adaptor also accepts input from joysticks. The output connectors can either be 16-pin connectors (for the Apple II+) or 9-pin connectors (for the Apple IIe or IIc).

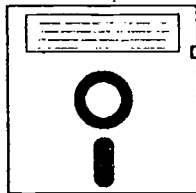

**Product Name:** WinSCAN: Limited Edition

**Vendor:** Academic Software, Inc.

**Computer:** IBM PC Family

**Manual Form:** Printed Manual

**Cost:** \$295.00

WinSCAN: Limited Edition is a general purpose interface that provides single-switch users independent control access to applications that run under Microsoft Windows. WinSCAN superimposes a scanning control display window in front of an application program running under Windows. This display may contain either words or picture icons to represent the functions needed to navigate Windows and operate specific software. The display can scan at an adjustable rate vertically or horizontally and can be repositioned anywhere. Custom control displays can be created for particular programs, printed out, and saved on disk for later use or further editing. This edition of WinSCAN offers up to 16 user definable "scan key" positions plus other built-in pop-up scanning controls for functions such as dragging. A library of 60 picture icons representing commonly needed keyboard and mouse functions is included.

WinSCAN works with the SS-ACCESS! (see entry) single-switch PC serial interface cable, which is included.

# Chapter 14

## Voice-Output Screen Readers and Reading Machines

This chapter includes software or software/hardware products which provide access to standard software through voice output. Optical Character Recognition (OCR) reading systems with voice output are also included in this chapter. The products in this chapter are designed to work with all or most software on the computer. A word processing program with voice output would not appear here because it is only a single application program.

Products that are strictly speech synthesizers are not found here but are listed in Chapter 17. Some of the software screen readers require speech synthesizers to be purchased separately.

Some pertinent resource listings in Appendices A and B are: Information Resources for Blind and Visually Impaired Individuals; Computer Assessment and Training Programs for Disabled Individuals; and Books and Pamphlets.

*The following product entries  
appear in this chapter:*

Artic TransBook, 467  
Artic TransType, 467  
ASAP (Automatic Speech Access  
Program), 468  
BookWise, 468  
Braille 'n Speak, 469  
Braille 'n Speak Classic, 469  
Braille Lite, 470  
BrailleMate 2, 470  
Business Vision, 471  
David, 471  
Echo II with Textalker & Echo II with  
Textalker-GS, 472  
Emacspeak, 472  
Gizmo, 473  
HandiCHAT and HandiCHAT Deluxe, 473  
IBM Screen Reader/2, 474  
IBM Screen Reader/DOS, 474  
Infovox 210, 475  
JAWS for Windows, 475  
JAWS Screenreader, 476  
Keynote Companion, 476  
Language Master Special Edition -  
LM6000SE, 477  
Magnum, 477  
Myna, 478  
Open Book, 478  
Open Book Unbound, 479  
outSPOKEN 1.7, 479  
outSPOKEN for Windows, 480  
Protalk23 for Windows, 480  
PROVOX, 481  
Reading AdvantEdge, 481  
ScanTELL, 482  
ScreenPower, 482  
ScreenPower for Windows, 483  
Seekline, 483  
Slimware, 484  
Slimware Window Bridge, 484  
SoundProof, 485  
Speaqualizer Speech Access System, 485  
Textalker-GS, 486  
TINYtalk, 486  
Type 'n Speak, 487  
Vocal-Eyes, 487  
Win Vision, 488  
Window-Eyes, 488  
WINKLiNE, 489  
WordScholar, 489

*The following products from  
other chapters can also be used  
as Voice-Output Screen Readers  
or Reading Machines:*

PCMaster & Windows Master, 460  
Speak Out VOILA, 440

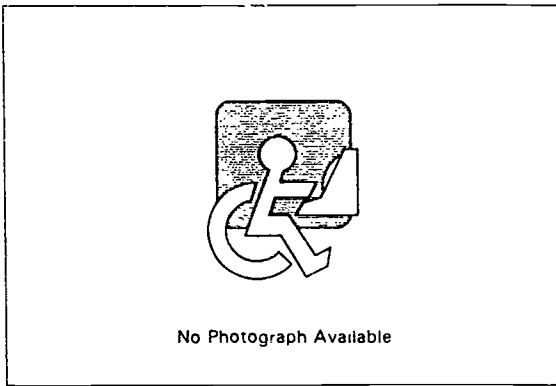

**Product Name:** Artic TransBook

**Vendor:** Artic Technologies

**Size:** 4.12" x 7.5" x 0.75"

**Weight:** Less than 1 lb.

**Power Source:** Rechargeable batteries

**Cost:** \$1,195.00 - \$1,945.00

Artic TransBook is a portable book file reader and speech synthesizer. Documents can be downloaded into TransBook's RAM disk or Micro Flash data cards and read anywhere using the built-in keypad. TransBook is compatible with Artic TransPort and all popular screen access programs. Other features include a talking alarm clock, fast file transfer, digital volume and tone control, 256K RAM for system and user RAM disk, and 512K ROM for system and ROM disk for access programs.

Model 631 is the standard TransBook and sells for \$1,195. Model 635 includes BusinessVision and sells for \$1,595. With BusinessVision and WinVision: \$1,945.

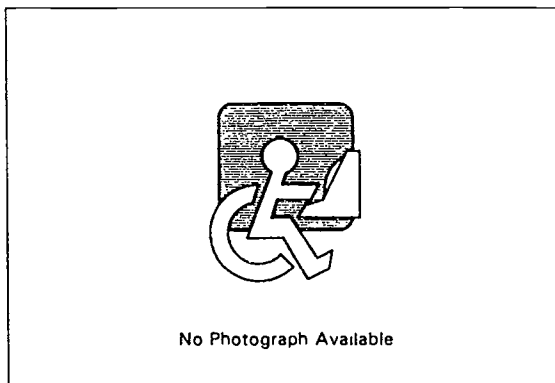

**Product Name:** Artic TransType

**Vendor:** Artic Technologies

**Size:** 10.2" x 4.2" x 1.25"

**Weight:** 1.5 lbs.

**Power Source:** Rechargeable batteries

**Cost:** \$1,395.00 - \$1,995.00

Artic TransType is a very small personal desk-top computer with a talking keyboard. Thousands of memos, names, phone numbers, projects, appointments, recipes, etc. can be stored in the internal electronic disk memory or in removable MicroFlash data cards. TransType can also act as a speech synthesizer for computer access, an alarm clock and message system, a calculator, and a computer terminal (via modem). A QWERTY keyboard with standard spacing provides comfortable touch typing. Function keys at the bottom will take the user directly to predefined files. A password and Owner ID helps keep data private.

Artic TransType BASIC is available for \$1,395 and offers 1,024K of total memory. Artic TransType DELUXE is available for \$1,995, offers 2,816K of total memory, and includes a full feature terminal program called TransTerm.

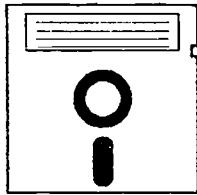

**Product Name:** ASAP (Automatic Speech Access Program)

**Vendor:** MicroTalk Software

**Computer:** IBM PC Family

**Cost:** \$525.00 - \$895.00

ASAP is a voice-output screen access program for the IBM line of computers using DOS. The program is designed to read important screen changes automatically (the movement of a highlight bar for example). Other features of ASAP include the ability to read text without using a "review mode," tracking of user-definable text attributes and automatic loading of custom configurations for computer programs. The program requires less than 35 of RAM and can be "loaded high."

Three versions of ASAP are available. ASAP Soft (\$525.00) is the software only. ASAP Lite (\$795.00) includes the software and a portable battery operated synthesizer that connects to any computer with a serial or parallel port. ASAP Classic (\$895.00) includes the software and a speech synthesizer that fits into one of the slots on a standard XT- or AT-style computer.

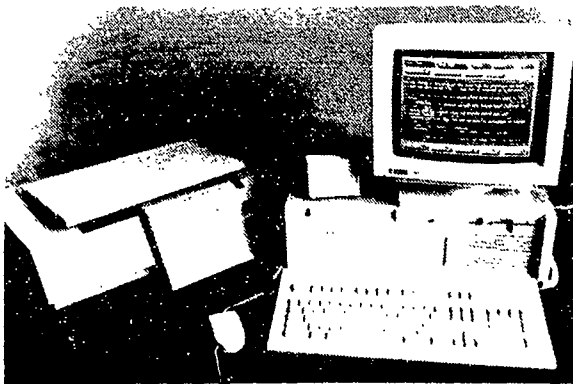

**Product Name:** BookWise

**Vendor:** Xerox Imaging Systems, Inc.

**Computer:** IBM PC Family, IBM PS/2 Family

**Cost:** \$4,495.00 - \$7,295.00

BookWise is a PC-based reading and tutoring system. BookWise scans books or other printed materials, recognizes the characters, and simultaneously displays the text on the computer screen and reads it aloud in synthesized speech. Documents to be read are placed on a scanner and the text is stored on a personal computer. The BookWise software offers several features designed for people who have reading impairments. A visual tracking feature highlights words, phrases or sentences on the computer screen as the synthesized voice is reading them. The user can also at any time hear and see definitions of words, or hear words spelled out or pronounced syllable by syllable. BookWise offers a choice of nine different voices.

BookWise is available in three different packages: (1) Bookwise software with DECtalk speech synthesizer and BookEdge scanner; (2) BookWise software with DECtalk and flatbed scanner; (3) BookWise software with DECtalk for those who already have a scanner.

501



**Product Name:** Braille 'n Speak

**Vendor:** Blazie Engineering

**Computer:** IBM PC Family

**Size:** 8" x 4" x 1"

**Weight:** 1 lb.

**Cost:** \$1,299.00 - \$1,399.00

The Braille 'n Speak is a portable talking and writing device with a braille keyboard. The user can type text in the same manner as on a braille writer, and review the text with the Braille 'n Speak's built-in speech synthesizer. Storage for 800 pages of braille in up to 77 files is included. The user can recall, review and edit these stored files. Text can also be transferred to a stationary computer or printer via the Braille 'n Speak's built-in serial port (up to 9600 baud). Text can be typed in Grade 2 braille and automatically translated into standard spelling for printing. A talking clock, calendar and calculator are provided. Word processing capabilities, including spell check, and the ability to run external software are also included.

Braille 'n Speak is powered by rechargeable nickel-cadmium batteries, and comes with a battery charger and headphones. The following eleven languages are available: Czech, French, German, Italian, Japanese, Korean, Portuguese, Slovak, Spanish, and Turkish. PC Master, a software program that allows the Braille 'n Speak to function as an alternate keyboard and screen review system for an IBM PC, is available for \$395.00.

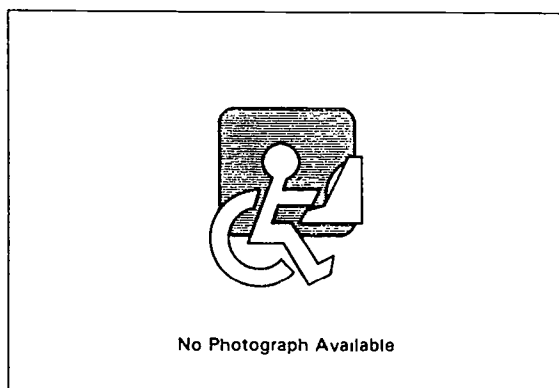

**Product Name:** Braille 'n Speak Classic

**Vendor:** American Printing House for the Blind (APH)

**Size:** 8.13" x 4.13" x 0.875"

**Weight:** 13.5 oz.

**Power Source:** Rechargeable battery

**Cost:** \$924.95

Braille 'n Speak Classic is designed to be an introductory level version of the Braille 'n Speak (see entry). The device has speech output and accepts input through the integrated seven-key braille keyboard. Some of the built-in functions include: a word processing program that can hold up to 40 word processor files in Grade 2 braille or ASCII braille, a word processor file organizing system, a talking telephone directory, capabilities to connect to a printer or braille embosser and automated Grade 2 braille-to-print translation, a talking clock and calendar, a scientific calculator, a talking computer terminal, and a battery powered speech synthesizer.

Braille 'n Speak Classic includes a soft leather carrying case and a cassette tape tutorial.

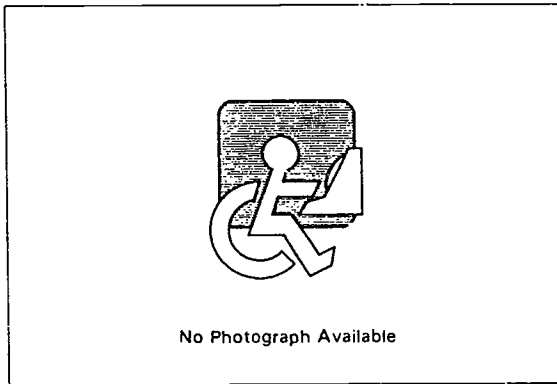

**Product Name:** Braille Lite  
**Vendor:** Blazie Engineering  
**Size:** 8.25" x 5" x 1.75"  
**Weight:** 2 lbs.  
**Power Source:** Rechargeable battery  
**Cost:** \$3,395.00 - \$3,495.00

Braille Lite is a speaking personal data assistant with an 18-cell refreshable braille display. Major features include a braille keyboard and simple command structure, adjustable speech synthesizer, storage for 800 pages of braille, print output, clock, calendar, telephone directory, calculator, and word processing. In addition, Braille Lite supports external software and has serial and parallel ports for interfacing. Included accessories are a soft leather carrying case, batter charger and AC adapter, earphone, serial interface cable, cassette tutorial, and braille quick-reference guide.

Braille Lite is available in English and ten other languages.

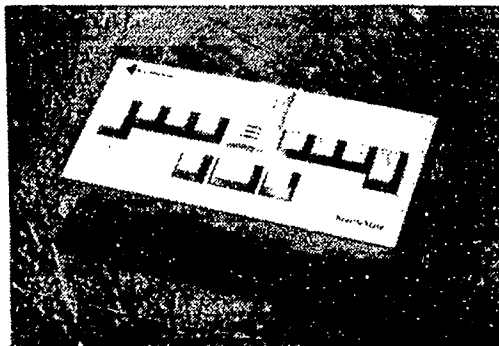

**Product Name:** BrailleMate 2  
**Vendor:** TeleSensory Corporation  
**Computer:** All (Hardware Independent)  
**Size:** 3.75" x 8.25" x 1.25"  
**Power Source:** Rechargeable battery  
**Cost:** \$1,595.00

BrailleMate 2 is a portable hand-held braille computer featuring an 8-key braille keyboard, one 8-dot braille cell and a built-in speech synthesizer. The unit includes a word processor, calculator, telephone book and calendar. The BrailleMate has two serial ports and one parallel port for connecting to other devices such as computers, modems and printers. The BrailleMate can be connected with PowerBraille 40, 65, or 80 (see entry) to provide split or extended braille information.

The BrailleMate is powered by built-in rechargeable batteries and comes with an AC power adapter. The device's storage capacity can be increased with an optional memory card (extra). Contact TeleSensory for more details.

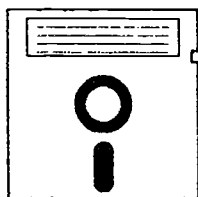

**Product Name:** Business Vision

**Vendor:** Artic Technologies

**Computer:** IBM PC Family

**Manual Form:** Braille/Tactile Manual,  
Electronic Manual, Printed Manual

**Cost:** \$495.00

Business Vision is a screen-to-voice program that contains all the features of Artic Vision (see entry) plus additional features for use with spreadsheet programs. Features include: speech access to matrix entries, cell definitions, row and column titles, and menu entries; ten user-definable Smart Zones for direct screen monitoring, with twenty controls each for monitoring and responding to changes within each Smart Zone; a key macro facility for supporting advanced constructs such as IF-THEN-ELSE; ability to "chain" Speech Windows (allowing one to call another); and Pop-Trax, which allows automatic location of pop-up menus on the screen. A built-in talking calculator offers four function operation and ten levels of memory to allow the user to review previous entries.

Business Vision D/K is a special version of this product designed for use with DECtalk and compatible speech synthesizers. An IBM PC or PS/2 computer with 256K of memory is the minimal suggested computer configuration for running either version of Business Vision. Price is for Business Vision alone; cost is \$395 when purchased with synthesizer.

---

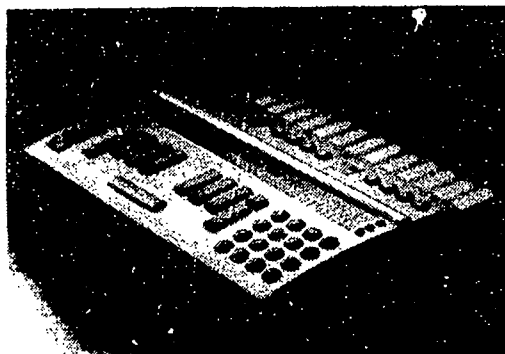

**Product Name:** David

**Vendor:** TeleSensory Corporation

**Size:** 12.8" x 10" x 2.6"

**Weight:** 7.9 Lbs.

**Power Source:** Rechargeable batteries

**Cost:** Contact manufacturer

David is a notebook computer designed especially for blind users incorporating tactile braille, synthetic speech, and other features. David is designed around an Intel 486 microprocessor and features 8MB RAM, a hard drive, 1.44MB diskette drive, serial and parallel interfaces, and battery operation. A 16-key pad can be used to control as many as 15 layers of commands. A large variety of macros and functions can be assigned to any control button. Braille keyboard, display navigation keys, and mode switches provide expanded capability.

An optional VGA monitor and/or standard QWERTY keyboard can be connected. The David Pro features a high-quality speech synthesizer, a larger hard drive, and special access software.



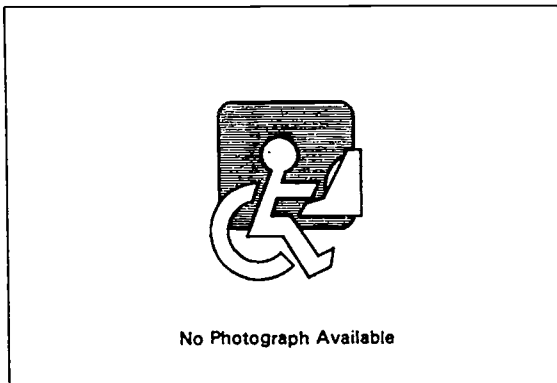

**Product Name:** Echo II with Textalker & Echo II with Textalker-GS

**Vendor:** American Printing House for the Blind (APH)

**Computer:** Apple II Family

**Cost:** \$145.55 - \$155.95

Echo II with Textalker and Echo II with Textalker-GS are integrated speech synthesis systems including both hardware and text-to-speech software. The Textalker software operates in the background and allows many public domain and non-copy protected programs to talk. Pitch, volume, rate of speech, amount of punctuation spoken, and others can be controlled from the keyboard. The software works with either ProDOS or DOS 3.3. Textalker-GS (\$155.95) also has the following features: works with most programs that are text-based including many commercial programs, a Quick Review that allows the user to review the screen without going into the review mode, compatibility with several operating systems including ProDOS8, DOS 3.3, GS/OS, and Pascal.

Echo II with Textalker requires a 5.25" disk drive, an Apple II+, IIe, or IIgs with at least 64K RAM for DOS 3.3 and 128K RAM for ProDOS. Echo II with Textalker-GS requires a 3.5" disk drive and an Apple IIgs with at least 512K RAM.

---

**Product Name:** Emacspeak

**Vendor:** T.V. Raman

**Computer:** IBM PC Family

**Cost:** Free



Emacspeak is a speech output system designed to allow individuals who cannot see the computer screen to work directly on a UNIX system. Emacspeak is built on top of Emacs and provides spoken feedback for all actions. The program currently supports the new Dectalk Express speech synthesizers and older versions such as MultiVoice. Emacspeak currently has extensions for many Emacs subsystems including: W3, GNUS, VM, and Eterm.

Emacspeak is available to be downloaded from the following sites:  
<ftp://crl.dec.com/pub/digital/emacspeak/emacspeak.tar.gz>; or  
<http://www.research.digital.com/CRL/personal/raman/emacspeak/emacspeak.tar.gz>.

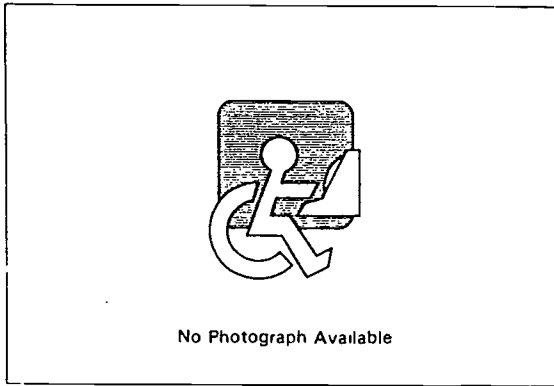

**Product Name:** Gizmo

**Vendor:** Artic Technologies

**Computer:** IBM PC Family, IBM PS/2 Family

**Size:** 4" x 5"

**Weight:** 0.5 lb.

**Cost:** \$250.00 - \$325.00

Gizmo is a control pad for operating screen reading and screen enlargement software. The surface of the pad has control buttons for Artic Vision and Business Vision screen readers and Artic Focus screen enlargement software (see separate entries). Gizmo eliminates the need to use the standard keyboard on the computer to control access software. This can help with access when other software running on the computer (such as terminal emulation software) takes control of the keyboard. Gizmo can also use Business Vision's macro-creating facility to assign unique functions to keys.

**Product Name:** HandiCHAT and HandiCHAT Deluxe

**Vendor:** Microsystems Software Inc.

**Computer:** Grid, IBM PC Family, IBM PS/2 Family, ITT, NEC (some or all models), TRS-80 Model 100, TRS-80 Model 200, Tandy 1000, Toshiba Laptops

**Manual Form:** Printed Manual

**Cost:** \$149.00 - \$295.00



HandiCHAT is a speech output program that may be run simultaneously with application programs. Two modes of operation are available. The first permits the user to use a pop-up window to enter text that is then immediately spoken (and not saved). The window may be defined as having between six and twenty lines. The other mode is used to speak some or all of the text on the PC screen. Options are: speaking the word or sentence at the cursor, speaking from the beginning of the line to the cursor, or speaking the entire contents of the screen. HandiCHAT is evoked via a user-defined "hot key" on the keyboard.

HandiCHAT (\$149.00) is compatible with DECTalk, Votrax, Computalker, Covox, RealVoice, Accent, and Echo speech synthesizers. HandiCHAT Deluxe (\$295.00) permits use and maintenance of a phrase library which can hold up to 1,296 phrases of 64 characters each. These phrases can be accessed by using a mouse, trackball, headmouse, or keyboard. Phrases may be combined, and may be assigned to macros which can then be accessed by pressing two keys. Both versions work with graphics programs.

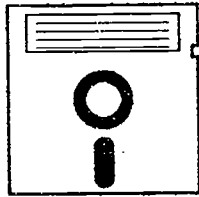

**Product Name:** IBM Screen Reader/2  
**Vendor:** IBM Corporation  
**Computer:** IBM PC Family, IBM PS/2 Family  
**Manual Form:** Audiotape Manual,  
Braille/Tactile Manual, Electronic Manual  
**Cost:** \$700.00

IBM Screen Reader/2 is a system that enables the user to read computer screen information using a speech synthesizer. The program works with standard software running under the OS/2 operating system, providing blind computer users with access to IBM's graphical user interface (GUI). The system is also compatible with Microsoft Windows applications being run under OS/2. The user can specify how text is to be read back--by the character, word, line, sentence, paragraph, or screen. The program recognizes and verbalizes objects (icons) and the program's windowing capability allows the user to read specified areas of the screen. The Screen Reader can be controlled from the standard keyboard or from an optional 18-key keypad. Profile Access Language software allows the user to specify custom sets of Screen Reader commands (profiles) for particular applications.

Information about this product can be obtained from (800) 426-4832 (U.S. voice) or (800) 426-3833 (U.S. TDD). It may be ordered by calling (800) 426-7630 (U.S. voice) or (800) 426-3383 (U.S. TDD). Canadian ordering and information is handled at (800) 465-7999.

---



**Product Name:** IBM Screen Reader/DOS  
**Vendor:** IBM Corporation  
**Computer:** IBM PC Family  
**Manual Form:** Audiotape Manual,  
Braille/Tactile Manual, Electronic Manual  
**Cost:** \$600.00

Screen Reader/DOS is a system that enables the user to read computer screen information using a speech synthesizer. The Screen Reader works with standard commercially available software that runs under DOS. Using a special keypad or the standard keyboard, the user can specify what part of the screen is to be read back, and how it is to be read back--by the character, word, line, sentence, paragraph, partial screen or full screen. An "autospeak" feature monitors the screen and alerts the user when changes occur. A "windowing" capability allows the user can read a specified "box" of text. Profile Access Language software allows the user to specify custom sets of Screen Reader commands (profiles) tailored for particular application software.

The Screen Reader provides access to the IBM PC family. The system consists of the keypad, special software, and documentation. A speech synthesizer is required. Information about this product may be obtained by calling (800) 426-4832 (U.S. voice) or (800) 426-3833 (U.S. TDD). It can be ordered from (800) 426-7630 (U.S. voice) or (800) 426-3383 (U.S. TDD). Canadian ordering and information is handled at (800) 465-7999.

507

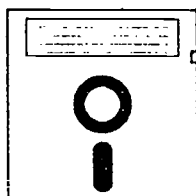

**Product Name:** Infovox 210

**Vendor:** Mayer-Johnson Company

**Computer:** Apple Macintosh Family

**Cost:** \$363.00 - \$873.00

Infovox 210 is a software program which allows Speaking Dynamically or other speech-output programs to output text-to-speech in many languages. One base program must be purchased for \$274.00 and the individual languages in addition. Languages available are: British English (\$89.00), Spanish, Italian, British English - Professional (\$189.00), Finnish (\$199.00), French (\$329.00), German (\$459.00), Swedish, Danish, Norwegian, and Icelandic (\$599.00).



**Product Name:** JAWS for Windows

**Vendor:** Henter-Joyce, Inc.

**Computer:** IBM PC Family

**Cost:** \$795.00

JAWS for Windows is a screen reader program providing voice output access to screen information in Microsoft Windows applications. JFW offers a complete menu system to control every aspect of the screen reader with a manager that is available at any time from any program. A feature called the Wizard provides built-in helpers that pop-up at the touch of a key and give a text name to graphic symbols it encounters in the application.

JFW supports the most popular speech synthesizers including DECTalk, Accent, Doubletalk, Keynote Gold, Infovox, Audapter, and many others. Other system requirements include a 386 or better microprocessor, 4 MB of RAM, and Windows or Windows for Workgroups.



**Product Name:** JAWS Screenreader

**Vendor:** Henter-Joyce, Inc.

**Computer:** IBM PC Family, IBM PS/2 Family

**Manual Form:** Audiotape Manual,  
Braille/Tactile Manual, Electronic Manual,  
Printed Manual

**Cost:** \$495.00

JAWS (Job Access with Speech) Screenreader is a screen access program that gives users voice output access to computer software. JAWS works with most speech synthesizers. Features of JAWS include a dual cursor design (a JAWS cursor is always available for screen review), macro recording, audible and visible Lotus 1-2-3-style menus, ability to use the keypad for single handed operation, windows for selective screen reading, detection and automatic speaking of many screen changes, variable voice configurations, automatic loading of custom configuration files and a "help mode."

A Braille version of the JAWS manual is available; contact manufacturer for details.



**Product Name:** Keynote Companion

**Vendor:** HumanWare, Inc.

**Cost:** \$1,995.00

Keynote Companion is a portable information management system designed especially for people who are blind or visually impaired. Keynote has built in software that allows the user to write with attractive layouts and typesyles, check spelling and make corrections with the aid of spoken suggestions, perform simple or complex scientific calculations, schedule or review appointments, set alarms, enter or retrieve addresses or telephone numbers, and access remote databases, bulletin boards, and electronic mail networks. Keynote can also work as an external synthesizer to a PC running Keysoft. Most computer printers can be used.

Text 2000 is optional software that allows American Printing House textbooks to be read on Keynote. A portable ALVA Braille Terminal can also be added.

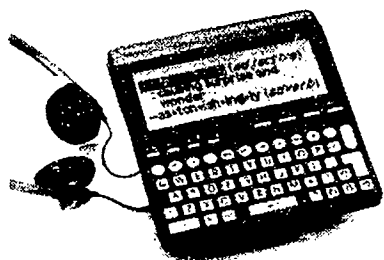

**Product Name:** Language Master Special Edition - LM6000SE

**Vendor:** Franklin Electronic Publishers, Inc.

**Size:** 6" x 6"

**Weight:** 12.2 oz.

**Power Source:** Battery or AC adapter

**Cost:** \$450.00

Language Master Special Edition is a special version of the Franklin Language Master electronic dictionary, spelling and pronunciation aid. Like other speaking models of the Language Master, the special edition provides a complete dictionary which gives definitions, pronounces the words, and reads all other entry information in digitized voice. The device also provides spelling assistance, a thesaurus, grammar assistance and vocabulary games. The Special Edition has been designed for individuals who are blind or visually impaired or have learning disabilities or speech impairments. The Special Edition displays information in adjustable size print, and presents information in speech which ordinarily would have to be read from the screen. User customization allows the user to adjust a variety of functions for special needs situations. For communication, up to 26 personal messages can be stored for playback at any time, and any message can be type for immediate text-to-speech playback (synthesized voice).

---



**Product Name:** Magnum

**Vendor:** VisuAide

**Size:** 7.75" x 4.75" x 1.75"

**Weight:** 2.2 lbs.

**Cost:** \$995.00

Magnum is a speech-driven personal digital assistant that stores recordings on floppy disks. The notetaking feature allows messages to be marked and accessed through a table of contents. Other features include an agenda and reminder function, an address book, various utilities, and braille keyboard entry. The device has an integrated microphone and speaker plus external microphone and speaker jacks.

Available options include: carrying bag, microphone and earphone.

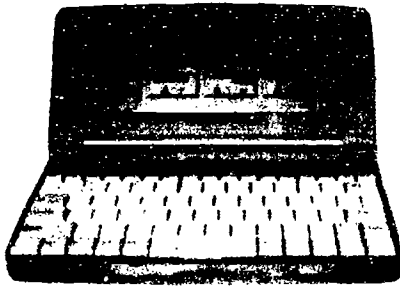

**Product Name:** Myna  
**Vendor:** TFi Engineering  
**Computer:** IBM PC Family  
**Size:** 9.6" x 4.7" x 1.16"  
**Weight:** 1.2 lbs.  
**Cost:** \$2,395.00

Myna is a talking 386 palm top computer that is fully compatible with IBM PCs. An internal DECTalk synthesizer with nine voices, a built-in speaker and external headphone jack, IBM Screen Reader, and IBM Book Manager software combine to provide complete screen-to-voice output. In addition, a PC-style QWERTY keyboard with braille mode and translator allows for type or braille input. Other features include: a personal organizer (address book, phone directory with touch tone dialer, text editor, memo-taker, scheduler, etc.), 4 MB RAM & 4 MB ROM, lithium battery backup, two PCMCIA type II slots for memory and peripheral IC cards, password protection for security, interlink software for data transfer, and a capability to use any screen reader and applications software.

Price includes computer, headphone, AC adapter, carrying case, full documentation, software, and one year warranty and technical support. The complete Myna plus WordPerfect on an IC card is available for \$2,745.00

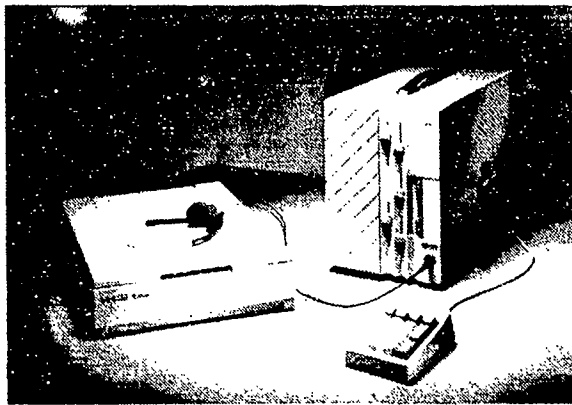

**Product Name:** Open Book  
**Vendor:** Arkenstone, Inc.  
**Computer:** All (Hardware Independent)  
**Size:** 10.7" x 7.5" x 16.7"  
**Weight:** 18 lbs.  
**Cost:** \$4,695.00 - \$5,495.00

The Open Book is an optical character recognition system which converts text pages into an electronic text file and reads them with a voice synthesizer. The system consists of a scanner, processing unit with the DECTalk speech synthesizer, and a 17-key keypad. Features of the system include automatic page orientation, automatic contrast adjustment, decolumnization of multicolumn documents and the ability to recognize a wide variety of type faces and font sizes. Text scanned with the OpenBook can be saved in the system's document library for future use. At least 25,000 pages can be stored and saved at any time.

The OpenBook is available in two models. The OpenBook Premium has a faster text recognition rate and can store more than twice as much text in the library as the Easy Edition. The Easy Edition can be upgraded to a Pentium 60 or Pentium 66 hard drive with miscellaneous components. Contact manufacturer for further details. See also entry for Open Book UnBound.



**Product Name:** Open Book Unbound

**Vendor:** Arkenstone, Inc.

**Computer:** IBM PC Family

**Manual Form:** Audiotape Manual,  
Braille/Tactile Manual, Electronic Manual,  
Large Print Manual

**Cost:** \$995.00

Open Book Unbound is reading software which enables the user to read printed documents with voice output. The software provides everything necessary to make an IBM personal computer or compatible act as an optical character reader, except the hardware scanner itself. The software provides scanning capability of 350 characters per second, depending on the speed of the computer processor used. Open Book Unbound can recognize a variety of fonts, and provides automatic decolumnization, automatic contrast control, and automatic orientation detection. Text scanned with Open Book Unbound can be saved in the program's document library for future use.

Open Book Unbound is compatible with Microsoft Windows and works with many speech synthesizers.

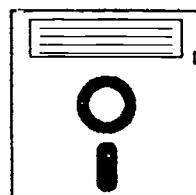

**Product Name:** outSPOKEN 1.7

**Vendor:** Berkeley Systems, Inc.

**Computer:** Apple Macintosh Plus,  
Apple Macintosh SE/II

**Manual Form:** Audiotape Manual,  
Braille/Tactile Manual, Electronic Manual,  
Printed Manual

**Cost:** \$495.00

outSPOKEN is a program that provides voice output access to text-based Macintosh software, such as word processors, databases, spreadsheets, and telecommunications programs. The numeric keypad is used instead of the mouse to control the cursor. The structure and content of the entire display (e.g., icons, ruler marks, and windows) can be communicated. Other commands permit the user to move between windows, find out the font and style of the current word, control voice speed, pitch, and volume, and identify frequently-used icons and symbols. A dictionary permits the user to modify the way specific words and icons are pronounced. A "mouse-off" feature prevents the mouse or trackball from being accidentally activated. There is an optional "review mode" which allows certain right-hand keys to be outSPOKEN keys.

The manual comes in print, on a tone-indexed cassette, and on disk, and is available in Braille at no cost on request. The package also includes Braille quick reference cards and embossed sheets giving tactile representations of typical Macintosh screen elements.



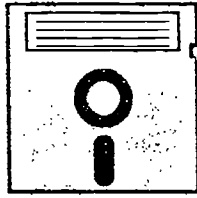

**Product Name:** outSPOKEN for Windows

**Vendor:** Berkeley Systems, Inc.

**Computer:** IBM PC Family

**Manual Form:** Audiotape Manual,  
Braille/Tactile Manual, Electronic Manual,  
Printed Manual

**Cost:** \$595.00

outSPOKEN for Windows is a screen reader that converts the graphics and text of Microsoft Windows to a full speech and audio interface. outSPOKEN speaks the line, word, character, or graphic corresponding to the keyboard-driven pointer's location. Various settings allow the program to be customized to suit each user individually.

outSPOKEN for Windows works with over thirty speech synthesizers and the purchase comes with unlimited free telephone technical support.

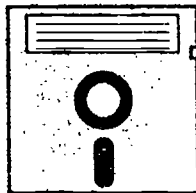

**Product Name:** Protalk23 for Windows

**Vendor:** Biolink Computer Research and  
Development, LTD

**Computer:** IBM PC Family

**Manual Form:** Electronic Manual, Printed Manual

**Cost:** \$995.00 - \$2,495.00

Protalk32 for Windows is a 32 bit text to speech and/or braille output screen reading program for Microsoft Windows users. Protalk is currently compatible with most Windows and Windows for Workgroups application programs (purchase price includes lifetime free updates). Protalk32 for Windows uses multimedia sound, can support refreshable braille, mouse feedback.

Two versions are available: Protalk32 for Windows 3.1/3.11 and 95 (\$995.00) and Protalk32 for Windows NT 3.5/3.51 (\$2,495.00). The NT version includes an integrated magnification utility with a magnification scale of 2 to 16 times.

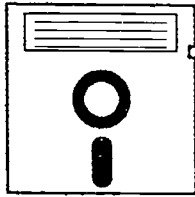

**Product Name:** PROVOX

**Vendor:** Kansys, Inc.

**Computer:** IBM PC Family

**Manual Form:** Audiotape Manual,  
Braille/Tactile Manual, Electronic Manual,  
Printed Manual

**Cost:** \$295.00

PROVOX is a voice-output screen access program designed to give the computer user control of voice output in both Direct and Review modes. Once installed, PROVOX outputs most keystrokes and screen display. The user can interrupt speech output to skip over portions of screen display, cause the repetition of previously spoken output, locate the cursor, or read only highlighted areas. Other options include moving up or down the screen one line, word, or character at a time and restricting voice output to a specified window. The user can specify whether or not silent characters such as "return" or "space" are spoken.

PROVOX supports fifteen voice synthesizers; contact the manufacturer for details. A demonstration package is available. Subsequent versions will be available to licensed users at a reduced cost.

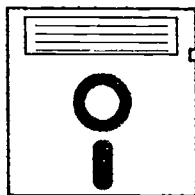

**Product Name:** Reading AdvantEdge

**Vendor:** Xerox Imaging Systems, Inc.

**Computer:** IBM PC Family

**Cost:** \$795.00 - \$2,995.00

The Reading AdvantEdge is an optical character recognition package that requires no additional hardware be installed in the computer (a scanner is still required). Features of the software include automatic page orientation, automatic contrast adjustment, the ability to scan multiple pages before the recognition process starts and the ability to save scanned materials in a variety of word processing formats. The software can also output the beginning of a page as text while the recognition process is taking place.

Reading AdvantEdge is compatible with Xerox's BookEdge and flatbed scanners, and most Hewlett-Packard scanners. The software requires an IBM or compatible computer with a 386 or higher processor. A software only version of the system is available for \$795.00. The system is available with various scanner options for prices ranging from \$1,295.00 to \$2,995.00. Contact the manufacturer for more details.

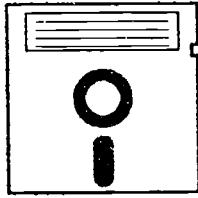

**Product Name:** ScanTELL  
**Vendor:** Compusult Limited  
**Computer:** IBM PC Family  
**Cost:** \$99.00

ScanTELL is a software program that identifies and speaks the names of bar-coded items and retail products when used with a PC, speech synthesizer, and bar code scanner. ScanTELL operates on both desktop and portable personal computers, employs audible user prompts and requires minimal keyboard usage, includes a database management system, and is available in English, French, and Spanish versions.

The program requires at least 2 MB of RAM, a 20 MB hard disk drive, and serial and parallel ports. ScanTELL is compatible with the following bar code scanners: Symbol Technologies, Spectra-Physics, Opticon, Worthington Data Solutions, and others. The listed price is for the software only; scanners and computers must be purchased separately.

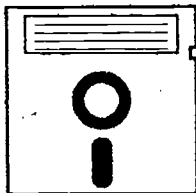

**Product Name:** ScreenPower  
**Vendor:** TeleSensory Corporation  
**Computer:** IBM PC Family  
**Manual Form:** Audiotape Manual,  
Braille/Tactile Manual, Electronic Manual,  
Printed Manual  
**Cost:** \$495.00

ScreenPower is a screen reading program ready to work with many popular application programs including WordPerfect and Lotus 1-2-3 and other software running in DOS. ScreenPower is both command and menu driven and allows the user to hear information displayed on the computer screen with a minimum of keystrokes. Reading options can be changed at any time to customize operation. An integrated macro system turns groups of functions into a single command.

ScreenPower is bundled with DECTalk PC and Pulse Data External and is also compatible with Accent SA, Pulse Data Internal, PulseData Voice Card, BrailleMate, and Vert Plus card.

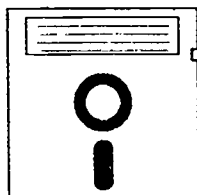

**Product Name:** ScreenPower for Windows

**Vendor:** TeleSensory Corporation

**Computer:** IBM PC Family

**Cost:** \$995.00

ScreenPower for Windows provides access to programs running under Microsoft Windows. The package uses braille and/or speech to navigate graphically-oriented screens. The explore mode takes the user through the tree structure of Windows to find and use any function through the number pad and braille display and focus tracking makes the user aware of any changes on the screen. Using the Optical Sensor Pointers of INKA, DM80, or David or the cursor routing strip of the PowerBraille 40 (see entries), the braille display acts as the mouse with click and drag functions.

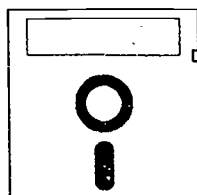

**Product Name:** Seekline

**Vendor:** Speech Systems for the Blind

**Computer:** IBM PC Family

**Cost:** \$45.00

Seekline is a screen reader program for IBM computers and compatibles using DOS. The program features cursor alignment, full user configuration of pitch, speed, tone, volume, read window area, etc., a dictionary, and more. A set-line watch feature watches an area of screen and reads it when it has been updated. Version 2.08 allows up to 10 window areas to be defined on the screen and echo standard BIOS/DOS video writes from any program. Demo copies of the program are available for \$5.00.

Seekline requires: 214K RAM, 400K EMS, and 286 or higher. The program utilized most commercial sound cards to accomplish text-to-speech.



**Product Name:** Slimware

**Vendor:** Syntha-Voice Computers Inc.

**Computer:** IBM PC Family, IBM PS/2 Models 25/30,  
Toshiba Laptops

**Cost:** \$495.00

Slimware (formerly called Powerkey) is a software program that processes screen and keyboard output into speech. The program is designed to work with most text-based application programs, including word processors, database managers, spreadsheet, communications, accounting, and terminal emulation programs. A "sticky key" feature permits users to enter commands that require a combination of keys by hitting the keys sequentially instead of simultaneously. Slimware also permits key repeat capability to be turned off.

Contact manufacturer for information on hardware that works with Slimware.



**Product Name:** Slimware Window Bridge

**Vendor:** Syntha-Voice Computers Inc.

**Computer:** IBM PC Family

**Manual Form:** Electronic Manual, Printed Manual

**Cost:** \$695.00

Window Bridge is a screen access program for IBM PC and compatible computers using Microsoft Windows or DOS. The program features automatic tracking of pull-down menus, automatic reading of dialog boxes, 100 user definable windows for software configuration, notepad functions, and full macro capability. The keyboard can be customized for one-handed typists; the mouse or a touchscreen can also be used. Speech and braille outputs can run simultaneously.

Window Bridge runs on IBM compatibles and requires Microsoft Windows. A speech synthesizer is also needed (extra). Window Bridge supports most synthesizers or braille displays, contact the manufacturer for complete details.



**Product Name:** SoundProof

**Vendor:** HumanWare, Inc.

**Computer:** Toshiba laptops

**Cost:** Contact manufacturer

SoundProof is software screen-reading program designed for individuals with learning disabilities. The program works with a speech synthesizer to "read" text as it is highlighted on the computer screen so that user can view and hear text at the same time. Anything which is displayed on-screen can be read including help menus, spell checks, data processing, and word processing material. The speed of the speech output and the portion of the screen to be read is determined by the user using either the keyboard or mouse. This program can be used with any other MS-DOS applications.

SoundProof is designed to be used with the Keynote GOLD series of computer and speech hardware (see entry). The program is sold bundled with the GOLD series or as a kit for desktop computers and selected Toshiba laptops; contact manufacturer regarding pricing details.

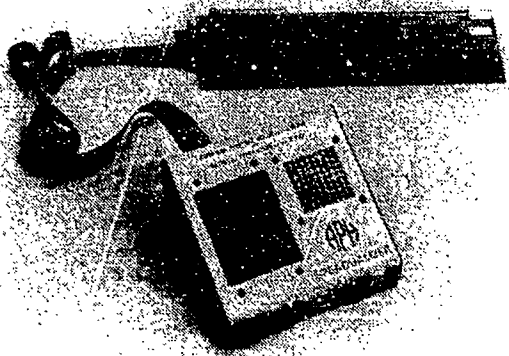

**Product Name:** Speaqualizer Speech Access System

**Vendor:** American Printing House for the Blind  
(APH)

**Computer:** IBM PC Family, IBM PS/2 Models 25/30

**Size:** 7" x 7" x 3"

**Cost:** \$925.55.

Speaqualizer is a hardware-based system that provides voice output of information appearing on the computer screen of IBM PC, XT, AT, PS/2 Model 30/286 computers. The Speaqualizer is "transparent," providing voice output for any software that sends character data to the screen and uses the operating system cursor. The Speaqualizer system consists of three parts: an internal circuit card for the computer, a control box, and a connecting cable. A keyboard on the control box is used to control what section of the screen will be read back and how it will be read. The user can adjust the speed and volume of the synthesized speech at any time, even while the Speaqualizer is talking. The user can also silence the speech at any time. The user can opt to hear each character read back as it is typed on the computer's keyboard. Upper case letters are signalled by a higher pitch of the voice. The Speaqualizer can review text displayed in columns.

Because it is hardware-based, the Speaqualizer does not consume any of the computer's memory while in operation.



**Product Name:** Textalker-GS

**Vendor:** American Printing House for the Blind (APH)

**Computer:** Apple IIGS

**Cost:** \$34.50

Textalker-GS is text-to-speech software that is designed especially for the Apple IIGS. Textalker-GS allows most programs that are text-based to speak, including many commercial programs. A Quick Review feature allows for reviewing the screen without actually going into Review mode.

Textalker-GS works with ProDOS8, DOS 3.3, GS/OS, and Pascal operating systems. System requirements include at least 512K RAM and a 3.5" disk drive.



**Product Name:** Tinytalk

**Vendor:** OMS Development

**Computer:** IBM PC Family

**Manual Form:** Electronic Manual

**Cost:** \$150.00

Tinytalk is a screen access program for IBM computers. Features of the program include automatic detection and reading of popup windows, tracking of highlight bars, and a "form tracking mode" for automatic reading of data entry prompts.

Tinytalk is compatible with IBM computers and requires less than 35K of memory. A fully functional demonstration version of the program is available for \$5.00 from the manufacturer. Tinytalk requires a speech synthesizer (extra). Contact OMS Development for details about compatible equipment.

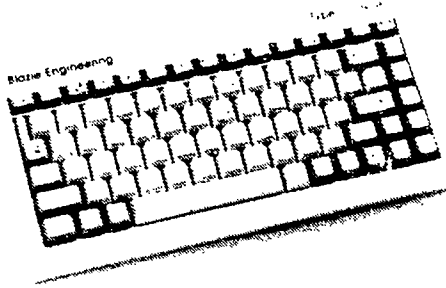

**Product Name:** Type 'n Speak  
**Vendor:** Blazie Engineering  
**Size:** 11" x 5.5" x 1.5"  
**Weight:** 4 lbs.  
**Power Source:** 9 volt battery or AC  
**Cost:** \$1,395.00 - \$1,495.00

Type 'n Speak is a portable voice-output writing and notetaking device. The features are similar to the Braille 'n Speak (see separate entry), but the device uses a QWERTY (typewriter-style) keyboard rather than a seven-key braille keyboard. Type 'n Speak does not have a visual display, but instead speaks any text typed into it using a synthesized voice. About 300 pages of text can be stored in the device memory. A built-in clock, calendar, spell checker, talking calculator, stopwatch, and the ability to run external software are included.

Type 'n Speak is available in eleven languages: English, Czech, French, German, Italian, Japanese, Korean, Portuguese, Slovak, Spanish, and Turkish. An optional disk drive can be added for reading IBM format floppy disks.



**Product Name:** Vocal-Eyes  
**Vendor:** GW Micro  
**Computer:** IBM PC Family, IBM PS/2 Family  
**Manual Form:** Audiotape Manual,  
Electronic Manual, Printed Manual  
**Cost:** \$450.00

Vocal-Eyes is a software package that processes screen and keyboard output from standard software programs, such as word processors, into speech. Features include: full support for video attributes, automatic box reading, auto-loading of set files, compatibility with windowed programs, definable "hot keys" for customized macros, cursor control, and "cut and paste" capabilities.

A demonstration disk is available. Contact manufacturer for information on compatibility with speech synthesis hardware (required; extra).





**Product Name:** Win Vision  
**Vendor:** Artic Technologies  
**Computer:** IBM PC Family  
**Cost:** \$495.00

Win Vision is a screen reading program for Microsoft Windows. In addition to reading text on the screen, Win Vision can automatically speak dialogue boxes as they pop up on the screen and can track pull-down menus, scroll bars, buttons, radio buttons, icons with text labels, and icons without text labels. Win Vision can also read check-off boxes and font information. Multiple DOS sessions, mouse cursor tracking, 256 color video drivers, multiple video resolutions, and many Windows accelerator cards are supported.

Price is for Win Vision alone; cost is \$395 when purchased with a synthesizer.



**Product Name:** Window-Eyes  
**Vendor:** GW Micro  
**Computer:** IBM PC Family  
**Cost:** \$495.00

Window-Eyes is a voice-output screen reading program for Microsoft Windows. The program is a stand-alone Microsoft Windows application designed to give the user control over how, when, and what is spoken. Window-Eyes was designed with many of the same features as Vocal-Eyes (see entry). The program offers 10 standard windows that can be read with a single keystroke and an additional 40 windows that can be accessed. Also 10 hyperactive windows are included that allow the user to monitor certain screen areas. Information under the mouse is automatically read as it is moved and mouse click support from the keyboard is offered. The user can assign over 90 Window-Eyes hot keys for routing and reading that will not disturb the underlying application program. Because Window-Eyes is a stand-alone application, it does not require a particular DOS screen reader to operate.

System requirements include: Windows or Windows for Workgroups, at least 4 MB of RAM, and any synthesizer with an SSIL driver.



**Product Name:** WINKLiNE

**Vendor:** Speech Systems for the Blind

**Computer:** IBM PC Family

**Cost:** \$45.00

WINKLiNE is a screen reading program for Microsoft Windows. The program speaks keys when struck, icons when selected, menus when opened, menu items selected, and all standard controls. All document text and other text written in Windows can be spoken; speech can be aborted with a key strike or mouse click. A demo copy is available for \$5.00.

WINKLiNE requires Microsoft Windows and a sound card.



**Product Name:** WordScholar

**Vendor:** Henter-Joyce, Inc.

**Computer:** IBM PC Family

**Cost:** Contact manufacturer

WordScholar is a software program designed for people with specific learning disabilities to improve reading comprehension, retention, and speed through a speech synthesizer. Text can be selected by the word, line, sentence, paragraph or entire document. As each word is spoken it is also highlighted visually in a stand-out color. A 310,000 word version of the American Heritage Dictionary is included and definitions can be accessed at any time. Speech and visual output can be adjusted according to the user's preferences.

WordScholar works with text based DOS applications and can be combined with a scanner or reading machine to access print materials. Most popular speech synthesizers are supported.

# Chapter 15

## Magnification Products for Computer Displays

This chapter includes software and hardware products whose primary purpose is to magnify the image on a standard computer screen. The products in this chapter are designed to work with all or most software on the computer. A word processing program with large print would not appear here because it is only a single application program.

Products with magnification features and speech output are listed in Chapter 14 (Voice-Output Screen Readers and Reading Machines) and cross-listed under the magnification function.

Some pertinent resource listings in Appendices A and B are: Information Resources for Blind and Visually Impaired Individuals; Computer Assessment and Training Programs for Disabled Individuals; and Books and Pamphlets.

*The following product entries appear in this chapter:*

Adjustable EZ Magnifier, 493  
B-Pop, 493  
Beamscope, 494  
Big-W, 494  
CloseView, 495  
Compu-Lenz, 495  
GNK Magnifier, 496  
inLARGE 2.0, 496  
Large-Type Display Utility Software, 497  
Lens 2 03, 497  
LP-DOS & LP-Windows, 498  
MAGic and MAGic Deluxe, 498  
Magnum Deluxe, 499  
Magnum GT, 499  
NuVu Magnifier, 500  
Panorama, 500  
Powerama, 501  
Screen Magnifier/2, 501  
Vantage CCD, 502  
Vista, 502  
ZoomText 5, 503

*The following products from other chapters can also be used as Magnification Products for Computer Displays:*

Speak Out VOILA, 440

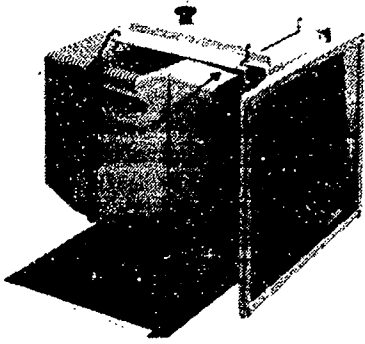

**Product Name:** Adjustable EZ Magnifier

**Vendor:** Less Gauss Inc.

**Computer:** All (Hardware Independent)

**Size:** Customized

**Cost:** \$198.00

The Adjustable EZ Magnifier is a hardware magnification device that attaches to the monitor and hangs down in front of it. The EZ provides infinite adjustment from zero to six inches from the screen. Protective optical non-glare glass allows the lense to be cleaned with household cleaner.

To order, provide the following dimensions: length of screen, width of screen, and width of space between top of monitor and screen.

---

**Product Name:** B-Pop

**Vendor:** Hexagon Products

**Computer:** IBM PC Family

**Manual Form:** Electronic Manual,  
Large Print Manual

**Cost:** \$39.00

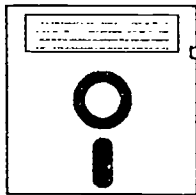

B-Pop is a memory-resident text enlargement software program that can be used to enlarge text appearing on the screen. Once it is loaded, B-Pop may be activated and deactivated by using a "hot key." The focus may be moved around with the arrow keys or by mouse movement; the function keys may be used to search for a character string or color attribute. When B-Pop is deactivated, the user is returned to the portion of the screen being used before B-Pop was activated.

B-Pop provides read-only screen magnification, and is automatically deactivated when information is typed into the application being magnified. Included with B-Pop are six large-character utility programs: B-Type, B-Print, and B-Dir, which provide large-character replacements for the DOS Type, Print, and Dir commands, respectively; B-Look, a text file browser; and B-Font and B-Apply, which can be used to reshape the characters used in Hexagon Products' programs.

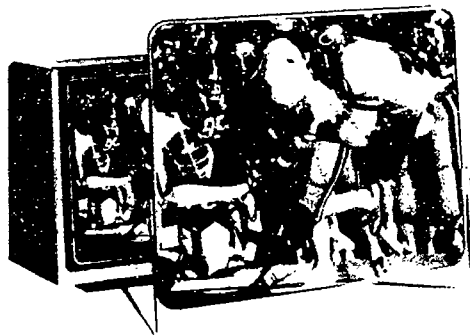

**Product Name:** Beamscope

**Vendor:** Florida New Concepts Marketing, Inc.

**Computer:** All (Hardware Independent)

**Cost:** \$68.95 - \$78.95

Beamscope is a fresnel lens that will enlarge the characters on a TV screen to more than twice their normal size when placed in front of the TV. Two different models are available. Model TS-25 is designed for 12" - 15" TVs, enlarging the screen diagonal to 25" (\$68.95). Model TS-30 fits 17" - 19" screens, enlarging the diagonal to 30" (\$78.95).

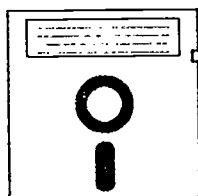

**Product Name:** Big-W

**Vendor:** Hexagon Products

**Computer:** IBM PC Family

**Manual Form:** Large Print Manual

**Cost:** \$39.00

Big-W is a screen magnifier for Microsoft Windows. The program can be run from Windows or from File Manager. The Big-W window automatically enlarges the area under the mouse cursor or the input text caret. The magnification level can be changed and the window itself can be resized or repositioned with standard Windows commands.



**Product Name:** CloseView

**Vendor:** Apple Computer, Inc.

**Computer:** Apple Macintosh Family

**Cost:** Sold bundled only

CloseView allows the screen on the entire Macintosh line to be magnified from 2 to 16 times. Working as an option on the Control Panel, CloseView also permits the screen display to be changed from black on white to white on black. It is possible to turn CloseView on and off, and to change the magnification, by using combinations of the Control, Option, and other keys.

CloseView requires Macintosh operating system software version 6.0 or higher, which requires at least one megabyte of memory. The program is included with all sets of operating system disks at no additional charge; documentation for the program is covered in the manual for the system.

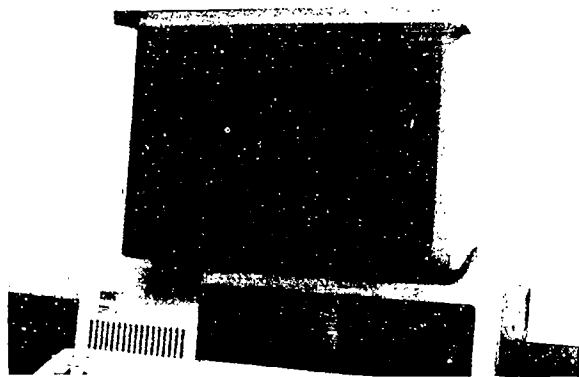

**Product Name:** Compu-Lenz

**Vendor:** Florida New Concepts Marketing, Inc.

**Computer:** All (Hardware Independent)

**Size:** 13.75" x 11.5"

**Weight:** 7 lbs.

**Cost:** \$204.95

Compu-Lenz is a combination screen magnifier (fresnel lens) and glare filter that fits on an existing monitor. Compu-Lenz displays the entire screen, magnifying it two to four times.

Compu-Lenz fits the IBM-PC and most other computers with monitors of similar size.

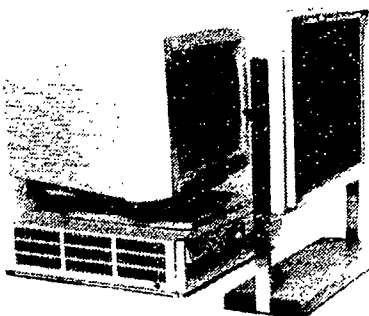

**Product Name:** GNK Magnifier

**Vendor:** Less Gauss Inc.

**Computer:** All (Hardware Independent)

**Cost:** \$269.00

The GNK Magnifier is a hardware magnification device designed to provide the maximum or minimum magnification that an individual user needs. The lense is attached to an oak base and alluminum frame so it can be placed at the desired distance from the computer screen. Protective optical non-glare glass allows the lense to be cleaned with household cleaner.

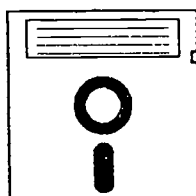

**Product Name:** inLARGE 2.0

**Vendor:** Berkeley Systems, Inc.

**Computer:** Apple Macintosh Plus

**Manual Form:** Electronic Manual,  
Large Print Manual

**Cost:** \$195.00

inLARGE 2.0 is a software application which permits the screen to be modified in several ways to facilitate Macintosh use by people with visual impairments. Modification features include: magnification by a factor of 2 to 16 times, screen inversion permitting white letters on a black background, automatic scanning in any of four directions (left, right, up, or down), automatic routing of the pointer to new windows, ability to set horizontal and vertical magnification independently, and an optional, customizable indicator of cursor location. The user may select any portion of the screen for magnification and black out any unmagnified portion. Most commands can be issued either from the keyboard or from a control panel document. inLARGE will permit modified views of all Mac features including graphics, text, and windows.

inLARGE 2.0 works with almost all Macintosh software including System 7. Minimum system requirements are a MacPlus or higher with 1MB RAM, System 6.05 or later, and 100K of floppy or hard disk space.



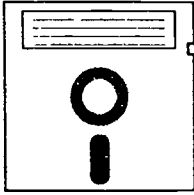

**Product Name:** Large-Type Display Utility Software

**Vendor:** National Institute for Rehabilitation Engineering

**Computer:** IBM PC Family, IBM PS/2 Family

**Cost:** \$150.00 - \$599.95

Large-Type Display Utility Software are programs that enlarge the print on the computer screen for most commercial software. There are three versions of the software. The 2X Multi-Mode (\$150.00) magnifies text or graphics up to two times in size. A magnified "window" tracks the cursor or be moved with arrow keys. This version works with VGA display. The 1X-8X Text-Mode version (\$499.95) provides one to eight times magnification. The magnified area can be viewed full screen or split screen, and magnification can track the cursor. This version displays only text, not graphics, and works with EGA or VGA display. The 1X-16X All-Mode version (\$599.95) provides one to eight times, 12 times or 16 times magnification. The magnified area can be viewed full screen or split screen, and magnification can track the cursor. This version displays text, graphics, and windows; it works with VGA display.

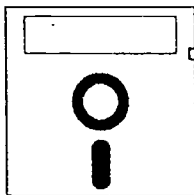

**Product Name:** Lens 2.03

**Vendor:** Konz. Ned

**Computer:** IBM PC Family

**Cost:** \$5.00

Lens 2.03 is a screen magnifier for Microsoft Windows that magnifies the area of screen around the mouse pointer. The program can also be set to track the text cursor in text applications or to display a magnified fixed area of the screen.

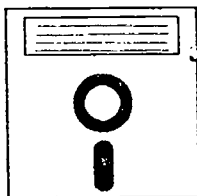

**Product Name:** LP-DOS & LP-Windows

**Vendor:** Optelec USA, Inc.

**Computer:** IBM PC Family

**Cost:** Contact manufacturer

LP-DOS and LP-Windows (LARGE PRINT for DOS and WINDOWS) provide screen magnification for low vision users. The program magnifies Microsoft Windows applications up to 16x and lets users view documents and graphics as they type, paint, or play. Users can switch magnification levels, alter screen colors, and pan images smoothly via simple keystroke or mouse control.

LP-DOS is also available for Windows 95 and offers split screens and mouse enhancements.

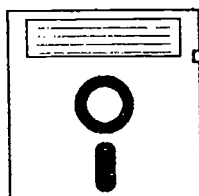

**Product Name:** MAGic and MAGic Deluxe

**Vendor:** Microsystems Software Inc.

**Computer:** IBM PC Family

**Manual Form:** Electronic Manual, Printed Manual

**Cost:** \$79.00 - \$295.00

MAGic is a memory-resident software program that provides screen magnification for most graphics and text based application programs running under DOS or Microsoft Windows (word processors, spreadsheets, etc.). MAGic enlarges the screen 2 times. Available modes include follow-the-cursor, follow-the-mouse, and follow-attribute-changes. MAGic Deluxe will magnify off-the-shelf text-based applications between 1.2X and 12X. Additional MAGic Deluxe features include 10 "bookmarks," screen location display, and a "smooth font." WinMAGic has a feature called MagniPORT, a dialog box that presents a magnified image of the area surrounding the cursor or mouse pointer.

MAGic requires 8KB of memory; MAGic Deluxe requires 15KB. An IBM PC with VGA, XGA, or SVGA display is required. A font editor is available for \$99.00.

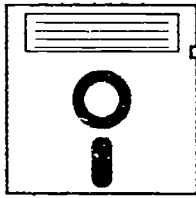

**Product Name:** Magnum Deluxe

**Vendor:** Artic Technologies

**Computer:** IBM PC Family

**Cost:** \$495.00

Magnum Deluxe is a magnification software program with the same features as Magnum GT. In addition, the Deluxe version offers more levels of magnification, automated reading commands, Color Translator system for Word Perfect, and other functions for DOS. For Microsoft Windows, the Deluxe version offers enhanced tracking, 32-times magnification, standard VGA support, Super-VGA support, Review Mode with variable speed panning and scrolling, and other functions.



**Product Name:** Magnum GT

**Vendor:** Artic Technologies

**Computer:** IBM PC Family, IBM PS/2 Family

**Cost:** \$295.00

Magnum GT is a screen enlargement program for IBM PC and PS/2 computers and compatibles running either DOS or Microsoft Windows. Magnum GT enlarges the image on the computer screen in whatever software the user is operating. Enlarged characters are shown in large fonts specifically designed for computer users with low vision. Enlargement of graphic images is also provided. A variety of viewing features are provided, including menu tracking, mouse tracking, ability to move the magnification area and then automatically return it to the application cursor location, split-screen viewing, scrolling screen viewing and bypassing of screen refreshes.

Magnum GT is software-based, requiring no additional hardware to operate. It requires a VGA video adapter. An IBM 286 or greater computer is suggested.

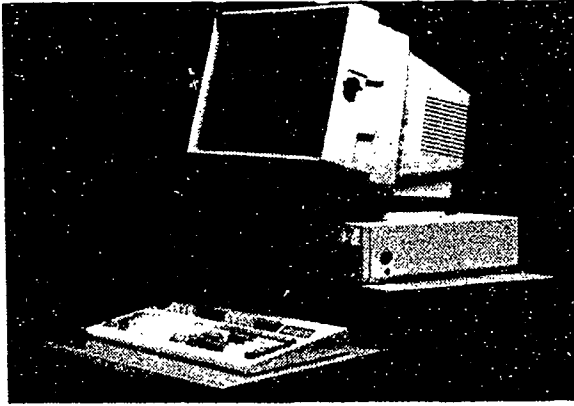

**Product Name:** NuVu Magnifier  
**Vendor:** Less Gauss Inc.  
**Computer:** All (Hardware Independent)  
**Size:** Up to 17"  
**Cost:** \$149.00

NuVu Magnifier is a hardware magnification device that attaches directly to the monitor with Velcro. The NuVu is designed to offer distortion free magnification for the entire field of view, clarification of image in addition to magnification, and reduction of magnifier glare using optical glass. Two levels of magnification are available.

---

**Product Name:** Panorama  
**Vendor:** Syntha-Voice Computers Inc.  
**Computer:** IBM PC Family, IBM PS/2 Family  
**Cost:** \$495.00

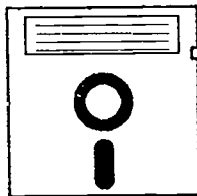

Panorama is a screen enlargement program for IBM PC, PS/2 or compatible computers running DOS. Panorama can enlarge text and graphics on the screen from two to ten times. Text is displayed in specially designed large fonts. Various viewing features are provided, including: horizontal and vertical scrolling, display in multiple windows, ability to follow application software's highlight bars, instant location of windows on screen and moving between windows. The user can also search for text or screen colors, automatically view screen changes such as error messages, and move the cursor by character, column, word, line, sentence or paragraph. The user can set the spacing between lines and characters in text viewing.

Panorama requires a computer with at least a 286 processor, 384K of extended memory, and either an EGA or a VGA video adapter. A scaled-down version, Panorama Junior, magnifies two to three times and is PC XT compatible.

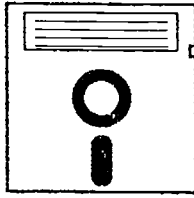

**Product Name:** Powerama

**Vendor:** Syntha-Voice Computers Inc.

**Computer:** IBM PC Family, IBM PS/2 Family

**Cost:** \$795.00

Powerama is a screen enlargement and voice-output screen reading program. Powerama integrates the features of Panorama screen enlarging software and SlimWare screen reading software (see separate entries). The large print display and voice output work together, so that text is displayed and read aloud simultaneously. Powerama can enlarge from two to ten times. Text is displayed in specially designed large fonts. Various viewing features are provided, including: horizontal and vertical scrolling, display and reading in multiple windows, ability to follow application software's highlight bars with viewing and voice, and instant location of windows on screen. The user can also search for text or screen colors, automatically view and hear screen changes such as error messages, and move the cursor by character, column, word, line, sentence or paragraph. The user can set the spacing between lines and characters in text viewing.

Powerama requires a computer with at least a 286 processor, 384K of extended memory, and either an EGA or a VGA video adapter. A scaled-down version, Powerama Junior, magnifies two to three times and is PC XT compatible.

---

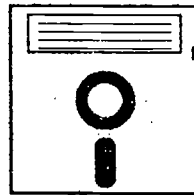

**Product Name:** Screen Magnifier/2

**Vendor:** IBM Corporation

**Computer:** IBM PC Family

**Cost:** \$495.00

Screen Magnifier/2 enlarges applications running under IBM's OS/2 operating system. The magnification level ranges from two to 32 times the normal size. A "reading mode" that pans the cursor along the lines is included and the reading speed can be controlled with one finger. Screen colors can be reversed and focus tracking ensures that users will see an error message that pops up on another part of the screen. Also, a locator lets users see just where the magnified window is on the system.

Information about the Screen Magnifier/2 can be obtained by calling (800) 426-4832 (U.S. voice) or (800) 426-4833 (U.S. TDD). To order Screen Magnifier/2, call (800) 426-7630 (U.S. voice) or (800) 426-3383 (U.S. TDD). Canadian ordering and information is available at (800) 465-7999.

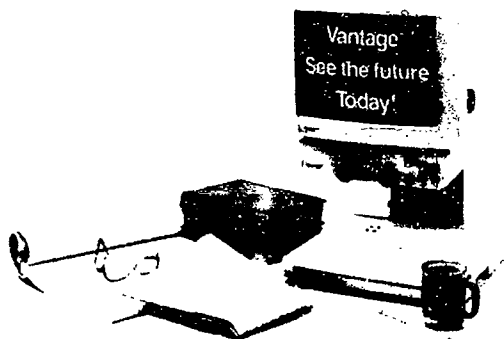

**Product Name:** Vantage CCD  
**Vendor:** TeleSensory Corporation  
**Computer:** IBM PC Family  
**Cost:** \$2,495.00

Vantage is a closed circuit television system that magnifies any printed text. The user positions text under a CCD camera, and the text appears, enlarged 3 to 45 times, on a video screen. The non-glare screen can be raised, lowered, and tilted. Underlining and overlining are possible, and a split screen can be used to view two texts. Vantage can also act as a monitor for Vista (see entry), providing large-print access to standard software on IBM-PC computers.

Vantage comes with a black and white 14" non-glare screen. Manuals are in large print format.



**Product Name:** Vista  
**Vendor:** TeleSensory Corporation  
**Computer:** IBM PC Family  
**Cost:** \$2,495.00

Vista is a hardware and software package that allows a portion of the screen display to be selected and enlarged. The system consists of an internal circuit card, a program on disk, and a mouse. By pressing certain buttons on the mouse and moving the mouse, the user can enlarge an area of the screen, move the area to be enlarged around the screen, mask off only one line for viewing, jump from the end of one line to the beginning of another, and stretch an image taller or wider. Magnification can be from 2 to 16 times.

Vista uses color, enhanced graphics, or monochrome monitors, will work with most software, and will magnify graphics and other screen attributes. Two models are available: Vista and Vista with Windows (this version does not include Microsoft Windows but is designed to be responsive to the Windows environment) which are designed for MS-DOS 386 or higher compatible computers.



**Product Name:** ZoomText 5

**Vendor:** AI Squared

**Computer:** IBM PC Family, IBM PS/2 Family

**Manual Form:** Large Print Manual

**Cost:** \$495.00 - \$595.00

ZoomText is a screen magnification program that magnifies characters on the screen from 2x to 16x. Versions exist for DOS, Microsoft Windows, and both environments. Features include: full-screen and partial-screen zoom windows, smooth-edged magnification, and advanced tracking.

ZoomText is \$495.00 and requires an EGA or VGA graphics adapter card. ZoomText Plus which includes all ZoomText features plus graphics magnification and a Microsoft Windows interface is also available (\$595.00).

# Chapter 16

## Braille and Tactile Output Systems

This chapter includes devices that have either braille or other tactile output. It includes braille printers (also known as embossers), portable braille "notebooks" with refreshable braille displays, and tactile or braille devices that are designed for accessing a standard computer screen.

Software for braille word processing or for formatting braille documents can be found in Chapter 21 (Personal Tool or Aid). Programs for teaching braille or braille transcription can be found in Chapter 19 (Training and Therapy).

Hardware or software that has braille output can also be located by looking in Index 2 under Output/Display: Tactile/Braille Display. Appendix A contains Information Resources for Blind and Visually Impaired Individuals.



*The following product entries appear in this chapter:*

ALVA Braille Terminals, 507  
Braille Blazer, 507  
Braille BookMaker and Braille Express 100 & 500, 508  
Braille-N-Print, 508  
BrailleAccess, 509  
BRAILLEX-2D, 509  
Braillo 200, 510  
Braillo 400 S, 510  
Braillo Comet, 511  
DM80/FM, 511  
Index Basic, 512  
Index Basic-D, 512  
Index Everest-D, 513  
INKA, 513  
Juliet Brailier, 514  
KTS Braille Display, 514  
Marathon Brailier, 515  
MasterTOUCH, 515  
Mountbatten Brailier, 516  
NOMAD Talking Touch Pad & NOMAD Gold, 516  
Notex 486, 517  
Ohtsuki BT-5000 Braille/Print Printer, 517  
Optacon II, 518  
Paragon Braille Printer, 518  
PowerBraille 40, 65, & 80, 519  
Ransley Braille Interface (RBI), 519  
Romeo Brailier Model RB-25, 520  
Romeo Brailier Model RB-40, 520  
TEXTALKER, 521  
Thomas Brailier, 521  
TranSend System, 522  
VersaPoint-40 Braille Embosser, 522

*The following products from other chapters can also be used as Braille or Tactile Output Systems:*

Braille Lite, 470  
David, 471  
InfoTouch, 182

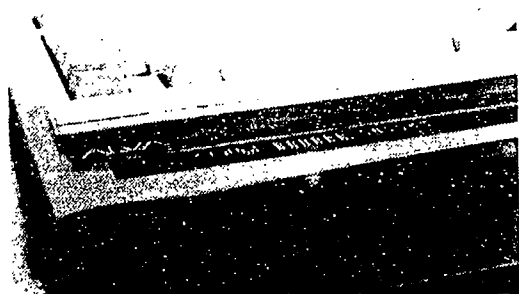

**Product Name:** ALVA Braille Terminals

**Vendor:** HumanWare, Inc.

**Computer:** IBM PC Family, IBM PS/2 Family

**Cost:** \$4,995.00 - \$14,495.00

ALVA Braille Terminals are electronic braille displays for use with MS-DOS compatible computers. Four models are available. The 23 and 43 are portable models, the 43 and 83 are desktop models. Each model includes: eight dot braille cells; 20, 40, or 80 column reading windows; three status cells for monitoring of cursor location and screen features; built-in parallel printer port and external keypad port; Grade II braille translation with AutoBraille by KANSYS.

Optional features include Microsoft Window and OS/2 access. The portable terminals use rechargeable batteries.

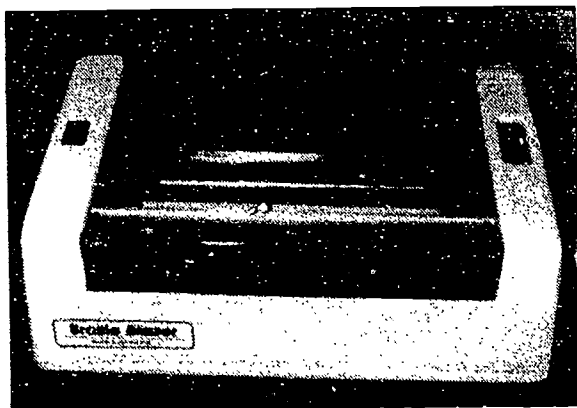

**Product Name:** Braille Blazer

**Vendor:** Blazie Engineering

**Computer:** All (Hardware Independent)

**Size:** 15" x 10" x 5"

**Weight:** 12 lbs.

**Power Source:** AC Adapter

**Cost:** \$1,695.00

Braille Blazer is a portable braille printer designed for users without special technical expertise or prior computer experience. Configuration is achieved with built-in synthesized speech. Four operating modes are included: light paper mode for proofreading and other applications on regular paper, regular mode for braille paper in all sizes, plastics mode for production of braille signs and labels on lightweight polymer, and sideways mode to print spreadsheets and screen dumps. Minimum paper width is one inch and the maximum paper width is 10 inches.

A carrying case is available for \$50.00.

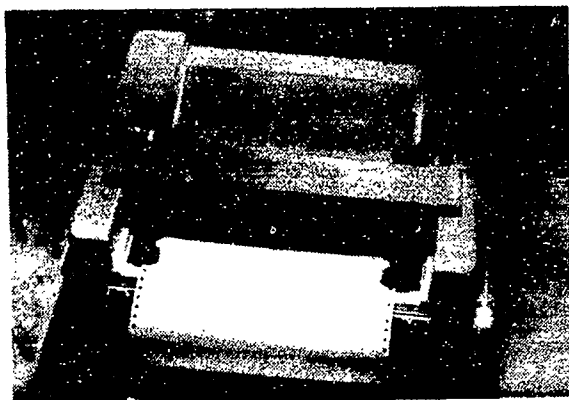

**Product Name:** Braille BookMaker and Braille Express 100 & 500

**Vendor:** Enabling Technologies Company

**Computer:** All (Hardware Independent)

**Size:** 21.25" x 18" x 8.75"

**Weight:** 52 lbs.

**Power Source:** 120V AC

**Cost:** \$7,995.00 - \$14,995.00

Braille BookMaker and Braille Express 100 & 150 are three models of braille embossers that allow the user to combine text and graphics on a single page without stopping. A rear panel impact control selector allows the user to adjust for different weights of paper from 20-pound computer paper to 100-pound tag. All three come with a calculator style keypad with an LCD screen for visual feedback.

Braille BookMaker (\$7,995.00) brailles on both sides of a page at the same time at a speed of 80 characters per second. The BookMaker is available with an optional 512K copy buffer. Braille Express Models 100 (\$10,500.00) brailles on both sides of a page at a speed of 100 characters per second and the Model 150 (\$14,995.00) brailles on both sides of a page at a speed of 150 characters per second. Both Express models come with a standard 512K copy buffer and can hold 500 pages in memory at a time.

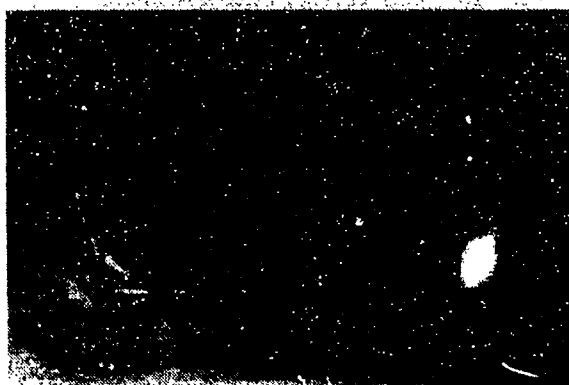

**Product Name:** Braille-N-Print

**Vendor:** HumanWare, Inc.

**Size:** 12" x 10" x 6"

**Weight:** 9 lbs.

**Power Source:** 120V AC

**Cost:** \$1,025.00

Braille-N-Print is a grade two Braille translation device that works in conjunction with a standard Perkins Braille. Braille-N-Print connects mechanically to the Perkins, decodes grade 1 and grade 2 Braille, and sends the decoded text to a standard printer. Thus the user may produce Braille output and inkprint output at the same time.

Two models are available: Mark II, for connection to multiple Perkins Braille, and Slimline, for connection to a single Perkins Braille. Contact manufacturer for details on purchasing Braille-N-Print with an Epson or Diconix printer.

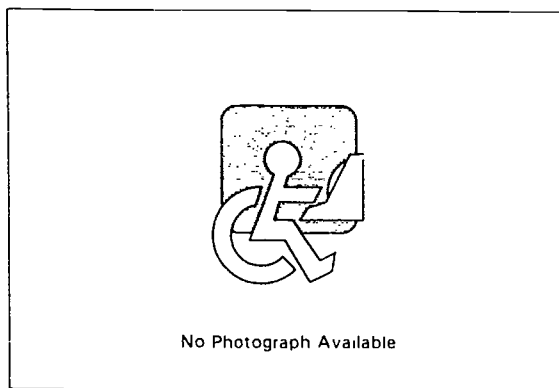

**Product Name:** BrailleAccess

**Vendor:** Access Systems International, LTD

**Computer:** IBM PC Family

**Size:** see text

**Cost:** \$4,995.00 - \$9,995.00

BrailleAccess is a braille terminal which reproduces what is displayed on the computer screen in dynamic braille. The display is fitted with identical multifunction operation keys allowing keys to be within easy reach where the user is reading on the display. Each key performs nine primary functions as well as a number of secondary functions depending on which portion of the key is pressed. These functions include moving around the screen, toggling screen attributes such as underlining, and changing the parameter menus.

BrailleAccess is available in four models. BrailleAccess 20, 27, and 40 display 20, 27, and 40 characters respectively, are each 11" x 12" x 1", and have four multifunction keys. BrailleAccess 80 displays 80 characters, is 21.5" x 9" x 1", and has eight multifunction keys.

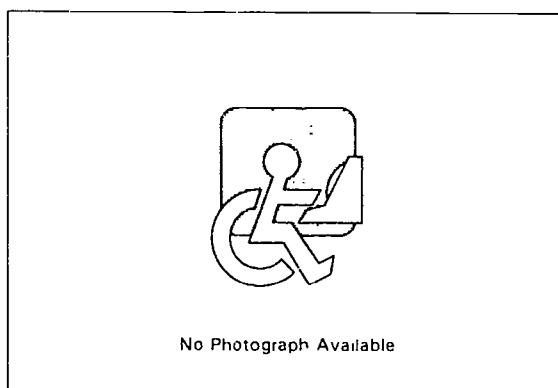

**Product Name:** BRAILLEX-2D

**Vendor:** ATR/JWA, Inc.

**Computer:** IBM-PC XT, IBM PC AT,  
IBM PS/2 Family

**Size:** 29" x 12.2" x 1.3"

**Weight:** 19 lbs.

**Cost:** Contact manufacturer

BRAILLEX-2D is a braille display for personal computers that allows the user to read the text on the screen and also understand the screen layout. The device features an 80 character horizontal braille display for the text and a secondary, vertical display that provides screen layout information. The vertical display represents every screen line by four dots and can show the presence and location of characters on the screen, the quality of the characters, screen attributes, etc. depending on the user's preferences. A key next to the corresponding screen line row allows the user to read the contents of the line in detail. BRAILLEX-2D provides access to programs running in DOS. It also provides access to Microsoft Windows when used with the WinDOTS (see entry) software program.

System requirements include: MGA, CGA, EGA, VGA or compatible video system, a compatible keyboard connector, and any operating system or software using character mode.



**Product Name:** Braillo 200  
**Vendor:** American Thermoform Corporation  
**Computer:** IBM PC Family  
**Size:** 22.62" x 25.74" x 33.93"  
**Weight:** 320 lbs.  
**Cost:** \$36,995.00

The Braillo 200 is a Braille printer that can print six and eight dot braille at 200 cells per second. A liquid crystal display indicates the page count. Operator controls include form feed, reset, and paper stop. The printer may be connected directly to a paper cutter. The page lengths and line length are both adjustable; the maximum line length is 42 characters.

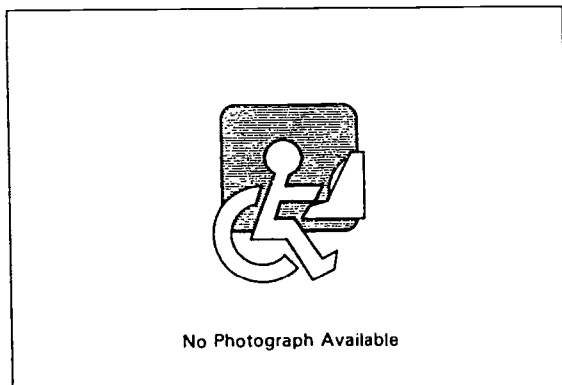

**Product Name:** Braillo 400 S  
**Vendor:** American Thermoform Corporation  
**Computer:** IBM PC Family  
**Size:** 48.36" x 26.13" x 39.78"  
**Weight:** 530 lbs.  
**Cost:** \$77,995.00

The Braillo 400 S is a Braille printer that can print six and eight dot braille at 400 cells per second. A liquid crystal display indicates the page count. Operator controls include form feed, reset, and paper stop. The printer may be connected directly to a paper cutter. The page lengths and line length are both adjustable; the maximum line length is 42 characters.

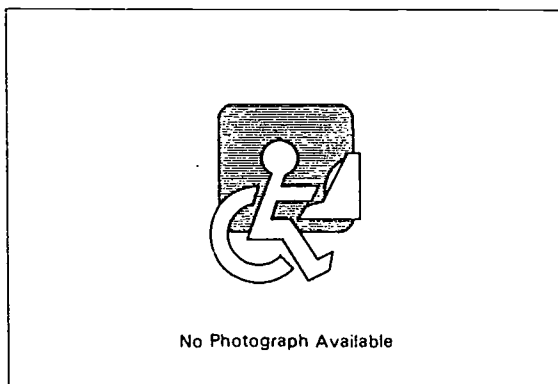

**Product Name:** Braillo Comet

**Vendor:** American Thermoform Corporation

**Computer:** IBM PC Family

**Size:** 22.75" x 5.5" x 14"

**Weight:** 35 lbs.

**Cost:** \$3,795.00

The Braillo Comet is a Braille printer that can print six and eight dot braille at 50-75 cells per second. The Braillo Comet can also print graphics. The line and page lengths can be adjusted, as can the dot height (for different thicknesses of paper). The printer uses continuous pin feed fanfold paper, and stops automatically when out of paper. On top of the printer are switches for line feed, form feed, and on-line/off-line.

Contact manufacturer for information on the graphics option (extra).

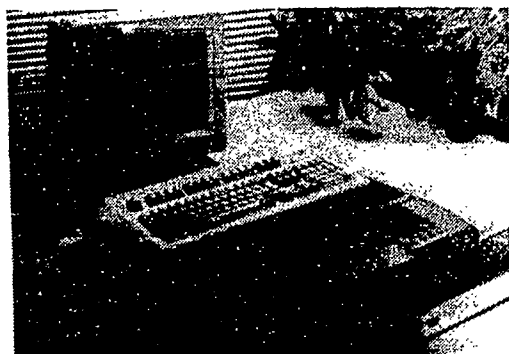

**Product Name:** DM80/FM

**Vendor:** TeleSensory Corporation

**Computer:** IBM PC Family

**Size:** 25.7" x 15.3" x 2.5" (both units combined)

**Weight:** 20.95 lbs.

**Cost:** \$12,995.00

DM80 is an 80-cell, 8-dot, braille display and the FM (Function Module) is a 9-key braille keyboard, numeric keypad, and two independently positionable 12-cell braille displays. Together, the DM80/FM allow access to most software applications. DM80 features an Optical Sensor Pointer that acts like a "braille mouse", or navigator, and moves the cursor to the desired location by monitoring the hand positions. Also, DM80 has six pre-defined mode switches and seven user-definable navigation function keys. The FM can control up to 511 user-definable input functions and 15 command layers. An integrated speech synthesizer and a microprocessor control both internal system operation and communication with the host computer. TeleSensory's DM80 can be purchased and used with or without the FM.

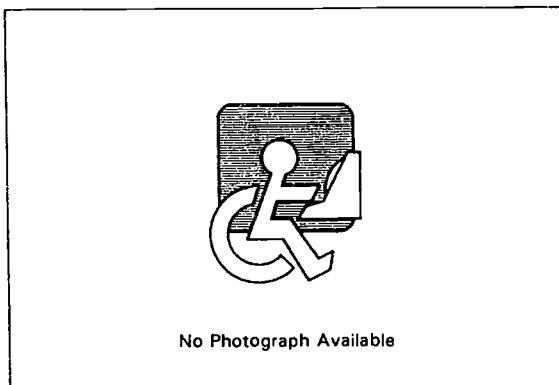

**Product Name:** Index Basic

**Vendor:** Access Systems International, LTD

**Computer:** All (Hardware Independent)

**Size:** 20.2" x 10" x 5"

**Weight:** 16 lbs.

**Cost:** \$2,525.00

Index Basic is a braille printer with functions including: multicopy, graphics reformatting, and sideways print mode. Parameters are altered using either dip switches or the setup program from the computer. Index Basic includes sixteen different standard braille tables, computer and literary in 6 or 8 dot braille with two user-defined tables. The print speed is 50 characters per second.

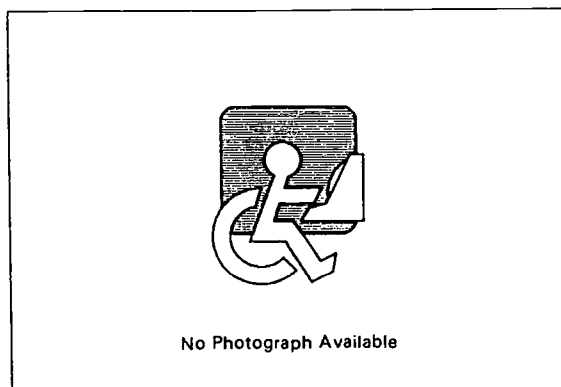

**Product Name:** Index Basic-D

**Vendor:** Access Systems International, LTD

**Computer:** All (Hardware Independent)

**Size:** 20.2" x 10" x 5"

**Weight:** 16 lbs.

**Cost:** \$3,395.00

Basic-D is a continuous tractor-fed printer that produces double sided braille on all paper, including thin "copy" paper. A speech interface guides the user through set-up in a number of languages. Front panel buttons are labelled in print and braille. Text and graphics can be printed on a single page. Up to 2400 pages can be printed in eight hours.

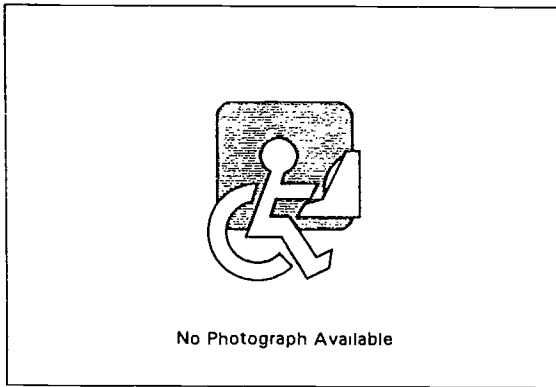

**Product Name:** Index Everest-D

**Vendor:** Access Systems International, LTD

**Computer:** All (Hardware Independent)

**Size:** 22" x 7" x 17"

**Weight:** 29 lbs.

**Cost:** \$3,695.00

Everest-D is a braille printer with a single sheet feeder and an internal speech system that speaks all set up parameters. Everest-D can produce double sided Interpoint Braille at 100 characters per second and has a print buffer of 400,000 characters allowing the user to send large documents without tying up the computer.

An optional acoustic hood reduces noise to a level normally accepted to be below the recommended level for office equipment.



**Product Name:** INKA

**Vendor:** TeleSensory Corporation

**Computer:** IBM PC Family

**Size:** 22.2" x 9.8" x 2.8"

**Weight:** 8.2 lbs.

**Cost:** \$7,495.00

INKA is an integrated output and input keyboard for braille users. The keyboard is in full 101-key QWERTY form augmented by braille dots on specific keys to aid orientation. The computer screen is represented by a high speed piezo-electric braille display incorporating 40 reliable eight-dot elements and integrated optical sensors. This braille display is supplemented with a four-element status field. INKA is equipped with an optical sensor pointer that serves the purpose of a "braille mouse" by monitoring hand positions immediately above the cells and navigating the cursor to the desired location. INKA includes four switches to assign to frequently used functions and can easily connect to most PC's via the standard keyboard port.

INKA offers an optional synthetic speech function to operate in parallel with the braille display.



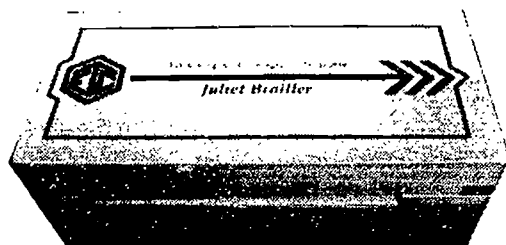

**Product Name:** Juliet Braille  
**Vendor:** Enabling Technologies Company  
**Computer:** All (Hardware Independent)  
**Size:** 11.5" x 24.63" x 9.4"  
**Weight:** 52 lbs.  
**Power Source:** 120V AC  
**Cost:** \$3,995.00

The Juliet is a desk-top braille printer which can braille in interpoint (capable of printing on both sides of a page) and has a printing speed of 42 to 55 characters per second. The Juliet accepts paper of any weight from 20 to 100 pounds and will print on paper up to 15 inches wide or a maximum of 56 braille cells per line. Juliet can produce text and graphics on the same page. A calculator style keypad is used to configure the printer. The Juliet has both serial and parallel connection ports. The Juliet also has a low power consumption mode that goes into effect after three minutes of inactivity.

The Juliet uses tractor feed paper and can be purchased with a single sheet feed option. Contact manufacturer for details.



**Product Name:** KTS Braille Display  
**Vendor:** American Thermoform Corporation  
**Computer:** IBM PC Family  
**Size:** 7" x 22" x 11"  
**Weight:** 8.8 - 17.6 lbs.  
**Cost:** \$5,695.00 - \$11,995.00

The KTS Braille Display is a refreshable braille display that is compatible with MS-DOS, UNIX, and CPM86 operating systems and most software programs. A dual interface allows the display to echo to a second screen or printer. Other features include a loadable character set and program to set up and change a personal braille table, integrated 8 dot braille keyboard, automatic cursor routing, and 14 dedicated function keys for screen navigation.

The KTS is available as a 40 cell display and an 80 cell display.

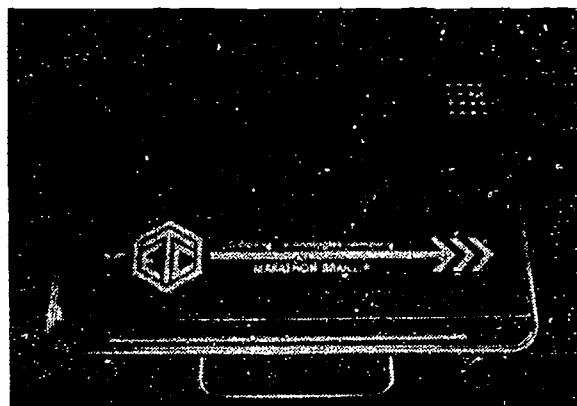

**Product Name:** Marathon Brailer

**Vendor:** Enabling Technologies Company

**Computer:** All (Hardware Independent)

**Size:** 21" x 18" x 8"

**Weight:** 75 lbs.

**Power Source:** 100V - 260V AC

**Cost:** \$12,995.00

The Marathon Brailer is a single sided braille embosser that embosses at a speed of 200 characters per second. The Marathon embosses on a tractor feed paper from weights of 20 to 100 pound tag. Other features include a multicopy function, a paper-out detector, and built-in sensors that monitor the line voltage and internal temperature of the printer in operation and stop embossing if these fluctuate to a degree that could harm the Marathon. The Marathon also features a calculator style keypad with an LCD screen for visual feedback.

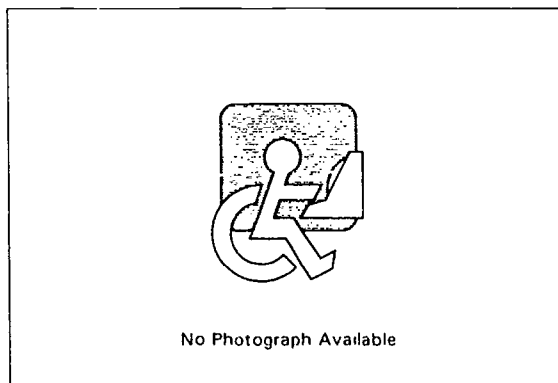

**Product Name:** MasterTOUCH

**Vendor:** HumanWare, Inc.

**Computer:** IBM PC Family

**Cost:** Contact manufacturer

MasterTOUCH Tablet is an interactive tactile computer screen. The touch-sensitive surface is divided by raised tactile ridges into 25 lines that correspond to the text lines on the screen. Touching the tablet surface at any point causes the word at the corresponding point on the visual screen to be spoken. Features include: "intelligent processing" of highlight bars, pop-up windows, prompts, and menus; speech cutoff when a keyboard key is pressed; context-sensitive help; windows that may be defined by the user as silent, automatically read when changed, or read conditionally on other screen changes; spreadsheet access option; full review mode; user-controlled keyboard echo and punctuation options; assignable macros; and the ability to save and run application-specific configurations.

The tablet comes with MasterTOUCH, a screen access program that may be purchased and run separately (although the two must be used together to permit analysis of screen layouts). Contact manufacturer for information on compatibility with Keynote GOLD (see entry).

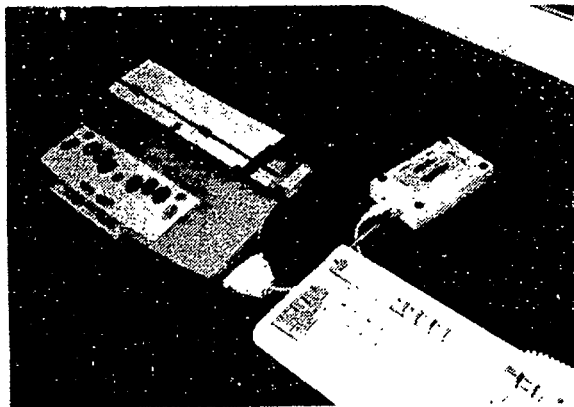

**Product Name:** Mountbatten Brailer

**Vendor:** HumanWare, Inc.

**Computer:** IBM PC Family

**Size:** 3.54" x 9.44"

**Weight:** 9.24 lbs.

**Cost:** \$2,495.00 - \$3,295.00

The Mountbatten Brailer is a portable braille writing device that also serves as a braille printer for a computer. The Mountbatten has a standard braille keyboard for typing text; the text can appear directly on braille printout, and can simultaneously be sent to a computer or standard ink printer if desired. The device will translate grade 2 braille typed on the keyboard into grade 1 braille and vice versa for printing on a printer or transferring to a computer. The user can also attach a standard QWERTY computer keyboard to the Mountbatten; text typed on that keyboard can automatically be translated into grade 2 braille by the Mountbatten. The braille embosser in the Moutbatten has an automatic correction feature for fixing mistakes on printed braille. It is possible to turn the braille printing off to use the Mountbatten as a silent notetaker. There is 32K of memory available for storing files, with an option to upgrade to 128K. The Mountbatten has a graphics mode for printing braille graphics. Variable impact adjustments and multi-strike settings enable various materials (such as nylon, plastic and metal foils) to be embossed.

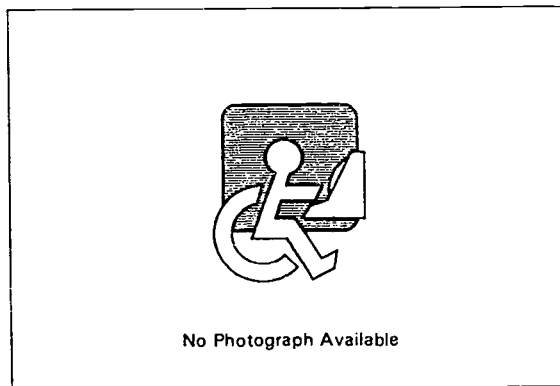

**Product Name:** NOMAD Talking Touch Pad & NOMAD Gold

**Vendor:** American Printing House for the Blind (APH)

**Computer:** Apple Macintosh Family, IBM PC Family

**Size:** 22.38" x 15.38"

**Weight:** 6.38 lbs.

**Cost:** \$1,142.95 - \$2,205.95

NOMAD Talking Touch Pad is a device that makes tactile pictures talk. Once the appropriate file is selected, the user can touch various points on the tactile graphic and NOMAD will describe them with synthesized speech. Calling up NOMAD files and programming graphic information is designed to be easy and can be saved for future use. TouchBlaster Software, a serial cable, both 3.5" and 5.25" disks, and sample graphics are included.

NOMAD Gold features Keynote Gold speech and has six foreign language capabilities built-in. NOMAD Graphics Packages(\$100.00) of raised-line graphics and preprogrammed information files are also available.

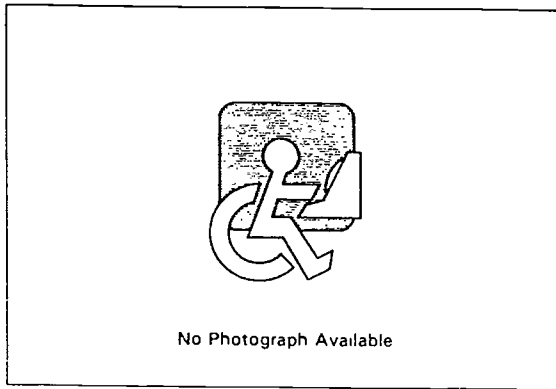

**Product Name:** Notex 486  
**Vendor:** ATR/JWA, Inc.  
**Computer:** IBM PC Family  
**Cost:** Contact manufacturer

Notex 486 is a MS-DOS based braille notebook personal computer. Notex features a refreshable 40 + 2 cell braille display with an 8-dot piezo-electric dialogue braille cell for screen navigation and fast reading. The braille keyboard has a full function key application. Notex is equipped with ports for a QWERTY keyboard, color monitor, and printer as well as a serial port for modem connections, speech synthesizers, etc. The device features an 80486 SLC processor with 2 MB RAM and a 60 MB integrated hard disk. A 3-1/2" integrated floppy disk drive is also included.

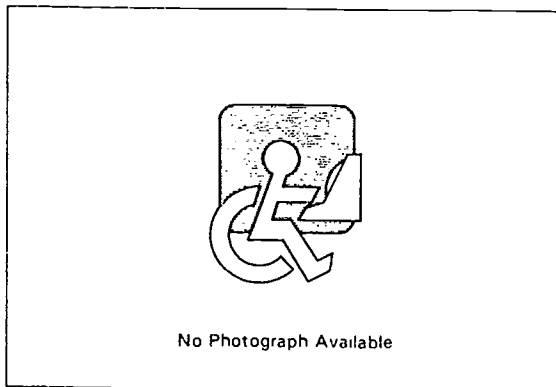

**Product Name:** Ohtsuki BT-5000 Braille/Print Printer  
**Vendor:** American Thermoform Corporation  
**Computer:** Apple II Family, IBM PC Family  
**Size:** 20.5" x 6.8" x 10.6"  
**Weight:** 29 lbs.  
**Cost:** \$5,695.00

Ohtsuki Printer is a braille printer capable of producing parallel lines of braille and standard ink print. The user sends the printer a grade 1 or grade 2 braille file via a computer's serial or parallel port, and the printer can print only standard ink print (dot matrix), only braille, or both types on alternate lines. The speed of printing is slightly lower when both types are used. Grade 2 braille can also be printed, but only if the user has the necessary translation software on the computer. Either single sheet paper or continuous feed paper may be used.

The manufacturer is able to provide the necessary braille paper and the ink cartridges for ink printing. Contact them about the cost.

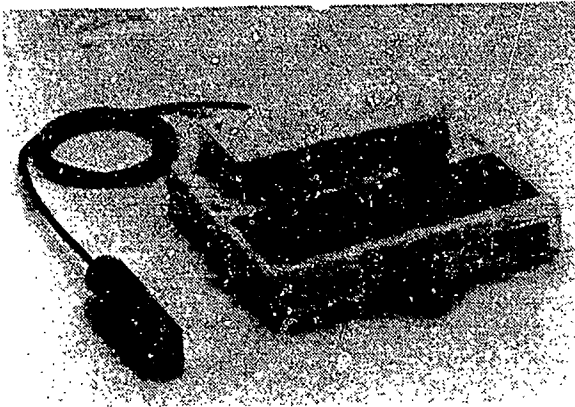

**Product Name:** Optacon II  
**Vendor:** TeleSensory Corporation  
**Computer:** All (Hardware Independent)  
**Size:** 2" x 9" x 6"  
**Weight:** 2 lbs.  
**Power Source:** Rechargeable battery  
**Cost:** \$3,695.00

Optacon II is a portable tactile reading system that gives the user direct access to printed material. A hand-held camera (about the size of a cigarette lighter) is scanned across the printed page. The retina of that camera perceives the contrast between the light page and dark print and sends the image to a vibrating tactile array. The user rests the index finger on that tactile array and is able to feel the letters move underneath the fingers. The entire unit is approximately the size of a portable cassette recorder. The Optacon II can be used to read a computer screen as well as printed material.

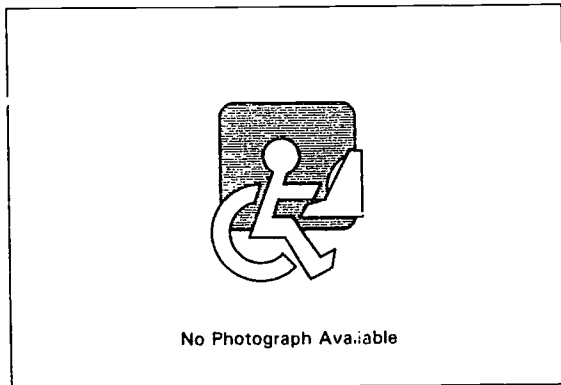

**Product Name:** Paragon Braille Printer  
**Vendor:** HumanWare, Inc.  
**Computer:** Apple II Family,  
Apple Macintosh Family, IBM PC Family  
**Size:** 11.5" x 24.6" x 9.4"  
**Weight:** 52 lbs.  
**Cost:** \$2,995.00

The Paragon Braille Printer is a heavy-duty embosser that can print on tractor-feed paper from 20 to 100 pounds in weight and up to 15 inches in width. An operating speed of 40 characters per second enables the Paragon to print more than 120 pages per hour. Other features include: the ability to combine text and graphics, a multi-copy buffer that frees the computer for other work, and a multi-strike feature that places braille on heavy plastics and some light metals. Paragon is compatible with braille translators for the IBM, Apple, and Macintosh.

Optional software is available to print raised characters. A single-sheet operation option is also available.



**Product Name:** PowerBraille 40, 65, & 80

**Vendor:** TeleSensory Corporation

**Size:** 12" x 11.5" x 1.5"

**Weight:** 5 lbs

**Cost:** Contact manufacturer

PowerBraille 40, 65, & 80 are refreshable braille displays for notebook and desktop computers. All three models offer interactive Grade 2 braille and touch cursor routing buttons that let the user move the system cursor to any character on the display for easy editing. Each user can also assign functions to the front panel keys. Other features include separate buttons for cursor and display movement, a tactile ruler for column position, and two serial ports and one parallel port with printer pass through for use with any computer. PowerBraille's battery can operate for seven hours. In addition, PowerBraille operates with an off-the-shelf power adapter or a car cigarette lighter adapter. All PowerBrailles include the user's choice of screen review software.

PowerBraille 40 features a 40-cell display, 65 features a 65-cell display (designed to be an effective size for most Microsoft Windows applications), and 80 features an 80-cell display.

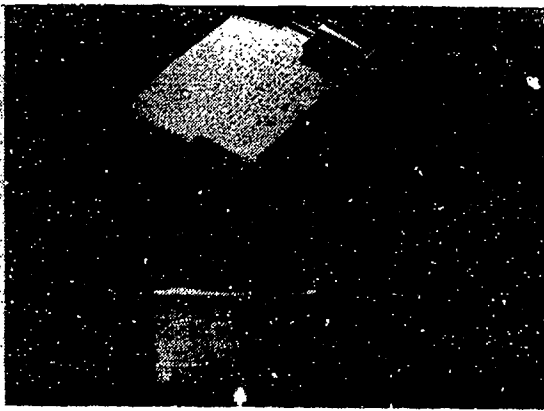

**Product Name:** Ransley Braille Interface (RBI)

**Vendor:** HumanWare, Inc.

**Computer:** All (Hardware Independent)

**Cost:** \$1,010.00

The Ransley Braille Interface (RBI) is a box that connects between any standard computer or computerized source and any standard Braille embosser. Automatically formatted Grade II Braille can then be produced in the same way that printed output would be generated from a non-Braille printer.

Knowledge of Braille is not required to use the RBI. The RBI is appropriate for low-volume production of materials that do not require special formatting.

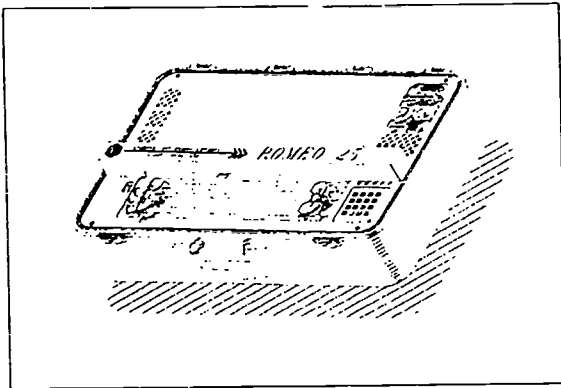

**Product Name:** Romeo Braille Model RB-25

**Vendor:** Enabling Technologies Company

**Computer:** All (Hardware Independent)

**Size:** 21.5" x 13.5" x 6"

**Weight:** 27 lbs.

**Power Source:** 120V AC

**Cost:** \$2,295.00

The Romeo Braille Model RB-25 is a single sided braille embosser. The RB-25 features full carriage width, multi-strike capability, graphics mode, can braille on paper from 20 to 100 pound tag at a speed of 25 characters per second. The RB-25 has both a parallel port and a 25-pin serial port, uses tractor feed paper, and has a calculator style keypad which is used to configure the printer. A carrying case is included.

A single sheet feed option is available.



**Product Name:** Romeo Braille Model RB-40

**Vendor:** Enabling Technologies Company

**Computer:** All (Hardware Independent)

**Size:** 21.5" x 13.5" x 6"

**Weight:** 27 lbs.

**Power Source:** 120V AC

**Cost:** \$3,495.00

The Romeo Braille Model RB-40 is a single sided braille embosser that can braille at a speed of 40 characters per second. The RB-40 has a specially designed die bar for producing high resolution graphics and can braille on paper from 20 to 100 pound tag. The RB-40 has both a parallel port and a 25-pin serial port, uses tractor feed paper, has a calculator style keypad used to configure the printer, and features a low power consumption mode for periods of inactivity. A suitcase style carrying case is included.

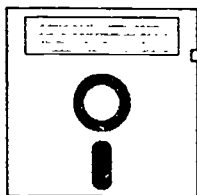

**Product Name:** TEXTALKER

**Vendor:** American Printing House for the Blind  
(APH)

**Computer:** Apple II Family

**Manual Form:** Audiotape Manual,  
Electronic Manual, Large Print Manual

**Cost:** \$21.75

TEXTALKER is a version of the Textalker.Blind program that comes on the Echo speech synthesizer utility disk. This version, by the American Printing House for the Blind, adds new features designed to improve access by speech. The program provides speech output of text displayed on the computer screen, allowing access to standard software programs for users unable to see the screen. Some new features include: review of tabular information by the column, repeat filter to eliminate multiple characters, faster selection of lines in review mode, ability to enter review mode at any time, and removal of pronunciation of "backspace" for left arrow key. TEXTALKER also provides "Intro," an electronic version of the manual readable with the Echo, and "Review," a program that provides control over the Echo's various speech modes.

An appropriate Echo speech synthesizer is required to use TEXTALKER. TEXTALKER includes versions for DOS 3.3 and ProDOS.

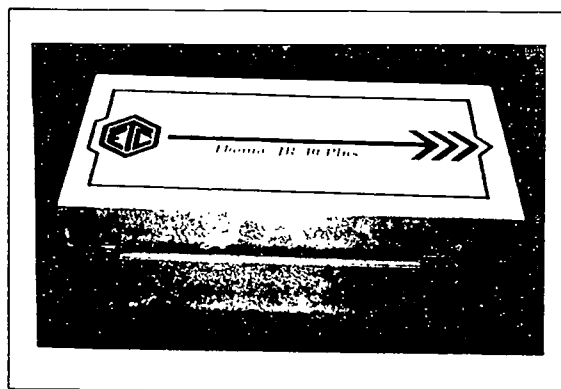

**Product Name:** Thomas Braille

**Vendor:** Enabling Technologies Company

**Computer:** All (Hardware Independent)

**Size:** 11.5" x 24.6" x 9.4"

**Weight:** 52 lbs.

**Power Source:** 120V AC

**Cost:** \$2,995.00

The Thomas Braille is a single sided desktop braille printer that can handle a full range of tractor-feed paper from 20 to 100 pounds in weight and up to 15 inches in width. Thomas can also place high quality braille on heavy plastics, light metals such as aluminum, and vinyl sheets. The operating speed of 40 characters per second allows the Thomas to produce more than 120 pages per hour. Other capabilities include: a multi-copy buffer that frees the computer for other work, dual controls, vertical printing, high-resolution graphics that allows the user to combine text and graphics, and raised print characters. The Thomas has both serial and parallel connection ports and comes with a calculator style keypad which is used to configure the printer and a low power consumption mode in periods of inactivity.

A single sheet feed option is available.



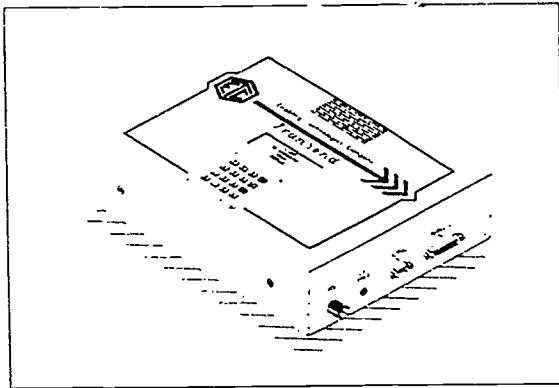

**Product Name:** TranSend System

**Vendor:** Enabling Technologies Company

**Computer:** Apple Macintosh Family, IBM PC Family

**Size:** 12" x 9.5" x 3"

**Weight:** 9.5 lbs.

**Cost:** \$1,005.00 - \$5,600.00

TranSend is a control unit that translates text from the computer into print and braille on the same page, line for line. TranSend can produce standard sized print, large print, grade 1 braille, grade 2 braille, or regular/large print with grade 1-2 braille on the same page. TranSend has a 512,000-character memory which can act as a printer buffer.

TranSend can be purchased as part of a package or separately. The package includes the TranSend control unit, Epson FX-870 or FX-1170 ink printers, and user's choice of a Romeo RB-25 (\$3,900.00), Thomas (\$4,600.00), or Juliet (\$5,600.00) braille embosser. The TranSend control unit alone costs \$1,005.00 and requires the previously existing embosser to be updated for \$110.00. Contact manufacturer for more details.



**Product Name:** VersaPoint-40 Braille Embosser

**Vendor:** TeleSensory Corporation

**Computer:** All (Hardware Independent)

**Power Source:** 120V AC

**Cost:** \$3,795.00

VersaPoint-40 Braille Embosser is a 40 character per second braille embosser. The system has a moveable platen which allows the VersaPoint to place a braille dot anywhere on the page. Each solenoid only needs to braille four cells per line, which reduces strain on the embossing heads. Paper type and width are user selectable up to 13 inches. VersaPoint uses tractor fed paper, prints six- or eight-dot braille, has a 30,000 character buffer, and uses standard parallel and serial ports. All configuration control parameters are easily set through the control panel rather than DIP switches.

The placement of the braille dots is completely software controlled, which enables the use of sideways embossing to allow printing of a full screen of information that retains exact screen format.

# Chapter 17

## Speech Synthesizers

This chapter includes both hardware and software speech synthesizers. Together with a "text-to-speech" program (frequently provided with the synthesizer), these devices can produce phonetically correct speech from electronic text. This makes speech synthesizers suitable for a number of different applications, including voice output software for communication (Chapter 5), voice output education, training and therapy programs (Chapters 19 and 20), and screen access programs for visually impaired computer users (Chapter 14).

These synthesizers are components designed to be used by other application programs. Some are circuit cards that install inside a computer; others are external components that connect to an input/output port on the computer. Some brands are designed for specific software; others can be operated with a wide variety of software.

Hardware and software products that use speech synthesizers are cross-listed under a number of functions in Index 1, including Screen to Voice (SV), Phone Control (PC) and Education, Training and Therapy (ET). In Index 2, check the feature Output/Display: Speech. Contact the synthesizer manufacturer for more information about what software works with a particular model.

*The following product entries appear in this chapter:*

Accent-MC, 525  
Accent-PC, 525  
Accent-SA, 526  
Artic TransPort, 526  
Audapter Speech System, 527  
CallText 5000, 527  
DECTalk, 528  
DECTalk PC & DECTalk Express, 528  
DJ ProPack Speech Module, 529  
Echo II, 529  
Echo LC, 530  
Echo PCII, 530  
Echo-PC, 531  
Infovox 500, 700 & 750, 531  
Keynote GOLD, 532  
Lite Talk, 532  
Messenger-IC, 533  
Mini Transport II, 533  
MultiVoice, 534  
SmarTalk, 534  
Sounding Board, 535  
Speak-Out, 535  
SynPhonix 210 and 215, 536  
SynPhonix 310 and 315, 536  
SynPhonix P27, 537  
VocaLite, 537  
VoiceCard, 538

*The following products from other chapters can also be used as Speech Synthesizers:*

Braille 'n Speak, 469  
Communication Icon Galleries CD-ROM, 78  
DAC, 126  
David, 471  
Echo II with Textalker & Echo II with Textalker-GS, 472  
Handy Speech Communication Aide, 134  
IntroVoice VI, 399  
Micro IntroVoice, 413  
Micro IntroVoice II, 414  
VoiceBachs, 159

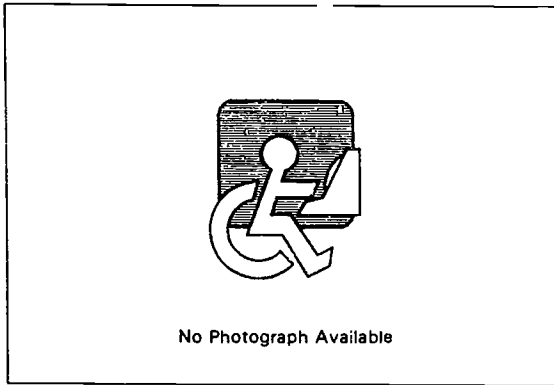

**Product Name:** Accent-MC  
**Vendor:** Aicom Corporation  
**Computer:** IBM PS/2 Family  
**Size:** 3.5" X 11.5" X 0.5"  
**Weight:** 0.75 lbs.  
**Cost:** \$745.00

Accent-MC is a speech synthesis board that plugs into IBM PS/2 microchannel computers. Speech output comes directly from the PS/2 speaker if no external speaker or headphones are connected. The Accent text processor can speak in two modes: text mode, which converts text to speech using preprogrammed grammatical and other rules, and spell mode, which speaks all text and punctuation character by character. Other features include: a standard text processor with a preprogrammed vocabulary of more than 20,000 words; an adjustable speech rate of approximately 60 to 850 words per minute; use of CTRL-X to instantly empty the speech buffer; and a Downloadable Custom Dictionary (DCD) to create pronunciation dictionaries of roughly 500 words of up to ten characters each. A software program (included) allows synthesizer settings to be saved for later use.

The Accent-MC has a 2K text buffer. Two 3.5 mm jacks for plugging in an external speaker or headphones are included. A foot pedal for controlling Accent-MC is available (extra). A screen review software program must be purchased separately; contact manufacturer for information on compatible programs.

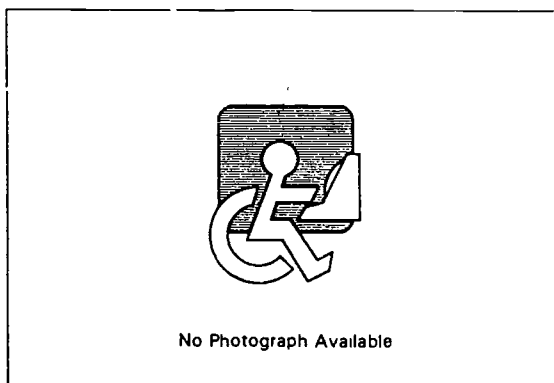

**Product Name:** Accent-PC  
**Vendor:** Aicom Corporation  
**Computer:** IBM PC Family  
**Size:** 5.2" x 10.5" x 0.5" (maximum component height)  
**Weight:** 0.75 lb.  
**Cost:** \$745.00

Accent-PC is a single board microcomputer that plugs into an IBM-PC or compatible to provide speech synthesis. The Accent text processor can speak in two modes: text mode, which converts text to ordinary speech observing preprogrammed grammatical and other rules, and spell mode, which speaks all text and punctuation character by character. Other features include: a standard text processor with a preprogrammed vocabulary of over 20,000 words; speech rate of approximately 60 to 850 words per minute; use of CTRL-X to instantly empty the speech buffer; and a Downloadable Custom Dictionary (DCD) to create dictionaries of roughly 500 ten-character words.

A standard RS-232C serial port is provided for interface with a computer, terminal, or printer; the user can select either the PC or the RS-232C as Accent-PC's host. A screen review voice output program must be purchased separately to operate Accent-PC.

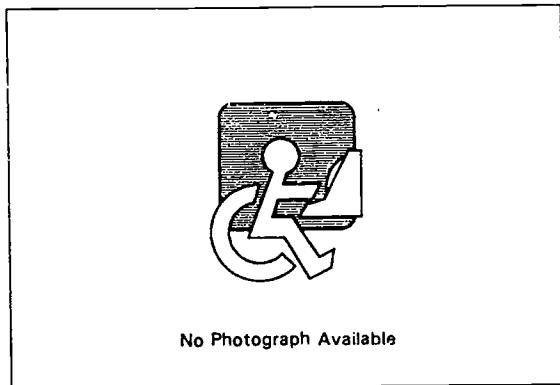

**Product Name:** Accent-SA  
**Vendor:** Aicom Corporation  
**Computer:** IBM PC Family  
**Size:** 5.7" x 8.5" x 1.6"  
**Weight:** 2.5 lbs.  
**Cost:** \$995.00

Accent-SA is a stand-alone version of the Accent-PC (see entry). The Accent text processor can speak in two modes: text mode, which converts text to ordinary speech observing preprogrammed grammatical and other rules, and spell mode, which speaks all text and punctuation character by character. Other features include: a standard text processor with a preprogrammed vocabulary of over 20,000 words; speech rate of approximately 60 to 850 words per minute; use of CTRL-X to instantly empty the speech buffer; and a Downloadable Custom Dictionary (DCD) to create dictionaries of roughly 500 ten-character words.

A standard RS-232C serial port is provided for interface with a computer; a battery and AC adapter are also included. Speech output software must be purchased separately.

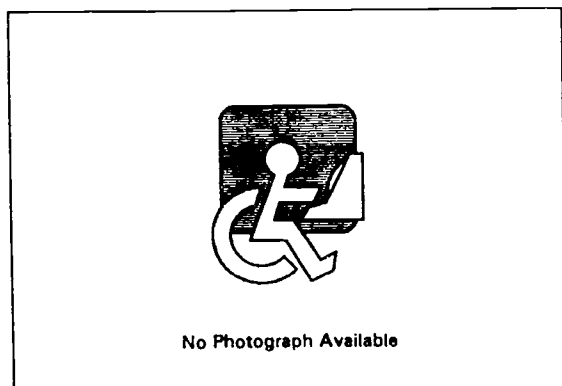

**Product Name:** Artic TransPort  
**Vendor:** Artic Technologies  
**Computer:** IBM PC Family, IBM PS/2 Family  
**Size:** 4" x 7" x 1.4"  
**Weight:** 1.25 lbs.  
**Cost:** \$895.00 - \$1,295.00

Artic TransPort is a portable pocket-sized speech synthesizer. Artic TransPort connects to the computer's serial port and is powered by its own rechargeable batteries. An internal memory is provided, for storing configuration, data and program files. These can then be loaded into a computer when the Artic TransPort is connected.

Artic TransPort is available in two models. TransPort 615 contains the Business Vision screen reading program stored in ROM, ready to be loaded on to a computer when the TransPort is connected. The transfer can be done automatically, with no need to read information on the computer screen. Transport 611 comes without Business Vision, for use with other screen reading software.

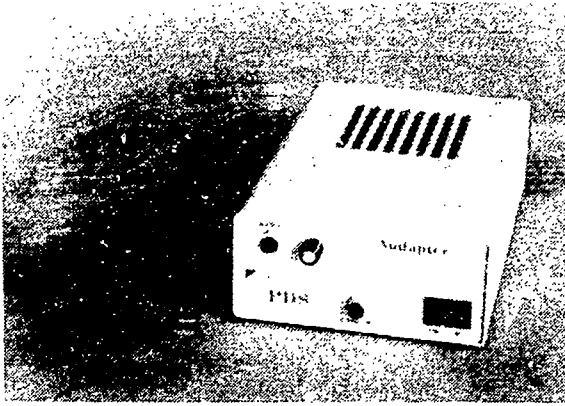

**Product Name:** Audapter Speech System

**Vendor:** Personal Data Systems, Inc.

**Computer:** All (Hardware Independent)

**Size:** 5.5" x 9" x 2.5"

**Weight:** 3 lbs.

**Cost:** \$895.00

Audapter is a speech output hardware system for converting alpha-numeric text to speech. The speech rate ranges up to 700 words per minute, and instantaneous speech halt controls are included. Menu selections allow users to set speech rate, voice, pitch, and other parameters, and to save settings in non-volatile memory.

Audapter can be used with any computer that can send ASCII text over a standard serial interface. No additional software is required to run Audapter. An internal battery pack is optional. Speech output software must be purchased separately.

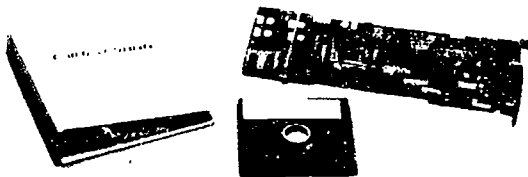

**Product Name:** CallText 5000

**Vendor:** Centigram

**Computer:** IBM PC Family

**Cost:** \$3,225.00

CallText 5000 is an internal circuit card that provides highly intelligible synthesized speech output for the IBM-PC. CallText 5000 converts any sequence of ASCII characters routed to it into English speech. A speaker can be connected directly to the board. CallText 5000 can also answer incoming phone calls, send a synthesized speech message, and dial outgoing calls. Three different male voices are provided.

For information about what programs designed for voice output are compatible with CallText 5000 (such as screen display to voice output programs), contact the manufacturer. Price is negotiable for consumers with disabilities.

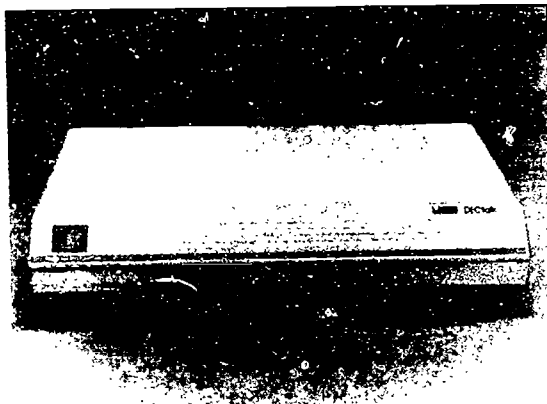

**Product Name:** DECTalk  
**Vendor:** Digital Equipment Corporation  
**Computer:** All (Hardware Independent)  
**Weight:** 19 lbs.  
**Cost:** \$4,495.00

DECTalk is a full-featured voice synthesizer compatible with many computer systems. DECTalk offers nine different voices (four male, four female, one child) as well as sentence rhythm and intonation. DECTalk converts text sent from the host computer to a pronunciation code using a combination of dictionaries and letter-to-sound rules. DECTalk then takes into consideration surrounding words and their effects on individual pronunciations. Rate of speech is adjustable from 120 to 350 words per minute. DECTalk provides a user-specified dictionary for commonly used acronyms, trade terms, and special words. DECTalk may "speak" through its internal speaker, headphones, an external speaker, or over the telephone.

DECTalk accepts input from the computer through a standard RS-232C communications port. For a demonstration of DECTalk over the telephone, interested parties may call (800) DEC-VOIC.

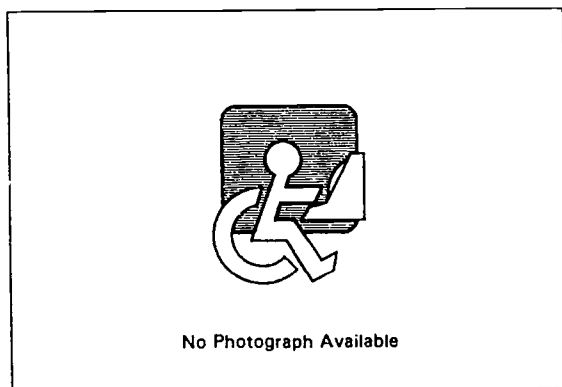

---

**Product Name:** DECTalk PC & DECTalk Express  
**Vendor:** Digital Equipment Corporation  
**Computer:** IBM PC Family  
**Cost:** \$1,199.00

The DECTalk PC is a personal computer option card for IBM compatible computers that can accept text from any application and turn it into synthesized speech output. The synthesized speech capability of the card includes nine predefined voices and one user defined voice; the rate of speech varies from 120 to 550 words per minute. The card connector is 8, 16, or 32 bits and fits into a full size PC option slot. The DECTalk Express is an external and portable version of the speech synthesizer.

Both versions include volume control and a user's manual.

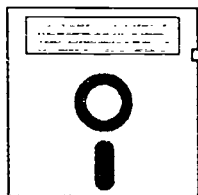

**Product Name:** DJ ProPack Speech Module

**Vendor:** Don Johnston Incorporated

**Computer:** Apple Macintosh Family

**Cost:** \$50.00

The DJ ProPack Speech Module is a software speech synthesizer that pronounces numbers and words correctly in context. The ProPack works with speech-ready Don Johnston software products including Write:OutLoud 2.0, Co:Writer 2.0, Ke:nx 3.0, and Ke:nx On:Board 3.0.

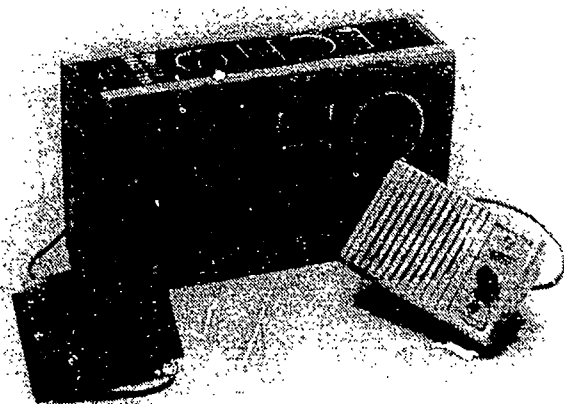

**Product Name:** Echo II

**Vendor:** Echo Speech Corporation

**Computer:** Apple II+, Apple IIGS, Apple IIe

**Cost:** \$116.95

Echo II (formerly Echo IIb) is a speech synthesizer for the Apple IIGS, II+, and IIe. The Echo II consists of a circuit card (fits in an expansion slot in the Apple), and an external speaker unit with volume control and headphone jack.

Programs can be written for the Echo II; there are also many programs already designed for use with the Echo II (contact Echo Speech Corporation for a list). This model will also work with many programs written for the Echo IIb or Echo +. The Echo II comes with a disk containing a number of demonstration and utility programs.



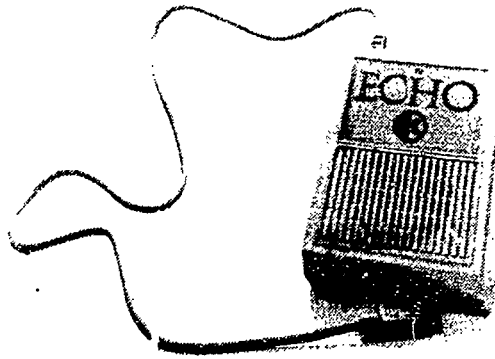

**Product Name:** Echo LC

**Vendor:** Echo Speech Corporation

**Computer:** Apple IIc, Apple Macintosh Family

**Cost:** \$116.95

Echo LC is a speech synthesizer for Apple IIc, Apple IIc+ or Macintosh LC computers. If used on the Mac LC, the Mac must be in IIe emulation mode. The Echo LC plugs into the modem port which is built into the computer. The Echo LC produces synthesized speech and also contains a dictionary of words encoded in female voice for natural-sounding playback. Volume control and headphone jack are provided.

The Echo LC is the successor to the Cricket and Echo IIc. It is compatible with the same body of software which supported these earlier products.



**Product Name:** Echo PCII

**Vendor:** Echo Speech Corporation

**Computer:** IBM PC Family, IBM PS/2 Family

**Cost:** \$89.00

Echo PCII is a speech synthesizer for the IBM PC, XT, AT, PS/2 Models 25 and 30, and compatibles. The Echo PCII comes with a text-to-speech program, Textaite, as well as a dictionary of over 1000 words which have been encoded in female voice for natural-sounding playback. The Echo PCII is compatible with numerous third-party software titles in early and special education; contact manufacturer for titles. The Echo PCII is also capable of emulating the IBM Speech Adaptor product, and will work with titles written to support it, such as "Listen to Learn."

The Echo PCII package is comprised of the Echo circuit board, the necessary software on 3.5" and 5.25" disks, an external speaker with headphone jack and volume control, and documentation.

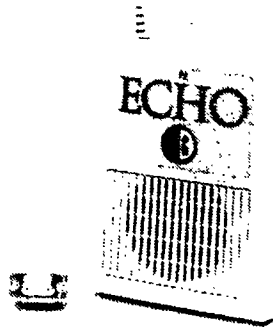

**Product Name:** Echo-PC

**Vendor:** Echo Speech Corporation

**Computer:** IBM PC Family, IBM PS/2 Family

**Cost:** \$116.95

The Echo-PC is a speech synthesizer for IBM PC and compatible computers. A stand-alone device which operates off the computer's serial port, the Echo-PC speaks ASCII text sent to it. The Echo-PC is compatible with most screen reading programs used by blind individuals. It features 16 different rates of speech, weighs less than a pound, and is battery operated.

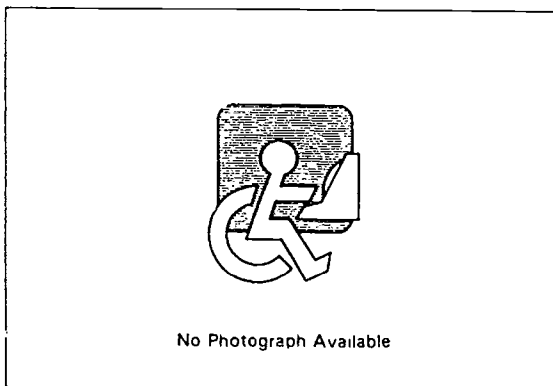

**Product Name:** Infovox 500, 700 & 750

**Vendor:** Reading Technology

**Computer:** IBM-PC PC, IBM-PC XT, IBM PC AT,  
IBM PS/2 Models 25/30

**Cost:** Contact manufacturer

Infovox 500, 700, & 750 are speech synthesizers with five built-in voices which can be further defined by changing pitch and intonation. With the included software, the text can be read continuously, sentence by sentence, line by line, word by word, or character by character. The reading speed can be varied and increased up to 400 words per minute. Eleven languages can be produced: American and British English, French, German, Italian, Spanish, Swedish, Norwegian, Danish, Finnish, and Icelandic.

Infovox speech synthesizers are manufactured in Sweden by Telia and distributed in the United States by Reading Technology.

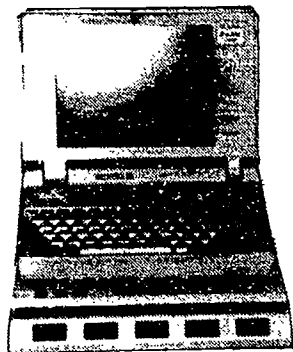

**Product Name:** Keynote GOLD

**Vendor:** HumanWare, Inc.

**Computer:** IBM PC Family, Toshiba Laptops

**Cost:** \$1,500.00 - \$5,000.00

Keynote GOLD is a speech synthesizer available for Toshiba laptops and IBM computers as either an internal card or external box. The synthesizer has 256K of memory and its own digital speech processor so that the computer's memory is not required for speech output.

Three models are available: a half size internal card for PCs, a card for laptops, and a stand alone version which plugs into the serial port. Keynote GOLD works with MasterTouch screen reading software as well as Keysoft and Sound-Proof (screen access and word processing software). Several languages are also available

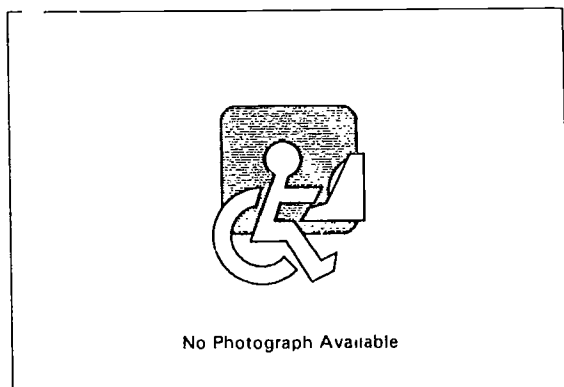

**Product Name:** Lite Talk

**Vendor:** Blazie Engineering

**Computer:** IBM PC Family

**Size:** 2" x 3" x 6"

**Weight:** 1 lb.

**Cost:** \$495.00

Lite Talk is a small speech synthesizer that connects to the computer through the serial or parallel port. Lite Talk features include a thumbwheel for controlling on, off, and volume and an earphone jack for private work.



**Product Name:** Messenger-IC

**Vendor:** Aicom Corporation

**Computer:** IBM PC Family

**Weight:** 1.5 oz.

**Cost:** \$995.00

Messenger-IC is a credit card size text-to-speech synthesizer with software commands and interface format that are compatible with Accent's Device Driver (see entry). The IC is fully supported by SystemSoft PCMCIA drivers Cardsoft and IBM PCMCIA drivers. The synthesizer accepts ASCII text as input under DOS/ Microsoft Windows or OS/2. Other features include realtime text-to-speech synthesis, on-board audio power amplifier with volume control, and a 2.5 mm phone jack for headphones or speaker.

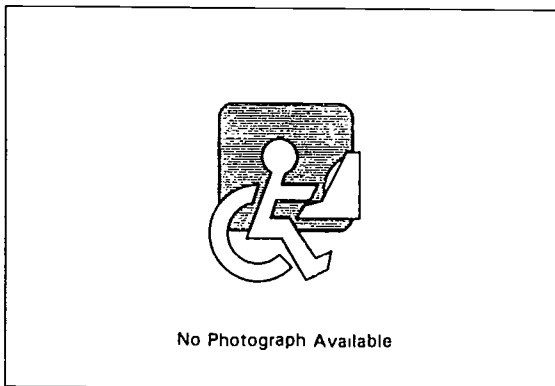

**Product Name:** Mini Transport II

**Vendor:** Artic Technologies

**Computer:** IBM PC Family

**Size:** 4.7" x 4.2" x 0.85"

**Weight:** 12 oz.

**Cost:** \$995.00 - \$1,195.00

Mini TransPort II is a portable synthesizer based on the Artic TransPort technology (see entry). Mini TransPort II features include: a message alarm clock, multi-synthesizer emulation, a quick-change battery pack, digital audio controls, and an internal speaker. Five built computer style keys are used for setup, Turbo, and running other features. A programmable Flash ROM accommodates internal program updates and gives 384K of extra memory.

Mini TransPort II is available in two models: Classic and Deluxe. The Deluxe model has an AdVEST text-to-speech translator, 832K ROM disk, and the Pocket Audio Lookup feature which allows the user to access the phone and address book without the computer.

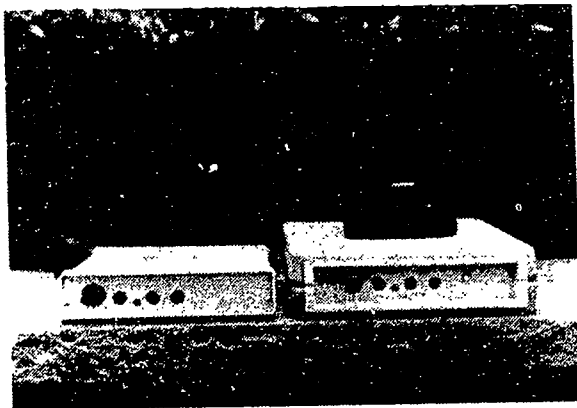

**Product Name:** MultiVoice

**Vendor:** Institute on Applied Technology, Children's Hospital

**Computer:** All (Hardware Independent)

**Size:** 9" x 7.5" x 1.75"

**Weight:** 3 lbs.

**Power Source:** Rechargeable battery

**Cost:** \$1,200.00

MultiVoice is a battery powered portable speech synthesizer with an internal speaker based on Digital's DECTalk technology. MultiVoice connects to a computer's serial port, and thus can be used with any software or device that can drive a serial speech synthesizer. The MultiVoice has ten voices: four male, four female, one child and one custom.

An optional carry case is available.

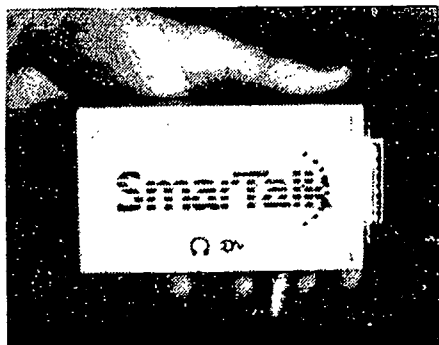

**Product Name:** SmarTalk

**Vendor:** Automated Functions, Inc.

**Computer:** IBM PC Family

**Size:** 4.63" x 2.75" x 1"

**Weight:** 5 oz.

**Cost:** \$369.00

SmarTalk is an external speech synthesizer that easily connects to all desktop and portable PC. SmarTalk functions include rewind, fast forward, index marker, and built in speaker. Speaking rates can reach 600 words per minute and a battery manager allows for over 40 hours of continuous speech on one battery. The synthesizer is compatible with most DOS and Microsoft Windows screen reading programs, including ASAP, JAWS, TinyTalk, Flipper, Screen Power, Soft VERT, Vocal-Eyes, An Open Book, JAWS for Windows, Outspoken for Windows, Window Bridge, and others.

The purchase price includes the synthesizer, AC adapter, software, and manual.

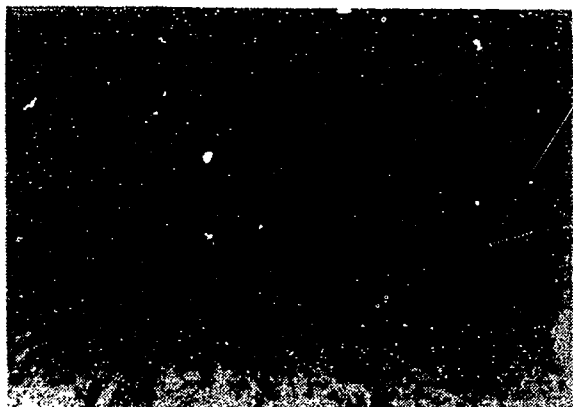

**Product Name:** Sounding Board

**Vendor:** GW Micro

**Computer:** IBM PC Family, IBM PS/2 Models 25/30, Toshiba Laptops

**Cost:** \$395.00 each

The Sounding Board is a speech synthesizer that is installed inside the computer. Features include "fastforward" and "rewind," hyperscan, and format and capitalization cues. The Sounding Board has ten levels of pitch, volume, and speech rate, and 26 levels of tone. The system also includes interactive "hot keys" for entering commands.

The Sounding Board comes in four models. The Sounding Board, for IBM PC and PS/2 Model 25 and 30 computers, has 16K onboard RAM, and an external Super Speaker. The Sounding Board LT, XE, and the Sounding Board Lite, for Toshiba laptop computers, include a monophonic headset. All models require purchase of speech synthesis software; contact manufacturer for information on compatible programs. The warranty lasts for one year.

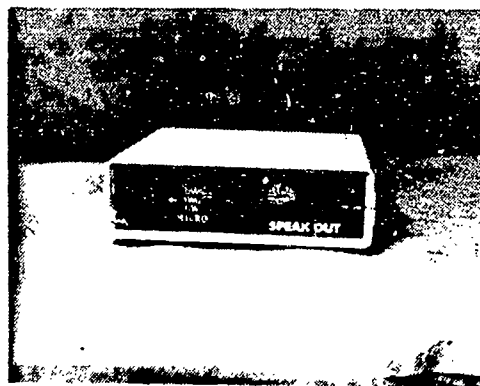

**Product Name:** Speak-Out

**Vendor:** GW Micro

**Computer:** IBM PC Family

**Size:** 5.25" x 5.25" x 1.5"

**Weight:** 1 lb.

**Cost:** \$650.00

Speak-Out is a battery powered external synthesizer that can be connected to any computer or other device with a serial or parallel port. Features include: capacity for 26 alarms, a reload switch for uploading software through the serial port, and a rapid charge circuit.

Speak-Out comes with a carrying case with space for the AC adapter/charger, a disk pocket, a belt clip, a short carrying strap, and a long carrying strap. A serial cable is included and a parallel cable is available for a nominal charge. Software for use on PC compatible computers is included.

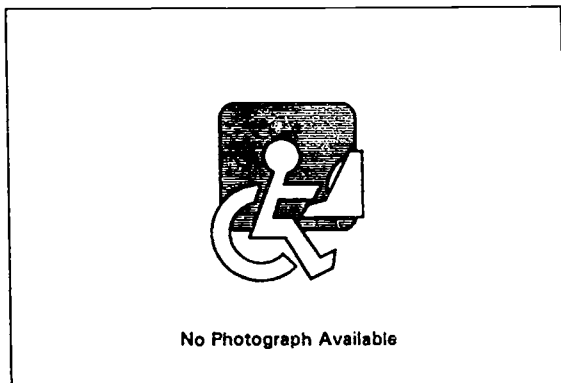

**Product Name:** SynPhonix 210 and 215

**Vendor:** Artic Technologies

**Computer:** IBM PC Family, IBM PS/2 Models 25/30

**Cost:** \$395.00 - \$895.00

SynPhonix 210 is an internal speech synthesizer for IBM PC and PS/2 Models 25 and 30 computers. Text sent from the computer to the synthesizer is translated into phonetically correct English pronunciation and spoken in a synthesized voice. The voice can come through the on-board speaker, a small external speaker, or headphones (all included). The user can control various qualities of the speech, including rate, pitch, and amplitude. The SynPhonix 210 can also be used to produce music, sound effects, and simulated singing. Volume and treble controls are located externally. The Artic Switch Interface (built in) allows switches to be plugged into the computer for use with Artic's screen access programs.

SynPhonix 210 is \$395.00, including PortTalk, a software program allowing the user to route output to the SynPhonix as if it were connected to a printer port. SynPhonix 215 is the SynPhonix 210 bundled with the VEST text-to-speech translator and either Artic Vision (\$795.00) or Business Vision (\$895.00) speech synthesis software. Options for the 215 include Turbo-Pedals (\$150.00) which can be pressed with the foot to provide Fast Forward, Rewind, access to Review mode, and instant Quiet capability.

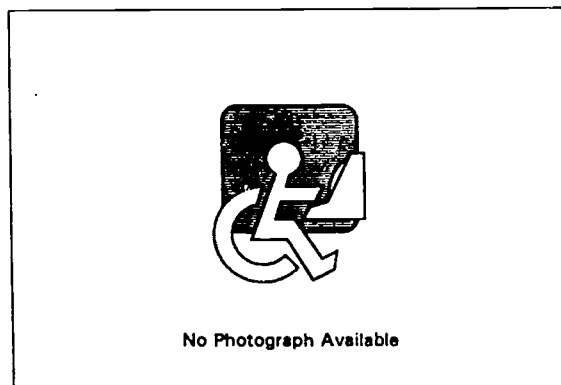

**Product Name:** SynPhonix 310 and 315

**Vendor:** Artic Technologies

**Computer:** IBM PS/2 Family

**Cost:** \$695.00 - \$1,095.00

SynPhonix 310 is an internal speech synthesizer for IBM PS/2 Models 50 and above (MicroChannel based) computers. Text sent from the computer to the synthesizer is translated into phonetically correct English pronunciation and spoken in a synthesized voice. The voice can come through the on-board speaker, a small external speaker, or headphones (all included). The user can control various qualities of the speech, including rate, pitch, and amplitude. Volume and treble controls are located externally. The Artic Switch Interface (built in) allows switches to be plugged into the computer for use with Artic's screen access program.

SynPhonix 310 is \$695.00, including PortTalk, a software program allowing the user to route output to the SynPhonix as if it were connected to a printer port. SynPhonix 315 is the SynPhonix 310 bundled with the VEST text-to-speech translator and either Artic Vision (\$995.00) or Business Vision (\$1,095.00) speech synthesis software. Options for the 315 include Turbo-Pedals (\$150.00) which can be pressed with the foot to provide Fast Forward, Rewind, access to Review mode, and instant Quiet capability.

567

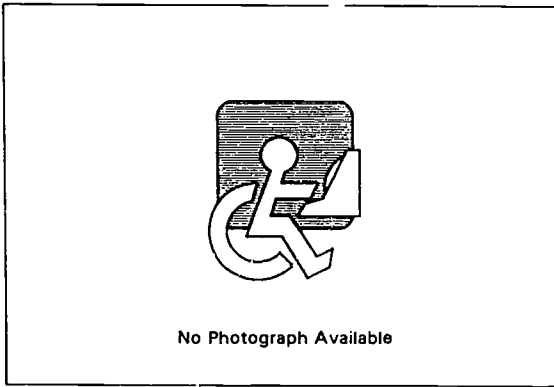

**Product Name:** SynPhonix P27

**Vendor:** Artic Technologies

**Computer:** IBM PC Family

**Size:** Credit card size

**Cost:** \$995.00

SynPhonix P27 is a portable internal PCMCIA speech synthesizer. No interface cables and power adapters are required and the P27 runs off of a small amount of the portable computer's power. Volume and tone are controlled with software. A miniature audio jack is located at the end of the P27 for plugging in an external speaker or headphones.

P27 works with all modern laptop computers containing the industry standard PCMCIA Type 2 or Type 3 slots.

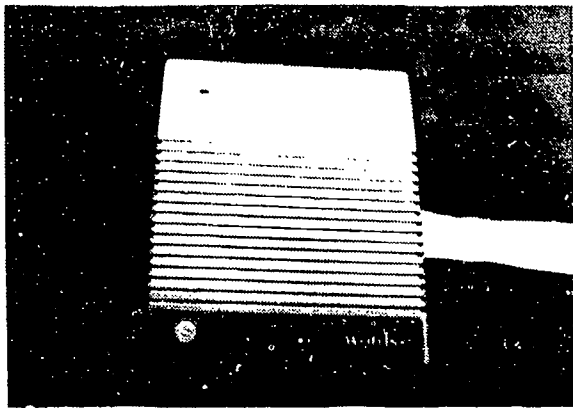

**Product Name:** VocaLite

**Vendor:** Words+, Inc.

**Computer:** All (Hardware Independent)

**Cost:** \$399.00

VocaLite is a stand alone, lightweight speech synthesizer. The synthesizer features Smooth Talker software (see separate entry) and a speaker/amplifier built into one unit. The device has a speaker, battery, volume control, and computer interface. The speech output is variable in pitch and speed but only male speech is provided.

VocaLite is compatible with most laptop and desktop computers. An upgrade is available for those users with Smooth Talker.



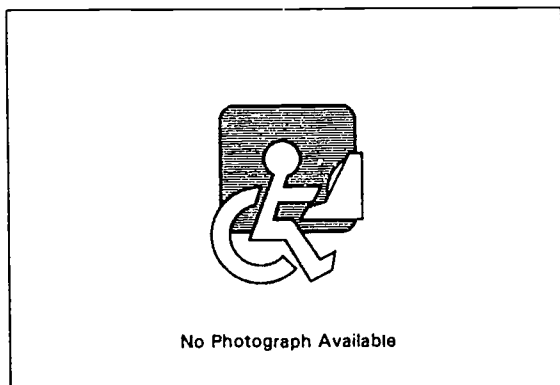

**Product Name:** VoiceCard

**Vendor:** GW Micro

**Computer:** IBM PC Family

**Cost:** \$999.00

VoiceCard is a speech synthesizer designed to be installed into an IBM-compatible 386 or better laptop computer which has a PCMCIA type II or III slot. VoiceCard is supported by Vocal-Eyes, Window-Eyes, and most other screen access software.

The standard version speaks English but a multi-lingual option that provides German, French, Spanish, and Italian is available for an additional \$245.00.

## Chapter 18

# Other Software and Hardware Adaptations

This chapter includes miscellaneous adaptations which do not fit into Chapters 11 - 17, but which are not applications software. Some examples of products in this chapter are: disk loaders, special desks, devices that slow computers down, systems for printing screen images, and software that will convert keyboard-operated programs into scanning programs.

Adaptations that are designed to modify the operation of the standard keyboard, such as keyguards, are listed in Chapter 11.

*The following product entries appear in this chapter:*

AbleOffice, 541  
ADJUSTable, 541  
Apple IIGS Owner's Guide: Disk Edition, 542  
AppleWorks Manuals: Special Editions, 542  
Brailled Keyboard Model--Apple IIe, 543  
CompuDesk HCP, 543  
Computer Workstation Furniture, 544  
Comtel, 544  
Disk Guide (2485), 545  
DOS Tape, 545  
Dual Channel Headset, 546  
EasyRiser, 546  
Generation IV Adjustable Computer Tables, 547  
Governor (2464), 547  
IntelliKeys Overlay Maker, 548  
Ke:nx Easy Overlays, 548  
Media Handling Products, 549  
Modular Turntable Desks, 549  
Rx WorkStation, 550  
Scanning Conversion Program, 550  
Talk-to-Me Tutorial Cassettes, 551  
Talking Utilities for ProDOS, 551  
TarsalRest, 552  
Variable Height Desk, 552

*The following products from other chapters can also be used as Other Software or Hardware Adaptations:*

Moisture Guard, 355  
SafeSkin Keyboard Protector, 363

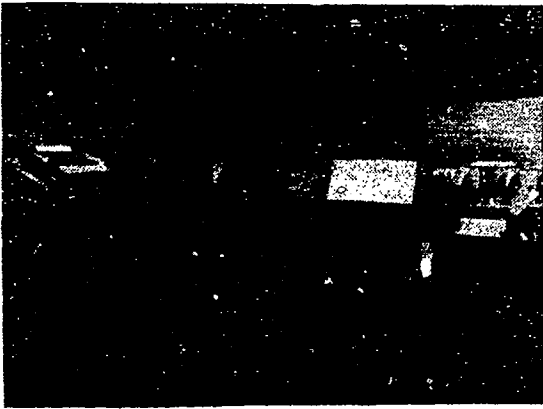

**Product Name:** AbleOffice

**Vendor:** CRT, Inc.

**Computer:** IBM-PC XT, IBM PS/2 Family

**Cost:** \$19.00 - \$3,450.00

AbleOffice is a modular workstation which can be configured for computer users with a wide range of mobility or upper extremity disabilities. AbleOffice provides one of three levels of assistance: unpowered, powered with switch controls, and entirely computer controlled. A control program and robotic arm are also available. The fourteen available modules include a keyboard mount, a telephone platform, and file and reading reference carousels.

Contact manufacturer for further technical, price, and ordering information.



**Product Name:** ADJUSTable

**Vendor:** Northport, Inc.

**Computer:** All (Hardware Independent)

**Size:** See text

**Weight:** 90 lbs.

**Cost:** \$835.00 - \$849.00

ADJUSTable is an adjustable work station that can be moved to any setting between 25" and 50" while the user is sitting or standing. The device can support a variety of accessories and peripheral devices such as monitor arms and drafting equipment.

Available accessories include: variable angle tabletop (\$16.50), CPU stand (\$59.75), side storage box (\$39.95), casters (\$37.75), and supplemental pneumatic cylinders (\$19.50) for lifting increased loads. Two models are available: Model JS tabletop measures 31.5" x 31.5" and Model JL measures 31.5" x 39.5".

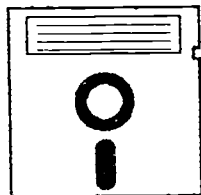

**Product Name:** Apple IIGS Owner's Guide: Disk Edition

**Vendor:** American Printing House for the Blind (APH)

**Computer:** Apple IIGS

**Manual Form:** Electronic Manual

**Cost:** \$5.00

The Apple IIGS Owner's Guide: Disk Edition is an ASCII text version of Apple Computer, Inc.'s Apple IIGS Owner's Guide on a single 3.5" disk. The disk contains a manual-reading program, permitting the user to read the entire guide with a speech synthesizer. The user may also print a large type or Braille copy of the text.

An appropriate Echo speech synthesizer is required.

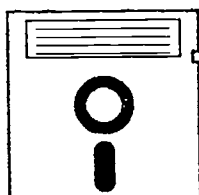

**Product Name:** AppleWorks Manuals: Special Editions

**Vendor:** American Printing House for the Blind (APH)

**Computer:** Apple II Family

**Cost:** \$23.90

AppleWorks Manuals: Special Editions include a four-track cassette version of the AppleWorks Tutorial, a 3.5" disk version of the AppleWorks Reference Manual, and braille and large type instructions called "Getting Started with Your AppleWorks Manuals." This product contains the manuals only and not the AppleWorks program.

System requirements include 128K RAM, a 3.5" disk drive, and an Echo, Slotbuster, or DoubleTalk speech synthesizer.

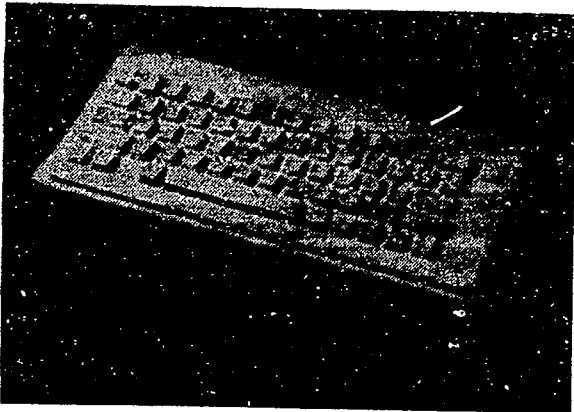

**Product Name:** Brailled Keyboard Model--Apple IIe

**Vendor:** American Printing House for the Blind (APH)

**Computer:** Apple IIe

**Size:** 13" x 6"

**Cost:** \$11.40/package of five

Brailled Keyboard Model--Apple IIe is a full-scale replica of a standard Apple IIe keyboard with keys identified in Braille. Certain keys with long names feature abbreviated or coded Braille identifications. The Brailled Keyboard Model is not an actual keyboard, but a training tool so that Braille readers can become comfortable with key positions before using an actual Apple IIe keyboard.

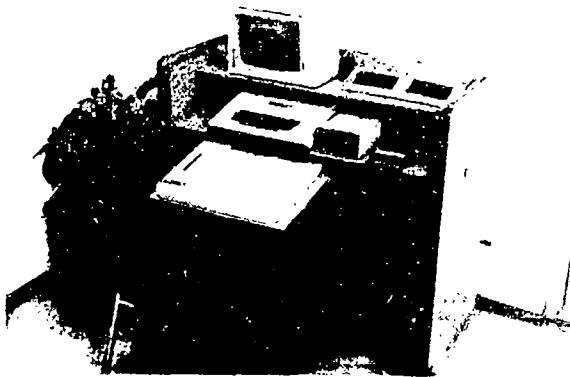

**Product Name:** CompuDesk HCP

**Vendor:** Craner Cabinetry

**Computer:** Apple II Family, Atari Family, Commodore Family, IBM PC Family, IBM PS/2 Family

**Size:** 42" x 24" x 48"

**Weight:** 225 lbs.

**Cost:** \$1,095.00 - \$1,195.00

CompuDesk HCP is an adjustable workstation designed specifically for computer users who have disabilities. The main work area can be adjusted with a hand crank in order to accommodate a variety of wheelchair heights. CompuDesk HCP is designed so that the user's arms will be naturally positioned for increased efficiency and comfort. CompuDesk HCP will accommodate a microcomputer, a monitor, a printer, external disk drives, printer paper, an expanded keyboard, and other necessary materials.

Two models are available. The HCP 4800 has a rollout, adjustable angle shelf which rests on the arms of the wheelchair and costs \$1,095.00. The HCP 6000 has a "U" shaped cutout which adjusts in width and costs \$1,195.00. Modified and custom designed tables are also available; contact manufacturer for details.

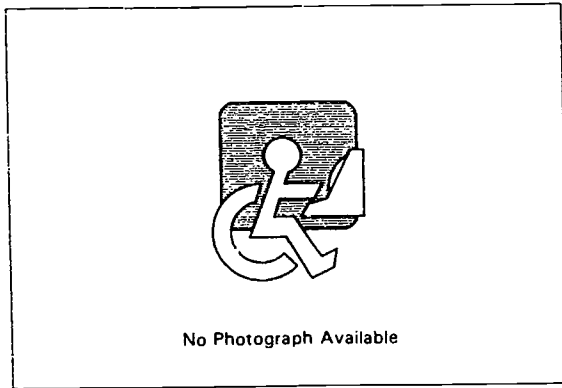

**Product Name:** Computer Workstation Furniture

**Vendor:** Various (Generic Product)

**Cost:** Varies

Research in human factors engineering and ergonomics has demonstrated the need to set up computer workstations that accommodate individuals. This includes the ability to place monitors and keyboards at an appropriate height and distance, and the provision of positioning support for the user's wrists. For example, monitor positioning devices are available as swivel stands, adjustable and extending arms, or integrated as shelving within a desk. Products labelled as "ergonomic" tend to be a bit more expensive than those which were not specifically designed with human factors in mind. However, appropriately designed and individualized workstations may be required to accommodate persons with disabilities.

Some manufacturers who provide products specifically for persons with disabilities also design and sell computer workstation tables. Specific sources can be found in local yellow pages, in the manufacturer list of this book, in listings from local rehabilitation service delivery programs, and often in gift specialty catalogs that carry personal convenience types of devices.

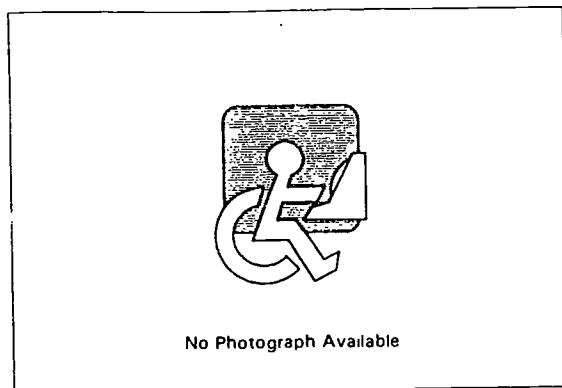

**Product Name:** Comtel

**Vendor:** Acrontech International, Inc.

**Size:** 4" x 6" x 1.25"

**Cost:** \$425.00

Comtel<sup>1</sup> is an audio mixer that allows a blind computer user to access computer information while talking to a telephone caller. Comtel includes a set of headphones with a microphone to leave the user's hands free to access the computer keyboard. The volume of the computer speech and the telephone can be controlled independently and the user can select to hear the caller in one ear and the computer in the other or to hear the caller and the computer in both ears. A tape recorder output jack is included for transcription.

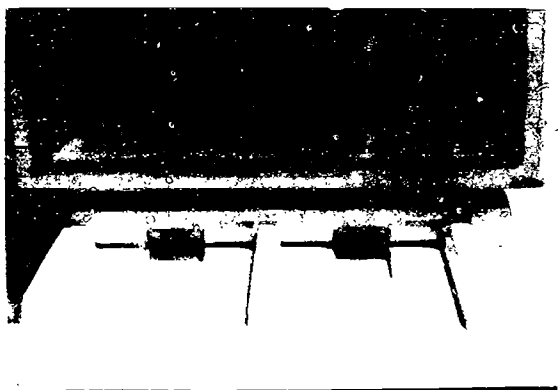

**Product Name:** Disk Guide (2485)

**Vendor:** TASH, Inc.

**Computer:** Apple II Family

**Size:** 15" x 8" x 3.5"

**Weight:** 1.5 lbs.

**Cost:** \$70.00

Disk Guide is a molded plastic base that rests in front of an Apple II computer disk drive. The guide provides a channel for a disk to be rested in while it is being slid into the drive. This guide will allow hand, foot, or mouthstick to be used to insert a disk.

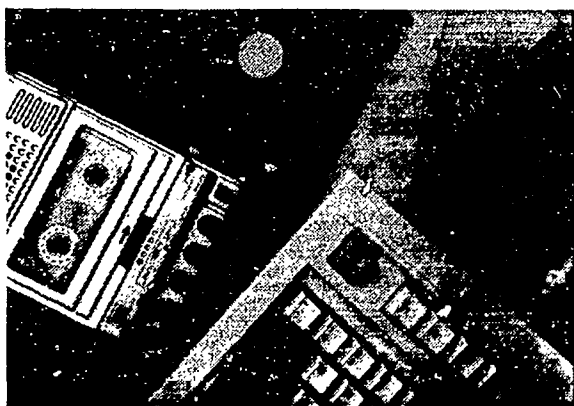

**Product Name:** DOS Tape

**Vendor:** Audio Computer Information, Inc.

**Computer:** IBM PC Family, IBM PS/2 Family

**Cost:** \$15.95

The DOS Tape is an audio tape tutorial that teaches users how to operate DOS for IBM PC and compatible computers. The second edition of the tape covers Version 6 of DOS, and is also suited to any version of DOS in use.

The DOS Tape comes with a printed reference card on DOS commands. The National Braille Press also sells the tape with a braille reference card. Other tapes are available on Microsoft Windows and modem issues.



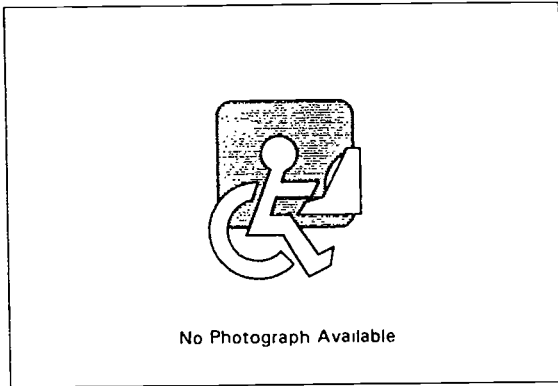

**Product Name:** Dual Channel Headset

**Vendor:** Maxi Aids, Inc.

**Cost:** \$230.00

The Dual Channel Headset allows the user to transmit and receive telephone conversations while using a standard dictation transcribing machine or a variety of voice output computer systems. Features include an adjustable voice tube and three step receiver volume control.

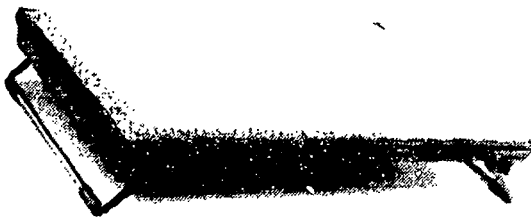

**Product Name:** EasyRiser

**Vendor:** Fox Bay Industries, Inc.

**Computer:** All (Hardware Independent)

**Cost:** \$199.95

EasyRiser is a platform for computer users who must stand. The platform can raise the user up to four and a half inches higher. EasyRiser is designed to be large enough to move around on, strong enough to hold the user, and light enough to move from place to place.

577

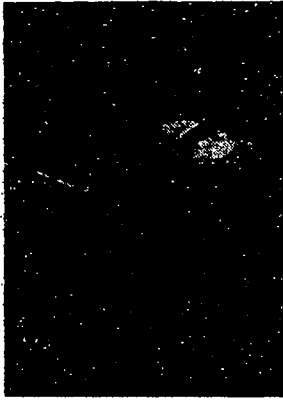

**Product Name:** Generation IV Adjustable Computer Tables

**Vendor:** Willow Pond Tools, Inc.

**Computer:** All (Hardware Independent)

**Cost:** \$708.00 - \$1,599.00

Generation IV Adjustable Computer Tables are a line of adaptable tables and accessories. Bilevel and single surface models in several sizes are available. Infills and side surfaces are also part of the Generation IV line to allow modification of a computer system for the user. A 14" height adjustment range is available. The tables are crank adjustable but can have an electric motor attached for \$695.00.

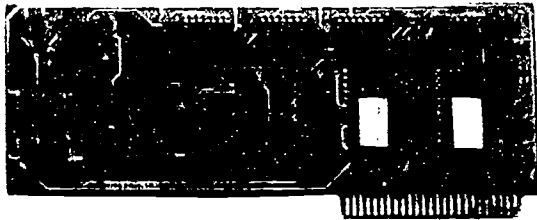

**Product Name:** Governor (2464)

**Vendor:** TASH, Inc.

**Computer:** Apple II+, Apple IIe

**Size:** 8" x 3" x 0.5"

**Weight:** 5 oz.

**Cost:** \$175.00

Governor is a speed control card to slow down computer games. Once the card is installed, the speed at which the various game functions run can be set by entering certain characters on the computer's keyboard. The Governor unit measures 8" x 3" x 0.5" and weighs 0.33 lbs.

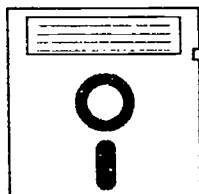

**Product Name:** IntelliKeys Overlay Maker

**Vendor:** IntelliTools, Inc.

**Computer:** Apple II Family, Apple Macintosh Family

**Manual Form:** Printed Manual

**Cost:** \$69.95

IntelliKeys Overlay Maker is a software program for creating customized overlays for the IntelliKeys keyboard. Overlays can be customized for the user, the activity and the chosen software. The Macintosh version allows the user to draw the overlay on the screen and define the areas of the keyboard. The program will then print out the overlay and send all the appropriate set-up information to the IntelliKeys keyboard. The Apple II version has 20 pre-defined overlay layouts. IntelliKeys Overlay Maker comes with a library of more than 200 common Picture Communication Symbols (from Mayer-Johnson Company), plus assorted computer symbols.

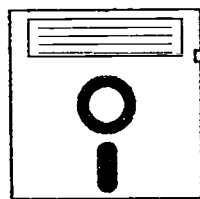

**Product Name:** Ke:nx Easy Overlays

**Vendor:** Don Johnston Incorporated

**Cost:** \$15.00 - \$25.00

Ke:nx Easy Overlays are ready-to-go solutions for alternate access to popular children's software. The overlays can be used with Ke:nx, Ke:nx On:Board, and Key Largo alternate keyboards (see entries). Ke:nx Easy Overlays are available for a painting program called Kid Pix, an interactive CD-ROM version of the story The Tortoise and the Hare, a program that allows students to experiment with numbers, patterns and shapes called Millie's Math House, a program that allows students to explore literacy activities called Bailey's Book House, a program that helps develop critical thinking skills and creativity called Thinkin' Things, and many other popular programs.

The overlays for switch sell for \$15.00 and the overlays for alternate keyboards sell for \$25.00.

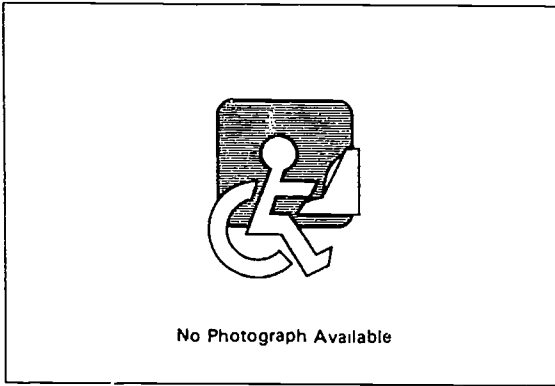

**Product Name:** Media Handling Products

**Vendor:** Various (Generic Product)

**Cost:** Varies

A variety of strategies are available to assist persons with mobility disabilities in performing basic tasks such as holding printed documentation vertically for accessible reading, loading and removing floppy disks, and turning computer equipment on and off. These strategies include: loading software onto hard disk drives to reduce the need for handling floppy disks; using computers with disk ejection systems which pop the disk out of a computer so it can be more easily grasped; using screen saver software to protect the computer screen while leaving the computer turned on; and plugging computer equipment into a multi-outlet power strip so that the computer, monitor, printer, and other peripherals may be turned on and off by flipping the power strip's switch. These strategies primarily involve equipment developed for mainstream computer users.

Specific sources can be found in local yellow pages, in the manufacturer list of this book, in listings from local rehabilitation service delivery programs, and often in gift specialty catalogs that carry personal convenience types of devices.



**Product Name:** Modular Turntable Desks

**Vendor:** Extensions for Independence

**Computer:** All (Hardware Independent)

**Cost:** \$1,045.00 - \$1,745.00

Modular Turntable Desks are straight, L-shaped, or single or double U-shaped tables with large turntables built into them. The turntables can be easily rotated by a non-functional hand or mouthstick to give the user access to any object on either table without excessive reaching.

Three models are available: Single Turntable Desk, Twin Turntable Medium Desk, and the Twin Turntable Executive Desk. Extension tables (\$329.00) to make straight desks L-shaped or U-shaped are available for all three models. Motor attachments are also available; contact manufacturer for details.

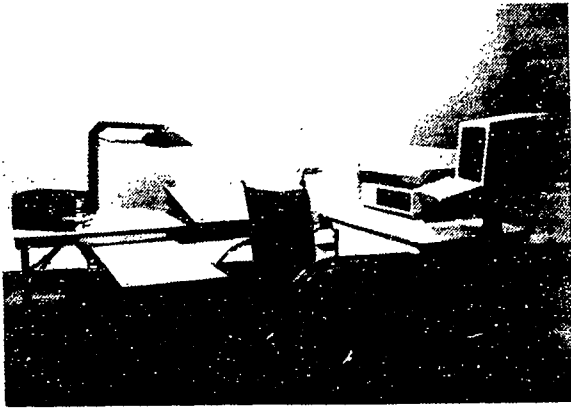

**Product Name:** Rx WorkStation  
**Vendor:** Consumer Care Products, Inc.  
**Cost:** Contact manufacturer

Rx WorkStations are modular work surface units which can be arranged for the user. The basic components of the WorkStations are the Slant Board/Easel which can be adjusted to any angle and used on any table, the height adjustable Worktables, and Pull-Out Side Tables which attach to any table.

The adjustable height and angle surfaces are controlled using mechanical or pneumatic options. The worksurfaces accept optional fixtures such as articulating arms, drawers, and stands which bring materials and supplies to the user. Contact the manufacturer for details on special configurations.

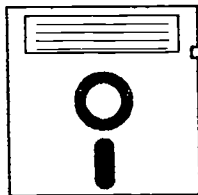

**Product Name:** Scanning Conversion Program  
**Vendor:** Stone Age Software, Inc.  
**Computer:** Apple II Family  
**Manual Form:** Printed Manual  
**Cost:** \$94.00

Scanning Conversion Program is used with modified Applesoft programs that accept input from the standard keyboard so that they may be operated by a single switch. A disk with seven Applesoft games already modified for use with scanning is included with purchase. A scanning array with user adjustable rate is incorporated into the modified programs. Manufacturer can modify additional Applesoft game programs for a separate fee (contact manufacturer for details).

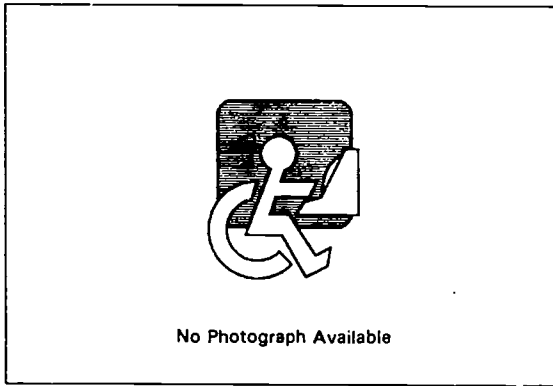

**Product Name:** Talk-to-Me Tutorial Cassettes

**Vendor:** Raised Dot Computing

**Computer:** IBM PC Family

**Cost:** \$75.00

Talk-to-Me Tutorial Cassettes are a series of instructional audio cassettes to help beginning and intermediate computer users learn to use popular software programs. The taped courses were designed by a blind computer programmer for visually impaired users, but are suitable for anyone interested in learning the programs. The series currently includes tutorials on MS-DOS 5.0, Word Perfect 5.0 and 5.1, dBASE, Lotus 123, and Procomm/Procomm Plus.



**Product Name:** Talking Utilities for ProDOS

**Vendor:** American Printing House for the Blind (APH)

**Computer:** Apple II Family

**Manual Form:** Audiotape Manual

**Cost:** \$23.05

Talking Utilities for ProDOS is a speech-accessible version of Apple Computer, Inc.'s "ProDOS User's Disk," a guide to the ProDOS operating system. The text on this utilities disk can be read entirely via speech synthesizer. The 5.25" disk contains adapted versions of two programs, "Filer" and "Convert." The disk also contains other programs for users who are getting started with ProDOS. A utility is provided that allows the user to read ASCII text files with synthesized speech.

An appropriate Echo speech synthesizer is required.



**Product Name:** TarsalRest

**Vendor:** Fox Bay Industries, Inc.

**Computer:** All (Hardware Independent)

**Cost:** \$47.95 - \$149.95

TarsalRest is a foot support for computer users available in an adjustable or non-adjustable version. A black rubberized platform is designed to prevent damage to shoes. The adjustable model has a height from six to 16 inches. The standard model is available at three inches and six inches.



**Product Name:** Variable Height Desk

**Vendor:** PosturMate, Inc.

**Computer:** All (Hardware Independent)

**Cost:** \$900.00 - \$2,700.00

The Variable Height Desk is a work surface designed to fit the posture of the person using it. The height of the desk is controlled by activating a switch for a built-in electric motor. The motor will raise the desk surface anywhere within the range of twenty six to forty seven inches.

The desk can be ordered in a variety of wood color finishes. A hand crank desk model is also available. Contact the manufacturer about available computer compatible models with power slant boards, varying desk sizes, and custom specialized desks.

# Chapter 19

## Training and Therapy Software

This chapter includes computer software that is designed to be used for training and therapy. Software that focuses on topics such as basic skills, ADL skills, communication skills, and vocational training is included here. Software that focuses on topics which are traditionally part of school curricula is not included in this chapter but is found in Chapter 20 (Adaptive Education Software).

The products in this chapter are cross-listed by a number of functions in Index 1. Although only software that is actually used for therapy or training is included, some programs do have an assessment component and are cross referenced under Assessment (AS). Other relevant function codes include: Keyboarding Training (KB), Language Therapy and Development (LT), Speech Therapy (ST), Signing (SI), Cognitive Rehabilitation (CR), and Vocational (VO).



**The following product entries appear in this chapter:**

- 101 Animations, 556  
 Adult Switch Progressions, 556  
 Adventures of Jimmy Jumper -  
     Prepositions, 557  
 Antonyms and Synonyms (Cognitive Disorders 12), 557  
 APH Presents the Talking Apple Computer, 558  
 Aphasia Series: I through VIII, 558  
 Association Pictures, 559  
 Attention, Perception & Discrimination Plus for Windows, 559  
 Audio Braille Game Tutorial, 560  
 Babysitting Basics, 560  
 Be a Winner Series, 561  
 Bear Jam, 561  
 BEST Faces, 562  
 Big/Little I and II, 562  
 Blocks in Motion, 563  
 Blueprint for Decision Making, 563  
 Body Builder, 564  
 Bozons' Quest, 564  
 Braille Tutorial, 565  
 Breakthrough to Language: Clinical Edition, 565  
 Breakthrough to Language: Home Edition, 566  
 Buddy's Body, 566  
 Build-A-Scene, 567  
 Cafet-for-Voice, 567  
 CanSpeak, 568  
 Captain's Log: Cognitive Training System, 568  
 Categories Plus for Windows, 569  
 Category Discrimination and Reasoning Plus for Windows, 569  
 Category Naming and Completion Plus for Windows, 570  
 Cause & Effect, 570  
 Cause 'n Effect, 571  
 CAV-ASL, 571  
 Children's Switch Progressions, 572  
 Circletime Tales & Circletime Tales Deluxe, 572  
 Cognitive Disorders I, II, III, IV, 573  
 Cognitive Rehabilitation Software, 573  
 Cogrehab Vol. 1, 574  
 Cogrehab Vol. 2, 574  
 Cogrehab Vol. 3 Version 2.0, 575  
 Cogrehab Vol. 4, 575  
 Cogrehab Vol. 5, 576  
 Cogrehab Vol. 6, 576  
 Cogrehab Vol. 7: Quest, 577  
 COINSNKEYS, 577  
 Color Find, 578  
 Colorful Concept Software, 578  
 Colors and Shapes, 579  
 Communication Training Program, 579  
 Community Signs, 580  
 Community Vehicles, 580  
 Completion From Partial Information Plus for Windows, 581  
 Computer CUP, 581  
 Computer Literacy Series, 582  
 CONCENTRATE! On Words & Concepts, 582  
 Construc, 583  
 Core Reading and Vocabulary Development, 583  
 Creature Antics and Creature Capers, 584  
 Creature Cartoons, 584  
 Creature Chorus, 585  
 Creature Features, 585  
 Creature Magic, 586  
 CrossWords, 586  
 Data Entry, 587  
 Deductive Reasoning Plus for Windows, 587  
 Definitions Plus for Windows, 588  
 Dino-Games, 588  
 Dinosaur Game, 589  
 Dollars & Cents Series, 589  
 Early and Advanced Switch Games, 590  
 Early Concepts, 590  
 Early Emerging Rules Series, 591  
 Early Learning 3.5/Complete Early Learning 5.25, 591  
 Early Learning I, 592  
 Edmark Functional Word Series, 592  
 Eency-Weency Spider Game, 593  
 Elementary Signer, 593  
 Employment Signs, 594  
 English on the Job, 594  
 Every Day Is A Holiday, 595  
 Exploring Early Vocabulary Series, 595  
 Family Fun, 596  
 Fast Food Game, 596  
 Feelings, 597  
 Find the Buttons, 597  
 Fingerspeller, 598  
 Fingerspelling & Numbers, 598  
 FingerZoids, 599  
 First Categories, 599  
 First Mate, 600  
 First Step Software, 600  
 First Verbs and Primeros Verbos, 601  
 First Words, 601  
 First Words II, 602  
 Following Directions: One- and Two-Level Commands, 602  
 Following Directions: Left and Right, 603  
 Food Facts, 603  
 Foundations I, 604  
 Foundations II, 604  
 Function Pictures, 605  
 Functional Vocabulary Plus for Windows, 605  
 Fundamental Concepts, 606  
 Further Adventures of Jimmy Jumper - Perseverance, 606  
 Getting Clean with Herkimer Level I, II, III, 607  
 GrammarPlay with Alps and Droops, 607  
 Grocery Store Words, 608  
 Hierarchical Attention Training, 608  
 Homographs, 609  
 Homophones, 609  
 Human Being Machine, 610  
 If You're Happy and You Know It, 610  
 Improving Your Self-Concept, 611  
 Inferential Naming for Cognitive and Language Disorders, 611  
 Inferential Naming Plus for Windows, 612  
 Information Signs, 612  
 Initial Phoneme Cuing for Aphasics, 613  
 Interaction Games, 613  
 Interaction Games II, 614  
 Job Readiness Series, 614  
 Job Seeking Series, 615  
 Job Success Series, 615  
 Join the Circus, 616  
 Joystick Trainer, 616  
 Keyboarding by Ability, 617  
 Keyboarding for Individual Achievement, 617  
 Keyboarding for People with Cerebral Palsy, 618  
 Keyboarding Program with Voice Output, 618  
 Keyboarding with One Hand, 619  
 Keys to Success: Comp. Keybd. Skills for Blind Children, 619  
 Laryngograph, 620  
 Learn to Scan, 620  
 Learning Activity Packets (LAPs), 621  
 Learning How to Learn Series, 621  
 Learning to Count, 622  
 Learning to Reason Series, 622  
 Learning to Spell Braille Signs, 623  
 Less, More, Make Equal, 623  
 Let's Go Shopping I and II, 624  
 Let's Go to the Circus, 624  
 Letter Find, 625  
 LetterTALK+, 625  
 Listen With Your Ears, 626  
 Living Alone, 626  
 Logi, 627  
 Logo TouchTools for the PowerPad, 627  
 Magic, 628  
 Make It In Time, 628  
 Make It Scan, 629  
 Mastering Personal Information (MPI), 629  
 Math Max, 630  
 Math on the Job, 630  
 Maze, 631  
 Medical Words, 631  
 Memory for Animated Sequences Plus for Windows, 632  
 Memory I, 632  
 Memory II, 633  
 Micro Guide to Careers Series, 633  
 Micro-LADS and Micro-LADS in French, 634  
 Microcomputer Evaluation of Career Areas (MECA), 634  
 Mind Castle I and II, 635  
 Minimal Contrast Stories Plus for Windows, 635  
 Minimal Contrast Therapy, 636  
 Mix 'N Match, 636  
 Money Matters, 637  
 Money Skills, 637  
 Motor Training Games, 638  
 Motor Training Games, 638  
 Multi-SCAN, 639  
 Multiple Meaning Words I Plus for Windows, 639  
 Multiple Meaning Words II Plus for Windows, 640  
 MusicWare, 640  
 MusicWare - Age Appropriate, 641  
 MY HOUSE: Language Activities of Daily Living, 641  
 My Paint & Talking Coloring Books, 642  
 MY SCHOOL: Language Activities of Daily Living, 642  
 MY TOWN: Language Activities of Daily Living, 643  
 Nasometer Model 6200-3, 643  
 New Frog & Fly, 644  
 Numeric Concepts I and II, 644  
 Occupations, 645  
 Octobus, 645  
 Old MacDonald's Farm I and II, 646  
 On the Job Series - Career Interests, 646  
 On the Job Series - Communication Skills, 647  
 On the Job Series - Mathematics, 647  
 On the Job Series - Problem Solving Skills, 648  
 One Switch Picasso, 648  
 Opening Windows, 649

- Opposites and Similarities Plus for Windows, 649  
 Order Processing, 650  
 Padded Food, 650  
 Padded Vehicles, 651  
 Paper Dolls I and II, 651  
 PC Typer, 652  
 Personal Development Software Series, 652  
 Pick-A-Meal, 653  
 Pictalk, 653  
 Picture Cue Dictionary, 654  
 Picture Identification Plus for Windows, 654  
 Picture Naming Plus for Windows, 655  
 Picture Scanner, 655  
 Picture/Theme Disks, 656  
 Pictures Programs: I, II and III, 656  
 Point to Pictures, 657  
 Positive Parenting, 657  
 PowerPad Preschool Pack I & II, 658  
 PowerTalker, 658  
 Prefix, 659  
 Preposition Fill-Ins, 659  
 Press to Play, 660  
 Primer 83, 660  
 Problem Solving I, 661  
 R.A.P.S. Software Series I PowerPad, 661  
 Rabbit Scanner, 662  
 Race the Clock, 662  
 Rate Drill in Articulation, Language and Fluency, 663  
 Reactions (R73), 663  
 Reading a Ruler - English & Metric, 664  
 Reading Comprehension for Adolescents, 664  
 Reasoning Skills on the Job, 665  
 Rhyming Pictures, 665  
 Rockets to the Moon, 666  
 Run Rabbit Run, 666  
 Safety Signs, 667  
 Scan & Match 1, 2, 3, and 4, 667  
 Scan It - Switch It, 668  
 Scanning Picasso, 668  
 Seasons, 669  
 Seek & Find, 669  
 Semantic Development Using Code Breaking Strategies, 670  
 Sentence Completion Plus for Windows, 670  
 Sentence Key & Picture Sequence Key, 671  
 Sentence Master, 671  
 Shell Game & Mouse Game, 672  
 Sight Words, 672  
 Silly Sandwich, 673  
 Simple Sentence Structure, 673  
 SimpleCom I: Yes/No Communication, 674  
 SimpleCom II: Needs/Wants Communication, 674  
 Single Switch Software, 675  
 Single Switch/MatchBox Pack 1, 675  
 Son of Seek and Find, 676  
 Sorting by Category Plus for Windows, 676  
 Sound Scope, 677  
 Special Education Public Domain Software, 677  
 SpeechViewer II, 678  
 Steps for Career Choice, 678  
 Storytime Series, 679  
 Storytime Series for Macintosh, 679  
 Studio4, 680  
 Subtle Messages, 681  
 Survival Words, 681  
 Swim, Swam, Swum. Mastering Irregular Verbs, 681  
 Switch Arcade, 682  
 Switch Arcade, 682  
 Switch Art, 683  
 Switch It - Change It, 683  
 Switch It - See It, 684  
 Switch Puzzles, 684  
 SwitchEnsemble, 685  
 Talking Hands, 685  
 Talking Literacy Kit for the Apple IIe (TALK IIe), 686  
 Talking Nouns, Talking Nouns II, and Talking Verbs, 686  
 Talking Touch Window, 687  
 Talking Typer, 687  
 TalkTime with Tucker, 688  
 Tea Party, 688  
 Teenage Switch Progressions, 689  
 Telling Time, 689  
 Telling Time, Parts of the Face, Learning Colors, 690  
 THINKable/DOS, 690  
 This is the Way We Wash Our Face, 691  
 This Old Man, 691  
 Timekeeper, 692  
 Touch and Match, 692  
 Touch and See, 693  
 TouchMoney, 693  
 Traffic Signs Plus for Windows, 694  
 Transportation Signs, 694  
 Trip to the Zoo, 695  
 Turn-Talking, 695  
 Twenty Categories, 696  
 UKanDu Little Books, 696  
 UKanDu Switches, Too!, 697  
 Understanding Attributes, 697  
 Verb Fill-Ins, 698  
 Verbal Analogies, 698  
 Verbal Analogies Plus for Windows, 699  
 Video Voice Speech Training System, 699  
 Visi-Pitch Model 3300, 700  
 Visual Confrontation Naming Plus for Windows, 700  
 Visual Memory Plus for Windows, 701  
 Visual Motor Skills, 701  
 Visual Pattern Memory Plus for Windows, 702  
 Visuospatial Skills I, 702  
 Visuospatial Skills II, 703  
 Vortex Machine Assisted Reader Software, 703  
 Wheels On The Bus I, II, III, 704  
 Wheels on the Bus I, II, III - Intellipics Activity, 704  
 Wheels on the Bus: COMPLETE, 705  
 Where is Puff?, 705  
 Word Association Plus for Windows, 706  
 Word Order in Sentences, 706  
 Word Order Plus for Windows, 707  
 Words and Concepts I, II, III, 707  
 WordWise Software, 708  
 Worm Squirm, 708  
 WSCC (Washington State Cooperative Curriculum), 709  
 Zoo Time, 709
- The following products from other chapters can also be used as Training or Therapy Software:***
- BlissWrite, 741  
 DigiTalk 1, 127  
 Language Master Special Edition - I.M6000SE, 477  
 Mac-Apple Communications Aid, 756  
 Magic Slate II, 756  
 MicroIllustrator, 758  
 Talking Public Domain Disks, 730  
 Talking Writer & Four Games, 766



**Product Name:** 101 Animations

**Vendor:** R.J. Cooper & Associates

**Computer:** Apple Macintosh Family, IBM PC Family

**Cost:** \$89.00

101 Animations is a simple cause and effect activity that puts a large and loud animation on the screen with every switch activation.

IBM version requires Microsoft Windows. The program works with a single switch or TouchWindow.



**Product Name:** Adult Switch Progressions

**Vendor:** R.J. Cooper & Associates

**Computer:** Apple II Family,  
Apple Macintosh Family, IBM PC Family

**Manual Form:** Printed Manual

**Cost:** \$75.00 - \$89.00

Adult Switch Progressions is a computer program that contains four simulation activities that are designed for people making the transition from randomly activating a single switch to activating a switch with specific timing, relative to real-life tasks appropriate for adults. The skills taught include cause/effect and attending to extended tasks (levels 0 and 1), following directions (level 2), and responding to visual/auditory computer information (levels 3 and 4). Each activity can be selected at any of the three levels. Other adjustable parameters are reaction speed, penalty (for inattention or inappropriate activation), length of reinforcement, reinforcement upon switch hit or release, and auditory feedback.

The Apple II version requires 128K of memory, a single switch or TouchWindow (see entry), and a switch interface or Adaptive Firmware Card (see entry). Recommended peripherals are a color monitor and an Echo speech synthesizer (see entry). The IBM version requires Microsoft Windows.

587



**Product Name:** Adventures of Jimmy Jumper -  
Prepositions

**Vendor:** Exceptional Children's Software, Inc.

**Computer:** Apple II Family

**Manual Form:** Printed Manual

**Cost:** \$29.95

The Adventures of Jimmy Jumper - Prepositions is a story presentation program which emphasizes prepositional concepts. The story of a young rabbit, Jimmy Jumper, is presented with synthesized speech and graphics, which illustrate prepositions such as on, over, under, beside, and between. The child uses a game paddle, adaptive switch, or the space bar to either make the rabbit move in the manner specified by the preposition or advance the story screen by screen.

Use of an Echo II speech synthesizer is optional.

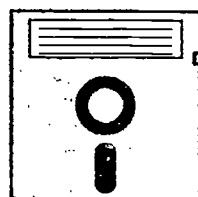

**Product Name:** Antonyms and Synonyms (Cognitive  
Disorders 12)

**Vendor:** Parrot Software

**Computer:** Apple II Family, IBM PC Family

**Cost:** \$104.95

Antonyms and Synonyms is a software program that includes twenty lessons for vocabulary development. Two types of lessons are included. The first type uses words to teach opposites and similarities; the user must select the opposite of a target word from a list of words, and then select the synonym of the target word from the same list. In the second type, users are asked to indicate whether two target words are antonyms or synonyms.

Ten lessons of each type are included. Progress for each user is stored for later retrieval. Lessons may also be printed. Specify type of computer and disk size (5.25" or 3.5") when ordering.



**Product Name:** APH Presents the Talking Apple Computer

**Vendor:** American Printing House for the Blind (APH)

**Computer:** Apple II Family

**Manual Form:** Audiotape Manual, Electronic Manual, Large Print Manual

**Cost:** \$18.00

APH Presents the Talking Apple Computer is a software program designed to introduce beginning students to Apple II computers equipped with appropriate speech synthesizers. The program options on the disk demonstrate features of the Apple II keyboard and some of the sights and sounds the student can expect to experience while using an Apple II computer with speech output. The options include common actions such as choosing from menus, quitting programs, changing the speech settings, etc. The program is designed for students age eight years to adult.

The package includes both a 3.5" and a 5.25" disk. An Echo, Slotbuster, or DoubleTalk speech synthesizer is required for the program and disk-based manual to talk.



**Product Name:** Aphasia Series: I through VIII

**Vendor:** Parrot Software

**Computer:** Apple IIGS, Apple IIc, Apple IIe, IBM PC Family

**Manual Form:** Printed Manual

**Cost:** \$104.95 each

These programs are designed for people with aphasia and others with reading and comprehension problems, and operate with a single switch or space bar. In Aphasia I (Noun Association) and Aphasia II (Opposites-Similarities) the client must match a word to an appropriate one from ten words on the screen. Aphasia III (Categories) operates in the same way, except that the clinician can control the time necessary for a response (from 3 to 30 seconds). Aphasia IV (Reading Comprehension) contains ten stories with adult themes, with literal and inferential levels. A reading cursor can highlight one line of the story at a time to help people with visual problems. Aphasia V (Sentence Completion) presents choices of words to fill in a sentence blank, choices that are semantically or visually similar, or not similar. Aphasia VI (Definitions) is identical except that three definitions are presented as options for a word; foreign language or user-defined definitions are possible. Aphasia VII (Picture Identification) flashes pictures and asks user to spell the name of the object, highlighting incorrect letters. Aphasia VIII (Picture Naming) displays a picture and the user chooses the correct name from three options.



**Product Name:** Association Pictures

**Vendor:** Parrot Software

**Computer:** Apple IIGS, Apple IIc, Apple IIe,  
IBM PC Family

**Cost:** \$104.95

Association Pictures is a two-level program for cognitive training based on the use of pictures. The first level is a picture identification task requiring users to correctly match a picture with a prompt (e.g., "Find the lamb"). The second level is an association task. At this level, users must correctly determine which picture displayed on the screen can be associated with a prompt (e.g., "What goes with key?"). Responses are made by pressing the space bar and return key. The program stores performance data and prints progress reports to the screen or to a printer.

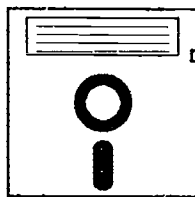

**Product Name:** Attention, Perception &  
Discrimination Plus for Windows

**Vendor:** Parrot Software

**Computer:** IBM PC Family

**Cost:** \$134.95

Attention, Perception and Discrimination Plus for Windows is a software program designed to help cognitively impaired individuals with matching, attention, and discrimination skills. The program allows for either a similarity paradigm or an oddity paradigm. The difficulty of the discrimination required can also be varied. The program requires Microsoft Windows.

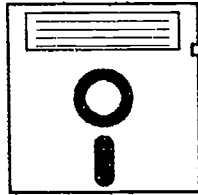

**Product Name:** Audio Braille Game Tutorial

**Vendor:** Access Unlimited

**Computer:** Apple II+, Apple IIc, Apple IIe

**Manual Form:** Printed Manual

**Cost:** \$40.00

Audio Braille Game Tutorial is a braille training program to help teach braille contractions. The program includes seven games to practice the following contractions: short form words, one cell upper signs, lower whole word signs, two cell initial letter signs, upper whole word signs, and one cell lower signs. Stimuli can be presented either alphabetically or in random order.

System requires an Echo + or Echo II speech synthesizer for voice output capabilities.

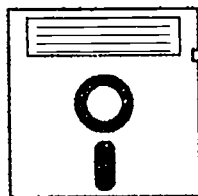

---

**Product Name:** Babysitting Basics

**Vendor:** MCE

**Computer:** Apple II Family

**Cost:** \$59.95 - \$89.95

Babysitting Basics is a computer software program designed to help the user understand the responsibilities of child care. The program uses interactive activities to discuss how a sitter should respond in an emergency, decide when to contact parents, know what information to get from parents before they leave, and other issues important to preparing for sitting jobs. The program is written for a 3rd-4th grade reading level and an 6th grade-adult interest level.

One copy may be purchased for \$59.95 or a five pack for \$89.95.



**Product Name:** Be a Winner Series

**Vendor:** Conover Company

**Computer:** Apple II Family, IBM PC Family

**Cost:** \$249.95

The Be a Winner Series covers four work-readiness topics for adults with a fourth to fifth grade reading level. The topics are motivation, setting goals, being assertive, and negotiation.

Apple II system requirements are 64K and one 5-1/4" or 3-1/2" disk drive. IBM system requirements are 256K and one 5-1/4" or 3-1/2" disk drive. Price is for the complete stand-alone system. Each topic is available individually for \$69.95. Network packages are available.

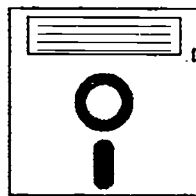

**Product Name:** Bear Jam

**Vendor:** Dunamis, Inc.

**Computer:** Apple II Family, Atari 400, Atari 800,  
Commodore 128, Commodore 64

**Manual Form:** Printed Manual

**Cost:** \$59.95

Bear Jam is an educational pre-reading program which provides practice in basic visual skills involved in later learning, including observing similarities, recognizing differences, and distinguishing patterns. The program includes six games with different user-selectable levels of difficulty, to train familiarity with shapes and colors. The program requires a PowerPad (see entry) and has animation, music, and color reinforcement for correct answers.

Included with the program is a supplementary guide, "Bear Jam for Exceptional Children" by Dolores Hagen, which presents 16 Bear Jam activities designed for children with disabilities.





**Product Name:** BEST Faces

**Vendor:** BEST, Inc.

**Computer:** IBM PC Family

**Cost:** \$35.00

BEST Faces is a program designed to assess and teach perceptual and cognitive skills of developmentally impaired children who function at a 3-5 year old cognitive level. The program contains four games designed to test and teach basic skills in a sequential manner, starting from the basic skills of cause and effect and moving to more advanced skills of matching, discriminating, associating and memorizing. The activities revolve around the features of a face. The teacher can customize the program by adjusting variables such as: game type, facial features, number of features, response time, visual and auditory instruction and the overlays. The program automatically tracks the number of correct and incorrect responses, the response time, and the overall time the learner is attending to the task.

Input to BEST Faces can be made with the BEST Switch Interface, PowerPad, Concept Keyboard or Unicorn Keyboard.

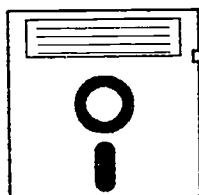

**Product Name:** Big/Little I and II

**Vendor:** UCLA Microcomputer Project

**Computer:** Apple II+, Apple IIGS, Apple IIe,  
Apple Macintosh Family

**Cost:** \$35.00 each

Big/Little I and II are single-switch scanning programs for 1 to 4 players. The scanning speed can be adjusted. Players' names may be entered. The programs use a little bear to scan between big and little items. Big/Little I and II can be configured by the teacher or clinician to show a variety of different sizes.

An Echo speech synthesizer, color monitor, and single switch are required. For Macintosh use, a Apple IIe emulation card is also required.

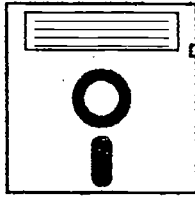

**Product Name:** Blocks in Motion

**Vendor:** Don Johnston Incorporated

**Computer:** Apple Macintosh Family

**Cost:** \$79.00

Blocks in Motion is an art and animation program that does not require fine motor skills. Toolbars with shapes and colors are available on screen from which to select. Animation features can move individual blocks or objects made from groups of blocks. Basic shape blocks and wooden blocks are included. Additional block kits are available for \$24.00 each: Letter & Number, Toys, Pencils and Stick Blocks, Cool Blocks, and Castle Blocks.

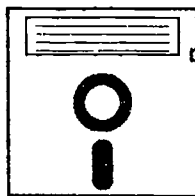

**Product Name:** Blueprint for Decision Making

**Vendor:** MCE

**Computer:** Apple II Family

**Cost:** \$69.95 - \$99.95

Blueprint for Decision Making is a software program which gives students practice in making decisions. The program user sees examples of problems involving parents and peers, then the user poses a personal situation to be resolved. To resolve the situation, the student must explain who has the problem, state the problem in a number of different ways, brainstorm for alternative solutions, and finally consider the consequences of each solution. When using a computer system with a printer, hard copy from the decision making activities can be obtained.

Blueprint for Decision Making is designed for junior high and high school age students; the program is written at a third grade reading level. The program may be purchased singly for \$69.95 or in a five pack for \$99.95.



**Product Name:** Body Builder

**Vendor:** Dunamis, Inc.

**Computer:** Apple IIGS, Apple IIe

**Manual Form:** Printed Manual

**Cost:** \$29.95

Body Builder is a software program that permits users to "build a body" using the PowerPad. The head, torso, legs and feet of four different characters--ballerina, grandmother, weight lifter, and spaceman--are included. Pictures may be printed out with the name of the user.

Body Builder requires a PowerPad and an Echo II speech synthesizer.

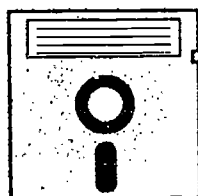

**Product Name:** Bozons' Quest

**Vendor:** Laureate Learning Systems, Inc.

**Computer:** Apple II Family

**Manual Form:** Printed Manual

**Cost:** \$65.00

Bozons' Quest is a computer game designed to teach cognitive strategies and left/right discrimination skills. A "Bozon" is moved left or right on the screen to search for "cosmic crystals" and points are accumulated while dangers are avoided. The computer says "right" or "left" with each move. A more advanced level uses an inverted game board, requiring movement decisions based on mirrored images. Bozons' Quest can be played using the keyboard, or a joystick, single switch, left/right rocker switch, or TouchWindow. If a single switch is used, the scan speed can be adjusted. The game may be played by one or two players; each player may use a different interface method.

The program requires an Apple II computer with 64K of memory, a monitor, an Echo speech synthesizer (extra; see entries), and a 5.25" disk drive. A color monitor is recommended.

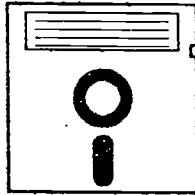

**Product Name:** Braille Tutorial

**Vendor:** Hexagon Products

**Computer:** IBM PC Family

**Manual Form:** Large Print Manual

**Cost:** \$39.00

Braille Tutorial (BT) is a software program designed to teach users how to read Grade 2 braille. The program draws large characters and braille cells on the screen in the size that can be read by most people with limited vision. The program features 12 lessons and a variety of test and drill styles.

BT requires EGA or VGA.



**Product Name:** Breakthrough to Language: Clinical Edition

**Vendor:** Creative Learning, Inc.

**Computer:** Apple II Family, IBM PC Family

**Cost:** \$1,495.00

Breakthrough to Language: Clinical Edition is a set of software programs for speech and language therapy. The clinical edition contains 21 program modules that teach over 700 words, 140 phonic rules, and 540 sentences. The program also features an integrated management system to allow therapists to track and monitor the clients' progress. Lessons can be customized for each user. Records from home users can be imported into the management system to monitor their performance while outside of the clinical environment.



**Product Name:** Breakthrough to Language: Home Edition

**Vendor:** Creative Learning, Inc.

**Computer:** Apple II Family, IBM PC Family

**Cost:** \$995.00

Breakthrough to Language: Home Edition is a speech and language therapy set of software programs. The home edition features 16 programs designed to provide comprehensive basic language skills. Included is the program Breakthrough to Writing.



**Product Name:** Buddy's Body

**Vendor:** UCLA Microcomputer Project

**Computer:** Apple II+, Apple IIGS, Apple IIe,  
Apple Macintosh Family

**Cost:** \$35.00 - \$36.00

Buddy's Body helps students learn to identify parts of the body. The program is divided into two levels: the face and the body. Animation sequences are used as Buddy introduces the features of his face and the parts of his body. The student is then asked to identify a particular part by touching that part on the surface of the PowerPad or IntelliKeys Keyboard. Correct responses are rewarded with a wiggle or a wave, and the speech synthesizer pronounces the name of that part of the body.

For Apple compatibility, the PowerPad, a speech synthesizer, and overlay are required; Macintosh users need the IntelliKeys Keyboard, speech synthesizer, overlay, color monitor, Apple IIe emulation card, and a 5.25" drive.



**Product Name:** Build-A-Scene

**Vendor:** R.J. Cooper & Associates

**Computer:** Apple II Family,  
Apple Macintosh Family, IBM PC Family

**Cost:** \$75.00 - \$89.00

Build-A-Scene is an adaptation of a cause and effect software program from the Early and Advanced Switch Games disk from R.J. Cooper (see entry). The game involves building a color picture: each time a switch is hit, a new piece of the picture is added. Four pictures are included. If the program is used with an Echo speech synthesizer (recommended; see entry), words and sounds are produced along with the picture. Animated effects are also included.

The Apple II version requires 128K memory, and a single switch with a switch interface or Adaptive Firmware Card (see entry), or a TouchWindow (see entry). A color monitor and an Echo speech synthesizer are recommended. The IBM version requires Microsoft Windows. Price includes shipping and handling.

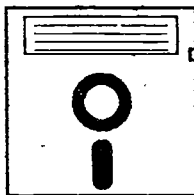

**Product Name:** Cafet-for-Voice

**Vendor:** Cafet, Inc.

**Computer:** IBM PC Family

**Manual Form:** Printed Manual

**Cost:** \$4,130.00

Cafet-for-Voice is a program designed for use by a speech-language pathologist in clinical treatment of voice disorders. The hardware, consisting of a plug-in circuit board, respiratory sensor, and tie-clip microphone, offers continuous real-time biofeedback that integrates airflow characteristics with voicing time and amplitude simultaneously. A wide variety of manipulable targets for respiration and voicing can be set by the clinician to structure a voice treatment program for nearly any functional and organic voice disorder. If used with a portable computer, the program is also suitable for bedside evaluation and treatment in hospitals and nursing homes. Session data is automatically captured on a separate diskette for later printout.

The price includes all necessary hardware and a three-day training specifically for treatment. The software alone for adding on to an existing Cafet system costs \$670.00 and includes a one-day seminar.



**Product Name:** CanSpeak

**Vendor:** CanSpeak

**Computer:** Apple Macintosh Family

**Manual Form:** Printed Manual

**Cost:** \$200.00

CanSpeak is a software application using Hypercard 2.1 or later (required), which gives individuals with communication impairments simultaneous access to syntactically correct English and Bliss Symbolics to augment communication. In addition, CanSpeak has been designed as an integral part of a program to assist speech and language clinicians to address individuals with aphasia, cerebral palsy, Down's Syndrome, and others. The program offers the user rapid access to the total Bliss vocabulary of some 2,000 symbols with corresponding English text and voice. Word finding assistance is provided by a number of strategies including the use of a decision tree matrix which can be modified for each individual. CanSpeak prompts the user to employ appropriate message type (Statement, Question, or Request) and logical sentence structure (Subject + Verb + Object). Sentences (Bliss + English) constructed on the main communication board can be edited and pasted to documents. Documents of any length can be constructed, saved, and printed. CanSpeak allows the user to select individual words, phrases, sentences, and/or documents to be spoken aloud by the computer using MacinTalk.

---



**Product Name:** Captain's Log: Cognitive Training System

**Vendor:** BrainTrain

**Computer:** Apple II+, Apple IIGS, Apple IIe, IBM PC Family, IBM PC jr, IBM PS/2 Family

**Manual Form:** Printed Manual

**Cost:** \$495.00 - \$1,495.00

Captain's Log was designed to train basic cognitive functions including attention, concentration, memory, visual/motor, and reasoning skills. Captain's Log consists of 28 programs in four modules: attention skills, visual/motor skills, numeric concepts/memory skills and conceptual skills. It utilizes a mouse, trackball, special joystick system, or a Sip 'n' Puff Visual Control System to control the system. Program options include three levels of difficulty in the game-like skill training, assessment mode or training mode, time of the trial, and presence or absence of visual cues or prompts.

Captain's Log will run on the Apple IIe, IIGS, II+, IBM PC, XT, PCjr., PS/2, AT, or IBM PC compatibles. Requirements for the Apple system are a mouse, the Timemaster II Clockcard, a color monitor, and 64K of memory. IBM requirements are a mouse, an RGB color monitor, and 512K of memory. For IBM and compatible computers, the price for the system is \$1,795.00; this includes 32 programs. For Apple II computers the price is \$1,495.00 and includes 28 programs. Individual modules are available for \$495.00 each. The Skipper's Club, a technical support service, is available for \$199.00/three years.

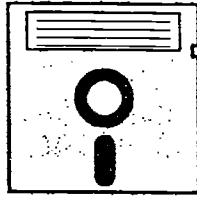

**Product Name:** Categories Plus for Windows

**Vendor:** Parrot Software

**Computer:** IBM PC Family

**Cost:** \$134.95

Categories Plus for Windows is a software program that presents a word and asks the user to respond within a certain time only if that word is in a specific category. The clinician specifies the category and sets the time within which the user must respond. Reward is both visual and auditory and progress is recorded. The program works with Microsoft Windows.

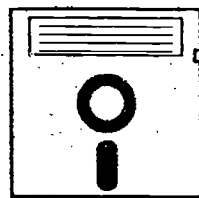

**Product Name:** Category Discrimination and Reasoning Plus for Windows

**Vendor:** Parrot Software

**Computer:** IBM PC Family

**Cost:** \$134.95

Category Discrimination and Reasoning Plus for Windows is a software program designed to address areas of thought organization that are essential to the language and cognitive recovery of individuals with head injury, non-dominant hemisphere involvement, and higher level aphasia and the treatment of the language disordered adolescent. The program takes the basic skills of category naming and completion and then exercises and teaches the processes behind discrimination, analysis, and reasoning. An included authoring program provides for personalized stimuli. The program requires Microsoft Windows.



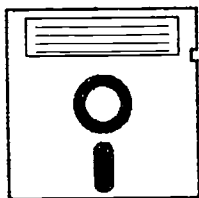

**Product Name:** Category Naming and Completion Plus for Windows

**Vendor:** Parrot Software

**Computer:** IBM PC Family

**Cost:** \$134.50

Category Naming and Completion Plus for Windows is a software program with a two-step format to reinforce the inherent language and cognitive components of categorization skills. In addition, the program addresses the areas of sequencing, discrimination, reasoning, and cognitive flexibility. Twenty informative lessons are provided and up to ten more lessons can be added. Vocabulary and categories can be adapted to the user's interests, occupation, cultural background, and specific language level. The program requires Microsoft Windows.

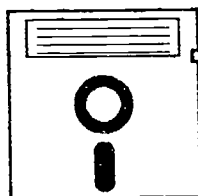

**Product Name:** Cause & Effect

**Vendor:** Judy Lynn Software

**Computer:** IBM PC Family

**Cost:** \$20.00

Cause & Effect is a software program designed to introduce the user to the computer and switch. The program is composed of a series of brightly colored animated geometric segments accompanied by captivating sounds that are activated by a single press of a switch or the space bar. Each of the 30 segments lasts three to five seconds and can be altered based on attention span and tracking ability. Response time is saved on the disk and can be printed out and graphed.

An EGA or VGA monitor is required.



**Product Name:** Cause 'n Effect

**Vendor:** Marblesoft

**Computer:** Apple IIGS, Apple IIc

**Cost:** \$25.00

Cause 'n Effect is an educational software program designed to teach the basic principle of cause and effect to the student. The program includes four different activities in which the student must initiate, change, or stop some activity on the computer screen. Responses during the program can be made by pressing any key on the keyboard, a mouse button, any typical single switch device, or a TouchWindow.

Extra options available for this program include speech output on an Echo or Cricket speech synthesizer.

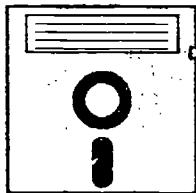

**Product Name:** CAV-ASL

**Vendor:** E & IS SignWare

**Computer:** Apple II Family,  
Apple Macintosh Family, IBM PC Family

**Manual Form:** Printed Manual

**Cost:** \$695.00

CAV-ASL (Computerized Animated Vocabulary of American Sign Language) is a program that allows learners to practice receptive skills in ASL Sign Language. English words selected by the user from the 2,600 word vocabulary are translated into animated displays of the equivalent ASL sign. Signs on the computer screen are seen from the same perspective as viewing a human signer. Motion of the signs can be sped up, slowed down, or frozen. English captions can be turned on and off. A series of words selected from any of the 16 data diskettes can be stored on a work disk by the user and played back in sequence.

Talking versions are available for the Apple and Macintosh computers. A French version is available for the IBM computer. Two disk drives are required; a graphics adaptor is required for the IBM version. The cost is \$695.00 for the complete silent package of 17 disks. Contact manufacturer for the prices of individual disks.



**Product Name:** Children's Switch Progressions

**Vendor:** R.J. Cooper & Associates

**Computer:** Apple II Family,  
Apple Macintosh Family, IBM PC Family

**Manual Form:** Electronic Manual, Printed Manual

**Cost:** \$75.00 - \$89.00

Children's Switch Progressions is a program that contains seven activities providing training in use of single switches (or a touch screen). The activities progress from requiring that a switch be activated randomly to requiring that the switch be activated at specifically timed intervals. Skills developed include understanding cause/effect and attending to an extended task (levels 0 and 1), following directions (level 2), and responding to visual prompts (level 3). Other parameters that can be adjusted are reaction speed, penalty for inattention or inappropriate switch activation, length of reinforcement, release (reinforcement upon switch hit or release), and auditory feedback as reinforcement.

A color monitor, single switch with switch interface or a TouchWindow (see entry), plus an Echo speech synthesizer for Apple computers and Soundblaster for IBM computers are recommended. The IBM version requires Microsoft Windows.

---

**Product Name:** Circletime Tales & Circletime Tales Deluxe

**Vendor:** Don Johnston Incorporated

**Computer:** Apple Macintosh Family

**Cost:** \$95.00



Circletime Tales is an educational software program which teaches colors, clothing, directions, and counting to pre-readers. Designed for group or individual use, such stories as the Eensy Weensy Spider and Five Little Ducks are included with animation and sound. Activities can be played all the way through or certain parts may be repeated. Circletime Tales Deluxe is a CD-ROM version of the program with more animation and music and features Spanish and English.

Both programs sell for \$95.00 each. Programs can be accessed through a single switch, TouchWindow, Ke:nx (see entries), mouse, or the keyboard.

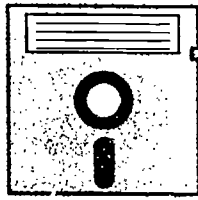

**Product Name:** Cognitive Disorders I, II, III, IV

**Vendor:** Parrot Software

**Computer:** Apple IIGS, Apple IIc, Apple IIe,  
IBM PC Family

**Manual Form:** Printed Manual

**Cost:** \$104.50 each

Cognitive Disorders is a series of four programs that provide training in various skills for clients with cognitive disorders. The first two programs include twenty lessons and an authoring system to allow clinicians to create up to ten additional lessons. The other programs allow clinicians to vary the difficulty of tasks. All programs include a tracking component that allow results to be stored and printed at any time.

Cognitive Disorders I, Category Naming and Completion, requires users to determine the category represented by a short list of words and to add a word to the list from another list of words. Cognitive Disorders II, Category Discrimination and Reasoning, has three-level problems requiring identification of a word that does not belong in a list, rationalization for the word's inappropriateness, and selection of an appropriate replacement word. Cognitive Disorders III, Attention/Perception, requires matching of a target shape to an identical shape in an adjoining group. Cognitive Disorders IV, Memory for Pictures, shows a picture and then requires the picture to be identified from a group of three pictures.

**Product Name:** Cognitive Rehabilitation Software

**Vendor:** Various (Generic Product)

**Cost:** Varies

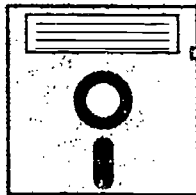

A variety of software packages are designed specifically for training persons with cognitive disabilities. A few of the functions this type of software may train are memory, independent living skills, and visual/perceptual skills. However, there are many mainstream software packages not specifically designed for cognitive rehabilitation which may also be effectively used to attain cognitive therapeutic goals. In choosing any software for this purpose, it is important to consider the specific cognitive disabilities of the individual in relation to the specific abilities of a software package.

A significant problem with software is the issue of cognitive access: the software may provide training in one type of cognitive skill, but may assume skill in another cognitive area that an individual does not possess. For example, a software program may provide training in memory skills but require substantial use of visual/perceptual abilities. However, in recent years this problem has been addressed by methods such as using voice prompts rather than requiring information to be read, and using touch screens rather than keyboards or mice as input devices.

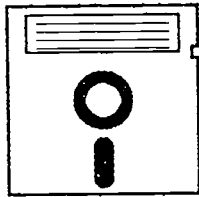

**Product Name:** Cogrehab Vol. 1

**Vendor:** Life Science Associates

**Computer:** IBM PC Family

**Manual Form:** Printed Manual

**Cost:** \$250.00

Cogrehab Vol. 1 is a memory and perceptual practice program with eight tasks addressing different skills in these areas. The tasks in Vol. 1 address: speed reading of word lists, reaction time to visual stimuli, speed of shape-matching, free memory recall, memory span capacity, mnemonic memory for word series, nonverbal sequence memory, and two administrative functions for keeping records and computing visual field information. Input is made via the keyboard.



**Product Name:** Cogrehab Vol. 2

**Vendor:** Life Science Associates

**Computer:** Apple II Family, TRS-80 Model I,  
TRS-80 Model III, TRS-80 Model IV

**Manual Form:** Printed Manual

**Cost:** \$150.00

Cogrehab Vol. 2 is a perceptual assessment and training program for visual perception and memory. The program consists of six tasks addressing skills in these areas, including: line bisection of horizontal and vertical lines, eye movement exercises with horizontal scanning, nonverbal shape matching, visual search for unusual shapes, and Single and Double Simultaneous Stimulation (SDSST). Input is made via the computer keyboard.



**Product Name:** Cogrehab Vol. 3 Version 2.0

**Vendor:** Life Science Associates

**Computer:** Apple II Family, TRS-80 Model I,  
TRS-80 Model III, TRS-80 Model IV

**Manual Form:** Printed Manual

**Cost:** \$175.00

Cogrehab Vol. 3 Version 2.0 is a memory training program designed particularly to supplement other therapy activities as homework. The program consists of five tasks, each addressing a different skill area, including: immediate memory recall, associative memory recall, recall of block patterns, advanced verbal memory exercise, and reading memory exercises. Record keeping and database capabilities are also included, as are foreign language word lists.

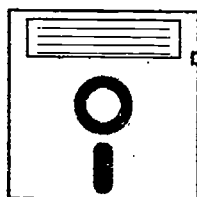

---

**Product Name:** Cogrehab Vol. 4

**Vendor:** Life Science Associates

**Computer:** Apple II Family, IBM PC Family

**Manual Form:** Printed Manual

**Cost:** \$95.00

Cogrehab Vol. 4 is a cognitive rehabilitation program which concentrates on three broad behavioral levels: attention, scanning, and problem solving. The program consists of three tasks, each of which addresses one of the areas of concentration, including: visual attention and vigilance, L/R and R/L scanning practice, and problem solving about logical sequences in number series. Input is made via the computer keyboard.

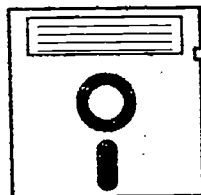

**Product Name:** Cogrehab Vol. 5

**Vendor:** Life Science Associates

**Computer:** Apple II Family, IBM PC Family

**Manual Form:** Printed Manual

**Cost:** \$200.00

Cogrehab Vol. 5, "Software for the Individual Emerging from Coma into Consciousness," includes 10 computer programs and a clinical guide to assist in evaluating and treating the cognitive aspects of response capability in the emerging coma patient. A hierarchy of "milestones," advancing from single discrete response to multi-switch response differentiation, guides the therapist in the choice of programs. With an interface (extra), responses can be recorded from any switch. The program makes frequent use of sound and bold displays. The programs may be customized. Automatic cumulation of scores enables analysis of performance changes across sessions.



**Product Name:** Cogrehab Vol. 6

**Vendor:** Life Science Associates

**Computer:** Apple II Family, IBM PC Family

**Manual Form:** Printed Manual

**Cost:** \$1,950.00

Cogrehab Vol. 6, "Driving Advisement System," is a series of computer programs for evaluating cognitive competence for safely operating a motor vehicle. The programs measure reaction time, perceptual motor tracking, decision making, and self-assessment of driving readiness. The Driving Advisement System includes software, steering and foot pedal modules, Input Adapter, and one-day training and application seminar.

607

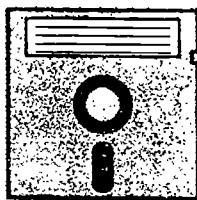

**Product Name:** Cogrehab Vol. 7: Quest

**Vendor:** Life Science Associates

**Computer:** Apple II Family, IBM PC Family

**Cost:** \$490.00

Cogrehab Vol. 7: Quest is a software program for providing training in language, memory, and associated cognitive and information processing problems. The program presents verbal stimuli which require a unique response in six categories: word finding (unscrambling letters to form a target word, typing the opposite to a given word), comprehension, retrieval/access to remote memory, abstract thinking (concept naming, choosing which word of four does not fall in the same category as the other three), logic (analogies), and quantification. A task builder/editor is also included.

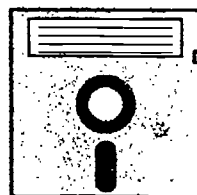

**Product Name:** COINSNKEYS

**Vendor:** Castle Special Computer Services, Inc.

**Computer:** Apple IIGS, Apple IIe, IBM PC Family,  
IBM PC jr

**Manual Form:** Printed Manual

**Cost:** \$50.00

COINSNKEYS is a coin recognition and counting practice program with voice prompt and output. Tasks in program include identifying real coins by spoken name, identifying real coins by spoken value, identifying the computer keys by name, practice counting one-to-one, and practice counting simulated coins and bills.

A speech synthesizer is required for voice output (not included with program). Program also includes instructions so that coins can be mounted on the keyboard. Price is for a single disk but a group pack of eight disks at \$16.00 each is also available. Contact manufacturer about obtaining personalized editions for individual student operation.





**Product Name:** Color Find

**Vendor:** Exceptional Children's Software, Inc.

**Computer:** Apple II Family

**Manual Form:** Printed Manual

**Cost:** \$19.95

Color Find is a color recognition and matching program for preschool children. The program presents large blocks of one of nine colors on the computer screen, and vocalizes instructions such as "press red." Color stickers corresponding to these colors are placed on the keyboard. The child is required to press the color key corresponding to the screen prompt color to be matched.

An Echo II Speech Synthesizer and color monitor for the Apple II are required for operation.



**Product Name:** Colorful Concept Software

**Vendor:** Attainment Company

**Computer:** Apple Macintosh Family

**Cost:** \$89.00

Colorful Concept Software is a Macintosh computer package designed to teach early learning skills including: number and word recognition, direction following, sequencing, cooperative learning, and attending. Each program includes "click 'n learn," "matching," and "you choose" options. The programs feature eye-catching visuals and human quality speech.

The software requires System 7, 256 colors, and 13" monitor. Programs are TouchWindow compatible.

**Product Name:** Colors and Shapes

**Vendor:** BEST, Inc.

**Computer:** IBM PC Family

**Cost:** \$125.00

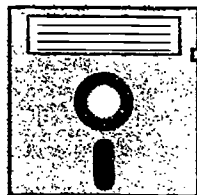

Colors and Shapes is a set of three disks designed to assess and teach cognitive and perceptual skills to developmentally impaired preschool age children. The programs revolve around colors and shapes. Once a color and shape discrimination is mastered, the teacher/therapist can focus on other perceptual and cognitive skills, such as figure-ground discrimination, object constancy, verbal association and problem-solving. The teacher/therapist can customize the program to match each child's skill level by controlling variables such as: input device, number of stimuli, complexity of stimuli, reward, response time and visual and/or auditory cuing.

Input to Colors and Shapes can be made with the BEST Switch Interface, PowerPad, Concept Keyboard or Unicorn Keyboard.

---

**Product Name:** Communication Training Program

**Vendor:** CSUS Assistive Device Center

**Cost:** \$41.65

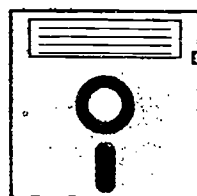

Communication Training Program presents scenarios which allow the user to interact as if in a real communication situation. Scenarios include going to a restaurant, buying a milkshake, and buying gasoline. User input generates a variety of computer responses creating new variations each time the interaction occurs.

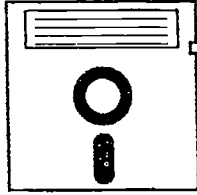

**Product Name:** Community Signs

**Vendor:** Conover Company

**Computer:** Apple II Family, IBM PC Family,  
IBM PS/2 Family

**Manual Form:** Printed Manual

**Cost:** \$289.00

Community Signs is an eight-disk microcomputer program that teaches signs which are essential for community living. The disks cover common information signs (e.g., "City Dump," "Coffee Shop," "Grocery Store," "Police Station"). The program is broken into an Instructional Segment, a Unit Review, and a Generalization Probe, and an Evaluation Segment where information is contained for each user on words attempted, words correct on the first try, and words correct on the second try.

An Apple II system with at least 64K of memory, one disk drive, and an appropriate speech synthesizer (see entries) are required. A color monitor, joystick, and printer may also be used with the program. An IBM version of the program requires 256K; network and hard drive loadable versions are also available. Community Signs includes eight disks, and administration manual, and six reproducible workbooks.

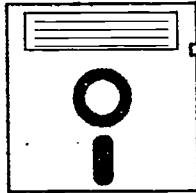

**Product Name:** Community Vehicles

**Vendor:** UCLA Microcomputer Project

**Computer:** Apple II+, Apple IIGS, Apple IIe,  
Apple Macintosh Family

**Cost:** \$35.00 - \$36.00

Community Vehicles is a computer program designed to teach children about various community vehicles. The program is for one to six players and has two levels. At Level 1, the child selects a vehicle associated with a community helper (fire engine, ambulance, school bus, police car, garbage truck). At Level 2, the child matches a vehicle to the community helper presented on the screen.

An Echo speech synthesizer, color monitor, and PowerPad are required for use on Apple II computers. For Macintosh use, the IntelliKeys Keyboard, overlay, and 5.25" disk drive are also required.



**Product Name:** Completion From Partial Information Plus for Windows

**Vendor:** Parrot Software

**Computer:** IBM PC Family

**Cost:** \$134.95

Completion From Partial Information Plus for Windows is software that teaches users to understand the whole from seeing a part of a language structure. The screen displays partial spellings of words in a category. After examining the partial information provided, the user is expected to type the whole word. The program requires Microsoft Windows.

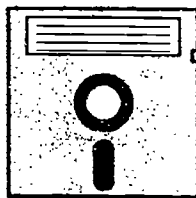

**Product Name:** Computer CUP

**Vendor:** Amidon Publications

**Computer:** Apple II+, Apple IIc, Apple IIe

**Manual Form:** Printed Manual

**Cost:** \$39.95 - \$229.50

Computer CUP (Concept Understanding Program) consists of six software sets on nine disks designed to teach basic concepts. Each set presents different concepts. Set 1 teaches top, through, away from, next to, inside, middle, farthest; Set 2 teaches around, over, between, nearest, corner, behind, row; Set 3 teaches center, side, below, right-left, forward, above, separated, in order; Set 4 teaches some/not many, few, widest, most, whole, second/third, several, almost; Set 5 teaches half, as many, not first or last, medium-sized, zero, every, pair, equal, least; Set 6 teaches different, after, beginning, other, alike, matches, always/never, skip. Presentations remain on the screen until a response is made. The keyboard is used for input.

Each set is \$39.95, and the complete series is \$229.50. Student performance sheets and a class record sheet are included.



**Product Name:** Computer Literacy Series

**Vendor:** Conover Company

**Computer:** IBM PC Family

**Cost:** \$1,198.95

The Computer Literacy Series consists of basic keyboarding skills software and program-specific computer literacy software augmented by live action videos. The basic keyboard skills portion consists of two typing tutors, typing drills, and typing games. The computer literacy series has programs dealing with MS-DOS, WordPerfect, Lotus 1-2-3, dBase, Windows, and computer viruses.

System requirements include 512K, a color monitor, hard drive, and one 5-1/4" or 3-1/2" disk drive. Price is for complete stand-alone series. The basic keyboarding portion can be purchased alone for \$225.00 and the computer literacy video/software series can be purchased for \$945.00. Network packages are also available.

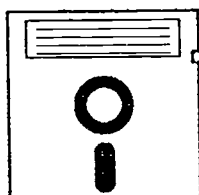

**Product Name:** CONCENTRATE! On Words & Concepts

**Vendor:** Laureate Learning Systems, Inc.

**Computer:** Apple IIGS, Apple II Family, Apple Macintosh Family, IBM PC Family

**Manual Form:** Printed Manual

**Cost:** \$95.00 - \$115.00 each

CONCENTRATE! On Words & Concepts is a series of educational games that reinforce the lessons of the Words & Concepts series (see entry) while developing short term memory skills. The games use the same vocabulary as their corresponding Words & Concepts programs. Students may play alone or with another player. The object of the game is to find matches based on vocabulary, categorization, word identification by function, or word association. During play, the computer provides auditory instruction and feedback. Interface options include TouchWindow (see entry), single switch, or keyboard. Scanning speed may be adjusted for single switch users.

The Apple version (\$95.00) requires an Apple II computer with 64K memory, a monitor, a speech synthesizer, and a 5.25" disk drive. The Apple IIGS version (\$115.00) requires one 3.5" disk drive and 1 MB of RAM. The IBM version (\$115.00) requires 640K of memory, a speech synthesizer, and a disk drive. A color monitor and TouchWindow are recommended. The Macintosh version (\$115.00) requires Macintosh LC or higher, System 7, hard drive, and 4 MB of RAM.

613



**Product Name:** Construc

**Vendor:** DEKRO, Inc.

**Computer:** IBM PC Family

**Cost:** \$59.00

Construc is a software program designed for individuals with head injuries stroke, or learning disabilities. The program's objectives are to recognize color within a pattern, copy a given pattern, train hand-eye coordination, and increase spatial perception skills. The computer generates a pattern which the student must copy. The level of difficulty is chosen by selecting the number of circles to form the pattern.



**Product Name:** Core Reading and Vocabulary Development

**Vendor:** Educational Activities, Inc.

**Computer:** Apple II Family,  
Apple Macintosh Family, IBM PC Family,  
IBM PS/2 Models 25/30, TRS-80 Model III,  
TRS-80 Model IV

**Manual Form:** Printed Manual

**Cost:** \$650.00 for set

Core Reading and Vocabulary Development is a language skills training program for reading levels of 1.0 to 3.0, intended for older children and adults. Students begin with 35 basic words and progress to over 200 through various activities. Tasks include reading, timed reading, question/answer, visual-memory development, spelling, writing, and problems that model and encourage thinking, vocabulary development, and phonetic patterns.

Price listed is for complete set of 18 disks, 18 back-up disks, 108 reproducible activity masters, and a teacher's guide.

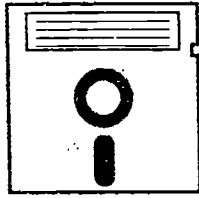

**Product Name:** Creature Antics and Creature Capers

**Vendor:** Laureate Learning Systems, Inc.

**Computer:** Apple IIGS, Apple II Family,  
Apple Macintosh Family, IBM PC Family

**Manual Form:** Printed Manual

**Cost:** \$65.00 - \$75.00 each

Creature Antics and Creature Capers are game programs designed to improve attention skills and teach cause and effect, turn-taking, and switch use. Users activate a single switch, TouchWindow (see entry), or the space bar to make "creatures" perform animated routines with accompanying sounds. Additional activations cause the routine to continue. Encoded speech is used throughout the programs. Each program uses a different set of creatures and animated routines.

Creature Antics and Creature Capers are compatible with Apple II and IBM computers. The Apple version of the programs are \$65.00 each and require 64K of memory, a speech synthesizer, and a disk drive. IBM versions of the programs are \$75.00 each and require 640K of memory, a speech synthesizer, and a disk drive. A color monitor and TouchWindow or a single switch are recommended. The Macintosh version of the programs are \$75.00 each and require Macintosh LC or higher, System 7, hard drive, and 4 MB of RAM.



**Product Name:** Creature Cartoons

**Vendor:** Laureate Learning Systems, Inc.

**Computer:** Apple Macintosh Family

**Cost:** \$75.00

Creature Cartoons is a program with five animated games designed to teach cause and effect and turn-taking skills. The program can be used with the keyboard, touch screen, single switch, or mouse.

The program requires a Macintosh LC or higher, system 7 software, hard drive, and 4 MB of RAM.

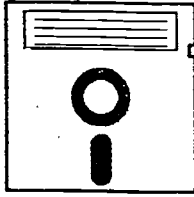

**Product Name:** Creature Chorus

**Vendor:** Laureate Learning Systems, Inc.

**Computer:** Apple IIGS, Apple II Family,  
IBM PC Family

**Manual Form:** Printed Manual

**Cost:** \$85.00 - \$95.00

Creature Chorus is a set of six games for use with the TouchWindow (see entry) and six games for use with a single switch or the space bar. Eight animated characters introduce the concepts of cause and effect, switch use, visual tracking, discrete pointing, and turn taking. Games range from very basic to challenging. An example of the single switch games is "Songfest," where creatures appear one at a time when a switch or the TouchWindow is activated. Once all the creatures are present, each switch activation causes them to perform a dance that continues until the next switch activation. A new arrangement is then created and repeated. An example of the TouchWindow games is "Shrinker," which uses an animated creature and a series of shrinking boxes to train pointing to a discrete area on the TouchWindow.

Creature Chorus is compatible with an Apple II computer and is \$85.00. The Apple IIGS versions and IBM versions of the program are \$95.00. A color monitor and TouchWindow or a single switch are recommended.

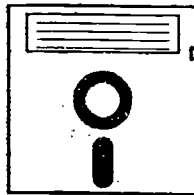

**Product Name:** Creature Features

**Vendor:** Laureate Learning Systems, Inc.

**Computer:** Apple IIGS, Apple IIe,  
Apple Macintosh Family, IBM PC Family

**Cost:** \$65.00 - \$75.00

Creature Features is an educational software program designed to teach the user cause and effect concepts and switch use. The user is given a group of graphic "creatures" and then asked to select one of them. Selection is made by using a switch. When the switch is activated the creature performs various animated routines in response to the switch use. The program also provides computer use practice.

The Apple IIGS version (\$65.00) requires 512K of memory, and a 5.25" disk drive. The IBM version (\$75.00) requires 640K of memory, a speech synthesizer, and a 3.5" disk drive. The IIe version (\$65.00) requires 64K memory, a monitor, a speech synthesizer, and a 5.25" disk drive. The Macintosh version (\$75.00) requires Macintosh LC or higher, System 7, hard drive, and 4 MB of RAM.



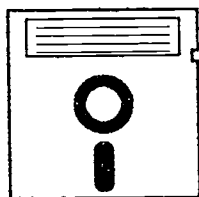

**Product Name:** Creature Magic

**Vendor:** Laureate Learning Systems, Inc.

**Computer:** Apple IIGS, Apple IIe,  
Apple Macintosh Family, IBM PC Family

**Cost:** \$65.00 - \$75.00

Creature Magic is a software program with four games designed to introduce language and cognitive concepts through animated routines. Concepts covered include non-existence, difference between objects, prepositions "in" and "on", and the importance of word order in simple sentences. The program can be used with the keyboard, touch screen, single switch, or mouse.

System requirements for the IBM version (\$75.00) include one 3-1/2" disk drive, hard drive, MCGA or VGA graphics, 640K of RAM, and a speech synthesizer. The Apple IIe version (\$65.00) requires one 5-1/4" disk drive, 64K of RAM, and an Echo II speech synthesizer. The Apple IIGS version (\$75.00) requires one 5-1/4" disk drive and 512K of RAM. The Macintosh version (\$75.00) requires Macintosh LC or higher, System 7, hard drive, and 4 MB of RAM.



**Product Name:** CrossWords

**Vendor:** Marblesoft

**Computer:** Apple IIGS

**Cost:** \$50.00 - \$100.00

CrossWords is a software program that can be used to create and run educational crossword puzzles, word search puzzles, spelling tests, and jumbled word puzzles. The program includes a text editor, which can be used to generate word lists or select words from existing lists. The crossword and word search puzzles may be displayed in three different sizes and all puzzles may be printed. Sound output discriminates, via pitch, between correct and incorrect answers; musical reinforcement is available as an option. A record keeping and reporting system is also included. A Special Access version includes support for the Echo, Cricket, or DoubleTalk speech synthesizer, compatibility with the TouchWindow, and a single-switch input feature. A demo training program is included.

CrossWords is \$50.00 for the standard version or \$75.00 for the Special Access version (both on 5.25" disks). CrossWords 3.5, which contains both versions on a single 3.5" disk, is \$100.00.



**Product Name:** Data Entry

**Vendor:** Attainment Company

**Computer:** Apple II Family, IBM PC Family

**Cost:** \$295.00

Data Entry is a program for training students to perform data entry tasks. Printed sheets with account numbers are provided; the student types the account number into the computer. At Level One, the student then enters "A" or "B" depending on the information on the sheet. At Level Two, the student enters "A," "B," and a dollar amount. At Level Three, the student is also required to proofread the screen for errors.

An Apple II or IBM compatible computer, one disk drive, and a monitor are required to use Data Entry; a printer is optional. A file box for storing account sheets, a technical manual, and a teacher's guide are also included.

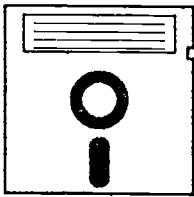

**Product Name:** Deductive Reasoning Plus for Windows

**Vendor:** Parrot Software

**Computer:** IBM PC Family

**Cost:** \$134.95

Deductive Reasoning Plus for Windows is a cognitive retraining program designed to facilitate reasoning skills in relatively high level cognitively impaired individuals. Each lesson consists of ten problems which each have a set of rules which describe a class of words. The user is then presented with words and asked to determine whether each is a member of the class or not. After four words are presented, the user is asked to identify the class. The program uses large, clear letters and large response buttons. Progress is saved and may be displayed or printed. Ten lessons are provided and the clinician can create additional, custom lessons. The program requires Microsoft Windows.

The program can be accessed with the keyboard, mouse, or a touch screen.

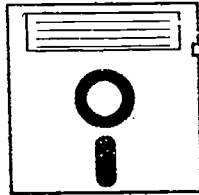

**Product Name:** Definitions Plus for Windows

**Vendor:** Parrot Software

**Computer:** IBM PC Family

**Cost:** \$134.95

Definitions Plus for Windows is a software program that lists a word at the top of the screen and asks the user to select the most appropriate definition from a list of three definitions displayed. The task is varied by using foil definitions that describe words semantically related to the word listed at the top of the screen. The vocabulary and categories can be adapted. The program works with Microsoft Windows.



**Product Name:** Dino-Games

**Vendor:** Academic Software, Inc.

**Computer:** Apple Macintosh Family, IBM PC Family

**Manual Form:** Printed Manual

**Cost:** \$25.00 each

Dino-Games is a series of four single-switch software programs designed primarily for children and youth. Each game works with SS-ACCESS!, Best Switch Interface, PowerPad, Intellikeys, alternate keyboards, and other input devices for the PC. Dino-Games require VGA graphics and a serial port.

DINO-DOTS is a collection of dot-to-dot games that teach number concepts, counting, sequencing skills, and spatial perception. DINO-FIND is a game of concentration that stimulates memory and pattern recognition and provides scanning practice. DINO-MAZE provides a series of motivating exercises where dinosaur characters move through mazes to reach goals. DINO-LIKE is a matching game which uses color, shape, and orientation of dinosaurs to enhance pattern matching skills.

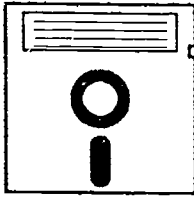

**Product Name:** Dinosaur Game  
**Vendor:** UCLA Microcomputer Project  
**Computer:** Apple IIe  
**Manual Form:** Printed Manual  
**Cost:** \$35.00

The Dinosaur Game is an educational game program for one to four players. The program uses color graphics and synthesized speech to help promote independence, turn-taking, sharing, and rule-following. The game is also designed to help with other skills such as sequencing and color identification. The players operate the game using a single switch. The instructor must load the disk and start the game; after that the students can play independently. The Dinosaur Game provides verbal instructions to the player on how and when to play.

The Dinosaur Game requires a color monitor, an Echo II speech synthesizer (see entry), and an adaptor for plugging switches into the computer's game port. The manufacturer designates this program for the three to five age range.

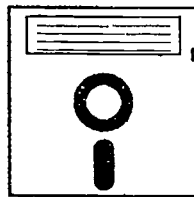

**Product Name:** Dollars & Cents Series  
**Vendor:** Attainment Company  
**Computer:** Apple Macintosh Family  
**Cost:** \$159.00

The Dollars & Cents Series is a software package designed to teach the value of a dollar. The series consists of three programs: First Money, Spending Money, and Making Change. All three programs feature human-quality speech, colorful graphics, a Canadian currency option, and TouchWindow compatibility. First Money is an introductory program for non-readers. Spending Money simulates buying items like a sweater or a soft drink. The user selects correct combinations of bills and coins and learns to comparison shop. Making Change is the advanced program and requires the user to enter purchases and give change back like a store clerk.

The package includes a paper Hands-On Money kit. Individual programs are also available for \$59.00 each. Site license software is available for \$529.00.

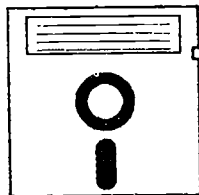

**Product Name:** Early and Advanced Switch Games

**Vendor:** R.J. Cooper & Associates

**Computer:** Apple II Family,  
Apple Macintosh Family, IBM PC Family

**Manual Form:** Electronic Manual, Printed Manual

**Cost:** \$75.00 - \$89.00

Early and Advanced Switch Games is a thirteen-game disk designed to provide training in use of single switches. The games progress incrementally from cause/effect tasks through timing and manipulation exercises to matching/selection exercises. Examples of games included are Noises, which provides instant positive reinforcement on switch activation; Build-A-Scene, which adds a part of a picture every time the switch is pressed; and an Advanced set of games that require counting, matching, and manipulation. User name, reaction speed, and type of scanning can be selected and saved.

A color monitor, single switch with switch interface, and Echo speech synthesizer are recommended for use with these games. The IBM version requires Microsoft Windows.

---

**Product Name:** Early Concepts

**Vendor:** UCLA Microcomputer Project

**Computer:** Apple II+, Apple IIGS, Apple IIe,  
Apple Macintosh Family

**Cost:** \$35.00



Early Concepts is a single-switch educational software program. Two concepts are taught: what is missing, and matching objects. One to four players may participate. The scanning speed (time that the cursor remains on a selection waiting for a player to press the switch) may be adjusted.

An Echo speech synthesizer, color monitor, and single switch are required for Apple II compatibility; for Macintosh computers, an Apple IIe emulation card and a 5.25" disk drive are also needed. A TouchWindow version is available for Apple computers.

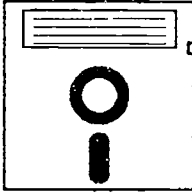

**Product Name:** Early Emerging Rules Series

**Vendor:** Laureate Learning Systems, Inc.

**Computer:** Apple IIGS, Apple IIe,  
Apple Macintosh Family, IBM PC Family

**Manual Form:** Printed Manual

**Cost:** \$150.00 - \$175.00

Early Emerging Rules Series is a set of three software programs that introduce early grammatical constructions using speech, pictures, and animated characters. The series is intended as a follow-up to the vocabulary training provided by First Words, First Words II, and First Verbs (see entries). Six instructional levels each include a game, four levels of training, and a test option. Students are presented pictures and asked to select the picture which represents the construction being trained. Various amounts of instruction, cuing, and feedback are provided on each training level.

The three programs are: Negation, which trains the determiner "No"; Plurals, which trains regular noun plurals; and Prepositions, which trains the prepositions "in" and "on." An Apple IIe computer with 64K of memory, a monitor, a speech synthesizer, and a 5.25" disk drive are required. A color monitor, TouchWindow (see entry), and printer are recommended. Apple IIGs, IBM, and Macintosh versions are also available.

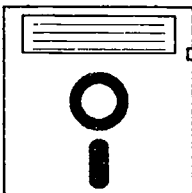

**Product Name:** Early Learning 3.5/Complete Early Learning 5.25

**Vendor:** Marblesoft

**Computer:** Apple IIGS, Apple IIc, Apple IIe,  
Apple Macintosh Family

**Manual Form:** Printed Manual

**Cost:** \$165.00 - \$200.00

Early Learning 3.5 is a set of 18 educational programs and a record-keeping system sold on a single 3.5" or 5.25" disk. All programs support input from a keyboard, hand controls, Power Pad, Touch Window, IntelliKeys, and switches.

Programs included are: Matching Colors, Learning Shapes, Counting Numbers, and Letter Match; Sorting Fun, Count the Shapes, Match the Shapes, and What Comes Next; Coins and Bills, Counting Money, and Making Change; Early Addition I and II, Sequencing Up, and Sequencing Down; and Early Subtraction I and II and More Than/Less Than. The programs require a 128K Enhanced Apple computer. Some programs require a color monitor. An Echo or Double Talk speech synthesizer may be used to provide speech output. The Macintosh version requires a Macintosh LC with a IIe emulator card. All Early Learning programs are also available separately; contact manufacturer for details. Early Learning 3.5 is \$165.00 for the 3.5" disk version (\$25.00 for additional backup copies). Complete Early Learning, which is the same set of programs on 5.25" disks, is \$200.00 (\$5.00 for additional backup copies).

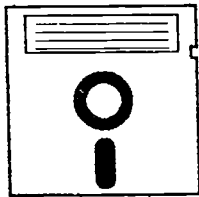

**Product Name:** Early Learning I

**Vendor:** Marblesoft

**Computer:** Apple IIGS, Apple IIc, Apple IIe,  
Apple Macintosh Family

**Manual Form:** Printed Manual

**Cost:** \$75.00

Early Learning I is a program for teaching recognition of colors, shapes, numbers, and letters. The four lessons included are: Matching Colors, Learning Shapes, Counting Numbers, and Letter Match. All have the option of being controlled with: a single switch, joystick, IntelliKeys, keyboard, paddles, PowerPad, or Edmark's Touch Window. The program may be set to ask for a yes or no response with no as default value. A speech synthesizer responds with correction and reinforcement. A record-keeping program is also included.

An Echo or Double Talk speech synthesizer and an enhanced 128K Apple are required to run Early Learning I. The Macintosh version requires a Macintosh LC with IIe emulator card. For the Matching Colors lesson a color monitor is required. Overlays are included for marking or color-coding the keys the student needs to depress; specify model of computer when ordering. Hand Controls (see entry) can be purchased for the switch option. Extra backup copies of the program are available (extra). PowerPad and IntelliKeys overlays can be purchased.

---

**Product Name:** Edmark Functional Word Series

**Vendor:** Edmark Corporation

**Computer:** Apple II Family

**Cost:** \$829.00

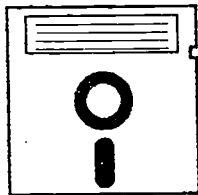

Edmark Functional Word Series consists of four modules that teach real-life vocabulary to youths and adults with few or no reading skills. Up to 400 words for shopping, working, eating out, and reading important signs are taught through short steps and multiple repetitions. Each lesson allows the user to learn a new sight word, practice sight recognition, reinforce that recognition and associate the word with its meaning through the use of illustrations. Graphics and human-quality speech are used to encourage students.

Price is for the complete set in computer and print format together. The complete set is available without the print format for \$649.00 and each module is available individually for \$229.00 with print and \$179.00 without print.

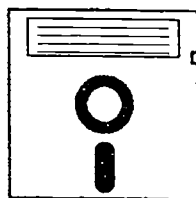

**Product Name:** Eency-Weency Spider Game  
**Vendor:** UCLA Microcomputer Project  
**Computer:** Apple II+, Apple II GS, Apple IIe  
**Cost:** \$35.00

Eency-Weency Spider Game is a single switch training program for one to four players. The players move the spider up the drain spout to win. The scanner randomly selects the sun (which moves the spider up one space) or rain clouds (which moves the spider down one space).

An Echo speech synthesizer, color monitor, and single switch are required.

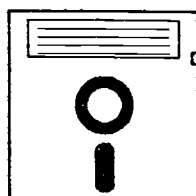

**Product Name:** Elementary Signer  
**Vendor:** E & IS SignWare  
**Computer:** Apple II Family,  
Apple Macintosh Family, IBM PC Family  
**Manual Form:** Printed Manual  
**Cost:** \$79.95 - \$99.95

Elementary Signer is designed to introduce elementary school age students to ASL Sign Language. Words selected by the student are translated into the equivalent ASL signs and displayed on the screen in computer animation. The 160 word vocabulary allows students to converse in simple sentences. Signs can be displayed with or without captions. Motions of the signs can be slowed down, sped up, frozen, or repeated. Learning Comprehension mode tests knowledge of signs and keeps score.

The program is \$79.95 for the silent version and \$99.95 for the talking version (talking version only for the Apple). A graphics adaptor is required for the IBM version. Two disk drives are required for the Apple version.



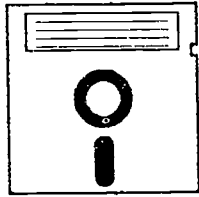

**Product Name:** Employment Signs

**Vendor:** Conover Company

**Computer:** Apple II Family, IBM PC Family,  
IBM PS/2 Family

**Manual Form:** Printed Manual

**Cost:** \$209.00

Employment Signs is a four-disk microcomputer program that teaches 40 signs which are essential in employment settings. The disks cover ten common information signs (e.g., "Apply Here," "Employee Lounge") and 30 common safety signs (e.g., "Caution Do Not Enter," "Eye Wash Fountain," "No Smoking"). The program is broken into an Instructional Segment, a Unit Review, and a Generalization Probe, and an Evaluation Segment where information is contained for each user on words attempted, words correct on the first try, and words correct on the second try.

Employment Signs includes four disks, an administration manual, and six workbooks. An Apple II system with at least 64K of memory, one disk drive, and an appropriate speech synthesizer are required; IBM versions require 256K; network and hard drive loadable versions are also available. A color monitor, joystick, and printer may also be used with the program.

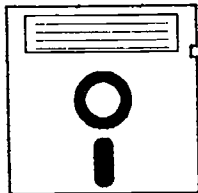

**Product Name:** English on the Job

**Vendor:** Conover Company

**Computer:** Apple II Family

**Cost:** \$59.95 - 1,695.00

English on the Job is a vocational exploration and assessment program. A series of activities show the relationship between basic English language skills and occupations. Students are given the opportunity to explore careers, practice language skills related to particular jobs, and access remedial information related to communication skills. This series helps students make the school-to-work adjustment by developing an understanding of the importance of basic English skills in areas of occupational interest.

English on the Job is available in printed and computer disk form. The complete computer system (\$1,695.00) includes 33 disks, 31 student guides, a management system, and teacher's guide. Individual career area disks are available for \$59.95 each. The computer version of English on the Job is compatible with Apple II system and IBM computers; network and hard drive loadable versions are also available.

025

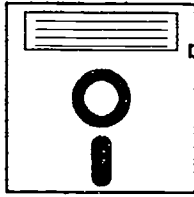

**Product Name:** Every Day Is A Holiday  
**Vendor:** UCLA Microcomputer Project  
**Computer:** Apple Macintosh Family  
**Cost:** \$45.00

Every Day is a Holiday is a set of two software programs designed for use with the TouchWindow, trackball, or mouse. The programs explore major holidays of the year divided into seasons. Holiday scenes or cards can be printed out. The Winter & Spring disk features Hanukkah, Christmas, Valentine's Day, birthdays, and Easter. The Summer & Fall disk features July 4th, Halloween, and Thanksgiving.

A color monitor is required.

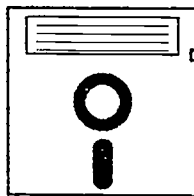

**Product Name:** Exploring Early Vocabulary Series  
**Vendor:** Laureate Learning Systems, Inc.  
**Computer:** Apple IIGS, Apple IIe,  
 Apple Macintosh Family, IBM PC Family  
**Cost:** \$90.00 - \$100.00

The Exploring Early Vocabulary Series consists of three programs designed to encourage users to explore and interact with vocabulary items in natural settings. Exploring First Verbs requires the user to select an object and then uses the verb in a sentence and shows its verb action. Exploring First Words I & II requires the user to select an object and then the object is animated and its name spoken. Other activities designed to expand vocabulary knowledge, enhance word identification in context, strengthen word relationships, and introduce the concept of categorization are also included. The programs can be used with the keyboard, touch screen, single switch, or mouse.

The Apple IIe versions (\$90.00) require one 5-1/4" disk drive, 64K of RAM, and an Echo II speech synthesizer. The Apple IIGS versions (\$100.00) require one 3-1/2" disk drive and 1 MB of RAM. The IBM versions (\$100.00) require one 3-1/2" disk drive, hard drive, MCGA or VGA graphics, 640K of RAM, and a speech synthesizer. The Macintosh versions (\$100.00) require Macintosh LC or higher, system 7 software, hard drive, and 4 MB of RAM.

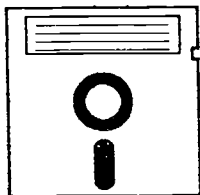

**Product Name:** Family Fun

**Vendor:** UCLA Microcomputer Project

**Computer:** Apple II+, Apple IIGS, Apple IIe,  
Apple Macintosh Family

**Cost:** \$35.00

Family Fun can be used to teach cause and effect and basic vocabulary. A group of 16 familiar objects or people found in the home are presented. As an object is touched on the PowerPad or IntelliKeys, the object appears on the monitor and the speech synthesizer reinforces the association by naming that object or person.

The program requires PowerPad, speech synthesizer, and overlay for Apple computers; for Macintosh computers, the IntelliKeys Keyboard, speech synthesizer, overlay, Apple IIe emulation card, and 5.25" disk drive are needed.



**Product Name:** Fast Food Game

**Vendor:** UCLA Microcomputer Project

**Computer:** Apple II+, Apple IIGS, Apple IIe,  
Apple Macintosh Family

**Cost:** \$35.00

Fast Food Game is a computer scanning program designed to provide practice in single switch use. Players move around an on-screen board by selecting "fast food" items. If a "sick face" is selected, the player loses her next turn.

A speech synthesizer, single switch, and color monitor are required; also an Apple IIe emulation card is needed for the Macintosh version.

027

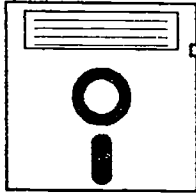

**Product Name:** Feelings

**Vendor:** UCLA Microcomputer Project

**Computer:** Apple II+, Apple IIGS, Apple IIe,  
Apple Macintosh Family

**Cost:** \$35.00

Feelings is an educational software program. Six feelings (happy, mad, sad, scared, love, tired) are depicted on a PowerPad overlay. The program has three levels: Level 1 describes each emotion, Level 2 requires the user to associate an emotion with an action, Level 3 requires the user to choose a picture to describe feelings.

A speech synthesizer, color monitor, and PowerPad are required; for the Macintosh, an Apple IIe emulation card and IntelliKeys are also needed.

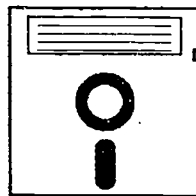

**Product Name:** Find the Buttons

**Vendor:** R.J. Cooper & Associates

**Computer:** Apple Macintosh Family, IBM PC Family

**Cost:** \$89.00

Find the Buttons is designed to teach blind children about graphical user interfaces (GUI). There are 10 buttons that can be sized and moved. As the user passes over one, a customized indicator sound is heard. When the user is in the areas with no buttons another sound is heard. Auditory feedback always indicates the movements of the mouse.

The IBM version requires Microsoft Windows.

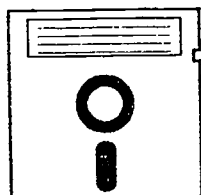

**Product Name:** Fingerspeller

**Vendor:** E & IS SignWare

**Computer:** Apple II Family,  
Apple Macintosh Family, IBM PC Family

**Manual Form:** Printed Manual

**Cost:** \$39.95 - \$49.95

Fingerspeller is a program that teaches ASL fingerspelling. The program displays line graphics of a hand forming the shape of an ASL letter. Letters on the computer screen are seen from the same perspective as viewing a human signer would give. Individual letters or words of up to 30 letters can be displayed at four user-selected speeds. Words can be captioned or non-captioned. A Learning Comprehension mode allows the user to test himself from a pre-programmed list of words stored on the disk or to create his own list of words. The program keeps score of these tests.

The silent version of the program is \$39.95; the talking version (available for the Apple only) is \$49.95. A Spanish version is available for the Apple. A graphics adapter is required to run the IBM version.



**Product Name:** Fingerspelling & Numbers

**Vendor:** Kopptronix Company

**Computer:** IBM PC Family

**Cost:** \$89.00

Fingerspelling & Numbers is a software program designed to teach basic fingerspelling, improve comprehension, and increase signing speed. Features include life-like photographs, moving animation of hands, a custom vocabulary, and control of the signing speed. The program is compatible with Microsoft Windows.



**Product Name:** FingerZoids

**Vendor:** E & IS SignWare

**Computer:** Apple Macintosh Family

**Manual Form:** Printed Manual

**Cost:** \$49.95

Fingerzoids is an arcade-type interactive game that teaches the American Sign Language (ASL) fingerspelling alphabet. Alien invaders in the shape of letters from the ASL alphabet descend from the top of the screen. The player shoots them down by pressing the corresponding English letter key. The program keeps score and posts high scores. Available for the Macintosh computer only.

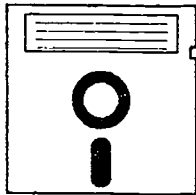

**Product Name:** First Categories

**Vendor:** Laureate Learning Systems, Inc.

**Computer:** Apple II Family,  
Apple Macintosh Family, IBM PC Family,  
IBM PS/2 Family

**Manual Form:** Printed Manual

**Cost:** \$200.00 - \$225.00

First Categories is a program that trains categorization skills by using voice output and pictures of 60 nouns in six categories. Activities offer training by inclusion or exclusion, with or without cuing. Students are presented either two or three pictures (with optional speech and/or text) and asked to select the picture which represents a correct answer. Lesson summaries and test performances may be viewed on-screen or printed; records can be saved to disk in the Apple IIGS and IBM versions. Interface options include TouchWindow (see entry), single switch (must be keyboard emulating for use with IBM version), and game controller; a mouse option is available for IBM and Apple IIGS versions.

The Apple II version (\$200.00) requires 64K memory, a monitor, a speech synthesizer, and a 5.25" disk drive. The Apple IIGS version (\$225.00) requires 512K memory, ROM version 01 or later, RGB monitor, and a 3.5" disk drive. The IBM version (\$225.00) requires 640K memory, DOS 3.3 or higher, VGA or MCGA graphics, DigiSpeech synthesizer, and a 3.5" disk drive. The Macintosh version (\$225.00) requires Macintosh LC or higher, System 7, hard drive, and 4 MB of RAM.

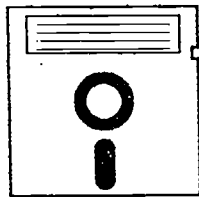

**Product Name:** First Mate  
**Vendor:** BrainTrain  
**Computer:** Apple II Family  
**Cost:** \$149.00 - \$375.00

First Mate is a software package for developing and training perceptual skills. Three modules are available: Attention Skills, Visual/Motor Skills, and Conceptual Skills. Attention Skills focuses on color discrimination/inhibition, scanning reaction/inhibition, scanning reaction time, and stimulus reaction/inhibition. Visual/Motor Skills focuses on spatial orientation, visual tracking and discrimination, visual tracking and inhibition, and visuospatial memory. Conceptual Skills focuses on pattern matching, numeric skills, symbolic matching, and number and letter sequencing. Scores can be printed out. Task difficulty is adjustable for each program. The programs can be used in assessment mode or training mode. First Mate can be controlled with the standard keyboard or with a joystick.

The three individual modules can be purchased separately for \$149.00 each or all three are \$375.00. Lab Packs are also available at \$295.00 for each set of the three programs or \$129.00 for each copy of a single program.

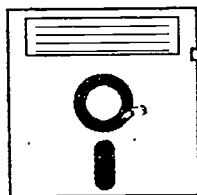

**Product Name:** First Step Software  
**Vendor:** Attainment Company  
**Computer:** Apple II Family  
**Cost:** \$289.00

First Step Software is a series of Apple II talking programs designed to teach everyday skills with pictures that talk. Getting Dressed is a basic dressing and vocabulary program that teaches clothing names, dressing sequences, and how to select appropriate items for different occasions. Head to Toe is a body awareness program that teaches identification of parts of the body and basic anatomical vocabulary. Room by Room is a household vocabulary program that teaches essential words for items around the home. Street by Street is a community vocabulary and awareness program that visits six typical neighborhoods and teaches words and signs.

Program requirements include 128K and an Echo Speech Processor. The software is TouchWindow compatible and is available in 5.25" or 3.5" disks. Price is for the complete series; each program is also available individually for \$59.00.

031



**Product Name:** First Verbs and Primeros Verbos

**Vendor:** Laureate Learning Systems, Inc.

**Computer:** Apple IIGS, Apple II Family,  
Apple Macintosh Family, IBM PC Family

**Manual Form:** Printed Manual

**Cost:** \$200.00 - \$225.00

First Verbs and its Spanish version, Primeros Verbos (not available for Apple IIGS or IBM), are programs that train and test 40 basic verbs using animated pictures and voice output. Each verb is represented by two pictures. Six instructional levels progress from identification of a single picture with instruction and cuing through discrimination between two different pictures with no instructions. Interface options include TouchWindow (see entry), single switch (must be keyboard emulating for IBM), keyboard, Left/Right Rocker Switch (see entry) and game controller. A mouse option is available for IBM, Macintosh, and Apple IIGS.

The Apple II version (\$200.00) requires 48K memory, a monitor, a speech synthesizer, and a 5.25" disk drive. The Apple IIGS version (\$225.00) requires 512K memory, ROM version 01 or later, RGB monitor, and a 3.5" disk drive. The IBM version (\$225.00) requires 640K memory, DOS 3.3 or higher, VGA or MCGA graphics, DigiSpeech synthesizer, and a 3.5" disk drive. The Macintosh version (\$225.00) requires Macintosh LC or higher, System 7, hard drive, and 4 MB of RAM.

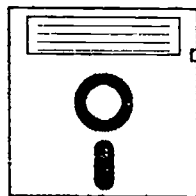

**Product Name:** First Words

**Vendor:** Laureate Learning Systems, Inc.

**Computer:** Apple IIGS, Apple II Family,  
Apple Macintosh Family, IBM PC Family

**Manual Form:** Printed Manual

**Cost:** \$200.00 - \$225.00

First Words is a program that trains and tests 50 basic nouns presented within 10 categories, using speech output. Each noun is represented by two different pictures. Six instructional levels progress from identification of a single picture with instruction and cuing through discrimination between two different pictures with no instructional support. Interface options include TouchWindow (see entry), single switch (must be keyboard emulating for use with IBM version), keyboard, Left/Right Rocker Switch (see entry) and game controller; a mouse option is available for IBM, Macintosh, and Apple IIGS versions.

The Apple II version (\$200.00) requires 48K memory, a monitor, a speech synthesizer, and a 5.25" disk drive. The Apple IIGS version (\$225.00) requires 512K memory, ROM version 01 or later, RGB monitor, and a 3.5" disk drive. The IBM version (\$225.00) requires 640K memory, DOS 3.3 or higher, VGA or MCGA graphics, DigiSpeech synthesizer, and a 3.5" disk drive. The Macintosh version (\$225.00) requires Macintosh LC or higher, System 7, hard drive, and 4 MB of RAM.





**Product Name:** First Words II

**Vendor:** Laureate Learning Systems, Inc.

**Computer:** Apple IIGS, Apple II Family,  
Apple Macintosh Family, IBM PC Family

**Manual Form:** Printed Manual

**Cost:** \$200.00 - \$225.00

First Words II is a program that follows the format and continues the training and testing of First Words (see entry) with 50 additional basic nouns presented within the same 10 categories used by First Words. A different animated creature accompanies the new vocabulary words. Interface options include TouchWindow (see entry), single switch (must be keyboard emulating for use with IBM version), keyboard, Left/Right Rocker Switch (see entry) and game controller; a mouse option is available for IBM, Macintosh, and Apple IIGS versions.

The Apple II version (\$200.00) requires 48K memory, a monitor, a speech synthesizer, and a 5.25" disk drive. The Apple IIGS version (\$225.00) requires 512K memory, ROM version 01 or later, RGB monitor, and a 3.5" disk drive. The IBM version (\$225.00) requires 640K memory, DOS 3.3 or higher, VGA or MCGA graphics, DigiSpeech synthesizer, and a 3.5" disk drive. The Macintosh version (\$225.00) requires Macintosh LC or higher, System 7, hard drive, and 4 MB of RAM.



**Product Name:** Following Directions: One- and  
Two-Level Commands

**Vendor:** Laureate Learning Systems, Inc.

**Computer:** Apple II Family

**Manual Form:** Printed Manual

**Cost:** \$235.00

Following Directions: One- and Two-Level Commands is a two-disk program that provides practice in following one and two step directions and using short term memory while teaching spatial relations and directional terms. Speech output directs the students to move animated characters to particular positions relative to the objects on the screen. Multiple levels present the exercises in progressively more difficult steps. A delay feature between auditory and visual stimuli may be used to further challenge short term memory. Scan speed, response time, and criterion for ending the lesson are adjustable. A lesson summary and test performance results may be viewed on-screen or printed.

Following Directions requires an Apple II computer with 64K memory, a monitor, a speech synthesizer, and a 5.25" disk drive. A color monitor, TouchWindow (see entry), and printer are recommended. Interface options include TouchWindow, a single switch, the keyboard, or a game controller.

033

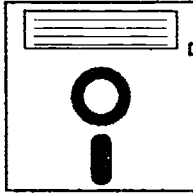

**Product Name:** Following Directions: Left and Right

**Vendor:** Laureate Learning Systems, Inc.

**Computer:** Apple II Family

**Manual Form:** Printed Manual

**Cost:** \$165.00

Following Directions: Left and Right provides practice in following directions and use of short term memory while reinforcing left/right discrimination concepts. In ten activities of increasing difficulty, students are asked to move objects to particular positions on the screen using the commands "left" and "right." Speech output, animated characters, and animated drawings of hands and objects are used throughout the program. Scan speed, response time, and criterion for ending the lesson may be adjusted. Lesson summaries and test performance results may be viewed on-screen or printed.

Following Directions: Left and Right requires an Apple II computer with 64K of memory, a monitor, a speech synthesizer, and a 5.25" disk drive. A color monitor, TouchWindow (see entry), and printer are recommended. Interface options include TouchWindow, a single switch, the keyboard, a game controller, or Left/Right Rocker Switch (see entry).

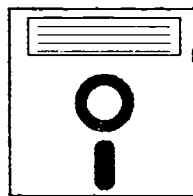

**Product Name:** Food Facts

**Vendor:** American Printing House for the Blind (APH)

**Computer:** Apple II Family

**Manual Form:** Braille/Tactile Manual, Large Print Manual, Printed Manual

**Cost:** \$30.00

Food Facts is an interactive software program created by Minnesota Educational Computing Corporation (MECC) and speech-adapted by APH. The program is designed to teach about the nutritional properties of foods. Topics include: vitamins, recommended daily allowances or nutrients, sugar content of foods, and more. Food Facts is designed for use by junior high to adult students.

System requirements include a 5.25" disk drive and at least 64K RAM.

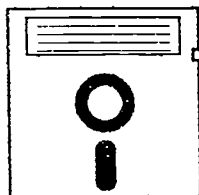

**Product Name:** Foundations I

**Vendor:** Psychological Software Services, Inc.

**Computer:** IBM PC Family

**Manual Form:** Printed Manual

**Cost:** \$360.00

Foundations I is a series of seven types of visual and auditory reaction training programs. Simple Visual Reaction Time I-II records reaction time to a square presented randomly in time and place. Visual Reaction Stimulus Discrimination I-II records reaction to the choice of a colored square presented at random intervals. Visual Reaction Differential Response records right or left reaction to a square presented on either side of a vertical line. Visual Reaction Auditory Prestimulus operates like Simple Visual Reaction, but includes a tone prior to the square, to signal or inhibit response. Simple Auditory Reaction measures response time to a tone. Visual Scanning records accuracy and speed of user response to a randomly presented variation in a tracking line. Visual Discrimination Differential Response I & II requires user to make a discrimination between two possible stimuli, and respond with either the left or right hand.

Microsoft Windows is required.

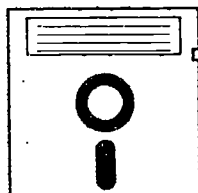

**Product Name:** Foundations II

**Vendor:** Psychological Software Services, Inc.

**Computer:** IBM PC Family

**Manual Form:** Printed Manual

**Cost:** \$400.00

Foundations II is a series of seven types of visual scanning, tracking, and reaction training programs. Visual Reaction Multiple Stimuli records reaction time to change in stimuli color. Visual Tracking records percent success of reaction to change in color of a randomly tracking stimulus. Visual Scanning II records reaction time and success in recognizing a cluster of digits surrounding a presented target symbol (e.g. \$, #, or %). Visual Scanning III records search reaction times for user to scan one vertical column of letters to select a pair of letters to match a corresponding pair of highlighted letters. Multiple Attention/Response requires the user to control the needles of 1-5 dials to stay within a target zone. Complex Attention records speech and accuracy at indicating if the sum of three single digits is odd or even. Simultaneous Multiple Attention records success at determining when moving stimuli surround a target colored block. Joystick input is used and data is collected for all programs.

Microsoft Windows is required.

035

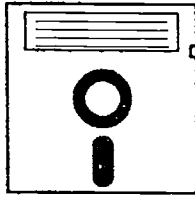

**Product Name:** Function Pictures

**Vendor:** Parrot Software

**Computer:** Apple IIGS, Apple IIc, Apple IIe,  
IBM PC Family

**Cost:** \$104.95

Function Pictures is a two-level program for cognitive training based on the use of pictures. The first level is a picture identification task requiring users to correctly match a picture with a prompt (e.g., "Find the hotdog.") The second level is a function identification task. At this level, users must correctly determine the function of a picture displayed on the screen by matching a picture with a prompt (e.g., "Which one swims?"). Responses are made by pressing the space bar and return key. Rewards are both visual animation and auditory reinforcement; pictures are displayed in color when a color monitor is used. The program stores performance data and prints progress reports to the screen or to a printer.

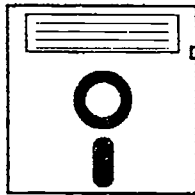

**Product Name:** Functional Vocabulary Plus for  
Windows

**Vendor:** Parrot Software

**Computer:** IBM PC Family

**Cost:** \$134.95

Functional Vocabulary Plus for Windows is software designed to provide practice for people with head injuries and other cognitive impairments who must enhance their vocabulary beyond standard dictionary definitions. In this program, users are asked to select the best description of a picture displayed on the screen. The descriptions are functional statements about the pictures displayed rather than labels or dictionary definitions. For example, while the dictionary definition of a trash can is "a container for garbage," a practical statement about a trash can is "it may have an odor." The program works with Microsoft Windows.



**Product Name:** Fundamental Concepts

**Vendor:** Judy Lynn Software

**Computer:** IBM PC Family

**Cost:** \$29.00

Fundamental Concepts is a software program designed to teach a variety of concepts to users at a cognitive age level of one to four years. Some of these concepts are shapes, colors, crayon scribbling, interlocking pieces, and more. Repetition of the demonstrations attempts to teach the user a particular concept without losing attention.

An EGA or VGA monitor is required.

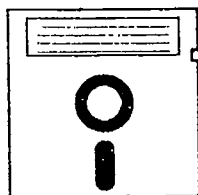

**Product Name:** Further Adventures of Jimmy Jumper  
- Perseverance

**Vendor:** Exceptional Children's Software, Inc.

**Computer:** Apple II Family

**Cost:** \$39.95

Further Adventures of Jimmy Jumper - Perseverance is a story presentation program designed to teach self-esteem and self-confidence. The program focuses on a small rabbit, Jimmy Jumper, who unlike the other rabbits cannot climb to the top of a dirt hill. Although the other rabbits tease Jimmy, he is also encouraged to persevere. Finally, Jimmy does make it to the top of the hill.

The program runs on an Apple II computer with at least 128K of RAM. Use of an Echo II speech synthesizer is optional. The program is available on either a 5.25" or 3.5" disk.

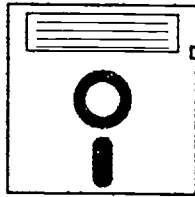

**Product Name:** Getting Clean with Herkimer Level I, II, III

**Vendor:** UCLA Microcomputer Project

**Computer:** Apple IIGS

**Cost:** \$45.00 - \$100.00

Getting Clean with Herkimer Level I, II, III are educational software programs designed to teach the user about cleanliness and grooming. Level I has activities about bathing and showering. Level II has the user identify things which are not helpful in getting clean. Level III focuses on grooming, health care, and cooking items. All programs can be used with a single switch, TouchWindow, mouse, or space bar.

The programs are compatible with the Apple IIGS and require a speech synthesizer for sound output.



**Product Name:** GrammarPlay with Alps and Droops

**Vendor:** Optimal-Ed Learning Materials

**Computer:** Apple II Family

**Manual Form:** Electronic Manual, Printed Manual

**Cost:** \$54.95

GrammarPlay with Alps and Droops is an educational program in game format, designed for use by dyslexic students. The student hunts for parts of speech in Grammarland, aided by Alps and thwarted by Droops. The ten learning games offered are: Subject Noun Hunt; Verb Hunt; Preposition Hunt; Prepositional Phrase Hunt; Adjective Hunt; Adverb Hunt; Pronoun Hunt; Mixed Practice with Subject Nouns; Verbs and Prepositional Phrases; Mixed Practice with Adjectives; Adverbs and Pronouns; and Mixed Practice with all the Basic Parts of Speech. Games increase in difficulty, and each game emphasizes particular phonic patterns. For variety, four game board configurations are able to be selected. One to four people can play at a time.



**Product Name:** Grocery Store Words

**Vendor:** Conover Company

**Computer:** Apple II Family, IBM PC Family

**Cost:** \$659.00

Grocery Store Words is a computer software program which helps the user prepare for making up a shopping list and going to the store. The program includes 250 words which are divided into the following categories: departments, shopping items, breads/grains, condiments, convenience foods, dairy/beverages, desserts/snacks, fruits/vegetables, household, meat/fish, and personal care. Both words and pictures appear on-screen for each item.

The program includes 26 disks, an administration manual, 6 workbooks, and a laminated shopping list. Apple II, IBM, network, and hard drive loadable versions are all available. A disk drive and speech synthesizer are required for all.



**Product Name:** Hierarchical Attention Training

**Vendor:** Parrot Software

**Computer:** Apple II Family, IBM PC Family

**Cost:** \$134.95

Hierarchical Attention Training is a training program for increasing attention skills. The four areas covered are Focused Attention (user presses the space bar each time a specific visual stimulus appears; stimuli are single digits or letters, or sequences of three numbers or letters), Selective Attention (same as Focused Attention, except that a constantly changing visual background is used to create distraction), Alternating Attention (the visual stimulus changes, from odd to even numbers, numbers less than to greater than 10, letters before M to after M, and letter sequences), and Divided Attention (same as Alternating Attention, with the additional requirement of keeping track of number of stimuli presented). Features include reaction time measurements, saving and printing of progress reports, and modification of difficulty level of lessons.

Specify type of computer and disk size (5.25" or 3.5" disk) when ordering. IBM version requires CGA, VGA, or EGA graphics; Apple version requires 128K of memory and an 80 column card.



**Product Name:** Homographs

**Vendor:** Parrot Software

**Computer:** Apple II Family, IBM PC Family

**Cost:** \$104.95

Homographs is a software program for teaching language skills by targeting words with multiple meanings. Two types of lessons are included. The first type presents two sentences, each of which may be completed by the addition of the same word; the user is asked to guess and enter the word that will complete the sentence. The second type presents two definitions and asks the user to enter the word that fits both definitions. Ten graded lessons for each lesson type are included. Progress is stored and may be retrieved for report generation. Lessons may also be printed.

Specify type of computer and disk size (5.25" or 3.5") when ordering. The IBM version requires CGA, VGA, or EGA graphics; the Apple version requires 128K of memory and an 80-column card.

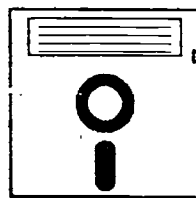

**Product Name:** Homophones

**Vendor:** Parrot Software

**Computer:** Apple II Family, IBM PC Family

**Cost:** \$104.95

Homophones is a software program that teaches language skills by targeting words that sound the same but have different meanings. The user is first presented with a word and asked to supply another spelling that sounds the same. Next, two sentences are presented with the target words omitted; the user is asked to type the correct spelling into each sentence. Fourteen graded lessons are included on each disk. Progress is stored for later retrieval. Lessons may also be printed.

Specify computer and disk size (5.25" or 3.5") when ordering. The IBM version requires CGA, VGA, or EGA graphics; the Apple version requires 128K of memory and an 80-column card.



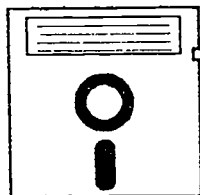

**Product Name:** Human Being Machine

**Vendor:** R.J. Cooper & Associates

**Computer:** Apple II Family

**Manual Form:** Electronic Manual, Printed Manual

**Cost:** \$75.00

Human Being Machine is a pair of software programs that permits an amusing body or face to be created. The two programs are Bodybuilder, which allows pictures of bodies to be built using a switch or touch screen, and Looney Goonies, which allows the user to build and animate faces using a switch or touch screen. The bodies and faces may be printed on a variety of printers; contact manufacturer for specific compatibility information.

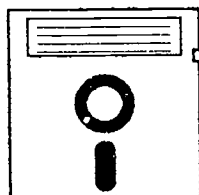

**Product Name:** If You're Happy and You Know It

**Vendor:** UCLA Microcomputer Project

**Computer:** Apple II+, Apple IIGS, Apple IIe,  
Apple Macintosh Family

**Cost:** \$35.00 - \$36.00

If You're Happy and You Know It is a computer program with an overlay for the nursery school song. Pressing one of the six pictures on the overlay causes an associated verse of the song to be "sung" by the computer.

A speech synthesizer, color monitor, and PowerPad are required; for the Macintosh, an Apple IIe emulation card and IntelliKeys are also needed.

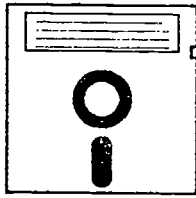

**Product Name:** Improving Your Self-Concept

**Vendor:** Conover Company

**Computer:** Apple II Family, IBM PC Family

**Cost:** \$69.95

Improving Your Self-Concept is software that provides an interactive assessment of strengths, weaknesses, likes, dislikes, and rules for users with a reading level of third to fourth grade and adolescent or adult interest level. Users are encouraged to see themselves as worthy persons and suggestions are made on ways to be more assertively honest with themselves and others.



**Product Name:** Inferential Naming for Cognitive and Language Disorders

**Vendor:** Parrot Software

**Computer:** Apple IIGS, Apple IIc, Apple IIe, IBM PC Family.

**Cost:** \$134.95

Inferential Naming for Cognitive and Language Disorders is a computer program for teaching naming and reasoning skills. Blanks representing a word are placed on the screen. The user may request up to five hints, each of which reveals a relevant semantic feature: category, function, location, size/shape/color, and one other prominent feature. The user then types in the word. Ten lessons are included; the clinician may create additional lessons. Lessons may also be printed out.

Memory requirements are 128K (Apple) or 256K (IBM). Specify computer and required disk size (3.5" or 5.25") when ordering.

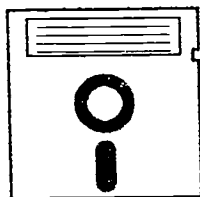

**Product Name:** Inferential Naming Plus for Windows

**Vendor:** Parrot Software

**Computer:** IBM PC Family

**Cost:** \$134.95

Inferential Naming Plus for Windows is a program with the object of determining the identity of a concealed word. Five semantic features are available to the user as clues to the identity of the word. These semantic features are category, function, location, size/shape/color, and one other prominent feature. A sixth clue is the first letter of the word and a seventh clue is the word with two other words in a multiple-choice paradigm. For each incorrect response, a new clue is provided. The program requires Microsoft Windows.



**Product Name:** Information Signs

**Vendor:** Conover Company

**Computer:** Apple II Family, IBM PC Family,  
IBM PS/2 Family

**Manual Form:** Printed Manual

**Cost:** \$209.00

Information Signs is a four-disk microcomputer program that teaches 40 signs which are essential for community living. The disks cover common information signs (e.g., "Admission," "For Rent," "Hospital," "Self Serve"). The program is broken into an Instructional Segment, a Unit Review, and a Generalization Probe, plus an Evaluation Segment where information is contained for each user on words attempted, words correct on the first try, and words correct on the second try.

The program includes 4 disks, an administration manual, and 6 workbooks. An Apple II system with at least 64K of memory, one disk drive, and an appropriate speech synthesizer are required. A color monitor, joystick, and printer may also be used with the program. IBM, network, and hard drive loadable versions are also available.



**Product Name:** Initial Phoneme Cuing for Aphasics

**Vendor:** Parrot Software

**Computer:** Apple IIGS, Apple IIc, Apple IIe,  
IBM PC Family

**Manual Form:** Printed Manual

**Cost:** \$104.95

Initial Phoneme Cuing for Aphasics is a program designed to teach aphasic clients initial letter recall. The program begins by providing keyboard practice, then three levels of operation follow, each with tutoring after errors. The first level requires the user to supply the first letter of the correct word from three words on the screen. The second level requires the user to supply only the correct letter when three choices are displayed. At the third level, the user supplies the first letter of the picture name in the absence of any clues. Eleven letters are used, each with unambiguous graphemic-phonemic correspondence. Each lesson is followed by a test to check mastery and transfer. Progress from each user is stored on the disk and is available as a report to the screen or a printer.

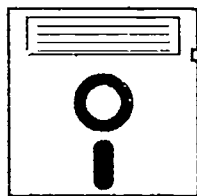

**Product Name:** Interaction Games

**Vendor:** Don Johnston Incorporated

**Computer:** Apple II Family

**Manual Form:** Printed Manual

**Cost:** \$45.00

Interaction Games is a set of nine switch operated games designed to teach cognitive, early academic and switch operation skills. The games allow players to experience competitive or team play through single switch input. Various skills are covered, including vertical and horizontal scanning, letter recognition, and the basic visual-motor skills involved in use of switches. The most complex game is "Scancentration," a scanning version of Concentration. In some games directions are provided via synthesized speech.

Two switches, a switch interface for the computer, and an Echo speech synthesizer are required to use Interaction Games. A minimum of 64K of memory is also required.

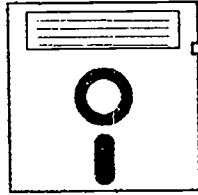

**Product Name:** Interaction Games II

**Vendor:** Don Johnston Incorporated

**Computer:** Apple IIGS, Apple IIe

**Cost:** \$45.00

Interaction Games II is a set of six software activities designed to teach cognitive, early academic, and switch operation skills. The program uses functions and parameters to change the user's name, select regular or step scanning, and control the rate of scan. The games provide cooperative and competitive activities for switch users. The activities include Horse Race, Match & Win, Slap Jack, and Mountain Climber.

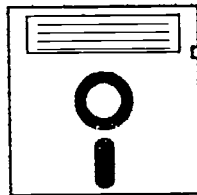

---

**Product Name:** Job Readiness Series

**Vendor:** MCE

**Computer:** Apple II Family, IBM PC Family

**Manual Form:** Printed Manual

**Cost:** \$249.95 - \$369.95

Job Readiness Series is a vocational training program that helps teach job readiness skills and behaviors in four different programs. Job Attitudes: Assessment and Improvement evaluates and recommends ways to improve attitudes for job success. Filling Out Job Applications leads users step-by-step through completing a job application. Successful Job Interviewing teaches users tips on how to plan and implement a successful interview. Resumes Made Easy uses a conversational style to motivate students to think about and develop their resumes.

Reading level of the programs is rated grades three to four, while the interest level is rated grade nine to adult. A single set of all four programs may be purchased for \$249.95 or a five pack for \$369.95.



**Product Name:** Job Seeking Series

**Vendor:** Conover Company

**Computer:** Apple II Family, IBM PC Family

**Cost:** \$285.00

The Job Seeking Series covers four skills needed for finding an adult job at a fifth to sixth grade reading level. The skills are resume writing, cover letter, filling out job applications, and interviewing. The resume and cover letter programs allow the user to create and print out actual, usable resumes and cover letters.

System requirements for the Apple II version are 64K, one 5-1/4" disk drive, and a printer. The IBM version requires 256K, one 5-1/4" or 3-1/2" disk drive, and a printer. Price is for the complete stand-alone system. Each program is available separately for \$59.00 - \$98.00. Network packages are available.

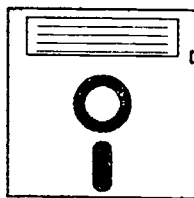

**Product Name:** Job Success Series

**Vendor:** MCE

**Computer:** Apple II Family, IBM PC Family

**Cost:** \$249.95 - \$369.95

Job Success Series is a set of educational software programs designed to help users succeed at their jobs. The set includes: Your Personal Habits, Your Work Habits, First Days on the Job, Looking Good, and Your First Job. Each program also includes an instructional guide for teaching suggestions as well as prerequisite skills, goals, and behavioral objectives. The four programs are written for a 4th-5th grade reading level and a 10th grade-adult interest level.

One set of the disks may be purchased for \$249.95 or a five pack of the set for \$369.95.

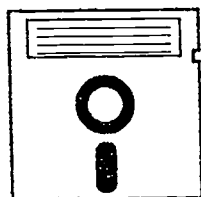

**Product Name:** Join the Circus

**Vendor:** Don Johnston Incorporated

**Computer:** Apple IIGS, Apple IIc, Apple IIe

**Manual Form:** Printed Manual

**Cost:** \$35.00

Join the Circus is a computer program designed to train use of a single switch. Four levels of play are included. The first level allows the user to hit the switch and watch a circus act from start to finish. The second level requires two switch activations: one to start the act and one to see the finale. The third level requires the student to touch the switch after each on-screen action. The fourth level allows play by two users taking turns. Options include a green light to provide a visual cue to hit the switch, an auditory cue to hit the switch, and action delay for users who need time to refocus attention to the monitor after hitting the switch.

Three circus acts are included in the program. An Echo speech synthesizer, switch interface, and single switches are required to use Join the Circus.



**Product Name:** Joystick Trainer

**Vendor:** R.J. Cooper & Associates

**Computer:** Apple II Family,  
Apple Macintosh Family, IBM PC Family

**Manual Form:** Electronic Manual, Printed Manual

**Cost:** \$75.00 - \$89.00

Joystick Trainer is a computer program that contains nine activities intended to train wheelchair users in the skills necessary to operate an electric wheelchair. The disk starts with simple exploratory activities for gross movement and cognitive awareness, moves through initial proportional path-oriented tasks, and graduates to maze games for fine control. As the user's skill level increases, incrementally more challenging tasks are presented.

The IBM version requires Microsoft Windows.



**Product Name:** Keyboarding by Ability

**Vendor:** Teacher's Institute for Special Education

**Computer:** Apple II Family, IBM PC Family

**Cost:** \$149.95

Keyboarding by Ability is a custom designed touch typing program. The program is ordered by number of usable fingers on each hand or use of mouthstick. Each program includes a complete set of lesson plans and instructional goals, supplemental graded data input lessons, and other features.

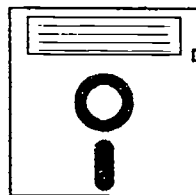

**Product Name:** Keyboarding for Individual Achievement

**Vendor:** Teacher's Institute for Special Education

**Computer:** Apple IIe, IBM PC Family

**Cost:** \$149.95

Keyboarding for Individual Achievement is a series of software programs designed to teach keyboarding skills to students with specific disabilities. Each version includes a complete set of lesson plans and instructional goals, supplemental graded data input exercises, graded spelling practice and quiz, timed and graded speed tests, and a printed record of all exercises.

Edition 1 for learning disabled students uses a visually cued alphabetical approach. Edition 2 for dyslexic students incorporates a split screen approach in which the upper screen sequentially monitors the student's performance on the lower screen using a visual cue. Edition 3 for visually impaired students varies depending on the computer; the Apple program has large type and data input exercises while the IBM program uses a split-screen, visual cue, and large type. Edition 4 for deaf students uses the alphabetical approach with 12 levels of spelling words and sentences for comprehension.





**Product Name:** Keyboarding for People with Cerebral Palsy

**Vendor:** Teacher's Institute for Special Education

**Computer:** Apple IIe, IBM PC Family

**Cost:** \$149.95

Keyboarding for People with Cerebral Palsy is designed to give a students keyboarding skills using a touch typing system custom designed for available usable fingers and grade level. The program includes: lesson plans and instructional goals, supplemental graded data input exercises, graded spelling quiz and timed speed tests, and a printed record of all exercises.



---

**Product Name:** Keyboarding Program with Voice Output

**Vendor:** Favin, David

**Computer:** Texas Instruments TI 99/4A

**Manual Form:** Printed Manual

**Cost:** Free

Keyboarding Program with Voice Output is a program that uses synthesized voice to teach the position of keys on the computer keyboard. In the first phase the student can press any key and the computer will speak the letter for that key. In the second phase, the program prompts the student to type a particular letter. The program prompts in either alphabetic or random order. In issuing instructions, the program addresses the student by name. A running score is presented in the lower right-hand corner of the screen.

A speech synthesizer is required to run this program. This program was developed through the Telephone Pioneers of America, and is free to anyone interested.

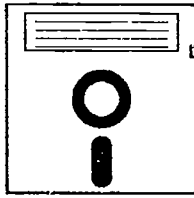

**Product Name:** Keyboarding with One Hand  
**Vendor:** Teacher's Institute for Special Education  
**Computer:** Apple IIe, IBM PC Family  
**Cost:** \$149.95

Keyboarding with One Hand is a typing tutorial that is designed to give students with the use of only one hand employable keyboard skills using a touch system designed for a standard computer keyboard. The program includes: a complete set of lesson plans and instructional goals, supplemental graded data input exercises, graded spelling practice and quiz, timed and graded speed tests, and a printed record of all exercises.



---

**Product Name:** Keys to Success: Comp. Keybd.  
Skills for Blind Children  
**Vendor:** Life Science Associates  
**Computer:** Apple II Family  
**Manual Form:** Printed Manual  
**Cost:** \$35.00

Keys to Success: Computer Keyboard Skills for Blind Children is a voice output program to help blind and partially sighted children learn the computer keyboard layout. Program includes keyboard tutorial, keyboard practice, timed keyboard practice, and a timed game for two players.

System requires an Echo II for voice output capabilities.



**Product Name:** Laryngograph

**Vendor:** Kay Elemetrics Corporation

**Manual Form:** Printed Manual

**Cost:** \$1,795.00

Laryngograph is a device that detects and processes laryngeal characteristics of a person's voice. The laryngograph can in turn be interfaced with a microcomputer to display and print these voice patterns. The user places two transducers (vibration detectors) against the larynx and speaks. The transducers are designed specifically to pick up and record movement of the cords, and the opening and closing of the vocal folds, independent of extraneous acoustic noise and the qualities of the resonance tract. The system detects the complete pattern of vocal fold closure in each vibrating cycle, including closure duration and completeness, closure velocity, and coordination (sharpness) of the closure event. The trace of these events (the EGG waveform) is generated, and can be transmitted to the computer or to an oscilloscope for display.

In order for the waveforms to be displayed on the computer screen, an interface unit and appropriate software are required. The Laryngograph works with the Visi-Pitch system, Computerized Speech Lab (CSL), RLS Videostroboscopy, and other systems (also from Kay Elemetrics).

---



**Product Name:** Learn to Scan

**Vendor:** Don Johnston Incorporated

**Computer:** Apple IIGS, Apple IIe

**Manual Form:** Printed Manual

**Cost:** \$40.00

Learn to Scan is a computer program designed to teach the elements of scanning with a single switch. Eight activities with speech feedback are included. The beginning level activities are designed to teach alignment of the cursor with a target. The intermediate levels involve moving a cursor to match items according to color, shape, and size. At the highest level, the learner moves the cursor to respond to matching tasks that require vocabulary recognition and matching. Performance level information can be obtained after each activity.

An Echo speech synthesizer, switch interface, and single switch are required to run Learn to Scan.



**Product Name:** Learning Activity Packets (LAPs)

**Vendor:** Conover Company

**Computer:** Apple II Family, IBM PC Family

**Cost:** \$995.00

Learning Activity Packets are software programs that provide diagnostic and practice exercises in math and English competencies related to job or technical skills, but do not have a skill enhancement component. All exercises are written with low-vocabulary requirements so that users with little or no knowledge of the career area can successfully complete each exercise. LAPs cover the following occupational areas; automotive, building maintenance, graphic design, cosmetology, custodial housekeeping, electronics, small engines, food service, business and office, manufacturing, distribution, health care, construction, horticulture, and computers.

Apple II version requirements are 64K and one 5-1/4" or 3-1/2" disk drive. IBM version requirements are 256K and one 5-1/4" or 3-1/2" disk drive. Price is for the complete stand-alone series. Individual career areas are available for \$79.95 each. Network packages are also available.

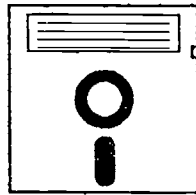

**Product Name:** Learning How to Learn Series

**Vendor:** Conover Company

**Computer:** IBM PC Family

**Cost:** \$699.95

The Learning How to Learn Series is a software program designed to teach basic skills useful to students in school as well as adults in the workplace. The series is divided into two levels based on reading level. Level 1 is targeted for students at a 4th-5th grade reading level and deals with following directions, building memory skills, study skills, and test taking. Level 2 is targeted for students with a 5th-7th grade reading level and deals with managing study time, following directions, memory skills, learning skills, and test taking.

System requirements include 64K for the Apple II version and 256K for the IBM version. Both offer 5-1/4" or 3-1/2" disks. Price is for a complete stand-alone series. A Level 1 package is also available for \$335.95 and each of the individual courses can be purchased for \$69.95. A Level 2 package is available for \$395.00 and each its individual courses can also be purchased for \$84.00. Network packages are available.

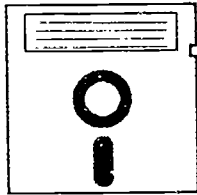

**Product Name:** Learning to Count

**Vendor:** Life Science Associates

**Computer:** IBM PC Family

**Cost:** \$40.00

Learning to Count is a software program designed for persons with head injuries or learning disabilities, or for anyone who has difficulty counting or making change. Objects such as cookies, candies, cups, and coins are shown, and the user enters in the number of objects shown. Difficulty increases as the user progresses through each of the 30 lessons. Responses are usually typed on the keyboard, but typing skills are not required. The program keeps a record for each student.

System requirements include EGA or VGA and 512K. A hard drive and printer are desirable.



**Product Name:** Learning to Reason Series

**Vendor:** MCE

**Computer:** Apple II Family

**Cost:** \$139.95

Learning to Reason is a set of three educational software programs designed to improve logical reasoning skills. The programs are True or False? (which has the user think about the validity and truth of statements); Puzzlers (which presents increasingly difficult problems requiring sequencing and reasoning skills); and Some, All, or None? (which discusses the relationship between objects in a set and the concepts of some, all, and none). All programs are written for a 2-3 grade reading level and a 2-5 grade interest level.

Programs may be purchased singly for \$59.95 each, in five packs of one program for \$89.95, or single copies of all three programs for \$139.95.

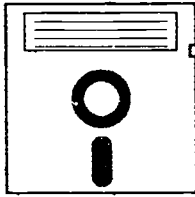

**Product Name:** Learning to Spell Braille Signs

**Vendor:** Exceptional Teaching Aids

**Computer:** Apple II Family

**Cost:** \$34.00

Learning to Spell Braille Signs combines voice-output computer software with hard copy braille to teach students how to spell braille signs. There are nineteen lists of signs and each list contains ten signs. The student can choose to work on any number of signs within a list. The package includes a clearly written print manual, the program disk (5-1/4" disk), a braille student workbook, and a recorded tour of the program on cassette.

An speech synthesizer is required to use Learning to Spell Braille Signs.

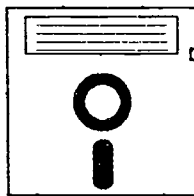

**Product Name:** Less, More, Make Equal

**Vendor:** DEKRO, Inc.

**Computer:** IBM PC Family

**Cost:** \$29.00

Less, More, Make Equal is a software program designed for individuals with head injuries, stroke, or learning disabilities. The program teaches skills in sequencing quantities from one to ten and make quantities equal by adding or subtracting. Within the program are three exercises: What is More?, What is Less?, and Let's Make Equal.

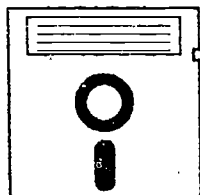

**Product Name:** Let's Go Shopping I and II

**Vendor:** UCLA Microcomputer Project

**Computer:** Apple II+, Apple IIGS, Apple IIe

**Cost:** \$35.00 each version

Let's Go Shopping is a switch training computer game program for one to four players. The players select items that would be sold in a given store using a switch or TouchWindow. Let's Go Shopping I presents items for a toy store or grocery store; Let's Go Shopping II presents items for a clothes store or pet store.

A speech synthesizer, color monitor, and single switch are required; for the Macintosh, an Apple IIe emulation card is also needed.



**Product Name:** Let's Go to the Circus

**Vendor:** Laureate Learning Systems, Inc.

**Computer:** Apple IIGS, Apple Macintosh Family,  
IBM PC Family

**Cost:** \$115.00

Let's Go to the Circus is a software program designed to strengthen vocabulary, introduce opposites, and reinforce basic concepts. Features include colorful scenes, high quality speech, animation, teacher control over lesson presentation, and automatic record-keeping. The program can be used with keyboard, touch screen, single switch, or mouse.

The Apple IIGS version requires one 3-1/2" disk drive and 1 MB of RAM. The IBM version requires one 3-1/2" disk drive, hard drive, MCGA or VGA graphics, 640K of RAM, and one of the following speech devices: Sound Blaster or compatible, PORTABLE sound Plus, Digispeech 201A, Echo PC II, Echo eDSP, Audio Capture & Playback Adapter, DoubleTalk PC, the Sound Source, or Speech Thing. The Macintosh version requires Macintosh LC or higher, System 7, hard drive, and 4 MB of RAM.

655



**Product Name:** Letter Find

**Vendor:** Exceptional Children's Software, Inc.

**Computer:** Apple II Family

**Manual Form:** Printed Manual

**Cost:** \$19.95

Letter Find is a training program to teach young children with visual impairments the position of keys on the keyboard. The teacher can define a range of letters or numbers for the children to find and place, and decide whether the program should proceed through that range of letters in alphabetical or random order. The computer provides verbal prompts of correctness of answers, and collects data on number of correct answers. The program also includes auditory addition drills.

The program uses an Echo II speech synthesizer. Manufacturer recommends that braille labels be applied to keys for easier access.

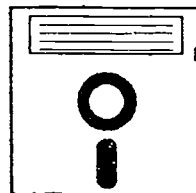

**Product Name:** LetterTALK+

**Vendor:** American Printing House for the Blind (APH)

**Computer:** Apple II Family

**Manual Form:** Audiotape Manual,  
Electronic Manual, Large Print Manual

**Cost:** \$30.50

LetterTALK+ is a software program designed to serve as an introduction to placement of the keys on an Apple II keyboard, an introduction to word processing, an introduction to audio computer games, and a means to practice using keys on the keyboard and listening to speech output. The program provides access to the computer screen in both large type text and speech output. A brailled styrene model of the Apple IIe keyboard and a brailled keyboard overlay for the Apple IIgs are also included.

System requirements include 128K of memory and one of the following speech synthesizers: Echo or Cricket (Echo Speech Corporation), Echo (APH), DoubleTalk or Slotbuster (RC Systems, Inc.).



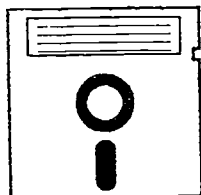

**Product Name:** Listen With Your Ears

**Vendor:** UCLA Microcomputer Project

**Computer:** Apple Macintosh Family

**Cost:** \$45.00

Listen with your Ears is a game of auditory discrimination for use with a single switch or a TouchWindow. The user identifies an object or action by the sound it makes. The twenty four choices include snoring, laughing, cat, doorbell, firetruck, and more.

A color monitor and Echo Speech Synthesizer are required.

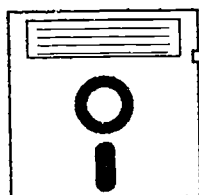

**Product Name:** Living Alone

**Vendor:** MCE

**Computer:** Apple II Family

**Manual Form:** Printed Manual

**Cost:** \$69.95

Living Alone is a personal skills tutorial computer program. It is low vocabulary software program that exposes users to daily living issues which they may face when living alone. Topics such as budgeting, finding a place to live, and living alone or with a roommate are addressed. The program consists of one disk, a backup disk, and an instruction guide.



**Product Name:** Logi

**Vendor:** DEKRO, Inc.

**Computer:** IBM PC Family

**Cost:** \$59.00

Logi is a software program designed for individuals with head injuries, stroke, or learning disabilities. The program's objectives are to analyze forms according to their shape and color and to rearrange forms according to their form, shapes, and spatial orientation. The beginning shape, color sequence, and shape sequence can be defined.

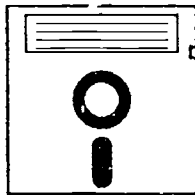

**Product Name:** Logo TouchTools for the PowerPad

**Vendor:** Dunamis, Inc.

**Computer:** Apple IIGS, Apple IIe

**Manual Form:** Printed Manual

**Cost:** \$29.95

Logo TouchTools for the PowerPad is a collection of demonstration programs designed to help users adapt and enhance Terapin LOGO 2.0 or above. The TouchTools are designed to give persons with a wide variety of visual, motor, and cognitive skills access to the computer. The programs allow the PowerPad (see separate entry) to be used as an alternative keyboard for several applications, including single keystroke LOGO, letter, shape, and number identification activities, and access to synthesized speech.

The Apple IIe uses a special configuration for speech output, which includes a super-serial card, Votrax Personal Speech System, and cable to hook Votrax up to the card. Contact manufacturer for compatibility and cost information.

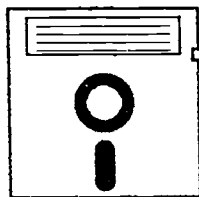

**Product Name:** Magic

**Vendor:** DEKRO, Inc.

**Computer:** IBM PC Family

**Cost:** \$109.00

Magic is a software program designed for individuals with head injuries, stroke, or learning disabilities. Objectives include recognizing and differentiating colors in a picture, copying a picture in detail, developing spatial perception skills, and developing efficient eye-hand coordination. The computer selects the picture from a large pool of pictures and selects a new color combination each time. The number of colors can be limited.

A mouse is required.

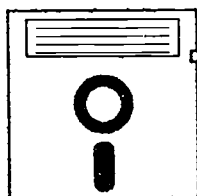

**Product Name:** Make It In Time

**Vendor:** Don Johnston Incorporated

**Computer:** Apple IIGS, Apple IIe

**Manual Form:** Printed Manual

**Cost:** \$40.00

Make It In Time is a computer program that teaches skills associated with using a single switch in a time-dependent situation. The program is a collection of eight activities in which the user needs to hit the switch at a specific point in time to successfully complete the task. Activities include: Money in the Bank, Puddle Jumper, Make That Kick, and Bowling Like a Champ.

An Echo speech synthesizer, switch interface, and single switch are required to use Make It In Time.

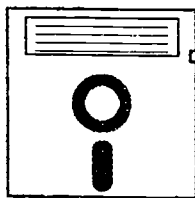

**Product Name:** Make It Scan

**Vendor:** Don Johnston Incorporated

**Computer:** Apple IIGS, Apple IIe

**Manual Form:** Printed Manual

**Cost:** \$40.00

Make It Scan is a software program with six switch use training games. The user may choose from multiple scanning options. Games include Bowl-A-Rama, Roll-A-Ball, Good Dog, Pinball, Walk About, and Park It. The program is intended to teach choice making and timing skills. Data collection capability is included.



**Product Name:** Mastering Personal Information (MPI)

**Vendor:** Parrot Software

**Computer:** Apple II Family, IBM PC Family

**Cost:** \$134.95

Mastering Personal Information (MPI) is a software program to train persons with cognitive impairments to recognize and write basic information such as name and address. The program has three levels of operations. The first level of difficulty requires clients to copy the target word letter by letter. If any errors occur, the client is given unlimited chances to correct each error. The next level of difficulty is revisualization, where the entire target response is presented and then masked. After the response is masked, the client copies the target response. If errors are made, the entire target is presented and then masked again. At the highest level, the client is expected to recall the spelling of familiar materials; if any errors occur, individual letters are tutored.

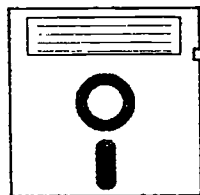

**Product Name:** Math Max

**Vendor:** DEKRO, Inc.

**Computer:** IBM PC Family

**Cost:** \$109.00

Math Max is software program designed for individuals with head injuries, stroke, or learning disabilities. The program's objectives are to attain speed in mental arithmetic, develop observational skills, increase reaction speed, and apply problem solving strategies. Ten math games are offered in three difficulty levels. Sound and clock can be toggled, practice sheets can be printed, and high-scores can be saved and records broken.

System requirements are VGA color and a mouse.



**Product Name:** Math on the Job

**Vendor:** Conover Company

**Computer:** Apple II Family

**Cost:** \$59.95 - \$1,695.00

Math on the Job is a vocational exploration and assessment program. This series is designed to help students make the school-to-work transition by giving them an opportunity to explore careers, practice basic math skills related to selected vocations, and access diagnostic and remedial related math information. The program is also designed to help educators integrate basic math and problem-solving skills into career exploration activities.

Math on the Job is available in printed and software forms. Reading levels for both versions are at a 4.0 grade level. The software version is available as a complete system or by individual career areas. The complete system (\$1,695.00) includes thirty-three disks, thirty-one student guides, management system and a teacher guide. Individual areas (\$59.95 each) include one disk, a student guide, and a teacher guide. Apple, IBM, network, and hard drive loadable versions are available.

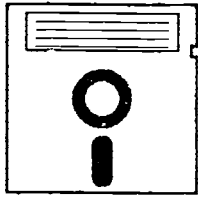

**Product Name:** Maze

**Vendor:** Computers to Help People, Inc.

**Computer:** Apple II Family

**Manual Form:** Printed Manual

**Cost:** \$50.00

Maze is a recreation and training program that uses color, graphics, and sound to guide the user through a maze. Mazes may be designed by the user, or a teacher or parent. The user guides the cursor through the maze by pressing keys on the keyboard. If a voice synthesizer is used, the words "up," "down," "left," and "right" accompany selections.

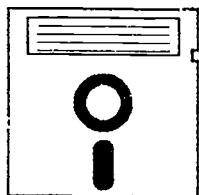

**Product Name:** Medical Words

**Vendor:** Conover Company

**Computer:** Apple II Family, IBM PC Family

**Cost:** \$299.00

Medical Words is a computer program which teaches signs and words that are important in getting medical help and explaining illnesses. The program focuses on four types of words: hospital signs, symptoms, ailments, and treatments. When pictures and words are correctly matched, the words are spelled out on-screen and appear with an appropriate graphic scene. Medical Words has an instructional segment, a unit review, a generalization probe, and an evaluation segment.

The program includes 9 disks, an administration manual, and 6 workbooks. Apple II, IBM, and network versions are available. All require a speech synthesizer and disk drive.

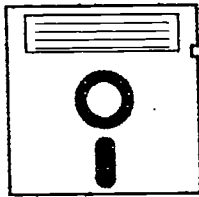

**Product Name:** Memory for Animated Sequences Plus for Windows

**Vendor:** Parrot Software

**Computer:** IBM PC Family

**Cost:** \$134.95

Memory for Animated Sequences Plus for Windows is a program for users with observational, attention, short term memory, receptive language, and expressive language impairments. Users watch an animated sequence of events lasting between a few seconds and a minute and then select statements that describe what they just observed. The animated sequences are presented in random order and the statements are taken from a large pool of stimuli. This allows the program to be used over and over by the same user. The program requires Microsoft Windows.

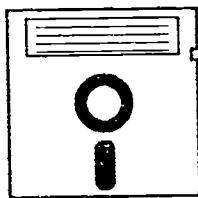

**Product Name:** Memory I

**Vendor:** Psychological Software Services, Inc.

**Computer:** IBM PC Family

**Manual Form:** Printed Manual

**Cost:** \$400.00

Memory I is a series of four different types of memory training programs. Spatial Memory asks users to learn an escape route from a concentric maze, where a correct guess advances the user and an incorrect one returns the cursor to the beginning. Verbal Memory (Sequenced Words) presents a series of words and asks the user to select the same words from an array of sixteen words, in the order that they were presented. Auditory Memory presents one or more tones that seem to slide up or down the scale and asks the user to reproduce the series of up/down combinations. Visual/Spatial Memory presents a symbol in a 5 x 4 matrix, then asks the user to recognize what symbol was seen from an array of ten symbols, and where on a blank array the symbol was presented.

Microsoft Windows is required.



**Product Name:** Memory II

**Vendor:** Psychological Software Services, Inc.

**Computer:** IBM PC Family

**Manual Form:** Printed Manual

**Cost:** \$400.00

Memory II is a series of different memory training programs, an advanced version of Memory I (see entry). Spatial Memory (Objects/Locations) presents an array of 30 objects with a frame briefly around one or two objects; the user must recall and select the framed item. Visual Memory (Sequenced/Spatial) asks the user to recall which of twelve squares changed colors, first a single square change then a sequence of color changes. Recognition Recall 1,2,3 presents 19 objects for a clinician-set period of time (from a few seconds to over a minute), then asks the user to recall which pictures were seen from a list of 90 words. Verbal Memory (Categorizing) asks the user to categorize 20 words into one of four groups (such as foods, animals, colors), then after completion of task to recall as many of the twenty words as possible.

Microsoft Windows is required.

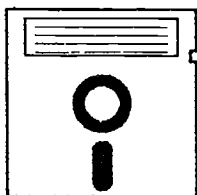

**Product Name:** Micro Guide to Careers Series

**Vendor:** Conover Company

**Computer:** Apple II Family, IBM PC Family

**Cost:** \$639.00

The Micro Guide to Career Series consists of eight easy to use programs that provide a quick reference to high-demand career areas. Each program features an inventory profile that encourages learners to compare their interest with those of a worker in that field and includes a job bank with over 75 concise job descriptions. The eight programs deal with high tech careers, nursing careers, fashion careers, counseling and teaching careers, sales careers, office occupations, self-employment, and liberal arts careers.

System requirements for the Apple II version are 64K and one 5-1/4" disk drive. The IBM version requires 512K and one 5-1/4" or 3-1/2" disk drive. Each program is available separately for \$84.00.





**Product Name:** Micro-LADS and Micro-LADS in French

**Vendor:** Laureate Learning Systems, Inc.

**Computer:** Apple IIGS, Apple II Family, Apple Macintosh Family, IBM PC Family

**Manual Form:** Printed Manual

**Cost:** \$165.00 - \$775.00

Micro-LADS (Microcomputer Language Assessment and Development System) and its French version are each a series of seven diskettes designed to teach over 45 fundamental syntactic rules. Students are presented with two or three pictures (depending on the grammatical construction being trained), with optional speech and/or text, and asked to select the picture which represents the correct construction. Scan speed, response time, and criterion for ending the lesson can be adjusted, and animation can be turned on or off. A lesson summary and test performance results can be viewed on-screen or printed.

The Apple II versions (\$165.00 - \$750.00) require 64K memory, a monitor, a speech synthesizer, and a 5.25" disk drive. The Apple IIGS versions (\$175.00 - \$775.00) require one 3.5" disk drive and 1 MB of RAM. The IBM version (\$175.00 - \$775.00) requires 640K memory, a speech synthesizer, and a disk drive. A color monitor and TouchWindow (see entry) are recommended. The Macintosh versions (\$175.00 - \$775.00) require Macintosh LC or higher, System 7, hard drive, and 4 MB of RAM. Interface options include TouchWindow, a single switch, the keyboard, or a game controller.

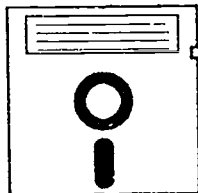

**Product Name:** Microcomputer Evaluation of Career Areas (MECA)

**Vendor:** Conover Company

**Computer:** Apple II Family

**Manual Form:** Printed Manual

**Cost:** \$250.00 - \$825.00

MECA is a series of vocational assessment packages with "hands-on" simulation of tasks within a trade area. Each package contains three Work Samples and a Learning Activity Packet (LAP). The Work Samples break down job-related tasks into steps, which are presented with graphics and written instructions at the bottom of the computer screen. The LAP presents basic academic skills activities relevant to the career area covered.

Software and training manuals are sold separately for all MECA kits for \$250.00 per kit. MECA kits are also sold with necessary hardware and supplies to complete tasks in training packages. These range from \$425.00 - \$825.00 including: automotive, building maintenance, graphic design, cosmetology, custodial housekeeping, electronics, small engines, food service, business and office, health care, manufacturing, construction, distribution, horticulture, and computers. System can be used with optional color monitor, or cassette player and cassette control device (CCD) for audio screen information for low or non readers. Apple II versions require 64K of memory and IBM versions require 256K.



**Product Name:** Mind Castle I and II

**Vendor:** MCE

**Computer:** Apple II Family, IBM PC Family

**Cost:** \$59.95

Mind Castle I is an educational software program which encourages the use of basic logic and reasoning skills. The program has an adventure game format which prompts the user to explore the different rooms of a castle. In each room the user has to solve a different logic problem or puzzle. Mind Castle II uses a similar format to emphasize more advanced problem-solving methods as well as confidence in problem solving and decision-making.

The programs run on either IBM or Apple computers. The two programs are sold separately, each for \$59.95; five packs of each program are \$89.95.



**Product Name:** Minimal Contrast Stories Plus for Windows

**Vendor:** Parrot Software

**Computer:** IBM PC Family

**Cost:** \$134.95

Minimal Contrast Stories Plus for Windows is software that presents stories with color pictures with the outcome dependent on whether the user uses the error sound. The story ends happily if the correct sound is used and unsatisfactorily if the sound error is used. For example, Bruno is able to break the log and confirm his strength if the user pronounces the final consonant in the word log. If the user does not pronounce the final consonant then Bruno breaks the law and goes to jail. The program works with Microsoft Windows.



**Product Name:** Minimal Contrast Therapy

**Vendor:** Parrot Software

**Computer:** Apple II Family

**Manual Form:** Printed Manual

**Cost:** \$104.95

Minimal Contrast Therapy is a treatment program for children with unintelligible speech. The user selects three phonological processes which contribute to a child's unintelligible speech. A series of minimal pairs are displayed on the screen in picture form. The child is then instructed to play a game in which he must move the target word into a box on the left side of the screen. He is informed that the picture will only move if he says the target word correctly.

Correct and incorrect responses are recorded by the computer and displayed in graphic form characteristic of a multiple-baseline design. Records of up to 12 clients may be kept on the disk at one time. The program was recently revised to include improved graphics. Users can send in old copies of the program with \$15.00 to receive a new copy.

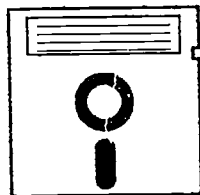

**Product Name:** Mix 'N Match

**Vendor:** Marblesoft

**Computer:** Apple IIGS, Apple IIc, Apple IIe,  
Apple Macintosh Family

**Manual Form:** Printed Manual

**Cost:** \$57.00

Mix 'N Match is a program designed to teach identification of objects by size, shape, and color. Sorting Fun teaches classification of objects by shape and color; Count the Shapes teaches identification by shape, color, and size; Match the Shapes teaches relationships between objects; and What Comes Next teaches patterns in a sequence. All four lessons have the options of switch input ("yes" and "no" responses) and synthesized voice reinforcement. A record-keeping system and keyboard overlays are also included.

A 128K Enhanced Apple computer and a color monitor are required to run Mix 'N Match. An Echo or Double Talk speech synthesizer is required for the voice output option. The Macintosh version requires a Macintosh LC with a IIe emulator card. The PowerPad keyboard, Touch Window, or IntelliKeys can be used as input devices for Mix 'N Match as well as other keyboards and switches. Backup copies of the program are available (extra). PowerPad and IntelliKeys overlays can be purchased separately.



**Product Name:** Money Matters

**Vendor:** MCE

**Computer:** Apple II Family

**Cost:** \$59.95

Money Matters is a tutorial program designed to teach knowledge and use of coins and bills. Concepts enforced includes using money, identifying and stating value of coins (penny, nickel, dime, and quarter) and bills (one, five, ten, twenty), counting money, and making change. The main menu may be accessed during any point in the program by pressing the escape key.

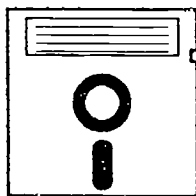

**Product Name:** Money Skills

**Vendor:** Marblesoft

**Computer:** Apple IIGS, Apple IIc, Apple IIe,  
Apple Macintosh Family

**Manual Form:** Printed Manual

**Cost:** \$57.00

Money Skills is a program for teaching identification of coins and bills, counting denominations and making change. The program deals with both U.S. and Canadian currency. The lessons can be set at increasing levels of difficulty. A built-in record keeping system is included. A variety of input options are available, including single switch scanning, hand controls, PowerPad, Touch Window, or IntelliKeys (see entries). A customized voice output option is offered as well.

A 128K Enhanced Apple is required to run Money Skills. In order to use the speech option, an Echo or Double Talk speech synthesizer is required. The Macintosh version requires a Macintosh LC with a IIc emulator card. The various alternative control systems are purchased separately. Backup copies are available (extra). PowerPad and IntelliKeys overlays can be purchased separately.



**Product Name:** Motor Training Games  
**Vendor:** Computers to Help People, Inc.  
**Computer:** Apple II Family  
**Manual Form:** Printed Manual  
**Cost:** \$15.00

Motor Training Games are recreation/training programs for the Apple family of computers. Motor Training Games are operated by one or two motor movements, and are designed to acquaint disabled individuals with control switches in a comfortable, low-stress atmosphere. Motor Training Games are also designed to aid therapists in evaluating and refining the motor abilities of a particular user. Motor Training Games consists of fourteen games appropriate for preschool through teen users, or higher.

One or two microswitches must be substituted for, or wired in parallel with, the Apple game buttons through the game I/O port.

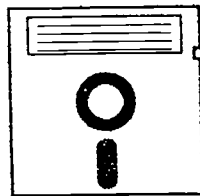

**Product Name:** Motor Training Games  
**Vendor:** Don Johnston Incorporated  
**Computer:** Apple II Family  
**Manual Form:** Electronic Manual, Printed Manual  
**Cost:** \$35.00

Motor Training Games is a set of 14 switch-operated games and formal activities designed to teach cognitive and switch-operation skills. The activities and games can be operated with a single switch. The main menu can be accessed at any point in the program by pressing the ESC key.

Motor Training Games can be used to develop skills needed to use Adaptive Firmware Card technology and switch-activated communication aids. A single switch and a switch interface for the computer are required to use Motor Training Games.

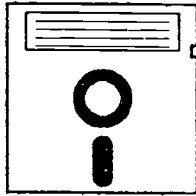

**Product Name:** Multi-SCAN

**Vendor:** Academic Software, Inc.

**Computer:** Apple Macintosh Family, IBM PC Family

**Manual Form:** Printed Manual

**Cost:** \$149.00

Multi-SCAN is a single switch activity center featuring four educational games in one package: Dot-to-Dot, Concentration, Mazes, and Matching. Skills emphasized include cause and effect, counting, spatial perception, pattern recognition, memory, and problem-solving. In addition, Multi-SCAN provides six graphic game libraries designed for a wide range of ages and abilities: Animals, Sports, Dinosaurs, Cosmetology, Independent Living, and Vocation. Multi-SCAN allows the user to select a graphic library, choose games, set a schedule of play for each user, and adjust the difficulty level and other settings for each game independently. Individual performance reports can be printed.

Multi-SCAN works with the keyboard and mouse buttons. The Macintosh version works with most alternate Macintosh control interfaces. The IBM compatible version requires Microsoft Windows and the SS-ACCESS! (see entry) single switch interface.

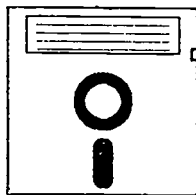

**Product Name:** Multiple Meaning Words I Plus for Windows

**Vendor:** Parrot Software

**Computer:** IBM PC Family

**Cost:** \$134.95

Multiple Meaning Words I Plus for Windows uses words that sound the same but have different spellings and different meanings (homophones). The program is intended for any person requiring help with word retrieval and vocabulary development. The program presents one member of a pair of homophones and asks the user to recall the other member of the pair. Then the user is asked to use the two words in a sentence. Responses are appropriately reinforced and progress is recorded in special data files. The program contains fifteen lessons and requires Microsoft Windows.

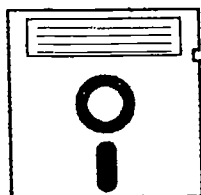

**Product Name:** Multiple Meaning Words II Plus for Windows

**Vendor:** Parrot Software

**Computer:** IBM PC Family

**Cost:** \$134.95

Multiple Meaning Words II Plus for Windows uses words that are spelled the same but have different meanings (homographs). The program presents either definitions of homograph pairs or sentences with blanks to be filled in by homographs. Responses are reinforced and progress is recorded in special data files. Fifteen lessons.

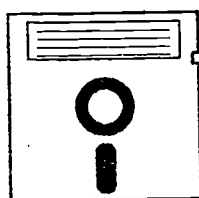

**Product Name:** MusicWare

**Vendor:** SoftTouch/kidTECH

**Computer:** Apple Macintosh Family

**Cost:** \$75.00 - \$95.00

MusicWare is a series of software designed to teach a variety of cognitive skills through music and animation. Five Little Ducks uses rhyme, rhythm, and repetition to build vocabulary and number concepts. Five Green & Speckled Frogs include activities dealing with cause and effect, numbers, and beginning subtraction. Old MacDonald's Farm teaches vocabulary and visual discrimination. Make It Go features seven original cause and effect programs. My Action Book teaches nine action verbs. Monkeys Jumping on the Bed features activities ranging from cause and effect, matching colors, and number or word concepts (Spanish or English). Input to the program is via single switch, TouchWindow, or expanded keyboard. All programs have choice of auditory or visual scan.

Overlays for IntelliKeys and Key Largo are available.

671



**Product Name:** MusicWare - Age Appropriate

**Vendor:** SoftTouch/kidTECH

**Computer:** Apple Macintosh Family

**Cost:** \$75.00 - \$95.00

MusicWare - Age Appropriate is a series of software programs designed specifically for certain ages. Teen Tunes is designed to teach cause and effect to teens and preteens through graphics, animations, and sounds. The Rodeo is designed to teach cause and effect, scanning, visual matching, number matching, and auditory selection to preschoolers, early elementary students, and preteens. Away We Ride includes activities such as matching the correct picture, sound, associated object or word to preschoolers, early elementary students, and preteens. All of the programs have auditory scans for students with visual impairments.

Each program accepts input from the mouse, IntelliKeys, Key Largo, TouchWindow, or single switch. Overlays for IntelliKeys and Key Largo are available.

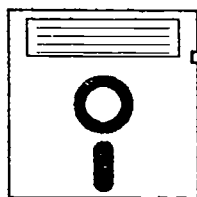

**Product Name:** MY HOUSE: Language Activities of Daily Living

**Vendor:** Laureate Learning Systems, Inc.

**Computer:** Apple IIGS, Apple II Family,  
Apple Macintosh Family, IBM PC Family

**Manual Form:** Printed Manual

**Cost:** \$175.00 - \$200.00

MY HOUSE: Language Activities of Daily Living is a functional language stimulation program. The program, which has speech output, includes six scenes which represent typical rooms of a house, and four activities within each room. In the Discover Labels and Discover Functions activities, the user selects an object within the room, and the computer speaks its label or function respectively. In the Identify Labels and Identify Functions activities, the computer prompts the user to find various objects according to their label or function. Interface options include the standard keyboard, TouchWindow (extra; see entry) or a single switch (extra).

The Apple II version (\$175.00) requires 64K of memory, a monitor, an Echo II speech synthesizer (see entry), and a 5.25" disk drive. The Apple IIGS version (\$200.00) requires one 3.5" disk drive and 1 MB of RAM. The IBM version requires 640K memory, a speech synthesizer, and a disk drive. The Macintosh version (\$200.00) requires Macintosh LC or higher, System 7, hard drive, and 4 MB of RAM. A TouchWindow (see entry) and color monitor are recommended.



**Product Name:** My Paint & Talking Coloring Books

**Vendor:** Laureate Learning Systems, Inc.

**Computer:** Apple IIGS, IBM PC Family

**Cost:** \$90.00

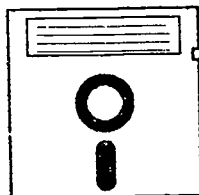

My Paint & Talking Coloring Books is a software package designed to encourage creativity, reinforce vocabulary and concepts, and offer recreational enjoyment for students with special needs. My Paint is a drawing program with large menu icons, different brush sizes, and many other features. My Paint can be used alone or in conjunction with the First Words I & II, First Verbs, and Circus Talking Coloring Books. Each Coloring Book has 20 talking pictures. No reading is required and the programs can be used with touch screen or mouse.

Each of the four Talking Coloring Books can be purchased with My Paint separately for \$50.00. The Apple IIGS version requires one 3-1/2" disk drive and 512K of RAM. The IBM version requires one 3-1/2" disk drive, hard drive, MCGA or VGA graphics, 640K of RAM, and one of the following speech devices: Sound Blaster, Echo PCII, the Sound Source, Adlib Personal Music System, Media MAster, or ProAudio Spectrum.

---

**Product Name:** MY SCHOOL: Language Activites of Daily Living

**Vendor:** Laureate Learning Systems, Inc.

**Computer:** Apple IIGS, Apple II Family, Apple Macintosh Family, IBM PC Family

**Manual Form:** Printed Manual

**Cost:** \$175.00 - \$200.00

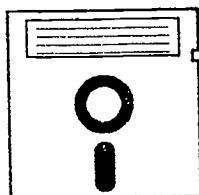

MY SCHOOL: Language Activities of Daily Living is an educational software program designed to teach students about the objects in their school environments. Students are presented with four activities: Discover Names, Identify Names, Discover Functions/Descriptions, and Identify Functions/Descriptions. These activities are placed in six school type settings: classroom, cafeteria, library, music-art room, playground, and hallway.

The program is available for Apple II computers for \$175.00; IBM, Macintosh, and Apple IIGS versions are \$200.00.

673

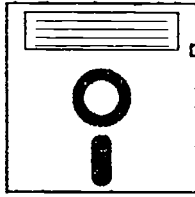

**Product Name:** MY TOWN: Language Activities of Daily Living

**Vendor:** Laureate Learning Systems, Inc.

**Computer:** Apple IIGS, Apple II Family, Apple Macintosh Family, IBM PC Family

**Cost:** \$175.00 - \$200.00

MY TOWN is educational software designed to acquaint the user with object names and their descriptions using familiar locations in a town. The program has four basic activities in six different settings. The activities include: discovering names (select an item within the scene on-screen and the program tells the user what it is), identifying names (program asks the user to find various items according to their names), discovering descriptions (select an item and the program gives a description of it), and identifying descriptions (program asks the user to find certain items according their description). Each of these activities can be explored within the context of graphics depicting a doctor's office, dentist's office, restaurant, park, city neighborhood, and suburban neighborhood. Over 100 objects can be located in the six settings.

The Apple II version (\$175.00) requires 64K memory, a speech synthesizer, and a disk drive. The Apple IIGS version (\$200.00) requires one 3.5" disk drive, and 1 MB of RAM. The IBM version (\$200.00) requires 640K memory, a speech synthesizer, and a disk drive. The Macintosh version (\$200.00) requires Macintosh LC or higher, System 7, hard drive, and 4 MB of RAM.

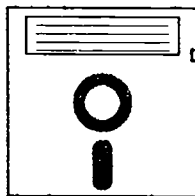

**Product Name:** Nasometer Model 6200-3

**Vendor:** Kay Elemetrics Corporation

**Computer:** IBM PC Family

**Manual Form:** Printed Manual

**Cost:** \$2,950.00

The Nasometer is a microcomputer-based system for the assessment and treatment of nasalance problems associated with the voice. A pair of microphones, one oral and one nasal separated by a baffle plate, separate and record acoustic output from a speaker's nose and mouth. This information is transferred to the computer and a ratio is calculated based on the nasal to oral acoustic output and reported as a nasalance percent. The percent is a measure of the perceived nasality in the speaker's voice. Durational measures also appear automatically. The software includes the ability to place goals for patient attempts, as well as providing picture group and text stimuli for specific exercises. Nasometer games are also provided to reinforce positive results. The software is controlled with mouse pull down menus and predefined keys.

The Nasometer includes specialized hardware, interface card, cables, and headset. This device is designed for use by speech language pathologists and is not recommended for home use.

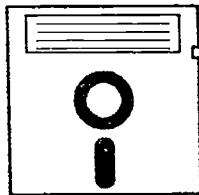

**Product Name:** New Frog & Fly

**Vendor:** Simtech Publications

**Computer:** Apple Macintosh Family

**Cost:** \$20.00

New Frog & Fly is a single switch accessible software program with high resolution color animation and sound. Select from a variety of switch activities ranging from basic cause and effect to speed training.

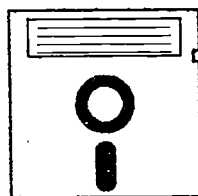

**Product Name:** Numeric Concepts I and II

**Vendor:** BrainTrain

**Computer:** Apple IIGS, Apple IIc, Apple IIe,  
IBM PC Family, IBM PC jr, IBM PS/2 Family

**Cost:** \$149.00 - \$249.00

Numeric Concepts I and II are two computer software modules developed for use as an introduction to eight basic numeric concepts. Three levels of difficulty are included. The puzzle-type format is used to help students understand numeric concepts and develop memory. Numeric Concepts I evaluates and teaches discrimination, combination, number line logic, and dimensions. Numeric Concepts II evaluates and teaches distinctions, ordinal numbers, sequence, and classification. Numeric Concepts I and II each contain four programs.

A computer with 64K (Apple) or 512K (IBM) of memory, one disk drive, and a color monitor are required. The programs may be run using either a joystick (extra) or the keyboard. Each program is \$149.00; the two programs may be purchased together for \$249.00. Contact manufacturer for information about lab pack prices.

675



**Product Name:** Occupations

**Vendor:** UCLA Microcomputer Project

**Computer:** Apple IIGS, Apple IIe,  
Apple Macintosh Family

**Cost:** \$35.00

Occupations is a software educational program designed to teach the user about jobs in the community. The program can be used by one to four players and their task is to identify a fireman, teacher, police officer, gas station attendant, dentist, and doctor. On Level I, the user selects any community worker. On Level II, the user also chooses the correct environment for that worker.

The program runs on Apple IIe and IIGS computers as well as Macintosh LC or LCII. The program requires either the PowerPad or IntelliKeys for use.

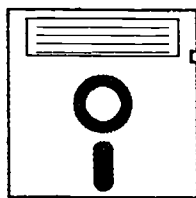

**Product Name:** Octobus

**Vendor:** DEKRO, Inc.

**Computer:** IBM PC Family

**Cost:** \$109.00

Octobus is a software program designed for individuals with head injuries, stroke, or learning disabilities. The program's objectives are to correlate algebraic notations with the correct result, associate two words or two parts of a saying, recognize patterns and compositions, recognize corresponding melodies, and memorize the positions of selected pictures in a group. Eight games are offered and each can be executed in visual, memory, or combination modes. New word files can be added to tailor the exercise to the needs of the student.

System requirements are VGA and a mouse.



**Product Name:** Old MacDonald's Farm I and II

**Vendor:** UCLA Microcomputer Project

**Computer:** Apple II+, Apple IIGS, Apple IIe

**Cost:** \$35.00 - \$36.00

Old MacDonald's Farm is a pair of computer programs based on the nursery song. Old MacDonald's Farm I has three levels. In level 1, the child selects any animal from the PowerPad overlay. In level 2, the child selects the correct animal when prompted by its name. In level 3, the child selects the correct animal after hearing its sound. Old MacDonald's Farm II, which is intended to teach use of prepositions, has two levels. In level 1, the child is required to find an animal associated with a particular preposition. In level 2, the child identifies the preposition from a choice of three animal locations.

An Echo speech synthesizer, PowerPad, and color monitor are required. An Intellikeys version is also available; the Apple IIe emulation card is required.



**Product Name:** On the Job Series - Career Interests

**Vendor:** Conover Company

**Computer:** Apple II Family,  
Apple Macintosh Family, IBM PC Family

**Cost:** \$59.95 - \$149.00

The Career Interests program uses a sixty-question inventory to identify the basic interest patterns of the user. Results are first presented in six basic categories and then converted to the twelve Guide for Occupational Exploration (GOE) scales. The highest areas of interest are then correlated to Conover's Education for Employment system. The program can be customized to include local resources, curriculum, or employers. Career Interests is written at a fifth grade reading level but the program can be used with a speech processor (except in Apple II version) for users with lower or no reading ability.

System requirements for the IBM include MCGA or VGA graphics, 640K, 3-1/2" disk drive, and a speech processor. Requirements for the Macintosh version include a color monitor, system 6.05 or higher, and 2 MB RAM. Requirements for the Apple II version are 48K and a 5-1/4" disk drive. The IBM and Macintosh versions both sell for \$149.00 and the Apple II version sells for \$59.95.

677

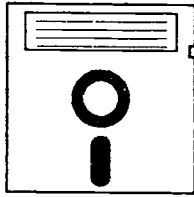

**Product Name:** On the Job Series - Communication Skills

**Vendor:** Conover Company

**Computer:** IBM PC Family

**Cost:** \$2,295.00

On the Job Series - Communication Skills is a job-specific diagnostic program. Each unit in the series covers the reading, writing, and other communication skills necessary to function in the workplace. The program is designed to show students what the specific occupation is, what persons in that job do, and skills necessary to perform that job.

Price is for the complete stand-alone computer system which includes 31 occupational areas, 31 student guides, a management system, and teacher's guide. Individual career areas are available for \$79.95 each.



**Product Name:** On the Job Series - Mathematics

**Vendor:** Conover Company

**Computer:** Apple Macintosh Family, IBM PC Family

**Cost:** \$4,495.00

The Mathematics program provides diagnostic tests of mathematical competencies in relation to specific careers and occupations. Programs for over fifty occupations are included. Each program features full-color computer graphics, immediate feedback, printed and scored reports, and an extensive management system.

Requirements for the IBM version include MCGA or VGA graphics, 640K, and two 3-1/2" or 5-1/4" disk drives. Requirements for the Macintosh version include color, system 6.05 or higher, and 2 MB RAM. Price is for the complete stand-alone system. Individual occupation programs are available for \$89.95. Contact the manufacturer for occupations.

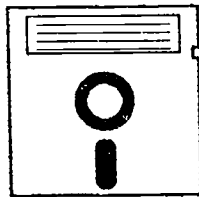

**Product Name:** On the Job Series - Problem Solving Skills

**Vendor:** Conover Company

**Computer:** IBM PC Family

**Cost:** \$1,365.00

On the Job Series - Problem Solving Skills is a job-specific diagnostic and skill enhancement program. Each unit in the series covers the skills necessary to think critically and solve problems related to the workplace. The programs are designed to teach students how to apply what they have learned to the problems and situations that arise in on-the-job settings.

Price is for the complete stand-alone computer system which includes 12 occupational areas, 12 student guides, 7 skill enhancement units, a management system, and a teacher's guide. Individual career areas are available for \$79.95 each.

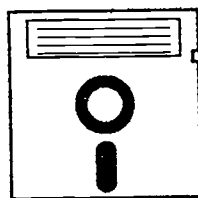

**Product Name:** One Switch Picasso

**Vendor:** Simtech Publications

**Computer:** Apple Macintosh Family

**Cost:** \$20.00

One Switch Picasso is a switch accessible software program that allows users to draw and color a picture. Users can select from four different pictures.

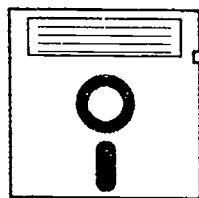

**Product Name:** Opening Windows

**Vendor:** American Printing House for the Blind (APH)

**Computer:** IBM PC Family

**Cost:** \$49.95

Opening Windows is a tutorial kit designed to teach blind and visually impaired computer users the various operations of Microsoft Windows. The kit includes: 11 tactile computer screen reproductions showing the layout of different Windows screens, an audio cassette tutorial, and a 3.5" disk with practice files.



**Product Name:** Opposites and Similarities Plus for Windows

**Vendor:** Parrot Software

**Computer:** IBM PC Family

**Cost:** \$134.95

Opposites and Similarities Plus for Windows is a software program designed to strengthen word retrieval and vocabulary. Users are asked to find word pairs that are the opposite of one another or that are similar to one another. The program presents a word and then asks the user to find an appropriate word from a list of words. Opposites and Similarities Plus requires Microsoft Windows.



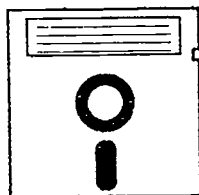

**Product Name:** Order Processing

**Vendor:** Attainment Company

**Computer:** Apple II Family, IBM PC Family

**Cost:** \$295.00

Order Processing is a software program designed to teach students how to process customer orders by entering information from printed account cards. Level One asks the user to enter a three digit number from an account card, then select the method of payment. Level Two requires the user to move to a different screen to check quantities ordered. Level Three requires the user to check the complete order and use inventory information to determine whether there is enough quantity. Level Four requires all ten data fields to be entered.

Program includes a 3.5" and 5.25" disk, a site license agreement, 255 account cards with storage case, and instructions. An Apple II or IBM compatible computer, one disk drive, and a monitor are required to use Order Processing; a printer is optional.

---

**Product Name:** Padded Food

**Vendor:** UCLA Microcomputer Project

**Computer:** Apple II+, Apple IIGS, Apple IIe,  
Apple Macintosh Family

**Cost:** \$35.00 - \$36.00

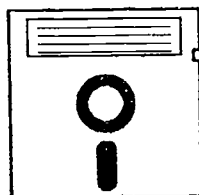

Padded Food may be used to teach cause and effect and basic vocabulary. The student is presented with an assortment of familiar foods and kitchen objects laid out on an overlay. When an object is touched, it appears on the monitor and the speech synthesizer pronounces the name of the food or object.

A speech synthesizer, color monitor, and PowerPad are required; in addition, for the Macintosh and Intellikeys an Apple IIe emulation card is needed.



**Product Name:** Padded Vehicles

**Vendor:** UCLA Microcomputer Project

**Computer:** Apple II+, Apple IIGS, Apple IIe,  
Apple Macintosh Family

**Cost:** \$35.00 - \$36.00

Padded Vehicles is a software program for a game that can be played by one to six players. Using a PowerPad overlay, the players identify ten vehicles: airplane, helicopter, motorcycle, car, truck, ambulance, garbage truck, fire engine, school bus, and police car. In level 1, the player selects any vehicle. In level 2, the player selects a vehicle that corresponds to a name prompt.

A speech synthesizer, PowerPad, and color monitor are required; for the Macintosh and Intellikeys an Apple IIe emulation card is also needed.

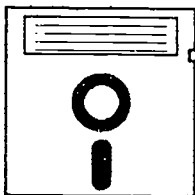

**Product Name:** Paper Dolls I and II

**Vendor:** UCLA Microcomputer Project

**Computer:** Apple II+, Apple IIGS, Apple IIe,  
Apple Macintosh Family

**Cost:** \$35.00 - \$36.00

Paper Dolls are a set of two software programs that let users select items of clothing to dress a figure (either male or female) using the PowerPad or IntelliKeys. Paper Dolls-Dress Me First features five articles of clothing. Paper Dolls-Dress Me Too features twelve articles of clothing, permitting the figure to be dressed for a school day, sunny day, rainy day, or silly day. A Spanish version of Dress Me Too is also available.

A speech synthesizer, PowerPad or IntelliKeys, and color monitor are required; for the Macintosh and Intellikeys, an Apple IIe emulation card is also needed.



**Product Name:** PC Typer

**Vendor:** American Printing House for the Blind (APH)

**Computer:** IBM PC Family

**Manual Form:** Audiotape Manual,  
Large Print Manual

**Cost:** \$49.95

PC Typer is a software program designed to help visually impaired students increase their keyboarding speed and accuracy. The student program has four main components: keyboard drills, a game for keyboarding practice, open typing, and a learn the keyboard feature that announces keys pressed to tell the key locations. An included teacher program allows the teacher to customize program features, create or edit lessons, and work on student records. A teacher's manual is included which explains how to use PC Typer, the teacher program, and the editing feature.

Price is for the complete version of PC Typer: one 3-1/2" and one 5-1/4" each of the student and teacher disks, a large print teacher's manual, and a teacher's manual on cassette. Lab packs of the student program are also available. Most commercially available speech synthesizers and screen access programs work with PC Typer.



**Product Name:** Personal Development Software Series

**Vendor:** Conover Company

**Computer:** Apple II Family, IBM PC Family

**Cost:** \$375.00

The Personal Development Software Series consists of five menu-driven, easy to use programs covering personal development issues. These five issues are self esteem, getting along with others, values, making friends, and stress. Each software program features challenging exercises and concise concepts. Various tutorials help users accept differences in themselves and others.

Apple II version requires 64K and one 5-1/4" disk drive. The IBM version requires 256K and one 5-1/4" or 3-1/2" disk drive. Price is for the complete stand-alone series. Each program is available individually for \$84.00. Network packages are available.

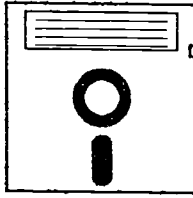

**Product Name:** Pick-A-Meal

**Vendor:** UCLA Microcomputer Project

**Computer:** Apple II Family, Apple Macintosh Family

**Cost:** \$35.00

Pick-A-Meal is a game designed to promote good nutrition for low functioning individuals or children. Level I teaches the four basic food groups and Level II helps the user learn how to select balanced meals for each meal of the day. The program can be used with a single switch or the keyboard. Scan speed is adjustable.

The Apple II version requires a color monitor, 5.25" disk drive, and Echo Speech Synthesizer. The Macintosh version requires a 2E card, a color monitor, 5.25" disk drive, and Echo LC.

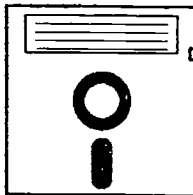

**Product Name:** Pictalk

**Vendor:** UCLA Microcomputer Project

**Computer:** Apple II+, Apple IIGS, Apple IIe

**Cost:** \$35.00

Pictalk is a software program intended to serve as a training aid before an alternative communication device is prescribed. Fifty-four pictures in six categories (places, things, people, action, foods, and emotions) are included. Selection is made by scanning rows and then columns within a selected row.

An Echo speech synthesizer, single switch, and color monitor are required.

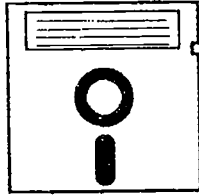

**Product Name:** Picture Cue Dictionary

**Vendor:** Attainment Company

**Computer:** Apple Macintosh Family

**Cost:** \$279.00

The Picture Cue Dictionary is a software program that offers access to 350 talking Picture Prompt Cards. The four programs included are Shopping, Select-A-Meal, Looking Good, and Keeping House. The display mode presents the pictures one-by-one in a sequence. Speed can be adjusted and the user can go forward, backward, and pause. A matching mode is also available. Users can hear the corresponding speech by clicking on or touching the picture displayed. Pictures can be printed for communication boards or other uses.

Each of the four programs are available seperately for \$59.00 - \$69.00. 14 MB free disk space is required. Program is TouchWindow compatible. Site licens€ is available for \$895.00.

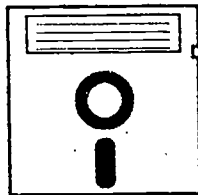

**Product Name:** Picture Identification Plus for Windows

**Vendor:** Parrot Software

**Computer:** IBM PC Family

**Cost:** \$134.95

Picture Identification Plus for Windows is software that presents a real-life picture along with the name of the picture and two foils. The user must select the word that best describes the picture. The foils are words that are semantically related to the picture name. The program includes 50 pictures and progress is traced and available for retrieval in report form. Picture Identification Plus requires Microsoft Windows.

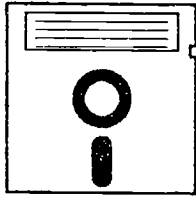

**Product Name:** Picture Naming Plus for Windows

**Vendor:** Parrot Software

**Computer:** IBM PC Family

**Cost:** \$134.95

Picture Naming Plus for Windows presents a real-life picture and asks the user to type the name of the picture. The program recognizes any one of a number of multiple names of pictures. There is an option to accept approximate spellings of the words when the clinician suspects that the user may use letter reversals or the user's spelling abilities are poor. The program includes 50 pictures and progress is tracked and available for retrieval. Picture Naming Plus works with Microsoft Windows.



**Product Name:** Picture Scanner

**Vendor:** R.J. Cooper & Associates

**Computer:** Apple II Family,  
Apple Macintosh Family, IBM PC Family

**Manual Form:** Printed Manual

**Cost:** \$75.00 - \$89.00

Picture Scanner is a single- or double-switch version of Point to Pictures (see separate entry). Picture Scanner starts at the cause/effect level (the Communication mode) with items to motivate and help the learner to use pictures as communication symbols, and progresses to matching and identifying pictures (Training mode) within a context such as a mall or home. In the Communication mode, pictures are presented one at a time until the learner activates a switch to select a picture. In the Training mode, a target picture is presented and the learner is requested to "find" it within the scanning sequence. Like Point to Pictures, the user has a choice of which pictures go in what order. Pictures can be selected from Picture/Theme disks (additional, \$75.00).

The IBM version requires Microsoft Windows.



**Product Name:** Picture/Theme Disks

**Vendor:** R.J. Cooper & Associates

**Computer:** Apple II Family,  
Apple Macintosh Family, IBM PC Family

**Manual Form:** Printed Manual

**Cost:** \$75.00 - \$89.00

Picture/Theme Disks are collections of color pictures with animation and digitized speech. The pictures are for use in Point to Pictures software and Picture Scanner software (see separate entries). The pictures can be inserted in the programs for training language skills and picture selection for augmentative communication. Each Picture/Theme Disk contains pictures relating to a central theme such as mall, playground, or home. There are also disks for Letters, Shapes, Numbers, and Colors.

The IBM version requires Microsoft Windows.

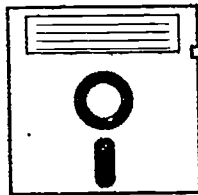

**Product Name:** Pictures Programs: I, II and III

**Vendor:** Parrot Software

**Computer:** Apple II Family, IBM PC Family

**Manual Form:** Printed Manual

**Cost:** \$104.95 each

The three Pictures Programs are: I-Function Pictures, II-Association Pictures, and III-Rhyming Pictures. Each program has two levels of operation. The first level teaches the name of pictures displayed on the screen. The second level teaches the function, an association or a rhyme of the pictures displayed. In each program six color pictures are displayed at a time.

Responses are made by pressing the space bar and the Return key, or by a single switch plugged into the game port. The programs may be purchased individually or as a set.

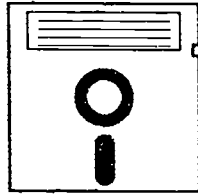

**Product Name:** Point to Pictures  
**Vendor:** R.J. Cooper & Associates  
**Computer:** Apple II Family  
**Manual Form:** Printed Manual  
**Cost:** \$75.00 - \$89.00

Point to Pictures is a touchpad-oriented program designed to help people with communication disorders learn about and use language. The program starts at the cause/effect level (Communication mode) with items to motivate and help a learner to use pictures as communication symbols, and progresses to matching and identifying pictures (Training mode), within a context such as a mall or home. Point to Pictures can also operate battery-operated toys and electrical appliances with an optional Toy Interface (\$75). Using optional Picture/Theme disks, the user can select where pictures go on the touchpad.

The Apple II version requires 128K of memory, an appropriate touchpad (TouchWindow, PowerPad, Unicorn Keyboard, IntelliKeys, Concept Keyboard), and an Echo II speech synthesizer. The IBM version requires Microsoft Windows.

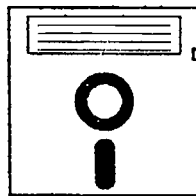

**Product Name:** Positive Parenting  
**Vendor:** MCE  
**Computer:** Apple II Family  
**Cost:** \$69.96 - \$99.95

Positive Parenting is a computer program designed to introduce users to the problems and challenges of parenting. The program uses interactive problems to discuss common parenting situations. As the user progresses through the activities, responses are tailored to the user's own set of circumstances. The software is written for a 3rd-4th grade reading level and an 9th grade-adult interest level.

One copy may be purchased for \$69.95 and a five pack for \$99.95.





**Product Name:** PowerPad Preschool Pack I & II

**Vendor:** Creative Communicating

**Computer:** Apple IIGS, Apple IIe

**Cost:** \$25.00 - \$100.00

PowerPad Preschool Pack I includes an electronic version of a pop-up book called Hide & Seek with Fluffy, an animated storybook called Five Little Fish, a search game called Mystery Box, and an object location game called Bus to School. Pack II includes an animated storybook with cause-effect and sequenced pictures called Five Little Frogs, an electronic version of a pop-up book called Magic Hats, a holiday version of Mystery Box, and a program that duplicates the traditional Pin the Tail on the Donkey game.

Each pack sells for \$100.00 and the individual programs can be purchased for \$25.00 each. The programs require a Dunamis PowerPad (see entry).

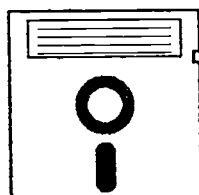

**Product Name:** PowerTalker

**Vendor:** UCLA Microcomputer Project

**Computer:** Apple IIGS

**Cost:** \$45.00

PowerTalker is a software program designed to act as a training communication board with the PowerPad (see entry). The program is suited for children of eighteen months to three years of age. PowerTalker must be set up by choosing to work in particular quadrants on the PowerPad, selecting from the set of sixteen phrases on the library disk, and picking appropriate graphics from those on the graphics library disk.

PowerTalker is compatible with Apple IIGS computers. It requires the PowerPad and a speech synthesizer (extra).

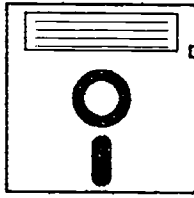

**Product Name:** Prefix

**Vendor:** DEKRO, Inc.

**Computer:** IBM PC Family

**Cost:** \$109.00

Prefix is a software program designed for individuals with head injuries, stroke, or learning disabilities. The program's objective is to internalize a thorough knowledge of how to manipulate quantities up to 20. Eight exercises are included with graphics of animals, fruits, dominoes, cards, and other common objects. The level of difficulty can be set by defining the range of numbers involved and the span of the operators. Detailed statistical information for each exercise can be saved and printed.

A mouse is required.

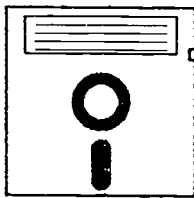

**Product Name:** Preposition Fill-Ins

**Vendor:** Parrot Software

**Computer:** Apple II Family

**Cost:** \$104.95

Preposition Fill-Ins is a program designed to provide cognitive training in use of prepositions. A sentence with the preposition missing is presented, followed by a list of three prepositions. The user selects the appropriate preposition using the space bar and the return key. The program provides visual and auditory reinforcement. Preposition Fill-Ins has features that keep track of user progress and that allow clinicians to author their own programs.



**Product Name:** Press to Play

**Vendor:** Don Johnston Incorporated

**Computer:** Apple Macintosh Family

**Cost:** \$45.00

Press to Play is a basic switch software series designed for broad age-group appeal. Games can be played in four modes: cause & effect, simple scan, complex scan, and point (the point mode uses the TouchWindow). Two titles are available: "Animals" features animals in humorous situations and "Speedy" features a boy wheelchair user engaging in daily activities.



**Product Name:** Primer 83

**Vendor:** Dynacomp, Inc.

**Computer:** Apple II Family

**Manual Form:** Audiotape Manual, Printed Manual

**Cost:** \$99.95

Primer 83 is a user oriented graphics program for individuals with dyslexia and related disorders. Primer 83 allows diagnosis of specific difficulties in letter recognition; alteration of character fonts and presentation time to improve discrimination; instantaneous recognition training for common words and sentence structures; and synthesized music with cadence-synchronized visual presentation of lyrics, including a song editor. Primer 83 enhances user motivation through rapid feedback and adaptive drills.



**Product Name:** Problem Solving I

**Vendor:** Psychological Software Services, Inc.

**Computer:** IBM PC Family

**Manual Form:** Printed Manual

**Cost:** \$400.00

Problem Solving I is a package of software programs that are designed to challenge higher level attention and executive skills. The Number Manipulations series contains a visual, paced, serial addition task, a number puzzle, and a multiple simultaneous addition task. The Maze Puzzle generates random mazes on each run. The Deduction program contains graphics routines designed to promote understanding of task and its utility. The Checker Exchange requires the user to exchange the positions of the two sets of checkers. The Cryptograms program contains 12 full sentences, the content of which is a wise reflection, observation or human nature or a philosophical statement. Also included is a more advanced program called the Knight's Challenge.

Microsoft Windows is required.

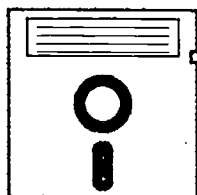

**Product Name:** R.A.P.S. Software Series I PowerPad

**Vendor:** Creative Communicating

**Computer:** Apple IIGS, Apple IIe

**Cost:** \$65.00

The R.A.P.S. Software Series includes the stories Looking Great, Showtime, and Too Bad for Dad on disks with corresponding PowerPad overlays. The software features repeated lines, colored graphics, animation, text, speech, story retelling, and games. Both stories are from the R.A.P.S. book.

A Dunamis PowerPad (see entry) is required.

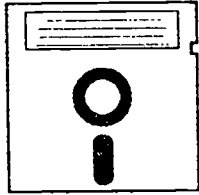

**Product Name:** Rabbit Scanner

**Vendor:** Exceptional Children's Software, Inc.

**Computer:** Apple II Family

**Manual Form:** Printed Manual

**Cost:** \$3.95

The Rabbit Scanner is a scanning training program that uses a graphic of a rabbit hopping across the screen in a single horizontal line. A carrot is placed in one of five positions on the screen. When the rabbit reaches the carrot, the child triggers a game paddle, adapted switch (adapter required), or the space bar. Color matching and shape matching programs are also included. The program can be adjusted to challenge the user appropriately.



**Product Name:** Race the Clock

**Vendor:** Mind Play

**Computer:** Apple II Family,  
Apple Macintosh Family, IBM PC Family,  
IBM PC jr

**Manual Form:** Printed Manual

**Cost:** \$49.99 - \$69.99

Race the Clock is a learning game designed after the popular "Concentration" game. The user tries to match pictures with pictures, pictures with words, or words with words. Each box in the array presented on the screen can display a verb or an animated figure acting out the verb's action. Selections may be made using the keyboard, a mouse, or a joystick (not included). Race the Clock permits authoring and is equipped with a "challenge upgrade option," which allows various skill levels involved to be adjusted, independent of each other.

The program is IBM (\$59.99) and Apple II (\$49.99) compatible; and a CD-ROM version this program is available for \$69.95. A Macintosh version is also available for \$69.99.



**Product Name:** Rate Drill in Articulation, Language and Fluency

**Vendor:** UNITED Educational Services, Inc.

**Computer:** Apple II Family

**Manual Form:** Printed Manual

**Cost:** \$45.00 - \$115.00

Rate Drill in Articulation, Language, and Fluency (RALF) is a training program for practice in rate of speech. Each part (Articulation, Language, or Fluency) allows the user to perform drills on either sentence or paragraph units in two different modes: determining actual word-per-minute (WPM) rates in practice, or pre-selecting WPM rates for each stimulus. A feature of the program called Inflection allows the user to practice the same sentence or paragraph units, with selected words capitalized for greater emphasis or stress.

In Part I (Articulation), the following phonemes are represented with five different sentence or paragraph combinations each: /l/, /r/, /s/, /z/, /th/ (voiced and unvoiced), /sh/, and /ch/. In Part II (Language), the concepts represented are: plurals, prepositions, tensing, possession, and negation. In Part III, five different paragraphs practice various rate drills. A disk is available separately for each part or as a kit.

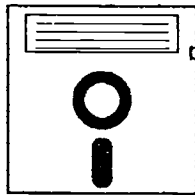

**Product Name:** Reactions (R73)

**Vendor:** Don Johnston Incorporated

**Computer:** Apple IIGS

**Cost:** \$40.00

Reactions is an early skills educational software program designed to teach cause-effect principles. There are six games which students play at a cause-effect level or actively make selections among four choices. Games include: Piano Tunes, Puzzle Game, and Shape Game. Switch input and selection parameters may be customized for each user.

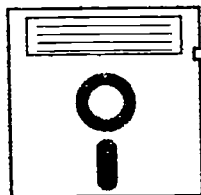

**Product Name:** Reading a Ruler - English & Metric

**Vendor:** Conover Company

**Computer:** Apple II Family, IBM PC Family

**Cost:** \$89.95 each

Reading a Ruler - English & Metric are two programs to give extra help for a student or employee who is having trouble learning how to read a ruler. The English version covers the basics of inches, feet, yards, half, quarters, eighths, and sixteenths. The metric version consists of an introduction to the system and different types of metric instruments used with rulers. Both programs include three lessons and three quizzes.

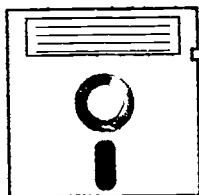

**Product Name:** Reading Comprehension for Adolescents

**Vendor:** Parrot Software

**Computer:** Apple IIGS, Apple IIc, Apple IIe, IBM PC Family

**Manual Form:** Printed Manual

**Cost:** \$104.95

Reading Comprehension for Adolescents is designed to increase literal and inferential comprehension skills. Ten short stories on topics of interest to adolescent students are used. The literal lesson requires comprehension of information provided in the story. The inferential lesson requires the student to make inferences about the information provided in the story. The program also teaches strategies for reading comprehension. The story may also be hidden after it is read so that the student must rely on comprehension and memory to answer questions. Progress is recorded on disk, and reports may be printed at any time.

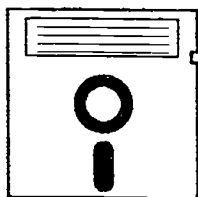

**Product Name:** Reasoning Skills on the Job

**Vendor:** Conover Company

**Computer:** Apple II Family

**Cost:** \$1,995.00

Reasoning Skills on the Job is a vocational exploration and assessment program. The program consists of skill identification and application, assessment, and remediation components. A variety of activities identify the need for reasoning skills in a selected occupational area and compare that requirement with an individual's ability to think critically and solve problems.

This program is available in printed and computer disk form. The computer form consists of vocational information disks, student guides, and a teacher's guide. Vocational disks can be purchased separately for \$99.95 per cluster. Apple and IBM versions are available.

^

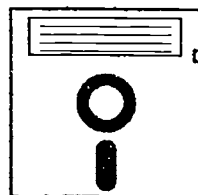

**Product Name:** Rhyming Pictures

**Vendor:** Parrot Software

**Computer:** Apple II Family, IBM PC Family

**Cost:** \$99.50

Rhyming Pictures is a two-level program for cognitive training based on the use of pictures. The first level is a picture identification task requiring users to correctly match a picture with a prompt (e.g., "Find the purse.") The second level is a rhyming task. At this level, users must correctly determine which picture rhymes with a word given as a prompt (e.g., "What rhymes with shoot?"). Responses are made by pressing the space bar and return key.



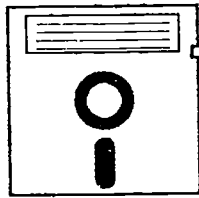

**Product Name:** Rockets to the Moon  
**Vendor:** UCLA Microcomputer Project  
**Computer:** Apple IIe, Apple Macintosh Family  
**Manual Form:** Printed Manual  
**Cost:** \$35.00

Rockets to the Moon is an educational game program for one to four players. Rockets to the Moon uses color graphics and synthesized speech to promote concepts such as sequencing, turn-taking, and color identification. Players use one shared single switch to operate the game. The game must be set up and the students names entered by the instructor: from there the students can play by themselves. The program tells the students verbally how and when to play.

Rockets to the Moon requires a color monitor, a speech synthesizer, and an adaptor for plugging switches into the computer's game port; for the Macintosh, an Apple IIe emulation card is also needed. The manufacturer recommends it for the three to five age range.



**Product Name:** Run Rabbit Run  
**Vendor:** Exceptional Children's Software, Inc.  
**Computer:** Apple II Family  
**Manual Form:** Printed Manual  
**Cost:** \$39.95

Run Rabbit Run is a software program that provides training in horizontal and vertical scanning concepts. The user guides a small rabbit down a path from the farmer's garden to his home. Along the way, the rabbit encounters a number of obstacles. The user presses a key to have the rabbit jump over the obstacles at the appropriate time. The program can be adjusted to challenge the user appropriately.

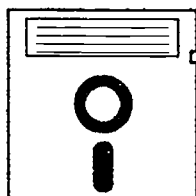

**Product Name:** Safety Signs

**Vendor:** Conover Company

**Computer:** Apple II Family, IBM PC Family,  
IBM PS/2 Family

**Manual Form:** Printed Manual

**Cost:** \$209.00

Safety Signs is a four-disk microcomputer program that teaches 40 signs which are essential for community living. The disks cover common warning signs (e.g., "Beware of Dog," "Stop," "No Smoking," "Police"). The program is broken into an Instructional Segment, a Unit Review, and a Generalization Probe, and an Evaluation Segment where information is contained for each user on words attempted, words correct on the first try, and words correct on the second try.

The program includes 4 disks, an administration manual, and 6 workbooks. An Apple II system with at least 64K of memory, one disk drive, and an appropriate speech synthesizer are required. A color monitor, joystick, and printer may also be used with the program. The IBM version requires 256K of memory.

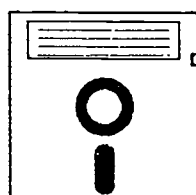

**Product Name:** Scan & Match 1, 2, 3, and 4

**Vendor:** Simtech Publications

**Computer:** Apple Macintosh Family

**Cost:** \$20.00 each

Scan & Match 1, 2, 3, and 4 are switch accessible software programs that give users practice in sequential linear scanning with picture matching activities. All four programs provide performance data which can be printed and saved to disk.

Scan & Match 1 features color graphics of puppies, kittens, flowers, and candy. Scan & Match 2 features color graphics of insects, cars, trucks, and dinosaurs. Scan & Match 3 features color graphics of babies, toys, and critters. Scan & Match 4 features color graphics of breakfast, lunch, dinner, and snack foods.



**Product Name:** Scan It - Switch It

**Vendor:** UCLA Microcomputer Project

**Computer:** Apple IIGS, Apple Macintosh Family

**Cost:** \$45.00

Scan It - Switch It is a program designed to teach horizontal and vertical scanning using a single switch or TouchWindow. Instruction progresses through five levels of difficulty from capturing a single object with a moving box to using scanning to select matching items. The number of items, size and orientation of boxes, number of boxes, and number of errors before a cue is given can be selected by the teacher. Players names can be entered and record keeping is available.

The Apple IIGS version requires a color monitor, 3.5" disk drive, and Echo Speech Synthesizer. The Macintosh version requires a color monitor, 3.5" disk drive, and Echo LC.

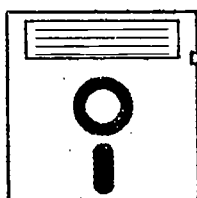

**Product Name:** Scanning Picasso

**Vendor:** Simtech Publications

**Computer:** Apple Macintosh Family

**Cost:** \$20.00

Scanning Picasso introduces sequential linear scanning in four activities involving drawing and coloring. The program Features a scanning activity menu and widely variable scanning speed.



**Product Name:** Seasons

**Vendor:** UCLA Microcomputer Project

**Computer:** Apple IIGS

**Cost:** \$45.00

Seasons is an educational software program designed to teach the user about the attributes of the four seasons. Users select a season from the menu and objects from each season scan the bottom of the screen. Items are selected by using either the mouse, TouchWindow, switch, or space bar. When a season is completed there is an option to type a brief statement about the scene.

Seasons is compatible with Apple IIGS computers only. A speech synthesizer is recommended.

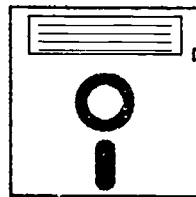

**Product Name:** Seek & Find

**Vendor:** UCLA Microcomputer Project

**Computer:** Apple IIGS, Apple Macintosh Family

**Cost:** \$55.00

Seek & Find is a software program on two disks designed to promote matching, figure ground and auditory discrimination utilizing four scenes: park, campground, the city, and a play room. Three or four levels are included in each version. Apple IIGS Level I requires the user to find the item to match in a scene. Level II requires the user to find the object without a visual prompt. Level III requires the user to identify the object by the sound it makes. Macintosh Level I requires the user to choose any object, Level II match the item, Level III find the item by name, and Level IV find the item by sound.

The Apple IIGS version requires a color monitor and a 3.5" disk drive. The Macintosh version requires a color monitor, a 3.5" disk drive, and a hard disk drive.

00

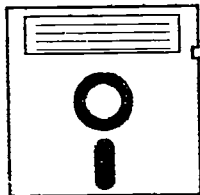

**Product Name:** Semantic Development Using Code Breaking Strategies

**Vendor:** Parrot Software

**Computer:** Apple IIGS, Apple IIc, Apple IIe, IBM PC Family

**Manual Form:** Printed Manual

**Cost:** \$104.95

Semantic Development Using Code Breaking Strategies is a computer program that requires users to determine an unknown sentence using an alphanumeric code. Blanks indicating the length of words in the code appear at the top of the screen. In the center of the screen, the coding strategy appears, indicating the code value for each letter. At the bottom of the screen is a prompt indicating what letter should be entered (e.g., "Enter the letter for code 7"). One code and ten lessons are provided. Clinicians may modify or add codes and lessons to suit specific client needs. Three levels of difficulty are offered: as the level increases, codes are withheld for some letters, so that the client must guess some letters on the basis of sentence context rather than the coding strategy. User progress is automatically tracked, and workbook-like assignments may be printed out.

Memory requirements are 128K for Apple computers. Specify computer and required disk size (3.5" or 5.25") when ordering.

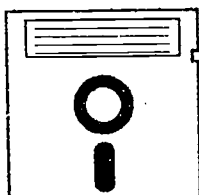

**Product Name:** Sentence Completion Plus for Windows

**Vendor:** Parrot Software

**Cost:** \$134.95

Sentence Completion Plus for Windows is a software program that uses a cloz procedure to elicit words. An open phrase or sentence is listed at the top of the screen and the user must select the word that finishes the phrase or sentence from three choices listed below. The vocabulary and categories can be adapted. The program works with Microsoft Windows.

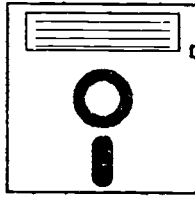

**Product Name:** Sentence Key & Picture Sequence Key

**Vendor:** Mayer-Johnson Company

**Computer:** Apple Macintosh Plus

**Cost:** \$89.00

Sentence Key & Picture Sentence Key are programs which encourage reading readiness skills. In Picture Sentence Key, the student selects a person, action, and object from columns of pictures to form a sentence. When the pictures are chosen, the appropriate word is "spoken" by the computer; the completed sentence is also spoken and the symbols for each word are animated. Sentence Key is a similar program except the actual words are selected instead of pictures.

These programs require a Macintosh Plus computer or higher, a hard disk, and HyperCard.



**Product Name:** Sentence Master

**Vendor:** Laureate Learning Systems, Inc.

**Computer:** Apple II Family,  
Apple Macintosh Family, IBM PC Family

**Cost:** \$475.00 each level

Sentence Master: A Program for Success in Reading is a software program designed to teach reading skills to students who have difficulty with phonics or oral language, or who have impulsive learning styles. The program uses speech output, graphics, and animation. Over-learning of the non-content words (such as "the," "is," and "here") is emphasized; however, equal attention is given to content words. Scan speed and response time are adjustable. A lesson summary of each activity may be read on-screen or printed.

Four levels of Sentence Master are available. Each level consists of eight Story Diskettes, each with its own Workbook Diskette and reproducible Story Booklet with written exercises. Each Workbook Diskette includes the activities Word Recognition, Sequential Recognition, Spelling, and Sentence Completion. Versions available for Apple IIc, Microsoft Windows on IBM compatible PCs, and Macintosh computers. Interface options include TouchWindow (see entry), single switch, or keyboard. A color monitor and printer are recommended.



**Product Name:** Shell Game & Mouse Game

**Vendor:** SoftTouch/kidTECH

**Computer:** Apple Macintosh Family

**Cost:** \$45.00 - \$75.00

Shell Game and Mouse Game are designed to increase cognitive skills in a game format. The games are designed to improve visual tracking, memory, hand placement, scanning, and cause and effect. Each program has three levels of difficulty. Input to the program is via single switch, TouchWindow, or expanded keyboard.



**Product Name:** Sight Words

**Vendor:** UCLA Microcomputer Project

**Computer:** Apple II+, Apple IIGS, Apple IIe

**Cost:** \$35.00

Sight Words is a software program designed for early training in sight recognition of vocabulary. Six categories of words are included. The scanning speed may be adjusted, and the words may be selected either by activating a switch or by pressing the space bar.

An Echo speech synthesizer and color monitor are required. A switch is optional.



**Product Name:** Silly Sandwich

**Vendor:** UCLA Microcomputer Project

**Computer:** Apple II+, Apple IIGS, Apple IIe,  
Apple Macintosh Family

**Cost:** \$35.00 - \$36.00

Silly Sandwich is a computer program that lets users build a sandwich, selecting from pictures on a PowerPad overlay. At Level 1, there are six items to select from; at Level 2, there are 12 items.

A speech synthesizer, PowerPad or IntelliKeys, and color monitor are required; for the Macintosh and Intellikeys, an Apple IIe emulation card is also needed.



**Product Name:** Simple Sentence Structure

**Vendor:** Laureate Learning Systems, Inc.

**Computer:** Apple IIGS, Apple IIe,  
Apple Macintosh Family, IBM PC Family

**Cost:** \$150.00 - \$175.00

Simple Sentence Structure is a language intervention program based on linguist Noam Chomsky's generative grammar theory. This program assists children with language disorders to correctly set universal word order parameters to their English Subject-Verb-Object word order setting by systematically presenting graphic sets of sentence pairs. The learner is then asked to choose a picture that illustrates a particular sentence. Speech, color graphics, and animation maintain the learner's attention. Four sentence sets (contrasting verbs, contrasting objects, contrasting subjects, and subject/object reversal) and six levels of training are available. Varying amounts of instruction, cuing, and feedback accommodate a wide range of learners.

The Apple IIe version sells for \$150.00 and the Apple IIGS, IBM, and Macintosh versions each sell for \$175.00.



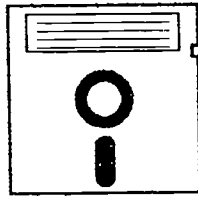

**Product Name:** SimpleCom I: Yes/No Communication

**Vendor:** Dunamis, Inc.

**Computer:** Apple IIGS, Apple IIe

**Manual Form:** Printed Manual

**Cost:** \$59.95

SimpleCom I: Yes/No Communication is a communication output program for expressing simple daily living needs and training early communication skills. The program utilizes training sequences that help the user in yes/no differentiation, and are designed to facilitate cause-effect association. The teacher may modify prompts, reinforcements, and speech output of the synthesizer.

The program operates with a PowerPad and an Echo II speech synthesizer, both extra; contact manufacturer for details.

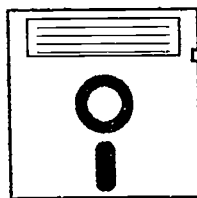

**Product Name:** SimpleCom II: Needs/Wants Communication

**Vendor:** Dunamis, Inc.

**Computer:** Apple IIGS, Apple IIe

**Manual Form:** Printed Manual

**Cost:** \$59.95

SimpleCom II: Needs/Wants Communication is a voice output program for communication of basic needs and wants. The program contains a list of ten basic needs including go to bathroom, drink, eat, go outside, help, hurt, music, play, sleep, and watch TV. These needs are displayed with large graphic symbols, and user activates voice output by touching the PowerPad. Additional needs or wants can be added by drawing other symbols with the MicroIllustrator program (extra).

A PowerPad and Echo speech synthesizer are required for operation (extra). Manufacturer can also custom design the needs menu at additional cost; contact manufacturer for details.

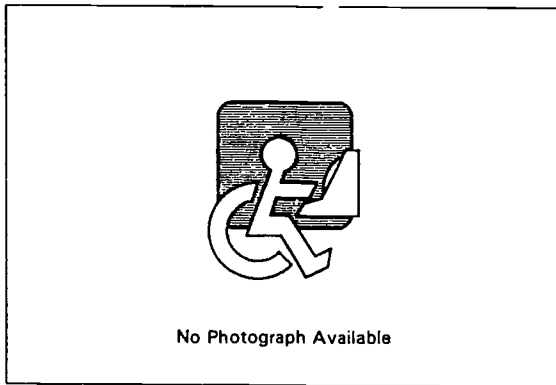

**Product Name:** Single Switch Software

**Vendor:** Various (Generic Product)

**Computer:** All (Hardware Independent)

**Cost:** Varies

Many pieces of software designed to be accessible for people with disabilities are listed in the software sections of this resource book. Building accessibility features into software products, however, is becoming more common for software developers targeting early education. The single switch and other accessibility features are more often included as a part of software oriented to the general education market. While this book catalogs some of these specific applications, many of these features may be found in more and more software as a standard feature.

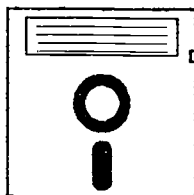

**Product Name:** Single Switch/MatchBox Pack I

**Vendor:** Creative Communicating

**Computer:** Apple IIGS

**Cost:** \$60.00

The Single Switch/MatchBox Pack includes a version of the pop-up book called Hide & Seek with Fluffy and a musical storybook called Five Frogs on a Log. Both can be read via a switch or mouse click and include picture overlays for the MatchBox keyboard cover.

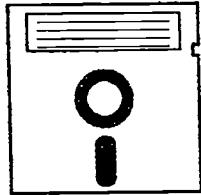

**Product Name:** Son of Seek and Find  
**Vendor:** UCLA Microcomputer Project  
**Computer:** Apple Macintosh Family  
**Cost:** \$55.00

Son of Seek and Find is a game designed to promote matching, figure ground discrimination, and auditory discrimination in scenes of a farm, classroom, or house. In Level I, the user finds the item to match in the scene. In Level II, the user finds the object asked for within the scene without visual prompt. In Level III, the user finds the object after hearing the sound it makes. The program is designed for use with the PowerPad, Intellikeys, or TouchWindow.

A color monitor, hard drive, and 3.5" disk drive are required.

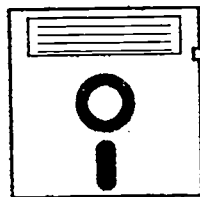

**Product Name:** Sorting by Category Plus for Windows  
**Vendor:** Parrot Software  
**Computer:** IBM PC Family  
**Cost:** \$134.95

Sorting by Category Plus for Windows is software that requires the user to sort words into appropriately related categories. The screen is divided into either two or three columns each with a corresponding category button. A word is then presented that belongs to one of the categories listed. The user presses the appropriate button to place each word into the correct category column. The program works with Microsoft Windows.



**Product Name:** Sound Scope

**Vendor:** GW Instruments

**Computer:** Apple Macintosh Family

**Manual Form:** Printed Manual

**Cost:** \$490.00 - \$4,990.00

Sound Scope is a hardware and software package for the Apple Macintosh that allows speech patterns to be displayed graphically. An optional hardware unit accepts the incoming audio signal and translates it into a digital signal. The software translates this signal's various characteristics into graphic representations on the computer screen. Viewing options include: wide and narrow band spectrograms (showing progression of frequency spectra with time), spectra displayed in fast Fourier transform (FFT) plots, fundamental frequency (variation of vibration of the larynx in an utterance), and multiple window viewing of several displays simultaneously. The user can edit, save, delete, play, append, amplify, zero, offset and normalize segments of an utterance. Utterances can be saved to disk and graphic displays printed out.

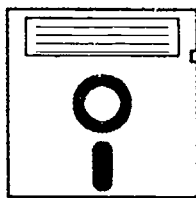

**Product Name:** Special Education Public Domain Software

**Vendor:** Technology for Language and Learning, Inc.

**Computer:** Apple II Family

**Cost:** \$5.00 per volume

Special Education Public Domain Software is a collection of computer programs to be used in the instruction of people who have language, learning, or physical disabilities. Topics covered by these programs include: reading, math, spelling, augmentative training, Morse code writing skills, cognitive rehabilitation, and language development. Some of the software may be used with the Power Pad, a single switch, or the TouchWindow. An Echo speech synthesizer may be used for speech output with some programs.

A catalog of program titles may be purchased for \$10.00. Each title is \$5.00.



**Product Name:** SpeechViewer II

**Vendor:** IBM Corporation

**Computer:** IBM PC Family

**Cost:** \$1,795.00

SpeechViewer II is a software and hardware package for use in speech therapy. The software has fifteen modules which are grouped according to clinical objectives. In the group of Awareness modules, the user controls graphics through loudness, pitch, and voicing onset. The Skill Building Modules have video game-style animation which is used to achieve preset goals of pitch, voicing, vowel accuracy, vowel contrasting, consonants, sequences of phonemes, syllables and words. Patterning modules use waveform, spectra, and spectrogram displays to provide clients with visual representations of running speech. SpeechViewer II software comes with instructions, "Getting Started" videotape, handheld microphone, speech adapter, speaker, power adapter and cables.

SpeechViewer II is IBM compatible. It requires at least 640K of memory and a 20MB hard disk. A color monitor is recommended. An upgrade for customers with SpeechViewer is available; contact the manufacturer. Information and ordering for this product are handled at (800) 228-0752 in the U.S. and (800) 465-7999 in Canada.

---

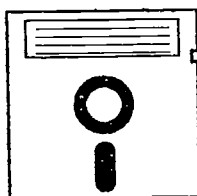

**Product Name:** Steps for Career Choice

**Vendor:** Conover Company

**Computer:** Apple II Family, IBM PC Family

**Cost:** \$195.00

Steps for Career Choice is a computerized self-exploration and career decision-making system intended for the older, more experienced user with a reading level of sixth grade and up. Program components include interest assessment based on the Guide for Occupational Exploration (GOE) system, self rating of the user's area of greatest competence, identification of career choices based on education level, prioritizing work-related values, a decision model, completing a career plan, and access to a data bank of 300 occupations.

System requirements for the Apple II version are 64K, two 5-1/4" disk drives, and a printer. Requirements for the IBM version are 256K, two 5-1/4" or 3-1/2" disk drives, and a printer. Price includes an administration manual.

709

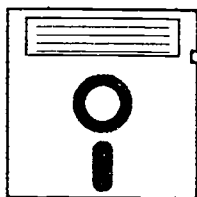

**Product Name:** Storytime Series

**Vendor:** Creative Communicating

**Computer:** Apple IIGS, Apple IIe

**Cost:** \$125.00 - \$265.00

The Storytime Series includes the Just for Fun! Series, the Holiday Fun! Series, and part I and II of the original Storytime Series. The Storytime Just for Fun! Series is a set of five software stories featuring simple colorful graphics, animation, enlarged text, and highlighted text to speech. The Storytime Holiday Fun! Series is a set of six stories featuring simple colorful graphics, animation, and text to speech. The Storytime I Series has the same features and includes stories called Forgetful's Secret, Bobby Bobby, Dirty Duds, Forgetful Goes to School, and Forgetful Mokes Cereal. The Storytime II Series includes stories called Time for Bed, Cooking Dinner, On the Farm, Let's Make Juice, and Going to the Toy Shop.

The series are available for use with the PowerPad (see entry), single switch, or mouse. The Holiday Fun! Series sells for \$150.00, Just for Fun! Series sells for \$125.00, both Storytime I and II sell for \$125.00 each and together for \$265.00.

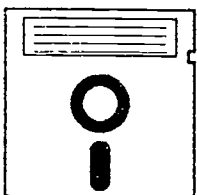

**Product Name:** Storytime Series for Macintosh

**Vendor:** Creative Communicating

**Computer:** Apple Macintosh Family

**Cost:** \$55.00 - \$125.00

The Storytime Series for Macintosh includes the original Storytime Tales, the Storytime Construction Series, and the Just for Fun! Series. Storytime Tales are animated picture-book software programs designed to encourage early learning skills. Story lines include baking a cake, washing clothing, and learning body parts. The Construction Series gives support for beginning risk-taking and creativity through scanning and/or direct selection. The Just for Fun! Series includes five stories featuring simple graphics, animation, digitized speech, and enlarged text.

Storytime Tales (\$95.00) and the Construction Series (\$55.00) are designed for use with the keyboard or single switch. The Just for Fun! Series (\$125.00) is available for use with the Intellikeys or single switch.



**Product Name:** Studio4

**Vendor:** DEKRO, Inc.

**Computer:** IBM PC Family

**Cost:** \$109.00

Studio4 is a software program designed for the low functioning patient or the younger child. The program offers training in basic problem solving techniques, simple mazes, copying patterns, matching complex shapes, sorting items based on visual characteristics, and altering quantities by manipulating individual items. Several levels of difficulty are available.



**Product Name:** Subtle Messages

**Vendor:** Subtle Impact Software, Inc.

**Computer:** IBM PC Family

**Cost:** \$225.00

Subtle Messages is a series of lessons on CD-ROM that teach the use of non-manual behaviors in American Sign Language. Each lesson of 20-30 minutes is designed for all ASL students and focuses on a specific non-manual behavior. The four lessons currently available are: Question Forms, Assertion & Negation, Topicalization, and Conditionals. All lessons are designed to be easy to use, are interactive and video intensive, present many models of deaf signers, provide immediate feedback, and keep track of student progress.

Minimum system requirements include: 486-25 Mhz computer, 4MB RAM, Microsoft Windows, double speed CD-ROM drive, and SVGA monitor. Price is for a three-CD set of all four lessons. Site/Network licenses are also available. Other lessons are being developed, contact manufacturer for details.



**Product Name:** Survival Words

**Vendor:** Conover Company

**Computer:** Apple II Family, IBM PC Family,  
IBM PS/2 Family

**Manual Form:** Printed Manual

**Cost:** \$179.00

Survival Words is a set of programs designed to teach words for community living, including "exit," "ped xing," "out of order," and "phone." Graphics and verbal reinforcement are incorporated in the learning exercises. Instruction, review, and evaluation functions are included.

The program includes 3 disks, an administration manual, and 6 workbooks. Input may be made via the keyboard or with a joystick. A speech synthesizer is required for verbal reinforcement during use of Survival Words. Apple II versions require 64K of memory and IBM versions need 256K of memory.

---

**Product Name:** Swim, Swam, Swum: Mastering  
Irregular Verbs



**Vendor:** Laureate Learning Systems, Inc.

**Computer:** Apple Macintosh Family

**Cost:** \$115.00

Swim, Swam, Swum: Mastering Irregular Verbs is a software program designed to train irregular verbs, reinforce reading skills, and provide practice with standard multiple choice format. The level of difficulty and individual verbs to be trained is specified by the teacher. Features include voice, animation, and automatic record-keeping. The program can be used with keyboard, touch screen, single switch, or mouse.

System requirements include a Macintosh LC or higher, system 7 software, hard drive, and 4 MB of RAM.





**Product Name:** Switch Arcade  
**Vendor:** Simtech Publications  
**Computer:** Apple Macintosh Family  
**Cost:** \$20.00

Switch Arcade is a collection of single-switch accessible carnival games. A shooting gallery, baseball throw, and dart toss are included. Features realistic color graphics, animation, and sounds.



---

**Product Name:** Switch Arcade  
**Vendor:** UCLA Microcomputer Project  
**Computer:** Apple IIGS  
**Cost:** \$35.00

Switch Arcade is a program for two players to play games with each other using single switch input. Games include: tug-of-war, racing cars, fishing, racing wheelchairs, and others. The games are designed for users three years of age and older.



**Product Name:** Switch Art

**Vendor:** Judy Lynn Software

**Computer:** IBM PC Family

**Cost:** \$29.00

Switch Art is a coloring program designed for users with limited motor skills and a cognitive age level as young as one year. Activation of the single switch or space bar is required to color the picture. No prior understanding of the coloring concept is needed. Switch Art is designed to reinforce color selection, hand eye coordination, vertical and horizontal tracking, and cause and effect.

An EGA or VGA monitor is required.

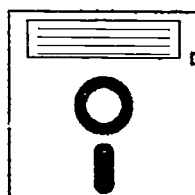

**Product Name:** Switch It - Change It

**Vendor:** UCLA Microcomputer Project

**Computer:** Apple II+, Apple IIGS, Apple IIe

**Cost:** \$35.00

Switch It - Change It is a switch-activated cause and effect program for training in the use of a single switch. Colorful, animated common objects are presented on the screen. Three-dimensional objects (extra) are shown to the user, who then selects the matching on-screen object using the switch.

An Echo speech synthesizer, color monitor, and single switch are required.



**Product Name:** Switch It - See It

**Vendor:** UCLA Microcomputer Project

**Computer:** Apple II+, Apple IIGS, Apple IIe,  
Apple Macintosh Family

**Cost:** \$35.00

Switch It - See It is a switch activated computer program for training in switch use and visual tracking. Colorful animated graphics and sound effects are presented. The program encourages visual tracking from right to left, up and down, and on the diagonals.

A speech synthesizer, single switch, and color monitor are required; for the Macintosh, an Apple IIe emulation card is also needed.

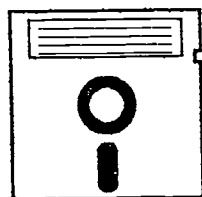

**Product Name:** Switch Puzzles

**Vendor:** Simtech Publications

**Computer:** Apple Macintosh Family

**Cost:** \$20.00

Switch Puzzles is a collection of switch accessible software puzzles. Each switch press adds a piece to the puzzle. Requires 5, 10, or 15 switch activations to complete.

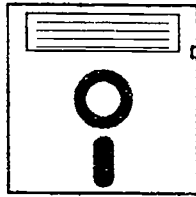

**Product Name:** SwitchEnsemble

**Vendor:** Switch In Time

**Computer:** Apple IIGS

**Cost:** \$175.00

SwitchEnsemble is a software program designed to enable users to "play" different musical instruments using switch input. The program uses the sound chip built into the Apple IIGS to create the sounds of instruments including flute, electric piano, bass, guitar, violin, and drums. There are different components of the program which allow the user to tap out rhythms, improvise, and play along with songs.

The standard keyboard can be used with this program but it is primarily designed to facilitate switch use. This program can be used with multiple or single switches with one person or a group. A switch interface is required (extra).

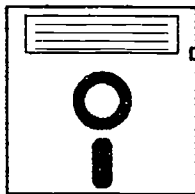

**Product Name:** Talking Hands

**Vendor:** EBSCO Curriculum Materials

**Computer:** Apple IIc, Apple IIe

**Manual Form:** Printed Manual

**Cost:** \$59.95 - \$185.95

Talking Hands is a fingerspelling drill and practice program for training and communication with the manual alphabet. The program will display handsigns for letters from A to Z as typed. The program can also be used to display hand signs serially or at random for drill. Up to 36 messages of ten lines and 80 characters in length can be stored on disk and played back for practice, and speed of sign presentation (from 1 - 40 signs per minute) can be user-specified.

Talking Hands costs \$59.95 for a single copy and \$189.95 for a five pack.

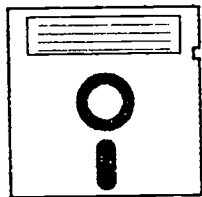

**Product Name:** Talking Literacy Kit for the Apple IIe (TALK IIe)

**Vendor:** American Printing House for the Blind (APH)

**Computer:** Apple IIe

**Manual Form:** Audiotape Manual, Printed Manual

**Cost:** \$40.75 - \$85.80

The Talking Literacy Kit (TALK) for the Apple IIe is a set of materials designed to provide visually impaired children and adults with their first exposure to microcomputers. Tactile, auditory and visual experiences are used. The Teacher Kit includes 11 computer parts for tactile inspection, a keyboard model with brailled keys, a teacher's manual (in print and on cassette), three braille reference guides, and two pieces of speech-output software. The Student Kit includes the following programs: APH Presents the Talking Apple (an introduction to Apple computers and TEXTALKER commands), and Talking Writer (a program that contains a typing tutor, three games, and an introduction to word processing).

TALK requires an appropriate Echo speech synthesizer. The student's version of TALK is \$40.75; the teacher's is \$85.80.

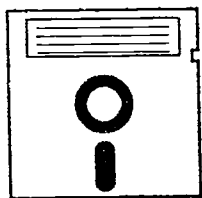

**Product Name:** Talking Nouns, Talking Nouns II, and Talking Verbs

**Vendor:** Laureate Learning Systems, Inc.

**Computer:** Apple IIGS, Apple IIe, Apple Macintosh Family, IBM PC Family, IBM PS/2 Family

**Manual Form:** Printed Manual

**Cost:** \$115.00 - \$130.00 each

The Talking Series is a set of three programs that continues training on the words introduced in First Words, First Words II, and First Verbs (see entries). Each program includes a plastic template that slides over the TouchWindow. A PowerPad version is also available for the Apple IIe. Activities include: Interactive Communication, Picture Identification, Picture Matching, and Nouns by Category.

The Apple II version (\$115.00) requires 128K memory, a monitor, a speech synthesizer, a TouchWindow or PowerPad (see entries), and a 5.25" disk drive. The Apple IIGS version (\$130.00) requires 1 MB memory, ROM version 01 or later, RGB monitor, a TouchWindow, and a 3.5" disk drive. The IBM version (\$130.00) requires 640K memory, DOS 3.3 or higher, VGA or MCGA graphics, DigiSpeech synthesizer, a TouchWindow, and a 3.5" disk drive. A color monitor is recommended for all versions. The Macintosh version requires Macintosh LC or higher, System 7, hard drive, and 4 MB of RAM.

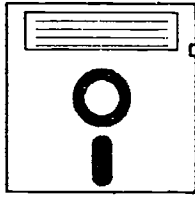

**Product Name:** Talking Touch Window

**Vendor:** Edmark Corporation

**Computer:** Apple II Family

**Manual Form:** Printed Manual

**Cost:** \$79.95

Talking Touch Window (formerly Talking With Your Touch Window) is a simple program for speech output with the Touch Window (see entry). The user can program any part of the Touch Window to represent a particular word or phrase. When that part is touched a speech synthesizer speaks the programmed word or phrase. Overlays can be created with words, pictures or symbols for the areas of the Touch Window corresponding to particular vocabulary.

A Touch Window and an Echo speech synthesizer (see entries) are required to use Talking Touch Window.

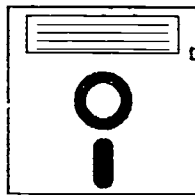

**Product Name:** Talking Typer

**Vendor:** American Printing House for the Blind (APH)

**Computer:** Apple II Family

**Cost:** \$37.95 - \$41.95

Talking Typer is designed to reinforce keyboarding skills. The Teacher's Edition includes one Teacher's Disk and three identical Student's Disks. The Teacher's Disk contains a special version of Talking Typer that allows the teacher to adapt, edit, and control the program and the lessons on the Student's Disks. Each Student's Disk contains 16 prepared lessons, with options for drills, a typing game, or open typing.

The Student's Disks are also available separately for \$27.10 - \$29.65 each. Talking Typer requires at least 128K RAM.



**Product Name:** TalkTime with Tucker  
**Vendor:** Laureate Learning Systems, Inc.  
**Computer:** IBM PC Family  
**Cost:** \$125.00

TalkTime with Tucker is a voice-activated software program designed to encourage users to talk. Speaking into the microphone causes Tucker to move and talk. The program accepts a broad range of sounds or speech. TalkTime can also be used with a keyboard or single switch.

A microphone is included. The program requires a 386-based PC, one 3-1/2" drive, a hard drive, MCGA or VGA graphics, and a Sound Blaster.



**Product Name:** Tea Party  
**Vendor:** UCLA Microcomputer Project  
**Computer:** Apple II+, Apple IIGS, Apple IIe,  
Apple Macintosh Family  
**Cost:** \$35.00 - \$36.00

Tea Party is a computer program designed as a follow-up to "Let's Go Shopping" (see entry). Using a PowerPad or IntelliKeys overlay, players "shop" at four different stores to select items for a tea party.

A speech synthesizer, PowerPad or IntelliKeys, and color monitor are required; for the Macintosh and Intellikeys, an Apple IIe emulation card is also needed.



**Product Name:** Teenage Switch Progressions

**Vendor:** R.J. Cooper & Associates

**Computer:** Apple II Family,  
Apple Macintosh Family, IBM PC Family

**Manual Form:** Electronic Manual, Printed Manual

**Cost:** \$75.00 - \$89.00

Teenage Switch Progressions is a set of five computer programs designed to be used by persons attempting transition from randomly activating a switch or touch screen for observation learning to activating a switch for specific timing. The five levels of programs are: cause/effect (level 0), attending to extended tasks (level 1), following directions (level 2), and responding to visual/auditory cues (levels 3 and 4). The scenes presented are twice as long as those in Children's Switch Progressions (see entry).

The Apple II version requires 128K of memory. The IBM version requires Microsoft Windows.

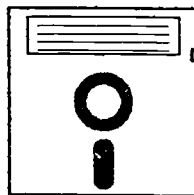

**Product Name:** Telling Time

**Vendor:** DEKRO, Inc.

**Computer:** IBM PC Family

**Cost:** \$87.80

Telling Time is a software program designed for individuals with head injuries, stroke, or learning disabilities. The program's objectives are to gain a clear understanding of time representations, interpret clock movements up to one minute, and translate time from analog to digital and vice versa. The clock can be defined with or without numbers and with Arabic or Roman numerals.



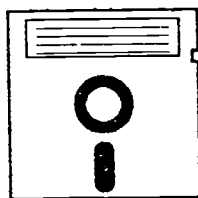

**Product Name:** Telling Time, Parts of the Face,  
Learning Colors

**Vendor:** Favin, David

**Computer:** Texas Instruments TI 99/4A

**Manual Form:** Printed Manual

**Cost:** Free

Telling Time, Parts of the Face, and Learning Colors are three programs with voice output designed to teach basic skills. Telling Time presents a clock face on the computer screen. Parts of the Face shows a color picture of a face and asks the student to identify parts. A correct answer is rewarded by a short refrain of a song. Learning Colors presents the full computer screen in a single color, and prompts the student to decide whether it is a certain color. The student answers yes or no using one of two switches.

A speech synthesizer is required for voice output. Contact the manufacturer about connecting switches to the computer. These programs were developed through the Telephone Pioneers of America, and are provided free to anyone interested.

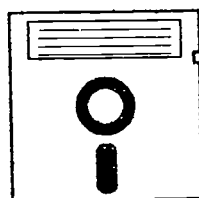

**Product Name:** THINKable/DOS

**Vendor:** IBM Corporation

**Computer:** IBM PC Family

**Cost:** \$495.00

THINKable/DOS is a software program that provides remedial practice for individuals who have attention and memory deficits that impair their abilities to function normally. The program uses real pictures, natural-sounding speech, and touch-screen input to provide controlled practice in visual attention, visual discrimination, recent memory, and sequential memory.

THINKable/DOS operates on any IBM 386 or 486 PS/1, ValuePoint, EduQuest, or PS/2 system. The IBM Audio Capture and Playback Adapter audio cards and the IBM 8516 Touch Display and Edmark Touch Window are supported. To get information about or order THINKable/DOS in the U.S. call (800) 228-0752, in Canada call (800) 465-7999.

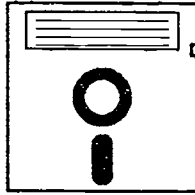

**Product Name:** This is the Way We Wash Our Face

**Vendor:** UCLA Microcomputer Project

**Computer:** Apple IIe, Apple Macintosh Family

**Manual Form:** Printed Manual

**Cost:** \$35.00 - \$36.00

This is the Way We Wash Our Face is a program that uses this familiar song to help teach such skills as turn-taking, sharing, beginning sequencing, and socialization in a small group. The program uses the PowerPad or IntelliKeys and an overlay that contains five pictures. By pressing on a picture, the student can hear the verse of "This is the Way. . ." that pertains to that picture. The program also presents an animated graphic for the verse. The "scene" on the computer screen returns to a bedroom scene after each verse, at which time another verse can be selected. The PowerPad can be passed amongst a group of students, each one taking a turn selecting a song. The song is sung by a speech synthesizer. The instructor must load the program and begin it; after that the students can operate it themselves.

The program requires a color monitor, a speech synthesizer, and a PowerPad; for the Macintosh and Intellikeys, an Apple IIe emulation card is also needed. The manufacturer suggests that this program be used with children ages 18 months to three years.

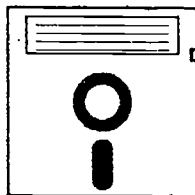

**Product Name:** This Old Man

**Vendor:** UCLA Microcomputer Project

**Computer:** Apple Macintosh Family

**Cost:** \$35.00

This Old Man is a three disk set of software for use with a single switch, keyboard, or TouchWindow to teach numbers and counting up to ten. The program includes animation of numbers one through ten with the nursery song, "This Old Man," being sung and signed by a teacher on screen. The program can accommodate up to 12 players.

A color monitor, hard drive, 3.5" disk drive, system 7.0 or later, Quick Time 1.5 or later, and 8M RAM are required.

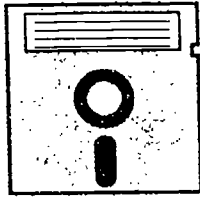

**Product Name:** Timekeeper

**Vendor:** Edmark Corporation

**Computer:** Apple II Family

**Cost:** \$39.95

Timekeeper is a computer program intended to teach the skill of telling time. Practice is provided in setting both analog and digital clocks, as well as matching both to time displayed as text. The teacher or clinician can control increments of time intervals (one hour, 15 minutes, five minutes, etc.) as well as other options. Musical and color graphic reinforcement is provided.

Timekeeper requires an Apple II computer with 64K of memory and a color monitor. Use of a TouchWindow (see entry) is optional.



**Product Name:** Touch and Match

**Vendor:** Edmark Corporation

**Computer:** Apple II Family

**Manual Form:** Printed Manual

**Cost:** \$29.95

Touch and Match is designed to develop the ability to find differences and similarities among categories of objects, and to match these objects based on their similarities or differences. Three main activities focus on matching identical pictures, finding which picture goes with another, and which picture does not belong.

Over 60 pictures of common objects in seven categories are included. Teachers can pick the category of objects to be addressed for each student. Features include data on right and wrong answers and a test mode. Selections are made by pointing to and pressing a picture on the TouchWindow (see entry).



**Product Name:** Touch and See

**Vendor:** Edmark Corporation

**Computer:** Apple II Family

**Manual Form:** Printed Manual

**Cost:** \$39.95

Touch and See is designed to teach matching of similar objects, while developing attention and short term memory skills. Twelve boxes with pictures or words beneath them are displayed. When a box is pressed, it reveals a shape, picture, letter or word. The matching box must then be found. Eight different levels of items can be presented for matching, including shapes, upper case letters, lower case letters, upper and lower case letters, numbers, pictures, pictures and words, and words.

The teacher has the option of selecting how much time children will have to complete the lesson (30, 45, 60, or 90 seconds). With the TouchWindow (see entry), touching the boxes on the screen reveals what is underneath without using the keyboard.

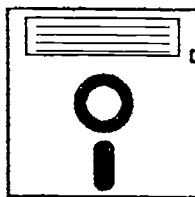

**Product Name:** TouchMoney

**Vendor:** Edmark Corporation

**Computer:** Apple II family

**Cost:** \$69.95

TouchMoney is designed to teach students to count money by incorporating touch, hearing, and speech. TouchMoney is composed of six lessons which begin with identifying coins and end with an arcade style game that challenges players to use their money counting skills. On-screen help function is available in each lesson and is context sensitive. TouchMoney includes built-in scanning for single switch users and is designed for optimal use with the TouchWindow. Easy-to-use options allow teachers to customize the program to meet individual student needs.

Reproducible worksheets for practice and review and a Teacher's Guide are included. TouchMoney requires 128K, a single disk drive, and Echo II speech synthesizer. Supports IIGS mouse and single switch, TouchWindow and color monitor are recommended.

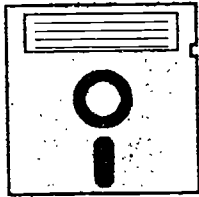

**Product Name:** Traffic Signs Plus for Windows

**Vendor:** Parrot Software

**Computer:** IBM PC Family

**Cost:** \$134.95

Traffic Signs Plus for Windows is a software program that teaches traffic sign recognition. The program features real-life photographs of signs in an actual city. Users see one of fifty traffic signs and are presented with three possible descriptions of the sign. Responses are reinforced and performance data are recorded. Traffic Signs Plus requires Microsoft Windows.

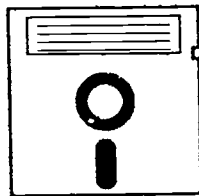

**Product Name:** Transportation Signs

**Vendor:** Conover Company

**Computer:** Apple II Family, IBM PC Family,  
IBM PS/2 Family

**Manual Form:** Printed Manual

**Cost:** \$289.00

Transportation Signs is a eight-disk microcomputer program that teaches signs which are essential for getting around within a community and for employment in the transportation industry. The disks cover common signs (e.g., "Don't Walk," "No U Turn," "People Working," "Handicapped Parking," "Slippery When Wet"). The program is broken into an Instructional Segment, a Unit Review, and a Generalization Probe, plus an Evaluation Segment where information is contained for each user on words attempted, words correct on the first try, and words correct on the second try.

The program includes 8 disks, an administration manual, and 6 workbooks. Apple II versions require 64K of memory and IBM versions require 256K; both need a speech synthesizer.

725

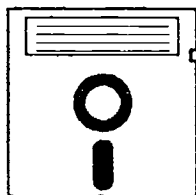

**Product Name:** Trip to the Zoo

**Vendor:** Marblesoft

**Computer:** Apple IIGS, Apple Macintosh Family

**Cost:** \$35.00 - \$60.00

Trip to the Zoo is an exploratory play program which allows use of a mouse, TouchWindow, IntelliKeys, or single switch device. Trip to the Zoo is an integrated series of HyperStudio stacks using graphics and sound capabilities. Stacks can be modified with HyperStudio.

System requirements for the Apple IIGS include at least 1 MB RAM, a 3-1/2" disk drive, color monitor, and GS/OS version 5.0.4. The Macintosh requires a color monitor, 4 MB RAM, 8-bit color, system 7, and a CD-ROM drive. The standard version requires HyperStudio 3.1 and sells for \$35.00 and a version which includes HyperStudio Run-time sells for \$45.00. The Macintosh CD-ROM version sells for \$60.00. IntelliKeys overlays can be purchased separately.

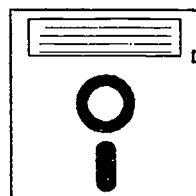

**Product Name:** Turn-Talking

**Vendor:** R.J. Cooper & Associates

**Computer:** Apple Macintosh Family, IBM PC Family

**Cost:** \$89.00

Turn-Talking is a software program designed to teach the non-verbal person how to interact appropriately in a conversation. A supervisor writes a script and has a person, close in age to the non-verbal person, record the phrases. Turn-Talking then conducts that conversation.

The IBM version requires Microsoft Windows.



**Product Name:** Twenty Categories

**Vendor:** Laureate Learning Systems, Inc.

**Computer:** Apple IIGS, Apple IIe, IBM PC Family

**Manual Form:** Printed Manual

**Cost:** \$200.00

Twenty Categories is a program that provides practice in using categorization skills through the use of multiple choice questions. Three hundred nouns in 20 categories are contained on two disks. The questions train categorization concepts in three ways: Inclusion Category to Noun, Inclusion Noun to Category, and Exclusion Category to Noun. Text and optional speech output ask the student to select the correct answer from among three choices. An animated scorekeeping display is optional. Scan speed, response time, and criterion for ending the lesson can be adjusted. Lesson summaries and test performances may be viewed on-screen or printed.

The Apple IIe version of Twenty Categories requires an Apple II computer with 64K memory, a monitor, a speech synthesizer, and a 5.25" disk drive. A color monitor, TouchWindow (see entry), and printer are recommended. The Apple IIGS version requires one 3.5" disk drive and 1 MB of RAM. The IBM version requires 640K of memory, a speech synthesizer, and a disk drive. A color monitor and TouchWindow are recommended. Interface options include TouchWindow, a single switch, the keyboard, or a game controller.



**Product Name:** UKanDu Little Books

**Vendor:** Don Johnston Incorporated

**Computer:** Apple Macintosh Family

**Cost:** \$45.00

UKanDu Little Books is a series of early literacy software with simple and short animated stories designed to help build language experience for emergent and early readers. Each program has three four-page animated stories that the user completes. At the end each story can be printed on one sheet to be folded into a book. Single-switch access is built-in.

Two titles are available. Out and About features a first-grade readability level and 63-word vocabulary. A Day at Play features a second-grade readability level and a 60-word vocabulary.



**Product Name:** UKanDu Switches, Too!

**Vendor:** Don Johnston Incorporated

**Computer:** Apple Macintosh Family

**Cost:** \$45.00

UKanDu Switches, Too! is a switch training and practice software series that also introduces basic literacy. Each program features three levels of activity: cause and effect, opposites, and story completion. Available titles are Eensy & Friends and Forgetful & Friends. The programs can be used with a single switch, Ke:nx (see entry), mouse, keyboard, or TouchWindow (see entry).

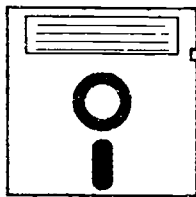

**Product Name:** Understanding Attributes

**Vendor:** Parrot Software

**Computer:** Apple IIGS, Apple IIc, Apple IIe,  
IBM PC Family

**Cost:** \$104.95

Understanding Attributes is a program that provides opportunities for improving adjective or attribute use. The user must first find the attribute in a sentence, e.g., "Find the word that shows SIZE in the sentence: 'It is a large box.'" Then the user must select a new size for the box from three possibilities, such as green, square, or small. The space bar and return key are the only keys used when running this program. The program keeps track of progress and prints progress reports. An authoring option allows the clinician to create lessons. Lessons can be displayed on the screen or sent to a printer.





**Product Name:** Verb Fill-Ins

**Vendor:** Parrot Software

**Computer:** Apple IIGS, Apple IIc, Apple IIe,  
IBM PC Family

**Manual Form:** Printed Manual

**Cost:** \$104.95

Verb Fill-Ins is a program designed to provide cognitive training in use of verbs. A sentence with the verb missing is presented, followed by a list of three verbs. The user selects the appropriate verb using the space bar and the return key. The program provides visual and auditory reinforcement. Verb Fill-Ins has features that keep track of user progress and allow clinicians to author their own programs.

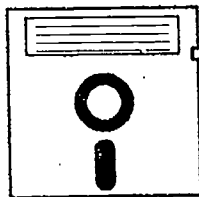

**Product Name:** Verbal Analogies

**Vendor:** Parrot Software

**Computer:** Apple IIGS, Apple IIc, Apple IIe,  
IBM PC Family

**Cost:** \$104.95

Verbal Analogies is a computer program that provides drills in building and understanding vocabulary. Analogies are presented (e.g., "SEVEN is to EIGHT as TWO is to ..."), and the client is asked to select the correct answer from a list of five possibilities (e.g., "ONE, THREE, FIVE, SEVEN, NINE"). The clinician may develop lessons, save progress information on up to ten clients, and print out progress reports and lessons.

Verbal Analogies is available in 3-1/2" or 5-1/4" sizes.

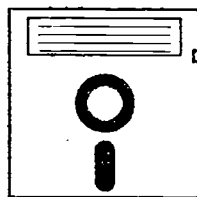

**Product Name:** Verbal Analogies Plus for Windows

**Vendor:** Parrot Software

**Computer:** IBM PC Family

**Cost:** \$134.95

Verbal Analogies Plus for Windows is a software program that drills users in word relationships. A sample analogy is presented to show a relationship. Then the first half of a test analogy is presented along with five possible choices for completing the analogy. The user simply selects the correct choice. Responses are reinforced and a second chance is offered for incorrect responses and the answer is supplied if that response is incorrect. New lessons can be created. The program requires Microsoft Windows.

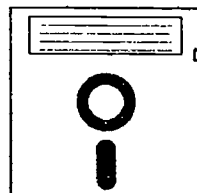

**Product Name:** Video Voice Speech Training System

**Vendor:** Micro Video Corp.

**Computer:** Apple IIGS, Apple IIe,  
Apple Macintosh Family, IBM PC Family

**Manual Form:** Printed Manual

**Cost:** \$2,995.00

The Video Voice Speech Training System is a combination of specialized hardware and software programs that provides graphic representations of vocal sounds on a color monitor screen. The system includes facilities for training vowels, word articulation, pitch and volume controls, and rhythmic elements of connected speech. Models of targets provided by the teacher or therapist are stored on disk. Either live, game-style, or immediate, direct-overlay feedback may be selected for therapy work. A variety of game formats are also included. Voice trials are scored for closeness to the model, and cartoon rewards appear when the score exceeds a therapist-selected performance goal. Models may quickly be adjusted to reflect improved production of targets. Scores may be stored on disk for later review in single session reports or cross-time analyses of progress.

The Apple II version requires two 5.25" disk drives; the IBM version requires 640K RAM, one 5.25" or 3.5" disk drive, and a hard drive. All versions require a color monitor (the IBM version supports EGA/VGA) and a custom A-D card (included).

730

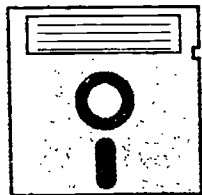

**Product Name:** Visi-Pitch Model 3300

**Vendor:** Kay Elemetrics Corporation

**Computer:** IBM PC Family

**Manual Form:** Printed Manual

**Cost:** \$2,950.00

Visi-Pitch Models 330 is a system that displays various qualities of speech visually on a computer screen. Speech qualities that can be viewed include pitch, intensity, glottal onset, V.O.T., vocal roughness, and timing. This system also has high fidelity playback allowing a voice sample to be recorded into the system and played back through a speaker at higher than CD quality for critical listening of the voice sample. Clinical Protocols are also built in for quantification of voice parameters as well as biofeedback therapy. Dual screen stimulus matching is also available. Six software modules are included: pitch and intensity trace, pitch games, vowel and silibant training, voice assessment program, waveform editor, and delayed auditory feedback.

The package includes specialized hardware and software, circuit card, microphone, stereo speaker, headphones, and specialized mouse pad. This system is designed for use by speech language pathologists and is not recommended for home use.



**Product Name:** Visual Confrontation Naming Plus  
for Windows

**Vendor:** Parrot Software

**Computer:** IBM PC Family

**Cost:** \$134.95

Visual Confrontation Naming (VCN) Plus for Windows was designed to provide practice for people with head injuries and other cognitive impairments who have difficulty recalling the names of objects and events they encounter in their day-to-day lives. Pictures are displayed on the screen and users are asked to type the name of each picture displayed. When users cannot recall the name of a picture or require too much time to recall a picture name, prompts are offered. The program can be varied in acceptance of spelling errors, latency of response measures, and automatic clues contingent upon user responses. The program works with Microsoft Windows.

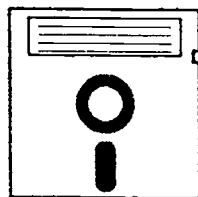

**Product Name:** Visual Memory Plus for Windows

**Vendor:** Parrot Software

**Computer:** IBM PC Family

**Cost:** \$134.95

Visual Memory Plus for Windows is software designed for neurologically impaired children and adults with short term memory and attention deficits. A picture is presented and the user is asked to find that picture when four pictures are presented as choices. The time delay between the presentation of the stimulus and the answer can be varied. The discrimination aspect can also be controlled to affect the difficulty of the task. The program requires Microsoft Windows.

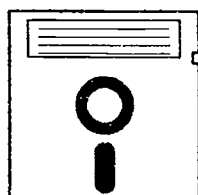

**Product Name:** Visual Motor Skills

**Vendor:** Judy Lynn Software

**Computer:** IBM PC Family

**Cost:** \$35.00

Visual Motor Skills is a software program designed to emphasize and reinforce switch cause and effect related concepts including basic visual motor skills, visual scanning, vertical and horizontal tracking, color and shape sorting, block stacking and alignment, pegboard concepts, and others. In most of the selections in this program, a lifelike hand picks up an object and then moves back and forth across the screen. Activating the switch or spacebar at the appropriate time will cause the hand to release the object.

A VGA monitor is required.

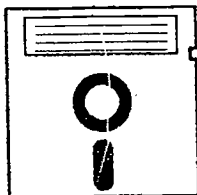

**Product Name:** Visual Pattern Memory Plus for Windows

**Vendor:** Parrot Software

**Computer:** IBM PC Family

**Cost:** \$134.95

Visual Pattern Memory Plus for Windows is software designed for neurologically impaired children and adults with short term visual memory and attention deficits. A picture grid of 16 pictures is presented, all but a specified number of pictures are temporarily removed, then the entire picture grid is re-displayed and the user is asked to identify those pictures that remained on the screen. The number of pictures displayed and time they are displayed can be varied. The program requires Microsoft Windows.



**Product Name:** Visuospatial Skills I

**Vendor:** Psychological Software Services, Inc.

**Computer:** IBM PC Family

**Manual Form:** Printed Manual

**Cost:** \$400.00

Visuospatial Skills I is a series of six visual spatial training programs. Maze I, II records time and errors for user to maneuver through a floor plan as rapidly as possible without hitting the walls. Cube-in-the-Box I, II records time intervals for user to keep a cursor in a randomly jumping frame. Line Orientation I, II displays an array of lines and asks the user to rotate a single line on the right of the screen to match a randomly selected item in the array, matching either visually or from memory. Fine Motor asks the user to maneuver the cursor along a track on the screen at a fast but steady pace (cursor will disappear briefly if user proceeds too quickly); program records time and number of restarts. Visual Perception (Closure and Integration of Parts) records success at recognizing a shape from visual presentation through a vertical slit sweeping across the screen, exposing only a portion at a time. Paddle Ball asks user to intercept a ball at the bottom of screen with game paddle to keep it in play.

Microsoft Windows is required.

733



**Product Name:** Visuospatial Skills II

**Vendor:** Psychological Software Services, Inc.

**Computer:** IBM PC Family

**Manual Form:** Printed Manual

**Cost:** \$400.00

Visuospatial Skills II is a series of seven visual spatial training programs. Perceptual/Motor I requires the user to position a line so that it mimics a target line. Guess Which Shape fills in a figure so that it emulates one of four, eight, or 16 target shapes; the user has to identify which target shape is being filled in. How Many Block requires the user to enter the number of blocks required to create a randomly-drawn pattern. Labyrinth is a 3-dimensional maze that is run within a designated time and penalty limit. Figure/Ground Perception requires identification of a drawing that emerges from a screen full of colored blocks within a time limit. Designer Patterns requires copying of a target design. Spatial Perception I requires the user to identify which block in a 5 x 5 matrix has just flashed on and off; the speed of presentation varies according to the number of correct and incorrect responses.

Microsoft Windows is required.

**Product Name:** Vortex Machine Assisted Reader Software

**Vendor:** Tenax Software Engineering

**Computer:** IBM PC Family

**Cost:** Free

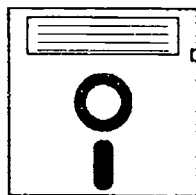

Vortex Machine Assisted Software is designed to help individuals with a reading disability read at over 1000 words a minute. Vortex is the first application of newly developed Machine Assisted Reading Software (MARS) technology that. In addition to the MARS features, Vortex allows on screen typeface control, on screen reading speed control, and on screen display position control.

Vortex requires a Microsoft Windows computer and a 386 CPU (for proper timing). Versions for other computers and operating systems are currently being planned. Vortex is available for downloading from the following sites as either Vortex.zip or Vortex1.zip: CompuServe Information Services, AI Expert Forum, Microsoft Windows Shareware Forum, Ziff-Davis Public Brand Software, on the Internet at oak.oakland.edu and ftp.csusm.edu. Vortex may also be available from local shareware vendors and for \$39.95 (for Vortex 2.0) directly from Tenax Software Engineering.



**Product Name:** Wheels On The Bus I, II, III

**Vendor:** UCLA Microcomputer Project

**Computer:** Apple II Family,  
Apple Macintosh Family, IBM PC Family

**Manual Form:** Printed Manual

**Cost:** \$35.00 - \$36.00

Wheels on the Bus I is a program that sings a song and shows animated pictures to go with it. A five-square overlay is placed on a PowerPad. Each overlay has a picture pertaining to a verse of the popular preschool song. When a square is touched, it activates the verse indicated by that picture. The song is sung by a speech synthesizer. Target skills include turn-taking, sharing, beginning sequencing, socialization in a small group, and picture recognition. The instructor must insert the disk and start the program; after that the students can play independently. Wheels on the Bus II and III provide additional verses of the nursery school songs.

Wheels on the Bus requires a color monitor, a PowerPad, and an Echo speech synthesizer. The suggested age range for use is 18 months to three years. Macintosh and Intellikeys version requires the Apple IIe emulation card. The IBM version requires PowerPad, IntelliKeys, TouchWindow, or single switch - spacebar, and a speech synthesizer.

---

**Product Name:** Wheels on the Bus I, II, III -  
Intellipics Activity

**Vendor:** UCLA Microcomputer Project

**Computer:** Apple Macintosh Family

**Cost:** \$25.00 each

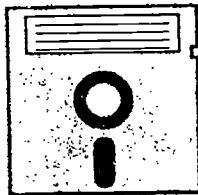

Wheels on the Bus I, II, III - Intellipics Activity is a variation of the popular nursery song that requires Intellipics (see entry) to run. Each disk features five or six verses with digitized sound and color animations. The programs can be used with Intellipics options and include both free choice and quiz options.

735



**Product Name:** Wheels on the Bus: COMPLETE

**Vendor:** UCLA Microcomputer Project

**Computer:** Apple Macintosh Family

**Cost:** \$55.00

Wheels on the Bus: COMPLETE includes all 16 verses from Wheels on the Bus I, II, and III (see entry). If Intellikeys is used, the user may select from three overlays, or the user may select from one to nine verses when playing. Two levels of play allow children to choose any picture or to find a given picture. Includes digitized music and animation.

The program is compatible with the following input methods: IntelliKeys, TouchWindow, single switch - spacebar, mouse, or trackball.

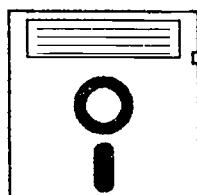

**Product Name:** Where is Puff?

**Vendor:** UCLA Microcomputer Project

**Computer:** Apple II+, Apple IIGS, Apple IIe,  
Apple Macintosh Family

**Cost:** \$35.00

Where is Puff? is a software program intended to teach the use of prepositions. Prepositions taught include: in, on, under, in front of, in back of, and next to. The scanning rate may be adjusted, and data may be collected on the student's progress.

A speech synthesizer, color monitor, and single switch are required; for the Macintosh, an Apple IIe emulation card is also needed.





**Product Name:** Word Association Plus for Windows

**Vendor:** Parrot Software

**Computer:** IBM PC Family

**Cost:** \$134.95

Word Association Plus for Windows is a software program that asks users to recognize words that are associated with other words (salt-pepper) or are parts of other words (toe-foot). The program presents a word and then asks the user to find an associated word in a list of words. Word Association Plus requires Microsoft Windows.

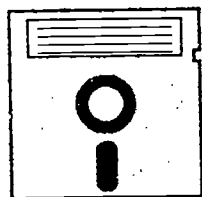

**Product Name:** Word Order in Sentences

**Vendor:** Parrot Software

**Computer:** Apple IIGS, Apple IIc, Apple IIe,  
IBM PC Family

**Cost:** \$104.95

Word Order in Sentences is a computer program designed to teach sentence structure. A scrambled sentence (e.g., "WEAR THOSE PANTS I CAN'T") is presented; the client presses the space bar to change the order of the words. The clinician may design lessons, save progress information for up to ten clients, and print out progress reports and lessons.

Word Order in Sentences is available on 3-1/2" or 5-1/4" disks.

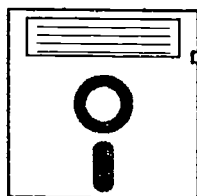

**Product Name:** Word Order Plus for Windows

**Vendor:** Parrot Software

**Computer:** IBM PC Family

**Cost:** \$134.95

Word Order Plus for Windows is a software program that uses a scrambled sentence paradigm. A scrambled set of words is displayed and the client must examine those words and construct a sentence using them. Words are selected with the mouse. The program requires Microsoft Windows.

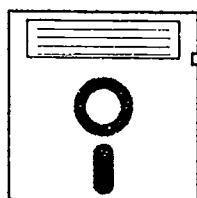

**Product Name:** Words and Concepts I, II, III

**Vendor:** Laureate Learning Systems, Inc.

**Computer:** Apple II Family,  
Apple Macintosh Family, IBM PC Family,  
IBM PS/2 Family

**Manual Form:** Printed Manual

**Cost:** \$200.00 - \$225.00 each

Words and Concepts is a set of three programs that integrate language and concept training using speech output and pictures of 40 nouns. Each program offers the following activities using different core vocabularies and pictures, usually at three levels of difficulty: Vocabulary, Categorization, Word Identification by Function, Word Association, Concept-Same, and Concept-Different. Touch Window (see entry), a single switch, the keyboard, and a game controller. A mouse option is available for the Apple IIGS and IBM versions.

The Apple II version (\$200.00) requires 64K memory, a monitor, a speech synthesizer, and a 5.25" disk drive. The Apple IIGS version (\$225.00) requires 1 MB memory, ROM version 01 or later, RGB monitor, and a 3.5" disk drive. The IBM version (\$225.00) requires 640K memory, DOS 3.3 or higher, VGA or MCGA graphics, DigiSpeech synthesizer, and a 3.5" disk drive. The Macintosh version (\$225.00) requires Macintosh LC or higher, System 7, hard drive, and 4 MB of RAM.



**Product Name:** WordWise Software

**Vendor:** Attainment Company

**Computer:** Apple Macintosh Family

**Cost:** \$289.00

WordWise Software is a series of computer programs designed to teach basic language skills through a combination of words, pictures, and two-way speech. A word list can be created for each student and users can record their own speech and compare it to the computers. In the quiz option, the user must match spoken words to pictures and text. Personalized picture pages can be printed for use with communication devices.

The six programs contain words pertaining to the following areas: people, community, house, outdoors, actions, and adjectives. Price is for the six programs and WordWise Language Cards (see entry). Each program is also available individually for \$59.00. Contact the manufacturer for site license information.



**Product Name:** Worm Squirm

**Vendor:** UCLA Microcomputer Project

**Computer:** Apple IIe, Apple Macintosh Family

**Manual Form:** Printed Manual

**Cost:** \$35.00 - \$36.00

Worm Squirm is a program designed to help develop fine motor skills, spatial relationships and directional concepts. The student tries to direct a worm through a path on the computer screen. The worm can be directed by pressing four large arrows (up, down, right, left) on the PowerPad expanded keyboard (see entry).

A color monitor and PowerPad are required to operate Worm Squirm; for the Macintosh and Intellikeys, an Apple IIe emulation card is also needed. The program is recommended for children age three to first grade.

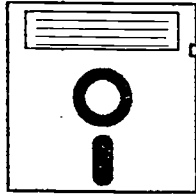

**Product Name:** WSCC (Washington State Cooperative Curriculum)

**Vendor:** J.E. Stewart

**Computer:** Apple II Family, IBM PC Family

**Cost:** \$17.00 per disk

WSCC (Washington State Cooperative Curriculum) is software goals and objectives for individuals with severe and profound disabilities. The curriculum includes 289 goals and 22,834 objectives in all with titles in: socialization, self help, gross motor, communication, pre-vocational, academic, and leisure. The programs are on 23 disks which may be purchased separately or as a set.

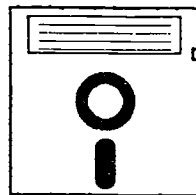

**Product Name:** Zoo Time

**Vendor:** UCLA Microcomputer Project

**Computer:** Apple II+, Apple IIGS, Apple IIe,  
Apple Macintosh Family

**Cost:** \$35.00 - \$36.00

Zoo Time is a computer program that presents five zoo animals. At level 1, the child may select any animal from the PowerPad or IntelliKeys overlay. At level 2, the child selects an animal from a name cue. At level 3, the child selects an animal based on a given action.

A speech synthesizer, PowerPad or IntelliKeys, and color monitor are required; for the Macintosh and IntelliKeys, an Apple IIe emulation card is also needed.

# Chapter 20

## Adaptive Educational Software

This chapter includes all application software and software/hardware packages whose primary function is to educate. Software that focuses on topics which are traditionally part of the school curricula is included in this chapter. Software that focuses on topics such as basic skills, ADL skills, communication skills, and vocational training is not in this chapter but is listed in Chapter 19 (Training and Therapy Software).

Only software specifically adapted for use by students with disabilities is included. There is a large amount of curricular skill software that was not designed specifically for students with disabilities but still has features that make it potentially useful to these students. There is simply too much of this software for us to list here. If you want to know more about how to creatively apply "regular" education software in special education settings, consult the list of Software Resources in Appendix B.

The products in this chapter are cross-listed by a number of functions in Index 1. If there is a testing component in a program, it will be cross-referenced under Assessment (AS). In addition, many programs in this section that do not have an evaluative component can often be used creatively for assessment purposes. Programs that focus on math are cross-listed with Math and Calculation (CN), programs that involve prereading skills are cross-listed with Early Skills (ES), and programs that involve some reading are cross-listed with Late Skills (LS).

*The following product entries appear in this chapter:*

Access to Math, 713  
APH/SEI Talking Software, 713  
Arithmetic 1, 2, and 3 with Speech, 714  
Basic Learning Skills Courseware, 714  
CAMEO, 715  
Career English, 715  
Complete Spelling Program, 716  
Drive to Live, 716  
Early Learning II, 717  
Early Learning III, 717  
Edmark Reading Program, Level 1 Software, 718  
Elementary Volume 1 - Mathematics, 718  
ERIN (Early Recognition Intervention Network), 719  
Focus on Facts, 719  
Focus on Nations, 720  
Geometric Figures and Spatial Concepts, 720  
H:2 Handicapped Arithmetic Flash Cards, 721  
JOKUS Software, 721  
K.C. & Clyde in Fly Bali, 722  
Learning the Alphabet, 722  
Listen and Spell, 723  
Prefixes, 723  
Program for Aphasics, 724  
Readable Stories Series, 724  
Reading Horizons, 725  
Sensible Speller: Talking APH Edition, 725  
Sharon's Programs, 726  
Sight Word Spelling, 726  
Speaking Speller, 727  
Spell-A-Word & 2+2, 727  
Spell-Talk, 728  
Spelling Tutor, 728  
SPELLIST, 729  
Spin and Spell, 729  
Study Buddy, 730  
Talking Public Domain Disks, 730  
Talking Riddles, 731  
Voice Math, 731  
Voice Reading Ability Drill, 732  
Wordplay with Alps and Droops, 732  
Write, 733  
Write This Way, 733  
Zero to Five, 734

*The following products from other chapters can also be used as Adaptive Educational Software:*

Core Reading and Vocabulary Development, 583  
Early Learning 3.5/Complete Early Learning 5.25, 591  
H:1 Handicapped Word Games, 752  
Keyboarding by Ability, 617  
Keyboarding for Individual Achievement, 617  
Keyboarding for People with Cerebral Palsy, 618  
Keyboarding with One Hand, 619  
Single Switch Software, 675  
Special Education Public Domain Software, 677  
Trace Math Aid, 769

742



**Product Name:** Access to Math

**Vendor:** Don Johnston Incorporated

**Computer:** Apple IIGS, Apple IIe

**Manual Form:** Printed Manual

**Cost:** \$70.00 - \$95.00

Access to Math is a software program that permits teachers or clinicians to create addition, subtraction, multiplication, and division problems for individual students, and to save these problems to disk. The program has features such as carry, borrow, and finger count that allow users to see both the work in progress and the steps used to complete the problems. The "finger count" command permits students to put lines on the screen and count each individual line. The "carry" and "borrow" commands place boxes on the screen which indicate the next steps in solving the problem and the correct positioning of the numbers in the problems.

The prices are \$95.00 for the teacher edition (includes one workbook disk and one student disk), and \$70.00 for the student edition (includes five disks; must be used with the teacher edition).

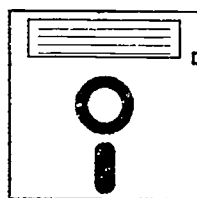

**Product Name:** APH/SEI Talking Software

**Vendor:** American Printing House for the Blind  
(APH)

**Computer:** Apple II Family

**Manual Form:** Braille/Tactile Manual,  
Large Print Manual

**Cost:** \$38.40 each

APH/SEI Talking Software is an adaptation of 33 tests from Sliwa Enterprises, Inc.'s educational software series for high school and college students and adults. Adjustable speech synthesis software is incorporated into each disk. At any point, the student may obtain information on scores, review question and answer choices, and alter the speech output. All information is provided in spoken form.

Titles available (on 5.25" disks) are: Afro-American Literature, American History 1 through 4, American Poetry, Ancient Civilizations, Asian/African History, Dickens, Early American Literature, European History 1 and 2, Fantasy, Foreign Governments and the United Nations, High School Literature 1 through 3, History of Space Flight, Modern British Literature, Mystery, Mythology, Edgar Allan Poe, Science Fiction, Sentence Completion, Shakespeare 1 and 2, Short Story, Steinbeck/Faulkner/Hemingway, Mark Twain, U.S. Government, Vocabulary Builder, Women Authors, and Word Analogy. An appropriate Echo speech synthesizer (see entries) is required.



**Product Name:** Arithmetic 1, 2, and 3 with Speech

**Vendor:** Life Science Associates

**Computer:** Apple II Family

**Manual Form:** Printed Manual

**Cost:** \$60.00 - \$175.00

These programs provide drill and practice on the four arithmetic operations and practice in solving simple word problems. Because they were written specifically for use with the ECHO II, there is correct pronunciation of mathematical symbols and two digit numbers. The teacher or student can set the level of difficulty of the problems, the score is given at the end of each program, and automatic record-keeping capabilities are included. All three programs include an introduction to the keyboard. Arithmetic 1 covers addition, subtraction, multiplication and division of whole numbers, and word problems (\$75.00). Arithmetic 2 covers mixed operations, two-step problems, and problems with missing elements (\$75.00). Arithmetic 3 contains timed drills on addition, subtraction, multiplication, division and mixed operations using whole numbers. A timed game for two players is included (\$60.00). The entire set of programs is \$175.00.



**Product Name:** Basic Learning Skills Courseware

**Vendor:** Conover Company

**Computer:** IBM PC Family

**Cost:** \$1,975.00

The Basic Learning Skills Courseware is a comprehensive series to teach adult learners with skills on a first through third grade level in the areas of reading, language, and mathematics. The software utilizes a human-digitized voice as well as graphics to explain lesson content and provide feedback. Lesson plans can be individually tailored and a comprehensive management system allows teachers to have direct access to the student's progress. Each program in the series contains a three-step approach to mastery of basic learning skills consisting of diagnostics, prescriptive, and mastery testing.

System requirements include 3-1/2" disk drive, hard drive, color monitor, and Digispeech, Covox Speechthing, Tandy Sound, SoundBlaster, or VoxCard. Price is for the complete stand-alone series. The reading program can be purchased separately for \$795.00, the language program for \$650.00, and the math program for \$765.00. Network packages are also available.



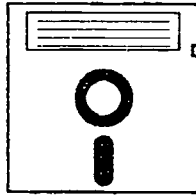

**Product Name:** CAMEO

**Vendor:** J.E. Stewart

**Computer:** Apple II Family,  
Apple Macintosh Family, IBM PC Family

**Cost:** \$17.00 per disk

CAMEO (Computer Assisted Management of Educational Objectives) is a software curriculum designed for individuals with mild and moderate disabilities. The set is a K-12 curriculum to help the user develop plans in different subjects. CAMEO has a total of 163 goals and 6,672 objectives which complement standard school curriculum areas. Titles include: language arts, daily living and social, physical education, and mathematics.

CAMEO consists of ten disks which are each \$17.00.



**Product Name:** Career English

**Vendor:** Conover Company

**Computer:** IBM PC Family

**Cost:** \$3,999.00

Career English is a comprehensive software series covering the essential English skills needed for success in the workplace. The eight courses in the series deal with punctuation, writing, sentences/nouns/pronouns, verb usage, modifiers, connectives and interjections, sentence completers and phrases, and sentence types and fragments. Career English provides the teacher with built-in accountability with both pre and post tests as well as a mastery test for each lesson.

System requirements include 640K and two 5-1/4" or 3-1/2" disk drives. Price is for one complete stand-alone series. Each of the eight courses are available separately at varying prices from \$149.95 - \$749.95. Network packages are also available.



**Product Name:** Complete Spelling Program

**Vendor:** SLED Software

**Computer:** Apple II Family, Commodore 64

**Manual Form:** Printed Manual

**Cost:** \$199.00 - \$230.00

Complete Spelling Program consists of instructional activities in spelling designed for students with spelling deficits or specific learning disabilities, from fourth grade to adult. The comprehensive, self-contained program includes five basic spelling rules, exceptions and generalizations, and provides repetitive exercises and reinforcement. The program features: tutorials for each rule, drill and practice, graphics, student pacing, correct answers and summary performance with the option to proceed available on request.

The lessons for the Commodore or PET version are priced as follows: "F-L-S or Z Rule," four tapes, \$38.00; "Doubling Rule or One, One, One," four tapes, \$38.00; "Silent E Rule," six tapes, \$57.00; "The Y Rule," six tapes, \$57.00; "Extension of the Doubling Rule," six tapes, \$57.00. The programs are available as a complete package for the Commodore 64 (five disks or 26 tapes) or PET (one disk or 26 tapes); the price is \$199.00. The same series of 26 lessons is offered for the Apple II family, as a four-disk package only, for \$230.00.

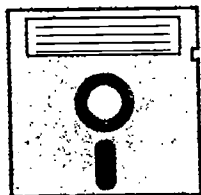

**Product Name:** Drive to Live

**Vendor:** Blessing, Maleta

**Computer:** Apple IIe, TRS-80 Model II

**Cost:** \$25.00

Drive to Live is a software program designed to assist persons in Drivers' Education training to learn driving rules. The program has a section of study questions and a test. The program is based on the 20 most frequently asked questions taken from the drivers' handbooks of Texas, New Mexico, Louisiana, Oklahoma, and Arkansas. Prior computer knowledge is not assumed. Each question is presented twice with the correct answer then each question is presented in multiple choice form until the student answers correctly; correct answers are rewarded by a positive statement (e.g., "YOU ARE RIGHT"). After running through the study questions, the student may choose to take the test or review the material. Questions on seatbelt use and drug use are included.

The program is available for the Apple IIe and TRS-80 Model II. A separate version that covers driving rules for Canadian provinces is also available.



**Product Name:** Early Learning II

**Vendor:** Marblesoft

**Computer:** Apple IIGS, Apple IIc, Apple IIe,  
Apple Macintosh Family

**Manual Form:** Printed Manual

**Cost:** \$57.00

Early Learning II is a program for teaching addition and number sequencing. The lessons Early Addition I and II teach addition with the graphic presentation of objects for reinforcement. The lessons Sequencing Up and Sequencing Down teach number sequences by requesting the student to fill in a missing number. All four lessons can be controlled with the keyboard, voice input, or one or two switches. The switch option presents "yes" and "no" choices. A speech synthesizer provides voice reinforcement. All lessons have increasing levels of difficulty. A record keeping program is also included. The program can "beep" when numbers are entered for the benefit of users with blindness.

A 128K Enhanced Apple is required to run Early Learning II. An Echo or Double Talk speech synthesizer is required for the option of voice reinforcement. The Macintosh version requires a Macintosh LC with a IIe emulator card. Keyboard overlays are included. Hand Controls (see entry) can be purchased for the switch option. Early Learning II can be used with the PowerPad, Touch Window, or IntelliKeys (see entries). Backup copies are available (extra). PowerPad and IntelliKeys overlays can be purchased.

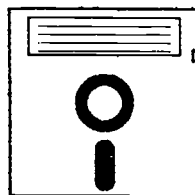

**Product Name:** Early Learning III

**Vendor:** Marblesoft

**Computer:** Apple IIGS, Apple IIc, Apple IIe,  
Apple Macintosh Family

**Manual Form:** Printed Manual

**Cost:** \$57.00

Early Learning III contains three programs designed to teach subtraction and number comparison. The Early Subtraction I and II programs display objects on the screen to teach subtraction of numbers from 1 to 19. More Than/Less Than teaches comparison of sets, numbers, and equations. All programs feature adjustable levels of difficulty. The program can "beep" when a number is input for the benefit of users with blindness.

Early Learning III requires a 128K Enhanced Apple. The input form may be a keyboard, hand controls, PowerPad, Touch Window, or IntelliKeys. An Echo or Double Talk speech synthesizer is recommended. A record-keeping system is included in the program. A keyboard overlay is also included. Backup copies are available (extra). IntelliKeys and PowerPad overlays can be purchased separately.

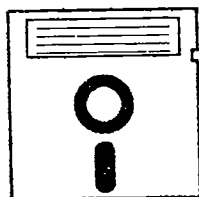

**Product Name:** Edmark Reading Program, Level 1 Software

**Vendor:** Edmark Corporation

**Computer:** Apple II Family

**Manual Form:** Printed Manual

**Cost:** \$450.00 - \$600.00

The Edmark Reading Program is the software version of a highly repetitive sight word approach for students from age three to adult. The student uses a joystick or TouchWindow (see entry) to make selections; keyboard use is another option, but is not required. The same prerequisites of the printed program apply: the student must be able to point, say or sign back a response, and have enough receptive language to understand the cues. Lessons move from pre-reading matching to word recognition, matching words to pictures, matching phrases to pictures, and short illustrated stories. A resource on disc allows the teacher to maintain data on three students at one time.

Use of an Echo speech synthesizer is required if the teacher wishes to provide verbal cues and reinforcement that differs to suit student response. The Edmark Reading Program for \$450.00 consists of one system disk and 15 lesson disks. A back-up disk is also included for a package price of \$600.00.



**Product Name:** Elementary Volume 1 - Mathematics

**Vendor:** American Printing House for the Blind (APH)

**Computer:** Apple II Family

**Manual Form:** Electronic Manual, Printed Manual

**Cost:** \$18.60

Elementary Volume 1 - Mathematics is an education program originally developed by MECC (Minnesota Educational Computing Corporation) and adapted for speech output by the American Printing House for the Blind. The program is designed so that all output is presented by a speech synthesizer. There are eleven programs included on a single 5.25" disk: Bagels, a mathematical logic and guessing game; Change, a change-counting drill; Hurtle, a game for teaching the coordinate system; Metric Estimate, where the student must estimate the length of a line (which can be printed in braille); Metric Length, a drill on converting metric units; Metric 21, a blackjack game for teaching metrics; Number, a guessing game; Round, a number-rounding drill; Speed Drill, a timed or untimed drill on arithmetic; Taxman, a program on factors and primes; and Tens, a drill on multiplying multiples of ten.

An appropriate Echo speech synthesizer (from Street Electronics), is required.

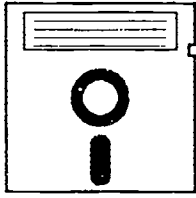

**Product Name:** ERIN (Early Recognition Intervention Network)

**Vendor:** J.E. Stewart

**Computer:** Apple II Family,  
Apple Macintosh Family, IBM PC Family

**Cost:** \$17.00 per disk

ERIN (Early Recognition Intervention Network) is a software curriculum for students with early childhood learning disabilities. ERIN has a total of 56 goals and 1,128 activities on two disks; one focuses on toddlers and infants, the other on primary school age children.



**Product Name:** Focus on Facts

**Vendor:** Exceptional Teaching Aids

**Computer:** Apple II Family

**Cost:** \$27.50

Focus on Facts is a software program designed to teach students important facts in everyday life, at school and at home. All information is presented to the student in synthesized voice. The student does not need to be able to see the screen to use the program. Students can choose to use multiple-choice or fill-in-the-blank format. The set includes a 5-1/4" disk, recorded tour of the program, and a manual.

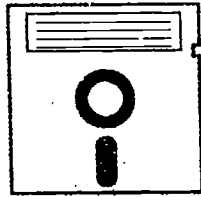

**Product Name:** Focus on Nations

**Vendor:** Exceptional Teaching Aids

**Computer:** Apple II Family

**Cost:** \$29.00

Focus on Nations is designed to challenge students to place countries in their geographic location. All information is presented to the student in synthesized voice. The student does not need to be able to see the screen to use this program. The program tests on the locations of 160 countries in eight tests. Test One deals with well-known countries, but by the time the student reaches Test Eight, the countries are lesser known. The set includes a 5-1/4" disk, recorded tour of the program, and a manual.

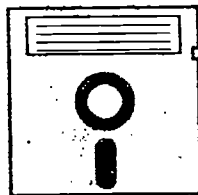

**Product Name:** Geometric Figures and Spatial Concepts

**Vendor:** Favin, David

**Computer:** Texas Instruments TI 99/4A

**Manual Form:** Printed Manual

**Cost:** Free

Geometric Figures and Spatial Concepts is a simple educational program with voice output. Various shapes (rectangles, circles, triangles, stars, etc.) are presented on the screen. The student is prompted by the synthesized voice to identify them. An object is shown in a variety of positions (such as inside a box, outside a house, or on a line), and the program prompts the student to indicate the right position word. A running score is presented in the lower right-hand corner of the screen.

A speech synthesizer is required to run the program. This program was developed through the Telephone Pioneers of America, and is free to anyone interested.



**Product Name:** H:2 Handicapped Arithmetic Flash Cards

**Vendor:** E. David & Associates

**Computer:** TRS-80 Color Computer

**Manual Form:** Printed Manual

**Cost:** \$24.95

H:2 Handicapped Arithmetic Flash Cards is a math practice program for persons unable to type on a standard keyboard. The program provides seven units with practice in simple addition, subtraction, and multiplication. Several input methods can be used with this program, including a joystick or mouse.

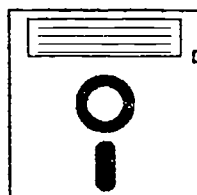

**Product Name:** JOKUS Software

**Vendor:** Don Johnston Incorporated

**Computer:** Apple Macintosh Family

**Cost:** \$50.00 - \$95.00

Jokus Software is a collection of single switch educational software programs. The programs do not require reading skills but rely on both graphics and sound. The programs each have an instructor's menu so that the settings of the program can be adjusted for the individual user. Once the start icon on the instructor's menu is clicked the program is handed over to the user.

The activities all accept a variety of input devices and names include: The Camelephant, Faces, ToyStore, Hit'n Time, aMAZEing ways, Pippi Longstocking, Vidur Viking, and Workshop. Jokus Software is compatible with all color Macintosh computers.



**Product Name:** K.C. & Clyde in Fly Ball

**Vendor:** Don Johnston Incorporated

**Computer:** Apple Macintosh Family

**Cost:** \$79.00

K.C. & Clyde in Fly Ball is an interactive adventure story program that focuses on words, context, and multiple story paths. Program features helpful to students with special needs include the low reading level and high interest level, automatic word and book scanning options, and TouchWindow or single switch access. The story begins when K.C. hits his baseball really far, and K.C. and Clyde look for it. The student must decide which way they should go and direct the story in one of up to 21 different paths. Along the way, words and concepts are explained depending on the the mode set by the teacher.

Program requires Macintosh LCII or higher, 8 MB RAM, hard drive, system 7, CD-ROM player, and 256 color monitor.

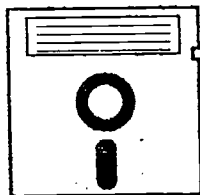

**Product Name:** Learning the Alphabet

**Vendor:** Favin, David

**Computer:** Texas Instruments TI 99/4A

**Manual Form:** Printed Manual

**Cost:** Free

Learning the Alphabet is an educational program with synthesized voice output. In the first phase of the program a single letter is presented occupying the full screen and spoken by the synthesizer. Associated with the letter is a word beginning with that letter. In the second phase of the program a particular letter is presented and spoken, and the student is asked if the letter has been identified correctly. The student makes a yes/no decision using two switches. In this phase of the program the letters are presented in random order. A running score is displayed in the lower right-hand corner of the screen.

A speech synthesizer is required to use this program. Contact the manufacturer about connecting switches to the computer. This program was developed through the Telephone Pioneers of America, and is free to anyone interested.





**Product Name:** Listen and Spell

**Vendor:** Exceptional Teaching Aids

**Computer:** Apple II Family

**Cost:** \$24.00 - \$44.00

Listen and Spell is an educational software program designed to improve the user's spelling ability. Using an Apple II computer and an Echo II speech synthesizer (extra), the program "speaks" a word and prompts the user to type it correctly. The program provides up to 400 words from which to choose; it gives the user twenty lists of words that each contain twenty words. An advanced version of this program, Listen and Spell 2000, provides up to 2000 words for spelling exercises; it uses the same equipment and format.

Listen and Spell includes one 5.25" disk, a user's manual, a listing of the 400 words, and a recorded tour of the program on cassette tape; it is sold for \$24.00. Listen and Spell 2000 includes two 5.25" disks, user's manual, cassette tour, and list of words; it is \$44.00. These programs are sold separately.



**Product Name:** Prefixes

**Vendor:** American Printing House for the Blind  
(APH)

**Computer:** Apple II Family

**Cost:** \$34.95

Prefixes is an interactive software program created by Minnesota Educational Computing Corporation (MECC) and speech-adapted by APH. The program is designed to teach about and provide practice for the use of the following prefixes: un, re, dis, pre, and in. The disk includes such activities as fill-in-the blank, type the prefix of the word, mark the prefix with the arrow keys, and complete the hidden word puzzle. Both a 5.25" and a 3.5" disk are included. The 3.5" disk includes graphics for low vision students. The program is designed for students age 8 to 12 years.

System requirements include 128K RAM and a disk drive.

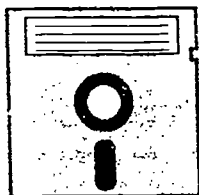

**Product Name:** Program for Aphasics

**Vendor:** Favin, David

**Computer:** Texas Instruments TI 99/4A

**Manual Form:** Printed Manual

**Cost:** Free

Program for Aphasics is a program for teaching spelling. The program displays and speaks a word, and the user is then asked to spell it. The user can "cheat" as much as desired in the attempt to spell a word, but once the attempt at spelling the word begins the prompting ceases. The prompting can be started again by the user, but this erases any previous partially spelled word.

A speech synthesizer is required for voice output. This program was developed through the Telephone Pioneers of America, and is free to anyone who is interested.

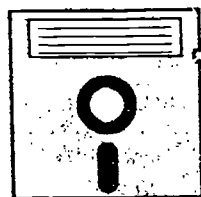

---

**Product Name:** Readable Stories Series

**Vendor:** Laureate Learning Systems, Inc.

**Computer:** Apple II Family

**Manual Form:** Printed Manual

**Cost:** \$110.00 each

The Readable Stories Series is a trio of programs designed to improve reading comprehension of early and intermediate-level readers. Each program consists of a story diskette and a question diskette. The stories use graphics, text, optional speech, and animation. Each story can be presented at three different levels, controlled for sentence length, word order, and the use of clauses and idioms. The reader uses the keyboard or a single switch to control the pace of presentation and to have any segment of the story or animation repeated. After the story is read, the reader is asked a series of comprehension questions. Visual and spoken encouragement is given in response to the reader's replies.

The three available programs are: The Birthday Surprise (focuses on main idea and sequence of events), The Puppet Show (focuses on comprehension of how and why events occurred), and The Hidden Toy (focuses on who, what, and where questions). An Apple II computer with 64K memory, a monitor, a speech synthesizer, and a 5.25" disk drive are required. A color monitor and a printer are recommended.

754

**Product Name:** Reading Horizons

**Vendor:** Conover Company

**Computer:** IBM PC Family

**Cost:** \$1,795.00

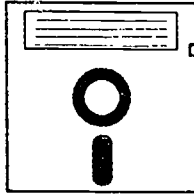

Reading Horizons is a software program to teach reading skills to adult students with no prior reading or keyboarding skills. The program provides a multi-sensory methodology, which includes audio, visual, and tactile components. In addition to reading skills, this program is designed to provide growth in spelling and handwriting skills. Each lesson requires the learner to complete handwritten work as well as computer responses and a human voice soundtrack provides instant feedback.

System requirements include 640K, a printer, one disk drive, CD-ROM player, and Covox Speechthing. Price is for a stand alone system. Various network packages are also available.

**Product Name:** Sensible Speller: Talking APH Edition

**Vendor:** American Printing House for the Blind (APH)

**Computer:** Apple II Family

**Manual Form:** Audiotape Manual, Printed Manual

**Cost:** \$97.00

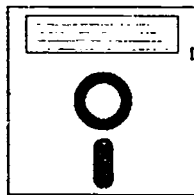

Sensible Speller: Talking APH Edition is a software program made by Sensible Software, Inc. and speech modified by APH. The Sensible Speller checks word processor documents against a disk-based Random House Dictionary of more than 80,000 words.

System requirements include: word processing program that stores documents using ProDOS and 128K RAM.

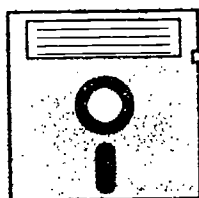

**Product Name:** Sharon's Programs

**Vendor:** Access Unlimited

**Computer:** Apple IIGS, Apple IIc, Apple IIe

**Cost:** \$25.00 each

Sharon's Programs is a collection of 15 large print computer programs that provide training in various basic skills. The programs are Simple Cause and Effect, Fun with Colors, Learning Directions, Big and Small, Same and Different, Scanning Fun, Knowing Directions, Learning Shapes, Learning Letters, Learning the Alphabet, Learning Numbers: One to Five, Silly Letters and Numbers, Learning Sight Words, Simple Addition, and Readiness Fun. The programs can be run using either the standard keyboard or alternative keyboards. Many of the programs can also be run using a single or dual switch with scanning.

An Apple IIe, IIc, or IIGS with one 5.25" inch disk drive is required. A color monitor is required for some programs and is recommended for all programs. Each program is \$25.00. All 15 programs are available for \$325.00. A sampler disk of four working programs is available free of charge on request.



**Product Name:** Sight Word Spelling

**Vendor:** Exceptional Children's Software, Inc.

**Computer:** Apple II Family

**Manual Form:** Printed Manual

**Cost:** \$29.95

Sight Word Spelling is a spelling practice program for common words and number sequences. The program presents teacher-generated lists of ten items each, which can include words of up to six letters or numbers of up to three digits. The program vocalizes each letter or number of the target item for the user to duplicate with the keyboard. Length of display, time, volume, and pitch of voice are user-specifiable. Program is intended for students at a first or second grade level of spelling.

Program requires an Echo II speech synthesizer for operation.

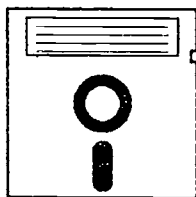

**Product Name:** Speaking Speller

**Vendor:** American Printing House for the Blind (APH)

**Computer:** Apple II Family

**Manual Form:** Braille/Tactile Manual, Electronic Manual, Large Print Manual

**Cost:** \$24.95

Speaking Speller is a spelling skills program with speech output. The program reads a word to the student in a synthesized voice: first alone, then in the context of a sentence. This sequence may be repeated if desired. The student is then required to spell the word on the computer keyboard. Speaking Speller allows the instructor to create custom lists of words, and to adjust the way the synthesizer pronounces the words by including phonetic spellings. The length of the word list is limited only by computer memory, and extra lists can be stored on disks. Speaking Speller has two sections. In the practice section, the student receives immediate reinforcement if a spelling is correct, or given the correct spelling if a spelling is incorrect. In the test section, the results are only given at the end of the session; either in printed form, on the screen, or in spoken form.

An appropriate Echo speech synthesizer is required to run Speaking Speller. The 5.25" disk comes with a ProDOS version on one side and an Apple DOS 3.3 version on the other.

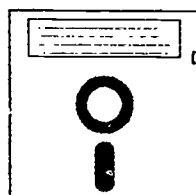

**Product Name:** Spell-A-Word & 2+2

**Vendor:** R.J. Cooper & Associates

**Computer:** Apple II Family, Apple Macintosh Family, IBM PC Family

**Cost:** \$75.00 - \$89.00

Spell-A-Word is a computer software program that provides drills in spelling. In Train mode, a word is presented to the student in large print and is simultaneously spoken. The student is then prompted to type in the word while large outlines on the screen are used as models. Correct letter entries are accepted and spoken; incorrect entries produce a buzz. Verbal praise and motivating sounds reward each completed word. After all words are trained, the Drill mode prompts the student verbally to type the word. The student may press the space bar to access a Help feature. After the student has correctly spelled the word, a line drawing is displayed that the student may color in as a reward. The 2+2 software is an arithmetic program which allows problems to be created for drill and practice. With both programs, the teacher may enter word lists, select Train and Drill levels, and print scores showing student progress.

The Apple II version requires 128K of memory. An Echo speech synthesizer is recommended (required for speech output). The IBM version requires Microsoft Windows.



**Product Name:** Spell-Talk

**Vendor:** Access Unlimited

**Computer:** Apple II Family

**Cost:** \$50.00

Spell-Talk (formerly called Tell and Spell) is a talking spelling program. The instructor can create lists of words, determining how they should be spelled and how the speech synthesizer should pronounce them. The program presents the words to the student, who must type in the correct spelling. Options include: storing word lists for future use, built-in "help" instructions, a teacher's security system, and record keeping.

An Echo speech synthesizer (extra) is required to use Spell-Talk.



**Product Name:** Spelling Tutor

**Vendor:** Access Unlimited

**Computer:** Apple II Family

**Manual Form:** Printed Manual

**Cost:** \$50.00

Spelling Tutor is a spelling practice program with voice output options useful for program operation and testing functions. Program allows creation and testing of spelling lists, with different user options within testing mode to proceed, cue, repeat or list spelling words. An additional feature allows use of the Study Buddy program (extra; see entry) to create vocabulary or word lists for use as spelling words in Spelling Tutor. Voice options include female and robotic voice.

Program requires an Echo speech synthesizer for voice output.

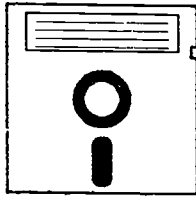

**Product Name:** SPELLIST

**Vendor:** Castle Special Computer Services, Inc.

**Computer:** Apple IIGS, Apple II Family

**Manual Form:** Printed Manual

**Cost:** \$50.00

SPELLIST is a spelling training program which provides practice at spelling from computer-generated dictation. Included in the program are options of assigning and practicing assigned words and phrases from over 800 words and phrases stored in standard lists or from those stored in customized word lists. The program voices the target word, pronounces each letter as the user spells the target, prompts and reinforces responses. Word lists may be adapted or added.

SPELLIST is suitable for use by many students in a classroom, one at a time. A speech synthesizer (extra) is required to use SPELLIST. Price is for a single disk but a group pack of eight disks for \$128.00 is also available. Contact manufacturer about obtaining personalized editions for individual student operation.

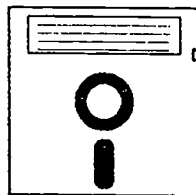

**Product Name:** Spin and Spell

**Vendor:** Access Unlimited

**Computer:** Apple II Family

**Cost:** \$45.00

Spin and Spell is a large print spelling program. The program presents the student with scrambled words in large type (1/4" or about 18-point). The student must try to unscramble the words. The student cannot enter the word spelled incorrectly, and is given chances until it is spelled correctly. Correct guesses show up in sequence until the spelled word is complete. Sound effect prompts and musical sequences are used for cues and reinforcement. Options include: storing word lists, teacher's security feature, and record keeping.

An Echo speech synthesizer (extra) is required to use Spin and Spell.



**Product Name:** Study Buddy

**Vendor:** Access Unlimited

**Computer:** Apple II Family

**Manual Form:** Printed Manual

**Cost:** \$50.00

Study Buddy is an educational study program that allows the user to enter words followed by a definition or concept description. Up to 50 words may be entered, for presentation in interactive tutorial fashion utilizing voice output. The user enters the word, then is prompted to type the meaning, with review and repeat options.

An Echo speech synthesizer is required for voice output option.



**Product Name:** Talking Public Domain Disks

**Vendor:** FDLRS/South Enabling Technologies Lab

**Computer:** Apple IIGS, Apple IIe

**Manual Form:** Electronic Manual

**Cost:** Free

Sets of public domain software are available on disk with voice output, from the Florida Diagnostic and Learning Resource System/South (FDLRS/South). The programs were selected and adapted so that synthesized voice output would provide all the information that the screen provides, so that they could be used by visually impaired students. The disks contain primarily educational programs. There are currently 26 disks available with programs on both sides. There is a disk of Morse code programs for amateur radio, a DOS utilities disk, six disks on math, fourteen disks on language arts, four on social studies, two with musical selections, one with a typing drill program, and seven with educational games. There are also disks with High School subject matter: seven on computer science, four on general science and physics, two on math, and seven on industrial arts. The rest of the disks are PRODOS programs related to word processing.

A speech synthesizer is required to use the programs with voice output. While there is no cost for the programs, two blank diskettes must be sent to FDLRS/South.

760



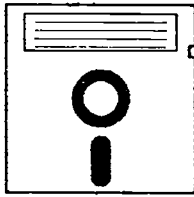

**Product Name:** Talking Riddles  
**Vendor:** Cross Educational Software  
**Computer:** Apple II Family  
**Manual Form:** Printed Manual  
**Cost:** \$24.95

Talking Riddles is a spelling and educational practice program with voice output. One game format presents 120 riddles in hangman format where the user must guess the answer by typing letters. Another format has 91 sayings to be guessed from short spoken clues. A third format contains 112 adjectives and 112 similes, for users to match a noun to fit a simile.

An Echo II speech synthesizer is required for voice output.

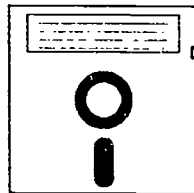

**Product Name:** Voice Math  
**Vendor:** Chatterbox Voice Learning Systems  
**Computer:** Apple II+, Apple IIGS  
**Manual Form:** Printed Manual  
**Cost:** \$295.00

Voice Math uses voice input and voice output to improve math skills. Math skills covered include numbers, time, dates and shapes. During training items are presented both on the screen and by the speech synthesizer. The student repeats the items to train the voice recognition unit in how the student says them. After training, items are presented on the screen and the child responds verbally. If the student is incorrect, the correct response is spoken by the speech synthesizer. The student then gets two more opportunities to answer.

Voice Math will not work with the Apple IIc. The program includes the software and a Sony headset/microphone. The Echo speech synthesizer and the Introvoice input module must be purchased separately.



**Product Name:** Voice Reading Ability Drill

**Vendor:** Chatterbox Voice Learning Systems

**Computer:** Apple II+, Apple IIGS

**Manual Form:** Printed Manual

**Cost:** \$295.00

The Voice Reading Ability Drill uses voice input and voice output to improve reading skills. During training, each word is presented as an illustration, in printed form, and spoken by the speech synthesizer. The student repeats the word to train the voice recognition component in the way that student says it. After training, each word is printed on the screen. If the student reads it aloud accurately, the illustration is presented along with a tune. If not, the correct word is spoken by the speech synthesizer. The student then gets two more opportunities to read the word.

The program includes 15 disk sides, headset/microphone and complete documentation. Approximately 800 words are organized into 4 levels: 120 short vowel words, 120 short vowel/consonant blend words, 120 long vowel and vowel blend words, and 200 sight words. The program will not run on the Apple IIc. Echo II speech synthesizer and Introvoice input module are required but not included.

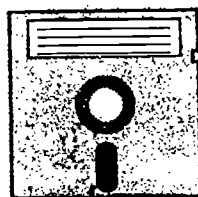

**Product Name:** Wordplay with Alps and Droops

**Vendor:** Optimal-Ed Learning Materials

**Computer:** Apple II Family

**Manual Form:** Electronic Manual, Printed Manual

**Cost:** \$75.95

Wordplay with Alps and Droops is an educational program in game format, designed to teach basic reading and spelling skills to dyslexic students. The student becomes a Wordseeker in Wordland, aided by Alps and thwarted by Droops. The games concentrate on three different skill areas: Reading Comprehension, Phonic Analysis, and Spelling. Seventeen different levels of play are possible, each concentrating on a different group of phonic patterns. These levels are arranged in developmental learning order. One to four players can play at a time.

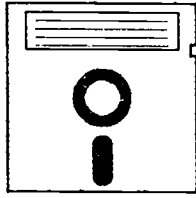

**Product Name:** Write

**Vendor:** Computers to Help People, Inc.

**Computer:** Apple II Family

**Manual Form:** Printed Manual

**Cost:** \$50.00

Write is a program that displays up to twenty words or phrases in large type on the screen. The user is prompted to copy the word letter by letter at the top of the screen. Sentences build up at the bottom. The user may also write words without copying, and new words may be entered into the available list on the spot. Sentences constructed may then be printed or spoken through a voice synthesizer. Write also allows the user to match letter by letter. Words may be spoken letter by letter, a word at a time, or a sentence at a time. Write features an automatic shift and audible feedback when a key is pressed.

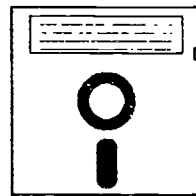

**Product Name:** Write This Way

**Vendor:** Edmark Corporation

**Computer:** Apple II Family, Apple Macintosh Family

**Cost:** \$195.00

Write This Way is a word processing program designed to recognize the specific language problems experienced by learning disabled and hearing impaired students. The program determines whether the student has entered any spelling or grammatical error and can indicate errors as the student works or in a later edit. The dictionary includes more than 50,000 words and words can be added. Teacher options allow the program to be individualized for specific needs. A teacher's guide is included.

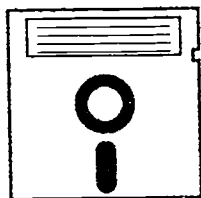

**Product Name:** Zero to Five

**Vendor:** Educational Technology International

**Computer:** Apple IIGS, Apple IIe, Commodore 64,  
IBM PC Family

**Cost:** \$1,750.00 - \$2,750.00

Zero to Five (also known as "Project Light") is a series of computer programs on interactive laser discs for developing pre-reading skills, vocabulary, grammar principles, and basic sentence structure. The software consists of CDs for CD-ROM use and two interactive video discs. A laser disc player (extra) and controller (included) are required.

Three packages are available. Package 1 (\$1,750.00) contains the Pre-Reading Series, consisting of Perceptual Training (which provides drills in visual perception skills) and Perceptual Thinking (which teaches a variety of thought tasks). Package 1 also contains Level I and II of the Language/Reading series, which provide training in basic language and reading skills. Package 2 (\$1,750.00) contains Levels III, IV, and V which provide drills in advanced verb and question forms and parts of speech, as well as basic reading materials and the Social Studies Series covering basic U.S. geography and natural resources. Package 3 (\$2,750.00) contains all the lessons in both Package 1 and 2. All programs contain diagnostic placement pre- and post-tests. Contact manufacturer for details about a hardware package.

784

# Chapter 21

## Personal Tool and Aid Software

This chapter contains software programs that are designed to be used on a long term basis by an individual as a personal tool or prosthesis. This includes programs which facilitate an individual's ability to write, draw, read, move about, and perform other daily functions. Software designed specifically to allow disabled computer users to access other software is included in Chapters 11, 12, 14, 15, and 16. Software designed primarily for communication or for environmental control is now listed in Chapter 5 and Chapter 9 respectively. Some examples of programs found in this chapter are: word processing programs with large print, software that provides features to accelerate typing, programs designed to prevent Repetitive Stress Injuries (RSI), drawing programs utilizing special input devices, computer based calculators, and braille translation and formatting programs.

Many of the programs in this chapter are also cross-listed by function in Index 1. Related functions include: Large Print (LP), Braille (BR), Word Processing (WP), Calculation (CN), Drawing (DR), Typing Acceleration (TA), and RSI Prevention (RS).

Appendices A and B contain information summaries on a variety of topics, including: Software Resources; Networks, Bulletin Boards and Databases; and Newsletters and Journals.

*The following product entries appear in this chapter:*

APH Scientific Calculator: for Apple II Computers, 737  
Atlas Speaks, 737  
Auto-Braille, 738  
B-Edit, 738  
BEX 3.1, 739  
BIG for 1-2-3, 739  
BIG for WordPerfect, 740  
Big.Calc, 740  
Biggy, 741  
BlissWrite, 741  
Braille-Talk, 742  
Braille-Term Program, 742  
Calc-Talk, 743  
Calcworthy, 743  
Checkbook Program, 744  
CINTEX 1, 744  
Co:Writer, 745  
Duxbury Braille Board for Microsoft Windows, 745  
Duxbury Braille Font, 746  
Duxbury Braille Translator (DBT), 746  
Duxbury Braille Translator for WordPerfect (DUXWP), 747  
Easy-Braille Translator, 747  
Edgar, 748  
Electric Crayon and Electric Crayon, Deluxe, 748  
ETgraphX, 749  
ExerciseBreak, 749  
Eye Relief, 750  
File-Talk, 750  
Finish Line, 751  
FormMate, 751  
Freedom Writer, 752  
H:1 Handicapped Word Computers, 752  
I Can Play, Too!, 753  
IBM-VBII, 753  
Keysoft, 754  
Keyterm, 754  
Large Print Word Processors, 755  
Letter Art with Braille Translator, 755  
Mac-Apple Communications Aid, 756  
Magic Slate II, 756  
Me Too!, 757  
MegaDots, 757  
MicroBraille 2, 758  
MicroIllustrator, 758  
Minspeak Application Programs (MAP), 759  
Multi-Line Dial-A-News System, 759  
NAMES, 760  
Noteworthy, 760  
PC Braille, 761  
Picture Braille, 761  
Picture Perfect, 762  
PowerPad Toolkit 4, 762  
Predict It, 763  
RAPIDTEXT, 763  
SeeBEEP, 764  
Strider, 764  
Talking Data Acquisition System Software, 765  
Talking Sensible Speller, 765  
Talking Utilities for DOS 3.1, 766  
Talking Writer & Four Games, 766  
TeleDesk Visually Impaired Operator Console, 767  
Telepathic II, 767  
Term-Talk, 768  
TextGrabber, 768  
Trace Math Aid, 769

TurboBraille, 769  
TypeIt4Me, 770  
VersaBraille Electric Webster, 770  
VisAbility, 771  
WinDOTS, 771  
Wish Writer, 772  
WiVox, 772  
Word-Talk, 773  
Work-Station Pro, 773  
Write:OutLoud, 774  
WriteAway, 774

*The following products from other chapters can also be used as a Personal Tool or Aid:*

Audible Cursor Routine, 121  
Braille 'n Speak Classic, 469  
CINTEX2, 271  
David, 471  
Governor (2464), 547  
HomeAccess, 283  
IntelliTalk, 137  
Language Master Special Edition - LM6000SE, 477  
Lingraphica, 139  
Motor Training Games, 638  
Phone Manager, 288  
SenSei System, 295  
Synergy Integrated Remote, 298  
Talking Screen, 156  
Talking Screen for Windows, 157  
TEAM, 299

756

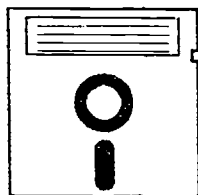

**Product Name:** APH Scientific Calculator: for Apple II Computers

**Vendor:** American Printing House for the Blind (APH)

**Computer:** Apple II Family

**Manual Form:** Audiotape Manual, Electronic Manual, Large Print Manual

**Cost:** \$36.00

APH Scientific Calculator: for Apple II Computers is software program with speech output that can do simple numerical calculations and performs many types of numerical algorithms. The main features are: a complex number mode and a real mode, ability to numerical integrations including complex line integrals, programmable capabilities, either degree or radian measure, redefinable keys, plotting functions including polar and parametric equations, and others.

The program is on a 5.25" disk. An Echo or a Slotbuster synthesizer is required.



**Product Name:** Atlas Speaks

**Vendor:** Arkenstone, Inc.

**Computer:** IBM PC AT

**Cost:** Contact manufacturer

Atlas Speaks gives the user access to geographical information using a PC or laptop. The directions can be directly saved to a Braille 'n Speak, printed on a Braille printer, or entered into a tape recorder. Small to large cities feature high performance geocoding, vector-based geographic features and attributes, up-to-date highways and roads, and road network classification and accurate zip codes. Major metro areas have those features plus parks and bodies of water. Rural areas feature only TIGER '92 Census data addresses, roads, and accurate ZIP codes. Atlas Speaks also accomodates information of personal interest to the user such as bus stops, friends' homes, shopping areas, etc.

Atlas Speaks requires a 386 minimum computer with 4 MB of RAM, MS-DOS 5.X - 6.X, a VGA monitor, and Microsoft Windows. A CD-ROM drive is strongly suggested. Most speech synthesizers, personal data devices, and braille displays are supported. See also entry for Strider.

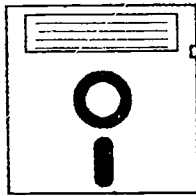

**Product Name:** Auto Braille

**Vendor:** Kansys, Inc.

**Computer:** IBM PC Family

**Manual Form:** Braille/Tactile Manual,  
Electronic Manual, Printed Manual

**Cost:** \$95.00

Auto Braille is a memory-resident version of TurboBraille (see entry). Auto Braille will intercept program output sent to the printer device (usually the parallel port LPT1) and translate it into Grade II, Grade I, or computer Braille. The program uses the same translation table and dot commands as those used by TurboBraille.

Auto Braille occupies approximately 48K of conventional memory.



**Product Name:** B-Edit

**Vendor:** Hexagon Products

**Computer:** IBM PC Family

**Manual Form:** Electronic Manual,  
Large Print Manual

**Cost:** \$39.00

B-Edit is a word processing program with character sizes that can be adjusted for all output, including help and error messages. The characters range from normal text size to large block characters that each take up four standard rows and eight standard columns. When run on video cards and monitors that support graphics, additional display sizes can be supported. B-Edit includes basic editing functions, a spelling checker with a 60,000 word dictionary, abbreviation/expansion capability, and it also supports 50 WordStar text editing commands.

B-Edit can be used on IBM-PC table and laptop models, and is available as shareware for \$39.00. Included with B-Edit are six large-character utility programs: B-Type, B-Print, and B-Dir, which provide large-character replacements for the DOS Type, Print, and Dir commands, respectively; B-Look, a text file browser; and B-Font and B-Apply, which can be used to reshape the characters used in Hexagon Products' programs.



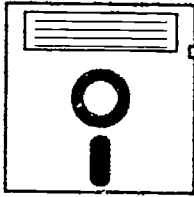

**Product Name:** BEX 3.1

**Vendor:** Raised Dot Computing

**Computer:** Apple IIGS, Apple IIc, Apple IIe

**Manual Form:** Audiotape Manual,  
Braille/Tactile Manual, Large Print Manual

**Cost:** \$450.00

BEX is a word processor that can create large print, braille, or synthesized speech output. Large print can appear on the screen or compatible dot-matrix printers. BEX can translate standard print files to grade 2 braille, or back-translate grade 2 braille files to print. Special symbols, called translators, can be typed into the files to determine whether grade 2 or grade 1 braille is produced. Word processing functions include editing, reviewing, changing, page numbering, creating running heads, and setting margins and tabs. Three preview modes create an exact image of the printed or embossed page for visual and voice review. Cursor control allows for movement by character, word, sentence, or paragraph, with or without speech output. BEX can be learned at three levels of complexity. The program directly reads DOS 3.3 and ProDOS text files, and can import text from other computers or scanners; contact manufacturer for further information.

An Apple IIe, IIc, or IIGS computer with a minimum of 128K is required. Contact manufacturer for details on compatibility with braille output devices, printers, and speech synthesis hardware. A family of add-ons is also available: ClasX, MathematIX, TranscriBEX, and pixCELLS.



**Product Name:** BIG for 1-2-3

**Vendor:** Hexagon Products

**Computer:** IBM PC Family

**Manual Form:** Electronic Manual,  
Large Print Manual

**Cost:** \$39.00

BIG for 1-2-3 is a memory-resident, display-enlarging software program designed specifically to work with (but not to replace) the Lotus 1-2-3 spreadsheet program. BIG is only activated when 1-2-3 is running; the program then enlarges differing parts of the 1-2-3 display, depending on the state of the spreadsheet. For example, when 1-2-3 displays an error message, BIG automatically enlarges the bottom line of the screen, and when the user selects a 1-2-3 menu BIG enlarges the menu choices and descriptions displayed on lines 2 and 3 of the screen.

BIG requires that the 1-2-3 display screen be divided into two horizontal windows, the second of which is reserved for the BIG display. BIG works with all text mode versions of 1-2-3; with version 3.0, text mode drivers must be used, and Perspective Windows cannot be invoked. Included with BIG are six large-character utility programs: B-Type, B-Print, and B-Dir, which provide large-character replacements for the DOS Type, Print, and Dir commands, respectively; B-Look, a text file browser; and B-Font and B-Apply, which can be used to reshape the characters used in Hexagon Products' programs.



**Product Name:** BIG for WordPerfect

**Vendor:** Hexagon Products

**Computer:** IBM PC Family

**Manual Form:** Electronic Manual,  
Large Print Manual

**Cost:** \$39.00

BIG for WordPerfect is a memory-resident, display-enlarging software program designed to work with WordPerfect versions 5.0 and 5.1 and LetterPerfect 1.0. The BIG program enlarges different parts of the screen depending on the state of WordPerfect. For example, during text input BIG enlarges WordPerfect's bottom line status and the area around the cursor; during spell checking, BIG shows the misspelled word and the replacement choices.

Included with BIG are several other large-character utility programs: B-Type, B-Dir, and B-Print, which provide large-character replacements for DOS commands; B-Look, a text file browser; and B-Font and B-Apply, which can be used to reshape the characters used in Hexagon Products' programs. A color or Hercules monochrome graphics display is required.

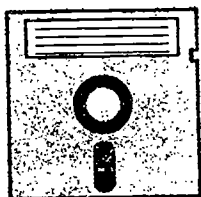

---

**Product Name:** Big:Calc

**Vendor:** Don Johnston Incorporated

**Computer:** Apple Macintosh Family

**Cost:** \$29.00

Big:Calc is a Macintosh calculator program designed especially for people with learning, visual, and physical disabilities. Features include: large number keys, high-quality speech, and built-in scanning. Key and background colors and calculator layout can be changed.

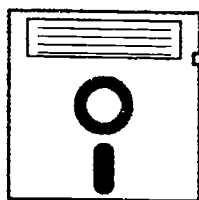

**Product Name:** Biggy

**Vendor:** R.J. Cooper & Associates

**Computer:** Apple Macintosh Family

**Cost:** \$29.00

Biggy is a software program that provides four large size cursors that work with any program.

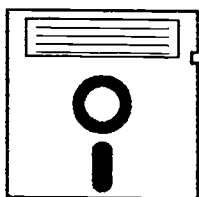

**Product Name:** BlissWrite

**Vendor:** Blissymbolics Communication International

**Computer:** Apple Macintosh Family, IBM PC Family

**Cost:** \$100.00

BlissWrite is a composing and editing program designed for the Blissymbol user. BlissWrite works in Blissymbol alone, in print alone, or in both Blissymbol and print together. The program can also translate back and forth between Blissymbol and print. The manufacturer is currently developing a telecommunications program called BlissNet which will incorporate BlissWrite; for more information contact Andrew McNamara at BCI.

Four versions are available. One version works with Windows 3.1 or higher and the regular keyboard and mouse. Version two works with Windows 3.1 and WiVik (see entry) for users who need adaptive access software. Both Microsoft Windows versions require a minimum 386 processor and a VGA monitor. Version three works with the Macintosh computer system 6.01 or higher and the regular keyboard and mouse. Version four works with the Macintosh computer system 6.01 or higher and Ke:nx (see entry) for those who need adaptive access software.



**Product Name:** Braille-Talk

**Vendor:** GW Micro

**Computer:** Apple IIGS, Apple IIc, Apple IIe,  
IBM PC Family, IBM PS/2 Family

**Manual Form:** Audiotape Manual,  
Electronic Manual, Large Print Manual

**Cost:** \$195.00

Braille-Talk is a Grade One or Two Braille translator program with voice output. Braille-Talk allows standard text to be translated into Braille for embossing. No prior knowledge of text-to-Braille translation is necessary to operate Braille-Talk. Information displayed on the screen is simultaneously spoken as each key is typed. Speech output may be momentarily silenced or turned off entirely at any time.

Braille-Talk supports a variety of Braille printers as well as most commercially available speech synthesizers.



**Product Name:** Braille-Term Program

**Vendor:** Blazie Engineering

**Cost:** \$80.00

The Braille-Term Program allows Braille 'n Speak and Type 'n Speak to be used for on-line communications via modem. Braille-Term allows the user to communicate with a modem to dial phone numbers. Other program features include a 50 entry dialing directory, auto-dial to redial a number until the line becomes free, efficient data transmission, session logging that allows the user to automatically save messages from on-line services into a separate log file, and easy to use set-up menu and help file.

772



**Product Name:** Calc-Talk

**Vendor:** GW Micro

**Computer:** Apple IIGS, Apple IIc, Apple IIe

**Manual Form:** Audiotape Manual,  
Electronic Manual, Large Print Manual

**Cost:** \$95.00

Calc-Talk is a voice output program that changes the standard Apple keyboard into a 24 function calculator with ten memories. In addition to voice output, Calc-Talk displays characters that are nearly an inch high, for visually impaired users. Scientific functions included are trigonometric, logarithms, exponents, and roots. All entries, functions and answers are spoken.

Calc-Talk supports most commercially available voice synthesizers.

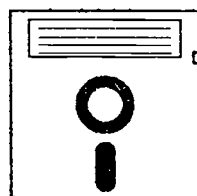

**Product Name:** Calcworthy

**Vendor:** GW Micro

**Computer:** IBM PC Family

**Cost:** \$49.00

Calcworthy is a pop-up calculator program with addition, subtraction, multiplication, division, times/minus, and percent functions. Other features include printing, ticker-tape review of the previous 50 entries, immediate export of the current display to application, and memory capabilities.

Calcworthy is compatible with all major screen reading programs but designed specifically for Vocal-Eyes. Other system requirements are 128K RAM and one 5-1/4" or 3-1/2" disk drive.

**Product Name:** Checkbook Program

**Vendor:** Blazie Engineering

**Cost:** \$99.00



The Checkbook Program allows the user to maintain an accurate electronic checkbook register of all entries for multiple accounts through Braille 'n Speak, Braille Lite, or Type 'n Speak (see entries). Entries include checks written, miscellaneous fees, accrued interest, and ATM withdrawals. The program can print checks or use the user's own bank checks. Statements may be printed, spoken, or saved in a file. An overdrawn-account warning is also included.

---

**Product Name:** CINTEX I

**Vendor:** NanoPac, Inc.

**Computer:** IBM PC Family

**Manual Form:** Electronic Manual, Printed Manual,  
Videotape Manual

**Cost:** \$1,290.00 - \$2,285.00

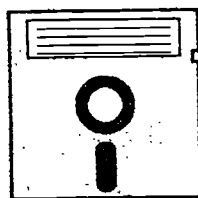

CINTEX I is a multi-function ECU software package designed for use with one or more switches (eyebrow, eyewink, sip and puff, etc.), joystick, selectable keys on a keyboard, or a full keyboard. The basic software contains word processing (with letter prediction as well as word prediction, and "built-in sticky key" features; the word prediction is able to "learn" the words that are used most frequently), environmental control, infrared control (TV's, VCR's, stereos, CD players and satellite dishes), rudimentary music composition, calculator, notepad, and telephone (answer, dial, disconnect, flash) capabilities.

The base price of \$1,290.00 includes software, speaker phone, ECU controller, manual, and technical support. CINTEX I requires 640K of memory and a game port if switch input is being used. Most commercially available speech synthesizers can be used for speech output. Contact manufacturer for information on other current and planned options for use with CINTEX.



**Product Name:** Co:Writer

**Vendor:** Don Johnston Incorporated

**Computer:** Apple Macintosh Family

**Cost:** \$290.00

Co:Writer is a software program which predicts words for the user. As a person types, this program offers the choice of up to ten words at once as selections for the next word to be typed. To use one of the "predicted" choices, the user simply selects the desired word and that word is automatically inserted into the user's text. This prediction program uses a built-in dictionary and a personalized vocabulary created by the user's word choices.

Co:Writer can be used with any Macintosh program that accepts text entry. 8MB RAM is recommended.



**Product Name:** Duxbury Braille Board for Microsoft Windows

**Vendor:** Duxbury Systems, Inc.

**Computer:** IBM PC Family

**Manual Form:** Electronic Manual, Printed Manual

**Cost:** \$295.00

The Duxbury Braille Board for Microsoft Windows produces ADA braille compliant signs (English only). The program is a stand-alone application that can create grade 2 braille and emboss it on a commercial embossing device. When combined with the Duxbury Braille Font (see entry), the Braille Board can create layouts in applications such as CASmate, CoreIDRAW, FlexiSIGN, Graphix Advantage, PageMaker, and SignLab.

System requirements include: 286, 386, 486, Pentium or better CPU; 2MB RAM, 1MB available hard drive space; Microsoft Windows.

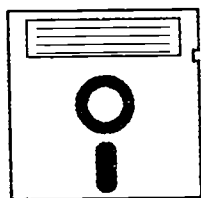

**Product Name:** Duxbury Braille Font

**Vendor:** Duxbury Systems, Inc.

**Computer:** Apple Macintosh Family, IBM PC Family

**Cost:** \$99.00

Duxbury Braille Font is available on the Apple Macintosh or IBM computer running Microsoft Windows. The font allows the 6-dot braille cell to be printed on any laser printer that handles TrueType or Adobe Type 1 fonts.

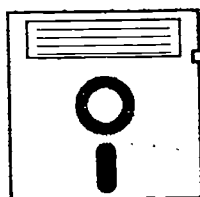

**Product Name:** Duxbury Braille Translator (DBT)

**Vendor:** Duxbury Systems, Inc.

**Computer:** Apple Macintosh Family, IBM PC Family

**Manual Form:** Braille/Tactile Manual,  
Electronic Manual, Printed Manual

**Cost:** \$495.00 - \$2,475.00

The Duxbury Braille Translator (DBT) is a software package for bidirectional print to braille conversion and editing. The software is available on DOS, Microsoft Windows, and Macintosh platforms. Major features include: editing multiple files of unlimited size, grade 1 or 2 American, British, French and Spanish languages, Computer Braille Code (CBC), six-key chording, ASCII/WordPerfect/SGML imports, access to external file format conversion, graphical dots-on-screen or ASCII equivalents, nestable styles and/or direct coding, and a translated line for learning braille. DBT includes the Duxbury Braille Font (see entry).

System requirements for DOS include: 286, 386, 486, Pentium or better CPU; 640K RAM; 4MB available hard drive space; and DOS 3.3 or higher. System requirements for Windows include: 386, 486, Pentium or better CPU; 4MB RAM; 4MB available hard drive space; and Microsoft Windows. System requirements for Macintosh include: Macintosh Plus or newer (including the Power Mac); 1MB RAM or 2MB RAM with System 7 or later; System 6.0.8 or later; and a suitable keyboard if six-key chording is desired. Contact manufacturer for further information.

776



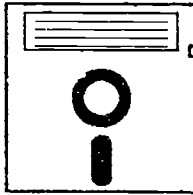

**Product Name:** Duxbury Braille Translator for WordPerfect (DUXWP)

**Vendor:** Duxbury Systems, Inc.

**Computer:** IBM PC Family

**Cost:** \$295.00

DUXWP is a scaled down version of Duxbury Braille Translator for DOS (see entry). The program translates WordPerfect files into formatted grade 1 or 2 braille. The program can be used with WordPerfect versions 5.0, 5.1, 5.1+, and 6.0 for DOS, as well as WordPerfect 5.1, 5.2, 6.0, and 6.1 for Microsoft Windows. Supported WordPerfect codes include tab, indent, center, bold, italic, underline, running header, block protect, table of contents, foreign language, font change, date code, special characters, and many more.

System requirements include: IBM PC, XT, 286, 386, 486, Pentium or better CPU; 640KB RAM, 2MB available hard drive space; MS-DOS version 3.3 or higher.



**Product Name:** Easy-Braille Translator

**Vendor:** Blazie Engineering

**Cost:** \$99.00

Easy-Braille Translator is a program that translates any ASCII text file into formatted Grade 2 Braille for use with Braille 'n Speak, Braille Lite, or Type 'n Speak. Easy-Braille is designed to be simple to operate and allows for word exceptions.

777

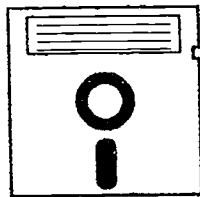

**Product Name:** Edgar

**Vendor:** Duxbury Systems, Inc.

**Computer:** IBM PC Family

**Manual Form:** Electronic Manual, Printed Manual

**Cost:** \$195.00

The Duxbury Braille Editor (Edgar) allows blind or sighted transcribers to compose and edit Braille files. Braille can be edited by using six of the home-row keys as if they were the keys of a Perkins Braille. Editing can also be done using Edgar's bidirectional translation capabilities. The six-dot Braille cells are graphically represented on the screen. Additional features include: multiple file editing, no practical limit on file size, and page formatting capabilities. The program also allows ASCII characters to appear on the computer screen so that a screen reader can read the document.

A CGA, EGA, Hercules, or VGA graphics card is required. Contact manufacturer for information on site licenses.



**Product Name:** Electric Crayon and Electric Crayon Deluxe

**Vendor:** Merit Studios

**Computer:** Apple IIGS, Apple IIc, Apple IIe, Commodore 64, IBM PC Family

**Manual Form:** Printed Manual

**Cost:** \$9.95

Electric Crayon is a program that provides line drawings on the computer screen which can be colored. The program can be controlled by the keyboard, a joystick or a mouse. The user directs a crayon-shaped pointer to a set of colors on the screen. The desired color is selected and the "crayon" turns to that color. The user then moves to the line drawing on the screen, directs the "crayon" to the desired area, and presses a button or key. That area of the drawing changes to the appropriate color. Finished pictures can be printed on a color printer or the line drawings can be printed on a black-and-white printer and colored by hand; contact manufacturer about printer compatibility. Drawings can be printed as calendars.

The titles currently available are: ABCs, Fun on the Farm, and This Land is Your Land, Holidays and Seasons, Dinosaurs are Forever, and "Teenage Mutant Ninja Turtles". Electric Crayon Deluxe, for which the titles Dinosaurs are Forever, At the Zoo, "Teenage Mutant Ninja Turtles," and Holidays and Seasons are available, can print with just the description of the drawing colored, is able to print banners, and includes four-color stickers. 3.5" inch disks are \$12.95 each, 5.25" disks are \$14.95.

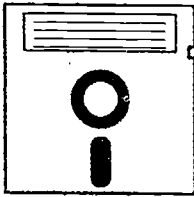

**Product Name:** ETgraphX

**Vendor:** Blazie Engineering

**Cost:** \$249.00

ETgraphX is a software program that converts conventional images on the PC into tactile braille graphics. The program saves and converts images from conventional drawing programs such as PC Paintbrush IV and works with scanned images.

ETgraphX can operate with any MS-DOS 2.0 or higher computer with a CGA, EGA, or VGA graphics adapter. Converted images are in a format compatible with the Braille Blazer and many other embossers.



**Product Name:** ExerciseBreak

**Vendor:** Hopkins Technology, LLC

**Computer:** Apple Macintosh Family, IBM PC Family

**Cost:** \$29.95 - \$39.95

ExerciseBreak is a software program designed to reduce stress, increase productivity, prevent fatigue, improve circulation, and avoid repetitive-motion injury for personal computer users. The program lets the user design a custom, on-line exercise program by scheduling regular breaks and selecting from more than 50 routines to stretch specific muscle groups. More than 70 anatomical illustrations demonstrate proper stretching techniques to assure that the exercise is beneficial.

The IBM version is available for use with DOS or Microsoft Windows and sells for \$29.95. The Macintosh version sells for \$39.95.

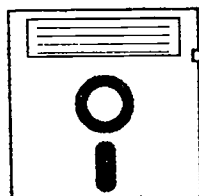

**Product Name:** Eye Relief  
**Vendor:** SkiSoft Publishing Corporation  
**Computer:** IBM PC Family  
**Manual Form:** Large Print Manual  
**Cost:** \$295.00

Eye Relief is a stand-alone word processing software program designed to be used by people with low vision. The word processing features can produce screen fonts at magnification levels from one to five times standard size, producing letters up to 1.4" in height. Word processing features include Insert, Delete, Cut, Paste, Copy, Find, and Replace. The software produces standard ASCII text files which can be loaded into other word processing packages. The program can be used to print documents with headers, footers, and page numbers in standard type on any printer, or in 18 point type on Laserjet or Postscript laser printers. Text is always shown on screen with word wrap, regardless of type size; no horizontal scrolling is required. The user can specify any number of pixels between adjacent letters and can control vertical spacing between lines.

Eye Relief cannot be used to provide magnification for other software packages. The program runs on IBM computers with 512K of RAM and a CGA, EGA, VGA, MCGA, or Hercules graphics card.

---

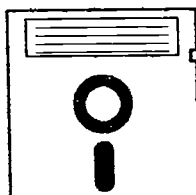

**Product Name:** File-Talk  
**Vendor:** GW Micro  
**Computer:** Apple IIGS, Apple IIc, Apple IIe  
**Manual Form:** Audiotape Manual,  
Electronic Manual, Large Print Manual  
**Cost:** \$195.00

File-Talk is a voice output database management program which allows creation of files, searches, sorts, and other database functions instantaneously. Records can contain 250 fields, with 3K of information, and can be sorted any time. Other features include on-screen arithmetic computations, auto modem dialing, date and time fields display, and printing of mailing labels, custom letters, and lists.

A speech synthesizer is required for voice output, and the program is compatible with most printers; contact manufacturer for details.

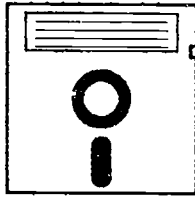

**Product Name:** Finish Line

**Vendor:** Innovative Designs, Inc.

**Computer:** IBM-PC XT, IBM PC AT,  
IBM PC Family, IBM PS/2 Family

**Manual Form:** Printed Manual

**Cost:** \$49.00 - \$59.00

Finish Line is a software program which can predict words for the user during text entry. Once the program learns the user's frequently typed words and phrases, then word and phrase choices will appear in pop-up windows as the user enters text. To select a word from the list, the user presses the "hot-key" which corresponds to the chosen word, the word or phrase is then automatically inserted into text. The "hot-keys" are designated by the user and the symbols of these keys appear in the pop-up windows next to corresponding choices.

Finish Line is compatible with IBM computers. A variety of input devices can be used. Output devices such as computer compatible speech synthesizers and TDDs can also be used. The DOS version is \$49.00 and a Microsoft Windows compatible version is \$59.00.

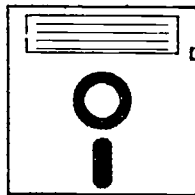

**Product Name:** FormMate

**Vendor:** Henter-Joyce, Inc.

**Computer:** IBM PC Family, IBM PS/2 Family

**Manual Form:** Audiotape Manual,  
Electronic Manual, Printed Manual

**Cost:** \$295.00

FormMate is a program that can be used to fill out preprinted forms on a computer. The program is prompt driven, one prompt or question per line, and the questions can be asked in any order, independent of the blanks on the form. Lotus 1-2-3-style menus are used. Selections are read and invoked by using the cursor pad keys or pressing the first letter of the desired choice. FormMate uses one information file to fill in all different related forms, keeping information about a single person or event in one place. Other features include data-type error checking on input, microspacing capability, independent print enhancement (underline, bold face, etc.), and continual availability of file names and descriptions, prompt and prompt help line, and current cell or field name.

FormMate works with most speech synthesizers and screen reading programs. Contact manufacturer for information on creation of custom forms.



**Product Name:** Freedom Writer  
**Vendor:** World Communications  
**Computer:** IBM PC Family  
**Manual Form:** Printed Manual  
**Cost:** \$295.00

Freedom Writer is a word processing program that can be operated with input devices other than the standard keyboard. Five versions are available: a mouse version, a cursor keys version, a scanning version, a joystick version, and a light pen version. All five versions present an image of a keyboard on part of the computer screen. The mouse and cursor key versions present a pointer on the screen. The user moves the pointer to the desired "key" on the screen and pushes the mouse button or a key on the cursor keypad in order to activate that "key." In the light pen version, the user directs a light pen at the desired "key" on the screen in order to activate it. Whatever the user "types" on the screen keyboard appears on the rest of the screen as text. The user can edit, delete and move text, and check spelling against either of two dictionaries: one provided and one that the user creates containing custom vocabulary. Text can be printed on a compatible printer.

The price listed is for a single version of Freedom Writer, not including the input device.



**Product Name:** H:1 Handicapped Word Games  
**Vendor:** E. David & Associates  
**Computer:** Commodore 64, TRS-80 Color Computer  
**Manual Form:** Printed Manual  
**Cost:** \$24.95

H:1 Handicapped Word Games is a variation of the games "hangman" and "scramble" made accessible to persons unable to accurately touch the computer keyboard. In this version, both the unknown word and definition are displayed, to practice both vocabulary and spelling skills. Vocabulary and definitions are user-specifiable.

1782

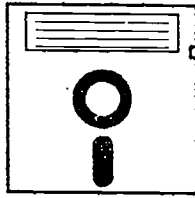

**Product Name:** I Can Play, Too!

**Vendor:** Mayer-Johnson Company

**Computer:** Apple Macintosh Family

**Cost:** \$89.00

I Can Play, Too! is a software program that allows users with communication needs to be included and use appropriate speech while playing games. Users can select things to say such as "You dirty rat", "Gotcha dude", "Your turn", and others. Seven different screens of saying correlate with the games Go Fish, Red Light/Green Light, Cootie, General Board Games, Checkers, Battleship, and Simon Says. The program features a child's human voice, animation, and a manual.

System requirements include a Macintosh Plus or higher, HyperCard 2.0 or higher, 2 MB of RAM, and a hard drive with 5 MB of disk space available. I Can Play, Too! can be used with the mouse, joystick, touch screen, alternate keyboard, Unicorn Board, IntelliKeys, Light Talker, Touch Talker, or switches. This software is not a computerized substitute for the games, but rather a communication aid to be used while playing the games.

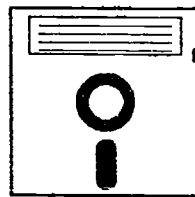

**Product Name:** IBM-VBII

**Vendor:** Cornucopia Software

**Computer:** IBM PC Family

**Manual Form:** Electronic Manual, Printed Manual

**Cost:** \$249.95

IBM-VBII software permits transfer of information between IBM PC compatible computers and VersaBraille II. After the IBM-VBII software is loaded onto a PC, VersaBraille files on disk can be loaded onto the PC and converted into MS DOS text files. IBM-VBII can also be used to convert MS DOS files into VersaBraille files; these files can then be copied onto a disk and loaded into VersaBraille II.

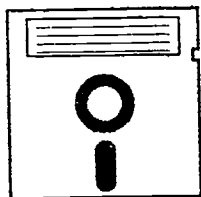

**Product Name:** Keysoft

**Vendor:** HumanWare, Inc.

**Computer:** IBM PC Family, IBM PS/2 Family

**Cost:** \$595.00

Keysoft is a voice output software package for information handling. The package is designed specifically for blind users, and does not require knowledge of DOS or screenreaders to operate. Keysoft consists of Keyword, Keypell and Keyplus. Keyword is a full-function word processor with screen reading functions built-in. Keypell is a spell checking program for Keyword documents. Keyplus is a calculator that can be used in simple four-function mode or with complete scientific functions.

A speech synthesizer is required to use Keysoft.

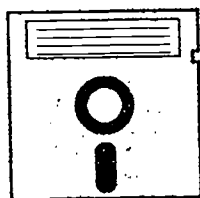

**Product Name:** Keyterm

**Vendor:** HumanWare, Inc.

**Computer:** IBM PC Family, IBM PS/2 Family

**Cost:** \$295.00

Keyterm is a telecommunications program with voice output. Keyterm is designed for blind users. Voice output is integrated into the software, so no screen reading software is required. No knowledge of DOS is required. Keyterm provides modem control and other features to allow users to access on-line services such as computer bulletin board systems, terminal connections to mainframes, and electronic mail networks.

A speech synthesizer is required to use Keyterm.



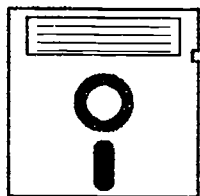

**Product Name:** Large Print Word Processors

**Vendor:** National Institute for Rehabilitation Engineering

**Computer:** IBM PC Family

**Manual Form:** Printed Manual

**Cost:** \$39.95 - \$299.95

Large Print Word Processors function like ordinary word processors, except that as keys are pressed the characters that appear on the screen are larger.

Four programs are available. Magnifying Children's Word Processor (\$39.95), with limited features, allows screen magnification either 2X or 4X. LV Publisher (\$139.95; requires 512K of memory) can magnify letters up to 36 points; the letters will print out at the magnification level set. The program can also enlarge graphics such as boxes and circles. ER Large Display Word Processor (\$299.95) and BE Large Display Word Processor (\$99.95) provide up to 5X magnification. The size of the printed characters need not be the size of the onscreen characters. The Large Display Word Processor programs can import and export ASCII files for use with other word processors. All programs require CGA, EGA, or VGA graphics cards. A Spelling Checker is available for the ER Large Display Word Processor for \$89.95; spell checking is included in the BE Large Display Word Processor.

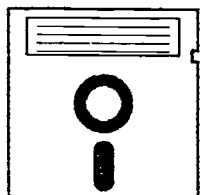

**Product Name:** Letter Art with Braille Translator

**Vendor:** Symbol Graphics

**Cost:** \$775.00

Letter Art creates professional, quality text, and graphics for materials ranging from business cards to billboard displays. With the optional Braille Translator, users can produce braille signs without any knowledge of braille. Signs can be combined with pictograms or English text. Letter Art supports all conventional engraving and polymer wash production methods.

Price is for the base package and Braille Translator. A package with 20 additional fonts is available for \$1,275.00 and with 65 additional fonts for \$1,705.00 (including Braille Translator). Various additional options and add-ons are available at extra cost.



**Product Name:** Mac-Apple Communications Aid

**Vendor:** Computers to Help People, Inc.

**Computer:** Apple II Family

**Manual Form:** Printed Manual

**Cost:** \$50.00

The Mac-Apple Communication Aid is a communication and writing program that may be controlled by switches or an expanded, mini, or standard keyboard. The user may perform simple text editing and calculation functions with Mac-Apple, and compile stored words, phrases and sentences and select them later. Mac-Apple automatically places two spaces at the end of a sentence, and capitalizes the next word entered. Also included in Mac-Apple are several programs that may be used to train users in switch input, and word and number recognition.

This program runs on the Apple II computer, but does not function with the Macintosh computer, despite the name.



**Product Name:** Magic Slate II

**Vendor:** Sunburst Communications, Inc.

**Computer:** Apple II Family

**Manual Form:** Printed Manual

**Cost:** \$65.00 - \$775.00

Magic Slate II is a word processing package with three levels of proficiency, each corresponding to a different character mode appearing on the screen and in printouts. The easiest level has large print characters in 20-column mode. The other two levels feature standard size characters in 40- or 80-column. Non-deletable text can be placed in files. Printing capabilities include near-letter quality, and multiple files can be printed from one disk. Magic Slate II has also been designed for use with a modem

A 128K Apple is required to run Magic Slate II, and an Apple IIe with an 80-column card, a IIc, or a IIGS are required to run the 80-column level of the program. The 20-column, 40-column, and 80-column versions are available separately, with supporting Teacher's Guides, for \$65.00 each; a 20-, 40-, or 80-column version for an Appleshare or Corvus network is \$260.00; a version with all three levels for a single-user is \$129.00; a three level version for a network is \$516.00. Magic Slate may be updated to Magic Slate II at no charge.

1786



**Product Name:** Me Too!

**Vendor:** William K. Bradford Publishing Company, Inc.

**Computer:** Apple IIGS, Apple IIe

**Cost:** \$99.50

Me Too! is a software program that permits students to run standard story writing programs using an alternative keyboard, switches, touch screen, or other adaptive peripherals. Menus permit the user to set a configuration according to the device they are using. The configuration is then sent to the Adaptive Firmware Card (extra).

Two expanded keyboard overlays are included. An enhanced 128K Apple IIe or an Apple IIGS are required to run the program. A variety of story writing programs that will work with Me Too! are available from the manufacturer. The story programs are based on such subjects as science, folktales, and everyday skills; titles include: Explore a Story, Explore a Science, Explore a Folktale, and Explore a Classic.

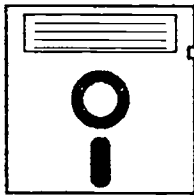

**Product Name:** MegaDots

**Vendor:** Raised Dot Computing

**Computer:** IBM PC Family

**Cost:** \$500.00

MegaDots is a word processing, braille translation, and large print program for the IBM computer that allows the user to produce ink or braille output from the same document. The program is a style-based word processor (the user assigns a style to a block of text and MegaDots handles all formatting commands). The program comes with predefined styles for items such as headings, items in a list, tables of contents and indexes. MegaDots can import files from several other programs (including Macintosh applications) and automatically applies styles, which can be changed, based on formatting commands used by the original program. Braille output can also be viewed on the screen as a dot pattern and documentation included with the program gives an overview of rules for producing proper braille documents.

MegaDots runs on IBM and compatible computers and supports most ink and braille printers. Contact Raised Dot Computing for more details.



**Product Name:** MicroBraille 2

**Vendor:** Micro Engineering

**Computer:** IBM PC Family

**Manual Form:** Electronic Manual, Printed Manual

**Cost:** \$155.00

MicroBraille 2 is a braille word processing program designed specifically for sighted transcribers. The program supports level 2 braille, music braille, diagrams, graphs, foreign languages, Nemeth math code, and six key or full keyboard operation. Other features include: full page display, automatic headings and page number, word wrap to indented cell for block paragraphs, sample drawings of diagrams and graphs, and search and replace designed for braille. Files can be imported from Duxbury (see entry) or text and can be exported to braille embossers through serial or parallel ports. The program prints simulated braille dots and placement dots on most printers.

System requirements include an IBM compatible PC with at least 256K of RAM memory and one 5.25" or 3.5" floppy disk drive (a hard disk is not required), DOS version 2.1 or later, and graphic capability.

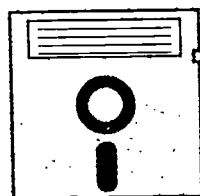

**Product Name:** MicroIllustrator

**Vendor:** Dunamis, Inc.

**Computer:** Apple II Family, Atari 400, Atari 800

**Manual Form:** Printed Manual

**Cost:** \$69.95

MicroIllustrator is a graphics program that operates by simple touch commands. Users can create, revise, adapt, and combine pictures, designs, diagrams, colors, and textures. Designs can also be mixed, expanded or reduced. All drawings can be stored to disk and retrieved for later display or modification.

MicroIllustrator requires use of PowerPad (see entry); contact Dunamis for details.

**Product Name:** Minspeak Application Programs (MAP)

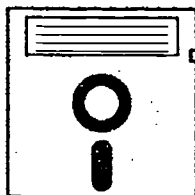

**Vendor:** Prentke Romich Company

**Computer:** Apple II Family,  
Apple Macintosh Family, IBM PC Family,  
IBM PS/2 Family

**Cost:** \$355.00

Minspeak Application Programs (MAPs) are pre-stored vocabularies for specific client groups. MAPs are provided on computer disk, and are loaded from a computer into one of Prentke Romich Company's communication aids: the Liberator, Touch Talker or Light Talker. Written by experts in the field, MAPs satisfy overall needs of a target population, and are also customizable to meet an individual's specific needs.

There are currently seven different MAPs available for the Liberator, Touch Talker or Light Talker. One program is also available for the IntroTalker (available in Touch Talker and Light Talker versions only). A Memory Transfer Interface cable (extra) is required to transfer MAPs from the computer to the communication aid. For Light Talker and Touch Talker, MAPs can also be purchased in the form of quick-load chips, for an additional \$25.00 per set. Contact manufacturer for further information on the vocabulary content, cognitive levels and skills needed for each of the vocabulary programs.

---

**Product Name:** Multi-Line Dial-A-News System

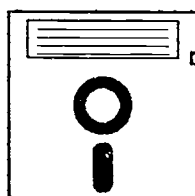

**Vendor:** Phone TTY, Inc.

**Computer:** IBM PC AT

**Cost:** \$750.00

The Multi-Line Dial-A-News System is bulletin board software for TDD users. The software can be used to provide information to TDD callers such as schedules and services provided lists. The Multi-Line System can hold up to 500 individual files. When a call is placed to the system the caller is given initial instructions, via the caller's TDD, explaining how to access available information. The caller is first given the current weather forecast and from that point can access other files either through typing a specific file name or by accessing a list. Command prompts and instructions can be accessed at any time.

The Multi-Line System is IBM compatible. The software requires a multi-line serial card, Phone TTY CM-4 modem, and Phone TTY TDDDM software.



**Product Name:** NAMES

**Vendor:** Kansys, Inc.

**Computer:** IBM PC Family

**Manual Form:** Braille/Tactile Manual,  
Electronic Manual, Printed Manual

**Cost:** \$95.00

NAMES is a program that can be used to store and print names, addresses, phone number, and "Tags" of identifying information. NAMES will display information to either a computer screen or a 8.5" x 11" sheet of labels. Each record is defined by a unique, variable length "Key" which is used for sorting data. The name, address, city, state, zip, home phone, work phone, and Tag fields are of fixed length. The user can load and save multiple lists, mark and unmark entries, and retrieve entries using Tags or Keys. Lists will accommodate 1,000+ entries.

NAMES can be used on most PC-compatible computers, and will work with most screen review programs and speech synthesizers.

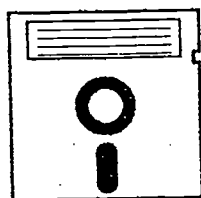

**Product Name:** Noteworthy

**Vendor:** GW Micro

**Computer:** IBM PC Family

**Cost:** \$69.00

Noteworthy is a voice interactive PC notetaker program designed for blind or visually impaired computer users. Noteworthy has a pop-up design that allows it to be activated from any other program. Complete editing tools such as delete and locate are included. Navigation commands allow the text to be read sentence-by-sentence or paragraph-by-paragraph, not by lines. Noteworthy can be set to allow 1,000 to 40,000 characters.

Noteworthy has been designed specifically for the Vocal-Eyes screen reader but is compatible with all other major screen reading programs. Other system requirements are 128K, one 5-1/4" or 3-1/2" disk drive, and video screen.

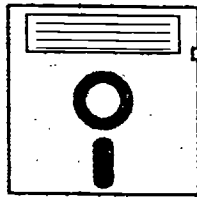

**Product Name:** PC Braille

**Vendor:** Braille Research & Literacy, Inc.

**Computer:** IBM PC Family

**Manual Form:** Braille/Tactile Manual,  
Electronic Manual, Printed Manual

**Cost:** \$295.00

PC Braille software translates and formats documents created via text editors and word processors into grade 0, 1, or 2 braille. WordPerfect 5.1 and 6.0 are directly supported. Translated documents can be printed on a braille printer or sent to a refreshable braille display using standard DOS commands. The provided tables (contraction, exception, and dot pattern) may be customized by the user.

PC Braille comes in two forms: command driven and menu style. PC Braille is available for DOS, Microsoft Windows, Unix, and IBM RT PC. A demo disk is available for \$10.

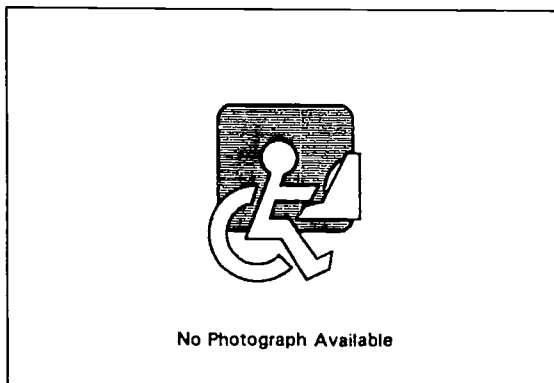

**Product Name:** Picture Braille

**Vendor:** American Printing House for the Blind  
(APH)

**Computer:** IBM PC Family

**Manual Form:** Braille/Tactile Manual,  
Electronic Manual, Large Print Manual

**Cost:** \$660.00

Picture Braille is a software and hardware system for producing tactile graphics. The system includes a hand-held image scanner, a computer mouse, and a software program. When combined with a braille embosser the system produces maps, line drawings, graphs, and other graphics. The software and scanner allow the user to import an image and then clean it up before embossing and also to create pictures using a drawing program or the mouse.

System requirements include an expansion slot for the scanner and one of the following braille embossers: MountBatten Brailier or Braille Blazer, and embossers from Enabling Technology, Index, and TeleSensory.

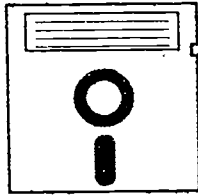

**Product Name:** Picture Perfect

**Vendor:** Mind Play

**Computer:** Apple II Family, IBM PC Family,  
IBM PC jr

**Manual Form:** Printed Manual

**Cost:** \$49.99

Picture Perfect is a drawing program designed for children. Drawings can be created by free-form drawing or by selecting any of 100 pre-drawn pictures, which can be added into existing compositions. The menu of options offered the user also includes the ability to select different types of rendering (line, shading, etc.). Input to the program can be via keyboard, joystick, or mouse, but a joystick or mouse is required for drawing.

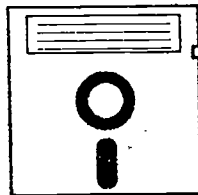

**Product Name:** PowerPad Toolkit 4

**Vendor:** Dunamis, Inc.

**Computer:** Apple IIGS, Apple IIe

**Manual Form:** Printed Manual

**Cost:** \$99.95

PowerPad ToolKit 4 is software designed to help the user create his or her own PowerPad setups. The program allows the user to define setups to include personal choices of graphics, speech, animation, text, and singing. Setup button sizes on the PowerPad can range from one to 144 buttons.

The ToolKit 4 runs on Apple IIe and IIGS computers. Speech synthesizer, PowerPad and Port, and printer are all extra.



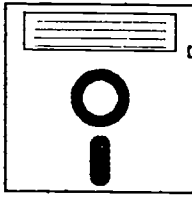

**Product Name:** Predict It  
**Vendor:** Don Johnston Incorporated  
**Computer:** Apple IIGS, Apple IIe  
**Manual Form:** Printed Manual  
**Cost:** \$95.00

Predict It is a word processor software program with predictive word capabilities. When the user types in the first letter of a word, a list of several words beginning with that letter appear at the bottom of the screen. If the desired word is in the list, the user types in the number corresponding to the correct word or positions the cursor at the correct word and presses the space bar. Access to punctuation and grammatically correct endings (-ing, -ed, -ly, etc.) is also provided. Predict It has standard word processor functions such as cut, copy, paste, move, delete, and save.

Predict It may be used with the Adaptive Firmware Card (extra; see entry).



**Product Name:** RAPIDTEXT  
**Vendor:** RAPIDTEXT, Inc.  
**Computer:** IBM PC Family  
**Manual Form:** Printed Manual  
**Cost:** \$3,995.00

RAPIDTEXT is a software program that interprets information from a steno machine and translates it into text. In a lecture situation, such as a classroom, a stenographer would input what is being said into the steno machine. The information is then translated into English and sent to a computer screen on the desk of a deaf person. If the deaf person wishes to communicate, he may signal the stenographer and then begin typing from the computer keyboard; his message would be received and read by the stenographer. Names of individual speakers may be pre-programmed and recalled by the stenographer. RAPIDTEXT now offers full captioning services.

RAPIDTEXT requires use of a desktop or laptop IBM computer with at least 640K of memory and a 20 MB hard drive, WordPerfect word processing software (version 5.0 or higher), and a steno machine.

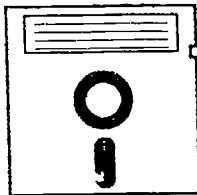

**Product Name:** SeeBEEP

**Vendor:** Microsystems Software Inc.

**Computer:** Grid, IBM PC Family, IBM PS/2 Family, ITT, NEC (some or all models), TRS-80 Model 100, TRS-80 Model 200, Tandy 1000, Toshiba Laptops

**Manual Form.:** Printed Manual

**Cost:** \$20.00

SeeBEEP is a memory resident utility program for PC users who are deaf or hard-of-hearing. Whenever the computer audibly beeps to indicate an error or for other reasons, SeeBEEP provides an additional visual indication. Two options are possible: the entire screen can flash and change color, or a visual "BEEP" can appear where the cursor is positioned. The flash time may be adjusted from 0.2 to 2 seconds. SeeBEEP can be turned on and off with pre-defined hot keys. The program works with DOS programs and with Microsoft Windows.

A shareware version that is not compatible with graphics mode is available on the manufacturer's bulletin board free of charge; contact manufacturer for further information.



**Product Name:** Strider

**Vendor:** Arkenstone, Inc.

**Computer:** IBM PC AT

**Cost:** Contact manufacturer

Strider is Atlas Speaks (see entry) loaded onto an IBM notebook or sub-notebook computer and bundled with a Global Positioning System (GPS) satellite receiver to continually monitor the user's current location. The GPS receiver is accurate to within 100 meters and an optional Differential GPS improves accuracy to within five to seven meters.

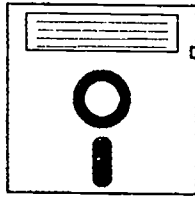

**Product Name:** Talking Data Acquisition System Software

**Vendor:** East Carolina University

**Computer:** IBM PC Family

**Cost:** Contact manufacturer

The Talking Data Acquisition System was designed to accommodate the needs of visually impaired chemistry students. The system consists of an IBM-compatible PC, the IBM Personal Science Laboratory, an electronic balance, and a digital multimeter (DMM) equipped with a serial port. The software runs under DOS and uses the Creative Labs Sound Blaster for speech and sound output. The system allows the blind student to make measurements of mass, temperature, pH, light intensity, AC and DC voltages and currents, resistance, frequency, and capacitance.

The system is not sold as a complete system. The user must purchase the separate components from their various vendors. David Lunney can provide information about what components are needed and will send out copies of the custom software used in the system. He also plans to make the software available through BBS's and the Internet.

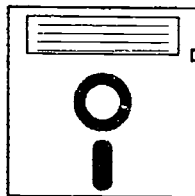

**Product Name:** Talking Sensible Speller

**Vendor:** Scantron Quality Computers

**Computer:** Apple IIGS, Apple IIc, Apple IIe

**Manual Form:** Audiotape Manual, Printed Manual

**Cost:** \$109.00

Talking Sensible Speller is a software program which enables visually impaired persons to hear text spelled, and features an 80,000 word dictionary from Random House. Options include: a tally of words in the document, a listing of all words, a listing of unique words and a listing of misspelled words (these may be sent to a printer). Misspelled words may be replaced in text individually or globally, and the program adds new words to the dictionary at the end of the run. TexTalker software (included) permits customization of speech output and provides a "Screen Review" option.

Talking Sensible Speller works with a variety of word processors. Owners of other versions of Talking Sensible Speller or non-speaking versions of Sensible Speller may receive a discount for trading in their disks; contact Sensible Software for details, and for information on obtaining the manual on audio tape.



**Product Name:** Talking Utilities for DOS 3.3  
**Vendor:** American Printing House for the Blind (APH)  
**Computer:** Apple II Family  
**Cost:** \$14.20

Talking Utilities for DOS 3.3 is a talking version of the Apple DOS 3.3 System Master with features added for speech synthesizer use. All of the programs included in the normal DOS 3.3 System Master are included and tied together in menus. Utilities for copying and deleting files, determining free space on a disk, verifying files, cataloging, and locking or unlocking files are also included. Two additional programs are included to make manipulation of files easier for speech output: Read Text Files which allows any text file to be spoken, and a menu choice called Use Speech which offers options to install Textalker (see entry) software onto other programs and to make a blank disk into a "talking disk."

A 5.25" disk drive and 64K RAM are required.

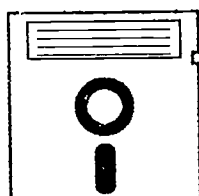

**Product Name:** Talking Writer & Four Games  
**Vendor:** Cross Educational Software  
**Computer:** Apple II Family  
**Manual Form:** Printed Manual  
**Cost:** \$24.95

Talking Writer is a voice output word processing program. Letters or whole words may be spoken as they appear on the screen. Punctuation and backspaces are also spoken. Text may be printed out in characters double the normal size. Text can be entered, inserted, deleted, and edited. Also included on the disk are four games: Typing, Music, Space-Invaders, and Dragon Maze.

The Echo + is required to run Talking Writer.

**Product Name:** TeleDesk Visually Impaired Operator Console

**Vendor:** Conveyant Systems, Inc.

**Cost:** Contact manufacturer

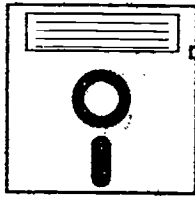

The TeleDesk Visually Impaired Operator Console (VIOC) is designed to meet the requirements of telephone operators who are blind or visually impaired. The VIOC is an adaptation of the TeleDesk Attendant Workstation that augments screen-based visual text information with audible prompts using text-to-speech synthesis. The VIOC offers computer based call processing features such as: call arrival, call answer, calling number, call type, call reason, called party name, active lines, etc.

In addition to the components of the standard TeleDesk Attendant Workstation, the VIOC includes a speech synthesizer, screen reading software, text-to-audible response management software, and PC speech mixer card for handset or headset integration. An optional version of the VIOC provides magnified screen text.

---

**Product Name:** Telepathic II

**Vendor:** Madenta Communications, Inc.

**Computer:** Apple Macintosh Family

**Cost:** \$295.00

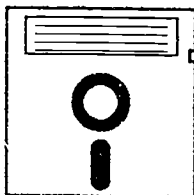

Telepathic II is a software program with predictive word capabilities. When the user enters the initial letters of a word the program provides a list of seven likely word choices. The list appears at the bottom of the computer screen and does not interrupt the user. The word list may be used simply as a way of checking correct spelling or words may be chosen from the list and inserted into text. A word may be selected by selecting it numerically from the keypad or clicking on it with the mouse. The program has a standard built-in dictionary which can be modified; additional dictionaries can be created. Telepathic II also has an auto-punctuation feature which can insert spacing and capitalization after punctuation. Additional features include: speech synthesis, abbreviation expansion, import, and export.

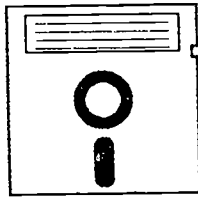

**Product Name:** Term-Talk

**Vendor:** GW Micro

**Computer:** Apple IIGS, Apple IIc, Apple IIe

**Manual Form:** Audiotape Manual,  
Electronic Manual, Large Print Manual

**Cost:** \$195.00

Term-Talk is a ProDOS talking terminal program for Apple computers. Term-Talk can be used to communicate with other computers, electronic bulletin boards, on-line databases, and mainframe computers with VT-100 terminal emulation. The program supports XMODEM, YMODEM, KERMIT, and ASCII file transfers. A dialing directory with automatic log-on macros, a built-in on-line editor, and auto answer and auto dial are also included. ProDOS and help utilities are built in.

A speech synthesizer must be purchased separately. Contact manufacturer for information on compatible synthesizers.

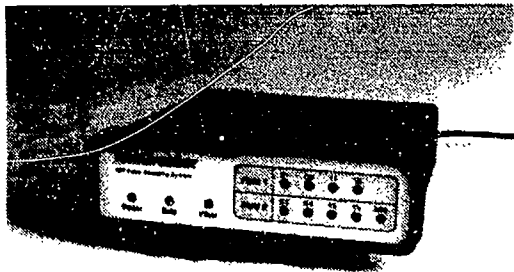

**Product Name:** TextGrabber

**Vendor:** SunBelt Industries, Inc.

**Computer:** IBM PC Family

**Cost:** \$299.95

TextGrabber allows the user to create a word-for-word transcript of most television programs through a personal computer. The device accesses the closed caption information contained on a video signal, converts the information to standard ASCII, and then transfers it to a personal computer over the serial port. TextGrabber comes with application software for MS-DOS and Microsoft Windows and the data can be imported into other programs.

TextGrabber is compatible with any computer that supports a RS-232 interface and a standard terminal or communications program.



**Product Name:** Trace Math Aid

**Vendor:** Computers to Help People, Inc.

**Computer:** Apple II Family, IBM PC Family

**Manual Form:** Electronic Manual, Printed Manual

**Cost:** \$15.00 - \$25.00

The Trace Math Aid is a program designed to assist students with physical disabilities in doing math exercises. The Math Aid does not generate math problems or correct them; it only acts as a worksheet area suited to single-finger or headstick typists. Special functions of Math Aid include on-screen borrowing and carrying operations. When finished working problems, the student may print them on a printer or save worksheets on disk for future reference. Worksheets may also be prepared in advance by a teacher or student.

The Apple version of the Trace Math Aid is \$15.00; the IBM version is \$25.00.

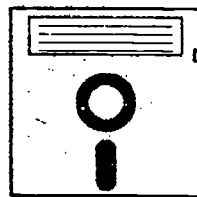

**Product Name:** TurboBraille

**Vendor:** Kansys, Inc.

**Computer:** IBM PC Family

**Manual Form:** Braille/Tactile Manual,  
Electronic Manual, Printed Manual

**Cost:** \$295.00

TurboBraille is a Braille translation program that produces Grade I, Grade II, Grade III, or computer Braille from text files. The program handles formatted ASCII files, files created with WordPerfect or WordStar, or files produced in Braille Intermediate Format (BIF). BIF files, which allow for more precise formatting, can be produced by the program from text files in any of the other three formats; however, knowledge about Braille is required to use BIF files. The program features external rule tables for Braille translation and supports a variety of Braille printers. The program also supports inclusion of graphic files in Braille documents.

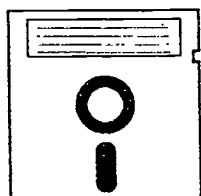

**Product Name:** Typelt4Me

**Vendor:** Ettore, Riccardo

**Computer:** Apple Macintosh Family

**Cost:** \$30.00

Typelt4Me is a software program that provides abbreviation expansion for word processing and other applications on the Macintosh computer. The abbreviations are defined by the user and can be up to 25 characters long. The number of defined abbreviations is limited only by disk size.

The program is shareware and can be downloaded from on-line services such as Compuserve, ZiffNet, eWorld, America OnLine, AppleLink, and others, or from local shareware vendors.

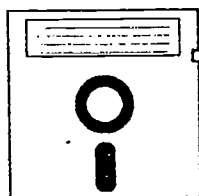

---

**Product Name:** VersaBraille Electric Webster

**Vendor:** Cornucopia Software

**Manual Form:** Audiotape Manual

**Cost:** \$299.95 - \$399.95

VersaBraille Electric Webster is a spelling checker for VersaBraille II and II+ (see entry). The menu-driven program comes with a 50,000 word built-in dictionary to which the user may add words.

VersaBraille Electric Webster is \$299.95 if purchased with VersaBraille II+, or \$399.95 if purchased separately.



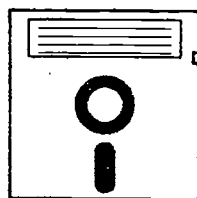

**Product Name:** VisAbility

**Vendor:** AI Squared

**Computer:** IBM PC Family

**Manual Form:** Electronic Manual, Printed Manual

**Cost:** \$495.00

VisAbility is a low-vision reading and form-filling program. The program works in conjunction with a scanner to enlarge printed or handwritten material, from 4x to 32x, on the computer screen. Hands-free reading modes pan smoothly through the entire image or within columns. Printed forms can be scanned and filled-in, while being enlarged on the screen. The completed form can be printed at normal size or a magnified size up to 8x.

VisAbility software requires an IBM PC or compatible with VGA, 2 MB of RAM and a Hewlett-Packard compatible scanner. A mouse and Hewlett Packard or Postscript printer are recommended.

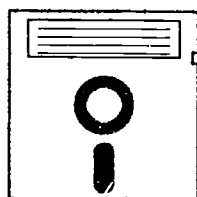

**Product Name:** WinDOTS

**Vendor:** ATR/JWA, Inc.

**Computer:** IBM PC Family

**Cost:** Contact manufacturer

WinDOTS is braille access software for Microsoft Windows. The program translates all elements needed for working with the Graphical User Interface into a format which may be presented on a braille display without changing the structure and layout of the original Windows screen. WinDOTS was designed to be used in conjunction with the BRAILLEX-2D (see entry) but is compatible with other braille displays.



**Product Name:** Wish Writer

**Vendor:** Consultants for Communication Technology

**Computer:** IBM PC Family

**Manual Form:** Printed Manual

**Cost:** \$300.00

Wish Writer is a word processing program designed to be accessed by either a single switch or the keyboard. The program puts an array of choices on the screen and the user selects by scanning through the choices with the switch. The user can type words one letter at a time or use word prediction lists to reduce the number of necessary keystrokes. Wish Writer integrates with the Handy Speech Communication Aide (see entry). A switch is not included. The text can be printed or spoken.



**Product Name:** WiVox

**Vendor:** Prentke Romich Company

**Computer:** IBM PC Family

**Cost:** \$160.00

WiVox is a software product that is designed to enhance writing and reading by providing auditory feedback of text entered into any Microsoft Windows application. WiVox works with the standard keyboard, as well as with the WiVik series of on-screen keyboards, including KeyREP. The program can be set to speak characters, partial words, words, or sentences.

An external speech synthesizer is required.



**Product Name:** Word-Talk

**Vendor:** GW Micro

**Computer:** Apple IIGS, Apple IIc, Apple IIe

**Manual Form:** Audiotape Manual,  
Electronic Manual, Large Print Manual

**Cost:** \$195.00

Word-Talk is a full-featured word processing program that offers synthesized speech output as well as screen display. Keys may be echoed as they are typed, or reviewed as letters, full words, lines, or complete screens. Entire documents may also be read from start to finish. Word-Talk uses the standard 80 column by 24 line display, and offers features such as cut and paste operations, simple insertions, re-formatting, block operations, search-and-replace operations, file merge, and import/export features. Speech may be momentarily silenced or turned off entirely at any time. Rate of speech may be set to any of three levels.

Word-Talk is compatible with most commercially available speech synthesizers as well as a variety of printers.



**Product Name:** Work-Station Pro

**Vendor:** GW Micro

**Computer:** Apple IIGS, Apple IIc, Apple IIe

**Manual Form:** Audiotape Manual,  
Electronic Manual, Large Print Manual

**Cost:** \$50.00

Work-Station Pro is a talking computer program that allows up to 12 ProDOS application programs to be linked together in a single system. When the ESC key is pressed during the running of any application, the Work-Station menu appears; any other application may then be selected without rebooting the computer.

Contact manufacturer for information on compatibility with speech synthesizers.



**Product Name:** Write:OutLoud

**Vendor:** Don Johnston Incorporated

**Computer:** Apple Macintosh Family

**Cost:** \$99.00

Write:OutLoud is a talking word processor for the Macintosh computer. The program will "speak" words and sentences as the user types them in. Words and sentences may be selected to be read after they are typed and saved. The user can select sentences to be read one after the other, skip sentences, or have the whole document read. Buttons allow the user to advance the cursor sentence by sentence. Write:OutLoud types in color; the user picks the color for the screen background and the text color. Documents can be printed in color as well if the user has a color printer.

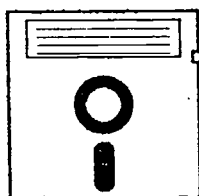

**Product Name:** WriteAway

**Vendor:** Institute on Applied Technology, Children's Hospital

**Computer:** IBM PC Family

**Manual Form:** Printed Manual

**Cost:** \$199.00

WriteAway is a flexible word processor designed to enhance the writing capabilities of children and adults with special learning needs. Multiple access modes include the standard keyboard, accommodations for one-finger typists, and built in scanning arrays for single switch operation accommodate physically challenged individuals. Word prediction and abbreviation expansion allow for effective communication and rate enhancement. Speech output and spell checking are also included.

A special switch adapter (\$70.00) is required for single switch scanning. A site licence allowing unlimited use within an institution can be purchased for \$725.00 and additional manuals are available for \$17.50.

# Appendix A

## Information Resources

This appendix includes sources of information about a variety of topics relevant to the application of technology in special education, rehabilitation and augmentative communication. These listings include printed publications, electronic sources such as computer networks, and some organizations that provide primarily information. Most organizations are listed in Appendix B (Service Providers and Organizations). The information provided here is not evaluative and inclusion on any of the lists does not imply endorsement or recommendation. Files and page numbers of the resource lists appear on the next page.

## Appendix A: Information Resources

A-1: Books and Pamphlets.....	777
A-2: Disability Resources on the Internet.....	781
A-3: Information Resources for Blind and Visually Impaired Individuals.....	782
A-4: Information Resources for Deaf and Hearing Impaired Individuals.....	786
A-5: Networks, Bulletin Boards and Databases.....	788
A-6: Newsletters and Journals.....	791
A-7: Selected Resources on Computers and Learning Disabilities.....	794
A-8: Software Resources.....	796

## Books and Pamphlets

This resource list provides information on books and pamphlets of interest to disabled persons and those working with them. Particular emphasis has been put on resources that pertain to computer access for people with disabilities. No recommendations or endorsements are implied by inclusion on this list. Contact each resource for more specific and up-to-date information.

Adaptive Technologies for Learning and Work Environments  
Joseph J. Lazzaro  
The American Library Association  
50 East Huron Street  
Chicago, IL 60611  
(312) 280-5108

*Focuses on personal computers and the adaptive technology designed to assist persons with disabilities. Intended for individuals with visual, hearing, motor, and speech disabilities. Also helpful for friends, family, co-workers, human resource specialists, managers, supervisors, etc. Information included on compliance with the ADA.*

Assistive Technology for Persons with Disabilities: Occupational Therapy

William C. Mann, Ph.D., OTR and Joseph P. Lane, MBA, MPA  
AOTA Products  
4720 Montgomery Lane  
P.O. Box 31220  
Bethesda, MD 20824-1220  
(800) SAY-AOTA (members only)  
(301) 948-9626 (non-members)

*Textbook that covers key areas of assistive technology - applications, services, resources, and advancements - and where to find devices and how to fund them. Designed for college classes on assistive technology and as a resource for occupational therapists and assistants.*

Assistive Technology Sourcebook  
Alexandra Enders and Marian Hall (editors)  
1990  
RESNA Press  
RESNA  
1700 N. Moore St. #1540  
Arlington, VA 22209-1903  
(703) 524-6686

*Provides an exhaustive listing of resources for individuals with disabilities and the professionals working with them. It also contains helpful brief articles explaining major concepts, philosophies, and technical information on all major areas on assistive technology.*

Breaking Barriers  
Jackie Levin and Lynn Scherfenberg  
AbleNet, Inc.  
1081 Tenth Avenue SE  
Minneapolis, MN 55414-1312  
(612) 379-0956  
(800) 322-0956

*An introduction to assistive technology for parents, teachers, and other service providers. Includes information about simple technology systems and how to use them during leisure, domestic, and vocational activities.*

CD-ROM Advantage  
D. Croft, D. Kendrick, and A. Gayzagian  
1994  
National Braille Press  
88 St. Stephen Street  
Boston, MA 02115  
(617) 266-6160  
(617) 437-0456 (FAX)

*Answers commonly asked questions about CD-ROM technology and how it works with speech and Braille. Includes practical advice from users, profiles blind users of CD-ROM, and lists over 100 CD-ROM titles.*

Communication Augmentation: A Casebook of Clinical Management  
David R. Beukelman, Kathryn M. Yorkston, and Patricia A. Dowden  
1985  
Pro-Ed, Inc.  
8700 Shoal Creek Blvd.  
Austin, TX 78757

*Augmentative communication practice discussed in terms of thirteen specific clinical examples. Additional information on needs assessment and intake for evaluation. 30 pp.*

Communication Programming for Persons with Severe Handicaps  
Carolyn Ramsey Musselwhite and Karen Waterman  
St. Louis  
1988  
Pro-Ed, Inc.  
8700 Shoal Creek Blvd.  
Austin, TX 78757

*Covers a variety of issues in developing communication systems for people with vocal impairments, including the use of speech and non-vocal techniques. Includes an annotated bibliography and resource lists. 408 pp.*

Computer Course Outlines  
Charlson & Tavis  
1994  
The Carroll Center for the Blind  
770 Centre Street  
Newton, MA 02158

*Course outlines for teaching computer applications in Word Perfect 5.1, Client Tracking System and Electronic Mail and outlines for teaching various speech, large print, and braille devices. Designed for knowledgeable instructors as a teaching guide.*

897

## Appendix A-1: Books and Pamphlets

Computer Resources for People with Disabilities  
Alliance for Technology Access  
1994

Special Needs Project  
3463 State Street, #282  
Santa Barbara, CA 93105  
(800) 333-6867  
(805) 333-2341 (FAX)

*Addresses persons with disabilities and their family and friends. A basic guide which includes a list of resources providing familiarity and advanced computer skills*

Computers and Exceptional Individuals, 2nd Ed

J.D. Lindsey  
1993  
Books on Special Children  
P.O. Box 305  
Congers, NY 10920  
(914) 638-1236  
(914) 638-0847 (FAX)

*Discusses specific computer concepts in hardware and software with people with speech and language disorders, physical disabilities, and gifted and talented. Also included are principles and procedures relative to implementing and evaluating applications in special education.*

Computers and the Americans with Disabilities Act: A Manager's Guide

John A. McCormick  
1994  
Wincres/McGraw Hill  
13311 Monterey Lane  
Blue Ridge Summit, PA 17294  
(800) 233-1128

*Provides lists of professional services for people with disabilities, special needs service organizations, government ADA compliance centers, and federal employment assistance programs.*

Considerations 4.2: Results of the Industry/Gov't Cooperative Effort  
G.C. Vanderheiden and C.C. Lee (coordinators)  
1988

Trace Research and Development Center  
S-151 Waisman Center  
1500 Highland Avenue  
Madison, WI 53705  
(608) 262-6966

*Results of industry, government, researcher, and consumer cooperative effort to study the designs of computers and develop recommendations for modifications to make them more accessible. The focus of these considerations is the ability for disabled persons to use standard computers and standard software. These considerations are continually revised based upon the work of the committee. Anyone may participate by reviewing them and sending in comments.*

Directory of Adaptive Technologies to Aid Libraries and Staff with Disabilities

D.A. Norlin, C. Gasque, C. Lewis, R. O'Donnell, and L. Webster  
1994  
American Library Association  
Dearborn Financial Publishing  
155 N. Wacker Drive  
Chicago, IL 60606  
(800) 545-2433  
(312) 836-9958 (FAX)

*Summarizes disability-related legislation, provides guidance for upgrading the work environment to comply with legislation, serves as a reference in identifying and selecting assistive devices, offers information about organizations providing support services, and identifies sources of funding for adaptive equipment and technology*

Directory of National Information Sources on Disabilities  
National Rehabilitation Information Center (NARIC)

8455 Colesville Road  
Suite 935  
Silver Spring, MD 20910  
(800) 346-2742  
(301) 588-9284 (TDD)

*Describes more than 950 resources. Listings describe disabilities served, users served, the organization, and information services provided. Printed in large type.*

Dwarfs Don't Live in Doll Houses

Angela Muir Van Etten  
1988  
Adaptive Living  
P.O. Box 60857  
Rochester, NY 14608-1717  
(716) 235-7270  
(716) 458-5455

*Autobiographical book dealing with issues facing dwarfs and other people with disabilities such as self-esteem, education, employment, male/female relationships, barriers, use of the media, fund-raising, and advocacy.*

Educational Software Preview Guide

1994-95  
ISTE (International Society for Technology in Education)  
1787 Agate Street  
University of Oregon  
Eugene, OR 97403-1923  
(503) 346-4414

*Lists over 500 titles of favorably reviewed software for K-12 classroom use by curriculum area.*

Extend Their Reach  
1990

Electronic Industries Association  
2500 Wilson Boulevard  
Arlington, VA 22201  
(703) 907-7600

*Gives introduction to the types of products available to overcome impairments of sight, speech, hearing, motion, etc. Also provides information on how to find funding and producers of assistive devices, listing of companies, and resources for further information.*

Fun for Everyone

Jackie Levin and Kathy Enselein  
AbleNet, Inc.  
1081 Tenth Avenue SE  
Minneapolis, MN 55414-1312  
(612) 379-0956  
(800) 322-0956

*Describes how many leisure activities and commercially available toys, games, and appliances can be modified using a variety of simple tools. This book addresses goals in play and leisure, and discusses strategies for participation.*

Integrating Computers into the Curriculum

Michael M. Behrmann  
1988  
Pro-Ed, Inc.  
8700 Shoal Creek Blvd.  
Austin, TX 78757

*Provides an overview of computer applications in special education. Includes information on computer basics, adaptive devices and toys, software applications, and using computers in instruction.*



Lifespace Access Profiles  
 W.B. Williams, G. Stemach, S. Wolfe, and C. Stanger  
 Lifespace Access  
 P.O. Box 2355  
 Sebastopol, CA 95473  
 (707) 829-9654

*A tool to address the physical, cognitive, emotional, and support issues of individuals utilizing assistive technology. Asks team members to rate the individual on 59 scales and presents a graph at the end of the scales.*

Living in the State of Stuck: How Technology Impacts the Lives of People with Disabilities  
 Marcia J. Scherer  
 1993  
 Brookline Books  
 P.O. Box 1047  
 Cambridge, MA 02238  
 (617) 868-0360  
 (617) 868-1772 (FAX)

*Focuses on what role assistive technology can play in the lives of people who have recently become disabled and on people born with severe disabilities. The author seeks attention for the human dimensions of technology.*

Resources the Disabled Can Use to Acquire and Fund Computers  
 Helen Hecker  
 1995  
 Twin Peaks Press  
 P.O. Box 129  
 Vancouver, WA 98666  
 (360) 694-2462  
 (360) 696-3210 (FAX)

*Lists sources for grants, programs, services, technology-related assistance, where to purchase computers at discounts, and where to get information about companies that produce special computer-related products.*

Selection and Use of Simple Technology in Home, School, Work, and Community Settings  
 Jackie Levin and Lynn Scherfenberg  
 AbleNet, Inc.  
 1081 Tenth Avenue SE  
 Minneapolis, MN 55414-1312  
 (612) 379-0956  
 (800) 322-0956

*Provides a model for decision-making that can help parents and service providers link technology to the identified needs, capabilities, and interests of their children/students. Uses real case studies to explain the process and its outcomes.*

Tax Options and Strategies for People with Disabilities  
 Steven B. Mendelsohn JD  
 1993  
 Demos Vermande  
 386 Park Avenue South, Suite 201  
 New York, NY 10016  
 (800) 532-8663  
 (212) 683-0072

*Provides information for people with disabilities about various tax regulations, laws, and policies. Includes discussion on how to handle adaptive equipment purchases, etc. on personal taxes.*

Technology and Persons with Disabilities  
 1985, 1986, 1988, 1990, 1993, 1994  
 Center on Disabilities  
 California State University, Northridge  
 18111 Nordhoff Street  
 Northridge, CA 91330-8349  
 (818) 885-2869  
 (818) 885-2578

*Contains papers based on the presentations at the CSUN conference held each year. Separate proceedings are published for each year.*

The Complete Directory for People with Disabilities  
 1991  
 Gale Research  
 P.O. Box 33477  
 Detroit, MI 48232  
 (800) 877-GALE  
 (313) 961-6083 (FAX)

*Biennially published directory of 6,000 products, goods, services, and facilities for people with disabilities. Subjects include: assistive aids, residential and educational facilities, rehabilitation services, funding sources, job training programs, periodicals, etc. Each entry provides an address and phone number for further information.*

Tools for Selecting Appropriate Learning Media  
 Caton  
 1994  
 American Printing House for the Blind  
 PO Box 6085  
 1839 Frankfort Avenue  
 Louisville, KY 40206-0085  
 (800) 223-1839

*An extension of the book, Print and Braille Literacy. Designed to help parents, teachers, and administrators make decisions concerning students' use of braille, print, or both as their primary reading medium/media.*

Trace ResourceBook  
 Borden, P., Lubich, J., & Vanderheiden, G.  
 1996-97  
 Trace Center  
 S-151 Waisman Center  
 1500 Highland Avenue  
 Madison, WI 53705  
 (608) 262-6966  
 (608) 263-5408 (TDD)

*This directory lists assistive technology products for communication, control, and computer access for people with disabilities. About 1,500 products are included. Each product entry includes a description, price, and photo (when available). Products are cross referenced by functions and features. Additional information resources are also listed. Approx. 900 pages.*

Type With One Hand  
 South-Western Publishing Co.  
 5101 Madison Road  
 Cincinnati, OH 45227  
 (513) 271-8811  
 (513) 527-6194 (FAX)

*Provides a new home row and drills for left or right handed typing.*

303

## Appendix A-1: Books and Pamphlets

---

Vendor Information Sheets  
Consumer Information Department of Sensory Access Foundation  
385 Sherman Avenue  
Suite 2  
Palo Alto, CA 94306  
(415) 329-0430  
(415) 323-1062 (FAX)

*List vendor names, addresses, phone numbers, fax numbers, BBS's and prices for access products for people who are blind or low vision. Sheets available for: screen readers, speech synthesizers, computer magnification, closed circuit televisions, braille devices and software, reading machines, and others.*

Virtual Reality and Persons with Disabilities  
1992, 1993, 1994, 1995  
Center on Disabilities  
California State University, Northridge  
18111 Nordhoff Street  
Northridge, CA 91330-8340  
(818) 995-2578  
(818) 885-2869

*Contains papers based on the presentations at the conference on virtual reality and persons with disabilities held annually. Separate proceedings are published for each year.*

## Disability Resources on the Internet

The Internet is a wonderful resource for information of all types, including disability-related information. The biggest problem is that the Internet is so vast that it is difficult to find anything on it. A most useful resource, therefore, is a listing of pointers to the location of disability-related information on the net. Rather than giving you a list of pointers to places (a listing that will be out of date by the time you read this, since it changes daily), we thought we would give you a pointer to a location on the web where a list of the other disability-related resources on the Internet is being maintained:

<http://www.webable.com>

Currently, multiple pointers are provided under each of the following topic areas (and sub-areas):

### Types of Internet Resources

Bulletin Board Systems (BBS)  
 CHAT (Conversational Hypertext Access Technology)  
 Databases  
 FTP sites  
 Listservs  
 Newsgroups  
 On-line newsletters  
 Telnet sites  
 World Wide Web (HTTP) sites

### Topics Covered

ADA  
 Amputee  
 Associations and Organizations  
 Attention Deficit Disorder  
 Autism  
 Blindness  
 Carpal Tunnel  
 Cerebral Palsy  
 Computer Speech  
 Deaf and Blind  
 Deafness  
 Diabetes  
 Disabilities  
 Disability Research in the UK  
 DOSLynx  
 Education  
 Employment  
 General Disability Sites  
 Government  
 Journals  
 Legal  
 Low Vision  
 Mobility  
 Multiple Sclerosis  
 Orientation and Mobility  
 Product Solutions Providers  
 Research Centers and Projects  
 Schizophrenia  
 Sign Language  
 Speech  
 Stroke  
 Stuttering  
 Technology  
 Traumatic Brain Injury  
 Typing Injuries  
 Vendors  
 Virtual Reality

## Information Resources for Blind and Visually Impaired Individuals

This list contains useful sources of information for blind and visually impaired computer users. The list is divided into four sections: Organizations, Newsletters & Journals, Networks, Databases & Bulletin Boards, and Books & Pamphlets. No recommendations or endorsements are implied by inclusion on this list. Contact each resource for more specific and up-to-date information.

### Organizations

**AFB Technology Center**  
American Foundation for the Blind, Inc.  
11 Penn Plaza  
Suite 300  
New York, NY 10001  
(212) 502-7642  
(212) 502-7773 (fax)

*Conducts product evaluations of assistive technology including braille technology, optical character readers, speech synthesizers, screen magnifiers, and closed circuit televisions. E-mail to [techctr@afb.org](mailto:techctr@afb.org).*

**American Council of the Blind**  
1155 15th Street, Suite 720  
Washington, DC 20005  
(202) 467-5081  
(202) 467-5085 (FAX)

*Publishes computer resource list about various devices and where to buy them. Visually Impaired Data Processors International, a computer users' special interest group, is part of ACB.*

**American Printing House for the Blind**  
P.O. Box 6085  
1839 Frankfort Avenue  
Louisville, KY 40206  
(502) 895-2405  
(800) 223-1839

*Producers of software for users with visual impairments. APH also produces user manuals in braille for Apple computers, instructional aids, tools, and supplies. Four-track recorder/players available. Tutorial kit for Microsoft Windows available for VI users.*

**Braille Institute**  
741 N. Vermont Avenue  
Los Angeles, CA 90029  
(213) 663-1111

*This is an educational organization for persons who are blind, deaf-blind, or partially sighted. It has technological resources, a talking book library, and a large community outreach program. A subsidy program for funding equipment is available to persons who are currently employed and legally blind.*

**Carroll Center for the Blind**  
70 Centre Street  
Newton, MA 02158  
(617) 969-6200

*Various publications and rehabilitation and educational programs are available for persons who are blind or visually impaired. A computer training program, Project CABLE, provides computer assessment, training on adaptive devices and software, and word processing training. Summer training courses for youth are also offered.*

**Central Blind Rehabilitation Center**  
Veterans Affairs  
Edward Hines, Jr. VA Hospital  
PO Box 5000 (124)  
Hines, IL 60141-5000  
(708) 216-2271

*Information on various types of computer access devices for people with visual impairments.*

**Centre for Sight Enhancement**  
School of Optometry  
University of Waterloo  
Waterloo, ON N2L 3G1  
CANADA  
(519) 888-4708  
(519) 746-2337 (FAX)

*A clinical, teaching, and research facility providing assessment, prescription, instruction and/or rehabilitation by a multidisciplinary professional team. Provides sight enhancement devices under the Provincial Ministry of Health's Assistive Devices Program.*

**Helen Keller National Center for Deaf-Blind Youths and Adults**  
111 Middle Neck Road  
Sands Point, NY 11050  
(516) 944-8900  
(516) 944-8637 (TTY)

*Only national program that provides diagnostic evaluation, short-term comprehensive rehabilitation and personal adjustment training, and job preparation and placement for Americans who are deaf-blind. Local services provided through regional offices, affiliated agencies, a National Training Team, and a Technical Assistance Center for older adults.*

## Appendix A-3: Information Resources for Blind and Visually Impaired Individuals

International Braille and Technology Center for the Blind  
National Center for the Blind  
1800 Johnson Street  
Baltimore, MD 21230  
(410) 659-9314

*Provides demonstrations, comparative evaluations, cost comparison, ADA compliance assistance, personal and telephone consultation pertaining to assistive technology for the visually impaired, tours, meeting and conference facilities. Resource for blind persons and sighted individuals. Overnight and dining accommodations may be available for a fee.*

National Association for Visually Handicapped  
22 West 21st Street  
New York, NY 10010  
(212) 889-3141

*Organization dealing with the needs of people who are partially sighted. Contact for information about computer access. Also a San Francisco office at 3201 Balboa Street, San Francisco CA 94121.*

National Braille Press, Inc.  
88 St. Stephen Street  
Boston, MA 02115  
(617) 266-6160

*Publications on personal computer technology for people who are blind. Many printer and modem manuals transcribed in braille.*

National Federation of the Blind  
1800 Johnson Street  
Baltimore, MD 21230  
(410) 659-9314

*Programs include: Committee on Evaluation of Technology (which evaluates current and proposed technology for people who are blind or visually impaired); International Braille and Technology Center for the Blind (a demonstration and evaluation center for computer technology for blind and visually impaired users); and NFB in Computer Science (a nationwide computer users' group which publishes an annual newsletter for people who are blind or visually impaired).*

Newspapers For the Blind  
DataCast Communications, Inc.  
900 Lady Ellen Place  
Suite 23  
Ottawa, ON K1Z 5L5  
CANADA  
(613) 725-2106  
(613) 722-8756 (FAX)

*Service that delivers an electronic version of Canada's well known newspapers to computers via a VBI decoder attached to cable TV. Available newspapers are: Montreal Gazette, La Presse, Ottawa Citizen, Toronto Star, Toronto Sun, Financial Post, The Globe and Mail.*

Recording for the Blind and Dyslexic (RFBBD)  
20 Rozel Road  
Princeton, NJ 08540  
(800) 221-4792  
(609) 452-0606

*Provides academic textbooks and other educational textbooks to people who cannot read standard print because of physical, perceptual, or other disabilities. Must be a registered member in order to borrow materials; call for details. Also sells reference books on disk and related software products.*

Sensory Access Foundation  
385 Sherman Avenue, Suite 2  
Palo Alto, CA 94306  
(415) 329-0430 (voice)  
(415) 329-0433 (TDD)

*Compiles and publishes consumer information on technology updates, including computer adaptations, for blind and visually impaired people. Assists in career placement for people who have visual impairments. Career services are only available within California; information services available worldwide. Publishes a magazine and has a technology training center.*

Smith-Kettlewell Eye Research Institute  
Rehabilitation Engineering Center  
2232 Webster Street  
San Francisco, CA 94115  
(415) 561-1619

*Research and development center on assistive technology (including work on computer access devices) for people who are blind or visually impaired.*

Technology Center (TC)  
American Foundation for the Blind  
11 Penn Plaza  
Suite 300  
New York, NY 10001  
(212) 502-7642  
(800) 232-5463

*Conducts evaluations of assistive technology for visually impaired people and provides information on those products. Coordinates the Careers and Technology Information Bank (CTIB), a collection of data from visually impaired people who use adaptive equipment in a variety of jobs. E-mail to [techtr@afb.org](mailto:techtr@afb.org). Gopher: [gopher@afb.org](mailto:gopher@afb.org) 5005.*

### Newsletters & Journals

Braille Forum  
American Council of the Blind  
1155 15th Street  
Suite 720  
Washington, DC 20005  
(202) 467-5081  
(202) 467-5085 (FAX)

*Publication dealing with blindness-related issues, such as legislation, technology, and product/service announcements.*

Computer Folks  
c/o Richard Ring  
269 Terhune Avenue  
Passaic, NJ 07055  
(201) 471-4211

*A magazine on cassette for blind computer users by blind computer users. Discusses and demonstrates adaptive technology.*

Journal of Visual Impairment and Blindness  
American Federation for the Blind  
11 Penn Plaza  
Suite 300  
New York, NY 10001  
(212) 502-7600

*Research journal on issues related to visual impairment and blindness. Includes research reviews, application papers, and articles on special topics (including assistive technology). Published monthly, except July and August.*

## Appendix A-3: Information Resources for Blind and Visually Impaired Individuals

Tactic  
Cloverbrook Center  
7000 Hamilton Avenue  
Cincinnati, OH 45231  
(513) 522-3860

*International quarterly offers information and reviews on technology for people with visual impairments. Published in braille, large print, and diskette (IBM compatible) formats.*

Technology Update  
Sensory Access Foundation  
385 Sherman Avenue Suite #2  
Palo Alto, CA 94306  
(415) 329-0430 (voice)  
(415) 329-0433 (TDD)

*Bimonthly newsletter with information regarding technology and vision impairment. Includes new product announcements, product reviews, and consumer information. Available in print, large print, cassette, and PC diskette.*

Visual Field  
Florida Instructional Materials Center  
5002 North Lois Avenue  
Tampa, FL 33614  
(813) 872-5281  
(813) 872-5284 (FAX)

*Biannual newsletter on products, projects, conferences, etc., related to education of students with visual impairments.*

### Networks, Bulletin Boards, & Databases

4 Sights Network  
Upshaw Institute for the Blind  
16625 Grand River  
Detroit, MI 48227  
(313) 272-3900  
(313) 272-7111 (dial in)

*This computer network provides bulletin boards and database information for blind and visually impaired individuals and those working with them. The information covers vocational and rehabilitation resources, assistive technology, educational information for parents, teachers, and students, public policy and more.*

Carl et Al  
American Printing House for the Blind  
Attn: Paul Brown  
PO Box 6085  
Louisville, KY 40206-0085  
(800) 223-1839  
(502) 895-1509 (FAX)

*An on-line database that lists materials in media accessible to people who are visually impaired. Over 120,000 records including braille books, large type materials, music scores, electronic books, sound recordings, software programs, and tactile graphics. Contact APH for billing and access information.*

### Books & Pamphlets

CD-ROM Advantage  
D. Croft, D. Kendrick, and A. Gayzagian  
1994  
National Braille Press  
88 St. Stephen Street  
Boston, MA 02115  
(617) 266-6160  
(617) 437-0456 (FAX)

*Answers commonly asked questions about CD-ROM technology and how it works with speech and Braille. Includes practical advice from users, profiles blind users of CD-ROM, and lists over 100 CD-ROM titles.*

Computer Access, Resource Manual  
Rosenbaum, et al.  
1987  
Carroll Center for the Blind  
770 Centre Street  
Newton, MA 02158

*Resource manual and curriculum for setting up an evaluation and training center in assistive technology applications for blind and visually impaired.*

Customer Service Representative Training Manual  
Ferrarin, Rosenbaum, et al.  
1994  
Carroll Center for the Blind  
770 Centre Street  
Newton, MA 02158

*A comprehensive curriculum for creating and providing job readiness skills for employment in customer service jobs to individuals with visual impairments utilizing assistive technology. For rehabilitation agencies, secondary institutions, or career counselors.*

Extend Their Reach  
1990  
Electronic Industries Association  
2500 Wilson Boulevard  
Arlington, VA 22201  
(703) 907-7600

*Gives introduction to the types of products available to overcome impairments of sight, speech, hearing, motion, etc. Also provides information on how to find funding and producers of assistive devices, listing of companies, and resources for further information.*

Job Readiness Workshop  
1994  
Carroll Center for the Blind  
770 Centre Street  
Newton, MA 02158  
(617) 969-6200

*Step by step guide on creating a resume and developing interviewing techniques. Sample resumes and example interview questions given.*

Medical Transcription Training Manual  
Ferrarini, Rosenbaum, et al.  
1994  
Carroll Center for the Blind  
770 Centre Street  
Newton, MA 02158  
(617) 969-6200

*Curriculum, guidelines, and resources for creating, or modifying medical transcription programs for persons with visual disabilities. 180 page manual includes detailed course outlines for terminology, transcription and computer instruction, resources, job information.*

Print and Braille Literacy: Selecting Appropriate Learning Media  
Hilda Caton, Ed.D.  
1991

American Printing House for the Blind, Inc.  
1839 Frankfort Avenue  
P.O. Box 6085  
Louisville, KY 40206  
(502) 895-2405

*Provides guidelines designed to insure that every visually impaired student will have adequate opportunity for learning to use the medium/media most appropriate for his or her needs. Guidelines were developed by a committee of experts in the field.*

814

Project CABLE Resource Manual, 2nd edition  
1987  
Project CABLE (Computer Access for the Blind in Educ. and  
Employment)  
Carroll Center for the Blind  
770 Centre Street  
Newton, MA 02158  
(617) 969-6200

*This manual includes curriculum, evaluation forms, lesson plans, and other resources to assist in setting up or running an employment program for persons who are blind or visually impaired. Other topics include funding and staffing.*

TeleSelling Training Manual  
1995  
Carroll Center for the Blind  
770 Centre Street  
Newton, MA 02158  
(617) 969-6200

*Curriculum, guidelines, and resources for creating, or modifying a telemarketing training program for persons with visual disabilities. Chapters included information about the field, developing a program, teleselling skills, computer course outlines, and job readiness workshop.*

Tools for Selecting Appropriate Learning Media  
Caton  
1994

American Printing House for the Blind  
PO Box 6085  
1839 Frankfort Avenue  
Louisville, KY 40206-0085  
(800) 223-1839

*An extension of the book, Print and Braille Literacy. Designed to help parents, teachers, and administrators make decisions concerning students' use of braille, print, or both as their primary reading medium/media.*

Vendor Information Sheets  
Consumer Information Department of Sensory Access Foundation  
385 Sherman Avenue  
Suite 2  
Palo Alto, CA 94306  
(415) 329-0430  
(415) 323-1062 (FAX)

*List vendor names, addresses, phone numbers, fax numbers, BBS's and prices for access products for people who are blind or low vision. Sheets available for: screen readers, speech synthesizers, computer magnification, closed circuit televisions, braille devices and software, reading machines, and others.*

## Information Resources for Deaf and Hearing Impaired Individuals

The following list contains information resources for people who are deaf or hearing impaired: Organizations, Newsletters & Journals, and Books. All deal in some way with applications of computers or other high technology to needs of people with hearing impairments. No recommendations or endorsements are implied by inclusion on this list. Contact each resource for more specific and up-to-date information.

### Organizations

Alexander Graham Bell Association for the Deaf  
3417 Volta Place NW  
Washington, DC 20007-2778  
(202) 337-5220 (voice/TDD)

*National organization offering support services to deaf individuals. Services include: publications, information, regional conferences and an international convention, research library, advocacy, grants, scholarships, and financial aid.*

DPI, Inc.  
151 Martinvale Lane  
San Jose, CA 95119-1368  
(408) 629-3700

*Organization whose activities include training individuals with disabilities to become computer programmers. Produces educational software developed to help college students who are deaf or hard of hearing, improve their English vocabulary and writing skills.*

Mill Neck Foundation, Inc.  
P.O. Box 100, Frost Mill Road  
Mill Neck, NY 11765  
(516) 922-3880

*Telecommunications van designed as a mobile learning lab and demonstration unit for TDDs. Travels in an interstate area in the northeastern region.*

National Association of the Deaf  
814 Thayer Avenue  
Silver Spring, MD 20910  
(301) 587-1788 (voice)  
(301) 587-1789 (TTY)

*Consumer organization advocating for equal access by people who are deaf or hard of hearing in the areas of employment, education, telecommunications, and rehabilitation. Also maintains a publications department, deaf awareness information, legal defense fund, public information center, youth programs, and certification programs for interpreters and for sign language instructions.*

National Information Center on Deafness  
Gallaudet University  
800 Florida Avenue, NE  
Washington, DC 20002  
(202) 651-5051 (voice)  
(202) 651-5052 (TTY)

*Provides deaf or hard of hearing individuals (as well hearing individuals) with direct information or appropriate references on a variety of issues. The center also publishes brief bibliographies and fact sheets on requested topics. There is a small charge for most publications; selected publications free.*

National Technical Institute for the Deaf (NTID)  
Rochester Institute for the Deaf - Div. of Public Affairs  
LBJ Building  
52 Lomb Memorial Drive  
Rochester, NY 14623-5604  
(716) 475-6400 (voice)  
(716) 475-2185 (TDD)

*The world's largest technical college for deaf students, offering the opportunity for deaf students to go to college in a hearing environment to facilitate transition to a hearing society. Funded by the U.S. Department of Education. Publishes a list of captioned educational videotapes.*

Software to Go  
Model Secondary School for the Deaf  
Gallaudet University  
800 Florida Avenue NE  
Washington, DC 20002-3695  
(202) 651-5705 (voice/TDD)  
(202) 651-5109 (fax)

*Serves as an evaluation and information clearinghouse, as well as a lending library of commercially produced software. Services available to schools and programs involved with the education of hearing impaired students. Publishes a catalog every 18 months and a "Top Titles" list every 6 months. Information is also available on the Internet at gopher.gallux.gallaudet.edu.*

### Newsletters & Journals

American Annals of the Deaf  
800 Florida Avenue  
Washington, DC 20002  
(202) 651-5340 (voice/TTY)  
(202) 651-5708 (FAX)

*Bimonthly research journal for professionals working with individuals who are deaf or hearing impaired.*



Hearing Health Magazine  
P.O. Drawer V  
Ingleside, TX 78362-0500  
(512) 776-7240 (voice/TDD)

*Worldwide bimonthly publication. Information for deaf and hearing-impaired people. Articles on new technology views, personal interest stories, legislative events, education and resources.*

SHHH (Self Help for Hard of Hearing People)  
7910 Woodmont Avenue  
Suite 1200  
Bethesda, MD 20814  
(301) 657-2248 (voice)  
(301) 657-2249 (TDD)

*Bimonthly journal about hearing loss. Includes educational reports and case studies. Also hosts an annual conference and has a publications list that people can order from.*

Volta Review  
Alexander Graham Bell Association for the Deaf  
3417 Volta Place NW  
Washington, DC 20007  
(202) 337-5220 (voice/TDD)

*A technical journal for people with hearing impairments which reports on a variety of technology-related topics and issues. Published seven times a year.*

#### Books

Extend Their Reach  
1990  
Electronic Industries Association  
2500 Wilson Boulevard  
Arlington, VA 22201  
(703) 907-7600

*Gives introduction to the types of products available to overcome impairments of sight, speech, hearing, motion, etc. Also provides information on how to find funding and producers of assistive devices, listing of companies, and resources for further information.*

## Networks, Bulletin Boards and Databases

This is a summary of databases and computerized networks of interest to people with disabilities and those working with them. The list includes databases that must be accessed by modem and those which can be stored on an individual computer. No recommendations or endorsements are implied by inclusion on this list. Contact each resource for more specific and up-to-date information before going on line.

4 Sights Network  
Upshaw Institute for the Blind  
16625 Grand River  
Detroit, MI 48227  
(313) 272-3900  
(313) 272-7111 (dial in)

*This computer network provides bulletin boards and database information for blind and visually impaired individuals and those working with them. The information covers vocational and rehabilitation resources, assistive technology, educational information for parents, teachers, and students, public policy and more.*

Ability OnLine  
919 Alness Street  
North York, ON M3J 2J1  
CANADA  
(416) 650-6207  
(416) 650-5411 (dial in)

*An electronic platform that links children and adolescents with disabilities and chronic illnesses with friends, peers, educators, health professionals, and family members.*

ABLE INFORM  
National Rehabilitation Information Center (NARIC)  
8455 Colesville Road, Suite 935  
Silver Spring, MD 20910  
(301) 588-9284  
(800) 227-0216

*An electronic bulletin board of assistive technology, disability, and rehabilitation information. Provides conferencing, bulletins, and classified listings of previously owned adaptive devices. Also allows on-line access to REHABDATA, ABLEDATA, and other NARIC databases.*

ABLEDATA  
Macro International  
8455 Colesville Road, Suite 935  
Silver Spring, MD 20910  
(301) 588-9284  
(800) 227-0216

*A computerized listing of all commercially available products for rehabilitation and independent living. There are three ways to access the database: calling the ABLEDATA office, searching by computer modem, or running the database on an individual computer. The third option is available through Macro International (on CD-ROM) and through the Trace Center (on CD-ROM or floppy disks)*

Accent on Information  
P.O. Box 700  
Bloomington, IL 61702  
(309) 378-2961

*A computerized product database organized by categories of equipment and by disability function.*

Careers and Technology Information Bank (CTIB)  
American Foundation for the Blind  
11 Penn Plaza  
Suite 300  
New York, NY 10001  
(212) 502-7639  
(800) 232-5463

*Database of 1500 blind and visually impaired people who use assistive technology at home, at work, or at school. Information based on each member's careers and personal background. Used by blind or visually impaired individuals, employers, teachers, parents, and rehabilitation professionals.*

Carl et Al  
American Printing House for the Blind  
Attn: Paul Brown  
PO Box 6085  
Louisville, KY 40206-0085  
(800) 223-1839  
(502) 895-1509 (FAX)

*An on-line database that lists materials in media accessible to people who are visually impaired. Over 120,000 records including braille books, large type materials, music scores, electronic books, sound recordings, software programs, and tactile graphics. Contact APH for billing and access information.*

CompuServe Disabilities Forum  
CompuServe  
P.O. Box 20212  
5000 Arlington Centre Blvd.  
Columbus, OH 43220  
(800) 848-8199

*CompuServe is a world-wide information service, open to anyone interested, which provides information and discussion forums on a wide array of topics. Included is a Disabilities Forum, dedicated with disability and rehabilitation.*

818

CONFER II, CONFER V, CONFER X  
 Advertel Communication Systems, Inc.  
 2067 Ascot  
 Ann Arbor, MI 48103-6101  
 (313) 665-2612  
 (313) 769-2852

*A computer conferencing network and software for VAX and UNIX that enables users to establish and participate in technology-related forums and conferences regarding individuals with communication impairments. Serves as a forum for the International Society for Augmentative and Alternative Communication (ISAAC).*

Cooperative Electronic Library on Disability (CO-NET)  
 Trace Center  
 S-151 Waisman Center  
 1500 Highland Avenue  
 Madison, WI 53705  
 (608) 262-6966 (voice)  
 (608) 263-5408 (TDD)

*Lists products, services, and information resources related to disability. Over 20,000 products, over 5,000 services, and over 50,000 publications are listed. Software is designed to be easy enough for beginning computer users and is accessible to users with disabilities. Available on CD-ROM; parts are also available on floppy disk and via the Internet.*

CUSSNet (Computer Use in Social Services Network)  
 School of Social Work  
 University of Texas at Arlington  
 UTA Box 19129  
 Arlington, TX 76019  
 (817) 273-3964

*This is a group of bulletin boards that share a conference, handle national and local mail and file transfer, provide for downloading of public domain software, and provide access to specialized databases on human services computing. One component specializes in information on computers and users with disabilities.*

Database of Educational Resources on Spinal Cord Injury  
 Institute for Rehabilitation and Research  
 Division of Education  
 1333 Mouround  
 Houston, TX 77030  
 (713) 797-5945

*Database contains 560 specialized educational materials relating to spinal cord injury, including both audiovisual and written materials. Printing of two subject areas is available at no charge. A printing of all resources is available for \$50.*

dERE - Net!  
 disABLED Electronic Resource Exchange Project, Inc.  
 4311 Portabello Drive  
 Gahanna, OH 43230  
 (614) 478-9940 (office)  
 (614) 478-dERE (BBS)

*A multi-node bulletin board offering two chat lines, disability news, support groups, e-mail, shareware and public domain software, technical support, doors, and a quarterly hardcopy newsletter for paid members. dERE also recycles equipment from corporations and individual donations for disabled users.*

Direct Link  
 P.O. Box 1036  
 Solvang, CA 93464  
 (805) 688-1603 (info line)  
 (805) 686-5284 (administration)

*Information and referral service. Links disabled people with providers of direct services. Can be contacted directly by phone (voice, not modem).*

Disabled Individuals Movement for Equality Network (DIMENET)  
 Independence Associates  
 c/o Eric Griffin or Roland Sykes  
 9 Taunton Green  
 Taunton, MA 02783  
 (508) 880-5325  
 (508) 880-5412 (dial in)

*A national computer network responsive to the needs of the independent living and disability rights movements. Features of the system include bulletins, news groups, e-mail, and transfer of files.*

EdLINC  
 Linc Associates  
 P.O. Box 14325  
 Columbus, OH 43214  
 (614) 793-0021

*Computer network which provides resource information for schools and educators. Access to the network is limited to schools. Once registered with EdLINC, educators may search and order educational materials on-line.*

ENABLE  
 West Virginia Research and Training Center  
 5088 Washington Street W  
 Cross Lanes, WV 25313  
 (304) 759-0716  
 (304) 759-0727 (dial in)

*Serves individuals with disabilities, their families, support groups, rehabilitation workers, educators, and others who may be concerned with disability issues.*

ERIC Clearinghouse on Disabilities and Gifted Education  
 Council for Exceptional Children  
 1920 Association Drive  
 Reston, VA 22091-1589  
 (703) 264-9474

*ERIC (Educational Resources Information Center) maintains a database of educational materials, reports, and bibliographic information on students with disabilities. The information is available via computer, microfiche, or paper copy.*

IBM Kiosk for Education  
 IKE Office  
 University of Washington  
 Box 352122  
 Seattle, WA 98195  
 (206) 543-5604

*Provides information about IBM-compatible software and hardware for higher education instruction and research. Also has a learning disability forum. Free to faculty, staff, and students at any institute of higher education. E-mail to ike@ike.engr.washington.edu.*

Job Accommodation Network (JAN)  
 West Virginia University  
 918 Chestnut Ridge Road, Suite 1  
 P.O. Box 6080  
 Morgantown, WV 26506-6080  
 (304) 293-7186  
 (800) 526-7234

*International information network and consulting resource for accomodating persons with disabilities in the workplace. Also has a separate phone line for questions on the ADA: (800) ADA-WORK. Maintains a electronic bulletin board with job accomodation information.*

## Appendix A-5: Networks, Bulletin Boards and Databases

---

NCHRTM Bulletin Board  
National Clearing House of Rehabilitation Training Materials  
816 W 6th Street  
Oklahoma State University  
Stillwater, OK 74078-0435  
(800) 223-5219  
(405) 624-3156 (dial in)

*Provides information sources contained in the NCHRTM Catalog 1992, access to ABLEDATA, ability to download information, documents, and shareware, as well as a message and conference area.*

Rare Disease Database  
NORD  
Box 8923  
New Fairfield, CT 06812  
(203) 746-6518

*This is a searchable database on CompuServe, accessible by PC and a modem. Contains health-related information, particularly on rare disorders, with resources that can be contacted for further assistance.*

REHABDATA  
National Rehabilitation Information Center (NARIC)  
8455 Colesville Road, Suite 935  
Silver Spring, MD 20910  
(301) 588-9284 (voice/TDD)  
(800) 346-2742 (voice/TDD)

*This database contains more than 46,000 bibliographic records with summaries of the materials in the NARIC library. NARIC is a library and information center on disability and rehabilitation. REHABDATA includes research reports, books, journal articles, and audiovisual materials. Searches of this database are available by calling a NARIC information specialist or by modem through the BBS at (301) 589-3563.*

TexAbility Board  
Texas Rehabilitation Commission Library  
4900 North Lamar Boulevard  
Austin, TX 78751  
(512) 483-4240

*Provides information about specific disability-related services available through Texas agencies, ADA information, lists of organizations and associations, lists books and periodicals, calendar of disability-related events, and resources for parents and teachers. In Texas, dial in at (800) BBS-TEXAS; outside Texas, dial in at (512) 483-4303.*

The Educational Software Selector (TESS)  
EPIE Institute  
103-3 West Montauk Highway  
Hampton Bays, NY 11946  
(516) 728-9100  
(516) 728-9228 (FAX)

*CD-ROM database of information on educational software. Contains data on: computer platform, supplier, grade level, review score, subject area, special needs area, intended use, and price.*

United States Society for Augmentative and Alternative  
Communication (USSAAC)  
Conferences, Inc.  
P.O. Box 5271  
Evanston, IL 60204-5271  
(708) 869-2122  
(708) 869-2161 (FAX)

*The purpose of USSAAC is to bring together individuals who are committed to providing communication for people with disabilities. Professionals, families, and consumers are linked through a national database. USSAAC membership includes membership in ISAAC.*

VocServe  
National Center for Research in Vocational Education (NCRVE)  
University of California-Berkeley  
2150 Shattuck Avenue, Suite 1250  
Berkeley, CA 94720-1674  
(800) 762-4093 (voice)  
(510) 643-6793 (modem)

*Formerly AdvocNet, VocServe is an electronic mail network that serves persons interested in vocational education including researchers, policymakers, and practitioners. The network offers private e-mail, public discussion groups, and electronic versions of some NCRVE publications. Can be reached on the Internet by telnet to vocserve.berkeley.edu or by modem.*

Your Voice Village, Inc.  
171 River Drive  
P.O. Box 606  
Hadley, MA 01035  
(800) 637-8720  
(415) 585-1134

*National/international online computer network of people with disabilities. Experts answer questions pertaining to medical, law, architecture, travel, and real estate. Also features political action, marketplace, and social connection.*

## Newsletters and Journals

This list provides information on periodicals that focus on a variety of disability issues, but particular emphasis has been placed on issues relating to computers or other high technology solutions. Periodicals of interest to rehabilitation professionals, caretakers, individuals with disabilities, and concerned friends and family are included. No recommendations or endorsements are implied by inclusion in this list. Contact each resource for specific, up-to-date information.

Alternatively Speaking  
Michael Williams  
Augmentative Communication, Inc.  
1 Surf Way  
Suite 237  
Monterey, CA 93940  
(408) 649-3050  
(408) 646-5428 (FAX)

*Quarterly newsletter dealing with AAC issues from a consumer perspective.*

American Journal of Occupational Therapy  
American Occupational Therapy Association (AOTA)  
4720 Montgomery Lane  
P.O. Box 31220  
Bethesda, MD 20824  
(301) 652-2682  
(800) 377-8555 TDD

*Publication that lists new approaches, practices, research, educational activities, and professional trends in occupational therapy.*

Assistive Technology  
RESNA  
1700 N. Moore Street #1540  
Arlington, VA 22209-1903  
(703) 524-6686

*Journal which focuses upon technological issues in the rehabilitation field.*

Assistive Technology News  
Technical Communications, Inc.  
19 Crescent Court  
Sterling, VA 20164  
(703) 406-7831  
(703) 406-3728 (FAX)

*Published 10 times a year. Covers a wide range of products on the market to assist people with disabilities in work and life. Also covers information and events regarding the Americans with Disabilities Act.*

Augmentative and Alternative Communication  
Decker Publications  
4 Hughson Street S, 4th Floor  
P.O. Box 620, LCD1  
Hamilton, ON L8N 3K7  
CANADA  
(905) 522-7017  
(905) 522-7829 (FAX)

*Quarterly journal focuses on non-verbal communication, integration theory, technology, and systems development, as well as assessment, treatment and education of alternative systems users.*

Augmentative Communication News  
Augmentative Communication, Inc.  
One Surf Way, Suite 237  
Monterey, CA 93940  
(408) 649-3050

*Bimonthly newsletter covering topics in augmentative communication. Each issue contains sections on consumer issues, equipment, clinical news, governmental affairs, and research.*

BlissWorld  
Blissymbolics Communication International  
1630 Lawrence Ave, W.  
Suite 104  
Toronto, ON M6L 1C5  
CANADA  
(416) 242-9114  
(416) 244-6543 (FAX)

*A newsletter forum for Bliss symbol users, clinicians, and other interested persons.*

Braille Forum  
American Council of the Blind  
1155 15th Street  
Suite 720  
Washington, DC 20005  
(202) 467-5081  
(202) 467-5085 (FAX)

*Publication dealing with blindness-related issues, such as legislation, technology, and product/service announcements.*

## Appendix A-6: Newsletters and Journals

Closing the Gap  
Closing the Gap, Inc.  
P.O. Box 68  
Henderson, MN 56044  
(612) 248-3294

*Bimonthly newspaper which provides information on the use of computers in special education and rehabilitation. Includes a "Software Previews" column, user comments, articles, and suggestions. Annual product directory published.*

Communicating Together  
Sharing to Learn  
Suite 215  
3-304 Stone Road West  
Guelph, ON N1G 4W4  
CANADA  
(519) 766-1757  
(519) 762-6682 (FAX)

*Quarterly journal which provides a means of sharing experiences and information on communication for non-speaking individuals. E-mail to [plindsay@oise.on.ca](mailto:plindsay@oise.on.ca) or [smcnaughton@oise.on.ca](mailto:smcnaughton@oise.on.ca).*

Communication Outlook  
Artificial Language Laboratory  
Michigan State University  
405 Computer Center  
East Lansing, MI 48824-1042  
(517) 353-0870  
(517) 353-4766 (FAX)

*International quarterly magazine addressed to individuals who experience communication handicaps due to neurological, sensory, or neuromuscular conditions.*

Computer Folks  
c/o Richard Ring  
269 Terhune Avenue  
Passaic, NJ 07055  
(201) 471-4211

*A magazine on cassette for blind computer users by blind computer users. Discusses and demonstrates adaptive technology.*

ConnSENSE (Connecticut's Special Educ. Network for Software Evaluation)  
University of Connecticut  
Box U-64  
249 Glenbrook Road  
Storrs, CT 06269-2064  
(203) 486-0172

*Concerned with evaluating courseware for students with disabilities. Has telecommunications system for special education administrators, and a telecommunications project for students with disabilities. Publishes the ConnSENSE Bulletin which contains reviews of software as they apply to students with special needs. Lists upcoming events and technological breakthroughs for people with disabilities as well as resource and reference information.*

DIRECTIONS: Technology in Special Education  
DREAMMS for Kids, Inc.  
2763 Tasha Drive  
Clearwater, FL 34621-1223

*Monthly newsletter features technology tips, adaptive software and hardware reviews, assistive technology articles and reviews, Department of Education updates, technology conference news, and special education product announcements. E-mail to [DREAMMS@aol.com](mailto:DREAMMS@aol.com).*

Disability Today  
Circulation Department  
P.O. Box 237  
Grimsby, ON L3M 4G3  
CANADA  
(905) 945-5577  
(905) 945-0818 (FAX)

*Quarterly journal dealing with wide range of disability related issues. Topics include: people profiles, accessible travel, education and prevention, and other resources.*

Education Technology News  
Business Publishing, Inc.  
951 Pershing Drive  
Silver Spring, MD 20910  
(301) 587-6300

*Bi-weekly newsletter that reports on computer advances in education. Reports on teacher training, software purchasing, obsolescence, new products, research, legislation, state and local news, meetings and conventions.*

Educational Technology  
Educational Technology Publications  
700 Palisade Avenue  
Englewood Cliffs, NJ 07632  
(201) 871-4007  
(201) 871-4009 (FAX)

*Monthly publication with articles, literature, and product reviews on the application of technology relating to education.*

Exceptional Parent Magazine  
120 State Street  
Hackensack, NJ 07601  
(201) 489-0871  
(800) 372-7368

*This publication is printed twelve times per year and is designed for parents of children with disabilities. Much of the material is written by parents and information on technology is included. One issue per year is devoted strictly to technology as well.*

Financing Assistive Technology  
Steven Mendelsohn  
Smiling Interface  
P.O. Box 2792  
Church Street Station  
New York, NY 10008  
(415) 864-2220

*Bimonthly newsletter that provides information on assistive technology funding resources for consumers, service-providers, businesses, and public policy-makers.*

IEEE Transactions on Rehabilitation Engineering  
School of Health and Rehabilitation Sciences  
117 D Pennsylvania Hall  
University of Pittsburgh  
Pittsburgh, PA 15261  
(412) 365-4850  
(412) 365-4858 (FAX)

*Quarterly publication of the Institute of Electrical and Electronics Engineers, Inc. (IEEE) Engineering in Medicine and Biology Society. Topics include: biomechanics, augmentative communication theory and implementation, functional electrical stimulation, orthotics and prosthetics, assistive technology, etc.*

Journal of Cognitive Rehabilitation  
6555 Carrollton Avenue  
Indianapolis, IN 46220  
(317) 257-9672

*Bimonthly journal that includes articles on the use of computers in cognitive rehabilitation retraining, software reviews, and printed source code to allow readers to program new applications.*

822

Journal of Special Education Technology  
Peabody College of Vanderbilt University  
Box 328  
Nashville, TN 37203  
(615) 322-8150

*Quarterly journal which has information, research, and reports on innovative practices applicable to educational technology.*

Journal of Visual Impairment and Blindness  
American Federation for the Blind  
11 Penn Plaza  
Suite 300  
New York, NY 10001  
(212) 502-7600

*Research journal on issues related to visual impairment and blindness. Includes research reviews, application papers, and articles on special topics (including assistive technology). Published monthly, except July and August.*

Learning and Leading with Technology (formerly Computer Teacher)  
ISTE (International Society for Technology and Education)  
1787 Agate Street  
University of Oregon  
Eugene, OR 97403-1923  
(503) 346-4414

*Published eight times per year. Includes articles, columns, software reviews, and new product announcements.*

Rehabilitation Digest  
Canadian Rehabilitation Council for the Disabled  
45 Shepard Avenue E., Suite 801  
Toronto, ON M2N 5W9  
CANADA  
(416) 250-7490  
(416) 229-1371 (FAX)

*Quarterly journal which contains information on technology as well as books and articles of interest to the rehab community including professionals and consumers with disabilities.*

SERC Newsletter  
Special Education Resource Center  
25 Industrial Park Road  
Middletown, CT 06457  
(203) 632-1485

*Outlines the Center's inservice activities, lists new acquisitions, provides bibliographies for research and additional information on educational resources for parents, educators, and others.*

Special Education Report  
Capitol Publications  
110 King Street, Suite 444  
Alexandria, VA 22314  
(703) 739-6555

*Bi-weekly newsletter containing information about federal, state, and local efforts to educate special education children. Covers new laws and regulations, court cases, and funding.*

Technology Update  
Sensory Access Foundation  
385 Sherman Avenue Suite #2  
Palo Alto, CA 94306  
(415) 329-0430 (voice)  
(415) 329-0433 (TDD)

*Bimonthly newsletter with information regarding technology and vision impairment. Includes new product announcements, product reviews, and consumer information. Available in print, large print, cassette, and PC diskette.*

The Advocate  
Autism Society of America  
7910 Woodmont Avenue, Suite 650  
Bethesda, MD 20814  
(301) 657-0881  
(800) 3-AUTISM

*Contains a variety of information about autism and serves as an advocacy and information forum for families. Lists conferences and referrals, also contains articles, interviews, and research updates on computers and autism. Quarterly.*

The Catalyst  
Western Center for Microcomputers in Special Education  
1259 El Camino Real, Suite 275  
Menlo Park, CA 94025  
(415) 855-8064

*Quarterly newsletter that provides information on technology adaptations for special education and rehabilitation.*

The Disability Rag & ReSource  
Advocado Press, Inc.  
Box 145  
Louisville, KY 40201  
(502) 459-5343

*Deals with social change and political issues affecting the disability rights movement. Occasionally contains articles regarding the relevance of technology and announcements about new technology.*

## Selected Resources on Computers for People with Learning Disabilities

This list includes basic information on resources which may be of benefit to people with learning disabilities. The list is divided into three categories: Organizations, Books & Pamphlets, and Newsletters & Journals. Particular emphasis is placed on resources related to the use of computers by people with learning disabilities. No recommendations or endorsements are implied by inclusion on this list.

### Organizations

Association on Higher Education and Disability (AHEAD)  
P.O. Box 21192  
Columbus, OH 43221  
(614) 488-4972

*This organization offers many pamphlets and books on the topic of learning disabilities and higher education to professional service providers only.*

ConnSENSE (Connecticut's Special Educ. Network for Software Evaluation)  
University of Connecticut  
Box U-64  
249 Glenbrook Road  
Storrs, CT 06269-2064  
(203) 486-0172

*Concerned with evaluating courseware for students with disabilities. Has telecommunications system for special education administrators, and a telecommunications project for students with disabilities. Publishes the ConnSENSE Bulletin which contains reviews of software as they apply to students with special needs. Lists upcoming events and technological breakthroughs for people with disabilities as well as resource and reference information.*

Learning Disabilities Association of America (LDAA)  
4156 Library Road  
Pittsburgh, PA 15234  
(412) 341-1515

*A national organization devoted to defining and finding solutions for the broad spectrum of learning problems. Inquirers are sent a free information packet and referred to one of LDAA's local chapters.*

Learning Disabilities Research and Training Center  
534 Aderhold Hall  
University of Georgia  
Athens, GA 30602  
(706) 655-5711

*Center specializing in learning disabilities, including the application of technology in meeting needs of people with LD. Focuses on adults with learning disabilities. Conducts various research and training activities.*

National Center for Learning Disabilities (NCLD)  
381 Park Avenue South  
New York, NY 10016  
(212) 545-7510

*Maintains a database of special programs, schools, and services for persons with learning disabilities. The listings are state-by-state. Inquirers can request a search of up to three states and printouts of the database listings will be sent to them. Also provides free information on learning disabilities.*

The Orton Dyslexia Society  
Chester Bldg. #328  
8600 LaSalle Road  
Baltimore, MD 21286  
(410) 296-0232  
(800) 222-3123

*A scientific and educational association involved in the study and treatment of dyslexia. Offers publications and information and referral services which help in understanding dyslexia, including a quarterly newsletter, annual journal, and information packet. Has 44 branches in the US offering a variety of local services, support groups, and networks.*

Recording for the Blind and Dyslexic (RFBD)  
20 Rozel Road  
Princeton, NJ 08540  
(800) 221-4792  
(609) 452-0606

*Provides academic textbooks and other educational textbooks to people who cannot read standard print because of physical, perceptual, or other disabilities. Must be a registered member in order to borrow materials; call for details. Also sells reference books on disk and related software products.*

### Books & Pamphlets

Directory of Facilities and Services for the Learning Disabled, 15th Edition  
1995-96  
Academic Therapy Publications  
20 Commercial Blvd.  
Novato, CA 94949-6191  
(415) 883-3314

*This directory contains a resource listing of programs and vendors around the country serving people with learning disabilities.*



**BOSC Directory - Facilities for People with Learning Disabilities**

Irene Slovak  
1995  
Books on Special Children  
P.O. Box 305  
Congers, NY 10920  
(914) 638-1236  
(914) 638-0847 (FAX)

*Contains profiles of colleges with programs for people with learning disabilities, independent living centers, special schools, vocational training programs, agencies which furnish services, commercial companies which make products, and others. Updated annually*

**Special Education Technology: Classroom Applications**

Rena Lewis  
1993  
Brooks/Cole Publishing Company  
511 Forest Lodge Road  
Pacific Grove, CA 93950  
(800) 354-9706

*Textbook designed to help pre- and in-service teachers understand how to use technology to benefit individuals with disabilities in the classroom. Focuses on computers, switches, augmentation communication, mobility devices, print translation for blind students, and listening devices for students with hearing disabilities.*

**Special Times and Special Choices**

Cambridge Development Laboratory  
86 West Street  
Waltham, MA 02154  
(800) 637-0047

*Two catalogs of software selected specifically for children with learning disabilities. Sections are divided by subject area. Published twice per year.*

**Making Technology Usable: Keeping the Interface Simple**

Leonard G. Perlman, Ed.D.  
1993  
Electronic Industries Foundation  
Rehabilitation Engineering Center  
919 18th Street, NW  
Suite 900  
Washington, DC 20006

*The views of consumers with learning disabilities, mental retardation, and their caregivers. Results of the final year of a five-year study.*

**Newsletters & Journals**

Journal of Learning Disabilities  
Pro-Ed, Inc.  
8700 Shoal Creek Blvd.  
Austin, TX 78757  
(512) 451-3246

*A multidisciplinary publication that covers practice, research, and theory related to learning disabilities. Includes coverage of computer use in the schools. Published ten times per year.*

## Software Resources

This list provides additional suggestions about where to look for information on software for special education and rehabilitation. It contains two sections, one listing organizations and one listing publications. No recommendations or endorsements are implied by inclusion on this list. Contact each resource for more specific and up-to-date information.

### Organizations

Apple Computer Disability Solutions  
Worldwide Disability Solutions Group  
MS 38-DS  
20525 Mariani Avenue  
Cupertino, CA 95014  
(800) 600-7808

*Macintosh solutions for children and adults with disabilities and rehabilitation professionals.*

ConnSENSE (Connecticut's Special Educ. Network for Software Evaluation)  
University of Connecticut  
Box U-64  
249 Glenbrook Road  
Storrs, CT 06269-2064  
(203) 486-0172

*Concerned with evaluating courseware for students with disabilities. Has telecommunications system for special education administrators, and a telecommunications project for students with disabilities. Publishes the ConnSENSE Bulletin which contains reviews of software as they apply to students with special needs. Lists upcoming events and technological breakthroughs for people with disabilities as well as resource and reference information.*

DPI, Inc.  
151 Martinvale Lane  
San Jose, CA 95119-1368  
(408) 629-3700

*Organization whose activities include training individuals with disabilities to become computer programmers. Produces educational software developed to help college students who are deaf or hard of hearing, improve their English vocabulary and writing skills.*

Florida Diagnostic and Learning Resources Services (FDLRS)  
5555 SW 93th Avenue  
Miami, FL 33165  
(305) 274-3501

*Offers evaluation for adaptive computer access and augmentative communication for Exception Education Students. Inservice training, public domain copying, and computer information resources.*

The Educational Software Selector (TESS)  
EPIE Institute  
103-3 West Montauk Highway  
Hampton Bays, NY 11946  
(516) 728-9100  
(516) 728-9228 (FAX)

*CD-ROM database of information on educational software. Contains data on: computer platform, supplier, grade level, review score, subject area, special needs area, intended use, and price.*

UCLA Microcomputer Project  
23-10 Rehabilitation Center  
1000 Veteran Avenue  
Los Angeles, CA 90024  
(310) 825-4821

*Provides a catalog of UCLA software, an instructional guide for parents and teachers on setting up computer systems, and an annual resource guide of hardware and software programs for people with disabilities.*

### Publications

Closing the Gap  
Closing the Gap, Inc.  
P.O. Box 68  
Henderson, MN 56044  
(612) 248-3294

*Bimonthly newspaper which provides information on the use of computers in special education and rehabilitation. Includes a "Software Previews" column, user comments, articles, and suggestions. Annual product directory published.*

Educational Software Preview Guide  
1994-95  
ISTE (International Society for Technology in Education)  
1787 Agate Street  
University of Oregon  
Eugene, OR 97403-1923  
(503) 346-4414

*Lists over 500 titles of favorably reviewed software for K-12 classroom use by curriculum area.*

Software Resource Guide  
National Lekotek Center  
2100 Ridge Avenue  
Evanston, IL 60201-2796  
(708) 328-0001

*Guidebook of 316 software programs appropriate for children with mental, physical, behavioral, sensory, and learning impairments*

828

Special Times and Special Choices  
Cambridge Development Laboratory  
86 West Street  
Waltham, MA 02154  
(800) 637-0047

*Two catalogs of software selected specifically for children with learning disabilities. Sections are divided by subject area. Published twice per year.*

Trace ResourceBook  
Borden, P., Lubich, J., & Vanderheiden, G.  
1996-97  
Trace Center  
S-151 Waisman Center  
1500 Highland Avenue  
Madison, WI 53705  
(608) 262-6966  
(608) 263-5408 (TDD)

*This directory lists assistive technology products for communication, control, and computer access for people with disabilities. About 1,500 products are included. Each product entry includes a description, price, and photo (when available). Products are cross referenced by functions and features. Additional information resources are also listed. Approx. 900 pages.*

#### Other

ABLEDATA  
Macro International  
8455 Colesville Road, Suite 935  
Silver Spring, MD 20910  
(301) 588-9284  
(800) 227-0216

*A computerized listing of all commercially available products for rehabilitation and independent living. There are three ways to access the database: calling the ABLEDATA office, searching by computer modem, or running the database on an individual computer. The third option is available through Macro International (on CD-ROM) and through the Trace Center (on CD-ROM or floppy disks).*

Cooperative Electronic Library on Disability (CO-NET)  
Trace Center  
S-151 Waisman Center  
1500 Highland Avenue  
Madison, WI 53705  
(608) 262-6966 (voice)  
(608) 263-5408 (TDD)

*Lists products, services, and information resources related to disability. Over 20,000 products, over 5,000 services, and over 50,000 publications are listed. Software is designed to be easy enough for beginning computer users and is accessible to users with disabilities. Available on CD-ROM; parts are also available on floppy disk and via the Internet.*

027

# **Appendix B**

## **Service Providers and Organizations**

This appendix includes resource lists of people and organizations which provide services relevant to the application of technology in special education, rehabilitation and augmentative communication. Services may range from supplying information to providing support to performing evaluations. The "Service Centers" listing concentrates particularly on evaluations. It is recommended strongly that an evaluation be performed on persons needing a communication or computer access system before major equipment is purchased. Readers are encouraged to send information about any service providers not listed to the Trace Center for inclusion in future editions. The information provided in this appendix is not evaluative, and inclusion on any of the resource lists does not imply endorsement or recommendation. Titles and page numbers of the listings appear on the next page.

## Appendix B: Service Providers and Organizations

B-1: Alliance for Technology Access: Member Sites.....	801
B-2: Computer Assessment and Training Programs for Disabled Individuals.....	804
B-3: Conferences.....	807
B-4: Organizations, Advocacy Groups and Self-Help Groups.....	808
B-5: Professional Associations.....	812
B-6: Resources on the Americans with Disabilities Act.....	813
B-7: Service Centers for Augmentative Communication and Computer Access.....	815
B-8: Technology-Related Assistance Act: State Programs.....	822
B-9: Training Programs in Technology for Special Education.....	826

## Alliance for Technology Access: Member Sites

Formerly called the National Special Education Alliance. A national network of local self-help groups dealing with computers and people with disabilities. Each group is self-operated and self-funded.

### Alabama

Birmingham Alliance for Technology Access Center  
Birmingham Independent Living Center  
206 13th Street South  
Birmingham, AL 35233  
(205) 251-2223 (voice & TDD)  
(205) 251-0605

Technology Assistance for Special Consumers  
P.O. Box 443  
Huntsville, AL 35804  
(205) 532-5996

### Alaska

Alaska Services for Enabling Technology  
P.O. Box 6485  
207 Moller Drive  
Sitka, AK 99835  
(907) 747-7615

### Arkansas

Technology Resource Center  
c/o Arkansas Easter Seal Society  
3920 Woodland Heights Road  
Little Rock, AR 72212  
(501) 227-3600

### California

Center for Accessible Technology  
Disabled Children's Computer Group (DCCG)  
2547 8th Street #12A  
Berkeley, CA 94710  
(510) 841-3224

Computer Access Center  
8901 Earhart Avenue  
Los Angeles, CA 90045  
(310) 829-6395

Special Awareness Computer Center  
Rehabilitation Center  
2975 North Sycamore Drive  
Simi Valley, CA 93065  
(805) 582-1881

Special Technology Center  
590 Castro Street  
Mountain View, CA 94041  
(415) 961-6789

Team of Advocates for Special Kids  
100 W. Cerritos Ave.  
Anaheim, CA 92805  
(714) 533-TASK

### Florida

Computer CITE  
215 E. New Hampshire Street  
Orlando, FL 32084  
(407) 898-2483

### Georgia

Tech-Able  
1140 Ellington Drive  
Conyers, GA 30207  
(404) 922-6768

### Hawaii

Aloha Special Technology Access Center  
1750 Kalakaua Avenue #1008  
Honolulu, HI 96826  
(808) 955-4464

### Illinois

Northern Illinois Center for Adaptive Technology  
1950 W. Roosevelt Avenue  
Chicago, IL 60608  
(312) 421-3373

### Kansas

Technology Resource Solutions for People (TRSP)  
3023 Canterbury  
or 1710 West Schilling Road  
Salina, KS 67401  
(913) 827-0301

830

## Appendix B-1: Alliance for Technology Access: Member Sites

---

### Kentucky

ATA Eastern Technical Assistance Office  
1531 Dawn Drive  
Louisville, KY 40216  
(502) 449-0645

Blue Grass Technology Center  
169 N. Limestone  
Lexington, KY 40507  
(606) 255-9951

Enabling Technologies of Kentuckiana (enTECH)  
Louisville Free Public Library  
301 York Street  
Louisville, KY 40203  
(502) 574-1637  
(800) 327-5284 (in Kentucky only)

SpeciaLink  
36 W. Fifth Street  
Covington, KY 41011  
(606) 491-2464

### Maryland

Learning Independence Through Computers, Inc.  
28 E. Ostend Street, Suite 140  
Baltimore, MD 21230  
(410) 659-5462  
(410) 659-5472 (FAX/TDD)

### Massachusetts

Massachusetts Special Technology Access Center  
12 Mudge Way 1-6  
Bedford, MA 01730  
(617) 275-2446

### Michigan

Living & Learning Resource Center  
Physically Impaired Association of Michigan  
600 W. Maple Street  
Lansing, MI 48906-3063  
(517) 487-0883  
(800) 833-1996 (MI)

### Minnesota

PACER Center  
4826 Chicago Avenue South  
Minneapolis, MN 55417  
(617) 827-2966  
(800) 53PACER (in Minnesota)

### Missouri

Technology Access Center  
12110 Clayton Road  
St. Louis, MO 63131  
(314) 569-8404  
(314) 569-8100

### Montana

Parents, Let's Unite for Kids  
MSU-Billings/ SPED Room 267  
1500 N. 30th Street  
Billings, MT 59101-0298  
(406) 657-2055

### New Jersey

Center for Enabling Technology  
9 Whippany Road  
622 Route 10W  
Suite 22B  
Whippany, NJ 07981  
(201) 428-1455

Computer Center for People with disAbilities (CCdA)  
c/o Family Resources, Inc  
35 Haddon Avenue  
Shrewsbury, NJ 07702  
(908) 7474-5310

### New York

Techspres Resource Center for Independent Living  
409 Columbia Street  
Utica, NY 13502  
(315) 797-4642 (V/TDD)

### North Carolina

Carolina Computer Access Center  
700 East Second Street  
Charlotte, NC 28202  
(704) 342-3004

### North Dakota

Pathfinder Parent Training and Information Center  
ATA Computer Resource Center  
1600 2nd Avenue SW  
Minot, ND 58701  
(701) 852-9426  
(701) 852-9436

### Ohio

Technology Resource Center, Inc.: Enabling People with Disabilities  
301 Valley Street  
Dayton, OH 45404  
(513) 222-5222

### Rhode Island

TechACCESS of Rhode Island  
300 Richmond Street  
Providence, RI 02903  
(401) 273-1990  
(401) 273-1991

### Tennessee

East Tennessee Special Technology Access Center, Inc  
3525 Emory Road, NW  
Powell, TN 37849  
(615) 947-2191  
(615) 947-2194

831

Technology Access Center of Middle Tennessee  
2222 Metro Center Blvd.  
Suite 126  
Nashville, TN 37228  
(617) 248-6733  
(800) 368-4651

West Tennessee Special Technology Resource Center  
60 Lyn Oak Cove  
Jackson, TN 38305  
(901) 668-3888

Virgin Islands

Virgin Islands Resource Center for the Disabled, Inc.  
P.O. Box 1825  
St. Thomas, VI 00803  
(809) 777-ABLE

Virginia

Tidewater Center for Technology Access  
Special Education Annex  
3352 Virginia Beach Boulevard  
Virginia Beach, VA 23452  
(804) 473-4095  
(804) 431-4090

Washington

Washington Technology Access Center (WTAC)  
8511 15th Avenue NE  
Seattle, WA 98115-3199  
(206) 526-1240

West Virginia

Project G.L.U.E  
c/o Children's Therapy Clinic  
2345 Chesterfield Avenue  
Charleston, WV 25304  
(304) 342-6501



## Computer Assessment and Training Programs for Disabled Individuals

This list contains information on programs and organizations that provide computer-oriented assessment and training for disabled persons, either children or adults, or that assess a person's computer-related skills and recommend adaptations. No recommendations or endorsements are implied by inclusion on this list. Contact each resource for more specific and up-to-date information.

Adaptive Technology Laboratory (ATL)  
Southern Connecticut State University  
Engleman Hall, Room 5  
501 Crescent Street  
New Haven, CT 06515  
(203) 392-5799

*Conducts service and education programs on adaptive technology for persons with learning, visual, and physical disabilities. Conducts computer access evaluations and training of persons with disabilities.*

Assistive Technology/Special Schools Program  
Orange County Department of Education  
P.O. Box 9050  
Costa Mesa, CA 92628-9050  
(714) 966-4140

*Program provides county-wide assistive technology services for students with disabilities. Students are trained in the use of adapted computer systems and assistive technology to help them become more independent.*

Carroll Center for the Blind  
70 Centre Street  
Newton, MA 02158  
(617) 969-6200

*Various publications and rehabilitation and educational programs are available for persons who are blind or visually impaired. A computer training program, Project CABLE, provides computer assessment, training on adaptive devices and software, and word processing training. Summer training courses for youth are also offered.*

Center for Adapted Technology  
Colorado Easter Seal Society  
5755 West Alameda  
Lakewood, CO 80226  
(303) 233-1666

*Provides a variety of services for persons with disabilities including: assessments and evaluations for assistive technology, computer training, equipment loaning, public domain software library, on-line bulletin boards, and publications.*

Center for Applied Rehabilitation Technology (CART)  
Rancho Los Amigos Medical Center  
7601 East Imperial Highway  
Downey, CA 90242  
(310) 940-6800  
(310) 803-8848 (FAX)

*Provides computer access evaluations, recommendations of appropriate equipment including hardware and software adaptations, assistance in setting up equipment, and beginning training for any adaptations recommended. Individuals of any age are served.*

Center for Computer Assistance to the Disabled (C-CAD)  
1950 Stemmons Frwy, Suite 4041  
Dallas, TX 75207  
(214) 746-4217

*Non-profit organization that provides computer training for individuals with disabilities. Consults and responds to requests for information about special adaptations or modifications to computers for use by the disabled.*

CETEC (Computer Education and Training Evaluation Center)  
Sensory Access Foundation  
385 Sherman Avenue, Suite 2  
Palo Alto, CA 94306  
(415) 329-0430 (voice)  
(415) 329-0433 (TDD)

*Provides individual assessments of technology needs of people with visual impairments within the state of California*

Communication Aids and Systems Clinic  
Trace Center  
S-121 Waisman Center  
1500 Highland Avenue  
Madison, WI 53705  
(608) 263-2522

*Multi-disciplinary team provides evaluations, treatment and consultative services for individuals of all ages who need augmentative communication systems, computer access or writing in a totally integrated system.*

Computer Counsellors  
2008 N Via Establo  
Santa Maria, CA 93454-8201  
(805) 925-5780

*Provides voice input and output computer training to people with disabilities. Run by Amy L. Malicki, LTM*

833

## Appendix B-2: Computer Assessment and Training Programs for Disabled Individuals

Computers to Help People, Inc.  
825 E. Johnson Street  
Madison, WI 53703  
(608) 257-5917

*Provides people with disabilities with vocational training in computer operation. Also sells software designed for people with physical disabilities.*

DPI, Inc.  
151 Martinvale Lane  
San Jose, CA 95119-1368  
(408) 629-3700

*Organization whose activities include training individuals with disabilities to become computer programmers. Produces educational software developed to help college students who are deaf or hard of hearing, improve their English vocabulary and writing skills.*

Easter Seal Children's Center  
3035 N. Druid Hills Road  
Atlanta, GA 30329  
(404) 633-9609

*Offers advice and training for computer use with children with disabilities. Includes services regarding computers, peripherals, appropriate software, occupational therapy, physical therapy, and speech therapy.*

Florida Diagnostic and Learning Resources Services (FDLRS)  
5555 SW 93th Avenue  
Miami, FL 33165  
(305) 274-3501

*Offers evaluation for adaptive computer access and augmentative communication for Exception Education Students, inservice training, public domain copying, and computer information resources.*

Infinitec  
United Cerebral Palsy Association of Greater Chicago  
155 N. Wacker Drive  
Chicago, IL 60606  
(312) 368-0380

*Functions include: assistive technology exhibits, community service, communication devices, library and resource center, policy area, product testing and evaluation, and technology exchange network. Resource for manufacturers, service providers, rehab professionals, technology suppliers, payer sources, and people with disabilities.*

LIFT, Inc.  
P.O. Box 1072  
Mountainside, NJ 07092  
(800) 552-5438  
(908) 789-2443

*Not-for-profit company that identifies, trains, and hires individuals with physical disabilities as computer programmers for major corporations.*

Maryland Rehabilitation Center  
2301 Argonne Drive  
Baltimore, MD 21218  
(410) 554-3000

*Provides evaluation of computer applications best suited for enhancing a disabled person's vocation. Acts as a diagnostic resource center in setting disabled students' vocational goals.*

Microcomputer Resource Lab  
Los Angeles Unified Schools District  
15530 Hesby Street  
Encino, CA 91436  
(818) 997-2330 ext. 186

*Provides technology assessments for Los Angeles Unified School District students with disabilities. Provides computer training for special education teachers in the use of computers and software for individuals with special needs. Also maintains extensive Pre K-12 educational software libraries for the Apple, Mac, and IBM platforms.*

Neil Squire Foundation  
Suite 220 - 2250 Boundary Road  
Burnaby, BC V5M 4L9  
CANADA  
(604) 473-9363  
(604) 473-9364

*Canadian non-profit organization whose purpose is to create opportunities for independence for individuals with severe physical disabilities. Through direct interaction the foundation researches, develops, and delivers appropriate innovative services and technology to meet their needs.*

NorthEast Independent Living Program  
20 Ballard Road  
Lawrence, MA 01843-1018  
(508) 687-4288

*Provides assistive technology training for persons with disabilities in an effort to increase their independent living skills.*

Office Systems for the Visually or Physically Impaired  
1822 North Wood Street  
Chicago, IL 60622  
(800) 253-4391

*Provides assistance in compliance and implementation of multiple sensory workplace accommodations, on-site or at Chicago office. Implementation includes training, system configuration services, and demonstration and sales of products. Computer access includes voice input, scanning input, screen magnification, and screen readers. AAC devices include software for a Mac or PC, as well as dedicated devices.*

Pennsylvania Technology Program (PennTECH)  
6340 Flank Drive  
Suite 600  
Harrisburg, PA 17112  
(715) 541-4960  
(800) 222-7372 (in PA only)

*Statewide program providing technical assistance, training, consultation, textbook production, and workshops pertaining to assistive technology. Purchase of assistive devices for student use.*

SAGE Employment & Community Services  
332 S. Convent Avenue  
Tucson, AZ 85701  
(520) 622-3933  
(520) 670-9221 (FAX)

*Involved with basic remediation and rehabilitation, vocational counseling, and research on the use of technology with individuals with severe and profound disabilities. Part of the Blake Foundation.*

Sister Kenny Institute  
800 E. 28th Street at Chicago Avenue  
Minneapolis, MN 55407  
(612) 863-4407

*Organization uses computer programs to provide language and cognitive therapy to adults with neurologic injuries.*

834

## Appendix B-2: Computer Assessment and Training Programs for Disabled Individuals

---

Special Education Technology - British Columbia (SET-BC)  
105-1750 West 75th Avenue  
Vancouver, BC V6P 6G2  
CANADA  
(604) 261-9450  
(604) 261-2256 (FAX)

*Provincial resource program that provides support to school districts in educating low incidence students through the use of technology. Services provided include: consultation on assessment of student needs and planning for the implementation of technology, equipment loan to students, training and information resources.*

Special Needs Center  
Duluth Public Library  
520 W. Superior Street  
Duluth, MN 55802  
(218) 723-3809

*Trains persons with disabilities in the use of Apple and IBM computers. Applications include word processing, database, AppleSoft Basic, Logo, and Adaptive Firmware Card. Product information on software, hardware, and adaptations is available. Also has an adaptive toy program*

STORER Computer Access Center  
Cleveland Sight Center  
1909 E. 101st Street  
Cleveland, OH 44106  
(216) 791-8118

*Offers orientation, evaluation, training, engineering support, and system rental to blind or visually impaired individuals. Also provides training for instructors, engineers, and vocational specialists in assistive computer technology. Offers housing and a full range of rehabilitation services.*

Technical Resource Centre  
200, 1201 - 5th Street SW  
Calgary, AB T2R 0Y6  
CANADA  
(403) 262-9445  
(403) 262-4539 (FAX)

*Does assessments and provides technical aids to help persons with disabilities better realize educational, vocational, social, and independent living potentials. Consults on the selection, operation, and application of aids. Equipment is loaned for trial use and assessment. Educates professionals. Maintains computerized library of information.*

Technology Resource Center, Inc.: Enabling People with Disabilities  
301 Valley Street  
Dayton, OH 45404  
(513) 222-5222

*Offers individuals, their families, and professionals a place to learn about and experience assistive communication devices for children and adults who are unable to speak, read, or write. We provide a rich assortment of adaptive input devices and specialized software for computer-based language development.*

Variety Club  
Warwick Hotel  
17th and Locust Streets  
Philadelphia, PA 19103  
(215) 735-0803

*Runs the Variety Club Camp and Developmental Center for children with disabilities. Assessment and computer training are provided. Provides other services for children with disabilities ranging from a medical equipment distribution program to children's field trips and parties. Children must be residents of the Delaware Valley.*

## Conferences

This resource list provides information on organizations that hold annual or other regularly scheduled conferences in the areas of augmentative communication, blindness, occupational therapy, and general disability. No recommendations or endorsements are implied by inclusion on this list. Contact each resource for more specific and up-to-date information.

American Council of the Blind  
1155 15th Street, Suite 720  
Washington, DC 20005  
(202) 467-5081  
(202) 467-5085 (FAX)

*Publishes computer resource list about various devices and where to buy them. Visually Impaired Data Processors International, a computer users' special interest group, is part of ACB.*

American Occupational Therapy Association (AOTA)  
4720 Montgomery Lane  
Bethesda, MD 20824  
(301) 652-2682  
(800) 377-8555 TDD

*AOTA is a nationwide organization of professionals concerned with all aspects of the occupational therapy field. The organization publishes the American Journal of Occupational Therapy. Membership includes a special interest section on technology.*

ASHA (American Speech-Language-Hearing Association)  
10801 Rockville Pike  
Rockville, MD 20852  
(301) 897-5700  
(800) 638-8255

*National association of professionals working in speech, language, and hearing fields. Membership includes many specialists in augmentative communication. Consumer Affairs Division disperses information and will provide referrals to certified speech-language pathologists and audiologists.*

California State University, Northridge  
18111 Nordhoff Street-DVSS  
Center on Disabilities  
Northridge, CA 91330-8340  
(818) 885-2578  
(818) 885-4929 (FAX)

Closing The Gap, Inc.  
P.O. Box 68  
Henderson, MN 56044  
(612) 248-3294

*National conference, workshops, and training. Also publishes a newspaper dedicated to the latest in technology for people with disabilities.*

Internat'l Society for Augmentative and Alternative Communication (ISAAC)  
P.O. Box 1762  
Station R  
Toronto, ON M4G 4A3  
CANADA  
(905) 737-9308  
(905) 737-0624 (FAX)

*The purpose of ISAAC is to advance the field of augmentative and alternative communication, to facilitate information exchange, and to focus attention on work in the field. Membership is international. Activities include conferences and publications.*

National Federation of the Blind  
1800 Johnson Street  
Baltimore, MD 21230  
(410) 659-9314

*Programs include: Committee on Evaluation of Technology (which evaluates current and proposed technology for people who are blind or visually impaired); International Braille and Technology Center for the Blind (a demonstration and evaluation center for computer technology for blind and visually impaired users); and NFB in Computer Science (a nationwide computer users' group which publishes an annual newsletter for people who are blind or visually impaired).*

Rehabilitation Technology Association  
West Virginia Research & Training Center  
5088 Washington St. West  
Cross Lanes, WV 25313  
(304) 759-0716 - voice/TDD

RESNA  
1700 N. Moore Street #1540  
Arlington, VA 22209-1903  
(703) 524-6686

*An association for the advancement of rehabilitation technology. Its membership includes rehabilitation professionals, service providers, researchers, vendors, and consumers. Some of RESNA's goals are to promote interaction between the above groups, improve the quality of life for people with disabilities through the application of science and technology, and to influence policy relating to the delivery of technology and services.*

## Organizations, Advocacy Groups and Self-Help Groups

The groups and organizations listed below are concerned with the education, rehabilitation, and employment of severely disabled individuals. The list is not comprehensive: states and communities may have agencies that can provide some of the same information and services. No recommendations or endorsements are implied by inclusion on this list. Contact each resource for more specific and up-to-date information.

ACTT Outreach (Activating Children Through Technology)  
27 Horrabin Hall  
Western Illinois University  
Macomb, IL 61455  
(309) 298-1014

*Training is offered to early childhood professionals and families which encourages the integration of technology in the pre-school curriculum. ACTT has developed a curriculum for ages birth-6 which utilize computers and special peripherals for communication and other skills. The training programs can be taken for graduate credit if desired.*

AFB Technology Center  
American Foundation for the Blind, Inc.  
11 Penn Plaza  
Suite 300  
New York, NY 10001  
(212) 502-7642  
(212) 502-7773 (fax)

*Conducts product evaluations of assistive technology including braille technology, optical character readers, speech synthesizers, screen magnifiers, and closed circuit televisions. E-mail to [techtr@afb.org](mailto:techtr@afb.org).*

Alexander Graham Bell Association for the Deaf  
3417 Volta Place NW  
Washington, DC 20007-2778  
(202) 337-5220 (voice/TDD)

*National organization offering support services to deaf individuals. Services include: publications, information, regional conferences and an international convention, research library, advocacy, grants, scholarships, and financial aid.*

ALS Association  
21021 Ventura Blvd. Suite 321  
Woodland Hills, CA 91364  
(818) 340-7500  
(800) 782-4747

*National organization that acts as a referral service for ALS patients in need of computers and computer assisted communication devices. Most such patients depend on computers to enable them to communicate with others.*

Arkansas Research & Training Center in Voc Rehab  
P.O. Box 1358  
Hot Springs, AR 71902  
(501) 624-4411 ext. 292 (training)  
(501) 624-4411 ext. 299 (publications)

*Research reports and reference materials available from the materials development and dissemination center. Training programs, including technology-related services, are available from the training center.*

Autism Society of America  
7910 Woodmont Avenue  
Suite 65D  
Bethesda, MD 20814  
(301) 657-0881  
(800) 3AUTISM

*National service and advocacy organization for people with autism. Special services are offered on a local level; public policy advocacy and information and referral services are offered on a national level.*

Blissymbolics Communication International  
1630 Lawrence Avenue, W.  
Suite 104  
Toronto, ON M6L 1C5  
CANADA  
(416) 242-9114  
(516) 244-6543 (FAX)

*Support and educational group involved in the design of computer programs using Blissymbols. Resource center for the use of Blissymbols. Distributes Blissymbols programs for augmentative communication.*

Bureau of Student Services and Exceptional Education  
Florida Dept. of Education  
Florida Education Center  
325 W. Gaines Street, Suite 544  
Tallahassee, FL 32399-0400  
(904) 922-0040  
(904) 487-8714

*State Education Agency which coordinates instructional technology applications in exceptional student education. Project areas include: policy and program development, implementation and evaluation, coordination of funded projects, and coordination of statewide assistive technology systems for students with disabilities.*

## Appendix B-4: Organizations, Advocacy Groups and Self-Help Groups

Carolina Computer Access Center  
700 East Second Street  
Charlotte, NC 28202  
(704) 342-3004

*Mission is to promote the use of computers, assistive devices, and software to increase the academic and vocational potential of people with disabilities. Maintains a lending library, offers information and assistance on the use of technology, and conducts workshops.*

Center for Adapted Technology  
Colorado Easter Seal Society  
5755 West Alameda  
Lakewood, CO 80226  
(303) 233-1666

*Provides a variety of services for persons with disabilities including: assessments and evaluations for assistive technology, computer training, equipment loaning, public domain software library, on-line bulletin boards, and publications.*

Center for Computer Assistance to the Disabled (C-CAD)  
1950 Stemmons Frwy, Suite 4041  
Dallas, TX 75207  
(214) 746-4217

*Non-profit organization that provides computer training for individuals with disabilities. Consults and responds to requests for information about special adaptations or modifications to computers for use by the disabled.*

Closing The Gap, Inc.  
P.O. Box 68  
Henderson, MN 56044  
(612) 248-3294

*National conference, workshops, and training. Also publishes a newspaper dedicated to the latest in technology for people with disabilities.*

D/ENUG (Disabled/Special Needs Users' Group)  
Boston Computer Society (BCS)  
101-A 1st Avenue  
Waltham, MA 0215401160  
(617) 290-5700

*D/ENUG is a special interest group of the Boston Computer Society. Also publishes a quarterly newsletter.*

East Range Developmental Achievement Resource Center  
800 A Avenue  
Eveleth, MN 55734  
(218) 744-5130

*An exchange network for information on the use of computers by persons with developmental disabilities and a regional assistive technology lending library.*

HEATH Resource Center  
1 Dupont Circle NW, Suite 800  
Washington, DC 20036  
(202) 939-9320  
(800) 54-HEATH

*National clearinghouse on post-secondary education for individuals with disabilities. Prepares and disseminates a resource directory, newsletter, and other publications.*

IBM Corporation Special Needs Systems  
P.O. Box 1328  
Internal Zip 5432  
Boca Raton, FL 33432  
(800) 426-4832

*Markets special line of computer access products for users with disabilities, designed for IBM systems.*

Independent Living Program  
Curative Rehabilitation Center  
2900 Curry Lane  
P.O. Box 8027  
Green Bay, WI 54308  
(414) 468-1161 ext. 132

*Provides services relating to the fitting and positioning of computer access devices to individuals sixteen years of age or older in Northeastern Wisconsin and the Fox Valley. Also works for funding advocacy. Site for WisTech and WisTech Tryout.*

Infinitec  
United Cerebral Palsy Association of Greater Chicago  
155 N. Wacker Drive  
Chicago, IL 60606  
(312) 368-0380

*Functions include: assistive technology exhibits, community service, communication devices, library and resource center, policy area, product testing and evaluation, and technology exchange network. Resource for manufacturers, service providers, rehab professionals, technology suppliers, payer sources, and people with disabilities.*

Integrated Technology Services  
Fairfax Public Schools  
2334 Gallows Road  
Dunnloring, VA 22027  
(703) 204-3939

*Resource center for technology for special education students and teachers in public schools. Have explored computer applications in the following areas: computer literacy, CAI, communication assistance, and vocational training.*

Job Accommodation Network (JAN)  
West Virginia University  
918 Chestnut Ridge Road, Suite 1  
P.O. Box 6080  
Morgantown, WV 26506-6080  
(304) 293-7186  
(800) 526-7234

*International information network and consulting resource for accommodating persons with disabilities in the workplace. Also has a separate phone line for questions on the ADA: (800) ADA-WORK. Maintains a electronic bulletin board with job accommodation information.*

Muscular Dystrophy Association (MDA)  
3300 E. Sunrise Drive  
Tucson, AZ 85718  
(800) 572-1717  
(520) 529-2000

*National voluntary health organization fighting 40 neuromuscular diseases through worldwide research, through a nationwide network of clinics, and through far-reaching professional and public health education.*

National ClearingHouse of Rehabilitation Training Materials (NCHRTM)  
Oklahoma State University  
816 West 6th Avenue  
Stillwater, OK 74078-0435  
(405) 624-7650  
(800) 223-5219

*Provides information on vocational rehabilitation and special education with primary emphasis on training materials for use by educators, disabled persons or counselors. Serves as a national repository for such training materials. Publishes the NCHRTM Memo (quarterly) to help disseminate information.*

## Appendix B-4: Organizations, Advocacy Groups and Self-Help Groups

National Down Syndrome Congress  
1605 Chantilly Drive, Suite 250  
Atlanta, GA 30324  
(404) 633-1555  
(800) 232-6372

*An organization of parents and professionals that provides information on services for persons with Down Syndrome.*

National Federation of the Blind  
1800 Johnson Street  
Baltimore, MD 21230  
(410) 659-9314

*Programs include: Committee on Evaluation of Technology (which evaluates current and proposed technology for people who are blind or visually impaired); International Braille and Technology Center for the Blind (a demonstration and evaluation center for computer technology for blind and visually impaired users); and NFB in Computer Science (a nationwide computer users' group which publishes an annual newsletter for people who are blind or visually impaired).*

National Head Injury Foundation  
1776 Massachusetts NW, Suite 100  
Washington, DC 20036-1904  
(202) 296-6443  
(800) 444-6443 (info & resources)

*Pursues various information and advocacy activities related to the prevention and treatment of brain injuries.*

National Information Center for Handicapped Children and Youth with Disabilities (NICHCY)  
P.O. Box 1492  
Washington, DC 20013  
(202) 884-8200  
(800) 695-0285

*A free information referral service that assists parents, educators, care-givers, and others in ensuring that children and youth with disabilities have better opportunities. Has fact sheets and other publications available.*

National Information Clearinghouse for Infants with Disabilities and Life-Threatening Conditions  
Center for Developmental Disabilities  
School of Medicine, Dept. of Pediatrics  
University of South Carolina  
Columbia, SC 29208  
(800) 922-9234 ext. 201

*Information specialists respond to individual requests and assist families in accessing services such as parent support and training, advocacy, health care, finance, technology, and others. Produces and disseminates bibliographies, fact sheets, and articles on related topics.*

National Information System for Vietnam Veterans and Their Families  
Center for Developmental Disabilities  
School of Medicine, Dept. of Pediatrics  
University of South Carolina  
Columbia, SC 29208  
(800) 922-9234 ext. 401

*Information specialists respond to requests for information about identifying, understanding, and accessing services for families of Vietnam Veterans who have children with disabilities or special health care needs. Produces and disseminates fact sheets.*

National Organization on Disability (NOD)  
910 16th Street NW, Suite 600  
Washington, DC 20006-2988  
(202) 293-5968  
(202) 293-5968 (TDD)

*Offers information and referral services to all individuals with disabilities. The mission is to promote the full participation of American people with physical, sensory, or mental disabilities in all aspects of life. No direct services are provided, referrals only*

National Rehabilitation Information Center (NARIC)  
8455 Colesville Road, Suite 935  
Silver Spring, MD 20910  
(301) 588-9284 (voice/TDD)  
(800) 34-NARIC (voice/TDD)

*NARIC is a rehabilitation information service and research library funded by the National Institute of Disability and Rehabilitation Research, U.S. Department of Education. It provides access to NIDRR-funded reports and information on assistive devices, and disseminates other rehabilitation-related information resources. Most of NARIC's database information is available on the ABLE INFORM BBS.*

National Spinal Cord Injury Association  
545 Concord Avenue  
Suite 29  
Cambridge, MA 02138  
(617) 441-8500  
(800) 441-3449 (fax)

*Provides information or referrals for the direct care of persons who have paraplegia or quadriplegia. Publishes a variety of materials, has local chapters, and provides training for ADA compliance.*

National Technical Institute for the Deaf (NTID)  
Rochester Institute for the Deaf - Div. of Public Affairs  
LBJ Building  
52 Lomb Memorial Drive  
Rochester, NY 14623-5604  
(716) 475-6400 (voice)  
(716) 475-2185 (TDD)

*The world's largest technical college for deaf students, offering the opportunity for deaf students to go to college in a hearing environment to facilitate transition to a hearing society. Funded by the U.S. Department of Education. Publishes a list of captioned educational videotapes.*

PACER Center  
4826 Chicago Avenue South  
Minneapolis, MN 55417  
(617) 827-2966  
(800) 53PACER (in Minnesota)

*PACER provides information, training, and assistance to parents of children with disabilities. Has a computer and technology center. Advice is also offered in the areas of appropriate education and interpretation of legal rights.*

PAM Assistance Centre  
Physically Impaired Association of Michigan  
601 W. Maple  
Lansing, MI 48906  
(800) 274-7426  
(517) 371-5897

*Provides information and technical assistance to people with disabilities and service providers in the selection, development, or adaptation of devices.*

Research and Training Center  
Stout Vocational Rehabilitation Institute  
School of Education & Human Services  
University of Wisconsin-Stout  
Menomonie, WI 54751  
(715) 232-1389

*Vocational evaluation and work adjustment: collects, develops, and disseminates information and materials on vocational evaluation and work adjustment, including the use of technology.*

Southwest Educational Development Lab/Regional Rehabilitation Exchange  
211 E. 7th Street  
Austin, TX 78701-3281  
(512) 476-6861

*This project develops and tests practices for daily living and exemplary programs. Technical assistance is provided and disseminated through a newsletter for Texas, New Mexico, Arkansas, Louisiana, and Oklahoma.*

TASH (The Association for Persons with Severe Handicaps)  
29 W. Susquehanna Avenue  
Suite 210  
Baltimore, MD 21204  
(410) 838-8274

*A non-profit, membership organization. Ongoing concerns include: advocacy for education and habilitation; support for educators, parents, and service providers; full participation in community settings; use and sharing of experience. Provides information and referral services, publishes a monthly newsletter and quarterly journal, and has chapters around the country.*

Technical Resource Centre  
200, 1201 - 5th Street SW  
Calgary, AB T2R 0Y6  
CANADA  
(403) 262-9445  
(403) 262-4539 (FAX)

*Does assessments and provides technical aids to help persons with disabilities better realize educational, vocational, social, and independent living potentials. Consults on the selection, operation, and application of aids. Equipment is loaned for trial use and assessment. Educates professionals. Maintains computerized library of information.*

Tetra Society of North America  
Plaza of Nations  
Suite 27, 770 Pacific Blvd. South  
Vancouver, BC V6B 5E7  
CANADA  
(604) 688-6464  
(604) 688-6463 (FAX)

*Tetra facilitates the formation of volunteer groups whose goal is to team technically inclined volunteers with people requiring simple assistive devices that they cannot find through regular channels. Either the device they need has not been invented, it needs to be adapted to their particular needs, or funding cannot be obtained to hire a rehabilitation professional.*

The Arc  
500 E. Border Street, Suite 300  
Arlington, TX 76010  
(817) 261-6003

*Information and referrals available regarding assistive technology and mental retardation. Many publications related to mental retardation are also available.*

The Hugh MacMillan Rehabilitation Centre  
350 Rumsey Road  
Toronto, ON M4G 1R8  
CANADA  
(416) 424-3805

*Two main programs offered. The Adaptive Communication Program provides services which include assessment and training for augmentative communication devices. The Microcomputer Applications Program is a research and development group that develops ways for people with disabilities to access and use computer systems.*

Trace Research and Development Center  
1500 Highland Avenue  
S-151 Waisman Center  
Madison, WI 53705  
(608) 262-6966 (voice)  
(608) 263-5408 (TDD)

*The Trace Center is a research and resource center on technology and disability. The center's chief area of specialty is access to computers and information systems. Activities include research, product development, creating and distributing information materials, and answering questions from consumers and service providers. Operates a publication service; ask for Publications and Media brochure.*

Volunteers for Medical Engineering (VME)  
c/o Maryland Rehabilitation Center  
2301 Argonne Drive  
Baltimore, MD 21218

*Voluntary association of engineers and medical professionals dedicated to research and development of new technology for people with disabilities. Services include custom design and modifications, computer loans, and a home automation demonstration center.*

World Institute on Disability  
510 16th St, Suite 100  
Oakland, CA 94612  
(510) 763-4100  
(510) 763-4109 (FAX)

Worldwide Disability Solutions Group  
Apple Computer, Inc.  
20525 Mariani Avenue, MS 38-DS  
Cupertino, CA 95014  
(800) 600-7808

*Through this office, Apple works with key education, rehabilitation, and advocacy organizations to identify the computer-related needs of disabled individuals and to assist in the development of responsive programs.*



## Professional Associations

This resource list provides information on professional associations in the areas of augmentative communication, computer access, rehabilitation, and general disability issues. No recommendations or endorsements are implied by inclusion on this list. Contact each resource for more specific and up-to-date information.

American Academy for Cerebral Palsy and Developmental Medicine  
6300 N. River Road  
Suite 727  
Rosemont, IL 60018  
(708) 282-0036

*Professional organization concentrating on the latest developments in the treatment of cerebral palsy and developmental medicine.*

American Occupational Therapy Association (AOTA)  
4720 Montgomery Lane  
Bethesda, MD 20824  
(301) 652-2682  
(800) 377-8555 TDD

*AOTA is a nationwide organization of professionals concerned with all aspects of the occupational therapy field. The organization publishes the American Journal of Occupational Therapy. Membership includes a special interest section on technology.*

ASHA (American Speech-Language-Hearing Association)  
10801 Rockville Pike  
Rockville, MD 20852  
(301) 897-5700  
(800) 638-8255

*National association of professionals working in speech, language, and hearing fields. Membership includes many specialists in augmentative communication. Consumer Affairs Division disperses information and will provide referrals to certified speech-language pathologists and audiologists.*

Council for Exceptional Children  
1920 Association Drive  
Reston, VA 22091-1589  
(703) 620-3660

*A major national association of special education teachers, university faculty, researchers, administrators, and university students training to be teachers. Publishes "Exceptional Children" and "Teaching Exceptional Children."*

Internat'l Society for Augmentative and Alternative Communication (ISAAC)  
P.O. Box 1762  
Station R  
Toronto, ON M4G 4A3  
CANADA  
(905) 737-9308  
(905) 737-0624 (FAX)

*The purpose of ISAAC is to advance the field of augmentative and alternative communication, to facilitate information exchange, and to focus attention on work in the field. Membership is international. Activities include conferences and publications*

RESNA  
1700 N. Moore Street #1540  
Arlington, VA 22209-1903  
(703) 524-6686

*An association for the advancement of rehabilitation technology. Its membership includes rehabilitation professionals, service providers, researchers, vendors, and consumers. Some of RESNA's goals are to promote interaction between the above groups, improve the quality of life for people with disabilities through the application of science and technology, and to influence policy relating to the delivery of technology and services.*

United States Society for Augmentative and Alternative Communication (USSAAC)  
Conferences, Inc.  
P.O. Box 5271  
Evanston, IL 60204-5271  
(708) 869-2122  
(708) 869-2161 (FAX)

*The purpose of USSAAC is to bring together individuals who are committed to providing communication for people with disabilities. Professionals, families, and consumers are linked through a national database. USSAAC membership includes membership in ISAAC.*

Volunteers for Medical Engineering (VME)  
c/o Maryland Rehabilitation Center  
2301 Argonne Drive  
Baltimore, MD 21218

*Voluntary association of engineers and medical professionals dedicated to research and development of new technology for people with disabilities. Services include custom design and modifications, computer loans, and a home automation demonstration center.*

## Resources on the Americans with Disabilities Act

The following organizations offer information on complying with the Americans with Disabilities Act. Contact each resource for further information.

### National:

National Council on Disabilities  
800 Independence Avenue SW  
Suite 814  
Washington, D.C. 20591

National Institute of Building Science  
1201 L Street NW  
Suite 400  
Washington, D.C. 20005

U.S. Chamber of Commerce  
1615 H. Street NW  
Washington, D.C. 20062

National Easter Seals Society  
Publications Department  
70 E. Lake Street  
Chicago, IL 60601

The President's Committee on Employment of People with Disabilities  
Washington, D.C. 20036-3470

### Disability and Business Technical Assistance Centers:

#### Region I - CT, ME, MA, HN, RI, VT

University of Southern Maine  
Muskie Institute of Public Affairs  
145 Newbury Street  
Portland, ME 04101  
(207) 874-6535 V/TDD  
(207) 874-6529 Fax

#### Region II - NJ, NY, Puerto Rico

United Cerebral Palsy Assoc. of NJ  
354 South Broad Street  
Trenton, NJ 08608  
(609) 392-4004 V/TDD  
(609) 392-3505 Fax

#### Region III - DE, DC, MD, PA, VA, WV

Independence Center of Northern VA  
2111 Wilson Boulevard, Suite 400  
Arlington, VA 22201  
(703) 525-3268 V/TDD  
(703) 525-6835 Fax

#### Region IV - AL, FL, GA, KY, MS, NC, SC, TN

United Cerebral Palsy Assoc., Inc.  
National Alliance of Business  
1776 Peachtree Road, Suite 310N  
Atlanta, GA 30309  
(404) 888-0022, (404)888-9007 TDD  
(404) 888-9091 Fax

#### Region V - IL, IN, MI, MN, OH, WI

University of IL at Chicago/UAP  
1640 West Roosevelt Road (M/C627)  
Chicago, IL 60608  
(312) 413-1407, (312)413-0453 TDD  
(312) 413-1326 Fax

#### Region VI - AR, LA, NM, OK, TX

2323 South Sheperd Boulevard, Suite 100  
Houston, TX 77019  
(713) 520-0232, (713) 520-5136 TDD  
(713) 520-5785 Fax

#### Region VII - IA, KS, NE, MO

University of Missouri at Columbia  
4816 Santana Drive  
Columbia, MO 65203  
(314) 882-3600 V/TDD  
(314) 884-4925 Fax

#### Region VIII - CO, MT, ND, SD, UT, WY

Meeting the Challenge, Inc.  
3630 Sinton Road, Suite 103  
Colorado Springs, CO 80907-5072  
(719) 444-0252, (719)444-0268 TDD  
(719) 444-0269 Fax

## Appendix B-6: Resources on the Americans with Disabilities Act

---

### Region IX - AZ, CA, HI, NV, Pacific Basin

Berkeley Planning Associates  
440 Grand Ave., Suite 500  
Oakland, CA 94610  
(510) 465-7884, (510) 465-3127 TDD  
(510) 465-7885

### Region X - AK, ID, OR, WA

Washington State Governor's Committee  
PO Box 9046  
Olympia, WA 98507-9046  
(206) 438-3168, (206) 438-3167 TDD  
(206) 438-4014 Fax

## ADA Technical Assistance Grants

ADA Technical Assistance Grants  
Contact: David Esquith  
MES 3424  
NIDRR  
330 C Street SW  
Washington, DC 20202-2572  
(202) 205-8801, (202) 205-5316 TDD

## Materials Development Projects

### Employment

Cornell University  
School of Industrial & Labor Relations  
106 Extension  
Ithaca, NY 14853-3901  
(607) 255-7727, (607) 255-2891 TDD  
(607) 255-2763 Fax

### Public Accommodation and Accessibility

Barrier Free Environments, Inc.  
Water Garden, Highway 70 West  
Raleigh, NC 27622  
(919) 782-7823 V/TDD  
(919) 878-1984 Fax

## National Training Projects

### Peer and Family Training Network

Parent Information Center  
151A Manchester Street  
PO Box 1422  
Concord, NH 03301  
(603) 224-7005 V/TDD  
(603) 224-4365 Fax

### Local Capacity-Building for Independent Living Centers

National Council on Independent Living  
3607 Chapel Road  
Newton Square, PA 19073  
(610) 353-6066, (610) 353-6083 TDD  
(610) 353-6753 FAX

## ADA Technical Assistance Contract

Abt Associates, Inc  
55 Wheeler Street  
Cambridge, MA 02138-1168  
(617)492-7100, (617)354-6618 TDD  
(617)492-5219 Fax

## Service Centers for Augmentative Communication and Computer Access

This list includes basic information on clinical programs that provide services in the areas of computer access for disabled persons and augmentative communication for non-vocal persons. The list is organized by state. Contact particular centers to determine if their services will suit your needs. No recommendations or endorsements are implied by inclusion on this list.

### Alabama

Augmentative Communication Service  
2430 11th Avenue North  
Birmingham, AL 35234  
(205) 251-0165

*A full time diagnostic agency specializing in augmentative communication.*

### Arizona

Children's Achievement Center  
3825 East Second Street  
Tucson, AZ 85716  
(520) 325-1517  
(520) 795-4702 (FAX)

*This center is primarily for preschool aged children with neuromuscular and developmental delays. Based on the child's needs, an individual program is devised in the areas of physical and occupational therapy, speech and language, and special education. Part of the Blake Foundation*

Upward Foundation  
6306 North Seventh Street  
Phoenix, AZ 85014  
(602) 279-5801  
(602) 279-0785 (FAX)

*Rehabilitation and educational center for young children with disabilities. Evaluations done on children with special needs: including augmentative communication.*

### California

Augmentative and Alternative Communication Assessment Program  
Los Angeles Unified School District  
c/o Widney High School  
2302 South Gramercy Place  
Los Angeles, CA 90018  
(213) 732-1976

*This program serves individuals aged 3 - 21 yrs. A full team of specialists perform evaluations, and fitting and training for equipment*

Augmentative Communication and Technology Services (A.C.T.S.)  
350 Santa Ana Ave.  
San Francisco, CA 94127-1953  
(415) 333-7739  
(415) 333-3456 (FAX)

*A community-based service delivery model, providing AAC assessment and intervention to children in the San Francisco Bay Area. Also provides training to families, staff and assists school districts in meeting the needs of students using augmentative communication and adaptive technology.*

Communication/Control Service  
Rehabilitation Engineering Center  
Children's Hospital at Stanford  
725 Welch Road  
Palo Alto, CA 94304  
(415) 497-8199  
(415) 497-8170

*Provides equipment and associated services for people with physical disabilities and/or speech impairments, including evaluations for computer access, augmentative communication systems, equipment training and consultation/therapy for schools.*

SDSU Assistive Device Assessment Program  
Clinical Training Center  
College of Human Services  
San Diego State University  
San Diego, CA 92182  
(619) 594-6151

*This organization runs tests and makes referrals covering all the bases on physical/mental disabilities and development.*

Speech, Hearing, & Neurosensory Center  
Speech-Language Pathology Department  
Children's Hospital & Health Center  
3020 Children's Way  
San Diego, CA 92123  
(619) 576-5837

*Speech, language, and voice evaluation and treatment for all disorders, aural rehabilitation, and augmentative communication.*

## Appendix B-7: Service Centers for Augmentative Communication and Computer Access

Technical Resource and Activity Center of Stockton  
510 Magnolia St.  
Stockton, CA 95202  
(209) 948-3971  
(209) 948-3805

*Provides assistive technology services to individuals who are served by the regional centers. Services include: assessment of AAC, environmental control and access, adaptive computer access, work access and control, seating, positioning and mobility needs, wheelchair repair and modification, instruction and information and referral services.*

UCLA Intervention Program  
23-10 Rehabilitation Center  
1000 Veteran Avenue  
Los Angeles, CA 90024  
(310) 825-4821

*This program works with young children (18 mo. - 5 yrs.) who have either physical or mental disabilities. A team of specialists work in all rehabilitation areas including computer instruction.*

### Colorado

Assistive Technology Clinics  
The Children's Hospital  
1056 East 19th Avenue, B-410  
Denver, CO 80218  
(303) 861-6250

*Perform evaluations and provides augmentative communication, learning enhancement training therapy and mobility training. Evaluations in the areas of seating, positioning and mobility, environmental control units, access, augmentative communication and learning enhancement.*

Communication Enhancement Center  
Boulder Community Hospital  
Mapleton Center for Rehabilitation  
311 Mapleton Avenue - PO Box 9130  
Boulder, CO 80301  
(303) 441-0230  
(303) 443-0561

*This medical center accepts inpatients and outpatients: deals with disabilities caused through physical and disease related injury (i.e. head trauma, stroke, and spinal cord injury).*

Fitzsimmons Army Medical Center  
Speech Language Rehabilitation Section  
Otolaryngology Service  
Peoria & Colfax  
Aurora, CO 80045-5001  
(303) 361-8120

*Provides diagnostic and treatment services to all ages. Services include rehabilitation engineering.*

Poudre Valley Hospital  
1024 Lemay Avenue  
Fort Collins, CO 80524  
(303) 495-7000

*Provides diagnostic services to all ages*

### Connecticut

Adaptive Technology Laboratory (ATL)  
Southern Connecticut State University  
Engleman Hall, Room 5  
501 Crescent Street  
New Haven, CT 06515  
(203) 392-5799

*Conducts service and education programs on adaptive technology for persons with learning, visual, and physical disabilities. Conducts computer access evaluations and training of persons with disabilities.*

### District of Columbia

National Rehabilitation Hospital  
102 Irving St., NW  
Washington, DC 20010-2949  
(202) 877-1440  
(202) 291-2836 (FAX)

*Offers evaluations and treatments to adults with brain injury, stroke, geriatric-related conditions and other neurologic conditions. Services are provided on either an inpatient or outpatient basis.*

### Florida

Assistive Technology Educational Network of Florida  
434 N. Tampa Avenue  
Orlando, FL 32805  
(407) 849-3504  
(800) 328-3678 (in state)

*Statewide center serving students ages 3 - 21 with assistive technology needs. Services include resource lab, loan library, training, and technical support.*

Florida Diagnostic and Learning Resources Services (FDLRS)  
5555 SW 93th Avenue  
Miami, FL 33165  
(305) 274-3501

*Offers evaluation for adaptive computer access and augmentative communication for Exception Education Students, inservice training, public domain copying, and computer information resources.*

### Illinois

Alan J. Brown Center for Alternative Communication &  
Environmental Control  
Rehabilitation Institute of Chicago  
345 East Superior Street, Room 980  
Chicago, IL 60611  
(312) 908-2556

*Center for augmentative communication, computer access, ECUs, and adapted toys. Offers evaluation, training, courses, and tutorials.*

Du Page Easter Seal Rosalie Dold Center for Children  
830 S. Addison Ave.  
Villa Park, IL 60181  
(708) 620-4433

*The center specializes in the use of personal computers in therapy with children ages 0 - 3.*

## Appendix B-7: Service Centers for Augmentative Communication and Computer Access

### Infinitec

United Cerebral Palsy Association of Greater Chicago  
155 N. Wacker Drive  
Chicago, IL 60606  
(312) 368-0380

*Functions include. assistive technology exhibits, community service, communication devices, library and resource center, policy area, product testing and evaluation, and technology exchange network. Resource for manufacturers, service providers, rehab professionals, technology suppliers, payer sources, and people with disabilities.*

Institute on Disability - Assistive Technology Unit  
University Affiliated Program  
University of Illinois at Chicago (M/C 627)  
1640 W. Roosevelt Rd, Room 412  
Chicago, IL 60608-1396  
(312) 413-1555  
(312) 413-0453 (TDD)

*Provides evaluation and fabrication services in home, school, office and manufacturing settings. Services provided in seating, positioning, mobility; environmental control; computer access; and augmentative communication.*

State of Illinois Mental Health and Developmental Center,  
Rehabilitation Services  
c/o Speech/Hearing Dept.  
1000 North Main Street  
Anna, IL 62906  
(618) 833-5161

*Inpatient services only. Screening, evaluations, speech/language therapy, and audiology services.*

### Indiana

Fort Wayne State Hospital & Training Center  
Speech and Hearing Department  
4900 St. Joe Road  
Ft. Wayne, IN 46835  
(219) 485-7554, ext. 647

*This department deals with augmentative communication use with MR/DD clients.*

Porter County Special Education Coop.  
750 Ransom Road  
Valparaiso, IN 46383  
(219) 464-9607

*Provides diagnostic evaluations for students in the area of speech and language, including augmentative communication.*

Rehabilitation Technology Centers  
615 North Michigan St.  
South Bend, IN 46601  
(219) 284-7134  
(219) 284-3259

*The centers work with seating/positioning, augmentative communication, environmental modifications, computer access, job/home evaluations, ADA consultation. Centers are also located in Indianapolis: (317) 845-3408, and Fort Wayne: (219) 471-5109.*

### Kansas

Augmentative Communication Program  
Heartspring  
2400 Jardine Drive  
Wichita, KS 67219  
(316) 262-8271  
(800) 835-1043

*Assessments, consultation, and treatment.*

The Capper Foundation  
T.M. Murrell Assistive Technology Center  
3500 S.W. 10th Avenue  
Topeka, KS 66604-1995  
(913) 272-4060

*Provides resource, evaluation, consultation and training services in a number of areas including augmentative communication, computer access, positioning, environmental control, educational technology, recreation and leisure, vocational assistance, and adaptive engineering. Also capable of loaning equipment. Outreach team will travel to any location in Midwest.*

### Kentucky

Redwood School and Rehabilitation Center  
71 Orphanage Road  
Fort Mitchell, KY 41017  
(606) 331-0880

*A diagnostic center serving people with multiple disabilities. Serves preschool through adult.*

### Louisiana

LSU Medical Center  
Louisiana State University  
Dept. of Communicative Disorders  
New Orleans, LA 70112  
(504) 568-4337  
(504) 568-4348

*Clinical assessment, evaluations, and therapy are provided in audiology, speech/language services, and augmentative communication. Hearing aid dispensing.*

### Maryland

Kennedy Krieger Institute  
707 North Broadway  
Baltimore, MD 21205  
(410) 550-9400  
(800) 873-3377

*Regional and national resource center that evaluates, diagnoses, and treats children and adolescents with disorders of the brain and helps them participate as fully as possible in family, school, and community life. Program settings include inpatient, outpatient, day hospital, home health, school and community services. Offers services to youngsters with Head Injuries, Pediatric Feeding Disorders, Metabolic and Degenerative Diseases, Cerebral Palsy, and Neurobehavioral problems.*

Maryland Rehabilitation Center  
2301 Argonne Drive  
Baltimore, MD 21218  
(410) 554-3000

*Provides evaluation of computer applications best suited for enhancing a disabled person's vocation. Acts as a diagnostic resource center in setting disabled students' vocational goals.*

United Cerebral Palsy of Central Maryland  
18 Delrey Avenue  
Catonsville, MD 21228  
(410) 744-3151

*Evaluations for augmentative communication.*

## Appendix B-7: Service Centers for Augmentative Communication and Computer Access

### Massachusetts

Adaptive Design  
c/o Massachusetts Hospital School  
3 Randolph Street, Box 09  
Canton, MA 02021  
(617) 828-2440

*Provide augmentative communication and other adaptive device services to the Hospital School and to other schools in the state.*

Communication Enhancement Center  
Children's Hospital  
300 Longwood Avenue  
Boston, MA 02115  
(617) 355-6466  
(617) 355-6486

*Evaluations for augmentative communication and writing systems. Clients include non-vocal people and those with physical disabilities. Also, evaluations to increase an individual's educational/vocational success via use of computer software and hardware.*

Franciscan Children's Hospital and Rehabilitation Center  
30 Warren Street  
Brighton, MA 02135  
(617) 254-3800

*Utilizes and provides instruction in the use of computer-based technology to enhance learning, leisure, communication, prevocational skill development, independent living, and environmental control.*

Project Tech  
Massachusetts Easter Seal Society  
484 Main Street, 6th Floor  
Worcester, MA 01608  
(508) 757-2756

*Provides assistive technology services to children and adults with disabilities in Massachusetts. TechTalk provides augmentative communication evaluations, consultations, inservice training, and direct treatment. AssisTech provides computer access solutions.*

Synergy-Adaptive Technology Services  
68 Hale Road  
East Walpole, MA 02032  
(508) 668-7424  
*Clinical assessment, evaluation, and training for adaptive equipment. Also offers customized integrated systems for communication, computer access, and/or environmental controls.*

### Michigan

Assistive Technology Resource Center  
Riley Center  
9601 Vine  
Allen Park, MI 48101  
(313) 928-0841  
(313) 928-0408

*This center provides a variety of services in augmentative and alternative communication and assistive technology to the school districts in Wayne County.*

Communication Enhancement Center  
Oakland Schools  
2100 Pontiac Lake Road  
Waterford, MI 48328  
(810) 858-1901

*Augmentative/alternative communication services, including evaluations. Demonstration center for technology and materials.*

Mott Children's Health Center  
806 Tauri Place  
Flint, MI 48503  
(810) 767-5750  
*Speech therapy and evaluations for school aged children.*

### Minnesota

Courage Center  
3915 Golden Valley Road  
Golden Valley, MN 55422  
(612) 520-0520  
*Variety of rehabilitation programs for children and adults, including computer access, augmentative communication, speech/language therapy, and occupational and physical therapy. Compuplay computer classes and Lekotek toy lending library also available. Physiatry services are also available. Evaluations given.*

Rum River Special Education Cooperative  
315 17th Lane NE  
Cambridge, MN 55008  
(612) 689-3600  
*Seven-member school district provides services/consultants for disabled students within three counties. Includes augmentative communication services.*

Tamarack Habilitation Technologies, Inc.  
1471 Energy Park Drive  
St. Paul, MN 55108  
(612) 644-9950  
(612) 644-0240 (FAX)  
*Sometimes provides services for augmentative communication, control and computer access in coordination with other access and rehabilitation issues. Primary services are orthotics, prosthetics, and custom seating.*

United Cerebral Palsy of Minnesota, Inc.  
1821 University Avenue  
Suite 286  
St. Paul, MN 55104-3064  
(612) 646-7588  
(800) 328-4827 ext. 1437  
*No evaluations, but operates a four week loan bank of communication equipment for professionals in the area to allow assessment of the appropriateness of a device for a client.*

### Montana

Adaptive Computer and Communication Technology Program (ACCT)  
The Rehabilitation Institute  
3011 Baltimore  
Kansas City, MO 64108  
(816) 756-2250 ext. 247  
*Services include, but are not limited to: interdisciplinary team evaluations, technology training assistance in locating funding, comprehensive reports and information services regarding adaptive equipment.*

Augmentative Communication Evaluation Program  
Children's Mercy Hospital  
2401 Gillham Road  
Kansas City, MO 64108-9898  
(816) 346-1300  
*Offers clinical assessment and evaluation for augmentative communication to patients whose speech is temporarily or permanently inadequate to meet their communication needs.*

847

## Appendix B-7: Service Centers for Augmentative Communication and Computer Access

SSM Outpatient Rehab Center  
350 Village Square Drive  
Hazelwood, MO 63042  
(314) 731-4555  
(800) 258-8988 (for MO and IL)

*A rehab center that provides services in physical, occupational, and communication therapy. Provides an augmentative communication clinic for both children and adults who have difficulty verbally communicating.*

### Nebraska

Barkley Speech-Language and Hearing Clinic  
253 Barkley Memorial Center  
University of Nebraska-Lincoln  
Lincoln, NE 68583  
(402) 472-5459

*Evaluations for augmentative communication: speech/language therapy. Emphasis on academic and psychological concerns. The center mainly accepts local referrals.*

Hattie B. Munroe Augmentative Communication Center  
University of Nebraska Medical Center  
600 South 42nd Street  
Omaha, NE 68198-5450  
(402) 559-6460

*Provides services relating to augmentative communication, speech and computer access.*

### New Hampshire

Communication Disorders Program  
Crotched Mountain Rehabilitation Center  
1 Verney Drive  
Greenfield, NH 03047  
(603) 547-3311

*Offers services in augmentative communication. Individuals 18-44 with brain injury are served through the Adult Brain Injury Program; Children/young adults (ages 6-22) through the Crotched Mountain Preparatory School and Rehabilitation Center.*

### New Jersey

Augmentative Communication Services  
Children's Specialized Hospital  
150 New Providence Road  
Mountainside, NJ 07092-2590  
(908) 233-3720 ext.250  
(908) 233-3720 ext.339

*Operates as a component of the Rehabilitation Technology Department. It offers team evaluations to children and adults needing AAC services. Services are available on an inpatient or outpatient basis. Outpatient services are open to both children and adults*

Cerebral Palsy Association of Middlesex County  
Oak Drive, Roosevelt Park  
Edison, NJ 08837  
(908) 549-6187

*Comprehensive program that operates a private school, adult programs and an infant program. It also offers augmentative communication and seating assessment.*

Communication Resource Center  
Office of Education, Department of Human Services  
10 Quakerbridge Plaza  
CN 710  
Trenton, NJ 08625  
(609) 588-3157

*This center provides clinical assessment and evaluation for augmentative devices. It also has the ability to loan devices for trial periods.*

### New Mexico

NMSU Speech and Hearing Center  
New Mexico State University  
PO Box 3001, Dept. 3SP  
Las Cruces, NM 88001  
(505) 646-2402

*Speech and hearing center. Performs evaluations for augmentative communication devices.*

### New York

Adaptive Living  
2 Charles Street  
P.O. Box 60857  
Rochester, NY 14608-1717  
(716) 235-7270  
(716) 458-5455

*Rehabilitation engineering practice that offers evaluations, consultations, accessibility audits, retail services, installation and training, design/fabrication, and seminars. Serves people with disabilities, health and vocational professionals, educators, businesses, and others.*

Assistive Technology Dept.  
Enable  
1603 Court Street  
Syracuse, NY 13208  
(315) 455-7591

*Evaluations for augmentative communication and computer access.*

Augmentative Communication Center/Program  
Queen's College, CAS  
65-30 Kissena Boulevard  
Flushing, NY 11367  
(718) 520-7358

*Evaluations and treatment for augmentative communication, speech/language therapy, graduate education program, SLP.*

SUNY-Buffalo Department of Occupational Therapy  
515 Stockton Kimball Tower  
State University of New York - Buffalo  
Buffalo, NY 14214  
(716) 831-3141

*Provides services to people with physical and cognitive disabilities to enable them to return to work. Includes assessments for computer adaptation.*

The Gibraltar A.C.C.  
Assistive Communication Center  
UCPA of WNY, INC  
4635 Union Road (children)-or-7 Community Drive (adult)  
Buffalo, NY 14225  
(716) 633-4448 (children)  
(716) 894-0139 (adult)

*This center offers services to non-speaking children and adults: including assessment, training, and follow-up. It also acts as a referral to other sources of assistance.*



## Appendix B-7: Service Centers for Augmentative Communication and Computer Access

### North Carolina

Clinical Center for the Study of Development and Learning  
CB #7255, Biological Science Research Center  
University of North Carolina at Chapel Hill  
Chapel Hill, NC 27599-7255  
(919) 966-5171 (clinic)

*National diagnostic and treatment center. Provides evaluations in many areas, including augmentative communication.*

### Oregon

Good Samaritan Hospital  
1015 N.W. 22nd Avenue  
Portland, OR 97210  
(503) 229-7711

*Many diagnostic programs offered. Evaluations and computer access.*

### Pennsylvania

IMPART Services  
United Cerebral Palsy of the Capital Area  
925 Linda Lane  
Camp Hill, PA 17011  
(717) 737-3477

*IMPART Services (Independence, Mobility, and Productivity through Applied Rehabilitation Technology) provides evaluations and recommendations to enable persons with disabilities to be independent through the use of technology. Evaluations and follow-up training are provided in the person's home or other appropriate locations.*

Pennsylvania Technology Program (PennTECH)  
6340 Flank Drive  
Suite 600  
Harrisburg, PA 17112  
(715) 541-4960  
(800) 222-7372 (in PA only)

*Statewide program providing technical assistance, training, consultation, textbook production, and workshops pertaining to assistive technology. Purchase of assistive devices for student use.*

### Tennessee

University of Tennessee Rehabilitation Engineering Center  
682 Court Avenue  
Memphis, TN 38163  
(901) 448-6445  
(901) 448-8781 (FAX)

*Seating and communication aids for people with disabilities.*

### Texas

Callier Center for Communication Disorders  
1966 Inwood Road  
Dallas, TX 75235-7798  
(214) 883-3600

*Evaluation and therapy for people with speech and language problems. Will perform evaluations for augmentative communication devices.*

The Freedom Center  
2219 Babcock Road  
San Antonio, TX 78229  
(512) 614-7138  
(512) 614-1910

*Augmentative communication evaluations and training, plus training in other areas such as mobility, self-care, work and leisure.*

### Washington

Assistive Technology Clinic  
Dept. of Rehab. Medicine, 356490  
University of Washington Medical Center  
Seattle, WA 98195-6490  
(206) 543-3674  
(206) 534-3134

*This clinic offers services to adults, including: evaluations, prescriptions for wheelchair seating, mobility, augmentative communication, computer interfaces, and implementation in clients' environments.*

CBAT, Inc.  
140 S. Arthur  
Suite 420  
Spokane, WA 99202  
(509) 533-1409  
(800) 500-1453

*Offers client evaluation, equipment set-up and configuration, client equipment training, and follow-up. E-mail to [cbenson@cbat.com](mailto:cbenson@cbat.com).*

Children's Adaptive Technology Service (CATS)  
Children's Hospital and Medical Center  
Mail Stop CH-89  
4800 Sand Point Way NE  
Seattle, WA 98105-0371  
(206) 526-2104  
(206) 526-2190

*Services relating to adaptive technology for children and adolescents, including power mobility, positioning, augmentative communication, and computer access.*

### Wisconsin

Augmentative Alternative Communication Clinic  
Dept. of Communication Disorders  
UW-Eau Claire  
121 HSS Building  
Eau Claire, WI 54702-4004  
(715) 836-4186  
(715) 836-4846 (FAX)

*Clinical assessment and evaluation of individuals with limited ability to speak, write, keyboard, or dial. E-mail to [kingtw@v.wec.edu](mailto:kingtw@v.wec.edu).*

Center for Augmentative and Alternative Communication  
School of Communicative Disorders  
UW-Stevens Point  
Stevens Point, WI 54481  
(715) 346-3667

*Clinical assessment and intervention services for individuals requiring augmentative or alternative communication strategies.*

Cerebral Palsy, Inc.  
2801 South Webster Avenue  
Green Bay, WI 54301  
(414) 337-1122

*Offers diagnostic assessment in: toys and switches, introductory communication aides, access to adaptive computers and switch interface. Alternative and augmentative communication evaluation and training for all ages and disabilities. Training, education and technical support for families and related professionals.*

849

## Appendix B-7: Service Centers for Augmentative Communication and Computer Access

SSM Outpatient Rehab Center  
350 Village Square Drive  
Hazelwood, MO 63042  
(314) 731-4555  
(800) 258-8988 (for MO and IL)

*A rehab center that provides services in physical, occupational, and communication therapy. Provides an augmentative communication clinic for both children and adults who have difficulty verbally communicating.*

### Nebraska

Barkley Speech-Language and Hearing Clinic  
253 Barkley Memorial Center  
University of Nebraska-Lincoln  
Lincoln, NE 68583  
(402) 472-5459

*Evaluations for augmentative communication; speech/language therapy. Emphasis on academic and psychological concerns. The center mainly accepts local referrals.*

Hattie B. Munroe Augmentative Communication Center  
University of Nebraska Medical Center  
600 South 42nd Street  
Omaha, NE 68198-5450  
(402) 559-6460

*Provides services relating to augmentative communication, speech and computer access.*

### New Hampshire

Communication Disorders Program  
Crotched Mountain Rehabilitation Center  
1 Verney Drive  
Greenfield, NH 03047  
(603) 547-3311

*Offers services in augmentative communication. Individuals 18-44 with brain injury are served through the Adult Brain Injury Program; Children/young adults (ages 6-22) through the Crotched Mountain Preparatory School and Rehabilitation Center.*

### New Jersey

Augmentative Communication Services  
Children's Specialized Hospital  
150 New Providence Road  
Mountainside, NJ 07092-2590  
(908) 233-3720 ext.250  
(908) 233-3720 ext.339

*Operates as a component of the Rehabilitation Technology Department. It offers team evaluations to children and adults needing AAC services. Services are available on an inpatient or outpatient basis. Outpatient services are open to both children and adults*

Cerebral Palsy Association of Middlesex County  
Oak Drive, Roosevelt Park  
Edison, NJ 08837  
(908) 549-6187

*Comprehensive program that operates a private school, adult programs and an infant program. It also offers augmentative communication and seating assessment.*

Communication Resource Center  
Office of Education, Department of Human Services  
10 Quakerbridge Plaza  
CN 710  
Trenton, NJ 08625  
(609) 588-3157

*This center provides clinical assessment and evaluation for augmentative devices. It also has the ability to loan devices for trial periods.*

### New Mexico

NMSU Speech and Hearing Center  
New Mexico State University  
PO Box 3001, Dept. 3SP  
Las Cruces, NM 88001  
(505) 646-2402

*Speech and hearing center. Performs evaluations for augmentative communication devices.*

### New York

Adaptive Living  
2 Charles Street  
P.O. Box 60857  
Rochester, NY 14608-1717  
(716) 235-7270  
(716) 458-5455

*Rehabilitation engineering practice that offers evaluations, consultations, accessibility audits, retail services, installation and training, design/fabrication, and seminars. Serves people with disabilities, health and vocational professionals, educators, businesses, and others.*

Assistive Technology Dept.  
Enable  
1603 Court Street  
Syracuse, NY 13208  
(315) 455-7591

*Evaluations for augmentative communication and computer access.*

Augmentative Communication Center/Program  
Queen's College, CAS  
65-30 Kissena Boulevard  
Flushing, NY 11367  
(718) 520-7358

*Evaluations and treatment for augmentative communication, speech/language therapy, graduate education program, SLP.*

SUNY-Buffalo Department of Occupational Therapy  
515 Stockton Kimball Tower  
State University of New York - Buffalo  
Buffalo, NY 14214  
(716) 831-3141

*Provides services to people with physical and cognitive disabilities to enable them to return to work. Includes assessments for computer adaptation.*

The Gibraltar A.C.C.  
Assistive Communication Center  
UCPA of WNY, INC  
4635 Union Road (children)-or-7 Community Drive (adult)  
Buffalo, NY 14225  
(716) 633-4448 (children)  
(716) 894-0139 (adult)

*This center offers services to non-speaking children and adults: including assessment, training, and follow-up. It also acts as a referral to other sources of assistance.*

## Appendix B-7: Service Centers for Augmentative Communication and Computer Access

### North Carolina

Clinical Center for the Study of Development and Learning  
CB #7255, Biological Science Research Center  
University of North Carolina at Chapel Hill  
Chapel Hill, NC 27599-7255  
(919) 966-5171 (clinic)

*National diagnostic and treatment center. Provides evaluations in many areas, including augmentative communication.*

### Oregon

Good Samaritan Hospital  
1015 N.W. 22nd Avenue  
Portland, OR 97210  
(503) 229-7711

*Many diagnostic programs offered. Evaluations and computer access.*

### Pennsylvania

IMPART Services  
United Cerebral Palsy of the Capital Area  
925 Linda Lane  
Camp Hill, PA 17011  
(717) 737-3477

*IMPART Services (Independence, Mobility, and Productivity through Applied Rehabilitation Technology) provides evaluations and recommendations to enable persons with disabilities to be independent through the use of technology. Evaluations and follow-up training are provided in the person's home or other appropriate locations.*

Pennsylvania Technology Program (PennTECH)  
6340 Flank Drive  
Suite 600  
Harrisburg, PA 17112  
(715) 541-4960  
(800) 222-7372 (in PA only)

*Statewide program providing technical assistance, training, consultation, textbook production, and workshops pertaining to assistive technology. Purchase of assistive devices for student use.*

### Tennessee

University of Tennessee Rehabilitation Engineering Center  
682 Court Avenue  
Memphis, TN 38163  
(901) 448-6445  
(901) 448-8781 (FAX)

*Seating and communication aids for people with disabilities.*

### Texas

Callie Center for Communication Disorders  
1900 Inwood Road  
Dallas, TX 75235-7798  
(214) 883-3000

*Evaluation and therapy for people with speech and language problems. Will perform evaluations for augmentative communication devices.*

The Freedom Center  
2219 Babcock Road  
San Antonio, TX 78229  
(512) 614-7338  
(512) 614-1910

*Augmentative communication evaluations and training, plus training in other areas such as mobility, self-care, work and leisure.*

### Washington

Assistive Technology Clinic  
Dept. of Rehab. Medicine, 356490  
University of Washington Medical Center  
Seattle, WA 98195-6490  
(206) 543-3674  
(206) 534-3134

*This clinic offers services to adults, including: evaluations, prescriptions for wheelchair seating, mobility, augmentative communication, computer interfaces, and implementation in clients' environments.*

CBAT, Inc.  
140 S. Arthur  
Suite 420  
Spokane, WA 99202  
(509) 533-1409  
(800) 500-1453

*Offers client evaluation, equipment set-up and configuration, client equipment training, and follow-up. E-mail to cbenson@cbat.com.*

Children's Adaptive Technology Service (CATS)  
Children's Hospital and Medical Center  
Mail Stop CH-89  
4800 Sand Point Way NE  
Seattle, WA 98105-0371  
(206) 526-2104  
(206) 526-2190

*Services relating to adaptive technology for children and adolescents, including power mobility, positioning, augmentative communication, and computer access.*

### Wisconsin

Augmentative Alternative Communication Clinic  
Dept. of Communication Disorders  
UW-Eau Claire  
121 HSS Building  
Eau Claire, WI 54702-4004  
(715) 836-4186  
(715) 836-4846 (FAX)

*Clinical assessment and evaluation of individuals with limited ability to speak, write, keyboard, or dial. E-mail to kingtw@uwec.edu.*

Center for Augmentative and Alternative Communication  
School of Communicative Disorders  
UW-Stevens Point  
Stevens Point, WI 54481  
(715) 346-3667

*Clinical assessment and intervention services for individuals requiring augmentative or alternative communication strategies.*

Cerebral Palsy, Inc.  
2801 South Webster Avenue  
Green Bay, WI 54301  
(414) 337-1122

*Offers diagnostic assessment in: toys and switches, introductory communication aides, access to adaptive computers and switch interface. Alternative and augmentative communication evaluation and training for all ages and disabilities. Training, education and technical support for families and related professionals.*

## Appendix B-7: Service Centers for Augmentative Communication and Computer Access

Communication Aids and Systems Clinic  
Trace Center  
S-121 Waisman Center  
1500 Highland Avenue  
Madison, WI 53705  
(608) 263-2522

*Multi-disciplinary team provides evaluations, treatment and consultative services for individuals of all ages who need augmentative communication systems, computer access or writing in a totally integrated system.*

Curative Rehabilitation Services  
1000 North 92nd Street  
Milwaukee, WI 53226  
(414) 259-1414

*Offers diagnostic assessment in a variety of areas, including augmentative communication, computer access and environmental control.*

Enabling Technology  
Sacred Heart Hospital  
900 W. Clairmont Ave.  
Eau Claire, WI 54701  
(715) 839-4365

*Provides interdisciplinary evaluation and training services for enabling technologies. Environmental control, seating and positioning, augmentative communication systems, switch activation, and computer access are addressed.*

Independent Living Program  
Curative Rehabilitation Center  
2900 Curry Lane  
P.O. Box 8027  
Green Bay, WI 54308  
(414) 468-1161 ext. 132

*Provides services relating to the fitting and positioning of computer access devices to individuals sixteen years of age or older in Northeastern Wisconsin and the Fox Valley. Also works for funding advocacy. Site for WisTech and WisTech Tryout.*

Marshfield Clinic  
Speech Pathology Dept.  
1000 N. Oak St.  
Marshfield, WI 54449  
(715) 387-5128

*Provides services in augmentative communication and computer access.*

Trace Center Communication Development Program  
S-157 Waisman Center  
1500 Highland Avenue  
Madison, WI 53705  
(608) 262-6966

*Provides community based services in augmentative communication for preschool-aged and adult individuals living in Dane County, Wis.*

### Canada

Bloorview Children's Hospital  
25 Buchan Court  
Willowdale, ON M2J 4S9  
CANADA  
(416) 494-2222

*A civic care facility for children and young adults with multiple disabilities. On site clinic for evaluation and prescription of augmentative devices, as well as addressing issues of computer access.*

Gorge Road Hospital  
63 Gorge Road East  
Victoria, BC V9A 1L2  
CANADA  
(604) 386-2464

*Adult extended care and rehabilitation hospital. Offers speech/language therapy and occupational therapy to disabled adults. Also provides assessment and training for computer access, environmental controls and some augmentative communication.*

The Hugh MacMillan Rehabilitation Centre  
350 Rumsey Road  
Toronto, ON M4G 1R8  
CANADA  
(416) 424-3805

*Two main programs offered. The Adaptive Communication Program provides services which include assessment and training for augmentative communication devices. The Microcomputer Applications Program is a research and development group that develops ways for people with disabilities to access and use computer systems.*

The Kinsman Rehabilitation Foundation of British Columbia  
Technology for Independent Living Division  
2256 West 12th Avenue  
Vancouver, BC V6K 4L2  
CANADA  
(604) 736-8841  
(606) 738-0015 (FAX)

*Provides augmentative communication systems and environmental control systems for people with severe physical disabilities. Also Technology Consulting Services.*

Technical Resource Centre  
200, 1201 - 5th Street SW  
Calgary, AB T2R 0Y6  
CANADA  
(403) 262-9445  
(403) 262-4539 (FAX)

*Does assessments and provides technical aids to help persons with disabilities better realize educational, vocational, social, and independent living potentials. Consults on the selection, operation, and application of aids. Equipment is loaned for trial use and assessment. Educates professionals. Maintains computerized library of information.*

## Technology-Related Assistance for Persons with Disabilities Act: State Programs

These federally funded state programs were created to help people overcome barriers when seeking technology related assistance. Different states have different programs in effect, including such things as support networks, information and demonstration centers, and loan banks.

### Alabama

Alabama STAR System for Alabamians with Disabilities  
2125 East South Boulevard  
P.O. Box 20752  
Montgomery, AL 36120-0752  
(205) 288-0240  
(205) 281-2276 (TDD)

### Alaska

Assistive Technologies of Alaska  
701 East Tudor Road  
Suite 280  
Anchorage, AK 99503-7445  
(800) 770-0138  
(907) 563-0146 (FAX)

### American Samoa

American Samoa Assistive Technology Act Project  
Division of Vocational Rehabilitation  
Department of Human Resources  
Pago Pago, 96799  
American Samoa  
(684) 633-2336  
(684) 233-7874 (TDD)

### Arizona

Arizona Technology Access Program (AzTAP)  
2600 North Wyatt Drive  
2nd Floor  
Tucson, AZ 85712  
(602) 324-3170  
(602) 324-3177 (TDD)

### Arkansas

Arkansas Increasing Capabilities Access Network (ICAN)  
2201 Brookwood, Suite 117  
Little Rock, AR 72202  
(501) 666-8868  
(800) 828-2799 (in state)

### California

California Assistive Technology System (CATS)  
California Department of Rehabilitation  
Independent Living Division  
830 K Street  
Sacramento, CA 95814  
(916) 327-3967  
(916) 324-7386 (FAX)

### Colorado

Colorado Assistive Technology Project  
Rocky Mountain Resource and Training Institute  
6355 Ward Rd, Suite 310  
Arvada, CO 80004  
(303) 420-2942  
(303) 420-8675 (FAX)

### Connecticut

Connecticut Assistive Technology Project  
Bureau of Rehabilitation Services  
10 Griffin Rd N  
Windsor, CT 06095  
(203) 298-2042  
(203) 298-2018 (TDD)

### Delaware

Delaware Assistive Technology Initiative  
Applied Science and Engineering Laboratories  
University of Delaware/A.I. duPont Institute  
1600 Rockland Rd, Rm 154  
Wilmington, DE 19899  
(302) 651-6970  
(302) 651-6794 (TDD)

### District of Columbia

District of Columbia Partnership for Assistive Technology  
801 Pennsylvania Avenue, SE  
Suite 210  
Washington, DC 20003  
(202) 546-9164  
(202) 546-9168 (TDD)

**Florida**

Florida Alliance for Assistive Services and Technology  
2002-A Old St. Augustine Road  
Tallahassee, FL 32399-0696  
(904) 487-3278 (phone/TDD)  
(904) 488-8062 (FAX)

**Georgia**

Georgia Tools for Life  
Division of Rehabilitation Services  
2 Peachtree St NW, Suite 23-411  
Atlanta, GA 30303  
(800) 726-9119  
(404) 657-3085 (TDD)

**Hawaii**

Hawaii Assistive Technology Training & Service Project  
677 Ala Moana Boulevard, Suite 403  
Honolulu, HI 96813  
(808) 532-7110 (phone/TDD)  
(808) 532-7120 (FAX)

**Idaho**

Idaho Assistive Technology Project  
129 W Third St  
Moscow, ID 83843  
(208) 885-3630  
(208) 885-3621 (TDD)

**Illinois**

Illinois Assistive Technology Project  
110 Iles Park Place  
Springfield, IL 62718  
(217) 522-7985 (voice/TDD)  
(800) 852-5100 (in state)

**Indiana**

Indiana ATTAIN Project  
Indiana Family and Social Services Administration  
Division of Aging and Rehabilitation Services  
402 W Washington St, Rm W453, PO Box 7083  
Indianapolis, IN 46207-7083  
(800) 545-7763  
(317) 232-6478 (FAX)

**Iowa**

Iowa Program for Assistive Technology (IPAT)  
Iowa University Affiliated Program  
University Hospital School  
Iowa City, IA 52242-1011  
(800) 331-3027 (phone/TDD)  
(319) 356-8284 (FAX)

**Kansas**

Assistive Technology for Kansas Project  
2601 Gabriel  
P.O. Box 738  
Parsons, KS 67357  
(316) 421-8367  
(316) 421-0954 (FAX/TDD)

**Kentucky**

Kentucky Assistive technology Services (KATS) Network  
427 Versailles Rd  
Frankfort, KY 40601  
(502) 573-4665 (phone/TDD)  
(800) 327-5287 (in state)

**Louisiana**

Louisiana Assistive Technology Project  
PO Box 3455, Bin #14  
Baton Rouge, LA 70821-3455  
(504) 342-8821  
(800) 922-3425

**Maine**

Maine CITE Coordinating Center  
Education Network of Maine  
46 University Drive  
Augusta, ME 04330  
(207) 621-3195 (phone/TDD)  
(207) 621-3193 (FAX)

**Mariana Islands**

Northern Mariana Islands Assistive Technology Project  
Governor's Developmental Disabilities Council  
P.O. Box 2565  
Saipan, MP 96950  
(670) 322-3014 (phone/TDD)  
(670) 322-4168 (FAX)

**Maryland**

Maryland Technology Assistance Project (TAP)  
Governor's Office for Handicapped Individuals  
300 W Lexington St, Box 10  
Baltimore, MD 21201  
(800) TECH-TAP  
(410) 333-6674 (FAX)

**Massachusetts**

Massachusetts Assistive Technology Partnership (MATP) Center  
MATP Center, Children's Hospital  
1295 Boylston Street  
Suite 310  
Boston, MA 02215  
(617) 735-7153  
(617) 735-6345 (FAX)

**Michigan**

Michigan TECH 2000 Project  
Michigan Rehabilitation Services/TECH 2000  
P.O. Box 30010  
Lansing, MI 48909-7510  
(517) 335-6874  
(517) 373-4035 (TDD)

**Minnesota**

Minnesota STAR Program  
300 Centennial Building  
658 Cedar St  
St Paul, MN 55155  
(800) 331-3027 (phone/TDD)  
(612) 282-6671 (FAX)

## Appendix B-B: Technology-Related Assistance Act: State Programs

---

### Missouri

Missouri Assistive Technology Project  
4731 South Cochise  
Suite 114  
Independence, MO 64055-6975  
(816) 373-5193  
(800) 647-8557 (in state)

### Mississippi

Mississippi Project START  
P.O. Box 1000  
Jackson, MS 39205-1000  
(601) 987-4872 (phone/TDD)  
(601) 364-2349 (FAX)

### Montana

MonTECH  
University of Montana, MUARID  
634 Eddy Ave  
Missoula, MT 59812  
(406) 243-5676  
(800) 732-0323 (TDD)

### Nebraska

Nebraska Assistive Technology Project  
301 Centennial Mall South  
PO Box 94987  
Lincoln, NE 68509-4987  
(402) 471-3647  
(402) 471-0117 (FAX)

### Nevada

Nevada Assistive Technology Collaborative  
Rehabilitation Division, Community-Based Services Development  
711 South Stewart St  
Carson City, NV 89710  
(702) 687-4452  
(702) 687-3388 (TDD)

### New Hampshire

New Hampshire Technology Partnership Project  
Institute on Disability  
#14, Ten Ferry St  
The Concord Center  
Concord, NH 00301  
(603) 244-0630 (phone/TDD)  
(603) 226-0389 (FAX)

### New Jersey

New Jersey Technology Assistive Resource Program  
135 East State Street  
CN 398  
Trenton, NJ 08625  
(609) 633-6959  
(800) 382-7765 (TDD)

### New Mexico

New Mexico Technology Assistance Program (NMTAP)  
435 St. Michael Dr, Bldg D  
Santa Fe, NM 87503  
(800) 866-2253 (phone/TDD)  
(505) 827-3746 (FAX)

### New York

New York State TRIAD Project  
NYS Office of Advocate for Persons with Disabilities  
One Empire State Plaza, Suite 1001  
Albany, NY 12223-1150  
(518) 474-2825  
(518) 473-4231 (TDD)

### North Carolina

North Carolina Assistive Technology Project  
Division of Vocational Rehabilitation Services  
1110 Navaho Dr, Suite 101  
Raleigh, NC 27609  
(919) 850-2787 (phone/TDD)  
(800) 852-0042

### North Dakota

North Dakota Interagency Program for Assistive Technology  
P.O. Box 743  
Cavalier, ND 58220  
(701) 265-4807 (phone/TDD)  
(701) 265-3150 (FAX)

### Ohio

Ohio T.R.A.I.N  
Ohio Super Computer Center  
1224 Kinnear Road  
Columbus, OH 43212  
(614) 292-2426 (phone/TDD)  
(800) 784-3425 (in-state)

### Oklahoma

Oklahoma ABLE Tech  
Oklahoma State University  
Wellness Center  
1514 W. Hall of Fame  
Oklahoma City, OK 74078-0618  
(800) 316-4119  
(405) 744-5511 (TDD)

### Oregon

Oregon TALN Project  
Chemeketa Community College, TALN Center  
4000 Lancaster Dr NE  
P.O. Box 14007  
Salem, OR 97309-7070  
(503) 399-4950 (phone/TDD)  
(503) 399-6978 (FAX)

### Pennsylvania

Pennsylvania's Initiative on Assistive Technology (PIAT)  
Institute on Disabilities/UAP  
Ritter Annex 433 (004-00)  
Temple University  
Philadelphia, PA 19122  
(215) 204-1356 (phone/TDD)  
(215) 204-9371 (FAX)

855

**Puerto Rico**

Puerto Rico Assistive Technology Project  
 University of Puerto Rico, Medical Sciences  
 College of Related Health Professions - Communication  
 Box 365667  
 San Juan, PR 00936  
 (800) 496-6035 (from US)  
 (800) 981-6033 (in PR)

**Rhode Island**

Rhode Island Assistive Technology Access Project  
 Rhode Island Department of Human Services  
 Office of Rehabilitation Services  
 40 Fountain St  
 Providence, RI 02903-1898  
 (401) 421-7005  
 (800) 752-8038 ext. 2608 (in state)

**South Carolina**

South Carolina Assistive Technology Project  
 Vocational Rehabilitation Department  
 PO Box 15  
 1410-C Boston Ave  
 West Columbia, SC 29171-0015  
 (803) 822-5404 (phone/TDD)  
 (803) 822-4301 (FAX)

**South Dakota**

DakotaLink  
 1925 Plaza Boulevard  
 Rapid City, SD 57702  
 (605) 394-1876  
 (800) 645-0673 (in state)

**Tennessee**

Tennessee Technology Access Project (TTAP)  
 710 James Robertson Parkway  
 Gateway Plaza, 11th Floor  
 Nashville, TN 37243-0675  
 (615) 532-6530  
 (800) 732-5059 (in state)

**Texas**

Texas Assistive Technology Partnership  
 University of Texas at Austin  
 Department of Special Education  
 EDB 306  
 Austin, TX 78712  
 (800) 828-7839  
 (512) 471-1844 (TDD)

**Utah**

Utah Assistive Technology Program  
 Utah State University  
 Center for Persons with Disabilities  
 UMC 6855  
 Logan, UT 84322-6855  
 (800) 333-UTAH (phone/TDD)  
 (801) 797-1982

**Virginia**

Virginia Assistive Technology System (VATS)  
 8004 Franklin Farms Drive  
 P.O. Box K-300  
 Richmond, VA 23288-0300  
 (804) 662-9993  
 (804) 662-9990 (TDD)

**Vermont**

Vermont Assistive Technology Program  
 103 South Mains Street  
 Weeks Building, First Floor  
 Waterbury, VT 05671-2305  
 (802) 241-2620 (phone/TDD)  
 (802) 241-3052 (FAX)

**Washington**

Washington Assistive Technology Alliance  
 DSHS/DVR  
 PO Box 45340  
 Olympia, WA 98504-5340  
 (800) 637-5627  
 (360) 438-8644 (TDD)

**Wisconsin**

Wisconsin Assistive Technology Program (WisTech)  
 Division of Vocational Rehabilitation  
 P.O. Box 7852  
 1 West Wilson, Room 950  
 Madison, WI 53707-7852  
 (608) 266-5395  
 (608) 266-9599 (TDD)

**West Virginia**

West Virginia Assistive Technology System: (WVATS)  
 Division of Rehabilitation Services  
 P.O. Box 50890, State Capitol  
 Charleston, WV 25305-0890  
 (800) 841-8436  
 (304) 253-4692 (TDD)

**Wyoming**

Wyoming's New Options in Technology (WYNOT)  
 Division of Vocational Rehabilitation  
 1100 Herschler Building  
 Cheyenne, WY 82002  
 (307) 777-7450  
 (306) 777-5939 (FAX)



## Training Programs in Technology for Special Education

This list contains information on both degree programs and workshops or other training opportunities in the area of computer applications for disabled persons. No recommendations or endorsements are implied by inclusion on this list. Contact each resource for more specific and up-to-date information.

ACTT Outreach (Activating Children Through Technology)  
27 Horrabin Hall  
Western Illinois University  
Macomb, IL 61455  
(309) 298-1014

*Training is offered to early childhood professionals and families which encourages the integration of technology in the pre-school curriculum. ACTT has developed a curriculum for ages birth-6 which utilize computers and special peripherals for communication and other skills. The training programs can be taken for graduate credit if desired.*

Augmentative Communication Program  
Speech and Audiology Department  
Fernald State School  
Box 9108  
Belmont, MA 02178  
(617) 894-3600 ext. 2283

*Offers augmentative communication consultations and inservice training to speech clinicians or other staff serving individuals with mental retardation within the Metropolitan Boston area. Referrals are made through the Massachusetts Dep. of Mental Retardation service coordinators or by contacting the coordinator at the above number.*

Carroll Center for the Blind  
70 Centre Street  
Newton, MA 02158  
(617) 969-6200

*Various publications and rehabilitation and educational programs are available for persons who are blind or visually impaired. A computer training program, Project CABLE, provides computer assessment, training on adaptive devices and software, and word processing training. Summer training courses for youth are also offered.*

Education Division  
Johns Hopkins University  
Center for Technology and Human Disabilities  
2500 East Northern Parkway  
Baltimore, MD 21214  
(410) 516-8273  
(410) 254-8466

*University offers a Master's degree in Technology for Education and in Technology Rehabilitation.*

Gallaudet University  
800 Florida Avenue NE  
School of Education and Human Services  
Washington, DC 20002  
(202) 651-5520

*Offers Master's degrees in Educational Technology, Special Education Administration and Supervision, Deaf Education, Counseling. Offers Doctoral programs in Special Education Administration, and Deaf Education.*

InterACT Training Program  
Trace Research and Development Center  
S-151 Waisman Center  
1500 Highland Avenue  
Madison, WI 53705  
(608) 262-6966  
(608) 263-5408 (TDD)

*The InterACT (Interdisciplinary Augmentative Communication and Technology) program allows University of Wisconsin-Madison students to earn a technology specialization with their degrees. Open to students in a variety of degree programs including: occupational therapy, physical therapy, speech/language, special education, and engineering.*

TTAP Outreach: Technology Team Assessment Process  
27 Horrabin Hall  
Western Illinois University  
Macomb, IL 61455  
(309) 298-1634

*Offers training on a cost-effective functional team technology assessment model. The model was developed to insure that children from birth to age eight receive a thorough team assessment and follow-up consultation as part of a comprehensive assessment process. Training is provided to assessment teams which include families, teachers, therapists, and a technology specialist.*

# Appendix C

## Glossary

The glossary includes terminology found in the product descriptions which might be new or unfamiliar to many readers. It does not attempt to be all-inclusive for the field of computer applications in special education and rehabilitation or augmentative communication; rather it serves to clarify possible points of confusion in the ResourceBook.

**Abbreviation expansion** An abbreviation expansion program allows a person entering text or data on a computer or communication aid to enter a long string of characters (a "macro") by simply typing in one or a few defined characters (the abbreviation). This system can save the user typing time and effort.

**Applications program** Any program that enables the user to accomplish some task using a computer, but not a task relevant only to the computer's operation. For instance, a word processing program would be an applications program, because it enables the user to create, edit and print text. But a program that strictly performs the function of speaking the contents of the computer screen via a speech synthesizer (a "talking screen" program) pertains mainly to the way in which the computer functions, and therefore would not be considered an applications program.

**Artificial Larynx** An electronic device which generates a tone to replace or enhance lost vocal tone. The tone is transmitted from the device either directly to the user's throat or (via a tube) into the nose or mouth. The user articulates the tone into speech in the normal manner.

**ASCII** American Standard Code for Information Interchange. A standardized system which assigns letters, numbers, and various other characters each their own code. This allows information to be transferred successfully from one computer or peripheral to another via various interfaces. It is important to note, however, that simply because one device produces ASCII output and another accepts ASCII input does not mean that they will necessarily operate flawlessly with one another.

**Auto-Repeat** The feature on computer keyboards which causes a particular character to repeat for as long as its key is depressed. This feature is fairly universal; it usually takes effect after a short delay. Hardware and software systems which disable the auto-repeat function are available for some computers.

**Baudot** The information exchange code most commonly used by TDDs (Telecommunication Devices for the Deaf). Most TDDs transmit only Baudot, but some offer the option of transmitting ASCII code as well. ASCII is used by computers when they communicate telephonically. The two codes are not compatible.

**Buffer** A set of memory circuits which are designed to store excess input until it can be accepted, or excess output until it can be sent. A printer, for instance, may have a buffer for storing text which is being sent to it from a computer faster than the printer can physically print it.

**CD-ROM (Compact Disk - Read Only Memory)** A form of storage like a floppy disk except that it is usually permanent (read-only) and has high storage capacity (typically 650 megabytes). A CD-ROM disk looks like an ordinary stereo CD, however, a CD-ROM is used to store computer data rather than music.

**Communication aid** Any device or system which augments a person's ability to communicate. This term can cover non-electronic devices such as communication boards, or electronic devices such as portable communication systems which allow the user to print and speak typed-in text.

**Control, controller** Technically these terms may be used for any switch or switch-like device which is used to control some system (computer, wheelchair, etc.) Typically they are applied to devices which incorporate several switches and which control a system in several ways; for example, a joystick used to control a video game.

**Cursor** The graphic character on a computer screen which indicates the point at which text is being added or edited.

**Database** A body of information that is stored and manipulated on a computer. A database management program is typically used to enter, edit, store, and manipulate this information.

**Digitizer** See speech digitizer.

**Direct Selection** Any technique for selecting choices in which a person points directly to the desired choice. This contrasts with scanning, in which choices are offered sequentially and the user signals when the selection is reached. Methods of direct selection include pointing, pressing various keys on a keyboard, or eye gaze selection. Generally speaking, direct selection methods are faster than other selection techniques. See also scanning.

**Disk, Diskette** One type of system for storing data in electronic form. The term "hard disk" refers to a large-capacity disk that is permanently installed in a disk drive. "Floppy disk" or "diskette" are terms used to refer to the type of disk that can be removed from the disk drive when not in use. The term "disk" by itself usually refers to a diskette (see also CD-ROM).

**Disk Drive** The mechanism that spins a disk and allows the computer to read it.

**DOS** Disk Operating System. See operating system.

**Download** ??

**Emulator** A device which imitates the action of another. A terminal emulator, for instance, is a system which is not a terminal per se, but is designed to operate like one.

**Encoding** A type of technique for increasing the number of selections possible on an electronic communication aid. The user enters an alphanumeric code, and the characters of the code determine which letter, word, phrase, etc. is called up. Thus an electronic communication aid with ten keys might have 1000 possible selections, each formed by pressing some three-key combination. See also levels.

**Firmware** A program or programs stored in circuitry, rather than in a disk or tape storage system. Optional firmware for microcomputers is often sold as a circuit board (or "card") which fits in one of the several option slots inside the computer. This is not a strictly observed term; any program may be referred to as "software" (see software).

**Hardware** Any component of an electronic system (such as a computer system) which is tangible; e.g., a computer, a monitor, a disk drive, a printer, etc. This category contrasts with software, which describes those components which consist only of electronic signals; e.g., programs, text files, and other quantities of information that can be stored on a disk or in a computer's memory. Although a program on a floppy disk is commonly referred to as software, technically the disk is hardware and the program on it is software.

**Host computer** In a computer system where various terminals (or computers connected in a network) are used to send input to a central computer, the central computer is commonly referred to as the host computer. See also terminal.

**Input** Any information entered into a computer by the user or sent to the computer by another device. See output.

**Interface** The point at which two electronic devices, such as a computer and a printer, communicate with each other. Also, an electrical connector or adaptive device which allows the interface to work properly.

**Internet** The name given to a large network of computers that are connected by high-speed information or data lines. The Internet also refers to the different services or things you can do on the Internet. Some of these activities include electronic mail (also known as E-Mail), gopher servers and FTP (ways to access documents and download them to your own computer), and the World-Wide-Web (a collection of compatible information servers throughout the world). Contact local Internet providers for more information.

**Jack** In a male-female electrical connection, the jack is the female connector. See plug.

**Keyboard Emulating Interface (KEI)** If some device such as a communication aid is to be used as an alternate keyboard for a computer, some system is usually required to allow the two to communicate successfully. A KEI takes the keystrokes from the alternate keyboard and makes them appear to the computer as indistinguishable from keystrokes on the normal keyboard. Some communication aid systems contain a KEI. Others are designed to operate with a standard KEI (one which complies with the standard industry protocol). In the latter case, the aid plugs into the KEI, which plugs into the computer like a ordinary keyboard.

**Keyguard** A plate which fits over the top of a keyboard and has holes over some or all of the keys. A keyguard can allow the user a place to rest the hands while typing, but primarily it is designed to prevent inadvertent key presses caused by poor motor control or other factors. Key latches, devices which hold down keys such as SHIFT, are commonly available with keyguards, and can facilitate one-finger typing.

**Keypad** Not a strictly defined term, keypad usually refers to any keyboard having significantly fewer keys than a standard typewriter or computer keyboard. Anything called a keypad can also be accurately referred to as a keyboard or part of a keyboard. The term often refers to the special separate set of numeric or cursor keys on some computer keyboards (sometimes called the numeric keypad).

**Latching** See toggle.

**LCD, LED** Liquid Crystal Display and Light Emitting Diode. These are types of display systems. LEDs are the type of displays, commonly used on alarm clocks, which glow and come in various colors: red, blue, green, etc. LCD displays are common on calculators, but are gray and do not glow.

**Levels** A system similar to encoding whereby the number of potential selections on an electronic communication aid can be greater than the number of buttons, keys, or scanning positions it has. The user makes one selection to choose a level; each level then has a different programmed value for each key, button, etc. Levels are sometimes known as "pages."

**Light Pen** An input device operated by pointing to locations on a computer's video screen. The device resembles a pen, and requires some special program to operate. Commonly used to make selections from menus or to create graphics.

**Load** To transfer a program from storage in memory (for instance on disk) to a computer's RAM. A program must be loaded in order to be run. See also RAM.

**Macro** A string of characters triggered by a defined shorter set of characters. See also abbreviation expansion.

**Mainframe** A term frequently used to distinguish large computer systems from mini- or microcomputers. A mainframe system is often designed to receive input from a number of terminals.

**Membrane keyboard** A keyboard whose individual keys are located under a flexible surface with no openings in it. The user activates the keys by pressing on the membrane.

**Memory** A system for storing data (information or programs) electronically. Data may be stored on tapes, on disks, or in circuitry. The two types of memory in the circuitry of a computer are ROM and RAM (see these definitions).

**Menu** A set of selections presented to the user of a computer or electronic aid, usually on a screen or other electronic display. If a program is called "menu-driven," this usually means that the user can operate it mostly by selecting from menus which the program offers.

**Microcomputer** An individual computer system that fits on a desk top, such as the type most people purchase for home use; sometimes known as a personal computer. This term contrasts with "mini computer," a larger, more powerful type of computer, generally used by businesses or government agencies. The term "mainframe," is commonly used to describe larger computer systems which accept input from various terminals, and which generally have larger memory and processing capacities.

**Microprocessor** The heart of a microcomputer system, the microprocessor is the circuitry that actually does the "computing." Any device which contains a microprocessor, even if it is not a computer per se, can be referred to as "microprocessor-based."

**Modem** A device which can transmit computer data over telephone lines.

**Monitor** The TV-like device which displays a video image of the data entered on a computer. Commonly referred to simply as the screen, or sometimes the CRT (cathode ray tube).

**Operating System** The program that allows the various parts of a computer system (the disk, the monitor, printers, etc.) to "talk" to each other. The operating system is usually the first thing "loaded" after a computer is turned on, as most other programs require it in order to run.

**Optical character reader (OCR)** A device which can optically analyze a printed text, recognize the letters or other characters, and store this information as a computer text file. OCRs are usually limited to recognizing the styles and sizes of type for which they are programmed.

**Output** Any information produced by a computer or any other device, and sent outward from that device. Output may be sent to another computer, to a peripheral, or to some display system such as a monitor.

**Overlay** A group of symbols, pictures, words, characters, etc. which are placed over the keyboard of a computer or communication device, or over the display of a communication device. The overlay usually reflects what output will be generated when a key is pressed or a selection is made, but for devices with no output other than the indication that a selection has been made, the symbol itself may serve as the message communicated.

**Parallel port** One type of interface whereby a computer or communication device is connected to another computer or communication device, or to some peripheral input or output device. The connection is frequently located on the back panel of a microcomputer.

**Peripheral** Any hardware that is separate from the computer itself: printers, speech synthesizers, disk drives, etc.

**Phoneme, phonetic spelling** A phoneme is a single discrete unit of sound used in speech. Phonetic spelling uses a character for each phoneme, rather than representing pronunciation indirectly as standard spelling does.

**Plug** In an electrical connection using a male and a female connector, the plug is the male connector. In this volume, the term plug has been frequently used solely to indicate the size and type of connector, and may refer to a device which is actually outfitted with a jack. See also jack.

**Port** An input/output connection on a computer. Frequently located on the back panel of microcomputers.

**Position** Any potentially selectable area in a scanning array; for instance, a 10 x 10 array may have 100 positions. When a position is selected, it is considered a selection. Positions are also known as locations.

**Program** A series of instructions to a computer. A program is what allows the computer user to execute some task on the computer (see software). Commercially available programs are frequently sold stored on disks, but programs may also be written directly on a computer or purchased in firmware form (see firmware).

**RAM** Random Access Memory. This is the type of memory in a computer where data is placed while it is in use. A program on a disk, for instance, is loaded into the computer's RAM before being run. RAM is cleared when a computer is shut off, however, and so the program must be stored again after being used. Computers are often described in terms of their RAM capacity: a "128K" computer has a RAM capacity of approximately 128,000 bytes (characters) of information. See also disk, memory, ROM.

**Refreshable braille display** Also known as a dynamic braille display, this type of system uses a set of braille cells, each consisting of six or eight retractable electronically operated reeds. An electronic code sent to the system raises and lowers the reeds to form braille characters which the user can sense by placing the fingers on top of the display. When the display is full, the first cell recomposes itself and the display fills up again. Some displays also scroll.

**ROM** Read Only Memory. This is permanent memory built into a computer's circuitry by the manufacturer. See RAM.

**RS-232** An interface standard for the serial port of a computer or microprocessor-based communication device. Serial ASCII code can be sent via an RS-232 interface.

**Scanning** A technique for making selections on a communication aid, computer, or environmental control system. Scanning involves moving sequentially through a given set of choices, and making a selection when the desired position is reached. Common physical forms for scanning arrays are menus on a computer screen, grids of squares with lights which light sequentially, and dial faces (like clocks) with pointers which revolve to point to symbols. Types of scanning include automatic, manual, row-and-column, and directed. In automatic scanning, the system scans automatically once started, and the user activates a switch momentarily to stop the scanning. Once stopped, the scanning sequence must be recommenced by another switch. In manual scanning, the user activates a switch continuously to scan the choices, releasing the switch to stop. In row-and-column scanning, the user selects first the row in a grid, then the column. Directed scanning involves using multiple switches or a joystick to scan in the desired direction. See also direct selection.

**Screen Reader** A program which speaks the contents of the computer's screen via a speech synthesizer. Such a program is usually also equipped with a system that allows the user to "navigate," or find his way around the screen, without the necessity of seeing the screen.

**Semantic compaction** A technique for reducing the number of selections a user must make to generate a phrase on a voice-output communication aid. Symbols for semantic units are used rather than number or letter codes (see encoding).

**Serial port** One type of interface for communication between a computer or electronic communication aid and another computer, electronic communication aid, or peripheral. The fact that two devices both have a serial port, however, does not automatically mean that information can be transferred between them flawlessly.

**Software** The part of a computer system which is not tangible, that is the programs or information that are processed by a computer or stored in memory. Commercially available software is usually sold in the form of a program or programs stored on a disk. See firmware, hardware, program, disk.

**Speech digitizer** A device which analyzes speech and converts particular sounds or utterances into digital patterns which can be stored just as other data is stored on a computer. These digital patterns can also be reconverted into their original sounds, allowing the computer to act as a digital "tape recorder." Speech digitization is also used in voice recognition systems. See speech synthesizer, voice recognition.

**Speech recognition** See voice recognition.



**Speech synthesizer** In contrast to the speech digitizer, which records and plays back what it "hears," the speech synthesizer receives input in the form of electronic text characters (letters, numbers, punctuation), and converts the discrete characters or words into artificial speech. Most speech synthesizers have a memory and processing system that applies standard pronunciation rules to determine the correct pronunciation. Synthesizers tend to sound more mechanical than digitizers; on the other hand they do not require that each and every phrase to be spoken be recorded beforehand, and they tend to use less memory storage space.

**Spreadsheet** A type of applications program that is designed for adding, editing, and manipulating tabulated information.

**Synthesizer** See speech synthesizer.

**TDD** Telecommunication Device for the Deaf. A device which allows a person to transmit typed-in messages over phone lines. Most TDDs have a keyboard for sending messages and an electronic display and/or printer for receiving them. In most cases, people on both ends of the line must have a TDD in order to communicate. TDDs transmit a special code (see Baudot) but may also transmit ASCII. In the past, the term TTY was sometimes used for this type of aid. Today, the term Text Telephone (TT) is gaining acceptance as well.

**Terminal** A device for entering data on the type of computer system which accepts data from more than one source at a time. The typical terminal has a keyboard for entering data and a screen for reviewing the data entered. A terminal does not process information in itself, but sends it on to the host computer system.

**Toggle** A switching action wherein the switch is turned on with one motion, off with another. Contrasts with momentary contact, wherein a switch remains on or off only while it is being activated by the user, reverting to its "normal" state (either on or off) as soon as it is no longer being activated. A common toggle switch is a wall switch for a light. This action can also be known as latching.

**Touch Pad, Touch Screen** Devices which allow a person to generate input to a computer by pressing on their surface. A touch pad is usually a continuous membrane surface divided into areas, each of which generates a different input (a character, command, etc.). A touch screen fits over the standard computer screen, and functions similar to a touch pad. Touch pads and screens are frequently used to make selections from menus or to create graphics.

**Transparent** Usable with all or an entire major class of software. This term is usually applied to a program or device which is usable with nearly all software appropriate to the computer system for which the program or device is designed. One should never assume that a device or program is absolutely transparent to all software without checking with the manufacturer.

**Voice Recognition** A technique used to recognize certain spoken utterances. A voice recognition system is "trained" to recognize an utterance by digitally encoding it once or several times (see speech digitizer). Thereafter when the system "hears" a phrase spoken, it compares it to the patterns for the utterances it has "heard" before, and matches it to one. All utterances to be recognized must be individually trained, and due to present limits on the technology, the maximum length of a recognized word or phrase is about two seconds. Voice recognition is commonly used in voice input systems for computers, which send a given input to the computer for each recognized utterance.

**Word Processor** A type of applications software that is used to enter, edit, manipulate, and format text. In order to be considered a word processing program rather than a simple text entry and editing program, a program should have fairly sophisticated capabilities.

# Index 1

## Products Listed by Function

This index includes lists of products according to function. Every product in the book with a given function will appear in that list. Within each list products are arranged alphabetically. Following the product name in parentheses are the other functions (as two-letter codes) assigned to that product. A key to all the functions and their two-letter codes is provided on the next page.

For example, if you were looking for an aid for Conversation/Interaction and wanted to find an aid that could also perform word processing functions you would look through the Conversation/Interaction (CI) function list and note all of those products with the WP (word processing) code. You would then look at the product descriptions for the several entries meeting both of those needs and contact the manufacturers of those devices you felt were most suitable.

## Index 1: Products Listed by FUNCTION

### *Titles of product lists in this index:*

Activities of Daily Living {AD}  
Adaptive Educational Software {ED}  
Alternate Inputs Usable with All Software {TI}  
Artificial Larynxes {AL}  
Assessment (Evaluation) {AS}  
Book/Paper Handling {BP}  
Braille {BR}  
Braille and Tactile Output Systems {BT}  
Calculation/Math Aids {CN}  
Call, Monitoring, and Memory Systems {CM}  
Cognitive Rehabilitation {CP}  
Conversation/Interaction {CI}  
Database Management/Spreadsheets {DS}  
Drawing {DR}  
Early Skills (Pre-Reading) {ES}  
Electronic Communication and Writing Aids {EA}  
Environmental Controls {EC}  
Games {GA}  
Input Adapters for Computers {IA}  
Input Devices Usable with Only Some Software {ID}  
Keyboard Emulating Interfaces (Adapters Only) {KE}  
Keyboarding Training Programs {KB}  
Keyguards {KG}  
Language Therapy/Development {LT}  
Large Print Output {LP}  
Later Skills (Includes Reading) {LS}  
Magnification Hardware and Software for Computer Displays {MG}  
Modifications for Standard Keyboards {KM}  
Mounting Systems {MS}  
Mouse and Touch Pad Emulation {MT}  
Non-Electronic Communication Aids {NA}  
Personal Tools or Aids (for Speaking, Writing, Drawing, Controlling, etc.) {PA}  
Phone Control/Access {PC}  
Pointing and Typing Aids {PT}  
Portable Writing {PW}  
Recreation {RE}  
Repetitive Strain Injury (RSI) Prevention {RS}  
Screen (Display) to Voice {SV}  
Signing {SI}  
Speech Aids {SA}  
Speech Synthesizers {SS}  
Speech Therapy (not Language Therapy) {ST}  
Telecommunication {TL}  
Telecommunication Devices for the Deaf (TDD's) {TD}  
Training and Communication Initiation Aids {TR}  
Training and Therapy Software {TT}  
Typing Acceleration Program {TA}  
Vocational {VO}  
Voice Amplifiers {VA}  
Voice-Output Screen Reader or Reading Machine {VS}  
Word Processing (Writing) {WP}

### *Function codes which may appear in parentheses after items in this index:*

AD Activities of Daily Living  
AL Artificial Larynx  
AS Assessment (Evaluation)  
BP Book/Paper Handling  
BR Braille  
BT Braille and Tactile Output Systems  
CI Conversation/Interaction  
CM Call, Monitoring, or Memory System  
CN Calculation/Math Aid  
CR Cognitive Rehabilitation  
DR Drawing  
DS Database Management/Spreadsheet  
EA Electronic Communication or Writing Aid  
EC Environmental Control  
ED Adaptive Educational Software  
ES Early Skills (Pre-Reading)  
GA Game  
IA Input Adapter for Computer  
ID Input Device Usable with Only Some Software  
KB Keyboarding Training Program  
KE Keyboard Emulating Interface  
KG Keyguard  
KM Modification for Standard Keyboard  
LP Large Print Output  
LS Later Skills (Includes Reading)  
LT Language Therapy/Development  
MG Magnification Hardware and Software for Computer Displays  
MS Mounting Systems  
MT Mouse or Touch Pad Emulation  
NA Non-Electronic Communication Aid  
PA Personal Tool or Aid (for Speaking, Writing, Drawing, Controlling, etc.)  
PC Phone Control/Access  
PT Pointing or Typing Aid  
PW Portable Writing  
RE Recreation  
RS Repetitive Strain Injury (RSI) Prevention  
SA Speech Aid  
SI Signing  
SS Speech Synthesizer  
ST Speech Therapy (not Language Therapy)  
SV Screen (Display) to Voice  
TA Typing Acceleration Program  
TD Telecommunication Device for the Deaf (TDD)  
TI Alternate Input Usable with All Software  
TL Telecommunication  
TR Training or Communication Initiation Aid  
TT Training and Therapy Software  
VA Voice Amplifier  
VO Vocational  
VS Voice-Output Screen Reader or Reading Machine  
WP Word Processing (Writing)

**Activities of Daily Living {AD}**

*Software designed to teach daily living skills. Other software and hardware may be useful in daily living, but not listed here.*

CAMEO (CN,ED,LS), 715  
 Community Signs (LS,LT,TT), 580  
 Dollars & Cents Series (CN,TT), 589  
 Edmark Functional Word Series (TT,VO), 592  
 Employment Signs (LS,LT,TT), 594  
 Food Facts (SV,TT), 603  
 Grocery Store Words (LS,TT), 608  
 Information Signs (LS,LT,TT), 612  
 Joystick, 224  
 Living Alone (TT), 626  
 Mastering Personal Information (MPI) (CR,TT), 629  
 Medical Words (LS,TT), 631  
 Money Skills (CN,LS,TT), 637  
 NeuroPage (CM,CR), 320  
 Paper Dolls I and II (ES,TT), 651  
 Pick-A-Meal (GA,TT), 653  
 Picture Cue Dictionary (CI,LT,NA,TT), 654  
 Positive Parenting (TT), 657  
 Safety Signs (LS,LT,TT), 667  
 Storytime Series (LP,TR,TT), 679  
 Storytime Series for Macintosh (LP,TR,TT), 679  
 Survival Words (AS,LS,LT,TT), 681  
 Telling Time (CR,TT), 689  
 Timekeeper (TT), 692  
 TouchMoney (CN,TT,VO), 693  
 Traffic Signs Plus for Windows (TT), 694  
 Transportation Signs (LS,LT,TT), 694

**Adaptive Educational Software {ED}**

*Application software and software/hardware packages whose function is to educate. Software that focuses on topics which are traditionally part of school curricula, but which are adapted for special needs is included in this code. Software that focuses on training and therapy of non-curricular skills is listed under Training and Therapy (TT). Some related function codes include Assessment (AS), Early Skills (ES), Later Skills (LS), and Calculation and Math Aids (CN).*

Access to Math (CN), 713  
 APH/SEI Talking Software (LS,SV), 713  
 Arithmetic 1, 2, and 3 with Speech (CN,LS,SV), 714  
 Basic Learning Skills Courseware (CN,LS), 714  
 CAMEO (AD,CN,LS), 715  
 Career English (LS,VO), 715  
 Complete Spelling Program (LS), 716  
 Core Reading and Vocabulary Development (LS,LT,TT), 583  
 Drive to Live (LS), 716  
 Early Learning 3.5/Complete Early Learning 5.25 (ES,LS,TT), 591  
 Early Learning II (CN,ES), 717  
 Early Learning III (CN,LS), 717  
 Edmark Reading Program, Level I Software (ES,LS), 718  
 Elementary Volume I - Mathematics (CN,LS,SV), 718  
 ERIN (Early Recognition Intervention Network) (AS,ES), 719  
 Focus on Facts (SV), 719  
 Focus on Nations (SV), 720  
 Geometric Figures and Spatial Concepts (ES), 720  
 H:1 Handicapped Word Games (GA,LS,PA,RE), 752  
 H:2 Handicapped Arithmetic Flash Cards (CN,LS,RE), 721  
 JOKUS Software (ES), 721  
 K.C. & Clyde in Fly Ball (LS), 722  
 Keyboarding by Ability (KB,TT), 617  
 Keyboarding for Individual Achievement (KB,TT), 617  
 Keyboarding for People with Cerebral Palsy (KB,TT), 618  
 Keyboarding with One Hand (KB,TT), 619  
 Learning the Alphabet (ES), 722  
 Listen and Spell (LS), 723  
 Prefixes (LS,SV), 723  
 Program for Aphasics (CR,LS), 724  
 Readable Stories Series (LS), 724

Reading Horizons (ES), 725  
 Sensible Speller: Talking APH Edition (LS,SV), 725  
 Sharon's Programs (ES,LS), 726  
 Sight Word Spelling (LS,SV), 726  
 Single Switch Software (TT), 675  
 Speaking Speller (LS,SV), 727  
 Special Education Public Domain Software (CR,LS,TT), 677  
 Spell-A-Word & 2+2 (CN,LS), 727  
 Spell-Talk (LS,SV), 728  
 Spelling Tutor (LS), 728  
 SPELLIST (LS), 729  
 Spin and Spell (LS), 729  
 Study Buddy, 730  
 Talking Public Domain Disks (LS,SV,TT,VO), 730  
 Talking Riddles (LS,SV), 731  
 Trace Math Aid (CN,PA), 769  
 Voice Math (CN), 731  
 Voice Reading Ability Drill (LS), 732  
 Wordplay with Alps and Droops (GA,LS), 732  
 Write (CI,LS,SV), 733  
 Write This Way (WP), 733  
 Zero to Five (LS), 734

**Alternate Inputs Usable with All Software {TI}**

*Alternate input systems which provide "transparent" access to a computer. "Alternate input" refers to a special device used as an alternative to the computer's standard input devices, including not only keyboards but also joysticks, mice, etc. "Transparent" means that the special input device can perform any operation that its standard equivalent can. Products are cross-referenced by input type in Index 2.*

Access Pack for Microsoft Windows (IA,KM,MT), 331  
 Access-I (CI,PW), 373  
 AccessDOS (IA,KM,MT), 332  
 Adap2U (MT), 373  
 ADAPTA-LAN (CI,LP,PC,WP), 374  
 Adaptive Firmware Card Model G32c (IA,KE,KM), 374  
 AlphaSmart Pro (PW), 375  
 AlphaTalker (CI,EA), 119  
 AmTRAC (MT), 375  
 Apple Adjustable Keyboard (RS), 376  
 Aurora 2.0 for DOS (CI,EA,LP,TA,WP), 376  
 Aurora for Windows (KM,TA,WP), 333  
 BallPoint Mouse (MT), 377  
 BAT Personal Keyboard, 377  
 Big Keys, 378  
 BioMuse, 378  
 Bloorview Miniature Keyboard, 379  
 Braille 'n Speak (BR,PW,SS,SV,VS), 669  
 Breakthru Box, 379  
 Butler-in-a-Box (EC,PC), 270  
 CINTEX I (EC,PA,PC,RE,TA,WP), 744  
 Cirque GlidePoint Trackpads (MT), 380  
 Comfort Keyboard System, 380  
 Concept Keyboard, 381  
 Cordless WinMouse (MT), 381  
 DARCI TOO, 382  
 DM80/FM (BR,BT), 511  
 Doors II, 382  
 DragonDictate Starter, Classic, and Power Editions, 383  
 EEK, 383  
 Equalizer (CI,DR,EA,PW,RE,WP), 131  
 ErgoLogic Model 7.1 Keyboard (RS), 384  
 Ergonomic Keyboard Systems (RS), 384  
 EvalPAC with RealVoice (AS,CI,EA,EC,PW), 131  
 Expanded Keyboard for Apple Macintosh and Apple IIGS, 385  
 Expanded Keyboard for IBM Computers (KG), 385  
 Expanded Keyboards for the Talking BlissApple (KG), 386  
 Expanded Numeric Keypads, 386  
 Expert Mouse (MT), 387  
 Eye Slaved Pointing System (EC,PC), 387  
 Eyegaze Computer System (EA,EC,PC), 132

ezMorse for Windows, 388  
 ezScan, 388  
 FastTRAP (MT), 389  
 Felix (MT), 389  
 First-Finger WinTrack (MT) 390  
 FlexPro (RS), 390  
 GEWA FTB 108 Enlarged Keyboard, 391  
 GEWA METB 121 Reduced Size Keyboard, 391  
 Gus! Multimedia Speech System (CI,EA,K:4), 133  
 HAL (Home Automation Link) (EC,PC), 392  
 Hand Controls (ID), 392  
 HandiCODE and HandiCODE Deluxe (ID), 393  
 HeadMaster Plus (MT), 393  
 HeadMouse (DR,MT), 394  
 Help U Key, 394  
 Help U Keyboard, 395  
 Hereward Tracker Ball & Joystick Module (MT), 395  
 Icontroller (MT), 396  
 IN-CUBE Voice Command for SPARC Station, 396  
 IN-CUBE Voice Command for Windows, NT (RS), 397  
 Instant Access, 397  
 IntelliKeys, 398  
 IntroVoice V, 398  
 IntroVoice VI (SS), 399  
 IRIS Reading Interface 3.0 (SI), 399  
 Jouse (MT), 400  
 Joystick to Mouse Driver (MT), 400  
 JustVoice, 401  
 K-U-1 (MT), 401  
 Ke:nx (KE,MT), 402  
 Ke:nx On:Board (M43), 402  
 Key Largo, 403  
 Keyport 176, 403  
 Keyport 300, 404  
 Keyport 60, 404  
 Kinesis Ergonomic Keyboard (RS), 405  
 King Keyboard (2440), 405  
 Kurzweil VOICE, 406  
 Kurzweil VOICE for Windows, 406  
 Laser Optic Keyboard (CI), 407  
 LIAISON (EC,KE,PC), 407  
 Liberator (CI,CN,EA,EC,PW), 137  
 LightBoard, 408  
 Lips:ick and WordWriter (MT), 408  
 Lisa... for Windows (ID), 409  
 MacKing (MT), 409  
 MacMini (MT), 410  
 Macist, 410  
 MacroMaster/Pro (KM), 411  
 MacTRAC (MT), 411  
 Magic Wand Keyboard with McKey Mouse Option, 412  
 Magnum (BR,PW,VS), 477  
 Maltron Keyboard, 412  
 MICE (MT), 413  
 Micro IntroVoice (SS), 413  
 Micro IntroVoice II (SS), 414  
 Microsoft Natural Keyboard (RS), 414  
 Microsoft Windows Sound System, 415  
 MIKE (Mouse Interface & Keyboard Emulation) (MT), 415  
 Mini Keyboard (2443 or 2450), 416  
 Mini-Keyboards, 416  
 MiniErgo-MF2 (KM,RS), 417  
 Minimal Motion Computer Access System, 417  
 Morse Code WSKE II, 418  
 Morsek Version 1.1, 418  
 Mouse Keys, 419  
 Mouse-Trak (MT), 419  
 MouseMan Cordless (MT), 420  
 MouseMover - Mac (5005) (MT), 420  
 MouseMover - PC Windows (5004) (MT), 421  
 MousePen (MT), 421  
 MouseStick II (MT), 422  
 Mouth Operated Joystick for Genesis Video Game (GA,RE), 422  
 Muppet Learning Keys (GA,ID), 423  
 My First Keyboard, 423

My-T-Mouse (KE), 424  
 MyKey (MT,RS), 424  
 Narwhal Expanded Keyboards for Adaptive Firmware Card, 425  
 Nintendo & Super Nintendo Joystick Module (RE), 425  
 NoMouse (MT), 426  
 OfficeTALK for Windows, 426  
 One Access (IA), 427  
 One-Hand Operated Joystick for Genesis Video Game, 427  
 OneStrk, 428  
 Optimouse (MT), 428  
 OsCaR, 429  
 PC-TRAC (MT), 429  
 Pen Style Mouse (MT), 430  
 PKD 84 and 101, 430  
 PortaPoint (MT), 431  
 PowerKey Software for IBM, 431  
 PowerPad (DR,RE), 432  
 PowerPad Starter Kit, 432  
 PowerSecretary (WP), 433  
 Pre-Dict-ate, 433  
 ProPoint (MT), 434  
 Proportional Keystroke Scanner, 434  
 QUADLynx Trackball (MT), 435  
 Reading Edge, 435  
 RealVoice (AS,CI,EA,EC,PW), 147  
 Remote Keyboard for the Apple II+ and IIe (DR), 436  
 RemotePoint (MT), 436  
 RevolvingDoors (MT), 437  
 Scanning WSKE II, 437  
 ScanPAC (CI,CN,EA,EC,PW), 150  
 ScottBridge Speech Access System, 438  
 ScreenDoors, 438  
 Select-Ease Keyboard (RS), 439  
 SenSei System (EC,PA,PC,TL), 295  
 Serial Trackball and PS/2 Trackball (MT), 439  
 SofType (TA), 440  
 Speak Out VOILA (LP,MG,SV,VS), 440  
 Speech Recognition Systems, 441  
 Stingray (MT), 441  
 Switch Modified PowerPad, 442  
 Switch-Adapted Mouse (SAM) (MT), 442  
 Switch-Back (ID), 443  
 SwitchMouse (MT), 443  
 SynergyMac and SynergyPC (CI,PW), 444  
 T-TAM Keyboard and Mouse Emulator (EA,IA,KM,MT), 463  
 TouchWindow (DR,DS,ID,RE,WP), 444  
 Trackball Pro (MT), 445  
 TrackMan Live! (MT), 445  
 TrackMan Voyager (MT), 446  
 Trak101 Keyboard (MT,RS), 446  
 Turbo Mouse 4.0 (MT), 447  
 Turbo Trackball (MT), 447  
 Vertical (RS), 448  
 VisionKey (EA), 158  
 Voice Mouse/Keyboard (VMK) Controller, 448  
 Voice User (RS), 449  
 WinKing Keyboard (2448F, 2448Q), 449  
 WinMini Keyboard (2447F, 2447Q) (MT), 450  
 WiViK 2.0 (Windows Visual Keyboard) (TA), 450

### Artificial Larynxes {AL}

Products that produce artificial vocalization (vocal tone) in the throat or mouth in order to allow oral speech.

Cooper-Rand Electronic Speech Aid (SA), 4  
 Denrick Speech Aid (SA), 4  
 Electronic Artificial Larynx (SA), 5  
 Nu-Vois (SA), 7  
 SERVVOX Inton (SA), 9  
 Tokyo Artificial Larynx (SA), 11

**Assessment (Evaluation) {AS}**

Products (not limited to computer hardware or software) which are designed to be assessment or evaluation tools. This designation is based upon the manufacturer's description; other products may be useful for assessment that are not so coded.

Ability Switch Tester (5955) (TR), 29  
 Activity Board (EC,TR), 30  
 Adventures of Jimmy Jumper - Prepositions (ES,LT,TT), 557  
 And Or Box (TR), 31  
 Battery Adapter (TR), 32  
 Battery Device Adapter (TR), 32  
 Battery Interrupter (TR), 33  
 Beeper (CM,TR), 313  
 Buddy's Body (ES,TT), 566  
 Call Bell (4500) (CM,TR), 314  
 Call Signal 2 (CM,TR), 314  
 Captain's Log: Cognitive Training System (CR,ES,LS,TT), 568  
 Chime Alarm (CM,TR), 315  
 Clock Communicator (CI,TR), 36  
 Comboard (2615) (CI,TR), 36  
 Communiclock (CI,TR), 37  
 Compartmentalized Communicator (CI,TR), 38  
 Counter Box (TR), 39  
 Counter Module (TR), 39  
 Delay Timer Box (EC,TR), 40  
 Dial Scan (CI,TR), 40  
 Dual Channel Latching Switch Interface (EC,TR), 41  
 E-Tran Scanner (CI,TR), 43  
 Emergency Call Alarm (CM,TR), 317  
 English on the Job (TT,VO), 594  
 ERN (Early Recognition Intervention Network) (ED,ES), 719  
 EvalPAC with RealVoice (CI,EA,EC,PW,VI), 131  
 Family Fun (ES,TT), 596  
 Further Adventures of Jimmy Jumper - Perseverance (ES,TT), 606  
 Inverter Module (TR), 44  
 Job Readiness Series (TT,VO), 614  
 Join the Circus (ES,TT), 616  
 Keypad (2425) (TR), 45  
 Laryngograph (ST,TT), 620  
 Learn to Scan (TR,TT), 620  
 Lighted Extra Loud Signalling Buzzer (CM,TR), 319  
 Lighted Signalling Buzzer (CM,TR), 319  
 Lighted Vibrating Signalling Buzzer (TR), 46  
 Logo TouchTools for the PowerPad (ES,TT), 627  
 Make It In Time (ES,TT), 628  
 Make It Scan (ES,TT), 629  
 Math on the Job (CN,TT,VO), 630  
 Microcomputer Evaluation of Career Areas (MECA) (TT,VO), 634  
 Motor Training Games (GA,PA,RE,TT), 638  
 Multi-Switch Module (TR), 47  
 Nasometer Model 6200-3 (ST,TT), 643  
 Padded Food (ES,TT), 650  
 Primer 83 (LS,TT), 660  
 Quad Talk (CI,TR), 52  
 Rabbit Scanner (ES,TT), 662  
 RealVoice (CI,EA,EC,PW,VI), 147  
 Reasoning Skills on the Job (TT,VO), 665  
 Rhythm Generator (TR), 52  
 Run Rabbit Run (ES,TT), 666  
 Sequential Scanner (CI,TR), 54  
 Series Adapter (TR), 54  
 Signal Buzzer (CM,TR), 325  
 Steeper Communication/Teaching Aid (CI,TR), 56  
 Survival Words (AD,LS,LT,TT), 681  
 Switch Latch (4388) (EC,TR), 56  
 Switch Latch/Timer (TR), 57  
 Talking Touch Window (CI,TR,TT), 687  
 Timer Module (EC,TR), 59  
 Toy Adapter (TR), 59  
 Toy Adapter Cables: CA-9/CA-12/CA-16 (TR), 60  
 Toy Cables (4378, 4379) (TR), 60  
 Training Aid 2 (EC,TR), 61  
 Tri-Responder (TR), 62

Versacan (CI,TR), 63  
 Vibrating Sack (TR), 64

**Book/Paper Handling {BP}**

Products which facilitate the handling of books or printed materials. This code refers to the physical handling of such materials.

APT Automaddak Page Turner System (EC), 268  
 Braille Blazer (BR,BT), 507  
 Braillo 200 (BR,BT), 510  
 Braillo 400 S (BR,BT), 510  
 Braillo Comet (BR,BT), 511  
 F73216-100 Page Turner/Keyboard Aid (PT), 17  
 Gewa Page Turner (EC), 280  
 H73217 Mouth Held Page Turners (PT), 19  
 Media Handling Products (EC,PT), 549  
 Motorized Easel (EC), 286  
 Mouthsticks (PT), 24  
 Next Page Page Turner (4600) (EC), 287  
 Saltus Reader (EC), 292  
 Touch Turner (EC), 301  
 Vacuum Wand (PT), 26

**Braille {BR}**

Devices or software that produce or incorporate braille code. This category is more inclusive than Braille and Tactile Output (BT).

ALVA Braille Terminals (BT), 507  
 Audio Braille Game Tutorial (GA,RE,TT), 560  
 Auto Braille (PA), 738  
 BEX 3.1 (LP,PA,SV,WP), 739  
 Braille 'n Speak (PW,SS,SV,VI,VS), 469  
 Braille 'n Speak Classic (CN,PA,SV,VS,WP), 469  
 Braille Blazer (BP,BT), 507  
 Braille BookMaker and Braille Express 100 & 500 (BT), 508  
 Braille Keypop Labels (KM), 334  
 Braille Lite (BT,CN,PW,SV,VS), 470  
 Braille Tutorial (TT), 565  
 Braille-N-Print (BT), 508  
 Braille-Talk (PA,SV), 742  
 BrailleAccess (BT), 509  
 Brailled Keyboard Model—Apple IIe, 543  
 Brailled Keyboard Overlay for the Apple IIGS (KM), 334  
 BrailleMate 2 (PW,VS), 470  
 BRAILLEX-2D (BT), 509  
 Braillo 200 (BP,BT), 510  
 Braillo 400 S (BP,BT), 510  
 Braillo Comet (BP,BT), 511  
 Checkbook Program (CN,PA,SV), 744  
 Combination Braille/Large Print Keypop Labels (KM,LP), 335  
 David (BT,PA,PW,SS,SV,VS), 471  
 DM80/FM (BT,TT), 511  
 Duxbury Braille Board for Microsoft Windows (PA), 745  
 Duxbury Braille Translator (DBT) (PA), 746  
 Duxbury Braille Translator for WordPerfect (DUXWP) (PA), 747  
 Easy-Braille Translator (PA), 747  
 Edgar (PA), 748  
 ETgraphX (DR,PA), 749  
 High Dots (KM), 344  
 IBM-VBII (PA), 753  
 Index Basic (BT), 512  
 Index Basic-D (BT), 512  
 Index Everest-D (BT), 513  
 InfoTouch (BT,CI,PC,TD,TL), 182  
 Juliet Brailier (BT), 514  
 KTS Braille Display (BT), 514  
 Learning to Spell Braille Signs (TT), 623  
 Lite Touch Telephone Communicator (PC,TD,TL), 183  
 Magnum (PW,VI,VS), 477  
 Marathon Brailier (BT), 515

## Index 1: Products Listed by FUNCTION

MegaDots (LP,PA), 757  
MicroBraille 2 (PA,WP), 758  
Mountbatten Braille (BT,PW), 516  
Myna (PW,SV,VS), 478  
NAMES (PA), 760  
Notex 486 (BT), 517  
Ohtsuki BT-5000 Braille/Print Printer (BT), 517  
Paragon Braille Printer (BT), 518  
PC Braille (PA), 761  
PCMaster & Windows Master (IA,SV,VS), 460  
Picture Braille (PA), 761  
PowerBraille 40, 65, & 80 (BT), 519  
Ransley Braille Interface (RBI) (BT), 519  
Romeo Braille Model RB-25 (BT), 520  
Romeo Braille Model RB-40 (BT), 520  
Thomas Braille (BT), 521  
TransSend System (BT), 522  
TurboBraille (PA), 769  
VersaPoint-40 Braille Embosser (BT), 522  
WinDOTS (PA), 771

### Braille and Tactile Output Systems {BT}

*Devices that have either braille or other tactile output. This category covers braille printers (also known as embossers), portable braille "notebooks" with refreshable braille displays, and tactile or braille devices designed for accessing a standard computer screen. Software that produces or translates braille is not included but would be coded Braille (BR).*

ALVA Braille Terminals (BR), 507  
Braille Blazer (BP,BR), 507  
Braille BookMaker and Braille Express 100 & 500 (BR), 508  
Braille Lite (BR,CI,PW,SV,VS), 470  
Braille-N-Print (BR), 508  
BrailleAccess (BR), 509  
BRAILLEX-2D (BR), 509  
Braillo 200 (BP,BR), 510  
Braillo 400 S (BP,BR), 510  
Braillo Comet (BP,BR), 511  
David (BR,PA,PW,SS,SV,VS), 471  
DM80/FM (BR,TD), 511  
Index Basic (BR), 512  
Index Basic-D (BR), 512  
Index Everest-D (BR), 513  
InfoTouch (BR,CI,PC,TD,TL), 182  
INKA, 513  
Juliet Braille (BR), 514  
KTS Braille Display (BR), 514  
Marathon Braille (BR), 515  
MasterTOUCH (SV), 515  
Mountbatten Braille (BR,PW), 516  
NOMAD Talking Touch Pad & NOMAD Gold (SV), 516  
Notex 486 (BR), 517  
Ohtsuki BT-5000 Braille/Print Printer (BR), 517  
Optacon II (LP), 518  
Paragon Braille Printer (BR), 518  
PowerBraille 40, 65, & 80 (BR), 519  
Ransley Braille Interface (RBI) (BR), 519  
Romeo Braille Model RB-25 (BR), 520  
Romeo Braille Model RB-40 (BR), 520  
TEXTALKER (SV), 521  
Thomas Braille (BR), 521  
TransSend System (BR), 522  
VersaPoint-40 Braille Embosser (BR), 522

### Calculation/Math Aids {CN}

*Products designed to facilitate the user's ability to do calculations or perform mathematical operations. Programs for teaching math will have both this code and the code ED (Adaptive Educational Software).*

Access to Math (ED), 713  
APH Scientific Calculator: for Apple II Computers (PA,SV), 737  
Arithmetic 1, 2, and 3 with Speech (ED,LS,SV), 714  
Basic Learning Skills Courseware (ED,LS), 714  
BigCalc (LP,PA), 740  
Braille 'n Speak Classic (BR,PA,SV,VS,WP), 469  
Braille Lite (BR,BT,PW,SV,VS), 470  
Calc-Talk (LP,PA,SV), 743  
Calcworthy (PA,SV), 743  
CAMEO (AD,ED,LS), 715  
Checkbook Program (BR,PA,SV), 744  
COINSNKEYS (ES,KB,TT), 577  
Dollars & Cents Series (AD,TT), 589  
Early Learning II (ED,ES), 717  
Early Learning III (ED,LS), 717  
Elementary Volume I - Mathematics (ED,LS,SV), 718  
H:2 Handicapped Arithmetic Flash Cards (ED,LS,RE), 721  
Keynote Companion (SV,TL,VS,WP), 476  
Keysoft (PA,SV,WP), 754  
Learning Activity Packets (LAPs) (LS,TT,VO), 621  
Learning to Count (TT), 622  
Less, More, Make Equal (CR,TT), 623  
Letter Find (ES,KB,SV,TT), 625  
Liberator (CI,EA,EC,PW,TT), 137  
Mac-Apple Communications Aid (CI,DR,ES,PA,TT,WP), 756  
Math Max (CR,GA,TT), 630  
Math on the Job (AS,TT,VO), 630  
Money Skills (AD,LS,TT), 637  
MusicWare (ES,GA,LS,TT), 640  
Octopus (CR,LS,TT), 645  
On the Job Series - Mathematics (TT,VO), 647  
Prefix (CR,TT), 659  
Reading a Ruler - English & Metric (TT,VO), 664  
ScanPAC (CI,EA,EC,PW,TT), 150  
Spell-A-Word & 2+2 (ED,LS), 727  
This Old Man (SI,TT), 691  
TouchMoney (AD,TT,VO), 693  
Trace Math Aid (ED,PA), 769  
Voice Math (ED), 731

### Call, Monitoring, and Memory Systems {CM}

*Products which feature the capability to summon assistance, to monitor a person's activities for safety reasons, or to supplement or aid memory.*

Accularm (TR), 311  
AlertCom, 311  
Auto Call Single Number Dialer (PC), 312  
Beep-in-Touch, 312  
Beeper (AS,TR), 313  
Buzzer Box (TR), 34  
Call Alert Model CA-100 (PC), 313  
Call Bell (4500) (AS,TR), 314  
Call Signal 2 (AS,TR), 314  
Chime Alarm (AS,TR), 315  
Companion 401 Communicator (CI,EA,TL,TR), 125  
Cord-Mate, 315  
Digitized Speech Message Machines, 316  
E-Z Call, 316  
Emergency Call Alarm (AS,TR), 317  
EZRA (CI,EC,PC), 277  
First Aid Kit (EC,PC), 278  
Handheld Computers and Personal Organizers (EA,WP), 133  
High Tech/Low Cost (EC,NA,PT,TR), 223  
Home Intercom Systems (CI), 317  
Intercom (4392) (EC), 318  
JANICE Model 100 Invalid Security Alert System, 318



Lighted Extra Loud Signalling Buzzer (AS,TR), 319  
 Lighted Signalling Buzzer (AS,TR), 319  
 NeuroPage (AD,CR), 320  
 Omni Page System, 320  
 PA-1 Portable Alarm, 321  
 People Pager, 321  
 Personal Alert Receiver, 322  
 Personal Pager, 322  
 Personal Pager, 323  
 Personal Pagers, 323  
 RC5000 Radio Home Control System (EC), 291  
 Remote Wireless Paging Alarm, 324  
 Screamer Alarm, 324  
 SideKick Receiver, 325  
 Signal Buzzer (AS,TR), 325  
 Sound Advice System, 326  
 Vibra-Call Receiver, 326  
 Vocal Assistant (CI,EA), 159  
 Watchman Master, 327  
 WatchMate, 327  
 WatchMate LC, 328  
 Wireless Personal Pager, 328

### Cognitive Rehabilitation {CR}

*Programs designed specifically to be useful in cognitive rehabilitation. This designation is based upon the manufacturer's stated intent in product design.*

Antonyms and Synonyms (Cognitive Disorders 12) (LS,TT), 557  
 Aphasia Series: I through VIII (LS,TT), 558  
 Association Pictures (TT), 559  
 Attention, Perception & Discrimination Plus for Windows (TT), 559  
 Captain's Log: Cognitive Training System (AS,ES,LS,TT), 568  
 Categories Plus for Windows (TT), 569  
 Category Discrimination and Reasoning Plus for Windows (TT), 569  
 Category Naming and Completion Plus for Windows (TT), 570  
 Cognitive Disorders I, II, III, IV (TT), 573  
 Cogrehab Vol. 1 (LS,TT), 574  
 Cogrehab Vol. 2 (LS,TT), 574  
 Cogrehab Vol. 3 Version 2.0 (LS,TT), 575  
 Cogrehab Vol. 4 (LS,TT), 575  
 Cogrehab Vol. 5 (LS,TT), 576  
 Cogrehab Vol. 6 (LS,TT), 576  
 Cogrehab Vol. 7: Quest (LS,TT), 577  
 Completion From Partial Information Plus for Windows (TT), 581  
 Construc (TT), 583  
 Deductive Reasoning Plus for Windows (TT), 587  
 Definitions Plus for Windows (TT), 588  
 First Mate (TI), 600  
 Foundations I (ES,TT), 604  
 Foundations II (ES,TT), 604  
 Function Pictures (TT), 605  
 Functional Vocabulary Plus for Windows (TT), 605  
 Hierarchical Attention Training (LS,TT), 608  
 Homographs (LS,TT), 609  
 Homophones (LS,TT), 609  
 Inferential Naming for Cognitive and Language Disorders (LS,LT,TT), 611  
 Inferential Naming Plus for Windows (TT), 612  
 Initial Phoneme Cuing for Aphasics (TT), 613  
 Less, More, Make Equal (CN,TT), 623  
 Lingraphica (CI,EA,PA), 139  
 Logi (TT), 627  
 Magic (TT), 628  
 Mastering Personal Information (MPI) (AD,TT), 629  
 Math Max (CN,GA,TT), 630  
 Memory for Animated Sequences Plus for Windows (TT), 632  
 Memory I (ES,LS,TT), 632  
 Memory II (ES,LS,TT), 633  
 NeuroPage (AD,CM), 320  
 Octobus (CN,LS,TT), 645  
 Opposites and Similarities Plus for Windows (TT), 649  
 Picture Identification Plus for Windows (TT), 654

Picture Naming Plus for Windows (TT), 655  
 Pictures Programs: I, II and III (ES,LS,TT), 656  
 Prefix (CN,TT), 659  
 Preposition Fill-Ins (TT), 659  
 Problem Solving I (TT), 661  
 Program for Aphasics (ED,LS), 724  
 Reading Comprehension for Adolescents (TT), 664  
 Rhyming Pictures (TT), 665  
 Sorting by Category Plus for Windows (TT), 676  
 Special Education Public Domain Software (ED,LS,TT), 677  
 Studio4 (TT), 680  
 Telling Time (AD,TT), 689  
 THINKable/DOS (TT), 690  
 Understanding Attributes (TT), 697  
 Verb Fill-Ins (TT), 698  
 Visual Confrontation Naming Plus for Windows (TT), 700  
 Visual Memory Plus for Windows (TT), 701  
 Visual Pattern Memory Plus for Windows (TT), 702  
 Visuospatial Skills I (TT), 702  
 Visuospatial Skills II (TT), 703  
 Word Association Plus for Windows (TT), 706

### Conversation/Interaction {CI}

*Hardware, software and aids designed to be used for communication on a daily basis. Software-based products will also be coded TT (Training and Therapy Software) or PA (Personal Tool or Aid). Aids designed mainly for communication training or therapy are coded TR - Training and Communication Initiation (see below).*

911 Telephone Terminal (EC,TL), 263  
 AbiliTech Communicator (EC,PC), 264  
 Ability Switch Phone Sequencer (EC,PC), 265  
 Abovo PCD (EA,PW), 118  
 Access-I (PW,TT), 373  
 ActionVoice (EA,TR), 118  
 ADAPTA-LAN (LP,PC,TI,WP), 374  
 ADDvox III System (SA,VA), 3  
 Alphabet Board Kit (NA), 69  
 AlphaPad (NA), 70  
 AlphaTalker (EA,TI), 119  
 Appointment Book (NA), 70  
 ASCII-TDD Software (TD,TL), 179  
 Attainment Communication Collection (NA), 71  
 Attainment Fifteen Talker (EA,TR), 119  
 Attainment Five Talker & Talker Plus (EA,TR), 120  
 Attainment Two Talker (EA,TR), 120  
 Audible Cursor Routine (EA,PA,TR), 121  
 AudScan II (EA), 121  
 Aurora 2.0 for DOS (EA,LP,TA,TI,WP), 376  
 BIGmack (EA,TR), 122  
 BlackHawk (EA), 122  
 Blissymbol Vocabulary Stamps (NA), 72  
 Bradley Board Communication Aid (NA), 74  
 Calendars (NA), 74  
 Canon Communicator CC-7S and CC-7P (EA), 123  
 CanSpeak (LT,TT), 568  
 Card Communicator (RE,TR), 34  
 CarryCom (EA), 123  
 Chain Talk (NA), 75  
 Cheap Talk 4 & 8 (EA,TR), 124  
 Clear Clock Communicator (TR), 35  
 Cleo Communication Board (NA), 75  
 Clock Communicator (AS,TR), 36  
 Comboard (2615) (AS,TR), 36  
 Communication Binder (NA), 76  
 Communication Board (NA), 76  
 Communication Folder and Tri-Folder (NA), 78  
 Communication Programs (EA,EC,TR), 124  
 Communication Sheets (NA), 79  
 Communication Symbol Holders (NA), 79  
 Communiclock (AS,TR), 37  
 Companion 401 Communicator (CM,EA,TL,TR), 125  
 Compartmentalized Clock Communicator (TR), 38

## Index 1: Products Listed by FUNCTION

- Compartmentalized Communicator (AS,TR), 38  
Core Picture Vocabulary (NA,TR), 80  
Core Vocabulary (NA), 80  
Crespeaker (EA,TL), 125  
Crestalk (EA), 126  
DAC (EA,SS), 126  
DeltaTalker (EA), 127  
Deluxe Communication Board Kit (NA), 81  
Deluxe Talk Board (NA), 81  
Dial Scan (AS,TR), 40  
Dialogue TTYs (PC,TD,TL), 180  
Dialogue VCO Read & Talk Telephone (TD,TL), 181  
DigiTalk I (EA,TR,TT), 127  
DigiVox (EA), 128  
Dual Clock Communicator (TR), 42  
Duo-Responder (TR), 42  
Dvorak One-Hand Typewriter (EA,PW), 128  
DynaSyms (NA), 82  
DynaVox2 & DynaVox2c (EA), 129  
E-Tran Scanner (AS,TR), 43  
EasyTalk (EA), 130  
Emotional Moods & Needs-G 3&4 (NA), 82  
Equalizer (DR,EA,PW,RE,TL,WP), 131  
EvalPAC with RealVoice (AS,EA,EC,PW,TI), 131  
Eye Transfer Communication System (NA), 83  
Eye-Com (NA), 83  
Eye-Com Board (NA), 84  
EZRA (CM,EC,PC), 277  
FingerFoniks (EA), 132  
Fold It System (NA), 84  
Foods I Like Menu Book (NA), 85  
Futura-TTY (TD,TL), 181  
GEWA Infra-Link Speaker-Telephone (EC,PC), 279  
Gus! Multimedia Speech System (EA,KM,TI), 133  
HandiPHONE (EC,PC), 281  
Handy Speech Communication Aide (EA,SS), 134  
Hawk (EA,TR), 134  
Heidico Intertalk (EA,TD), 135  
Help Me to Help Myself Handbook (NA), 86  
Help U Type and Speak (EA,KM), 135  
Holiday Kit (NA), 86  
Home Intercom Systems (CM), 317  
I Can Speak (EA), 136  
ICU-G 1&2 (NA), 87  
Illustrated Menu (NA), 87  
Individualized Communication Systems (NA), 88  
InfoTouch (BR,BT,PC,TD,TL), 182  
Intele-Modem (TD,TL), 182  
IntelliTalk (EA,PA), 137  
Laser Optic Keyboard (TI), 407  
Liberator (CN,EA,EC,PW,TI), 137  
Life Experiences Communication Kit (NA), 89  
Light Activated Switch Panel (TR), 46  
LightWRITER SL35 (EA), 138  
LightWRITER SL5 (EA), 138  
LightWRITER SL85 (EA), 139  
Lingraphica (CR,EA,PA), 139  
Long Wallet (NA), 89  
Lynx (EA,TR), 140  
Mac-Apple Communications Aid (CN,DR,ES,PA,TT,WP), 756  
Macaw Series (EA), 140  
Mealtime Stickers (NA), 90  
Mega-Book (NA), 90  
MegaWolf (EA), 141  
Message Center (TD,TL), 183  
MessageMate 20 (EA,TR), 141  
MessageMate 40 (EA,TR), 142  
Messenger (EA,TR), 142  
Meta4 (EA), 143  
Mid-Sized Communication Book (NA), 91  
Mini Picture Set (NA), 91  
Mini Talking Card Reader (EA,TR), 143  
Mini-MessageMate (EA,TR), 144  
Minicom IV (PW,TD,TL), 184  
Miniprint 425 (PC,TD,TL), 185  
Minspeak Application Programs (MAP) (PA), 759  
MultiPhone (EC,PC), 287  
Nine Compartment Row/Column Scanner (TR), 48  
Nu-Vue-Cue (NA), 92  
Oakland Schools Picture Dictionary (NA), 92  
Object Communicator (NA), 93  
Object Display (NA), 93  
Object Stand or Calendar Box (3 or 5) (NA,TR), 94  
Object-Picture Talk Board (NA,TR), 94  
Opticomunicator (NA), 95  
Parrot (EA,TR), 144  
Passport Kits (NA), 95  
Pay Phone TTY (PC,TD,TL), 186  
PCS Color Stickers (NA), 96  
PCS Stamps (NA), 96  
PEACEbook (NA), 97  
Pegasus (EA,EC), 145  
Personal Communication Terminal (PCT) (TD,TL), 186  
Personal Trainer (EA,TR), 145  
Phone-TTY CM-4 Computer Modem (PC,TD,TL), 187  
Pick 'n Stick Color Micros (NA), 98  
PK SYMS Categorical Dictionary (NA), 100  
Pictalk (ES,TR,TT), 653  
Picture Communication Symbols, Books I, II & III (NA), 101  
Picture Cue Dictionary (AD,LT,NA,TT), 654  
Picture Prompt Cards (NA), 102  
Picture Prompt Stickers (NA), 102  
Picture Prompt System (NA), 103  
Picture Your Blissymbols (NA), 103  
Pictures, Please! (NA), 104  
Pocket Book (NA), 104  
Pocket-Sized and Double Pocket-Sized Communication Book (NA), 105  
Polycom (EA,PC,PW,TL,WP), 146  
Porta Boards (NA), 106  
Porta Book (NA), 106  
Porta Printer Plus (TD,TL), 187  
PortaView (TD,TL), 188  
Positron Express (TD,TL), 188  
Quad Talk (AS,TR), 52  
ReadyScan (EA), 147  
RealVoice (AS,EA,EC,PW,TI), 147  
Robot Voice Synthesizer (SA), 9  
Round Clock Communicator (TR), 53  
Say-It-All II Plus (EA,KG,PW), 148  
Say-It-Simply Plus (EA,TR), 148  
Scan Com (EA,EC), 149  
Scan-It-All (EA,EC), 149  
ScanLite (TR), 53  
ScanPAC (CN,EA,EC,PW,TI), 150  
Scribe (EA,KG,PW), 150  
Secretary (EA,PW,TR), 151  
Self-Talk Stickers (NA), 107  
Sequential Scanner (AS,TR), 54  
Shadow Talker (EA,TR), 151  
SIDD (Software Interface for the Deaf and Disabled) (TD,TL), 189  
Silent Speaker (NA), 108  
SimpleCom I: Yes/No Communication (TR,TT), 674  
SimpleCom II: Needs/Wants Communication (TR,TT), 674  
SM85 Smart ASCII/Baudot Modem (PC,TD,TL), 186  
SpeakEasy (EA), 152  
Speaking Dynamically (EA), 152  
Specialist (EA,NA,TR), 153  
Steeper Communication/Teaching Aid (AS,TR), 56  
Stickers for Talk Boards (NA), 108  
Supercom 4400 TTY (TD,TL), 190  
Superprint 100, 200, 400 (PC,TD,TL), 190  
Superprint 4425 (PC,TD,TL), 191  
Superprint ES TTY (PC,TD,TL), 191  
Switch Module (EA,TR), 153  
Switchboard (EA), 154  
SynergyMac and SynergyPC (PW,TI), 444  
System 2000 (EA), 154  
Talk Back III (EA,TR), 155  
Talk Back VI (EA,TR), 155

Talk:About (EA), 156  
 Talking Nouns, Talking Nouns II, and Talking Verbs (TR,TT), 686  
 Talking Pictures Communication Board (NA), 109  
 Talking Pictures, Kits I - VII (NA,SI), 109  
 Talking Screen (EA,PA), 156  
 Talking Screen for Windows (EA,PA), 157  
 Talking Switch Plates (EA,TR), 157  
 Talking Touch Window (AS,TR,TT), 687  
 TDD 2700, 2730, and 2830 (PC,TD,TL), 192  
 TDD Trainer System (TD,TR), 58  
 TeleBraille III (PC,TD,TL), 193  
 ToneTalker (TD,TL), 194  
 Touch 'N Talk Communication Board (NA), 110  
 Touch 'N Talk Communication Notebook (NA), 110  
 Touch 'N Talk Communication Stickers (NA), 111  
 Touch 'N Talk Micros (NA), 111  
 TS2010X Text to Speech Personal Communicating Device (EA), 158  
 Turn-Talking (TR,TT), 695  
 Uniphone TDD/TT (TD,TL), 195  
 VCS 3700 with TDD Software (TD,TL), 196  
 V-Scan (AS,TR), 63  
 Vocal Assistant (CM,EA), 159  
 Voice Amplifier (SA,VA), 11  
 VoiceBachs (EA,SS), 159  
 VoicePal (EA,TR), 160  
 VoicePal Plus (EA,TR), 160  
 VOIS 160 (EA), 161  
 VX-5000 Cordless Phone (EC PC), 305  
 WalkerTalker (EA), 161  
 WhisperWolf (EA), 162  
 WinTalk (TD,TL), 196  
 WordWise Language & Master Cards (NA), 112  
 WordWise Sticker Set (NA), 112  
 Writalk Electronic Pen Pad (TD,TL), 197  
 Write (ED,LS,SV), 733  
 Writing Utensil Grips (NA,PT), 113  
 Yak Bak (EA,TR), 162  
 Zoo Kit (NA), 113

### Database Management/Spreadsheets {DS}

*Specially adapted hardware or software that provides the user with electronic database or spreadsheet capabilities. An example would be a voice-output spreadsheet program designed for blind computer users. Products which provide special access to many different software programs would not be included here (see "Alternate Inputs Usable with All Software." TI).*

BIG for 1-2-3 (LP,PA), 739  
 File-Talk (PA,SI), 750  
 TouchWindow (DR,ID,RE,TI,WP), 444

### Drawing {DR}

*Special hardware or software designed to facilitate a disabled person's ability to draw.*

Blocks in Motion (RE,TT), 563  
 Electric Crayon and Electric Crayon Deluxe (PA,RE), 748  
 Equalizer (CI,EA,PW,RE,TI,WP), 131  
 ETgraphX (BR,PA), 749  
 HeadMouse (MT,TI), 394  
 Mac-Apple Communications Aid (CI,CN,ES,PA,TT,WP), 756  
 MicroIllustrator (PA,RE,TT), 758  
 My Paint & Talking Coloring Books (ES,LT,TT), 642  
 One Switch Picasso (RE,TT), 648  
 Picture Perfect (PA,RE), 762  
 PowerPad (RE,TI), 432  
 Remote Keyboard for the Apple II+ and IIc (TI), 436  
 Scanning Picasso (RE,TT), 668  
 TouchWindow (DS,ID,RE,TI,WP), 444

### Early Skills (Pre-Reading) {ES}

*Software designed to teach skills that are pre-reading. "Later Skills" (LS) designates post-reading skills.*

Adventures of Jimmy Jumper - Prepositions (AS,LT,TT), 557  
 Bear Jam (TT), 561  
 BEST Faces (TT), 562  
 Big/Little I and II (TT), 562  
 Body Builder (TT), 564  
 Buddy's Body (AS,TT), 566  
 Captain's Log: Cognitive Training System (AS,CR,LS,TT), 568  
 Cause 'n Effect (TT), 571  
 Circletime Tales & Circletime Tales Deluxe (TT), 572  
 Cognitive Rehabilitation Software (LS,LT,TT), 573  
 COINSNKEYS (CN,KB,TT), 577  
 Color Find (TT), 578  
 Colorful Concept Software (TT), 578  
 Colors and Shapes (TT), 579  
 Community Vehicles (TT), 580  
 Computer CUP (LT,TT), 581  
 Creature Cartoons (GA,TT), 584  
 Dino-Games (TR,TT), 588  
 Dinosaur Game (GA,TR,TT), 589  
 Early Concepts (TT), 590  
 Early Learning 3.5/Complete Early Learning 5.25 (ED,LS,TT), 591  
 Early Learning I (TT), 592  
 Early Learning II (CN,ED), 717  
 Edmark Reading Program, Level I Software (ED,LS), 718  
 Eency-Weency Spider Game (TT), 593  
 ERIN (Early Recognition Intervention Network) (AS,ED), 719  
 Family Fun (AS,TT), 596  
 Fast Food Game (TT), 596  
 Feelings (TT), 597  
 First Categories (LS,LT,TT), 599  
 First Verbs and Primeros Verbos (LT,TT), 601  
 First Words (LT,TT), 601  
 First Words II (LT,TT), 602  
 Following Directions: One- and Two-Level Commands (TT), 602  
 Following Directions: Left and Right (TT), 603  
 Foundations I (CR,TT), 604  
 Foundations II (CR,TT), 604  
 Fundamental Concepts (TT), 606  
 Further Adventures of Jimmy Jumper - Perseverance (AS,TT), 606  
 Geometric Figures and Spatial Concepts (ED), 720  
 If You're Happy and You Know It (TT), 610  
 Interaction Games (GA,TR,TT), 613  
 Interaction Games II (GA,TR,TT), 614  
 Join the Circus (AS,TT), 616  
 JOKUS Software (ED), 721  
 Learning the Alphabet (ED), 722  
 Let's Go Shopping I and II (TT), 624  
 Letter Find (CN,KB,SV,TT), 625  
 Logo TouchTools for the PowerPad (AS,TT), 627  
 Mac-Apple Communications Aid (CI,CN,DR,PA,TT,WP), 756  
 Make It In Time (AS,TT), 628  
 Make It Scan (AS,TT), 629  
 Memory I (CR,LS,TT), 632  
 Memory II (CR,LS,TT), 633  
 Mix 'N Match (TT), 636  
 MusicWare (CN,GA,LS,TT), 640  
 MusicWare - Age Appropriate (GA,TT), 641  
 My Paint & Talking Coloring Books (DR,LT,TT), 642  
 Old MacDonald's Farm I and II (LS,TT), 646  
 Padded Food (AS,TT), 650  
 Padded Vehicles (TT), 651  
 Paper Dolls I and II (AD,TT), 651  
 Pictalk (CI,TR,TT), 653  
 Pictures Programs: I, II and III (CR,LS,TT), 656  
 Press to Play (TR,TT), 660  
 Rabbit Scanner (AS,TT), 662  
 Reactions (R73) (TT), 663  
 Reading Horizons (ED), 725  
 Rockets to the Moon (GA,TR,TT), 666  
 Run Rabbit Run (AS,TT), 666

## Index 1: Products Listed by FUNCTION

Sharon's Programs (ED,LS), 726  
Shell Game & Mouse Game (GA,TT), 672  
Silly Sandwich (TT), 673  
Simple Sentence Structure (LT,TT), 673  
Switch Art (TT), 683  
Switch It - Change It (TT), 683  
Switch It - See It (TT), 684  
Tea Party (TT), 688  
Telling Time, Parts of the Face, Learning Colors (TT), 690  
This is the Way We Wash Our Face (TR,TT), 691  
Touch and Match (TT), 692  
Touch and See (TT), 693  
UKanDu Switches, Too! (TT), 697  
Visual Motor Skills (TT), 701  
Wheels On The Bus I, II, III (TR,TT), 704  
Wheels on the Bus I, II, III - Intellipics Activity (GA,TT), 704  
Wheels on the Bus: COMPLETE (TT), 705  
Where is Puff? (TT), 705  
Worm Squirm (TR,TT), 708  
Zoo Time (TT), 709

### Electronic Communication and Writing Aids {EA}

*Dedicated electronic conversation and writing aids. Most offer printed output, synthesized voice output, or both.*

A.I.P.S. Wolf (Alternate Input Peripheral System), 117  
Able2Speak, 117  
Abovo PCD (CI,PW), 118  
ActionVoice (CI,TR), 118  
AlphaTalker (CI,TT), 119  
Attainment Fifteen Talker (CI,TR), 119  
Attainment Five Talker & Talker Plus (CI,TR), 120  
Attainment Two Talker (CI,TR), 120  
Audible Cursor Routine (CI,PA,TR), 121  
  udScan II (CI), 121  
Aurora 2.0 for DOS (CI,LP,TA,TI,WP), 376  
BIGmack (CI,TR), 122  
BlackHawk (CI), 122  
Canon Communicator CC-7S and CC-7P (CI), 123  
CarryCom (CI), 123  
Cheap Talk 4 & 8 (CI,TR), 124  
Communication Programs (CI,EC,TR), 124  
Communilight 24 (TR), 37  
Companion 401 Communicator (CI,CM,TL,TR), 125  
Crespeaker (CI,TL), 125  
Crestalk (CI), 126  
DAC (CI,SS), 126  
DeltaTalker (CI), 127  
DigiTalk 1 (CI,TR,TT), 127  
DigiVox (CI), 128  
Dvorak One-Hand Typewriter (CI,PW), 128  
DynaVox2 & DynaVox2c (CI), 129  
DynaVox2 DOS & DynaVox2 Mac, 129  
EasyTalk (CI), 130  
Electronic Speech Synthesizers, 130  
Equalizer (CI,DR,PW,RE,TI,WP), 131  
EvalPAC with RealVoice (AS,CI,EC,PW,TI), 131  
Eyegaze Computer System (EC,PC,TI), 132  
FingerFoniks (CI), 132  
Gus! Multimedia Speech System (CI,KM,TI), 133  
Handheld Computers and Personal Organizers (CM,WP), 133  
Handy Speech Communication Aide (CI,SS), 134  
Hawk (CI,TR), 134  
Heidico Intertalk (CI,TD), 135  
Help U Type and Speak (CI,KM), 135  
HyperBliss 3.2, 136  
I Can Speak (CI), 136  
IntelliTalk (CI,PA), 137  
Liberator (CI,CN,EC,PW,TI), 137  
LightWRITER SL35 (CI), 138  
LightWRITER SL5 (CI), 138

LightWRITER SL85 (CI), 139  
Lingraphica (CI,CR,PA), 139  
Lynx (CI,TR), 140  
Macaw Series (CI), 140  
MegaWolf (CI), 141  
MessageMate 20 (CI,TR), 141  
MessageMate 40 (CI,TR), 142  
Messenger (CI,TR), 142  
Meta4 (CI), 143  
Mini Talking Card Reader (CI,TR), 143  
Mini-MessageMate (CI,TR), 144  
Parrot (CI,TR), 144  
Pegasus (CI,EC), 145  
Personal Trainer (CI,TR), 145  
Picture Icon X-CHANGE, 146  
Polycom (CI,PC,PW,TL,WP), 146  
ReadyScan (CI), 147  
RealVoice (AS,CI,EC,PW,TI), 147  
Say-It-All II Plus (CI,KG,PW), 148  
Say-It-Simply Plus (CI,TR), 148  
Scan Com (CI,EC), 149  
Scan-It-All (CI,EC), 149  
ScanPAC (CI,CN,EC,PW,TI), 150  
Scribe (CI,KG,PW), 150  
Secretary (CI,PW,TR), 151  
Shadow Talker (CI,TR), 151  
SpeakEasy (CI), 152  
Speaking Dynamically (CI), 152  
Specialist (CI,NA,TR), 153  
Switch Module (CI,TR), 153  
Switchboard (CI), 154  
System 2000 (CI), 154  
T-TAM Keyboard and Mouse Emulator (IA,KM,MT,TT), 463  
Talk Back III (CI,TR), 155  
Talk Back VI (CI,TR), 155  
Talk About (CI), 156  
Talking Screen (CI,PA), 156  
Talking Screen for Windows (CI,PA), 157  
Talking Switch Plates (CI,TR), 157  
TS2010X Text to Speech Personal Communicating Device (CI), 158  
VisionKey (TI), 158  
Vocal Assistant (CI,CM), 159  
VoiceBachs (CI,SS), 159  
VoicePal (CI,TR), 160  
VoicePal Plus (CI,TR), 160  
VOIS 160 (CI), 161  
WalkerTalker (CI), 161  
WhisperWolf (CI), 162  
Yak Bak (CI,TR), 162

### Environmental Controls {EC}

*Devices or systems whose functions is to control some other device in the person's environment: lamp, TV, telephone, etc. Exceptions are (1) devices used to control computers and (2) devices used to control battery-operated devices (such as toys) for the purpose of encouraging switch operation or teaching communication skills. The former are listed under Alternate Inputs Usable with All Software (TI), the latter are listed under Training and Communication Initiation (TR)*

911 Telephone Terminal (CI,TL), 263  
AbiliTech Commander IR, 263  
AbiliTech Commander X-10, 264  
AbiliTech Communicator (CI,PC), 264  
AbiliTech Home Control System (PC), 265  
Ability Switch Phone Sequencer (CI,PC), 265  
Able-Phone 100WA (PC), 266  
Able-Phone 1900 and 2000 (PC), 266  
Able-Phone 6000SX (PC), 267  
ACS Headsets (PC), 267  
Activity Board (AS,TR), 30  
Adapted Telephone Interfaces (PC), 268  
APT Automaddak Page Turner System (BP), 268  
Automatic Drapery Opener System, 269

- Bed Control (DBC-1), 269  
 Big Button Bed Control, 270  
 Butler-in-a-Box (PC, TI), 270  
 CCT Environmental Control, 271  
 CINTEX I (PA, PC, RE, TA, TI, WP), 744  
 CINTEX2 (PA, PC), 271  
 Communication Programs (CI, EA, TR), 124  
 Control I (PC), 272  
 Controller, 272  
 Custom Speaker Phone (PC), 273  
 Delay Timer Box (AS, TR), 40  
 DEUCE (PC), 273  
 Dual Channel Latching Switch Interface (AS, TR), 41  
 E Z Keys (KM, TA), 339  
 E.A.S.I. dialer (2110) (PC), 274  
 EASICORDER, 274  
 Environment Control, 275  
 Environmental Control Units, 275  
 EvalPAC with RealVoice (AS, CI, EA, PW, TI), 131  
 Expanded Keyboard for Automatic Telephone (PC), 276  
 Eye Slaved Pointing System (PC, TI), 387  
 Eyegaze Computer System (EA, PC, TI), 132  
 EZ-TV Adapted Infrared Remote Control for Televisions, 276  
 EZRA (CI, CM, PC), 277  
 F71863 Touchables Touch Phone Attachments (PC), 277  
 First Aide Kit (CM, PC), 278  
 Fone Holder (PC), 278  
 FreeSwitch, 279  
 GEWA Infra-Link Speaker-Telephone (CI, PC), 279  
 GEWA Infra-Link System (PC), 280  
 Gewa Page Turner (BP), 280  
 Giant Push Button Telephone Adapter (PC), 281  
 HAL (Home Automation Link) (PC, TI), 392  
 HandiPHONE (CI, PC), 281  
 Head Position Interface, 222  
 HECS-1 (PC), 282  
 High Tech/Low Cost (CM, NA, PT, TR), 223  
 Home Control Systems, 282  
 HomeAccess (PA), 283  
 In & Out Automatic Door Controller, 283  
 Infrared Remote Control IRTI-1, 284  
 Intercom (4392) (CM), 318  
 Kincontrol (4105), 284  
 LIAISON (KE, PC, TI), 407  
 Liberator (CI, CN, EA, PW, TI), 137  
 Mastervoice Environmental Control Single User Unit (PC), 285  
 Media Handling Products (BP, PT), 549  
 Memory Button Telephones (PC), 285  
 Mini-Environmental Control (ECU) Box, 286  
 Motorized Easel (BP), 286  
 MultiPhone (CI, PC), 287  
 Next Page Page Turner (4600) (BP), 287  
 On/Off Remote Switch, 288  
 Pegasus (CI, EA), 145  
 Phone Manager (PA, PC), 288  
 PhoneAccess (PC), 289  
 Portable Telephones (PC), 289  
 PowerLink 2, 290  
 PROXi (PC), 290  
 RC5000 Radio Home Control System (CM), 291  
 RealVoice (AS, CI, EA, PW, TI), 147  
 RELAX (8200), 291  
 Remote Control Speakerphone Model RC3000 (PC), 292  
 Saltus Reader (BP), 292  
 Sapura S2000 CL (PC), 292  
 Scan Com (CI, EA), 149  
 Scan-It-All (CI, EA), 149  
 Scanning Director, 293  
 Scanning Remote Control (SRC), 294  
 Scanning X-10 Powerhouse, 294  
 ScanPAC (CI, CN, EA, PW, TI), 150  
 SenSei System (PA, PC, TI, TL), 295  
 Simplicity Series ECUs (PC), 295  
 Single-Appliance Continuous Control Unit (TR), 296  
 Single-Switch Multi-Appliance Control Unit & Modules, 296  
 Single-Switch TV Control Unit, 297  
 Sip/Puff Bed Control, 297  
 Slide Projector Control (RE, TR), 55  
 Speaker Phones (PC), 298  
 Switch Latch (4388) (AS, TR), 56  
 Synergy Integrated Remote (PA), 298  
 T-140 Series Puff/Sip Speakerphones (PC), 299  
 TEAM (PA), 299  
 Telephone Holder & Line Connector (PC), 300  
 Telephone Management System (PC), 300  
 Timer Module (AS, TR), 59  
 Touch Turner (BP), 301  
 Training Aid 2 (AS, TR), 61  
 TVRC and TVRCS, 301  
 U-Control, 302  
 Ultra 4 Remote System & Scanning Ultra 4, 302  
 Universal Control System with Tongue Touch Keypad (PC), 303  
 Universal Remote Controls, 303  
 Universal Telephone Adapter (PC), 304  
 Universal Television Remote Control, 304  
 URC-400 Series Universal Remote Control, 305  
 VX-5000 Cordless Phone (CI, PC), 305  
 Wireless TV & VCR Remote Controls, 306  
 X-10 Home Control Interface, 306  
 X-10 Powerhouse System, 307
- ### Games {GA}
- Software products that consist of a game or are written in a game format. Educational programs with a game format will also be listed under Adaptive Educational Software (ED).*
- Audio Braille Game Tutorial (BR, RE, TT), 560  
 Bozons' Quest (LS, TT), 564  
 Creature Antics and Creature Capers (TR, TT), 584  
 Creature Cartoons (ES, TT), 584  
 Creature Magic (LS, LT, RE, TT), 586  
 CrossWords (LS, TT), 586  
 Dinosaur Game (ES, TR, TT), 589  
 Every Day Is A Holiday (RE, TT), 595  
 FingerZoids (SI, TT), 599  
 Governor (2464) (PA), 547  
 H:1 Handicapped Word Games (ED, LS, PA, RE), 752  
 Interaction Games (ES, TR, TT), 613  
 Interaction Games II (ES, TR, TT), 614  
 Listen With Your Ears (TT), 626  
 Math Max (CN, CR, TT), 630  
 Maze (RE, TT), 631  
 Mind Castle I and II (LS, TT), 635  
 Motor Training Games (AS, PA, RE, TT), 638  
 Motor Training Games (TR, TT), 638  
 Mouth Operated Joystick for Genesis Video Game (RE, TI), 422  
 Multi-SCAN (TR, TT), 639  
 Muppet Learning Keys (ID, TI), 423  
 MusicWare (CN, ES, LS, TT), 640  
 MusicWare - Age Appropriate (ES, TT), 641  
 Pick-A-Meal (AD, TT), 653  
 PowerPad Preschool Pack I & II (TT), 658  
 Race the Clock (RE, TT), 662  
 Rockets to the Moon (ES, TR, TT), 666  
 Shell Game & Mouse Game (ES, TT), 672  
 Son of Seek and Find (TT), 676  
 Switch Arcade (RE, TT), 682  
 Switch Arcade (TT), 682  
 Talking Literacy Kit for the Apple IIe (TALK IIe) (KB, TT, WP), 686  
 Trip to the Zoo (TT), 695  
 Wheels on the Bus I, II, III - Intellipics Activity (ES, TT), 704  
 Wordplay with Alps and Droops (ED, LS), 732

## Input Adapters for Computers {IA}

*Special adapters that go between adaptive devices (switches, controls, keyboards, etc.) and the standard computer. These adapters have no function in and of themselves except to act as an adapter to allow the special input device to be plugged into the computer. The adapters may simply adapt from one type of connector to another (for instance a box that connects switch plugs to a joystick plug), or they may provide more sophisticated functions (for example keyboard emulating interfaces for adapting communication aids to computers).*

Access Pack for Microsoft Windows (KM,MT,TI), 331  
AccessDOS (KM,MT,TI), 332  
Adaptive Firmware Card Model G32c (KE,KM,TI), 374  
Apple Computer Input Adapter, 453  
BEST Switch Interface, 453  
ClickIt!, 454  
Computer Interface Box, 454  
Computer Switch Interface, 455  
CrossScanner, 455  
DA-II Adapter, 456  
Input Adapter, 456  
Internal I/O Port Adapter, 457  
Judy Lynn PC Adapter, 457  
Keyboard Expander, 458  
Keyboard Interfaces (KE), 458  
Mac PowerPad Interface for Single Switches, 459  
Macintosh Switch Interface (M09), 459  
One Access (TI), 427  
PCMaster & Windows Master (BR,SV,VS), 460  
PlayMAGIC, 460  
Porter, The, 461  
PowerSwitch, 461  
SS-ACCESS!, 462  
SuperPort, 462  
Switch Interface, 463  
SynPhonix 210 and 215 (SS), 536  
T-TAM Keyboard and Mouse Emulator (EA,KM,MT,TI), 463  
Universal Input Adaptor, 464  
WinSCAN: Limited Edition, 464

## Input Devices Usable with Only Some Software {ID}

*Special input devices that can be used with computers but which do not provide "transparent" access; that is, they do not allow the user to operate all software that could be operated with an equivalent "standard" input device, such as a keyboard or mouse. Instead, these input devices are designed to be used in conjunction with software written expressly for them. If a special hardware or software adaptor is available that converts the input device to transparent input device, then it is listed under Alternate Inputs Usable with All Software (TI), above.*

Hand Controls (TI), 392  
Listen for Windows (TI), 409  
Muppet Learning Keys (GA,TI), 423  
Switch-Back (TI), 443  
TouchWindow (DR,DS,RE,TI,WP), 444

## Keyboard Emulating Interfaces (Adapters Only) {KE}

*Adapters which allow some device that does not normally emulate a standard computer keyboard to emulate a standard computer keyboard. For instance, certain keyboard emulation interfaces can be connected between an electronic communication aid and a computer so that the user of the aid can operate the computer using the communication aid instead of the computer's regular keyboard.*

Adaptive Firmware Card Model G32c (IA,KM,TI), 374  
Ke:nx (MT,TI), 402

Keyboard Interfaces (IA), 458  
LIAISON (EC,PC,TI), 407  
My-T-Mouse (TI), 424

## Keyboarding Training Programs {KB}

*Software which facilitates the acquisition of keyboarding skills (using the standard computer keyboard). Only keyboarding programs especially designed for disabled computer users are included.*

COINSNKEYS (CN,ES,TT), 577  
Computer Literacy Series (TT), 582  
Keyboarding by Ability (ED,TT), 617  
Keyboarding for Individual Achievement (ED,TT), 617  
Keyboarding for People with Cerebral Palsy (ED,TT), 618  
Keyboarding Program with Voice Output (TT), 618  
Keyboarding with One Hand (ED,TT), 619  
Keys to Success: Comp. Keybd. Skills for Blind Children (SV,TT), 619  
Letter Find (CN,ES,SV,TT), 625  
Opening Windows (TT), 649  
PC Typer (TT), 652  
Talking Literacy Kit for the Apple IIe (TALK IIe) (GA,TT,WP), 686  
Talking Typer (SV,TT), 687  
Talking Writer & Four Games (LP,PA,SV,TT,WP), 766

## Keyguards {KG}

*Plastic or metal plate that covers the computer keyboard, with holes positioned over each of the keys. Also, any device with a built-in or optional keyguard.*

Custom Keyguard (KM), 336  
Expanded Keyboard for IBM Computers (TI), 385  
Expanded Keyboards for the Talking BlissApple (TI), 386  
KeyGuard (KM), 349  
Keyguard (KM), 349  
Keyguards (KM), 350  
PowerPad Keyguard (KM), 359  
Reinforced Keyguard (KM), 362  
Say-It-All II Plus (CI,EA,PW), 148  
Scribe (CI,EA,PW), 150

## Language Therapy/Development {LT}

*Software designed to be used for language therapy or language development. Not the same as Speech Therapy (ST).*

Adventures of Jimmy Jumper - Prepositions (AS,ES,TT), 557  
Breakthrough to Language: Clinical Edition (ST,TT), 565  
Breakthrough to Language: Home Edition (ST,TT), 566  
CanSpeak (CI,TT), 568  
Cognitive Rehabilitation Software (ES,LS,TT), 573  
Community Signs (AD,LS,TT), 580  
Computer CUP (ES,TT), 581  
CONCENTRATE! On Words & Concepts (LS,TT), 582  
Core Reading and Vocabulary Development (ED,LS,TT), 583  
Creature Magic (GA,LS,RE,TT), 586  
Early Emerging Rules Series (LS,TT), 591  
Employment Signs (AD,LS,TT), 594  
Exploring Early Vocabulary Series (LS,TT), 595  
First Categories (ES,LS,TT), 599  
First Step Software (TT), 600  
First Verbs and Primeros Verbos (ES,TT), 601  
First Words (ES,TT), 601  
First Words II (ES,TT), 602  
GrammarPlay with Alps and Droops (LS,TT), 607  
Inferential Naming for Cognitive and Language Disorders (CR,LS,TT), 611  
Information Signs (AD,LS,TT), 612  
Let's Go to the Circus (TT), 624

Micro-LADS and Micro-LADS in French (TT), 634  
 Multiple Meaning Words I Plus for Windows (TT), 639  
 Multiple Meaning Words II Plus for Windows (TT), 640  
 MY HOUSE: Language Activities of Daily Living (LS,TT), 641  
 My Paint & Talking Coloring Books (DR,ES,TT), 642  
 MY TOWN: Language Activities of Daily Living (LS,TT), 643  
 Picture Cue Dictionary (AD,CI,NA,TT), 654  
 Rate Drill in Articulation, Language and Fluency (ST,TT), 663  
 Safety Signs (AD,LS,TT), 667  
 Semantic Development Using Code Breaking Strategies (LS,TT), 670  
 Sentence Completion Plus for Windows (TT), 670  
 Sentence Key & Picture Sequence Key (TT), 671  
 Simple Sentence Structure (ES,TT), 673  
 Survival Words (AD,AS,LS,TT), 681  
 Swim, Swam, Swum: Mastering Irregular Verbs (LS,TT), 681  
 Transportation Signs (AD,LS,TT), 694  
 Twenty Categories (LS,TT), 696  
 Verbal Analogies (LS,TT), 698  
 Verbal Analogies Plus for Windows (TT), 699  
 Word Order in Sentences (LS,TT), 706  
 Word Order Plus for Windows (TT), 707  
 Words and Concepts I, II, III (LS,TT), 707  
 WordWise Software (TT), 708

### Large Print Output {LP}

Software or devices specifically designed to produce large print, either on the screen or on paper. The product must be designed to be usable by people with visual impairments.

ADAPTA-LAN (CI,PC,TI,WP), 374  
 Adjustable EZ Magnifier (MG), 493  
 Aurora 2.0 for DOS (CI,EA,TA,TI,WP), 376  
 B-Edit (PA,TA,WP), 738  
 Beamscope (MG), 494  
 BEX 3.1 (BR,PA,SV,WP), 739  
 BIG for 1-2-3 (DS,PA), 739  
 BIG for WordPerfect (PA), 740  
 Big-W (MG), 494  
 Big:Calc (CN,PA), 740  
 Biggy (PA), 741  
 Calc-Talk (CN,PA,SV), 743  
 CloseView (MG), 495  
 Combination Braille/Large Print Keypat Labels (BR,KM), 335  
 Compu-Lenz (MG), 495  
 Eye Relief (PA,WP), 750  
 Gizmo (SV,VS), 473  
 GINK Magnifier (MG), 496  
 inLARGE 2.0 (MG), 496  
 Language Master Special Edition - LM6000SE (LS,PA,SV,TT,VS), 477  
 Large Print Word Processors (PA,WP), 755  
 Large-Type Display Utility Software (MG), 497  
 LP-DOS & LP-Windows (MG), 498  
 MAGic and MAGic Deluxe (MG), 498  
 Magic Slate II (LS,PA,TT,WP), 756  
 Magnum GT (MG), 499  
 MegaDots (BR,PA), 757  
 NuVu Magnifier (MG), 500  
 Optacon II (BT), 518  
 Panorama (MG), 500  
 Powerama (MG), 501  
 Screen Magnifier/2 (MG), 501  
 Speak Out VOILA (MG,SV,TI,VS), 440  
 Storytime Series (AD,TR,TT), 679  
 Storytime Series for Macintosh (AD,TR,TT), 679  
 Talking Writer & Four Games (KB,PA,SV,TT,WP), 766  
 Vantage CCD (MG), 502  
 VisAbility (PA), 771  
 Vista (MG), 502  
 Zoom Text 5 (MG), 503

### Later Skills (Includes Reading) {LS}

Software designed to teach post-reading academic skills. Early Skills (ES) designates skills that are pre-reading.

Antonyms and Synonyms (Cognitive Disorders 12) (CR,TT), 557  
 APH/SEI Talking Software (ED,SV), 713  
 Aphasia Series: 1 through VIII (CR,TT), 558  
 Arithmetic I, 2, and 3 with Speech (CN,ED,SV), 714  
 Basic Learning Skills Courseware (CN,ED), 714  
 Be a Winner Series (TT,VO), 561  
 Blueprint for Decision Making (TT), 563  
 Bozons' Quest (GA,TT), 564  
 CAMEO (AD,CN,ED), 715  
 Captain's Log: Cognitive Training System (AS,CRES,TT), 568  
 Career English (ED,VO), 715  
 Cognitive Rehabilitation Software (ES,LT,TT), 573  
 Cogrehab Vol. 1 (CR,TT), 574  
 Cogrehab Vol. 2 (CR,TT), 574  
 Cogrehab Vol. 3 Version 2.0 (CR,TT), 575  
 Cogrehab Vol. 4 (CR,TT), 575  
 Cogrehab Vol. 5 (CR,TT), 576  
 Cogrehab Vol. 6 (CR,TT), 576  
 Cogrehab Vol. 7: Quest (CR,TT), 577  
 Community Signs (AD,LT,TT), 580  
 Complete Spelling Program (ED), 716  
 CONCENTRATE! On Words & Concepts (LT,TT), 582  
 Core Reading and Vocabulary Development (ED,LT,TT), 583  
 Creature Magic (GA,LT,RE,TT), 586  
 CrossWords (GA,TT), 586  
 Drive to Live (ED), 716  
 Early Emerging Rules Series (LT,TT), 571  
 Early Learning 3.5/Complete Early Learning 5.25 (ED,ES,TT), 591  
 Early Learning III (CN,ED), 717  
 Edmark Reading Program, Level 1 Software (ED,ES), 718  
 Elementary Volume 1 - Mathematics (CN,ED,SV), 718  
 Employment Signs (AD,LT,TT), 594  
 Exploring Early Vocabulary Series (LT,TT), 595  
 First Categories (ES,LT,TT), 599  
 GrammarPlay with Alps and Droops (LT,TT), 607  
 Grocery Store Words (AD,TT), 608  
 H:1 Handicapped Word Games (ED,GA,PA,RE), 752  
 H:2 Handicapped Arithmetic Flash Cards (CN,ED,RE), 721  
 Hierarchical Attention Training (CR,TT), 608  
 Homographs (CR,TT), 609  
 Homophones (CR,TT), 609  
 Inferential Naming for Cognitive and Language Disorders (CR,LT,TT), 611  
 Information Signs (AD,LT,TT), 612  
 Job Seeking Series (TT,VO), 615  
 K.C. & Clyde in Fly Ball (ED), 722  
 Language Master Special Edition - LM6000SE (LP,PA,SV,TT,VS), 477  
 Learning Activity Packets (LAPs) (CN,TT,VO), 621  
 Learning How to Learn Series (TT), 621  
 Learning to Reason Series (TT), 622  
 Listen and Spell (ED), 723  
 Magic Slate II (LP,PA,TT,WP), 756  
 Medical Words (AD,TT), 631  
 Memory I (CR,ES,TT), 632  
 Memory II (CR,ES,TT), 633  
 Mind Castle I and II (GA,TT), 635  
 Money Matters (TT), 637  
 Money Skills (AD,CN,TT), 637  
 MusicWare (CN,ES,GA,TT), 640  
 MY HOUSE: Language Activities of Daily Living (LT,TT), 641  
 MY SCHOOL: Language Activities of Daily Living (TT), 642  
 MY TOWN: Language Activities of Daily Living (LT,TT), 643  
 Numeric Concepts I and II (TT), 644  
 Octobus (CN,CR,TT), 645  
 Old MacDonald's Farm I and II (ES,TT), 646  
 Personal Development Software Series (TT), 652  
 Pictures Programs: I, II and III (CR,ES,TT), 656  
 Prefixes (ED,SV), 723  
 Primer 83 (AS,TT), 666

Program for Aphasics (CR,ED), 724  
 Readable Stories Series (ED), 724  
 Safety Signs (AD,LT,TT), 667  
 Semantic Development Using Code Breaking Strategies (LT,TT), 670  
 Sensible Speller: Talking APH Edition (ED,SV), 725  
 Sentence Master (TT), 671  
 Sharon's Programs (ED,ES), 726  
 Sight Word Spelling (ED,SV), 726  
 Sight Words (TT), 672  
 Speaking Speller (ED,SV), 727  
 Special Education Public Domain Software (CR,ED,TT), 677  
 Spell-A-Word & 2+2 (CN,ED), 727  
 Spell-Talk (ED,SV), 728  
 Spelling Tutor (ED), 728  
 SPELLIST (ED), 729  
 Spin and Spell (ED), 729  
 Survival Words (AD,AS,LT,TT), 681  
 Swim, Swam, Swum: Mastering Irregular Verbs (LT,TT), 681  
 Talking Public Domain Disks (ED,SV,TT,VO), 730  
 Talking Riddles (ED,SV), 731  
 Transportation Signs (AD,LT,TT), 694  
 Twenty Categories (LT,TT), 696  
 UKanDu Little Books (TT), 696  
 Verbal Analogies (LT,TT), 698  
 Voice Reading Ability Drill (ED), 732  
 Vortex Machine Assisted Reader Software (TT), 703  
 Word Order in Sentences (LT,TT), 706  
 Wordplay with Alps and Droops (ED,GA), 732  
 Words and Concepts I, II, III (LT,TT), 707  
 Write (CI,ED,SV), 733  
 WSCC (Washington State Cooperative Curriculum) (TT), 709  
 Zero to Five (ED), 734

**Magnification Hardware and Software for Computer Displays {MG}**

*Software or hardware products whose primary purpose is to magnify the image on a standard computer screen. This category includes only large print products that are designed to work with all software applications. Products that produce large print in a single application are given the function code Large Print (LP).*

Adjustable EZ Magnifier (LP), 493  
 B-Pop, 493  
 Beamscope (LP), 494  
 Big-W (LP), 494  
 CloseView (LP), 495  
 Compu-Lenz (LP), 495  
 GNK Magnifier (LP), 496  
 inLARGE 2.0 (LP), 496  
 Large-Type Display Utility Software (LP), 497  
 Lens 2.03, 497  
 LP-DOS & LP-Windows (LP), 498  
 MAGic and MAGic Deluxe (LP), 498  
 Magnum Deluxe, 499  
 Magnum GT (LP), 499  
 NuVu Magnifier (LP), 500  
 Panorama (LP), 500  
 Powerama (LP), 501  
 Screen Magnifier/2 (LP), 501  
 Speak Out VOILA (LP,SV,TI,VS), 440  
 Vantage CCD (LP), 502  
 Vista (LP), 502  
 ZoomText 5 (LP), 503

**Modifications for Standard Keyboards {KM}**

*Hardware or software that modifies how a computer's standard keyboard operates. Hardware adaptations include keyguards, key latches, moisture guards, foot operated shift keys, etc. Software adaptations include programs for adjusting the keyboard repeat rate, programs for accelerated typing, programs for rearranging the keyboard, and programs that electronically "lock" keys such as a SHIFT. This code includes only products which adapt a computer's standard keyboard. Actual alternative keyboards are listed under Alternate Inputs Usable with All Software (TI). Adaptations and modifications for parts of the computer other than the keyboard can be found under Other Software or Hardware Adaptations (OA).*

1-Key, 331  
 Access Pack for Microsoft Windows (IA,MT,TI), 331  
 AccessDOS (IA,MT,TI), 332  
 Adaptive Firmware Card Model G32e (IA,KE,TI), 374  
 Articulating Drawers, 332  
 ASER Ergonomic Keyboard Layout (RS), 333  
 Aurora for Windows (TA,TI,WP), 333  
 Braille Keytop Labels (BR), 334  
 Brailled Keyboard Overlay for the Apple IIGS (BR), 334  
 CarpalRest (RS), 335  
 Combination Braille/Large Print Keytop Labels (BR,LP), 335  
 Comfortype (RS), 336  
 Custom Keyguard (KG), 336  
 DataArm (RS), 337  
 Dvorak Computer Keyboard, 337  
 Dvorak Conversion Keytop Labels, 338  
 Dvorak Keyboard Layouts, 338  
 E Z Keys (EC,TA), 339  
 Easy Access (MT), 339  
 Ergorest Articulated Forearm Rests (RS), 340  
 Expanded Keyboard Emulator (TA), 340  
 Filch, 341  
 FlexShield Keyboard Protectors, 341  
 Gus! Multimedia Speech System (CI,EA,TI), 133  
 Half-QWERTY One-handed Keyboard Software, 342  
 HandiKEY and HandiKEY Deluxe, 342  
 HandiSHIFT, 343  
 HandiWORD and HandiWORD International (TA), 343  
 Help U Type (TA), 344  
 Help U Type and Speak (CI,EA), 135  
 High Dots (BR), 344  
 Home-Row Key Indicators, 345  
 HX-20 Protective Cover, 345  
 JDN Shorthand (5073) (TA), 346  
 KeyAbility, 346  
 Keyboard Covers, 347  
 Keyboard Overlays for Apple IIe and IIGs, 347  
 Keyboard Wrist Rest, 348  
 Keycache (TA), 348  
 KeyGuard (KG), 349  
 Keyguard (KG), 349  
 Keyguards (KG), 350  
 Keylocks, 350  
 KeyMagic, 351  
 KeyREP (TA), 351  
 KeyStopper, 352  
 KeyWiz (TA), 352  
 LAP CAT (RS), 353  
 Left or Right Handed Keyboards, 353  
 MacQWERTY, 354  
 MacroMaster/pro (TI), 411  
 Magic Fingers (TA), 354  
 MiniErgo-MF2 (RS,TI), 417  
 Moisture Guard, 355  
 MOUSE PERCH (RS), 355  
 NOHOLD, 356  
 Notebook Computer Wrist Rest, 356  
 OmniKey Keyboards, 357  
 On/Off Adaptor Switch, 357  
 One-Hand Keyboard Package, 358  
 PAL (TA), 358



PECK Computer Software, 359  
 PowerPad Keyguard (KG), 359  
 PRD+ (Productivity Plus) Basic Edition (TA), 360  
 Prefix, 360  
 ProKey (TA), 361  
 QuickKeys (TA), 361  
 Reinforced Keyguard (KG), 362  
 Roll & Slide Keyboard Wrist Support, 362  
 SafeSkin Keyboard Protector, 363  
 Step On It! Computer Control Pedals, 363  
 Stick-On Keylocks, 364  
 Sticky, 364  
 T-TAM Keyboard and Mouse Emulator (EA,IA,MT,TT), 463  
 Tempo for Windows (TA), 365  
 Tempo II Plus (TA), 365  
 TempoEZ (TA), 366  
 TimeOut UltraMacros (TA), 366  
 Uni-Key, 367  
 VT520 Terminals - Accessibility Features, 367  
 WordWriter (TA,WP), 368  
 WRIST PERCH (RS), 368  
 ZoomCaps, 369

### Mounting Systems {MS}

*Devices used to mount switches, communication systems, or computer access devices so that an individual can access them optimally.*

Adaptive Fixtures Kit, 165  
 Communication Station, 165  
 Daessy Desktop Mount, 166  
 Daessy Folding Mount, 166  
 Flexible Wheel Chair/Table Mounting Kit, 167  
 Head Mounting Kit, 167  
 Laptrays, 168  
 Low-Tech Adaption Materials, 168  
 Magic Arm System, 169  
 Mighty Mount, 169  
 Moulded Plastic Wheelchair Tray, 170  
 Mounting Packages & Switches, 170  
 Mounting Switch Mount, 171  
 PowerBook Mounting Plate, 171  
 Quick 'n Easy 2, 172  
 Slim Armstrong, 172  
 Support Station, 173  
 Switch Mounting Hardware, 173  
 Switch Mounting Kit, 174  
 Switch Mounts, 174  
 TASH Mounting Parts, 175  
 Universal Switch Mounting System, 175  
 WCMK, 176

### Mouse and Touch Pad Emulation {MT}

*Special inputs which can be used in place of a standard mouse or touch pad, or any interface (adapter) that allows some special input device to function like a mouse or touchpad.*

Access Pack for Microsoft Windows (IA,KM,TT), 331  
 AccessDOS (IA,KM,TT), 332  
 Adap2U (TT), 373  
 AmTRAC (TT), 375  
 BallPoint Mouse (TT), 377  
 Cirque GlidePoint Trackpads (TT), 380  
 Cordless WinMouse (TT), 381  
 Easy Access (KM), 339  
 Expert Mouse (TT), 387  
 FastTRAP (TT), 389  
 Felix (TT), 389  
 First-Finger WinTrack (TT), 390  
 HeadMaster Plus (TT), 393  
 HeadMouse (DR,TT), 394

Hereward Tracker Ball & Joystick Module (TT), 395  
 Icontroller (TT), 396  
 Jouse (TT), 400  
 Joystick to Mouse Driver (TT), 400  
 K-U-I (TT), 401  
 Ke:nx (KE,TT), 402  
 LipStick and WordWriter (TT), 408  
 MacKing (TT), 409  
 MacMini (TT), 410  
 MacTRAC (TT), 411  
 MICE (TT), 413  
 MIKE (Mouse Interface & Keyboard Emulation) (TT), 415  
 Mouse-Trak (TT), 419  
 MouseMan Cordless (TT), 420  
 MouseMover - Mac (5005) (TT), 420  
 MouseMover - PC Windows (5004) (TT), 421  
 MousePen (TT), 421  
 MouseStick II (TT), 422  
 MyKey (RS,TT), 424  
 NoMouse (TT), 426  
 Optimouse (TT), 428  
 PC-TRAC (TT), 429  
 Pen Style Mouse (TT), 430  
 PortaPoint (TT), 431  
 ProPoint (TT), 434  
 QUADLynx Trackball (TT), 435  
 RemotePoint (TT), 436  
 RevolvingDoors (TT), 437  
 Serial Trackball and PS/2 Trackball (TT), 439  
 Stingray (TT), 441  
 Switch-Adapted Mouse (SAM) (TT), 442  
 SwitchMouse (TT), 443  
 T-TAM Keyboard and Mouse Emulator (EA,IA,KM,TT), 463  
 Trackball Pro (TT), 445  
 TrackMan Live! (TT), 445  
 TrackMan Voyager (TT), 446  
 Trak101 Keyboard (RS,TT), 446  
 Turbo Mouse 4.0 (TT), 447  
 Turbo Trackball (TT), 447  
 WinMini Keyboard (2447F, 2447Q) (TT), 450

### Non-Electronic Communication Aids {NA}

*Communication aids which do not involve electricity, as well as materials used in developing non-electronic communication systems. This includes communication boards, eye-gaze boards, pre-printed communication symbols, etc. You can look up non-electronic aids by the symbol system they use in Index 2, under Input Symbol System.*

AccessBliss 2.2, 69  
 Alphabet Board Kit (CI), 69  
 AlphaPad (CI), 70  
 Appointment Book (CI), 70  
 Attainment Communication Collection (CI), 71  
 Blissymbol Templates, 71  
 Blissymbol Vocabulary Stamps (CI), 72  
 Blissymbols Gallery, 72  
 Boardmaker 3.0, 73  
 Boardmaker for Windows, 73  
 Bradley Board Communication Aid (CI), 74  
 Calendars (CI), 74  
 Chain Talk (CI), 75  
 Cleo Communication Board (CI), 75  
 Communication Binder (CI), 76  
 Communication Board (CI), 76  
 Communication Board Builder, 77  
 Communication Displays for Engineered Preschool Env., 77  
 Communication Folder and Tri-Folder (CI), 78  
 Communication Icon Galleries CD-ROM (SS), 78  
 Communication Sheets (CI), 79  
 Communication Symbol Holders (CI), 79  
 Core Picture Vocabulary (CI,TR), 80  
 Core Vocabulary (CI), 80  
 Deluxe Communication Board Kit (CI), 81

Deluxe Talk Board (CI), 81  
 DynaSyms (CI), 82  
 Emotional Moods & Needs-G 3&4 (CI), 82  
 Eye Transfer Communication System (CI), 83  
 Eye-Com (CI), 83  
 Eye-Com Board (CI), 84  
 Fold It System (CI), 84  
 Foods I Like Menu Book (CI), 85  
 Help Me at Home & School-G 5&6, 85  
 Help Me to Help Myself Handbook (CI), 86  
 High Tech/Low Cost (CM,EC,PT,TR), 223  
 Holiday Kit (CI), 86  
 ICU-G 1&2 (CI), 87  
 Illustrated Menu (CI), 87  
 Imaginart Gallery, 88  
 Individualized Communication Systems (CI), 88  
 Life Experiences Communication Kit (CI), 89  
 Long Wallet (CI), 89  
 Mealtime Stickers (CI), 90  
 Mega-Book (CI), 90  
 Mid-Sized Communication Book (CI), 91  
 Mini Picture Set (CI), 91  
 Nu-Vue-Cue (CI), 92  
 Oakland Schools Picture Dictionary (CI), 92  
 Object Communicator (CI), 93  
 Object Display (CI), 93  
 Object Stand or Calendar Box (3 or 5) (CI,TR), 94  
 Object-Picture Talk Board (CI,TR), 94  
 Opticomunicator (CI), 95  
 Passport Kits (CI), 95  
 PCS Color Stickers (CI), 96  
 PCS Stamps (CI), 96  
 PCS Wordless Edition, 97  
 PEACEbook (CI), 97  
 Pick 'n Stick Color Micros (CI), 98  
 Pick 'N Stick Color Packs, 98  
 Pick 'N Stick Fast Food, 99  
 Pick 'n Stick on Disk, 99  
 Pick 'n Stick Primary Pack, 100  
 PICSYMS Categorical Dictionary (CI), 100  
 Picture Communication Symbols - Combination Book, 101  
 Picture Communication Symbols, Books I, II & III (CI), 101  
 Picture Cue Dictionary (AD,CI,LT,TT), 654  
 Picture Prompt Cards (CI), 102  
 Picture Prompt Stickers (CI), 102  
 Picture Prompt System (CI), 103  
 Picture Your Blissymbols (CI), 103  
 Pictures, Please! (CI), 104  
 Pocket Book (CI), 104  
 Pocket Picture Holder, 105  
 Pocket-Sized and Double Pocket-Sized Communication Book (CI), 105  
 Porta Boards (CI), 106  
 Porta Book (CI), 106  
 Select-A-Meal and Shopping Smart, 107  
 Self-Talk Stickers (CI), 107  
 Silent Speaker (CI), 108  
 Specialist (CI,EA,TR), 153  
 Stickers for Talk Boards (CI), 108  
 Talking Pictures Communication Board (CI), 109  
 Talking Pictures, Kits I - VII (CI,SI), 109  
 Touch 'N Talk Communication Board (CI), 110  
 Touch 'N Talk Communication Notebook (CI), 110  
 Touch 'N Talk Communication Stickers (CI), 111  
 Touch 'N Talk Micros (CI), 111  
 WordWise Language & Master Cards (CI), 112  
 WordWise Sticker Set (CI), 112  
 Writing Utensil Grips (CI,PT), 113  
 Zoo Kit (CI), 113

**Personal Tools or Aids (for Speaking, Writing, Drawing, Controlling, etc.) {PA}**

Software programs that are designed to be used on a long term basis by an individual as a personal tool or prosthetic aid. This includes programs which facilitate an individual's ability to communicate, write, draw, control, and move about. It does not include programs whose only function is to provide access to other software; these would be classified under Alternate Inputs Usable with All Software (TI). Some examples of personal tools are: word processing programs with large print, software for environmental control, and software for communication or conversing by synthesized speech.

APH Scientific Calculator: for Apple II Computers (CN,SV), 737  
 Atlas Speaks, 737  
 Audible Cursor Routine (CI,EA,TR), 121  
 Auto Braille (BR), 738  
 B-Edit (LP,TA,WP), 738  
 BEX 3.1 (BR,LP,SV,WP), 739  
 BIG for 1-2-3 (DS,LP), 739  
 BIG for WordPerfect (LP), 740  
 Big-Calc (CN,LP), 740  
 Biggy (LP), 741  
 BlissWrite (TT,WP), 741  
 Braille 'n Speak Classic (BR,CN,SV,VS,WP), 469  
 Braille-Talk (BR,SV), 742  
 Braille-Term Program (TL), 742  
 Calc-Talk (CN,LP,SV), 743  
 Calcworthy (CN,SV), 743  
 Checkbook Program (BR,CN,SV), 744  
 CINTEX I (EC,PC,RE,TA,TT,WP), 744  
 CINTEX2 (EC,PC), 271  
 Co:Writer (TA), 745  
 David (BR,BT,PW,SS,SV,VS), 471  
 Duxbury Braille Board for Microsoft Windows (BR), 745  
 Duxbury Braille Font, 746  
 Duxbury Braille Translator (DBT) (BR), 746  
 Duxbury Braille Translator for WordPerfect (DUXWP) (BR), 747  
 Easy-Braille Translator (BR), 747  
 Edgar (BR), 748  
 Electric Crayon and Electric Crayon Deluxe (DR,RE), 748  
 ETgraphX (BR,DR), 749  
 ExerciseBreak (RS), 749  
 Eye Relief (LP,WP), 750  
 File-Talk (DS,SV), 750  
 Finish Line (TA), 751  
 FormMate, 751  
 Freedom Writer (WP), 752  
 Governor (2464) (GA), 547  
 H:1 Handicapped Word Games (ED,GA,LS,RE), 752  
 HomeAccess (EC), 283  
 I Can Play, Tool (RE,TR), 753  
 IBM-VBII (BR), 753  
 IntelliTalk (CI,EA), 137  
 Keysoft (CN,SV,WP), 754  
 Keyterm (SV,TL), 754  
 Language Master Special Edition - LM6000SE (LP,LS,SV,TT,VS), 477  
 Large Print Word Processors (LP,WP), 755  
 Letter Art with Braille Translator, 755  
 Lingraphica (CI,CR,EA), 139  
 Mac-Apple Communications Aid (CI,CN,DR,ES,TT,WP), 756  
 Magic Slate II (LP,LS,TT,WP), 756  
 Me Tool, 757  
 MegaDots (BR,LP), 757  
 MicroBraille 2 (BR,WP), 758  
 MicroIllustrator (DR,RE,TT), 758  
 Minspeak Application Programs (MAP) (CI), 759  
 Motor Training Games (AS,GA,RE,TT), 638  
 Multi-Line Dial-A-News System (TD,TL), 759  
 NAMES (BR), 760  
 Noteworthy (WP), 760  
 PC Braille (BR), 761  
 Phone Manager (EC,PC), 288  
 Picture Braille (BR), 761

Picture Perfect (DR,RE), 762  
 PowerPad Toolkit 4, 762  
 Predict It (TA,WP), 763  
 RAPIDTEXT, 763  
 SeeBEEP, 764  
 SenSei System (EC,PC,TI,TL), 295  
 Strider, 764  
 Synergy Integrated Remote (EC), 298  
 Talking Data Acquisition System Software, 765  
 Talking Screen (CI,EA), 156  
 Talking Screen for Windows (CI,EA), 157  
 Talking Sensible Speller (SV), 765  
 Talking Utilities for DOS 3.3 (SV), 766  
 Talking Writer & Four Games (KB,LP,SV,TT,WP), 766  
 TEAM (EC), 299  
 TeleDesk Visually Impaired Operator Console (PC,SV,TL), 767  
 Telepathic II (TA), 767  
 Term-Talk (SV), 768  
 TextGrabber, 768  
 Trace Math Aid (CN,ED), 769  
 TurboBraille (BR), 769  
 Typelt4Me (TA), 770  
 VersaBraille Electric Webster, 770  
 VisAbility (LP), 771  
 WinDOTS (BR), 771  
 Wish Writer (WP), 772  
 WiVox (WP), 772  
 Word-Talk (SV,WP), 773  
 Work-Station Pro, 773  
 Write:OutLoud (WP), 774  
 WriteAway (TA,WP), 774

**Phone Control/Access {PC}**

*Products which provide control over the answering or dialing functions of a telephone, or products specifically designed to be used with a telephone. This does not include voice output communication aids or software that could be used to converse on the phone.*

AbiliTech Communicator (CI,EC), 264  
 AbiliTech Home Control System (EC), 265  
 Ability Switch Phone Sequencer (CI,EC), 265  
 Able-Phone 100WA (EC), 266  
 Able-Phone 1900 and 2000 (EC), 266  
 Able-Phone 6000SX (EC), 267  
 ACS Headsets (EC), 267  
 ADAPTA-LAN (CI,LP,TI,WP), 374  
 Adapted Telephone Interfaces (EC), 268  
 Auto Call Single Number Dialer (CM), 312  
 Butler-in-a-Box (EC,TI), 270  
 Call Alert Model CA-100 (CM), 313  
 CallText 5000 (SS), 527  
 CINTEX 1 (EC,PA,RE,TA,TI,WP), 744  
 CINTEX2 (EC,PA), 271  
 Comtel, 544  
 Control 1 (EC), 272  
 Custom Speaker Phone (EC), 273  
 DEUCE (EC), 273  
 Dialogue TTYs (CI,TD,TL), 180  
 Dual Channel Headset, 546  
 E.A.S.I.dialer (2110) (EC), 274  
 Expanded Keyboard for Automatic Telephone (EC), 276  
 Eye Slaved Pointing System (EC,TI), 387  
 Eyegaze Computer System (EA,EC,TI), 132  
 EZRA (CI,CM,EC), 277  
 F71863 Touchables Touch Phone Attachments (EC), 277  
 First Aide Kit (CM,EC), 278  
 Fone Holder (EC), 278  
 GEWA Infra-Link Speaker-Telephone (CI,EC), 279  
 GEWA Infra-Link System (EC), 280  
 Giant Push Button Telephone Adapter (EC), 281  
 HAL (Home Automation Link) (EC,TI), 392  
 HandiPHONE (CI,EC), 281  
 Handset for Speech Amplification (SA,VA), 6

HECS-1 (EC), 282  
 InfoTouch (BR,BT,CI,TD,TL), 182  
 LIAISON (EC,KE,TI), 407  
 Lite Touch Telephone Communicator (BR,TD,TL), 183  
 Mastervoice Environmental Control Single User Unit (EC), 285  
 Memory Button Telephones (EC), 285  
 MIC300i Computer Modem (TD,TL), 184  
 Miniprint 425 (CI,TD,TL), 185  
 MultiPhone (CI,EC), 287  
 Pay Phone TTY (CI,TD,TL), 186  
 Phone Manager (EC,PA), 288  
 Phone-TTY CM-4 Computer Modem (CI,TD,TL), 187  
 PhoneAccess (EC), 289  
 Polycom (CI,EA,PW,TL,WP), 146  
 Portable Telephones (EC), 289  
 PROXi (EC), 290  
 Remote Control Speakerphone Model RC3000 (EC), 292  
 Sapura S2000 CL (EC), 293  
 SenSei System (EC,PA,TI,TL), 295  
 Simplicity Series ECUs (EC), 295  
 SM85 Smart ASCII/Baudot Modem (CI,TD,TL), 189  
 Speaker Phones (EC), 298  
 Superprint 100, 200, 400 (CI,TD,TL), 190  
 Superprint 4425 (CI,TD,TL), 191  
 Superprint ES TTY (CI,TD,TL), 191  
 T-140 Series Puff/Sip Speakerphones (EC), 299  
 TDD 2700, 2730, and 2830 (CI,TD,TL), 192  
 TeleBraille III (CI,TD,TL), 193  
 TeleDesk Visually Impaired Operator Console (PA,SV,TL), 767  
 Telephone Holder & Line Connector (EC), 300  
 Telephone Management System (EC), 300  
 UltraSilent (TD), 194  
 Universal Control System with Tongue Touch Keypad (EC), 303  
 Universal Telephone Adapter (EC), 304  
 VX-5000 Cordless Phone (CI,EC), 305

**Pointing and Typing Aids {PT}**

*Devices whose purpose is to facilitate an individual's ability to point to objects or press keys. Headsticks, mouthsticks, and lightbeam pointers are all included in this category. There are other devices useful for pointing and typing which have not been included in this book, however, such as hand splints or typing sticks.*

Adjustable Head Pointer, 15  
 Adjustable Head Pointer, 15  
 Adjustable Head Pointer PC 7590, 16  
 Baton Laser Pointer, 16  
 Clear-View Head Pointer, 17  
 F73216-100 Page Turner/Keyboard Aid (BP), 17  
 Gripper Prehensor, 18  
 H71830 Adjustable Head Pointer, 18  
 H73217 Mouth Held Page Turners (BP), 19  
 Handpointers, 19  
 Head Pointers: AD-1, AD-2, AD-3, 20  
 Heyer-Abadie Modular Mouthstick, 20  
 High Tech/Low Cost (CM,EC,NA,TR), 223  
 Laser Light Pointer, 21  
 Light Beam Indicator, 21  
 Light Pointer, 22  
 Light Pointer, 22  
 Light Pointers, 23  
 LightBeam, 23  
 Media Handling Products (BP,EC), 549  
 Mouthsticks (BP), 24  
 RedLite, 24  
 Slip-On Typing Aid, 25  
 Talking Laser Beam, 25  
 Vacuum Wand (BP), 26  
 Viewpoint Optical Indicator, 26  
 Writing Utensil Grips (CI,NA), 113

### Portable Writing {PW}

Portable aids which have a printer or can be connected to one. This includes portable communication aids, as well as portable electronic "notebooks" with braille, voice, or large print output.

Above PCD (CI,EA), 118  
 Access-1 (CI,TT), 373  
 AlphaSmart Pro (TI), 375  
 Artic TransBook (VS), 467  
 Artic TransType (SV,VS), 467  
 Braille 'n Speak (BR,SS,SV,TI,VS), 469  
 Braille Lite (BR,BT,CN,SV,VS), 470  
 BrailleMate 2 (BR,VS), 470  
 David (BR,BT,PA,SS,SV,VS), 471  
 Dvorak One-Hand Typewriter (CI,EA), 128  
 Equalizer (CI,DR,EA,RE,TI,WP), 131  
 EvalPAC with RealVoice (AS,CI,EA,EC,TI), 131  
 Liberator (CI,CN,EA,EC,TT), 137  
 Magnum (BR,TI,VS), 477  
 Minicom IV (CI,TD,TL), 184  
 Mountbatten Braille (BR,BT), 516  
 Myna (BR,SV,VS), 478  
 Polycom (CI,EA,PC,TL,WP), 146  
 RealVoice (AS,CI,EA,EC,TT), 147  
 Say-It-All II Plus (CI,EA,KG), 148  
 ScanPAC (CI,CN,EA,EC,TT), 150  
 Scribe (CI,EA,KG), 150  
 Secretary (CI,EA,TR), 151  
 SynergyMac and SynergyPC (CI,TI), 444  
 Type 'n Speak (SV,VS), 487

### Recreation {RE}

Software whose function is to provide recreation. If a program has a game format, but the primary function is education and training, it will also be listed under Adaptive Educational Software (ED) and Training and Therapy Software (TT).

Audio Braille Game Tutorial (BR,GA,TT), 560  
 Blocks in Motion (DR,TT), 563  
 Card Communicator (CI,TR), 34  
 CINTEX I (EC,PA,PC,TA,TI,WP), 744  
 Creature Magic (GA,LS,LT,TT), 586  
 Electric Crayon and Electric Crayon Deluxe (DR,PA), 748  
 Equalizer (CI,DR,EA,PW,TI,WP), 131  
 Every Day Is A Holiday (GA,TT), 595  
 H:1 Handicapped Word Games (ED,GA,LS,PA), 752  
 H:2 Handicapped Arithmetic Flash Cards (CN,ED,LS), 721  
 Human Being Machine (TT), 610  
 I Can Play, Too! (PA,TR), 753  
 Maze (GA,TT), 631  
 MicroIllustrator (DR,PA,TT), 758  
 Motor Training Games (AS,GA,PA,TT), 638  
 Mouth Operated Joystick for Genesis Video Game (GA,TI), 422  
 Nintendo & Super Nintendo Joystick Module (TI), 425  
 One Switch Picasso (DR,TT), 648  
 Picture Perfect (DR,PA), 762  
 PowerPad (DR,TT), 432  
 Race the Clock (GA,TT), 662  
 Scanning Picasso (DR,TT), 668  
 Slide Projector Control (EC,TR), 55  
 Switch Arcade (GA,TT), 682  
 Switch Puzzles (TR,TT), 684  
 SwitchEnsemble (TR,TT), 685  
 TouchWindow (DR,DS,ID,TI,WP), 444

### Repetitive Strain Injury (RSI) Prevention {RS}

Products designed to prevent or control RSIs such as carpal tunnel syndrome, in connection with computer input devices. Categorization is based on manufacturer's claims, not independent testing.

Apple Adjustable Keyboard (TI), 376  
 ASER Ergonomic Keyboard Layout (KM), 333  
 CarpalRest (KM), 335  
 Comfortype (KM), 336  
 DataArm (KM), 337  
 ErgoLogic Model 7.1 Keyboard (TI), 384  
 Ergonomic Keyboard Systems (TI), 384  
 Ergorest Articulated Forearm Rests (KM), 340  
 ExerciseBreak (PA), 749  
 FlexPro (TI), 390  
 IN-CUBE Voice Command for Windows, NT (TI), 397  
 Kinesis Ergonomic Keyboard (TI), 405  
 LAP CAT (KM), 353  
 Microsoft Natural Keyboard (TI), 414  
 MiniErgo-MF2 (KM,TI), 417  
 MOUSE PERCH (KM), 355  
 MyKey (MT,TI), 424  
 Select-Ease Keyboard (TI), 439  
 Trak101 Keyboard (MT,TI), 446  
 Vertical (TI), 448  
 Voice User (TI), 449  
 WRIST PERCH (KM), 368

### Screen (Display) to Voice {SV}

Software or hardware which will read the contents of the computer screen through a voice synthesizer, so that the software can be operated by a user who cannot see the computer screen. This includes "screen access" hardware or software, which provides voice output of screen information for any standard software the user is running. It also includes individual application programs that provide sufficient voice output to be used by a visually impaired person.

APH Presents the Talking Apple Computer (TT), 558  
 APH Scientific Calculator: for Apple II Computers (CN,PA), 737  
 APH/SEI Talking Software (ED,LS), 713  
 AppleWorks Manuals: Special Editions, 542  
 Arithmetic 1, 2, and 3 with Speech (CN,ED,LS), 714  
 Artic TransPort (SS), 526  
 Artic TransType (PW,VS), 467  
 ASAP (Automatic Speech Access Program) (VS), 468  
 BEX 3.1 (BR,LP,PA,WP), 739  
 Braille 'n Speak (BR,PW,SS,TI,VS), 469  
 Braille 'n Speak Classic (BR,CN,PA,VS,WP), 469  
 Braille Lite (BR,BT,CN,PW,VS), 470  
 Braille-Talk (BR,PA), 742  
 Business Vision (VS), 471  
 Calc-Talk (CN,LP,PA), 743  
 Calcworthy (CN,PA), 743  
 Checkbook Program (BR,CN,PA), 744  
 David (BR,BT,PA,PW,SS,VS), 471  
 Elementary Volume 1 - Mathematics (CN,ED,LS), 718  
 File-Talk (DS,PA), 750  
 Focus on Facts (ED), 719  
 Focus on Nations (ED), 720  
 Food Facts (AD,TT), 603  
 Gizmo (LP,VS), 473  
 HandiCHAT and HandiCHAT Deluxe (VS), 473  
 HandiCODE and HandiCODE Deluxe (TI), 393  
 IBM Screen Reader/2 (VS), 474  
 IBM Screen Reader/DOS (VS), 474  
 Infovox 210 (VS), 475  
 IRIS Reading Interface 3.0 (TI), 399  
 JAWS for Windows (VS), 475  
 JAWS Screenreader (VS), 476  
 Keynote Companion (CN,TL,VS,WP), 476  
 Keys to Success: Comp. Keybd. Skills for Blind Children (KB,TT), 619

Keysoft (CN,PA,WP), 754  
 Keyterm (PA,TL), 754  
 Language Master Special Edition - LM6000SE  
 (LP,LS,PA,TT,VS), 477  
 Letter Find (CN,ES,KB,TT), 625  
 LetterTALK+ (TT,WP), 625  
 MasterTOUCH (BT), 515  
 Messenger-IC (SS), 533  
 Myna (BR,PW,VS), 478  
 NOMAD Talking Touch Pad & NOMAD Gold (BT), 516  
 outSPOKEN I.7 (VS), 479  
 outSPOKEN for Windows (VS), 480  
 PCMaster & Windows Master (BR,IA,VS), 460  
 Prefixes (ED,LS), 723  
 Protalk23 for Windows (VS), 480  
 PROVOX (VS), 481  
 ScreenPower (VS), 482  
 ScreenPower for Windows (VS), 483  
 Seekline (VS), 483  
 Sensible Speller: Talking APH Edition (ED,LS), 725  
 Sight Word Spelling (ED,LS), 726  
 Slimware (VS), 484  
 Slimware Window Bridge (VS), 484  
 SoundProof (VS), 485  
 Speak Out VOILA (LP,MG,TI,VS), 440  
 Speaking Speller (ED,LS), 727  
 Spequalizer Speech Access System (VS), 485  
 Spell-Talk (ED,LS), 728  
 Talking Public Domain Disks (ED,LS,TT,VO), 730  
 Talking Riddles (ED,LS), 731  
 Talking Sensible Speller (PA), 765  
 Talking Typewriter (KB,TT), 687  
 Talking Utilities for DOS 3.3 (PA), 766  
 Talking Writer & Four Games (KB,LP,PA,TT,WP), 766  
 TeleDesk Visually Impaired Operator Console (PA,PC,TL), 767  
 Term-Talk (PA), 768  
 TEXTALKER (BT), 521  
 Tinytalk (VS), 486  
 Type 'n Speak (PW,VS), 487  
 Vocal-Eyes (VS), 488  
 Win Vision (VS), 488  
 Window-Eyes (VS), 488  
 WINKLINE (VS), 489  
 Word-Talk (PA,WP), 773  
 WordScholar (VS), 489  
 Write (CI,ED,LS), 733

### Signing {SI}

*Products that employ sign language for people who are deaf (fingerspelling, ASL, etc.).*

CAV-ASL (TT), 571  
 Elementary Signer (TT), 593  
 Fingerspeller (TT), 598  
 Fingerspelling & Numbers (TT), 598  
 FingerZoids (GA,TT), 599  
 Subtle Messages (TT), 680  
 Talking Hands (TT), 685  
 Talking Pictures, Kits I - VII (CI,NA), 109  
 This Old Man (CN,TT), 691

### Speech Aids {SA}

*Devices that make oral speech possible for a person for whom oral speech would otherwise be difficult, impossible, or hard to understand. These should not be confused with communication aids, which supplement or replace oral speech with some other mode of communication, such as pointing to pictures or typing on a portable computer.*

ADDvox III System (CI,VA), 3

Amplifiers (VA), 3  
 Cooper-Rand Electronic Speech Aid (AL), 4  
 Denrick Speech Aid (AL), 4  
 Electronic Artificial Larynx (AL), 5  
 Electronic Speech Clarifiers, 5  
 Handset for Speech Amplification (PC,VA), 6  
 Mini Vox Amplifier, 6  
 Nu-Vois (AL), 7  
 Park Speech Amplifier (VA), 7  
 Passy-Muir Speaking Valves, 8  
 Rand Voice Amplifier (VA), 8  
 Robot Voice Synthesizer (CI), 9  
 SERVOX Inton (AL), 9  
 Speech Enhancer 100, 200 & 400, 10  
 Speechmaker (VA), 10  
 Tokyo Artificial Larynx (AL), 11  
 Voice Amplificaid (CI,VA), 11  
 Voicette (VA), 12

### Speech Synthesizers {SS}

*Hardware or software products that generate synthetic human speech. Together with a "text-to-speech" program (frequently provided with the synthesizer), these devices can produce phonetically correct speech from electronic text. These synthesizers are components designed to be used by other application programs. You can locate products (including software) that have speech output by looking in Index 2, under Output/Display: Speech.*

Accent-MC, 525  
 Accent-PC, 525  
 Accent-SA, 526  
 Artic TransPort (SV), 526  
 Audapter Speech System, 527  
 Braille 'n Speak (BR,PW,SV,TI,VS), 469  
 CallText 5000 (PC), 527  
 Communication Icon Galleries CD-ROM (NA), 78  
 DAC (CI,EA), 126  
 David (BR,BT,PA,PW,SV,VS), 471  
 DECTalk, 528  
 DECTalk PC & DECTalk Express, 528  
 DJ ProPack Speech Module, 529  
 Echo II, 529  
 Echo II with Textalker & Echo II with Textalker-GS (VS), 472  
 Echo LC, 530  
 Echo PCII, 530  
 Echo-PC, 531  
 Handy Speech Communication Aide (CI,EA), 134  
 Infovox 500, 700 & 750, 531  
 IntroVoice VI (TI), 399  
 Keynote GOLD, 532  
 Lite Talk, 532  
 Messenger-IC (SV), 533  
 Micro IntroVoice (TI), 413  
 Micro IntroVoice II (TI), 414  
 Mini Transport II, 533  
 MultiVoice, 534  
 SmarTalk, 534  
 Sounding Board, 535  
 Speak-Out, 535  
 SynPhonix 210 and 215 (IA), 536  
 SynPhonix 310 and 315, 536  
 SynPhonix P27, 537  
 VocaLite, 537  
 VoiceBachs (CI,EA), 159  
 VoiceCard, 538

**Speech Therapy (not Language Therapy) {ST}**

*Products designed to facilitate the development of oral speech skills. This does not include language skill development, which has its own code (Language Therapy, LT).*

- Breakthrough to Language: Clinical Edition (LT,TT), 565
- Breakthrough to Language: Home Edition (LT,TT), 566
- Cafet-for-Voice (TT), 567
- Laryngograph (AS,TT), 620
- Minimal Contrast Stories Plus for Windows (TT), 635
- Minimal Contrast Therapy (TT), 636
- Nasometer Model 6200-3 (AS,TT), 643
- Rate Drill in Articulation, Language and Fluency (LT,TT), 663
- Sound Scope (TT), 677
- SpeechViewer II (TT), 678
- TalkTime with Tucker (TT), 688
- Video Voice Speech Training System (TT), 699
- Visi-Pitch Model 3300 (TT), 700
- Voice Switch, 258

**Telecommunication {TL}**

*Products designed to facilitate nonspeech communication over telephone lines. For speech communication, see Phone Control (PC) and Conversation/Interaction (CI).*

- 911 Telephone Terminal (CI,EC), 263
- ASCII-TDD Software (CI,TD), 179
- Braille-Term Program (PA), 742
- Companion 401 Communicator (CI,CM,EA,TR), 125
- Crespeaker (CI,EA), 125
- Dialogue TTYs (CI,PC,TD), 180
- Dialogue VCO Read & Talk Telephone (CI,TD), 181
- Futura-TTY (CI,TD), 181
- InfoTouch (BR,BT,CI,PC,TD), 182
- Intele-Modem (CI,TD), 182
- Keynote Companion (CN,SV,VS,WP), 476
- Keyterm (PA,SV), 754
- Lite Touch Telephone Communicator (SR,PC,TD), 183
- Message Center (CI,TD), 183
- MIC300i Computer Modem (PC,TD), 184
- Minicom IV (CI,PW,TD), 184
- Miniprint 425 (CI,PC,TD), 185
- Multi-Line Dial-A-News System (PA,TD), 759
- Pay Phone TTY (CI,PC,TD), 186
- Personal Communication Terminal (PCT) (CI,TD), 186
- Phone-TTY CM-4 Computer Modem (CI,PC,TD), 187
- Polycom (CI,EA,PC,PW,WP), 146
- Porta Printer Plus (CI,TD), 187
- PortaView (CI,TD), 188
- Positron Express (CI,TD), 188
- SenSci System (EC,PA,PC,TI), 295
- SIDD (Software Interface for the Deaf and Disabled) (CI,TD), 189
- SM85 Smart ASCII/Baudot Modem (CI,PC,TD), 189
- Supercom 4400 TTY (CI,TD), 190
- Superprint 100, 200, 400 (CI,PC,TD), 190
- Superprint 4425 (CI,PC,TD), 191
- Superprint ES TTY (CI,PC,TD), 191
- TDD 2700, 2730, and 2830 (CI,PC,TD), 192
- TeleBraille III (CI,PC,TD), 193
- TeleDesk Visually Impaired Operator Console (PA,PC,SI), 767
- ToneTalker (CI,TD), 194
- Uniphone TDD/TT (CI,TD), 195
- VCS 3500 with TDD Software (CI,TD), 196
- WinTalk (CI,TD), 196
- Writalk Electronic Pen Pad (CI,TD), 197

**Telecommunication Devices for the Deaf (TDD's) {TD}**

*Devices which have been specifically designed for deaf individuals to communicate over telephone lines. It includes systems which use ASCII code (a standard computer code), Baudot code (the traditional TDD code), touch tones or voice to transfer information. Telewriters are also included.*

- ASCII-TDD Software (CI,TL), 179
- Atlantic 144 TTY, 179
- Compact TTY, 180
- Dialogue TTYs (CI,PC,TL), 180
- Dialogue VCO Read & Talk Telephone (CI,TL), 181
- Futura-TTY (CI,TL), 181
- Heidico Intertalk (CI,EA), 135
- InfoTouch (BR,BT,CI,PC,TL), 182
- Intele-Modem (CI,TL), 182
- Lite Touch Telephone Communicator (BR,PC,TL), 183
- Message Center (CI,TL), 183
- MIC300i Computer Modem (PC,TL), 184
- Minicom IV (CI,PW,TL), 184
- Miniprint 425 (CI,PC,TL), 185
- Multi-Line Dial-A-News System (PA,TL), 759
- NexCom 300vi & 300ve, 185
- Pay Phone TTY (CI,PC,TL), 186
- Personal Communication Terminal (PCT) (CI,TL), 186
- Phone-TTY CM-4 Computer Modem (CI,PC,TL), 187
- Porta Printer Plus (CI,TL), 187
- PortaView (CI,TL), 188
- Positron Express (CI,TL), 188
- SIDD (Software Interface for the Deaf and Disabled) (CI,TL), 189
- SM85 Smart ASCII/Baudot Modem (CI,PC,TL), 189
- Supercom 4400 TTY (CI,TL), 190
- Superprint 100, 200, 400 (CI,PC,TL), 190
- Superprint 4425 (CI,PC,TL), 191
- Superprint ES TTY (CI,PC,TL), 191
- TDD 2700, 2730, and 2830 (CI,PC,TL), 192
- TDD Detector, 192
- TDD Trainer System (CI,TR), 58
- TeleBraille III (CI,PC,TL), 193
- TeleView 40 & 80, 193
- ToneTalker (CI,TL), 194
- UltraSilent (PC), 194
- Uniphone 1000, 195
- Uniphone TDD/TT (CI,TL), 195
- VCS 3500 with TDD Software (CI,TL), 196
- WinTalk (CI,TL), 196
- Writalk Electronic Pen Pad (CI,TL), 197

**Training and Communication Initiation Aids {TR}**

*Electric and electronic devices which can be used to initiate communication or train individuals in the use of switches, selection techniques, and other augmentative communication skills. This code also covers software that performs these same functions. Electronic communication aids with less than 32 selections are included in this category because of their limited maximum vocabulary. Rotary scanners and linear scanners are also included.*

- 101 Animations (TT), 556
- Ability Switch Tester (5955) (AS), 29
- AC Adaptor FRE-103C, 29
- Accularm (CM), 311
- ActionVoice (CI,EA), 118
- Activity Board (AS,EC), 30
- Activity Boxes, 30
- Adult Switch Progressions (TT), 556
- AND Module, 31
- And Or Box (AS), 31
- Attainment Fifteen Talker (CI,EA), 119
- Attainment Five Talker & Talker Plus (CI,EA), 120

- Attainment Two Talker (CI,EA), 120  
 Audible Cursor Routine (CI,EA,PA), 121  
 Battery Adapter (AS), 32  
 Battery Device Adapter (AS), 32  
 Battery Interrupter (AS), 33  
 Battery Interrupters, 33  
 Beeper (AS,CM), 313  
 BIGmack (CI,EA), 122  
 Buzzer Box (CM), 34  
 Call Bell (4500) (AS,CM), 314  
 Call Signal 2 (AS,CM), 314  
 Card Communicator (CI,RE), 34  
 Cause & Effect (TT), 570  
 Cheap Talk 4 & 8 (CI,EA), 124  
 Chime Alarm (AS,CM), 315  
 Chime Box, 35  
 Clear Clock Communicator (CI), 35  
 Clock Communicator (AS,CI), 36  
 Comboard (2615) (AS,CI), 36  
 Communication Programs (CI,EA,EC), 124  
 Communication Training Program (TT), 579  
 Communiclock (AS,CI), 37  
 Communilight 24 (EA), 37  
 Companion 401 Communicator (CI,CM,EA,TL), 125  
 Compartmentalized Clock Communicator (CI), 38  
 Compartmentalized Communicator (AS,CI), 38  
 Computer Keyboard Switch, 210  
 Computer Switch Plate, 210  
 Core Picture Vocabulary (CI,NA), 80  
 Counter Box (AS), 39  
 Counter Module (AS), 39  
 Creature Antics and Creature Capers (GA,TT), 584  
 Creature Chorus (TT), 585  
 Creature Features (TT), 585  
 Delay Timer Box (AS,EC), 40  
 Dial Scan (AS,CI), 40  
 DigiTalk 1 (CI,EA,TT), 127  
 Dino-Games (ES,TT), 588  
 Dinosaur Game (ES,GA,TT), 589  
 Dual Action Latch, 41  
 Dual Channel Latching Switch Interface (AS,EC), 41  
 Dual Clock Communicator (CI), 42  
 Duo-Responder (CI), 42  
 E-Tran Scanner (AS,CI), 43  
 Emergency Call Alarm (AS,CM), 317  
 Environmental Control for Kids, 43  
 Finger Isolation Button, 218  
 Hawk (CI,EA), 134  
 High Tech/Low Cost (CM,EC,NA,PT), 223  
 I Can Play, Too! (PA,RE), 753  
 Intention Module, 44  
 Interaction Games (ES,GA,TT), 613  
 Interaction Games II (ES,GA,TT), 614  
 Invertor Module (AS), 44  
 Joystick Trainer (TT), 616  
 Keypad (2425) (AS), 45  
 Latch Box, 45  
 Learn to Scan (AS,TT), 620  
 Light Activated Switch Panel (CI), 46  
 Lighted Extra Loud Signalling Buzzer (AS,CM), 319  
 Lighted Signalling Buzzer (AS,CM), 319  
 Lighted Vibrating Signalling Buzzer (AS), 46  
 LinkSwitch, 47  
 Lynx (CI,EA), 140  
 MessageMate 20 (CI,EA), 141  
 MessageMate 40 (CI,EA), 142  
 Messenger (CI,EA), 142  
 Mini Talking Card Reader (CI,EA), 143  
 Mini-MessageMate (CI,EA), 144  
 Motor Training Games (GA,TT), 638  
 Multi-SCAN (GA,TT), 639  
 Multi-Switch Module (AS), 47  
 Music Button, 48  
 New Frog & Fly (TT), 644  
 Nine Compartment Row/Column Scanner (CI), 48  
 Nine Volt Battery Adapter Module, 49  
 Object Stand or Calendar Box (3 or 5) (CI,NA), 94  
 Object-Picture Talk Board (CI,NA), 94  
 On/Off Module, 49  
 Parrot (CI,EA), 144  
 Peg Switch, 50  
 Personal Trainer (CI,EA), 145  
 Pictalk (CI,ES,TT), 653  
 Picture Scanner (TT), 655  
 Picture/Theme Disks (TT), 656  
 PigTail Adapters, 50  
 Point to Pictures (TT), 657  
 Portable Sound Source II, 51  
 PowerTalker (TT), 658  
 Press to Play (ES,TT), 660  
 Puzzle Switches, 51  
 Quad Talk (AS,CI), 52  
 Rhythm Generator (AS), 52  
 Rockets to the Moon (ES,GA,TT), 666  
 Round Clock Communicator (CI), 53  
 Say-It-Simply Plus (CI,EA), 148  
 Scan & Match 1, 2, 3, and 4 (TT), 667  
 Scan It - Switch It (TT), 668  
 ScanLite (CI), 53  
 Secretary (CI,EA,PW), 151  
 Sequential Scanner (AS,CI), 54  
 Series Adapter (AS), 54  
 Shadow Talker (CI,EA), 151  
 Signal Buzzer (AS,CM), 325  
 SimpleCom I: Yes/No Communication (CI,TT), 674  
 SimpleCom II: Needs/Wants Communication (CI,TT), 674  
 Single-Appliance Continuous Control Unit (EC), 296  
 Six Position Activity Box, 55  
 Slide Projector Control (EC,RE), 55  
 Specialist (CI,EA,NA), 153  
 Steeper Communication/Teaching Aid (AS,CI), 56  
 Storytime Series (AD,LP,TT), 679  
 Storytime Series for Macintosh (AD,LP,TT), 679  
 Switch Latch (4388) (AS,EC), 56  
 Switch Latch and Timer, 57  
 Switch Latch/Timer (AS), 57  
 Switch Module (CI,EA), 153  
 Switch Puzzles (RE,TT), 684  
 SwitchEnsemble (RE,TT), 685  
 Talk Back III (CI,EA), 155  
 Talk Back VI (CI,EA), 155  
 Talking Nouns, Talking Nouns II, and Talking Verbs (CI,TT), 686  
 Talking Switch Plates (CI,EA), 157  
 Talking Touch Window (AS,CI,TT), 687  
 TDD Trainer System (CI,TD), 58  
 This is the Way We Wash Our Face (ES,TT), 691  
 Three Position Activity Box, 58  
 Timer Module (AS,EC), 59  
 Toy Adapter (AS), 59  
 Toy Adapter Cables: CA-9/CA-12/CA-16 (AS), 60  
 Toy Cables (4378, 4379) (AS), 60  
 Trace Beeper Box, 61  
 Training Aid 2 (AS,EC), 61  
 Tri-Responder (AS), 62  
 Tubular Vibrator, 62  
 Turn-Talking (CI,TT), 695  
 Universal Module, 63  
 Versascan (AS,CI), 63  
 Vibrating Sack (AS), 64  
 VoiceMate, SwitchMate, ScanMate (2701-2708), 64  
 VoicePal (CI,EA), 160  
 VoicePal Plus (CI,EA), 160  
 Wheels On The Bus I, II, III (ES,TT), 704  
 Worm Squirm (ES,TT), 708  
 WPS Loquitur 115 and 250, 65  
 Yak Bak (CI,EA), 162

**Training and Therapy Software {TT}**

*Computer software used for training or therapy. Included programs focus on such topics as basic skills, ADL skills, communication skills, and vocational training. Some related function codes are Assessment (AS), Keyboarding Training (KB), Language Therapy and Development (LT), Speech Therapy (ST), Signing (SI), and Cognitive Rehabilitation (CR).*

101 Animations (TR), 556  
 Adult Switch Progressions (TR), 556  
 Adventures of Jimmy Jumper - Prepositions (AS,ES,LT), 557  
 Antonyms and Synonyms (Cognitive Disorders 12) (CR,LS), 557  
 APH Presents the Talking Apple Computer (SV), 558  
 Aphasia Series: I through VIII (CR,LS), 558  
 Association Pictures (CR), 559  
 Attention, Perception & Discrimination Plus for Windows (CR), 559  
 Audio Braille Game Tutorial (BR,GA,RE), 560  
 Babysitting Basics (VO), 560  
 Be a Winner Series (LS,VO), 561  
 Bear Jam (ES), 561  
 BEST Faces (ES), 562  
 Big/Little I and II (ES), 562  
 BlissWrite (PA,WP), 741  
 Blocks in Motion (DR,RE), 563  
 Blueprint for Decision Making (LS), 563  
 Body Builder (ES), 564  
 Bozons' Quest (GA,LS), 564  
 Braille Tutorial (BR), 565  
 Breakthrough to Language: Clinical Edition (LT,ST), 565  
 Breakthrough to Language: Home Edition (LT,ST), 566  
 Buddy's Body (AS,ES), 566  
 Build-A-Scene, 567  
 Cafet-for-Voice (ST), 567  
 CanSpeak (CL,LT), 568  
 Captain's Log: Cognitive Training System (AS,CR,ES,LS), 568  
 Categories Plus for Windows (CR), 569  
 Category Discrimination and Reasoning Plus for Windows (CR), 569  
 Category Naming and Completion Plus for Windows (CR), 570  
 Cause & Effect (TR), 570  
 Cause 'n Effect (ES), 571  
 CAV-ASL (SI), 571  
 Children's Switch Progressions, 572  
 Circletime Tales & Circletime Tales Deluxe (ES), 572  
 Cognitive Disorders I, II, III, IV (CR), 573  
 Cognitive Rehabilitation Software (ES,LS,LT), 573  
 Cogrehab Vol. 1 (CR,LS), 574  
 Cogrehab Vol. 2 (CR,LS), 574  
 Cogrehab Vol. 3 Version 2.0 (CR,LS), 575  
 Cogrehab Vol. 4 (CR,LS), 575  
 Cogrehab Vol. 5 (CR,LS), 576  
 Cogrehab Vol. 6 (CR,LS), 576  
 Cogrehab Vol. 7: Quest (CR,LS), 577  
 COINSNKEYS (CN,ES,KB), 577  
 Color Find (ES), 578  
 Colorful Concept Software (ES), 578  
 Colors and Shapes (ES), 579  
 Communication Training Program (TR), 579  
 Community Signs (AD,LS,LT), 580  
 Community Vehicles (ES), 580  
 Completion From Partial Information Plus for Windows (CR), 581  
 Computer CUP (ES,LT), 581  
 Computer Literacy Series (KB), 582  
 CONCENTRATE! On Words & Concepts (LS,LT), 582  
 Construc (CR), 583  
 Core Reading and Vocabulary Development (ED,LS,LT), 583  
 Creature Antics and Creature Capers (GA,TR), 584  
 Creature Cartoons (ES,GA), 584  
 Creature Chorus (TR), 585  
 Creature Features (TR), 585  
 Creature Magic (GA,LS,LT,RE), 586  
 CrossWords (GA,LS), 586  
 Data Entry (VO), 587  
 Deductive Reasoning Plus for Windows (CR), 587  
 Definitions Plus for Windows (CR), 588

DigiTalk 1 (CI,EA,TR), 127  
 Dino-Games (ES,TR), 588  
 Dinosaur Game (ES,GA,TR), 589  
 Dollars & Cents Series (AD,CN), 589  
 Early and Advanced Switch Games, 590  
 Early Concepts (ES), 590  
 Early Emerging Rules Series (LS,LT), 591  
 Early Learning 3.5/Complete Early Learning 5.25 (ED,ES,LS), 591  
 Early Learning 1 (ES), 592  
 Edmark Functional Word Series (AD,VO), 592  
 Eency-Weency Spider Game (ES), 593  
 Elementary Signer (SI), 593  
 Employment Signs (AD,LS,LT), 594  
 English on the Job (AS,VO), 594  
 Every Day Is A Holiday (GA,RE), 595  
 Exploring Early Vocabulary Series (LS,LT), 595  
 Family Fun (AS,ES), 596  
 Fast Food Game (ES), 596  
 Feelings (ES), 597  
 Find the Buttons, 597  
 Fingerspeller (SI), 598  
 Fingerspelling & Numbers (SI), 598  
 FingerZoids (GA,SI), 599  
 First Categories (ES,LS,LT), 599  
 First Mate (CR), 600  
 First Step Software (LT), 600  
 First Verbs and Primeros Verbos (ES,LT), 601  
 First Words (ES,LT), 601  
 First Words II (ES,LT), 602  
 Following Directions: One- and Two-Level Commands (ES), 602  
 Following Directions: Left and Right (ES), 603  
 Food Facts (AD,SV), 603  
 Foundations I (CR,ES), 604  
 Foundations II (CR,ES), 604  
 Function Pictures (CR), 605  
 Functional Vocabulary Plus for Windows (CR), 605  
 Fundamental Concepts (ES), 606  
 Further Adventures of Jimmy Jumper - Perseverance (AS,ES), 606  
 Getting Clean with Herkimer Level I, II, III, 607  
 GrammarPlay with Alps and Droops (LS,LT), 607  
 Grocery Store Words (AD,LS), 608  
 Hierarchical Attention Training (CR,LS), 608  
 Homographs (CR,LS), 609  
 Homophones (CR,LS), 609  
 Human: Being Machine (RE), 610  
 If You're Happy and You Know It (ES), 610  
 Improving Your Self-Concept, 611  
 Inferential Naming for Cognitive and Language Disorders (CR,LS,LT), 611  
 Inferential Naming Plus for Windows (CR), 612  
 Information Signs (AD,LS,LT), 612  
 Initial Phoneme Cuing for Aphasics (CR), 613  
 Interaction Games (ES,GA,TR), 613  
 Interaction Games II (ES,GA,TR), 614  
 Job Readiness Series (AS,VO), 614  
 Job Seeking Series (LS,VO), 615  
 Job Success Series (VO), 615  
 Join the Circus (AS,ES), 616  
 Joystick Trainer (TR), 616  
 Keyboarding by Ability (ED,KB), 617  
 Keyboarding for Individual Achievement (ED,KB), 617  
 Keyboarding for People with Cerebral Palsy (ED,KB), 618  
 Keyboarding Program with Voice Output (KB), 618  
 Keyboarding with One Hand (ED,KB), 619  
 Keys to Success: Comp. Keybd. Skills for Blind Children (KB,SV), 619  
 Language Master Special Edition - LM6000SE (LP,LS,PA,SV,VS), 477  
 Laryngograph (AS,ST), 620  
 Learn to Scan (AS,TR), 620  
 Learning Activity Packets (LAPs) (CN,LS,VO), 621  
 Learning How to Learn Series (LS), 621  
 Learning to Count (CN), 622  
 Learning to Reason Series (LS), 622  
 Learning to Spell Braille Signs (BR), 623



- Less, More, Make Equal (CN,CR), 623  
 Let's Go Shopping I and II (ES), 624  
 Let's Go to the Circus (LT), 624  
 Letter Find (CN,ES,KB,SV), 625  
 LetterTALK+ (SV,WP), 625  
 Listen With Your Ears (GA), 626  
 Living Alone (AD), 626  
 Logi (CR), 627  
 Logo TouchTools for the PowerPad (AS,ES), 627  
 Mac-Apple Communications Aid (CI,CN,DR,ES,PA,WP), 756  
 Magic (CR), 628  
 Magic Slate II (LP,LS,PA,WP), 756  
 Make It In Time (AS,ES), 628  
 Make It Scan (AS,ES), 629  
 Mastering Personal Information (MPI) (AD,CR), 629  
 Math Max (CN,CR,GA), 630  
 Math on the Job (AS,CN,VO), 630  
 Maze (GA,RE), 631  
 Medical Words (AD,LS), 631  
 Memory for Animated Sequences Plus for Windows (CR), 632  
 Memory I (CR,ES,LS), 632  
 Memory II (CR,ES,LS), 633  
 Micro Guide to Careers Series (VO), 633  
 Micro-LADS and Micro-LADS in French (LT), 634  
 Microcomputer Evaluation of Career Areas (MECA) (AS,VO), 634  
 Microllustrator (DR,PA,RE), 758  
 Mind Castle I and II (GA,LS), 635  
 Minimal Contrast Stories Plus for Windows (ST), 635  
 Minimal Contrast Therapy (ST), 636  
 Mix N Match (ES), 636  
 Money Matters (LS), 637  
 Monzy Skills (AD,CN,LS), 637  
 Motor Training Games (AS,GA,PA,RE), 638  
 Motor Training Games (GA,TR), 638  
 Multi-SCAN (GA,TR), 639  
 Multiple Meaning Words I Plus for Windows (LT), 639  
 Multiple Meaning Words II Plus for Windows (LT), 640  
 MusicWare (CN,ES,GA,LS), 640  
 MusicWare - Age Appropriate (ES,GA), 641  
 MY HOUSE: Language Activities of Daily Living (LS,LT), 641  
 My Paint & Talking Coloring Books (DR,ES,LT), 642  
 MY SCHOOL: Language Activities of Daily Living (LS), 642  
 MY TOWN: Language Activities of Daily Living (LS,LT), 643  
 Nasometer Model 6200-3 (AS,ST), 643  
 New Frog & Fly (TR), 644  
 Numeric Concepts I and II (LS), 644  
 Occupations, 645  
 Octopus (CN,CR,LS), 645  
 Old MacDonald's Farm I and II (ES,LS), 646  
 On the Job Series - Career Interests (VO), 646  
 On the Job Series - Communication Skills (VO), 647  
 On the Job Series - Mathematics (CN,VO), 647  
 On the Job Series - Problem Solving Skills (VO), 648  
 One Switch Picasso (DR,RE), 648  
 Opening Windows (KB), 649  
 Opposites and Similarities Plus for Windows (CR), 649  
 Order Processing (VO), 650  
 Padded Food (AS,ES), 650  
 Padded Vehicles (ES), 651  
 Paper Dolls I and II (AD,ES), 651  
 PC Typer (KB), 652  
 Personal Development Software Series (LS), 652  
 Pick-A-Meal (AD,GA), 653  
 Pictalk (CI,ES,TR), 653  
 Picture Cue Dictionary (AD,CI,LT,NA), 654  
 Picture Identification Plus for Windows (CR), 654  
 Picture Naming Plus for Windows (CR), 655  
 Picture Scanner (TR), 655  
 Picture/Theme Disks (TR), 656  
 Pictures Programs: I, II and III (CR,ES,LS), 656  
 Point to Pictures (TR), 657  
 Positive Parenting (AD), 657  
 PowerPad Preschool Pack I & II (GA), 658  
 PowerTalker (TR), 658  
 Prefix (CN,CR), 659  
 Preposition Fill-Ins (CR), 659  
 Press to Play (ES,TR), 660  
 Primer 83 (AS,LS), 660  
 Problem Solving I (CR), 661  
 R.A.P.S. Software Series I PowerPad, 661  
 Rabbit Scanner (AS,ES), 662  
 Race the Clock (GA,RE), 662  
 Rate Drill in Articulation, Language and Fluency (LT,ST), 663  
 Reactions (R73) (ES), 663  
 Reading a Ruler - English & Metric (CN,VO), 664  
 Reading Comprehension for Adolescents (CR), 664  
 Reasoning Skills on the Job (AS,VO), 665  
 Rhyming Pictures (CR), 665  
 Rockets to the Moon (ES,GA,TR), 666  
 Run Rabbit Run (AS,ES), 666  
 Safety Signs (AD,LS,LT), 667  
 Scan & Match 1, 2, 3, and 4 (TR), 667  
 Scan It - Switch It (TR), 668  
 Scanning Picasso (DR,RE), 668  
 Seasons, 669  
 Seek & Find, 669  
 Semantic Development Using Code Breaking Strategies (LS,LT), 670  
 Sentence Completion Plus for Windows (LT), 670  
 Sentence Key & Picture Sequence Key (LT), 671  
 Sentence Master (LS), 671  
 Shell Game & Mouse Game (ES,GA), 672  
 Sight Words (LS), 672  
 Silly Sandwich (ES), 673  
 Simple Sentence Structure (ES,LT), 673  
 SimpleCom I: Yes/No Communication (CI,TR), 674  
 SimpleCom II: Needs/Wants Communication (CI,TR), 674  
 Single Switch Software (ED), 675  
 Single Switch/MatchBox Pack I, 675  
 Son of Seek and Find (GA), 676  
 Sorting by Category Plus for Windows (CR), 676  
 Sound Scope (ST), 677  
 Special Education Public Domain Software (CR,ED,LS), 677  
 SpeechViewer II (ST), 678  
 Steps for Career Choice (VO), 678  
 Storytime Series (AD,LP,TR), 679  
 Storytime Series for Macintosh (AD,LP,TR), 679  
 Studio4 (CR), 680  
 Subtle Messages (SI), 680  
 Survival Words (AD,AS,LS,LT), 681  
 Swim, Swam, Swum: Mastering Irregular Verbs (LS,LT), 681  
 Switch Arcade (GA,RE), 682  
 Switch Arcade (GA), 682  
 Switch Art (ES), 683  
 Switch It - Change It (ES), 683  
 Switch It - See It (ES), 684  
 Switch Puzzles (RE,TR), 684  
 SwitchEnsemble (RE,TR), 685  
 Talking Hands (SI), 685  
 Talking Literacy Kit for the Apple IIe (TALK IIe) (GA,KB,WP), 686  
 Talking Nouns, Talking Nouns II, and Talking Verbs (CI,TR), 686  
 Talking Public Domain Disks (ED,LS,SV,VO), 730  
 Talking Touch Window (AS,CI,TR), 687  
 Talking Typer (KB,SV), 687  
 Talking Writer & Four Games (KB,LP,PA,SV,WP), 766  
 TalkTime with Tucker (ST), 688  
 Tea Party (ES), 688  
 Teenage Switch Progressions, 689  
 Telling Time (AD,CR), 689  
 Telling Time, Parts of the Face, Learning Colors (ES), 690  
 THINKable/DOS (CR), 690  
 This is the Way We Wash Our Face (ES,TR), 691  
 This Old Man (CN,SI), 691  
 Timekeeper (AD), 692  
 Touch and Match (ES), 692  
 Touch and See (ES), 693  
 TouchMoney (AD,CN,VO), 693  
 Traffic Signs Plus for Windows (AD), 694  
 Transportation Signs (AD,LS,LT), 694  
 Trip to the Zoo (GA), 695  
 Turn-Talking (CI,TR), 695

Twenty Categories (LS,LT), 696  
 UKanDu Little Books (LS), 696  
 UKanDu Switches, Too! (ES), 697  
 Understanding Attributes (CR), 697  
 Verb Fill-Ins (CR), 698  
 Verbal Analogies (LS,LT), 698  
 Verbal Analogies Plus for Windows (LT), 699  
 Video Voice Speech Training System (ST), 699  
 Visi-Pitch Model 3300 (ST), 700  
 Visual Confrontation Naming Plus for Windows (CR), 700  
 Visual Memory Plus for Windows (CR), 701  
 Visual Motor Skills (ES), 701  
 Visual Pattern Memory Plus for Windows (CR), 702  
 Visuospatial Skills I (CR), 702  
 Visuospatial Skills II (CR), 703  
 Vortex Machine Assisted Reader Software (LS), 703  
 Wheels On The Bus I, II, III (ES,TR), 704  
 Wheels on the Bus I, II, III - Intellipics Activity (ES,GA), 704  
 Wheels on the Bus: COMPLETE (ES), 705  
 Where is Puff? (ES), 705  
 Word Association Plus for Windows (CR), 706  
 Word Order in Sentences (LS,LT), 706  
 Word Order Plus for Windows (LT), 707  
 Words and Concepts I, II, III (LS,LT), 707  
 WordWise Software (LT), 708  
 Worm Squirm (ES,TR), 708  
 WSCC (Washington State Cooperative Curriculum) (LS), 709  
 Zoo Time (ES), 709

**Typing Acceleration Program {TA}**

*Software that speeds up the rate at which a person types, through some technique such as word prediction or abbreviation expansion. These products are also cross listed more specifically in Index 2 by their Input Expand/Accell features.*

Aurora 2.0 for DOS (CI,EA,LP,TI,WP), 376  
 Aurora for Windows (KM,TI,WP), 333  
 B-Edit (LP,PA,WP), 738  
 CINTEX I (EC,PA,PC,RE,TI,WP), 744  
 Co:Writer (PA), 745  
 E Z Keys (EC,KM), 339  
 Expanded Keyboard Emulator (KM), 340  
 Finish Line (PA), 751  
 HandiWORD and HandiWORD International (KM), 343  
 Help U Type (KM), 344  
 JDN Shorthand (5073) (KM), 346  
 Keycache (KM), 348  
 KeyREP (KM), 351  
 KeyWiz (KM), 352  
 Magic Fingers (KM), 354  
 PAL (KM), 358  
 PRD+ (Productivity Plus) Basic Edition (KM), 360  
 Predict It (PA,WP), 763  
 ProKey (KM), 361  
 QuicKeys (KM), 361  
 SofType (TI), 440  
 Telepathic II (PA), 767  
 Tempo for Windows (KM), 365  
 Tempo II Plus (KM), 365  
 TempoEZ (KM), 366  
 TimeOut UltraMacros (KM), 366  
 Typelt4Me (PA), 770  
 WiViK 2.0 (Windows Visual Keyboard) (TI), 450  
 WordWriter (KM,WP), 368  
 WriteAway (PA,WP), 774

**Vocational {VO}**

*Software designed to teach or assess vocational skills to assist in vocational placement, or to manage vocational programs*

Babysitting Basics (TT), 560  
 Be a Winner Series (LS,TT), 561  
 Career English (ED,LS), 715  
 Data Entry (TT), 587  
 Edmark Functional Word Series (AD TT), 592  
 English on the Job (AS,TT), 594  
 Job Readiness Series (AS,TT), 614  
 Job Seeking Series (LS,TT), 615  
 Job Success Series (TT), 615  
 Learning Activity Packets (LAPs) (CN,LS,TT) 621  
 Math on the Job (AS,CN,TT), 630  
 Micro Guide to Careers Series (TT), 633  
 Microcomputer Evaluation of Career Areas (MECA) (AS,TT), 634  
 On the Job Series - Career Interests (TT), 646  
 On the Job Series - Communication Skills (TT), 647  
 On the Job Series - Mathematics (CN,TT), 647  
 On the Job Series - Problem Solving Skills (TT), 648  
 Order Processing (TT), 650  
 Reading a Ruler - English & Metric (CN,TT), 664  
 Reasoning Skills on the Job (AS,TT), 665  
 Steps for Career Choice (TT), 678  
 Talking Public Domain Disks (ED,LS,SV,TT), 730  
 TouchMoney (AD,CN,TT), 693

**Voice Amplifiers {VA}**

*Small portable audio amplifiers designed to increase the volume of a person's voice. These are products for people with weak or soft speech, not hearing aids or other amplifiers for hearing impaired people.*

ADDvox III System (CI,SA), 3  
 Amplifiers (SA), 3  
 Handset for Speech Amplification (PC,SA), 6  
 Park Speech Amplifier (SA), 7  
 Rand Voice Amplifier (SA), 8  
 Speechmaker (SA), 10  
 Voice Amplificaider (CI,SA), 11  
 Voicette (SA), 12

**Voice-Output Screen Reader or Reading Machine {VS}**

*Software or software/hardware products which provide access to standard software through voice output. Also includes Optical Character Recognition (OCR) reading systems with voice output. Products which are strictly speech synthesizers are not included but are coded under Speech Synthesizer (SS).*

Artic TransBook (PW), 467  
 Artic TransType (PW,SV), 467  
 ASAP (Automatic Speech Access Program) (SV), 468  
 BookWise, 468  
 Braille 'n Speak (BR,PW,SS,SV,TI), 469  
 Braille 'n Speak Classic (BR,CN,PA,SV,WP), 469  
 Braille Lite (BR,BT,CN,PW,SV), 470  
 BrailleMate 2 (BR,PW), 470  
 Business Vision (SV), 471  
 David (BR,BT,PA,PW,SS,SV), 471  
 Echo II with Textalker & Echo II with Textalker-GIS (SS), 472  
 Emacspeak, 472  
 Gizmo (LP,SV), 473  
 HandiCHAT and HandiCHAT Deluxe (SV), 474  
 IBM Screen Reader/2 (SV), 474  
 IBM Screen Reader/DOS (SV), 474  
 Infovox 210 (SV), 475  
 JAWS for Windows (SV), 475

JAWS Screenreader (SV), 476  
 Keynote Companion (CN,SV,TL,WP), 476  
 Language Master Special Edition - LM6000SE  
 (LP,LS,PA,SV,TT), 477  
 Magnum (BR,PW,TI), 477  
 Myna (BR,PW,SV), 478  
 Open Book, 478  
 Open Book Unbound, 479  
 outSPOKEN 1.7 (SV), 479  
 outSPOKEN for Windows (SV), 480  
 PCMaster & Windows Master (BR,IA,SV), 460  
 Protalk23 for Windows (SV), 480  
 PROVOX (SV), 481  
 Reading AdvantEdge, 481  
 ScanTELL, 482  
 ScreenPower (SV), 482  
 ScreenPower for Windows (SV), 483  
 Seekline (SV), 483  
 Slimware (SV), 484  
 Slimware Window Bridge (SV), 484  
 SoundProof (SV), 485  
 Speak Out VOILA (LP,MG,SV,TI), 440  
 Speaqualizer Speech Access System (SV), 485  
 Textalker-GS, 486  
 TINYtalk (SV), 486  
 Type 'n Speak (PW,SV), 487  
 Vocal-Eyes (SV), 487  
 Win Vision (SV), 488  
 Window-Eyes (SV), 488  
 WINKLINE (SV), 489  
 WordScholar (SV), 489  
 Write:OutLoud (PA), 774  
 WriteAway (PA,TA), 774

### Word Processing (Writing) {WP}

*Software or devices which have specific features designed for writing, storing, retrieving and editing text. Simple programs that allow the user to compose text but not to store, edit and manipulate it do not qualify as word processing programs. This code only includes programs or devices especially designed for disabled computer users. Special input and output systems (See Alternate Inputs and Alternate Display Systems: above) can be used to gain access to standard commercial word processing programs.*

ADAPTA-LAN (CI,LP,PC,TI), 374  
 Aurora 2.0 for DOS (CI,EA,LP,TA,TI), 376  
 Aurora for Windows (KM,TA,TI), 333  
 B-Edit (LP,PA,TA), 738  
 BEX 3.1 (BR,LP,PA,SV), 739  
 BlissWrite (PA,TT), 741  
 Braille 'n Speak Classic (BR,CN,PA,SV,VS), 469  
 CINTEX I (EC,PA,PC,RE,TA,TI), 744  
 Equalizer (CI,DR,EA,PW,RE,TI), 131  
 Eye Relief (LP,PA), 750  
 Freedom Writer (PA), 752  
 Handheld Computers and Personal Organizers (CM,EA), 133  
 Keynote Companion (CN,SV,TL,VS), 476  
 Keysoft (CN,PA,SV), 754  
 Large Print Word Processors (LP,PA), 755  
 LetterTALK+ (SV,TT), 625  
 Mac-Apple Communications Aid (CI,CN,DR,ES,PA,TT), 756  
 Magic Slate II (LP,LS,PA,TT), 756  
 MicroBraille 2 (BR,PA), 758  
 Noteworthy (PA), 760  
 Polycom (CI,EA,PC,PW,TL), 146  
 PowerSecretary (TI), 433  
 Predict It (PA,TA), 763  
 Talking Literacy Kit for the Apple IIe (TALK IIe) (GA,KB,TT), 686  
 Talking Writer & Four Games (KB,LP,PA,SV,TT), 766  
 TouchWindow (DR,DS,ID,RE,TI), 444  
 Wish Writer (PA), 772  
 WiVox (PA), 772  
 Word-Talk (PA,SV), 773  
 WordWriter (KM,TA), 368  
 Write This Way (ED), 733

## Index 2

# Products Listed by Input/Output Feature

This index includes lists of products (except switches) according to certain input and output features. Each list includes any product in the book with that feature. Products are arranged alphabetically within each list. The function codes assigned to that product follow in parentheses. Switches are listed separately in Index 3.

For example, if you are looking for a word processing program with both large print and synthesized speech output, you would go to the list titled "Output Display: Large Print." As you look through the list you would note those products with the function codes WP (word processing) and SV (screen display to voice). By searching in this manner you would identify five programs that meet the function/feature criteria. You would then go to the individual product descriptions to check on the type of computer, age appropriateness, additional features, etc. Once the search has been narrowed, call the manufacturer for up-to-date information on the product.

## Index 2: Products Listed by INPUT/OUTPUT FEATURE

### *Titles of product lists in this index:*

Input Expand/Accel: Abbreviation Expansion  
Input Expand/Accel: Encoding (Chart or Memory Based)  
Input Expand/Accel: Levels or Pages  
Input Expand/Accel: Morse  
Input Expand/Accel: Predictive

Input Method: Directed Scanning  
Input Method: Scanning

Input Symbol System: Auditory Presentation (eg Auditory Scanning)  
Input Symbol System: Bliss Symbols  
Input Symbol System: Photos/Pictures/Line Drawings  
Input Symbol System: User Selectable Symbols  
Input Symbol System: Whole Words

Input Type: Air (Sip/Puff)  
Input Type: Contact (Zero Pressure)  
Input Type: Eye Movement and Eye Gaze  
Input Type: Head Controlled  
Input Type: Input Jack - Accepts Any Switch  
Input Type: Joystick/Wobblestick  
Input Type: Light Sensitive (Optical)  
Input Type: Movement Activated  
Input Type: Noise (Sound or Vocalization)  
Input Type: OCR (Optical Character Recognition)  
Input Type: Pressure Sensitive  
Input Type: Speech Recognition  
Input Type: Wireless

Output/Display: Braille Printer  
Output/Display: Deaf Baudot (for TDD's)  
Output/Display: Ideographic/Pictographic Symbols  
Output/Display: Large Print  
Output/Display: Modem (ASCII)  
Output/Display: Speech Output  
Output/Display: Tactile/Braille Display (Dynamic)

Switch Inputs: Uses Analog Control  
Switch Inputs: Uses Dual Switch  
Switch Inputs: Uses Joystick (4 or 5 Switches)  
Switch Inputs: Uses Multiple Switches (3 to 16 Switches)  
Switch Inputs: Uses Single Switch

### *Function codes which may appear in parentheses after items in this index:*

AD Activities of Daily Living  
AL Artificial Larynx  
AS Assessment (Evaluation)  
BP Book/Paper Handling  
BR Braille  
BT Braille and Tactile Output Systems  
CI Conversation/Interaction  
CM Call, Monitoring, or Memory System  
CN Calculation/Math Aid  
CR Cognitive Rehabilitation  
DR Drawing  
DS Database Management/Spreadsheet  
EA Electronic Communication or Writing Aid  
EC Environmental Control  
ED Adaptive Educational Software  
ES Early Skills (Pre-Reading)  
GA Game  
IA Input Adapter for Computer  
ID Input Device Usable with Only Some Software  
KB Keyboarding Training Program  
KE Keyboard Emulating Interface  
KG Keyguard  
KM Modification for Standard Keyboard  
LP Large Print Output  
LS Later Skills (Includes Reading)  
LT Language Therapy/Development  
MG Magnification Hardware and Software for Computer Displays  
MS Mounting Systems  
MT Mouse or Touch Pad Emulation  
NA Non-Electronic Communication Aid  
PA Personal Tool or Aid (for Speaking, Writing, Drawing, Controlling, etc.)  
PC Phone Control/Access  
PT Pointing or Typing Aid  
PW Portable Writing  
RE Recreation  
RS Repetitive Strain Injury (RSI) Prevention  
SA Speech Aid  
SI Signing  
SS Speech Synthesizer  
ST Speech Therapy (not Language Therapy)  
SV Screen (Display) to Voice  
TA Typing Acceleration Program  
TD Telecommunication Device for the Deaf (TDD)  
TI Alternate Input Usable with All Software  
TL Telecommunication  
TR Training or Communication Initiation Aid  
TT Training and Therapy Software  
VA Voice Amplifier  
VO Vocational  
VS Voice-Output Screen Reader or Reading Machine  
WP Word Processing (Writing)

**Input Expand/Accel: Abbreviation Expansion**

*System whereby the user types a short series of characters (letters, numbers, etc.) and this short series of characters (the abbreviation) triggers a longer series of characters (the expansion). Sometimes known as a "macro."*

Adaptive Firmware Card Model G32c (IA,KE,KM,TI), 374  
 B-Edit (LP,PA,TA,WP), 738  
 Bloorview Miniature Keyboard (TI), 379  
 Crestalk (CI,EA), 126  
 E Z Keys (EC,KM,TA), 339  
 EvalPAC with RealVoice (AS,CI,EA,EC,PW,TI), 131  
 Expanded Keyboard Emulator (KM,TA), 340  
 GEWA FTB 108 Enlarged Keyboard (TI), 391  
 GEWA METB 121 Reduced Size Keyboard (TI), 391  
 Gus! Multimedia Speech System (CI,EA,KM,TA), 133  
 HandiCODE and HandiCODE Deluxe (SV,TI), 393  
 JDN Shorthand (5073) (KM,TA), 346  
 KeyREP (KM,TA), 351  
 KeyWiz (KM,TA), 352  
 LIAISON (EC,KE,PC,TI), 407  
 LightWRITER SL35 (CI,EA), 138  
 MacroMaster/pro (KM,TA), 411  
 Magic Fingers (KM,TA), 354  
 Mastervoice Environmental Control Single User Unit (EC,PC), 285  
 PRD+ (Productivity Plus) Basic Edition (KM,TA), 360  
 ProKey (KM,TA), 361  
 QuickKeys (KM,TA), 361  
 RealVoice (AS,CI,EA,EC,PW,TI), 147  
 ScanPAC (CI,CN,EA,EC,PW,TI), 150  
 Scribe (CI,EA,KG,PW), 150  
 Switch-Back (ID,TI), 443  
 Talk:About (CI,EA), 156  
 Talking Screen (CI,EA,PA), 156  
 Tempo for Windows (KM,TA), 365  
 Tempo II Plus (KM,TA), 365  
 TempoEZ (KM,TA), 366  
 TimeOut UltraMacros (KM,TA), 366  
 Typelt4Me (PA,TA), 770  
 VoiceBachs (CI,EA,SS), 159  
 WiViK 2.0 (Windows Visual Keyboard) (TA,TI), 450

**Input Expand/Accel: Encoding (Chart or Memory Based)**

*A system for allowing the number of possible selections to be greater than the number of selection areas (such as keys on keyboard). The user enters a code (often a series of digits) in order to make a selection. A communication aid with a ten-key keyboard, for example, could be used to access 1000 items of vocabulary, each with a three-digit code.*

Help U Type and Speak (CI,EA,KM), 135  
 Liberator (CI,CN,EA,EC,PW,TI), 137  
 VOIS 160 (CI,EA), 161

**Input Expand/Accel: Levels or Pages**

*A system for allowing the number of possible selections to be greater than the number of selection areas (such as keys on a keyboard). The system has a number of different meanings for each key, depending upon the "level" (or "page") active. To make a selection, the user picks the desired level and the desired key.*

BlackHawk (CI,EA), 122  
 DAC (CI,EA,SS), 126  
 DynaVox2 & DynaVox2c (CI,EA), 129  
 EasyTalk (CI,EA), 130  
 Equalizer (CI,DR,EA,PW,RE,TI,WP), 131  
 GEWA FTB 108 Enlarged Keyboard (TI), 391  
 GEWA METB 121 Reduced Size Keyboard (TI), 391

HandiKEY and HandiKEY Deluxe (KM), 342  
 LIAISON (EC,KE,PC,TI), 407  
 Lingraphica (CI,CR,EA,PA), 139  
 MegaWolf (CI,EA), 141  
 Say-It-All II Plus (CI,EA,KG,PW), 148  
 WhisperWolf (CI,EA), 162  
 WiViK 2.0 (Windows Visual Keyboard) (TA,TI), 450

**Input Expand/Accel: Morse**

*System where the user indicates selections by Morse code. "Dot and dash" patterns are assigned to each possible choice. Frequently done with one or two switches.*

Adaptive Firmware Card Model G32c (IA,KE,KM,TI), 374  
 CarryCom (CI,EA), 123  
 DARCI TOO (TI), 382  
 DEUCE (EC,PC), 273  
 EvalPAC with RealVoice (AS,CI,EA,EC,PW,TI), 131  
 ezMorse for Windows (TI), 388  
 HandiCODE and HandiCODE Deluxe (SV,TI), 393  
 Jouse (MT,TI), 400  
 Morse Code WSKE II (TI), 418  
 Scan Com (CI,EA,EC), 149  
 Scanning WSKE II (TI), 437

**Input Expand/Accel: Predictive**

*A system that predicts what character the user will type next. A typical predictive system will provide the user with possible completions of a word that the user has begun typing. If the correct word appears, the user can immediately select it, and need not finish typing it.*

Aurora 2.0 for DOS (CI,EA,LP,TA,TI,WP), 376  
 Aurora for Windows (KM,TA,TI,WP), 333  
 CINTEX I (EC,PA,PC,RE,TA,TI,WP), 744  
 Co:Writer (PA,TA), 745  
 Doors II (TI), 382  
 E Z Keys (EC,KM,TA), 339  
 Equalizer (CI,DR,EA,PW,RE,TI,WP), 131  
 Expanded Keyboard Emulator (KM,TA), 340  
 Finish Line (PA,TA), 751  
 Gus! Multimedia Speech System (CI,EA,KM,TI), 133  
 HandiWORD and HandiWORD International (KM,TA), 343  
 Help U Type (KM,TA), 344  
 HyperBliss 3.2 (EA), 136  
 Keycache (KM,TA), 348  
 KeyREP (KM,TA), 351  
 KeyWiz (KM,TA), 352  
 Liberator (CI,CN,EA,EC,PW,TI), 137  
 Mouse Keys (TI), 419  
 One Access (IA,TI), 427  
 Pre-Dict-ate (TI), 433  
 Predict It (PA,TA,WP), 763  
 RevolvingDoors (MT,TI), 437  
 Telepathic II (PA,TA), 767  
 VoiceBachs (CI,EA,SS), 159  
 Wish Writer (PA,WP), 772  
 WordWriter (KM,TA,WP), 368  
 WriteAway (PA,TA,WP), 774

**Input Method: Directed Scanning**

*Scanning systems using a row-and-column grid of choices, with a directional control (such as a joystick). The user can move in any desired direction to arrive at a selection.*

Adaptive Firmware Card Model G32c (IA,KE,KM,TI), 374  
 DynaVox2 & DynaVox2c (CI,EA), 129  
 EvalPAC with RealVoice (AS,CI,EA,EC,PW,TI), 131  
 Proportional Keystroke Scanner (TI), 434

Scan-It-All (C.I.EA.EC). 149  
 ScanPAC (C.I.CN.EA.EC.PW.TI). 150  
 Switchboard (C.I.EA). 154  
 X-10 Home Control Interface (EC). 306

**Input Method: Scanning**

*A selection technique whereby choices are presented to the user sequentially, and the user indicates when the right choice is arrived at (usually by activating a switch). To indicate choices, the scanning system may have a clock hand, a series of lights that light sequentially, or (on a computer screen) a moving cursor. Scanning may employ one, two or more switches, and may be done with a variety of techniques (automatic, row-and-column, etc.).*

Able2Speak (EA). 117  
 ActionVoice (C.I.EA.TR). 118  
 Adaptive Firmware Card Model G32c (I.A.KE.KM.TI). 374  
 AlphaTalker (C.I.EA.TI). 119  
 Audible Cursor Routine (C.I.EA.PA.TR). 121  
 Aurora 2.0 for DOS (C.I.EA.LP.TA.TI.WP). 376  
 Aurora for Windows (KM.TA.TI.WP). 333  
 Bed Control (DBC-1) (EC). 269  
 Blocks in Motion (DR.RE.TT). 563  
 Canon Communicator CC-7S and CC-7P (C.I.EA). 123  
 Card Communicator (C.I.RE.TR). 34  
 CarryCom (C.I.EA). 123  
 Cheap Talk 4 & 8 (C.I.EA.TR). 124  
 Clock Communicator (AS.CI.TR). 36  
 Comboard (2615) (AS.CI.TR). 36  
 Communication Programs (C.I.EA.EC.TR). 124  
 Communiclock (AS.CI.TR). 37  
 Communilight 24 (EA.TR). 37  
 Compartmentalized Communicator (AS.CI.TR). 38  
 Control I (EC.PC). 272  
 Controller (EC). 272  
 DARCI TOO (TI). 382  
 DEUCE (EC.PC). 273  
 Dial Scan (AS.CI.TR). 40  
 Dino-Games (ES.TR.TT). 588  
 Dinosaur Game (ES.GA.TR.TT). 589  
 Dual Clock Communicator (CI.TR). 42  
 DynaVox2 & DynaVox2c (C.I.EA). 129  
 E-Tran Scanner (AS.CI.TR). 43  
 Early Concepts (ES.TT). 590  
 EASICORDER (EC). 274  
 EasyTalk (C.I.EA). 130  
 Equalizer (C.I.DR.EA.PW.RE.TI.WP). 131  
 EvalPAC with RealVoice (AS.CI.EA.EC.PW.TI). 131  
 EZRA (C.I.CM.EC.PC). 277  
 ezScan (TI). 388  
 First Aide Kit (CM.EC.PC). 278  
 First Categories (ES.LS.LT.TT). 599  
 First Verbs and Primeros Verbos (ES.LT.TT). 601  
 First Words (ES.LT.TT). 601  
 First Words II (ES.LT.TT). 602  
 GEWA Infra-Link Speaker-Telephone (C.I.EC.PC). 279  
 Gus! Multimedia Speech System (C.I.EA.KM.TI). 133  
 Handy Speech Communication Aide (C.I.EA.SS). 134  
 Help U Key (TI). 394  
 HyperBliss 3.2 (EA). 136  
 I Can Speak (C.I.EA). 136  
 Instant Access (TI). 397  
 Interaction Games (ES.GA.TR.TT). 613  
 Interaction Games II (ES.GA.TR.TT). 614  
 Join the Circus (AS.ES.TT). 616  
 Ke:nx (KE.MT.TT). 402  
 Kincontrol (4105) (EC). 284  
 I earn to Scan (AS.TR.TT). 620  
 Liberator (C.I.CN.EA.EC.PW.TI). 137  
 LightWRITER SL85 (C.I.EA). 139  
 Lynx (C.I.EA.TR). 140  
 Mac-Apple Communications Aid (C.I.CN.DR.ES.PA.TT.WP). 756  
 Macaw Series (C.I.EA). 140

Make It In Time (AS.ES.TT). 628  
 MessageMate 20 (C.I.EA.TR). 141  
 MessageMate 40 (C.I.EA.TR). 142  
 Meta4 (C.I.EA). 143  
 Micro-LADS and Micro-LADS in French (LT.TT). 634  
 Money Skills (AD.CN.LS.TT). 637  
 Motor Training Games (AS.GA.PA.RE.TT). 638  
 Motor Training Games (GA.TR.TT). 638  
 Multi-SCAN (GA.TR.TT). 639  
 Nine Compartment Row/Column Scanner (C.I.TR). 48  
 One Access (IA.TI). 427  
 OneStrk (TI). 428  
 Pick-A-Meal (AD.GA.TT). 653  
 Pictalk (C.I.ES.TR.TT). 653  
 Picture Scanner (TR.TT). 655  
 Rabbit Scanner (AS.ES.TT). 662  
 ReadyScan (C.I.EA). 147  
 RevolvingDoors (MT.TI). 437  
 Rockets to the Moon (ES.GA.TR.TT). 666  
 Round Clock Communicator (C.I.TR). 53  
 Run Rabbit Run (AS.ES.TT). 666  
 Scan & Match 1, 2, 3, and 4 (TR.TT). 667  
 Scan Com (C.I.EA.EC). 149  
 Scan It - Switch It (TR.TT). 668  
 Scan-It-All (C.I.EA.EC). 149  
 ScanLite (C.I.TR). 53  
 Scanning Conversion Program. 550  
 Scanning Director (EC). 293  
 Scanning Picasso (DR.RE.TT). 668  
 Scanning Remote Control (SRC) (EC). 294  
 Scanning WSKE II (TI). 437  
 Scanning X-10 Powerhouse (EC). 294  
 ScanPAC (C.I.CN.EA.EC.PW.TI). 150  
 Sequential Scanner (AS.CI.TR). 54  
 Sight Words (LS.TT). 672  
 Single-Switch Multi-Appliance Control Unit & Modules (EC). 296  
 Single-Switch TV Control Unit (EC). 297  
 SofType (TA.TI). 440  
 Speaking Dynamically (C.I.EA). 152  
 Special Education Public Domain Software (CR.ED.LS.TT). 677  
 Steeper Communication/Teaching Aid (AS.CI.TR). 56  
 Storytime Series (AD.LP.TR.TT). 679  
 Storytime Series for Macintosh (AD.LP.TR.TT). 679  
 Switchboard (C.I.EA). 154  
 SwitchMouse (MT.TI). 443  
 TouchMoney (AD.CN.TT.VO). 693  
 Trip to the Zoo (GA.TT). 695  
 TVRC and TVRCS (EC). 301  
 Versascan (AS.CI.TR). 63  
 Vocal Assistant (C.I.CM.EA). 159  
 VoicePal Plus (C.I.EA.TR). 160  
 Where is Puff? (ES.TT). 705  
 WhisperWolf (C.I.EA). 162  
 Wish Writer (PA.WP). 772  
 WriteAway (PA.TA.WP). 774  
 X-10 Powerhouse System (EC). 307

**Input Symbol System: Auditory Presentation (eg Auditory Scanning)**

*A system which presents the user with a series of choices auditorially (for instance spoken by a speech synthesizer). When the system arrives at the desired choice the user indicates it (usually with a switch).*

Audible Cursor Routine (C.I.EA.PA.TR). 121  
 AudScan II (C.I.EA). 121  
 Letter Find (C.N.ES.KB.SI.TT). 625  
 Lynx (C.I.EA.TR). 140  
 Sight Word Spelling (ED.LS.SI). 726



**Input Symbol System: Bliss Symbols**

*A special set of international pictographic symbols.*

- AccessBliss 2.2 (NA), 69
- BlissWrite (PA.TT.WP), 741
- Blissymbol Templates (NA), 71
- Blissymbol Vocabulary Stamps (CI.NA), 72
- CanSpeak (CI.LT.TT), 568
- Core Vocabulary (CI.NA), 80
- HyperBliss 3.2 (EA), 136
- Pegasus (CI.EA.EC), 145

**Input Symbol System: Photos/Pictures/Line Drawings**

*A system which depends upon this type of symbol extensively enough that the user does not have to understand any other system (such as the alphabet).*

- Attainment Communication Collection (CI.NA), 71
- Bear Jam (ES.TT), 561
- Big/Little I and II (ES.TT), 562
- Boardmaker for Windows (NA), 73
- Buddy's Body (AS.ES.TT), 566
- Canon Communicator CC-7S and CC-7P (CI.EA), 123
- Cleo Communication Board (CI.NA), 75
- Communication Sheets (CI.NA), 79
- Communitlight 24 (EA.TR), 37
- Community Vehicles (ES.TT), 580
- Core Picture Vocabulary (CI.NA.TR), 80
- DAC (CI.EA.SS), 126
- Deluxe Communication Board Kit (CI.NA), 81
- Dinosaur Game (ES.GA.TR.TT), 589
- DynaSyms (CI.NA), 82
- DynaVox2 & DynaVox2c (CI.EA), 129
- Early Concepts (ES.TT), 590
- Eency-Weency Spider Game (ES.TT), 593
- Family Fun (AS.ES.TT), 596
- Fast Food Game (ES.TT), 596
- Feelings (ES.TT), 597
- Gus! Multimedia Speech System (CI.EA.KM.TI), 133
- Help Me at Home & School-G 5&6 (NA), 85
- Help Me to Help Myself Handbook (CI.NA), 86
- ICU-G 1&2 (CI.NA), 87
- If You're Happy and You Know It (ES.TT), 610
- Interaction Games (ES.GA.TR.TT), 613
- Interaction Games II (ES.GA.TR.TT), 614
- Let's Go Shopping I and II (ES.TT), 624
- Liberator (CI.CN.EA.EC.PW.TI), 137
- Life Experiences Communication Kit (CI.NA), 89
- Lingraphica (CI.CR.EA.PA), 139
- Motor Training Games (GA.TR.TT), 638
- Oakland Schools Picture Dictionary (CI.NA), 92
- Old MacDonald's Farm I and II (ES.LS.TT), 646
- Opticomunicator (CI.NA), 95
- Padded Food (AS.ES.TT), 650
- Padded Vehicles (ES.TT), 651
- Paper Dolls I and II (AD.ES.TT), 651
- Passport Kits (CI.NA), 95
- Pegasus (CI.EA.EC), 145
- Personal Trainer (CI.EA.TR), 145
- Pick 'N Stick Color Packs (NA), 98
- Pick 'N Stick Fast Food (NA), 99
- Pick 'n Stick Primary Pack (NA), 100
- PICSYMS Categorical Dictionary (CI.NA), 100
- Pictalk (CI.ES.TR.TT), 653
- Picture Scanner (TR.TT), 655
- Pictures, Please! (CI.NA), 104
- Point to Pictures (TR.TT), 657
- Quad Talk (AS.CI.TR), 52
- Rockets to the Moon (ES.GA.TR.TT), 666
- Select-A-Meal and Shopping Smart (NA), 107
- Self-Talk Stickers (CI.NA), 107

- Silent Speaker (CI.NA), 108
- Silly Sandwich (ES.TT), 673
- SimpleCom II: Needs/Wants Communication (CI.TR.TT), 674
- Specialist (CI.EA.NA.TR), 153
- Stickers for Talk Boards (CI.NA), 108
- Switch It - Change It (ES.TT), 683
- Switch It - See It (ES.TT), 684
- Talking Pictures Communication Board (CI.NA), 109
- Talking Pictures, Kits I - VII (CI.NA.SI), 109
- Talking Screen (CI.EA.PA), 156
- Talking Screen for Windows (CI.EA.PA), 157
- Talking Touch Window (AS.CI.TR.TT), 687
- Tea Party (ES.TT), 688
- This is the Way We Wash Our Face (ES.TR.TT), 691
- Touch 'N Talk Communication Stickers (CI.NA), 111
- Touch 'N Talk Micros (CI.NA), 111
- Tri-Responder (AS.TR), 62
- Wheels On The Bus I, II, III (ES.TR.TT), 704
- Where is Puff? (ES.TT), 705
- WordWise Language & Master Cards (CI.NA), 112
- WordWise Sticker Set (CI.NA), 112
- Worm Squirm (ES.TR.TT), 708
- Zoo Time (ES.TT), 709

**Input Symbol System: User Selectable Symbols**

*Any system where users can select, create, and use their own set of symbols.*

- ActionVoice (CI.EA.TR), 118
- Activity Board (AS.EC.TR), 30
- Alphabet Board Kit (CI.NA), 69
- AlphaTalker (CI.EA.TI), 119
- Appointment Book (CI.NA), 70
- Attainment Fifteen Talker (CI.EA.TR), 119
- Attainment Five Talker & Talker Plus (CI.EA.TR), 120
- Attainment Two Talker (CI.EA.TR), 120
- Calendars (CI.NA), 74
- Chain Talk (CI.NA), 75
- Clock Communicator (AS.CI.TR), 36
- Comboard (2615) (AS.CI.TR), 36
- Communication Binder (CI.NA), 76
- Communication Folder and Tri-Folder (CI.NA), 78
- Communication Symbol Holders (CI.NA), 79
- Communiclock (AS.CI.TR), 37
- Communitlight 24 (EA.TR), 37
- Compartmentalized Communicator (AS.CI.TR), 38
- Deluxe Communication Board Kit (CI.NA), 81
- Deluxe Talk Board (CI.NA), 81
- Dial Scan (AS.CI.TR), 40
- Dual Clock Communicator (CI.TR), 42
- Duo-Responder (CI.TR), 42
- DynaVox2 & DynaVox2c (CI.EA), 129
- EasyTalk (CI.EA), 130
- EvalPAC with RealVoice (AS.CI.EA.EC.PW.TI), 131
- Expanded Keyboards for the Talking BlissApple (KG.TI), 386
- Eye Transfer Communication System (CI.NA), 83
- Eye-Com Board (CI.NA), 84
- Fold It System (CI.NA), 84
- Hawk (CI.EA.TR), 134
- Individualized Communication Systems (CI.NA), 88
- IntelliKeys (TI), 398
- Keypad (2425) (AS.TR), 45
- Keypoint 300 (TI), 404
- Keypoint 60 (TI), 404
- King Keyboard (2440) (TI), 405
- Light Activated Switch Panel (CI.TR), 46
- LightBoard (TI), 408
- Logo TouchTools for the PowerPad (AS.ES.TT), 627
- Lynx (CI.EA.TR), 140
- MegaWolf (CI.EA), 141
- MessageMate 20 (CI.EA.TR), 141
- MessageMate 40 (CI.EA.TR), 142
- Mid-Sized Communication Book (CI.NA), 91



Mini Talking Card Reader (CI,EA,TR), 143  
Mini-MessageMate (CI,EA,TR), 144  
Narwhal Expanded Keyboards for Adaptive Firmware Card (TI), 425  
Opticomunicator (CI,NA), 95  
Parrot (CI,EA,TR), 144  
Pegasus (CI,EA,EC), 145  
Pocket Picture Holder (NA), 105  
Pocket-Sized and Double Pocket-Sized Communication Book (CI,NA), 105  
Porta Book (CI,NA), 106  
PowerPad (DR,RE,TI), 432  
PowerPad Starter Kit (TI), 432  
Quad Talk (AS,CI,TR), 52  
RealVoice (AS,CI,EA,EC,PW,TI), 147  
Round Clock Communicator (CI,TR), 53  
Say-It-All II Plus (CI,EA,KG,PW), 148  
Say-It-Simply Plus (CI,EA,TR), 148  
ScanPAC (CI,CN,EA,EC,PW,TI), 150  
Sequential Scanner (AS,CI,TR), 54  
Shadow Talker (CI,EA,TR), 151  
SimpleCom I: Yes/No Communication (CI,TR,TT), 674  
SpeakEasy (CI,EA), 152  
Speaking Dynamically (CI,EA), 152  
Steeper Communication/Teaching Aid (AS,CI,TR), 56  
Switch Modified PowerPad (TI), 442  
Switchboard (CI,EA), 154  
Talk Back III (CI,EA,TR), 155  
Talk Back VI (CI,EA,TR), 155  
Talking Pictures Communication Board (CI,NA), 109  
Talking Screen for Windows (CI,EA,PA), 157  
Touch 'N Talk Communication Board (CI,NA), 110  
Touch 'N Talk Communication Notebook (CI,NA), 110  
Tri-Responder (AS,TR), 62  
Versascan (AS,CI,TR), 63  
Vocal Assistant (CI,CM,EA), 159  
VoicePal Plus (CI,EA,TR), 160  
VOIS 160 (CI,EA), 161  
WalkerTalker (CI,EA), 161  
WhisperWolf (CI,EA), 162

### **Input Symbol System: Whole Words**

*A system that provides menus of words for the user to choose from.*

Able2Speak (EA), 117  
Adaptive Firmware Card Model G32e (IA,KE,KM,TI), 374  
Alphabet Board Kit (CI,NA), 69  
Communication Programs (CI,EA,EC,TR), 124  
DAC (CI,EA,SS), 126  
Deluxe Communication Board Kit (CI,NA), 81  
Emotional Moods & Needs-G 3&4 (CI,NA), 82  
Foods I Like Menu Book (CI,NA), 85  
Handy Speech Communication Aide (CI,EA,SS), 134  
Help Me at Home & School-G 5&6 (NA), 85  
Help Me to Help Myself Handbook (CI,NA), 86  
Help U Type and Speak (CI,EA,KM), 135  
ICU-G 1&2 (CI,NA), 87  
King Keyboard (2440) (TI), 405  
Mac-Apple Communications Aid (CI,CN,DR,ES,PA,TT,WP), 756  
Passport Kits (CI,NA), 95  
Personal Trainer (CI,EA,TR), 145  
Self-Talk Stickers (CI,NA), 107  
Sight Words (LS,TT), 672  
Silent Speaker (CI,NA), 108  
Talking Touch Window (AS,CI,TR,TT), 687  
VoiceBachs (CI,EA,SS), 159

### **Input Type: Air (Sip/Puff)**

*Input devices operated by sip-and-puff style switches. This code is only applied to systems that come equipped with such a switch. Systems that accept any switch as input can often be connected to sip-and-puff switches purchased separately (see "Input Jack," below)*

Able-Phone 1900 and 2000 (EC,PC), 266  
Baton Laser Pointer (PT), 16  
Captain's Log: Cognitive Training System (AS,CR,ES,LS,TT), 568  
Custom Speaker Phone (EC,PC), 273  
First Aide Kit (CM,EC,PC), 278  
HIECS-1 (EC,PC), 282  
Jouse (MT,TI), 400  
Mouth Operated Joystick for Genesis Video Game (GA,RE,TI), 422  
One-Hand Operated Joystick for Genesis Video Game (TI), 427  
Proportional Keystroke Scanner (TI), 434  
Sip/Puff Bed Control (EC), 297  
T-140 Series Puff/Sip Speakerphones (EC,PC), 299  
URC-400 Series Universal Remote Control (EC), 305  
VX-5000 Cordless Phone (CI,EC,PC), 305

### **Input Type: Contact (Zero Pressure)**

*Systems that require absolutely no pressure, only contact, to activate.*

BioMuse (TI), 378

### **Input Type: Eye Movement and Eye Gaze**

*Systems based upon the movement of the eyes. This includes electronic and non-electronic systems based on gaze, but does not include switch-type systems based on wrinkling the eyebrows or blinking (see "Movement Activated" below).*

Eye Slaved Pointing System (EC,PC,TI), 387  
Eye Transfer Communication System (CI,NA), 83  
Eye-Com (CI,NA), 83  
Eye-Com Board (CI,NA), 84  
Eyegaze Computer System (EA,EC,PC,TI), 132  
Nu-Vue-Cue (CI,NA), 92  
Object Communicator (CI,NA), 93  
Opticomunicator (CI,NA), 95  
VisionKey (EA,TI), 158

### **Input Type: Head Controlled**

*Systems controlled by movement of the head, including systems controlled with head-mounted light pointers. Also any head-controlled input device.*

ActionVoice (CI,EA,TR), 118  
Adjustable Head Pointer (PT), 15  
Adjustable Head Pointer (PT), 15  
Adjustable Head Pointer PC 7590 (PT), 16  
AlphaTalker (CI,EA,TI), 119  
Captain's Log: Cognitive Training System (AS,CR,ES,LS,TT), 568  
Clear-View Head Pointer (PT), 17  
Doors II (TI), 382  
EvalPAC with RealVoice (AS,CI,EA,EC,PW,TI), 131  
H71830 Adjustable Head Pointer (PT), 18  
H73217 Mouth Held Page Turners (BP,PT), 19  
Head Pointers: AD-1, AD-2, AD-3 (PT), 20  
HeadMaster Plus (MT,TI), 393  
HeadMouse (DR,MT,TI), 394  
Help U Keyboard (TI), 395  
Heyer-Abadie Modular Mouthstick (PT), 20  
Laser Light Pointer (PT), 21  
Laser Optic Keyboard (CI,TI), 407  
Liberator (CI,CN,EA,EC,PW,TI), 137  
Light Activated Switch Panel (CI,TR), 46

Light Beam Indicator (PT), 21  
 Light Pointer (PT), 22  
 Light Pointer (PT), 22  
 Light Pointers (PT), 23  
 LightBeam (PT), 23  
 LightBoard (TI), 408  
 Lynx (CI,EA,TR), 140  
 Mouse Keys (TI), 419  
 Mouthsticks (BP,PT), 24  
 Scan-It-All (CI,EA,EC), 149  
 ScreenDoors (TI), 438  
 SynergyMac and SynergyPC (CI,PW,TI), 444  
 Talking Laser Beam (PT), 25  
 Vacuum Wand (BP,PT), 26  
 Viewpoint Optical Indicator (PT), 26  
 WiViK 2.0 (Windows Visual Keyboard) (TA,TI), 450

### Input Type: Input Jack - Accepts Any Switch

*Systems that have an input jack (or plug) which can be connected to a variety of switches. Communication aids and computer access systems that are switch-operated are indicated by this code.*

101 Animations (TR,TT), 556  
 Ability Switch Phone Sequencer (CI,EC,PC), 265  
 Ability Switch Tester (5955) (AS,TR), 29  
 Able-Phone 100WA (EC,PC), 266  
 Able-Phone 1900 and 2000 (EC,PC), 266  
 Able2Speak (EA), 117  
 AC Adaptor FRE-103C (TR), 29  
 Access-I (CI,PW,TI), 373  
 ActionVoice (CI,EA,TR), 118  
 Adap2U (MT,TI), 373  
 Adaptive Firmware Card Model G32e (IA,KE,KM,TI), 374  
 Adult Switch Progressions (TR,TT), 556  
 Adventures of Jimmy Jumper - Prepositions (AS,ES,LT,TT), 557  
 AlphaTalker (CI,EA,TI), 119  
 AND Module (TR), 31  
 And Or Box (AS,TR), 31  
 Aphasia Series: I through VIII (CR,LS,TT), 558  
 Apple Computer Input Adapter (IA), 453  
 APT Automaddak Page Turner System (BP,EC), 268  
 Audible Cursor Routine (CI,EA,PA,TR), 121  
 Battery Adapter (AS,TR), 32  
 Battery Device Adapter (AS,TR), 32  
 Battery Interrupter (AS,TR), 33  
 Beeper (AS,CM,TR), 313  
 BEST Faces (ES,TT), 562  
 BEST Switch Interface (IA), 453  
 Big/Little I and II (ES,TT), 562  
 Big:Calc (CN,LP,PA), 740  
 BiGmack (CI,EA,TR), 122  
 Blocks in Motion (DR,RE,TT), 563  
 Bozons' Quest (GA,LS,TT), 564  
 Build-A-Scene (TT), 567  
 Buzzer Box (CM,TR), 34  
 Call Signal 2 (AS,CM,TR), 314  
 Canon Communicator CC-7S and CC-7P (CI,EA), 123  
 Card Communicator (CI,RE,TR), 34  
 Cause & Effect (TR,TT), 570  
 Cheap Talk 4 & 8 (CI,EA,TR), 124  
 Children's Switch Progressions (TT), 572  
 Chime Alarm (AS,CM,TR), 315  
 CINTEX I (EC,PA,PC,RE,TA,TI,WP), 744  
 CINTEX2 (EC,PA,PC), 271  
 Clear Clock Communicator (CI,TR), 35  
 Clock Communicator (AS,CI,TR), 36  
 Cogrehab Vol. 5 (CR,LS,TT), 576  
 Colors and Shapes (ES,TT), 579  
 Comboard (2615) (AS,CI,TR), 36  
 Communication Programs (CI,EA,EC,TR), 124  
 Communiclock (AS,CI,TR), 37  
 Communilight 24 (EA,TR), 37  
 Compartmentalized Clock Communicator (CI,TR), 38  
 Compartmentalized Communicator (AS,CI,TR), 38  
 Computer Switch Interface (IA), 455  
 CONCENTRATE! On Words & Concepts (LS,LT,TT), 582  
 Control I (EC,PC), 272  
 Controller (EC), 272  
 Counter Box (AS,TR), 39  
 Counter Module (AS,TR), 39  
 Creature Antics and Creature Capers (GA,TR,TT), 584  
 Creature Cartoons (ES,GA,TT), 584  
 Creature Chorus (TR,TT), 585  
 Creature Features (TR,TT), 585  
 Creature Magic (GA,LS,LT,RE,TT), 586  
 CrossScanner (IA), 455  
 DARCI TOO (TI), 382  
 Delay Timer Box (AS,EC,TR), 40  
 DEUCE (EC,PC), 273  
 Dial Scan (AS,CI,TR), 40  
 Dino-Games (ES,TR,TT), 588  
 Dinosaur Game (ES,GA,TR,TT), 589  
 Dual Channel Latching Switch Interface (AS,EC,TR), 41  
 Dual Clock Communicator (CI,TR), 42  
 Duo-Responder (CI,TR), 42  
 DynaVox2 & DynaVox2c (CI,EA), 129  
 E-Tran Scanner (AS,CI,TR), 43  
 E.A.S.I. dialer (2110) (EC,PC), 274  
 Early and Advanced Switch Games (TT), 590  
 Early Concepts (ES,TT), 590  
 Early Learning I (ES,TT), 592  
 Early Learning II (CN,ED,ES), 717  
 EASICORDER (EC), 274  
 EasyTalk (CI,EA), 130  
 Eency-Weency Spider Game (ES,TT), 593  
 Emergency Call Alarm (AS,CM,TR), 317  
 Equalizer (CI,DR,EA,PW,RE,TI,WP), 131  
 EvalPAC with RealVoice (AS,CI,EA,EC,PW,TI), 131  
 Exploring Early Vocabulary Series (LS,LT,TT), 595  
 EZ-TV Adapted Infrared Remote Control for Televisions (EC), 276  
 ezMorse for Windows (TI), 388  
 EZRA (CI,CM,EC,PC), 277  
 ezScan (TI), 388  
 Fast Food Game (ES,TT), 596  
 First Categories (ES,LS,LT,TT), 599  
 First Verbs and Primeros Verbos (ES,LT,TT), 601  
 First Words (ES,LT,TT), 601  
 First Words II (ES,LT,TT), 602  
 Fundamental Concepts (ES,TT), 606  
 Further Adventures of Jimmy Jumper - Perseverance (AS,ES,TT), 606  
 Getting Clean with Herkimer Level I, II, III (TT), 607  
 GEWA Infra-Link Speaker-Telephone (CI,EC,PC), 279  
 Gewa Page Turner (BP,EC), 280  
 Gus! Multimedia Speech System (CI,EA,KM,TI), 133  
 HandiKEY and HandiKEY Deluxe (KM), 342  
 HandiPHONE (CI,EC,PC), 281  
 Help U Key (TI), 394  
 HomeAccess (EC,PA), 283  
 Human Being Machine (RE,TT), 610  
 HyperBliss 3.2 (EA), 136  
 I Can Play, Too! (PA,RE,TR), 753  
 I Can Speak (CI,EA), 136  
 Infrared Remote Control IRTI-I (EC), 284  
 Input Adapter (IA), 456  
 Instant Access (TI), 397  
 Intention Module (TR), 44  
 Interaction Games (ES,GA,TR,TT), 613  
 Interaction Games II (ES,GA,TR,TT), 614  
 Intercom (4392) (CM,EC), 318  
 Invertor Module (AS,TR), 44  
 Join the Circus (AS,ES,TT), 616  
 JOKUS Software (ED,ES), 721  
 K.C. & Clyde in Fly Ball (ED,LS), 722  
 Kincontrol (4105) (EC), 284  
 Latch Box (TR), 45  
 Learn to Scan (AS,TR,TT), 620  
 Learning the Alphabet (ED,ES), 722  
 Let's Go Shopping I and II (ES,TT), 624

## Index 2: Products Listed by INPUT/OUTPUT FEATURE

- Let's Go to the Circus (LT.TT). 624  
Liberator (CI,CN,EA,EC,PW.TI). 137  
Lighted Extra Loud Signalling Buzzer (I,SCM,TR). 319  
Lighted Signalling Buzzer (I,SCM,TR). 319  
Lighted Vibrating Signalling Buzzer (I,ST,TR). 46  
LightWRITER SL85 (C,IEA). 139  
LinkSwitch (TR). 47  
Listen With Your Ears (GA.TT). 626  
Lynx (C,IEA,TR). 140  
Mac PowerPad Interface for Single Switches (IA). 459  
Mac-Apple Communications Aid (CI,CN,DR,ES,PA,TT,WP). 756  
Make It In Time (AS,ES,TT). 628  
Me Too! (PA). 757  
MessageMate 20 (C,IEA,TR). 141  
MessageMate 40 (C,IEA,TR). 142  
Messenger (C,IEA,TR). 142  
Meta4 (C,IEA). 143  
Micro-LADS and Micro-LADS in French (LT.TT). 634  
Mini-Environmental Control (ECU) Box (EC). 286  
Mix 'N Match (ES,TT). 636  
Money Skills (AD,CN,LS,TT). 637  
Morse Code WSKE II (II). 418  
Motor Training Games (AS,G,I,PA,RE,TT). 638  
Motor Training Games (GA,TR,TT). 638  
Motorized Easel (BP,EC). 286  
MouseMover - PC Windows (5004) (MT,TT). 421  
Multi-SCAN (GA,TR,TT). 639  
Multi-Switch Module (AS,TR). 47  
MusicWare (CN,ES,GA,LS,TT). 640  
MusicWare - Age Appropriate (ES,GA,TT). 641  
New Frog & Fly (TR,TT). 644  
Next Page Page Turner (4600) (BP,EC). 287  
Nine Volt Battery Adapter Module (TR). 49  
Nintendo & Super Nintendo Joystick Module (RE,TT). 425  
On/Off Module (TR). 49  
On/Off Remote Switch (EC). 288  
One Access (IA,TT). 427  
One Switch Picasso (DR,RE,TT). 648  
PA-1 Portable Alarm (CM). 321  
Personal Pager (CM). 323  
Phone Manager (EC,PA,PC). 288  
PhoneAccess (EC,PC). 289  
Pick-A-Meal (AD,GA,TT). 653  
Pictalk (CI,ES,TR,TT). 653  
Pictures Programs: I, II and III (CR,ES,LS,TT). 656  
Press to Play (ES,TR,TT). 660  
Rabbit Scanner (AS,ES,TT). 662  
Reactions (R73) (ES,TT). 663  
ReadyScan (C,IEA). 147  
Remote Wireless Paging Alarm (CM). 324  
RevolvingDoors (MT,TT). 437  
Rhythm Generator (AS,TR). 52  
Rockets to the Moon (ES,GA,TR,TT). 666  
Round Clock Communicator (CI,TR). 53  
Run Rabbit Run (AS,ES,TT). 666  
Saltus Reader (BP,EC). 292  
Scan & Match I, 2, 3, and 4 (TR,TT). 667  
Scan Com (C,IEA,EC). 149  
Scan It - Switch It (TR,TT). 668  
Scan-It-All (C,IEA,EC). 149  
ScanLite (CI,TR). 53  
Scanning Conversion Program. 550  
Scanning Director (EC). 293  
Scanning Picasso (DR,RE,TT). 668  
Scanning Remote Control (SRC) (EC). 294  
Scanning WSKE II (TI). 437  
Scanning X-10 Powerhouse (EC). 294  
ScanPAC (CI,CN,EA,EC,PW,TT). 150  
Screamer Alarm (CM). 324  
SenSci System (EC,PA,PC,TT,TL). 295  
Sequential Scanner (AS,CI,TR). 54  
Series Adapter (AS,TR). 54  
Sharon's Programs (ED,ES,LS). 726  
Sight Words (LS,TT). 672  
Single Switch/MatchBox Pack 1 (TT). 675  
Single-Appliance Continuous Control Unit (EC,TR). 296  
Single-Switch Multi-Appliance Control Unit & Modules (EC). 296  
Single-Switch TV Control Unit (EC). 297  
Slide Projector Control (EC,RE,TR). 55  
SoftType (TA,TT). 440  
Speaking Dynamically (C,IEA). 152  
Special Education Public Domain Software (CR,ED,LS,TT). 677  
SS-ACCESS! (IA). 462  
Steeper Communication/Teaching Aid (AS,CI,TR). 56  
Storytime Series (AD,LP,TR,TT). 679  
Storytime Series for Macintosh (AD,LP,TR,TT). 679  
Swim, Swam, Swum: Mastering Irregular Verbs (LS,LT,TT). 681  
Switch Arcade (GA,RE,TT). 682  
Switch Art (ES,TT). 683  
Switch It - Change It (ES,TT). 683  
Switch It - See It (ES,TT). 684  
Switch Latch/Timer (AS,TR). 57  
Switch Module (C,IEA,TR). 153  
Switch Puzzles (RE,TR,TT). 684  
Switch-Adapted Mouse (SAM) (MT,TT). 442  
Switch-Back (ID,TT). 443  
Switchboard (C,IEA). 154  
SwitchEnsemble (RE,TR,TT). 685  
SwitchMouse (MT,TT). 443  
SynergyMac and SynergyPC (CI,PW,TT). 444  
Talk Back III (C,IEA,TR). 155  
TalkTime with Tucker (ST,TT). 688  
Teenage Switch Progressions (TT). 689  
Telephone Management System (EC,PC). 300  
Telling Time, Parts of the Face, Learning Colors (ES,TT). 690  
This Old Man (CN,SI,TT). 691  
Timer Module (AS,EC,TR). 59  
Touch Turner (BP,EC). 301  
Toy Adapter (I,ST,TR). 59  
Toy Adapter Cables: CA-9/CA-12/CA-16 (AS,TR). 60  
Toy Cables (4378, 4379) (AS,TR). 60  
Trace Beeper Box (TR). 61  
Training Aid 2 (AS,EC,TR). 61  
Trip to the Zoo (GA,TT). 695  
Tubular Vibrator (TR). 62  
TVRC and TVRCS (EC). 301  
Twenty Categories (LS,LT,TT). 696  
UKanDu Little Books (LS,TT). 696  
UKanDu Switches, Too! (ES,TT). 697  
Universal Input Adaptor (IA). 464  
Universal Module (TR). 63  
Versascan (AS,CI,TR). 63  
Vibrating Sack (AS,TR). 64  
Visual Motor Skills (ES,TT). 701  
Vocal Assistant (CI,CM,EA). 159  
VoicePal (C,IEA,TR). 160  
VoicePal Plus (C,IEA,TR). 160  
Where is Puff? (ES,TT). 705  
WhisperWolf (C,IEA). 162  
WinSCAN: Limited Edition (IA). 464  
Wireless TV & VCR Remote Controls (EC). 306  
Wish Writer (PA,WP). 772  
Words and Concepts I, II, III (LS,LT,TT). 777  
WriteAway (PA,TA,WP). 774  
X-10 Powerhouse System (EC). 307

### Input Type: Joystick/Wobblestick

Systems that accept a joystick or wobblestick as input. The joystick can be discrete (four or five switches) or analog (proportional)

- Captain's Log: Cognitive Training System (AS,CR,ES,LS,TT). 568  
Community Signs (ID,LS,LT,TT). 580  
DA-II Adapter (IA). 456  
DARCI TOO (TI). 382  
Doors II (TI). 382  
DynaVox2 & DynaVox2c (C,IEA). 129  
Edmark Reading Program, Level 1 Software (ED,ES,LS). 718  
Electric Crayon and Electric Crayon Deluxe (DR,PA,RE). 748

Employment Signs (AD.LS.LT.TT). 594  
 EvalPAC with RealVoice (AS.CI.EA.EC.PW.TI). 131  
 First Mate (CR.TT). 600  
 Foundations I (CR.ES.TT). 604  
 Foundations II (CR.ES.TT). 604  
 HandiPHONE (CI.EC.PC). 281  
 Information Signs (AD.LS.LT.TT). 612  
 Joystick Trainer (TR.TT). 616  
 LIAISON (EC.KE.PC.TI). 407  
 LipStick and WordWriter (MT.TI). 408  
 Memory I (CR.ES.LS.TT). 632  
 Memory II (CR.ES.LS.TT). 633  
 Meta4 (CI.EA). 143  
 Motorized Easel (BP.EC). 286  
 MouseStick II (MT.TI). 422  
 Mouth Operated Joystick for Genesis Video Game (GA.RE.TI). 422  
 Nintendo & Super Nintendo Joystick Module (RE.TI). 425  
 Numeric Concepts I and II (LS.TT). 644  
 One-Hand Operated Joystick for Genesis Video Game (TI). 427  
 Picture Perfect (DR.PA.RE). 762  
 Proportional Keystroke Scanner (TI). 434  
 Race the Clock (GA.RE.TT). 562  
 Safety Signs (AD.LS.LT.TT). 667  
 ScanPAC (CI.CN.EA.EC.PW.TI). 150  
 Survival Words (AD.AS.LS.LT.TT). 681  
 SwitchEnsemble (RE.TR.TT). 655  
 SynergyMac and SynergyPC (CI.PW.TI). 444  
 Transportation Signs (AD.LS.LT.TT). 694  
 Universal Input Adaptor (IA). 464  
 Visuospatial Skills I (CR.TT). 702  
 X-10 Home Control Interface (EC). 306

### Input Type: Light Sensitive (Optical)

Systems that are controlled by a projected or received source of light. Includes light pens as well as longer range light pointers.

ActionVoice (CI.EA.TR). 118  
 EvalPAC with RealVoice (AS.CI.EA.EC.PW.TI). 131  
 Freedom Writer (PA.WP). 252  
 Laser Light Pointer (PT). 21  
 Light Activated Switch Panel (CI.TR). 46  
 Light Beam Indicator (PT). 21  
 Light Pointer (PT). 22  
 Light Pointer (PT). 22  
 LightBoard (TI). 408  
 Optimouse (MT.TI). 428  
 Vacuum Wand (BP.PT). 26  
 Viewpoint Optical Indicator (PT). 26

### Input Type: Movement Activated

Systems that are controlled by some type of movement not necessarily involving pressure. Devices specifically requiring pressure to activate will be listed under Input Type: Pressure Sensitive, rather than here.

JANICE Model 100 Invalid Security Alert System (CM). 318  
 MICE (MT.TI). 413  
 Shadow Talker (CI.EA.TR). 151

### Input Type: Noise (Sound or Vocalization)

Systems which are activated by a general sound.

Able-Phone 100WA (EC.PC). 266  
 Able-Phone 1900 and 2000 (EC.PC). 266  
 Personal Alert Receiver (CM). 322  
 Personal Pagets (CM). 323  
 Remote Control Speakerphone Model RC3000 (EC.PC). 292  
 TalkTime with Tucker (ST.TT). 688  
 TDD Detector (TD). 192

Watchman Master (CM). 327

### Input Type: OCR (Optical Character Recognition)

Systems which can scan a printed text and determine what characters (letters, numbers, etc.) are on the page. This information can then be stored as a computer text file.

BookWise (VS). 468  
 IRIS Reading Interface 3.0 (ST.TI). 399  
 Open Book Unbound (VS). 479  
 OsCaR (TI). 429  
 Reading Edge (TI). 435

### Input Type: Pressure Sensitive

Most touchpads and non-standard keyboards, plus anything activated by pushing, pulling or grasping. Also any non-electronic communication system where choices are indicated by pointing.

ActionVoice (CI.EA.TR). 118  
 Activity Board (AS.EC.TR). 30  
 Adap2U (MT.TI). 373  
 Adaptive Firmware Card Model G32c (IA.KE.KM.TI). 374  
 Adult Switch Progressions (TR.TT). 556  
 AlertCom (CM). 311  
 AlphaTalker (CI.EA.TI). 119  
 Attainment Fifteen Talker (CI.EA.TR). 119  
 Attainment Five Talker & Talker Plus (CI.EA.TR). 120  
 Attainment Two Talker (CI.EA.TR). 120  
 Automatic Drapery Opener System (EC). 269  
 BAT Personal Keyboard (TI). 377  
 Bear Jam (ES.TT). 561  
 BEST Faces (ES.TT). 562  
 BigCalc (CN.LP.PA). 740  
 BIGmack (CI.EA.TR). 122  
 BlackHawk (CI.EA). 122  
 Blocks in Motion (DR.RE.TT). 563  
 Bloorview Miniature Keyboard (TI). 379  
 Body Builder (ES.TT). 564  
 Bozons' Quest (GA.LS.TT). 564  
 BrailleAccess (BR.BT). 509  
 Breakthru Box (TI). 379  
 Buddy's Body (AS.ES.TT). 566  
 Build-A-Scene (TT). 567  
 Captain's Log: Cognitive Training System (AS.CR.ES.LS.TT). 568  
 CCT Environmental Control (EC). 271  
 Cheap Talk 4 & 8 (CI.EA.TR). 124  
 Children's Switch Progressions (TT). 572  
 Cirque GlidePoint Trackpads (MT.TI). 380  
 Cleo Communication Board (CI.NA). 75  
 Cogchab Vol. 6 (CR.LS.TT). 576  
 Colorful Concept Software (ES.TT). 578  
 Communication Binder (CI.NA). 76  
 Communication Folder and Tri-Folder (CI.NA). 78  
 Communication Sheets (CI.NA). 79  
 Community Vehicles (ES.TT). 580  
 Companion 401 Communicator (CI.CM.EA.TI.TR). 125  
 CONCENTRATE! On Words & Concepts (LS.LT.TT). 582  
 Concept Keyboard (TI). 381  
 Controller (EC). 272  
 Core Picture Vocabulary (CI.NA.TR). 80  
 Creature Antics and Creature Capers (GA.TR.TT). 584  
 Creature Cartoons (ES.GA.TT). 584  
 Creature Chorus (TR.TT). 585  
 Creature Magic (GA.LS.LT.RE.TT). 586  
 Crespeaker (CI.EA.TI). 125  
 DA-II Adapter (IA). 456  
 Deductive Reasoning Plus for Windows (CR.TT). 587  
 DeltaTalker (CI.EA). 127  
 Duo-Responder (CI.TR). 42

## Index 2: Products Listed by INPUT/OUTPUT FEATURE

- DynaVox2 & DynaVox2c (CI,EA). 129  
 E-Z Call (CM). 316  
 E.A.S.I.dialer (2110) (EC,PC). 274  
 Early Learning 3.5/Complete Early Learning 5.25 (ED,ES,LS,TT). 591  
 Early Learning III (CN,ED,LS). 717  
 EasyTalk (CI,EA). 130  
 Edmark Reading Program, Level I Software (ED,ES,LS). 718  
 EvalPAC with RealVoice (AS,CI,EA,EC,PW,TI). 131  
 Every Day Is A Holiday (GA,RE,TT). 595  
 Expanded Keyboard for Apple Macintosh and Apple IIGS (TI). 385  
 Expanded Keyboard for Automatic Telephone (EC,PC). 276  
 Expanded Keyboard for IBM Computers (KG,TI). 385  
 Expanded Keyboards for the Talking BlissApple (KG,TI). 386  
 Expanded Numeric Keypads (TI). 386  
 Exploring Early Vocabulary Series (LS,LT,TT). 595  
 EZ-TV Adapted Infrared Remote Control for Televisions (EC). 276  
 Family Fun (AS,ES,TT). 596  
 Feelings (ES,TT). 597  
 FingerFoniks (CI,EA). 132  
 First Step Software (LT,TT). 600  
 First Verbs and Primeros Verbos (ES,LT,TT). 601  
 First Words (ES,LT,TT). 601  
 First Words II (ES,LT,TT). 602  
 Fold It System (CI,NA). 84  
 Following Directions: One- and Two-Level Commands (ES,TT). 602  
 Following Directions: Left and Right (ES,TT). 603  
 Freedom Writer (PA,WP). 752  
 Getting Clean with Herkimer Level I, II, III (TT). 607  
 Hand Controls (ID,TI). 392  
 HandiCODE and HandiCODE Deluxe (SV,TI). 393  
 Handpointers (PT). 19  
 Hawk (CI,EA,TR). 134  
 HECS-1 (EC,PC). 282  
 Help Me to Help Myself Handbook (CI,NA). 86  
 Human Being Machine (RE,TT). 610  
 I Can Play, Too! (PA,RE,TR). 753  
 If You're Happy and You Know It (ES,TT). 610  
 Individualized Communication Systems (CI,NA). 88  
 IntelliKeys (TI). 398  
 JANICE Model 100 Invalid Security Alert System (CM). 318  
 Jouse (MT,TI). 400  
 K.C. & Clyde in Fly Ball (ED,LS). 722  
 Ke:nx (KE,MT,TI). 402  
 Keyboard Covers (KM). 347  
 Keypad (2425) (AS,TR). 45  
 Keypoint 176 (TI). 403  
 Keypoint 300 (TI). 404  
 Keypoint 60 (TI). 404  
 King Keyboard (2440) (TI). 405  
 Let's Go to the Circus (LT,TT). 624  
 Liberator (CI,CN,EA,EC,PW,TI). 137  
 Life Experiences Communication Kit (CI,NA). 89  
 LightWRITER SL35 (CI,EA). 138  
 LightWRITER SL5 (CI,EA). 138  
 Listen With Your Ears (GA,TT). 626  
 Logo TouchTools for the PowerPad (AS,ES,TT). 627  
 Lynx (CI,EA,TR). 140  
 Macaw Series (CI,EA). 140  
 MacKing (MT,TI). 409  
 MacMini (MT,TI). 410  
 Macrat (TI). 410  
 Magic Wand Keyboard with McKey Mouse Option (TI). 412  
 Make It Scan (AS,ES,TT). 629  
 Maltron Keyboard (TI). 412  
 Me Too! (PA). 757  
 MegaWolf (CI,EA). 141  
 MessageMate 20 (CI,EA,TR). 141  
 MessageMate 40 (CI,EA,TR). 142  
 Meta4 (CI,EA). 143  
 Micro-LADS and Micro-LADS in French (LT,TT). 634  
 Microllustrator (DR,PA,RE,TT). 758  
 Mid-Sized Communication Book (CI,NA). 91  
 Mini Keyboard (2443 or 2450) (TI). 416  
 Mini-Keyboards (TI). 416  
 Mini-MessageMate (CI,EA,TR). 144  
 Minimal Motion Computer Access System (TI). 417  
 Money Skills (AD,CN,LS,TT). 637  
 Morsek Version 1.1 (TI). 418  
 MouseMover - Mac (5005) (MT,TI). 420  
 MousePen (MT,TI). 421  
 Muppet Learning Keys (GA,ID,TI). 423  
 Music Button (TR). 48  
 MusicWare - Age Appropriate (ES,GA,TT). 641  
 MY HOUSE: Language Activities of Daily Living (LS,LT,TT). 641  
 My Paint & Talking Coloring Books (DR,ES,LT,TT). 642  
 Narwhal Expanded Keyboards for Adaptive Firmware Card (TI). 425  
 Object-Picture Talk Board (CI,NA,TR). 94  
 Old MacDonald's Farm I and II (ES,LS,TT). 646  
 OneStrk (TI). 428  
 Padded Food (AS,ES,TT). 650  
 Padded Vehicles (ES,TT). 651  
 Paper Dolls I and II (AD,ES,TT). 651  
 Parrot (CI,EA,TR). 144  
 Passport Kits (CI,NA). 95  
 PEACEbook (CI,NA). 97  
 Peg Switch (TR). 50  
 Pegasus (CI,EA,EC). 145  
 People Pager (CM). 321  
 Personal Pager (CM). 323  
 Personal Pagers (CM). 323  
 Personal Trainer (CI,EA,TR). 145  
 Picture Cue Dictionary (AD,CI,LT,NA,TT). 654  
 Pocket Picture Holder (NA). 105  
 Pocket-Sized and Double Pocket-Sized Communication Book (CI,NA). 105  
 Point to Pictures (TR,TT). 657  
 Porta Book (CI,NA). 106  
 PowerPad (DR,RE,TI). 432  
 PowerPad Starter Kit (TI). 432  
 Quad Talk (AS,CI,TR). 52  
 R.A.P.S. Software Series I PowerPad (TT). 661  
 RC5000 Radio Home Control System (CM,EC). 291  
 RELAX (8200) (EC). 291  
 Remote Keyboard for the Apple II+ and IIe (DR,TI). 436  
 Remote Wireless Paging Alarm (CM). 324  
 Say-It-All II Plus (CI,EA,KG,PW). 148  
 Say-It-Simply Plus (CI,EA,TR). 148  
 Scan It - Switch It (TR,TT). 668  
 ScreenDoors (TI). 438  
 Scribe (CI,EA,KG,PW). 150  
 Self-Talk Stickers (CI,NA). 107  
 Serial Trackball and PS/2 Trackball (MT,TI). 439  
 Signal Buzzer (AS,CM,TR). 325  
 Silly Sandwich (ES,TT). 673  
 SimpleCom I: Yes/No Communication (CI,TR,TT). 674  
 SimpleCom II: Needs/Wants Communication (CI,TR,TT). 674  
 Single-Appliance Continuous Control Unit (EC,TR). 296  
 Son of Seek and Find (GA,TT). 676  
 Speaking Dynamically (CI,EA). 152  
 Special Education Public Domain Software (CR,ED,LS,TT). 677  
 Specialist (CI,EA,NA,TR). 153  
 Spell-A-Word & 2+2 (CN,ED,LS). 727  
 Storytime Series (AD,LP,TR,TT). 679  
 Storytime Series for Macintosh (AD,LP,TR,TT). 679  
 Swim, Swam, Swum: Mastering Irregular Verbs (LS,LT,TT). 681  
 Switch Modified PowerPad (TI). 442  
 SwitchEnsemble (RE,TR,TT). 685  
 System 2000 (CI,EA). 154  
 Talk Back III (CI,EA,TR). 155  
 Talk Back VI (CI,EA,TR). 155  
 Talking Nouns, Talking Nouns II, and Talking Verbs (CI,TR,TT). 686  
 Talking Pictures Communication Board (CI,NA) 109  
 Talking Pictures, Kits I - VII (CI,NA,SI). 109  
 Talking Switch Plates (CI,EA,TR). 157  
 Talking Touch Window (AS,CI,TR,TT). 687  
 Tea Party (ES,TT). 688  
 Teenage Switch Progressions (TT). 689  
 THINKable/DOS (CR,TT). 690  
 This is the Way We Wash Our Face (ES,TR,TT). 691

This Old Man (CN,SI,TT), 691  
 Timekeeper (AD,TT), 692  
 Touch 'N Talk Communication Board (CI,NA), 110  
 Touch 'N Talk Communication Notebook (CI,NA), 110  
 Touch 'N Talk Micros (CI,NA), 111  
 Touch and Match (ES,TT), 692  
 Touch and See (ES,TT), 693  
 TouchMoney (AD,CN,TT,VO), 693  
 TouchWindow (DR,DS,ID,RE,TI,WP), 444  
 Tri-Responder (AS,TR), 62  
 Trip to the Zoo (GA,TT), 695  
 TS2010X Text to Speech Personal Communicating Device (CI,EA), 158  
 UKanDu Little Books (LS,TT), 696  
 UKanDu Switches, Too! (ES,TT), 697  
 Ultra 4 Remote System & Scanning Ultra 4 (EC), 302  
 Universal Control System with Tongue Touch Keypad (EC,PC), 303  
 URC-400 Series Universal Remote Control (EC), 305  
 VoiceBachs (CI,EA,SS), 159  
 VoicePal (CI,EA,TR), 160  
 VoicePal Plus (CI,EA,TR), 160  
 VOIS 160 (CI,EA), 161  
 WalkerTalker (CI,EA), 161  
 Wheels On The Bus I, II, III (ES,TR,TT), 704  
 WhisperWolf (CI,EA), 162  
 WinKing Keyboard (2448F, 2448O) (TI), 449  
 Wireless TV & VCR Remote Controls (EC), 306  
 Words and Concepts I, II, III (LS,LT,TT), 707  
 Worm Squirm (ES,TR,TT), 708  
 Yak Bak (CI,EA,TR), 162  
 Zoo Time (ES,TT), 709

### Input Type: Speech Recognition

Systems that can recognize specific spoken words or phrases, and accept them as input.

Access-1 (CI,PW,TI), 373  
 Butler-in-a-Box (EC,PC,TI), 270  
 Controller (EC), 272  
 DragonDictate Starter, Classic, and Power Editions (TI), 383  
 HAL (Home Automation Link) (EC,PC,TI), 392  
 HandiPHONE (CI,EC,PC), 281  
 HomeAccess (EC,PA), 283  
 IN-CUBE Voice Command for SPARC Stations (TI), 396  
 IN-CUBE Voice Command for Windows, NT (RS,TI), 397  
 IntroVoice V (TI), 398  
 IntroVoice VI (SS,TI), 399  
 JustVoice (TI), 401  
 Kurzweil VOICE (TI), 406  
 Kurzweil VOICE for Windows (TI), 406  
 Listen for Windows (ID,TI), 409  
 Magnum (BR,PW,TI,VS), 477  
 Mastervoice Environmental Control Single User Unit (EC,PC), 285  
 Micro IntroVoice (SS,TI), 413  
 Micro IntroVoice II (SS,TI), 414  
 Microsoft Windows Sound System (TI), 415  
 OfficeTALK for Windows (TI), 426  
 PhoneAccess (EC,PC), 289  
 Picture Scanner (TR,TT), 655  
 PowerSecretary (TI,WP), 433  
 Pre-Dict-ate (TI), 433  
 Readable Stories Series (ED,LS), 724  
 Sapura S2000 CL (EC,PC), 293  
 ScottBridge Speech Access System (TI), 438  
 Simplicity Series ECUs (EC,PC), 295  
 Sound Scope (ST,TT), 677  
 Speak Out VOII.A (LP,MG,SV,TV,VS), 440  
 Speech Recognition Systems (TI), 441  
 SpeechViewer II (ST,TT), 678  
 TeleDesk Visually Impaired Operator Console (PA,PC,SV,TI), 767  
 Video Voice Speech Training System (ST,TT), 699  
 Visi-Pitch Model 3300 (ST,TT), 700  
 Voice Math (CN,ED), 731

Voice Mouse/Keyboard (VMK) Controller (TI), 448  
 Voice Reading Ability Drill (ED,LS), 732  
 Voice User (RS,TI), 449

### Input Type: Wireless

Systems having a wireless connection between two of its components.

Automatic Drapery Opener System (EC), 269  
 Beep-in-Touch (CM), 312  
 Cord-Mate (CM), 315  
 DEUCE (EC,PC), 273  
 EZRA (CI,CM,EC,PC), 277  
 First Aide Kit (CM,EC,PC), 278  
 FreeSwitch (EC), 279  
 GEWA Infra-Link Speaker-Telephone (CI,EC,PC), 279  
 GEWA Infra-Link System (EC,PC), 280  
 HeadMouse (DR,MT,TI), 394  
 In & Out Automatic Door Controller (EC), 283  
 Infrared Remote Control IRTI-1 (EC), 284  
 On/Off Remote Switch (EC), 288  
 Personal Pager (CM), 322  
 Personal Pagers (CM), 323  
 Single-Appliance Continuous Control Unit (EC,TR), 296  
 Sound Advice System (CM), 326  
 Synergy Integrated Remote (EC,PA), 298  
 Ultra 4 Remote System & Scanning Ultra 4 (EC), 302  
 Universal Television Remote Control (EC), 304  
 Voice Amplificader (CI,SA,VA), 11  
 Wireless Personal Pager (CM), 328

### Output/Display: Braille Printer

Software or hardware that can drive a braille printer, or a braille printer itself.

Auto Braille (BR,PA), 738  
 BEX 3.1 (BR,LP,PA,SV,WP), 739  
 Braille Blazer (BP,BR,BT), 507  
 Braille BookMaker and Braille Express 100 & 500 (BR,BT), 508  
 Braille-Talk (BR,PA,SV), 742  
 Braillo 200 (BP,BR,BT), 510  
 Braillo 400 S (BP,BR,BT), 510  
 Braillo Comet (BP,BR,BT), 511  
 Checkbook Program (BR,CN,PA,SV), 744  
 Duxbury Braille Board for Microsoft Windows (BR,PA), 745  
 Duxbury Braille Font (P,I), 746  
 Duxbury Braille Translator (DBT) (BR,PA), 746  
 Duxbury Braille Translator for WordPerfect (DUXWP) (BR,PA), 747  
 Edgar (BR,PA), 748  
 ETgraphX (BR,DR,PA), 749  
 Index Everest-D (BR,BT), 513  
 InfoTouch (BR,BT,CI,PC,TD,TL), 182  
 Juliet Brailier (BR,BT), 514  
 Marathon Brailier (BR,BT), 515  
 MicroBraille 2 (BR,PA,WP), 758  
 Mountbatten Brailier (BR,BT,PIW), 516  
 Ohtsuki BT-5000 Braille Print Printer (BR,BT), 517  
 PC Braille (BR,PA), 761  
 Ransley Braille Interface (RBI) (BR,BT), 519  
 Romeo Brailier Model RB-25 (BR,BT), 520  
 Romeo Brailier Model RB-40 (BR,BT), 520  
 TeleBraille III (CI,PC,TD,TL), 193  
 Thomas Brailier (BR,BT), 521  
 TurboBraille (BR,PA), 769  
 VersaPoint-40 Braille Embosser (BR,BT), 522  
 Work-Station Pro (P,I), 773

**Output/Display: Deaf Baudot (for TDD's)**

*Devices that use Baudot code—the code traditionally sent and received by TDDs (Telecommunication Devices for the Deaf). Some TDDs also send and receive ASCII code (a standard computer code)*

- Atlantic 144 TTY (TD). 179
- Compact TTY (TD). 180
- Dialogic TTYs (CI.PC.TD.TL). 180
- InfoTouch (BR.BT.CI.PC.TD.TL). 182
- Intele-Modem (CI.TD.TL). 182
- Lite Touch Telephone Communicator (BR.PC.TD.TL). 183
- MIC300i Computer Modem (PC.TD.TL). 184
- Minicom IV (CI.PW.TD.TL). 184
- Miniprint 425 (CI.PC.TD.TL). 185
- Multi-Line Dial-A-News System (PA.TD.TL). 759
- NexCom 300vi & 300ve (TD). 185
- Pay Phone TTY (CI.PC.TD.TL). 186
- Personal Communication Terminal (PCT) (CI.TD.TL). 186
- Phone-TTY CM-4 Computer Modem (CI.PC.TD.TL). 187
- SIDD (Software Interface for the Deaf and Disabled) (CI.TD.TL). 189
- SM85 Smart ASCII/Baudot Modem (CI.PC.TD.TL). 189
- Superprint 100, 200, 400 (CI.PC.ID.TL). 190
- Superprint 4425 (CI.PC.TD.TL). 191
- Superprint ES TTY (CI.PC.TD.TL). 191
- TDD 2700, 2730, and 2830 (CI.PC.TD.TL). 192
- TDD Detector (TD). 192
- TDD Trainer System (CI.TD.TR). 58
- TeleBraille III (CI.PC.TD.TL). 193
- UltraSilent (PC.TD). 194
- Uniphone 1000 (TD). 195
- VCS 3500 with TDD Software (CI.TD.TL). 196

**Output/Display: Ideographic/Pictographic Symbols**

*Products that can print or display pictograph-based messages.*

- DynaVox2 & DynaVox2c (CI.EA). 129

**Output/Display: Large Print**

*Products whose output can be printed or displayed in large characters.*

- Aurora 2.0 for DOS (CI.EA.LP.TA.TI.WP). 376
- B-Edit (LP.PA.TA.WP). 738
- B-Pop (MG). 493
- Beamscope (LP.MG). 494
- BEX 3.1 (BR.LP.PA.SV.WP). 739
- BIG for 1-2-3 (DS.LP.PA). 739
- BIG for WordPerfect (LP.PA). 740
- Calc-Talk (CN.LP.PA.SV). 743
- CloseView (LP.MG). 495
- Compu Lenz (LP.MG). 495
- Eye Relief (LP.PA.WP). 750
- Gizmo (LP.SV.VS). 473
- inLARGE 2.0 (LP.MG). 496
- Language Master Special Edition - LM6000SE (LP.LS.PA.SV.TT.VS). 477
- Large Print Word Processors (LP.PA.WP). 755
- Large-Type Display Utility Software (LP.MG). 497
- MAGic and MAGic Deluxe (LP.MG). 498
- Magic Slate II (LP.LS.PA.TT.WP). 756
- Magnum Deluxe (MG). 499
- Magnum GI (LP.MG). 499
- MegaDots (BR.LP.PA). 757
- Optacon II (BT.LP). 518
- Panorama (LP.MG). 500
- Powerama (LP.MG). 501
- Screen Magnifier/2 (LP.MG). 501

- Sharon's Programs (ED.ES.LS). 726
- Speak Out VOILA (LP.MG.SV.TT.VS). 440
- Spell-A-Word & 2+2 (CN.ED.LS). 727
- Spin and Spell (ED.LS). 729
- Talking Data Acquisition System Software (PA). 765
- Talking Writer & Four Games (KB.LP.PA.SV.TT.WP). 766
- VisAbility (LP.PA). 771
- Vista (LP.MG). 502
- Write (CI.ED.LS.SV). 733
- WriteAway (PA.TA.WP). 774
- ZoomText 5 (LP.MG). 503

**Output/Display: Modem (ASCII)**

*Products that can send serial ASCII code over telephone lines if used with a modem.*

- ASCII-TDD Software (CI.TD.TL). 179
- Braille-Term Program (PA.TL). 742
- HandiPHONE (CI.EC.PC). 281
- InfoTouch (BR.BT.CI.PC.TD.TL). 182
- Intele-Modem (CI.TD.TL). 182
- MIC300i Computer Modem (PC.TD.TL). 184
- NexCom 300vi & 300ve (TD). 185
- Personal Communication Terminal (PCT) (CI.TD.TL). 186
- SIDD (Software Interface for the Deaf and Disabled) (CI.TD.TL). 189
- SM85 Smart ASCII/Baudot Modem (CI.PC.TD.TL). 189
- Superprint 100, 200, 400 (CI.PC.TD.TL). 190
- Superprint 4425 (CI.PC.TD.TL). 191
- Superprint ES TTY (CI.PC.TD.TL). 191
- TeleBraille III (CI.PC.TD.TL). 193

**Output/Display: Speech Output**

*Products that provide synthesized or digitized speech output, either by themselves or in conjunction with a speech synthesizer or digitizer*

- Able2Speak (EA). 117
- Accent-MC (SS). 525
- Accent-PC (SS). 525
- Accent-SA (SS). 526
- ActionVoice (CI.EA.TR). 118
- Adaptive Firmware Card Model G32e (IA.KE.KM.TI). 374
- Adult Switch Progressions (TR.TT). 556
- Adventures of Jimmy Jumper - Prepositions (AS.ES.LT.TT). 557
- AlphaTalker (CI.EA.TI). 119
- APH Scientific Calculator: for Apple II Computers (CN.PA.SV). 737
- APH/SEI Talking Software (ED.LS.SV). 713
- Apple IIGS Owner's Guide: Disk Edition. 542
- AppleWorks Manuals: Special Editions (SV). 542
- Arithmetic 1, 2, and 3 with Speech (CN.ED.LS.SV). 714
- Artic TransBook (PW.VS). 467
- Artic Transport (SS.SV). 526
- Artic TransType (PW.SV.VS). 467
- Attainment Fifteen Talker (CI.EA.TR). 119
- Attainment Five Talker & Talker Plus (CI.EA.TR). 120
- Attainment Two Talker (CI.EA.TR). 120
- Audapter Speech System (SS). 527
- Audible Cursor Routine (CI.EA.PA.TR). 121
- Audio Braille Game Tutorial (BR.GA.RE.TT). 560
- AudScan II (CI.EA). 121
- Aurora 2.0 for DOS (CI.EA.LP.TA.TI.WP). 376
- Aurora for Windows (KM.TA.TI.WP). 333
- Basic Learning Skills Courseware (CN.ED.LS). 714
- Bear Jam (ES.TT). 561
- BEX 3.1 (BR.LP.PA.SV.WP). 739
- Big/Little I and II (ES.TT). 562
- BigCalc (CN.VP.PD). 740
- BigGmack (CI.EA.TR). 122
- BlackHawk (CI.EA). 122
- BookWise (VS). 468



- Braille 'n Speak (BR,PW,SS,SV,TI,VS), 469  
 Braille 'n Speak Classic (BR,CN,PA,SV,VS,WP), 469  
 Braille Lite (BR,BT,CN,PW,SV,VS), 470  
 Braille-Talk (BR,PA,SV), 742  
 Buddy's Body (AS,ES,TT), 566  
 Business Vision (SV,VS), 471  
 Butler-in-a-Box (EC,PC,TI), 270  
 Calc-Talk (CN,LP,PA,SV), 743  
 Calcworthy (CN,PA,SV), 743  
 CallText 5000 (PC,SS), 527  
 Canon Communicator CC-7S and CC-7P (CI,EA), 123  
 CanSpeak (CI,LT,TT), 568  
 CarryCom (CI,EA), 123  
 Cheap Talk 4 & 8 (CI,EA,TR), 124  
 Checkbook Program (BR,CN,PA,SV), 744  
 Children's Switch Progressions (TT), 572  
 COINSNKEYS (CN,ES,KB,TT), 577  
 Color Find (ES,TT), 578  
 Colorful Concept Software (ES,TT), 578  
 Communication Icon Galleries CD-ROM (NA,SS), 78  
 Communication Programs (CI,EA,EC,TR), 124  
 Community Signs (AD,LS,LT,TT), 580  
 Community Vehicles (ES,TT), 580  
 Companion 401 Communicator (CI,CM,EA,TL,TR), 125  
 CONCENTRATE! On Words & Concepts (LS,LT,TT), 582  
 Core Reading and Vocabulary Development (ED,LS,LT,TT), 583  
 Creature Antics and Creature Capers (GA,TR,TT), 584  
 Creature Cartoons (ES,GA,TT), 584  
 Creature Chorus (TR,TT), 585  
 Creature Features (TR,TT), 585  
 Creature Magic (GA,LS,LT,RE,TT), 586  
 Crespeaker (CI,EA,TL), 125  
 DAC (CI,EA,SS), 126  
 DECTalk (SS), 528  
 DECTalk PC & DECTalk Express (SS), 528  
 DeltaTalker (CI,EA), 127  
 Denrick Speech Aid (AL,SA), 4  
 DigiTalk I (CI,EA,TR,TT), 127  
 DigiVox (CI,EA), 128  
 Dinosaur Game (ES,GA,TR,TT), 589  
 DJ ProPack Speech Module (SS), 529  
 Doors II (TI), 382  
 DynaVox2 & DynaVox2c (CI,EA), 129  
 Early and Advanced Switch Games (TT), 590  
 Early Concepts (ES,TT), 590  
 Early Learning 3.5/Complete Early Learning 5 25 (ED,ES,LS,TT), 591  
 Early Learning I (ES,TT), 592  
 Early Learning II (CN,ED,ES), 717  
 Early Learning III (CN,ED,LS), 717  
 EasyTalk (CI,EA), 130  
 Echo II (SS), 529  
 Echo II with Textalker & Echo II with Textalker-GS (SS,VS), 472  
 Echo LC (SS), 530  
 Echo PCII (SS), 530  
 Echo-PC (SS), 531  
 Edmark Reading Program, Level I Software (ED,ES,LS), 718  
 Eency-Weency Spider Game (ES,TT), 593  
 Elementary Volume I - Mathematics (CN,ED,LS,SV), 718  
 Employment Signs (AD,LS,LT,TT), 594  
 Equalizer (CI,DR,EA,PW,RE,TI,WP), 131  
 EvalPAC with RealVoice (AS,CI,EA,EC,PW,TI), 131  
 Expanded Keyboard Emulator (KM,TA), 340  
 Exploring Early Vocabulary Series (LS,LT,TT), 595  
 Eyegaze Computer System (EA,EC,PC,TI), 132  
 Family Fun (AS,ES,TT), 596  
 Fast Food Game (ES,TT), 596  
 Feelings (ES,TT), 597  
 File-Talk (DS,PA,SV), 750  
 Fingertphoniks (CI,EA), 132  
 First Categories (ES,LS,LT,TT), 599  
 First Step Software (LT,TT), 600  
 First Verbs and Primeros Verbos (ES,LT,TT), 601  
 First Words (ES,LT,TT), 601  
 First Words II (ES,LT,TT), 602  
 Focus on Facts (ED,SV), 719  
 Focus on Nations (ED,SV), 720  
 Following Directions: One- and Two-Level Commands (ES,TT), 602  
 Following Directions: Left and Right (ES,TT), 603  
 Food Facts (AD,SV,TT), 603  
 Further Adventures of Jimmy Jumper - Perseverance (AS,ES,TT), 606  
 Gizmo (LP,SV,VS), 473  
 Gus! Multimedia Speech System (CI,EA,KM,TI), 133  
 HandiCHAT and HandiCHAT Deluxe (SV,VS), 473  
 HandiCODE and HandiCODE Deluxe (SV,TI), 393  
 Handy Speech Communication Aide (CI,EA,SS), 134  
 Hawk (CI,EA,TR), 134  
 Help U Key (TI), 394  
 Help U Keyboard (TI), 395  
 Help U Type and Speak (CI,EA,KM), 135  
 I Can Play, Too! (PA,RE,TR), 753  
 I Can Speak (CI,EA), 136  
 IBM Screen Reader/2 (SV,VS), 474  
 IBM Screen Reader/DOS (SV,VS), 474  
 If You're Happy and You Know It (ES,TT), 610  
 Index Everest-D (BR,BT), 513  
 Information Signs (AD,LS,LT,TT), 612  
 Infovox 210 (SV,VS), 475  
 Infovox 500, 700 & 750 (SS), 531  
 IntelliTalk (CI,EA,PA), 137  
 Interaction Games (ES,GA,TR,TT), 613  
 Interaction Games II (ES,GA,TR,TT), 614  
 IntroVoice VI (SS,TI), 399  
 IRIS Reading Interface 3.0 (SV,TI), 399  
 JAWS for Windows (SV,VS), 475  
 JAWS Screenreader (SV,VS), 476  
 Joystick Trainer (TR,TT), 616  
 Keyboarding Program with Voice Output (KB,TT), 618  
 Keynote Companion (CN,SV,TL,VS,WP), 476  
 Keynote GOLD (SS), 532  
 Keys to Success: Comp. Keybd. Skills for Blind Children (KB,SV,TT), 619  
 Keysoft (CN,PA,SV,WP), 754  
 Keyterm (PA,SV,TL), 754  
 Language Master Special Edition - LM6000SE (LP,LS,PA,SV,TT,VS), 477  
 Laser Optic Keyboard (CI,TI), 407  
 Learning the Alphabet (ED,ES), 722  
 Learning to Spell Braille Signs (BR,TT), 623  
 Let's Go Shopping I and II (ES,TT), 624  
 Let's Go to the Circus (LT,TT), 624  
 Letter Find (CN,ES,KB,SV,TT), 625  
 LetterTALK+ (SV,TT,WP), 625  
 Liberator (CI,CN,EA,EC,PW,TI), 137  
 LightWRITER SL85 (CI,EA), 139  
 Lingraphica (CI,CR,EA,PA), 139  
 Listen and Spell (ED,LS), 723  
 Lite Talk (SS), 532  
 Logo TouchTools for the PowerPad (AS,ES,TT), 627  
 Lynx (CI,EA,TR), 140  
 Macaw Series (CI,EA), 140  
 Magnum (BR,PW,TI,VS), 477  
 MasterTOUCH (BT,SV), 515  
 Maze (GA,RE,TT), 631  
 MegaWolf (CI,EA), 141  
 MessageMate 20 (CI,EA,TR), 141  
 MessageMate 40 (CI,EA,TR), 142  
 Messenger (CI,EA,TR), 142  
 Messenger-IC (SS,SV), 533  
 Meta4 (CI,EA), 143  
 Micro IntroVoice (SS,TI), 413  
 Micro IntroVoice II (SS,TI), 414  
 Micro-LADS and Micro-LADS in French (LT,TT), 634  
 Mini Talking Card Reader (CI,EA,TR), 143  
 Mini Transport II (SS), 533  
 Mini-MessageMate (CI,EA,TR), 144  
 Mix 'N Match (ES,TT), 636  
 Money Skills (AD,CN,LS,TT), 637  
 MultiVoice (SS), 534  
 My Paint & Talking Coloring Books (DR,ES,LT,TT), 642



## Index 2: Products Listed by INPUT/OUTPUT FEATURE

- Myna (BR,PW,SV,VS), 478  
 NOMAD Talking Touch Pad & NOMAD Gold (BT,SV) 516  
 Noteworthy (PA,WP), 760  
 Nu-Vois (AL,SA), 7  
 Old MacDonald's Farm I and II (ES,LS,TT), 646  
 On the Job Series - Career Interests (TT,VO), 646  
 outSPOKEN 1.7 (SV,VS), 479  
 outSPOKEN for Windows (SV,VS), 480  
 Padded Food (AS,ES,TT), 650  
 Padded Vehicles (ES,TT), 651  
 Paper Dolls I and II (AD,ES,TT), 651  
 Parrot (CIEA,TR), 144  
 PC Typer (KB,TT), 652  
 PCMaster & Windows Master (BR,IA,SV,VS), 460  
 Pegasus (CIEA,EC), 145  
 Personal Trainer (CIEA,TR), 145  
 Phone Manager (EC,PA,PC), 288  
 Pictalk (CIES,TR,TT), 653  
 Picture Cue Dictionary (AD,CILT,NA,TT), 654  
 Picture Scanner (TR,TT), 655  
 Point to Pictures (TR,TT), 657  
 Prefixes (LD,LS,SV), 723  
 Press to Play (ES,TR,TT), 660  
 Program for Aphasics (CRED,LS), 724  
 Protalk23 for Windows (SV,VS), 480  
 PROVOX (SV,VS), 481  
 R.A.P.S. Software Series I PowerPad (TT), 661  
 Readable Stories Series (ED,LS), 724  
 Reading Edge (TI), 435  
 Reading Horizons (ED,ES), 725  
 RealVoice (AS,CIEA,EC,PW,TI), 147  
 Rockets to the Moon (ES,GA,TR,TT), 666  
 Safety Signs (AD,LS,LT,TT), 667  
 Say-It-All II Plus (CIEA,KG,PW), 148  
 Say-It-Simply Plus (CIEA,TR), 148  
 Scan-It-All (CIEA,EC), 149  
 ScanPAC (CICN,EA,EC,PW,TI), 150  
 ScanTELL (VS), 482  
 ScreenPower (SV,VS), 482  
 ScreenPower for Windows (SV,VS), 483  
 Seekline (SV,VS), 483  
 Sensible Speller: Talking APH Edition (ED,LS,SV), 725  
 Shadow Talker (CIEA,TR), 151  
 Sight Word Spelling (ED,LS,SV), 726  
 Sight Words (LS,TT), 672  
 Silly Sandwich (ES,TT), 673  
 SimpleCom I: Yes/No Communication (CITR,TT), 674  
 SimpleCom II: Needs/Wants Communication (CITR,TT), 674  
 Slimware (SV,VS), 484  
 Slimware Window Bridge (SV,VS), 484  
 SmarTalk (SS), 534  
 Sounding Board (SS), 535  
 SoundProof (SV,VS), 485  
 Speak Out VOILA (LP,MG,SV,TI,VS), 440  
 Speak-Out (SS), 535  
 Speaking Dynamically (CIEA), 152  
 Speaking Speller (ED,LS,SV), 727  
 Speechqualizer Speech Access System (SV,VS), 485  
 Special Education Public Domain Software (CRED,LS,TT), 677  
 Specialist (CIEA,NA,TR), 153  
 Spell-A-Word & 2+2 (CN,ED,LS), 727  
 Spell-Talk (ED,LS,SV), 728  
 Spelling Tutor (ED,LS), 728  
 SPELLIST (ED,LS), 729  
 Storytime Series (AD,LP,TR,TT), 679  
 Storytime Series for Macintosh (AD,LP,TR,TT), 679  
 Study Buddy (ED), 730  
 Survival Words (AD,AS,LS,LT,TT), 681  
 Swim, Swam, Swum: Mastering Irregular Verbs (LS,LT,TT), 681  
 Switch It - Change It (ES,TT), 683  
 Switch It - See It (ES,TT), 684  
 Switch Module (CIEA,TR), 153  
 SynergyMac and SynergyPC (CIPW,TI), 444  
 SynPhonix 210 and 215 (IA,SS), 536  
 SynPhonix 310 and 315 (SS), 536  
 SynPhonix P27 (SS), 537  
 System 2000 (CIEA), 154  
 Talk Back III (CIEA,TR), 155  
 Talk Back VI (CIEA,TR), 155  
 Talk:About (CIEA), 156  
 Talking Data Acquisition System Software (PA), 765  
 Talking Literacy Kit for the Apple IIc (TALK IIc) (GA,KB,TT,WP) 686  
 Talking Nouns, Talking Nouns II, and Talking Verbs (CITR,TT), 686  
 Talking Public Domain Disks (ED,LS,SV,TT,VO), 730  
 Talking Riddles (ED,LS,SV), 731  
 Talking Screen (CIEA,PA), 156  
 Talking Screen for Windows (CIEA,PA), 157  
 Talking Sensible Speller (PA,SV), 765  
 Talking Switch Plates (CIEA,TR), 157  
 Talking Touch Window (AS,CITR,TT), 687  
 Talking Typer (KB,SV,TT), 687  
 Talking Utilities for DOS 3.3 (PA,SV), 766  
 Talking Utilities for ProDOS, 551  
 Talking Writer & Four Games (KB,LP,PA,SV,TT,WP), 766  
 TalkTime with Tucker (ST,TT), 688  
 TDD Detector (TD), 192  
 Tea Party (ES,TT), 688  
 TeleDesk Visually Impaired Operator Console (PA,PC,SV,TL), 767  
 Telling Time, Parts of the Face, Learning Colors (ES,TT), 690  
 Term-Talk (PA,SV), 769  
 TEXTALKER (BT,SV), 521  
 Textalker-GS (VS), 486  
 THINKable/DOS (CR,TT), 690  
 This is the Way We Wash Our Face (ES,TR,TT), 691  
 Transportation Signs (AD,LS,LT,TT), 694  
 TS2010X Text to Speech Personal Communicating Device (CIEA), 158  
 Twenty Categories (LS,LT,TT), 696  
 Type 'n Speak (PW,SV,VS), 487  
 UKanDu Little Books (LS,TT), 696  
 UKanDu Switches, Too! (ES,TT), 697  
 Vocal Assistant (CICM,EA), 159  
 Vocal-Eyes (SV,VS), 487  
 VocaLite (SS), 537  
 Voice Math (CN,ED), 731  
 Voice Reading Ability Drill (ED,LS), 732  
 VoiceBachs (CIEA,SS), 159  
 VoiceMate, SwitchMate, ScanMate (2701-2708) (TR), 64  
 VoicePal (CIEA,TR), 160  
 VOIS 160 (CIEA), 161  
 WalkerTalker (CIEA), 161  
 Wheels On The Bus I, II, III (ES,TR,TT), 704  
 Where is Puff? (ES,TT), 705  
 WhisperWolf (CIEA), 162  
 Win Vision (SV,VS), 488  
 Window-Eyes (SV,VS), 488  
 WINKLINE (SV,VS), 489  
 WiVox (PA,WP), 772  
 Word-Talk (PA,SV,WP), 773  
 Words and Concepts I, II, III (LS,LT,TT), 707  
 WordScholar (SV,VS), 489  
 WordWise Software (LT,TT), 708  
 Work-Station Pro (PA), 773  
 Worm Squirm (ES,TR,TT), 708  
 Write (CIEA,LS,SV), 733  
 Write:OutLoud (PA,WP), 774  
 WriteAway (FATA,WP), 774  
 Yak Bak (CIEA,TR), 162  
 Zoo Time (ES,TT), 709

**Output/Display: Tactile/Braille Display (Dynamic)**

Products that provide changing tactile output. The most common form is a dynamic (refreshable) braille display, which has small pins that raise and lower electronically to form braille characters.

ALVA Braille Terminals (BR,BT). 507  
 Braille Lite (BR,BT,CN,PW,SV,VS). 470  
 BrailleAccess (BR,BT). 509  
 DM80/FM (BR,BT,TI). 511  
 InfoTouch (BR,BT,CI,PC,TD,TL). 182  
 INKA (BT). 513  
 KTS Braille Display (BR,BT). 514  
 Lite Touch Telephone Communicator (BR,PC,TD,TL). 183  
 Optacon II (BT,LP). 518  
 PCMaster & Windows Master (BR,IA,SV,VS). 460  
 PowerBraille 40, 65, & 80 (BR,BT). 519  
 Vibra-Call Receiver (CM). 326

**Switch Inputs: Uses Analog Control**

Products using an analog control, such as a proportional joystick

LIAISON (EC,KE,PC,TI). 407  
 Proportional Keystroke Scanner (TI). 434

**Switch Inputs: Uses Dual Switch**

Products accepting a dual switch or two single switches as input.

Ability Switch Tester (5955) (AS,TR). 29  
 Adaptive Firmware Card Model G32e (IA,KE,KM,TI). 374  
 AND Module (TR). 31  
 And Or Box (AS,TR). 31  
 Apple Computer Input Adaptor (IA). 453  
 BEST Faces (ES,TT). 562  
 BEST Switch Interface (IA). 453  
 Call Signal 2 (AS,CM,TR). 314  
 Cause 'n Effect (ES,TT). 571  
 Cogrehab Vol. 5 (CR,LS,TT). 576  
 Colors and Shapes (ES,TT). 579  
 Comboard (2615) (AS,CI,TR). 36  
 Compartmentalized Communicator (AS,CI,TR). 38  
 Computer Switch Interface (IA). 455  
 Control I (EC,PC). 272  
 Controller (EC). 272  
 DARCI TOO (TI). 382  
 Dial Scan (AS,CI,TR). 40  
 Dual Channel Latching Switch Interface (AS,EC,TR). 41  
 Duo-Responder (CI,TR). 42  
 DynaVox2 & DynaVox2c (CI,EA). 129  
 EvalPAC with RealVoice (AS,CI,EA,EC,PW,TI). 131  
 ezMorse for Windows (TI). 388  
 ezScan (TI). 388  
 First Verbs and Primeros Verbos (ES,LT,TT). 601  
 First Words (ES,LT,TT). 601  
 First Words II (ES,LT,TT). 602  
 Geometric Figures and Spatial Concepts (ED,ES). 720  
 Gus! Multimedia Speech System (CI,EA,KM,TI). 133  
 HandiCODE and HandiCODE Deluxe (SV,TI). 393  
 Infrared Remote Control IRTI-1 (EC). 284  
 Interaction Games (ES,GA,TR,TT). 613  
 Interaction Games II (ES,GA,TR,TT). 614  
 Join the Circus (AS,ES,TT). 616  
 Keyboard Covers (KM). 347  
 Kincontrol (4105) (EC). 284  
 Learning the Alphabet (ED,ES). 722  
 Mac PowerPad Interface for Single Switches (IA). 459  
 MessageMate 20 (CI,EA,TR). 141  
 Morse Code WSKE II (TI). 418  
 MorseK Version 1.1 (TI). 418

Motor Training Games (AS,GA,PA,RE,TT). 638  
 Next Page Page Turner (4600) (BP,EC). 287  
 On/Off Module (TR). 49  
 Picture Scanner (TR,TT). 655  
 Scanning Director (EC). 293  
 Scanning Remote Control (SRC) (EC). 294  
 Scanning WSKE II (TI). 437  
 Scanning X-10 Powerhouse (EC). 294  
 ScanPAC (CI,CN,EA,EC,PW,TI). 150  
 Series Adapter (AS,TR). 54  
 Sharon's Programs (ED,ES,LS). 726  
 Single-Appliance Continuous Control Unit (EC,TR). 296  
 Steeper Communication/Teaching Aid (AS,CI,TR). 56  
 Switch Interface (IA). 463  
 Switch Latch (4388) (AS,EC,TR). 56  
 Switch Latch/Timer (AS,TR). 57  
 Switchboard (CI,EA). 154  
 SwitchEnsemble (RE,TR,TT). 685  
 SwitchMouse (MT,TI). 443  
 Touch Turner (BP,EC). 301  
 Training Aid 2 (AS,EC,TR). 61  
 TVRC and TVRCS (EC). 301  
 Ultra 4 Remote System & Scanning Ultra 4 (EC). 302  
 Universal Input Adaptor (IA). 464  
 Universal Module (TR). 63  
 Versascan (AS,CI,TR). 63  
 VoiceMate, SwitchMate, ScanMate (2701-2708) (TR). 64  
 VoicePal (CI,EA,TR). 160  
 WPS Loquitur 115 and 250 (TR). 65

**Switch Inputs: Uses Joystick (4 or 5 Switches)**

Products accepting input from a four-switch or five-switch joystick.

DARCI TOO (TI). 382  
 DynaVox2 & DynaVox2c (CI,EA). 129  
 Edmark Reading Program, Level 1 Software (ED,ES,LS). 718  
 EvalPAC with RealVoice (AS,CI,EA,EC,PW,TI). 131  
 Foundations I (CR,ES,TT). 604  
 LipStick and WordWriter (MT,TI). 408  
 Memory I (CR,ES,LS,TT). 632  
 Memory II (CR,ES,LS,TT). 633  
 One-Hand Operated Joystick for Genesis Video Game (TI). 427  
 Picture Perfect (DR,PA,RE). 762  
 Race the Clock (GA,RE,TT). 662  
 ScanPAC (CI,CN,EA,EC,PW,TI). 150  
 Survival Words (AD,AS,LS,LT,TT). 681  
 SwitchMouse (MT,TI). 443  
 Universal Input Adaptor (IA). 464  
 Visuospatial Skills I (CR,TT). 702  
 X-10 Home Control Interface (EC). 306

**Switch Inputs: Uses Multiple Switches (3 to 16 Switches)**

Products accepting 3 - 16 switches as input.

Ability Switch Tester (5955) (AS,TR). 29  
 AlphaTalker (CI,EA,TI). 119  
 BEST Faces (ES,TT). 562  
 BEST Switch Interface (IA). 453  
 Cheap Talk 4 & 8 (CI,EA,TR). 124  
 Cogrehab Vol. 5 (CR,LS,TT). 576  
 Colors and Shapes (ES,TT). 579  
 Compartmentalized Communicator (AS,CI,TR). 38  
 DARCI TOO (TI). 382  
 EZ-TV Adapted Infrared Remote Control for Televisions (EC). 276  
 FreeSwitch (EC). 279  
 GEWA Infra-Link Speaker-Telephone (CI,EC,PC). 279  
 Giewa Page Turner (BP,EC). 280  
 HandiCODE and HandiCODE Deluxe (SV,TI). 393  
 Keyboard Covers (KM). 347

## Index 2: Products Listed by INPUT/OUTPUT FEATURE

Lynx (C.I.E.A.T.R.), 140  
Money Skills (AD.CN.LS.TT), 637  
Morsek Version 1.1 (TI), 418  
MouseMover - Mac (5005) (MT.TI), 420  
MouseMover - PC Windows (5004) (MT.TI), 421  
Multi-Switch Module (AS.TR), 47  
Next Page Page Turner (4600) (BP.EC), 287  
RC5000 Radio Home Control System (C.M.EC), 291  
Steeper Communication/Teaching Aid (AS.CI.TR), 56  
Switch Modified PowerPad (TI), 442  
Switch-Adapted Mouse (SAM) (MT.TI), 442  
Switch-Back (ID.TI), 443  
Switchboard (C.I.E.A.), 154  
SwitchEnsemble (RE.TR.TT), 685  
Talk Back III (C.I.E.A.T.R.), 155  
Ultra 4 Remote System & Scanning Ultra 4 (EC), 302  
VoicePal (C.I.E.A.T.R.), 160  
VoicePal Plus (C.I.E.A.T.R.), 160  
Wireless TV & VCR Remote Controls (EC), 306  
WPS Loquitor 115 and 250 (TR), 65

### Switch Inputs: Uses Single Switch

*Products accepting a single switch as input*

101 Animations (TR.TT), 556  
Ability Switch Phone Sequencer (C.I.E.C.PC), 265  
Ability Switch Tester (5955) (AS.TR), 29  
Able-Phone 100WA (EC.PC), 266  
Able2Speak (EA), 117  
AC Adaptor FRE-103C (TR), 29  
Adaptive Firmware Card Model G32e (I.A.K.E.KM.TI), 374  
Adventures of Jimmy Jumper - Prepositions (AS,ES,I.T.TT), 557  
Aphasia Series: I through VIII (CR.LS.TT), 558  
Apple Computer Input Adapter (IA), 453  
Audible Cursor Routine (C.I.E.A.P.A.TR), 121  
Battery Adapter (AS.TR), 32  
Battery Device Adapter (AS.TR), 32  
Battery Interrupter (AS.TR), 33  
Bed Control (DBC-1) (EC), 269  
BEST Faces (ES.TT), 562  
BEST Switch Interface (IA), 453  
Big/Little I and II (ES.TT), 562  
Big/Calc (CN.LP.PA), 740  
BIGmack (C.I.E.A.T.R.), 122  
Blocks in Motion (DR.RE.TT), 563  
Build-A-Scene (TT), 567  
Buzzer Box (CM.TR), 34  
Call Signal 2 (AS.CM.TR), 314  
Canon Communicator CC-7S and CC-7P (C.I.E.A.), 123  
Card Communicator (C.I.RE.TR), 34  
CarryCom (C.I.E.A.), 123  
Cause & Effect (TR.TT), 570  
Cause 'n Effect (ES.TT), 571  
CCT Environmental Control (EC), 271  
Chime Alarm (AS.CM.TR), 315  
Clock Communicator (AS.CI.TR), 36  
Cogrehab Vol. 5 (CR.LS.TT), 576  
Colors and Shapes (ES.TT), 579  
Comboard (2615) (AS.CI.TR), 36  
Communication Programs (C.I.E.A.EC.TR), 124  
Communiclock (AS.CI.TR), 37  
Communiight 24 (EA.TR), 37  
Compartmentalized Clock Communicator (C.I.TR), 38  
Computer Switch Interface (IA), 455  
Controller (EC), 272  
Counter Box (AS.TR), 39  
Counter Module (AS.TR), 39  
Creature Antics and Creature Capers (GA.TR.TT), 584  
Creature Cartoons (ES.GA.TT), 584  
Creature Chorus (TR.TT), 585  
Creature Features (TR.TT), 585  
CrossScanner (IA), 455  
DARCI TOO (TI), 382

Delay Timer Box (AS.EC.TR), 40  
Dial Scan (AS.CI.TR), 40  
Dino-Games (ES.TR.TT), 588  
Dinosaur Game (ES.GA.TR.TT), 589  
Dual Action Latch (TR), 41  
Dual Clock Communicator (C.I.TR), 42  
DynaVox2 & DynaVox2c (C.I.E.A.), 129  
E-Tran Scanner (AS.CI.TR), 43  
Early Concepts (ES.TT), 590  
Early Learning I (ES.TT), 592  
Early Learning II (CN,ED,ES), 717  
Ecency-Weency Spider Game (ES.TT), 593  
EvalPAC with RealVoice (AS.CI.E.A.EC.PW.TI), 131  
Exploring Early Vocabulary Series (LS.LT.TT), 595  
ezMorse for Windows (TI), 388  
EZRA (C.I.CM.EC.PC), 277  
ezScan (TI), 388  
Fast Food Game (ES.TT), 596  
First Categories (ES,LS,LT.TT), 599  
First Verbs and Primeros Verbos (ES,LT.TT), 601  
First Words (ES,LT.TT), 601  
First Words II (ES,LT.TT), 602  
Fundamental Concepts (ES.TT), 606  
Getting Clean with Herkimer Level I, II, III (TT), 607  
GEWA Infra-Link Speaker-Telephone (C.I.EC.PC), 279  
Gewa Page Turner (BP.EC), 280  
Gus! Multimedia Speech System (C.I.E.A.KM.TI), 133  
HandiCODE and HandiCODE Deluxe (SV.TI), 393  
HeadMaster Plus (MT.TI), 393  
HECS-1 (EC.PC), 282  
Help U Key (TI), 394  
HyperBliss 3.2 (EA), 136  
In & Out Automatic Door Controller (EC), 283  
Input Adapter (IA), 456  
Instant Access (TI), 397  
Intention Module (TR), 44  
Inventor Module (AS.TR), 44  
Join the Circus (AS,ES,TT), 616  
Judy Lynn PC Adapter (IA), 457  
K.C. & Clyde in Fly Ball (ED,LS), 722  
Ke:nx (KE,MT,TT), 402  
Kincontrol (4105) (EC), 284  
Learn to Scan (AS,TR,TT), 620  
Let's Go Shopping I and II (ES,TT), 624  
Let's Go to the Circus (LT,TT), 624  
Liberator (C.I.CN.EA.EC.PW.TI), 137  
Lighted Vibrating Signalling Buzzer (AS.TR), 46  
LightWRITER SL85 (C.I.E.A.), 139  
Listen With Your Ears (GA.TT), 626  
Lynx (C.I.E.A.T.R.), 140  
Mac-Apple Communications Aid (C.I.CN.DR,ES,PA,TT,WP), 756  
Make It In Time (AS,ES,TT), 628  
Make It Scan (AS,ES,TT), 629  
MessageMate 20 (C.I.E.A.T.R.), 141  
Messenger (C.I.E.A.T.R.), 142  
Micro-LADS and Micro-LADS in French (LT,TT), 634  
Mini-Environmental Control (ECU) Box (EC), 286  
Mix 'N Match (ES,TT), 636  
Money Skills (AD.CN.LS.TT), 637  
Morsek Version 1.1 (TI), 418  
Motor Training Games (AS.GA.PA,RE.TT), 638  
Motor Training Games (GA,TR,TT), 638  
Motorized Easel (BP.EC), 286  
Mouth Operated Joystick for Genesis Video Game (GA,RE,TT), 422  
Multi-SCAN (GA,TR,TT), 639  
MusicWare (CN,ES,GA,LS,TT), 640  
MusicWare - Age Appropriate (ES,GA,TT), 641  
MY HOUSE: Language Activities of Daily Living (LS,LT,TT), 641  
New Frog & Fly (TR,TT), 644  
Next Page Page Turner (4600) (BP.EC), 287  
Nine Volt Battery Adapter Module (TR), 49  
On/Off Remote Switch (EC), 288  
One Access (IA,TT), 427  
One Switch Picasso (DR,RE,TT), 648  
Personal Pager (CA), 323

- Phone Manager (EC,PA,PC), 288  
 Pick-A-Meal (AD,GA,TT), 653  
 Pictalk (CI,ES,TR,TT), 653  
 Picture Scanner (TR,TT), 655  
 Pictures Programs: I, II and III (CR,ES,LS,TT), 656  
 PowerLink 2 (EC), 290  
 Press to Play (ES,TR,TT), 660  
 Quad Talk (AS,CI,TR), 52  
 Rabbit Scanner (AS,ES,TT), 662  
 Reactions (R73) (ES,TT), 663  
 ReadyScan (CI,EA), 147  
 Remote Wireless Paging Alarm (CM), 324  
 RevolvingDoors (MT,TI), 437  
 Rhythm Generator (AS,TR), 52  
 Rockets to the Moon (ES,GA,TR,TT), 666  
 Round Clock Communicator (CI,TR), 53  
 Run Rabbit Run (AS,ES,TT), 666  
 Saltus Reader (BP,EC), 292  
 Scan & Match 1, 2, 3, and 4 (TR,TT), 667  
 Scan Com (CI,EA,EC), 149  
 Scan It - Switch It (TR,TT), 668  
 Scan-It-All (CI,EA,EC), 149  
 ScanLite (CI,TR), 53  
 Scanning Director (EC), 293  
 Scanning Picasso (DR,RE,TT), 668  
 Scanning Remote Control (SRC) (EC), 294  
 Scanning WSKE II (TI), 437  
 Scanning X-10 Powerhouse (EC), 294  
 ScanPAC (CI,CN,EA,EC,PW,TI), 150  
 Screamer Alarm (CM), 324  
 SenSei System (EC,PA,PC,TI,TL), 295  
 Sequential Scanner (AS,CI,TR), 54  
 Sharon's Programs (ED,ES,LS), 726  
 Sight Words (LS,TT), 672  
 Single Switch/MatchBox Pack 1 (TT), 675  
 Single-Switch Multi-Appliance Control Unit & Modules (EC), 296  
 Single-Switch TV Control Unit (EC), 297  
 Slide Projector Control (EC,RE,TR), 55  
 SpeakEasy (CI,EA), 152  
 Speaking Dynamically (CI,EA), 152  
 SS-ACCESS! (IA), 462  
 Steeper Communication/Teaching Aid (AS,CI,TR), 56  
 Storytime Series (AD,LP,TR,TT), 679  
 Swim, Swam, Swum: Mastering Irregular Verbs (LS,LT,TT), 681  
 Switch Arcade (GA,RE,TT), 682  
 Switch Arcade (GA,TT), 682  
 Switch Art (ES,TT), 683  
 Switch Interface (IA), 463  
 Switch It - Change It (ES,TT), 683  
 Switch It - See It (ES,TT), 684  
 Switch Latch (4388) (AS,EC,TR), 56  
 Switch Latch/Timer (AS,TR), 57  
 Switch Puzzles (RE,TR,TT), 684  
 Switchboard (CI,EA), 154  
 SwitchEnsemble (RE,TR,TT), 685  
 SwitchMouse (MT,TI), 443  
 Telephone Management System (EC,PC), 300  
 This Old Man (CN,SI,TT), 691  
 Timer Module (AS,EC,TR), 59  
 Touch Turner (BP,EC), 301  
 TouchMoney (AD,CN,TT,VO), 693  
 Toy Adapter (AS,TR), 59  
 Toy Adapter Cables: CA-9/CA-12/CA-16 (AS,TR), 60  
 Toy Cables (4378, 4379) (AS,TR), 60  
 Training Aid 2 (AS,EC,TR), 61  
 Tubular Vibrator (TR), 62  
 TVRC and TVRCS (EC), 301  
 UKanDu Little Books (LS,TT), 696  
 UKanDu Switches, Too! (ES,TT), 697  
 Universal Input Adaptor (IA), 464  
 Universal Module (TR), 63  
 Versascan (AS,CI,TR), 63  
 Vibrating Sack (AS,TR), 64  
 Visual Motor Skills (ES,TT), 701  
 Vocal Assistant (CI,CM,EA), 159  
 VoiceMate, SwitchMate, ScanMate (2701-2708) (TR), 64  
 VoicePal (CI,EA,TR), 160  
 VX-5000 Cordless Phone (CI,EC,PC), 305  
 Where is Puff? (ES,TT), 705  
 WhisperWolf (CI,EA), 162  
 Wish Writer (PA,WP), 772  
 Words and Concepts I, II, III (LS,LT,TT), 707  
 WPS Loquitor 115 and 250 (TR), 65  
 WriteAway (PA,TA,WP), 774

# Index 3

## Switches Listed by Input/Output Feature

This index includes all switches listed by the type of input and by the number of switches. Within each list the switches appear alphabetically. After each switch are three-letter codes which tell what other categories that switch is listed under. A key to the input/output features and three-letter codes used in this index appears on the next page.

***Titles of product lists in this index:***

Input Type: Air (Sip/Puff) {ITA}  
Input Type: Contact (Zero Pressure) {ITC}  
Input Type: Eye Movement and Eye Gaze {ITE}  
Input Type: Head Controlled {ITH}  
Input Type: Input Jack - Accepts Any Switch {ITI}  
Input Type: Joystick/Wobblestick {ITJ}  
Input Type: Light Sensitive (Optical) {ITL}  
Input Type: Movement Activated {ITM}  
Input Type: Noise (Sound or Vocalization) {ITN}  
Input Type: Pressure Sensitive {ITP}  
Input Type: Wireless {ITW}

Switch Outputs: Dual Switch {SO2}  
Switch Outputs: Joystick (4 or 5 Switches) {SOJ}  
Switch Outputs: Multiple switches (3 to 16 Switches) {SOM}  
Switch Outputs: Single Switch {SO1}

***Input/Output Feature codes which may appear in parentheses after items in this index:***

ITA Input Type: Air (Sip/Puff)  
ITC Input Type: Contact (Zero Pressure)  
ITE Input Type: Eye Movement or Eye Gaze  
ITH Input Type: Head Controlled  
ITI Input Type: Input Jack - Accepts Any Switch  
ITJ Input Type: Joystick/Wobblestick  
ITL Input Type: Light Sensitive (Optical)  
ITM Input Type: Movement Activated  
ITN Input Type: Noise (Sound or Vocalization)  
ITP Input Type: Pressure Sensitive  
ITW Input Type: Wireless

SO1 Switch Outputs: Single Switch  
SO2 Switch Outputs: Dual Switch  
SOJ Switch Outputs: Joystick (4 or 5 Switches)  
SOM Switch Outputs: Multiple switches (3 to 16 Switches)

### Input Type: Air (Sip/Puff) {ITA}

*Input devices operated by sip-and-puff style switches. This code is only applied to systems that come equipped with such a switch. Systems that accept any switch as input can often be connected to sip-and-puff switches purchased separately (see "Input Jack," below).*

- 4-Pneumatic Switch: CM-17 (SOM), 201
- Air Wave Switch (SO1), 204
- Breath Input Device (SO2), 207
- Double Sip & Double Puff Switches (SO2), 214
- Dual Pneumatic Switch: CM-14 (SO2), 215
- Dual Puff-Sip Switch DPS-2 (ITP), 216
- HD Latching Pneumatic Switch (SO1), 221
- LD Latching Puff Switch, 226
- Pneumatic Switch (SO2), 240
- Pneumatic Switch (5100, 5101) (SO2), 241
- Sip & Puff Switch (SO1), 247

### Input Type: Contact (Zero Pressure) {ITC}

*Systems that require absolutely no pressure, only contact, to activate.*

- Capacitive Touchplate Interface (SOM), 208
- Cylindrical Touch Switch (5300) (SO2), 213
- Double Touch Switch (SO1), 215
- Magnetic Finger Switch (ITM,SO1), 229
- Minimal Motion Splint-Mounted Switch Kits, 233
- P-Switch (ITM,ITP,SO1), 235
- Photocell Switch (SO1), 236

### Input Type: Eye Movement and Eye Gaze {ITE}

*Systems based upon the movement of the eyes. This includes electronic and non-electronic systems based on gaze, but does not include switch-type systems based on wrinkling the eyebrows or blinking (see "Movement Activated" below).*

- IST Switch (ITL,ITM,SO1), 224
- Twinkle Switch (ITW,SO1,SO2), 255

### Input Type: Head Controlled {ITH}

*Systems controlled by movement of the head, including systems controlled with head-mounted light pointers. Also any head-controlled input device.*

- Facial Switch (ITP,SO1), 218
- Petite Pillow Switch (ITP), 236

### Input Type: Input Jack - Accepts Any Switch {ITI}

*Systems that have an input jack (or plug) which can be connected to a variety of switches. Communication aids and computer access systems that are switch-operated are indicated by this code.*

- Remote Ability Switch Adapter (SO1), 243

### Input Type: Joystick/Wobblestick {ITJ}

*Systems that accept a joystick or wobblestick as input. The joystick can be discrete (four or five switches) or analog (proportional).*

- 4-Switch Joystick: CM-19 (SOJ), 202
- Joystick (SOJ), 224
- Joystick Interface Control (SOJ), 225

- Joystick with Pad Switch (5012) (ITP,SOJ), 225
- Mini Joystick with Push Switch (5020) (ITP,SOJ), 232
- PRC Joystick (SOJ), 241

### Input Type: Light Sensitive (Optical) {ITL}

*Systems that are controlled by a projected or received source of light. Includes light pens as well as longer range light pointers.*

- IST Switch (ITE,ITM,SO1), 224
- Light-Activated Switch (SO1), 228

### Input Type: Movement Activated {ITM}

*Systems that are controlled by some type of movement not necessarily involving pressure. Devices specifically requiring pressure to activate will be listed under Input Type: Pressure Sensitive, rather than here.*

- Continuous Movement Switch (CMS) (SO1), 210
- Eyebrow Switch (SO1), 217
- Finger Flex Switch (SO1), 218
- Flex Switch (5855) (ITP,SO1), 219
- Head Control Switch (SO1), 221
- Head Position Interface (SOJ), 222
- Head Switch Kit (SO1), 222
- Headband Switch (SO1), 223
- IST Switch (ITE,ITL,SO1), 224
- Magnetic Finger Switch (ITC,SO1), 229
- Mercury Switch (SO1), 230
- Mercury Tilt Switch (SO1), 231
- Overhead Pull Switch (ITP,SO1), 235
- P-Switch (ITC,ITP,SO1), 235
- Pull Switch (ITP,SO1), 242
- SCATIR Switch, 245
- Sensor Switch (SO1), 245
- Shadow Switch (SO1), 245
- String Switch (ITP), 250
- String Switch (ITP,SO1), 250
- Tilt Switch (SO1), 252
- Tip Switch (5840) (SO1), 253
- Twitch Switch (SO1), 256

### Input Type: Noise (Sound or Vocalization) {ITN}

*Systems which are activated by a general sound.*

- Voice Activated Switch (SO1), 258
- Voice Switch (SO1), 258

### Input Type: Pressure Sensitive {ITP}

*Most touchpads and non-standard keyboards, plus anything activated by pushing, pulling or grasping. Also any non-electronic communication system where choices are indicated by pointing.*

- 4-Plate Switch: CM-15 (SOM), 201
- 4-Pushbutton Switch: CM-16 (SOM), 201
- 5-Pushbutton Switch: CM-18 (SOM), 202
- 5-Tread Switch Slot Control: CM-50 (SOM), 202
- Adjustable Pressure Switch, 203
- Air Cushion Switch (SO1), 203
- Air Cushion Switch (Single or Dual) (SO1,SO2), 203
- Air Switch, 204
- Analog Switch Pad (SO1), 204
- Arm Slot Control (SOM), 205
- Armslot Switch Controller ASC-5 (SOM), 205
- Big Red, Yellow, Green, and Blue (SO1), 206
- Body Parts Switch (SO1), 206

- Body Switch BS-1 (SOI), 206  
 Buddy Button (5710-5773), 207  
 Button Switch (SOI), 207  
 Button Switch (SOI), 208  
 Cap Switch (5806) (SOI), 208  
 Clamp-On Bump Switch (SOI), 209  
 Classic Paddle Switch (SOI), 209  
 Coil Spring Wobble Stick Switch (SOI), 209  
 Computer Keyboard Switch (SOI), 210  
 Computer Switch Plate (SOI), 210  
 Controflex Foot Switches (SOI), 211  
 Controflex Ribbon Switches (SOI), 211  
 Control & Momentary Control Center Switches (SOM), 211  
 Crestwood Touch Latch Switch (SOI), 212  
 Cup Switch (5807) (SOI), 212  
 Cushion Switch (SOI), 213  
 Deluxe Paddle Switch II and Mini Deluxe Paddle Switch (SOI), 214  
 Dual Plate Switch: CM-12 (SO2), 215  
 Dual Puff-Sip Switch DPS-2 (ITA), 216  
 Dual Pushbutton Switch: CM-13 (SO2), 216  
 Dual Rocking Lever Switch (SO2), 216  
 Dual Tongue Switch TS-2C (SO2), 217  
 Facial Switch (ITH,SOI), 218  
 Finger Isolation Button (SOI), 218  
 Flex Switch (5855) (ITM,SOI), 219  
 Flexit Switch (SOI), 219  
 Flexswitch II (SOI), 220  
 Grasp Switch (5865) (SOI), 220  
 Grip & Puff Switch (SOI), 220  
 Grip Switch (SOI), 221  
 Head Switch, 222  
 Intention Switch (SOI), 223  
 Joystick with Pad Switch (5012) (ITJ,SOJ), 225  
 Jumbo Plate Switch (SOI), 225  
 L.T. Switch (SOI), 226  
 Leaf Switch (SOI), 226  
 Leaf Switch (SOI), 227  
 Leaf Switch (5860) (SOI), 227  
 Leaf Switch: CM-2/CM-7 (SOI), 227  
 Left/Right Rocker Switch (SO2), 228  
 Lever Switch: CM-8/CM-9 (SOI), 228  
 LightSwitch (SOI), 229  
 Low Force Adjustable Rod Switch (SOI), 229  
 Mat Switch, 230  
 Membrane Plate Switch (SOI), 230  
 Micro Light Switch (5850), 231  
 Micro Switch (SOI), 231  
 Mini Cup Switch (5808) (SOI), 232  
 Mini Joystick with Push Switch (5020) (ITJ,SOJ), 232  
 Mini Rocking Lever Switch (SO2), 232  
 Mounting Switch (SOI), 233  
 Multi-Control Press Switch (SOI,SO2,SOM), 233  
 Normally Closed Sensing Cell (SOI), 234  
 Normally Open Sensing Cells, 234  
 Omron Switch, 234  
 Overhead Pull Switch (ITM,SOI), 235  
 P-Switch (ITC,ITM,SOI), 235  
 Patty Cake Press (SOI), 235  
 Penta Switch (5024) (SOM), 236  
 Petite Pillow Switch (ITH), 236  
 Pillow Switch (5875) (SOI), 237  
 Pinch Switch (SOI), 237  
 Pinch Switch (SOI), 237  
 Plate Switch (SOI), 238  
 Plate Switch (SOI), 238  
 Plate Switch (5830-34) (SOI), 238  
 Plate Switch On Stand (SOI), 239  
 Plate Switch: CM-10 (SOI), 239  
 Plate Switches (SOI,SOM), 239  
 Plate Switches (SOI), 240  
 Play Mat Switch, 240  
 Pressure Switch (SOI), 241  
 Pressure Switch (SOI), 242  
 Pull Switch (ITM,SOI), 242  
 Pushbutton Switch: CM-11 (SOI), 243  
 Rocker Switch (5505) (SO2), 243  
 Rocking Plate Switch (SO2), 244  
 Roller Switch Music Box, 244  
 Round Pad Switch (5805) (SOI), 244  
 Signal Buzzer Plate (SOI), 246  
 Signal Switch (SOI), 246  
 Single Rocking Lever Switch (SOI), 246  
 Snappy Switch, 247  
 Soft Switch (5820, 5821) (SOI), 247  
 Specs Switch, 248  
 Sponge Nurse Call Switch (SOI), 248  
 Square Pad Switch (5810) (SOI), 248  
 Squeeze Switch (SOI), 249  
 Standard Paddle Switch (SOI), 249  
 Star Switch (5026) (SOI), 249  
 String Switch (ITM), 250  
 String Switch (ITM,SOI), 250  
 Super-Sensitive Normally Open Switch (SOI), 250  
 Tactile Touch Pad (SOI), 251  
 Taction Pads (SOI), 251  
 TAS Switch (SOI), 252  
 Thumb Switch: CM-5 (SOI), 252  
 Tongue Switch (SO2), 253  
 Touch Pads (SOI), 254  
 Touch Switch: CM-4 (SOI), 254  
 Tread Switch: CM-1 (SOI), 254  
 Treadle Switch (5880) (SOI), 255  
 Twin Plate Switch (SO2), 255  
 Universal Adaptive Switch System (SOI,SO2,SOM), 256  
 Vertical Plate Switch (SOI), 257  
 Vertical Wobble Switch (SOI), 257  
 Vibration Switch (SOI), 257  
 Wafer Switch (5018) (SOM), 258  
 Wobble Switch (SOI), 259  
 Wobble Switch (SOI), 259
- Input Type: Wireless {ITW}**  
*Systems having a wireless connection between two of its components.*
- Twinkle Switch (ITE,SOI,SO2), 255
- Switch Outputs: Dual Switch {SO2}**  
*Opens and closes two circuits.*
- Air Cushion Switch (Single or Dual) (ITP,SOI), 203  
 Breath Input Device (ITA), 207  
 Cylindrical Touch Switch (5300) (ITC), 213  
 Double Sip & Double Puff Switches (ITA), 214  
 Dual Plate Switch: CM-12 (ITP), 215  
 Dual Pneumatic Switch: CM-14 (ITA), 215  
 Dual Pushbutton Switch: CM-13 (ITP), 216  
 Dual Rocking Lever Switch (ITP), 216  
 Dual Tongue Switch TS-2C (ITP), 217  
 Left/Right Rocker Switch (ITP), 228  
 Mini Rocking Lever Switch (ITP), 232  
 Multi-Control Press Switch (ITP,SOI,SOM), 233  
 Pneumatic Switch (ITA), 240  
 Pneumatic Switch (5100, 5101) (ITA), 241  
 Rocker Switch (5505) (ITP), 243  
 Rocking Plate Switch (ITP), 244  
 Tongue Switch (ITP), 253  
 Twin Plate Switch (ITP), 255  
 Twinkle Switch (ITE,ITW,SOI), 255  
 Universal Adaptive Switch System (ITP,SOI,SOM), 256



**Switch Outputs: Joystick (4 or 5 Switches) {SOJ}***A joystick that acts like four or five switches.*

4-Switch Joystick: CM-19 (ITJ), 202  
 Head Position Interface (ITM), 222  
 Joystick (ITJ), 224  
 Joystick Interface Control (ITJ), 225  
 Joystick with Pad Switch (5012) (ITJ,ITP), 225  
 Mini Joystick with Push Switch (5020) (ITJ,ITP), 232  
 PRC Joystick (ITJ), 241

**Switch Outputs: Multiple switches (3 to 16 Switches) {SOM}***Multiple Switches housed in a single unit.*

4-Plate Switch: CM-15 (ITP), 201  
 4-Pneumatic Switch: CM-17 (ITA), 201  
 4-Pushbutton Switch: CM-16 (ITP), 201  
 5-Pushbutton Switch: CM-18 (ITP), 202  
 5-Tread Switch Slot Control: CM-50 (ITP), 202  
 Arm Slot Control (ITP), 205  
 Armslot Switch Controller ASC-5 (ITP), 205  
 Capacitive Touchplate Interface (ITC), 208  
 Control & Momentary Control Center Switches (ITP), 211  
 Multi-Control Press Switch (ITP,SO1,SO2), 233  
 Penta Switch (5024) (ITP), 236  
 Plate Switches (ITP,SO1), 239  
 Universal Adaptive Switch System (ITP,SO1,SO2), 256  
 Wafer Switch (5018) (ITP), 258

**Switch Outputs: Single Switch {SO1}***Opens and closes one circuit.*

Air Cushion Switch (ITP), 203  
 Air Cushion Switch (Single or Dual) (ITP,SO2), 203  
 Air Wave Switch (ITA), 204  
 Analog Switch Pad (ITP), 204  
 Big Red, Yellow, Green, and Blue (ITP), 206  
 Body Parts Switch (ITP), 206  
 Body Switch BS-1 (ITP), 206  
 Button Switch (ITP), 207  
 Button Switch (ITP), 208  
 Cap Switch (5806) (ITP), 208  
 Clamp-On Bump Switch (ITP), 209  
 Classic Paddle Switch (ITP), 209  
 Coil Spring Wobble Stick Switch (ITP), 209  
 Computer Keyboard Switch (ITP), 210  
 Computer Switch Plate (ITP), 210  
 Continuous Movement Switch (CMS) (ITM), 210  
 Controflex Foot Switches (ITP), 211  
 Controflex Ribbon Switches (ITP), 211  
 Crestwood Converter Switch, 212  
 Crestwood Touch Latch Switch (ITP), 212  
 Cup Switch (5807) (ITP), 212  
 Cushion Switch (ITP), 213  
 Deluxe Paddle Switch II and Mini Deluxe Paddle Switch (ITP), 214  
 Double Touch Switch (ITC), 215  
 Eyebrow Switch (ITM), 217  
 Facial Switch (ITH,ITP), 218  
 Finger Flex Switch (ITM), 218  
 Finger Isolation Button (ITP), 218  
 Flex Switch (5855) (ITM,ITP), 219  
 Flexi-Switch, 219  
 Flexit Switch (ITP), 219  
 Flexswitch II (ITP), 220  
 Grasp Switch (5865) (ITP), 220  
 Grip & Puff Switch (ITP), 220  
 Grip Switch (ITP), 221  
 HD Latching Pneumatic Switch (ITA), 221  
 Head Control Switch (ITM), 221  
 Head Switch Kit (ITM), 222  
 Headband Switch (ITM), 223  
 Intention Switch (ITP), 223  
 IST Switch (ITE,ITL,ITM), 224  
 Jelly Bean, 224  
 Jumbo Plate Switch (ITP), 225  
 L.T. Switch (ITP), 226  
 Leaf Switch (ITP), 226  
 Leaf Switch (ITP), 227  
 Leaf Switch (5860) (ITP), 227  
 Leaf Switch: CM-2/CM-7 (ITP), 227  
 Lever Switch: CM-8/CM-9 (ITP), 228  
 Light-Activated Switch (ITL), 228  
 LightSwitch (ITP), 229  
 Low Force Adjustable Rod Switch (ITP), 229  
 Magnetic Finger Switch (ITC,ITM), 229  
 Membrane Plate Switch (ITP), 230  
 Mercury Switch (ITM), 230  
 Mercury Tilt Switch (ITM), 231  
 Micro Switch (ITP), 231  
 Mini Cup Switch (5808) (ITP), 232  
 Mounting Switch (ITP), 233  
 Multi-Control Press Switch (ITP,SO2,SOM), 233  
 Normally Closed Sensing Cell (ITP), 234  
 Overhead Pull Switch (ITM,ITP), 235  
 P-Switch (ITC,ITM,ITP), 235  
 Patty Cake Press (ITP), 235  
 Photocell Switch (ITC), 236  
 Pillow Switch (5875) (ITP), 237  
 Pinch Switch (ITP), 237  
 Pinch Switch (ITP), 237  
 Plate Switch (ITP), 238  
 Plate Switch (ITP), 238  
 Plate Switch (5830-34) (ITP), 238  
 Plate Switch On Stand (ITP), 239  
 Plate Switch: CM-10 (ITP), 239  
 Plate Switches (ITP,SOM), 239  
 Plate Switches (ITP), 240  
 Pressure Switch (ITP), 241  
 Pressure Switch (ITP), 242  
 Pull Switch (ITM,ITP), 242  
 Pushbutton Switch: CM-11 (ITP), 243  
 Remote Ability Switch Adapter (ITI), 243  
 Round Pad Switch (5805) (ITP), 244  
 Sensor Switch (ITM), 245  
 Shadow Switch (ITM), 245  
 Signal Buzzer Plate (ITP), 246  
 Signal Switch (ITP), 246  
 Single Rocking Lever Switch (ITP), 246  
 Sip & Puff Switch (ITA), 247  
 Soft Switch (5820, 5821) (ITP), 247  
 Sponge Nurse Call Switch (ITP), 248  
 Square Pad Switch (5810) (ITP), 248  
 Squeeze Switch (ITP), 249  
 Standard Paddle Switch (ITP), 249  
 Star Switch (5026) (ITP), 249  
 String Switch (ITM,ITP), 250  
 Super-Sensitive Normally Open Switch (ITP), 250  
 Tactile Touch Pad (ITP), 251  
 Taction Pads (ITP), 251  
 TAS Switch (ITP), 252  
 Thumb Switch: CM-5 (ITP), 252  
 Tilt Switch (ITM), 252  
 Tip Switch (5840) (ITM), 253  
 Touch Pads (ITP), 254  
 Touch Switch: CM-4 (ITP), 254  
 Tread Switch: CM-1 (ITP), 254  
 Treadle Switch (5880) (ITP), 255  
 Twinkle Switch (ITE,ITW,SO2), 255  
 Twitch Switch (ITM), 256  
 Ultimate Switch, 256  
 Universal Adaptive Switch System (ITP,SO2,SOM), 256  
 Vertical Plate Switch (ITP), 257

### Index 3: SWITCHES Listed by Input/Output Feature

---

Vertical Wobble Switch (ITP), 257  
Vibration Switch (ITP), 257  
Voice Activated Switch (ITN), 258  
Voice Switch (ITN), 258  
Wobble Switch (ITP), 259  
Wobble Switch (ITP), 259

# Index 4

## Products Listed by Computer

This index lists all products for each computer, followed by the functions of that product and the page location. Whenever possible the computer family has been specified. The listings for specific models within that family generally include only those products made specifically for that model (e.g., a keyguard) or with clearly stated restrictions regarding certain models. In all other cases, including those where software compatibility with all models in the family is not clearly specified, the computer family has been used. The manufacturer should always be contacted for up-to-date information on which models a program works with.

For example, someone interested in software for the Apple IIGS should check both the Apple IIGS and Apple II Family lists. The manufacturer of the software that is identified as meeting the function needs and having the necessary input and output features should then be contacted to determine whether the program will run on the Apple IIGS.

*Titles of product lists in this index:*

All Computers (Hardware Independent)  
 Apple Macintosh Portable  
 Apple II +  
 Apple IIc  
 Apple IIe  
 Apple IIGS  
 Apple II Family  
 Apple Macintosh Family  
 Apple Macintosh Plus  
 Apple Macintosh SE/II  
 Atari 400  
 Atari 800  
 Atari Family  
 Atari ST Family  
 Block Transfer Terminals  
 Commodore 128  
 Commodore 64  
 Commodore Amiga  
 Commodore Family  
 Datavue Spark  
 Epson HX-20  
 Grid  
 IBM-PC PC  
 IBM-PC XT  
 IBM PC AT  
 IBM PC Family  
 IBM PC jr  
 IBM PS/2 Family  
 IBM PS/2 Models 25/30  
 IBM PS/2 Models 50/60  
 IBM PS/2 Models 70/80  
 ITT  
 NEC (some or all models)  
 Nintendo  
 Sun Microsystems SPARCstation  
 Tandy 1000  
 Texas Instruments TI 99/4A  
 Toshiba Laptops  
 TRS-80 Color Computer  
 TRS-80 Model 100  
 TRS-80 Model 200  
 TRS-80 Model I  
 TRS-80 Model II  
 TRS-80 Model III  
 TRS-80 Model IV

*Function codes which may appear in parentheses after items in this index:*

AD Activities of Daily Living  
 AL Artificial Larynx  
 AS Assessment (Evaluation)  
 BP Book/Paper Handling  
 BR Braille  
 BF Braille and Tactile Output Systems  
 CI Conversation/Interaction  
 CM Call, Monitoring, or Memory System  
 CN Calculation/Math Aid  
 CR Cognitive Rehabilitation  
 DR Drawing  
 DS Database Management/Spreadsheet  
 EA Electronic Communication or Writing Aid  
 EC Environmental Control  
 ED Adaptive Educational Software  
 ES Early Skills (Pre-Reading)  
 GA Game  
 IA Input Adapter for Computer  
 ID Input Device Usable with Only Some Software  
 KB Keyboarding Training Program  
 KE Keyboard Emulating Interface  
 KG Keyguard  
 KM Modification for Standard Keyboard  
 LP Large Print Output  
 LS Later Skills (Includes Reading)  
 LT Language Therapy/Development  
 MG Magnification Hardware and Software for Computer Displays  
 MS Mounting Systems  
 MT Mouse or Touch Pad Emulation  
 NA Non-Electronic Communication Aid  
 PA Personal Tool or Aid (for Speaking, Writing, Drawing, Controlling, etc.)  
 PC Phone Control/Access  
 PT Pointing or Typing Aid  
 PW Portable Writing  
 RE Recreation  
 RS Repetitive Strain Injury (RSI) Prevention  
 SA Speech Aid  
 SI Signing  
 SS Speech Synthesizer  
 ST Speech Therapy (not Language Therapy)  
 SV Screen (Display) to Voice  
 TA Typing Acceleration Program  
 TD Telecommunication Device for the Deaf (TDD)  
 TI Alternate Input Usable with All Software  
 TL Telecommunication  
 TR Training or Communication Initiation Aid  
 TT Training and Therapy Software  
 VA Voice Amplifier  
 VO Vocational  
 VS Voice-Output Screen Reader or Reading Machine  
 WP Word Processing (Writing)

**All Computers (Hardware Independent)**

*This list includes products which are designed to work with computers, but are independent of the make and model of computer. These products may still have specific hardware requirements, such as memory and interfaces, they simply do not require a specific make and model. Products which work with particular makes and models will be listed under those categories.*

ADJUSTable, 541  
 Adjustable EZ Magnifier (LP, MG), 493  
 Armslot Switch Controller ASC-5, 205  
 Articulating Drawers (KM), 332  
 Audapter Speech System (SS), 527  
 Beamscope (LP, MG), 494  
 Body Switch BS-1, 206  
 Braille Blazer (BP, BR, BT), 507  
 Braille BookMaker and Braille Express 100 & 500 (BR, BT), 508  
 BrailleMate 2 (BR, PW, VS), 470  
 CarpalRest (KM, RS), 335  
 Comfortype (KM, RS), 336  
 Compu-Lenz (LP, MG), 495  
 Control 1 (EC, PC), 272  
 DataArm (KM, RS), 337  
 DECTalk (SS), 528  
 Dual Puff-Sip Switch DPS-2, 216  
 EasyRiser, 546  
 Environment Control (EC), 275  
 Ergorest Articulated Forearm Rests (KM, RS), 340  
 FlexShield Keyboard Protectors (KM), 341  
 Generation IV Adjustable Computer Tables, 547  
 GNK Magnifier (LP, MG), 496  
 High Dots (BR, KM), 344  
 Home-Row Key Indicators (KM), 345  
 Index Basic (BR, BT), 512  
 Index Basic-D (BR, BT), 512  
 Index Everest-D (BR, BT), 513  
 Juliet Braille (BR, BT), 514  
 Key Largo (TI), 403  
 Keyboard Wrist Rest (KM), 348  
 LAP CAT (KM, RS), 353  
 Marathon Braille (BR, BT), 515  
 Micro Light Switch (5850), 231  
 Modular Turntable Desks, 549  
 MOUSE PERCH (KM, RS), 355  
 MultiVoice (SS), 534  
 NuVu Magnifier (LP, MG), 500  
 Open Book (VS), 478  
 Optacon II (BT, LP), 518  
 Ransley Braille Interface (RBI) (BR, BT), 519  
 Reading Edge (TI), 435  
 Roll & Slide Keyboard Wrist Support (KM), 362  
 Romeo Braille Model RB-25 (BR, BT), 520  
 Romeo Braille Model RB-40 (BR, BT), 520  
 SafeSkin Keyboard Protector (KM), 363  
 SCATIR Switch, 245  
 Single Switch Software (ED, TT), 675  
 Slip-On Typing Aid (PT), 25  
 SM85 Smart ASCII/Baudot Modem (CI, PC, TD, TL), 189  
 Speech Recognition Systems (TI), 441  
 Star Switch (5026), 249  
 Stick-On Keylocks (KM), 364  
 String Switch, 250  
 TarsalRest, 552  
 Thomas Braille (BR, BT), 521  
 Touch 'N Talk Micros (CI, NA), 111  
 Variable Height Desk, 552  
 VersaPoint-40 Braille Embosser (BR, BT), 522  
 vocaLite (SS), 537  
 WRIST PERCH (KM, RS), 368

**Apple Macintosh Portable**

*This list includes products which have been specifically described by their manufacturers as working with the Macintosh Portable. Many products listed under other Apple Macintosh models will also work with the Portable. Contact the manufacturers of specific products for more information about model compatibility.*

Ke:nx (KE, MT, TI), 402

**Apple II+**

*This list includes products which specifically work with the Apple II+ If a product works with all Apple II series computers, it will not be listed here, but will be under "Apple II Family." If it works with the Apple II+ and another model (say, the IIe), it will be listed here and under that other model.*

Audio Braille Game Tutorial (BR, GA, RE, TT), 560  
 Big/Little I and II (ES, TT), 562  
 Buddy's Body (AS, ES, TT), 566  
 Captain's Log: Cognitive Training System (AS, CR, ES, LS, TT), 568  
 Community Vehicles (ES, TT), 580  
 Computer CUP (ES, LT, TT), 581  
 Early Concepts (ES, TT), 590  
 Echo II (SS), 529  
 Eency-Weency Spider Game (ES, TT), 593  
 Family Fun (AS, ES, TT), 596  
 Fast Food Game (ES, TT), 596  
 Feelings (ES, TT), 597  
 Governor (2464) (GA, PA), 547  
 If You're Happy and You Know It (ES, TT), 610  
 Let's Go Shopping I and II (ES, TT), 624  
 Narwhal Expanded Keyboards for Adaptive Firmware Card (TI), 425  
 Old MacDonald's Farm I and II (ES, LS, TT), 646  
 Padded Food (AS, ES, TT), 650  
 Padded Vehicles (ES, TT), 651  
 Paper Dolls I and II (AD, ES, TT), 651  
 Pictalk (CI, ES, TR, TT), 653  
 PowerPad (DR, RE, TI), 432  
 Remote Keyboard for the Apple II+ and IIe (DR, TI), 436  
 Sight Words (LS, TT), 672  
 Silly Sandwich (ES, TT), 673  
 Switch It - Change It (ES, TT), 683  
 Switch It - See It (ES, TT), 684  
 Tea Party (ES, TT), 688  
 Voice Math (CN, ED), 731  
 Voice Reading Ability Drill (ED, LS), 732  
 Where is Puff? (ES, TT), 705  
 Zoo Time (ES, TT), 709

**Apple IIc**

*This list includes products which specifically work with the Apple IIc. If a product works with all Apple II series computers, it will not be listed here, but will be under "Apple II Family." If it works with the Apple IIc and another model, it will be listed here and under that other model.*

Aphasia Series: I through VIII (CR, LS, TT), 558  
 Association Pictures (CR, TT), 559  
 Audio Braille Game Tutorial (BR, GA, RE, TT), 560  
 BEX 3.1 (BR, LP, PA, SV, WP), 739  
 Braille-Talk (BR, PA, SV), 742  
 Calc-Talk (CN, LP, PA, SV), 743  
 Cause 'n Effect (ES, TT), 571  
 Cognitive Disorders I, II, III, IV (CR, TT), 573  
 Computer CUP (ES, LT, TT), 581  
 Early Learning 3 5 Complete Early Learning 5 25 (ED, ES, LS, TT), 591  
 Early Learning I (ES, TT), 592  
 Early Learning II (CN, ED, ES), 717  
 Early Learning III (CN, ED, LS), 717

Echo LC (SS), 530  
 Electric Crayon and Electric Crayon Deluxe (DR.P.A.RE.), 758  
 File-Talk (DS.P.A.SV), 750  
 Function Pictures (CR.TT), 605  
 Hand Controls (ID.TI), 392  
 Inferential Naming for Cognitive and Language Disorders (CR.LS.LT.TT), 611  
 Initial Phoneme Cuing for Aphasics (CR.TT), 613  
 Join the Circus (AS.ES.TT), 616  
 MacTRAC (MT.TI), 411  
 Mix 'N Match (ES.TT), 636  
 Money Skills (AD.CN.LS.TT), 637  
 Numeric Concepts I and II (LS.TT), 644  
 QUADLynx Trackball (MT.TI), 435  
 Reading Comprehension for Adolescents (CR.TT), 664  
 Semantic Development Using Code Breaking Strategies (LS.LT.TT), 670  
 Sharon's Programs (ED.ES.LS), 726  
 Talking Hands (SI.TT), 685  
 Talking Sensible Speller (P.A.SV), 765  
 Term-Talk (P.A.SV), 768  
 TimeOut UltraMacros (K.M.T.A.), 366  
 Turbo Trackball (MT.TI), 447  
 Understanding Attributes (CR.TT), 697  
 Verb Fill-Ins (CR.TT), 698  
 Verbal Analogies (LS.LT.TT), 698  
 Word Order in Sentences (LS.LT.TT), 706  
 Word-Talk (P.A.SV.WP), 773  
 Work-Station Pro (PA), 773  
 X-10 Home Control Interface (EC), 306

### Apple IIe

*This list includes products which specifically work with the Apple IIe. If a product works with all Apple II series computers, it will not be listed here, but will be under "Apple II Family." If it works with the Apple IIe and another model, it will be listed here and under the other model.*

Access to Math (CN,ED), 713  
 Adaptive Firmware Card Model G32e (IA,KE,KM.TI), 374  
 Aphasia Series: I through VIII (CR.LS.TT), 558  
 Association Pictures (CR.TT), 559  
 Audio Braille Game Tutorial (BR.G.A.RE.TT), 560  
 BEX 3.1 (BR.LP.P.A.SV.WP), 739  
 Big/Little I and II (ES.TT), 562  
 Bloorview Miniature Keyboard (TI), 379  
 Body Builder (ES.TT), 564  
 Braille-Talk (BR.P.A.SV), 742  
 Brailled Keyboard Model--Apple IIe (BR), 543  
 Buddy's Body (AS.ES.TT), 566  
 Calc-Talk (CN.LP.P.A.SV), 743  
 Captain's Log: Cognitive Training System (AS.CR.ES.LS.TT), 568  
 Cognitive Disorders I, II, III, IV (CR.TT), 577  
 COINSNKEYS (CN.ES.KB.TT), 577  
 Community Vehicles (ES.TT), 580  
 Computer CUP (ES.LT.TT), 581  
 Creature Features (TR.TT), 585  
 Creature Magic (GA.LS.LT.RE.TT), 586  
 DARCI TOO (TI), 382  
 Dinosaur Game (ES.GA.TR.TT), 589  
 Drive to Live (ED.LS), 716  
 Early Concepts (ES.TT), 590  
 Early Emerging Rules Series (LS.LT.TT), 591  
 Early Learning 3.5/Complete Early Learning 5.25 (ED.ES.LS.TT), 591  
 Early Learning I (ES.TT), 592  
 Early Learning II (CN.ED.ES), 717  
 Early Learning III (CN.ED.LS), 717  
 Echo II (SS), 529  
 Fency-Weency Spider Game (ES.TT), 593  
 Electric Crayon and Electric Crayon Deluxe (DR.P.A.RE.), 748  
 EvalPAC with RealVoice (AS.CI.E.A.EC.PIW.TI), 131  
 Exploring Early Vocabulary Series (LS.LT.TT), 595

Family Fun (AS.ES.TT), 596  
 Fast Food Game (ES.TT), 596  
 Feelings (ES.TT), 597  
 File-Talk (DS.P.A.SV), 750  
 Function Pictures (CR.TT), 605  
 Governor (2464) (GA.P.A.), 547  
 Hand Controls (ID.TI), 392  
 If You're Happy and You Know It (ES.TT), 610  
 Inferential Naming for Cognitive and Language Disorders (CR.LS.LT.TT), 611  
 Initial Phoneme Cuing for Aphasics (CR.TT), 613  
 IntelliKeys (TI), 398  
 Interaction Games II (ES.GA.TR.TT), 614  
 Join the Circus (AS.ES.TT), 616  
 Keyboard Covers (KM), 347  
 Keyboard Overlays for Apple IIe and IIgs (KM), 347  
 Keyboarding for Individual Achievement (ED.KB.TT), 617  
 Keyboarding for People with Cerebral Palsy (ED.KB.TT), 618  
 Keyboarding with One Hand (ED.KB.TT), 619  
 Keyguards (KG.KM), 350  
 King Keyboard (2440) (TI), 405  
 Learn to Scan (AS.TR.TI), 620  
 Let's Go Shopping I and II (ES.TT), 624  
 LightBoard (TI), 408  
 Logo TouchTools for the PowerPad (AS.ES.TT), 627  
 MacTRAC (MT.TI), 411  
 Make It In Time (AS.ES.TT), 628  
 Make It Scan (AS.ES.TT), 629  
 Me Too! (PA), 757  
 Mini Keyboard (2443 or 2450) (TI), 416  
 Mix 'N Match (ES.TT), 636  
 Moisture Guard (KM), 355  
 Money Skills (AD.CN.LS.TT), 637  
 Narwhal Expanded Keyboards for Adaptive Firmware Card (TI), 425  
 Numeric Concepts I and II (LS.TT), 644  
 Occupations (TI), 645  
 Old MacDonald's Farm I and II (ES.LS.TT), 646  
 Padded Food (AS.ES.TT), 650  
 Padded Vehicles (ES.TT), 651  
 Paper Dolls I and II (AD.ES.TT), 651  
 Pictalk (CI.ES.TR.TT), 653  
 Picture Icon X-CHANGE (EA), 146  
 PowerPad (DR.RE.TI), 432  
 PowerPad Preschool Pack I & II (GA.TT), 558  
 PowerPad Starter Kit (TI), 432  
 PowerPad Toolkit 4 (PA), 762  
 Predict It (P.A.T.A.WP), 763  
 QUADLynx Trackball (MT.TI), 435  
 R.A.P.S. Software Series I PowerPad (TT), 661  
 Reading Comprehension for Adolescents (CR.TT), 664  
 Remote Keyboard for the Apple II+ and IIe (DR.TI), 436  
 Rockets to the Moon (ES.GA.TR.TT), 666  
 Semantic Development Using Code Breaking Strategies (LS.LT.TT), 670  
 Sharon's Programs (ED.ES.LS), 726  
 Sight Words (LS.TT), 672  
 Silly Sandwich (ES.TT), 673  
 Simple Sentence Structure (ES.LT.TT), 673  
 SimpleCom I: Yes/No Communication (CI.TR.TT), 674  
 SimpleCom II: Needs/Wants Communication (CI.TR.TT), 674  
 Storytime Series (AD.LP.TR.TT), 679  
 Switch It - Change It (ES.TT), 683  
 Switch It - See It (ES.TT), 684  
 Talking Hands (SI.TT), 685  
 Talking Literacy Kit for the Apple IIe (TALK IIe) (GA.KB.IT.WP), 686  
 Talking Nouns, Talking Nouns II, and Talking Verbs (CI.TR.TI), 686  
 Talking Public Domain Disks (ED.LS.SV.TI.TI), 730  
 Talking Sensible Speller (P.A.SV), 765  
 Tea Party (ES.TT), 688  
 Term-Talk (P.A.SV), 768  
 This is the Way We Wash Our Face (ES.TR.TI), 691  
 TimeOut UltraMacros (K.M.T.A.), 366  
 Turbo Trackball (MT.TI), 447  
 Twenty Categories (LS.LT.TT), 696

Understanding Attributes (CR.TT). 697  
 Verb Fill-Ins (CR.TT). 698  
 Verbal Analogies (LS.LT.TT). 698  
 Video Voice Speech Training System (ST.TT). 699  
 Where is Puff? (ES.TT). 705  
 Word Order in Sentences (LS.LT.TT). 706  
 Word-Talk (PA.SV.WP). 773  
 Work-Station Pro (PA). 773  
 Worm Squirm (ES.TR.TT). 708  
 X-10 Home Control Interface (EC). 306  
 Zero to Five (ED.LS). 734  
 Zoo Time (ES.TT). 709

## Apple IIGS

*This list includes products which specifically work with the Apple IIGS. If a product works with all Apple II series computers, it will not be listed here, but will be under "Apple II Family." If it works with the Apple IIGS and another model, it will be listed here and under that other model*

Access to Math (CN.ED). 713  
 Adaptive Firmware Card Model G32c (IA.KE.KM.TI). 374  
 AlphaSmart Pro (PW.TI). 375  
 Aphasia Series: I through VIII (CR.I.S.TT). 558  
 Apple Adjustable Keyboard (RS.TT). 376  
 Apple IIGS Owner's Guide: Disk Edition. 542  
 Association Pictures (CR.TT). 559  
 BEX 3.1 (BR.LP.PA.SV.WP). 739  
 Big/Little I and II (ES.TT). 562  
 Body Builder (ES.TT). 564  
 Braille-Talk (BR.PA.SV). 742  
 Brailled Keyboard Overlay for the Apple IIGS (BR.KM). 334  
 Breakthru Box (TI). 379  
 Buddy's Body (AS.ES.TT). 566  
 Calc-Talk (CN.LP.PA.SV). 743  
 Captain's Log: Cognitive Training System (AS.CR.ES.LS.TT). 568  
 Cause 'n Effect (ES.TT). 571  
 Cognitive Disorders I, II, III, IV (CR.TT). 573  
 COINSNKEYS (CN.ES.KB.TT). 577  
 Community Vehicles (ES.TT). 580  
 CONCENTRATE! On Words & Concepts (LS.LT.TT). 582  
 Creature Antics and Creature Capers (GA.TR.TT). 584  
 Creature Chorus (TR.TT). 585  
 Creature Features (TR.TT). 585  
 Creature Magic (GA.LS.LT.RE.TT). 586  
 CrossWords (GA.LS.TT). 586  
 DARCI TOO (TI). 382  
 Early Concepts (ES.TT). 590  
 Early Emerging Rules Series (LS.LT.TT). 591  
 Early Learning 3 5/Complete Early Learning 5 25 (ED.ES.LS.TT). 591  
 Early Learning I (ES.TT). 592  
 Early Learning II (CN.ED.ES). 717  
 Early Learning III (CN.ED.LS). 717  
 Echo II (SS). 529  
 Fancy-Weency Spider Game (ES.TT). 593  
 Electric Crayon and Electric Crayon Deluxe (DR.PA.RE). 748  
 Expanded Keyboard for Apple Macintosh and Apple IIGS (TI). 385  
 Expanded Numeric Keypads (TI). 386  
 Exploring Early Vocabulary Series (LS.LT.TT). 595  
 Family Fun (AS.ES.TT). 596  
 Fast Food Game (ES.TT). 596  
 Feelings (ES.TT). 597  
 File-Talk (DS.PA.SV). 750  
 First Verbs and Primeros Verbos (ES.LT.TT). 601  
 First Words (ES.LT.TT). 601  
 First Words II (ES.LT.TT). 602  
 Junction Pictures (CR.TT). 605  
 Getting Clean with Herkimer Level I, II, III (TI). 607  
 Hand Controls (II). 392  
 HeadMaster Plus (MT.TI). 393  
 If You're Happy and You Know It (ES.TT). 610

Inferential Naming for Cognitive and Language Disorders (CR.LS.LT.TT). 611  
 Initial Phoneme Cuing for Aphasics (CR.TT). 613  
 IntelliKeys (TI). 398  
 Interaction Games II (ES.GA.TR.TT). 614  
 Join the Circus (AS.ES.TT). 616  
 Keyboard Overlays for Apple IIe and IIgs (KM). 347  
 Keyguards (KG.KM). 350  
 King Keyboard (2440) (TI). 405  
 Learn to Scan (AS.TR.TT). 620  
 Let's Go Shopping I and II (ES.TT). 624  
 Let's Go to the Circus (LT.TT). 624  
 LIAISON (EC.KE.PC.TI). 407  
 LightBoard (TI). 408  
 Logo TouchTools for the PowerPad (AS.ES.TT). 627  
 Macrat (TI). 410  
 Magic Wand Keyboard with McKey Mouse Option (TI). 412  
 Make It In Time (AS.ES.TT). 628  
 Make It Scan (AS.ES.TT). 629  
 Me Too! (PA). 757  
 Micro-LADS and Micro-LADS in French (LT.TT). 634  
 Mini Keyboard (2443 or 2450) (TI). 416  
 Mini-Keyboards (TI). 416  
 Mix 'N Match (ES.TT). 636  
 Moisture Guard (KM). 355  
 Money Skills (AD.CN.LS.TT). 637  
 MY HOUSE: Language Activities of Daily Living (LS.LT.TT). 641  
 My Paint & Talking Coloring Books (DR.ES.LT.TT). 642  
 MY SCHOOL: Language Activities of Daily Living (LS.TT). 642  
 MY TOWN: Language Activities of Daily Living (LS.LT.TT). 643  
 Narwhal Expanded Keyboards for Adaptive Firmware Card (TI). 425  
 Numeric Concepts I and II (LS.TT). 644  
 Occupations (TT). 645  
 Old MacDonald's Farm I and II (ES.LS.TT). 646  
 Padded Food (AS.ES.TT). 650  
 Padded Vehicles (ES.TT). 651  
 Paper Dolls I and II (AD.ES.TT). 651  
 Pictalk (CI.ES.TR.TT). 653  
 Picture Icon X-CHANGE (EA). 146  
 PowerPad (DR.RE.TI). 432  
 PowerPad Preschool Pack I & II (GA.TT). 658  
 PowerPad Starter Kit (TI). 432  
 PowerPad Toolkit 4 (PA). 762  
 PowerTalker (TR.TT). 658  
 Predict It (PA.TA.WP). 763  
 R.A.P.S. Software Series I PowerPad (TT). 661  
 Reactions (R73) (ES.TT). 663  
 Reading Comprehension for Adolescents (CR.TT). 664  
 Scan It - Switch It (TR.TT). 668  
 Seasons (TT). 669  
 Seek & Find (TT). 669  
 Semantic Development Using Code Breaking Strategies (LS.LT.TT). 670  
 Sharon's Programs (ED.ES.LS). 726  
 Sight Words (LS.TT). 672  
 Silly Sandwich (ES.TT). 673  
 Simple Sentence Structure (ES.LT.TT). 673  
 SimpleCom I: Yes/No Communication (CI.TR.TT). 674  
 SimpleCom II: Needs/Wants Communication (CI.TR.TT). 674  
 Single Switch/MatchBox Pack I (TT). 675  
 SPELLIST (ED.LS). 729  
 Storytime Series (AD.LP.TR.TT). 679  
 Switch Arcade (GA.TT). 682  
 Switch It - Change It (ES.TT). 683  
 Switch It - See It (ES.TT). 684  
 SwitchEnsemble (RE.TR.TT). 685  
 Talking Nouns, Talking Nouns II, and Talking Verbs (CI.TR.TT). 686  
 Talking Public Domain Disks (ED.LS.SV.TT.VO). 730  
 Talking Sensible Speller (PA.SV). 765  
 Tea Party (ES.TT). 688  
 Term-Talk (PA.SV). 768  
 Textalker-GS (VS). 486  
 TimeOut UltraMacros (K.M.T.A). 366  
 Trip to the Zoo (GA.TT). 695  
 Turbo Trackball (MT.TI). 447

Twenty Categories (LS,LT,TT), 696  
 Understanding Attributes (CR,TT), 697  
 Verb Fill-Ins (CR,TT), 698  
 Verbal Analogies (LS,LT,TT), 698  
 Video Voice Speech Training System (ST,TT), 699  
 Voice Math (CN,ED), 731  
 Voice Reading Ability Drill (ED,LS), 732  
 Where is Puff? (ES,TT), 705  
 Word Order in Sentences (LS,LT,TT), 706  
 Word-Talk (PA,SV,WP), 773  
 Work-Station Pro (PA), 773  
 Zero to Five (ED,LS), 734  
 Zoo Time (ES,TT), 709

**Apple II Family**

*This list includes products which work with all of the Apple II series of computers (II+, IIc, IIe, IIGS). It also includes any products for which the manufacturer has not provided model-compatibility information. Products which only work with specific models are listed under those models. Please consult the product description or the manufacturer about specific requirements, such as memory or operating system.*

Adult Switch Progressions (TR,TT), 556  
 Adventures of Jimmy Jumper - Prepositions (AS,ES,LT,TT), 557  
 AlphaTalker (CIEA,TI), 119  
 Antonyms and Synonyms (Cognitive Disorders 12) (CR,LS,TT), 557  
 APH Presents the Talking Apple Computer (SV,TT), 558  
 APH Scientific Calculator: for Apple II Computers (CN,PA,SV), 737  
 APH/SEI Talking Software (ED,LS,SV), 713  
 Apple Computer Input Adapter (IA), 453  
 AppleWorks Manuals: Special Editions (SV), 542  
 Arithmetic 1, 2, and 3 with Speech (CN,ED,LS,SV), 714  
 Babysitting Basics (TT,VO), 560  
 Be a Winner Series (LS,TT,VO), 561  
 Bear Jam (ES,TT), 561  
 Blueprint for Decision Making (LS,TT), 563  
 Bozons' Quest (GA,LS,TT), 564  
 Breakthrough to Language: Clinical Edition (LT,ST,TT), 565  
 Breakthrough to Language: Home Edition (LT,ST,TT), 566  
 Build-A-Scene (TT), 567  
 CAMEO (AD,CN,ED,LS), 715  
 CAV-ASL (SI,TT), 571  
 Children's Switch Progressions (TT), 572  
 Cogrehab Vol. 2 (CR,LS,TT), 574  
 Cogrehab Vol. 3 Version 2.0 (CR,LS,TT), 575  
 Cogrehab Vol. 4 (CR,LS,TT), 575  
 Cogrehab Vol. 5 (CR,LS,TT), 576  
 Cogrehab Vol. 6 (CR,LS,TT), 576  
 Cogrehab Vol. 7: Quest (CR,LS,TT), 577  
 Color Find (ES,TT), 578  
 Community Signs (AD,LS,LT,TT), 580  
 Complete Spelling Program (ED,LS), 716  
 CompuDesk HCP, 543  
 Computer Interface Box (IA), 454  
 Computer Switch Interface (IA), 455  
 CONCENTRATE! On Words & Concepts (LS,LT,TT), 582  
 Core Reading and Vocabulary Development (ED,LS,LT,TT), 583  
 Creature Antics and Creature Capers (GA,TR,TT), 584  
 Creature Chorus (TR,TT), 585  
 Custom Keypad (KG,KM), 336  
 DA-II Adapter (IA), 456  
 Data Entry (TT,VO), 587  
 Disk Guide (2485), 545  
 Dvorak Conversion Keypad Labels (KM), 338  
 Early and Advanced Switch Games (TT), 590  
 Echo II with Textalker & Echo II with Textalker-GS (SS,VS), 472  
 Edmark Functional Word Series (AD,TT,VO), 592  
 Edmark Reading Program, Level I Software (ED,ES,LS), 718  
 Elementary Signer (SI,TT), 593  
 Elementary Volume I - Mathematics (CN,ED,LS,SV), 718  
 Employment Signs (AD,LS,LT,TT), 594  
 English on the Job (AS,TT,VO), 594  
 ERIN (Early Recognition Intervention Network) (AS,ED,ES), 719

Expanded Keyboards for the Talking BlissApple (KG,TI), 386  
 Finger-peller (SI,TT), 598  
 First Categories (ES,LS,LT,TT), 599  
 First Mate (CR,TT), 600  
 First Step Software (LT,TT), 600  
 First Verbs and Primeros Verbos (ES,LT,TT), 601  
 First Words (ES,LT,TT), 601  
 First Words II (ES,LT,TT), 602  
 Focus on Facts (ED,SV), 719  
 Focus on Nations (ED,SV), 720  
 Following Directions: One- and Two-Level Commands (ES,TT), 602  
 Following Directions: Left and Right (ES,TT), 603  
 Food Facts (AD,SV,TT), 603  
 Further Adventures of Jimmy Jumper - Perseverance (AS,ES,TT), 606  
 GrammarPlay with Alps and Droops (LS,LT,TT), 607  
 Grocery Store Words (AD,LS,TT), 608  
 Hierarchical Attention Training (CR,TT), 608  
 Homographs (CR,LS,TT), 609  
 Homophones (CR,LS,TT), 609  
 Human Being Machine (RE,TT), 610  
 Improving Your Self-Concept (TT), 611  
 Information Signs (AD,LS,LT,TT), 612  
 Input Adapter (IA), 456  
 IntelliKeys Overlay Maker, 548  
 IntelliTalk (CIEA,PA), 137  
 Interaction Games (ES,GA,TR,TT), 613  
 Internal I/O Port Adapter (IA), 457  
 Job Readiness Series (AS,TT,VO), 614  
 Job Seeking Series (LS,TT,VO), 615  
 Job Success Series (TT,VO), 615  
 Joystick Trainer (TR,TT), 616  
 Keyboard Interfaces (IA,KE), 458  
 Keyboarding by Ability (ED,KB,TT), 617  
 Keypad (KG,KM), 349  
 Keylocks (KM), 350  
 Keys to Success: Comp. Keybd. Skills for Blind Children (KB,SV,TT), 619  
 Learning Activity Packets (LAPs) (CN,LS,TT,VO), 621  
 Learning to Reason Series (LS,TT), 622  
 Learning to Spell Braille Signs (BR,TT), 623  
 Letter Find (CN,ES,KB,SV,TT), 625  
 LetterTALK+ (SV,TT,WP), 625  
 Liberator (CI,CN,EA,EC,PW,TI), 137  
 Listen and Spell (ED,LS), 723  
 Living Alone (AD,TT), 626  
 Mac-Apple Communications Aid (CI,CN,DRES,PA,TT,WP), 756  
 Magic Slate II (LP,LS,PA,TT,WP), 756  
 Mastering Personal Information (MPI) (AD,CR,TT), 629  
 Math on the Job (AS,CN,TT,VO), 630  
 Maze (GA,RE,TT), 631  
 Medical Words (AD,LS,TT), 631  
 Micro Guide to Careers Series (TT,VO), 633  
 Micro-LADS and Micro-LADS in French (LT,TT), 634  
 Microcomputer Evaluation of Career Areas (MECA) (AS,TT,VO), 634  
 MicroIllustrator (DR,PA,RE,TT), 758  
 Mind Castle I and II (GA,LS,TT), 635  
 Minimal Contrast Therapy (ST,TT), 636  
 Minspeak Application Programs (MAP) (CI,PA), 759  
 Money Matters (LS,TT), 637  
 Motor Training Games (AS,GA,PA,RE,TT), 638  
 Motor Training Games (GA,TR,TT), 638  
 Muppet Learning Keys (GA,ID,TI), 423  
 MY HOUSE: Language Activities of Daily Living (LS,LT,TT), 641  
 MY SCHOOL: Language Activities of Daily Living (LS,TT), 642  
 MY TOWN: Language Activities of Daily Living (LS,LT,TT), 643  
 Ohtsuki BT-5000 Braille/Print Printer (BR,BT), 517  
 On the Job Series - Career Interests (TT,VO), 646  
 Order Processing (TT,VO), 650  
 Paragon Braille Printer (BR,BT), 518  
 Personal Development Software Series (LS,TT), 652  
 Pick-A-Meal (AD,GA,TT), 653  
 Picture Perfect (DR,PA,RE), 762  
 Picture Scanner (TR,TT), 655  
 Picture/Theme Disks (TR,TT), 656



- Pictures Programs: I, II and III (CR,ES,LS,TT), 656  
 Point to Pictures (TR,TT), 657  
 Porter, The (IA), 461  
 Positive Parenting (AD,TT), 657  
 Prefixes (ED,LS,SV), 723  
 Preposition Fill-Ins (CR,TT), 659  
 Primer 83 (AS,LS,TT), 660  
 Rabbit Scanner (AS,ES,TT), 662  
 Race the Clock (GA,RE,TT), 662  
 Rate Drill in Articulation, Language and Fluency (LT,ST,TT), 663  
 Readable Stories Series (ED,LS), 724  
 Reading a Ruler - English & Metric (CN,TT,VO), 664  
 Reasoning Skills on the Job (AS,TT,VO), 665  
 Rhyming Pictures (CR,TT), 665  
 Run Rabbit Run (AS,ES,TT), 666  
 Safety Signs (AD,LS,LT,TT), 667  
 Scanning Conversion Program, 550  
 Sensible Speller: Talking APH Edition (ED,LS,SV), 725  
 Sentence Master (LS,TT), 671  
 Sight Word Spelling (ED,LS,SV), 726  
 Speaking Speller (ED,LS,SV), 727  
 Special Education Public Domain Software (CR,ED,LS,TT), 677  
 Spell-A-Word & 2+2 (CN,ED,LS), 727  
 Spell-Talk (ED,LS,SV), 728  
 Spelling Tutor (ED,LS), 728  
 SPELLIST (ED,LS), 729  
 Spin and Spell (ED,LS), 729  
 Steps for Career Choice (TT,VO), 678  
 Study Buddy (ED), 730  
 SuperPort (IA), 462  
 Survival Words (AD,AS,LS,LT,TT), 681  
 Switch Interface (IA), 463  
 Talking Riddles (ED,LS,SV), 731  
 Talking Touch Window (AS,CI,TR,TT), 687  
 Talking Typer (KB,SV,TT), 687  
 Talking Utilities for DOS 3.3 (PA,SV), 766  
 Talking Utilities for ProDOS, 551  
 Talking Writer & Four Games (KB,LP,PA,SV,TT,WP), 766  
 Teenage Switch Progressions (TT), 689  
 TEXTALKER (BT,SV), 521  
 Timekeeper (AD,TT), 692  
 Touch and Match (ES,TT), 692  
 Touch and See (ES,TT), 693  
 TouchMoney (AD,CN,TT,VO), 693  
 TouchWindow (DR,DS,ID,RE,TI,WP), 444  
 Trace Math Aid (CN,ED,PA), 769  
 Transportation Signs (AD,LS,LT,TT), 694  
 Universal Input Adaptor (IA), 464  
 Wheels On The Bus I, II, III (ES,TR,TT), 704  
 Wordplay with Alps and Droops (ED,GA,LS), 732  
 Words and Concepts I, II, III (LS,LT,TT), 707  
 Write (CI,ED,LS,SV), 733  
 Write This Way (ED,WP), 733  
 WSCC (Washington State Cooperative Curriculum) (LS,TT), 709  
 ZoomCaps (KM), 369
- Apple Macintosh Family**  
*This list includes products which work with all of the Apple Macintosh family of computers. It also includes any products for which the manufacturer has not provided model-compatibility information. Products which only work with specific models are listed under those models. Please consult the product description or the manufacturer about specific requirements, such as memory or operating system*
- 101 Animations (TR,TT), 556  
 AccessBliss 2.2 (NA), 69  
 Adult Switch Progressions (TR,TT), 556  
 AlphaSmart Pro (PW,TI), 375  
 AlphaTalker (CI,EA,TI), 119  
 Apple Adjustable Keyboard (RS,TI), 376  
 BAT Personal Keyboard (TI), 377  
 Beep-in-Touch (CM), 312  
 Big Keys (TI), 378  
 Big/Little I and II (ES,TT), 562  
 Big-Calc (CN,LP,PA), 740  
 Biggy (LP,PA), 741  
 BlissWrite (PA,TT,WP), 741  
 Blissymbols Gallery (NA), 72  
 Blocks in Motion (DR,RE,TT), 563  
 Boardmaker 3.0 (NA), 73  
 Breakthru Box (TI), 379  
 Buddy's Body (AS,ES,TT), 566  
 Build-A-Scene (TT), 567  
 CAMEO (AD,CN,ED,LS), 715  
 CanSpeak (CI,LT,TT), 568  
 CAV-ASL (SI,TT), 571  
 Children's Switch Progressions (TT), 572  
 Circletime Tales & Circletime Tales Deluxe (ES,TT), 572  
 Cirque GlidePoint Trackpads (MT,TI), 380  
 ClickIt! (IA), 454  
 CloseView (LP,MG), 495  
 Co:Writer (PA,TA), 745  
 Colorful Concept Software (ES,TT), 578  
 Comfort Keyboard System (TI), 380  
 Communication Icon Galleries CD-ROM (NA,SS), 78  
 Community Vehicles (ES,TT), 580  
 CONCENTRATE! On Words & Concepts (LS,LT,TT), 582  
 Core Reading and Vocabulary Development (ED,LS,LT,TT), 583  
 Creature Antics and Creature Capers (GA,TR,TT), 584  
 Creature Cartoons (ES,GA,TT), 584  
 Creature Features (TR,TT), 585  
 Creature Magic (GA,LS,LT,RE,TT), 586  
 CrossScanner (IA), 455  
 Custom Keyguard (KG,KM), 336  
 DARCI TOO (TI), 382  
 Dino-Games (ES,TR,TT), 588  
 DJ ProPack Speech Module (SS), 529  
 Dollars & Cents Series (AD,CN,TT), 589  
 Doors II (TI), 382  
 Duxbury Braille Font (PA), 746  
 Duxbury Braille Translator (DBT) (BR,PA), 746  
 Dvorak Conversion Keytop Labels (KM), 338  
 DynaVox2 DOS & DynaVox2 Mac (EA), 129  
 Early and Advanced Switch Games (TT), 590  
 Early Concepts (ES,TT), 590  
 Early Emerging Rules Series (LS,LT,TT), 591  
 Early Learning 3.5/Complete Early Learning 5.25 (ED,ES,LS,TT), 591  
 Early Learning I (ES,TT), 592  
 Early Learning II (CN,ED,ES), 717  
 Early Learning III (CN,ED,LS), 717  
 Easy Access (KM,MT), 339  
 Echo LC (SS), 530  
 Elementary Signer (SI,TT), 593  
 ERIN (Early Recognition Intervention Network) (AS,ED,ES), 719  
 Every Day Is A Holiday (GA,RE,TT), 595  
 ExerciseBreak (PA,RS), 749  
 Expanded Keyboard for Apple Macintosh and Apple IIGS (TI), 385  
 Expanded Numeric Keypads (TI), 386  
 Exploring Early Vocabulary Series (LS,LT,TT), 595  
 Family Fun (AS,ES,TT), 596  
 Fast Food Game (ES,TT), 596  
 Feelings (ES,TT), 597  
 Felix (MT,TI), 389  
 Find the Buttons (TT), 597  
 Fingerspeller (SI,TT), 598  
 FingerZoids (GA,SI,TT), 599  
 First Categories (ES,LS,LT,TT), 599  
 First Verbs and Primeros Verbos (ES,LT,TT), 601  
 First Words (ES,LT,TT), 601  
 First Words II (ES,LT,TT), 602  
 Half-QWERTY One-handed Keyboard Software (KM), 342  
 HeadMaster Plus (MT,TI), 393  
 HeadMouse (DR,MT,TI), 394  
 Hereward Tracker Ball & Joystick Module (MT,TI), 395  
 HomeAccess (EC,P,I), 283  
 HyperBliss 3.2 (EA), 136  
 I Can Play, Too! (PA,RE,TR), 753

- If You're Happy and You Know It (ES,TT), 610  
 Imaginart Gallery (NA), 88  
 Infovox 210 (SV,VS), 475  
 Instant Access (TI), 397  
 IntelliKeys (TI), 398  
 IntelliKeys Overlay Maker, 548  
 IntelliTalk (CI,EA,PA), 137  
 JOKUS Software (ED,ES), 721  
 Joystick Trainer (TR,TT), 616  
 K.C. & Clyde in Fly Ball (ED,LS), 722  
 Ke:nx On:Board (M43) (TI), 402  
 Keyboard Overlays for Apple IIe and IIgs (KM), 347  
 Keyguard (KG,KM), 349  
 Keyguards (KG,KM), 350  
 KeyMagic (KM), 351  
 Kinesis Ergonomic Keyboard (RS,TI), 405  
 Let's Go to the Circus (LT,TT), 624  
 LIAISON (EC,KE,PC,TI), 407  
 Liberator (CI,CN,EA,EC,PW,TI), 137  
 LightBoard (TI), 408  
 LipStick and WordWriter (MT,TI), 408  
 Listen With Your Ears (GA,TT), 626  
 Mac PowerPad Interface for Single Switches (IA), 459  
 Macintosh Switch Interface (M09) (IA), 459  
 MacKing (MT,TI), 409  
 MacMini (MI,II), 410  
 MacQWERTY (KM), 354  
 Macrat (TI), 410  
 Magic Wand Keyboard with McKey Mouse Option (TI), 412  
 Micro-LADS and Micro-LADS in French (LT,TT), 634  
 MIKE (Mouse Interface & Keyboard Emulation) (MT,TI), 415  
 Mini-Keyboards (TI), 416  
 Minspeak Application Programs (MAP) (CI,PA), 759  
 Mix 'N Match (ES,TT), 636  
 Moisture Guard (KM), 355  
 Money Skills (AD,CN,LS,TT), 637  
 Mouse-Trak (MT,TI), 419  
 MouseMover - Mac (5005) (MT,TI), 420  
 MousePen (MT,TI), 421  
 Multi-SCAN (GA,TR,TT), 639  
 Muppet Learning Keys (GA,ID,TI), 423  
 MusicWare (CN,ES,GA,LS,TT), 640  
 MusicWare - Age Appropriate (ES,GA,TT), 641  
 MY HOUSE: Language Activities of Daily Living (LS,LT,TT), 641  
 MY SCHOOL: Language Activities of Daily Living (LS,TT), 642  
 MY TOWN: Language Activities of Daily Living (LS,LT,TT), 643  
 MyKey (MT,RS,TI), 424  
 New Frog & Fly (TR,TT), 644  
 NexCom 300vi & 300ve (TD), 185  
 NOMAD Talking Touch Pad & NOMAD Gold (BT,SI), 516  
 Occupations (TT), 645  
 On the Job Series - Career Interests (TT,VO), 645  
 On the Job Series - Mathematics (CN,TT,VO), 647  
 One Switch Picasso (DR,RE,TT), 648  
 Padded Food (AS,ES,TT), 650  
 Padded Vehicles (ES,TT), 651  
 Paper Dolls I and II (AD,ES,TT), 651  
 Paragon Braille Printer (RR,BT), 518  
 PhoneAccess (EC,PC), 289  
 Pick 'n Stick on Disk (NA), 99  
 Pick-A-Meal (AD,GA,TT), 653  
 Picture Cue Dictionary (AD,CI,LT,NA,TT), 654  
 Picture Scanner (TR,TT), 655  
 Picture/Theme Disks (TR,TT), 656  
 PowerBook Mounting Plate (MS), 171  
 PowerSecretary (TI,WP), 433  
 Pre-Dict-ate (TI), 433  
 Press to Play (ES,TR,TT), 660  
 PROXi (EC,PC), 290  
 QuickKeys (KM,TA), 361  
 Race the Clock (GA,RE,TT), 662  
 RemotePoint (MT,TI), 436  
 RevolvingDoors (MT,TI), 437  
 Rockets to the Moon (ES,GA,TR,TT), 666  
 Scan & Match 1, 2, 3, and 4 (TR,TT), 667  
 Scan It - Switch It (TR,TT), 668  
 Scanning Picasso (DR,RE,TT), 668  
 ScottBridge Speech Access System (TI), 438  
 ScreenDoors (TI), 438  
 Seek & Find (TT), 669  
 Sentence Master (LS,TT), 671  
 Shell Game & Mouse Game (ES,GA,TT), 672  
 Silly Sandwich (ES,TT), 673  
 Simple Sentence Structure (ES,LT,TT), 673  
 Son of Seek and Find (GA,TT), 676  
 Sound Scope (ST,TT), 677  
 Speaking Dynamically (CI,EA), 152  
 Spell-A-Word & 2+2 (CN,ED,LS), 727  
 Stingray (MT,TI), 441  
 Storytime Series for Macintosh (AD,LP,TR,TT), 679  
 Swim, Swam, Swum: Mastering Irregular Verbs (LS,LT,TT), 681  
 Switch Arcade (GA,RE,TT), 682  
 Switch It - See It (ES,TT), 684  
 Switch Puzzles (RE,TR,TT), 684  
 Switch-Adapted Mouse (SAM) (MT,TI), 442  
 Switch-Back (ID,TI), 443  
 SynergyMac and SynergyPC (CI,PW,TI), 444  
 T-TAM Keyboard and Mouse Emulator (EA,IA,KM,MT,TI), 463  
 Talk:About (CI,EA), 156  
 Talking Nouns, Talking Nouns II, and Talking Verbs (CI,TR,TT), 686  
 Tea Party (ES,TT), 688  
 Teenage Switch Progressions (TT), 689  
 Telepathic II (PA,TA), 767  
 Tempo II Plus (KM,TA), 365  
 TempoEZ (KM,TA), 366  
 This is the Way We Wash Our Face (ES,TR,TT), 691  
 This Old Man (CN,SI,TT), 691  
 TouchWindow (DR,DS,ID,RE,TI,WP), 444  
 Trackball Pro (MT,TI), 445  
 TranSend System (BR,BT), 522  
 Trip to the Zoo (GA,TT), 695  
 Turbo Mouse 4.0 (MT,TI), 447  
 Turbo Trackball (MT,TI), 447  
 Turn-Talking (CI,TR,TT), 695  
 Typelt4Me (PA,TA), 770  
 UKanDu Little Books (LS,TT), 696  
 UKanDu Switches, Too! (ES,TT), 697  
 Universal Control System with Tongue Touch Keypad (EC,PC), 303  
 Vertical (RS,TI), 448  
 Video Voice Speech Training System (ST,TT), 699  
 VisionKey (EA,TI), 158  
 Wheels On The Bus I, II, III (ES,TR,TT), 704  
 Wheels on the Bus I, II, III - Intellipics Activity (ES,GA,TT), 704  
 Wheels on the Bus: COMPLETE (ES,TT), 705  
 Where is Puff? (ES,TT), 705  
 Words and Concepts I, II, III (LS,LT,TT), 707  
 WordWise Software (LT,TT), 708  
 WordWriter (KM,TA,WP), 368  
 Worm Squirm (ES,TR,TT), 708  
 Write This Way (ED,WP), 733  
 Write:OutLoud (PA,WP), 774  
 X-10 Home Control Interface (EC), 306  
 Zoo Time (ES,TT), 709  
 ZoomCaps (KM), 369

**Apple Macintosh Plus**

*This list includes products which specifically work with the Macintosh Plus. If a product works with all models of Macintosh, it will not be listed here, but will be listed under "Apple Macintosh Family." If it works with the Mac Plus and another model of Mac, it will be listed here and under that other model.*

- Communication Board Builder (NA), 77  
 inLARGE 2.0 (LP,MG), 496  
 MacTRAC (MT,TI), 411  
 outSPOKEN 1.7 (SV,VS), 479  
 QUADLynx Trackball (MT,TI), 435  
 Sentence Key & Picture Sequence Key (LT,TT), 671

**Apple Macintosh SE/II**

*This list includes products which work with the Macintosh SE and Macintosh II computers, as well as "sub-models" within those product lines (such as the Mac Ix). Please note that some of the products on this list may work with only the Mac SE or only the Mac II. If a product works with all models of Mac, it will not be listed here, but will appear under "Apple Macintosh Family." If it works with certain other models (such as the Mac Plus), it will be listed here and under those other models.*

Communication Board Builder (NA), 77  
 Ke:nx (KE,MT,TI), 402  
 MacTRAC (MT,TI), 411  
 MouseStick II (MT,TI), 422  
 outSPOKEN 1.7 (SF,VS), 479  
 SenSei System (EC,PA,PC,TI,TL), 295

**Atari 400**

*This list includes products which specifically work with the Atari 400. If a product works with other specific Atari models, it will be listed under those other models as well. If it works with ALL Atari models, it will be listed under "Atari (all or some models)," and not here.*

Bear Jam (ES,TT), 561  
 MicroIllustrator (DR,PA,RE,TT), 758  
 PowerPad (DR,RE,TI), 432

**Atari 800**

*This list includes products which specifically work with the Atari 800. If a product works with other specific Atari models, it will be listed under those models as well. If it works with ALL Atari models, it will be listed under "Atari (all or some models)," and not here.*

Bear Jam (ES,TT), 561  
 MicroIllustrator (DR,PA,RE,TT), 758  
 PowerPad (DR,RE,TI), 432

**Atari Family**

*This list includes products that work with any model of Atari computer, as well as products for which the manufacturer has not specified model compatibility.*

CompuDesk HCP, 543  
 Custom Keyguard (KG,KM), 336

**Atari ST Family**

*This list includes products which specifically work with the Atari ST. If a product works with other specific Atari models, it will be listed under those other models as well. If it works with ALL Atari models, it will be listed under "Atari (all or some models)," and not here.*

Filch (KM), 341

**Block Transfer Terminals**

Help U Type (KM,TA), 344

**Commodore 128**

*This list includes products which specifically work with the Commodore 128. If a product works with all Commodore computers, it will not be listed here, but will be under "Commodore (all or some models)." If it works with the 128 and another model (such as the Commodore 64), it will be listed here and under that other model.*

Bear Jam (ES,TT), 561  
 PowerPad (DR,RE,TI), 432

**Commodore 64**

*This list includes products which specifically work with the Commodore 64. If a product works with all Commodore computers, it will not be listed here, but will appear under "Commodore (all or some models)." If it works with the 64 and another model, it will be listed here and under that other model.*

Bear Jam (ES,TT), 561  
 Complete Spelling Program (ED,LS), 716  
 Custom Keyguard (KG,KM), 336  
 Electric Crayon and Electric Crayon Deluxe (DR,PA,RE), 748  
 H:1 Handicapped Word Games (ED,GALS,PA,RE), 752  
 PowerPad (DR,RE,TI), 432  
 X-10 Home Control Interface (EC), 306  
 Zero to Five (ED,LS), 734

**Commodore Amiga**

*This list includes products which specifically work with Commodore Amiga computers. If a product works with all Commodore computers, it will not be listed here, but will appear under "Commodore (all or some models)." If it works with specific other models, it will be listed here and under those other models.*

AmTRAC (MT,TI), 375  
 Breakthru Box (TI), 379  
 Expanded Numeric Keypads (TI), 386  
 Filch (KM), 341  
 Mini-Keyboards (TI), 416  
 Trackball Pro (MT,TI), 445

**Commodore Family**

*This list includes products which work with any Commodore computers. It also includes any products for which the manufacturer has not provided model-compatibility information. Products which only work with specific Commodore models (such as the Amiga) are listed under those models. Please consult the product description or the manufacturer about specific requirements such as operating system or memory.*

CompuDesk HCP, 543

**Datavue Spark**

*This list includes only products that have been specifically designed to work with the Datavue Spark computer. Software and hardware designed to work with any MS-DOS computer will be listed under "IBM-PC Family."*

Filch (KM), 341

**Epson HX-20**

*This list includes products which work with the HX-20, or are based on that machine.*

HX-20 Protective Cover (KM), 345  
On/Off Adaptor Switch (KM), 357  
Reinforced Keyguard (KG,KM), 362

**Grid**

*This list includes products which have been specifically described by their manufacturers as working with Grid computers.*

Filch (KM), 341  
HandiCHAT and HandiCHAT Deluxe (SV,VS), 473  
HandiCODE and HandiCODE Deluxe (SV,VI), 393  
HandiKEY and HandiKEY Deluxe (KM), 342  
HandiSHIFT (KM), 343  
HandiWORD and HandiWORD International (KM,TA), 343  
SeeBEEP (PA), 764

**IBM-PC PC**

*This list includes products which specifically work with the original IBM PC, and don't require the power of a PC XT or PC AT. Some of these may also work on an XT, AT or PS/2, in which case they will also be listed under those computers.*

Infovox 500, 700 & 750 (SS), 531

**IBM-PC XT**

*This list includes products which work specifically with the PC XT model of the IBM PC family. If a product works with other models as well, it will be listed under those models, or simply under "IBM PC Family."*

AbleOffice, 541  
Big Keys (TI), 378  
BRAILLEX-2D (BR,BT), 509  
Finish Line (PA,TA), 751  
GEWA FTB 108 Enlarged Keyboard (TI), 391  
GEWA METB 121 Reduced Size Keyboard (TI), 391  
Infovox 500, 700 & 750 (SS), 531  
MyKey (MT,RS,VI), 424

**IBM PC AT**

*This list includes products which work only with the AT model of the IBM-PC family. If a product works with the AT and other models, it will be listed under "IBM PC Family."*

Atlas Speaks (PA), 737  
Big Keys (TI), 378  
BRAILLEX-2D (BR,BT), 509  
Finish Line (PA,TA), 751  
GEWA FTB 108 Enlarged Keyboard (TI), 391  
GEWA METB 121 Reduced Size Keyboard (TI), 391  
Infovox 500, 700 & 750 (SS), 531  
IRIS Reading Interface 3.0 (SV,VI), 399  
MiniErgo-MF2 (KM,RS,VI), 417  
Multi-Line Dial-A-News System (PA,TD,VI), 759  
MyKey (MT,RS,VI), 424  
OsCaR (TI), 429  
Strider (PA), 764  
T-TAM Keyboard and Mouse Emulator (EA,IA,KM,MT,VI), 463

**IBM PC Family**

*This list includes products which work with all models of the IBM Personal Computer. It also includes any products for which the manufacturer has not provided model-compatibility information. Products which only work with the IBM PC AT (and not with other models) are listed under "IBM PC AT." For compatibility with the PC jr, see that list. Please consult the product description or the manufacturer about specific requirements such as memory and operating system.*

1-Key (KM), 331  
101 Animations (TR,TT), 556  
AbiliTech Commander IR (EC), 263  
AbiliTech Commander X-10 (EC), 264  
AbiliTech Communicator (CI,EC,PC), 264  
AbiliTech Home Control System (EC,PC), 265  
Able2Speak (EA), 117  
Accent-PC (SS), 525  
Accent-SA (SS), 526  
Access Pack for Microsoft Windows (IA,KM,MT,VI), 331  
Access-I (CI,PW,VI), 373  
AccessDOS (IA,KM,MT,VI), 332  
Adap2U (MT,VI), 373  
ADAPTA-LAN (CI,LP,PC,VI,WP), 374  
Adult Switch Progressions (TR,TT), 556  
AlphaSmart Pro (PW,VI), 375  
AlphaTalker (CI,EA,VI), 119  
ALVA Braille Terminals (BR,BT), 507  
Antonyms and Synonyms (Cognitive Disorders 12) (CR,LS,TT), 557  
Aphasia Series: I through VIII (CR,LS,TT), 558  
Artic TransPort (SS,SV), 526  
ASAP (Automatic Speech Access Program) (SV,VS), 468  
ASER Ergonomic Keyboard Layout (KM,RS), 333  
Association Pictures (CR,TT), 559  
Atlantic 144 TTY (TD), 179  
Attention, Perception & Discrimination Plus for Windows (CR,TT), 559  
AudScan II (CI,EA), 121  
Aurora 2.0 for DOS (CI,EA,LP,TA,VI,WP), 376  
Aurora for Windows (KM,TA,VI,WP), 333  
Auto Braille (BR,PA), 738  
B-Edit (LP,PA,TA,WP), 738  
B-Pop (MG), 493  
Basic Learning Skills Courseware (CN,ED,LS), 714  
BAT Personal Keyboard (TI), 377  
Be a Winner Series (LS,TT,VO), 561  
Beep-in-Touch (CM), 312  
BEST Faces (ES,TT), 562  
BEST Switch Interface (IA), 453  
BIG for 1-2-3 (DS,LP,PA), 739  
BIG for WordPerfect (LP,PA), 740  
Big-W (LP,MG), 494  
BioMuse (TI), 378  
BlissWrite (PA,TT,WP), 741  
Bloorview Miniature Keyboard (TI), 379  
Boardmaker for Windows (NA), 73  
BookWise (VS), 468  
Braille 'n Speak (BR,PW,SS,SV,VI,VS), 469  
Braille Keytop Labels (BR,KM), 334  
Braille Tutorial (BR,TT), 565  
Braille-Talk (BR,PA,SV), 742  
BrailleAccess (BR,BT), 509  
Braillo 200 (BP,BR,BT), 510  
Braillo 400 S (BP,BR,BT), 510  
Braillo Comet (BP,BR,BT), 511  
Breakthrough to Language: Clinical Edition (LT,ST,TT), 565  
Breakthrough to Language: Home Edition (LT,ST,TT), 566  
Breakthru Box (TI), 379  
Breath Input Device, 207  
Build-A-Scene (TT), 567  
Business Vision (SV,VS), 471  
Butler-in-a-Box (EC,PC,VI) 270  
Cafet-for-Voice (ST,TT), 567  
Calcworthy (CN,PA,SV), 743

- CallText 5000 (PC,SS), 527  
 CAMEO (AD,CN,ED,LS), 715  
 Captain's Log: Cognitive Training System (AS,CR,ES,LS,TT), 568  
 Career English (ED,LS,VO), 715  
 CarryCom (CI,EA), 123  
 Categories Plus for Windows (CR,TT), 569  
 Category Discrimination and Reasoning Plus for Windows (CR,TT), 569  
 Category Naming and Completion Plus for Windows (CR,TT), 570  
 Cause & Effect (TR,TT), 570  
 CAV-ASL (SI,TT), 571  
 CCT Environmental Control (EC), 271  
 Children's Switch Progressions (TT), 572  
 CINTEX I (EC,PA,PC,RE,TA,TI,WP), 744  
 CINTEX2 (EC,PA,PC), 271  
 Cirque GlidePoint Trackpads (MT,TI), 380  
 Cognitive Disorders I, II, III, IV (CR,TT), 573  
 Cogrehab Vol. 1 (CR,LS,TT), 574  
 Cogrehab Vol. 4 (CR,LS,TT), 575  
 Cogrehab Vol. 5 (CR,LS,TT), 576  
 Cogrehab Vol. 6 (CR,LS,TT), 576  
 Cogrehab Vol. 7: Quest (CR,LS,TT), 577  
 COINSNKEYS (CN,ES,KB,TT), 577  
 Colors and Shapes (ES,TT), 579  
 Combination Braille/Large Print Keypad Labels (BR,KM,LP), 335  
 Comfort Keyboard System (TI), 380  
 Community Signs (AD,LS,LT,TT), 580  
 Completion From Partial Information Plus for Windows (CR,TT), 581  
 CompuDesk HCP, 543  
 Computer Literacy Series (KB,TT), 582  
 CONCENTRATE! On Words & Concepts (LS,LT,TT), 582  
 Concept Keyboard (TI), 381  
 Construc (CR,TT), 583  
 Cordless WinMouse (MT,TI), 381  
 Core Reading and Vocabulary Development (ED,LS,LT,TT), 583  
 Creature Antics and Creature Capers (GA,TR,TT), 584  
 Creature Chorus (TR,TT), 585  
 Creature Features (TR,TT), 585  
 Creature Magic (GA,LS,LT,RE,TT), 586  
 CrossScanner (IA), 455  
 Custom Keyguard (KG,KM), 336  
 DARCI TOO (TI), 382  
 Data Entry (TT,VO), 587  
 DECTalk PC & DECTalk Express (SS), 528  
 Deductive Reasoning Plus for Windows (CR,TT), 587  
 Definitions Plus for Windows (CR,TT), 588  
 Dino-Games (ES,TR,TT), 588  
 DM80/FM (BR,BT,TI), 511  
 DOS Tape, 545  
 DragonDictate Starter, Classic, and Power Editions (TI), 383  
 Duxbury Braille Board for Microsoft Windows (BR,PA), 745  
 Duxbury Braille Font (PA), 746  
 Duxbury Braille Translator (DBT) (BR,PA), 746  
 Duxbury Braille Translator for WordPerfect (DUXWP) (BR,PA), 747  
 Dvorak Computer Keyboard (KM), 337  
 Dvorak Conversion Keypad Labels (KM), 338  
 Dvorak Keyboard Layouts (KM), 338  
 DynaVox2 DOS & DynaVox2 Mac (EA), 129  
 E Z Keys (EC,KM,TA), 339  
 Early and Advanced Switch Games (TT), 590  
 Early Emerging Rules Series (LS,LT,TT), 591  
 Echo PCII (SS), 530  
 Echo-PC (SS), 531  
 Edgar (BR,PA), 748  
 FEK (TI), 383  
 Electric Crayon and Electric Crayon Deluxe (DR,PA,RE), 748  
 Elementary Signer (SI,TT), 593  
 Emacspeak (VS), 472  
 Employment Signs (AD,LS,LT,TT), 594  
 Equalizer (CI,DR,EA,PW,RE,TI,WP), 131  
 ErgoLogic Model 7.1 Keyboard (RS,TI), 384  
 ERIN (Early Recognition Intervention Network) (AS,ET,ES), 719  
 ExerciseBreak (PA,RS), 749  
 Expanded Keyboard Emulator (KM,TA), 340  
 Expanded Keyboard for IBM Computers (KG,TI), 385  
 Expanded Numeric Keypads (TI), 386  
 Expert Mouse (MT,TI), 387  
 Exploring Early Vocabulary Series (LS,LT,TT), 595  
 Eye Relief (LP,PA,WP), 750  
 Eye Slaved Pointing System (EC,PC,TI), 387  
 ezMorse for Windows (TI), 388  
 ezScan (TI), 388  
 FastTRAP (MT,TI), 389  
 Felix (MT,TI), 389  
 Filch (KM), 341  
 Find the Buttons (TT), 597  
 Fingerspeller (SI,TT), 598  
 Fingerspelling & Numbers (SI,TT), 598  
 Finish Line (PA,TA), 751  
 First Categories (ES,LS,LT,TT), 599  
 First Verbs and Primeros Verbos (ES,LT,TT), 601  
 First Words (ES,LT,TT), 601  
 First Words II (ES,LT,TT), 602  
 First-Finger WinTrack (MT,TI), 390  
 FlexPro (RS,TI), 390  
 FormMate (PA), 751  
 Foundations I (CR,ES,TT), 604  
 Foundations II (CR,ES,TT), 604  
 Freedom Writer (PA,WP), 752  
 Function Pictures (CR,TT), 605  
 Functional Vocabulary Plus for Windows (CR,TT), 605  
 Fundamental Concepts (ES,TT), 606  
 Futura-TTY (CI,TD,TL), 181  
 Gizmo (LP,SV,VS), 473  
 Grocery Store Words (AD,LS,TT), 608  
 Gus! Multimedia Speech System (CI,EA,KM,TI), 133  
 HAL (Home Automation Link) (EC,PC,TI), 392  
 Half-QWERTY One-handed Keyboard Software (KM), 342  
 HandiCHAT and HandiCHAT Deluxe (SV,VS), 473  
 HandiCODE and HandiCODE Deluxe (SV,TI), 393  
 HandiKEY and HandiKEY Deluxe (KM), 342  
 HandiSHIFT (KM), 343  
 HandiWORD and HandiWORD International (KM,TA), 343  
 Handy Speech Communication Aide (CI,EA,SS), 134  
 HeadMaster Plus (MT,TI), 393  
 HeadMouse (DR,MT,TI), 394  
 Help U Key (TI), 394  
 Help U Keyboard (TI), 395  
 Help U Type (KM,TA), 344  
 Help U Type and Speak (CI,EA,KM), 135  
 Hereward Tracker Ball & Joystick Module (MT,TI), 395  
 Hierarchical Attention Training (CR,LS,TT), 608  
 HomeAccess (EC,PA), 283  
 Homographs (CR,LS,TT), 609  
 Homophones (CR,LS,TT), 609  
 I Can Speak (CI,EA), 136  
 IBM Screen Reader/2 (SV,VS), 474  
 IBM Screen Reader/DOS (SV,VS), 474  
 IBM-VBII (BR,PA), 753  
 Icontroller (MT,TI), 396  
 Improving Your Self-Concept (TT), 611  
 IN-CUBE Voice Command for Windows, NT (RS,TI), 397  
 Inferential Naming for Cognitive and Language Disorders (CR,LS,LT,TT), 611  
 Inferential Naming Plus for Windows (CR,TT), 612  
 Information Signs (AD,LS,LT,TT), 612  
 Initial Phoneme Cuing for Aphasics (CR,TT), 613  
 INKA (BT), 513  
 Input Adapter (IA), 456  
 Instant Access (TI), 397  
 IntelliKeys (TI), 398  
 IntelliTalk (CI,EA,PA), 137  
 IntroVoice V (TI), 398  
 IntroVoice VI (SS,TI), 399  
 JAWS for Windows (SV,VS), 475  
 JAWS Screenreader (SV,VS), 476  
 JDN Shorthand (5073) (KM,TA), 346  
 Job Readiness Series (AS,TT,VO), 614  
 Job Seeking Series (LS,TT,VO), 615

## Index 4: Products Listed by COMPUTER

- Job Success Series (TT,VO). 615  
Jouse (MT,TI). 400  
Joystick to Mouse Driver (MT,TI). 400  
Joystick Trainer (TR,TT). 616  
Judy Lynn PC Adapter (IA). 457  
JustVoice (TI). 401  
K-U-1 (MT,TI). 401  
KeyAbility (KM). 346  
Keyboard Expander (IA). 458  
Keyboard Interfaces (IA,KE). 458  
Keyboarding by Ability (ED,KB,TT). 617  
Keyboarding for Individual Achievement (ED,KB,TT). 617  
Keyboarding for People with Cerebral Palsy (ED,KB,TT). 618  
Keyboarding with One Hand (ED,KB,TT). 619  
Keycache (KM,TA). 348  
KeyGuard (KG,KM). 349  
Keyguard (KG,KM). 349  
Keynote GOLD (SS). 532  
Keyport 176 (TI). 403  
Keyport 300 (TI). 404  
Keyport 60 (TI). 404  
KeyREP (KM,TA). 351  
Keysoft (CN,PA,SV,WP). 754  
KeyStopper (KM). 352  
Keyterm (PA,SV,TL). 754  
KeyWiz (KM,TA). 352  
Kinesis Ergonomic Keyboard (RS,TI). 405  
King Keyboard (2440) (TI). 405  
KTS Braille Display (BR,BT). 514  
Kurzweil VOICE (TI). 406  
Kurzweil VOICE for Windows (TI). 406  
Large Print Word Processors (LP,PA,WP). 755  
Large-Type Display Utility Software (LP,MG). 497  
Laser Optic Keyboard (CI,TI). 407  
Learning Activity Packets (LAPs) (CN,LS,TT,VO). 621  
Learning How to Learn Series (LS,TT). 621  
Learning to Count (CN,TT). 622  
Lens 2.03 (MG). 497  
Less, More, Make Equal (CN,CR,TT). 623  
Let's Go to the Circus (LT,TT). 624  
LIAISON (EC,KE,PC,TI). 407  
Liberator (CI,CN,EA,EC,PW,TI). 137  
LightBoard (TI). 408  
Listen for Windows (ID,TI). 409  
Lite Talk (SS). 532  
Logi (CR,TT). 627  
LP-DOS & LP-Windows (LP,MG). 498  
MacroMaster/pro (KM,TI). 411  
Magic (CR,TT). 628  
MAGic and MAGic Deluxe (LP,MG). 498  
Magic Fingers (KM,TA). 354  
Magic Wand Keyboard with McKey Mouse Option (TI). 412  
Magnum Deluxe (MG). 499  
Magnum GT (LP,MG). 499  
Maltron Keyboard (TI). 412  
Mastering Personal Information (MPI) (AD,CR,TT). 629  
MasterTOUCH (BT,SV). 515  
Math Max (CN,CR,GA,TT). 630  
Medical Words (AD,LS,TT). 631  
MegaDots (BR,LP,PA). 757  
Memory for Animated Sequences Plus for Windows (CR,TT). 632  
Memory I (CR,ES,LS,TT). 632  
Memory II (CR,ES,LS,TT). 633  
Messenger-1C (SS,SV). 533  
Meta4 (CI,EA). 143  
MIC300i Computer Modem (PC,TD,TL). 184  
MICE (MT,TI). 413  
Micro Guide to Careers Series (TT,VO). 633  
Micro IntroVoice (SS,TI). 413  
Micro IntroVoice II (SS,TI). 414  
Micro-LADS and Micro-LADS in French (LT,TT). 634  
MicroBraille 2 (BR,PA,WP). 758  
Microsoft Natural Keyboard (RS,TI). 414  
Microsoft Windows Sound System (TI). 415  
MIKE (Mouse Interface & Keyboard Emulation) (MT,TI). 415  
Mind Castle I and II (GA,LS,TT). 635  
Mini Keyboard (2443 or 2450) (TI). 416  
Mini Transport II (SS). 533  
Mini-Keyboards (TI). 416  
Minimal Contrast Stories Plus for Windows (ST,TT). 635  
Minimal Motion Computer Access System (TI). 417  
Minspeak Application Programs (MAP) (CI,PA). 759  
Morse Code WSKE II (TI). 418  
Morsek Version 1.1 (TI). 418  
Mountbatten Braille (BR,BT,PW). 516  
Mouse Keys (TI). 419  
Mouse-Trak (MT,TI). 419  
MouseMan Cordless (MT,TI). 420  
MouseMover - PC Windows (5004) (MT,TI). 421  
MousePen (MT,TI). 421  
Multi-SCAN (GA,TR,TT). 639  
Multiple Meaning Words I Plus for Windows (LT,TT). 639  
Multiple Meaning Words II Plus for Windows (LT,TT). 640  
My First Keyboard (TI). 423  
MY HOUSE: Language Activities of Daily Living (LS,LT,TT). 641  
My Paint & Talking Coloring Books (DR,ES,LT,TT). 642  
MY SCHOOL: Language Activities of Daily Living (LS,TT). 642  
MY TOWN: Language Activities of Daily Living (LS,LT,TT). 643  
My-T-Mouse (KE,TI). 424  
Myna (BR,PW,SV,VS). 478  
NAMES (BR,PA). 760  
Nasometer Model 6200-3 (AS,ST,TT). 643  
NeuroPage (AD,CM,CR). 320  
NexCom 300vi & 300ve (TD). 185  
NOHOLD (KM). 356  
NOMAD Talking Touch Pad & NOMAD Gold (BT,SV). 516  
NoMouse (MT,TI). 426  
Noteworthy (PA,WP). 760  
Notex 486 (BR,BT). 517  
Numeric Concepts I and II (LS,TT). 644  
Octobus (CN,CR,LS,TT). 645  
OfficeTALK for Windows (TI). 426  
Ohtsuki BT-5000 Braille/Print Printer (BR,BT). 517  
OmniKey Keyboards (KM). 357  
On the Job Series - Career Interests (TT,VO). 646  
On the Job Series - Communication Skills (TT,VO). 647  
On the Job Series - Mathematics (CN,TT,VO). 647  
On the Job Series - Problem Solving Skills (TT,VO). 648  
One Access (IA,TI). 427  
One-Hand Keyboard Package (KM). 358  
OneStrk (TI). 428  
Open Book Unbound (VS). 479  
Opening Windows (KB,TT). 649  
Opposites and Similarities Plus for Windows (CR,TT). 649  
Optimouse (MT,TI). 428  
Order Processing (TT,VO). 650  
outSPOKEN for Windows (SV,VS). 480  
PAL (KM,TA). 358  
Panorama (LP,MG). 500  
Paragon Braille Printer (BR,BT). 518  
PC Braille (BR,PA). 761  
PC Typer (KB,TT). 652  
PC-TRAC (MT,TI). 429  
PCMaster & Windows Master (BR,IA,SV,VS). 460  
PECK Computer Software (KA). 359  
Pen Style Mouse (MT,TI). 430  
Personal Development Software Series (LS,TT). 652  
Phone Manager (EC,PA,PC). 288  
Phone-TTY CM-4 Computer Modem (CI,PC,TD,TL). 187  
PhoneAccess (EC,PC). 289  
Pick 'n Stick on Disk (NA). 99  
Picture Braille (BR,PA). 761  
Picture Identification Plus for Windows (CR,TT). 654  
Picture Naming Plus for Windows (CR,TT). 655  
Picture Perfect (DR,PA,RE). 762  
Picture Scanner (TR,TT). 655  
Picture/Theme Disks (TR,TT). 656  
Pictures Programs: I, II and III (CR,ES,LS,TT). 656  
PKD 84 and 101 (TI). 430  
PortaPoint (MT,TI). 431

- Positron Express (CI,TD,TL), 188  
 Powerama (LP,MG), 501  
 PowerKey Software for IBM (TI), 431  
 PowerPad (DR,RE,TI), 432  
 PowerPad Starter Kit (TI), 432  
 PowerSwitch (IA), 461  
 PRD+ (Productivity Plus) Basic Edition (KM,TA), 360  
 Prefix (CN,CR,TT), 659  
 Prefix (KM), 360  
 Problem Solving I (CR,TT), 661  
 ProKey (KM,TA), 361  
 ProPoint (MT,TI), 434  
 Proportional Keystroke Scanner (TI), 434  
 Protalk23 for Windows (SV,VS), 480  
 PROVOX (SV,VS), 481  
 PROXi (EC,PC), 290  
 Race the Clock (GA,RE,TT), 662  
 RAPIDTEXT (PA), 763  
 Reading a Ruler - English & Metric (CN,TT,VO), 664  
 Reading AdvantEdge (VS), 481  
 Reading Comprehension for Adolescents (CR,TT), 664  
 Reading Horizons (ED,ES), 725  
 RemotePoint (MT,TI), 436  
 Rhyming Pictures (CR,TT), 665  
 Safety Signs (AD,LS,LT,TT), 667  
 Scanning WSKE II (TI), 437  
 ScanTELL (VS), 482  
 ScottBridge Speech Access System (TI), 438  
 Screen Magnifier/2 (LP,MG), 501  
 ScreenPower (SV,VS), 482  
 ScreenPower for Windows (SV,VS), 483  
 SeeBEEP (PA), 764  
 Seekline (SV,VS), 483  
 Select-Ease Keyboard (RS,TI), 439  
 Semantic Development Using Code Breaking Strategies (LS,LT,TT), 670  
 Sentence Master (LS,TT), 671  
 Serial Trackball and PS/2 Trackball (MT,TI), 439  
 SIDD (Software Interface for the Deaf and Disabled) (CI,TD,TL), 189  
 Simple Sentence Structure (ES,LT,TT), 673  
 Slimware (SV,VS), 484  
 Slimware Window Bridge (SV,VS), 484  
 SmarTalk (SS), 534  
 SofType (TA,TI), 440  
 Sorting by Category Plus for Windows (CR,TT), 676  
 Sounding Board (SS), 535  
 Speak Out VOILA (LP,MG,SV,TI,VS), 440  
 Speak-Out (SS), 535  
 Speaqualizer Speech Access System (SV,VS), 485  
 SpeechViewer II (ST,TT), 678  
 Spell-A-Word & 2+2 (CN,ED,LS), 727  
 SS-ACCESS! (IA), 462  
 Step On It! Computer Control Pedals (KM), 363  
 Steps for Career Choice (TT,VO), 678  
 Sticky (KM), 364  
 Studio4 (CR,TT), 680  
 Subtle Messages (SI,TT), 680  
 Survival Words (AD,AS,LS,LT,TT), 681  
 Switch Art (ES,TT), 683  
 Switch-Adapted Mouse (SAM) (MT,TI), 442  
 SwitchMouse (MT,TI), 443  
 Synergy Integrated Remote (EC,PA), 298  
 SynergyMac and SynergyPC (CI,PH,TI), 444  
 SynPhonix 210 and 215 (IA,SS), 536  
 SynPhonix P27 (SS), 537  
 Talk-to-Me Tutorial Cassettes, 551  
 Talking Data Acquisition System Software (PA), 765  
 Talking Nouns, Talking Nouns II, and Talking Verbs (CI,TR,TT), 686  
 Talking Screen (CI,EA,PA), 156  
 Talking Screen for Windows (CI,EA,PA), 157  
 TalkTime with Tucker (ST,TT), 688  
 TEAM (EC,PA), 299  
 Teenage Switch Progressions (TT), 689  
 Telling Time (AD,CR,TT), 689  
 Tempo for Windows (KM,TA), 365  
 TextGrabber (PA), 768  
 THINKable/DOS (CR,TT), 690  
 TINYtalk (SV,VS), 486  
 TouchWindow (DR,DS,ID,RE,TI,WP), 444  
 Trace Math Aid (CN,ED,PA), 769  
 TrackMan Live! (MT,TI), 445  
 TrackMan Voyager (MT,TI), 446  
 Traffic Signs Plus for Windows (AD,TT), 694  
 Trak101 Keyboard (MT,RS,TI), 446  
 TranSend System (BR,BT), 522  
 Transportation Signs (AD,LS,LT,TT), 694  
 TurboBraille (BR,PA), 769  
 Turn-Talking (CI,TR,TT), 695  
 Twenty Categories (LS,LT,TT), 696  
 U-Control (EC), 302  
 Understanding Attributes (CR,TT), 697  
 Uni-Key (KM), 367  
 Vantage CCD (LP,MG), 502  
 VCS 3500 with TDD Software (CI,TD,TL), 196  
 Verb Fill-Ins (CR,TT), 698  
 Verbal Analogies (LS,LT,TT), 698  
 Verbal Analogies Plus for Windows (LT,TT), 699  
 Vertical (RS,TI), 448  
 Video Voice Speech Training System (ST,TT), 699  
 VisAbility (LP,PA), 771  
 Visi-Pitch Model 3300 (ST,TT), 700  
 VisionKey (EA,TI), 158  
 Vista (LP,MG), 502  
 Visual Confrontation Naming Plus for Windows (CR,TT), 700  
 Visual Memory Plus for Windows (CR,TT), 701  
 Visual Motor Skills (ES,TT), 701  
 Visual Pattern Memory Plus for Windows (CR,TT), 702  
 Visuospatial Skills I (CR,TT), 702  
 Visuospatial Skills II (CR,TT), 703  
 Vocal-Eyes (SV,VS), 487  
 Voice Mouse/Keyboard (VMK) Controller (TI), 448  
 Voice User (RS,TI), 449  
 VoiceCard (SS), 538  
 Vortex Machine Assisted Reader Software (LS,TT), 703  
 VT520 Terminals - Accessibility Features (KM), 367  
 Wheels On The Bus I, II, III (ES,TR,TT), 704  
 Win Vision (SV,VS), 488  
 WinDOTS (BR,PA), 771  
 Window-Eyes (SV,VS), 488  
 WinKing Keyboard (2448F, 2448Q) (TI), 449  
 WINKLiNE (SV,VS), 489  
 WinMini Keyboard (2447F, 2447Q) (MT,TI), 450  
 WinSCAN: Limited Edition (IA), 464  
 WinTalk (CI,TD,TL), 196  
 Wish Writer (PA,WP), 772  
 WiViK 2.0 (Windows Visual Keyboard) (TA,TI), 450  
 WiVox (PA,WP), 772  
 Word Association Plus for Windows (CR,TT), 706  
 Word Order in Sentences (LS,LT,TT), 706  
 Word Order Plus for Windows (LT,TT), 707  
 Words and Concepts I, II, III (LS,LT,TT), 707  
 WordScholar (SV,VS), 489  
 WriteAway (PA,TA,WP), 774  
 WSCC (Washington State Cooperative Curriculum) (LS,TT), 709  
 X-10 Home Control Interface (EC), 306  
 Zero to Five (ED,LS), 734  
 ZoomCaps (KM), 369  
 ZoomText 5 (LP,MG), 503

### IBM PC jr

This list includes only products which specifically work with the IBM PC jr. Products which also work with other IBM PCs will appear here and under "IBM PC Family."

- Captain's Log: Cognitive Training System (AS,CR,ES,LS,TT), 568  
 COINSNKEYS (CN,ES,KB,TT), 577  
 Muppet Learning Keys (GA,ID,TI), 423

## Index 4: Products Listed by COMPUTER

Numeric Concepts I and II (LS,TT). 644  
Picture Perfect (DR,PA,RE). 762  
Race the Clock (GA,RE,TT). 662

### IBM PS/2 Family

*This list includes products which work with all of the IBM Personal System/2 computers. It also includes any products for which the manufacturer has not provided model-compatibility information. Products which only work with specific models are listed under those models.*

1-Key (KM). 331  
AbleOffice, 541  
Accent-MC (SS). 525  
Access Pack for Microsoft Windows (IA,KM,MT,TI). 331  
AccessDOS (LA,KM,MT,TI). 332  
ALVA Braille Terminals (BR,BT). 507  
Artic TransPort (SS,SV). 526  
BallPoint Mouse (MT,TI). 377  
BookWise (VS). 468  
Braille-Talk (BR,PA,SV). 742  
BRAILLEX-2D (BR,BT). 509  
Breakthru Box (TI). 379  
Breath Input Device, 207  
Captain's Log: Cognitive Training System (AS,CR,ES,LS,TT). 568  
Cirque GlidePoint Trackpads (MT,TI). 380  
Community Signs (AD,LS,LT,TT). 580  
CompuDesk HCP, 543  
DARCI TOO (TI). 382  
DOS Tape, 545  
Dvorak Computer Keyboard (KM). 337  
Echo PCII (SS). 530  
Echo-PC (SS). 531  
Employment Signs (AD,LS,LT,TT). 594  
ErgoLogic Model 7.1 Keyboard (RS,TI). 384  
Expanded Keyboard for IBM Computers (KG,TI). 385  
Expanded Numeric Keypads (TI). 386  
Expert Mouse (MT,TI). 387  
ezScan (TI). 388  
FastTRAP (MT,TI). 389  
Filch (KM). 341  
Finish Line (PA,TA). 751  
First Categories (ES,LS,LT,TT). 599  
FormMate (PA). 751  
GEWA FTB 108 Enlarged Keyboard (TI). 391  
GEWA METB 121 Reduced Size Keyboard (TI). 391  
Gizmo (LP,SV,VS). 473  
HandiCHAT and HandiCHAT Deluxe (SV,VS). 473  
HandiCODE and HandiCODE Deluxe (SV,TI). 393  
HandiKEY and HandiKEY Deluxe (KM). 342  
HandiSHIFT (KM). 343  
HandiWORD and HandiWORD International (KM,TA). 343  
HeadMaster Plus (MT,TI). 393  
HeadMouse (DR,MT,TI). 394  
Help U Key (TI). 394  
Help U Keyboard (TI). 395  
Help U Type (KM,TA). 344  
Help U Type and Speak (CI,EA,KM). 135  
Hereward Tracker Ball & Joystick Module (MT,TI). 395  
IBM Screen Reader/2 (SV,VS). 474  
Iconroller (MT,TI). 396  
Information Signs (AD,LS,LT,TT). 612  
IntelliKeys (TI). 398  
IRIS Reading Interface 3.0 (SV,TI). 399  
JAWS Screenreader (SV,VS). 476  
Judy Lynn PC Adapter (IA). 457  
Keycache (KM,TA). 348  
Keyguard (KG,KM). 349  
Keysoft (CN,PA,SV,WP). 754  
Keyterm (PA,SV,TL). 754  
King Keyboard (2440) (TI). 405  
Large-Type Display Utility Software (LP,MG). 497  
Liberator (CI,CN,EA,EC,PW,TI). 137

MacroMaster/pro (KM,TI). 411  
Magic Wand Keyboard with McKey Mouse Option (TI). 412  
Magnum GT (LP,MG). 499  
Maltron Keyboard (TI). 412  
MIC300i Computer Modem (PC,TD,TL). 184  
Mini Keyboard (2443 or 2450) (TI). 416  
Mini-Keyboards (TI). 416  
MiniErgo-MF2 (KM,RS,TI). 417  
Minspeak Application Programs (MAI<sup>®</sup>) (CI,PA). 759  
Mouse-Trak (MT,TI). 419  
MousePen (MT,TI). 421  
Muppet Learning Keys (GA,ID,TI). 423  
MyKey (MT,RS,TI). 424  
NeuroPage (AD,CM,CR). 320  
Numeric Concepts I and II (LS,TT). 644  
Panorama (LP,MG). 500  
PC-TRAC (MT,TI). 429  
PKD 84 and 101 (TI). 430  
Powerama (LP,MG). 501  
ProPoint (MT,TI). 434  
Safety Signs (AD,LS,LT,TT). 667  
SeeBEEP (PA). 764  
Serial Trackball and PS/2 Trackball (MT,TI). 439  
Step On It! Computer Control Pedals (KM). 363  
Survival Words (AD,AS,LS,LT,TT). 681  
SwitchMouse (MT,TI). 443  
SynPhonix 310 and 315 (SS). 536  
T-TAM Keyboard and Mouse Emulator (EA,IA,KM,MT,TI). 463  
Talking Nouns, Talking Nouns II, and Talking Verbs (CI,TR,TT). 686  
Trackball Pro (MT,TI). 445  
Transportation Signs (AD,LS,LT,TT). 694  
Vocal-Eyes (SV,VS). 487  
WiViK 2.0 (Windows Visual Keyboard) (TA,TI). 450  
Words and Concepts I, II, III (LS,LT,TT). 707  
ZoomText 5 (LP,MG). 503

### IBM PS/2 Models 25/30

*This list includes products which work with the IBM PS/2 Model 25 and/or Model 30. If a product works with all of the PS/2 models, it would not be listed here, but would appear under "IBM PS/2 Family." If it works with the Model 25 or 30, and also with certain other models, it would appear here and under those other models.*

Core Reading and Vocabulary Development (ED,LS,LT,TT). 583  
Infovox 500, 700 & 750 (SS). 531  
Keyboard Expander (IA). 458  
Proportional Keystroke Scanner (TI). 434  
Slimware (SV,VS). 484  
Sounding Board (SS). 535  
Spequalizer Speech Access System (SV,VS). 485  
SynPhonix 210 and 215 (IA,SS). 536

### IBM PS/2 Models 50/60

*This list includes products which work with the IBM PS/2 Model 50 and/or Model 60. If a product works with all of the PS/2 models, it would not be listed here, but would appear under "IBM PS/2 Family." If it works with the Model 50 or 60, and also with certain other models, it would appear here and under those other models.*

OsCaR (TI). 429  
Proportional Keystroke Scanner (TI). 434



**IBM PS/2 Models 70/80**

*This list includes products which work with the IBM PS/2 Model 70 and/or Model 80. If a product works with all of the PS/2 models, it would not be listed here, but would appear under "IBM PS/2 Family." If it works with the Model 70 or 80, and also with certain other models, it would appear here and under those other models.*

OsCaR (TI), 429

**ITT**

*This list includes products which have been specifically described by their manufacturers as working with ITT computers.*

HandiCHAT and HandiCHAT Deluxe (SV,VS), 473  
HandiCODE and HandiCODE Deluxe (SV,TI), 393  
HandiKEY and HandiKEY Deluxe (KM), 342  
HandiSHIFT (KM), 343  
HandiWORD and HandiWORD International (KM,TA), 343  
SeeBEEP (PA), 764

**NEC (some or all models)**

*This list includes only products which are designed specifically to work with particular models of NEC computers. Software and hardware designed to work with any MS-DOS computer will be listed under "IBM-PC Family."*

Filch (KM), 341  
HandiCHAT and HandiCHAT Deluxe (SV,VS), 473  
HandiCODE and HandiCODE Deluxe (SV,TI), 393  
HandiKEY and HandiKEY Deluxe (KM), 342  
HandiSHIFT (KM), 343  
HandiWORD and HandiWORD International (KM,TA), 343  
SeeBEEP (PA), 764

**Nintendo**

*This list includes devices which are specifically capable of controlling Nintendo games.*

Nintendo & Super Nintendo Joystick Module (RE,TI), 425  
PlayMAGIC (IA), 460

**Sun Microsystems SPARCstation**

Hereward Tracker Ball & Joystick Module (MT,TI), 395  
IN-CUBE Voice Command for SPARC Stations (TI), 396  
Kinesis Ergonomic Keyboard (RS,TI), 405  
Mouse-Trak (MT,TI), 419  
Trackball Pro (MT,TI), 445

**Tandy 1000**

*This list includes only products which are designed specifically to work with the Tandy 1000 computer. Software and hardware designed to work with any MS-DOS computer will be listed under "IBM-PC Family."*

HandiCHAT and HandiCHAT Deluxe (SV,VS), 473  
HandiCODE and HandiCODE Deluxe (SV,TI), 393  
HandiKEY and HandiKEY Deluxe (KM), 342  
HandiSHIFT (KM), 343  
HandiWORD and HandiWORD International (KM,TA), 343  
SeeBEEP (PA), 764

**Texas Instruments TI 99/4A**

*This list includes products which are specifically designed to work with the Texas Instruments TI 99/4A computer.*

Audible Cursor Routine (CI,EA,PA,TR), 121  
Communication Programs (CI,EA,EC,TR), 124  
Custom Keyguard (KG,KM), 336  
Geometric Figures and Spatial Concepts (ED,ES), 720  
Keyboarding Program with Voice Output (KB,TT), 618  
Learning the Alphabet (ED,ES), 722  
Program for Aphasics (CR,ED,LS), 724  
Telling Time, Parts of the Face, Learning Colors (ES,TT), 690

**Toshiba Laptops**

*This list includes only products specifically designed to work with particular models of Toshiba laptop computers. Software and hardware designed to work with any MS-DOS computer will be listed under "IBM-PC Family."*

AudScan II (CI,EA), 121  
Filch (KM), 341  
HandiCHAT and HandiCHAT Deluxe (SV,VS), 473  
HandiCODE and HandiCODE Deluxe (SV,TI), 393  
HandiKEY and HandiKEY Deluxe (KM), 342  
HandiSHIFT (KM), 343  
HandiWORD and HandiWORD International (KM,TA), 343  
Keynote GOLD (SS), 532  
PC-TRAC (MT,TI), 429  
SeeBEEP (PA), 764  
Slimware (SV,VS), 484  
Sounding Board (SS), 535  
SoundProof (SV,VS), 485

**TRS-80 Color Computer**

*This list includes products which specifically work with the TRS-80 Color Computer. If a product works with other specific TRS-80 models, it will be listed under those other models as well. If it works with ALL TRS-80 models, it will be listed under "TRS-80 Family," and not here.*

H:1 Handicapped Word Games (ED,GA,LS,PA,RE), 752  
H:2 Handicapped Arithmetic Flash Cards (CN,ED,LS,RE), 721

**TRS-80 Model 100**

*This list includes products which specifically work with the TRS-80 Model 100. If a product works with other specific models, it will be listed under those other models as well. If it works with ALL TRS-80 computers, it will be listed under "TRS-80 Family," and not here.*

HandiCHAT and HandiCHAT Deluxe (SV,VS), 473  
HandiCODE and HandiCODE Deluxe (SV,TI), 393  
HandiKEY and HandiKEY Deluxe (KM), 342  
HandiSHIFT (KM), 343  
HandiWORD and HandiWORD International (KM,TA), 343  
SeeBEEP (PA), 764

**TRS-80 Model 200**

*This list includes products which specifically work with the TRS-80 Model 200. If a product works with other specific models, it will be listed under those other models as well. If it works with ALL TRS-80 models, it will be listed under "TRS-80 Family," and not here.*

HandiCHAT and HandiCHAT Deluxe (SV,VS), 473  
HandiCODE and HandiCODE Deluxe (SV,TI), 393  
HandiKEY and HandiKEY Deluxe (KM), 342

## Index 4: Products Listed by COMPUTER

---

HandiSHIFT (KM), 343  
HandiWORD and HandiWORD International (KMTA), 343  
SeeBEEP (PA), 764

### TRS-80 Model I

*This list includes products which specifically work with the TRS-80 Model I. If a product works with other specific TRS-80 models, it will be listed under those other models as well. If it works with ALL TRS-80 models, it will be listed under "TRS-80 Family," and not here.*

Cogrehab Vol. 2 (CR,LS,TT), 574  
Cogrehab Vol. 3 Version 2.0 (CR,LS,TT), 575

### TRS-80 Model II

*This list includes products which specifically work with the TRS-80 Model II. If a product works with other specific TRS-80 models, it will be listed under those other models as well. If it works with ALL TRS-80 models, it will be listed under "TRS-80 Family," and not here.*

Drive to Live (ED,LS), 716

### TRS-80 Model III

*This list includes products which specifically work with the TRS-80 Model III. If a product works with other specific TRS-80 models, it will be listed under those other models as well. If it works with ALL TRS-80 models, it will be listed under "TRS-80 Family," and not here.*

Cogrehab Vol. 2 (CR,LS,TT), 574  
Cogrehab Vol. 3 Version 2.0 (CR,LS,TT), 575  
Core Reading and Vocabulary Development (ED,LS,LT,TT), 583

### TRS-80 Model IV

*This list includes products which specifically work with the TRS-80 Model IV. If a product works with other specific TRS-80 models, it will be listed under those other models as well. If it works with ALL TRS-80 models, it would be listed under "TRS-80 Family," and not here.*

Cogrehab Vol. 2 (CR,LS,TT), 574  
Cogrehab Vol. 3 Version 2.0 (CR,LS,TT), 575  
Core Reading and Vocabulary Development (ED,LS,LT,TT), 583

930

## **Index 5**

# **Manufacturers Listed with their Products**

This index includes the name, address, phone and a list of products for every manufacturer in the ResourceBook. Manufacturers are listed alphabetically. The page location for each of the manufacturer's products follows the product name. The index provides the necessary contact information on the manufacturers, and also allows you to locate a product description when all you know is the name of a manufacturer.

## Index 5: MANUFACTURERS Listed with their Products

**A4 Tech (USA) Corporation**  
20254-56 Paseo Robles, Walnut, CA 91789  
(909) 468-0071  
FAX (909) 468-2231  
Cordless WinMouse, 381  
First-Finger WinTrack, 390  
Pen Style Mouse, 430

**Abacus**  
5370 52nd Street, SE, Grand Rapids, MI 49512  
(616) 698-0330  
(800) 451-4319  
FAX (616) 698-0325  
NoMouse, 426

**AbiliTech Inc.**  
P.O. Box 635, Thief River Falls, MN 56701  
(218) 681-5766  
FAX (218) 681-6405  
AbiliTech Commander IR, 263  
AbiliTech Commander X-10, 264  
AbiliTech Communicator, 264  
AbiliTech Home Control System, 265

**Ability Center of Greater Toledo**  
Rehabilitation Technology Department, 5605  
Monroe Street, Sylvania, OH 43560  
(419) 885-5733  
TT/TDD (419) 885-5733  
FAX (419) 882-4813  
Roll & Slide Keyboard Wrist  
Support, 362

**Ability Research, Inc.**  
P.O. Box 1721, Minnetonka, MN 55345  
(612) 939-0121  
FAX (612) 890-8393  
ActionVoice, 118  
LightBeam, 23  
LightBoard, 408  
LightSwitch, 229

**Ability Systems Corporation**  
1422 Arnold Avenue, Roslyn, PA 19001  
(215) 657-4338  
Proportional Keystroke Scanner, 434

**AbleNet, Inc.**  
1081 10th Avenue S.E., Minneapolis, MN 55414  
(800) 322-0956  
(612) 379-0956  
FAX (612) 379-9143  
Battery Device Adapter, 32  
Big Red, Yellow, Green, and Blue, 206  
BIGmack, 122  
Computer Switch Interface, 455  
Internal I/O Port Adapter, 457  
Jelly Bean, 274  
PigTail Adapters, 50  
PowerLink 2, 290  
Series Adapter, 54  
Slide Projector Control, 55  
Slim Armstrong, 172  
SpeakEasy, 152  
Specs Switch, 248  
String Switch, 250  
Switch Latch and Timer, 57  
Universal Switch Mounting System, 175

**Academic Software, Inc.**  
331 West Second Street, Lexington, KY 40507  
(606) 233-2332  
(800) 842-2357  
FAX (606) 231-0725  
asiwel@aol.com  
Analog Switch Pad, 204  
Dino-Games, 588  
Multi-SCAN, 639  
Picture Icon X-CHANGE, 146  
SS-ACCESS!, 462  
Universal Adaptive Switch System, 256  
WinSCAN: Limited Edition, 464

**Access Systems International, LTD**  
415 English Avenue, Monterey, CA 93940  
(408) 375-5313  
BrailleAccess, 509  
Index Basic, 512  
Index Basic-D, 512  
Index Everest-D, 513

**Access Technology**  
1435 N. Meridian, Indianapolis, IN 46202  
(317) 686-6093  
FAX (317) 686-6094  
SoftType, 440

**Access to Recreation, Inc.**  
2509 East Thousand Oaks Boulevard, Suite 430, Thousand Oaks, CA 91362  
(800) 634-4351  
FAX (805) 498-8186  
Personal Pager, 322  
Slip-On Typing Aid, 25

**Access Unlimited**  
3535 Briarpark Drive #102, Houston, TX 77042  
(713) 781-7441  
(800) 848-0311  
FAX (713) 781-3550  
Audio Braille Game Tutorial, 560  
Sharon's Programs, 726  
Spell-Talk, 728  
Spelling Tutor, 728  
Spin and Spell, 729  
Study Buddy, 730

**Acrontech International, Inc.**  
Williamsville Executive Center, 5500 Main Street, Williamsville, NY 14221  
(716) 854-3814  
Comtel, 544

**ACS Communications**  
250 Technology Circle, Scotts Valley, CA 95066  
(800) 995-5500  
ACS Headsets, 267

**ACS Technologies, Inc.**  
1400 Lee Road, Coraopolis, PA 15108  
(800) 227-2922  
Controller, 272  
DAC, 126  
EvalPAC with RealVoice, 131  
HX-20 Protective Cover, 345  
Light Pointer, 22  
On/Off Adaptor Switch, 357

Quick 'n Easy 2, 172  
RealVoice, 147  
Reinforced Keyguard, 362  
ScanPAC, 150  
Twinkle Switch, 255

**AdapTek Interface**  
4832 E. Mercer Way, Mercer Island, WA 98040  
(206) 230-0076  
FAX (206) 230-0076  
ad.p2u@eskimo.com  
W.W.  
<http://www.eskimo.com/~jlubin/adaptek>  
Adap2U, 373

**Adaptation, Inc.**  
ISU Research Park, 2501 North Loop Drive, Ames, IA 50010  
(515) 296-7171  
(800) 723-2783  
FAX (515) 296-9910  
adaptaac@aol.com  
FreeSwitch, 279  
LinkSwitch, 47  
Personal Pager, 323  
Taction Pads, 251  
Vibration Switch, 257  
VoicePal 160  
VoicePal Plus, 160

**Advanced Gravis Computer Technology Ltd.**  
111-7400 MacPherson Avenue, Burnaby, BC V5J 5B6 CANADA  
(604) 431-5020  
(800) 663-8558  
FAX (604) 431-5155  
MouseStick II, 422

**Advanced Input Devices**  
W. 250 A.I.D. Drive, Coeur d'Alene, ID 83814  
(208) 765-8000  
(800) 444-5923  
FAX (208) 772-7613  
PKD 84 and 101, 430

**Advanced Peripheral Technologies**  
14416 Erin Court, Lockport, IL 60441  
(708) 301-4508  
VX-5000 Cordless Phone, 305

**Affinity Micro Systems, LTD**  
934 Pearl Street, Suite H, Boulder, CO 80302  
(800) 367-6771  
(303) 442-4840  
affinity@henge1.hcnge.com  
Tempo for Windows, 300  
Tempo II Plus, 365  
TempoEZ, 366

**AI Squared**  
P.O. Box 669, Manchester Center, VT 05255-0669  
(802) 362-3612  
FAX (802) 362-1670  
VisAbility, 771  
ZoomText 5, 503

**Aicom Corporation**  
1590 Oakland Road, Suite B112, San Jose,  
CA 95131  
(408) 453-8251  
FAX (408) 453-8255  
Accent-MC, 525  
Accent-PC, 525  
Accent-SA, 526  
Messenger-IC, 533

**AJ Weiner/New England Computer Products**  
88 North Main Street, Randolph, MA 02368  
(800) 634-6692  
MA (617) 963-9313  
MacroMaster/pro, 411

**AllMed Inc.**  
297 High Street, Dedham, MA 02026  
(617) 329-2900  
(800) 225-2610  
Articulating Drawers, 332  
ASER Ergonomic Keyboard Layout, 333  
Keyboard Wrist Rest, 348  
Notebook Computer Wrist Rest, 356

**Altra**  
520 W. Cedar Street, Rawlins, WY 82301  
(307) 328-1342  
FAX (307) 328-1346  
Felix, 389

**American Printing House for the Blind (APH)**  
P.O. Box 6085, Louisville, KY 40206-0085  
(502) 895-2405  
(800) 223-1839

APH Presents the Talking Apple Computer, 558  
APH Scientific Calculator: for Apple II Computers, 737  
APH/SEI Talking Software, 713  
Apple IIGS Owner's Guide: Disk Edition, 542  
AppleWorks Manuals: Special Editions, 542  
Braille 'n Speak Classic, 469  
Brailled Keyboard Model--Apple IIe, 543  
Brailled Keyboard Overlay for the Apple IIGS, 334  
Echo II with Textalker & Echo II with Textalker-GS, 472  
Elementary Volume 1 - Mathematics, 718  
Food Facts, 603  
LetterTALK+, 625  
NOMAD Talking Touch Pad & NOMAD Gold, 516  
Opening Windows, 649  
PC Typer, 652  
Picture Braille, 761  
Portable Sound Source II, 51  
PreFixes, 723  
Sensible Speller: Talking APH Edition, 725  
Speaking Speller, 727  
Speaqualizer Speech Access System, 485  
Talking Literacy Kit for the Apple IIe (TALK IIe), 686  
Talking Typer, 687  
Talking Utilities for DOS 3.3, 766  
Talking Utilities for ProDOS, 551  
TEXTALKER, 521  
Textalker-GS, 486

**American Thermoform Corporation**  
2311 Travers Avenue, City of Commerce, CA 90040  
(213) 723-9021  
Braillo 200, 510  
Braillo 400 S, 510  
Braillo Comet, 511  
KTS Braille Display, 514  
Ohtsuki BT-5000 Braille/Print Printer, 517

**Ameriphone, Inc.**  
12082 Western Avenue, Garden Grove, CA 92641-2990  
(800) 874-3005  
TT/TDD (800) 772-2889  
Auto Call Single Number Dialer, 312  
Call Alert Model CA-100, 313  
Dialogue TTYs, 180  
Dialogue VCO Read & Talk Telephone, 181  
Remote Control Speakerphone Model RC3000, 292

**Amidon Publications**  
1966 Benson Ave., St. Paul, MN 55116  
(800) 328-6502  
(612) 690-2401  
FAX (612) 690-4009  
Computer CUP, 581

**Apple Computer, Inc.**  
Worldwide Disability Solutions Group, MS 38DS, 1 Infinite Loop, Cupertino, CA 95014  
(800) 600-7808  
TT/TDD (800) 755-0601  
applesdsg@eworld.com  
WWW: <http://www.apple.com/disability/>  
Apple Adjustable Keyboard, 376  
CloseView, 495  
Easy Access, 339

**Appoint**  
1332 Vendels Circle, Paso Robles, CA 93446  
(800) 448-1184  
(805) 239-8976  
MousePen, 421

**APT Technology, Inc.**  
8765 Township Road #513, Shreve, OH 44676  
(216) 567-2001  
Armslot Switch Controller ASC-5, 205  
Bed Control (DBC-1), 269  
Body Switch BS-1, 206  
DA-II Adapter, 456  
DEUCE, 273  
Dual Puff-Sip Switch DPS-2, 216  
Dual Tongue Switch TS-2C, 217  
EASICORDER, 274  
Infrared Remote Control IRTI-I, 284  
LIAISON, 407  
Scanning Remote Control (SRC), 294  
TVRC and TVRCS, 301

**Arkenstone, Inc.**  
1390 Borregas Avenue, Sunnyvale, CA 94089  
(800) 444-4443  
(408) 752-2200  
TT/TDD (800) 833-2753  
info@arkenstone.org  
Atlas Speaks, 737  
Open Book, 478  
Open Book Unbound, 479  
Strider, 764

**Artic Technologies**  
55 Park Street, Troy, MI 48083  
(810) 588-7370  
FAX (810) 588-2650

Artic TransBook, 467  
Artic TransPort, 526  
Artic TransType, 467  
Business Vision, 471  
Gizmo, 473  
Magnum Deluxe, 499  
Magnum GT, 499  
Mini Transport II, 533  
SynPhonix 210 and 215, 536  
SynPhonix 310 and 315, 536  
SynPhonix P27, 537  
Win Vision, 488

**Articulate Systems, Inc.**  
600 West Cummings Park, Suite 4500, Woburn, MA 01801  
(800) 443-7077  
FAX (617) 935-0490  
PowerSecretary, 433

**Artificial Language Laboratory**  
Michigan State University, 405 Computer Center, East Lansing, MI 48824-1042  
(517) 353-5399  
FAX (517) 353-4766

SCATIR Switch, 245  
TAS Switch, 252

**Artificial Speech Aids**  
2027 Read Street, #53, Omaha, NE 68112-3438  
(402) 453-6320

Tokyo Artificial Larynx, 11

**Asher Engineering Corporation**  
15115 Ramonna Blvd., Baldwin Park, CA 91706  
(818) 962-4063

QUADLynx Trackball, 435  
Turbo Trackball, 447

**AT & T Accessible Communication Products Center**  
5 Woodlawn Road, Parsippany, NJ 07054  
(800) 233-1222

Electronic Artificial Larynx, 5  
TDD 2700, 2730, and 2830, 192

**AT & T SourceBook**  
15 West 6th Street, Cincinnati, OH 45202  
(800) 451-2100

Handset for Speech Amplification, 6

**Index 5: MANUFACTURERS Listed with their Products**

**Atlantic Technologies, Inc.**  
6631 Amsterdam Way, Wilmington, NC  
28405  
(910) 350-0700  
FAX (910) 392-7093  
Atlantic 144 TTY, 179

**ATR/JWA, Inc.**  
P.O. Box 180, Fairfax Station, VA 22039  
(703) 715-6072  
FAX (703) 903-9142  
BRAILLEX-2D, 509  
Notex 486, 517  
WinDOTS, 771

**Attainment Company**  
P.O. Box 930160, Verona, WI 53593-0160  
(800) 327-4269  
FAX (800) 942-3865

Appointment Book, 70  
Attainment Communication  
Collection, 71  
Attainment Fifteen Talker, 119  
Attainment Five Talker & Talker  
Plus, 120  
Attainment Two Talker, 120  
Colorful Concept Software, 578  
Data Entry, 587  
Dollars & Cents Series, 589  
First Step Software, 600  
Illustrated Menu, 87  
Mealtime Stickers, 90  
Mini Picture Set, 91  
Order Processing, 650  
Picture Cue Dictionary, 654  
Picture Prompt Cards, 102  
Picture Prompt Stickers, 102  
Picture Prompt System, 103  
Pocket Book, 104  
Select-A-Meal and Shopping Smart, 107  
WordWise Language & Master  
Cards, 112  
WordWise Software, 708  
WordWise Sticker Set, 112

**Audio Computer Information, Inc.**  
P.O. Box 216, Spring Grove, MN 55974  
(507) 498-3279  
DOS Tape, 545

**Aurora Systems, Inc.**  
2647 Kingsway, Vancouver, BC V5R 5H4  
CANADA  
(604) 436-2694  
(800) 361-8255  
FAX (604) 436-2695  
aurora@cyberstore.ca  
Aurora 2.0 for DOS, 376  
Aurora for Windows, 333

**Automated Functions, Inc.**  
6424 N. 28th Street, Arlington, VA 22207  
(703) 536-7741  
SmarTalk, 534

**AVSI**  
17059 El Cajon Avenue, Yorba Linda, CA  
92686  
(714) 524-4488  
TT/TDD (714) 524-4488  
FAX (714) 996-1127  
72763.1307@compuserve.com  
WWW: <http://www.ausi.com>

Butler-in-a-Box, 270  
Mastervoice Environmental Control  
Single User Unit, 285

**Axis Corporation**  
555 Sparkman Drive, Suite 1618 G,  
Huntsville, AL 35816  
(205) 722-0922

Able2Speak, 117

**Ballert International, Inc.**  
P.O. Box 1447, Northbrook, IL 60065  
(800) 345-3456  
MICE, 413

**Berkeley Systems, Inc.**  
2095 Rose St., Berkeley, CA 94709  
(510) 540-5535 ext. 716  
TT/TDD (510) 540-0709  
FAX (510) 849-9426  
osw@berksys.com  
inLARGE 2.0, 496  
outSPOKEN 1.7, 479  
outSPOKEN for Windows, 480

**BEST, Inc.**  
Boston Educational Systems & Technology,  
63 Forest Street, Chestnut Hill, MA 02167  
(617) 277-0179  
FAX (617) 277-1275

BEST Faces, 562  
BEST Switch Interface, 453  
Colors and Shapes, 579

**Bilbo Innovations, Inc.**  
2701 University Avenue, Madison, WI  
53705  
(800) 203-0092  
(608) 233-6121  
sbb@bilbo.boy.com  
WWW: <http://www.txdirect.net/verbex/>  
Step On It! Computer Control Pedals, 363

**BloControl Systems, Inc.**  
2555 Park Boulevard, Palo Alto, CA 94306  
(415) 329-8494  
FAX (415) 329-8498  
biomuse@well.com

BioMuse, 378

**Biolink Computer Research and  
Development, LTD**  
Suite 105 - 140 West 15th Street, North  
Vancouver, BC V7M 1R6 CANADA  
(604) 984-4099  
BBS (604) 985-8431  
FAX (604) 985-8493

Protalk23 for Windows, 480

**Blazie Engineering**  
105 East Jarrettsville Road, Forest Hill, MD  
21050  
(410) 893-9333  
BBS (410) 893-8944  
FAX (410) 836-5040  
info@blazie.com  
WWW: <http://blazie.com/>

Braille 'n Speak, 469  
Braille Blazer, 507  
Braille Lite, 470  
Braille-Term Program, 742  
Checkbook Program, 744  
Easy-Braille Translator, 747  
ETgraphX, 749  
Lite Talk, 532  
Lite Touch Telephone  
Communicator, 183  
PCMaster & Windows Master, 460  
Type 'n Speak, 487

**Blessing, Maleta**  
327 W. Melba, Gladewater, TX 75647  
(903) 845-4244  
Drive to Live, 716

**Blissymbolics Communication  
International**  
1630 Lawrence Avenue, W., Suite 104,  
Toronto, ON M6L 1C5 CANADA  
(416) 242-9114  
FAX (416) 244-6543

AccessBliss 2.2, 69  
BlissWrite, 741  
Blissymbol Templates, 71  
Blissymbol Vocabulary Stamps, 72  
Core Vocabulary, 80  
HyperBliss 3.2, 136  
Picture Your Blissymbols, 103

**Bradley Enterprises**  
1204 Beech Street, Wilmington, DE 19805  
(302) 658-0203

Bradley Board Communication Aid, 74

**Braille Research & Literacy, Inc.**  
1245 Hancock Street, Suite 4, Quincy, MA  
02169  
(617) 472-5848  
FAX (617) 472-6003  
PC Braille, 761

**BrainTrain**  
727 Twin Ridge Lane, Richmond, VA 23235  
(804) 320-0105  
FAX (804) 320-0242

Captain's Log: Cognitive Training  
System, 568  
First Mate, 600  
Numeric Concepts I and II, 644

**Burkhart, Linda J.**  
6201 Candle Court, Eldersburg, MD 21784  
(410) 795-4561  
FAX (410) 795-8834

Head Control Switch, 221  
Head Switch Kit, 222  
Light Pointer, 22  
Light-Activated Switch, 228  
Pressure Switch, 241  
Pull Switch, 242  
Toy Adapter, 59

**C-CAD (Center for Computer Assistance to the Disabled)**  
 Suite 4041, 1950 Stemmons Frwy, Dallas, TX 75207  
 (214) 746-4217  
 BBS (214) 746-4213  
 TT/TDD (214) 746-5303  
 FAX (214) 746-4203  
 Stickey, 364

**Cafet, Inc.**  
 4208 Evergreen Lane, Suite 213, Annandale, VA 22003  
 (703) 941-8903  
 FAX (703) 658-4529  
 Cafet-for-Voice, 567

**Canon U.S.A., Inc.**  
 One Canon Plaza, Lake Success, NY 11042  
 (516) 488-6700  
 Canon Communicator CC-7S and CC-7P, 123

**CanSpeak**  
 807 Brissac Way, Orleans, ON K4A 3C8 CANADA  
 (613) 824-8461  
 woods.george@ic.gc.ca  
 CanSpeak, 568

**Castle Special Computer Services, Inc.**  
 9801 San Gabriel Northeast, Albuquerque, NM 87111  
 (505) 293-8379  
 COINSNKEYS, 577  
 SPELLIST, 729

**CE Software, Inc.**  
 1801 Industrial Circle, P.O. Box 65580, West Des Moines, IA 50265  
 (515) 224-1995  
 ProKey, 361  
 QuicKeys, 361

**Centigram**  
 91 E. Tasman Drive, San Jose, CA 95134  
 (408) 428-3500  
 CallText 5000, 527

**CH Products**  
 970 Park Center Drive, Vista, CA 92083  
 (619) 598-2518  
 Trackball Pro, 445

**Chatterbox Voice Learning Systems**  
 2265 Westwood Boulevard, Suite 907, Los Angeles, CA 90064  
 (310) 823-7994  
 Voice Math, 731  
 Voice Reading Ability Drill, 732

**Cirque**  
 433 W. Lawndale Drive, Salt Lake City, UT 84115  
 (800) 454-3375  
 Cirque GlidePoint Trackpads, 380

**Cleo of New York**  
 Trent Building, South Buckout Street, Irving, NY 10533  
 (800) 321-0595  
 Adjustable Head Pointer, 15  
 Cleo Communication Board, 75

**Comm-Tel**  
 1208 Kahului Street, Honolulu, HI 96825  
 (808) 396-5941  
 TT/TDD (808) 396-5124  
 FAX (808) 396-6095  
 SIDD (Software Interface for the Deaf and Disabled), 189

**Command Corp, Inc.**  
 3761 Venture Drive, P.O. Box 956099, Duluth, GA 30136-5598  
 (404) 813-7950  
 FAX (404) 813-0113  
 in3@commandcorp.com  
 WWW: [http://www.commandcorp.com/incube\\_welcom.html](http://www.commandcorp.com/incube_welcom.html)  
 IN-CUBE Voice Command for SPARC Stations, 396  
 IN-CUBE Voice Command for Windows, NT, 397

**Communication Development Products, Inc.**  
 P.O. Box 531, MCV Station, Richmond, VA 23298  
 (804) 672-2550  
 Fold It System, 84

**Communication/Therapy Skill Builders**  
 555 Academic Court, San Antonio, TX 78204-2498  
 (800) 228-0752  
 FAX (800) 232-1223  
 Pictures, Please!, 104  
 Self-Talk Stickers, 107

**Compusult Limited**  
 40 Bannister Street, P.O. Box 1000, Mount Pearl, NF A1N 3C9 CANADA  
 (709) 745-7914  
 FAX (709) 745-7927  
 scantell@compusult.nf.ca  
 WWW: <http://www.compusult.nf.ca>  
 ScanTELL, 482

**Computers to Help People, Inc.**  
 825 E. Johnson Street, Madison, WI 53703  
 (608) 257-5917  
 TT/TDD (608) 257-1270  
 76025.1265@compuserve.com  
 Mac-Apple Communications Aid, 756  
 Maze, 631  
 Motor Training Games, 638  
 NOHOLD, 356  
 Trace Math Aid, 769  
 Write, 733

**Conover Company**  
 P.O. Box 155, Omro, WI 54963  
 (414) 231-4667  
 FAX (414) 231-4809  
 Basic Learning Skills Courseware, 714  
 Be a Winner Series, 561

Career English, 715  
 Community Signs, 580  
 Computer Literacy Series, 582  
 Employment Signs, 594  
 English on the Job, 594  
 Grocery Store Words, 608  
 Improving Your Self-Concept, 611  
 Information Signs, 612  
 Job Seeking Series, 615  
 Learning Activity Packets (LAPs), 621  
 Learning How to Learn Series, 621  
 Math on the Job, 630  
 Medical Words, 631  
 Micro Guide to Careers Series, 633  
 Microcomputer Evaluation of Career Areas (MECA), 634  
 On the Job Series - Career Interests, 646  
 On the Job Series - Communication Skills, 647  
 On the Job Series - Mathematics, 647  
 On the Job Series - Problem Solving Skills, 648  
 Personal Development Software Series, 652  
 Reading a Ruler - English & Metric, 664  
 Reading Horizons, 725  
 Reasoning Skills on the Job, 665  
 Safety Signs, 667  
 Steps for Career Choice, 678  
 Survival Words, 681  
 Transportation Signs, 694

**Consultants for Communication Technology**  
 508 Bellevue Terrace, Pittsburgh, PA 15202  
 (412) 761-6062  
 FAX (412) 761-7336  
 CCT Environmental Control, 271  
 Handy Speech Communication Aide, 131  
 Meta4, 143  
 One Access, 427  
 Phone Manager, 288  
 ToneTalker, 194  
 Wish Writer, 772

**Consumer Care Products, Inc.**  
 P.O. Box 684, 810 N. Water Street, Sheboygan, WI 53082  
 (414) 459-8353  
 Rx WorkStation, 550

**Conveyant Systems, Inc.**  
 2332 McGaw Avenue, Irvine, CA 92714  
 (714) 756-7100  
 FAX (714) 756-7129

TeleDesk Visually Impaired Operator Console, 767

**Cord-Mate, Inc.**  
 705 Wallingford Road, Cheshire, CT 06410  
 (800) 922-7990  
 Cord-Mate, 315

**Cornucopia Software**  
 Post Office Box 6111, Albany, CA 94706  
 (510) 528-7000  
 IBM-VBII, 753  
 VersaBraille Electric Webster, 770

## Index 5: MANUFACTURERS Listed with their Products

### CoStar Corporation

100 Field Point Road, Greenwich, CT 06830-6406  
(203) 661-9700  
FAX (203) 661-1540  
Stingray, 441

### Craner Cabinetry

3190 South 4140 West, West Valley City, UT 84120  
(801) 966-1127  
CompuDesk HCP, 543

### Creative Communicating

P.O. Box 3358, Park City, UT 84060  
(801) 645-7737  
FAX (801) 645-7737

Light Activated Switch Panel, 46  
PowerPad Preschool Pack I & II, 658  
R.A.P.S. Software Series I PowerPad, 661  
Single Switch/MatchBox Pack I, 675  
Storytime Series, 679  
Storytime Series for Macintosh, 679  
Switch Modified PowerPad, 442

### Creative Learning, Inc.

206 Sacramento Street, Suite 305, Nevada City, CA 95959  
(916) 292-4262  
(800) 284-0584  
mindplay@rtd.com

Breakthrough to Language: Clinical Edition, 565

Breakthrough to Language: Home Edition, 566

### Creative Switch Industries

P.O. Box 5256, Des Moines, IA 50306  
(515) 287-5748  
FAX (505) 285-0514

AC Adaptor FRE-103C, 29  
And Or Box, 31  
Battery Interrupters, 33  
Button Switch, 207  
Chime Box, 35  
Classic Paddle Switch, 209  
Coil Spring Wobble Stick Switch, 209  
Counter Box, 39  
Deluxe Paddle Switch II and Mini Deluxe Paddle Switch, 214  
Double Paddle Switch, 214  
Flexit Switch, 219  
Latch Box, 45  
Low Force Adjustable Row Switch, 229  
Mat Switch, 230  
Mercury Switch, 230  
Multi-Control Press Switch, 233  
Pinch Switch, 237  
Standard Paddle Switch, 249

### Crestwood Company

6625 N. Sidney Place, Milwaukee, WI 53209  
(414) 352-5678  
FAX (414) 352-5679

Alphabet Board Kit, 69  
Beeper, 313  
Card Communicator, 34  
Chain Talk, 75  
Communiclock, 37  
Communilight 24, 37  
Control & Momentary Control Center Switches, 211

### Crespeaker, 125

Crestalk, 126  
Crestwood Converter Switch, 212  
Crestwood Touch Latch Switch, 212  
Deluxe Communication Board Kit, 81  
Deluxe Talk Board, 81  
Duo-Responder, 42  
Flexible Wheelchair/Table Mounting Kit, 167  
Jumbo Plate Switch, 225  
Membrane Plate Switch, 230  
Messenger, 142  
Micro Switch, 231  
Mini Talking Card Reader, 143  
Mounting Packages & Switches, 170  
Object Communicator, 93  
Object Display, 93  
Object Stand or Calendar Box (3 or 5), 94  
Object-Picture Talk Board, 94  
Opticomunicator, 95  
Passport Kits, 95  
Porta Boards, 106  
Porta Book, 106  
Quad Talk, 52  
Remote Wireless Paging Alarm, 324  
Robot Voice Synthesizer, 9  
Screamer Alarm, 324  
Shadow Switch, 245  
Stickers for Talk Boards, 108  
Talk Back III, 155  
Talk Back VI, 155  
Talking Laser Beam, 25  
Talking Pictures Communication Board, 109  
Talking Pictures, Kits I - VII, 109  
Tri-Responder, 62  
Twin Plate Switch, 255  
Voice Amplifier, 11  
Voice Switch, 258

### Cross Educational Software

508 E. Kentucky Ave., P.O. Box 1536, Ruston, LA 71270  
(318) 255-8921  
(800) 768-1969  
FAX (318) 255-8921  
markcross@aol.com

Talking Riddles, 731

Talking Writer & Four Games, 766

### CRT, Inc.

490 Tenth St., NW, Atlanta, GA 30332  
(800) 457-9555  
(404) 876-8580  
FAX (404) 875-9409

AbleOffice, 541

### CSUS Assistive Device Center

California State University--Sacramento, 6000 J Street, Sacramento, CA 95819-6027  
(915) 278-6422

Communication Training Program, 579

### Cylogic, Inc.

4120 Phinney Avenue North, Seattle, WA 98109  
(206) 524-3188  
(800) 295-6442

Voice User, 449

### D.C. & D., Inc.

42 Skinner Road, East Windsor, CT 06016  
(203) 623-7364

Above PCD, 118

TS2010X Text to Speech Personal Communicator, 158

### D.J. Technical Sales, LTD

2647 Kingway, Vancouver, BC V5R 5H4 CANADA  
(604) 436-2694  
FAX (604) 436-2695

Communication Station, 165

### Deafworks

P.O. Box 1265, Provo, UT 84603-1265  
(800) 877-8973  
TT/TDD (801) 465-1957  
FAX (801) 465-1958

TDD Trainer System, 58

### DEKRO, Inc.

2758 Margaret Mitchell Dr., Atlanta, GA 30327  
(404) 351-1103

Construc, 583

Less, More, Make Equal, 623

Logi, 627

Magic, 628

Math Max, 630

Octobus, 645

Prefix, 659

Studio4, 680

Telling Time, 689

### Dickey Engineering

17 Autumn Lane, Newbury, NH 03255  
(508) 664-2010

Salvus Reader, 292

Sponge Nurse Call Switch, 248

### Digital Equipment Corporation

PO Box cs2008, Nashua, NH 03061  
(800) 344-4825  
(800) 354-9000

DECtalk, 528

DECtalk: PC & DECtalk, Express, 528

VT520 Terminals - Accessibility

Features, 367

### Dimango Products

7258 Kensington Road, Brighton, MI 48116  
(810) 486-0770

On/Off Remote Switch, 288

### DIRAD Technologies, Inc.

14 Computer Drive East, Albany, NY 12205  
(518) 438-6000  
TT/TDD (518) 459-6710  
FAX (518) 458-2782

UltraSilent, 194

### Don Johnston Incorporated

P.O. Box 639, 1000 N. Rand Rd., Bldg 115, Wauconda, IL 60084

(800) 999-4660

(708) 526-2682

FAX (708) 526-4177

djde@aol.com

Access to Math, 713



**Adaptive Firmware Card Model**  
G32e, 374  
**BASS Switches**, 205  
**Battery Adapter**, 32  
**BigCalc**, 740  
**Blissymbols Gallery**, 72  
**Blocks in Motion**, 563  
**Chime Alarm**, 315  
**CircleTime Tales & CircleTime Tales Deluxe**, 572  
**Co:Writer**, 745  
**Communication Icon Galleries CD-ROM**, 78  
**Core Picture Vocabulary**, 80  
**Dial Scan**, 49  
**DJ ProPack Speech Module**, 529  
**Ellipse Switches**, 217  
**Head Mounting Kit**, 167  
**Imaginart Gallery**, 88  
**Interaction Games**, 613  
**Interaction Games II**, 614  
**Join the Circus**, 616  
**JOKUS Software**, 721  
**K.C. & Clyde in Fly Ball**, 722  
**Ke:nx**, 402  
**Ke:nx Easy Overlays**, 548  
**Ke:nx On:Board (M43)**, 492  
**Key Largo**, 403  
**Keyguards**, 350  
**L.T. Switch**, 226  
**Learn to Scan**, 620  
**Left/Right Rocker Switch**, 228  
**Macintosh Switch Interface (M09)**, 459  
**Make It In Time**, 628  
**Make It Scan**, 629  
**Moisture Guard**, 355  
**Motor Training Games**, 638  
**Mounting Switch**, 233  
**Mounting Switch Mount**, 171  
**Plate Switch**, 238  
**Porter, The**, 461  
**PowerBook Mounting Plate**, 171  
**Predict It**, 763  
**Press to Play**, 660  
**Reactions (R73)**, 663  
**Sensor Switch**, 245  
**Switch Interface**, 463  
**Switch Latch/Timer**, 57  
**Switch Mounting Kit**, 174  
**Talk: About**, 156  
**UKanDu Little Books**, 696  
**UKanDu Switches, Tool**, 697  
**Write:OutLoud**, 774

**DQP, Inc.**  
3001 Deep Lake/Bndry Rd., Colville, WA 99114  
(509) 732-4263  
FAX (509) 732-4071  
Able-Phone 100WA, 266  
Able-Phone 1900 and 2000, 266  
Able-Phone 6000SX, 267

**Dragon Systems, Inc.**  
320 Nevada Street, Newton, MA 02160  
(617) 965-5200  
FAX (617) 527-0372  
DragonDictate Starter, Classic, and Power Editions, 383

**Dunamis, Inc.**  
3423 Fowler Boulevard, Lawrenceville, GA 30244-4264  
(800) 828-2443  
(707) 279-1144  
FAX (707) 279-0809  
dunamisben@aol.com

Bear Jam, 561  
Body Builder, 564  
Logo TouchTools for the PowerPad, 627  
Mac PowerPad Interface for Single Switches, 459  
MicroIllustrator, 758  
PowerKey Software for IBM, 431  
PowerPad, 432  
PowerPad Keyguard, 359  
PowerPad Starter Kit, 432  
PowerPad Toolkit 4, 762  
PowerSwitch, 461  
SimpleCom I: Yes/No Communication, 674  
SimpleCom II: Needs/Wants Communication, 674  
SuperPort, 462

**Duxbury Systems, Inc.**  
435 King Street, P.O. Box 1504, Littleton, MA 01460  
(508) 486-9766  
FAX (508) 486-9712  
duxbury@world.std.com

Duxbury Braille Board for Microsoft Windows, 745  
Duxbury Braille Font, 746  
Duxbury Braille Translator (DBT), 746  
Duxbury Braille Translator for WordPerfect (DUXWP), 747  
Edgar, 748

**Dynacomp, Inc.**  
2935 E. Lake Road, Levonia, NY 14487  
(716) 265-4040  
Primer 83, 660

**E & IS SignWare**  
2612 Minnetonka Drive, P.O. Box 521, Cedar Falls, IA 50613  
FAX (319) 266-7800  
CAV-ASL, 571  
Elementary Signer, 593  
Fingerspeller, 598  
FingerZoids, 599

**E. David & Associates**  
22 Russett Lane, Storrs, CT 06268  
(203) 429-1785  
H:1 Handicapped Word Games, 752  
H:2 Handicapped Arithmetic Flash Cards, 721  
OneStrk, 428

**East Carolina University**  
David Lunney, Department of Chemistry & Science, Institute for the Disabled, Greenville, NC 27858  
(919) 328-6711  
FAX (919) 328-6210  
chlunney@ecuvms.cis.ecu.edu  
Talking Data Acquisition System Software, 765

**Easy Home Control**  
4931 Edsal Drive, Lyndhurst, OH 44124  
(216) 381-9700  
FAX (216) 368-6445

Ability Switch Phone Sequencer, 265  
Remote Ability Switch Adapter, 243

**EBSCO Curriculum Materials**  
P.O. Box 1943, Birmingham, AL 35201  
(800) 633-8623  
FAX (205) 991-1482  
Talking Hands, 685

**Echo Speech Corporation**  
6460 Via Real, Carpinteria, CA 93013  
(805) 684-4593

Echo II, 529  
Echo LC, 530  
Echo PCII, 530  
Echo-PC, 531

**Edmark Corporation**  
6727 185th Avenue NE, P.O. Box 97021, Redmond, WA 98073-9721  
(206) 556-8400  
(800) 362-2890  
FAX (206) 556-8430

Edmark Functional Word Series, 592  
Edmark Reading Program, Level 1 Software, 718  
Talking Touch Window, 687  
Timekeeper, 692  
Touch and Match, 692  
Touch and See, 693  
TouchMoney, 693  
TouchWindow, 444  
Write This Way, 733

**Educational Activities, Inc.**  
1937 Grand Ave., Baldwin, NY 11510  
(800) 645-3739  
FAX (516) 623-9282  
edact@panix.com;  
76264.3170@compuserve.com

Core Reading and Vocabulary Development, 583

**Educational Technology International**  
P.O. Box 64188, Virginia Beach, VA 23464  
(804) 523-5680  
FAX (804) 624-1766  
Zero to Five, 734

**EKEG Electronics Company LTD**  
P.O. Box 46199, Station D, Vancouver, BC V6J 5G5 CANADA  
(604) 857-0828  
FAX (604) 857-2726

Activity Board, 30  
Breakthru Box, 379  
Expanded Keyboard for Apple Macintosh and Apple IIGS, 385  
Expanded Keyboard for Automatic Telephone, 276  
Expanded Keyboard for IBM Computers, 385  
Expanded Keyboards for the Talking BlissApple, 386  
Expanded Numeric Keypads, 386  
Macrat, 410  
Mini-Keyboards, 416

Narwhal Expanded Keyboards for Adaptive Firmware Card. 425  
Remote Keyboard for the Apple II+ and IIc. 436

**Embracing Concepts, Inc.**  
40 Humboldt Street, Rochester, NY 14609  
(716) 654-9090  
FAX (716) 458-0593  
Switchskins, 251

**Enabling Technologies Company**  
3102 S.E. Jay Street, Stuart, FL 34997  
(800) 777-3687  
FAX (407) 220-2920  
Braille BookMaker and Braille Express 100 & 500, 508  
InfoTouch, 182  
Juliet Braille, 514  
Marathon Braille, 515  
Romeo Braille Model RB-25, 520  
Romeo Braille Model RB-40, 520  
Thomas Braille, 521  
TransSend System, 522

**Envirotrol Company, Inc.**  
6575 Burger Drive, SE, Grand Rapids, MI 49546-7209  
(616) 940-0122

T-140 Series Puff/Sip Speakerphones, 299  
URC-400 Series Universal Remote Control, 305

**Equal Access Computer Technology, Inc.**  
39 Oneida Road, Acton, MA 01720  
(508) 263-6437  
FAX (508) 263-6537  
eact@world.std.com

Minimal Motion Computer Access System, 417  
Minimal Motion Splint-Mounted Switch Kits, 233

**Ergologic Enterprises, Inc.**  
47000 Warm Springs Boulevard, Unit 432, Fremont, CA 94539  
(800) 665-9929  
FAX (408) 996-3195

Ergologic Model 7.1 Keyboard, 384

**Ergonomic-Interface Keyboard Systems, Inc.**  
P.O. Box 2636, La Jolla, CA 92038  
(619) 454-0000  
Vertical, 448

**ErgonomiXX, Inc.**  
525-K East Market Street, Box 295, Leesburg, VA 22075  
(800) 784-1047  
(703) 771-1047

MyKey, 424

**Ettore, Riccardo**  
Attn. Typelt4Me, 67 rue de la limite, 1970 W-Oppem, BELGIUM  
FAX 32-2-7679217  
Typelt4Me, 770

**Exceptional Children's Software, Inc.**  
2215 Ohio, Lawrence, KS 66046  
(913) 832-1850

Adventures of Jimmy Jumper - Prepositions, 557  
Color Find, 578  
Further Adventures of Jimmy Jumper - Perseverance, 606  
Letter Find, 625  
Rabbit Scanner, 662  
Run Rabbit Run, 666  
Sight Word Spelling, 726

**Exceptional Teaching Aids**  
20102 Woodbine Ave., Castro Valley, CA 94546  
(510) 582-4859  
(800) 549-6999  
FAX (510) 582-5911

Focus on Facts, 719  
Focus on Nations, 720  
High Dots, 344  
Learning to Spell Braille Signs, 623  
Listen and Spell, 723

**Extensions for Independence**  
555 Saturn Blvd. #B-368, San Diego, CA 92154  
(619) 423-1748  
FAX (619) 329-8392

Heyer-Abadie Modular Mouthstick, 20  
Modular Turntable Desks, 549  
Motorized Easel, 286  
Stick-On Keylocks, 364  
Universal Telephone Adapter, 304

**Favin, David**  
221 Queens Drive South, Little Silver, NJ 07739  
(201) 949-7602  
FAX (908) 949-2031  
4394dlf@hogpa.hp.att.com

Audible Cursor Routine, 121  
Communication Programs, 124  
Environment Control, 275  
Geometric Figures and Spatial Concepts, 720  
Keyboarding Program with Voice Output, 618  
Learning the Alphabet, 722  
Program for Aphasics, 724  
Telling Time, Parts of the Face, Learning Colors, 690

**FDLRS/South Enabling Technologies Lab**  
Dade County Public Schools, 5555 S.W. 93rd Ave., Miami, FL 33165  
(305) 274-3501  
FAX (302) 598-7752

Talking Public Domain Disks, 730

**Florida New Concepts Marketing, Inc.**  
P.O. Box 261, Port Richey, FL 34673  
(813) 842-3231  
FAX (813) 845-7544

Beamscope, 494  
Compu-Lenz, 495

**Fox Bay Industries, Inc.**  
4150 "B" Place NW #101, Auburn, WA 98001  
(800) 874-8527  
(206) 941-9197

CarpalRest, 335  
EasyRiser, 546  
TarsalRest, 552

**Franklin Electronic Publishers, Inc.**  
Franklin Learning Resources Division, One Franklin Plaza, Burlington, NJ 08016-4907  
(800) 525-9673  
(609) 386-2500

Language Master Special Edition - LM6000SE, 477

**Fred Sammons, Inc.**  
P.O. Box 386, Western Springs, IL 60558-0386  
(800) 323-5547

Adjustable Head Pointer, 15  
Clear-View Head Pointer, 17  
Communication Sheets, 79  
Fone Holder, 278  
Giant Push Button Telephone Adapter, 281  
Mouthsticks, 24  
Vacuum Wand, 26

**Futura Wave Communications, Inc.**  
13803 Urbana Lane, Bowie, MD 20720  
(301) 262-7833  
TT/TDD (301) 262-7833  
FAX (301) 262-7833

Futura-TTY, 181

**Gallaudet Research Institute-TAP**  
Technology Assessment Program, 800 Florida Avenue, Northeast, MSSD-200, Washington, DC 20002  
(202) 651-5257

TT/TDD (202) 651-5257  
FAX (202) 651-5476  
nswilliams@gallua.gallaudet.edu  
WWW: http://fshb41.gallaudet.edu  
ASCII-TDD Software, 179

**GMR Labs**  
1030 East El Camino Real, #308, Sunnyvale, CA 94087  
(800) 234-8288  
FAX (408) 243-3731  
roark@gmrlabs.com

Vocal Assistant, 159

**Graley Marketing**  
15935 El Soneto Drive, Whittier, CA 90603  
(310) 947-7848

Communication Board, 76

**Great Talking Box Company**  
2211 Fortune Drive, Suite B, San Jose, CA 95131  
(800) 361-8255

CarryCom, 123  
EasyTalk, 130

**Greatest of Ease Company**  
2443 Fillmore Street, San Francisco, CA  
94115  
(415) 441-6649  
Personal Papers, 323

**Greystone Digital**  
P.O. Box 1888, Huntersville, NC 28078  
FAX (704) 875-3293  
Big Keys, 378

**Gus Communications, Inc.**  
P.O. Box 4362, Blaine, WA 98231  
(604) 279-0110  
FAX (604) 279-8474  
gharris@guscom.com  
WWW: <http://www.direct.ca/gus/index.html>  
Gus! Multimedia Speech System, 133

**GW Instruments**  
35 Medford St., Somerville, MA 02143  
(617) 625-4096  
FAX (617) 625-1322  
Sound Scope, 677

**GW Micro**  
310 Racquet Drive, Fort Wayne, IN 46825  
(219) 483-3625  
FAX (219) 482-2492  
support@gwmicro.com

Braille-Talk, 742  
Calc-Talk, 743  
Calworthy, 743  
File-Talk, 750  
Noteworthy, 760  
Sounding Board, 535  
Speak-Out, 535  
Term-Talk, 768  
Vocal-Eyes, 487  
VoiceCard, 538  
Window-Eyes, 488  
Word-Talk, 773  
Work-Station Pro, 773

**H.K. EyeCan, LTD**  
36 Burland Street, Ottawa, ON K2B 6J8  
CANADA  
(613) 828-0056  
(800) 356-3362  
FAX (613) 596-4300  
VisionKey, 158

**Hach Associates**  
P.O. Box 11754, Winston-Salem, NC 27116-1754  
(800) 624-7968  
FAX (800) 410-7282  
Concept Keyboard, 381

**HARC Mercantile, LTD**  
1111 West Centre Avenue, PO Box 3055,  
Kalamazoo, MI 49003-3055  
(800) 445-9968  
(616) 324-1615  
TT/TDD (800) 413-5245  
FAX (616) 324-2387  
People Pager, 321  
Positron Express, 188  
Uniphone iDD/TT, 195

**Health Care Keyboard Company**  
12040-G West Feerick Street, Wauwatosa,  
WI 53222  
(414) 536-2160  
FAX (414) 536-2170  
hlthcare@earth.excepc.com  
Comfort Keyboard System, 380

**Heldico, Inc.**  
561 Keystone Avenue #296, Reno, NV  
89501  
(702) 324-7104  
FAX (702) 324-7104  
Heldico Intertalk, 135  
Message Center, 183

**Help Me to Help Myself Communication Aids**  
857 Beech Avenue, Cincinnati, OH 45205-1644  
(513) 921-7409  
sscott@tso.cin.ix.net  
Emotional Moods & Needs-G 3&4, 82  
Foods I Like Menu Book, 85  
Help Me at Home & School-G 5&6, 85  
Help Me to Help Myself Handbook, 86  
ICU-G 1&2, 87

**Henter-Joyce, Inc.**  
2100 62nd Avenue North, St. Petersburg, FL  
33702  
(800) 336-5658  
(813) 528-8900  
BBS (813) 528-8903  
FAX (813) 528-8901  
7477.3306@compuserve.com  
FormMate, 751  
JAWS for Windows, 475  
JAWS Screenreader, 476  
WordScholar, 489

**Hersh & Treadgold**  
6657 Camelia Drive, San Jose, CA 95120  
(408) 997-7017  
Beep-in-Touch, 312  
NeuroPage, 320

**Hexagon Products**  
P.O. Box 1295, Park Ridge, IL 60068  
(708) 692-3355  
76064.1776@compuserve.com  
B-Edit, 738  
B-Pop, 493  
BIG for 1-2-3, 739  
BIG for WordPerfect, 740  
Big-W, 494  
Braille Tutorial, 565

**Hooleon Corporation**  
260 Justin Drive, Cottonwood, AZ 86326  
(800) 937-1337  
FAX (520) 634-4620  
Braille Keytop Labels, 334  
Combination Braille/Large Print Keytop  
Labels, 335  
Dvorak Conversion Keytop Labels, 338  
FlexShield Keyboard Protectors, 341  
Home-Row Key Indicators, 345  
KeyStopper, 352

**Hopkins Technology, LLC**  
421 Hazel Lane, Hopkins, MN 55343  
(612) 931-9376  
FAX (612) 931-9377  
74017.614@compuserve.com  
WWW: <http://www.hoptechno.com>  
ExerciseBreak, 749

**Hugh MacMillan Rehabilitation Centre**  
350 Rumsey Rd., Toronto, ON M4G 1R8  
CANADA  
(416) 425-6220

Accularm, 311  
Capacitive Touchplate Interface, 208  
Dual Channel Latching Switch  
Interface, 41  
Head Position Interface, 222  
Joystick Interface Control, 225

**HumanWare, Inc.**  
6245 King Road, Loomis, CA 95650  
(800) 722-3393  
(708) 620-0722  
FAX (916) 652-7296

ALVA Braille Terminals, 507  
Braille-N-Print, 508  
Keynote Companion, 476  
Keynote GOLD, 532  
Keysoft, 754  
Keyterm, 754  
MasterTOUCH, 515  
Mountbatten Braille, 516  
Paragon Braille Printer, 518  
Ransley Braille Interface (RBI), 519  
SoundProof, 485

**IBM Corporation**  
Special Needs Systems, P.O. Box 1328,  
Internal Zip 5432, Boca Raton, FL 33432  
(800) 426-4832  
TT/TDD (800) 426-4833

AccessDOS, 332  
IBM Screen Reader/2, 474  
IBM Screen Reader/DOS, 474  
KeyGuard, 349  
Screen Magnifier/2, 501  
SpeechViewer II, 678  
THINKable/DOS, 690

**IC-Systems**  
P.O. Box 401, Fruitport, MI 49415  
(616) 847-3623

Telephone Management System, 300

**Imaginart International, Inc.**  
307 Arizona St., Bisbee, AZ 85603  
(800) 828-1376  
(520) 432-5741  
FAX (520) 432-5134

Eye-Com Board, 84  
Pick 'n Stick Color Micros, 98  
Pick 'n Stick Color Packs, 98  
Pick 'n Stick Fast Food, 99  
Pick 'n Stick on Disk, 99  
Pick 'n Stick Primary Pack, 100  
Pocket Picture Holder, 105  
Touch 'N Talk Communication  
Board, 110  
Touch 'N Talk Communication  
Notebook, 110  
Touch 'N Talk Communication  
Stickers, 111

## Index 5: MANUFACTURERS Listed with their Products

- Touch 'N Talk Micros, 111
- In Touch Systems**  
11 Westview Road, Spring Valley, NY 10977  
(800) 332-6244  
Magic Wand Keyboard with McKey Mouse Option, 412
- Infogrip, Inc.**  
1141 East Main Street, Ventura, CA 93001  
(805) 652-0770  
(800) 397-0921  
FAX (805) 652-0880  
76106.430@compuserve.com  
WWW: <http://www.infogrip.com/infogrip>  
BAT Personal Keyboard, 377
- Infra-Link, Inc.**  
P.O. Box 1008, Portland, OR 97224  
(800) 395-3596  
FAX (503) 598-7531  
First Aide Kit, 278  
GEWA Infra-Link Speaker-Telephone, 279  
GEWA Infra-Link System, 280
- Innocomp**  
Innovative Computer Applications, Suite 302, Warrensville Heights, OH 44128  
(216) 464-3636  
(800) 382-8622  
FAX (206) 464-3638  
innocomp@aol.com  
Baton Laser Pointer, 16  
Instant Access, 397  
Laser Light Pointer, 21  
Say-It-All II Plus, 148  
Say-It-Simply Plus, 148  
Scan-It-All, 149
- Innovation Management Group, Inc.**  
21550 Oxnard Street, Suite 300, Woodland Hills, CA 91367  
(818) 346-3581  
FAX (818) 346-3973  
73061.647@compuserve.com  
Joystick to Mouse Driver, 400  
My-T-Mouse, 424
- Innovative Designs, Inc.**  
2464 El Camino Real, Suite 245, Santa Clara, CA 95051  
(408) 985-9255  
FAX (408) 247-6624  
70402.2003@compuserve.com  
Finish Line, 751
- Instante!**  
926 Proctor Avenue, P.O. Box 116, Ogdensburg, NY 13669  
(800) 267-9111  
(613) 592-4642  
WatchMate, 327  
WatchMate LC, 328
- Institute on Applied Technology, Children's Hospital**  
Communication Enhancement Center, Fegan Plaza, 300 Longwood Avenue, Boston, MA 02115  
(617) 355-6998  
MultiPhone, 287  
MultiVoice, 534  
WriteAway, 774
- Intelligent Peripheral Devices, Inc.**  
20380 Town Center Lane, Suite 270, Cupertino, CA 95014  
(408) 252-9400  
FAX (408) 252-9409  
alpiasmart@eworld.com  
AlphaSmart Pro, 375
- IntelliTools, Inc.**  
55 Leveroni Court, Suite 9, Novato, CA 94949  
(415) 382-5959  
FAX (415) 382-5950  
ClickIt!, 454  
IntelliKeys, 398  
IntelliKeys Overlay Maker, 548  
IntelliTalk, 137
- Interactive Products, Inc.**  
1600 Valley River Drive, Suite 170, Eugene, OR 97401  
(503) 341-4964  
FAX (503) 341-4965  
74744.1420@compuserve.com  
JustVoice, 401
- Interlink Electronics**  
545 Flynn Road, Camarillo, CA 93012  
(805) 484-1331  
FAX (805) 484-8989  
PortaPoint, 431  
ProPoint, 434  
RemotePoint, 436
- International Management Services, Inc.**  
363 East Central Street, Franklin, MA 02038-1300  
(508) 520-1555  
FAX (508) 420-3338  
rwenig@delphi.com  
Maltron Keyboard, 417
- International Technology, Inc.**  
6546 Fields Ertel Road, Cincinnati, OH 45249  
(513) 489-7512  
Laser Optic Keyboard, 407
- ISCAN, Inc.**  
89 Cambridge Street, Burlington, MA 01803  
(617) 273-4455  
Eye Slaved Pointing System, 387  
Optimouse, 428
- ITAC Systems, Inc.**  
3113 Benton Street, Garland, TX 75042  
(214) 494-3073  
Mouse-Trak, 419
- J.E. Stewart**  
18518 Kenlake Place Northeast, Seattle, WA 98155  
(206) 486-4510  
CAMEO, 715  
ERIN (Early Recognition Intervention Network), 719  
WSCC (Washington State Cooperative Curriculum), 709
- JANICE Invalid Security Alert Systems, Inc.**  
7218 Lanai, Long Beach, CA 90808  
(213) 421-3367  
FAX (213) 421-3367  
JANICE Model 100 Invalid Security Alert System, 318
- Jim's Instrument Manufacturing, Inc.**  
1201 Highland Court, Iowa City, IA 52240  
(319) 351-3429  
FAX (319) 354-8901  
Light Beam Indicator, 21
- Judy Lynn Software**  
278 Dunhams Corner Road, East Brunswick, NJ 08816  
(908) 390-8845  
Cause & Effect, 570  
Fundamental Concepts, 606  
Judy Lynn PC Adapter, 457  
Switch Art, 683  
Visual Motor Skills, 701
- Kansys, Inc.**  
4301 Wimbledon Ter. 2B, Lawrence, KS 66047  
(913) 843-0351  
Auto Braille, 738  
NAMES, 760  
PROVOX, 481  
TurboBraille, 769
- Kapable Kids**  
P.O. Box 250, Bohemia, NY 11716  
(800) 356-1564  
Buzzer Box, 34  
Dual Action Latch, 41  
Flexi-Switch, 219  
Leaf Switch, 226  
Patty Cake Press, 235  
Peg Switch, 50  
Play Mat Switch, 240  
Squeeze Switch, 249  
Tactile Touch Pad, 251
- Kay Elemetrics Corporation**  
12 Maple Avenue, P.O. Box 2025, Pine Brook, NJ 07058  
(201) 227-2000  
Laryngograph, 620  
Nasometer Model 6200-3, 643  
Visi-Pitch Model 3300, 700
- Kensington Microwave Limited**  
2855 Campus Drive, San Mateo, CA 94403  
(415) 572-2700  
(800) 535-4242  
Expert Mouse, 387  
Turbo Mouse 4.0, 447

## Index 5: MANUFACTURERS Listed with their Products

**Kepler Electronic Publishing, Inc.**  
1525 Centennial Drive, Kingston, ON K7L  
4V2 CANADA  
(613) 384-1386  
FAX (613) 384-3208  
kepler@fox.nstm.ca  
WWW:  
<http://www.novatech.on.ca/kepler/page1.html>  
PAL, 358

**Key Tronic**  
P.O. Box 14687, Mail Stop 142-D, Spokane,  
WA 99214  
(800) 262-6006  
WA (509) 9. 8-8000  
FAX (509) 927-5224

FlexPro, 390  
Trak101 Keyboard, 446

**Kidtech, Inc.**  
625 Kathleen Court, Niceville, FL 32578  
(904) 678-9260  
(800) 681-4056  
FAX (904) 678-9160  
kidteck@aol.com

My First Keyboard, 423

**Kinesis Corporation**  
22232 17th Avenue S.E., Bothell, WA  
98021-7425  
(206) 402-8100  
FAX (206) 402-8181

Kinesis Ergonomic Keyboard, 405

**Kinetic Designs, Inc.**  
14231 Anatevka Lane SE, Olalla, WA 98359  
(206) 857-7943  
FAX (206) 857-2640

Filch, 341  
Morsek Version 1.1, 418

**Kolvox Communications**  
4100 Yonge Street, Suite 607, Toronto, ON  
M2P 2B5 CANADA  
(416) 221-2400  
FAX (416) 218-3110

OfficeTALK for Windows, 426

**Konz, Ned**  
810 21st Avenue North, St. Petersburg, FL  
33704  
nedkonz@gate.net;  
76046.223@compuserve.com

Lens 2.03, 497

**Kopptronix Company**  
Box 367, Stanhope, NJ 07874  
(201) 543-6819  
FAX (201) 543-0430

Fingerspelling & Numbers, 598

**Krown Research, Inc.**  
10371 West Jefferson Blvd., Culver City, CA  
90232  
(213) 839-0181  
(800) 833-1968

SM85 Smart ASCII/Baudot Modem, 189

**Kurzweil Applied Intelligence, Inc.**  
411 Waverly Oaks, Waltham, MA 02154  
(617) 893-5151

Kurzweil VOICE, 406  
Kurzweil VOICE for Windows, 406

**KY Enterprises**  
3039 East 2nd Street, Long Beach, CA  
90803-5164  
(310) 433-5244  
FAX (310) 433-3970

Big Button Bed Control, 270  
Custom Speaker Phone, 273  
EZRA, 277  
In & Out Automatic Door Controller, 283  
Mouth Operated Joystick for Genesis  
Video Game, 422  
One-Hand Operated Joystick for Genesis  
Video Game, 427  
Sip/Puff Bed Control, 297  
Universal Television Remote  
Control, 304

**Laureate Learning Systems, Inc.**  
110 East Spring Street, Winooski, VT 05404  
(800) 562-6801  
(802) 655-4755

Bozons' Quest, 564  
CONCENTRATE! On Words &  
Concepts, 582  
Creature Antics and Creature Capers, 584  
Creature Cartoons, 584  
Creature Chorus, 585  
Creature Features, 585  
Creature Magic, 586  
Early Emerging Rules Series, 591  
Exploring Early Vocabulary Series, 595  
First Categories, 599  
First Verbs and Primeros Verbos, 601  
First Words, 601  
First Words II, 602  
Following Directions: One- and Two-  
Level Commands, 602  
Following Directions: Left and Right, 603  
Let's Go to the Circus, 624  
Micro-LADS and Micro-LADS in  
French, 634  
MY HOUSE: Language Activities of  
Daily Living, 641  
My Paint & Talking Coloring Books, 642  
MY SCHOOL: Language Activities of  
Daily Living, 642  
MY TOWN: Language Activities of Daily  
Living, 643  
Readable Stories Series, 724  
Sentence Master, 671  
Simple Sentence Structure, 673  
Swim, Swam, swum: Mastering Irregular  
Verbs, 681  
Talking Nouns, Talking Nouns II, and  
Talking Verbs, 686  
TalkTime with Tucker, 688  
Twenty Categories, 696  
Words and Concepts I, II, III, 707

**LC Technologies, Inc.**  
9455 Silver King Court, Fairfax, VA 22031  
(703) 385-7133  
(800) EYEGAZE  
FAX (703) 385-7137

Eyegaze Computer System, 132

**Less Gauss Inc.**  
Suite 160, 187 East Market Street, Rhinebeck,  
NY 12572  
(800) 872-1051  
(914) 876-5432  
FAX (914) 876-2005

Adjustable EZ Magnifier, 493  
GNK Magnifier, 496  
NuVu Magnifier, 500

**Lexmark International, Inc.**  
1221 Alverser Drive, Midlothian, VA 23113-  
2650  
(800) 438-2468  
FAX (800) 522-3422  
Select-Ease Keyboard, 439

**Life Science Associates**  
1 Fenimore Road, Bayport, NY 11705  
(516) 472-2111  
FAX (516) 472-8146  
franklsu@aol.com

Arithmetic 1, 2, and 3 with Speech, 714  
Cogrehab Vol. 1, 574  
Cogrehab Vol. 2, 574  
Cogrehab Vol. 3 Version 2.0, 575  
Cogrehab Vol. 4, 575  
Cogrehab Vol. 5, 576  
Cogrehab Vol. 6, 576  
Cogrehab Vol. 7: Quest, 577  
Input Adapter, 456  
Keys to Success: Comp. Keybd. Skills for  
Blind Children, 619  
Learning to Count, 622

**Logitech, Inc.**  
6505 Kaiser Drive, Fremont, CA 94555  
(510) 795-8500

MouseMan Cordless, 420  
TrackMan Live!, 445  
TrackMan Voyager, 446

**Luminaud, Inc.**  
8688 Tyler Boulevard, Mentor, OH 44060  
(216) 255-9082  
(800) 255-3408  
FAX (216) 255-2250

911 Telephone Terminal, 263  
Clamp-On Bump Switch, 209  
Companion 401 Communicator, 125  
Cooper-Rand Electronic Speech Aid, 4  
Denrick Speech Aid, 4  
Finger Flex Switch, 218  
HD Latching Pneumatic Switch, 221  
Headband Switch, 223  
LD Latching Puff Switch, 226  
Magnetic Finger Switch, 229  
Mercury Tilt Switch, 231  
Mini Vox Amplifier, 6  
Nu-Vois, 7  
Pressure Switch, 242  
Rand Voice Amplifier, 8  
Speech Enhancer 100, 200 & 400, 10  
Voicette, 12  
Wireless Personal Pager, 328

**Maddak, Inc.**  
6 Industrial Ave., Pequannock, NJ 07440  
(800) 443-4926  
(201) 628-7600

APT Automaddak Page Turner  
System, 268

## Index 5: MANUFACTURERS Listed with their Products

F71863 Touchables Touch Phone Attachments, 277  
F73216-100 Page Turner/Keyboard Aid, 17  
H71830 Adjustable Head Pointer, 18  
H73217 Mouth Held Page Turners, 19

**Madenta Communications, Inc.**  
9411A - 20 Avenue, Edmonton, AB T6N 1E5 CANADA  
(403) 450-8926  
(800) 661-8406  
FAX (403) 988-6182

Doors II, 382  
KeyMagic, 351  
Pre-Dict-ate, 433  
PROXi, 290  
RevolvingDoors, 437  
Switch-Back, 443  
Telepathic II, 767

**Magic Laboratories, Inc.**  
1733 Woodside Road, Suite 315, Redwood City, CA 94061  
(800) 368-6244  
FAX (415) 368-4535

VoiceBachs, 159

**Makita**  
14930 Northam Street, La Mirada, CA 90638  
(800) 4-MAKITA  
(714) 522-8088

Automatic Drapery Opener System, 269

**Marblesoft**  
12301 Central Avenue, NE, Suite 205, Blaine, MN 55434  
(612) 755-1402

Cause 'n Effect, 571  
CrossWords, 586  
Early Learning 3.5/Complete Early Learning 5.25, 591  
Early Learning I, 592  
Early Learning II, 717  
Early Learning III, 717  
Hand Controls, 392  
Keyboard Overlays for Apple IIe and IIgs, 347  
Mix 'N Match, 636  
Money Skills, 637  
Trip to the Zoo, 695

**Marquardt Switches, Inc.**  
2711 Route 20 East, Cazenovia, NY 13035  
(800) 282-ERGO  
FAX (315) 655-8042  
MiniErgo-MF2, 417

**Matias Corporation**  
178 Thistledown Boulevard, Rexdale, ON M9V 1K1 CANADA  
(416) 749-3124  
FAX (416) 740-4132  
ematias@dgp.toronto.edu  
ftp: ftp://explorer.dgp.toronto.edu/pub/Half-QWERTY/  
WWW:  
<http://www.dgp.toronto.edu/people/ematias/ brochure.html>

Half-QWERTY One-handed Keyboard Software, 342

**Maxi Aids, Inc.**  
42 Executive Boulevard, P.O. Box 3209, Farmingdale, NY 11735  
(516) 752-0521  
FAX (516) 752-0689  
DataArm, 337  
Dual Channel Headset, 546  
Left or Right Handed Keyboards, 353

**Mayer-Johnson Company**  
P.O. Box 1579, Solana Beach, CA 92075  
(619) 550-0084  
FAX (619) 550-0084  
mayerj@aol.com

Boardmaker 3.0, 73  
Boardmaker for Windows, 73  
Communication Binder, 76  
Communication Board Builder, 77  
Communication Displays for Engineered Preschool Env., 77  
Communication Folder and Tri-Folder, 78  
Ho'iday Kit, 86  
I Can Play, Too!, 753  
Individualized Communication Systems, 88  
Infovox 210, 475  
Life Experiences Communication Kit, 89  
Long Wallet, 89  
Mega-Book, 90  
Mid-Sized Communication Book, 91  
PCS Color Stickers, 96  
PCS Stamps, 96  
PCS Wordless Edition, 97  
Picture Communication Symbols - Combination Book, 101  
Picture Communication Symbols, Books I, II & III, 101  
Pocket-Sized and Double Pocket-Sized Communication Book, 105  
Sentence Key & Picture Sequence Key, 671  
Speaking Dynamically, 152  
Zoo Kit, 113

**MCE**  
Division of Lawrence Productions, 1800 S. 35th St., Galesburg, MI 49053  
(616) 665-7075  
FAX (616) 665-7060

Babysitting Basics, 560  
Blueprint for Decision Making, 563  
Job Readiness Series, 614  
Job Success Series, 615  
Learning to Reason Series, 622  
Living Alone, 626  
Mind Castle I and II, 635  
Money Matters, 637  
Positive Parenting, 657

**McIntyre Computer Systems Division**  
22809 Shagbark, Birmingham, MI 48025  
(810) 645-5090  
LipStick and WordWriter, 408

**Med Labs, Inc.**  
28 Vereda Cordillera, Goleta, CA 93117  
(805) 968-2486

E-Z Call, 316  
PA-1 Portable Alarm, 321  
Scan Com, 149

**Meeting the Challenge**  
3630 Sinton Road, Suite 103, Colorado Springs, CO 80907  
(719) 444-0252  
(800) 864-4264

KeyAbility, 346  
ZoomCaps, 369

**Merit Studios**  
13707 Gamma Road, Dallas, TX 75244  
(214) 385-2353  
FAX (214) 385-8205

Electric Crayon and Electric Crayon Deluxe, 748

**Merritt Computer Products, Inc.**  
5565 Red Bird Center Drive, Suite 150, Dallas, TX 75237  
(214) 339-0753  
FAX (214) 339-1313

SafeSkin Keyboard Protector, 363

**Micro Engineering**  
5714 Skyloft Drive, Riverside, CA 92509-5569  
(909) 685-6338

MicroBraille 2, 758

**Micro Video Corp.**  
210 Collingwood, Suite 100, P.O. Box 7357, Ann Arbor, MI 48107  
(800) 537-2182  
(313) 996-0626  
FAX (313) 996-3838

Video Voice Speech Training System, 699

**Microflip, Inc.**  
11211 Petsworth Lane, Glenn Dale, MD 20769  
(301) 262-6020  
FAX (301) 262-4978

MIC300i Computer Modem, 184  
WinTalk, 196

**Microlog Corporation**  
20270 Goldenrod Lane, Germantown, MD 20876  
(301) 428-3227  
FAX (301) 540-5557

VCS 3500 with TDD Software, 196

**Microsoft Corporation**  
One Microsoft Way, Redmond, WA 98052  
(800) 426-9400  
(206) 454-2030 x11

Access Pack for Microsoft Windows, 331  
BallPoint Mouse, 377  
Dvorak Keyboard Layouts, 338  
Microsoft Natural Keyboard, 414  
Microsoft Windows Sound System, 415

**Microspeed Inc.**  
5005 Brandin Court, Fremont, CA 94538  
(510) 490-1403  
FAX (510) 490-1165

AmTRAC, 375  
FastTRAP, 389  
MacTRAC, 411  
PC-TRAC, 429

**Microsystems Software Inc.**  
600 Worcester Road, Framingham, MA  
01701  
(800) 828-2600  
(508) 879-9000  
BBS (508) 875-8009  
FAX (508) 626-8515

ADAPTA-LAN, 374  
HandiCHAT and HandiCHAT  
Deluxe, 473  
HandiCODE and HandiCODE  
Deluxe, 393  
HandiKEY and HandiKEY Deluxe, 342  
HandiPHONE, 281  
HandiSHIFT, 343  
HandiWORD and HandiWORD  
International, 343  
MAGic and MAGic Deluxe, 498  
SeeBEEP, 764  
TEAM, 299

**MicroTalk Software**  
917 Clear Creek Drive, Texarkana, TX  
75503  
(903) 832-3471  
Modem (903) 832-3722  
FAX (903) 832-3722

ASAP (Automatic Speech Access  
Program), 468

**Mind Play**  
160 W. Fort Lowell Road, Tucson, AZ  
85705-3812  
(520) 221-7911  
(800) 221-7911

Picture Perfect, 762  
Race the Clock, 662

**MRF Adaptive Resources, Inc.**  
248 Farmview Lane, Mount Joy, PA 17552  
(800) 249-4687  
(717) 653-6807

HomeAccess, 283  
PhoneAccess, 289

**NanoPac, Inc.**  
4833 South Sheridan Road, Suite 402, Tulsa,  
OK 74145-5718  
(918) 665-0329  
FAX (918) 665-0361  
70524.3306@compuserve.com;  
dsjb79a@prodigy.com

CINTEX I, 744  
CINTEX2, 271

**Nassau Applied Technology Resource  
Center**  
380 Washington Avenue, Roosevelt, NY  
11575  
(516) 378-2000  
FAX (516) 378-0357

Adjustable Pressure Switch, 203  
Air Switch, 204  
Computer Interface Box, 454  
Delay Timer Box, 40  
E-Tran Scanner, 43  
Mini-Environmental Control (ECU)  
Box, 286  
Omron Switch, 234  
Plate Switches, 239

**National Institute for Rehabilitation  
Engineering**  
P.O. Box 1, Hewitt, NJ 07421  
(800) 736-2216  
(201) 853-6585  
dons@warwick.net

Electronic Speech Clarifiers, 5  
Electronic Speech Synthesizers, 130  
Large Print Word Processors, 755  
Large-Type Display Utility Software, 497  
Uni-Key, 367

**Neil Squire Foundation**  
2250 Boundary Road, Suite 220, Burnaby,  
BC V5M 4L9 CANADA  
(604) 473-9363  
FAX (604) 473-9364

1-Key, 331  
Breath Input Device, 207  
ezMorse for Windows, 388  
ezScan, 388  
Keyboard Expander, 458

**New Abilities Systems, Inc.**  
1940 Colony Street, Suite 2, Mountain View,  
CA 94043  
(415) 988-8889  
FAX (415) 988-8898

Universal Control System with Tongue  
Touch Keypad, 303

**New Breakthroughs**  
P.O. Box 25228, Eugene, OR 97402  
(503) 741-5070  
FAX (503) 896-0123  
breakthrus@aol.com  
AlphaPad, 70

**Nexlon, Inc.**  
3191 South Valley St., Suite 205, Salt Lake  
City, UT 84109  
(801) 466-1258  
TT/TDD (801) 466-1259  
FAX (801) 466-1259

NexCom 300vi & 300ve, 185

**Nisus Software, Inc.**  
107 S. Cedros Avenue, Solana Beach, CA  
92075  
(800) 922-2993  
(619) 481-1477  
FAX (619) 481-6154  
info@nisus-soft.com; sales@nisus-soft.com  
ftp: ftp://ftp.nisus-soft.com/pub/nisus/  
WWW: http://www.nisus-soft.com/~nisus

MacQWERTY, 354

**Northgate Computer Systems, Inc.**  
10025 Valley View Road, Suite 110,  
Minneapolis, MN 55344  
(800) 548-1993

OmniKey Keyboards, 357

**Northport, Inc.**  
3701 South Cedar Drive, Excelsior, MN  
55331  
(612) 474-7996  
FAX (612) 474-7996

ADJUSTable, 541

**Oakland Schools-Communication  
Enhancement Center**  
Attn. Ina Kerstain, 2100 Pontiac Lake Road,  
Waterford, MI 48328  
(810) 858-1901

Oakland Schools Picture Dictionary, 92

**OMS Development**  
610-B Forest Avenue, Wilmette, IL 60091  
(708) 251-5787  
(800) 831-0272  
FAX (708) 251-5793  
ebholman@metcom.com

EEK, 383  
Keycache, 348  
SwitchMouse, 443  
Tinytalk, 486

**Optelec USA, Inc.**  
6 Lyberty Way, P.O. Box 729, Westford, MA  
01886  
(800) 828-1056  
(508) 392-0707

LP-DOS & LP-Windows, 498

**Optimal-Ed Learning Materials**  
1455 East Tropicana Avenue, 600, Las  
Vegas, NV 89119  
(702) 736-0706  
FAX (702) 263-1094

GrammarPlay with Alps and Droops, 607  
Wordplay with Alps and Droops, 732

**ORCCA Technology, Inc.**  
218 McDowell Road, Lexington, KY 40502  
(606) 268-1635  
FAX (606) 268-1635  
orcca@galileo.mix.net

EZ-TV Adapted Infrared Remote Control  
for Televisions, 276  
ScanLite, 53  
Snappy Switch, 247

**Origin Instruments Corporation**  
854 Greenview Drive, Grand Prairie, TX  
75050  
(214) 606-8740  
FAX (214) 606-8741  
HeadMouse, 394

**Park Surgical Company, Inc.**  
5001 New Utrecht Avenue, Brooklyn, NY  
11219  
(718) 436-9200  
FAX (718) 854-2431

Park Speech Amplifier, 7

**Parrot Software**  
6505 Pleasant Lake Court, West Bloomfield,  
MI 48322  
(800) 727-7681  
fweiner@interserv.com

Artonyms and Synonyms (Cognitive  
Disorders 12), 557  
Aphasia Series: I through VIII, 558  
Association Pictures, 559  
Attention, Perception & Discrimination  
Plus for Windows, 559  
Categories Plus for Windows, 569  
Category Discrimination and Reasoning  
Plus for Windows, 569

Category Naming and Completion Plus for Windows, 570  
 Cognitive Disorders I, II, III, IV, 573  
 Completion From Partial Information Plus for Windows, 581  
 Deductive Reasoning Plus for Windows, 587  
 Definitions Plus for Windows, 588  
 Function Pictures, 605  
 Functional Vocabulary Plus for Windows, 605  
 Hierarchical Attention Training, 608  
 Homographs, 609  
 Homophones, 609  
 Inferential Naming for Cognitive and Language Disorders, 611  
 Inferential Naming Plus for Windows, 612  
 Initial Phoneme Cuing for Aphasics, 613  
 Mastering Personal Information (MPI), 629  
 Memory for Animated Sequences Plus for Windows, 632  
 Minimal Contrast Stories Plus for Windows, 635  
 Minimal Contrast Therapy, 636  
 Multiple Meaning Words I Plus for Windows, 639  
 Multiple Meaning Words II Plus for Windows, 640  
 Opposites and Similarities Plus for Windows, 649  
 Picture Identification Plus for Windows, 654  
 Picture Naming Plus for Windows, 655  
 Pictures Programs: I, II and III, 656  
 Preposition Fill-Ins, 659  
 Reading Comprehension for Adolescents, 664  
 Rhyming Pictures, 665  
 Semantic Development Using Code Breaking Strategies, 670  
 Sentence Completion Plus for Windows, 670  
 Sorting by Category Plus for Windows, 676  
 Traffic Signs Plus for Windows, 694  
 Understanding Attributes, 697  
 Verb Fill-Ins, 698  
 Verbal Analogies, 698  
 Verbal Analogies Plus for Windows, 699  
 Visual Confrontation Naming Plus for Windows, 700  
 Visual Memory Plus for Windows, 701  
 Visual Pattern Memory Plus for Windows, 702  
 Word Association Plus for Windows, 706  
 Word Order in Sentences, 706  
 Word Order Plus for Windows, 707

**Passy-Muir, Inc.**  
 4521 Campus Drive, Suite 273, Irvine, CA 92715  
 (800) 634-5397  
 (714) 833-8255

Passy-Muir Speaking Valves, 8

**PC Compatibles**  
 30 Buxton Farm Road, Stamford, CT 06905  
 (800) 201-0613  
 (203) 461-9155  
 FAX (203) 461-9002  
 LAP CAT, 353  
 MOUSE PERCH, 355

WRIST PERCH, 368

**Penny & Giles Computer Products**  
 163 Pleasant St., Attleboro, MA 02703  
 (508) 226-3008

Hereward Tracker Ball & Joystick Module, 395

**Personal Data Systems, Inc.**  
 100 West Rincon Avenue, Suite 103, Campbell, CA 95008  
 (408) 866-1126  
 FAX (408) 866-1128

Audapter Speech System, 527

**Phone TTY, Inc.**  
 202 Lexington Avenue, Hackensack, NJ 07601  
 (201) 489-7889  
 TT/TDD (201) 489-7890

Multi-Line Dial-A-News System, 759  
 Phone-TTY CM-4 Computer Modem, 187

**Phonic Ear Inc.**  
 3880 Cypress Drive, Petaluma, CA 94954-7600  
 (800) 227-0735  
 (707) 769-1110

VOIS 160, 161

**Pitts Corporation**  
 4260 North 650 East, Provo, UT 84604  
 (801) 225-6441

Eye-Com, 83

**Polytel Computer Products Corporation**  
 1287 Hammerwood Ave., Sunnyvale, CA 94089  
 (408) 745-1540  
 FAX (408) 745-6340

Keypon 176, 403  
 Keypon 300, 404  
 Keyport 60, 404

**Poppin and Company**  
 Communication Materials, Box 5439, Arlington, VA 22205  
 (703) 533-9627

DynaSyms, 82  
 PICSYMS Categorical Dictionary, 100

**PosturMate, Inc.**  
 P.O. Box 6907, Eureka, CA 95502-6907  
 (707) 445-4841

Variable Height Desk, 552

**Prentke Romich Company**  
 1022 Heyl Road, Wooster, OH 44691  
 (800) 262-1933  
 OH (216) 262-1984

Air Cushion Switch (Single or Dual), 203  
 AlphaTalker, 119  
 Arm Slot Control, 205  
 Call Signal 2, 314  
 Control 1, 272  
 Custom Keyguard, 336  
 Daessy Desktop Mount, 166  
 Daessy Folding Mount, 166  
 DeltaTalker, 127

Dual Rocking Lever Switch, 216  
 HeadMaster Plus, 393  
 HECS-1, 282  
 Jouse, 400  
 Keyboard Interfaces, 458  
 KeyREP, 351  
 Liberator, 137  
 MIKE (Mouse Interface & Keyboard Emulation), 415  
 Mini Rocking Lever Switch, 232  
 Minspeak Application Programs (MAP), 759  
 P-Switch, 235  
 Pneumatic Switch, 240  
 PRC Joystick, 241  
 Scanning Director, 293  
 Scanning X-10 Powerhouse, 294  
 ScreenDoors, 438  
 Single Rocking Lever Switch, 246  
 T-TAM Keyboard and Mouse Emulator, 463  
 Tongue Switch, 253  
 Training Aid 2, 61  
 Versascan, 63  
 Viewpoint Optical Indicator, 26  
 WalkerTalker, 161  
 WCMK, 176  
 WiViK 2.0 (Windows Visual Keyboard), 450  
 WiVox, 772  
 Wobble Switch, 259  
 WordWriter, 368

**Productivity Software International**  
 211 East 43rd Street #2202, New York, NY 10017  
 (212) 818-1144  
 FAX (212) 818-1197

PECK Computer Software, 359  
 PRD+ (Productivity Plus) Basic Edition, 360

**ProHance Technologies, Inc.**  
 1558 Siesta Drive, Los Altos, CA 94024  
 (415) 967-5774

Serial Trackball and PS/2 Trackball, 439

**Psychological Software Services, Inc.**  
 6555 Carrollton Avenue, Indianapolis, IN 46220  
 (317) 257-9672

Foundations I, 604  
 Foundations II, 604  
 Memory I, 632  
 Memory II, 633  
 Problem Solving I, 661  
 Visuospatial Skills I, 702  
 Visuospatial Skills II, 703

**Quartet Technology, Inc.**  
 11 School Street, N. Chelmsford, MA 01863  
 (508) 692-9313  
 FAX (508) 251-4951

Simplicity Series ECUs, 295  
 Voice Mouse/Keyboard (VMK) Controller, 448

**R.D. Clark, Inc.**  
 1902 E. Cove Court, Findlay, OH 45840-6607  
 (419) 422-3487  
 Nu-Vue-Cue, 92



**R.J. Cooper & Associates**  
 24843 Del Prado, Suite 283, Dana Point, CA  
 92629  
 (714) 240-1912  
 (800) RJCOOPER  
 FAX (714) 240-9785  
 rjcoop@aol.com

101 Animations, 556  
 Adult Switch Progressions, 556  
 Biggy, 741  
 Build-A-Scene, 567  
 Children's Switch Progressions, 572  
 CrossScanner, 455  
 Early and Advanced Switch Games, 590  
 Find the Buttons, 597  
 Human Being Machine, 610  
 Joystick Trainer, 616  
 Magic Arm System, 169  
 Picture Scanner, 655  
 Picture/Theme Disks, 656  
 Point to Pictures, 657  
 Spell-A-Word & 2+2, 727  
 Switch-Adapted Mouse (SAM), 442  
 Teenage Switch Progressions, 689  
 Turn-Talking, 695

**Raised Dot Computing**  
 408 S. Baldwin Street, Madison, WI 53703  
 (608) 257-9595  
 (800) 347-9594  
 FAX (608) 257-4143  
 cnavy@delphi.com  
 WWW: <http://www/well.com/www/dnavy>

BEX 3.1, 739  
 MegaDots, 757  
 Talk-to-Me Tutorial Cassettes, 551

**RAPIDTEXT, Inc.**  
 230 Newport Center Drive, Suite 250,  
 Newport Beach, CA 92660-7510  
 (714) 644-6500  
 TT/TDD (714) 644-7131  
 FAX (714) 644-5706

RAPIDTEXT, 763

**Reading Technology**  
 9269 Mission Gorge Road, Suite 108, Santee,  
 CA 92071  
 (619) 491-2142  
 Infovox 500, 700 & 750, 531

**Safko International, Inc.**  
 1438 W. Broadway, Suite B240, Tempe, AZ  
 85282  
 (602) 731-9805  
 FAX (602) 731-9835  
 safkoint@eworld.com  
 SenSei System, 295

**Sammons-Preston Corporation**  
 P.O. Box 89, Jackson, MI 49204  
 (800) 631-7277  
 (517) 787-1600

Adjustable Head Pointer PC 7590, 16

**Seantron Quality Computers**  
 20200 E. Nine Mile Road, Saint Clair Shores,  
 MI 48080  
 (800) 443-6697

Talking Sensible Speller, 765  
 TimeOut UltraMacros, 366

**ScottBridge, Inc.**  
 405 El Camino Real, #113, Menlo Park, CA  
 94025  
 (415) 813-0561  
 FAX (415) 424-8456  
 ngscott@arch.stanford.edu

ScottBridge Speech Access System, 438

**See A Need**  
 8864 Kalmar Drive, Colorado Springs, CO  
 80920  
 (719) 282-0141

RedLite, 24

**Sentient Systems Technology, Inc.**  
 2100 Wharton Street, Suite 630, Pittsburgh,  
 PA 15203  
 (412) 381-4883  
 (800) 344-1778  
 FAX (412) 381-5241

DigiTalk 1, 127  
 DigiVox, 128  
 DynaVox2 & DynaVox2c, 129  
 DynaVox2 DOS & DynaVox2 Mac, 129

**Siemens Hearing Instruments, Inc.**  
 6 East Piper Lane, Suite 128, Prospect  
 Heights, IL 60070  
 (800) 333-9083  
 (708) 808-1200  
 FAX (708) 808-1299  
 SERVVOX Inton, 9

**Silent Call Corporation**  
 P.O. Box 868, Clarkston, MI 48347-0868  
 (313) 673-0221

Omni Page System, 320  
 Personal Alert Receiver, 322  
 SideKick Receiver, 325  
 Vibra-Call Receiver, 326

**Simple Works**  
 PO Box 719, Mount Desert, ME 04660-0719  
 (207) 244-3263  
 FAX (207) 244-3265  
 70310.171@compuserve.com;  
 2726865@mcimiac.com  
 Prefix, 360

**Simtech Publications**  
 134 East Street, Litchfield, CT 06759  
 (203) 567-1173  
 switchcdon@aol.com  
 WWW: <http://www.tiac.net/users/simtech>

New Frog & Fly, 644  
 One Switch Picasso, 648  
 Scan & Match 1, 2, 3, and 4, 667  
 Scanning Picasso, 668  
 Switch Arcade, 682  
 Switch Puzzles, 684

**SkiSoft Publishing Corporation**  
 1644 Massachusetts Avenue, Suite 79,  
 Lexington, MA 02173  
 (800) 662-3622  
 (617) 863-1876

Eye Relief, 750

**SLED Software**  
 P.O. Box 16322, Minneapolis, MN 55416  
 (612) 926-5820

Complete Spelling Program, 716

**Softar Corporation**  
 23 Sunset Road, Winchester, MA 01890  
 (617) 721-1010  
 FAX (617) 721-2590

K-U-I, 401

**SoftTouch/kidTECH**  
 4182 Piewood Lake Drive, Bakersfield, CA  
 93309

(805) 396-8676  
 FAX (805) 396-8760

MusicWare, 640  
 MusicWare - Age Appropriate, 641  
 Shell Game & Mouse Game, 672

**Sound Advice Systems, Inc.**  
 9405 Parklind Drive, St. Louis, MO 63126  
 (314) 286-3800  
 FAX (314) 892-3930

Sound Advice System, 326

**SPECTECH**  
 P.O. Box 1369, Greenwood, IN 46142  
 (800) 765-7483  
 (317) 888-1159  
 FAX (317) 888-0315  
 stvas@aol.com

ReadyScan, 147

**Speech Systems for the Blind**  
 76 Wheaton Drive, Attleboro, MA 02703  
 (508) 226-0447  
 73030.3644@compuserve.com

Seekline, 483  
 WINKLINE, 489

**SSK Technology, Inc.**  
 5619 Scotts Valley Drive, Suite 280, Scotts  
 Valley, CA 95066  
 (800) SSK-0579  
 TT/TDD (800) 775-1630

Writalk Electronic Pen Pad, 197

**Stanton Magnetics**  
 101 Sunnyside Boulevard, Plainview, NY  
 11803  
 (516) 349-0235  
 FAX (516) 349-0230

ADDvox III System, 3

**Stone Age Software, Inc.**  
 P.O. Box 7700374, Coral Springs, FL 33077-  
 0374  
 (305) 340-6845  
 FAX (305) 340-6845

Scanning Conversion Program, 550

## Index 5: MANUFACTURERS Listed with their Products

**Subtle Impact Software, Inc.**  
7195 Sand Trap Drive, Colorado Springs, CO  
80925  
(719) 382-5437  
TT/TDD (719) 382-5437  
FAX (719) 382-5437  
subtle@usa.net;  
73424.2367@compuserve.com  
Subtle Messages, 680

**SunBelt Industries, Inc.**  
1254 Fish Hook Way, Ponte Vedra Beach, FL  
32082  
(904) 285-4788  
FAX (904) 285-9882  
TextGrabber, 768

**Sunburst Communications, Inc.**  
101 Carleton St., Pleasantville, NY 10570  
(800) 321-7511  
FAX (914) 747-4109  
sunburst4@aol.com;  
sunburst.svc@applelink.apple.com

Magic Slate II, 756  
Muppet Learning Keys, 423

**Suncom Technologies**  
6400 West Gross Point Road, Niles, IL  
60648  
(708) 647-4040  
FAX (708) 647-7828  
Iconroller, 396

**Support Engineering Associates**  
P.O. Box 7184, 109 Fourth Street, Bldg. 4,  
Garden City, NY 11530  
(516) 741-7560  
Support Station, 173

**Switch In Time**  
101 Clay Street, Cambridge, MA 02140  
(617) 354-6577  
SwitchEnsemble, 385

**Symbol Graphics**  
1047 West 6th Street, Corona, CA 91720  
(909) 736-4040  
FAX (909) 737-0652  
Letter Art with Braille Translator, 755

**Synergy**  
66 Hale Road, East Walpole, MA 02032  
(508) 668-7424

Synergy Integrated Remote, 298  
SynergyMac and SynergyPC, 444

**Syntha-Voice Computers Inc.**  
9009-1925 Pine Street, Niagra Falls, NY  
14301  
(905) 662-0565  
(800) 263-4540  
BBS (905) 662-0569  
FAX (905) 662-0568  
help@synthavoices.on.ca  
ftp: synthavoices.on.ca  
Panorama, 500  
Powerama, 501  
Slimware, 484  
Slimware Window Bridge, 484

**T.V. Raman**  
(617) 692-7637  
raman@crl.dec.com  
WWW:  
http://www.cr.dec.com/crl/people/biographies  
/raman.html  
Emacspeak, 472

**Tapeswitch Corporation**  
100 Schmitt Boulevard, Farmingdale, NY  
11735  
(516) 694-6312  
FAX (516) 594-6304

Air Wave Switch, 204  
Controflex Foot Switches, 211  
Controflex Ribbon Switches, 211  
Flexswitch II, 220  
Normally Closed Sensing Cell, 234  
Normally Open Sensing Cells, 234  
Super-Sensitive Normally Open  
Switch, 250  
Touch Pads, 254

**TASH, Inc.**  
91 Station Street, Unit 1, Ajax, ON L1S 3H2  
CANADA  
(905) 686-4129  
(800) 463-5685  
FAX (905) 686-6895  
tashcan@aol.com

Ability Switch Tester (5955), 29  
Bloorview Miniature Keyboard, 379  
Buddy Button (5710-5773), 207  
Call Bell (4500), 314  
Cap Switch (5806), 208  
Comboard (2615), 36  
Cup Switch (5807), 212  
Cylindrical Touch Switch (5300), 213  
Disk Guide (2485), 545  
E.A.S.I. dialer (2110), 274  
Flex Switch (5855), 219  
Governor (2464), 547  
Grasp Switch (5865), 220  
Intercom (4392), 318  
JDN Shorthand (5073), 346  
Joystick with Pad Switch (5012), 225  
Keyguard, 349  
Keylocks, 350  
Keypad (2425), 45  
Kincontrol (4105), 284  
King Keyboard (2440), 405  
Leaf Switch (5860), 227  
MacKing, 409  
MacMini, 410  
Micro Light Switch (5850), 231  
Mighty Mount, 169  
Mini Cup Switch (5808), 232  
Mini Joystick with Push Switch  
(5020), 232  
Mini Keyboard (2443 or 2450), 416  
MouseMover - Mac (5005), 420  
MouseMover - PC Windows (5004), 421  
Next Page Page Turner (4600), 287  
Penta Switch (5024), 236  
Pillow Switch (5875), 237  
Plate Switch (5830-34), 238  
Pneumatic Switch (5100, 5101), 241  
RELAX (8200), 291  
Rocker Switch (5505), 243  
Round Pad Switch (5805), 244  
Soft Switch (5820, 5821), 247  
Square Pad Switch (5810), 248  
Star Switch (5026), 249  
Switch Latch (4388), 56

TASH Mounting Parts, 175  
Tip Switch (5840), 253  
Toy Cables (4378, 4379), 60  
Treadle Switch (5880), 255  
Ultra 4 Remote System & Scanning Ultra  
4, 302  
VoiceMate, SwitchMate, ScanMate  
(2701-2708), 64  
Wafer Switch (5018), 258  
WinKing Keyboard (2448F, 2448Q), 438  
WinMini Keyboard (2447F, 2447Q), 450

**Teacher's Institute for Special Education**  
2947 Bayside Court, Wantagh, NY 11793  
(516) 781-2020  
FAX (516) 781-4070

Keyboarding by Ability, 617  
Keyboarding for Individual  
Achievement, 617  
Keyboarding for People with Cerebral  
Palsy, 618  
Keyboarding with One Hand, 619

**TechnoGenesis, Inc.**  
P.O. Box 11976, Prescott, AZ 86304-1976  
(520) 778-5611  
(520) 776-4248  
FAX (520) 778-2423  
High Tech/Low Cost, 223

**Technology for Language and Learning,  
Inc.**  
P.O. Box 327, East Rockaway, NY 11518  
(516) 625-4550  
FAX (516) 621-3321  
Special Education Public Domain  
Software, 677

**Telecom International**  
28302 Industrial Boulevard, #H, Hayward,  
CA 94545  
(510) 785-4000  
Porta Printer Plus, 187  
PortaView, 188  
TeleView 40 & 80, 193

**TeleSensory Corporation**  
455 North Bernardo Avenue, P.O. Box 7455,  
Mountain View, CA 94039  
(415) 960-0920  
(800) 804-8004

BrailleMate 2, 470  
David, 471  
DM80/FM, 511  
INKA, 513  
Optacon II, 518  
OsCaR, 429  
PowerBraille 40, 65, & 80, 519  
ScreenPower, 482  
ScreenPower for Windows, 483  
TeleBraille III, 193  
Vantage CCD, 502  
VersaPoint-40 Braille Embosser, 522  
Vista, 502

**Temasek Telephone, Inc.**  
21 Airport Blvd., Suite G, South San  
Francisco, CA 94080  
(415) 875-6666  
(800) 647-8887  
Sapura S2000 CL, 293

**Tenax Software Engineering**  
2103 Software Engineering, Suite 141.  
Olympia, WA 98502  
(360) 866-1686

Vortex Machine Assisted Reader  
Software, 703

**TFI Engineering**  
529 Main Street, Boston, MA 02129  
(800) 843-6962  
(617) 242-7007  
FAX (617) 242-2007  
Myna, 478

**Therapeutic Toys, Inc.**  
P.O. Box 418, Moodus, CT 06469  
(800) 638-0676

Activity Boxes, 30  
Body Parts Switch, 206  
Cushion Switch, 213  
Grip Switch, 221  
Plate Switches, 240  
Signal Buzzer Plate, 246  
Six Position Activity Box, 55  
Three Position Activity Box, 58

**TIGER Communication System, Inc.**  
328 Main Street East, Suite 514, Rochester,  
NY 14604  
(800) 724-7301

PEACEbook, 97  
Personal Trainer, 145  
Specialist, 153

**Tolfa Corporation**  
1001 N. Rengstorff Avenue, Mountain View,  
CA 94043  
(415) 390-9566  
Lingraphica, 139

**Touch Turner**  
443 View Ridge Dr., Everett, WA 98203  
(206) 252-1541  
FAX (206) 259-4390  
Touch Turner, 301

**Toys for Special Children, Inc.**  
385 Warburton Avenue, Hastings-on-Hudson,  
NY 10706  
(914) 478-0960  
(800) 832-8697

Air Cushion Switch, 203  
AND Module, 31  
Apple Computer Input Adapter, 453  
Battery Interrupter, 33  
Button Switch, 208  
Cheap Talk 4 & 8, 124  
Clear Clock Communicator, 35  
Clock Communicator, 36  
Compartmentalized Clock  
Communicator, 38  
Compartmentalized Communicator, 38  
Computer Keyboard Switch, 210  
Computer Switch Plate, 210  
Continuous Movement Switch  
(CMS), 210  
Counter Module, 39  
Double Sip & Double Puff Switches, 214  
Double Touch Switch, 215  
Dual Clock Communicator, 42  
Finger Isolation Button, 218  
Grip & Puff Switch, 220

Gripper Prehensor, 18  
Head Switch, 222  
Intention Module, 44  
Intention Switch, 223  
Invertor Module, 44  
Joystick, 224  
Keyboard Covers, 347  
Leaf Switch, 227  
Lighted Extra Loud Signalling  
Buzzer, 319  
Lighted Signalling Buzzer, 319  
Lighted Vibrating Signalling Buzzer, 46  
Multi-Switch Module, 47  
Music Button, 48  
Nine Compartment Row/Column  
Scanner, 48  
Nine Volt Battery Adapter Module, 49  
Nintendo & Super Nintendo Joystick  
Module, 425  
On/Off Module, 49  
Overhead Pull Switch, 235  
Petite Pillow Switch, 236  
Photocell Switch, 236  
Pinch Switch, 237  
Plate Switch, 238  
Plate Switch On Stand, 239  
PlayMAGIC, 460  
Pull Switch, 242  
Puzzle Switches, 51  
Rhythm Generator, 52  
Rocking Plate Switch, 244  
Roller Switch Music Box, 244  
Round Clock Communicator, 53  
Sequential Scanner, 54  
Shadow Talker, 151  
Signal Buzzer, 325  
Signal Switch, 246  
Single-Appliance Continuous Control  
Unit, 296  
Single-Switch Multi-Appliance Control  
Unit & Modules, 296  
Single-Switch TV Control Unit, 297  
Sip & Puff Switch, 247  
String Switch, 250  
Switch Module, 153  
Switch Mounting Hardware, 173  
Talking Switch Plates, 157  
Tilt Switch, 252  
Timer Module, 59  
Tongue Switch, 253  
Tubular Vibrator, 62  
Twitch Switch, 256  
Ultimate Switch, 256  
Universal Input Adaptor, 464  
Universal Module, 63  
Vertical Plate Switch, 257  
Vertical Wobble Switch, 257  
Vibrating Switch, 64  
Voice Activated Switch, 258  
Wireless V & VCR Remote  
Controls, 306  
Wobble Switch, 259

**Trace Center**  
S-151 Waisman Center, 1500 Highland  
Avenue, Madison, WI 53705  
(608) 262-5966  
TT/TDD (608) 263-5408  
FAX (608) 262-8848  
info@trace.wisc.edu  
ftp://ftp.trace.wisc.edu  
Gopher: trace.wisc.edu  
WWW: http://www.trace.wisc.edu/  
Trace Beeper Box, 61

**Trademark Medical**  
1053 Headquarters Park, Fenton, MO 63026  
(800) 325-9044  
FAX (314) 349-3294  
Silent Speaker, 108

**Trask Office Products**  
31 Maple Street, Brandon, VE 05733  
(802) 247-6747  
One-Hand Keyboard Package, 358

**Trident Technologies**  
3309 Winthrop #85, Fort Worth, TX 76116  
(817) 738-2485  
Personal Communication Terminal  
(PCT), 186

**Typewriting Institute for the Handicapped**  
3102 W. Augusta Avenue, Phoenix, AZ  
85051  
(602) 939-5344  
Dvorak Computer Keyboard, 337  
Dvorak One-Hand Typewriter, 128

**UCLA Microcomputer Project**  
23-10 Rehabilitation Center, 1000 Veteran  
Avenue, Los Angeles, CA 90024  
(310) 825-4821  
FAX (310) 206-7744

Big/Little I and II, 562  
Buddy's Body, 566  
Community Vehicles, 580  
Dinosaur Game, 589  
Early Concepts, 590  
Eency-Weency Spider Game, 593  
Every Day Is A Holiday, 595  
Family Fun, 596  
Fast Food Game, 596  
Feelings, 597  
Getting Clean with Herkimer Level I, II,  
III, 607  
If You're Happy and You Know It, 610  
Let's Go Shopping I and II, 624  
Listen With Your Ears, 626  
Occupations, 645  
Old MacDonald's Farm I and II, 646  
Padded Food, 650  
Padded Vehicles, 651  
Paper Dolls I and II, 651  
Pick-A-Meal, 653  
Pictalk, 653  
PcwerTalker, 658  
Rockets to the Moon, 666  
Scan It - Switch It, 668  
Seasons, 669  
Seek & Find, 669  
Sight Words, 672  
Silly Sandwich, 673  
Son of Seek and Find, 676  
Switch Arcade, 682  
Switch It - Change It, 683  
Switch It - See It, 684  
Tea Party, 688  
This is the Way We Wash Our Face, 691  
This Old Man, 691  
Wheels On The Bus I, II, III, 704  
Wheels on the Bus I, II, III - Intellipics  
Activity, 704  
Wheels on the Bus: COMPLETE, 705  
Where is Puff?, 705  
Worm Squirm, 708  
Zoo Time, 709

## Index 5: MANUFACTURERS Listed with their Products

**Ultratec, Inc.**  
450 Science Drive, Madison, WI 53711  
(608) 238-5400

Compact TTY, 180  
Intele-Modem, 182  
Minicom IV, 184  
Miniprint 425, 185  
Pay Phone TTY, 186  
Supercom 4400 TTY, 190  
Superprint 100, 200, 400, 190  
Superprint 4425, 191  
Superprint ES TTY, 191  
TDD Detector, 192  
Uniphone 1000, 195  
Watchman Master, 327

**UNITED Educational Services, Inc.**  
P.O. Box 1099, Buffalo, NY 14224  
(800) 458-7900  
(716) 853-1287  
FAX (716) 853-1287

Rate Drill in Articulation, Language and Fluency, 663

**USA Company**  
Lock Box 9669, Marina Del Ray, CA 90295  
(310) 397-4217

AlertCom, 311

**Van Duerr Discovery Industries**  
426 Broadway, Suite 207, Chico, CA 95928  
(800) 597-2003  
TT/TDD (916) 893-1560  
FAX (916) 893-1560

Comfortype, 336

**Variety Ability Systems, Inc. (VASI)**  
3701 Danforth Avenue, Scarborough  
(Toronto), ON MIN 2G2 CANADA  
(416) 698-1415  
(800) 891-4514  
FAX (416) 698-5860

Moulded Plastic Wheelchair Tray, 170

**Various (Generic Product)**  
Sources vary - see product description

Adapted Telephone Interfaces, 268  
Amplifiers, 3  
Calendars, 74  
Cognitive Rehabilitation Software, 573  
Communication Symbol Holders, 79  
Computer Workstation Furniture, 544  
Custom-Made Switches, 213  
Digitized Speech Message Machines, 316  
Environmental Control for Kids, 43  
Environmental Control Units, 275  
Ergonomic Keyboard Systems, 384  
Handheld Computers and Personal Organizers, 133  
Handpointers, 19  
Home Control Systems, 282  
Home Intercom Systems, 317  
Laptrays, 168  
Light Pointers, 23  
Low-Tech Adaption Materials, 168  
Media Handling Products, 549  
Memory Button Telephones, 285  
Portable Telephones, 289  
Single Switch Software, 675  
Speaker Phones, 298  
Switch Mounts, 174  
Universal Remote Controls, 303

Writing Utensil Grips, 113

**Verbex Voice Systems**  
1090 King Georges Post Road, Building 107,  
Edison, NJ 08837  
(800) 275-8729

Listen for Windows, 409

**VisuAide**  
841 Jean-Paul Vincent Boulevard, Longueuil,  
PQ J4G 1R3 CANADA  
(514) 463-1717  
FAX (514) 463-0120

IRIS Reading Interface 3.0, 399  
Magnum, 477

**Voice Connection**  
17971 Skypark Circle, Suite F, Irvine, CA  
92714  
(714) 261-2366  
FAX (714) 261-8563

HAL (Home Automation Link), 392  
IntroVoice V, 398  
IntroVoice VI, 399  
Micro IntroVoice, 413  
Micro IntroVoice II, 414

**Voice Recognition Technologies**  
Computer Voice Systems Division, 220  
Henley Road, Woodmere, NY 11598-2523  
(516) 295-3230  
FAX (516) 295-3230  
quantaryt@aol.com

Speech Recognition Systems, 441

**VOILA Technology, Inc.**  
54 Castle Road, Rochester, NY 14623  
(716) 321-1451

Speak Out VOILA, 440

**Wayne County Regional Education Service Agency**  
ADAMLAB, 33500 Van Born Road, Wayne,  
MI 48184  
(313) 467-1415  
FAX (313) 326-2610

A.I.P.S. Wolf (Alternate Input Peripheral System), 117  
BlackHawk, 122  
Hawk, 134  
Lynx, 140  
MegaWolf, 141  
WhisperWolf, 162

**Western Psychological Services**  
12031 Wilshire Blvd., Los Angeles, CA  
90025  
(800) 648-8857  
(310) 478-2061  
FAX (310) 478-7838

WPS Loquitur 115 and 250, 65

**WesTest Engineering Corporation**  
1470 N. Main St., Bountiful, UT 84010  
(801) 298-7100  
(801) 292-7379  
75054.1230@compuserve.com

DARCI TOO, 382

**Whitmyer Biomechanix, Inc.**  
848 Blountstown Highway, Suite H,  
Tallahassee, FL 32304  
(904) 575-5510  
FAX (904) 576-4798

Facial Switch, 218

**William K. Bradford Publishing Company, Inc.**  
16 Craig Road, Acton, MA 01720  
(508) 263-6996

Me Too!, 757

**Williams Sound Corporation**  
10399 West 70th Street, Eden Prairie, MN  
55344  
(612) 943-2252  
(800) 328-6190

Speechmaker, 10

**Willow Pond Tools, Inc.**  
Adaptive Division, P.O. Box 544, Pembroke,  
NH 03275  
(603) 485-2321  
FAX (603) 485-2303

Ergorest Articulated Forearm Rests, 340  
Generation IV Adjustable Computer Tables, 547

**Words+, Inc.**  
40015 Sierra Highway, Bldg. B-145,  
Palmdale, CA 93550  
(805) 266-8500

AudScan II, 121  
EZ Keys, 339  
Equalizer, 131  
Expanded Keyboard Emulator, 340  
Eyebrow Switch, 217  
FingerFoniks, 132  
IST Switch, 224  
KeyWiz, 352  
Magic Fingers, 354  
MessageMate 20, 141  
MessageMate 40, 142  
Mini-MessageMate, 144  
Morse Code WSKE II, 418  
Pegasus, 145  
Scanning WSKE II, 437  
System 2000, 154  
Talking Screen, 156  
Talking Screen for Windows, 157  
U-Control, 302  
Vocalite, 537

**WorkLink Innovations**  
2452 Armstrong Street, Livermore, CA  
94550  
(510) 606-3760  
FAX (510) 606-3769  
clairca@aol; claire@ix.netcom.com  
Access-1, 373

**World Communications**  
245 Tonopah Drive, Fremont, CA 94539  
(510) 656-0911

Freedom Writer, 752  
Help U Key, 394  
Help U Keyboard, 395  
Help U Type, 344  
Help U Type and Speak, 135  
I Can Speak, 136  
Mouse Keys, 419

**X-10 (USA), Inc.**

91 Ruckman Road Box 420, Closter, NJ  
07624-0420  
(201) 784-9700  
FAX (201) 284-9464

RC5000 Radio Home Control  
System, 291  
X-10 Home Control Interface, 306  
X-10 Powerhouse System, 307

**Xerox Imaging Systems, Inc.**

9 Centennial Drive, Peabody, MA 01960  
(800) 248-6550

BookWise, 468  
Reading AdvantEdge, 481  
Reading Edge, 435

**YES! Entertainment Corporation**

3875 Hopyard Road, Suite 375, Pleasanton,  
CA 94588  
(800) 222-9376

Yak Bak, 162

**Zygo Industries, Inc.**

P.O. Box 1008, Portland, OR 97207  
(800) 234-6006  
(503) 684-6006  
FAX (503) 684-6011

4-Plate Switch: CM-15, 201  
4-Pneumatic Switch: CM-17, 201  
4-Pushbutton Switch: CM-16, 201  
4-Switch Joystick: CM-19, 202  
5-Pushbutton Switch: CM-18, 202  
5-Tread Switch Slot Control: CM-  
50, 202  
Adaptive Fixtures Kit, 165  
Dual Plate Switch: CM-12, 215  
Dual Pneumatic Switch: CM-14, 215  
Dual Pushbutton Switch: CM-13, 216  
Emergency Call Alarm, 317  
Eye Transfer Communication System, 83  
GEWA FTB 108 Enlarged Keyboard, 391  
GEWA METB 121 Reduced Size  
Keyboard, 391  
Gewa Page Turner, 280  
Head Pointers: AD-1, AD-2, AD-3, 20  
Leaf Switch: CM-2/CM-7, 227  
Lever Switch: CM-8/CM-9, 228  
LightWRITER SL35, 138  
LightWRITER SL5, 138  
LightWRITER SL85, 139  
Macaw Series, 140  
Parrot, 144  
Plate Switch: CM-10, 239  
Polycom, 146  
Pushbutton Switch: CM-11, 243  
Scribe, 150  
Secretary, 151  
Steeper Communication/Teaching Aid, 56  
Switchboard, 154  
Telephone Holder & Line Connector, 300  
Thumb Switch: CM-5, 252  
Touch Switch: CM-4, 254  
Toy Adapter Cables: CA-9/CA-12/CA-  
16, 60  
Tread Switch: CM-1, 254

## **Index 6**

# **Alphabetical Listing of all Products**

This index contains an alphabetical listing of every product in the ResourceBook. The name of the manufacturer and page location of the product follow each entry. If you know the name of a product, this index provides a quick way to find out if it is in the ResourceBook.

- 1-Key (Neil Squire Foundation), 331  
 101 Animations (R.J. Cooper & Associates), 556  
 4-Plate Switch: CM-15 (Zygo Industries, Inc.), 201  
 4-Pneumatic Switch: CM-17 (Zygo Industries, Inc.), 201  
 4-Pushbutton Switch: CM-16 (Zygo Industries, Inc.), 201  
 4-Switch Joystick: CM-19 (Zygo Industries, Inc.), 202  
 5-Pushbutton Switch: CM-18 (Zygo Industries, Inc.), 202  
 5-Tread Switch Slot Control: CM-50 (Zygo Industries, Inc.), 202  
 911 Telephone Terminal (Luminaud, Inc.), 263  
 A.I.P.S. Wolf (Alternate Input Peripheral System) (Wayne County Regional Education Service Agency), 117  
 AbiliTech Commander IR (AbiliTech Inc.), 263  
 AbiliTech Commander X-10 (AbiliTech Inc.), 264  
 AbiliTech Communicator (AbiliTech Inc.), 264  
 AbiliTech Home Control System (AbiliTech Inc.), 265  
 Ability Switch Phone Sequencer (Easy Home Control), 265  
 Ability Switch Tester (5955) (TASH, Inc.), 29  
 Able-Phone 100WA (DQP, Inc.), 266  
 Able-Phone 1900 and 2000 (DQP, Inc.), 266  
 Able-Phone 6000SX (DQP, Inc.), 267  
 Able2Speak (Axis Corporation), 117  
 AbleOffice (CRT, Inc.), 541  
 Abovo PCD (D.C. & D., Inc.), 118  
 AC Adaptor FRE-103C (Creative Switch Industries), 29  
 Accent-MC (Aicom Corporation), 525  
 Accent-PC (Aicom Corporation), 525  
 Accent-SA (Aicom Corporation), 526  
 Access Pack for Microsoft Windows (Microsoft Corporation), 331  
 Access to Math (Don Johnston Incorporated), 713  
 Access-1 (WorkLink Innovations), 373  
 AccessBliss 2.2 (Blissymbolics Communication International), 69  
 AccessDOS (IBM Corporation), 332  
 Accularm (Hugh MacMillan Rehabilitation Centre), 311  
 ACS Headsets (ACS Communications), 267  
 ActionVoice (Ability Research, Inc.), 118  
 Activity Board (EKEG Electronics Company LTD), 30  
 Activity Boxes (Therapeutic Toys, Inc.), 30  
 Adap2U (AdapTek Interface), 373  
 ADAPTA-LAN (Microsystems Software Inc.), 374  
 Adapted Telephone Interfaces (Various (Generic Product)), 268  
 Adaptive Firmware Card Model G32c (Don Johnston Incorporated), 374  
 Adaptive Fixtures Kit (Zygo Industries, Inc.), 165  
 ADDvox III System (Stanton Magnetics), 3  
 ADJUSTable (Northport, Inc.), 541  
 Adjustable EZ Magnifier (Less Gauss Inc.), 493  
 Adjustable Head Pointer (Cleo of New York), 15  
 Adjustable Head Pointer (Fred Sammons, Inc.), 15  
 Adjustable Head Pointer PC 7590 (Sammons-Preston Corporation), 16  
 Adjustable Pressure Switch (Nassau Applied Technology Resource Center), 203  
 Adult Switch Progressions (R.J. Cooper & Associates), 556  
 Adventures of Jimmy Jumper - Prepositions (Exceptional Children's Software, Inc.), 557  
 Air Cushion Switch (Toys for Special Children, Inc.), 203  
 Air Cushion Switch (Single or Dual) (Prentke Romich Company), 203  
 Air Switch (Nassau Applied Technology Resource Center), 204  
 Air Wave Switch (Tapeswitch Corporation), 204  
 AlertCom (USA Company), 311  
 Alphabet Board Kit (Crestwood Company), 69  
 AlphaPad (New Breakthroughs), 70  
 AlphaSmart Pro (Intelligent Peripheral Devices, Inc.), 375  
 AlphaTalker (Prentke Romich Company), 119  
 ALVA Braille Terminals (HumanWare, Inc.), 507  
 Amplifiers (Various (Generic Product)), 3  
 AmTRAC (Microspeed Inc.), 375  
 Analog Switch Pad (Academic Software, Inc.), 204  
 AND Module (Toys for Special Children, Inc.), 31  
 And Or Box (Creative Switch Industries), 31  
 Antonyms and Synonyms (Cognitive Disorders 12) (Parrot Software), 557  
 APH Preser:s the Talking Apple Computer (American Printing House for the Blind (APH)), 558  
 APH Scientific Calculator: for Apple II Computers (American Printing House for the Blind (APH)), 737  
 APH/SEI Talking Software (American Printing House for the Blind (APH)), 713  
 Aphasia Series: 1 through VIII (Parrot Software), 558  
 Apple Adjustable Keyboard (Apple Computer, Inc.), 376  
 Apple Computer Input Adapter (Toys for Special Children, Inc.), 453  
 Apple IIGS Owner's Guide: Disk Edition (American Printing House for the Blind (APH)), 542  
 AppleWorks Manuals: Special Editions (American Printing House for the Blind (APH)), 542  
 Appointment Book (Attainment Company), 70  
 APT Automaddak Page Turner System (Maddak, Inc.), 268  
 Arithmetic 1, 2, and 3 with Speech (Life Science Associates), 714  
 Arm Slot Control (Prentke Romich Company), 205  
 Armslot Switch Controller ASC-5 (APT Technology, Inc.), 205  
 Artic TransBook (Artic Technologies), 467  
 Artic TransPort (Artic Technologies), 526  
 Artic TransType (Artic Technologies), 467  
 Articulating Drawers (AliMed Inc.), 332  
 ASAP (Automatic Speech Access Program) (MicroTalk Software), 468  
 ASCII-TDD Software (Gallaudet Research Institute-TAP), 179  
 ASER Ergonomic Keyboard Layout (AliMed Inc.), 333  
 Association Pictures (Parrot Software), 559  
 Atlantic 144 TTY (Atlantic Technologies, Inc.), 179  
 Atlas Speaks (Arkenstone, Inc.), 737  
 Attainment Communication Collection (Attainment Company), 71  
 Attainment Fifteen Talker (Attainment Company), 119  
 Attainment Five Talker & Talker Plus (Attainment Company), 120  
 Attainment Two Talker (Attainment Company), 120  
 Attention, Perception & Discrimination Plus for Windows (Parrot Software), 559  
 Audapter Speech System (Personal Data Systems, Inc.), 527  
 Audible Cursor Routine (Favin, David), 121  
 Audio Braille Game Tutorial (Access Unlimited), 560  
 AudScan II (Words+, Inc.), 121  
 Aurora 2.0 for DOS (Aurora Systems, Inc.), 376  
 Aurora for Windows (Aurora Systems, Inc.), 333  
 Auto Braille (Kansys, Inc.), 738  
 Auto Call Single Number Dialer (Ameriphone, Inc.), 312  
 Automatic Drapery Opener System (Makita), 269  
 B-Edit (Hexagon Products), 738  
 B-Pop (Hexagon Products), 493  
 Babysitting Basics (MCE), 560  
 BallPoint Mouse (Microsoft Corporation), 377  
 Basic Learning Skills Courseware (Conover Company), 714  
 BASS Switches (Don Johnston Incorporated), 205  
 BAT Personal Keyboard (Infogrip, Inc.), 377  
 Baton Laser Pointer (Innocomp), 16  
 Battery Adapter (Don Johnston Incorporated), 32  
 Battery Device Adapter (AbleNet, Inc.), 32  
 Battery Interrupter (Toys for Special Children, Inc.), 33  
 Battery Interrupters (Creative Switch Industries), 33  
 Be a Winner Series (Conover Company), 561  
 Beamscope (Florida New Concepts Marketing, Inc.), 494  
 Bear Jam (Dunamis, Inc.), 561  
 Bed Control (DBC-1) (APT Technology, Inc.), 269  
 Beep-in-Touch (Hersh & Treadgold), 312  
 Beeper (Crestwood Company), 313  
 BEST Faces (BEST, Inc.), 562  
 BËST Switch Interface (BEST, Inc.), 453  
 BEX 3.1 (Raised Dot Computing), 739  
 Big Button Bed Control (KY Enterprises), 270  
 BIG for 1-2-3 (Hexagon Products), 739  
 BIG for WordPerfect (Hexagon Products), 740  
 Big Keys (Greystone Digital), 378  
 Big Red, Yellow, Green, and Blue (AbleNet, Inc.), 206  
 Big-W (Hexagon Products), 494  
 Big/Little I and II (UCLA Microcomputer Project), 562  
 Big/Calc (Don Johnston Incorporated), 740  
 Biggy (R.J. Cooper & Associates), 741  
 BIGmack (AbleNet, Inc.), 122  
 BioMuse (BioControl Systems, Inc.), 378

- BlackHawk (Wayne County Regional Education Service Agency), 122
- BlissWrite (Blissymbolics Communication International), 741
- Blissymbol Templates (Blissymbolics Communication International), 71
- Blissymbol Vocabulary Stamps (Blissymbolics Communication International), 72
- Blissymbols Gallery (Don Johnston Incorporated), 72
- Blocks in Motion (Don Johnston Incorporated), 563
- Bloorview Miniature Keyboard (TASH, Inc.), 379
- Blueprint for Decision Making (MCE), 563
- Boardmaker 3.0 (Mayer-Johnson Company), 72
- Boardmaker for Windows (Mayer-Johnson Company), 73
- Body Builder (Dunamis, Inc.), 564
- Body Parts Switch (Therapeutic Toys, Inc.), 206
- Body Switch BS-1 (APT Technology, Inc.), 206
- BookWise (Xerox Imaging Systems, Inc.), 468
- Bozons' Quest (Laureate Learning Systems, Inc.), 564
- Bradley Board Communication Aid (Bradley Enterprises), 74
- Braille 'n Speak (Blazie Engineering), 469
- Braille 'n Speak Classic (American Printing House for the Blind (APH)), 469
- Braille Blazer (Blazie Engineering), 507
- Braille BookMaker and Braille Express 100 & 500 (Enabling Technologies Company), 508
- Braille Keypop Labels (HooLeon Corporation), 334
- Braille Lite (Blazie Engineering), 470
- Braille Tutorial (Hexagon Products), 565
- Braille-N-Print (HumanWare, Inc.), 508
- Braille-Talk (GW Micro), 742
- Braille-Term Program (Blazie Engineering), 742
- BrailleAccess (Access Systems International, LTD), 509
- Brailled Keyboard Model—Apple IIe (American Printing House for the Blind (APH)), 543
- Brailled Keyboard Overlay for the Apple II GS (American Printing House for the Blind (APH)), 334
- BrailleMate 2 (TeleSensory Corporation), 470
- BRAILLEX-2D (ATR/JWA, Inc.), 509
- Braillo 200 (American Thermoform Corporation), 510
- Braillo 400 S (American Thermoform Corporation), 510
- Braillo Comet (American Thermoform Corporation), 511
- Breakthrough to Language: Clinical Edition (Creative Learning, Inc.), 565
- Breakthrough to Language: Home Edition (Creative Learning, Inc.), 566
- Breakthru Box (EKEG Electronics Company LTD), 379
- Breath Input Device (Neil Squire Foundation), 207
- Buddy Button (5710-5773) (TASH, Inc.), 207
- Buddy's Body (UCLA Microcomputer Project), 566
- Build-A-Scene (R.J. Cooper & Associates), 567
- Business Vision (Artic Technologies), 471
- Butler-in-a-Box (AVSI), 270
- Button Switch (Creative Switch Industries), 207
- Button Switch (Toys for Special Children, Inc.), 208
- Buzzer Box (Kapable Kids), 34
- Cafet-for-Voice (Cafet, Inc.), 567
- Calc-Talk (GW Micro), 743
- Calcworthy (GW Micro), 743
- Calendars (Various (Generic Product)), 74
- Call Alert Model CA-100 (Ameriphone, Inc.), 313
- Call Bell (4500) (TASH, Inc.), 314
- Call Signal 2 (Prentke Romich Company), 314
- CallText 5000 (Centigram), 527
- CAMEO (J.E. Stewart), 715
- Canon Communicator CC-7S and CC-7P (Canon U.S.A., Inc.), 123
- CanSpeak (CanSpeak), 568
- Cap Switch (5806) (TASH, Inc.), 208
- Capacitive Touchplate Interface (Hugh MacMillan Rehabilitation Centre), 208
- Captain's Log: Cognitive Training System (BrainTrain), 568
- Card Communicator (Crestwood Company), 34
- Career English (Conover Company), 715
- CarpalRest (Fox Bay Industries, Inc.), 335
- CarryCom (Great Talking Box Company), 123
- Categories Plus for Windows (Parrot Software), 569
- Category Discrimination and Reasoning Plus for Windows (Parrot Software), 569
- Category Naming and Completion Plus for Windows (Parrot Software), 570
- Cause & Effect (Judy Lynn Software), 570
- Cause 'n Effect (Marblesoft), 571
- CAV-ASL (E & IS SignWare), 571
- CCT Environmental Control (Consultants for Communication Technology), 271
- Chain Talk (Crestwood Company), 75
- Cheap Talk 4 & 8 (Toys for Special Children, Inc.), 124
- Checkbook Program (Blazie Engineering), 744
- Children's Switch Progressions (R.J. Cooper & Associates), 572
- Chime Alarm (Don Johnston Incorporated), 315
- Chime Box (Creative Switch Industries), 35
- CINTEX 1 (NanoPac, Inc.), 744
- CINTEX2 (NanoPac, Inc.), 271
- Circletime Tales & Circletime Tales Deluxe (Don Johnston Incorporated), 572
- Cirque GlidePoint Trackpads (Cirque), 380
- Clamp-On Bump Switch (Luminaud, Inc.), 209
- Classic Paddle Switch (Creative Switch Industries), 209
- Clear Clock Communicator (Toys for Special Children, Inc.), 35
- Clear-View Head Pointer (Fred Sammons, Inc.), 17
- Cleo Communication Board (Cleo of New York), 75
- ClickIt! (IntelliTools, Inc.), 454
- Clock Communicator (Toys for Special Children, Inc.), 36
- CloseView (Apple Computer, Inc.), 495
- Co-Writer (Don Johnston Incorporated), 745
- Cognitive Disorders I, II, III, IV (Parrot Software), 573
- Cognitive Rehabilitation Software (Various (Generic Product)), 573
- Cogrehab Vol. 1 (Life Science Associates), 574
- Cogrehab Vol. 2 (Life Science Associates), 574
- Cogrehab Vol. 3 Version 2.0 (Life Science Associates), 575
- Cogrehab Vol. 4 (Life Science Associates), 575
- Cogrehab Vol. 5 (Life Science Associates), 576
- Cogrehab Vol. 6 (Life Science Associates), 576
- Cogrehab Vol. 7: Quest (Life Science Associates), 577
- Coil Spring Wobble Stick Switch (Creative Switch Industries), 209
- COINSNKEYS (Castle Special Computer Services, Inc.), 577
- Color Find (Exceptional Children's Software, Inc.), 578
- Colorful Concept Software (Attainment Company), 578
- Colors and Shapes (BEST, Inc.), 579
- Combination Braille/Large Print Keypop Labels (HooLeon Corporation), 335
- Comboard (2615) (TASH, Inc.), 36
- Comfort Keyboard System (Health Care Keyboard Company), 380
- Comfortype (Van Duerr Discovery Industries), 336
- Communication Binder (Mayer-Johnson Company), 76
- Communication Board (Graley Marketing), 76
- Communication Board Builder (Mayer-Johnson Company), 77
- Communication Displays for Engineered Preschool Env. (Mayer-Johnson Company), 77
- Communication Folder and Tri-Folder (Mayer-Johnson Company), 78
- Communication Icon Galleries CD-ROM (Don Johnston Incorporated), 78
- Communication Programs (Favin, David), 124
- Communication Sheets (Fred Sammons, Inc.), 79
- Communication Station (D.J. Technical Sales, LTD), 165
- Communication Symbol Holders (Various (Generic Product)), 79
- Communication Training Program (CSUS Assistive Device Center), 579
- Communiclock (Crestwood Company), 37
- Communitlight 24 (Crestwood Company), 37
- Community Signs (Conover Company), 580
- Community Vehicles (UCLA Microcomputer Project), 580
- Compact TTY (Ultratec, Inc.), 180
- Companion 401 Communicator (Luminaud, Inc.), 125
- Compartmentalized Clock Communicator (Toys for Special Children, Inc.), 38
- Compartmentalized Communicator (Toys for Special Children, Inc.), 38
- Complete Spelling Program (SLED Software), 716



## Index 6: Alphabetical Listing of all PRODUCTS

- Completion From Partial Information Plus for Windows (Parrot Software), 581
- Compu-Lenz (Florida New Concepts Marketing, Inc.), 495
- CompuDesk HCP (Craner Cabinetry), 543
- Computer CUP (Amidon Publications), 581
- Computer Interface Box (Nassau Applied Technology Resource Center), 454
- Computer Keyboard Switch (Toys for Special Children, Inc.), 210
- Computer Literacy Series (Conover Company), 582
- Computer Switch Interface (AbleNet, Inc.), 455
- Computer Switch Plate (Toys for Special Children, Inc.), 210
- Computer Workstation Furniture (Various (Generic Product)), 544
- Comtel (Acrontech International, Inc.), 544
- CONCENTRATE! On Words & Concepts (Laureate Learning Systems, Inc.), 582
- Concept Keyboard (Hach Associates), 381
- Construc (JEKRO, Inc.), 583
- Continuous Movement Switch (CMS) (Toys for Special Children, Inc.), 210
- Controflex Foot Switches (Tapeswitch Corporation), 211
- Controflex Ribbon Switches (Tapeswitch Corporation), 211
- Control & Momentary Control Center Switches (Crestwood Company), 211
- Control I (Prentke Romich Company), 272
- Controller (ACS Technologies, Inc.), 272
- Cooper-Rand Electronic Speech Aid (Luminaud, Inc.), 4
- Cord-Mate (Cord-Mate, Inc.), 315
- Cordless WinMouse (AT Tech (USA) Corporation), 381
- Core Picture Vocabulary (Don Johnston Incorporated), 80
- Core Reading and Vocabulary Development (Educational Activities, Inc.), 583
- Core Vocabulary (Blissymbolic Communication International), 80
- Corner Box (Creative Switch Industries), 39
- Counter Module (Toys for Special Children, Inc.), 39
- Creature Antics and Creature Capers (Laureate Learning Systems, Inc.), 584
- Creature Cartoons (Laureate Learning Systems, Inc.), 584
- Creature Chorus (Laureate Learning Systems, Inc.), 585
- Creature Features (Laureate Learning Systems, Inc.), 585
- Creature Magic (Laureate Learning Systems, Inc.), 586
- Crespeaker (Crestwood Company), 125
- Crestalk (Crestwood Company), 126
- Crestwood Converter Switch (Crestwood Company), 212
- Crestwood Touch Latch Switch (Crestwood Company), 212
- CrossScanner (R.J. Cooper & Associates), 455
- CrossWords (Marblesoft), 586
- Cup Switch (5807) (TASH, Inc.), 212
- Cushion Switch (Therapeutic Toys, Inc.), 213
- Custom Keyguard (Prentke Romich Company), 336
- Custom Speaker Phone (KY Enterprises), 273
- Custom-Made Switches (Various (Generic Product)), 213
- Cylindrical Touch Switch (5300) (TASH, Inc.), 213
- DA-II Adapter (APT Technology, Inc.), 456
- DAC (ACS Technologies, Inc.), 126
- Daessy Desktop Mount (Prentke Romich Company), 166
- Daessy Folding Mount (Prentke Romich Company), 166
- DARCI TOO (WesTesi Engineering Corporation), 382
- Data Entry (Attainment Company), 587
- DataArm (Maxi Aids, Inc.), 337
- David (TeleSensory Corporation), 471
- DEctalk (Digital Equipment Corporation), 528
- DEctalk PC & DEctalk Express (Digital Equipment Corporation), 528
- Deductive Reasoning Plus for Windows (Parrot Software), 587
- Definitions Plus for Windows (Parrot Software), 588
- Delav Timer Box (Nassau Applied Technology Resource Center), 40
- DeltaTalker (Prentke Romich Company), 127
- Deluxe Communication Board Kit (Crestwood Company), 81
- Deluxe Paddle Switch II and Mini Deluxe Paddle Switch (Creative Switch Industries), 214
- Deluxe Talk Board (Crestwood Company), 81
- Denrick Speech Aid (Luminaud, Inc.), 4
- DLUCI (APT Technology, Inc.), 273
- Dial Scan (Don Johnston Incorporated), 40
- Dialogue TTYs (Ameriphone, Inc.), 180
- Dialogue VCO Read & Talk Telephone (Ameriphone, Inc.), 181
- DigiTalk I (Sentient Systems Technology, Inc.), 127
- Digitized Speech Message Machines (Various (Generic Product)), 316
- DigiVox (Sentient Systems Technology, Inc.), 128
- Dino-Games (Academic Software, Inc.), 588
- Dinosaur Game (UCLA Microcomputer Project), 589
- Disk Guide (2485) (TASH, Inc.), 545
- DJ ProPack Speech Module (Don Johnston Incorporated), 529
- DM8u/FM (TeleSensory Corporation), 511
- Dollars & Cents Series (Attainment Company), 589
- Doors II (Madentia Communications, Inc.), 382
- DOS Tape (Audio Computer Information, Inc.), 545
- Double Paddle Switch (Creative Switch Industries), 214
- Double Sip & Double Puff Switches (Toys for Special Children, Inc.), 214
- Double Touch Switch (Toys for Special Children, Inc.), 215
- DragonDictate Starter, Classic, and Power Editions (Dragon Systems, Inc.), 383
- Drive to Live (Blessing, Maleta), 716
- Dual Action Latch (Kapable Kids), 41
- Dual Channel Headset (Maxi Aids, Inc.), 546
- Dual Channel Latching Switch Interface (Hugh MacMillan Rehabilitation Centre), 41
- Dual Clock Communicator (Toys for Special Children, Inc.), 42
- Dual Plate Switch: CM-12 (Zygo Industries, Inc.), 215
- Dual Pneumatic Switch: CM-14 (Zygo Industries, Inc.), 215
- Dual Puff-Sip Switch DPS-2 (APT Technology, Inc.), 216
- Dual Pushbutton Switch: CM-13 (Zygo Industries, Inc.), 216
- Dual Rocking Lever Switch (Prentke Romich Company), 216
- Dual Tongue Switch TS-2C (APT Technology, Inc.), 217
- Duo-Responder (Crestwood Company), 42
- Duxbury Braille Board for Microsoft Windows (Duxbury Systems, Inc.), 745
- Duxbury Braille Font (Duxbury Systems, Inc.), 746
- Duxbury Braille Translator (DBT) (Duxbury Systems, Inc.), 746
- Duxbury Braille Translator for WordPerfect (DUXWP) (Duxbury Systems, Inc.), 747
- Dvorak Computer Keyboard (Typewriting Institute for the Handicapped), 337
- Dvorak Conversion Keytop Labels (Hooleon Corporation), 338
- Dvorak Keyboard Layouts (Microsoft Corporation), 338
- Dvorak One-Hand Typewriter (Typewriting Institute for the Handicapped), 128
- DynaSyms (Poppin and Company), 82
- DynaVox2 & DynaVox2c (Sentient Systems Technology, Inc.), 129
- DynaVox2 DOS & DynaVox2 Mac (Sentient Systems Technology, Inc.), 129
- E-Z Keys (Words+, Inc.), 339
- E-Tran Scanner (Nassau Applied Technology Resource Center), 43
- E-Z Call (Med Labs, Inc.), 316
- E.A.S.I. dialer (2110) (TASH, Inc.), 274
- Early and Advanced Switch Games (R.J. Cooper & Associates), 590
- Early Concepts (UCLA Microcomputer Project), 590
- Early Emerging Rules Series (Laureate Learning Systems, Inc.), 591
- Early Learning 3.5/Complete Early Learning 5.25 (Marblesoft), 591
- Early Learning I (Marblesoft), 592
- Early Learning II (Marblesoft), 717
- Early Learning III (Marblesoft), 717
- EASICORDER (APT Technology, Inc.), 274
- Easy Access (Apple Computer, Inc.), 339
- Easy-Braille Translator (Blazie Engineering), 747
- EasyRiser (Fox Bay Industries, Inc.), 546
- EasyTalk (Great Talking Box Company), 130
- Echo II (Echo Speech Corporation), 529
- Echo II with Texttalker & Echo II with Texttalker-GS (American Printing House for the Blind (APH)), 472
- Echo LC (Echo Speech Corporation), 530
- Echo PCII (Echo Speech Corporation), 530
- Echo-PC (Echo Speech Corporation), 531
- Edgar (Duxbury Systems, Inc.), 748
- Edmark Functional Word Series (Edmark Corporation), 592
- Edmark Reading Program, Level I Software (Edmark Corporation), 718
- EEK (OMS Development), 383

- Ency-Weency Spider Game (*UCLA Microcomputer Project*), 593  
 Electric Crayon and Electric Crayon Deluxe (*Merit Studios*), 748  
 Electronic Artificial Larynx (*AT & T Accessible Communication Products Center*), 5  
 Electronic Speech Clarifiers (*National Institute for Rehabilitation Engineering*), 5  
 Electronic Speech Synthesizers (*National Institute for Rehabilitation Engineering*), 130  
 Elementary Signer (*E & IS SignWare*), 593  
 Elementary Volume I - Mathematics (*American Printing House for the Blind (APH)*), 718  
 Ellipse Switches (*Don Johnston Incorporated*), 217  
 EmacSpeak (*T.V. Raman*), 472  
 Emergency Call Alarm (*Zygo Industries, Inc.*), 317  
 Emotional Moods & Needs-G 3&4 (*Help Me to Help Myself Communication Aids*), 82  
 Employment Signs (*Conover Company*), 594  
 English on the Job (*Conover Company*), 594  
 Environment Control (*Favin, David*), 275  
 Environmental Control for Kids (*Various (Generic Product)*), 43  
 Environmental Control Units (*Various (Generic Product)*), 275  
 Equalizer (*Words+, Inc.*), 131  
 ErgoLogic Model 7.1 Keyboard (*Ergologic Enterprises, Inc.*), 384  
 Ergonomic Keyboard Systems (*Various (Generic Product)*), 384  
 Ergorest Articulated Forearm Rests (*Willow Pond Tools, Inc.*), 340  
 ERIN (Early Recognition Intervention Network) (*J.E. Stewart*), 719  
 ETgraphX (*Blazie Engineering*), 749  
 EvalPAC with RealVoice (*ACS Technologies, Inc.*), 131  
 Every Day Is A Holiday (*UCLA Microcomputer Project*), 595  
 ExerciseBreak (*Hopkins Technology, LLC*), 749  
 Expanded Keyboard Emulator (*Words+, Inc.*), 340  
 Expanded Keyboard for Apple Macintosh and Apple IIGS (*EKEG Electronics Company LTD*), 385  
 Expanded Keyboard for Automatic Telephone (*EKEG Electronics Company LTD*), 276  
 Expanded Keyboard for IBM Computers (*EKEG Electronics Company LTD*), 385  
 Expanded Keyboards for the Talking BlissApple (*EKEG Electronics Company LTD*), 386  
 Expanded Numeric Keypads (*EKEG Electronics Company LTD*), 386  
 Expert Mouse (*Kensington Microware Limited*), 387  
 Exploring Early Vocabulary Series (*Laureate Learning Systems, Inc.*), 595  
 Eye Relief (*SkiSoft Publishing Corporation*), 750  
 Eye Slaved Pointing System (*ISCAN, Inc.*), 387  
 Eye Transfer Communication System (*Zygo Industries, Inc.*), 83  
 Eye-Com (*Pitts Corporation*), 83  
 Eye-Com Board (*ImaginarT International, Inc.*), 84  
 Eyebrow Switch (*Words+, Inc.*), 217  
 Eyegaze Computer System (*LC Technologies, Inc.*), 132  
 EZ-TV Adapted Infrared Remote Control for Televisions (*ORCCA Technology, Inc.*), 276  
 ezMorse for Windows (*Neil Squire Foundation*), 388  
 EZRA (*KY Enterprises*), 277  
 ezScan (*Neil Squire Foundation*), 388  
 F71863 Touchables Touch Phone Attachments (*Maddak, Inc.*), 277  
 F73216-100 Page Turner/Keyboard Aid (*Maddak, Inc.*), 17  
 Facial Switch (*Whitmyer Biomechanix, Inc.*), 218  
 Family Fun (*UCLA Microcomputer Project*), 596  
 Fast Food Game (*UCLA Microcomputer Project*), 596  
 FastTRAP (*Microspeed, Inc.*), 389  
 Feelings (*UCLA Microcomputer Project*), 597  
 Felix (*Altra*), 389  
 Filch (*Kinetic Designs, Inc.*), 341  
 File-Talk (*GW Micro*), 750  
 Find the Buttons (*R.J. Cooper & Associates*), 597  
 Finger Flex Switch (*Luminaud, Inc.*), 218  
 Finger Isolation Button (*Toys for Special Children, Inc.*), 218  
 FingerFoniks (*Words+, Inc.*), 132  
 Fingerspeller (*E & IS SignWare*), 598  
 Fingerspelling & Numbers (*Kopptronix Company*), 598  
 FingerZoids (*E & IS SignWare*), 599  
 Finish Line (*Innovative Designs, Inc.*), 751  
 First Aide Kit (*Infra-Link, Inc.*), 278  
 First Categories (*Laureate Learning Systems, Inc.*), 599  
 First Mate (*BrainTrains*), 600  
 First Step Software (*Attainment Company*), 600  
 First Verbs and Primeros Verbos (*Laureate Learning Systems, Inc.*), 601  
 First Words (*Laureate Learning Systems, Inc.*), 601  
 First Words II (*Laureate Learning Systems, Inc.*), 602  
 First-Finger WinTrack (*A4 Tech (USA) Corporation*), 390  
 Flexi-Switch (*FlexiSwitch (TASH, Inc.)*), 219  
 Flexi-Switch (*Kapable Kids*), 219  
 Flexible Wheelchair/Table Mounting Fit (*Crestwood Company*), 167  
 Flexit Switch (*Creative Switch Industries*), 219  
 FlexPro (*Key Tronic*), 390  
 FlexShield Keyboard Protectors (*Hooleon Corporation*), 341  
 Flexswitch II (*Tapeswitch Corporation*), 220  
 Focus on Facts (*Exceptional Teaching Aids*), 719  
 Focus on Nations (*Exceptional Teaching Aids*), 720  
 Fold It System (*Communication Development Products, Inc.*), 84  
 Following Directions: One- and Two-Level Commands (*Laureate Learning Systems, Inc.*), 602  
 Following Directions: Left and Right (*Laureate Learning Systems, Inc.*), 603  
 Fone Holder (*Fred Sammons, Inc.*), 278  
 Food Facts (*American Printing House for the Blind (APH)*), 603  
 Foods I Like Menu Book (*Help Me to Help Myself Communication Aids*), 85  
 FormMate (*Henter-Joyce, Inc.*), 751  
 Foundations I (*Psychological Software Services, Inc.*), 604  
 Foundations II (*Psychological Software Services, Inc.*), 604  
 Freedom Writer (*World Communications*), 752  
 FreeSwitch (*Adaptivation, Inc.*), 279  
 Function Pictures (*Parrot Software*), 605  
 Functional Vocabulary Plus for Windows (*Parrot Software*), 605  
 Fundamental Concepts (*Judy Lynn Software*), 606  
 Further Adventures of Jimmy Jumper - Perseverance (*Exceptional Children's Software, Inc.*), 606  
 Futura-TTY (*Futura Wave Communications, Inc.*), 181  
 Generation IV Adjustable Computer Tables (*Willow Pond Tools, Inc.*), 547  
 Geometric Figures and Spatial Concepts (*Favin, David*), 720  
 Getting Clean with Herkimer Level I, II, III (*UCLA Microcomputer Project*), 607  
 GEWA FTB 108 Enlarged Keyboard (*Zygo Industries, Inc.*), 391  
 GEWA Infra-Link Speaker-Telephone (*Infra-Link, Inc.*), 279  
 GEWA Infra-Link System (*Infra-Link, Inc.*), 280  
 GEWA METB 121 Reduced Size Keyboard (*Zygo Industries, Inc.*), 391  
 Gewa Page Turner (*Zygo Industries, Inc.*), 280  
 Giant Push Button Telephone Adapter (*Fred Sammons, Inc.*), 281  
 Gizmo (*Artic Technologies*), 473  
 GNK Magnifier (*Less Gauss, Inc.*), 496  
 Governor (2464) (*TASH, Inc.*), 547  
 GrammarPlay with Alps and Droops (*Optimal-Ed Learning Materials*), 607  
 Grasp Switch (5865) (*TASH, Inc.*), 220  
 Grip & Puff Switch (*Toys for Special Children, Inc.*), 220  
 Grip Switch (*Therapeutic Toys, Inc.*), 221  
 Gripper Prehensor (*Toys for Special Children, Inc.*), 18  
 Grocery Store Words (*Conover Company*), 608  
 Gus! Multimedia Speech System (*Gus Communications, Inc.*), 133  
 H71830 Adjustable Head Pointer (*Maddak, Inc.*), 18  
 H73217 Mouth Held Page Turners (*Maddak, Inc.*), 19  
 H:1 Handicapped Word Games (*E. David & Associates*), 752  
 H:2 Handicapped Arithmetic Flash Cards (*E. David & Associates*), 721  
 HAL (Home Automation Link) (*Voice Connection*), 392  
 Half-QWERTY One-handed Keyboard Software (*Matias Corporation*), 342  
 Hand Controls (*Marblesoft*), 392  
 Handheld Computers and Personal Organizers (*Various (Generic Product)*), 133  
 HandiCHAT and HandiCHAT Deluxe (*Microsystems Software, Inc.*), 473  
 HandiCODE and HandiCODE Deluxe (*Microsystems Software, Inc.*), 393

## Index 6: Alphabetical Listing of all PRODUCTS

- HandiKEY and HandiKEY Deluxe (*Microsystems Software Inc.*). 342
- HandiPHONE (*Microsystems Software Inc.*). 281
- HandiSHIFT (*Microsystems Software Inc.*). 343
- HandiWORD and HandiWORD International (*Microsystems Software Inc.*). 343
- Handpointers (*Various (Generic Product)*). 19
- Handset for Speech Amplification (*AT & T SourceBook*). 6
- Handy Speech Communication Aide (*Consultants for Communication Technology*). 134
- Hawk (*Wayne County Regional Education Service Agency*). 134
- HD Latching Pneumatic Switch (*Luminaud, Inc.*). 221
- Head Control Switch (*Burkhart, Linda J.*). 221
- Head Mounting Kit (*Don Johnston Incorporated*). 167
- Head Pointers: AD-1, AD-2, AD-3 (*Zygo Industries, Inc.*). 20
- Head Position Interface (*Hugh MacMillan Rehabilitation Centre*). 222
- Head Switch (*Toys for Special Children, Inc.*). 222
- Head Switch Kit (*Burkhart, Linda J.*). 222
- Headband Switch (*Luminaud, Inc.*). 223
- HeadMaster Plus (*Prentke Romich Company*). 393
- HeadMouse (*Origin Instruments Corporation*). 394
- HECS-1 (*Prentke Romich Company*). 282
- Heidico Intertalk (*Heidico, Inc.*). 135
- Help Me at Home & School-G 5&6 (*Help Me to Help Myself Communication Aids*). 85
- Help Me to Help Myself Handbook (*Help Me to Help Myself Communication Aids*). 86
- Help U Key (*World Communications*). 394
- Help U Keyboard (*World Communications*). 395
- Help U Type (*World Communications*). 344
- Help U Type and Speak (*World Communications*). 135
- Hereward Tracker Ball & Joystick Module (*Penny & Giles Computer Products*). 395
- Heyer-Abadie Modular Mouthstick (*Extensions for Independence*). 20
- Hierarchical Attention Training (*Parrot Software*). 608
- High Dots (*Exceptional Teaching Aids*). 344
- High Tech/Low Cost (*TechnoGenesis, Inc.*). 223
- Holiday Kit (*Mayer-Johnson Company*). 86
- Home Control Systems (*Various (Generic Product)*). 282
- Home Intercom Systems (*Various (Generic Product)*). 317
- Home-Row Key Indicators (*Hooleon Corporation*). 345
- HomeAccess (*MRF Adaptive Resources, Inc.*). 283
- Homographs (*Parrot Software*). 609
- Homophones (*Parrot Software*). 609
- Human Being Machine (*R.J. Cooper & Associates*). 610
- HX-20 Protective Cover (*ACS Technologies, Inc.*). 345
- HyperBliss 3.2 (*Blissymbolics Communication International*). 136
- I Can Play, Too! (*Mayer-Johnson Company*). 753
- I Can Speak (*World Communications*). 136
- IBM Screen Reader/2 (*IBM Corporation*). 474
- IBM Screen Reader/DOS (*IBM Corporation*). 474
- IBM-VBII (*Cornucopia Software*). 753
- Iconroller (*Suncom Technologies*). 396
- ICU-G 1&2 (*Help Me to Help Myself Communication Aids*). 87
- If You're Happy and You Know It (*UCLA Microcomputer Project*). 610
- Illustrated Menu (*Attainment Company*). 87
- Imaginat Gallery (*Don Johnston Incorporated*). 88
- Improving Your Self-Concept (*Conover Company*). 611
- In & Out Automatic Door Controller (*KY Enterprises*). 283
- IN-CUBE Voice Command for SPARC Stations (*Command Corp. Inc.*). 396
- IN-CUBE Voice Command for Windows, NT (*Command Corp. Inc.*). 397
- Index Basic (*Access Systems International, LTD*). 512
- Index Basic-D (*Access Systems International, LTD*). 512
- Index Everest-D (*Access Systems International, LTD*). 513
- Individualized Communication Systems (*Mayer-Johnson Company*). 88
- Inferential Naming for Cognitive and Language Disorders (*Parrot Software*). 611
- Inferential Naming Plus for Windows (*Parrot Software*). 612
- Information Signs (*Conover Company*). 612
- InfoTouch (*Enabling Technologies Company*). 182
- Infovox 210 (*Mayer-Johnson Company*). 475
- Infovox 500, 700 & 750 (*Reading Technology*). 531
- Infrared Remote Control IRTI-1 (*APT Technology, Inc.*). 284
- Initial Phoneme Cuing for Aphasics (*Parrot Software*). 613
- INKA (*TeleSensory Corporation*). 513
- inLARGE 2.0 (*Berkeley Systems, Inc.*). 496
- Input Adapter (*Life Science Associates*). 456
- Instant Access (*Innocomp*). 397
- Intele-Modem (*Ultratec, Inc.*). 182
- IntelliKeys (*IntelliTools, Inc.*). 398
- IntelliKeys Overlay Maker (*IntelliTools, Inc.*). 548
- IntelliTalk (*IntelliTools, Inc.*). 137
- Intention Module (*Toys for Special Children, Inc.*). 44
- Intention Switch (*Toys for Special Children, Inc.*). 223
- Interaction Games (*Don Johnston Incorporated*). 613
- Interaction Games II (*Don Johnston Incorporated*). 614
- Intercom (4392) (*TASH, Inc.*). 318
- Internal I/O Port Adapter (*AbleNet, Inc.*). 457
- IntroVoice V (*Voice Connection*). 398
- IntroVoice VI (*Voice Connection*). 399
- Inventor Module (*Toys for Special Children, Inc.*). 44
- IRIS Reading Interface 3.0 (*VisuAide*). 399
- IST Switch (*Words+, Inc.*). 224
- JANICE Model 100 Invalid Security Alert System (*JANICE Invalid Security Alert Systems, Inc.*). 318
- JAWS for Windows (*Henter-Joyce, Inc.*). 475
- JAWS Screenreader (*Henter-Joyce, Inc.*). 476
- JDN Shorthand (5073) (*TASH, Inc.*). 346
- Jelly Bean (*AbleNet, Inc.*). 224
- Job Readiness Series (*MCE*). 614
- Job Seeking Series (*Conover Company*). 615
- Job Success Series (*MCE*). 615
- Join the Circus (*Don Johnston Incorporated*). 616
- JOKUS Software (*Don Johnston Incorporated*). 721
- Jouse (*Prentke Romich Company*). 400
- Joystick (*Toys for Special Children, Inc.*). 224
- Joystick Interface Control (*Hugh MacMillan Rehabilitation Centre*). 225
- Joystick to Mouse Driver (*Innovation Management Group, Inc.*). 400
- Joystick Trainer (*R.J. Cooper & Associates*). 616
- Joystick with Pad Switch (5012) (*TASH, Inc.*). 225
- Judy Lynn PC Adapter (*Judy Lynn Software*). 457
- Juliet Braille (*Enabling Technologies Company*). 514
- Jumbo Plate Switch (*Crestwood Company*). 225
- JustVoice (*Interactive Products, Inc.*). 401
- K-U-1 (*iofac Corporation*). 401
- K.C. & Clyde in Fly Ball (*Don Johnston Incorporated*). 722
- Ke:nx (*Don Johnston Incorporated*). 402
- Ke:nx Easy Overlays (*Don Johnston Incorporated*). 548
- Ke:nx On:Board (M43) (*Don Johnston Incorporated*). 402
- Key Largo (*Don Johnston Incorporated*). 403
- KeyAbility (*Meeting the Challenge*). 346
- Keyboard Covers (*Toys for Special Children, Inc.*). 347
- Keyboard Expander (*Neil Squire Foundation*). 458
- Keyboard Interfaces (*Prentke Romich Company*). 458
- Keyboard Overlays for Apple IIe and IIgs (*Marblesoft*). 347
- Keyboard Wrist Rest (*AliMed Inc.*). 348
- Keyboarding by Ability (*Teacher's Institute for Special Education*). 617
- Keyboarding for Individual Achievement (*Teacher's Institute for Special Education*). 617
- Keyboarding for People with Cerebral Palsy (*Teacher's Institute for Special Education*). 618
- Keyboarding Program with Voice Output (*Favin, David*). 618
- Keyboarding with One Hand (*Teacher's Institute for Special Education*). 619
- Keycache (*OMS Development*). 348
- KeyGuard (*IBM Corporation*). 349
- Keyguard (*TASH, Inc.*). 349
- Keyguards (*Don Johnston Incorporated*). 350
- Keylocks (*TASH, Inc.*). 350
- KeyMagic (*Madenia Communications, Inc.*). 351
- Keynote Companion (*HumanWare, Inc.*). 476
- Keynote GOLD (*HumanWare, Inc.*). 532

- Keypad (2425) (TASH, Inc.), 45  
 Keypoint 176 (Polytel Computer Products Corporation), 403  
 Keypoint 300 (Polytel Computer Products Corporation), 404  
 Keypoint 60 (Polytel Computer Products Corporation), 404  
 KeyREP (Prentke Romich Company), 351  
 Keys to Success: Comp. Keybd. Skills for Blind Children (Life Science Associates), 619  
 Keysoft (HumanWare, Inc.), 754  
 KeyStopper (Hooleon Corporation), 352  
 Keyterm (HumanWare, Inc.), 754  
 KeyWiz (Words+, Inc.), 352  
 Kincontrol (4105) (TASH, Inc.), 284  
 Kinesis Ergonomic Keyboard (Kinesis Corporation), 405  
 King Keyboard (2440) (TASH, Inc.), 405  
 KTS Braille Display (American Thermoform Corporation), 514  
 Kurzweil VOICE (Kurzweil Applied Intelligence, Inc.), 406  
 Kurzweil VOICE for Windows (Kurzweil Applied Intelligence, Inc.), 406  
 L.T. Switch (Don Johnston Incorporated), 226  
 Language Master Special Edition - LM6000SE (Franklin Electronic Publishers, Inc.), 477  
 LAP CAT (PC Compatibles), 353  
 Laptrays (Various (Generic Product)), 168  
 Large Print Word Processors (National Institute for Rehabilitation Engineering), 755  
 Large-Type Display Utility Software (National Institute for Rehabilitation Engineering), 497  
 Laryngograph (Kay Elemetrics Corporation), 620  
 Laser Light Pointer (Innocomp), 21  
 Laser Optic Keyboard (International Technology, Inc.), 407  
 Latch Box (Creative Switch Industries), 45  
 LD Latching Puff Switch (Luminaud, Inc.), 226  
 Leaf Switch (Kapable Kids), 226  
 Leaf Switch (Toys for Special Children, Inc.), 227  
 Leaf Switch (5860) (TASH, Inc.), 227  
 Leaf Switch: CM-2/CM-7 (Zygo Industries, Inc.), 227  
 Learn to Scan (Don Johnston Incorporated), 620  
 Learning Activity Packets (LAPs) (Conover Company), 621  
 Learning How to Learn Series (Conover Company), 621  
 Learning the Alphabet (Favin, David), 722  
 Learning to Count (Life Science Associates), 622  
 Learning to Reason Series (MCE), 622  
 Learning to Spell Braille Signs (Exceptional Teaching Aids), 623  
 Left or Right Handed Keyboards (Maxi Aids, Inc.), 353  
 Left/Right Rocker Switch (Don Johnston Incorporated), 228  
 Lens 2.03 (Konz, Ned), 497  
 Less, More, Make Equal (DEKRO, Inc.), 623  
 Let's Go Shopping I and II (UCLA Microcomputer Project), 624  
 Let's Go to the Circus (Laureate Learning Systems, Inc.), 624  
 Letter Art with Braille Translator (Symbol Graphics), 755  
 Letter Find (Exceptional Children's Software, Inc.), 625  
 LetterTALK+ (American Printing House for the Blind (APH)), 625  
 Lever Switch: CM-8/CM-9 (Zygo Industries, Inc.), 228  
 LIAISON (APT Technology, Inc.), 407  
 Liberator (Prentke Romich Company), 137  
 Life Experiences Communication Kit (Mayer-Johnson Company), 89  
 Light Activated Switch Panel (Creative Communicating), 46  
 Light Beam Indicator (Jim's Instrument Manufacturing, Inc.), 21  
 Light Pointer (ACS Technologies, Inc.), 22  
 Light Pointer (Burkhart, Linda J.), 22  
 Light Pointers (Various (Generic Product)), 23  
 Light-Activated Switch (Burkhart, Linda J.), 228  
 LightBeam (Ability Research, Inc.), 23  
 LightBoard (Ability Research, Inc.), 408  
 Lighted Extra Loud Signalling Buzzer (Toys for Special Children, Inc.), 319  
 Lighted Signalling Buzzer (Toys for Special Children, Inc.), 319  
 Lighted Vibrating Signalling Buzzer (Toys for Special Children, Inc.), 46  
 LightSwitch (Ability Research, Inc.), 229  
 LightWRITER SL35 (Zygo Industries, Inc.), 138  
 LightWRITER SL5 (Zygo Industries, Inc.), 138  
 LightWRITER SL85 (Zygo Industries, Inc.), 139  
 Lingraphica (Tolfa Corporation), 139  
 LinkSwitch (Adaptation, Inc.), 47  
 LipStick and WordWriter (McIntyre Computer Systems Division), 408  
 Listen and Spell (Exceptional Teaching Aids), 723  
 Listen for Windows (Verbex Voice Systems), 409  
 Listen With Your Ears (UCLA Microcomputer Project), 626  
 Lite Talk (Blazie Engineering), 532  
 Lite Touch Telephone Communicator (Blazie Engineering), 183  
 Living Alone (MCE), 626  
 Logi (DEKRO, Inc.), 627  
 Logo TouchTools for the PowerPad (Dunamis, Inc.), 627  
 Long Wallet (Mayer-Johnson Company), 89  
 Low Force Adjustable Rod Switch (Creative Switch Industries), 229  
 Low-Tech Adaption Materials (Various (Generic Product)), 168  
 LP-DOS & LP-Windows (Opielec U.S.A. Inc.), 498  
 Lynx (Wayne County Regional Education Service Agency), 140  
 Mac PowerPad Interface for Single Switches (Dunamis, Inc.), 459  
 Mac-Apple Communications Aid (Computers to Help People, Inc.), 756  
 Macaw Series (Zygo Industries, Inc.), 140  
 Macintosh Switch Interface (M09) (Don Johnston Incorporated), 459  
 MacKing (TASH, Inc.), 409  
 MacMini (TASH, Inc.), 410  
 MacQWERTY (Nisus Software, Inc.), 354  
 Macrat (EKEG Electronics Company LTD), 410  
 MacroMaster/pro (AJ Weiner/New England Computer Products), 411  
 MacTRAC (Microspeed Inc.), 411  
 Magic (DEKRO, Inc.), 628  
 MAGIC and MAGIC Deluxe (Microsystems Software Inc.), 498  
 Magic Arm System (R.J. Cooper & Associates), 169  
 Magic Fingers (Words+, Inc.), 354  
 Magic Slate II (Sunburst Communications, Inc.), 756  
 Magic Wand Keyboard with McKey Mouse Option (In Touch Systems), 412  
 Magnetic Finger Switch (Luminaud, Inc.), 229  
 Magnum (VisuAide), 477  
 Magnum Deluxe (Artic Technologies), 499  
 Magnum GT (Artic Technologies), 499  
 Make It In Time (Don Johnston Incorporated), 628  
 Make It Scan (Don Johnston Incorporated), 629  
 Maltron Keyboard (International Management Services, Inc.), 412  
 Marathon Brailier (Enabling Technologies Company), 515  
 Mastering Personal Information (MPI) (Parrot Software), 629  
 MasterTOUCH (HumanWare, Inc.), 515  
 Mastervoice Environmental Control Single User Unit (AVSI), 285  
 Mat Switch (Creative Switch Industries), 230  
 Math Max (DEKRO, Inc.), 630  
 Math on the Job (Conover Company), 630  
 Maze (Computers to Help People, Inc.), 631  
 Me Too! (William K. Bradford Publishing Company, Inc.), 757  
 Mealtime Stickers (Attainment Company), 90  
 Media Handling Products (Various (Generic Product)), 549  
 Medical Words (Conover Company), 631  
 Mega-Book (Mayer-Johnson Company), 90  
 MegaDots (Raised Dot Computing), 757  
 MegaWolf (Wayne County Regional Education Service Agency), 141  
 Membrane Plate Switch (Crestwood Company), 230  
 Memory Button Telephones (Various (Generic Product)), 285  
 Memory for Animated Sequences Plus for Windows (Parrot Software), 632  
 Memory I (Psychological Software Services, Inc.), 632  
 Memory II (Psychological Software Services, Inc.), 633  
 Mercury Switch (Creative Switch Industries), 230  
 Mercury Tilt Switch (Luminaud, Inc.), 231  
 Message Center (Heidico, Inc.), 183  
 MessageMate 20 (Words+, Inc.), 141  
 MessageMate 40 (Words+, Inc.), 142  
 Messenger (Crestwood Company), 142  
 Messenger-IC (Aicom Corporation), 533  
 Meta4 (Consultants for Communication Technology), 143  
 MIC300i Computer Modem (Microslip, Inc.), 184  
 MICE (Ballert International, Inc.), 413  
 Micro Guide to Careers Series (Conover Company), 633  
 Micro IntroVoice (Voice Connection), 413  
 Micro IntroVoice II (Voice Connection), 414  
 Micro Light Switch (5850) (TASH, Inc.), 221

## Index 6: Alphabetical Listing of all PRODUCTS

- Micro Switch (*Crestwood Company*). 231  
Micro-LADS and Micro-LADS in French (*Laureate Learning Systems, Inc.*). 634  
MicroBraille 2 (*Micro Engineering*). 758  
Microcomputer Evaluation of Career Areas (MECA) (*Conover Company*). 634  
Microllustrator (*Dunamis, Inc.*). 758  
Microsoft Natural Keyboard (*Microsoft Corporation*). 414  
Microsoft Windows Sound System (*Microsoft Corporation*). 415  
Mid-Sized Communication Book (*Mayer-Johnson Company*). 91  
Mighty Mount (*TASH, Inc.*). 169  
MIKE (Mouse Interface & Keyboard Emulation) (*Prentke Romich Company*). 415  
Mind Castle I and II (MCE). 635  
Mini Cup Switch (5808) (*TASH, Inc.*). 232  
Mini Joystick with Push Switch (5020) (*TASH, Inc.*). 232  
Mini Keyboard (2443 or 2450) (*TASH, Inc.*). 416  
Mini Picture Set (*Attainment Company*). 91  
Mini Rocking Lever Switch (*Prentke Romich Company*). 232  
Mini Talking Card Reader (*Crestwood Company*). 143  
Mini Transport II (*Artic Technologies*). 533  
Mini Vox Amplifier (*Luminaud, Inc.*). 6  
Mini-Environmental Control (ECU) Box (*Nassau Applied Technology Resource Center*). 286  
Mini-Keyboards (*EKEG Electronics Company LTD*). 416  
Mini-MessageMate (*Words+, Inc.*). 144  
Minicom IV (*Ultratec, Inc.*). 184  
MiniErgo-MF2 (*Marquardt Switches, Inc.*). 417  
Minimal Contrast Stories Plus for Windows (*Parrot Software*). 635  
Minimal Contrast Therapy (*Parrot Software*). 636  
Minimal Motion Computer Access System (*Equal Access Computer Technology, Inc.*). 417  
Minimal Motion Splint-Mounted Switch Kits (*Equal Access Computer Technology, Inc.*). 233  
Miniprint 425 (*Ultratec, Inc.*). 185  
Minspeak Application Programs (MAP) (*Prentke Romich Company*). 759  
Mix 'N Match (*Marblesoft*). 636  
Modular Turntable Desks (*Extensions for Independence*). 549  
Moisture Guard (*Don Johnston Incorporated*). 355  
Money Matters (MCE). 637  
Money Skills (*Marblesoft*). 637  
Morse Code WSKE II (*Words+, Inc.*). 418  
Morsek Version 1.1 (*Kinetic Designs, Inc.*). 418  
Motor Training Games (*Computers to Help People, Inc.*). 638  
Motor Training Games (*Don Johnston Incorporated*). 638  
Motorized Easel (*Extensions for Independence*). 286  
Moulded Plastic Wheelchair Tray (*Variety Ability Systems, Inc. (VASI)*). 170  
Mountbatten Braille (*HumanWare, Inc.*). 516  
Mounting Packages & Switches (*Crestwood Company*). 170  
Mounting Switch (*Don Johnston Incorporated*). 233  
Mounting Switch Mount (*Don Johnston Incorporated*). 171  
Mouse Keys (*World Communications*). 419  
MOUSE PERCH (*PC Compatibles*). 355  
Mouse-Frak (*ITAC Systems, Inc.*). 419  
MouseMan Cordless (*Logitech, Inc.*). 420  
MouseMover - Mac (5005) (*TASH, Inc.*). 420  
MouseMover - PC Windows (5004) (*TASH, Inc.*). 421  
MousePen (*Appoint*). 421  
MouseStick II (*Advanced Gravvis Computer Technology Ltd*). 422  
Mouth Operated Joystick for Genesis Video Game (*KY Enterprises*). 422  
Mouthsticks (*Fred Sammons, Inc.*). 24  
Multi-Control Press Switch (*Creative Switch Industries*). 233  
Multi-Line Dial-A-News System (*Phone TTY, Inc.*). 759  
Multi-SCAN (*Academic Software, Inc.*). 639  
Multi-Switch Module (*Toys for Special Children, Inc.*). 47  
MultiPhone (*Institute on Applied Technology, Children's Hospital*). 287  
Multiple Meaning Words I Plus for Windows (*Parrot Software*). 639  
Multiple Meaning Words II Plus for Windows (*Parrot Software*). 640  
MultiVoice (*Institute on Applied Technology, Children's Hospital*). 534  
Muppet Learning Keys (*Sunburst Communications, Inc.*). 423  
Music Button (*Toys for Special Children, Inc.*). 48  
MusicWare (*SoftTouch/kidTECH*). 640  
MusicWare - Age Appropriate (*SoftTouch/kidTECH*). 641  
My First Keyboard (*Kidtech, Inc.*). 423  
MY HOUSE: Language Activities of Daily Living (*Laureate Learning Systems, Inc.*). 641  
My Paint & Talking Coloring Books (*Laureate Learning Systems, Inc.*). 642  
MY SCHOOL: Language Activities of Daily Living (*Laureate Learning Systems, Inc.*). 642  
MY TOWN: Language Activities of Daily Living (*Laureate Learning Systems, Inc.*). 643  
My-T-Mouse (*Innovation Management Group, Inc.*). 424  
MyKey (*ErgonomiXX, Inc.*). 424  
Myna (*TFI Engineering*). 478  
NAMES (*Kansys, Inc.*). 760  
Narwhal Expanded Keyboards for Adaptive Firmware Card (*EKEG Electronics Company LTD*). 425  
Nasometer Model 6200-3 (*Kay Elemetrics Corporation*). 643  
NeuroPage (*Hersh & Treadgold*). 320  
New Frog & Fly (*Simtech Publications*). 644  
NexCom 300vi & 300ve (*Nexion, Inc.*). 185  
Next Page Page Turner (4600) (*TASH, Inc.*). 287  
Nine Compartment Row/Column Scanner (*Toys for Special Children, Inc.*). 48  
Nine Volt Battery Adapter Module (*Toys for Special Children, Inc.*). 49  
Nintendo & Super Nintendo Joystick Module (*Toys for Special Children, Inc.*). 425  
NOHOLD (*Computers to Help People, Inc.*). 356  
NOMAD Talking Touch Pad & NOMAD Gold (*American Printing House for the Blind (APH)*). 516  
NoMouse (*Abacus*). 426  
Normally Closed Sensing Cell (*Tapeswitch Corporation*). 234  
Normally Open Sensing Cells (*Tapeswitch Corporation*). 234  
Notebook Computer Wrist Rest (*AliMed Inc.*). 356  
Noteworthy (*GW Micro*). 760  
Notex 486 (*ATR/JWA, Inc.*). 517  
Nu-Vois (*Luminaud, Inc.*). 7  
Nu-Vue-Cue (*R.D. Clark, Inc.*). 92  
Numeric Concepts I and II (*BrainTrain*). 644  
NuVu Magnifier (*Less Gauss Inc.*). 500  
Oakland Schools Picture Dictionary (*Oakland Schools-Communication Enhancement Center*). 92  
Object Communicator (*Crestwood Company*). 93  
Object Display (*Crestwood Company*). 93  
Object Stand or Calendar Box (3 or 5) (*Crestwood Company*). 94  
Object-Picture Talk Board (*Crestwood Company*). 94  
Occupations (*UCLA Microcomputer Project*). 645  
Octobus (*DEKRO, Inc.*). 645  
OfficeTALK for Windows (*Kolvox Communications*). 426  
Ohtsuki BT-5000 Braille/Print Printer (*American Thermoform Corporation*). 517  
Old MacDonald's Farm I and II (*UCLA Microcomputer Project*). 646  
Omni Page System (*Silent Call Corporation*). 320  
OmniKey Keyboards (*Northgate Computer Systems, Inc.*). 357  
Oniron Switch (*Nassau Applied Technology Resource Center*). 234  
On the Job Series - Career Interests (*Conover Company*). 646  
On the Job Series - Communication Skills (*Conover Company*). 647  
On the Job Series - Mathematics (*Conover Company*). 647  
On the Job Series - Problem Solving Skills (*Conover Company*). 648  
On/Off Adaptor Switch (*ACS Technologies, Inc.*). 357  
On/Off Module (*Toys for Special Children, Inc.*). 49  
On/Off Remote Switch (*Dimango Products*). 288  
One Access (*Consultants for Communication Technology*). 427  
One Switch Picasso (*Simtech Publications*). 648  
One-Hand Keyboard Package (*Trask Office Products*). 358  
One-Hand Operated Joystick for Genesis Video Game (*KY Enterprises*). 427  
OneSirk (*E. David & Associates*). 428  
Open Book (*Arkenstone, Inc.*). 478  
Open Book Unbound (*Arkenstone, Inc.*). 479  
Opening Windows (*American Printing House for the Blind (APH)*). 649  
Opposites and Similarities Plus for Windows (*Parrot Software*). 649

- Optacon II (*TeleSensory Corporation*), 518  
 Opticomunicator (*Crestwood Company*), 95  
 Optimouse (*ISCAN, Inc.*), 428  
 Order Processing (*Attainment Company*), 659  
 OsCaR (*TeleSensory Corporation*), 429  
 outSPOKEN 1.7 (*Berkeley Systems, Inc.*), 479  
 outSPOKEN for Windows (*Berkeley Systems, Inc.*), 480  
 Overhead Pull Switch (*Toys for Special Children, Inc.*), 235  
 P-Switch (*Prentke Romich Company*), 235  
 PA-1 Portable Alarm (*Med Labs, Inc.*), 321  
 Padded Food (*UCLA Microcomputer Project*), 650  
 Padded Vehicles (*UCLA Microcomputer Project*), 651  
 PAL (*Kepler Electronic Publishing, Inc.*), 358  
 Panorama (*Syntha-Voice Computers Inc.*), 500  
 Paper Dolls I and II (*UCLA Microcomputer Project*), 651  
 Paragon Braille Printer (*HumanWare, Inc.*), 518  
 Park Speech Amplifier (*Park Surgical Company, Inc.*), 7  
 Parrot (*Zygo Industries, Inc.*), 144  
 Passport Kits (*Crestwood Company*), 95  
 Passy-Muir Speaking Valves (*Passy-Muir, Inc.*), 8  
 Patty Cake Press (*Kapable Kids*), 235  
 Pay Phone TTY (*Ultralec, Inc.*), 186  
 PC Braille (*Braille Research & Literacy, Inc.*), 761  
 PC Typer (*American Printing House for the Blind (APH)*), 652  
 PC-TRAC (*Microspeed Inc.*), 429  
 PCMaster & Windows Master (*Blazie Engineering*), 460  
 PCS Color Stickers (*Mayer-Johnson Company*), 96  
 PCS Stamps (*Mayer-Johnson Company*), 96  
 PCS Wordless Edition (*Mayer-Johnson Company*), 97  
 PEACEbook (*TIGER Communication System, Inc.*), 97  
 PECK Computer Software (*Productivity Software International*), 359  
 Peg Switch (*Kapable Kids*), 50  
 Pegasus (*Words+, Inc.*), 145  
 Pen Style Mouse (*A4 Tech (USA) Corporation*), 430  
 Penta Switch (5024) (*TASH, Inc.*), 236  
 People Pager (*HARC Mercantile, LTD*), 321  
 Personal Alert Receiver (*Silent Call Corporation*), 322  
 Personal Communication Terminal (PCT) (*Trident Technologies*), 1  
 Personal Development Software Series (*Conover Company*), 652  
 Personal Pager (*Access to Recreation, Inc.*), 322  
 Personal Pager (*Adaptation, Inc.*), 323  
 Personal Pagers (*Greatest of Ease Company*), 323  
 Personal Trainer (*TIGER Communication System, Inc.*), 145  
 Petite Pillow Switch (*Toys for Special Children, Inc.*), 236  
 Phone Manager (*Consultants for Communication Technology*), 288  
 Phone-ITTY CM-4 Computer Modem (*Phone TTY, Inc.*), 187  
 PhoneAccess (*MRF Adaptive Resources, Inc.*), 289  
 Photocell Switch (*Toys for Special Children, Inc.*), 236  
 Pick 'n Stick Color Micros (*Imaginart International, Inc.*), 98  
 Pick 'N Stick Color Packs (*Imaginart International, Inc.*), 98  
 Pick 'N Stick Fast Food (*Imaginart International, Inc.*), 99  
 Pick 'n Stick on Disk (*Imaginart International, Inc.*), 99  
 Pick 'n Stick Primary Pack (*Imaginart International, Inc.*), 100  
 Pick-A-Meal (*UCLA Microcomputer Project*), 653  
 PICSYMS Categorical Dictionary (*Poppin and Company*), 100  
 Pictalk (*UCLA Microcomputer Project*), 653  
 Picture Braille (*American Printing House for the Blind (APH)*), 761  
 Picture Communication Symbols - Combination Book (*Mayer-Johnson Company*), 101  
 Picture Communication Symbols, Books I, II & III (*Mayer-Johnson Company*), 101  
 Picture Cue Dictionary (*Attainment Company*), 654  
 Picture Icon X-CHANGE (*Academic Software, Inc.*), 146  
 Picture Identification Plus for Windows (*Parrot Software*), 654  
 Picture Naming Plus for Windows (*Parrot Software*), 655  
 Picture Perfect (*Mind Play*), 762  
 Picture Prompt Cards (*Attainment Company*), 102  
 Picture Prompt Stickers (*Attainment Company*), 102  
 Picture Prompt System (*Attainment Company*), 103  
 Picture Scanner (*R.J. Cooper & Associates*), 655  
 Picture Your Blissymbols (*Blissymbolics Communication International*), 103  
 Picture/Theme Disks (*R.J. Cooper & Associates*), 656  
 Pictures Programs: I, II and III (*Parrot Software*), 656  
 Pictures, Please! (*Communication/Therapy Skill Builders*), 104  
 PigTail Adapters (*AbleNet, Inc.*), 50  
 Pillow Switch (5875) (*TASH, Inc.*), 237  
 Pinch Switch (*Creative Switch Industries*), 237  
 Pinch Switch (*Toys for Special Children, Inc.*), 237  
 PKD 84 and 101 (*Advanced Input Devices*), 430  
 Plate Switch (*Don Johnston Incorporated*), 238  
 Plate Switch (*Toys for Special Children, Inc.*), 238  
 Plate Switch (5830-34) (*TASH, Inc.*), 238  
 Plate Switch On Stand (*Toys for Special Children, Inc.*), 239  
 Plate Switch: CM-10 (*Zygo Industries, Inc.*), 239  
 Plate Switches (*Nassau Applied Technology Resource Center*), 239  
 Plate Switches (*Therapeutic Toys, Inc.*), 240  
 Play Mat Switch (*Kapable Kids*), 240  
 PlayMAGIC (*Toys for Special Children, Inc.*), 460  
 Pneumatic Switch (*Prentke Romich Company*), 240  
 Pneumatic Switch (5100, 5101) (*TASH, Inc.*), 241  
 Pocket Book (*Attainment Company*), 104  
 Pocket Picture Holder (*Imaginart International, Inc.*), 105  
 Pocket-Sized and Double Pocket-Sized Communication Book (*Mayer-Johnson Company*), 105  
 Point to Pictures (*R.J. Cooper & Associates*), 657  
 Polycom (*Zygo Industries, Inc.*), 146  
 Porta Boards (*Crestwood Company*), 106  
 Porta Book (*Crestwood Company*), 106  
 Porta Printer Plus (*Telcom International*), 187  
 Portable Sound Source II (*American Printing House for the Blind (APH)*), 51  
 Portable Telephones (*Various (Generic Product)*), 289  
 PortaPoint (*Interlink Electronics*), 431  
 PortaView (*Telcom International*), 188  
 Porter, The (*Don Johnston Incorporated*), 461  
 Positive Parenting (*MCE*), 657  
 Positron Express (*HARC Mercantile, LTD*), 188  
 Powerama (*Syntha-Voice Computers Inc.*), 501  
 PowerBook Mounting Plate (*Don Johnston Incorporated*), 171  
 PowerBraille 40, 65, & 80 (*TeleSensory Corporation*), 519  
 PowerKey Software for IBM (*Dunamis, Inc.*), 431  
 PowerLink 2 (*AbleNet, Inc.*), 290  
 PowerPad (*Dunamis, Inc.*), 432  
 PowerPad Keyguard (*Dunamis, Inc.*), 359  
 PowerPad Preschool Pack I & II (*Creative Communicating*), 658  
 PowerPad Starter Kit (*Dunamis, Inc.*), 432  
 PowerPad Toolkit 4 (*Dunamis, Inc.*), 762  
 PowerSecretary (*Articulate Systems, Inc.*), 433  
 PowerSwitch (*Dunamis, Inc.*), 461  
 PowerTalker (*UCLA Microcomputer Project*), 658  
 PRC Joystick (*Prentke Romich Company*), 241  
 PRD+ (Productivity Plus) Basic Edition (*Productivity Software International*), 360  
 Pre-Dict-ate (*Madenta Communications, Inc.*), 433  
 Predict It (*Don Johnston Incorporated*), 763  
 Prefix (*DEKRO, Inc.*), 659  
 Prefix (*Simple Works*), 360  
 Prefixes (*American Printing House for the Blind (APH)*), 723  
 Preposition Fill-Ins (*Parrot Software*), 659  
 Press to Play (*Don Johnston Incorporated*), 660  
 Pressure Switch (*Burkhart, Linda J.*), 241  
 Pressure Switch (*Luminaud, Inc.*), 242  
 Primer 83 (*Dynacom, Inc.*), 660  
 Problem Solving I (*Psychological Software Services, Inc.*), 661  
 Program for Aphasics (*Favin, David*), 724  
 ProKey (*CE Software, Inc.*), 361  
 ProPoint (*Interlink Electronics*), 434  
 Proportional Keystroke Scanner (*Ability Systems Corporation*), 434  
 Protalk23 for Windows (*Biolink Computer Research and Development, LTD*), 480  
 PROVox (*Kansys, Inc.*), 481  
 PROXi (*Madenta Communications, Inc.*), 290  
 Pull Switch (*Burkhart, Linda J.*), 242  
 Pull Switch (*Toys for Special Children, Inc.*), 242  
 Pushbutton Switch: CM-11 (*Zygo Industries, Inc.*), 243  
 Puzzle Switches (*Toys for Special Children, Inc.*), 51  
 Quad Talk (*Crestwood Company*), 52  
 QUADLynx Trackball (*Asher Engineering Corporation*), 435

## Index 6: Alphabetical Listing of all PRODUCTS

- Quick 'n Easy 2 (ACS Technologies, Inc.), 172  
QuickKeys (CE Software, Inc.), 361  
R.A.P.S. Software Series I PowerPad (Creative Communicating), 661  
Rabbit Scanner (Exceptional Children's Software, Inc.), 662  
Race the Clock (Mind Play), 662  
Rand Voice Amplifier (Luminaud, Inc.), 8  
Ransley Braille Interface (RBI) (HumanWare, Inc.), 519  
RAPIDTEXT (RAPIDTEXT, Inc.), 763  
Rate Drill in Articulation, Language and Fluency (UNITED Educational Services, Inc.), 663  
RC5000 Radio Home Control System (X-10 (USA), Inc.), 291  
Reactions (R73) (Don Johnston Incorporated), 663  
Readable Stories Series (Laureate Learning Systems, Inc.), 724  
Reading a Ruler - English & Metric (Conover Company), 664  
Reading AdvantEdge (Xerox Imaging Systems, Inc.), 481  
Reading Comprehension for Adolescents (Parrot Software), 664  
Reading Edge (Xerox Imaging Systems, Inc.), 435  
Reading Horizons (Conover Company), 725  
ReadyScan (SPECTECH), 147  
RealVoice (ACS Technologies, Inc.), 147  
Reasoning Skills on the Job (Conover Company), 665  
RedLite (See A Need), 24  
Reinforced Keyguard (ACS Technologies, Inc.), 362  
RELAX (8200) (TASH, Inc.), 291  
Remote Ability Switch Adapter (Easv Home Control), 243  
Remote Control Speakerphone Model RC3000 (Ameriphone, Inc.), 292  
Remote Keyboard for the Apple II+ and IIe (EKEG Electronics Company LTD), 436  
Remote Wireless Paging Alarm (Crestwood Company), 324  
RemotePoint (Interlink Electronics), 436  
RevolvingDoors (Madenta Communications, Inc.), 437  
Rhyming Pictures (Parrot Software), 665  
Rhythm Generator (Toys for Special Children, Inc.), 52  
Robot Voice Synthesizer (Crestwood Company), 9  
Rocker Switch (5505) (TASH, Inc.), 243  
Rockets to the Moon (UCLA Microcomputer Project), 666  
Rocking Plate Switch (Toys for Special Children, Inc.), 244  
Roll & Slide Keyboard Wrist Support (Ability Center of Greater Toledo), 362  
Roller Switch Music Box (Toys for Special Children, Inc.), 244  
Romeo Braille Model RB-25 (Enabling Technologies Company), 520  
Romeo Braille Model RB-40 (Enabling Technologies Company), 520  
Round Clock Communicator (Toys for Special Children, Inc.), 53  
Round Pad Switch (5805) (TASH, Inc.), 244  
Run Rabbit Run (Exceptional Children's Software, Inc.), 666  
Rx WorkStation (Consumer Care Products, Inc.), 550  
SafeSkin Keyboard Protector (Merritt Computer Products, Inc.), 363  
Safety Signs (Conover Company), 667  
Saltus Reader (Dickey Engineering), 292  
Sapura S2000 CL (Temasek Telephone, Inc.), 293  
Say-It-All II Plus (Innocomp), 148  
Say-It-Simply Plus (Innocomp), 148  
Scan & Match 1, 2, 3, and 4 (Simtech Publications), 667  
Scan Com (Med Labs, Inc.), 149  
Scan It - Switch It (UCLA Microcomputer Project), 668  
Scan-It-All (Innocomp), 149  
ScanLite (ORCCA Technology, Inc.), 53  
Scanning Conversion Program (Stone Age Software, Inc.), 550  
Scanning Director (Prentke Romich Company), 293  
Scanning Picasso (Simtech Publications), 668  
Scanning Remote Control (SRC) (APT Technology, Inc.), 294  
Scanning WSKE II (Words+, Inc.), 437  
Scanning X-10 Powerhouse (Prentke Romich Company), 294  
ScanPAC (ACS Technologies, Inc.), 150  
ScanTELL (Computusult Limited), 452  
SCATIR Switch (Artificial Language Laboratory), 245  
ScottBridge Speech Access System (ScottBridge, Inc.), 438  
Screamer Alarm (Crestwood Company), 324  
Screen Magnifier/2 (IBM Corporation), 501  
ScreenDoors (Prentke Romich Company), 438  
ScreenPower (TeleSensory Corporation), 482  
ScreenPower for Windows (TeleSensory Corporation), 483  
Scribe (Zygo Industries, Inc.), 150  
Seasons (UCLA Microcomputer Project), 669  
Secretary (Zygo Industries, Inc.), 151  
SeeBEEP (Microsystems Software, Inc.), 764  
Seek & Find (UCLA Microcomputer Project), 669  
Seekline (Speech Systems for the Blind), 483  
Select-A-Meal and Shopping Smart (Attainment Company), 107  
Select-Ease Keyboard (Lexmark International, Inc.), 439  
Self-Talk Stickers (Communication/Therapy Skill Builders), 107  
Semantic Development Using Code Breaking Strategies (Parrot Software), 670  
SenSei System (Sufko International, Inc.), 295  
Sensible Speller: Talking APH Edition (American Printing House for the Blind (APH)), 725  
Sensor Switch (Don Johnston Incorporated), 245  
Sentence Completion Plus for Windows (Parrot Software), 670  
Sentence Key & Picture Sequence Key (Mayer-Johnson Company), 671  
Sentence Master (Laureate Learning Systems, Inc.), 671  
Sequential Scanner (Toys for Special Children, Inc.), 54  
Serial Trackball and PS/2 Trackball (ProHance Technologies, Inc.), 439  
Series Adapter (AbleNet, Inc.), 54  
SERVOX Inton (Siemens Hearing Instruments, Inc.), 9  
Shadow Switch (Crestwood Company), 245  
Shadow Talker (Toys for Special Children, Inc.), 151  
Sharon's Programs (Access Unlimited), 726  
Shell Game & Mouse Game (SoftTouch/kidTECH), 672  
SIDD (Software Interface for the Deaf and Disabled) (Comm-Tel), 189  
SideKick Receiver (Silent Call Corporation), 325  
Sight Word Spelling (Exceptional Children's Software, Inc.), 726  
Sight Words (UCLA Microcomputer Project), 672  
Signal Buzzer (Toys for Special Children, Inc.), 325  
Signal Buzzer Plate (Therapeutic Toys, Inc.), 246  
Signal Switch (Toys for Special Children, Inc.), 246  
Silent Speaker (Trademark Medical), 108  
Silly Sandwich (UCLA Microcomputer Project), 673  
Simple Sentence Structure (Laureate Learning Systems, Inc.), 673  
SimpleCom I: Yes/No Communication (Dunamis, Inc.), 674  
SimpleCom II: Needs/Wants Communication (Dunamis, Inc.), 674  
Simplicity Series ECUs (Quartet Technology, Inc.), 295  
Single Rocking Lever Switch (Prentke Romich Company), 246  
Single Switch Software (Various (Generic Product)), 675  
Single Switch/MatchBox Pack I (Creative Communicating), 675  
Single-Appliance Continuous Control Unit (Toys for Special Children, Inc.), 296  
Single Switch Multi-Appliance Control Unit & Modules (Toys for Special Children, Inc.), 296  
Single-Switch TV Control Unit (Toys for Special Children, Inc.), 297  
Sip & Puff Switch (Toys for Special Children, Inc.), 247  
Sip/Puff Bed Control (KY Enterprises), 297  
Six Position Activity Box (Therapeutic Toys, Inc.), 55  
Slide Projector Control (AbleNet, Inc.), 55  
Slim Armstrong (AbleNet, Inc.), 172  
Slimware (Syntha-Voice Computers Inc.), 484  
Slimware Window Bridge (Syntha-Voice Computers Inc.), 484  
Slip-On Typing Aid (Access to Recreation, Inc.), 25  
SM85 Smart ASCII/Baudot Modem (Krown Research, Inc.), 189  
SmarTalk (Automated Functions, Inc.), 534  
Snappy Switch (ORCCA Technology, Inc.), 247  
Soft Switch (5820, 5821) (TASH, Inc.), 247  
SoftType (Access Technology), 440  
Son of Seek and Find (UCLA Microcomputer Project), 676  
Sorting by Category Plus for Windows (Parrot Software), 676  
Sound Advice System (Sound Advice Systems, Inc.), 326  
Sound Scope (GW Instruments), 677  
Sounding Board (GW Micro), 535  
SoundProof (HumanWare, Inc.), 485  
Speak Out VOILA (VOILA Technology, Inc.), 440  
Speak-Out (GW Micro), 535  
SpeakEasy (AbleNet, Inc.), 152  
Speaker Phones (Various (Generic Product)), 298  
Speaking Dynamically (Mayer-Johnson Company), 152

- Speaking Speller (*American Printing House for the Blind (APH)*). 727
- Speaqualizer Speech Access System (*American Printing House for the Blind (APH)*). 485
- Special Education Public Domain Software (*Technology for Language and Learning, Inc.*). 677
- Specialist (*TIGER Communication System, Inc.*). 153
- Specs Switch (*AbleNet, Inc.*). 248
- Speech Enhancer 100, 200 & 400 (*Luminavd, Inc.*). 10
- Speech Recognition Systems (*Voice Recognition Technologies*). 441
- Speechmaker (*Williams Sound Corporation*). 10
- SpeechViewer II (*IBM Corporation*). 678
- Spell-A-Word & 2+2 (*R.J. Cooper & Associates*). 727
- Spell-Talk (*Access Unlimited*). 728
- Spelling Tutor (*Access Unlimited*). 728
- SPELLIST (*Castle Special Computer Services, Inc.*). 729
- Spin and Spell (*Access Unlimited*). 729
- Sponge Nurse Call Switch (*Dickey Engineering*). 248
- Square Pad Switch (5810) (*TASH, Inc.*). 248
- Squeeze Switch (*Kapable Kids*). 249
- SS-ACCESS! (*Academic Software, Inc.*). 462
- Standard Paddle Switch (*Creative Switch Industries*). 249
- Star Switch (5026) (*TASH, Inc.*). 249
- Steeper Communication/Teaching Aid (*Zygo Industries, Inc.*). 56
- Step On It! Computer Control Pedals (*Bilbo Innovations, Inc.*). 363
- Steps for Career Choice (*Conover Company*). 678
- Stick-On Keylocks (*Extensions for Independence*). 364
- Stickers for Talk Boards (*Crestwood Company*). 108
- Stickey (C-CAD (*Center for Computer Assistance to the Disabled*)). 364
- Stingray (*CoStar Corporation*). 441
- Storytime Series (*Creative Communicating*). 679
- Storytime Series for Macintosh (*Creative Communicating*). 679
- Strider (*Arkenstone, Inc.*). 764
- String Switch (*AbleNet, Inc.*). 250
- String Switch (*Toys for Special Children, Inc.*). 250
- Studio4 (*DEKRO, Inc.*). 680
- Study Buddy (*Access Unlimited*). 730
- Subtle Messages (*Subtle Impact Software, Inc.*). 680
- Super-Sensitive Normally Open Switch (*Tapeswitch Corporation*). 250
- Supercom 4400 TTY (*Ultratec, Inc.*). 190
- SuperPort (*Dunamis, Inc.*). 462
- Superprint 100, 200, 400 (*Ultratec, Inc.*). 190
- Superprint 4425 (*Ultratec, Inc.*). 191
- Superprint ES TTY (*Ultratec, Inc.*). 191
- Support Station (*Support Engineering Associates*). 173
- Survival Words (*Conover Company*). 681
- Swim, Swam, Swum: Mastering Irregular Verbs (*Laureate Learning Systems, Inc.*). 681
- Switch Arcade (*Simtech Publications*). 682
- Switch Arcade (*UCLA Microcomputer Project*). 682
- Switch Art (*Judy Lynn Software*). 683
- Switch Interface (*Don Johnston Incorporated*). 463
- Switch It - Change It (*UCLA Microcomputer Project*). 683
- Switch It - See It (*UCLA Microcomputer Project*). 684
- Switch Latch (4388) (*TASH, Inc.*). 56
- Switch Latch and Timer (*AbleNet, Inc.*). 57
- Switch Latch/Timer (*Don Johnston Incorporated*). 57
- Switch Modified PowerPad (*Creative Communicating*). 442
- Switch Module (*Toys for Special Children, Inc.*). 153
- Switch Mounting Hardware (*Toys for Special Children, Inc.*). 173
- Switch Mounting Kit (*Don Johnston Incorporated*). 174
- Switch Mounts (*Varius (Generic Product)*). 174
- Switch Puzzles (*Simtech Publications*). 684
- Switch-Adapted Mouse (SAM) (*R.J. Cooper & Associates*). 442
- Switch-Back (*Madenta Communications, Inc.*). 443
- Switchboard (*Zygo Industries, Inc.*). 154
- SwitchEnsemble (*Switch In Time*). 685
- SwitchMouse (*OMS Development*). 443
- Switchskins (*Embracing Concepts, Inc.*). 251
- Synergy Integrated Remote (*Synergy*). 298
- SynergyMac and SynergyPC (*Synergy*). 444
- SynPhonix 210 and 215 (*Artic Technologies*). 536
- SynPhonix 310 and 315 (*Artic Technologies*). 536
- SynPhonix P27 (*Artic Technologies*). 537
- System 2000 (*Words+, Inc.*). 154
- T-140 Series Puff/Sip Speakerphones (*Envirotrol Company, Inc.*). 299
- T-TAM Keyboard and Mouse Emulator (*Prentke Romich Company*). 463
- Tactile Touch Pad (*Kapable Kids*). 251
- Taction Pads (*Adaptivation, Inc.*). 251
- Talk Back III (*Crestwood Company*). 155
- Talk Back VI (*Crestwood Company*). 155
- Talk-to-Me Tutorial Cassettes (*Raised Dot Computing*). 551
- Talk:About (*Don Johnston Incorporated*). 156
- Talking Data Acquisition System Software (*East Carolina University*). 765
- Talking Hands (*EBSCO Curriculum Materials*). 685
- Talking Laser Beam (*Crestwood Company*). 25
- Talking Literacy Kit for the Apple IIe (TALK IIe) (*American Printing House for the Blind (APH)*). 686
- Talking Nouns, Talking Nouns II, and Talking Verbs (*Laureate Learning Systems, Inc.*). 686
- Talking Pictures Communication Board (*Crestwood Company*). 109
- Talking Pictures, Kits I - VII (*Crestwood Company*). 109
- Talking Public Domain Disks (*FDLRS/South Enabling Technologies Lab*). 730
- Talking Riddles (*Cross Educational Software*). 731
- Talking Screen (*Words+, Inc.*). 156
- Talking Screen for Windows (*Words+, Inc.*). 157
- Talking Sensible Speller (*Scantron Quality Computers*). 765
- Talking Switch Plates (*Toys for Special Children, Inc.*). 157
- Talking Touch Window (*Edmark Corporation*). 687
- Talking Typewriter (*American Printing House for the Blind (APH)*). 687
- Talking Utilities for DOS 3.3 (*American Printing House for the Blind (APH)*). 766
- Talking Utilities for ProDOS (*American Printing House for the Blind (APH)*). 551
- Talking Writer & Four Games (*Cross Educational Software*). 766
- TalkTime with Tucker (*Laureate Learning Systems, Inc.*). 688
- TarsalRest (*Fox Bay Industries, Inc.*). 552
- TAS Switch (*Artificial Language Laboratory*). 252
- TASH Mounting Parts (*TASH, Inc.*). 175
- TDD 2700, 2730, and 2830 (*AT & T Accessible Communication Products Center*). 192
- TDD Detector (*Ultratec, Inc.*). 192
- TDD Trainer System (*Deafworks*). 58
- Tea Party (*UCLA Microcomputer Project*). 688
- TEAM (*Microsystems Software, Inc.*). 299
- Teenage Switch Progressions (*R.J. Cooper & Associates*). 689
- TeleBraille III (*TeleSensory Corporation*). 193
- TeleDesk Visually Impaired Operator Console (*Conveyant Systems, Inc.*). 767
- Telepathic II (*Madenta Communications, Inc.*). 767
- Telephone Holder & Line Connector (*Zygo Industries, Inc.*). 300
- Telephone Management System (*IC-Systems*). 300
- TeleView 40 & 80 (*Telcom International*). 193
- Telling Time (*DEKRO, Inc.*). 689
- Telling Time, Parts of the Face, Learning Colors (*Favin, David*). 690
- Tempo for Windows (*Affinity Micro Systems, LTD*). 365
- Tempo II Plus (*Affinity Micro Systems, LTD*). 365
- TempoEZ (*Affinity Micro Systems, LTD*). 366
- Term-Talk (*GW Micro*). 768
- TEXTALKER (*American Printing House for the Blind (APH)*). 521
- Textalker-GS (*American Printing House for the Blind (APH)*). 486
- TextGrabber (*SunBelt Industries, Inc.*). 768
- THINKable/DOS (*IBM Corporation*). 690
- This is the Way We Wash Our Face (*UCLA Microcomputer Project*). 691
- This Old Man (*UCLA Microcomputer Project*). 691
- Thomas Braille (*Enabling Technologies Company*). 521
- Three Position Activity Box (*Therapeutic Toys, Inc.*). 58
- Thumb Switch: CM-5 (*Zygo Industries, Inc.*). 252
- Tilt Switch (*Toys for Special Children, Inc.*). 252
- Timekeeper (*Edmark Corporation*). 692
- TimeOut UltraMacros (*Scantron Quality Computers*). 366
- Timer Module (*Toys for Special Children, Inc.*). 59
- Tinytalk (*OMS Development*). 486



## Index 6: Alphabetical Listing of all PRODUCTS

- Tip Switch (5840) (TASH, Inc.), 253  
 Tokyo Artificial Larynx (Artificial Speech Aids), 11  
 Tone Talker (Consultants for Communication Technology), 194  
 Tongue Switch (Prentke Romich Company), 253  
 Tongue Switch (Toys for Special Children, Inc.), 253  
 Touch 'N Talk Communication Board (Imaginart International, Inc.), 110  
 Touch 'N Talk Communication Notebook (Imaginart International, Inc.), 110  
 Touch 'N Talk Communication Stickers (Imaginart International, Inc.), 111  
 Touch 'N Talk Micros (Imaginart International, Inc.), 111  
 Touch and Match (Edmark Corporation), 692  
 Touch and See (Edmark Corporation), 693  
 Touch Pads (Typeswitch Corporation), 254  
 Touch Switch: CM-4 (Zygo Industries, Inc.), 254  
 Touch Turner (Touch Turner), 301  
 TouchMoney (Edmark Corporation), 693  
 TouchWindow (Edmark Corporation), 444  
 Toy Adapter (Burkhart, Linda J.), 59  
 Toy Adapter Cables: CA-9/CA-12/CA-16 (Zygo Industries, Inc.), 60  
 Toy Cables (4378, 4379) (TASH, Inc.), 60  
 Trace Beeper Box (Trace Center), 61  
 Trace Math Aid (Computers to Help People Inc.), 769  
 Trackball Pro (CH Products), 445  
 TrackMan Live! (Logitech, Inc.), 445  
 TrackMan Voyager (Logitech, Inc.), 446  
 Traffic Signs Plus for Windows (Parrot Software), 694  
 Training Aid 2 (Prentke Romich Company), 61  
 Trak101 Keyboard (Key Tronic), 446  
 TranSend System (Enabling Technologies Company), 522  
 Transportation Signs (Conover Company), 694  
 Tread Switch: CM-1 (Zygo Industries, Inc.), 254  
 Treadle Switch (5880) (TASH, Inc.), 255  
 Tri-Responder (Crestwood Company), 62  
 Trip to the Zoo (Marblesoft), 695  
 TS2010X Text to Speech Personal Communicating Device (D.C. & D., Inc.), 158  
 Tubular Vibrator (Toys for Special Children, Inc.), 62  
 Turbo Mouse 4.0 (Kensington Microwave Limited), 447  
 Turbo Trackball (Asher Engineering Corporation), 447  
 TurboBraille (Kansys, Inc.), 769  
 Turn-Talking (R.J. Cooper & Associates), 695  
 TVRC and TVRCS (APT Technology, Inc.), 301  
 Twenty Categories (Laureate Learning Systems, Inc.), 696  
 Twin Plate Switch (Crestwood Company), 255  
 Twinkle Switch (ACS Technologies, Inc.), 255  
 Twitch Switch (Toys for Special Children, Inc.), 256  
 Type 'n Speak (Blazie Engineering), 487  
 Typelt4Me (Ettore, Riccardo), 770  
 U-Control (Words+, Inc.), 302  
 UKanDu Little Books (Don Johnston Incorporated), 696  
 UKanDu Switches, Too! (Don Johnston Incorporated), 697  
 Ultimate Switch (Toys for Special Children, Inc.), 256  
 Ultra 4 Remote System & Scanning Ultra 4 (TASH, Inc.), 302  
 UltraSilent (DiRAD Technologies, Inc.), 194  
 Understanding Attributes (Parrot Software), 697  
 Uni-Key (National Institute for Rehabilitation Engineering), 367  
 Uniphone 1000 (Ultratec, Inc.), 195  
 Uniphone TDD/TT (HARC Mercantile, LTD), 195  
 Universal Adaptive Switch System (Academic Software, Inc.), 256  
 Universal Control System with Tongue Touch Keypad (New Abilities Systems, Inc.), 303  
 Universal Input Adaptor (Toys for Special Children, Inc.), 464  
 Universal Module (Toys for Special Children, Inc.), 63  
 Universal Remote Controls (Various (Generic Product)), 303  
 Universal Switch Mounting System (AbleNet, Inc.), 175  
 Universal Telephone Adapter (Extensions for Independence), 304  
 Universal Television Remote Control (KY Enterprises), 304  
 URC-400 Series Universal Remote Control (Envirocontrol Company, Inc.), 305  
 Vacuum Wand (Fred Sammons, Inc.), 26  
 Vantage CCD (TeleSensory Corporation), 502  
 Variable Height Desk (PosturMate, Inc.), 552  
 VCS 3500 with TDD Software (Microlog Corporation), 196  
 Verb Fill-Ins (Parrot Software), 698  
 Verbal Analogies (Parrot Software), 698  
 Verbal Analogies Plus for Windows (Parrot Software), 699  
 VersaBraille Electric Webster (Cornucopia Software), 770  
 VersaPoint-40 Braille Embosser (TeleSensory Corporation), 522  
 Versascan (Prentke Romich Company), 63  
 Vertical (Ergonomic-Interface Keyboard Systems, Inc.), 448  
 Vertical Plate Switch (Toys for Special Children, Inc.), 257  
 Vertical Wobble Switch (Toys for Special Children, Inc.), 257  
 Vibra-Call Receiver (Silent Call Corporation), 326  
 Vibrating Sack (Toys for Special Children, Inc.), 64  
 Vibration Switch (Adaptivation, Inc.), 257  
 Video Voice Speech Training System (Micro Video Corp.), 699  
 Viewpoint Optical Indicator (Prentke Romich Company), 26  
 VisAbility (AI Squared), 771  
 Visi-Pitch Model 3300 (Kay Elemetrics Corporation), 700  
 VisionKey (H.K. EyeCan LTD), 158  
 Vista (TeleSensory Corporation), 502  
 Visual Confrontation Naming Plus for Windows (Parrot Software), 700  
 Visual Memory Plus for Windows (Parrot Software), 701  
 Visual Motor Skills (Judy Lynn Software), 701  
 Visual Pattern Memory Plus for Windows (Parrot Software), 702  
 Visuospatial Skills I (Psychological Software Services, Inc.), 702  
 Visuospatial Skills II (Psychological Software Services, Inc.), 703  
 Vocal Assistant (GMR Labs), 159  
 Vocal-Eyes (GW Micro), 487  
 Vocal.ite (Words+, Inc.), 537  
 Voice Activated Switch (Toys for Special Children, Inc.), 258  
 Voice Amplificader (Crestwood Company), 11  
 Voice Math (Chatterbox Voice Learning Systems), 731  
 Voice Mouse/Keyboard (VMK) Controller (Quartet Technology, Inc.), 448  
 Voice Reading Ability Drill (Chatterbox Voice Learning Systems), 732  
 Voice Switch (Crestwood Company), 258  
 Voice User (Cyllogic, Inc.), 449  
 VoiceBachs (Magic Laboratories, Inc.), 159  
 VoiceCard (GW Micro), 538  
 VoiceMate, SwitchMate, ScanMate (2701-2708) (TASH, Inc.), 64  
 VoicePal (Adaptivation, Inc.), 160  
 VoicePal Plus (Adaptivation, Inc.), 160  
 Voicette (Luminaud, Inc.), 12  
 VOIS 160 (Phonic Ear, Inc.), 161  
 Vortex Machine Assisted Reader Software (Tenax Software Engineering), 703  
 VT520 Terminals - Accessibility Features (Digital Equipment Corporation), 367  
 VX-5000 Cordless Phone (Advanced Peripheral Technologies), 305  
 Wafer Switch (5018) (TASH, Inc.), 258  
 Walker Talker (Prentke Romich Company), 161  
 Watchman Master (Ultratec, Inc.), 327  
 WatchMate (InstanTel), 327  
 WatchMate LC (InstanTel), 328  
 WCMK (Prentke Romich Company), 176  
 Wheels On The Bus I, II, III (UCLA Microcomputer Project), 704  
 Wheels on the Bus I, II, III - Intellipics Activity (UCLA Microcomputer Project), 704  
 Wheels on the Bus: COMPLETE (UCLA Microcomputer Project), 705  
 Where is Puff? (UCLA Microcomputer Project), 705  
 WhisperWolf (Wayne County Regional Education Service Agency), 162  
 Win Vision (Artic Technologies), 488  
 WinDOTS (ATR/JWA, Inc.), 771  
 Window-Eyes (GW Micro), 488  
 Winking Keyboard (2448F, 2448Q) (TASH, Inc.), 449  
 WINKLINE (Speech Systems for the Blind), 489  
 WinMini Keyboard (2447F, 2447Q) (TASH, Inc.), 450  
 WinSCAN - Limited Edition (Academic Software, Inc.), 464  
 WinTalk (Microflip, Inc.), 196  
 Wireless Personal Pager (Luminaud, Inc.), 328  
 Wireless TV & VCR Remote Controls (Toys for Special Children, Inc.), 306  
 Wish Writer (Consultants for Communication Technology), 772

- WiViK 2.0 (Windows Visual Keyboard) (*Prentke Romich Company*), 450
- WiVox (*Prentke Romich Company*), 772
- Wobble Switch (*Prentke Romich Company*), 259
- Wobble Switch (*Toys for Special Children, Inc.*), 259
- Word Association Plus for Windows (*Parrot Software*), 706
- Word Order in Sentences (*Parrot Software*), 706
- Word Order Plus for Windows (*Parrot Software*), 707
- Word-Talk (*GW Micro*), 773
- Wordplay with Alps and Droops (*Optimal-Ed Learning Materials*), 732
- Words and Concepts I, II, III (*Laureate Learning Systems, Inc.*), 707
- WordScholar (*Henter-Joyce, Inc.*), 489
- WordWise Language & Master Cards (*Attainment Company*), 112
- WordWise Software (*Attainment Company*), 708
- WordWise Sticker Set (*Attainment Company*), 112
- WordWriter (*Prentke Romich Company*), 368
- Work-Station Pro (*GW Micro*), 773
- Worm Squirm (*UCLA Microcomputer Project*), 708
- WPS Loquitur 115 and 250 (*Western Psychological Services*), 65
- WRIST PERCH (*PC Compatibles*), 368
- Writalk Electronic Pen Pad (*SSK Technology, Inc.*), 197
- Write (*Computers to Help People, Inc.*), 733
- Write This Way (*Edmark Corporation*), 733
- Write:OutLoud (*Don Johnston Incorporated*), 774
- WriteAway (*Institute on Applied Technology, Children's Hospital*), 774
- Writing Utensil Grips (*Various (Generic Product)*), 113
- WSCC (Washington State Cooperative Curriculum) (*J.E. Stewart*), 709
- X-10 Home Control Interface (*X-10 (USA), Inc.*), 306
- X-10 Powerhouse System (*X-10 (USA), Inc.*), 307
- Yak Bak (*YES! Entertainment Corporation*), 162
- Zero to Five (*Educational Technology International*), 734
- Zoo Kit (*Mayer-Johnson Company*), 113
- Zoo Time (*UCLA Microcomputer Project*), 709
- ZoomCaps (*Meeting the Challenge*), 369
- ZoomText 5 (*AI Squared*), 503