

DOCUMENT RESUME

ED 387 914

EA 027 110

AUTHOR Ligman, Bryan K.; Fisher, Eugene J.  
 TITLE Reducing Radon in Schools: A Team Approach.  
 INSTITUTION Environmental Protection Agency, Washington, DC.  
 Office of Radiation and Indoor Air.  
 REPORT NO EPA-402-R-94-008  
 PUB DATE Apr 94  
 NOTE 181p.  
 PUB TYPE Guides - Non-Classroom Use (055)

EDRS PRICE MF01/PC08 Plus Postage.  
 DESCRIPTORS Air Flow; Building Design; Design Requirements;  
 \*Educational Facilities Design; Elementary Secondary  
 Education; Guidelines; \*Hazardous Materials; Physical  
 Environment; \*Radiation; Radiation Effects; \*School  
 Safety; \*Ventilation  
 IDENTIFIERS \*Radon

ABSTRACT

This document presents the process of radon diagnostics and mitigation in schools to help educators determine the best way to reduce elevated radon levels found in a school. The guidebook is designed to guide school leaders through the process of measuring radon levels, selecting the best mitigation strategy, and directing the efforts of a multidisciplinary team in improving the overall indoor-air quality of the school. The book focuses on using a team approach, because effective radon mitigation requires specialized knowledge in several disciplines. EPA has extensively researched two highly successful radon-control strategies: (1) mitigation using active soil depressurization (ASD); and (2) mitigation using the school's ventilation system. Chapters 1 and 2 review what radon is, why it is a concern, and the mechanisms by which it enters and accumulates in a building. Chapters 3 and 4 outline the initial investigation process, in which the condition of the ventilation system is examined to determine whether restoring the ventilation to its intended operating condition could reduce radon levels to below the Environmental Protection Agency's (EPA's) action level. The option of retesting is discussed in the fifth chapter. Chapter 6 discusses the detailed investigation phase that may be necessary if premitigation levels are too high or improving the ventilation system did not sufficiently reduce radon levels. Active subslab depressurization systems are described in chapter 7. The eighth and ninth chapters outline the process of making postmitigation measurements and discuss steps to ensure the long-term effectiveness of the mitigation strategy. Information regarding building codes and worker protection is offered in chapter 10. One table and 21 figures are included. Appendices contain a glossary and list of acronyms, a list of resource organizations, references, metric conversion factors, mitigation cost information, and two case studies based on the experience of EPA's research team. (LMI)

\*\*\*\*\*  
 \* Reproductions supplied by EDRS are the best that can be made \*  
 \* from the original document. \*  
 \*\*\*\*\*

EA

# REDUCING RADON IN SCHOOLS: A TEAM APPROACH

ED 387 914

U.S. DEPARTMENT OF EDUCATION  
Office of Educational Research and Improvement  
EDUCATIONAL RESOURCES INFORMATION  
CENTER (ERIC)

- This document has been reproduced as received from the person or organization originating it
- Minor changes have been made to improve reproduction quality

• Points of view or opinions stated in this document do not necessarily represent official OERI position or policy

"PERMISSION TO REPRODUCE THIS  
MATERIAL HAS BEEN GRANTED BY

*M. Hester*

TO THE EDUCATIONAL RESOURCES  
INFORMATION CENTER (ERIC)."



EA 027 110

EPA 402-R-94-008  
APRIL 1994

# REDUCING RADON IN SCHOOLS: A TEAM APPROACH

Prepared by

Bryan K. Ligman  
and  
Eugene J. Fisher

U.S. Environmental Protection Agency  
Office of Radiation and Indoor Air  
Radon Division (6604J)  
Washington, DC 20460

## NOTICE

The U.S. Environmental Protection Agency (EPA) strives to provide accurate, complete, and useful information. However, neither EPA nor any person contributing to the preparation of this document makes any warranty, expressed or implied, with respect to the material. Nor does EPA assume any liability for, or for damages arising from, the use of any information, method, or process in this document. Mention of firms, trade names, or commercial products in this document does not constitute endorsement or recommendation for use.

## ACKNOWLEDGEMENTS

The information contained in this document is based largely on the evaluations and demonstrations conducted by the School Evaluation Program (SEP) of the Environmental Protection Agency's (EPA) Office of Radiation and Indoor Air and the research conducted by the Air and Energy Engineering Research Laboratory of EPA's Office of Research and Development.

Susan Galbraith of Cogito Technical Services was the primary author of this document which was prepared under contract number 68D20185 with Sandford Cohen & Associates. Terry Brennan of Camroden Associates prepared many of the figures in this document.

Drafts of this document have been reviewed by a large number of individuals in the government and in the private and academic sectors. Comments from these reviewers have helped significantly to improve the completeness, accuracy, and clarity of the document. The following reviewers offered input: Stephany DeScisciolo, David Rowson, Lee Salmon, Anita Schmidt, and Chris Bayham of EPA's Radon Division; A.B. Craig, Kelly Leovic, and Tim Dyess of EPA's Office of Research and Development; John Girman of EPA's Indoor Air Division; Sam Windham of EPA's National Air and Radiation Environmental Laboratory; Katie Mazer of EPA Region 1; Paul A. Giardina and Larainne Koehler of EPA Region 2; Lewis Fellison of EPA Region 3; Chuck Wakamo and Patsy Brooks of EPA Region 4; Donna M. Ascenzi and Mike Miller of EPA Region 6; Michael Bandrowski of EPA Region 9; Ronald Pass of Alabama; Donald Flater and Joyce Spencer of Iowa; William Bell of Massachusetts; George Bruchmann of Michigan; Joseph Milone of Nebraska; Tonalee Key of New Jersey; Craig Kneeland of New York; Rich Prill of Washington; Bill Angell of Midwest Universities Radon Consortium; Bill Brodhead of WPB Enterprises Inc.; William Turner of H.L. Turner Group; Andrew Persily of National Institute of Standards and Technology; Gary Hodgden of Midwest Radon; Brad Turk of Mountain West Technical Associates; Stephen Albright and Jack Hughes of Albright Hughes Construction Inc.

A special thanks is extended to all the school districts who volunteered their schools for evaluation and demonstration work. The local state and regional EPA support which contributed to the logistics of the SEP was invaluable to the program's success. Your support was much appreciated.

## Contents

<b>Purpose</b>	1-1
<b>1.0 Introduction</b>	1-2
1.1 Radon Facts	1-5
<i>Figure 1-1: Deaths from Radon and Other Causes</i>	1-6
1.2 Radon Measurements	1-7
<b>2.0 The Indoor Environment and Radon</b>	2-1
2.1 Building Dynamics	2-2
<i>Figure 2-1: Air Pressure Relationships</i>	2-4
<i>Table 2-1: Selected Ventilation Recommendations</i>	2-8
2.2 Radon Mitigation Strategies	2-9
<i>Figure 2-2: Active Soil Depressurization</i>	2-11
<b>3.0 Evaluating and Correcting Radon Problems</b>	3-1
3.1 Problem Assessment and Strategy	3-1
<i>Figure 1-2: School Mitigation Flowchart</i>	3-3
3.2 The Initial Investigation Team	3-8
3.3 Evaluate and Map Your Radon Test Results	3-10
<i>Sample Working Floorplan 1</i>	3-13
3.4 Initial Investigation	3-14
<i>Figure 3-2: Typical Mechanical Plan and Equipment Schedule</i>	3-18
<i>Figure 3-3: Design Air Pressures</i>	3-20
<i>Figure 3-4: Design Outdoor Air Flow Rates</i>	3-22
<i>Sample Working Floorplan. 2</i>	3-23
<i>Sample Working Floorplan 3</i>	3-26
<i>Sample Working Floorplan 4</i>	3-34
<b>4.0 HVAC System Restoration</b>	4-1
4.1 Restore the Ventilation System	4-1
<i>Sample Working Floorplan 5</i>	4-4
4.2 Seal Large Radon Entry Points	4-5
<i>Figure 4-1: Sealing a Sump Hole</i>	4-6

<b>5.0 Retest Radon Levels</b>	5-1
5.1 Evaluate Retest Results	5-2
<i>Figure 5-1: Radon Levels and Control Cycles</i>	5-3
<i>Sample Working Floorplan 6</i>	5-4
<b>6.0 Detailed Investigation</b>	6-1
6.1 Assemble a Radon Team	6-1
6.2 Radon Mitigation Techniques	6-2
<i>Figure 6-1: ASD Beneath a Membrane</i>	6-5
<i>Figure 6-2: ASD with Multiple Suction Points</i>	6-5
6.3 Elements of the Detailed Investigation	6-7
<i>Figure 6-3: Elements of the Detailed Building Investigation</i>	6-8
<i>Sample Working Floorplan 7</i>	5-10
<i>Figure 6-4: Flowchart for Evaluating ASD-based Mitigation</i>	6-12
<i>Sample Working Floorplan 8</i>	6-17
<i>Figure 6-5: Vacuum Test of Pressure Field Extension</i>	6-25
<i>Figure 6-6: Fan Door Test Results</i>	6-28
<i>Figure 6-7: Carbon Dioxide as an Indicator of Ventilation</i>	6-33
<i>Figure 6-8: Calculating the Percent of Outdoor Air</i>	6-35
<i>Figure 6-9: Converting % Outdoor Air to CFM/Person</i>	6-35
<i>Sample Working Floorplan 9</i>	6-36
<b>7.0 Design and Implementation of Mitigation Techniques</b>	7-1
7.1 Active Soil Depressurization	7-3
7.2 Pressurization	7-8
<i>Figure 7-1: Mitigation by Pressurization</i>	7-10
7.3 Dilution	7-11
<i>Figure 7-2: Mitigation by Dilution</i>	7-13
<i>Sample Working Floorplan 10</i>	7-14
<b>8.0 Post-Mitigation Measurements</b>	8-1
<i>Figure 8-1: Post-Mitigation Measurements</i>	8-1
8.1 Evaluate Results of Post-Mitigation Radon Measurements	8-2
<b>9.0 Long-Term Radon Management</b>	9-1
9.1 Periodic Radon Testing	9-1
9.2 HVAC System Maintenance	9-2
9.3 Installation of New HVAC Equipment, Building Renovations	9-5
<b>10.0 Special Considerations</b>	10-1
10.1 Building Codes	10-1
10.2 Worker Protection	10-2

Contents

<b>Appendix A: Glossary and Acronyms</b>	A-1
Glossary	A-1
Acronyms	A-8
<b>Appendix B Resources</b>	B-1
References	B-1
Regional Radon Training Centers	B-1
EPA Regional Offices	B-2
State Radon Contacts	B-3
Bibliography	B-4
<b>Appendix C Metric Conversion Factors</b>	C-1
<b>Appendix D Mitigation Cost Information</b>	D-1
<b>Appendix E Case Studies</b>	E-1



## Overview

This document will assist you in determining the best way to reduce elevated radon levels found in a school. It is designed to guide you through the process of confirming a radon problem, selecting the best mitigation strategy, and directing the efforts of a multidisciplinary team assembled to address elevated radon levels in a way that will contribute to the improvement of the overall indoor air quality of the school.

Chapters 1 and 2 review what radon is, why it is a concern, and the mechanisms by which it enters and accumulates in a building. Chapters 3 and 4 outline the Initial Investigation, in which you will examine the condition of your school's ventilation system and determine whether restoring the ventilation system to its intended operating condition could reduce radon levels to below EPA's action level of 4 pCi/L. This determination is based on: 1) the school's pre-mitigation radon levels, and 2) a physical inspection of the ventilation system. If significant improvements are made to the ventilation system, Chapter 5 discusses the option of retesting to determine whether this action alone has solved the problem.

Chapter 6 discusses the Detailed Investigation that may be necessary if: 1) pre-mitigation levels are above 10 pCi/L, or 2) improving the ventilation system did not sufficiently reduce radon levels. Chapter 7 describes active subslab depressurization systems, which have proven effective at reducing extremely elevated radon levels in both residences and schools. Chapters 8 and 9 outline the process of making post-mitigation measurements and discuss steps to ensure the long-term effectiveness of your mitigation strategy. Chapter 10 provides information regarding building codes and worker protection. This document also offers two case studies based on real-life experiences of EPA's research team and cost information for six research sites.

Each chapter of the guide builds upon the previous chapter and makes use of photographs, floor plans, and graphs to illustrate the steps involved in designing the proper mitigation strategy for a school. The guide is not meant to be a "how-to" manual on radon mitigation, but rather a resource for managing a team made up of radon mitigation contractors, HVAC engineers, school personnel, and parent representatives. EPA believes such a team is helpful to achieve successful mitigation.

By following this guide, you will not only have reduced your school's radon levels, but you will also have a good understanding of the steps necessary to ensure the integrity of your mitigation strategy.

## Purpose

This document presents the process of *radon diagnostics* and *mitigation* in schools. It describes what radon is, why it is a concern, and strategies for correcting radon problems. It also discusses how to select the best mitigation approach, based on indoor radon concentrations and features of the building and its mechanical systems.

**Radon diagnostics** means evaluating building characteristics and radon distribution to understand the causes of a radon problem.

**Mitigation** means treatment or correction of a problem.

EPA has found that effective radon mitigation in schools requires specialized knowledge in several disciplines. For this reason, school radon problems can best be resolved through the use of a team approach. This document is targeted at the team leader, the person responsible for coordinating the effort and achieving satisfactory compliance with the technical objectives.

The team leader may be the school's facility manager or a hired consultant such as a mechanical engineer or radon mitigation contractor. The team leader should be familiar with radon mitigation diagnostics and mitigation strategies in order to identify qualified team players (e.g., district personnel, consultants, contractors) and coordinate their efforts. This document provides background information about diagnostic and mitigation techniques that have been successfully applied in school buildings. It does not address radon measurement protocols. Radon measurement protocols for schools can be found in the EPA document entitled *Radon Measurement in Schools - Revised Edition* (see **Appendix B**).

EPA has extensively researched two highly successful radon control strategies: 1) mitigation using active soil depressurization (ASD), and 2) mitigation using the school's ventilation system. This document presents information about both strategies and assists you in choosing the approach that best fits your school.

School staff are an important factor in the success of any radon control program. Facility staff bring valuable experience to building investigations and will probably be responsible for monitoring the operation of radon mitigation systems. The school administration must support the activities necessary to long-term success, but facility staff generally carry out those activities. This document can help a school district use the skills and resources available within its own staff when possible and be a well-informed consumer of outside services when necessary.

## 1.0 Introduction

Radon is a naturally-occurring radioactive gas found in the soil. It can enter buildings through cracks and openings to the ground and accumulate indoors until it reaches dangerous concentrations. Radon has been identified as the second leading cause of lung cancer after smoking. The higher the radon concentration and the longer the exposure time, the higher the risk of developing radon-related lung cancer.

Radon is odorless, tasteless, and colorless. It does not announce its presence by smelling like spoiled food or making our eyes itch. In fact, we need specialized instruments to detect radon at all. Testing for radon is straightforward and radon problems can be corrected, but the motivation to act must come from our ability to *think* about the health risks.

**The U.S. Environmental Protection Agency (EPA) recommends that all schools test for radon and mitigate areas with elevated concentrations.** EPA's National School Radon Survey, performed during 1990, obtained radon measurements from 927 randomly-selected schools across the United States.

Almost one out of every five schools surveyed had at least one ground-contact room with radon above EPA's action level of 4 *picocuries per liter* (4 pCi/L) using short term measurement devices. Based on these initial measurements, it appears that approximately 15,000 U.S. schools have at least one room with a potential radon problem. Radon is often unevenly distributed within a building. Overall, short-term radon concentrations in roughly 2.7% of all ground-contact schoolrooms were over 4 pCi/L, indicating a nationwide total of 73,000 schoolrooms with a potential radon problem.

*picocuries per liter*: Radon concentrations are described on the basis of the radioactivity per unit volume of air.

EPA has developed various resources to promote accurate and meaningful radon measurements and assist in correcting radon problems. EPA's Office of Radiation and Indoor Air (ORIA) and Office of Research and Development (ORD) have been studying a wide variety of schools across the country that have elevated levels of radon. ORIA's School Evaluation Program (SEP) and ORD's school research and development program were intended to identify diagnostic techniques that can be useful for understanding the dynamics of radon entry and movement in schools and to test mitigation strategies that can control the radon problem. An ORD

document, *Radon Prevention in the Design and Construction of Schools and Other Large Buildings*, suggests ways to keep radon out of new buildings (see **Appendix B** for more information).

In addition to radon, indoor air in schools can contain a variety of other contaminants whose effects range from discomfort to serious, even life-threatening health hazards. Both elevated radon concentrations and other indoor air quality (IAQ) problems are often caused or made worse by deficiencies in the ventilation system. EPA research indicates that many of our nation's schools are not properly ventilated with outdoor air. Their heating, ventilation, and air conditioning (HVAC) systems frequently do not introduce enough outdoor air to meet current standards nor to meet the standards that applied when the buildings were constructed. Inadequate outdoor air *ventilation* can lead to accumulation of radon and other indoor air contaminants. Unfortunately, most people do not understand the potential health effects of poorly maintained ventilation equipment.

The term *ventilation* as used in this document refers to the flow of air into, within, and out of a building. Mechanical air handling equipment often blends outdoor ventilation air with recirculated room air.

EPA believes that correction of ventilation problems should be an important part of school radon control programs because ventilation is a critical element of indoor air quality. In addition, EPA research findings indicate that schools should identify and correct ventilation system malfunctions and deficiencies as an initial step in responding to a radon problem, because:

- 1) The indoor concentration of an airborne contaminant such as radon is a result of the dynamic balance between the rate of contaminant entry (or production) and the rate of contaminant removal, both of which are strongly affected by the ventilation system. It is best to have the ventilation system operating as desired before conducting a detailed investigation, so that the data collected represents "normal" conditions.
- 2) Changing ventilation system operation can have the effect of increasing or decreasing radon levels. In most schools, correcting outdoor air ventilation inadequacies will result in lower radon levels. In others, correcting some ventilation malfunctions (e.g., replacing a broken exhaust fan) could increase indoor radon concentrations.

## Purpose/Introduction

3) If the ventilation system creates strong negative pressures in the building, ventilation adjustments may be needed before any other approach to radon control can be successful.

Design goals, differences in age, construction materials, mechanical equipment, number of occupants, room layout, construction, and operation make each building unique. This document discusses how to select the radon mitigation strategy best suited to the unique features of your building and its mechanical systems. You will learn how to conduct a walkthrough inspection to identify radon entry points and assess the condition of the ventilation system. This document also describes the diagnostic techniques used by researchers and professional building investigators.

Many schools may be able to reduce radon below 4 pCi/L by identifying and correcting ventilation system problems. This approach generally improves indoor air quality, extends the useful life of buildings, furnishings, and mechanical equipment, and typically improves the health and comfort of students and staff. A ventilation-based approach to radon control may also help build support for facility operation as a budget priority. However, this mitigation strategy will not work in every school and requires conscientious long-term maintenance. Radon concentrations may be too high to treat successfully by using the ventilation system alone. Some building structures are not suited to this approach, and some buildings are not equipped with mechanical ventilation.

EPA has also developed and tested another radon control technique known as *ASD* (active soil depressurization) that has been used successfully in both residential and non-residential buildings. Effective *ASD* systems can be designed for most building designs and site conditions. *ASD* has little or no effect on other building functions and causes only small increases in energy consumption. However, *ASD* only treats soil gas contaminants such as radon; it will not address other indoor air quality problems.

*ASD* prevents radon entry by reducing air pressure in the soil beneath the foundation.

The source of radon beneath your school will always be there. Any radon control strategy must be maintained for the lifetime of the building. This document will help the school district to decide what radon control strategy is best suited to its needs and establish a program that prevents recurrence of the radon problem.

## 1.1 Radon Facts

Radon gas is continually released by uranium-bearing rocks and soil as the uranium undergoes natural radioactive decay. The gas moves through the soil freely because it is chemically nonreactive and does not combine with other materials. When the radon gas reaches the outdoor air, it is quickly diluted to low concentrations. However, radon can accumulate under the slabs and foundations of buildings and can easily enter through cracks and openings, sometimes causing high indoor concentrations.

Radon decays into other radioactive elements (which are solid particles)-- often referred to as radon decay products or radon progeny. When radon progeny are inhaled, they can lodge in the lungs and deliver radiation doses to sensitive lung tissue as the progeny continue to decay.

The health risks of radon gas have been clearly recognized by organizations such as the National Academy of Sciences, the U.S. Public Health Service, the Centers for Disease Control and Prevention, the World Health Organization, the American Lung Association, the American Medical Association, EPA and many other national and international health and science organizations. Radon is a known human carcinogen and is estimated to be the second leading cause of lung cancer. Only smoking causes more lung cancer deaths. EPA estimates that radon causes between 7,000 - 30,000 lung cancer deaths each year in the U.S. By comparison, roughly 23,000 people in this country die as a result of drunk driving accidents, 4,400 die of injuries caused by fires, and 1,000 are killed in airplane crashes annually (as illustrated in Figure 1-1). Scientists agree that the risks associated with radon increase as the concentration and length of exposure increase. In addition, smoking combined with radon is an especially serious health risk. The risk of dying from radon related lung cancer is much greater for smokers than it is for non-smokers.

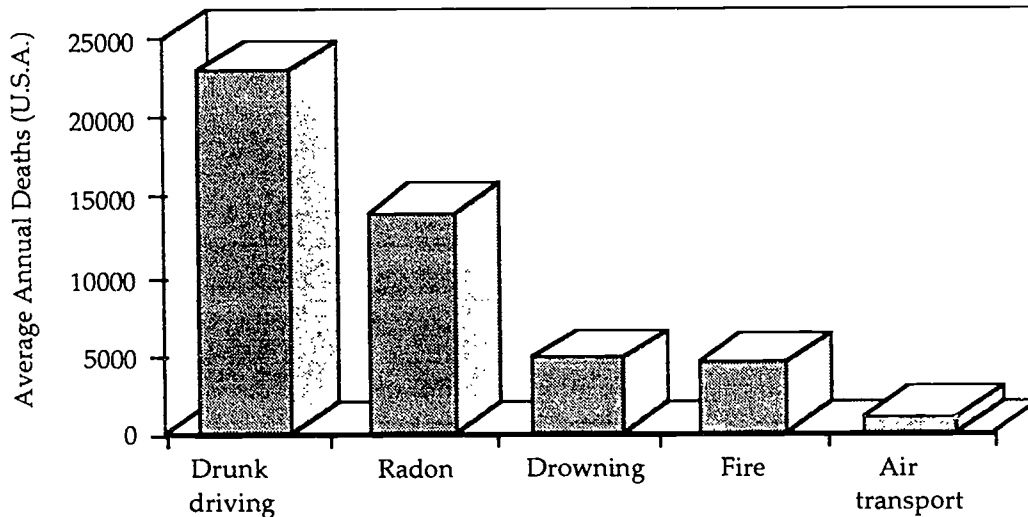

**Fig. 1-1: Deaths from Radon and Other Causes**

The numbers of deaths from causes other than radon come from a 1990 report of the National Safety Council.

EPA currently recommends taking action to reduce radon levels in schools and homes where the concentration of radon is 4.0 pCi/L or higher based on follow-up measurement results. Based on this action level, this document defines mitigation as successful when radon concentrations during occupied periods are below 4 pCi/L. However, any radon exposure poses a risk, even at concentrations below 4.0 pCi/L, because radon is a carcinogen with no known threshold level (i.e., the concentration below which no potential harm exists).

Soil gas (which consists of air, water vapor, and any natural or synthetic contaminants that are found in the spaces between soil particles and the cracks in bedrock) is the most common source of radon problems in the United States. Soil gas is drawn into buildings by pressure differentials between the soil surrounding the substructure and the building interior. Radon can also be found in natural aquifers, from which it may enter private wells.

The amount of radon in a given room will depend on five factors:

- *source strength* -- the concentration of radon in the soil or bedrock underlying the building
- the *permeability* of material below the slab -- the ability of soil gas to move through pores and cracks in the fill, soil, and rock beneath the slab
- the number and size of radon *entry routes* -- openings to the ground

- the size and direction of *pressure differentials* between indoors and the subslab
- the *outdoor air ventilation rate* -- the amount of outdoor air brought into the room

Radon control strategies involve influencing the last three factors. Large radon entry routes can be sealed.

*Pressure differentials* and outdoor air ventilation rates can be changed by adjusting the existing building ventilation system or installing new ventilation equipment. Active soil depressurization (ASD) works by creating and maintaining a *negative pressure field* in the soil below the foundation.

The term *pressure differential* is used to describe the difference between air pressures measured at two locations.

A *negative pressure field* is an area that is maintained at a relatively lower air pressure than an adjoining location.

## 1.2 Radon Measurements

EPA's radon measurement protocol for schools is described in *Radon Measurement in Schools; Revised Edition* (see **Appendix B**), which replaces the earlier *Radon Measurement in Schools: An Interim Report*. Use only measurement devices and testing contractors that are listed with EPA's *Radon Measurement Proficiency (RMP)* program or are state-certified. Many states require the use of certified personnel to conduct radon testing or install radon reduction systems. Ask your state radon contact for a list of qualified contractors. Schools can use their own staff members to test for radon or use professional radon measurement contractors (unless prohibited by state laws and/or regulations). If school staff are used to perform the tests, EPA recommends that they receive training in radon measurement (see *Radon Measurement in Schools; Revised Edition* for recommended training).

EPA's RMP program evaluates the accuracy of radon measurement devices and the people who use them. EPA issues individual identification cards to testers who pass the RMP measurement proficiency test. Your state radon office has lists of RMP program participants. Some states also operate their own certification programs.

*Radon Measurement in Schools; Revised Edition* calls for an initial phase during which short-term measurements should be made in all frequently-occupied rooms



## Purpose/Introduction

that contact the ground, including classrooms, gymnasiums, cafeterias, and offices. EPA recommends testing during the coldest months, when the heating system is operating and windows and doors are closed (except for normal exit and entry). HVAC equipment should be operated normally, including normal occupied-unoccupied cycling, and testing should be scheduled to take place during the week.

Short-term tests are from two to ninety days in duration, providing a determination of whether or not high radon concentrations are present and whether additional measurements are needed. EPA does not recommend testing in locker rooms and kitchens, because high humidity affects some radon measurement devices. Other rooms not recommended for inclusion in testing programs include hallways, toilets, closets, and storerooms.

EPA's *Indoor Radon and Radon Decay Product Measurement Protocols* describes a variety of instruments for measuring indoor radon concentrations. A minimum of a 48 continuous hour test period should be used. Devices that produce results within a short time (e.g., two- to five- day measurements) offer the advantage of rapid feedback, allowing a prompt response if radon levels are high.

The school test protocol is designed to identify all regularly-occupied ground contact rooms that may have elevated radon concentrations. *Because radon levels can vary dramatically over time, EPA strongly advises that schools not expend funds to reduce radon concentrations on the basis of initial short-term tests alone.*

A second, follow-up test should be conducted in ALL areas where initial test results show radon levels at or over 4 pCi/L. This test may be done with either a short-term or a long-term measurement device. Devices that measure radon over a period of months are more representative of *annual average exposures*. Indoor radon concentrations have been observed to vary seasonally, at least partly because outdoor air ventilation rates are usually reduced when outdoor temperatures are extreme. The purpose of the follow-up test is to make sure that you actually have a radon problem in areas where the initial result was greater than or equal to 4 pCi/L. Follow-up measurements may also be considered for rooms: 1) in which initial test results are only slightly below 4 pCi/L *and* 2) adjacent to areas with radon concentrations equal to or above 4 pCi/L. HVAC equipment should operate normally, as before.

The *annual average exposure* to radon is the exposure as a function of time. Because of seasonal variations in radon concentrations, occupant risk can best be evaluated by determining the annual average exposure.

If the follow-up test was short-term (less than 90 days), calculate the average of the initial and follow-up test results for each test location. Corrective action is needed if the average radon level in any area is 4.0 pCi/L or higher. If the follow-up test period was long-term (i.e., over 90 days), disregard the initial test results and use only the long-term test, taking corrective action in areas with long-term test results of 4.0 pCi/L or higher.

Indoor radon levels can change over time. Openings to earth may appear or enlarge as buildings settle or new wings are added to existing buildings. Air circulation patterns and pressure relationships change when fans are added, removed or replaced by equipment of a different size. As a result, rooms in which radon test results are below 4 pCi/L may develop higher radon concentrations in the future. EPA recommends that schools be periodically retested.

For complete information on EPA's recommended testing approach for schools, see *Radon Measurement in Schools - Revised Edition*, EPA 402-R-92-014.

## 2.0 The Indoor Environment and Radon

This section discusses radon in the context of the overall indoor environment. Radon is an indoor air quality problem and is often found in conjunction with other IAQ problems. Building air dynamics that impact radon entry and distribution will also be discussed. The radon mitigation strategies that are typically used in school buildings are then presented and discussed. These strategies control radon by influencing the air dynamics in the building.

This document is primarily concerned with radon and the aspects of ventilation that affect indoor radon concentrations. It does not provide detailed information about other indoor air contaminants or other aspects of the indoor environment. If you are interested in the potential for indoor air quality (IAQ) problems, a brief discussion on other common indoor air contaminants is presented below. Information about IAQ is available from other sources to supplement the discussion that follows. For example, EPA and the National Institute for Occupational Safety and Health (NIOSH) have produced *Building Air Quality*, an IAQ guidance document for building owners and managers of non-residential buildings that can be obtained by calling the EPA's IAQ Information Clearinghouse at 800-438-4318. EPA is also developing IAQ guidance for schools.

Radon is an important indoor air contaminant because it can cause lung cancer. However, radon is only one part of the IAQ picture in your school. Indoor air typically contains a variety of contaminants at low concentrations. It is important to be aware of potential IAQ problems as you perform the radon control investigations outlined in this document. Awareness of potential IAQ problems is key to maintaining an indoor environment that is safe for the occupants. Identifying and correcting IAQ problems may help prevent future complaints and illnesses.

As you inspect each outdoor air intake to evaluate damper operation, think about the intake location. Are there sources of odors or pollutants nearby? ("Near" is a relative term - consider the wind direction and the strength of the contaminant source.) For example, if vehicles idle near an outdoor air intake, exhaust fumes may be drawn into the building. Rooftop air intakes can create problems if they are located close to exhaust outlets or sewer vents, or if water puddles on the roof remain long enough to become sites for microbiological growth.

A puddle is an obvious location for microbiological growth, but IAQ problems can develop in much smaller amounts of water. Persistent high humidities can stimulate mold and mildew growth on walls, windows, and other surfaces. Condensate drain pans that don't drain completely often show signs of

microbiological growth, such as visible algae or odors.

Many chemicals -- from the cleaning agents used by custodial staff to the chemicals used in science classes -- can cause IAQ problems. Proper storage, use, and disposal of chemicals are important elements of IAQ management. Air from chemical storage areas should be exhausted directly to outdoors, not circulated through occupied areas of the building.

The term *plenum* is used to describe a) portions of the air distribution system that make use of the building structure, and b) the sheet metal that connects distribution ductwork to an air handling unit. Many buildings use the space above a dropped ceiling as a plenum.

**Air plenums and mechanical rooms**

**are not proper storage areas.** State and/or local school building codes and standards outline the requirements for proper chemical storage areas. Consult an IAQ professional regarding these requirements if you suspect improper storage of chemicals.

These are just a few of the IAQ problems commonly found in schools. Consider these examples as you conduct your building investigation(s), and seek additional guidance if you need help to investigate or correct a suspected IAQ problem. Many potential IAQ problems are relatively straightforward to correct once you recognize the potential problem. For example, in the case of vehicles idling near an outdoor air intake, one possible solution would be to relocate the vehicles and prohibit idling near air intakes in the future. However, some solutions are more complex. An indoor mold and mildew problem resulting from high relative humidity will probably not be solved by cleaning the surfaces on which mold and mildew grow. It will also require correcting or adjusting the HVAC system so that relative humidity is maintained below the level that promoted mold and mildew growth in the first place. As you perform the building investigations described in this document, take note of potential IAQ problems and seek additional guidance if you need help to investigate or correct a suspected IAQ problem.

## 2.1 Building Dynamics

A building can be thought of as a dynamic system. Air flows into, out of, and within the building change in response to outdoor conditions (e.g., temperature, wind) and indoor conditions (e.g., doors opening and closing, fan systems cycling on and off). These air flows, in turn, influence the rate of radon entry, the distribution of radon within the building, and the rate at which radon is removed by dilution.

Air needs both a pathway and a driving force in order to move between two points. Pathways for air movement can be planned or unplanned. Windows and air distribution ducts are planned pathways -- the building designer intended air to move along these routes. Unplanned pathways for air movement include utility tunnels, plumbing chases, the hollow interiors of block walls, cracks and holes in the building structure, and unsealed seams in ductwork. Pathways change when doors, windows, and air distribution dampers open and close. They also change as walls are moved, buildings are expanded, and foundations settle over time.

Pressure differences are the driving force behind air movement. Air flows from areas of relatively higher (*positive*) pressure to areas of relatively lower (*negative*) pressure along any available pathways. As fans move air, they create pressure differences between rooms and between the building interior and the outdoors. If the air pressure in ground-contact rooms is lower than the air pressure in the soil outside a building, soil gas will flow into the building.

#### a. Air Circulation Patterns

When air is removed from a room, an equal amount of air must enter the room. When air is blown into a room, an equal amount of air must leave. Whether a mechanically ventilated room is under negative, positive, or neutral pressure relative to outdoors depends on the balance between the quantity of air that is supplied and the quantity that is removed as return or exhaust.

Figure 2-1 illustrates these examples:

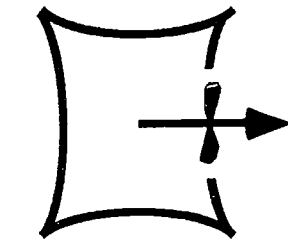

a. Negative Pressure

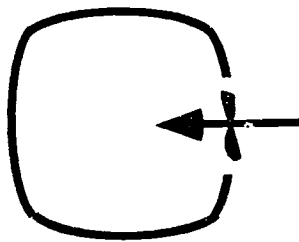

b. Positive Pressure

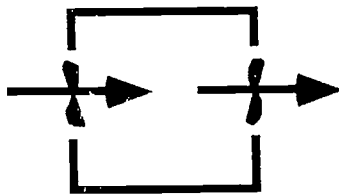

c. Neutral Pressure

In example a): An exhaust fan removes 500 cubic feet per minute (cfm) of air from a room. This lowers the air pressure, creating just enough negative pressure to draw 500 cfm of air into the make-up room through cracks and openings. Air movement into a room through cracks and openings in the building is called *infiltration*. If this room has openings to earth and radon in the soil, radon will be drawn into the building.

In example b): A supply fan blows 500 cfm of air into a room. This raises the air pressure and creates just enough positive pressure to push 500 cfm of air out of the room through cracks and openings. Air movement out of a room through cracks and openings is called *exfiltration*. Even if there are openings to earth and radon is in the soil, soil gas and radon will not enter as long as the positive pressure is maintained. This is the principle behind pressurization as a radon mitigation technique.

In example c): A room has both a 500 cfm supply fan and a 500 cfm exhaust fan. Five hundred cfm of air moves through the room, but the room remains at *neutral pressure*. (neither positive nor negative). There is no infiltration or exfiltration. As long as it is at neutral pressure, this room should not have a radon problem. However, it is difficult to maintain an exact neutral pressure balance over time.

Figure 2-1: Air Pressure Relationships

In rooms that have no mechanical supply or exhaust, one area can be under negative pressure while another area is positively pressurized. For example:

A room has steam radiators for heating, but no mechanical ventilation. Warm air rises, creating positive pressure at the upper level of the room. The warm air exfiltrates outdoors through cracks and openings high in the walls, in the roof, and at the roof-wall joint. This creates a negative pressure at floor level and causes the infiltration of an equal amount of air through cracks and holes (e.g., at the floor-wall joint and through any openings in the slab). *If this room has any openings to earth and radon in the soil below the foundation, it could have a radon problem.*

The example above describes the *stack effect*, the pressure difference created by warm air rising. In general, the greater the indoor/outdoor temperature difference and the taller the building, the stronger the stack effect. Wind also creates pressure differences. Wind blowing against the walls pressurizes some rooms while depressurizing others. Wind blowing across the top of a building pulls air upward. Overall, both wind and the stack effect tend to draw radon into buildings and move it upward.

Air flow patterns in a large building can be complicated, because pathways and pressure relationships change as doors open and close and fans cycle on and off. Comparing the amount of air that is supplied to the amount that is returned or exhausted will reveal whether air leaks into or out of any particular area. However, it may be difficult to discover where infiltration air is coming from or where exfiltration air is going.

EPA researchers have found that many schools tend to *run negative* (operate under negative pressure relative to outdoors), increasing the likelihood of radon problems. Schools (or areas within a school) may run negative under a number of conditions:

- Areas without mechanical ventilation tend to run negative because air pressures in the building are dominated by wind and the stack effect.
- Areas that rely on exhaust fans to draw in outdoor air for ventilation are depressurized by the operation of the exhaust fans.
- Areas such as toilets, kitchens, science laboratories, and darkrooms usually run negative by design, to keep odors and pollutants out of surrounding rooms.
- Areas that have both supply and exhaust fans will run negative if the total fan-powered exhaust is greater than the total fan-powered outdoor air intake. This may occur if:
  - the building was not designed to run positive
  - energy conservation measures have reduced outdoor air flow by closing air intake dampers on unit ventilators or air handling units

- air handling equipment no longer provides and distributes ventilation air according to the design
- additional exhaust fans have been installed since the original construction
- filters and/or coils are dirty, reducing air flow
- Areas that are pressurized during occupied periods may run negative during evenings and weekends (due to stack and wind effects), when HVAC systems are commonly set back or turned off. Radon levels may build up during these unoccupied periods, then drop again when the HVAC system resumes its occupied cycle.
- Mechanical rooms or other locations containing combustion appliances will run negative when that equipment is firing, unless there is an adequate source of outdoor air for combustion.

Pressure relationships are relative. Active soil depressurization, the most widely-used approach to radon mitigation, works by withdrawing air from the soil under the building foundation (to create a negative pressure field) and venting it above roof level. ASD can prevent radon from entering the building as long as the air pressure generated by the ASD system is lower than the air pressure in any ground-contact room.

#### **b. Outdoor Air Ventilation**

There are many ways to bring outdoor air into a building. Some systems rely on natural ventilation, using operable windows to regulate the entry of outdoor air; other systems use mechanical air handling equipment to provide a flow of outdoor air that dilutes indoor air contaminants and is heated or cooled to maintain comfort conditions. Mechanical ventilation systems may depend on a large number of small units (such as unit ventilators) distributed through the building, with an outdoor air intake at each unit. They may use central air handling units that distribute ventilation air through ducts and plenums. Many school buildings combine several approaches to outdoor air ventilation.

The higher the outdoor air ventilation rate (usually expressed as cubic feet/minute per person, or cfm/person), the more outdoor air is available to dilute radon and other indoor air contaminants. The volume of outdoor air that a ventilation system supplies to a space depends on the use of the space. For example, rooms that contain sources of air contaminants (such as locker rooms or smoking lounges) require more outdoor air per occupant than offices or classrooms. (See Table 2-1.)



Ventilation standards, such as the American Society of Heating, Refrigeration, and Air-Conditioning Engineers' *ASHRAE Standard 62*, describe the outdoor air requirements for different building types and room uses. **Table 2-1** shows the current ASHRAE recommendations for various areas in school buildings. Recommended outdoor air ventilation rates have changed over time. From 1936 to 1973, *Standard 62* called for 10 cfm of outdoor air per person in classrooms. In 1973, this quantity was reduced to 5 cfm/person, but in 1989, *Standard 62* was revised again to call for 15 cfm of outdoor air per person. State and local codes do not always echo the recommendations of the professional organizations (such as ASHRAE) who develop model standards. Your state's Education Department can help to identify the codes that applied when your school was designed and the codes or standards that govern new school construction in your area.

The relationship between the HVAC system and indoor radon can be complex. A ventilation system that maintains all or part of the building under negative pressure (such as a ventilation system that includes exhaust fans but no supply fans) tends to draw in radon-containing soil gas. Increasing the outdoor air ventilation rate in such a system could increase or decrease indoor radon concentrations, depending on the size and distribution of below-grade and above-grade openings. This type of ventilation system can also prevent an ASD system from working effectively by competing with or defeating the negative pressure developed by the ASD system.

Even ventilation systems that have mechanically-supplied outdoor air can create problems for ASD systems if the ventilation system is designed or constructed in a way that draws soil gas into the building. Examples of features that "mine" soil gas include:

- Return ducts that are routed through earth-floored crawlspaces or utility tunnels or that are located under the building slab
- Air handling units installed with the return side tight against the slab, if there is also an opening through the slab (e.g., a floor-wall crack or piping that penetrates the slab) inside the return plenum
- Above-ceiling return plenums are located in an area where masonry walls have open block tops

It is, therefore, important to understand the potential impacts that HVAC systems and ASD systems may have on each other. Both systems manipulate the building's air dynamics; installing or adjusting either type of system without knowledge of how it may affect the other could seriously jeopardize the performance of the radon control strategy.

Application	Occupancy (people/1000 ft <sup>2</sup> )	Cfm/person
<b>Instructional areas</b>		
Classrooms	50	15
Laboratories	30	20
Music rooms	50	15
Training shops	30	20
<b>Staff areas</b>		
Conference rooms	50	20
Offices	7	20
Smoking lounges	70	60
<p>Bus garage: 1.5 cfm per square foot of floor area. Distribution among people must consider worker location and concentration of running engines; stands where engines are run must incorporate systems for positive engine exhaust withdrawal. Contaminant sensors may be used to control ventilation.</p>		
<b>Assembly rooms</b>		
Auditoriums	150	15
Libraries	20	15
Gymnasiums		
spectator areas	150	15
playing floor	30	20
<b>Food and beverage service</b>		
Cafeteria	100	20
Kitchen	20	15
<p>Additional airflow may be needed to provide make-up air for hood exhaust(s). The sum of the outdoor air and transfer air of acceptable quality from adjacent spaces shall be sufficient to provide an exhaust rate of not less than 1.5 cfm/square foot.</p>		
<b>Miscellaneous</b>		
Corridors: 0.1 cfm/square foot		
Locker rooms: 0.5 cfm/square foot		
Nurse's offices (patient areas)	10	25
Restrooms: 50 cfm/urinal or water closet		

**Table 2-1: Selected Outdoor Air Ventilation Recommendations**

SOURCE: ASHRAE Standard 62-1989, *Ventilation for Acceptable Air Quality*

## 2.2 Radon Mitigation Strategies

Radon control depends on: a) *changing pressure relationships to prevent radon entry* (pressurizing the building interior or using ASD to depressurize the space under the building), b) *diluting the radon after it enters* the building, or c) an approach that combines these principles. Strategies that prevent radon entry have been applied successfully in buildings with a wide range of radon concentrations. Strategies that use outdoor air to dilute radon after it has entered the building are most practical if the pre-mitigation radon concentration is only slightly elevated.

Some mitigation approaches use the existing building HVAC system, while others require the installation of dedicated radon control equipment. For long term control over the radon problem, any corrective actions must be institutionalized (incorporated into your normal operations).

### a. Radon Mitigation using Active Soil Depressurization

*Active soil depressurization (ASD)* systems use dedicated radon control equipment to prevent radon entry. ASD functions by creating a negative pressure field in the soil beneath the building foundation. Because most buildings have floor slabs, ASD is also referred to as "subslab depressurization." However, soil depressurization can also be accomplished in areas without slabs by creating suction under an installed membrane. As long as the air pressure below the building slab (or installed membrane) is lower than the air pressure in any ground-contact rooms, radon cannot flow into the building. If there are any cracks or holes in the slab or foundation walls, air will be drawn from the building interior into the subslab area.

In a typical ASD design, one or more holes are opened through the floor slab, and a small pit is dug beneath each slab penetration (see **Figure 2-2**). Piping (usually 4" or 6" diameter) is installed at each slab penetration and used as ductwork. The piping runs from the subslab pit to one or more dedicated radon control fans, chosen for their ability to operate under conditions of high static pressure and relatively low air flow. The radon control fans operate continuously, drawing radon from under the slab and exhausting it to outdoors, where it dissipates. Sensors on the pipe are linked to an alarm system that alerts building operators if the pressure in the pipe drops, allowing radon concentrations to rise.

ASD is the most widely-used method of radon control, and will probably be part of the mitigation plan for any school with radon concentrations above 10 pCi/L. The complexity of an ASD design will depend on the characteristics of the foundation and the subslab material (factors that will be discussed in **Section 6: The Detailed Building Investigation**).

ASD offers several advantages:

- It is effective regardless of the pre-mitigation radon concentration.
- It has been more widely studied and applied than any other mitigation strategy, and has been proven successful in a wide range of buildings and site conditions.
- The fans used in ASD systems are relatively small, and therefore have only a minor impact on energy consumption.
- The ASD system is not affected by normal occupant activities such as opening and closing windows.

The disadvantages of ASD are that:

- It only affects radon and other soil gases, and will not correct other existing indoor air quality problems.
- Before the ASD system can be successful, it may be necessary to seal large openings to earth and correct excessive negative pressures in the building.
- A large number of suction points may be required in some buildings.

Figure 2-2 illustrates a typical ASD system layout.

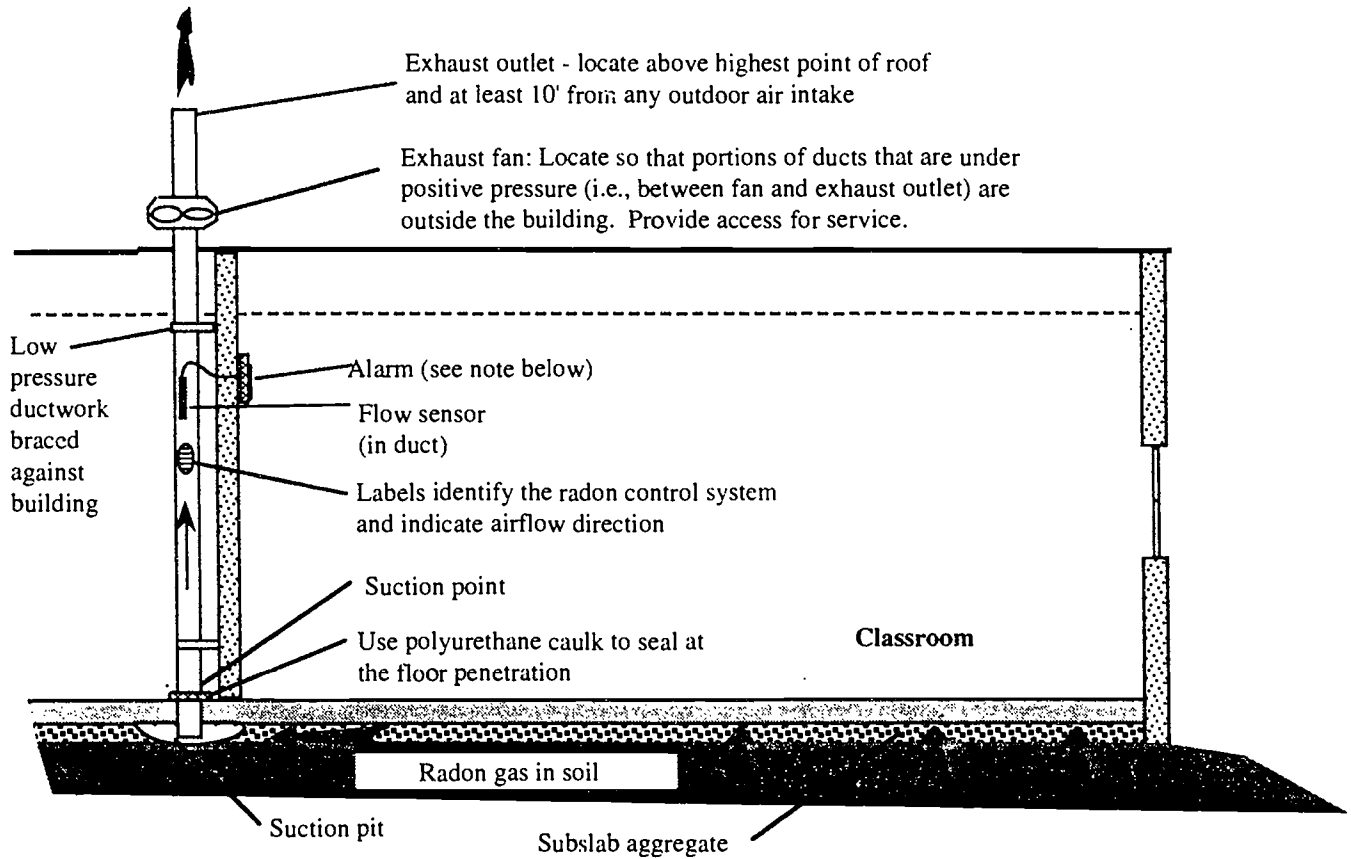

**Figure 2-2: Active Soil Depressurization**

This mitigation technique uses a fan to exhaust air from beneath the slab so that the air pressure beneath the slab is lower than the air pressure in the occupied space above the slab. Radon is drawn through the soil into the low pressure duct and exhausted above the roof. The presence of coarse aggregate below the slab helps to extend the negative pressure field.

*Note:* The alarm will be triggered if the negative pressure field below the slab weakens or fails. A *pressure sensor* or *flow sensor* connected to the alarm should be installed either in the low-pressure duct or at a hole drilled through the slab.

## b. Radon Mitigation Using the Ventilation System

A building's ventilation system can sometimes be adjusted to introduce additional outdoor air so that radon concentrations are lowered by dilution or by pressurizing the building to prevent radon entry. For either dilution or pressurization, the ventilation system must have mechanically-supplied outdoor air. **Figures 7-1 and 7-2 in Section 7** illustrate these approaches to radon mitigation.

*Dilution* with additional outdoor air can be a successful approach to radon control if: 1) initial and follow-up tests indicate that the radon concentration is no higher than 10 pCi/L, 2) occupied areas are not being supplied with enough outdoor air for ventilation, 3) the existing ventilation system has sufficient capacity to increase the flow of outdoor air, *and* 4) the increased outdoor air flow does not introduce levels of pollutants or moisture that could create IAQ problems.

A dilution-based mitigation design requires careful evaluation of outdoor air flows into every affected area of the building. Dilution will only work if outdoor air mixes thoroughly with room air. The control system must be arranged so that adequate outdoor air flows into the building whenever it is occupied. If outdoor air intake dampers are closed during unoccupied periods, the occupied cycle should start early enough to lower radon to levels below 4 pCi/L before occupants arrive.

Dilution offers several advantages as a mitigation approach:

- It offers an alternative in buildings where ASD is not appropriate.
- It makes use of the building's existing ventilation system.
- In most cases, increasing the flow of outdoor ventilation air will improve general indoor air quality.
- Even if dilution alone cannot reduce radon below 4 pCi/L, it may still be valuable as a means of supporting other radon mitigation measures.

There are also disadvantages:

- Dilution alone is not likely to succeed if pre-mitigation radon levels are higher than 10 pCi/L.
- Outdoor air flows must be maintained continuously during occupied periods in order to control the radon concentration. If the freeze protection system shuts down outdoor air flows during a period of cold weather, radon is likely to approach its pre-mitigation levels.
- If a ventilation system has been poorly maintained in the past, it will require financial commitment and policy changes to achieve reliable, long-term control of the radon problem.

- The introduction of additional outdoor air may increase energy costs. The amount of the energy penalty will vary from school to school.
- Radon concentrations may rise to high levels when the ventilation system is not operating (for example, during the "night" or "unoccupied" cycle).

*In some cases, radon control and improved indoor air quality can be achieved without increasing energy costs, simply by adjusting air distribution within the building.* Researchers have found schools in which the outdoor air intakes are blocked off, but large exhaust fans are removing the same amount of air that originally entered through the outdoor air intakes. While classrooms in these schools are not supplied with enough outdoor ventilation air, large quantities of outdoor air are being drawn through exterior doors and corridors to replace the air removed by the exhaust fans.

*Pressurization* of the occupied space is, in theory, an effective way to prevent radon entry. However, it is not a practical mitigation strategy for most schools. This mitigation approach is best suited to tightly-constructed buildings with central air handling systems. The building's existing ventilation system must be adjusted (e.g., by increasing the supply air flow and/or decreasing the return air flow) until any room with a radon problem is pressurized relative to the subslab.

The advantages of pressurization are that:

- It can be effective regardless of the pre-mitigation radon concentration.
- It makes use of the building's existing ventilation system.
- It can be used to support the operation of ASD systems in buildings that have high pre-mitigation radon concentrations but are poorly suited to ASD.
- If the existing HVAC system already introduces adequate outdoor air to meet ventilation needs, it might be possible to pressurize a building without increasing energy costs by reducing the flow of return air.

However, pressurization has some disadvantages:

- For radon control, the building must run neutral to slightly positive whenever the building is occupied. This requires a clear understanding of building dynamics and good control over both the quantity of outdoor air blown into the building *and* the amount of air leaking out of the building. Control of the outdoor air flow would be impractical for schools with multiple small units (such as unit ventilators), and sealing leaks could be a major expense in some buildings.

- As with dilution, outdoor air flows must be maintained continuously during occupied periods in order to control the radon concentration. If the freeze protection system shuts down outdoor air flows during a period of cold weather, radon is likely to rise above 4 pCi/L.
- Occupants may unintentionally defeat a pressurization system by opening doors or windows or operating locally-controlled exhaust fans (e.g., kitchen range hoods, paint spray booths).
- As with dilution, any radon mitigation system that introduces additional outdoor air may also increase energy costs.

### c. Sealing

*Sealing* openings to the ground is rarely successful as a stand-alone solution to radon problems. It is impractical to seal every potential radon pathway in an existing building. If there is a pressure difference to propel it, radon can (and will) move through openings that are invisible to the human eye. A radon atom can fit into a tiny floor crack as easily as a golf ball can fit into the Grand Canyon. However, it may be necessary to seal large openings so that other radon mitigation strategies can be successful. See pages 4-5 and 4-6 in **Section 4.2** for additional discussion of sealing.



### 3.0 Evaluating and Correcting Radon Problems

This section presents a flow diagram showing the radon mitigation process in school buildings and provides guidance in performing the initial investigation. The flow diagram is intended to promote understanding of the investigative process and how this process leads to selecting the best mitigation approach for a particular building. Some pointers are provided to help select the team who will perform the initial investigation. Detailed guidance is then presented, describing how the initial investigation is performed.

Results of EPA's school radon survey indicate that schoolrooms with elevated radon concentrations are likely to have concentrations between 4 and 10 pCi/L. At the same time, EPA field researchers have found that schools with elevated radon levels are often undersupplied with outdoor ventilation air (that is, the supply of outdoor air is not enough to meet current standards). Inadequate outdoor air ventilation can occur for reasons such as: poor initial design, lack of system

**Commissioning** is a process that involves extensive testing of system performance under different operating conditions. Buildings should be commissioned after construction is completed and before occupants move in.

*commissioning*, and/or lack of preventive maintenance. Inadequate maintenance of HVAC systems is common due to budget constraints and lack of in-house HVAC expertise. Compounding the problem, the outdoor air intakes of many schools have been partially or completely closed in an attempt to save energy. EPA's work in schools suggest that many, with radon levels between 4 and 10 pCi/L, may be mitigated by restoring or modifying the building's ventilation system.

Because adequate outdoor air ventilation is frequently lacking, **EPA recommends that a ventilation evaluation be performed as a first step toward mitigating radon.** This evaluation will provide you with a better understanding of how well your HVAC system is functioning to provide outdoor air ventilation and whether the ventilation system may be used -- alone or in combination with an ASD system -- to reduce radon concentrations.

#### 3.1 Problem Assessment and Strategy

This document presents a step by step investigative process that will enable you to determine the best radon mitigation strategy for each building you are mitigating. **Figure 3-1** is a flowchart that graphically illustrates the steps you will be taking as

you proceed through this document and perform these investigations within the building. This flowchart will serve as your "map" to radon mitigation.

Unfortunately, there is no single radon mitigation strategy that is applicable to all school buildings. Comprehensive building investigations and diagnostics are the only effective way to determine what mitigation strategy to implement. Radon concentration, entry, and distribution are dependent on the indoor air dynamics (see **Section 2.2**). A building's HVAC system is capable of drastically changing these dynamics, and its potential influence must be understood.

The **Initial Investigation** described in **Section 3.4** begins with an examination of the building and its ventilation systems. The investigation team will identify ventilation-related HVAC deficiencies and large openings to earth that may be radon entry points. The Initial Investigation also provides an opportunity to begin collecting information that will be of interest if a detailed investigation is necessary, such as: 1) whether the way the ventilation system operates could interfere with the effectiveness of a radon mitigation strategy, and 2) how correcting ventilation deficiencies may affect radon concentrations.

The **Detailed Investigation (Section 6)** requires more technical skills and equipment than the initial investigation and typically involves consultants, such as radon mitigation contractors and mechanical engineers. **Section 6** describes the diagnostic techniques used by building investigators, presents the basic components of radon mitigation systems, and discusses how information collected during the investigation helps in selecting a mitigation strategy. This information will help a "team leader" select and direct consultants.

Look over **Figure 3-1** and refer to it often as you proceed through this document. Some of the terms in the figure, as well as the descriptions of the diamond-shaped boxes that follow, may seem unfamiliar to you now, but will be defined and discussed in detail in the sections ahead.

## Evaluating and Correcting Radon Problems

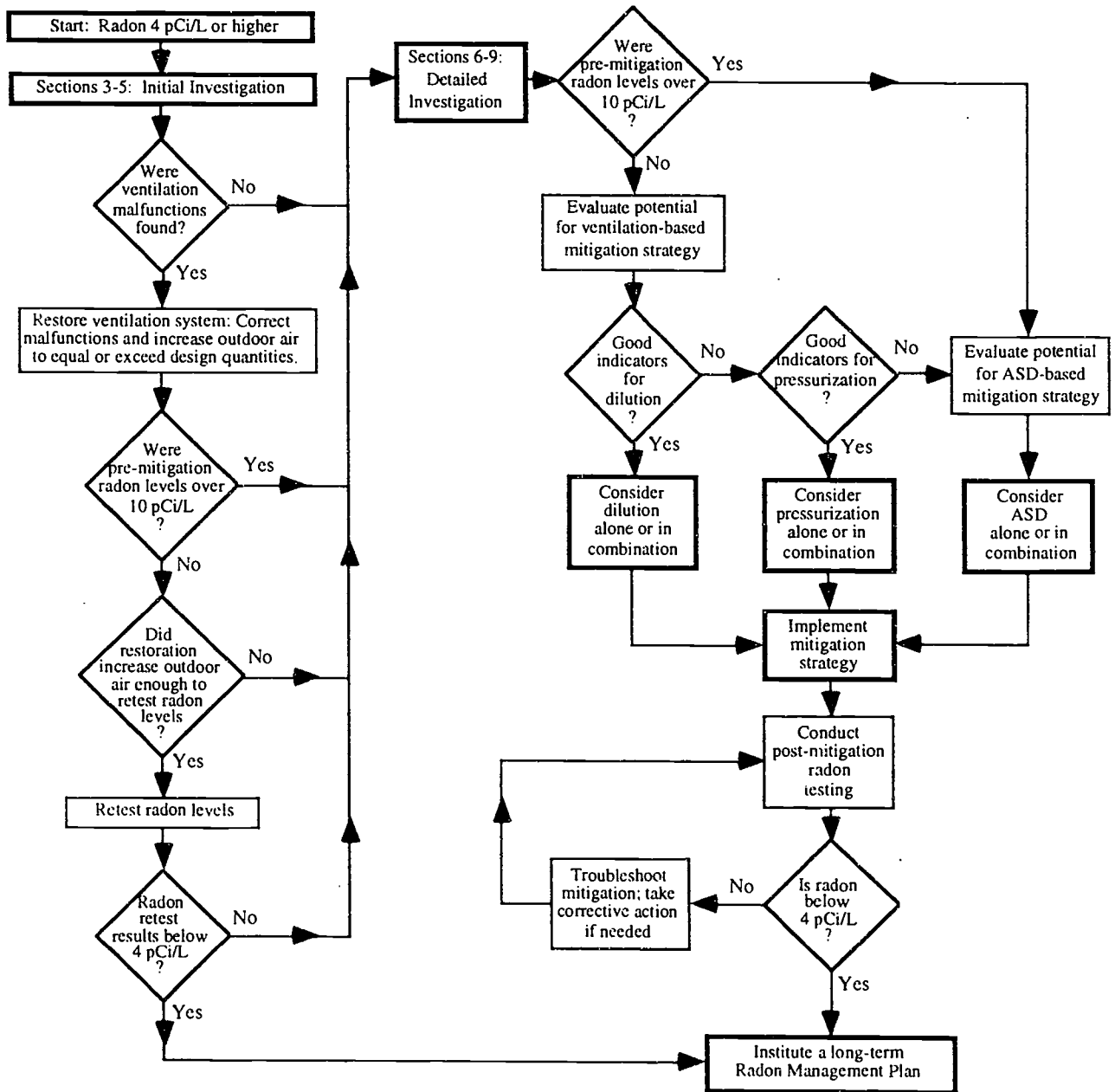

**Figure 3-1: School Mitigation Flowchart**

The following discussion is intended to help you work with **Figure 3-1, the School Mitigation Flowchart**. The diamond-shaped boxes on the left correspond to the "decision" boxes on the flowchart. These decision boxes will be discussed in greater detail in the remainder of the document. The description provided below explains the relevance of each decision point and will assist you in seeing how all the pieces lead to the selection of an effective radon mitigation strategy.

### INITIAL INVESTIGATION

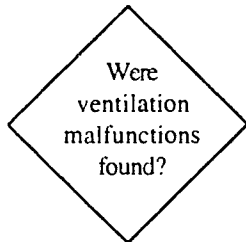

Review the results of the **Initial Investigation**. Did you identify ventilation system malfunctions? If so, it is advisable to restore the entire ventilation system to proper functioning, giving priority to equipment that serves areas with elevated radon concentrations. (See **Section 4**).

If you did not find any ventilation system problems, your school mechanical system may be supplying roughly the amount of outdoor ventilation air that is described in the plans and/or specifications. Pages 3-20 to 3-22 describe how to use the mechanical plans and mechanical schedules to discover the design outdoor air ventilation rates. You will need to obtain measurements of air flows if you want to know how much outdoor air is *actually* provided to any area. **Section 6.3 3c** of this document describes how to evaluate outdoor air flow quantities (see pages 6-30 to 6-34).

The current American Society of Heating, Refrigeration, and Air-Conditioning Engineers (ASHRAE) standard (now being adopted into many codes) calls for at least 15 cubic feet per minute (cfm) of outdoor air per person in classrooms. Most existing school mechanical systems were designed to provide less than this amount. Pre-1973 schools were often designed to provide 10 cfm/person of outdoor air; after 1973, most were designed at 5 cfm/person. **NOTE:** The ASHRAE standard is for minimum outdoor air volumes.

If the outdoor air ventilation rate is below 15 cfm per person in any occupied space, EPA recommends increasing the outdoor air flow to a minimum of 15 cfm/person. This will tend to lower radon concentrations by diluting the radon with outdoor air.

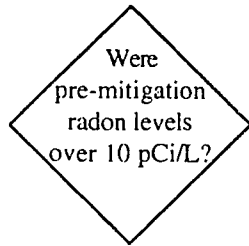

Throughout this document, you will see the term *pre-mitigation radon level*. This term refers to the radon concentration before taking corrective action, and is either: 1) the averaged result of two short-term tests, or 2) the result of the long-term follow-up test. If your pre-mitigation tests showed radon concentrations **no higher than 10 pCi/L**, it may be possible to treat the radon problem successfully by correcting gross problems with the HVAC system and sealing large openings to the ground (such as sumps). Corrective actions that can be identified by school personnel without the assistance of outside consultants may be enough to resolve the radon problem and may also improve indoor air quality.

Where radon concentrations are **above 10 pCi/L**, changes in ventilation alone are unlikely to provide dependable, lasting control over the radon problem. In most cases, ASD (alone or combined with a ventilation-based strategy) will be the preferred mitigation approach. A **Detailed Investigation**, generally involving outside professionals, will be needed to evaluate the building and develop a detailed mitigation plan (see **Section 6**).

The 10 pCi/L level used here is not meant as an absolute dividing point. It is intended to help you in selecting the mitigation strategy that will be most effective in reducing radon concentrations now and in the future. EPA's research and demonstration work has shown that radon levels below 10 pCi/L can be reduced through the controlled introduction of outdoor air by a properly functioning HVAC system. On the other hand, levels above 10 pCi/L usually require a more aggressive approach, such as ASD.

EPA does not intend to exclude any proven mitigation approach from consideration. Under some circumstances, ASD can be the most practical approach to correcting low-level radon problems (for example, in areas that are already well ventilated or in areas that have no mechanical ventilation). ASD may also be needed if initial ventilation improvements do not reduce the radon concentration below 4 pCi/L. Some areas with radon levels over 10 pCi/L *might* be corrected with improved ventilation. However, with higher radon concentrations, it may not be possible to achieve long-term, reliable control of the problem using a ventilation-based mitigation approach, and the health

consequences of failure become more serious. Nonetheless, ventilation improvements made in an attempt to reduce radon concentrations are likely to generally benefit indoor air quality and assist the efficient operation of an ASD system.

Did restoration increase outdoor air enough to retest radon levels ?

If the **Initial Investigation** discovered areas in which outdoor air ventilation was drastically reduced, and if the restoration work has increased outdoor air flows to at least the quantities specified in the original design, then radon concentrations that were below 10 pCi/L may have been reduced to less than 4 pCi/L. Retesting for radon in these areas may (or may not) save you the effort and expense of a **Detailed Investigation**. Consider the following examples:

1) The outdoor air damper on a 750 cfm unit ventilator is closed and the damper actuator is disconnected. Investigators assume a leakage rate of 75 cfm (5%) through the damper. They decide that, if the damper and controls are restored to provide at least 300 cfm of outdoor air during occupied periods, the four-fold increase in outdoor air flow is very likely to lower radon from the pre-mitigation level of 10 pCi/L to below 4 pCi/L. Retesting after restoration seems to be a good investment.

2) The outdoor air damper on a unit ventilator appears to open and close, but the filter is dirty. The unit is probably not introducing as much outdoor air as it should. However, it is hard to predict how a clean filter will affect the indoor radon level. Actual air flows should be measured during a **Detailed Investigation**.

Radon retest results below 4 pCi/L?

If a radon retest shows that radon is below 4 pCi/L in all areas, institute a long term radon management plan as described in **Section 9**. If some areas remain above 4 pCi/L, conduct a **Detailed Investigation** as described in **Section 6**.

## DETAILED INVESTIGATION

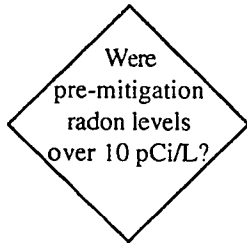

If pre-mitigation radon levels were over 10 pCi/L, ASD will probably be needed to keep indoor radon levels consistently below 4 pCi/L. Many schools will probably require a combined approach. Figure 6-4 on page 6-12 presents a flowchart for evaluating the potential for ASD. If conditions are not favorable for ASD, pressurization or dilution can support the operation of an ASD system.

If pre-mitigation radon levels were less than or equal to 10 pCi/L, a ventilation-based mitigation strategy may be able to maintain radon below 4 pCi/L. Dilution and pressurization will need to be evaluated to determine whether a ventilation strategy is feasible.



Use the equation below to evaluate the potential for *dilution*: (lowering radon levels by introducing additional outdoor air). For meaningful results, use actual measured air flows. Pages 6-6 to 6-7 and 7-11 to 7-13 describe dilution in more detail.

$$\text{Estimated final radon level} = \text{Pre-mitigation radon level} \times \frac{\text{Initial outdoor airflow}}{\text{Final outdoor airflow}}$$

Notes:

- 1) If your HVAC system relies on exhaust fans to draw outdoor air into the building, increasing the outdoor air ventilation rate will increase dilution, due to the increased makeup air, but also cause the building to operate under a stronger negative pressure relative to outdoors. The effect on radon levels is unpredictable.
- 2) Outdoor air flow must not exceed the ability of the HVAC equipment to condition (heat or cool) the air. The amount of dilution depends on the flow of outdoor air, so radon concentrations will rise when outdoor air dampers close to their minimum position and when fans cycle off.
- 3) If you would have to raise the outdoor air flow above 15 cfm/person to bring radon below 4 pCi/L, dilution is probably not a practical mitigation approach.

Favorable indicators for *pressurization* (increasing indoor air pressure to prevent radon entry) are:

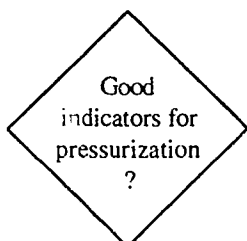

- the subslab material is low permeability, (e.g., sand or clay)
- there are many obstacles to ASD, such as inaccessible slab leaks or interior subslab footings
- the building shell is tight or can be easily tightened
- the building has a fan-powered outdoor air supply (with or without fan-powered exhaust) and sufficient heating and/or cooling capacity
- radon concentrations are below 10 pCi/L (see below)

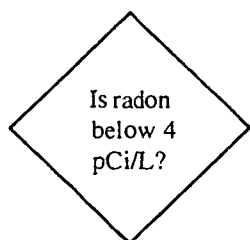

If the results of post-mitigation testing show radon levels below 4 pCi/L, institute a long-term radon management plan. If the results are 4 pCi/L or higher, troubleshoot the mitigation system and retest.

### 3.2 The Initial Investigation Team

EPA recommends organizing a building investigation team, including such members as maintenance personnel and the school district's HVAC specialist(s), who may be either a member of the district staff or an outside contractor such as a mechanical contractor, control technician, or test and balance (TAB) contractor. Even though it may appear that a single individual has a complete understanding of your school building and how it functions, the use of a team approach promotes discovery of new information and full consideration of your alternatives. The building investigation team should include someone who is familiar with the building structure, HVAC system, and operating and maintenance practices. Equally important, some member of the team should have the authority and knowledge to safely remove HVAC access panels for inspection and manipulate the HVAC control system so that the effect of HVAC operation on air pressure relationships can be determined.

Ideally, school personnel included on the team should:

- have time to allocate to the radon issue
- be well adapted to training



- accept the administrative responsibility for seeing the job is well done
- have the ability to maintain accurate records

**Potential Team Members and What They Can Contribute to the Initial Investigation**

- School administration representative - can serve as a liaison with school superintendent's office, board of education, and other district decisionmakers; could also be media contact person
- Facility staff member(s) - familiar with school mechanical system design, operation, and maintenance; can provide access to equipment and change controls if necessary during the investigation
- The school district's HVAC specialist (this may be an outside contractor)
- Teacher/staff representative - liaison with other staff members; can help build support for mitigation effort
- PTA representative - liaison with other parents; can help to build support for mitigation effort



This photograph shows a building investigation team organized by EPA. Team members gather to review the architectural and mechanical plans and discuss the building design before beginning the walkthrough investigation.

If a detailed investigation (described in **Section 6**) is required, additional team members may be needed. School personnel with little training or experience in radon reduction should use experienced EPA-listed or state-certified radon

mitigation contractors to gain the advantage of their expertise and specialized knowledge of local problems. EPA recommends the use of firms whose individual representatives have met the requirements of the EPA Radon Contractor Proficiency (RCP) program. Listings of these contractors can be obtained from your state radon office; some states also operate their own certification programs. Ideally, you should use a radon contractor with proven experience in school buildings similar to yours, or -- at minimum -- experience in large, non-residential buildings.

The participation of a registered engineer or architect may be required on work affecting mechanical systems, structural components, and life and safety codes. A mechanical engineer who specializes in HVAC systems is particularly important if your radon contractor is not familiar with school HVAC systems.

EPA's four Regional Radon Training Centers (RRTCs), as well as a number of private vendors, offer a range of training courses in radon measurement and mitigation. See **Appendix B** for more information.

### 3.3 Evaluate and Map Your Radon Test Results

Before starting to work with the radon test results, make certain that you are confident in those results. Ask yourself the following questions:

- If the measurements were performed by an outside contractor, was the company listed with EPA's RMP program (or state certified, in states that have certification programs)?
- If the measurements were performed in house, were the EPA protocols followed?
- Did the school district receive data from all of the detectors?
- Were HVAC operating conditions maintained as intended during the test period?

If the school district is not confident that the radon testing was performed in accordance with EPA's *Radon Measurement in Schools - Revised Edition*, consider repeating some or all of the tests.

Check your results to see whether there were quality control or quality assurance problems in the analysis of your measurement devices. *Radon Measurement in Schools - Revised Edition* (see **Appendix B**) describes the use of blanks (test devices that are sent for analysis without being exposed) and duplicates (additional test

devices placed in the same location over the same time period) for quality assurance/quality control. For duplicate pairs where the average of the two measurements is greater than or equal to 4 pCi/L, the results should not differ by more than 25%. Consistent failure in duplicate agreement should be investigated. Blanks that fail to yield results at or near 0.0 pCi/L (e.g., 0.5 pCi/L) indicate that the manufacturing, shipping, storage, or processing of the detector may have affected the accuracy of your measurements.

One of the most valuable ways to record information collected during a building investigation is to take notes on a small floorplan of the building (typically a 8 1/2" x 11" plan), referred to in this document as a *working floorplan*. Taking notes on a floorplan will help you to develop an understanding of the spatial relationships involved in radon distribution, air flow patterns, and the use of ventilation equipment in your building. This document presents a series of example floorplans you can refer to as you take notes on your own working floorplan.

Start your building investigation by obtaining a small floorplan of your building(s), such as a fire escape floorplan. This is called your *working floorplan* to distinguish it from large architectural/mechanical plans. Take notes on the working floorplan as you collect information.

If there are no signs of problems with the radon measurements, map your *pre-mitigation radon levels* onto your working floorplan. It may be helpful to shade or color this radon map to show areas of high, medium, or low radon concentrations. For example, you may want to leave rooms which were not tested white on the map, and choose separate colors or shading patterns for rooms that tested below 4 pCi/l, between 4 and 10 pCi/L, and over 10 pCi/L. **Sample Working Floorplan 1** provides an example.

The term *pre-mitigation radon level* refers to the radon concentration before taking corrective action, and is either: 1) the averaged result of two short-term tests, or 2) the result of the long-term follow-up test. For example, if the initial test result was 10 pCi/L and the short-term follow-up test result was 4 pCi/L, the pre-mitigation radon level would be:

$$(10 + 4) / 2 = 14 / 2 = 7 \text{ pCi/L}$$

Radon levels in non-residential buildings often vary widely from room to room. Your radon map may reveal patterns of increased radon levels, including "hot spots" that could become a focus for later diagnostic and mitigation work. Patterns of elevated radon concentrations may correspond to factors such as the location of radon entry points, the HVAC system design or operation, or the wind direction



during the test period. Variations between rooms or zones can sometimes be explained by differences in ventilation rates or air pressure relationships that are caused by the mechanical systems. A pattern of consistent radon levels throughout a zone served by a single air handling unit may indicate that the ventilation system in that area is "mining" and distributing radon (see pages 6-15 and 6-16 for more information).

If the pre-mitigation test results show radon levels below 4 pCi/L in most of your building, you may want to confine your investigation to rooms with elevated radon concentrations and the mechanical systems that provide ventilation air to those elevated rooms. However, a building-wide inspection is a practical first step in improving preventive maintenance and overall air quality. EPA recommends including the entire building in the initial investigation, so that all HVAC system deficiencies can be identified and corrected.

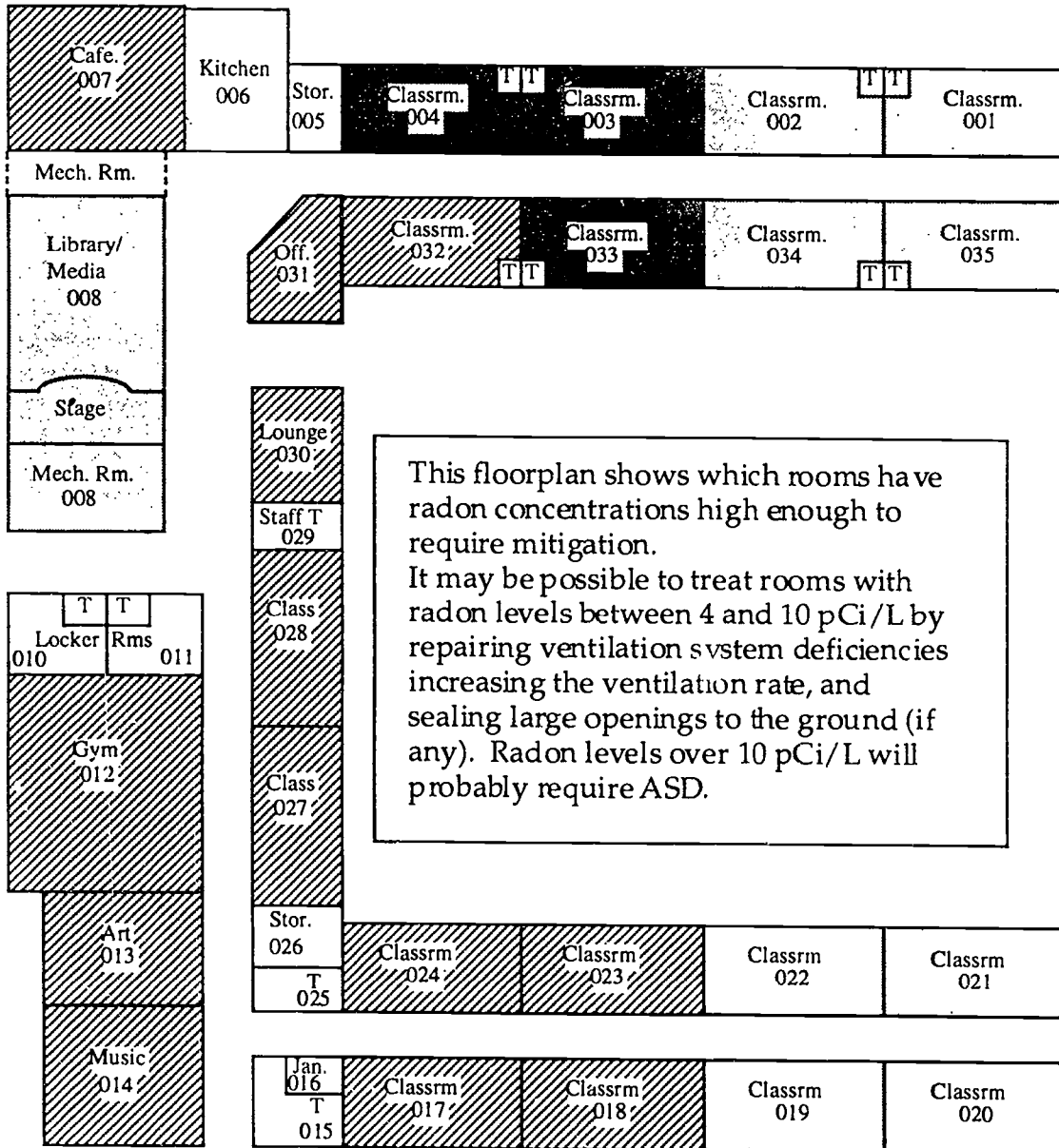
# Sample Working Floorplan 1

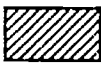

This floorplan shows which rooms have radon concentrations high enough to require mitigation. It may be possible to treat rooms with radon levels between 4 and 10 pCi/L by repairing ventilation system deficiencies increasing the ventilation rate, and sealing large openings to the ground (if any). Radon levels over 10 pCi/L will probably require ASD.

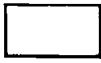
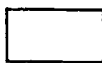
-  shows radon test results of 4 - 10 pCi/L
-  shows radon test results over 10 pCi/L
-  shows radon test results below 4 pCi/L
-  not tested for radon

### 3.4 Initial Investigation

The scope of the Initial Investigation depends on the capabilities of the investigation team and the amount of work you choose to accomplish before conducting a detailed investigation. *At minimum, EPA recommends using the Initial Investigation to identify malfunctioning ventilation equipment, then restoring the ventilation system to proper functioning before conducting a Detailed Investigation.*

The team leader should read **Section 6** to understand the elements of the Detailed Investigation, then plan an investigation strategy that makes best use of the skills and availability of team members. While the team is examining the construction documents and inspecting the building, it may make sense to get a head start on the Detailed Investigation by collecting information, such as:

- 1) locations of large openings to earth -- *sealing these openings may help to reduce radon entry*
- 2) areas where the outdoor air ventilation rate (either as specified in the design or as the building is operated), is lower than current recommendations -- *these areas may be candidates for mitigation using dilution*
- 3) areas that are designed to operate under negative pressure -- *these areas may be radon entry points*
- 4) factors that are key to ASD (such as foundation types, sub-slab fill material, etc.) -- *if this is accomplished during the initial investigation, it can save time during the detailed investigation*

*Consider the original building and each addition as if they were separate buildings, because differences in design, construction, and operation can produce very different air and radon distribution patterns.* Pay particular attention to the ventilation units that serve rooms with elevated radon, and include all of the rooms served by those units. This means that, if a single air handling unit or general exhaust fan serves the entire building, the entire building should be inspected as a part of the radon investigation. Remember, by including the entire building in the Initial Investigation, you may identify HVAC system deficiencies that are causing discomfort or air quality problems.



The one-story wing extending to the right is an addition to the original building. Investigators should treat the original building and the addition as two separate buildings.

The Initial Investigation can be divided into two parts, the review of building plans and the walkthrough inspection. After a review of the building plans and other related documents, investigators compare their understanding of the building design to the actual conditions and identify radon entry points and HVAC system deficiencies.

### INITIAL INVESTIGATION

1. Review the building plans
  - a. Create an inventory of HVAC equipment within the building
  - b. Understand the intended design of the HVAC system
  - c. Identify openings to the ground that may allow soil gas entry
  - d. Identify foundation types and design (intended) subslab fill material
2. Conduct a walkthrough inspection
  - a. Evaluate the condition of the ventilation system
  - b. Confirm soil gas entry at openings to the ground

## 1. Review the Building Plans (Initial Investigation)

Construction documents such as specifications and architectural and mechanical plans, if available, show how the building was originally designed to operate. Collect and examine all available architectural and mechanical plans, equipment manuals, specifications, *test and balance* reports, and other documentation. "As-built" plans, if available, should show changes that were made during construction. AHERA (Asbestos Hazard Emergency Response Act) management plans may provide the most up-to-date floorplans, heating zone information, and remodeling/modification plans. AHERA plans can also alert inspection teams to areas where special safety precautions are required.

*Testing and balancing* involves testing and adjusting the HVAC system so that airflows conform to design specifications. See Section 9, page 9-4 for more information.

The plans and specifications show how your building might function under ideal conditions, if all equipment were properly installed and maintained. This information can help to establish the limits of performance that can be expected of the existing equipment. For example, if your unit ventilator coils only have enough capacity to condition 100 cfm of outdoor air, then a plan to dilute radon with 250 cfm of outdoor air would involve more work than merely opening an outdoor air damper.

It is important to understand the designer's control strategy -- the strategy by which various fans and dampers operate -- in order to understand a radon problem and how the HVAC system might be used to fix it. Information about the designer's intentions is available from the specifications and mechanical equipment schedules. During the walkthrough inspection, you will see how the building actually operates.

If architectural/mechanical plans and specifications are unavailable, much of this information can be obtained during the walkthrough inspection. However, you should attempt to find the building plans, if possible. Some of the information they contain is time-consuming and expensive to collect by any other means, but necessary for a complete understanding of the building's air dynamics.



**a. Create an inventory of HVAC equipment within the building**

An inventory of HVAC equipment helps to ensure a thorough inspection of the building. When reviewing HVAC plans, you may discover exhaust fans or other small items of equipment that have been forgotten because they are located in remote or inaccessible locations. These items may cause radon or other IAQ problems if they are overlooked during maintenance.

Note the location and air volume capacity of each item of air handling equipment, including both total cfm and outside air cfm if available. This information can be found on mechanical equipment schedules such as the example in **Figure 3-2**. Mechanical equipment schedules are usually found on the mechanical plans, and are sometimes reproduced in the mechanical specifications.

If you are aware of locations where actual building conditions are different from the design shown on the plans, note those locations on your working floorplan. There may be items of equipment on the plans that were never installed or were installed in a different way than indicated on the plans. Update the inventory during the walkthrough inspection. (If you are not directly responsible for maintaining the HVAC equipment, use the walkthrough as an opportunity to talk with the individuals who are. Their input can contribute a great deal of information.)

Evaluating and Correcting Radon Problems

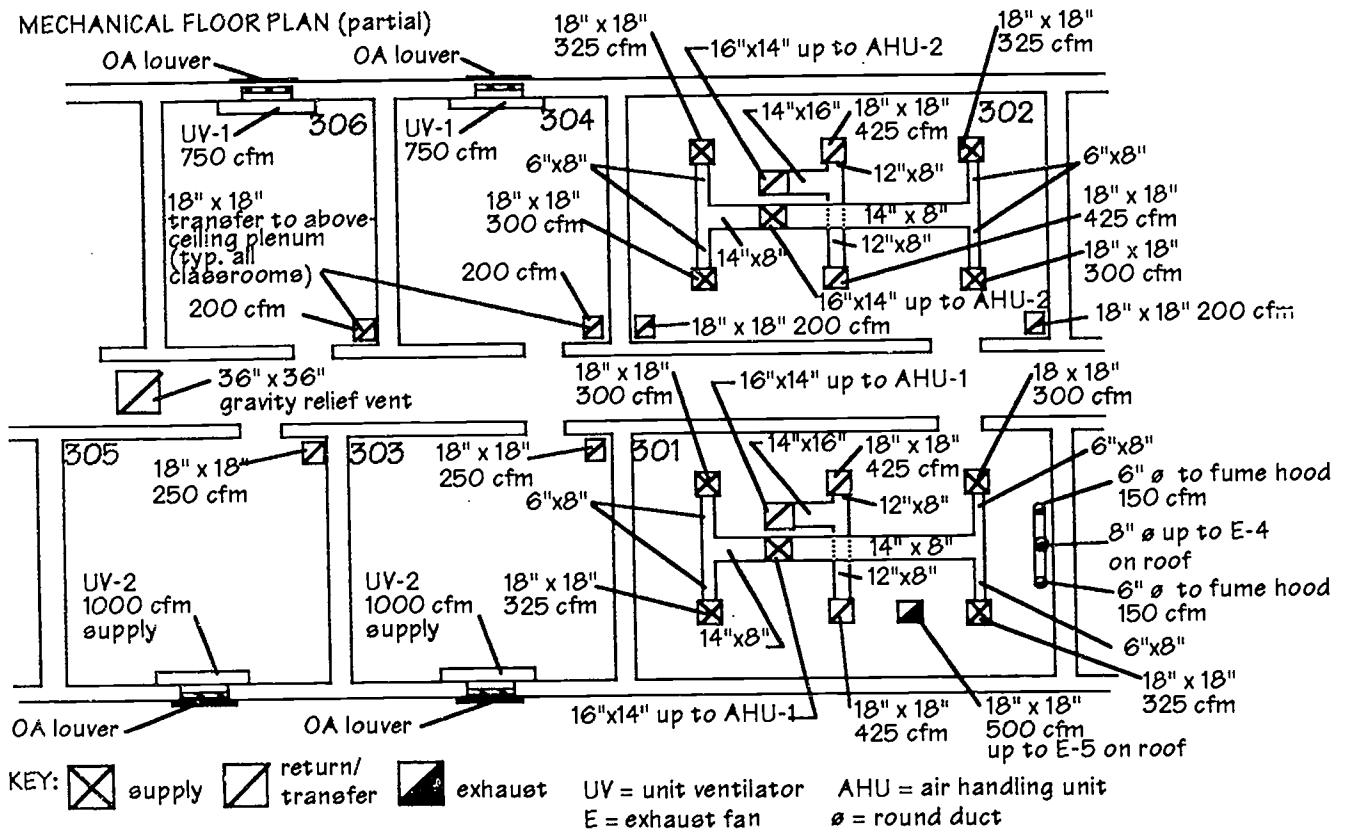

MECHANICAL EQUIPMENT SCHEDULE (partial)

UNIT NO.	LOCATION	SA CFM	MIN OA CFM	HEATING COIL HW@				MOTOR			NOTES
				EAT°F	LAT°F	MBH	GPM	HP	V	Ø	
UV-1	CLASSROOMS	750	200	59.1	102.9°	35.7	2.4	1/8	120	1	1
UV-2	CLASSROOMS	1000	250	59.8	102.9	46.7	3.1	1/8	120	1	1
AHU-1	SCIENCE 301	1250	400	45	90	61	4.1	1/8	120	1	2,3
AHU-2	LIBRARY 302	1250	400	57.4	90	44.1	2.9	1/8	120	1	1

- NOTES: 1. E.A. T. WITH MIN. O.A. @ + 35°F (DAMPERS LOCKED OUT BELOW + 35°F EXCEPT AS NOTED)  
 2. OUTDOOR AIR DAMPER NOT LOCKED OUT BELOW + 35°F  
 3. INTERLOCK WITH EXHAUST FAN E-5

SA = supply air                      MIN OA = minimum outdoor air (cfm)                      EAT = entering air temperature  
 LAT = leaving air temperature                      MBH = thousand BTU/hour                      GPM = gallons/minute  
 HP = horsepower                      V = volts                      Ø = phase

**Figure 3-2: Typical School Mechanical Plan and Equipment Schedule**

The *mechanical plan* shows the intended air flows into and out of each room, thus revealing which rooms are designed to operate under negative, positive, or neutral pressure. The *mechanical equipment schedule* shows minimum outdoor air flows for each piece of ventilation equipment. Using the equipment schedule and the room population, it is possible to calculate the intended outdoor air ventilation rate in cfm/person. Exhaust fans (such as E-4 and E-5 in this example) are typically described in a separate schedule. CAUTION: Construction documents reveal the designer's intent. They do not necessarily show the way the building was constructed or is operated.

**b. Understand the intended design of the HVAC system**

Mark your working floorplan to show:

- ventilation zones (the areas served by each air handling unit or unit ventilator)
- areas designed to operate under negative pressure
- areas that are not supplied with enough outdoor ventilation air to meet current standards

*Which rooms operate under negative pressure by design?*

On your working floorplan, mark areas that are designed to operate under negative pressure with a "-" sign (see **Sample Working Floorplan 2**, page 3-23).

You can assume that an area is designed to run negative if: 1) it is on the lowest floor and has no mechanical ventilation *or* 2) if it is mechanically exhausted but has no mechanically supplied ventilation. You can assume that an area is designed to run positive if it has mechanically-supplied ventilation and no mechanical exhaust. If a space has both supply and exhaust (or return) ventilation, it may run negative or positive, depending on the net air flow and the airtightness of the space.

Bathrooms, kitchens, smoking lounges, locker rooms, darkrooms, laboratories with hoods, industrial arts areas, art rooms, and chemical storage rooms are generally designed to run negative, using exhaust fans to confine and remove odors or contaminants. Pay particular attention to the design of these and other "special use" areas. For classrooms, you can save effort by checking "typical" designs in each section of the building rather than evaluating the plans for each individual room.

A room or zone is designed to run positive if:

$$\text{Supply cfm} > (\text{Return cfm} + \text{Exhaust cfm})$$

A room or zone is designed to run negative if:

$$\text{Supply cfm} < (\text{Return cfm} + \text{Exhaust cfm})$$

**Note:**

In these formulas, "supply" means the total quantity of air mechanically blown into the space.

> means "greater than."

< means "less than."

The same room may have supply diffusers, return grilles, exhaust fans or any combination. Mechanical plans generally show the intended air flow through registers, grilles, and diffusers, while mechanical equipment schedules indicate the design capacities of air handlers and unit ventilators.

ROOM	PLANNED AIR FLOWS (CFM)			DESIGN AIR PRESSURE Supply - (Ret. + Exh.)
	SUPPLY	RETURN	EXHAUST	
SCIENCE 301	1250	850	500/800 <sup>1</sup>	100/400 cfm negative
LIBRARY 302	1250	850		400 cfm positive
CLASSROOMS 303., 305	1000	750 <sup>2</sup>		250 cfm positive
CLASSROOMS 304, 306	750	550 <sup>2</sup>		200 cfm positive

<sup>1</sup> E-5 operates constantly (500 cfm exhaust), E-4 operates as needed (additional 300 cfm exhaust)

<sup>2</sup> Return cfm = supply cfm - minimum outdoor air cfm

### Figure 3-3: Design Air Pressures

This chart was created using the information presented in Figure 3-2. Note that air leaving classrooms 303, 304, 305, and 306 through the transfer grilles does not count as return air, because it is not being returned to an air handling unit, and does not count as exhaust air, because it is not moved by an exhaust fan.

*What areas, if any, are inadequately supplied with outdoor air?*

EPA researchers have found underventilation problems (i.e., levels of carbon dioxide which may indicate the accumulation of indoor air contaminants) in areas where the design outdoor air flow is less than 15 cfm/person. As you read this section, mark your working floorplan to indicate areas in which the outdoor air supply is less than 15 cfm/person (see **Sample Floorplan 2**). If both the initial outdoor air ventilation rate and the pre-mitigation radon concentration are low enough, it may be possible to dilute radon below 4 pCi/L by increasing the supply of outdoor air.

1. Where outdoor air is supplied by operable windows instead of fans, outdoor air ventilation rates change as the windows are opened and closed. These areas are likely to have less than 15 cfm/person of outdoor air ventilation, at least some of the time (e.g., during unpleasant weather). Mark your working floorplan to indicate

where operable windows are used for outdoor air ventilation. Check during the walkthrough inspection to make sure that the windows are still operable.

2. In areas with mechanically-supplied ventilation, you can estimate the rate of outdoor air flow to evaluate the adequacy of outdoor air ventilation. Unless the HVAC system is very well maintained and is periodically tested and balanced, actual air flows may be quite different from the design. However, you can begin to assess the situation by making a quick estimate of outdoor air flow for a few "typical" classrooms. Select one or two classrooms from each area of the school, making sure to include rooms from the original building and any additions. If elevated radon was only found in a small number of rooms, use those rooms.

For each room, collect the following information:

- the number of occupants
- the outdoor air flow rate

#### Number of occupants

For the number of occupants in a classroom, use the larger number of: a) the largest group of occupants present during a normal day, or b) the number of desks.

In assembly areas where the occupant population varies widely (such as auditoriums, gymnasiums, and libraries), it may be difficult to decide what number of occupants to use. Ventilation equipment in assembly areas should be restored to provide at least as much outdoor ventilation air as was provided in the original design.

#### Outdoor air flow rate

If a recent test and balance (TAB) report is available, use the measured air flow obtained when the outdoor air damper was at minimum setting. If you do not have a recent TAB report, use the minimum outdoor air flow as shown on the mechanical plans or mechanical equipment schedule.

When you know the number of occupants and the outdoor air ventilation rate, the outdoor air ventilation rate in cfm/person can be estimated using the following equation:

$$\text{Outdoor air ventilation rate (cfm/person)} = \frac{\text{outdoor air flow (cfm)}}{\text{number of occupants}}$$

Be careful to use the numbers for outdoor air, rather than total supply air. Total supply air includes recirculated air as well as outdoor air.

ROOM	MINIMUM OUTDOOR AIR (CFM)	NUMBER OF OCCUPANTS	MINIMUM OUTDOOR AIR (CFM/PERSON)
SCIENCE 301	400	25	16
CLASSROOMS 303, 305	250	25	10
CLASSROOMS 304, 306	200	22	9

**Figure 3-4: Outdoor Air Ventilation Rates in cfm/person**

This chart is based on the example school illustrated in Figure 3-2. The outdoor air ventilation rate in cfm/person should be compared to an applicable standard to see whether the space is adequately ventilated. At minimum, a school should conform to the ventilation standards that applied when it was constructed. Ideally, it should conform to *ASHRAE Standard 62-1989*, which calls for 15 cfm/person of outdoor air in classrooms, 20 cfm/person in laboratories (such as the science room). The library has been omitted because it is an assembly area with a highly variable population.

These rooms were designed in 1970. At the time of construction, all of the rooms probably met the ASHRAE recommended outdoor air ventilation rate (then 10 cfm/person in classrooms). Since 1970, the room population and the ASHRAE standard have both changed, so that none of the rooms meet current ASHRAE recommendations.

**Note:** Even though the total building outdoor air supply meets or exceeds *ASHRAE 62-1989* (i.e., 15 cfm of outdoor air per person in classrooms), poor air distribution could cause areas of underventilation. Consider air flow patterns and any complaints, such as stuffiness, as you evaluate ventilation.

### Sample Working Floorplan 2

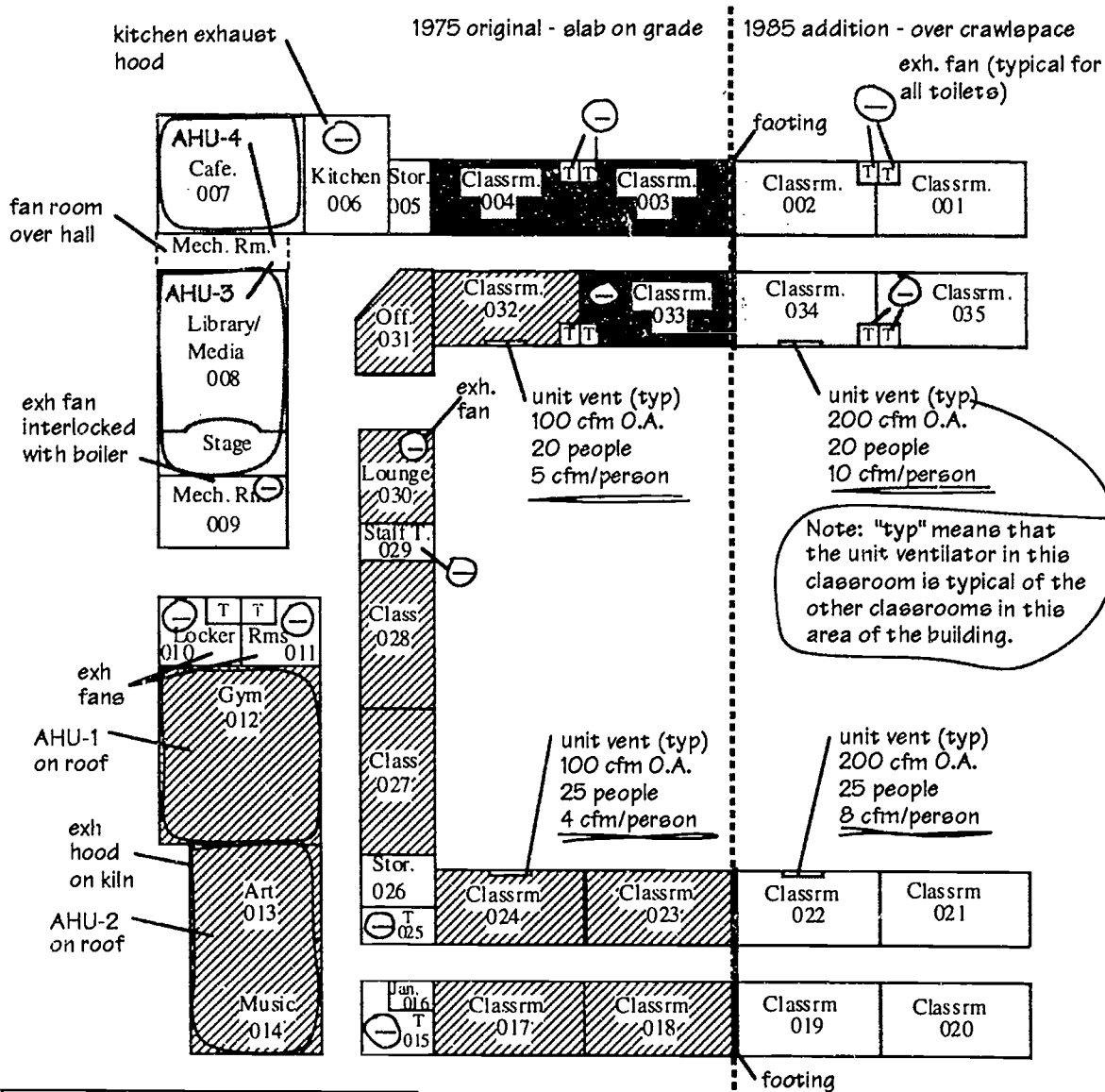

This floorplan builds on **Sample Working Floorplan 1** by adding information from the construction plans and specifications. It shows the HVAC zones, design outdoor air ventilation rates in classrooms, and rooms designed to operate under negative pressure (rooms where more air is exhausted than is mechanically-supplied).

- shows area designed to operate under negative pressure
- not tested for radon
- shows radon test results of 4 - 10 pCi/L
- shows radon test results over 10 pCi/L
- AHU = air handling unit
- unit vent = wall-mounted unit ventilator

**c. Identify openings to the ground that may allow soil gas entry**

The extent and location of openings to the ground may help to explain the distribution of radon in the building and can affect the choice of an appropriate mitigation strategy. Examine the architectural and mechanical plans for openings to the ground that could be radon entry points **and note these locations on your working floorplan**. Examples might include floor/wall joints; expansion joints; utility tunnels; below-grade utility entries or sewer exits; pipe penetrations for steam, hot water, or cooling water; open sump pits; and transitions between different foundation types (such as crawlspaces or basements adjacent to areas built slab-on-grade).

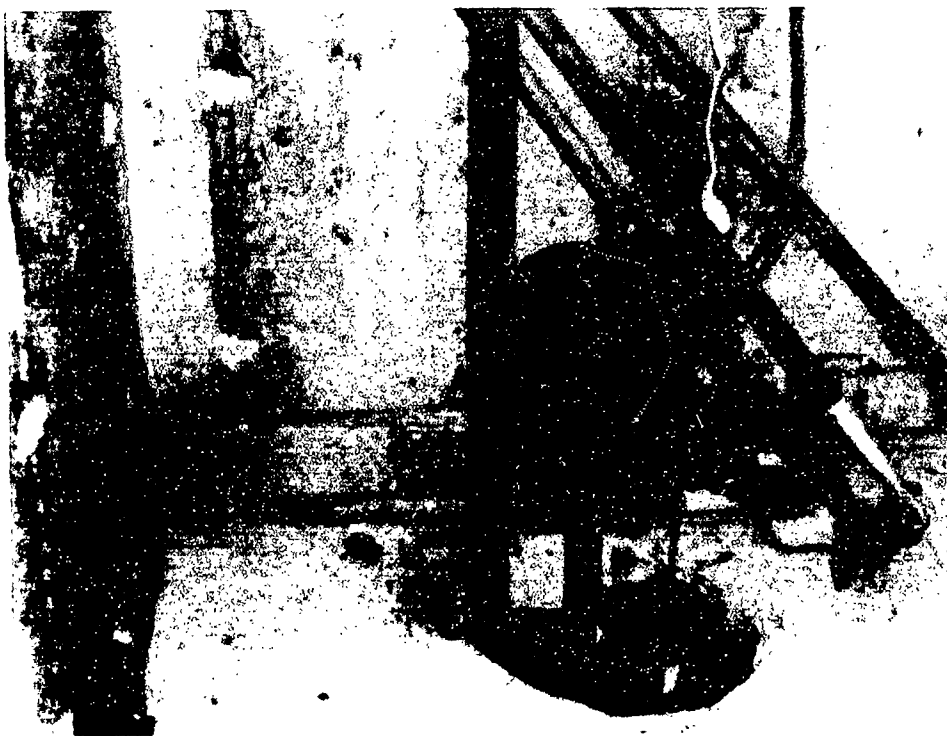

Sumps are often radon entry points. A sump can be sealed to prevent radon entry while preserving its intended function. See Figure 4-1 on page 4-6.



**d. Identify foundation types and design (intended) subslab fill material**

Information about the foundation type(s) and subslab fill material can be obtained from the foundation plans. Identify the footing types and their location on your working floorplan. The type and thickness of subslab fill material intended by the building designer should also be indicated on the foundation plans. Check the foundation type(s) and fill material in any additions, as well as in the original building. Note this information on your working floor plans.

**Sample Working Floorplan 3** builds on **Sample Working Floorplan 2** (page 3-23) by adding information about potential entry points shown on the mechanical plans.

### Sample Working Floorplan 3

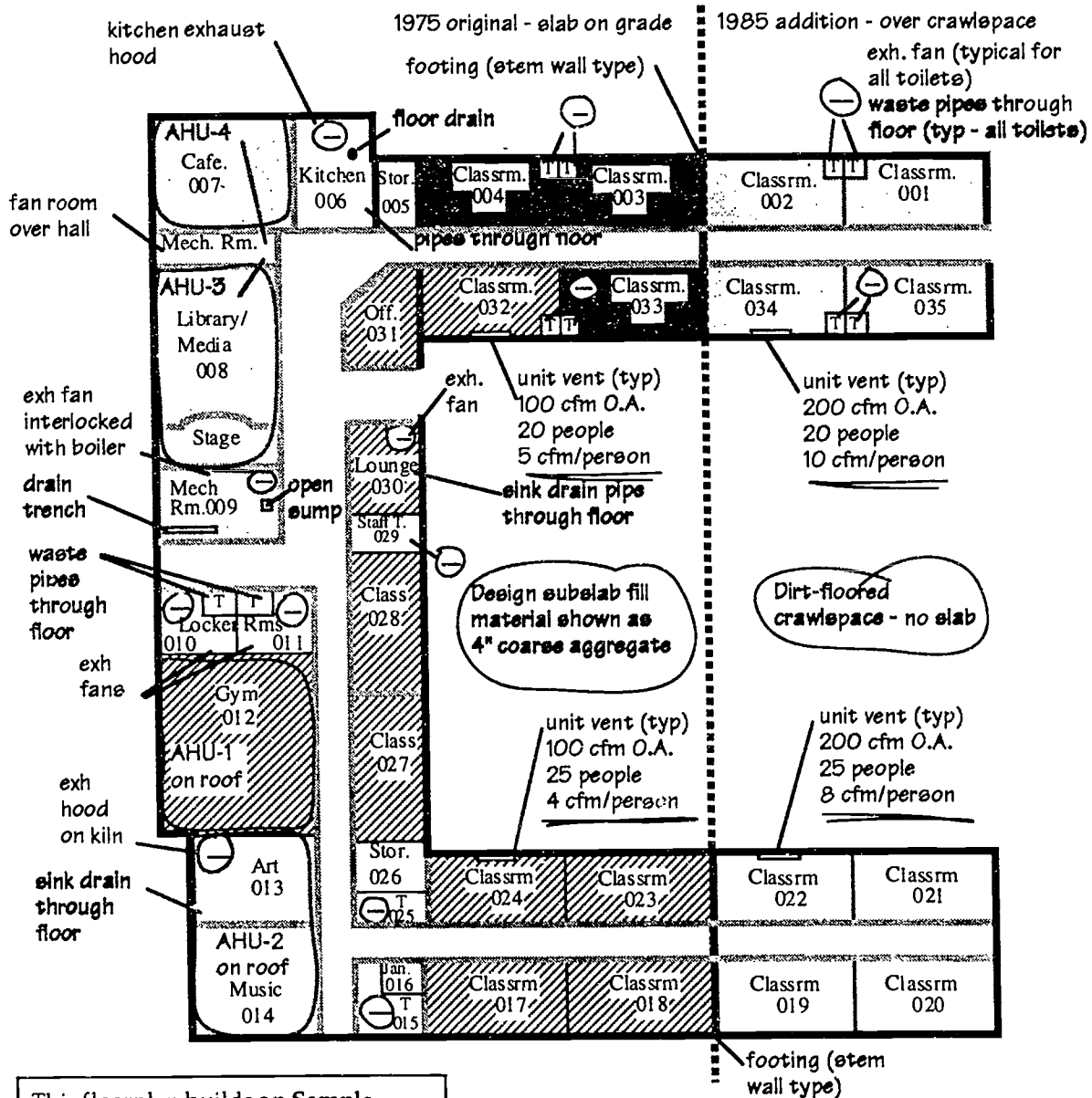

This floorplan builds on Sample Working Floorplan 2 by noting where there are openings through the slab. These openings are potential radon entry points.

The new notes are printed in bold lettering to make them more obvious.

- shows area designed to operate under negative pressure
- poured concrete
- masonry block
- not tested for radon
- shows radon test results below 4 pCi/L
- shows radon test results of 4 - 10 pCi/L
- shows radon test results over 10 pCi/L



## 2. Conduct a Walkthrough Inspection

No matter how complete and current your existing records may appear, an on-site inspection of the school building is essential.

Tools for the walkthrough inspection include:

- your working floorplan with notes showing radon test results and information from building plans and specifications
- flashlight
- stiff wire, thin screwdriver, or ice pick for examining cracks and holes
- protective clothing as needed (see discussion of worker protection in **Section 10.2**, pages 10-2 and 10-3).
- heatless chemical smoke
- whatever tools are needed for access to equipment, such as: ladder, wrenches, screwdrivers, and nut drivers

Heatless chemical smoke is an essential tool for building investigations. Chemical smoke reveals air circulation patterns without affecting those patterns because it is the same temperature as the air. It is available in various dispensers, commonly referred to as "smoke tubes," "smoke pencils," or "smoke guns." The "smoke" is a mist of fine particles that is created when two chemicals combine. A building investigator squeezes out a small amount of the "smoke," then observes the direction and vigor of smoke movement. The smoke is extremely sensitive to pressure differences. Building investigators, including radon mitigation contractors who do diagnostic work, use chemical smoke regularly, and should be able to direct you to a supplier. **NOTE:** The most common chemical smoke uses titanium tetrachloride. Avoid inhaling the smoke, because it can irritate your respiratory system.

The walkthrough should take place when the building is occupied -- or operating as if occupied. To help understand your findings, make a record of weather conditions, damper settings, fans that are or are not operating, and other pertinent conditions while you are conducting the investigation. As you examine the HVAC system, you may need to manipulate the controls in order to identify deficiencies (such as outdoor air dampers that do not open).

Building investigators should remain alert to features of the building and mechanical equipment that would indicate one type of radon control over another.

If the HVAC system was designed to supply 10 cfm of outdoor air/person (as ASHRAE *Standard 62* recommended from 1936 until 1973) and the system seems to be in good working order, increasing outdoor air flows to dilute radon may not be practical. If the subslab aggregate is crushed stone, an ASD system should be able to develop a large negative pressure field below the slab.

**a. Evaluate the condition of the ventilation system**

This inspection is intended to identify gross problems with the HVAC system. Detailed examination of the HVAC system condition and operation involves tools, measurements, instrumentation and skills with which you may be unfamiliar, and will be covered during the Detailed Investigation.

Look for signs of inadequate outdoor air or of ventilation malfunctions, particularly in areas where occupants have complained about stuffiness or discomfort. Indicate locations of problems on your working floorplan. **Sample Floorplan 4** on page 3-34 provides an example. Signs of ventilation problems include the following:

- blocked or obstructed outdoor air intakes
- clogged filters
- supply fans that are off when they should be operating
- broken or malfunctioning controls, such as outdoor air dampers, thermostats, or time clocks
- fan motors with worn or loose belts
- corroded fan housings that allow air leakage
- missing ceiling tiles that open into air plenums
- blocked or obstructed diffusers or grilles
- freeze stats that have tripped and never been reset
- fire dampers which have failed and are closed in ducts or plenums



You don't need the help of a mechanical engineer to identify problems like this. The exhaust fan disconnect on the roof has been switched "off," probably the last time the fan was serviced. The disconnect switch will override any signals from the control system, and the fan cannot operate until the switch is set to "on" again.

It is common to find rooms in which air supplies have been blocked either accidentally (e.g., by placing books, boxes, or papers on the outlets of unit ventilators) or deliberately (e.g., by closing dampers or taping air outlets to eliminate drafts). Chemical smoke can be used to confirm that dampers are open. Even though a visual inspection suggests that a damper is open, other obstructions may exist within the duct or within the intake grille itself. Check the supply diffusers, return air grilles, and outdoor air intakes using the chemical smoke to verify air flow.

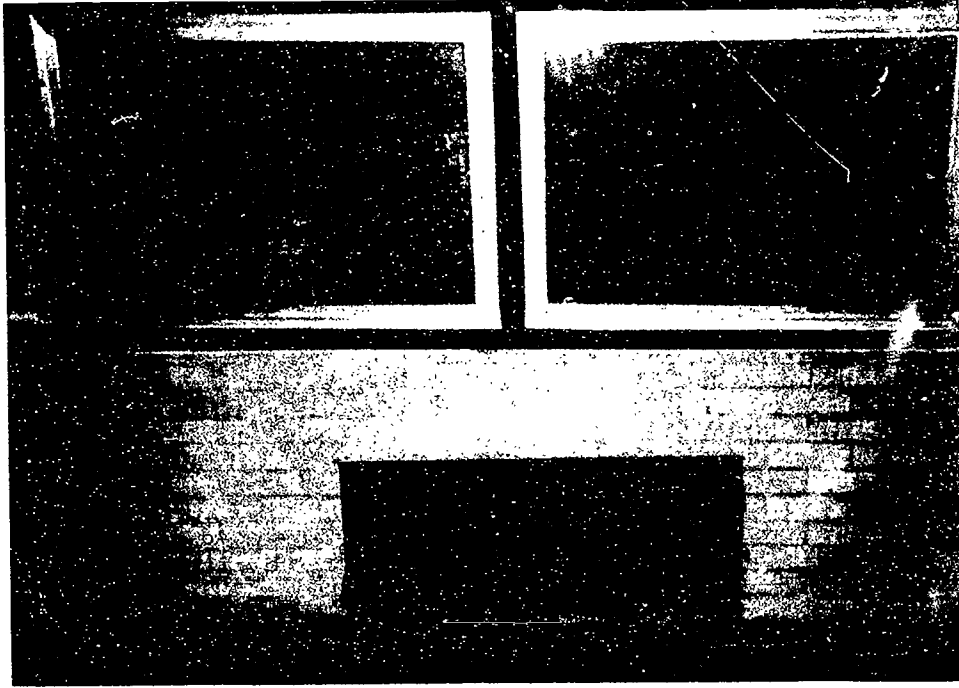

Whatever the control settings may indicate, little or no outdoor air is being supplied to this area of the building, because the outdoor air intake has been blocked off. There may be a history of problems related to the low outdoor air ventilation rate (for example, complaints about stuffiness).

Safety devices such as freeze stats and fire dampers sometimes cause problems by cutting off the flow of outdoor ventilation air.

#### Freeze stats

Although most codes call for a minimum flow of outdoor air, regulations in some parts of the country allow the control strategy to eliminate outdoor air flow completely as a freeze protection measure. A freeze stat is a device (generally located in the mixed air stream) that shuts off the associated fan or closes the outdoor air damper when the temperature drops below a setpoint. Manual freeze stats must be reset before the equipment will operate again. Inadequate outdoor air ventilation can result if a freeze stat is not reset after it trips or if it is set to trip at a high temperature.

### Fire dampers

Fire dampers that are installed where ducts or ceiling plenums penetrate fire-rated barriers can close (even when there has not been a fire) and obstruct air flow. The mechanical floor plans should show fire damper locations. Gain access to these dampers through access panels in the ductwork and check to confirm that the fire dampers are in the open position.

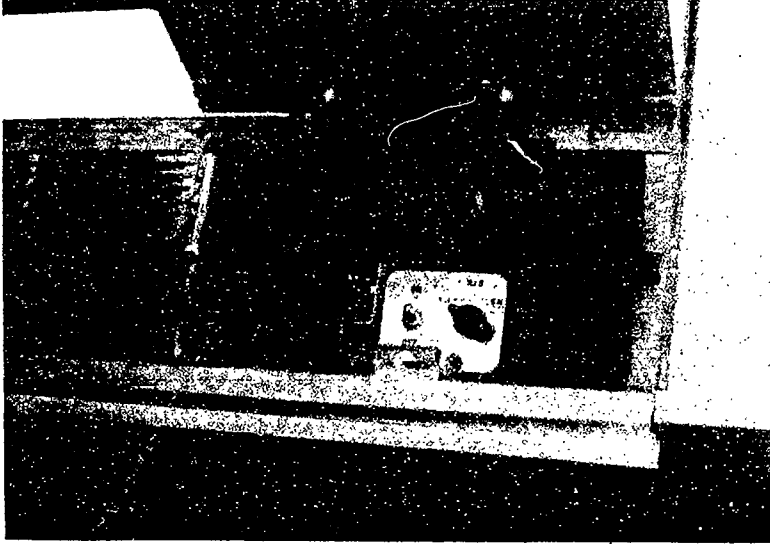

This photograph shows the fan controls of a typical classroom unit ventilator. The controls are readily accessible. If teachers and students can change fan operation at will, they need to understand how their actions affect radon concentrations, as well as overall indoor air quality.

Record the timing of occupied and unoccupied cycles. If outdoor air dampers are open during the occupied cycle and closed during the unoccupied cycle, lengthening the occupied cycle may reduce radon concentrations during occupied periods. Also note how pieces of equipment such as unit ventilators and exhaust fans are controlled. Exhaust fans that continue to operate during unoccupied periods may be drawing in radon. On the other hand, teachers or other staff members may turn "off" unit ventilators or fans that are noisy, distracting, or cause drafts.

## Evaluating and Correcting Radon Problems

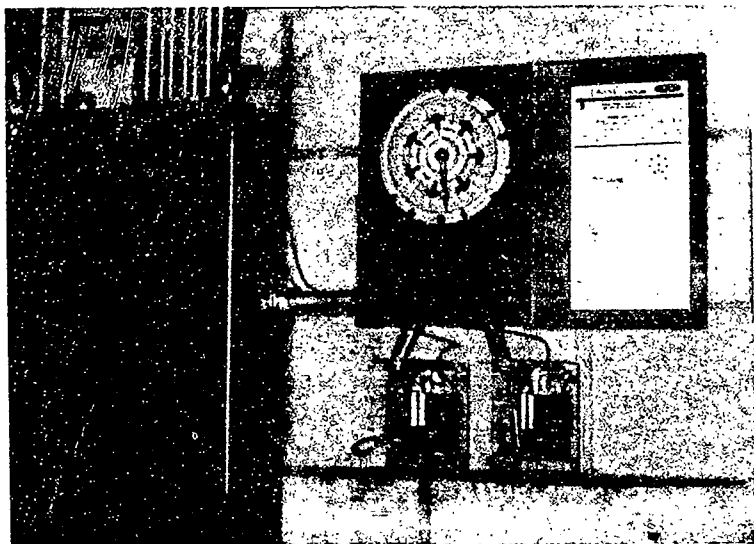

If the control system uses time clocks, make sure they read the correct time. Radon and indoor air quality problems can arise if time clock settings slip due to power outages or other factors.

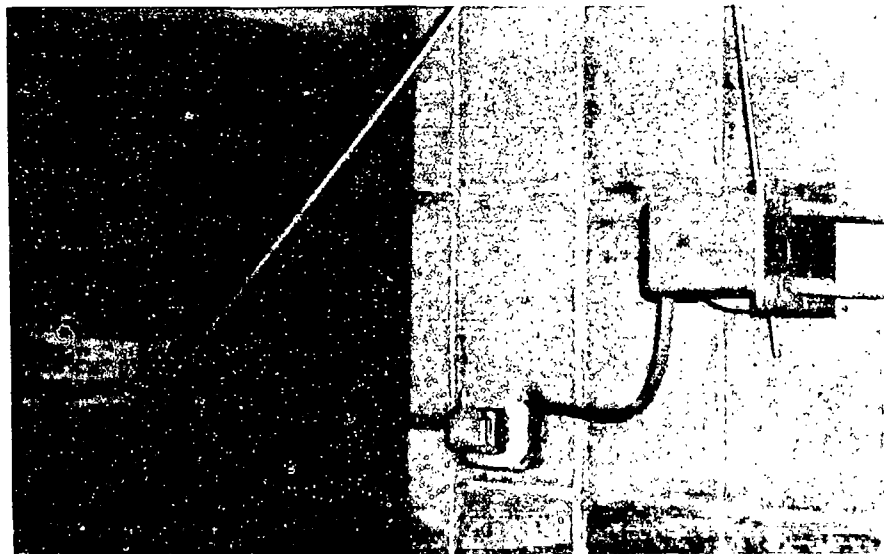

Manipulate the controls until they call for the outdoor air damper to open, then observe the actual damper position. This outdoor air damper is closed.



Check the condition of the filters at each piece of air handling equipment. Filters should fit into their frames without gaps or cracks. Clogged filters can cause underventilation by restricting air flow. Filters can overload until they sag or "blow out" of their frames and allow unfiltered air to pass. This causes dirt to build up on fans and coils, reducing the performance of mechanical equipment and shortening its useful life.

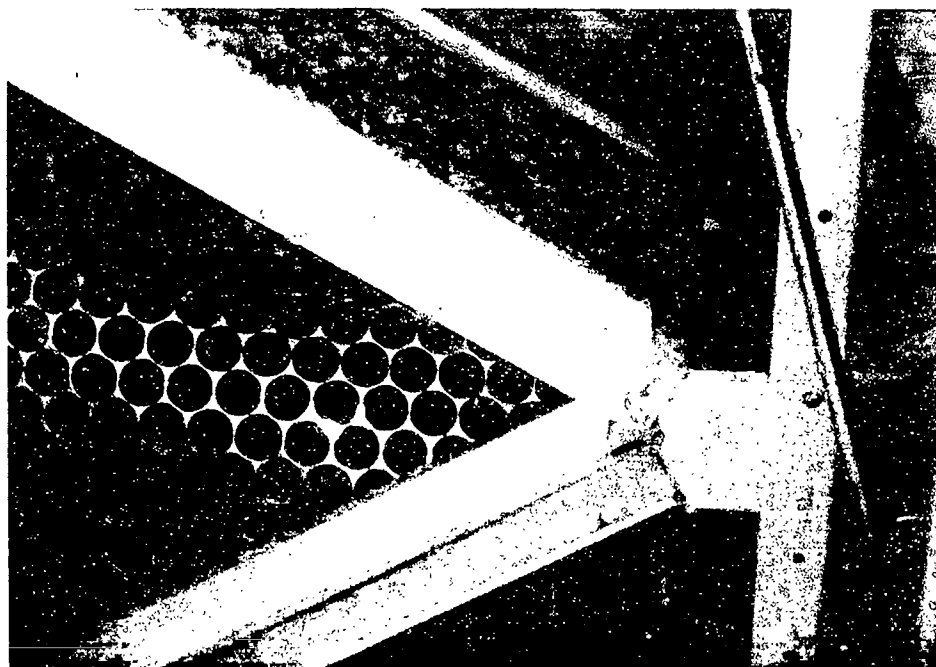

This photo shows a common, low-efficiency filter that has "blown out" due to the excessive dirt that collected as a result of infrequent filter changes. Medium-efficiency pleated filters offer a longer effective life and remove smaller particles from the indoor air. Medium-efficiency filters should be substituted for low-efficiency filters wherever possible.

Wherever your examination of the building plans indicated that a room or zone should operate under negative pressure, use heatless chemical smoke to check air flow patterns. *Note:* Air will be entering the room through some openings and leaving through others. Focus on whether the room seems to be drawing in air from outdoors, particularly through openings to the subslab or crawlspace. Check at pipe penetrations, electrical outlets, the floor-wall joint, and other openings in the floor or masonry walls. Mark the direction of air flow on your working floorplan with notes and/or arrows as shown on **Sample Working Floorplan 4**.

### Sample Working Floorplan 4

1975 original building -  
over 6" coarse aggregate

1985 addition -  
over (dirt-floored) crawlspace

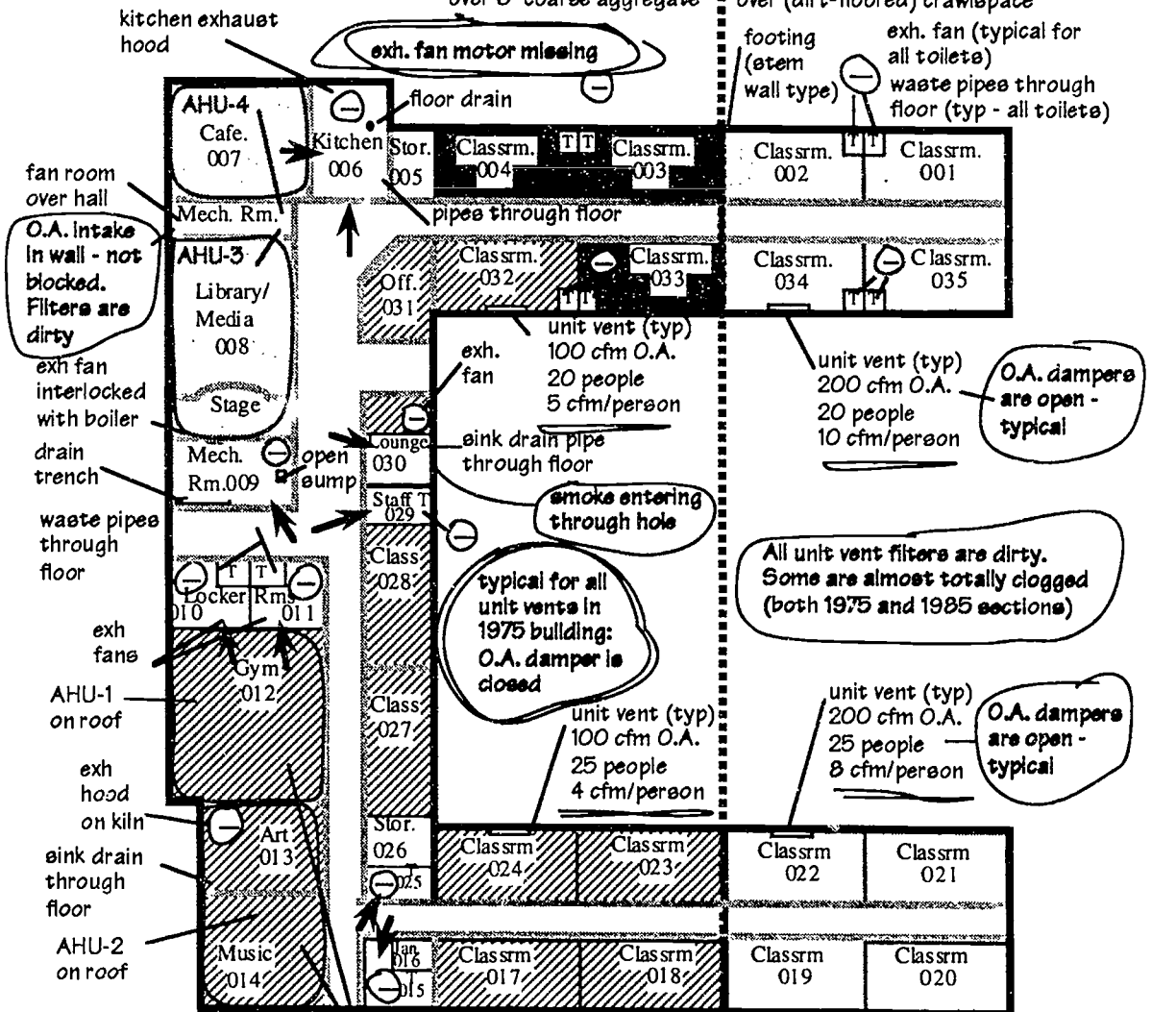

**AHU-1 and AHU-2: filters are clogged; O.A. Intakes closed off with plywood; leaky supply duct at roof penetration (AHU-2)**

**broken unit vent fan**

**TIME CLOCK SCHEDULE:**  
occupied: 0900-1600  
unoccupied: 1600-0900

This floorplan builds on Sample Working Floorplan 3 by adding observations from the walkthrough:  
1) ventilation system problems  
2) air flow patterns

The new notes are circled and printed in bold lettering to make them more obvious.

- ⊖ shows area designed to operate under negative pressure
- ← shows direction of airflow using chemical smoke (weather: cloudy, wind < 5 mph, temperature around 20° F)
- ▬ poured concrete
- masonry block
- not tested for radon
- shows radon test results below 4 pCi/L
- ▨ shows radon test results of 4 - 10 pCi/L
- shows radon test results over 10 pCi/L

**b. Confirm soil gas entry at openings to the ground**

This portion of the walkthrough investigation is intended to identify locations that should be sealed to prevent radon entry. **WARNING: Utility tunnels may contain asbestos insulation, which should not be disturbed in any way during the investigation.**

Review the condition of potential radon entry points that were discovered during the review of the building plans (page 3-24). Identify additional radon entry points that were not shown in the plans, such as holes and cracks in the slab or the foundation walls. Note your findings on your working floorplan. Although sealing radon entry points is rarely sufficient to correct a radon problem, it always improves the performance of other mitigation techniques. In some cases, it may be necessary to seal large openings to the earth before any mitigation technique can be successful. The size and locations of radon entry points can also affect the design of ASD systems (e.g., fan sizing, placement of suction points).

Potential radon entry points include the following locations:

- cracks at expansion joints and at the edges of slabs
- utility pipe penetrations
- utility tunnels containing heating pipes, conduit, and water pipes
- subslab supply or return ducts or tunnels
- dirt-floored crawlspaces
- sumps
- block walls
- unsealed cold-pour slab joints and control saw-joints
- large unsealed cracks caused by settling and/or slab shrinkage



This dry sump may be an easy place to examine the subslab material (such as fill and native soil). It is also likely to be a radon entry point. The investigator is using chemical smoke to see whether air is entering through the perimeter drain pipe.

To confirm whether a suspected radon entry point is actually allowing soil gas to enter, probe cracks and holes with a stiff wire (such as a straightened coat hanger) to see how far they extend. Release a small amount of heatless chemical smoke by a suspected radon entry point and observe the direction and vigor of smoke movement. If the smoke is drawn into the crack or blows back into the room, the crack extends through the foundation into the underlying material. The direction of smoke movement shows whether the area you are in is under positive or negative pressure relative to the subslab area at the time of your inspection. If smoke is drawn into the crack, the area is operating under positive pressure relative to the subslab; if the smoke is blown away from the crack, the area is operating under negative pressure relative to the subslab and radon may be entering.

**NOTE: The air pressure below the slab can be different from the air pressure outdoors (for example, on a windy day). The fact that a room is positive relative to the outdoors does not mean that it will be positive relative to the subslab (which is the source of radon gas).**

## Evaluating and Correcting Radon Problems



Left: This photograph illustrates the use of chemical smoke to evaluate pressure differences. In this case, the smoke is entering the room, indicating that the room is under negative pressure relative to the area below the slab.

Right: The area around these plumbing pipes should be checked with chemical smoke to see whether it is a radon entry point.

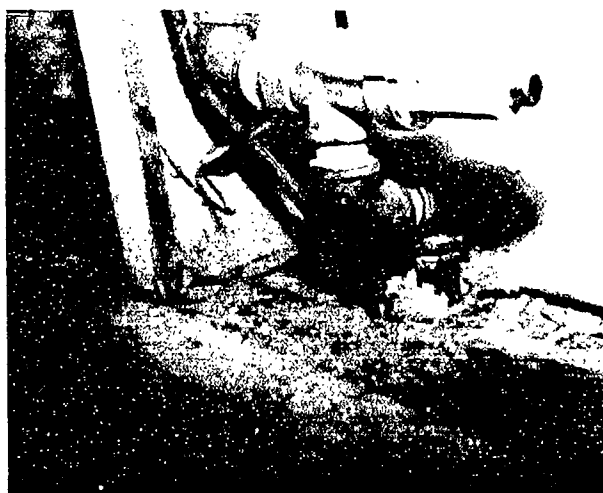

## Evaluating and Correcting Radon Problems



Trim or interior finish work often covers the floor-wall joint and hides cracks that allow radon to enter. If the smoke test shows soil gas entry, this floor-wall crack may need to be sealed during mitigation.

## 4.0 Ventilation System Restoration

This section discusses restoration of the ventilation system. This is the next step after performing the initial investigation. The restoration involves correcting the ventilation deficiencies that were identified in the initial investigation and sealing any large radon entry points.

By the end of the initial investigation, you should have collected the following information:

- areas where the radon concentration is above 4 pCi/L
- locations of openings to the ground
- locations of gross ventilation system deficiencies or malfunctions
- rooms that run negative

It may be possible to correct your radon problems by closing large openings to the ground and correcting the ventilation system problems you have identified. You may need to obtain professional assistance for this corrective work. Radon contractors who are listed by EPA's Radon Contractor Proficiency (RCP) program have been trained in the proper selection and application of sealants. HVAC engineers or mechanical contractors may be needed to design modifications, repair or adjust the ventilation system.

### 4.1 Restore the Ventilation System

During the initial investigation, you developed one or more working floorplans showing the locations of: 1) rooms with elevated radon concentrations, 2) rooms supplied with less than 10 cfm/person of outdoor air, 3) rooms designed to run negative, and 4) obvious ventilation problems such as broken equipment or obstructed outdoor air intakes. Use this information to restore the ventilation system, focusing on equipment that serves areas with elevated radon concentrations.

#### a. Repair Ventilation System Deficiencies

If you have mechanically-supplied outdoor air ventilation, repair the deficiencies you have identified so that, if possible, the ventilation system provides *at least* as much outdoor air as was specified in the original design. Carrying out this

restoration throughout the entire school will help ensure that radon concentrations remain low throughout the school, and will benefit indoor air quality in general.

Sometimes simple changes in the control of outdoor air intakes can significantly increase the outdoor air ventilation rate. Examples include:

- removing barriers that obstruct outdoor air intakes
- increasing the minimum setting on outdoor air dampers
- repairing defective unit ventilators and making sure that they operate (and bring in outdoor air) whenever the school is occupied

Other deficiencies may be more complicated and expensive to repair. If the school district does not have an HVAC engineer on staff, it may be necessary to seek outside assistance to identify the cause of the ventilation system problems and the most appropriate corrective actions.

If possible, increase the outdoor air ventilation to 15 cfm of outdoor air/person in classrooms in accordance with *ASHRAE Standard 62-1989*. To avoid depressurizing the building, mechanically supply additional outdoor air rather than increasing exhaust quantities.

**CAUTION:** *The capacity of your heating or cooling coils determines the amount of outdoor air that can be conditioned, and may prohibit meeting ASHRAE 62-1989 on a year-round basis.* However, if the radon control strategy requires 15 cfm/person of outdoor air ventilation, indoor radon levels will rise when outdoor air flows are less than this amount.

- In some areas of the country, freeze protection for coils may limit outdoor air flows in winter. However, schools built according to pre-1973 ASHRAE standards should have sufficient coil capacity to condition at least 10 cfm/person of outdoor air ventilation.
- Indoor moisture problems can develop in hot, humid climate zones if outdoor air flows are increased beyond the capacity of cooling equipment to dehumidify the air.

#### **b. Modify Pressure Relationships**

It may be difficult or impossible to prevent radon from entering rooms that operate under negative pressure relative to the outdoors. Schools which rely on natural ventilation or use exhaust fans to draw in outdoor air often run negative,



particularly if renovations have tightened the building, making it more difficult for *make-up* (replacement) air to enter. It may be possible to counteract these negative pressure influences by:

- changing air distribution within the building so make-up air can flow where it is needed - an engineer should approve any plan of this sort, to avoid violating fire codes.
  - undercut the bottoms of doors or install vaned openings in doors
  - open transoms
- supplying outdoor air to rooms that run negative
  - install outdoor air dampers that open when local exhaust fans are running
  - install unit ventilators or air handling units to introduce and condition outdoor air

Schools that have mechanically-supplied outdoor ventilation air can also run negative. If zones within your school run negative, even though you have mechanically-supplied outdoor air ventilation and the outdoor air dampers appear to open properly, your system may be out of balance. Air balancing by a certified test and balance company can restore the ventilation system to proper adjustment, reducing or eliminating the negative pressures that are drawing radon into the building. See page 9-4 in Section 9 for guidance in obtaining quality test and balance services. Also consider whether additional exhaust fans may have been installed, increasing the powered exhaust cfm so that it outweighs the supply of make-up air.

### c. Review Equipment Cycles

It may be possible to reduce the average radon concentration in your school by manipulating the occupied and unoccupied cycles of your HVAC equipment. (HVAC control cycles are discussed on pages 2-6, 2-12, 2-13, 3-30 and 3-31, 6-30 and 6-31.) Schools commonly run more negative during the unoccupied cycle. If this is the case for your building, initial improvements might include making certain that exhaust fans are shut down during unoccupied periods and starting the occupied cycle earlier in the day.

**Sample Working Floorplan 5** on page 4-4 shows sealing requirements and corrective actions for ventilation deficiencies in the example school.

### Sample Working Floorplan 5

1975 original - slab on grade

1985 addition - over crawlpace

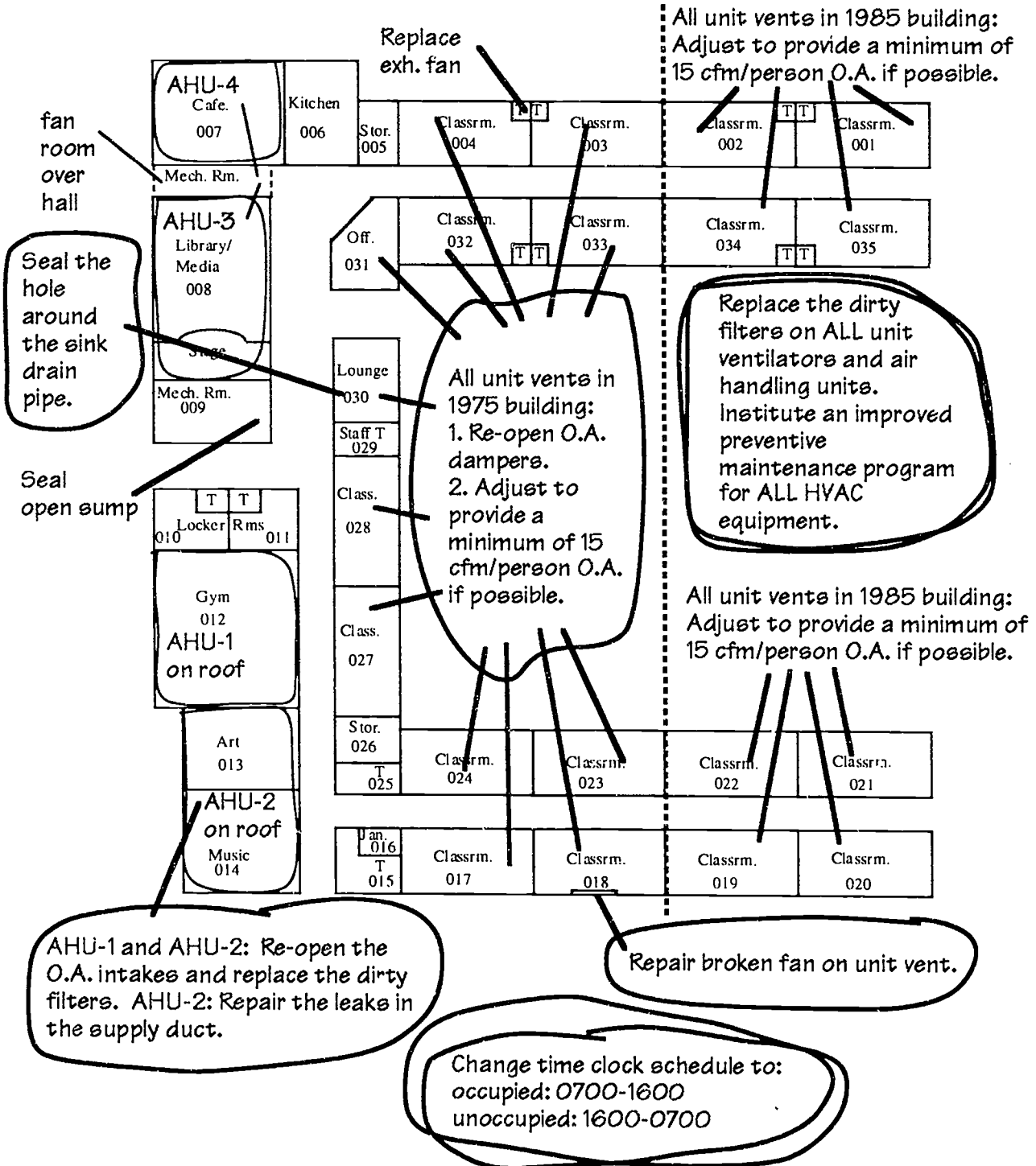

## 4.2 Seal Large Radon Entry Points

Radon problems can rarely be corrected by sealing alone. Soil gas will enter a building through any available openings to the ground whenever pressure differentials create suction on the soil. Radon atoms are small enough to move freely, even through small cracks in the slab or foundation walls that are not obvious to the human eye. The time and expense involved in locating and sealing all such openings is generally not justified.

On the other hand, sealing helps to support other radon mitigation strategies. For example, ASD systems depend on the ability to develop a pressure field beneath the slab. Large openings to the ground can restrict pressure field development. It is worthwhile to seal large openings that are readily accessible.

Cracks and openings that can be closed permanently should be cleaned (to improve adhesion) and sealed with polyurethane caulk. *Note: Polyurethane caulk gives off toxic fumes during installation. Installers should follow manufacturers' directions and safety precautions -- wear appropriate protection and ventilate the area.*



This workman is grinding and cleaning a floor-wall joint so it can be sealed with polyurethane caulk. Concrete dust and any other material that might interfere with the sealant's ability to stick must be removed before the sealant is applied.

Some openings to earth should be sealed with a removable material, so that they are accessible in the future. Sump holes are an example of this type of opening. Open sumps should be covered with an impermeable material such as plexiglass, PVC sheets, treated 3/4" plywood, or sheet metal. The cover should be sealed around the edges with silicone caulk. It may be necessary to replace the existing sump pump with a submersible model and put a trapped floor drain in the newly created sump cover.

Figure 4-1 shows one approach to sealing a sump hole. The sump cover is equipped with a trap so that water from the floor surface can continue to drain into the sump.

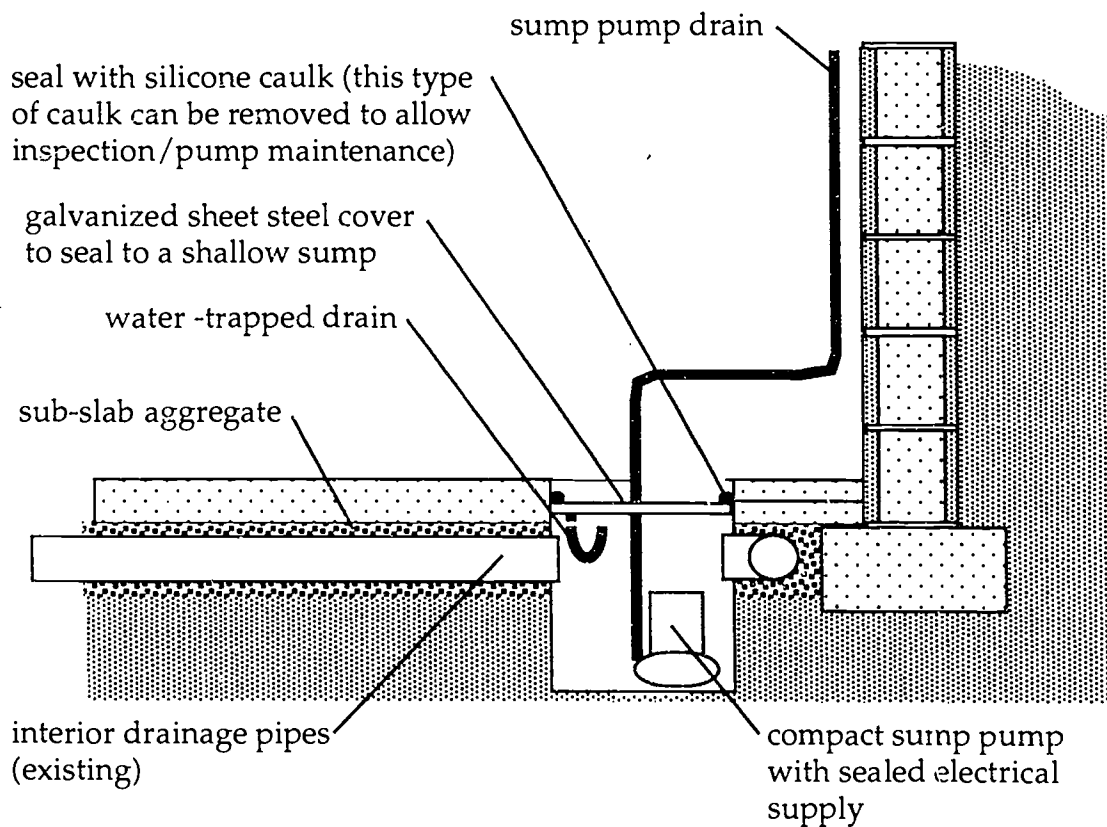

**Figure 4-1: Sealing a Sump Hole**

Source: Camroden Associates

## 5.0 Retest Radon Levels

After completing ventilation system restoration, it is time to decide whether to carry out a Detailed Investigation or retest radon concentrations in the school to see whether a Detailed Investigation is needed. This section provides guidance in making this decision. If a decision is made to retest for radon, specific guidance is provided as to how the measurements should be performed and how the retest results should be interpreted.

If the pre-mitigation radon levels were greater than 10 pCi/L, you should proceed to **Section 6, Detailed Investigation** and (in most cases) design and install an ASD system. Where pre-mitigation radon levels were 10 pCi/L or lower and outdoor air ventilation was blocked or severely restricted, it may be worthwhile to retest for radon to determine whether restoration of the ventilation system (i.e., removing obstructions, reconnecting damper operators) has increased outdoor air flows enough to lower the radon concentration below 4 pCi/L. If actual air flow measurements are available, the dilution equation presented in **Figure 3-1** (and discussed on page 3-7) can be used to determine whether retesting radon before the Detailed Investigation is a practical option. Without air flow measurements, the decision to retest must be made on the basis of common sense by considering pre-mitigation radon levels and the magnitude of the change in outdoor air ventilation rates. NOTE: Even if the dilution equation shows that radon should be below 4 pCi/L, a radon retest must be performed to confirm that mitigation is successful.

In order to determine the effects of the ventilation system restoration relatively quickly, EPA recommends making short-term radon measurements in areas where pre-mitigation measurement results were above 4 pCi/L. Conduct two short-term radon tests, either simultaneously or sequentially, and average the results. During radon testing, use the quality assurance procedures discussed in *Radon Measurement in Schools - Revised Edition*.

The radon test results will be affected by HVAC equipment cycling. Operate the HVAC equipment on the occupied cycle 24 hours/day throughout the test period. If the test is performed when the ventilation system is operating on normal occupied/unoccupied cycling, test results are likely to be higher than occupants actually encounter during occupied periods (i.e., radon levels usually rise during the unoccupied cycle). Outdoor air dampers should not be allowed to open any further than their minimum setting. This will simulate outdoor air ventilation during extreme weather conditions. Measurement results obtained under these conditions will reflect the radon concentrations when the ventilation system is operating at minimum outdoor air ventilation rates.

## 5.1 Evaluate Retest Results

Review the retest results, including quality assurance measurements. It is common for some areas to require additional work while others are below 4 pCi/L.

- Areas that show radon concentrations at or above 4 pCi/L during the retest -- such as Classrooms 003, 004, and 033 on **Sample Working Floorplan 6** -- will require further mitigation, probably including active soil depressurization. Conduct a detailed investigation (see **Section 6**) to select the best mitigation approach for areas that require additional treatment after the initial improvements. If the radon level is less than 10 pCi/L, pressurization or additional dilution are potential alternatives to ASD. Negative pressure reduction could also be helpful. At higher radon concentrations, ASD alone or in combination with dilution, pressurization, or reduction of negative pressures will be needed.
- Where the averaged results of the radon retest are below 4 pCi/L, you have learned that the HVAC system can be used to control radon. Now you need to adjust the system so that radon levels remain below 4 pCi/L whenever the building is occupied. **Figure 5-1** on page 5-3 shows how occupied/unoccupied cycling affects radon concentrations in a typical school. Within each *ventilation zone*, (room or rooms served by the same piece of ventilation equipment), determine which room has the highest retest results. In that room, use a continuous radon monitor (CRM) to collect continuous radon readings for a minimum of 48 hours while the HVAC equipment cycles normally. Use the CRM results to determine the ventilation system start-up and shut-down times necessary to maintain radon levels below 4 pCi/L whenever the building is occupied. (NOTE: You may need professional assistance to obtain and interpret continuous radon measurements.)

*Example: Continuous radon readings in a classroom show that radon concentrations start to fall at 7:30 am, when the ventilation system begins its occupied cycle, but do not drop below 4 pCi/L until 8:30 am. The students arrive at 8:00 am. In this room, the occupied cycle should be adjusted to begin 1/2 hour earlier (i.e., at 7:00 am) so that radon levels will be below 4 pCi/L by 8:00 am.*

If the retest shows radon at or below 4 pCi/L in the entire building after the initial improvements: 1) use the procedure described above to adjust the occupied/unoccupied cycle(s), and then 2) go to **Section 9, Long Term Radon Management**. Long term radon management is critically important to prevent

radon problems from recurring in the future. *NOTE: Wherever the HVAC system is used as part of the radon control strategy, radon concentrations can be expected to vary with changes in the outdoor air ventilation rate (as illustrated in Figure 5-1). Record and maintain outdoor air damper settings, the timing of occupied and unoccupied cycles, and any other modifications that were made as part of the HVAC-based mitigation strategy. Label the HVAC system to: 1) state that the HVAC system is being used to control radon and 2) indicate the critical settings that must be maintained. Avoid any change to key HVAC components that might cause radon levels to rise.*

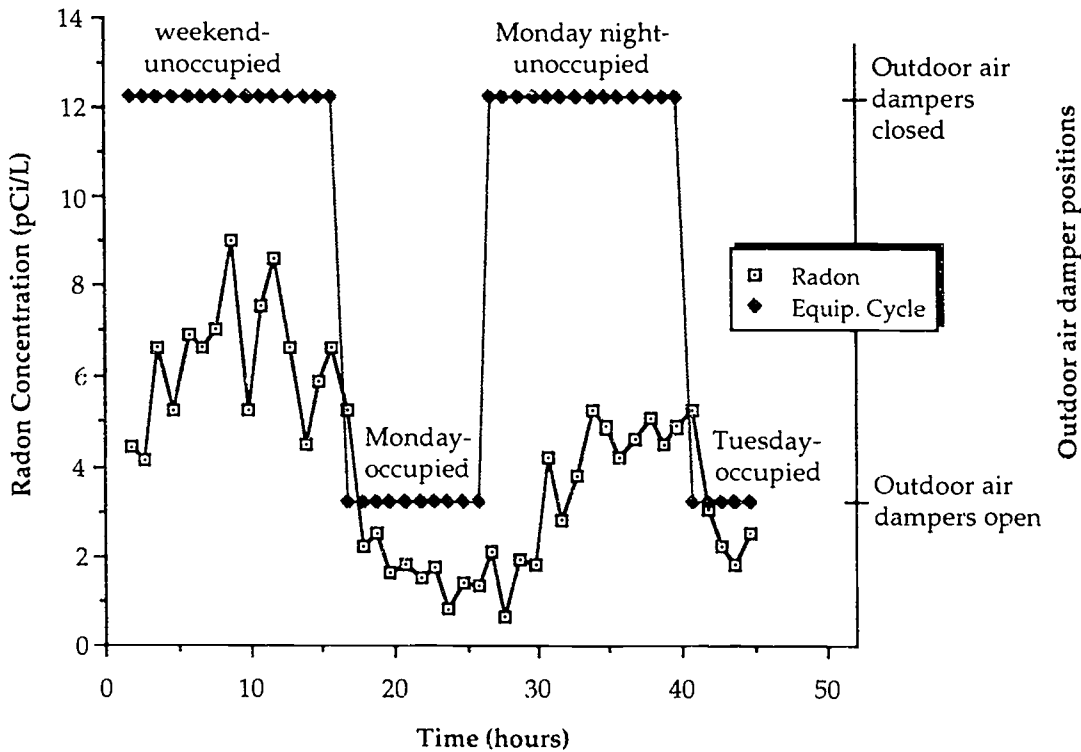
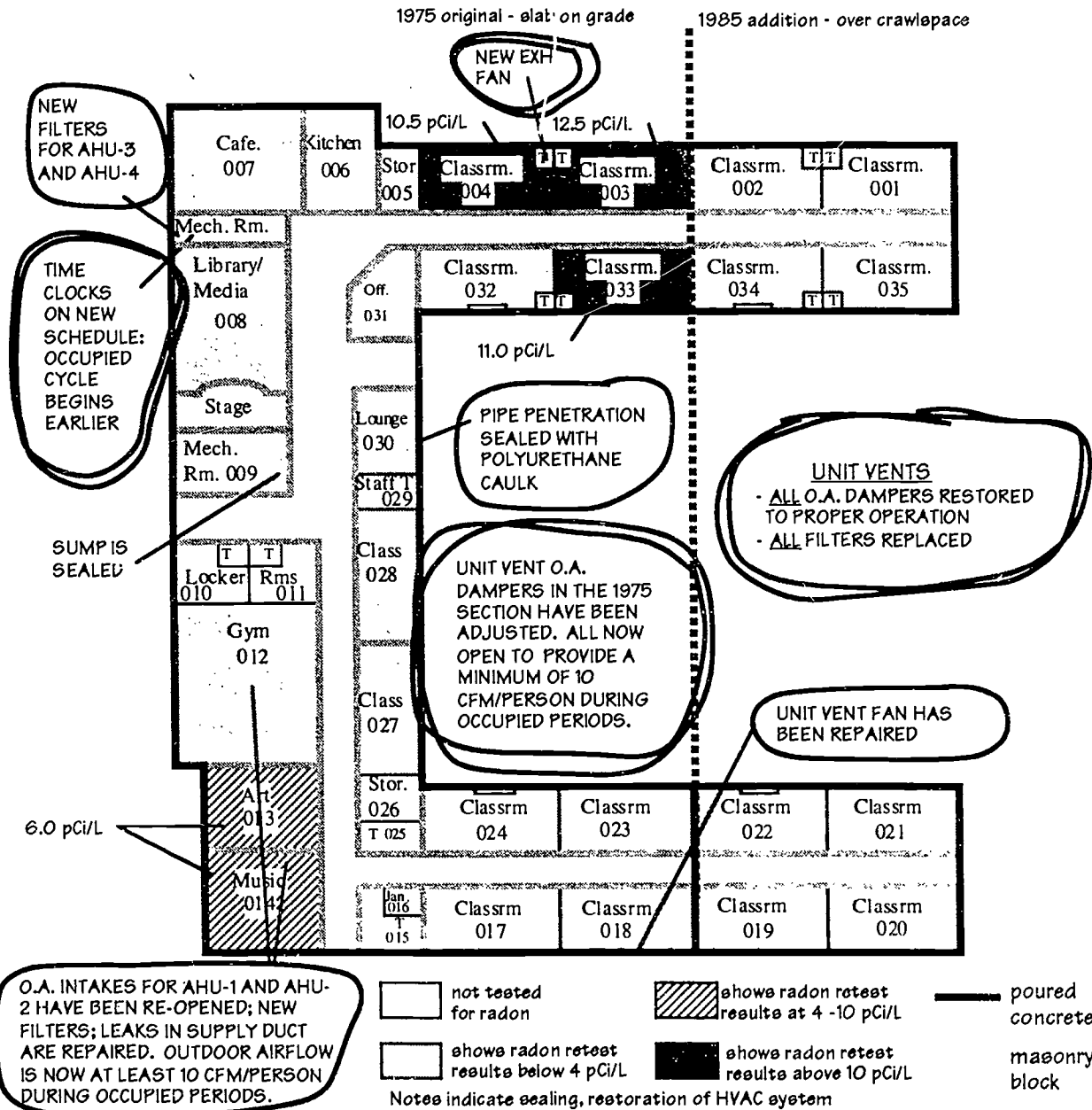

**Figure 5-1: Radon Levels and Control Cycles**

The squared-off pattern shows the timing of occupied/unoccupied cycling. Radon levels start to fall when the occupied cycle begins and outdoor air dampers open. When outdoor air dampers close for the unoccupied cycle, radon levels rise.

NOTE: Your building may or may not behave in this manner.

### Sample Working Floorplan 6



Restoration of the HVAC system appears to have reduced radon below 4 pCi/L in most of the rooms that were originally between 4 and 10 pCi/L. The school should institute a program of preventive maintenance and annual retesting to ensure that radon levels in those areas remain below 4 pCi/L.

Meanwhile, radon remains at or above 10 pCi/L in the three classrooms that were originally over 10 pCi/L. A detailed investigation will be required to design a successful approach to mitigation in those three classrooms using *active soil depressurization (ASD)*. The Art and Music classrooms also remain above 4 pCi/L and will require a detailed investigation.



## 6.0 Detailed Investigation

This section provides guidance in performing the detailed investigation. Mitigation strategies are discussed in detail to help you understand how the elements of the investigation will affect the selection of a strategy. Basic information is provided on how typical radon diagnostics are performed during the investigation to determine the viability of each mitigation strategy. The team requirements are also discussed, to help select additional qualified team members.

A detailed building investigation is needed under any of the following circumstances:

- pre-mitigation indoor radon levels are higher than 10 pCi/L in some areas of the building
- an initial building investigation did not find obvious ventilation problems
- initial ventilation system restoration was not successful at reducing radon below 4 pCi/L

As with the initial inspection, architectural and mechanical plans and specifications (where available) supplement the information available from direct inspection of the building. Investigators should have specific knowledge of radon control methods, foundation construction practice, radon diagnostic tests, and HVAC equipment and controls.

### 6.1 The Detailed Investigation Team

A team approach to the investigation is suggested to promote full consideration of potential mitigation strategies. The team should include representation in three critical areas of knowledge:

- 1) Someone familiar with the building, the occupancy schedule, and the HVAC equipment. This will probably be a school staff person.
- 2) Someone who has successfully participated in the EPA's Radon Contractor Proficiency Program (RCP) or is a state-certified radon mitigation contractor should be used for the foundation investigation. Experienced radon contractors should be able to provide specialized equipment for radon diagnostics, such as radon sniffers, chemical smoke, pressure gauges, and slab drilling equipment.

## Detailed Investigation

Information on specific radon measurement firms and mitigation contractors in your area can be obtained from your state radon office (see **Appendix B**).

- 3) A school facility person, mechanical contractor, and/or a mechanical engineer who knows the applicable codes and is able to evaluate the ventilation system. This could be an engineer from an HVAC company under contract to perform school HVAC maintenance, design, and/or renovation work.

It is critically important to use experienced, trained people when evaluating, repairing, designing and installing air handling equipment. Registered mechanical engineers are traditionally used to evaluate, design and oversee repairs and new installations of ventilation equipment.

### Potential Team Members and What They Can Contribute to the Detailed Investigation

- School administration representative - can serve as liaison with school superintendent's office, board of education, and other district decisionmakers; could also be liaison with media
- Facility manager - familiar with school mechanical system design, operation, and maintenance; can provide access to equipment and change controls if necessary during the investigation
- Teacher/staff representative - liaison with other staff members; can help build support for mitigation effort
- PTA representative - liaison with other parents; can help to build support for mitigation effort
- RCP contractor - familiar with radon diagnostics and mitigation, can interpret radon measurement results, can conduct and interpret subslab vacuum test
- Mechanical contractor - familiar with HVAC installation and modification
- Mechanical engineer - familiar with HVAC systems, can conduct and interpret ventilation assessment
- Indoor air quality consultants - can identify, assess, develop mitigation plans and interpret ventilation assessment for radon and other potential IAQ problems.

## 6.2 Radon Mitigation Techniques

The goal of the Detailed Building Investigation is to identify one or more radon mitigation strategies that are likely to be successful in your building. As discussed in **Section 2**, radon mitigation systems can function by preventing radon from entering the building, diluting indoor radon concentrations, or a combination of these approaches. This section provides an overview to familiarize you with current radon mitigation techniques.

Mitigation approaches that change pressure relationships to prevent soil gas from entering the building can be successful *regardless* of the radon concentration. Soil gas cannot enter when the air pressure indoors is higher than the air pressure under the occupied space, a goal that can be achieved by lowering the air pressure in the soil or by raising the air pressure inside the building. *ASD* and *pressurization* both prevent radon entry by controlling pressure differences.

*Sealing* cracks and openings to the ground helps to prevent radon entry. Because sealing is rarely successful as a stand-alone approach to mitigation, it will not be discussed in detail in this section. However, sealing may be necessary to ensure the success of other mitigation strategies. Sealing of *above-grade* openings such as leaky windows or unweatherstripped doors can be important to the success of mitigation based on pressurization. **Section 4**, pages 4-5 and 4-6 provides more information on sealing techniques.

*Dilution* is most appropriate for treating radon levels of 10 pCi/L or below. **Section 3.4** discussed an approach to mitigating low radon levels by repairing or adjusting the ventilation system to increase the flow of outdoor air into the building. **Section 6.2.c** describes a more detailed technical evaluation of dilution as a mitigation approach.

#### a. Active soil depressurization

Active soil depressurization (ASD) systems use ductwork and fans to lower the air pressure in the soil below the building slab (or through an installed membrane barrier, if there is no slab). The system develops and maintains a negative pressure field by withdrawing soil gas through one or more *suction points*, holes through the slab or membrane. When the system functions properly, air is sucked out of the building through any foundation cracks, so that radon cannot enter. The soil gas withdrawn by the ASD fans is ducted out of the building and exhausted above (and away from) the highest air intake or building opening so that it will not be drawn back indoors.

Subslab conditions are critical to the success of this mitigation approach. If the soils are fine-grained, wet, or tightly-compacted, the negative pressure field will only extend for a short distance, and multiple suction points will be necessary. In a typical ASD installation, fill material and/or soil is removed below each suction point to increase pressure field extension. If air moves too easily through the soil or there are holes in the foundation, the fan could suck air without developing an adequate negative pressure field. ASD fans are designed to operate at high static pressures and low air flows.

ASD systems have been effectively used in buildings with slab on grade, basement and crawlspace foundations. The complexity of designing and installing these systems varies depending on the foundation details (as well as other building features, such as fire walls). It is recommended that the system be designed and installed with the aid of a radon contractor who is listed in the EPA Radon Contractor Proficiency (RCP) program or is state-certified.

### *ASD under slabs*

The following diagnostic procedures are used to evaluate the potential for ASD under a slab:

- review of architectural and mechanical plans and construction specifications
- visual inspection to examine the foundation and subslab material
- vacuum test (**Figure 6-1** illustrates how ASD systems can be adapted to deal with subslab obstacles)

### *ASD under a membrane*

Crawlspaces usually do not have concrete floor slabs. A plastic membrane can be rolled out (as shown in **Figure 6-2**) and suction can be applied beneath the membrane to depressurize the soil. The pressure field can be extended by creating a grid of perforated pipe or other drainage material under the membrane. No diagnostic procedures are needed to evaluate a building's suitability for this mitigation technique; proper fan selection and quality control during installation are the keys to success. Use of the crawlspace area for storage will be limited. To avoid puncturing or other damage, walking on the membrane should be restricted to emergency access to utility lines, unless it is both underlain and covered with sand.

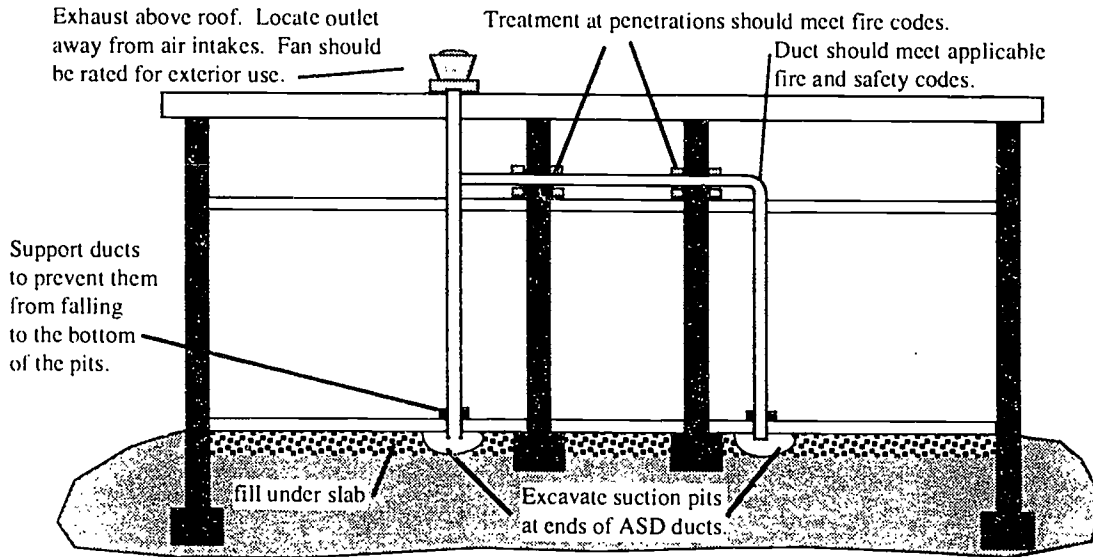

**Figure 6-1: ASD with Multiple Suction Points**

A single fan develops a pressure field strong enough to mitigate radon in both of these classrooms. A second suction point is needed because the footings under the corridor walls are obstacles to pressure field development.

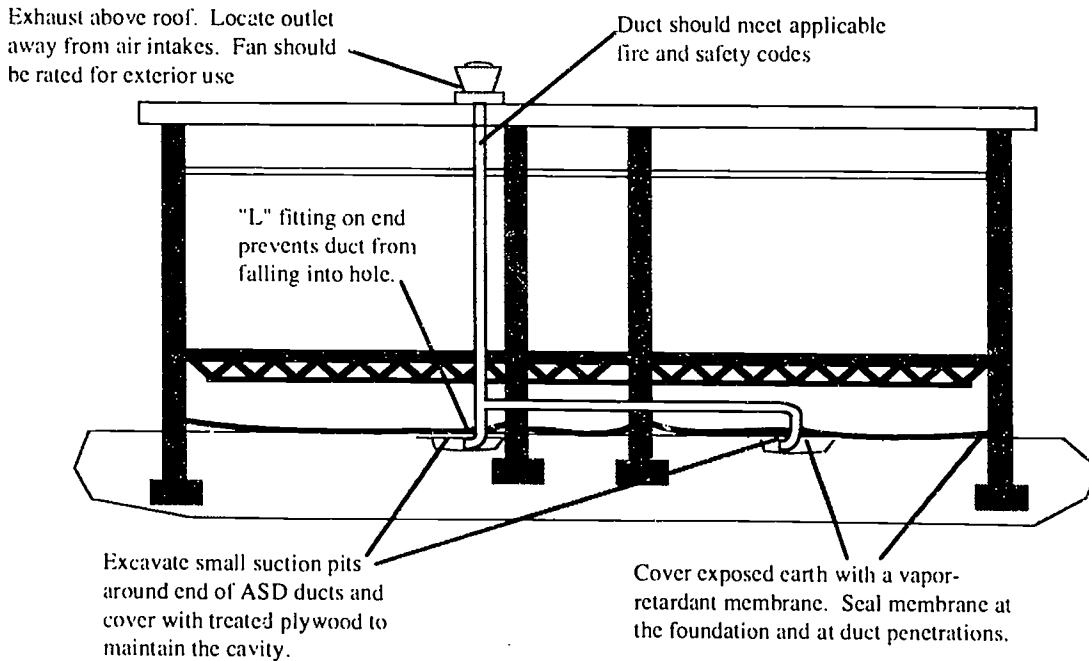

**Figure 6-2: ASD Beneath a Membrane**

Areas of exposed earth must be covered with a membrane so a negative pressure field can develop.

### *Other applications of active soil depressurization*

Sometimes it is possible to control radon levels by withdrawing air from a crawlspace, utility tunnel, or subslab ventilation duct, rather than creating suction under a slab or membrane. These alternatives to ASD require careful study. For example, pipes routed through utility tunnels may be covered with asbestos insulation that could be disturbed by the operation of the mitigation fan.

#### **b. Pressurizing the occupied space**

Pressurization systems use fans to blow conditioned (filtered, then heated or cooled) outdoor air into the building, so that the indoor air pressure is higher than the air pressure in the soil. A building can be thought of as a large box with a number of air leaks between the inside and the outside. The larger the total leakage area, the more outdoor air will be needed to pressurize the building. Mitigation using pressurization may involve tightening the building shell to reduce the leakage area. NOTE: Providing outdoor air to meet current ventilation standards does not necessarily mean that a space will be pressurized. Pressurization occurs when the quantity of air that is mechanically supplied to a space is greater than the quantity of air that is mechanically removed.

The following diagnostic procedures are used to evaluate the potential for pressurization:

- review of architectural and mechanical plans and construction specifications
- inspection of building structure
- *fan door test* (see page 6-26)

A *fan door test* is conducted by placing a calibrated fan in a door opening and recording the indoor-outdoor air pressure differences created when the fan operates at different speeds (i.e., different air flows). The pressure differences and air flows generated during the test are used to calculate the leakage area of the building.

### c. Dilution

Increasing the amount of outdoor air entering the building reduces radon concentrations by dilution. This strategy can be accomplished either by increasing the exhaust rate or by blowing additional outdoor air into the building. If the change in outdoor air flows could occur without affecting pressure differentials, the effect on indoor radon concentrations could be predicted simply by applying this equation:

$$\text{Final radon level} = \text{Pre-mitigation radon level} \times \frac{\text{Initial outdoor air flow}}{\text{Final outdoor air flow}}$$

For example, doubling the outdoor air ventilation rate would cut radon concentrations in half, tripling the outdoor air ventilation rate would lower radon to 1/3 of the pre-mitigation level, and so on. The dilution equation should be applied to air flow quantities that are measured with the outdoor air damper(s) at the minimum "occupied" setting. In many cases, the same weather conditions that cause outdoor air dampers to close to the minimum setting also cause maximum radon entry (e.g., cold outdoor temperatures).

Changes in outdoor air flows often do change air pressure relationships, with results that may either support or hinder your radon control efforts. Blowing in additional outdoor ventilation air is the preferred way to lower radon concentrations by dilution, because it tends to pressurize the building (or at least reduce negative pressures). Increasing the exhaust rate is a less effective approach to dilution, because it tends to depressurize the building and may actually increase radon entry.

The following diagnostic procedures are used to evaluate the potential for dilution:

- review of architectural and mechanical plans and construction specifications
- inspection of building mechanical systems
- calculation or direct measurement of outdoor air ventilation rates
  - direct measurement of flow rates
  - carbon dioxide measurements
  - calculation of outdoor air ventilation rates using temperature measurements (known as "thermal mass balance")

### 6.3 Elements of the Detailed Investigation

Figure 6-3 summarizes the relationship between the three mitigation strategies and the elements of the detailed building investigation. The detailed investigation builds on what was learned during the initial investigation, but may also involve a number of diagnostic tests, shown in *italics* in Figure 6-3. These tests collect information that is either useful or necessary in selecting and designing a mitigation system.

Figure 6-3: Elements of the Detailed Investigation

	ASD	Pressurization	Dilution
<b>FOUNDATION INVESTIGATION</b>			
Review foundation plans/specs	X		
Visual inspection	X		
<i>Subslab radon test</i>	X		
<i>Subslab vacuum test</i>	X		
<b>BUILDING SHELL INVESTIGATION</b>			
Review building plans/specs		X	
Visual inspection		X	
<i>Fan pressurization test</i>		X	
<b>VENTILATION INVESTIGATION</b>			
Review HVAC plans/specs	X	X	X
- ventilation control strategy	X	X	X
- air pressure relationships	X	X	X
- equipment capacity		X	X
Visual inspection	X	X	X
<i>Ventilation evaluation</i>		X	X
<i>Pressure differentials</i>	X	X	

As suggested in Section 3, it is helpful to take notes on a *working floorplan*, a small floorplan of the building. Recording information on a floorplan will help you to understand the spatial relationships involved in radon distribution, air flow patterns, and the use of ventilation equipment in your building.



### DETAILED INVESTIGATION

1. Review the radon test results
2. Review the plans, construction specifications and other documentation
  - a. Identify factors that affect active soil depressurization
  - b. Identify factors that affect pressurization
  - d. Identify factors that affect dilution
3. Conduct a building inspection and diagnostic testing
  - a. Foundation inspection and diagnostic testing
  - b. Building shell inspection and diagnostic testing
  - c. Ventilation inspection and diagnostic testing

#### 1. Review the radon test results

Review all radon test results for the areas of interest and consider whether there seem to be any patterns in the distribution of radon. If radon concentrations are relatively similar within an area that has a common air distribution system, the air distribution system might be the radon source. Scattered locations with high radon concentrations may be locations of entry points. **Sample Working Floorplan 7** shows the radon test history for the example school shown in **Sample Working Floorplans 1 through 6**.

### Sample Working Floorplan 7

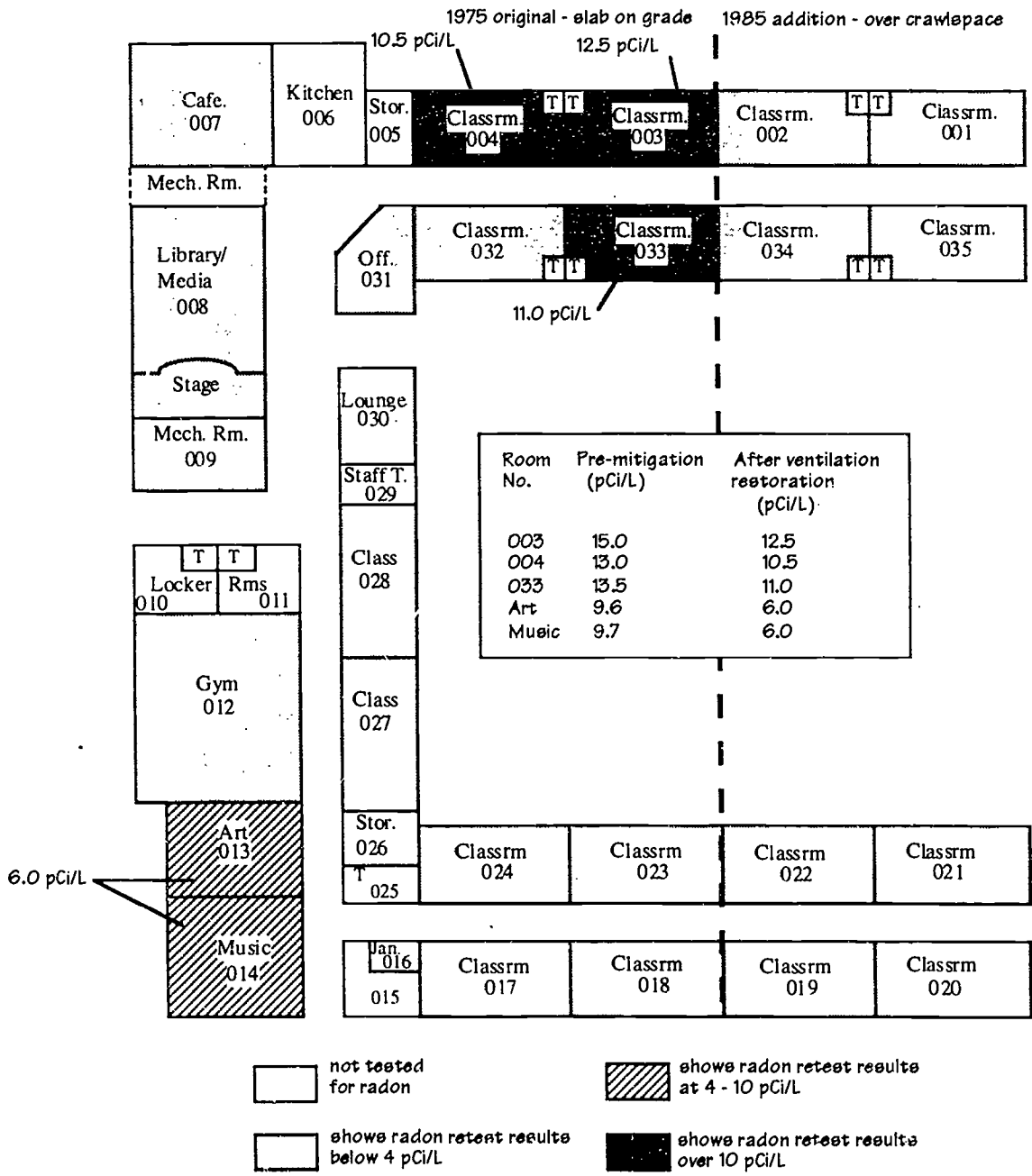

This floorplan shows the radon test history for the example school shown in Sample Working Floorplans 1 through 6. Note that radon test results in the Art and Music areas are very similar. Because these rooms share a common air handling unit (AHU-2), investigators should consider the possibility that the air distribution system is affecting radon distribution.

**2. Review the plans, construction specifications, and other documentation**

The Detailed Investigation team should make use of the information during the Initial Investigation, such as the inventory of HVAC equipment and the working floorplans (and other records) showing HVAC zones, areas that operate under negative pressure by design, design outdoor air ventilation rates, and observations of the ventilation system and potential radon entry points. (Records of ventilation system restoration work and sealing work should also be included, along with the results of any radon retesting.) If no Initial Investigation was conducted, review pages 3-14 through 3-38 and collect this data during the Detailed Investigation.

Obtain and examine available architectural and mechanical plans, specifications, and other construction documents for all rooms with elevated radon concentrations. Consider the original building and any addition as if each were a separate building.

**a. Identify factors that affect active soil depressurization**

To be successful, an active soil depressurization (ASD) system must establish and maintain a negative pressure field in the soil beneath the building. Throughout the Detailed Investigation, attempt to identify features that would promote or impede the installation and operation of an ASD system. **Figure 6-4** and the accompanying discussion expand on the flowchart shown in **Figure 3-1** (page 3-3) and present a process for evaluating ASD-based mitigation.

Detailed Investigation

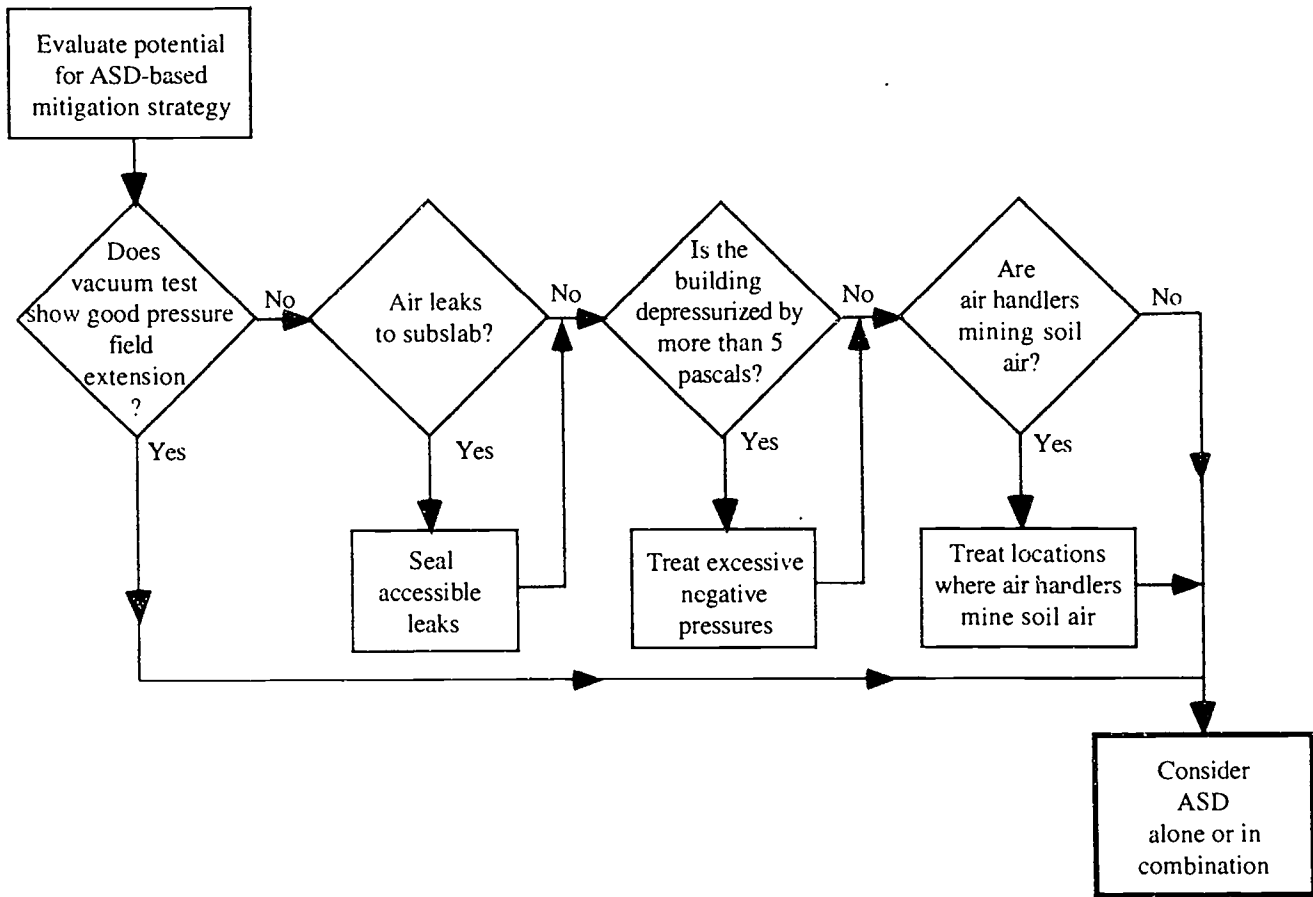
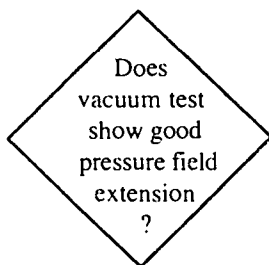

Figure 6-4: Flowchart for Evaluating ASD-based Mitigation



An experienced radon mitigation contractor (EPA-listed or state-certified) will be able to conduct the vacuum test and interpret the results. Good pressure field extension under the slab indicates that ASD is likely to be successful. If it is too difficult to withdraw air from beneath the slab, a large number of suction points may be needed, increasing the cost of ASD. If it is too easy to withdraw air from beneath the slab, foundation leaks may be present that could defeat pressure field extension.

The vacuum test cannot be conducted in areas without slabs (e.g., dirt-floored crawlspaces). However, where a membrane can be installed on the floor, *sub-membrane depressurization* is a mitigation technique that operates on the same principle as ASD. (See page 6-4 and Figure 6-2 on page 6-5.)

Air leaks  
to subslab?

If tests with chemical smoke or measurements of pressure differences indicate that soil gas is entering through cracks or holes in the slab, *sealing* (eliminating easily-accessible radon pathways) may be important to the success of your radon mitigation efforts. This is particularly true if ASD is being used and vacuum test results indicate poor pressure field extension.

Is the  
building  
depressurized by  
more than 5  
pascals?

If pressure differential measurements indicate that the building appears to operate at 5 or more *pascals* (0.02" water column [W.C.]) negative relative to the outdoors and the vacuum test did not show good pressure field extension, negative pressures in the building might interfere with the success of an ASD system. Consider adjusting the HVAC system to increase the outdoor air flow into the building, reducing the amount of powered exhaust (but maintaining the exhaust quantities necessary to remove airborne contaminants), or adding air handling equipment to supply more conditioned outdoor air. Ideally, the total volume of mechanically-supplied outdoor air should equal or exceed the total powered exhaust.

A *pascal* is a unit of air pressure equal to 0.004" water column.

Are  
air handlers  
mining soil  
air?

In some buildings, the ventilation system functions to unintentionally draw soil air indoors. Look for the following:

- return ductwork below the slab
- return ductwork in a crawlspace
- a mechanical room that functions as the return air plenum for an air handler
- a masonry wall (i.e., hollow block cores) that ends in a return air plenum
- a return plenum built tight against the slab, so that openings such as pipe penetrations, cracks in the slab, and/or the floor-wall crack are under negative pressure

If air handlers are mining soil air, it is important to seal the pathway that allows soil air to enter the building. Sub-slab ductwork is very difficult to seal, and may have to be abandoned and re-routed above the slab.

Architectural and mechanical plans reveal pathways for air movement that may affect radon distribution within the building. Some pathways are obvious, such as air distribution ducts, corridors, and stairways. Less obvious pathways include plumbing chases, interior subslab walls and footings, crawlspaces and utility tunnels. You may need to block pathways or modify pressure relationships within them in order to correct the radon problem in some areas. Vertical pathways are of particular interest if there is elevated radon in the upper levels of a multi-story building.

Review the architectural and mechanical plans and specifications (if available) for a description of the *substructure* construction in each area, whether there is fill beneath the slab, and a description of the type of fill. The number and type of fans and the number of suction points required for a successful ASD system will depend on: 1) the number and location of subslab barriers (such as subslab walls on footings), 2) the ease of air movement through the material under the slab, and 3) cracks and holes (in the slab and foundation walls) that connect the subslab soil to the indoor and outdoor air. Ideal conditions for ASD would include: low-permeability native soil covered by a layer of clean, coarse, permeable fill or drainage material under the slab, no holes or significant cracks in the foundation, and no subslab barriers.

#### Foundation type

The type of foundation affects the selection and design of a mitigation method. Most schools are slab on grade construction, while fewer have crawlspaces and basements. An ASD system can only develop a negative pressure field in the soil if there is a barrier between the soil and the building interior. Crawlspaces without slabs would require installation of a slab or membrane in order to use ASD.

The same building may combine two or more foundation types. Transitions between foundation types (or between the original building and later additions) are likely to have obstacles to pressure field extension below the slab, such as footings. If there are many obstacles below the slab, an ASD system design could require a large number of suction points, adding to the cost and difficulty of installation.

#### Subslab material

Construction plans and specifications describe the materials that should be under the building slab. Dry fine sand, silt, or clay are tight soils that inhibit soil gas movement. Active soil depressurization will be more effective and less expensive to install if there is a coarse aggregate (such as coarse, crushed stone or coarse, clean gravel) under the slab.

If the foundation is relatively airtight and there is porous, crushed aggregate under the slab, one small fan with a small number of suction points may be all that

is needed. In one research school, a negative pressure field was extended through 3/4 inch diameter aggregate under 50,000 square feet of slab with a single suction point. At the other extreme, a building with compacted sand under the slab and many subslab walls required 14 suction points for the same floor area.

#### Barriers and/or large air leaks

Foundation plans show slab joints, interior subslab walls on footings, and transitions between different foundation types that can obstruct the development of an ASD pressure field below the slab.

Utility tunnels beneath the slab can be pathways for radon movement into buildings. They are usually obstacles to a standard ASD system, but it is sometimes possible to depressurize utility tunnels as a variation on ASD. **WARNING: *Utility tunnels sometimes contain asbestos, even after it has been removed from other locations. The district's asbestos officer should be consulted before creating air movement in tunnels that contain asbestos-containing material.***

#### Ventilation systems that "mine" radon

Sometimes a trench below the slab forms the return air duct for an air handling system. This is not simply a radon entry point; it is the equivalent of *mining* soil gas for distribution to the building and must be contended with in any mitigation plan.

If the building has ductwork below the slab or in a crawlspace, note the location(s) on your working floorplan. Supply or return air ducts located in crawlspaces or under the slab can mine radon and distribute it in a building. Subslab supply ducts are under positive pressure when the air handler is running, but leaks in the ducts may draw in soil gas when fans are off. Return ducts in crawlspaces or under the slab are under negative pressure and will draw in soil gas through leaks, whether or not the return fan is operating. Wherever the return duct leaks, it will lower air pressure under the slab. This competes with the ASD system, which is trying to accomplish the same thing. Appropriate diagnostics can determine what effect subslab return ducts will have on an ASD system. Abandoned ductwork can sometimes be used as part of an ASD system.

Ventilation systems can also mine soil gas in ways that are more difficult to discover than subslab ductwork. Either of the following features might be found as a detail on the construction plans, although they are more likely to be discovered during the walkthrough inspection:

- (1) An air handler may be installed so the return air side depressurizes a mechanical room (or a smaller area, such as portions of the floor slab and wall that are within

## Detailed Investigation

the return air cabinet). If there is an opening to the ground within the return air plenum, the unit will draw soil gas into the building.

- (2) In an area with an above-ceiling return air plenum, a masonry wall that penetrates the floor slab has open block tops. The return air plenum operates under negative pressure, pulling soil gas up through the block cores and back to the air handling unit, which blows soil gas into the building.

### Features that should be avoided during the vacuum test

As you review the building plans, look for potential hazards that may be encountered while drilling holes in the slab, such as radiant hydronic heating pipes *in* the slab or electrical conduit or water pipes *under* the slab. Note the locations of these features on your working floorplan, and avoid them when you drill holes for the vacuum test.



### Sample Working Floorplan 8

1975 original - slab on grade | 1985 addition - over crawlspace

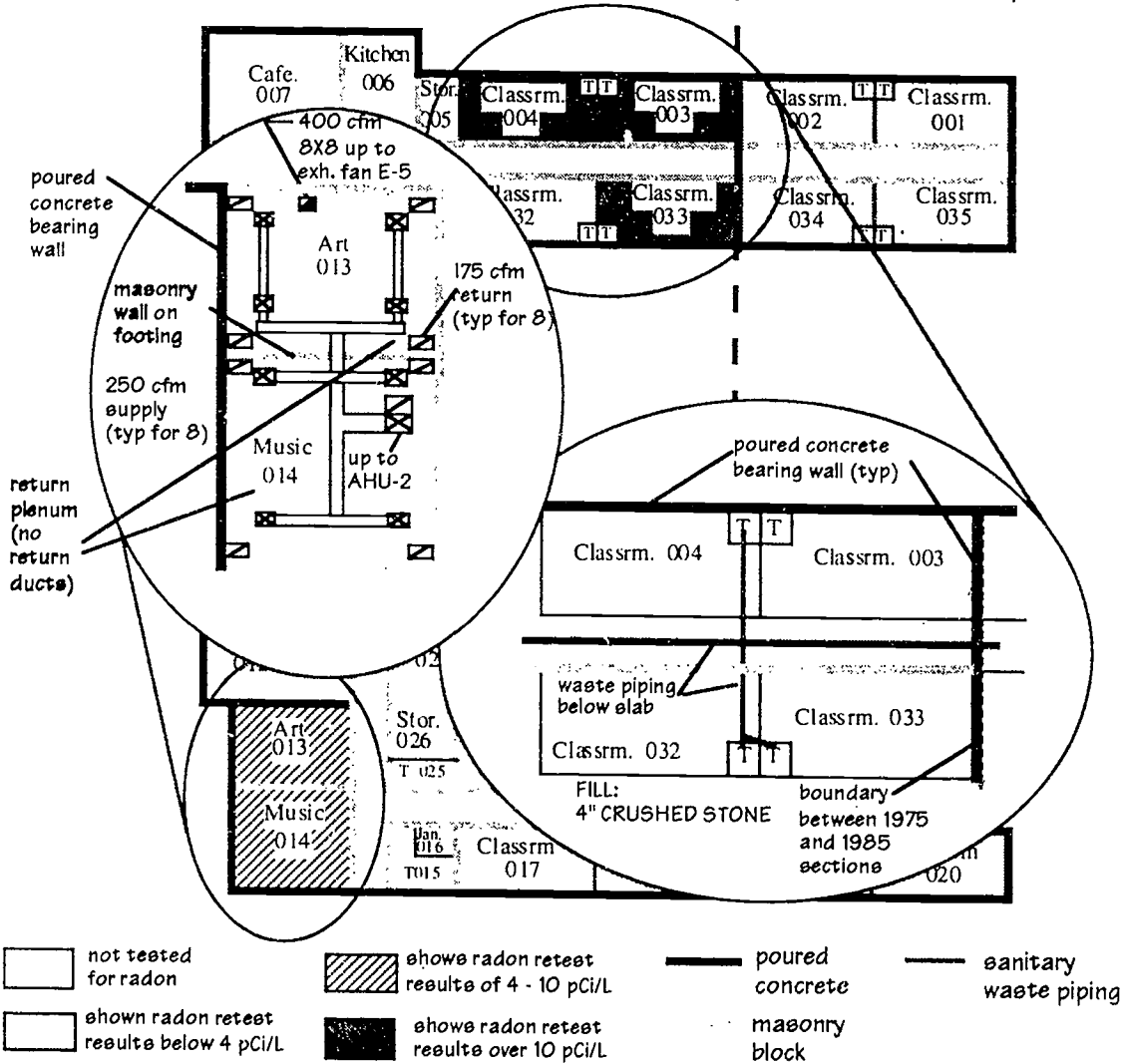

This floorplan shows part of the mechanical floorplan for the Art and Music area and the foundation plan for the classroom area. Note that:

1. The substructure of the classroom area is slab on grade over crushed stone. This is likely to promote development of a negative pressure field -- a good sign for ASD. Investigators should avoid the waste piping when drilling for the subslab vacuum test.
2. The area above the ceiling of the Art and Music areas is a return plenum that extends across a masonry wall. Negative pressure in the return air plenum could be pulling radon up through the block cores.

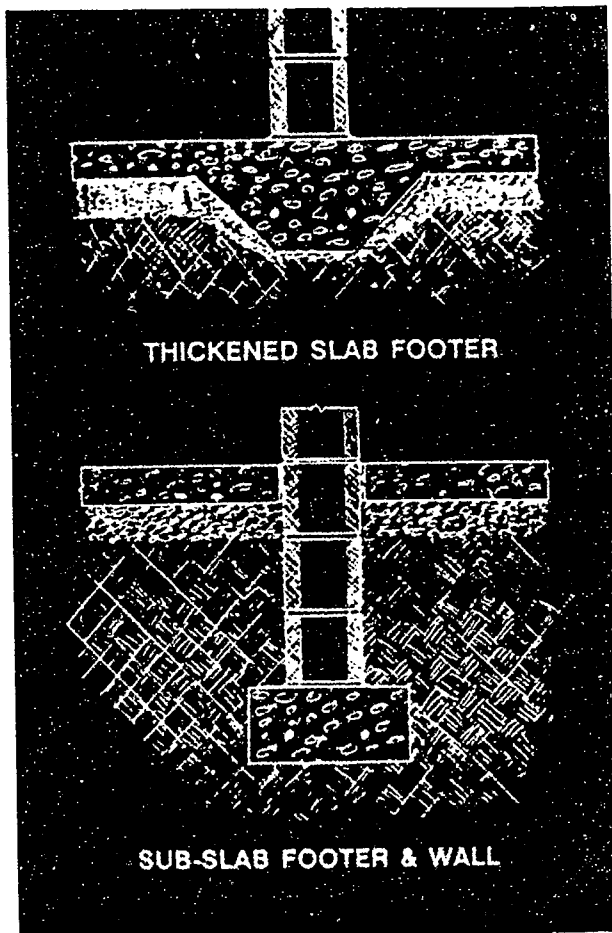

Check the architectural plans for information about the footing design used in your building. Interior footings affect ASD system design because they are obstacles to pressure field extension. The design shown to the left, with a block wall extending below the slab, poses additional problems because radon can enter the building through the block cores. If there is a return plenum at the top of the wall, negative pressure in the plenum is likely to draw radon up through the block cores. Once in the plenum, the radon mixes with the return airstream and is distributed back into the occupied space.

**b. Identify factors that affect pressurization**

Four basic types of outdoor air ventilation systems are typically found in schools. The type of ventilation system found in a building affects its suitability for pressurization. If different areas of the same building have different ventilation systems, some areas may run negative by design, while other areas may be designed to operate at neutral or positive pressure.

Read the following discussion of ventilation system designs and compare them to your *mechanical plans and specifications*. If your existing ventilation system

would not support pressurization and you are not planning renovations in the near future, pressurization is probably not a practical mitigation option.

- ***Buildings with no mechanical ventilation:*** Buildings that rely entirely on natural ventilation, with no supply or exhaust fans, tend to run negative relative to the subslab soil. For radon mitigation based on pressurization, a mechanical ventilation system would have to be installed to supply and distribute conditioned air. The amount of outdoor air ventilation required would depend on the tightness of the building, but should be sufficient to provide adequate conditioned outdoor air (preferably 15 cfm/person, but at least 10 cfm/person) without opening windows. Pressurization systems can easily be defeated by open windows or propped-open exterior doors.
- ***Buildings with fan powered outdoor ventilation air but no exhaust:*** If a building has fan powered outdoor ventilation air with no mechanical exhaust, the HVAC system was probably designed to pressurize the building. This is an ideal starting point for mitigation by pressurization. You will need to know the amount of outdoor air being blown into the building when it is in the occupied mode, the capacity of heating and cooling coils, and the tightness of the building shell. If the building is too leaky, tightening it will help to control radon and save fuel costs by reducing the infiltration of outdoor air during unoccupied periods, when the HVAC system is not pressurizing the building.
- ***Buildings with exhaust but no fan powered outdoor air ventilation:*** If a building has exhaust fans (or passive roof vents) but no mechanically-supplied outdoor air ventilation, the HVAC system tends to depressurize the building. To mitigate radon using pressurization, a greater amount of outdoor air must be blown into the building than is being exhausted. In this situation, a ventilation system that supplies conditioned outdoor air to the building must be designed and installed, because there is no existing equipment available to use. The amount of outdoor air needed depends on the amount of air exhausted and the tightness of the building.
- ***Buildings with exhaust and outdoor air ventilation:*** Some buildings have both outdoor air intake fans and exhaust fans. If the volume of powered exhaust is greater than the volume of outdoor air introduced by the mechanical system, then the building is depressurized by the difference in air flows. (See **Section 3.4.1.b.**, page 3-19.) It may be possible to use the existing equipment to pressurize the building, either by reducing exhaust or by increasing outdoor air flow and tightening the building.

### **c. Identify factors that affect dilution**

If you conducted an Initial Investigation, you may already have all of the information described below. If not, review your plans, specifications, and the most recent test and balance report (if available), and see pages 3-16 to 3-26 for guidance.

The goal of the review is to achieve the following:

- create an inventory of air handling equipment within the building
  - list all supply, return and exhaust fans and their locations
  - record any air flows shown on the equipment schedule (or, if available, from more recent measurements by test and balance or controls contractors). For supply fans with outdoor air intakes, note minimum and maximum outdoor cfm as well as total supply air cfm.
- review control setpoints and logic for all air handling equipment
  - for each air handling unit, note the outdoor air damper control sequences, including mixed air setting and freezestat setting
  - review occupied and unoccupied cycles for damper settings and fan operation
  - note exhaust fan controls (which fans are controlled by time clocks, which by local switching, and which -- if any -- run continuously)
- review the HVAC system design and mark the working floorplan
  - show any areas that rely on operable windows for outdoor air ventilation
  - show the areas served by each item of air handling equipment

## **2. Conduct a building inspection and diagnostic testing**

A walkthrough building inspection by school personnel, the radon contractor, and a mechanical engineer is an important part of the detailed investigation. The inspection can include evaluation of the subslab area, building shell, and/or HVAC system, depending on the type(s) of mitigation under consideration.

The walkthrough provides an opportunity for the members of the team to share views on the important features of the building. It is critical for a school person who

is familiar with the building and the HVAC equipment to be part of this effort. Mitigation based on pressurization or dilution can only be successful if facility staff, including staff members who may be responsible for energy conservation programs, understand how the mitigation system functions.

Before beginning the walkthrough inspection, review pages 3-27 through 3-38 for a description of the tools you will require and the types of information to collect. You will also need a drill (and bit) to open a hole in the slab, preferably a 1 1/4" masonry core drill. A 1 1/4" drill bit is the right size to drill holes for the vacuum suction test.

Building investigators may use any or all of the following tests as they evaluate mitigation alternatives:

- subslab radon test
- vacuum test of pressure field extension
- pressure differential measurements
- ventilation evaluation
- fan door test

#### **a. Foundation inspection and diagnostic testing**

The foundation inspection should follow (and build upon) information collected during the review of construction documents. It consists of an examination of the subslab aggregate and radon entry points. In addition, several diagnostic tests -- subslab radon test, the vacuum test of pressure field extension, and pressure differential measurements -- are generally conducted during the foundation investigation. While inspecting the substructure, consider locations where holes can be drilled through the slab, used for the vacuum test, and then unobtrusively repaired.

Use heatless chemical smoke to check for air movement at suspected radon entry points, and note whether the smoke is entering or leaving the building. Potential entry points are listed on page 3-35, and should have been recorded on your working floorplan if you conducted an Initial Investigation.

If there is no way to observe the subslab material through existing openings, drill a hole (preferably in an inconspicuous location such as a supply closet) to see whether your building plans and specifications describe the actual conditions.

**Warnings:**

1. *Holes drilled through floor tiles that contain asbestos must be made by appropriate personnel, taking required precautions.*
2. *When you are considering where to put the hole, do not drill through the slab over pipes, electrical conduit, ducts, or footings.*

Drill a hole through the slab at a location that avoids hitting any footings or thickened slab areas as shown on the plans. Remove the concrete dust and debris from the hole and examine the subslab material. If possible, take a sample so that you can handle it. Refill the hole with polyurethane caulk when you have finished examining the subslab aggregate and conducting diagnostic testing.

Subslab treatments reflect the requirements of the specific site and the materials that are locally available. In different regions of the country, you might find coarse gravel or crushed stone, compacted sand, native earth, or other materials beneath the slab. Note your observations. Is the material coarse or fine? Wet or dry? Crushed rock or rounded naturally-occurring stone? Native or imported fill? Is it consistent with the information in the plans and specifications? Record your answers on the working floorplan. You should examine sub-slab material in all locations where the foundation was built at different times (such as additions).

**Subslab radon test**

Soil gas radon measurements may be taken beneath the slab in slab on grade or basement buildings or wings. This has some value in understanding radon sources and locating "hot spots" that could affect the choice of locations for ASD suction points. EPA has found typical subslab radon levels that varied from 200 pCi/L to 8,000 pCi/L, with a mean of 1,500 pCi/L. These radon levels would be incredibly high if they were measured in room air, but are normal subslab radon concentrations, even for buildings with radon levels near 4.0 pCi/L.

Some radon measurement equipment can be used to take short term radon measurements at suspected entry points. This technique of radon "sniffing" provides information about the relative importance of different entry points.

## Vacuum test of pressure field extension

The material beneath the slab is often sand fill or sand and gravel that was native to the site. In many buildings, a layer of crushed aggregate is placed over the native material. This feature provides a plenum-like space that makes it easy for an ASD system to depressurize below the slab and create a negative pressure field.

The *vacuum test* or *vacuum test of pressure field extension* involves drilling several holes through the slab, putting suction on one hole, and observing the effect on air movement at the other holes. A shop vacuum cleaner with a variable speed control is used to assess the air flow resistance of the subslab material and the distance that a low pressure field can be extended from the suction point. This information can be used to determine the number and location of suction points and to evaluate the fan performance characteristics that are important if ASD is the chosen mitigation strategy.

Generally, the less air that can be drawn from under the slab, the more difficult it is to extend a low pressure field beneath the slab. Low air flows (10 - 20 cfm or less) usually indicate that more suction points are needed for a successful soil depressurization system. However, it is also possible to find low air flows with excellent pressure field extension, when: 1) a layer of coarse subslab aggregate overlies impermeable soils, 2) the slab is tightly sealed, 3) the exterior foundation is tight, and 4) there are no air bypasses (such as uncapped masonry walls) extending through the slab.

At the other end of the spectrum, a vacuum test that finds little or no resistance to air movement indicates one or more of the following possibilities: 1) there is a leak in the slab near the test location, 2) the foundation and subslab soil are extremely permeable, 3) there is an unknown air pathway. Any of those conditions are also obstacles to pressure field development. In the second case, where there is little or no resistance to air flow, it is critically important to seal holes in the slab to support the operation of the ASD system.

Detailed Investigation

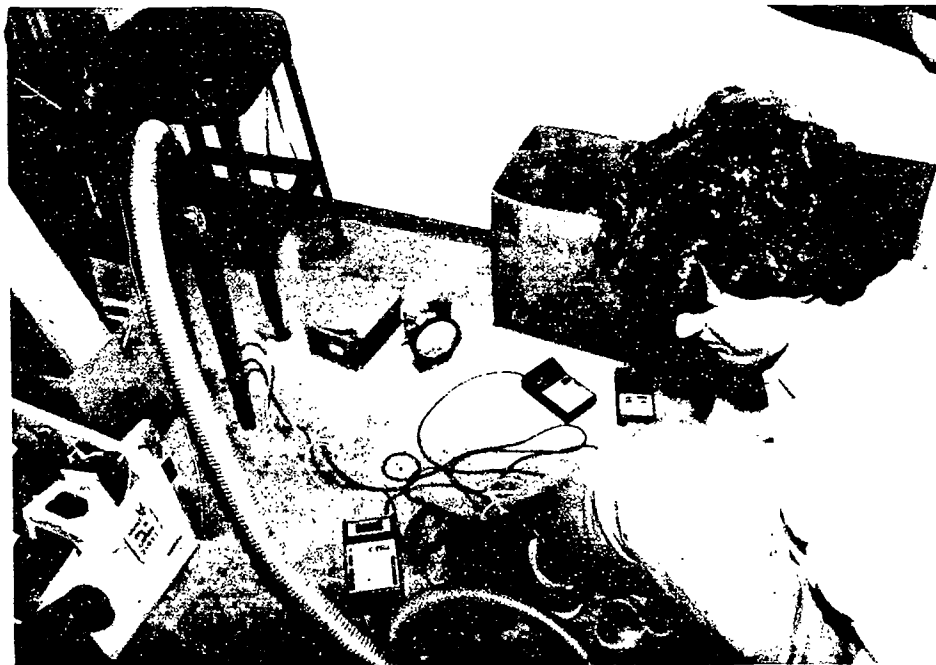

This photograph shows a building investigator conducting the vacuum test. The suction hole was drilled away from the wall to avoid running into a subslab footing.

Vacuum tests should be performed in each wing of the building (i.e., in the original building and each addition), usually in the rooms with the most elevated radon levels. There is a risk that a limited sample will find areas that are not representative of the school in general, or even of the room in which the tests are being made. For example, soil conditions near perimeter footings may be different from soil conditions under the middle of the slab. NOTE: Fill the drilled holes when the vacuum test is completed. Polyurethane caulk is typically used to fill the holes.



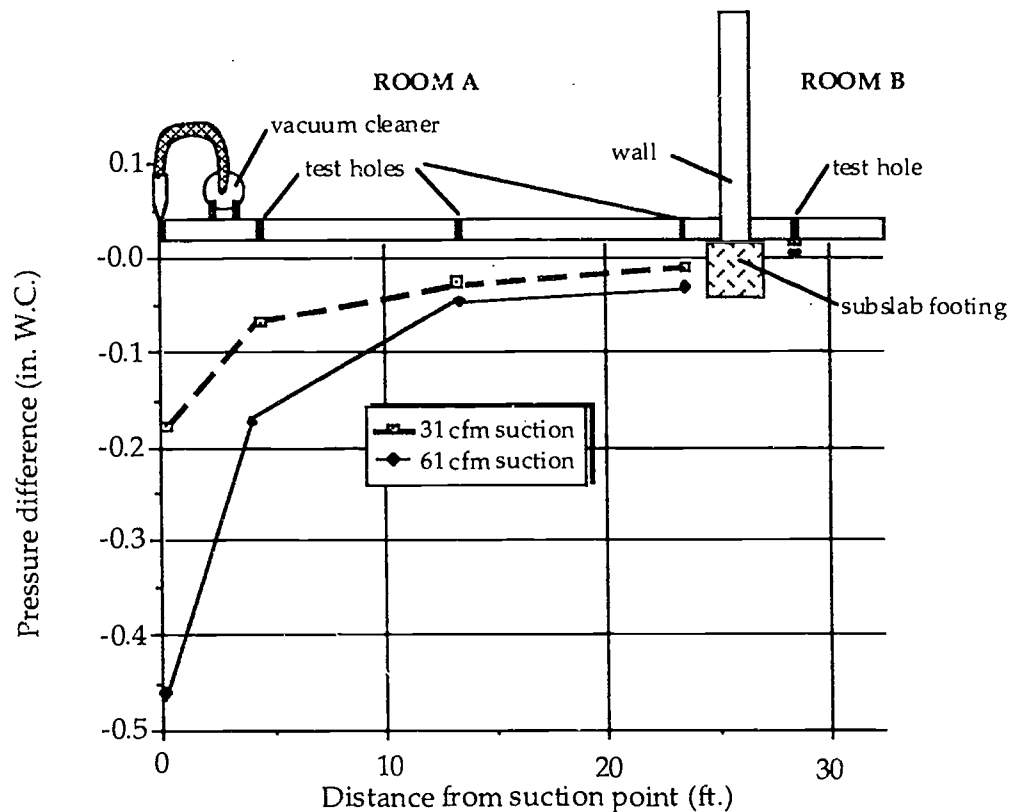

**Figure 6-5: Vacuum Test of Pressure Field Extension**

The upper part of this figure represents a cross section of a floor slab during a subslab vacuum test, showing the locations of the suction point, four test holes, and a subslab footing. The graph shows that the negative pressure field under the slab is strongest near the suction point. The pressure differential drops off with increasing distance from the suction point. Lines have been drawn to show the strength of the pressure field as a curve. These lines stop at the test hole just to the left of the subslab footing, because the footing interrupts pressure field extension. At the far right test hole, the pressure under the slab is slightly higher than the pressure in the room, an indication that radon may be entering the building. Although it might be possible to correct a radon problem in Room A with a single ASD suction point, a second suction point would be needed to treat Room B.

Figure 6-5 illustrates the results of a typical vacuum test. **Sample Working Floorplan 9** on page 6-36 shows the results of diagnostic radon measurements and a vacuum test of pressure field extension for the sample building illustrated in earlier floorplans.

## **b. Building shell inspection and diagnostic testing**

The more openings there are in a building, the more air must be supplied to maintain pressurization. A walkthrough inspection can help to determine whether building occupants are using operable windows and exterior doors for outdoor air ventilation and temperature control. Devices such as automatic door closers can serve as a reminder that doors should be kept closed. However, pressurization will not work if the doors and windows are used to maintain comfort conditions.

Chemical smoke -- or, often, a simple visual inspection -- can identify leaks (e.g., at window sashes) that would need to be sealed to support a pressurization system. These leaks will be most obvious during a fan door test.

### **Fan door test**

The leakage area through the building shell determines how much outdoor air is needed to slightly pressurize the building. The leakage area can be estimated using a fan door test. Fan door tests are made by depressurizing or pressurizing the building with several different air flows. One or more calibrated fan doors can be used to provide the needed air flows. The difference in air pressure between the inside and outside of the building is measured for each different air flow. The data collected should form a curve that clearly shows the amount of air needed to pressurize the building.



This photograph shows a fan door test. The fan and its adjustable frame completely fill the exterior door opening shown in the background. Doors and windows throughout the building are closed during the test. Pressure gauges (shown in foreground) indicate air pressures in the building and outdoors at different fan speeds. Because the fan performance (cfm at different rotation rates and static pressures) is well-documented, the test results can be used to calculate the "tightness" of the building. In large buildings, two or more fan doors may be required for this test.

Figure 6-6 illustrates the results of fan door testing.

### Pressure differential measurements

Pressure relationships between the inside and outside of the building are one of the key variables to study during the detailed building investigation. Slight positive pressures (as low as +.001 inches water column) help to keep radon out of the building. Negative pressures cause increased radon entry. A sensitive differential pressure gauge (micromanometer) is used to measure indoor-outdoor pressure differentials at penetrations through the slab or through the crack in a closed door or window. Pressure differential measurements help investigators to assess the potential for ASD and pressurization.

## Detailed Investigation

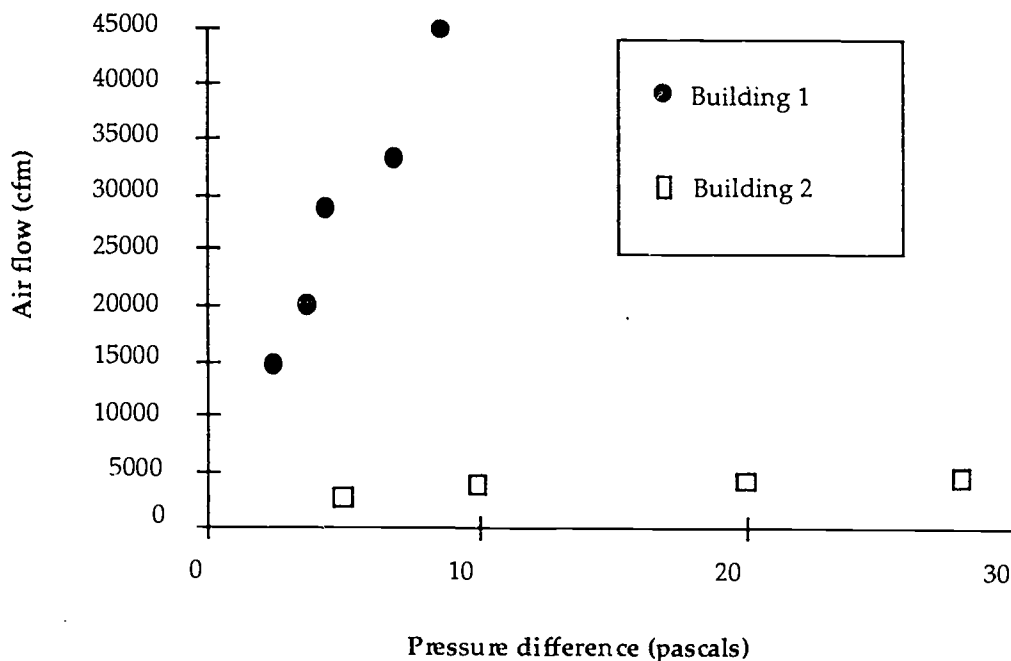

**Figure 6-6: Fan Door Test Results**

The fan door test results for these two buildings show that, assuming the same pressure difference, much more air would move into (or out of) Building 1 than Building 2. It is *not* possible to determine from these results alone whether Building 1 is leakier than Building 2, because the volume of the two buildings must be taken into account.

Open interior (room) doors can interfere with intended pressure differentials. They may also indicate occupant discomfort due to excessive temperatures or stagnant air. Pressurization can only be a successful mitigation technique if it is possible to maintain the desired pressure relationships by minimizing uncontrolled openings.

Measuring the indoor-subslab pressure differential through the test hole that was drilled for the vacuum test can reveal whether the building is running strongly negative. The negative pressure exerted by the building's exhaust fans can compete with the suction applied to the subslab material. A larger ASD fan can be selected to compensate for this effect. In some cases, however, a soil depressurization system will only work if exhaust fan suction is reduced, either by reducing the amount of air exhausted from the building or by supplying more outdoor air to the building. You may need to consider reducing negative pressures if the building is 5 or more pascals (0.02" W.C.) negative relative to the subslab.

Measurements taken through exterior walls are very sensitive to outdoor wind pressures. To assess the outdoor air pressure, it is always wise to make pressure difference measurements across walls on all orientations and average the results. If the mechanical equipment does not dramatically pressurize or depressurize the building, a windspeed greater than a few miles per hour can obscure the effect of the mechanical equipment. Postpone pressure difference measurements until calm conditions exist.

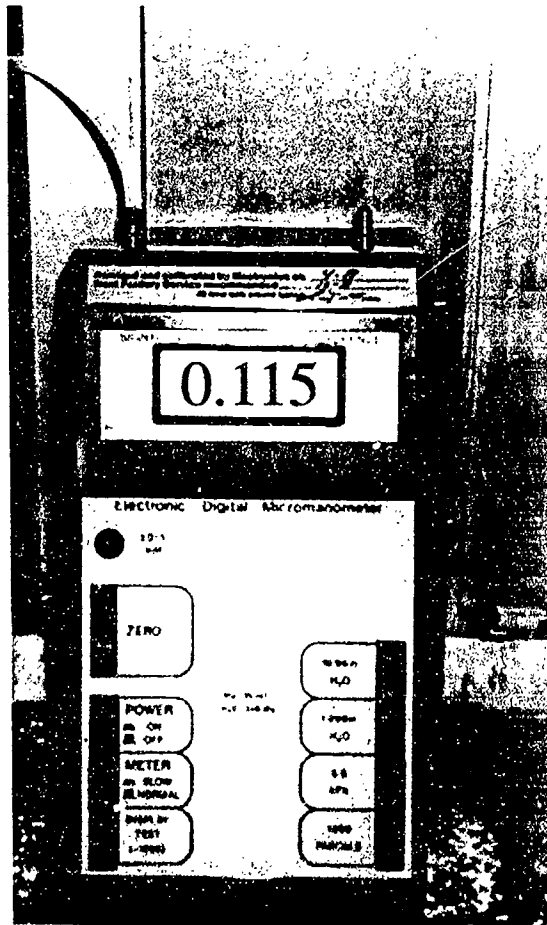

The micromanometer (differential pressure gauge) at left is being used to assess the indoor/outdoor pressure differential. The reading shows the building interior running 0.115 inches W.C. positive relative to outdoors.

### c. Ventilation inspection and diagnostic testing

During the initial investigation, available tools and expertise are used to identify ventilation system problems. This could mean anything from a simple visual inspection (e.g., Is the fan motor missing? Are the outdoor air intakes blocked?) to a detailed assessment of equipment condition, control sequencing, and air flows. During the Detailed Investigation, the team should finish collecting relevant information about the ventilation system condition and operation. For example, an HVAC engineer should inspect the condition of the ventilation system to identify needed repairs and confirm that equipment has enough capacity to condition additional outdoor ventilation air. The general condition of the HVAC system helps to indicate whether pressurization or dilution are practical approaches to mitigation, because both strategies require a long-term commitment to good maintenance. Key equipment items are:

- outdoor air intake - maximum air flow in full open position
- heating coils (and heating plant) - maximum outdoor air flow that can be heated under design conditions
- cooling coils (and cooling plant) - maximum outdoor air flow that can be cooled and dehumidified under design conditions
- supply fans - total powered supply cfm
- exhaust fans - total powered exhaust cfm

Building investigators should evaluate the ventilation control strategy, the method used to turn on and control the amount of outdoor air ventilation. Typical strategies for controlling outdoor air entry are:

- manually opened windows
- manually operated individual or master switches for outdoor air dampers
- time clock switches for outdoor air dampers
- computer controlled switches for outdoor air dampers

HVAC equipment must be observed to see whether it is actually operational, operates on schedule, and produces air flows that are close to design quantities. Simple observations such as checking the position of an outside air damper blade or the direction of air flow with chemical smoke can identify obvious malfunctions.

However, a more sophisticated ventilation evaluation is required to measure or estimate actual air flows.

It is important to know how far outdoor air intakes are opened under different operating conditions. Damper control strategies include:

- *fixed airflow* - outdoor air is open when fans are on, outdoor air is closed when fans are off
- *variable outdoor airflow* with a fixed minimum setting
  - outdoor air damper is open to a minimum setting when fans are on and the HVAC system is in the heating mode
  - outdoor damper modulates between minimum and maximum opening when fans are on and the outdoor air temperature is low enough to provide "free" cooling within the space
  - outdoor air damper is closed when fans are off
- *freeze protection* - outdoor air dampers close and equipment shuts down when outdoor temperatures fall below freezing (to protect coils)

Test and observe the operation of the outdoor air dampers. This may require manipulating the control system by resetting thermostats and/or discharge stats. In some cases, this is a simple process; in other cases an off-site computer operator may have to make the required changes.

NOTE: Return and outdoor air damper controls are often interlocked, with return dampers closing as outdoor air dampers open. Sometimes exhaust fans and outdoor air damper controls are interlocked so that the outdoor air damper opens (to provide make-up air) when the exhaust fan is on.

## Ventilation evaluation

To evaluate the adequacy of outdoor air ventilation, investigators must measure or estimate the flow of outdoor air into the building. This will also make it possible to evaluate dilution as a potential mitigation strategy, using the equation presented on page 6-7.

As previously mentioned, ASHRAE *Standard 62-1989* (now being adopted into many codes) recommends a minimum of 15 cubic feet per minute (cfm) outdoor air ventilation per person in classrooms.

One way to estimate outdoor air flow is to measure carbon dioxide concentrations. The building's human occupants are a source of carbon dioxide (CO<sub>2</sub>) and water vapor, which are given off when they exhale. People produce CO<sub>2</sub> at a predictable rate, depending on the activities they are engaged in. Elevated CO<sub>2</sub> concentrations may indicate that an area is not being supplied with adequate outdoor ventilation air.

6-31 111

BEST COPY AVAILABLE

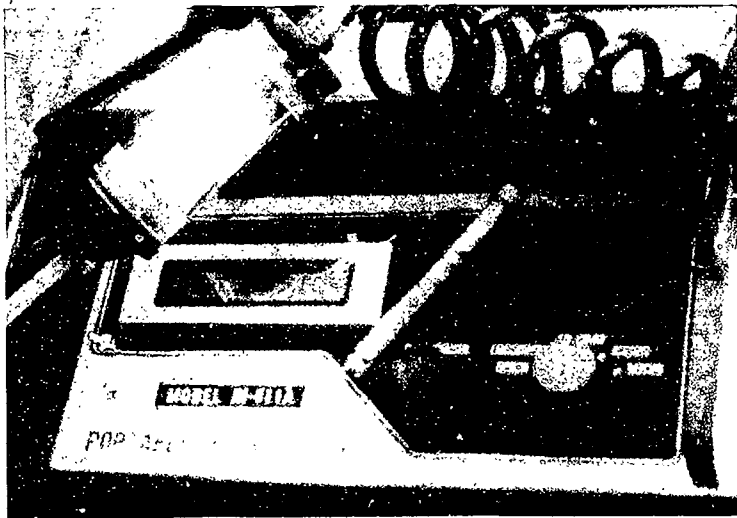

The photograph at left shows a carbon dioxide sensor. This is an "active" sampler (with an air pump). "Passive" sensors (without pumps) have a slower response time, but are generally less expensive.

The carbon dioxide concentration in an occupied classroom depends on the number of people in the classroom, the length of time they have been in the room, the outdoor air ventilation rate, and the outdoor CO<sub>2</sub> concentration. Carbon dioxide readings taken in classrooms either before lunchtime or during mid-afternoon (before school lets out) can be used to estimate the outdoor air ventilation rate on the day of the measurement. Levels of 1000 ppm or lower are expected if outdoor air ventilation rates meet the current ASHRAE standard of 15 cfm outside air per person. EPA researchers have found CO<sub>2</sub> levels in schools ranging from 500 ppm to 5,000 ppm. In general, the higher the CO<sub>2</sub> level for a given occupancy, the lower the outdoor air flow. **Figure 6-7** can be used to estimate the outdoor air ventilation rate for different CO<sub>2</sub> concentrations, assuming that CO<sub>2</sub> levels have come to *equilibrium* (stabilized). *NOTE: It can take many hours for carbon dioxide to reach equilibrium in buildings with low outdoor air flows. While CO<sub>2</sub> levels over 1000 ppm are a strong indicator of low outdoor air ventilation rates, areas with CO<sub>2</sub> concentrations below 1000 ppm can still have outdoor air ventilation problems.*



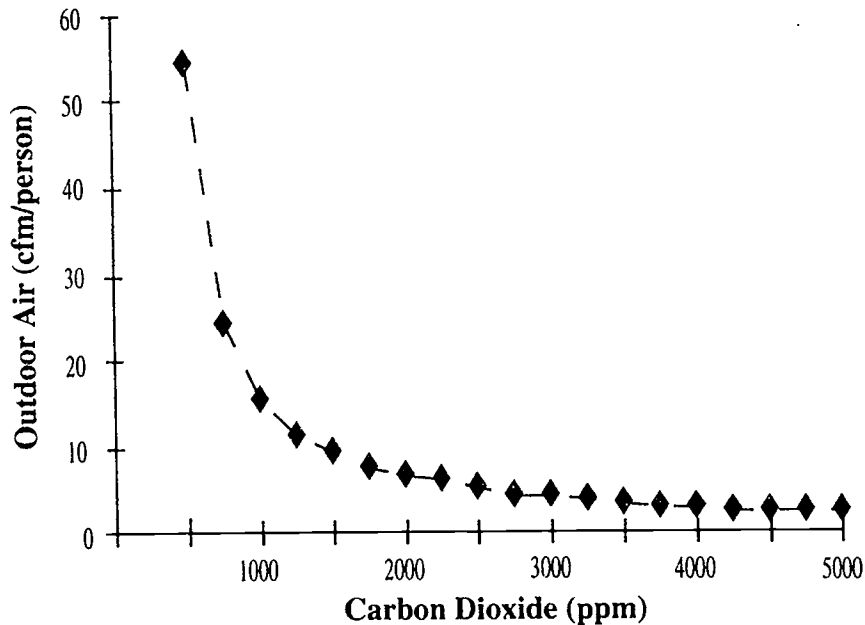

**Figure 6-7: Carbon Dioxide as an Indicator of Ventilation**

This figure shows carbon dioxide concentrations at different outdoor air ventilation rates. It is important to note that measured carbon dioxide concentrations represent the dynamic balance between carbon dioxide production (exhaled breath) and removal (dilution by outdoor air). The carbon dioxide concentration in a space does not reach equilibrium until the occupant population and the outdoor air ventilation rate have remained constant for 5 air changes.

A better way to assess the outdoor air flow rate is to measure or estimate: 1) the *fan-powered ventilation rate* (or *total air flow*) and 2) the percent of the total air flow that is made up of outdoor air. The fan-powered ventilation rate includes both outdoor air *and* air that is withdrawn from an area and then recirculated.

## Detailed Investigation

The best way to obtain the fan-powered ventilation rate is to measure actual air flows. Air flows in ducts are measured using a pitot tube or hot wire anemometer traverse. Air flows at grilles and diffusers are measured using flow hoods. These measurements should be performed only by experienced people.



This building investigator is using a flow hood at the outdoor air intake for a classroom unit ventilator. When the cloth "sleeve" of the flow hood is held tightly against the wall or ceiling, it channels air through a sensor grid that measures air flow.

The percentage of outdoor air can be obtained by taking measurements of either carbon dioxide or temperature in three locations: 1) the *outdoor air* (preferably near the intake), 2) the *return airstream*, and 3) the *mixed airstream*. (See Figures 6-8 and 6-9.) For either of these techniques, the results will be more accurate when there is a large difference between the airstreams. If temperature measurements are used, multiple readings must be taken at each airstream to obtain an average, and the mixed air must be measured before it is heated or cooled. Access problems can make this impossible in some HVAC systems. It is very important to obtain multiple measurements at different points in the mixed airstream. Stratification of the outdoor air or return airstreams can distort calculations of the average mixed air temperature.

Figures 6-8 and 6-9 show the equations used to calculate the percent of outdoor air and the outdoor air ventilation rate in cfm/person.

Sample Working Floorplan 9 on page 6-36 shows the results of the building inspection and diagnostic testing in an example school.

### Figure 6-8: Calculating the Percent of Outdoor Air

Using temperature measurements:

$$\text{Outdoor air (percent)} = \frac{T_{\text{return air}} - T_{\text{mixed air}}}{T_{\text{return air}} - T_{\text{outdoor air}}} \times 100$$

Where: T = temperature in degrees Fahrenheit

Using carbon dioxide measurements:

$$\text{Outdoor air (percent)} = \frac{C_s - C_r}{C_o - C_r} \times 100$$

Where:  $C_s$  = ppm of carbon dioxide in the supply air (if measured in a room), or

$C_s$  = ppm of carbon dioxide in the mixed air (if measured at an air handler)

$C_r$  = ppm of carbon dioxide in the return air

$C_o$  = ppm of carbon dioxide in the outdoor air

### Figure 6-9: Converting % Outdoor Air to CFM/Person

The outdoor airflow (in cfm) can be calculated from the percent of outdoor air and the total airflow:

$$\text{Outdoor airflow (cfm)} = \text{Total airflow (cfm)} \times \% \text{ Outdoor air}$$

The outdoor airflow in cfm per person can then be calculated for each room or zone.

$$\text{Outdoor airflow (cfm/person)} = \frac{\text{Outdoor airflow (cfm)}}{\text{Number of occupants}}$$

### Sample Working Floorplan 9

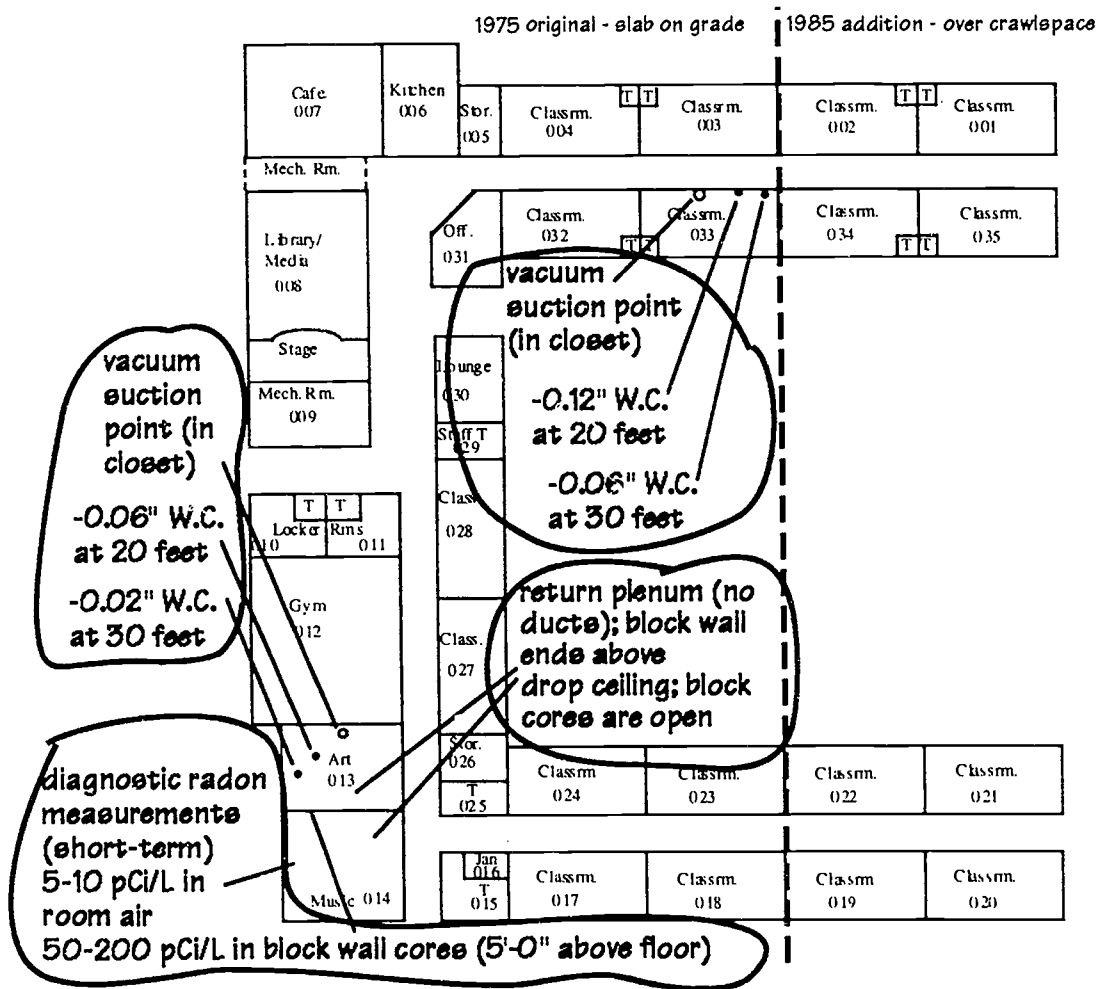

This floorplan builds on previous **Sample Working Floorplans** by showing the results of the building inspection and diagnostic testing. NOTE: Not all of the diagnostic tests described in the text were needed in order to identify appropriate mitigation strategies for this building.

A single suction point (for the vacuum test of pressure field extension) was adequate for the three classrooms because they are adjacent, were built at the same time, and have a common foundation system. The results indicate good pressure field extension. The vacuum test of pressure field extension conducted in the Art and Music area is less promising for ASD. In addition, investigators looked above the drop ceiling and observed that 1) the masonry wall ends above the ceiling and 2) the masonry block tops are open. Diagnostic radon measurements show higher radon levels inside the block cores than in the room air. This indicates that negative pressure in the return plenum is drawing radon up the wall and into AHU-2, which blows it into the Art and Music rooms.

Based on these results, it appears that ASD will be a successful mitigation strategy for the classrooms. In the Art and Music rooms, it is important to prevent the ventilation system from mining soil gas. If the block wall is easily accessible and in good condition, it may be possible to correct the radon problem by sealing the block cores. Another option is to install return ductwork (seal seams carefully).

## 7.0 Design and Implementation of Mitigation Techniques

This section provides an overview of design and implementation considerations for each type of radon mitigation system that is used in school buildings. It is intended to help you understand and oversee the work of the radon mitigation contractors, HVAC contractors, test and balance firms, and HVAC control contractors who will be involved in the actual installation work.

As you consider alternative ways to reduce radon concentrations in your building, remember that control of radon requires a long-term commitment. Consider the following criteria:

- effectiveness
- permanence
- durability
- installation and operating costs
- conformity with codes
- reliability
- maintenance
- occupant comfort
- ability to institutionalize the solution
- ease and likelihood of defeating the mitigation system

While most of the above criteria are self-explanatory, the last two deserve further discussion.

***Ability to institutionalize the solution:*** Any mitigation approach will require periodic inspection and maintenance that must be integrated into normal building operations. It may be necessary to develop new inspection checklists or staff training programs. Operating manuals that explain how the radon control system is intended to function should be provided to current facility staff and incorporated into the orientation of new staff members. An alarm system should be installed to provide a warning if the system fails.

***Ease and likelihood of defeating the mitigation system:*** Systems that can easily be defeated (either knowingly or unknowingly) create potential problems. For example, open doors and windows can defeat a mitigation system based on building pressurization. Mitigation approaches based on dilution can be defeated if possible energy savings are given a higher priority than proper outdoor air ventilation.

### Monitoring the Radon Mitigation System

Facility staff must understand the operating principle of the radon mitigation system, recognize its critical components, and be attentive to its proper functioning. A variety of sensors, monitors, and alarms can be installed to check the performance of the mitigation system and set off alarms if the system is not working. For mitigation strategies that utilize the ventilation system, sensors and monitors can be integrated with the HVAC control system. However, it is important that someone assume responsibility for checking those sensors, monitors and alarms regularly.

**Monitoring Airflow:** Dilution-based mitigation systems function by increasing outdoor air flow into the building. It is important to measure the actual air flow, if possible, rather than basing an estimate on the position of the outdoor air damper. Small differences in damper position can have a large effect on air flow. *Air monitoring stations, temperature sensors, or pressure sensors* can be used to measure actual outdoor air flow, depending on the ventilation system layout.

**Monitoring Pressure Differential:** Pressurization or ASD-based mitigation systems function by maintaining the appropriate pressure difference between the occupied space and the sub-floor area (soil below the slab, crawlspace, or utility tunnel). *Pressure sensors* are necessary to monitor pressure differentials.

**Alarms:** Visible or audible alarms should be installed to notify operators if the mitigation system is not functioning properly. If your mitigation system operation is affected by ventilation system cycling, you may want to interlock the alarm system with your time clocks. Checking the alarm should become a routine responsibility of facility staff. Make sure that it is possible to confirm the proper operation of the alarm system itself.

### Labeling the Radon Control System

The components of the radon mitigation system should be clearly labeled so that facility staff and outside contractors will recognize its importance. Labels should identify the components as part of the radon control system and should indicate desired air flow directions. Addresses and telephone numbers for service personnel should be attached securely in a prominent location. The name and phone number of the facility staff person who is responsible for the system should also be listed.

HVAC system problems sometimes arise when system components are serviced, altered, or replaced by workers who are unaware of their intended function (e.g., fans installed backwards so that they exhaust air, rather than supplying it). Labels that identify system components and air flow directions can help prevent this type of problem.

## 7.1 Active soil depressurization

Active soil depressurization (ASD) is the most widely-used approach to radon mitigation in residences and has proven to be an effective technique in schools as well. As described in **Section 6** of this document, an ASD system creates a negative pressure field beneath the slab, under an installed membrane, or in a crawlspace or utility tunnel. When the system is functioning properly, soil gas is unable to enter the occupied space. Instead, air tends to leak *out* of the building through any unsealed cracks and holes in the slab. The negative pressure field reverses the direction of soil gas air flow so that radon is drawn out from under the slab and exhausted to outdoors.

### a. System Components

ASD systems consist of the following components:

- exhaust fan(s)
- a concrete slab or an installed membrane
- one or more suction points, with a suction pit beneath each suction point
- low pressure ducts to connect the fan and the suction points
- exhaust outlet(s)
- labels to identify components as part of a radon control system
- monitor and alarm to signal system failure
- fire control dampers (if ducts penetrate fire-rated barriers)

**Exhaust fan(s):** In-line centrifugal fans are typically used for soil depressurization systems. The fans can move enough air (up to 200 - 700 cfm at the high flow end of the performance curve) and create enough suction (1.5 to 3 inches water column at the low to middle flow end of the performance curve) to meet most soil depressurization needs. In-line fans are easily attached to ducts. The fan(s) should be located outside of the occupied space (preferably outside the building and above the roof line) and as close as possible to the exhaust outlet. This design strategy helps to keep radon-containing air from leaking into the building by keeping the pressurized section of ductwork (i.e., the section of ductwork from the fan to the discharge) outside of the building.

**Concrete slab or installed membrane:** An ASD system functions by reducing the air pressure in the soil or fill material so that it is lower than the air pressure in the building. A negative pressure field can only be developed and sustained if there is a barrier between the soil and the occupied space.

**Suction point(s) and suction pit(s):** The ASD fan exerts suction at holes drilled through the slab (or openings in the installed membrane). Suction pits (created by removing soil beneath each suction point) improve pressure field development by reducing resistance where air velocity is highest and minimizing the total static pressure drop in the system.

**Low pressure ducts:** Schedule 40 PVC pipe is commonly used for ducts in soil depressurization systems. It is easy to find, easy to work with, and does not corrode. Depending upon the duct routing, PVC may not meet fire code requirements for installation inside the building, in which case steel is normally used. Whatever material is selected, careful sealing at joints is needed to support pressure field development. Condensation will occur inside ASD ductwork, so duct materials must be chosen to resist damage from condensation.

**Exhaust outlet:** Exhaust outlet(s) for radon control systems should be located a minimum of 10 feet above ground level, and a minimum of 10 feet from outdoor air intakes, operable windows, or doors. Exercise care when locating the exhaust outlet; it should be placed far enough away from air intakes to ensure that radon-containing air does not re-enter the building.

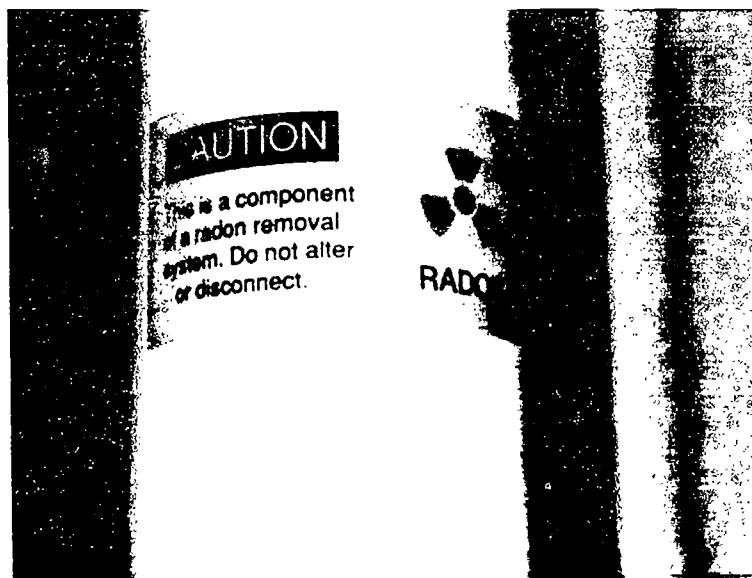

**Labels:** Any radon control system must be labeled as such. If the system is not clearly labeled, its purpose may be forgotten as the people managing the building change.

The label on this ASD system is designed to convey important information without causing panic.



**Monitors and alarms:** The personnel managing the building need to know that the system is working. Monitors generally sense pressure differentials in the ducts of the ASD system or between the subslab area and the occupied space, with alarms or lights to indicate malfunctions of the radon control system.

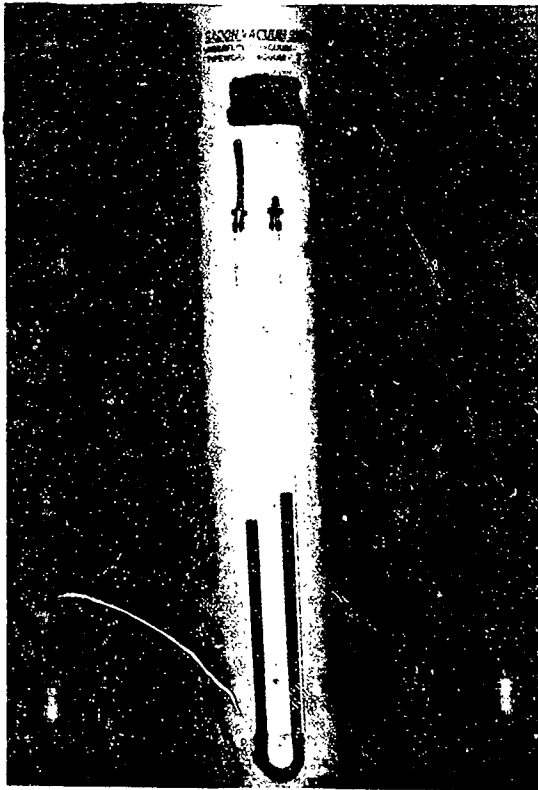

The "U"-shaped loop at left is a liquid manometer mounted on the ductwork of an ASD system. When the ASD system is functioning properly (as in this photograph), the liquid reaches higher on one side of the "U" than on the other. The difference in height between the two sides indicates the pressure differential between the inside of the duct and the room. Note: The duct is clearly labeled as being part of a radon control system, and includes the installer's telephone number.

The photograph at right illustrates another pressure sensor used in ASD systems. Each pressure sensor in this system feeds information to a central location. By contrast, the sensor design shown above requires staff to walk through the building and examine each manometer in its installed location.

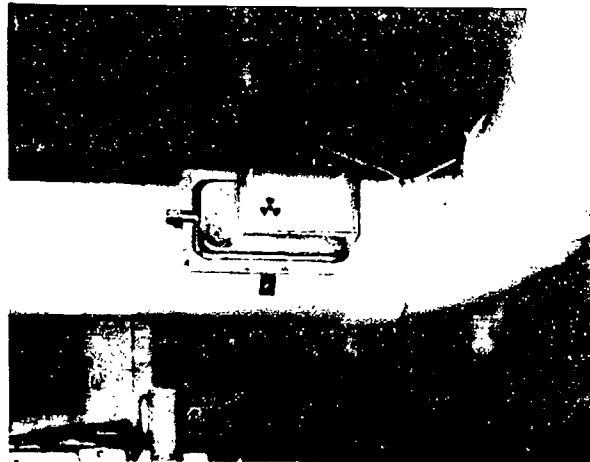

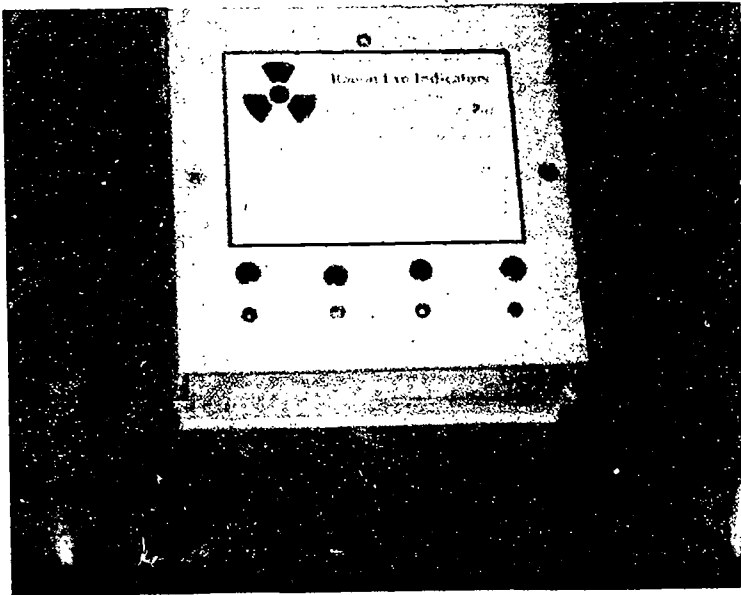

The lights along the bottom of this box indicate that the ASD system fans are operating. The fans are intended to operate continuously, so the ASD system should be checked whenever any of the lights go out. NOTE: If the indicator lights were designed to be "off" under normal conditions and turn "on" as a sign of trouble, a burnt-out indicator bulb could leave occupants uninformed of an ASD system failure. With this design, a burnt-out bulb sends a false alarm that is easy to identify and correct.

**Fire control dampers:** Fire control dampers may be required as part of the ASD system design. For example, walls between corridors and rooms are considered fire walls, and any penetrations through those walls must comply with fire codes. *Note:* Many radon mitigation contractors may be unfamiliar with the code requirements that govern non-residential buildings such as schools. An engineer with experience in school HVAC systems should review the design of the radon mitigation system for conformance with codes.

#### b. Design Considerations

Most radon mitigation contractors are more familiar with ASD systems than with other techniques. This mitigation strategy is adaptable to a wide range of building designs and can be successful in treating buildings with high or low pre-mitigation radon concentrations. **Figure 2-2** on page 2-11 and **Figures 6-1** and **6-2** on page 6-5 show typical ASD system designs. NOTE: ASD in a school building involves different design considerations from ASD in a single-family home. Your radon mitigation contractor should work with an HVAC engineer to design any school ASD system, so that these differences are taken into account:

- **Building and fire codes:** Building and fire codes that apply to schools are very different from those that apply to single-family homes. State and local code requirements should be investigated to make sure that the system design, materials, and installation are in compliance.

- Negative pressure influences: The ASD system can only prevent radon entry as long as the air pressure beneath the slab is lower than the air pressure in the occupied space. Strong negative pressures in the building (such as large exhaust fans) can sometimes overpower an ASD system. Mechanical ventilation systems are a source of negative pressure that differentiates schools from most homes. The school's HVAC system may require adjustment to reduce negative pressures and allow the ASD system to function properly. Sealing leaky air distribution ducts can help to bring HVAC systems into proper balance and reduce negative pressures in the building.
- Subslab obstacles: Schools are more likely than single-family homes to have obstacles beneath the slab such as interior subslab walls and footings. Multiple suction points may be necessary to ensure pressure field extension to areas surrounded by subslab walls.
- Sealing is recommended to reduce leakage between the occupied space and the area beneath the slab (or between the occupied space and the crawlspace). Excessive leakage can make it difficult or impossible to maintain a negative pressure field.



The photograph at left shows an ASD outlet on a school rooftop. It has been located away from outdoor air intakes. When an ASD system is designed for any building, the ASD outlets should be placed to keep radon from re-entering into the building.

## 7.2 Pressurization

Pressurization and ASD both create a pressure gradient that blocks radon entry into the building by maintaining a higher pressure within the building than beneath the slab. Instead of withdrawing air from beneath the slab to create a negative pressure field, pressurization functions by blowing enough additional outdoor air into the building to maintain a higher air pressure indoors than outdoors.

A mitigation system can work by pressurizing the sector(s) of the building that contain elevated radon or by pressurizing the entire building. Pressurization of individual rooms is generally impractical, because it may be impossible to maintain a room under positive pressure when the door is open and impossible to institutionalize a policy of keeping doors closed.

### a. System Components

Pressurization of the occupied space requires the following components:

- outdoor air intake
- supply air fan(s) and heating and/or cooling coil(s)
- ducts to distribute supply air
- monitor and alarm to signal system failure
- fire control dampers (if ducts penetrate fire-rated barriers)

This strategy is most economical if existing equipment can be used. Most modern school buildings are designed to operate at a neutral or slightly positive pressure with respect to the outdoors, a design strategy which helps to control drafts and maintain comfort conditions. In such buildings, restoring the HVAC system so that it functions according to its original design can often reduce radon below 4 pCi/L. However, if the amount of air leakage or the rate of powered exhaust is higher than anticipated in the design, a higher outdoor air flow rate may be needed to achieve a positive pressure in the occupied space.

### b. Design Considerations

Pressurization requires the introduction of enough mechanically-supplied outdoor air into the occupied space to counteract the negative pressures exerted by the stack effect and the building's exhaust fans. The amount of additional air

needed for successful pressurization thus depends on the amount of air that is exhausted or leaks out of the building.

- **Sealing:** Tight building construction supports successful pressurization. Consider sealing to help reduce leakage from the space that is being pressurized. Locations to seal could include leaky windows, unweatherstripped exterior doors, and utility penetrations. Interior sealing may be needed as well, including the installation of automatic door closers.
- **Air distribution:** Proper air distribution within the area to be pressurized is important to ensure success. Check air flow patterns and pressure relationships using chemical smoke.
- **HVAC system capacity:** If the HVAC system is modified to increase the flow of outdoor air beyond original design quantities, greater heating or cooling capacity may be needed. An HVAC engineer can analyze the costs and benefits of a heat recovery system, which could provide energy savings and enhance the capacity of your existing coils.

Figure 7-1 illustrates mitigation by pressurization.

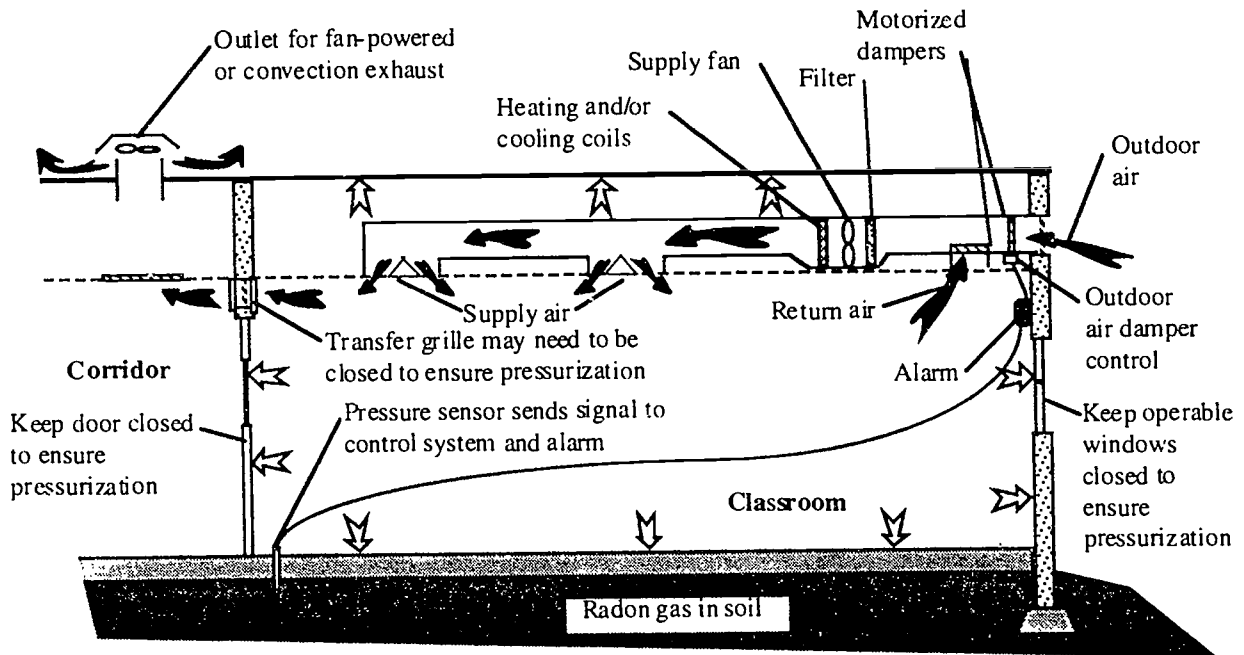

**Figure 7-1: Mitigation by Pressurization**

This mitigation strategy counteracts the negative pressure effects of exhaust fans and natural convection by increasing the flow of mechanically-supplied outdoor air into the building (or, in some buildings, by reducing the amount of general exhaust). The black arrows in the diagram above show air flow patterns. The white arrows show pressurization in the room. Radon cannot enter as long as the air pressure inside the building is higher than the air pressure under the slab. Doors and operable windows must remain closed to ensure pressurization.

A *pressure sensor*, located away from exterior walls to minimize wind effects, measures the indoor/subslab pressure differential. The pressure sensor provides information to the control system, which regulates the flow of outdoor air by adjusting the motorized dampers. The alarm notifies occupants if the system fails to maintain the desired pressure relationship.

### 7.3 Dilution

Dilution works by increasing the percentage of outdoor air in room air. In theory, doubling the outdoor air flow would reduce radon to 1/2 its original concentration, quadrupling the outdoor air flow would reduce radon to 1/4 its original concentration, and so on (see the formula in **Section 6**, page 6-7). In reality, however, the relationship between the outdoor air flow and the indoor radon concentration is also affected by air distribution patterns and pressure relationships. The combined effect of these influences on radon concentrations must be measured directly because it varies from situation to situation.

If your building relies on exhaust fans to draw outdoor air into the building (as make-up air), raising the rate of exhaust could successfully dilute the radon. However, raising the exhaust rate also increases the tendency for the building to run negative, which could draw in more radon. If your school has mechanically-supplied outdoor air, an increase in outdoor air flow might reduce negative pressure in the building, lowering the radon level further than the formula would predict.

The design outdoor air flow in many school buildings is 5 cfm/person, only 1/3 of the outdoor air ventilation rate currently recommended by ASHRAE. Correcting gross HVAC system problems as discussed in sections 3 and 4 may still leave outdoor air flows at 5 cfm/person or less.

If radon levels tested at less than 10 pCi/L with an outdoor air flow rate of 5 cfm/person or lower, mitigation by dilution may be a practical approach for your building. The increased flow of outdoor air reduces radon concentrations and also lowers the concentrations of other airborne contaminants that have originated within the building.

#### NOTES:

1. Use of a dilution approach to radon mitigation is likely to increase energy consumption. However, this increase in energy use may be offset by improved efficiency of the HVAC equipment. Properly functioning controls, clean filters, and clean coils can all help to reduce energy consumption.
2. The capacity of heating and cooling coils determines the quantity of outdoor air that can be conditioned and could prevent meeting the recommendations of *ASHRAE Standard 62-1989*.

### a. System Components

A mitigation system based on diluting radon in the occupied space requires the following components:

- outdoor air intake
- fan(s) and heating and/or cooling coil(s)
- ducts to distribute supply air
- monitor and alarm to signal system failure
- fire control dampers (if ducts penetrate fire-rated barriers)

As with pressurization of the occupied space, this mitigation strategy is most economical if existing equipment can be used.

### b. Design Considerations

- Air distribution: Proper air distribution is important to the success of this mitigation strategy. Do not assume that the air flows shown on mechanical plans are correct; an experienced person should measure actual air flows.
- HVAC system capacity: If the HVAC system is modified to increase the flow of outdoor air beyond original design quantities, greater heating or cooling capacity may be needed. An HVAC engineer can analyze the costs and benefits of a heat recovery system, which could provide energy savings and enhance the capacity of your existing coils.
- Pre-mitigation radon concentrations: Dilution alone is unlikely to be a practical mitigation approach if the pre-mitigation concentrations are high. EPA's experience suggests that other mitigation measures will be needed if pre-mitigation radon levels are above 10 pCi/L.
- Outdoor contaminants: The outdoor air must not introduce levels of outdoor air pollutants that could cause indoor air problems.
- Moisture considerations: The HVAC system must be able to remove enough moisture from the outdoor ventilation air to maintain the indoor relative humidity at a level that is comfortable and does not promote microbiological growth (e.g., mold, mildew).

Figure 7-2 illustrates mitigation by dilution. **Sample Working Floorplan 10** shows mitigation recommendations for the school shown in previous floorplans.



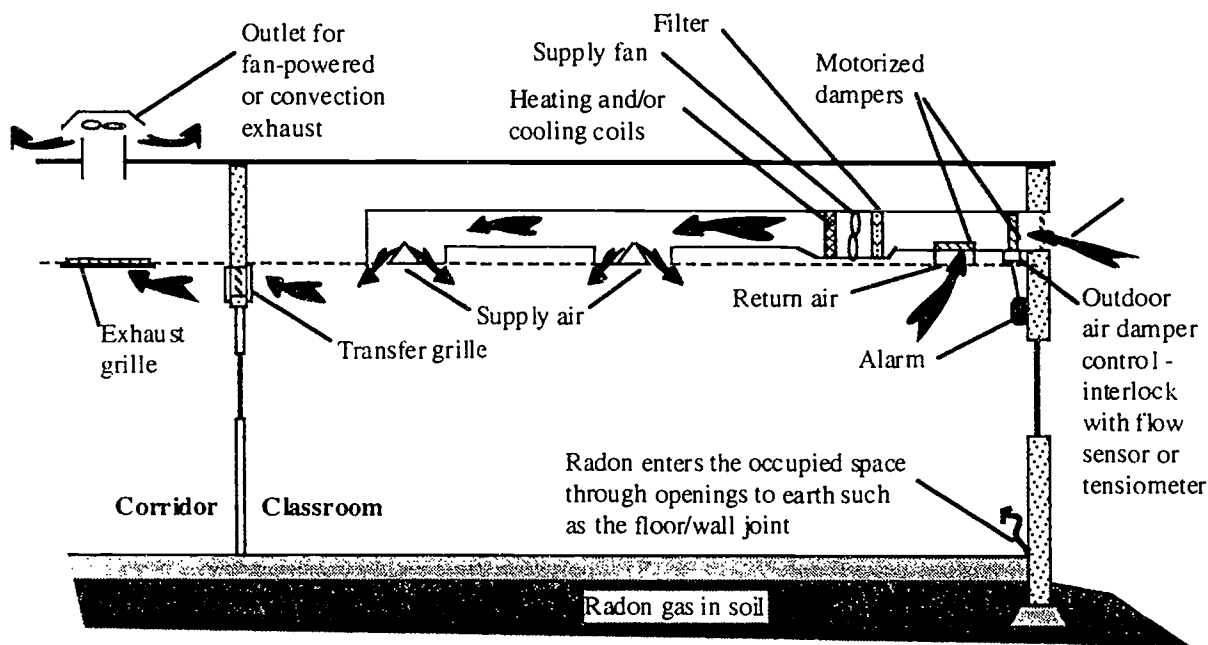

Figure 7-2: Mitigation by Dilution

This mitigation strategy increases the flow of mechanically-supplied outdoor air into the building, mixing the outdoor air with room air to lower the concentration of radon and other airborne contaminants. If the total volume of mechanically-supplied air is increased, this strategy will also tend to reduce radon entry by counteracting the negative pressure effects of exhaust fans and natural convection. The black arrows in the diagram show air flow patterns.

The control system must maintain a minimum flow of outdoor air into the building to provide the necessary dilution. A *flow sensor* (which measures air flow) or a *tensiometer* (which measures the damper opening) will set off the alarm if the flow of outdoor air is reduced below the setpoint. Doors and windows can be opened without disrupting the mitigation system; in fact, radon concentrations should be lower when windows are open.

Mitigation by dilution requires the ability to introduce and condition (heat or cool) an increased flow of outdoor air. It is only a practical mitigation approach for schools in which initial outdoor air flows and initial radon concentrations are both relatively low.

### Sample Working Floorplan 10

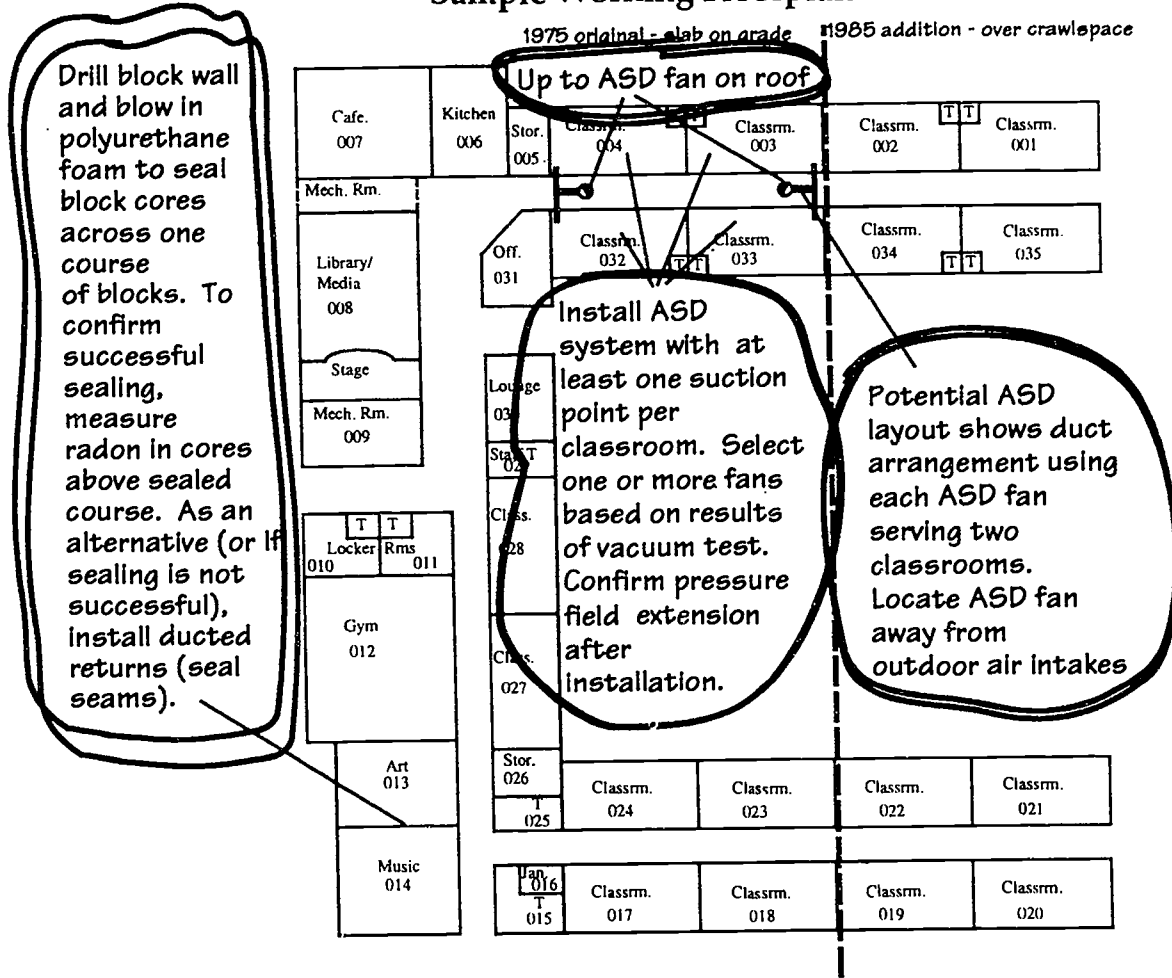

This floorplan builds on previous **Sample Working Floorplans** by showing the mitigation strategy for the three classrooms and the Art and Music area. The notes indicate methods of assessing mitigation system performance that will allow fine-tuning when the mitigation systems are installed.

## 8.0 Post-Mitigation Measurements

This section provides guidance in performing post-mitigation measurements. It provides specific guidance as to how the measurements should be performed and how the building's mechanical systems should be operated during the testing period.

After the mitigation system is in place and operating, test the radon concentrations in each area that has been treated. Use professional radon testers listed in EPA's RMP program or state-certified testers or school personnel who have been properly trained to perform the measurements. (See *Radon Measurement in Schools - Revised Edition* for the level of training recommended.) The flowchart below shows the recommended decisionmaking sequence.

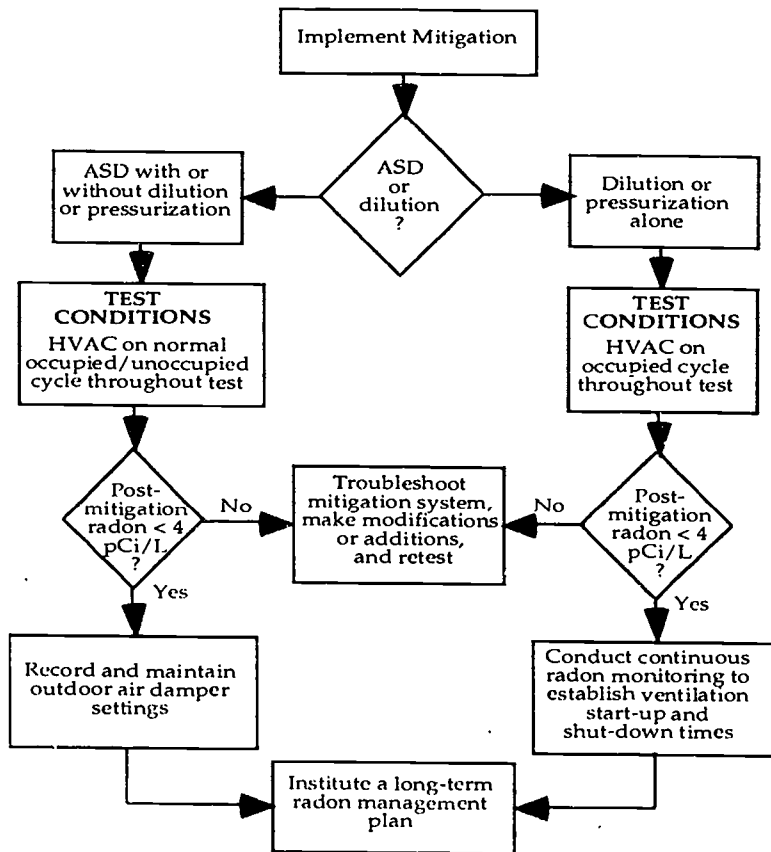

Figure 8-1: Post-Mitigation Measurements

## Post-Mitigation Measurements

- Wherever ASD has been used as a mitigation strategy: Conduct radon testing in keeping with EPA's measurement protocols. If radon measurements are performed by a contractor, be sure the company is listed with EPA's RMP program (or certified by your state). Either short-term or long-term measurement devices may be used. Short-term devices have the advantage of providing a relatively quick indication of whether the mitigation strategy is successful; long-term devices provide results that are more representative of the annual average radon level. Operate the HVAC system on its normal occupied/unoccupied cycle, even if your mitigation strategy combines ASD with pressurization or dilution.
- Where dilution or pressurization have been used without ASD: The radon test results will be affected by HVAC equipment cycling. In order to determine whether the ventilation system is controlling radon relatively quickly, EPA recommends that you perform a short term radon measurement test following EPA protocols and use test devices obtained from an RMP-listed organization. The ventilation system must operate in the occupied cycle with outdoor air dampers in the minimum position throughout the entire testing period. If the test is performed when the ventilation system is operating on normal occupied/unoccupied cycling, test results are likely to be higher than occupants actually encounter during occupied periods (i.e., radon levels usually rise during the unoccupied cycle).

### 8.1 Evaluate Results of Post-Mitigation Radon Measurements

- Where the post-mitigation radon measurements show radon below 4 pCi/L, you have brought the radon concentration under control.
  - If you are using ASD: Establish a long term radon management program (see **Section 9**). NOTE: Remember that radon concentrations are sensitive to air flow patterns and air pressure relationships. Record and maintain outdoor, return, and exhaust air damper settings, the timing of occupied and unoccupied cycles, and the quantities of powered exhaust. Before making any changes to the ventilation system, consider the potential effect on radon concentrations.
  - If your mitigation strategy uses pressurization or dilution without ASD: You have learned that the HVAC system can be used to control radon. Now you need to adjust the HVAC system so that radon remains below 4 pCi/L whenever the building is occupied. **Figure 5-1** on page 5-3 shows how

occupied/unoccupied cycling affects radon concentrations in a typical school. Within each *ventilation zone*, (room or rooms served by the same piece of ventilation equipment), determine which room has the highest retest results. In that room, use a continuous radon monitor (CRM) to collect continuous radon readings for a minimum of 48 hours while the HVAC equipment cycles normally. (NOTE: You may need professional assistance to obtain and interpret continuous radon measurements.)

Use the CRM results to determine the ventilation system start-up and shut-down times necessary to maintain radon levels below 4 pCi/L whenever the building is occupied. Start the occupied cycle early enough for radon to drop below 4 pCi/L by the time the first building occupants arrive. When you have adjusted the timing of the control cycles, go to **Section 9**. Long term radon management is critically important to prevent radon problems from recurring in the future. NOTE: Record and maintain outdoor air damper settings, the timing of occupied and unoccupied cycles, and any other modifications that were made as part of the HVAC-based mitigation strategy. Avoid any change to key HVAC components that might cause radon levels to rise.

- Areas in which the post-mitigation radon measurements show radon greater than or equal to 4 pCi/L will require further attention. Review the operating principle(s) of your mitigation strategy and discuss them with your HVAC engineer, radon mitigation contractor, and other individuals who have been involved in designing, installing, and operating the mitigation system. Conduct a careful inspection of the mitigation system to confirm that all components have been installed correctly and are functioning properly. Additional (or improved) sealing or other adjustments may be needed to support the operation of the mitigation system. Additional radon measurements, such as continuous radon readings, can provide valuable periodic information concerning the effects the HVAC system has on radon concentrations (e.g., occupied/unoccupied cycling, use of large exhaust fans such as kitchen range hoods).

## 9.0 Long Term Radon Management

Unless you are aware of the conditions that can cause radon to enter your building and remain vigilant in avoiding those conditions, your radon problems are likely to recur in the future. This is relatively straight forward and need not be a cause of alarm, but should remind you to plan seriously for long term management of the radon problem. This section is designed to guide you through the important components of a long-term radon management plan.

When the mitigation system is installed, it is important to obtain or create an instruction manual. The manual should describe the function and operation of the system, as well as recommended maintenance practices.

Earlier sections of this document have pointed out that HVAC systems require regular maintenance in order to function properly and prevent indoor air quality problems. Any new mechanical equipment that has been installed to correct radon problems also requires periodic inspection and maintenance. Even radon mitigation strategies that do not involve mechanical equipment, such as sealing, are likely to need occasional repairs. *In short, any radon or indoor air quality plan requires a long term management program.*

### 9.1 Periodic Radon Testing

Many factors can cause indoor radon levels in your building to change over time. New openings to earth may develop due to settling, deterioration of the building structure, or construction or renovation work. Pressure relationships can change if the ventilation system becomes unbalanced or HVAC equipment is added, removed, or replaced. These influences may produce elevated radon levels in rooms in which the initial radon test results were below 4 pCi/L. Periodic retesting of the entire school is important to be confident that your radon mitigation system is functioning properly and that additional rooms have not developed radon problems. **EPA recommends annual retesting of all areas that have been mitigated.** The annual retest should be performed when the outdoor air dampers are most likely to be at their minimum position (i.e., winter in northern portions of the country, summer in southern areas).

NOTE: It may be important to adjust the start-stop times of HVAC equipment, in which case continuous radon measurements will be required.

## Long-Term Radon Management

- Wherever ASD has been used as a mitigation strategy: Use test devices that are listed in EPA's Radon Measurement Proficiency (RMP) program and conduct radon testing in keeping with EPA's measurement protocols. Operate the HVAC system on its normal occupied/unoccupied cycle, even if your mitigation strategy combines ASD with pressurization or dilution.
- Where dilution or pressurization have been used without ASD: The radon test results will be affected by HVAC equipment cycling. If the test is done when HVAC equipment is operating on normal occupied/unoccupied cycling, your results will probably be higher than occupants actually encounter during occupied periods (i.e., radon levels usually rise during the unoccupied cycle). To avoid this distortion of the radon test results, operate the HVAC equipment on occupied cycle 24 hours/day throughout the test period. In addition, outdoor air dampers should not be allowed to open any further than their minimum setting during the test period; this simulates outdoor air ventilation during extreme weather conditions.

## 9.2 HVAC System Maintenance

If you do not have a Preventive Maintenance (PM) program in place for the HVAC system, EPA *strongly* recommends that you develop such a program. It is possible to save energy through a conscientiously-applied preventive maintenance program. The PM program must be properly budgeted and implemented, not merely planned on paper, and may require additional funding for staff training and development. HVAC system operators must have an adequate understanding of the overall system design, its intended function, and its limitations.

The following general elements should be part of a PM plan:

*Periodic inspection, cleaning, and service as warranted:* Consult the operating manuals for your mechanical equipment and develop a maintenance schedule. Make certain that all items of mechanical equipment are included in the program. Critical HVAC system components that require PM in order to maintain comfort and deliver adequate ventilation include:

- outdoor air intake openings
- damper controls
- air filters
- drip pans
- cooling and heating coils
- fan belts

- humidification equipment and controls
- distribution systems
- exhaust fans
- time clock settings (e.g., to correct for power outages, annual changeover between standard and daylight savings time, and changes in building use)

**Adjustment and calibration of control system components:** HVAC systems should be tested and balanced whenever remodeling or construction activity changes room layouts, population density or airflow patterns. (See page 9-4 for more about testing and balancing.)

After an appropriate "occupied-unoccupied" cycle has been selected and instituted, inspect the controls periodically to confirm that the control system is operating as intended. Time clock settings can slip gradually out of adjustment or become disrupted by power outages.

Some professional and trade associations offer guidance that can help in developing a preventive maintenance program. For example, the American Society of Heating, Refrigeration, and Air-Conditioning Engineers' *ASHRAE 1-1989: Guideline for the Commissioning of HVAC Systems* includes recommendations for periodic maintenance. The Air-Conditioning and Refrigeration Institute (ARI) offers *Air Conditioning and Refrigeration Equipment General Maintenance Guidelines for Improving the Indoor Environment*. The Sheet Metal and Air Conditioning Contractors' National Association (SMACNA) publishes a manual entitled *Indoor Air Quality* and other related documents, including *HVAC Duct Systems Inspection Guide*, *HVAC Systems -- Testing, Adjusting and Balancing* and *HVAC Air Duct Leakage Test Manual*. This listing of publications is provided for your information and does not constitute an EPA endorsement.



### Testing and Balancing

Problems during installation, operation, maintenance, and servicing of the HVAC system could prevent it from operating as designed, increase operating costs, and decrease equipment life. Each system should be tested periodically and adjusted as needed to ensure its initial and continued performance. *Testing and balancing* involves the testing, adjusting, and balancing of HVAC system components so that the entire system provides airflows that are in accordance with the design specifications. New design specifications may be required if building usage or the occupant population have changed. Typical components and system parameters tested include: all supply, return, exhaust, and outdoor airflow rates; control settings and operation; air temperatures; fan speeds and power consumption; filter resistance.

The typical test and balance contractor coordinates with the control contractor to verify and ensure the most effective system operation within the design specifications, identify and correct any problems, and ensure the safety of the system. A test and balance report should provide a complete record of the design, preliminary measurements, and final test data. The report should include any discrepancies between the test data and the design specifications, along with reasons for those discrepancies. To facilitate future performance checks and adjustments, appropriate records should be kept on all damper positions, equipment capacities, control types and locations, control settings and operating logic, airflow rates, static pressures, pressure relationships between zones, fan speeds, and horsepower.

Effective balancing requires a skilled technician with the proper experience and instruments. Use of a test and balance contractor who is certified by the Associated Air Balance Council (AABC) or the National Environmental Balancing Bureau (NEBB) will help to ensure quality services. Defining test and balance work as a professional service exempts it from competitive bidding requirements. This allows schools to select the best-qualified firm and pay for necessary work on a time and materials basis rather than being obligated to accept the lowest fixed bid.

**Construction or renovation projects:** Testing and balancing should be performed during new construction and when space is renovated or changed to provide for new occupancy. Testing and balancing provides a check on the work of the mechanical contractor. If the HVAC system is properly adjusted, measured airflows should be within 10% of design quantities. However, measured airflows that seem to match design quantities exactly should raise suspicions about the legitimacy of the test and balance report.

To avoid conflict of interest, some engineers recommend that the test and balance firm work directly for and report directly to the owner, rather than subcontracting through the mechanical contractor. This approach can create coordination difficulties and make it difficult to allocate responsibility in case of problems. As an alternative, the owner could hire a second, independent test and balance firm to "spot check" the work of the mechanical contractor's test and balance firm.

**Testing and balancing of existing building systems:** Testing and balancing of existing building systems should be performed whenever there is reason to believe the system is not functioning as designed or when current records do not accurately reflect the actual operation of the system. The Associated Air Balance Council (AABC) and National Environmental Balancing Bureau (NEBB) recommend routine testing and balancing every 3-5 years.

An economical approach to testing and balancing existing systems is to divide the job into stages. A detailed test report for a school HVAC system should cost roughly \$1,000 to \$5,000, depending on the size and complexity of the system. The facility operator or the school's consulting engineers can then examine the report and issue bid documents that describe precisely what adjustments are needed.

### 9.3 Installation of New HVAC Equipment, Building Renovations

Renovations or the installation of new HVAC equipment can alter pressure relationships within your building and disrupt or defeat your radon control strategy. Structural modifications or additions could stress the existing slab and create or enlarge openings to earth. Be particularly attentive when projects are likely to depressurize the building. Examples include:

- *One or more new exhaust fans are being installed.* Make certain that adequate make-up air is provided.
- *The building shell is being tightened by replacing windows or doors or is being air-sealed for energy conservation.* This could reduce the infiltration air available for your existing exhaust systems and also lower the ventilation rate. Be careful to introduce and distribute adequate outdoor air to serve your ventilation needs.

## 10.0 Special Considerations

This section provides an overview of some considerations in regard to building codes and worker protection.

### 10.1 Building Codes

Building codes are intended to promote good construction practices and prevent health and safety hazards. Trade associations such as the American Society of Heating, Refrigeration, and Air-Conditioning Engineers (ASHRAE) and the National Fire Protection Association (NFPA) develop recommendations for appropriate design and installation, and those recommendations are given the force of law when adopted by state or local regulatory bodies. Contact your state Education Department or a consulting engineer to learn about the code requirements that apply to your school.

Code requirements are enforceable during construction and renovation; however, those requirements change over time as code organizations adapt to new information and technologies. In general, buildings are not required to modify their structure or operation to meet changes in the codes. Indeed, many buildings do not operate in conformance with current codes nor with the codes they had to meet during construction. For example, the outdoor air flows that ASHRAE's *Standard 62* recommends for classrooms were reduced from 30 cfm/person to 10 cfm/person in the 1930's and reduced again to 5 cfm/person in 1973. Concern over indoor air quality stimulated reconsideration of the standard, so that its most recent version, *Standard 62-1989*, calls for 15 cfm/person. However, many schools that reduced outdoor air flows districtwide in the 1970s continue to operate at outdoor air ventilation rates of 5 cfm/person or less.

#### a. Building Codes and Radon Mitigation Projects

The participation of a registered engineer or architect may be legally required for work affecting mechanical systems, structural components, and life and safety codes. Radon mitigation contractors whose experience has been limited to residential work may not know the codes or standards that apply to schools.

Code requirements affect the selection of materials used for mitigation and the way those materials are installed. Some system designs require the use of non-combustible ductwork rather than PVC. NFPA (National Fire Protection

## Special Considerations

Association) standards (*Plastic Systems for the Removal of Non-Flammable Corrosive Fumes*) prohibit the use of plastic piping to penetrate fire-rated walls or floors, although it can be routed through fire-rated shafts or fire-rated partitions. Non-combustible materials are also required if ductwork is installed within an air plenum, but PVC piping is acceptable for use in the space above a drop ceiling. Fire dampers must be installed where ductwork penetrates fire rated barriers.

## 10.2 Worker Protection

Normal safety precautions observed during routine operation of the building must be followed closely during radon and indoor air quality investigations. When the investigator is not familiar with the mechanical equipment in that particular facility, an operator or engineer should be present at all times in equipment areas. Potential safety hazards include:

- electrocution
- injury from contacting fans, belts, dampers or slamming doors
- burns from steam or hot water lines
- falls in ventilation shafts or from ladders or roofs

Investigators evaluating radon and indoor air quality generally do not encounter situations in which specific personal protection measures (e.g., protective garments and respirators) are required. However, safety shoes and eyeglasses are generally recommended for working around mechanical equipment. Investigators may need additional protection in the vicinity of certain building areas or HVAC equipment when severe contamination is present (e.g., microbiological, chemical or asbestos). Such decisions are site specific and should be made in consultation with an experienced industrial hygienist. General considerations include the following:

**Radon:** Radon concentrations in unventilated areas with exposed earth (such as utility tunnels and crawlspaces) or in sumps may be high enough to warrant the use of a respirator in those locations. A respirator with *HEPA* (high efficiency particulate air) and organic vapors filters is a common piece of protective equipment for radon investigators, but cannot seal properly around facial hair. Professional investigators who have not shaved their beards often use positive pressure masks. If radon measurements are not being taken during the investigation, ventilation of the work area with outdoor air is another effective way to reduce worker exposure.

**Microbiological:** Care must be taken when serious building related illness (e.g.,

Legionnaire's disease) is under investigation or when extensive microbiological growth has occurred. Investigators with allergy problems should be especially cautious. The array of potential contaminants makes it difficult to know what sort of personal protection will be effective. At a minimum, investigators should minimize their exposure to air in the interior of ducts or other HVAC equipment unless respiratory protection is used. If there is reason to suspect biological contamination (e.g., visible mold growth), expert advice should be obtained about the kind of respiratory protection to use and how to use it. Possible protective measures against severe microbiological contamination include disposable coveralls and properly fitted respirators.

**Asbestos:** A radon investigation often includes inspection above accessible ceilings, in crawl spaces or utility tunnels, inside shafts, and around mechanical equipment. Where material suspected of containing asbestos is present, the investigator should take appropriate precautions. This might include disposable coveralls and a properly fitted respirator. Many areas that contain asbestos are labeled with instructions that should be followed.

*Note:* The requirements for proper fit, physical condition of the wearer, and other considerations involved in selection of the proper respirator must be evaluated by an occupational safety and health specialist. There is a NIOSH (National Institute for Occupational Safety and Health) Respirator Decision Logic for proper respirator selection, and OSHA (the Department of Occupational Safety and Health) has regulations for an appropriate respirator protection program. EPA's RCP program includes limited worker protection training for radon contractors. EPA's *Radon Mitigation Standards* for residences (see **Appendix B**) discusses worker health and safety.

## Appendix A: Glossary and Acronyms

### Glossary

Above-grade - Above ground level.

Active soil depressurization - A mitigation strategy that functions by withdrawing radon-containing soil gas from below the building slab (or, in the absence of a slab, from under an installed membrane) and exhausting it outdoors before it can enter the building.

Aggregate (subslab)- Crushed stone, gravel, or other fill material placed in the excavation before the building slab is poured.

Air exchange rate - Used in two ways: 1) the number of times that the outdoor air replaces the volume of air in a building per unit time, typically expressed as air changes per hour; 2) the number of times that the ventilation system replaces the air within a room or area within the building.

Air flow monitoring station - An instrument that measures air volume.

Air handling unit - A device, usually connected to ductwork, to move air, which also may clean and condition the air.

Anemometer - A device to sense and measure air velocity of air flow at a point.

Annual average (radon) exposure - Radon exposure averaged over one year.

As-built - In the construction industry, *as-built plans* refers to floorplans that have been corrected to reflect differences between the original design and the actual construction.

ASHRAE *Standard 62* - the ASHRAE standard that, among other features, establishes recommended outdoor air ventilation rates for different building uses. The current version is *ASHRAE Standard 62-1989*.

Backdrafting (of combustion appliances) - A condition where the normal movement of combustion products up a flue is reversed, so that the combustion products can enter the building.

Below-grade - Below ground level.

## Glossary and Acronyms

Biological contaminants - Agents derived from or that are living organisms (e.g., viruses, bacteria, fungi, and mammal and bird antigens) that can be inhaled and can cause many types of health effects including allergic reactions, respiratory disorders, hypersensitivity diseases, and infectious diseases. Also referred to as "microbiologicals" or "microbials."

Blanks - In the context of radon measurement, *blanks* are unexposed measurement devices sent for analysis along with exposed devices used as a means of quality assurance.

Blower door - See *fan door*.

Building shell - Elements of a building that enclose the internal space, including walls, windows, doors, roofs, and floors (including those in contact with earth).

Carbon dioxide (CO<sub>2</sub>) - Carbon dioxide is a component of exhaled breath, and is measured as an indicator of the outdoor air ventilation rate.

Carcinogen - A substance, exposure to which increases the probability of developing cancer.

Commissioning - Start-up of a building that includes testing and adjusting HVAC, electrical, plumbing, and other systems to assure proper functioning and adherence to design criteria. Commissioning also includes the instruction of building representatives in the use of the building systems.

Concentration - The quantity of a substance per unit volume.

Conditioned air - Air that has been heated, cooled, humidified, or dehumidified to maintain an interior space within the "comfort zone." (Sometimes referred to as "tempered" air.)

Contaminants (air) - Materials in the air that, at high enough concentrations, cause undesirable health effects.

Damper - A device used to vary the volume of air passing through an air outlet, air inlet, or duct often controlled by pneumatic devices.

Decay (radioactive) - The transformation of one radioactive element into another, resulting in the release of radioactivity.

Diagnostics (radon) - Procedures used to identify or characterize conditions within buildings that may contribute to radon entry or elevated radon levels or may provide information regarding the performance of a mitigation system.

Dilution - Mitigation strategy that lowers the concentration of airborne contaminants (e.g., radon) by increasing the fraction of outdoor air (e.g., air in which the radon concentration is very low) in the supply air stream.

Duplicates - In the context of radon measurement, *duplicates* are multiple measurement devices of the same type, exposed at the same location and over the same time period for use as a means of quality assurance.

Dynamics - In the context of this guide, *dynamics* is used to describe patterns of air flow of air (and the flow of airborne contaminants) into, through, and out of a building.

Entry routes (soil gas) - Openings between the building interior and the ground.

Equilibrium - The point at which the entry (or creation) rate of a contaminant equals the removal rate.

Exfiltration - Air movement out of an enclosed space (e.g., a building) through cracks and openings.

Exhaust - Indoor air that is removed from a building. When indoor air is exhausted from a building, outdoor air (including soil gas) infiltrates the building to replace the exhausted air.

Fan coil unit - Fan and heat exchanger for heating and/or cooling assembled within a common casing.

Fan door - A diagnostic tool for building investigations, sometimes referred to as a *blower door*. A fan door includes a calibrated fan with a known performance curve, pressure measurement devices, and a frame that allows the fan to be placed in a door or window opening. Air flows and pressure differences are measured at several fan speeds and used to calculate the leakage area of the building.

Fan pressurization test - A diagnostic test conducted using a *fan door*.

Fire control damper - See *fire damper*.



## Glossary and Acronyms

Fire damper - Device that automatically interrupts air flow through part of an air distribution system to restrict passage of flame. Installed in a fire-rated wall or floor, a fire damper closes automatically in the event of a fire to maintain the integrity of the fire-rated separation.

Fire rated wall/floor - A wall or floor system designed to separate areas for the purpose of offering protection from fire and smoke.

Fill - Material placed in a building excavation before the slab is poured.

Flow hood - A diagnostic tool for building investigations. A flow hood measures air flow at air outlets or inlets by directing the air stream through an air flow monitoring station.

Flow sensor - A sensor that indicates air flow in a duct.

Follow-up (radon) testing - Testing designed to confirm the results of the initial testing using identical testing devices and similar test conditions.

Footing - A concrete base, supporting a foundation wall, that is used to distribute the weight of a building over the soil or subgrade underlying the building.

Foundation - The below-grade structure of a building.

Freeze stat - A safety device designed to protect heating and/or cooling coils from freezing by shutting off outdoor air flow into a building below the device's setpoint.

Grade - (usage: *below-grade*, *above grade*) Ground level.

Heatless chemical smoke - A tool for building investigations consisting of a chemically-generated smoke that makes air circulation patterns visible.

Hydronic - An HVAC term, refers to heating system piping.

Indoor Radon Abatement Act - The legislation that establishes Federal radon policy and directs the U.S. Environmental Protection Agency in its radon-related activities.

Infiltration - Air movement into an enclosed space (e.g., a building) through cracks and openings.

Initial (radon) testing - Testing designed to identify all regularly-occupied ground contact rooms that may have elevated radon concentrations.

Institutionalize - Incorporate into normal operations.

Long-term (radon) testing - Tests that are more than 90 days in duration.

Make-up air - Air that enters a space to replace the air removed by exhaust fans and/or combustion appliances.

Manometer - An instrument that measures air pressure.

Membrane - In the context of this guide, a *membrane* is a flexible material resistant to air passage, such as a plastic film, that is laid over an earthen or gravel floor (e.g., of a crawlspace) as part of a sub-membrane depressurization system.

Microbiological - In the field of IAQ, *microbiologicals* are living things so small that individuals can only be seen through a microscope (e.g., algae, fungi, bacteria, viruses).

Micromanometer - An extremely sensitive instrument for measuring air pressure, capable of measuring air pressure differences as small as one thousandth of an inch W. C. (water column).

Mining - In this guide, *mining* refers to a phenomenon in which the arrangement of the ventilation system inadvertently draws soil gas into a building.

Mitigation - Treatment or correction of a problem.

Negative pressure - Room A is under negative pressure relative to Room B if the air pressure in Room A is lower than the air pressure in Room B.

Neutral pressure - Room A is under neutral pressure relative to Room B if the air pressure in Room A is the same as the air pressure in Room B.

Outdoor air intake - An opening in the building exterior that is a planned entry point for outdoor air.

Pascal - A unit of air pressure measuring .004 inches of water column.

## Glossary and Acronyms

Passive vent - An opening in the building exterior that is a planned exit point for exfiltration air.

Permeability - The ability of soil gas to move through pores and cracks in the fill, soil, and rock beneath the slab.

Permeable - Porous, allowing the passage of air.

Picocuries - A unit of measurement used to describe the radon concentration. A curie is the amount of any radionuclide that undergoes exactly  $3.7 \times 10^{10}$  radioactive disintegrations per second. A picocurie is one trillionth ( $10^{-12}$ ) of a curie, or 0.037 disintegrations per second.

Pitot tube traverse - A measurement strategy involving the measurement of air pressures in the cross section of a duct.

Plenum - The term *plenum* is used to describe a) portions of the air distribution system that make use of the building structure (e.g., the space above a dropped ceiling is often used as a return plenum) and b) the sheet metal that connects distribution ductwork to an air handling unit.

Positive pressure - Room A is under positive pressure relative to Room B if the air pressure in Room A is higher than the air pressure in Room B.

Pre-mitigation radon concentration - The radon concentration before corrective action; either 1) the averaged result of two short-term tests, or 2) the result of a long-term follow-up test.

Pressure differentials - The difference between air pressures measured at two locations.

Pressure field - A *negative pressure field* is an area that is maintained at a relatively lower air pressure than an adjoining location.

Pressure field extension (PFE) - The extent to which the sub-slab area is depressurized by the suction applied at a suction point, as evidenced by the distance that a pressure change is induced in the sub-slab area.

Pressure sensor - In an ASD system, a device used to assess whether the ASD system is maintaining the desired air pressure difference between the building interior and the subslab.

Pressurization - Radon mitigation strategy based on adjusting ventilation until the air pressure inside the building is consistently higher than the air pressure than the area below the slab.

Radioactive decay - See *decay*.

Quality Assurance - A complete program designed to produce results which are valid, scientifically defensible, and of known precision, bias, and accuracy.

Quality Control - Measurements made to ensure and monitor data quality.

Radon - A radioactive gas produced by the decay of radium.

Radon daughters - See *radon decay products*.

Radon decay products - The four radioactive elements that immediately follow radon-222 in the decay chain. These elements are polonium-218, lead-214, bismuth-214, and polonium-214. These elements have such short half-lives that they exist only in the presence of radon.

Radon progeny - See *radon decay products*.

Return - Ventilation system components involved in the removal and recirculation of ventilation air, as in *return fan, return ducts, return grilles*.

Run negative - Operate under negative pressure.

Run neutral - Operate under neutral pressure.

Run positive - Operate under positive pressure.

Schedule, mechanical equipment - Often shortened to *schedule*, refers to a table listing items of mechanical equipment and describing the performance characteristics required by the designer.

Setpoint - The value of the controlled condition at which a controlled device (e.g. a freeze stat or fire damper) is set to operate.

Short-term (radon) testing - Radon tests that are between 2 and 90 days in duration.

## Glossary and Acronyms

Soil gas - The mixture of air, water vapor, and any natural or synthetic contaminants found in the spaces between soil particles and the cracks in rock.

Source strength - The concentration of radon in the soil or bedrock underlying the building.

Stack effect - The overall upward movement of air inside a building that results from heated air rising and escaping through openings in the building envelope, thus causing indoor air pressure in the lower portions of a building to be lower than the pressure in the soil beneath or surrounding the building foundation.

Stratification - Arrangement in layers. In this guide, stratification is used to describe the fact that layers of colder air tend to underlie layers of warmer air.

Sub-membrane depressurization - ASD beneath an installed membrane.

Substructure - The building foundation.

Suction pit - Part of an ASD system; a pit created by removing subslab aggregate below a suction point.

Suction point - Part of an ASD system; the location at which ASD ductwork penetrates the building slab (or an installed membrane).

Supply - Ventilation system components involved in providing ventilation air, as in *supply fan*, *supply ducts*, *supply diffusers*.

Tensiometer - A device that measures a damper's position.

Test and balance (TAB) - A term used in the HVAC industry, referring to the testing, adjusting, and balancing of the HVAC system so that airflows conform to design specifications.

Tightness - In the context of building construction, the ease with which air leaks through cracks and openings in the building shell.

Transom - A manually-controlled opening above a door used to allow air to exit a room.

Underventilation - In this guide, refers to inadequate supply of outdoor air.

Unit ventilator - A fan-coil unit package device for applications in which the use of outdoor air and return air mixing is intended to satisfy tempering requirements and ventilation needs.

Uranium - The radioactive element that decays, through a series of steps, into radium, radon, radon progeny, and, finally, into lead.

Vacuum test - The vacuum test of pressure field extension is a diagnostic test used to evaluate the potential success of mitigation using ASD.

Ventilation - Process of supplying or removing air by natural or mechanical means to or from any space; such air may or may not have been conditioned.

Ventilation zone - In this guide, the room or rooms provided with ventilation air by a particular unit of ventilation equipment.

Working floorplan - In this guide, a small floorplan such as a fire escape floorplan, used for recording notes and observations.

### Acronyms

AABC - Associated Air Balance Council

ACM - asbestos-containing material

AHU - air handling unit

ASHRAE - American Society of Heating, Refrigerating, and Air-Conditioning Engineers, Inc.

AHERA - Asbestos Hazard Emergency Response Act

ASD - active soil depressurization

CFM (or cfm) - cubic feet per minute

CO<sub>2</sub> - carbon dioxide

CRM - continuous radon monitor

Glossary and Acronyms

EPA - (U.S.) Environmental Protection Agency

HEPA - high efficiency particulate air (filter)

HVAC - heating, ventilation, and air conditioning

IAQ - indoor air quality

MA - make-up air

NEBB - National Environmental Balancing Bureau

NFPA - National Fire Protection Association

NSC - National Safety Council

NIOSH - (U.S.) National Institute for Occupational Safety and Health

OA - outdoor air

ORD - (U.S. EPA) Office of Research and Development

ORIA - (U.S. EPA) Office of Radiation and Indoor Air

pCi/L - picocuries per liter

PFE - pressure field extension

PM - preventive maintenance

ppm - parts per million

PVC - polyvinyl chloride

RA - return air

RCP - (U.S. EPA) Radon Contractor Proficiency program

RMP - (U.S. EPA) Radon Measurement Proficiency program

RRTC - (U.S.) Regional Radon Training Center

SA - supply air

SEP - (U.S. EPA) School Evaluation Program

SMACNA - Sheet Metal and Air Conditioning Contractors' National Association,  
Inc.

TAB - testing, adjusting, and balancing (of HVAC systems)

UV - unit ventilator

W.C. - water column



## Appendix B: Resources

### REFERENCES

Contact your State or Regional EPA offices to obtain these documents:

1. *Radon Measurement in Schools - Revised Edition*, EPA 402-R-92-014.
2. *Radon Prevention in the Design and Construction of Schools and Other Large Buildings*, EPA 625-R-92-016.
3. *Radon Mitigation Standards*, EPA 402-R-93-078.
4. *Building Air Quality*, EPA 400-1-91-033.

### REGIONAL RADON TRAINING CENTERS

EPA's four Regional Radon Training Centers (RRTCs) provide a range of training in radon measurement and mitigation to the public. Contact the training centers directly for information on course offerings, schedules, and fees.

#### **Eastern Regional Radon Training Center**

Rutgers University  
Radiation Science  
Kilmer Campus, Building 4087  
New Brunswick, NJ 08903  
(908) 932-2582

#### **Mid-West Universities Radon Consortium**

University of Minnesota  
1985 Buford Avenue (240)  
St. Paul, MN 55108-6136  
(612) 624-8747

#### **Western Regional Radon Training Center**

Department of Industrial Sciences  
Colorado State University  
Fort Collins, CO 80523  
(800) 462-7459/(303) 491-7801

#### **Southern Regional Radon Training Center**

Auburn University  
Department of Civil Engineering  
238 Harbert  
Auburn University, AL 36849-5337  
(800) 626-2703/(205) 844-6271

Resources

**EPA REGIONAL OFFICES**

**Region 1: CT, MA, ME, NH, RI, VT**  
Radiation Program Manager  
U.S. Environmental Protection Agency  
John F. Kennedy Federal Building  
Room 2311  
Boston, MA 02203  
(617) 565-4502

**Region 2: NJ, NY (also Guam, Virgin Islands, Puerto Rico)**  
Chief, Radiation Branch (AWM-RAD)  
U.S. Environmental Protection Agency  
Federal Plaza, Room 1005A  
New York, NY 10278  
(212) 264-4110

**Region 3: DE, MD, PA, VA, WV**  
Radiation Program Manager  
Special Program Section (3AT12)  
U.S. Environmental Protection Agency  
841 Chestnut Street  
Philadelphia, PA 19107  
(215) 597-8326

**Region 4: AL, FL, GA, KY, MS, NC, SC, TN**  
Radiation Program Manager  
U.S. Environmental Protection Agency  
345 Courtland Street, N.E.  
Atlanta, GA 30365  
(404) 347-3907

**Region 5: IL, IN, MI, MN, OH, WI**  
Radiation Program Manager  
(AT-185)  
U.S. Environmental Protection Agency  
77 West Jackson Boulevard,  
Chicago, IL 60604-3507  
(312) 886-6175

**Region 6: AR, LA, OK, NM, TX**  
Radiation Program Manager  
U.S. Environmental Protection Agency  
Chief, Technical Section (6T-ET)  
Air, Pesticides, and Toxics Division  
1445 Ross Avenue  
Dallas, TX 75202-2733  
(214) 655-7224

**Region 7: IA, KS, MO, NE**  
Radiation Program Manager  
U.S. Environmental Protection Agency  
726 Minnesota Avenue  
Kansas City, KS 66101  
(913) 551-7605

**Region 8: CO, MT, ND, SD, UT, WY**  
Radiation Program Manager  
(8HWM-RP)  
U.S. Environmental Protection Agency  
999 18th Street, Suite 500  
Denver, CO 80202-2405  
(303) 293-1440

**Region 9: AZ, CA, HI, NV**  
Radiation Program Manager  
(A1-1)  
U.S. Environmental Protection Agency  
75 Hawthorne Street  
San Francisco, CA 94105  
(415) 744-1048

**Region 10: AK, ID, OR, WA**  
Radiation Program Manager  
(AT-082)  
U.S. Environmental Protection Agency  
1200 Sixth Avenue  
Seattle, WA 98101  
(206) 553-7660

## STATE RADON CONTACTS

<b>Alabama</b> 800-582-1866 205-242-5315	<b>Idaho</b> 800-445-8647 208-334-6584	<b>Minnesota</b> 800-798-9050 612-627-5012	<b>Ohio</b> 800-523-4439 614-644-2727	<b>Washington</b> 800-323-9727 206-753-4518
<b>Alaska</b> 800-478-8324 907-465-3019	<b>Illinois</b> 800-325-1245 217-786-7127	<b>Mississippi</b> 800-626-7739 601-354-6657	<b>Oklahoma</b> 405-271-8118	<b>West Virginia</b> 800-922-1255 304-558-3526
<b>Arizona</b> 602-255-4845	<b>Indiana</b> 800-272-9723 317-633-0150	<b>Missouri</b> 800-669-7236 314-751-6083	<b>Oregon</b> 503-731-4014	<b>Wisconsin</b> 698-267-4795
<b>Arkansas</b> 501-661-2301	<b>Iowa</b> 800-383-5992 515-242-5992	<b>Montana</b> 406-444-3671	<b>Pennsylvania</b> 800-237-2366 717-783-3594 717-783-3595	<b>Wyoming</b> 800-458-5847 307-777-6015
<b>California</b> 800-745-7236 916-324-2208	<b>Kansas</b> 913-296-6183	<b>Nebraska</b> 800-334-9491 402-471-2168	<b>Rhode Island</b> 401-277-2438	<b>Guam</b> 617-646-8863
<b>Colorado</b> 800-846-3986 303-692-3057	<b>Kentucky</b> 502-564-3700	<b>Nevada</b> 702-687-5394	<b>South Carolina</b> 800-768-0362	<b>Puerto Rico</b> 809-767-3563
<b>Connecticut</b> 203-566-3122	<b>Louisiana</b> 800-256-2494 504-925-7042	<b>New Hampshire</b> 800-852-3345 x4674 603-271-4674	<b>South Dakota</b> 800-438-3367 605-773-6035	<b>Virgin Islands</b> 800-468-0138
<b>Delaware</b> 800-554-4636 302-739-3028	<b>Maine</b> 800-232-0842 207-287-5676	<b>New Jersey</b> 800-648-0394 609-987-6396	<b>Tennessee</b> 800-232-1139 615-532-0733	
<b>District of Columbia</b> 202-727-5728	<b>Maryland</b> 800-872-3666 410-631-3301	<b>New Mexico</b> 505-827-4300	<b>Texas</b> 512-834-6688	
<b>Florida</b> 800-543-8279 904-488-1525	<b>Massachusetts</b> general info: 617-727-6214 technical info: 413-586-7525	<b>New York</b> 800-458-1158 518-458-6451	<b>Utah</b> 800-458-0145 801-536-4250	
<b>Georgia</b> 800-745-0037 404-657-6534	<b>Michigan</b> 800-723-6642 517-335-8037 517-335-8190	<b>North Carolina</b> 919-571-4141	<b>Vermont</b> 800-640-0601 802-865-7730	
<b>Hawaii</b> 808-586-4700		<b>North Dakota</b> 701-221-5188	<b>Virginia</b> 800-468-0138 804-786-5932	

## Resources

### BIBLIOGRAPHY

1. American Association of School Administrators, *Schoolhouse in the Red*, Arlington, VA, 1992.
2. American Society of Heating, Refrigeration, and Air-Conditioning Engineers, *ASHRAE Standard 62-1989: Ventilation for Acceptable Indoor Air Quality*, American Society of Heating, Refrigerating and Air-Conditioning Engineers, Inc., Atlanta, 1989.
3. American Society of Testing and Materials (ASTM E779), "Standard Test Method for Determining Air Leakage Rate by Fan Pressurization," 1987.
4. Brennan, T., M. Clarkin, W. Turner, G. Fisher, R. Thompson, "School Buildings With Air Exchange Rates That Do Not Meet Minimum Professional Guidelines or Codes and Implications for Radon Control," *Proceedings of the 1991 ASHRAE Indoor Air Quality, Healthy Buildings Conference*.
5. Brennan, T., G. Fisher, R. Thompson, W. A. Turner, "Extended Heating, Ventilation, and Air Conditioning Diagnostics in Schools in Maine," *Proceedings of the 1991 International Symposium on Radon and Radon Reduction Technology*, Philadelphia, PA.
6. Brennan, T., G. Fisher, B. Ligman, W. Turner, R. Thompson, "Fan Pressurization of School Buildings," presented at Building Thermal Envelope V. Conference 1992, Clearwater Beach, FL.
7. Craig, A.B., K.W. Leovic, and D.B. Harris, "Design of Radon Resistant and Easy-to-Mitigate New School Buildings," presented at the 1991 International Symposium on Radon and Radon Reduction Technology, Philadelphia, PA, April 1991.
8. Fisher, G., R. Thompson, T. Brennan, W. Turner, "Diagnostic Evaluations of Twenty-six U.S. Schools - EPA's School Evaluation Program," *Proceedings of the 1991 International Symposium on Radon and Radon Reduction Technology*, Philadelphia, PA, EPA.
9. Fisher, G., B. Ligman, T. Brennan, R. Shaughnessy, B. Turn, B. Snead, "Radon Mitigation in Schools Utilizing Heating, Ventilation and Air-Conditioning Systems," *Proceedings of the 1993 International Workshop on Indoor Radon Remedial Action*, Rimini, Italy.
10. Leovic, K.W., A.B. Craig, D.W. Saum, "Radon Mitigation in Schools," *ASHRAE Journal*, Vol. 32, No. 2, February 1990.
11. Leovic, K.W., "Summary of EPA's Radon Reduction Research in Schools During 1989-90," U.S. EPA, Office of Research and Development, EPA-600/8-90-072 (NTIS PB91-102038), October 1990.
12. Leovic, K.W., A.B. Craig, and D.B. Harris, "Update on Radon Mitigation Research in Schools," EPA-600/D-91-229 (NTIS PB91-242958), presented at the 1991 Annual AARST National Fall Conference, Rockville, MD, October 1991.
13. Leovic, D.W., A.B. Craig, and D.B. Harris, "Radon Prevention in the Design and Construction of Schools and Other Large Buildings," *Architecture/Research*, Vol. 1, No. 1, pp 32-33, October 1991.
14. Leovic, K.W., H.E. Rector, and N.L. Nagda, "Costs of Radon Diagnostics and Mitigation in School Buildings," presented at the 85th Annual Meeting and Exhibition of the Air and Waste Management Association, Kansas City, MO, June 21-26, 1992.

15. Leovic, K.W., H. Rector, and N. Nagda, "Costs of Radon Diagnostics and Mitigation in School Buildings," presented at the 85th Annual AWMA Conference, Kansas City, MO, June 1992.
16. Parker, J.D., "HVAC Systems in the Current Stock of U.S. K-12 Schools," EPA-600/R-92-125 (NTIS PB 92-218338), July 1992.
17. Persily, A. *Manual for Ventilation Assessment in Commercial Buildings*, U.S. Department of Commerce, NIST, Building and Fire Research Laboratory, Gaithersburg, MD, January 1994.
18. Phillips, J., L. Ratcliff, J. Bergsten, "Results of the National School Radon Survey," *Proceedings of the 1992 International Symposium on Radon and Radon Reduction Technology*, Minneapolis, MN, EPA.
19. Pyle, B.E. and K.W. Leovic, "A Comparison of Radon Mitigation Options for Crawl Space School Buildings," Presented at the 1991 Symposium on Radon and Radon Reduction Technology, Philadelphia, PA, April 1991.
20. Shaughnessy, R., T. Brennan, E. Levetin, B. Ligman, et. al. "Trenton Elementary School, School Evaluation program Report," Office of Radiation and Indoor Air, U.S. EPA, 1993.
21. Shaughnessy, R.J., B.H. Turk, E. Levetin, T. Brennan, G. Fisher, and B.K. Ligman, "Impact of Ventilation/Pressurization on Indoor Air Contaminants in Schools," draft report submitted to U.S. EPA, Office of Radiation and Indoor Air, Washington, DC, 1993.
22. Thompson, R., G. Fisher, T. Brennan, W.A. Turner, "HVAC Retrofit for Healthy Schools," *Proceedings of the ASHRAE Health Building Conference - IAQ '91*, Washington, DC.
23. Turk, B.H., G. Powell, G. Fisher et. al., "Multi-Pollutant Mitigation by Manipulation of Crawlspace Pressure Differentials," *Proceedings of the 1992 International Symposium on Radon and Radon Reduction Technology*, U.S. EPA, Research Triangle Park, NC, 1992.
24. Turk, B.H., G. Powell, G. Fisher, B. Ligman, et. al., "Improving General Indoor Air Quality While Controlling Specific Pollutants in Schools," *Proceedings of the 1993 International Conference on Indoor Air Quality and Climate*, Helsinki, Finland.
25. U.S. Environmental Protection Agency, U.S. Department of Health and Human Services, and U.S. Public Health Service, *A Citizen's Guide to Radon (Second Edition)*, May 1992.
26. U.S. Environmental Protection Agency, *Radon Measurement in Schools - Revised Edition*, Office of Radiation and Indoor Air, U.S. EPA, EPA-402-R-92-014, July 1993.
27. U.S. Environmental Protection Agency, *Radon Mitigation Standards*, Office of Radiation and Indoor Air, EPA-402-R-93-078, October, 1993.

## Appendix C: Metric Conversion Factors

Although it is EPA policy to use metric units in its documents, non-metric units have been used in this report to be consistent with common practice in the radon mitigation field. Readers may refer to the following conversion factors as needed.

<i>Non-Metric</i>	<i>Times</i>	<i>Yields Metric</i>
cubic foot (ft <sup>3</sup> )	28.3	liters (L)
cubic foot per minute (ft <sup>3</sup> /min)	0.47	liters per second (L/s)
foot (ft)	0.305	meter (m)
gallon (gal.)	3.79	liters (L)
horsepower (hp)	746	watts (W)
inch (in.)	2.54	centimeters (cm)
inch of water column (in. WC)	248.9	pascals (Pa)
mil (0.001 in)	25.4	micrometers (μm)
picocurie per liter (pCi/L)	37	becquerels per cubic meter (Bq/m <sup>3</sup> )
pound per square inch (psi)	6894.8	pascals (Pa)
square foot (ft <sup>2</sup> )	0.093	square meter (m <sup>2</sup> )

## Appendix D: Mitigation Cost Information

It is difficult to provide general estimates of radon mitigation costs due to parameters that vary from school to school. Parameters such as building size, type of ventilation system, extent of the radon problem, and building construction all influence the cost of radon diagnostics and mitigation. However, in an attempt to provide some guidance to school districts who need to estimate these costs in planning their radon program, the following discussion is provided with the caution that this information be used with discretion. The cost estimates presented below do not include operation and maintenance costs.

EPA has obtained mitigation cost data by: 1) surveying mitigators and 2) performing mitigation demonstrations in school buildings.

The survey consisted of a questionnaire that was developed by EPA's Office of Research and Development and sent to nine radon mitigators with experience in school buildings. This survey described two typical school buildings of different sizes and were identified as requiring an Active Soil Depressurization (ASD) system. Building 1 was described as requiring two suction points and Building 2 requiring 10 suction points. The respondents were asked to estimate costs for 5 work elements associated with radon diagnostics and mitigation. Seven of the nine mitigators responded with complete cost information. The final analysis is summarized below in Table 1.

Work Element	Building 1 (20,000 ft <sup>2</sup> ) Average Cost	Building 2 (50,000 ft <sup>2</sup> ) Average Cost
1) Review Building Plans	\$265.00	\$454.00
2) ASD Diagnostics	\$1,337.00	\$3,088.00
3) ASD System Design	\$925.00	\$1,254.00
4) ASD Material Costs	\$3,231.00	\$9,453.00
5) ASD System Installation & Checkout	\$4,466.00 (for 2 suction points)	\$12,150.00 (for 10 suction points)
Totals*	\$10,068.00	\$26,334.00
Cost per ft <sup>2</sup>	\$0.50	\$0.53
Cost per suction point	\$5,034.00	\$2,633.00

\* - Totals were computed using the average totals for each mitigator rather than each work element.

TABLE 1: AVERAGE MITIGATION & DIAGNOSTIC COSTS FOR ASD FROM SURVEY

## Mitigation Cost Information

The results of the survey provide an estimate of the cost factors for ASD diagnostics and mitigation in schools. Based upon the survey results, it is estimated that an average cost for ASD diagnostics and installation in a typical school would be \$0.50 per ft<sup>2</sup>. About 20% of this estimate would be devoted to the diagnostics and the remaining 80% to the installation. These costs would be higher in schools with extensive subslab walls, poor pressure field extension, and extensive building code and/or asbestos complications. Costs would be lower in schools with good pressure field extension and no subslab barriers.

In addition to the survey, EPA has demonstrated radon mitigation in several schools using local contractors and local design professionals to design and install ventilation systems, as well as install ASD systems. Based on these experiences, ventilation costs could range from no installation cost, such as when minor adjustments are the only requirement to an existing system, to the installation of an entire mechanical ventilation system which varies in cost depending upon the size of the system. The costs experienced by EPA are summarized below according to site. A brief description of the mitigation system and the costs associated with the system are presented. These costs are likely to be higher than would actually be experienced by school districts due to the expedited construction schedules of several of the projects. Costs reflect hardware, engineering fees, and installation costs.

Site 1: HVAC system controls were restored and modified to increase outdoor air as originally designed.

Building Area: 19,200 ft<sup>2</sup>  
Cost of Project: \$17,700  
Costs per Square Foot: \$0.92/ft<sup>2</sup>

Site 2: HVAC system controls were restored and modified to increase outdoor air as originally designed.

Building Area: 25,700 ft<sup>2</sup>  
Cost of Project: \$10,340  
Cost per Square Foot: \$0.40/ft<sup>2</sup>

Site 3: Complete ventilation system was installed in two buildings. The first building's system consisted of a heat recovery ventilator that exhausts air from a crawl space, resulting in depressurization, and provides outdoor ventilation to the classrooms. The second building's system consisted of a roof top ventilation system that provides outdoor air to the classrooms which pressurizes the occupied space to prevent radon entry. Extensive hydronic (installation of hot water heating coils and piping) work was also performed to condition outdoor air to maintain a comfortable classroom temperature. The building's previous condition provided no mechanical outdoor air ventilation.



Total Buildings Area: 11,690 ft<sup>2</sup>  
Cost of Project: \$120,700  
Cost per Square Foot: \$10.33/ft<sup>2</sup>

Site 4: Active subslab depressurization system was installed. School was classified as difficult to mitigate due to the poor pressure field extension. High pressure suction fans were installed as part of the system.

Building Area: 13,600 ft<sup>2</sup>  
Cost of Project: \$11,600  
Cost per Square foot: \$0.85/ft<sup>2</sup>

Site 5: A combination mitigation approach was used. Active subslab depressurization system was installed. The entire HVAC system was also replaced due to poor indoor air quality (i.e. high indoor CO<sub>2</sub> concentrations, mold and mildew growth). A new ventilation system was installed to provide outdoor air to the classrooms. This system was designed to maintain acceptable relative humidity levels in the building despite the introduction of a large quantity of high relative humidity outdoor air.

Building Area: 13,240 ft<sup>2</sup>

Active Subslab Depressurization System

Cost of Project: \$12,140  
Cost per Square Foot: \$0.92/ft<sup>2</sup>

HVAC System

Cost of Project: \$104,990  
Cost per Square Foot: \$7.93/ft<sup>2</sup>

Site 6: A combination mitigation approach was used. An innovative tunnel depressurization system was installed with a variable frequency drive which changes the fan speed to maintain a constant depressurization and to reduce energy consumption. The HVAC system was also restored to provide outdoor air to the classrooms.

Building Area: 50,000 ft<sup>2</sup>

Tunnel Depressurization System

Cost of Project: \$21,100  
Cost per Square Foot: \$0.42/ft<sup>2</sup>

## Mitigation Cost Information

### HVAC System Restoration

Cost of Project: \$18,900

Cost per Square Foot: \$0.38/ft<sup>2</sup>

This information provides actual cost data resulting from 6 school radon mitigation installations. Costs vary depending on the existing HVAC equipment (i.e. condition of the system and it's capabilities) and what other equipment needs may be required. ASD cost are higher than the survey data due to the increased number of suction points required to extend a negative pressure field in the compact, low permeability material found beneath the concrete slabs.

## Appendix E: Case Studies

### Case Study 1

#### I. INTRODUCTION

This case study is an example of a school that was successfully mitigated by implementing two mitigation strategies. By installing an ASD system and replacing the HVAC system the radon concentrations are maintained below EPA's action level of 4 pCi/l. The project was expected to be difficult due to the condition of the existing HVAC system and the fine grained material under the slab. This project also provided the opportunity to address the concerns of meeting the outdoor ventilation rate of 15 cfm/person in a school classroom, as recommended in the ASHRAE standard 62-1989 "Ventilation for Acceptable Indoor Air Quality", in a high relative humidity climate as found in the state of Florida. The completed project provides the occupants of this school with recommended outdoor air rates and radon concentrations below 4 pCi/l.

#### II. SCHOOL DESCRIPTION

The school is an elementary school built in 1968 located in the state of Florida. The building is single story, masonry block construction, with a floor area of approximately 13,240 ft<sup>2</sup>. It is shaped like a "figure eight" with 5 classrooms in each of the "loops" of the eight (see school's floor plan). The roof is a built up flat roof that supports the roof-top HVAC equipment.

#### III. INITIAL INVESTIGATION

The initial investigation was performed by several "team members" including the following: EPA listed radon proficient mitigation contractors, a mechanical engineer and a school facility operator. The combined expertise was essential in determining the most appropriate mitigation strategies for this building.

##### Pre-mitigation Radon Measurements

The pre-mitigation radon measurement data consisted of initial measurement results as well as the follow up measurement results. The initial measurements were performed using charcoal canisters over a 48 hour period. The follow up measurements were performed, in accordance with Florida radon measurement protocols, using electret ion chambers that were opened during occupied times and closed during unoccupied times. Two sets of follow up measurements were performed for a period of 11 to 13 days; the first set was taken in September and the second set was taken in January. The initial measurement results ranged from 2 pCi/l to 20 pCi/l with the average being 12 pCi/l. The raw data from the initial measurements were not available for tabulation. The follow-up measurement results are reproduced in Table 1.

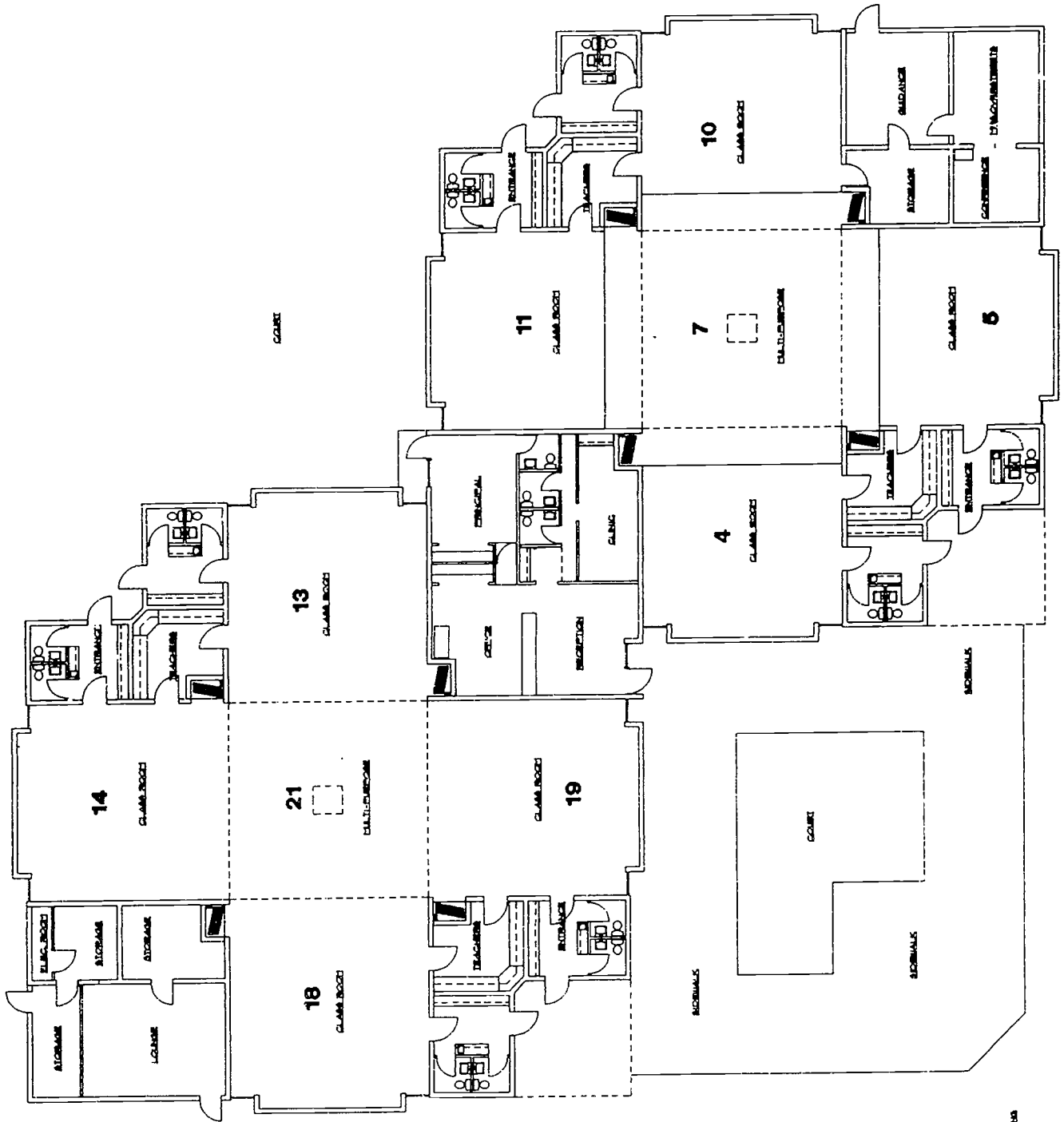

TRENTON ELEMENTARY SCHOOL FLOOR PLAN



Room #	Follow-up Measurement Results 09/23/91 to 10/04/91 (occupied hrs. only)	Follow-up Measurement Results 01/21/92 to 02/03/92 (occupied hrs. only)	Follow-up Measurement Average
1	7.0	21.8	14.4
2	9.2	21.8	15.5
3	10.0	36.6	23.3
4	8.1	37.1	22.6
5	6.7	30.3	18.3
6	6.8	36.6	21.6
7	8.8	34.1	21.5
10	8.9	28.7	18.8
11	8.6	31.0	19.8
12	8.6	30.1	19.4
13	8.1	15.1	11.6
14	7.8	22.9	15.4
15	8.3	17.2	12.8
18	5.1	14.9	10.0
19	6.6	13.7	10.2
20	8.0	11.7	9.9
21	6.7	16.3	11.5
23	1.8	4.7	3.3
23c	8.0	24.6	16.3

TABLE 1: Follow-up Radon Measurement Results

### Building Plan Review

The only building plans available were a site plan, floor plan, architectural elevation plan and one sheet of the plumbing plans. Mechanical or foundation plans were not available. A review of the floor plan revealed that the school was designed for 8 classrooms and 2 multi-purpose rooms located in the center areas of the "loops" of the figure eight. The plumbing plan provided information on possible entry points around plumbing penetrations. Each of the 8 classrooms had two rest rooms with pipe penetrations through the slab.

### Walk Through Inspection

Observations during the walk through included: excessive biological (mold & mildew) growth on carpeting and walls in several classrooms. The multipurpose rooms were being used as classrooms, contrary to the rooms' original designed use. The roof appeared to leak in several locations. Each of the exterior classrooms had 1 operable window that was designated as an emergency exit. A 1¼ inch hole was drilled through the slab to visually inspect the subslab material. The material was a sand/dirt composition that was tightly compacted.

## HVAC Evaluation

The HVAC system consisted of rooftop package units with electric strip heating. Each of the exterior classrooms was equipped with a thermostat that controlled 1 of the 8 roof top package units, i.e. one unit for each of the exterior classrooms. The multipurpose rooms, located in the center of the "loops" of the figure eight, was heated and cooled by each of the 4 classrooms surrounding it, i.e. a portion of air from each of the 4 roof top package units supplied air to each of the multipurpose rooms. The roof top package units were original equipment dating back to 1968. The units were rusted beyond repair and were noisy. The interior of the units were reservoirs of biological growth with visible growth in the drain pans and on the insulated panels of the unit. Outdoor air intake capabilities consisted of a small (4" by 4") hole in the return air duct of each unit that was located beneath a shroud which covered the roof penetration of the ductwork. Using chemical smoke, it was determined that outdoor air was not entering through the intakes into the roof top units due to the small size of the opening and the condition of the filter that was placed in the opening. The building was equipped with 9 roof top exhaust fans of which 1 was operational.

## Initial Investigation Conclusions

After the initial investigation was complete, the team concluded that the HVAC system, as a stand alone strategy, would not be capable of reducing the radon concentrations below 4 pCi/l due to the high levels originally measured. However, due to the deteriorated equipment and the lack of outdoor ventilation the team concluded that the mitigation strategy must deal with the HVAC system. Because of the HVAC system's age and condition, it was determined that the system was beyond restoration and any effort to restore the system would be futile. The initial radon concentrations exceeded 10 pCi/l indicating that detailed diagnostics needed to be performed to determine whether ASD could be used as part of the mitigation strategy. Therefore, a final decision of what to do with the existing HVAC system would be made upon completion of the detailed investigation.

## IV. DETAILED INVESTIGATION

### Walk Through Inspection

The walk through involved an inspection of the building shell and performing a blower door test to determine the "tightness" of the building. The leakage area of the building was so large that accurate test results could not be obtained. Visually inspecting the building shell for obvious "leaks" revealed large openings to the outside where the HVAC ductwork penetrated through the roof. The rest of the building shell appeared relatively "tight." The large openings would have to be sealed and a repeat blower door test performed in order to determine whether building pressurization would be an effective radon control strategy.

### Subslab Vacuum Test

The detailed diagnostics involved performing a subslab vacuum test to determine the pressure field extension for the sand/dirt material under the slab. As expected, the pressure field

extension was quite poor with an extension of 12 feet at .002 inches w.c. pressure differential and an air volume of 17 cfm. With such poor communication through the subslab material, a high pressure ASD system would have to be used with multiple suction points in order to cover the entire slab area. The effect of the ventilation system on the pressure field extension was taken into consideration while the vacuum test was being performed. Under normal operating conditions, the HVAC system would not inhibit the pressure field extension obtained during the test.

## V. THE MITIGATION SYSTEM

With all the data collected from the initial and detailed investigation, the team concluded that the mitigation strategy would consist of the following:

1. Install an ASD system.
2. Replace the existing 9 rooftop package HVAC units.
3. Replace the existing 8 exhaust fans that were non-operational.

The strategy incorporated an ASD and HVAC approach due to the high radon concentrations and poor subslab pressure field extension. This combined approach controls radon by reversing the flow of soil gas via the ASD system and dilutes the radon that may inadvertently enter due to the poor soil communication via the HVAC system.

### Final Mitigation

**ASD SYSTEM:** The ASD system consisted of 3 centrifugal high suction fans and 18 slab penetrations where suction was applied. Each of the ASD system's piping was routed above the drop ceiling and exits through the roof to an in-line centrifugal fan. The operating conditions of each system are shown in Table 2.

SYSTEM #	Pressure Diff. @ Slab penetrations (inches w.c.)	Total Air Volume of system (cfm)
1	1.4	64
2	3.2	17
3	2.5	51

TABLE 2: ASD system performance

**HVAC SYSTEM:** The HVAC system consisted of replacing the existing nine (9) roof top package units and the installation of two (2) new 100% outdoor air units. The outdoor air units were designed to introduce 15 cfm/person in each of the 10 classrooms. It was necessary to install this "separate" outdoor air system in order to remove moisture from the outdoor air before it is introduced into the classrooms. These units are designed to remove the moisture required to maintain relative humidity levels in the classrooms that are acceptable for occupant comfort and inhibit biological growth, i.e. mold, mildew, etc. The 8 exhaust fans were also replaced with new

equipment. The increased air volume being exhausted, resulting from the replaced exhaust fans, did not affect the effectiveness of the ASD system. The total air being exhausted from the classrooms is less than the total outdoor air being supplied, therefore maintaining positive pressure in the classrooms relative to the sublab..

Post Mitigation Radon Testing

Continuous radon monitors were used to measure the radon concentrations in classrooms 19, 21 and 5. These rooms were chosen because of their central location and initial radon concentrations. The results of the continuous radon measurements provide information on the effect the HVAC operation has on radon concentrations. Figure 1 is a graph of the radon concentration results in classroom 19 over a period of one week during the month of May 1993 with the ASD system operating during the entire test period. The outdoor air unit operation was also monitored for on/off status only. It is clearly evident that the ASD system has reduced the radon concentration when compared to the initial measurement results. However, radon concentrations approached the 4 pCi/l action level despite the continuous operation of the ASD system. The introduction of the outdoor air combined with the ASD system maintains concentrations, during the building's occupied times, well below 4 pCi/l. This positively confirms the "team's" conclusion to use a combined ASD/HVAC mitigation strategy for reducing radon concentrations in this school.

CONTINUOUS RADON CONCENTRATIONS & O.A. OPERATION  
ROOM 19; 5/16/93 TO 5/23/93

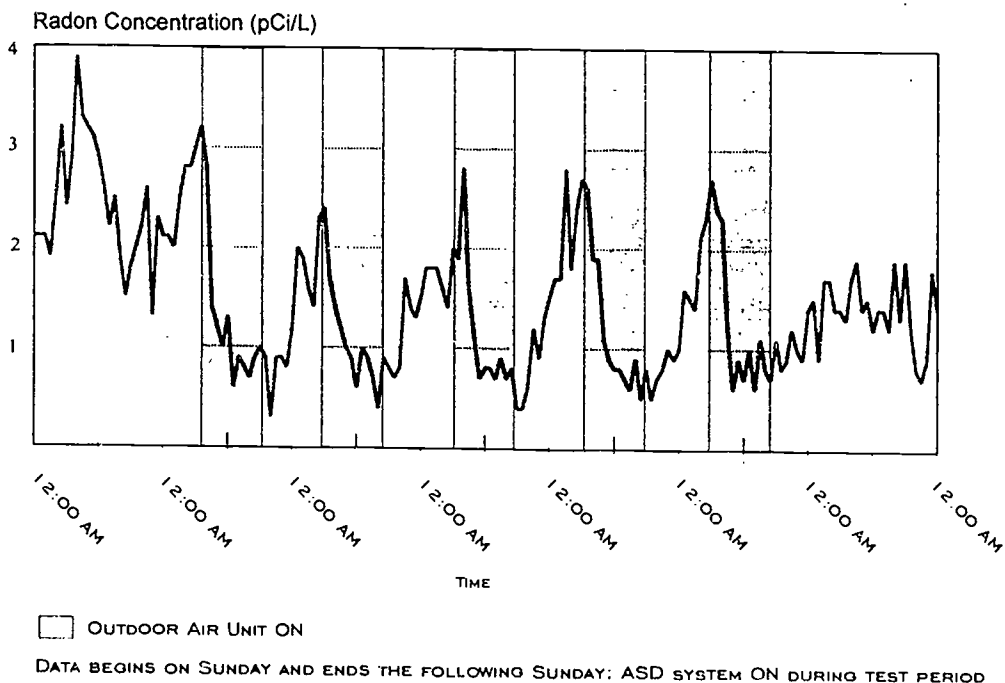

FIGURE 1: POST MITIGATION RADON MEASUREMENTS



## VI. COST INFORMATION

The costs for this project can be broken into 3 categories; 1) ASD system cost, 2) ventilation system cost, and 3) engineering and testing, adjusting & balancing costs. This cost information is shown below in Table 3. The costs shown below are likely to be higher than would actually be experienced by school districts due to the expedited construction schedule for this demonstration project.

	Equipment Cost	Labor Cost	Cost/ft <sup>2</sup>
ASD	-----	\$12,140.00 <sup>1</sup>	\$0.92
HVAC	\$37,273.00	\$48,251.00	\$6.46
Engineering	-----	\$19,500.00	\$1.47

TABLE 3: Cost Information

<sup>1</sup> Includes equipment costs

## VII. CONCLUSIONS

This case study represents a combination approach to radon mitigation. The resulting mitigation system is a good example of an integrated approach that reduces radon concentrations and contributes to improving indoor air quality by introducing the recommended outdoor air rate of 15 cfm/person. Radon concentrations have been monitored over a 12 month time period in classrooms 19, 21 and 5. These data indicate that the ASD system is maintaining radon concentrations below 4 pCi/L most of the time. However the concentrations do peak above 4 pCi/L when the HVAC system is shut down, such as during night time operation. The HVAC system contributes to the control of radon by providing outdoor air to the building thereby diluting the radon that has "eluded" the ASD system. The team's conclusion to use a combined approach was well justified based on the monitoring data as well as the resulting carbon dioxide (CO<sub>2</sub>) data. A 47% reduction in CO<sub>2</sub> concentration was observed resulting from the increased outdoor air into the classrooms. The average pre-mitigation CO<sub>2</sub> concentration (obtained during periodic walk through in all classrooms) was 1672 parts per million (ppm) and the post-mitigation CO<sub>2</sub> average was 880 ppm. An integrated approach to radon mitigation in schools which controls radon, as well as contributes to improving indoor air quality, should be the goal of radon mitigation whenever possible.

Case Study 2

I. INTRODUCTION

This case study is an example of a school with moderately elevated radon levels (<10 pCi/L). At the time of the initial team investigation, there was virtually no outdoor air being delivered to the classrooms via the school's ventilation system. The only outdoor air being introduced into the building was through natural infiltration and the occasional use of operable classroom windows. In addition, the school had subslab ductwork which has the potential to be a significant source of radon entry and required a thorough investigation. This case study is an example of a school that was mitigated by restoring the ventilation system, however this mitigation strategy is not proving to be fully successful because of limitations in the ventilation system's original design.

II. SCHOOL DESCRIPTION

The building is a single-story, slab-on-grade, masonry structure with a hexagonal layout located in the State of New Mexico (see Figure 1). An open courtyard is located in the center of the building. Individual, residential-type forced air furnaces provide heat and ventilation for each classroom. The building is not equipped with air conditioning. Each classroom has operable windows. The total floor area of the school is approximately 26,000 ft<sup>2</sup>, with 22 occupied rooms (classrooms, offices, libraries, and lounges). The building was first occupied in 1968 and currently includes kindergarten through 6th grade.

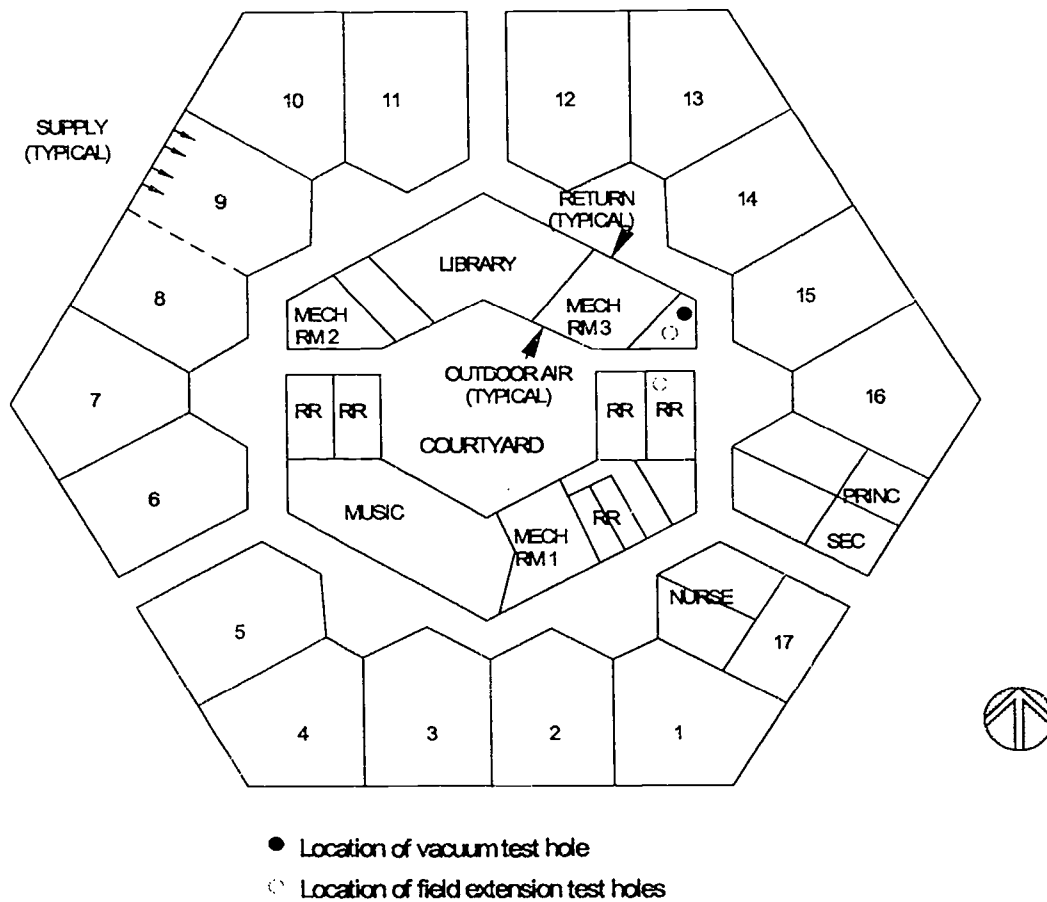

FIGURE 1: SCHOOL FLOOR PLAN

### III. INITIAL INVESTIGATION

The initial investigation was performed by a team of people that included the following: EPA listed radon proficient mitigation contractors, a mechanical engineer and a school facility operator. The local mechanical contractor who was responsible for servicing the HVAC equipment at the school was contacted and became a team member in evaluating the ventilation system.

#### Pre-mitigation Radon Measurements

The pre-mitigation radon measurement data consisted of initial measurement results as

Case Studies

well as follow-up measurement results performed by the State of New Mexico's Environment Department, Radon Program. The initial measurements were performed using charcoal canisters for a 72 hour period between March 1 and March 4, 1991. The follow-up measurements were performed using Alpha Track Detectors (ATD) over a 4 month period between April 19 and August 14, 1991. Both the initial and follow-up measurements and their respective placement locations are reproduced in Table 1.

Location	Initial Radon Meas. (CC 3/1 - 3/4/91) pCi/L	Follow-up Radon Meas. (ATD 4/19 - 8/14/91) pCi/L
Library	4.4	2.7
Nurse	4.0	3.7
Principal's office	6.7	2.0
Room 1	4.5	5.0
Room 2	5.9	4.2
Room 3	4.6	4.7
Room 4	4.2	4.7
Room 5	5.4	5.3
Room 6	5.8	3.5
Room 7	4.6	1.6
Room 8	5.0	----
Room 9	5.2	3.4
Room 10	3.7	3.5
Room 11	4.5	0.9
Room 12	4.6	2.9
Room 13	4.7	4.3
Room 14	5.4	5.3
Room 15	5.6	2.9
Room 16	4.0	4.2

CC - Charcoal Canister detector  
 ATD - Alpha Track detector

TABLE 1: INITIAL AND FOLLOW-UP RADON MEASUREMENT RESULTS

The initial radon test results indicate that 18 of the 19 rooms tested during winter time were at or above the EPA's guideline of 4 pCi/L. Follow-up radon test results indicate that 6 of the 19 rooms had radon concentrations above 4 pCi/L. The warmer period in which the follow-up measurements were performed may explain the lower radon concentrations due to decreased stack effect and open windows (open windows were likely since the building does not have air conditioning). The decision was made to evaluate the entire school due to the radon potential that was observed in 18 of the 19 rooms initially measured.

### Building Plan Review

A review of the building plans revealed valuable information on the construction characteristics of the slab/foundation and the design/operational features of the ventilation system. The foundation plans indicated a 4 inch slab with a waterproofing membrane directly under the slab. The membrane was placed over 4 inches of gravel that was layered over compacted earth. Foundation footings were located under the exterior perimeter walls and under the interior corridor walls. There were no footings under the walls that separated the classrooms.

Individual, residential-type forced air furnaces provided heat and ventilation for each classroom. There are 20 furnaces divided up into three mechanical rooms with a common outdoor air and return air in each mechanical room. The quantity of outdoor air for each classroom is controlled by dampers, and determined by the set points for temperature sensors located in the air streams. Air is returned to the mechanical rooms via transfer grilles between classrooms and corridor and from the corridor into the mechanical rooms. Ventilation is distributed to the classrooms through supply ducts that are located below the concrete slab floor. A pressure relief damper is located in the ceiling of each classroom. EPA has found the combined configuration of subslab ductwork and residential HVAC equipment to be uncommon.

The plans also indicated that it might not be possible to deliver the ASHRAE guideline of 15 cubic feet per minute (cfm) per occupant of outdoor air, due to existing equipment heating capacity limitations.

### Walk Through Inspection

Prior to the walk through, all radon measurements and notes from reviewing the building plans were transferred onto a fire exit floor plan. Several key observations were made during the walk through inspection of the building. The ventilation system was found to be operating with the outdoor air dampers in the closed position. The building's 12 exhaust fans were inspected and 9 were found to be operational. The school facility person took note of the 3 fans that were inoperable. Classroom supply vents, transfer grilles, and relief dampers were also observed.

Despite the relatively low pre-mitigation radon levels, the team suspected that a mitigation strategy based on ventilation alone may not be effective because of the existence of

## Case Studies

the subslab ductwork. Therefore, a 1¼" hole was drilled through the slab in order to initially assess the potential for an Active Soil Depressurization (ASD) system as well as to verify that the material specified in the building plans was present. The subslab material beneath consisted of ¼" pebbles which corresponded with the building plans. Slab locations to conduct future vacuum tests were also noted.

### HVAC Evaluation

Upon further investigation of the ventilation system, it was discovered that the pneumatic actuators for the outdoor air dampers were not responding to the control system's signals, i.e. to open or close. The ventilation system's control diagrams were located and inspected to determine the system's control sequence. It was determined that the system had been modified from the original design control diagram. A closer examination of the outdoor air damper actuators revealed that the pneumatic lines coming into the actuator had been soldered closed. This explained why the actuators were not responding to the control system's signals to open the dampers. Several of the actuators were found to be inoperable and needed to be repaired. In addition, the control sequence had been changed to cycle the ventilation fans in response to the thermostats located in each classroom. This caused the fans to operate only when the thermostat called for heat. During the course of the day the fans would cycle on and off depending on the heating requirement of the classrooms. On days when the temperature was moderate and outdoor air could be used to cool the school, the control sequence prevented the fans from being activated.

The relief dampers located in the classrooms were connected to the control system via pneumatic lines. The relief dampers opened in conjunction with the outdoor air dampers to provide pressure relief in the classroom for increased outdoor air ventilation when the outdoor temperature is moderate.

The furnace air filters were the fiberglass panel type with an arrestance efficiency of 30% and appeared to be relatively clean.

Because the team had individuals with air balancing expertise and the necessary equipment, air flow measurements were performed on all the furnace units to determine total air volume delivered to the classrooms. The results indicated that the air volume of several units were not within acceptable tolerances ( typically 10% of design air volume). The total air volume of 11 units deviated from design by more than 10% (see Table 2).

Subslab ductwork was found to originate from each mechanical room and routed to the classrooms. Radon has the potential to accumulate in subslab ductwork because ductwork is inherently leaky and is in direct contact with the soil. When the ventilation system fan is not operating radon can accumulate and be distributed into the building. When subslab ductwork is used for supply air, radon can only accumulate in the ductwork when the ventilation fan is not

operating. However, air leaks in the ductwork can allow supply air to increase the pressure of the soil gas in the subslab material, perhaps enhancing radon entry through existing cracks and openings in the slab. When the ductwork is used for return air, radon can accumulate when the ventilation fan is off as well as "mine" radon when the fan is operating, i.e. duct is depressurized and draws radon in.

### Initial Investigation Conclusions

The results of the initial investigation indicated that restoration of the ventilation system would be an appropriate mitigation strategy for two reasons 1) initial radon concentrations were below 10 pCi/L, 2) outdoor air ventilation rates were extremely low given the fact that the outdoor air dampers were found disabled. Given these results the team concluded that the following ventilation related items would be implemented:

1. Unplug and reconnect the pneumatic control lines to the outdoor air damper actuators.
2. Check and repair all broken damper actuators.
3. Disable the relief dampers in each classroom. The team concluded that disabling the relief dampers would not inhibit the flow of air through the classrooms when the ventilation system is supplying 100% outside air, due to the leakage area in the building envelope. By disabling the dampers, the building's leakage area is reduced which helps to pressurize the classrooms to reduce radon entry.
4. Make repairs and modifications to the ventilation system's controls so that the percentage of outdoor air being introduced during occupied time is 25% to 30% of the total air volume as specified in the original design. Because of the ventilation system's lack of heating capacity, the recommended 15 cfm of outdoor air could not be met without equipment replacement.
5. Test and balance the furnace units to restore the units' supply air volume to within 10% of the design specifications.
6. Change and upgrade the furnace filters to a pleated type filter with a dust spot efficiency of 30%. Even though the existing filters were clean, the upgraded filters remove smaller airborne particles and have a longer life.

The team also concluded that a limited detailed investigation would be performed because of the concern that radon could be accumulating in the subslab supply air ductwork during the ventilation fan's off cycle. This situation could present a problem during morning

Case Studies

start-ups because accumulated radon would be forced into the classrooms when the fan is turned on.

		Before Vent. Restoration	After Vent. Restoration		
Location	Design Total Flow (cfm)	Measured Total Flow (cfm)	Measured Total Flow (cfm)*	Estimated min. outdoor air (cfm/room) <sup>†</sup>	Estimated min. outdoor air (cfm/person)**
1	1300	750	1200	300	10
2	940	960	960	240	8
3	950	720	830	210	7
4	940	870	870	220	7.3
5	1160	760	1100	280	9.2
6	950	990	990	250	8.3
7	940	880	880	220	7.3
8	1300	690	980	250	8.3
9	1300	1180	1200	300	10
10	950	1190	980	250	8.3
11	940	1080	1100	280	9.3
12	940	1390	1200	300	10
13	950	920	920	230	7.7
14	940	1010	1000	250	8.3
15	1100	670	830	210	7
16	1300	840	1300	330	11
17	1100	600	1100	280	9.3
office	950	750	750	190	19

\* - After HVAC restoration was performed

† - Outdoor air estimated at minimum conditions (25%)

\*\* - Number of occupants assumed to be 30 for all classrooms. 10 for the office

TABLE 2: VENTILATION SYSTEM SUPPLY AIR FLOWS



#### IV. DETAILED INVESTIGATION

The detailed investigation consisted of performing a subslab vacuum test. This diagnostic test was performed to assess the potential successfulness of an ASD system. The team wanted to know whether an ASD strategy was a viable alternative strategy due to the uncertainty in controlling radon resulting from the subslab ductwork.

##### Subslab Vacuum Test

The 1/4" hole drilled during the initial investigation was used as the suction hole in performing the vacuum test. Test holes were drilled at approximately 1 foot and 15 feet away from the vacuum test hole (see Figure 1). Suction was drawn on the 1/4" hole, using a vacuum cleaner, while the pressure differential was measured at the test holes to determine the pressure field extension (PFE) in the material beneath the slab. The PFE developed under the slab extended to the farthest test hole when the vacuum was operated. At maximum vacuum operating conditions the subslab region below the nearest test hole was depressurized 0.66 inches water column (WC) (165 Pascals). The farthest test hole was depressurized 0.006 inches WC (1.5 Pascals) while the flow through the vacuum was approximately 30 cfm. To reach the farthest test hole the pressure field extended past two subslab supply air ducts and two footings. The layer of stone pebbles observed earlier is the main factor for the good PFE. As a result, ASD could be a feasible radon control technique for this school building.

#### V. THE MITIGATION SYSTEM

The ventilation system was restored and all classroom's outdoor air ventilation rates were increased. Table 2 illustrates the results of the test and balance that was performed on the furnace units. Four units could not be balanced to within the 10% tolerance due to motor and pulley limitations. The classroom outdoor air ventilation rates ranged from 7.0 to 11.0 cfm/person after the restoration had occurred. When compared to the estimated 1.0 cfm/person which existed before the mitigation efforts, a large improvement was made. The ventilation system's controls were restored to provide outdoor air ventilation at all times during occupied hours.

##### Post Mitigation Radon Testing

With the ventilation system operating continuously during occupied times, post mitigation measurements were performed over a 2 week period using Electret Ion Chambers. Results of the measurements are shown in Table 3. The results indicate that all the rooms are below the guideline of 4 pCi/L. The concentration of 3.9 pCi/L for classroom 15 may be due to the supply air imbalance. This classroom's supply air is 24% lower than as designed. Proper air volume could not be obtained due to the capacity of the fan's motor.

In order to establish the ventilation system's start-up and shut down times (to verify that

Case Studies

the radon concentration is below 4 pCi/L whenever the classrooms are occupied), a continuous radon monitor was placed in classroom 14. Figure 2 shows the averaged hourly radon concentration taken over a 2 day period. The classrooms become occupied at 7:00 am and unoccupied at 3:00 pm. The time clocks that control the ventilation system's mode of operation was set for a 6:00 am start-up time and a 5:00 pm shut down time. The results of this measurement indicate that radon is above 4 pCi/L for approximately 3 hours (7:00 am to 10:00 am) of the occupied time. It is speculated that this is due to the radon that has accumulated in the subslab supply air ductwork during the unoccupied time (night setback mode) and is being forced into the room when the system is started in the morning. To account for this, the time clocks should be changed for a start-up time of approximately 2:00 am. This will give sufficient time for the ventilation system to "purge" the supply air ductwork and dilute the radon in the classroom so that the concentration is below 4 pCi/L when the classrooms become occupied. This case is an extreme example of start-up time due to the radon that appears to be "pushed" into the classrooms at the beginning of the ventilation start-up. The current shut-down time does not need adjustment since radon does not exceed 4 pCi/L until approximately 10:00 pm when the school is unoccupied.

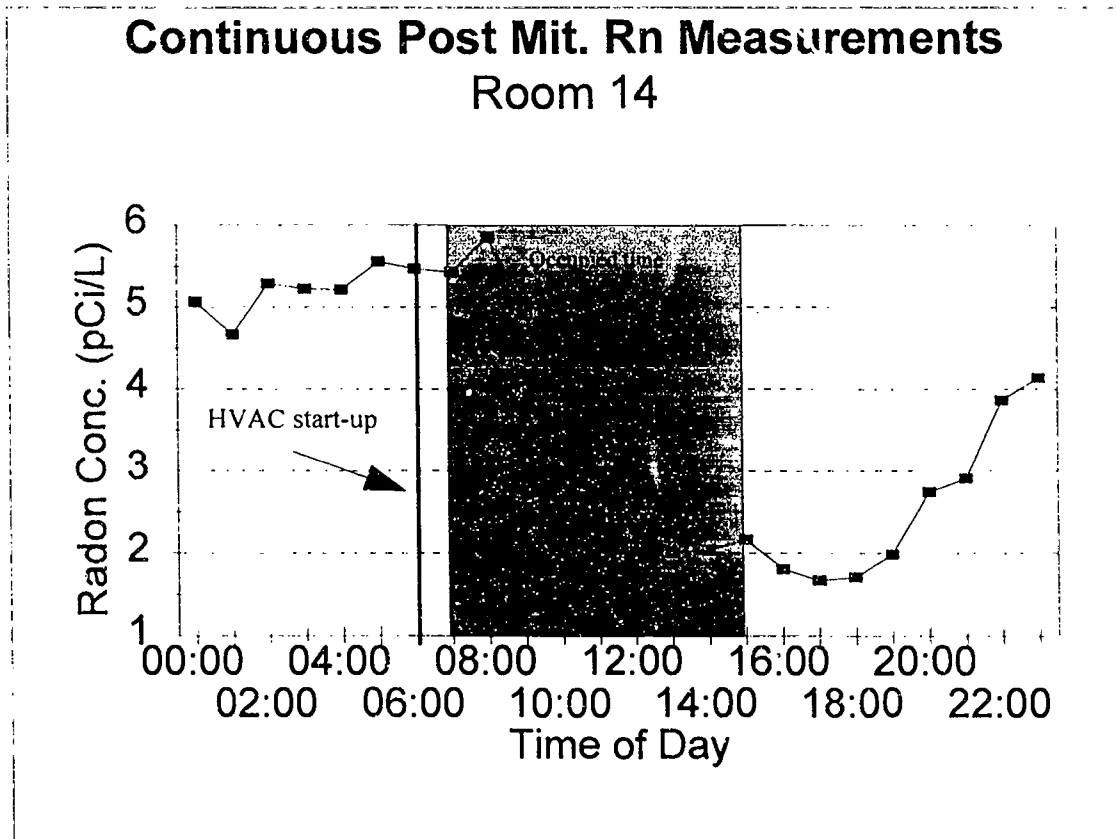

FIGURE 2: Continuous Post Mitigation Radon Measurements

Location	Post Mit. Radon Meas. (EIC 4/5 - 4/19/93) pCi/L
Library	4.9*
Music	2.3
Nurse	2.7
Principal's office	1.5
Room 1	1.8
Room 2	2.5
Room 3	2.4
Room 4	1.7
Room 5	2
Room 6	2.2
Room 7	2.1
Room 8	1.7**
Room 9	1.4
Room 10	2.1
Room 11	2.5
Room 12	2.4
Room 13	1.7
Room 14	2.9
Room 15	3.9
Room 16	1.7
Room 17	2.1

EIC - Electret Ion Chamber; concentration has been corrected for gamma background for New Mexico

\* - Individual HVAC unit for Library was found operating under cycling condition vs continuous.

\*\* - Found breaker for Room 8 furnace tripped - fan off - cause unknown.

TABLE 3: POST MITIGATION MEASUREMENT RESULTS

## VI. COST INFORMATION

The cost of the ventilation system restoration was \$10,340. The work performed was limited to the items listed in the initial investigation conclusions section. The cost per square foot equates to \$0.40.

## VII. CONCLUSIONS

This case study illustrates the importance of performing diagnostics and understanding the impact a building's ventilation system can have on radon concentrations. The restoration of the ventilation system reduced radon concentration below 4 pCi/L and significantly increased the outdoor air ventilation rates. The subslab supply air ductwork concerns appear to have been justified based on the continuous radon measurement results. In many cases, subslab ductwork can impact the successfulness of a ventilation strategy as well as an ASD strategy. Its impact must be carefully evaluated.

With the ventilation fans operating continuously during occupied times, radon concentrations are maintained below 4 pCi/L and the classrooms are being mechanically ventilated with outdoor air rates that were recommended when the school was built (ASHRAE standard 62 recommended 10 cfm/person in 1968). However, the building occupants have complained of temperature discomfort on cold days. This condition is due to the inherent limitations of using residential equipment in a school building. Due to temperature discomfort, the decision was made to change the ventilation fan's operation from continuous to cycling during occupied hours. The selection of the ventilation restoration as a stand alone mitigation strategy may prove to be unacceptable.

This case study reemphasizes the need to recognize the ventilation system as a radon control system. The introduction of properly conditioned outdoor air to meet ventilation standards is essential to the effectiveness of a ventilation based mitigation strategy. Without the continuous introduction of outdoor air, radon levels are not consistently reduced to below 4 pCi/L. Therefore, the possibility of a combined strategy (ASD and proper ventilation), is now being considered by EPA to ensure radon levels are consistently below 4 pCi/L when the building is occupied.